Overview of Odor Detection Instrumentation and the Potential for Human Odor Detection in Air Matrices

Sichu Li

MP090053
March 2009

Overview of Odor Detection Instrumentation and the Potential for Human Odor Detection in Air Matrices

Sichu Li

MP090053
March 2009

MITRE Nanosystems Group

Email: sichu@mitre.org

<http://www.mitre.org/tech/nanotech/index.html>

Sponsors: MITRE Innovation Program
and U.S. Government Nano-enabled Technology Initiative
Project No. 07MSR216 and 15095320
Dept. E552

Approved for public release;
distribution unlimited.

Copyright © 2009 by The MITRE Corporation.
All rights reserved.

Abstract

Human odor, its component volatile organic compounds (VOCs), and its emission from the body are briefly reviewed along with the current status of odor detection technologies and their potential for identifying humans by their odor in air matrices. The instruments discussed include chemical sensors, biosensors, electronic noses (E-noses), mass spectrometers (MS), differential optical absorption spectrometers (DOAS), and other field deployable analytical instruments. These instruments are examined with regard to their capabilities for odor detection and field deployment, as well as their potential application for human odor detection and identification. For direct detection of human odor VOCs from air matrices, E-nose technology could be a more promising candidate. However, sensitivity is still an issue for trace VOC detection and specificity is also a huge challenge. Recognizing there is still a long journey ahead until a truly artificial nose is developed, a recommendation is provided to refine and enhance current detection capabilities by integrating an interferent filter and a gas chromatograph to eliminate interference effects.

Table of Contents

1.0	Introduction.....	5
2.0	Odor	5
2.1	Human Odor Emission.....	6
2.2	Human Odor VOC Detection.....	8
3.0	Current Status of Instrumentation for Odor Detection	10
3.1	Chemical Sensors.....	11
3.1.1	Surface Acoustic Wave (SAW) Sensor	11
3.1.2	Quartz Crystal Microbalance (QCM) Sensor	12
3.1.3	Metal Oxide Sensor.....	13
3.1.4	E-nose	14
3.1.4.1	E-nose based on metal oxide sensor array	15
3.1.5	Current R&D Efforts.....	20
3.2	Biosensors	21
3.3	Gas Chromatography (GC) system	23
3.4	Real-time Detection Systems	24
3.4.1	Mass Spectrometer-based Systems	25
3.4.1.1	Detection method	25
3.4.1.2	Commercial Systems	26
3.4.2	Optical Spectroscopy	27
3.5	Hybrid GC/Chemical Sensor System.....	28
4.0	Instrumentation for Human Odor Detection in Air Matrices.....	31
4.1	Instrumentation Limitation.....	31
5.0	Summary	34
6.0	Acknowledgement	35
7.0	Glossary	36
8.0	References.....	37

List of Figures

Figure 1: Schlieren image of the thermal boundary layer and plume of an 11-year-old girl.....	7
Figure 2: A schematic representation of different components of human nose and their functionalities for odor smelling	9
Figure 3: The SAW mini-CAD system from MSA	12
Figure 4: Schematic diagram of the gas testing system for VOCs	13
Figure 5: A Schematic diagram of metal oxide sensor for VOC detection.	14
Figure 6: Karlsruhe gradient metal oxide semiconductor array.....	16
Figure 7: KAMINA gas sensing chip with gradient microarray mounted in its housing.	16
Figure 8: A Cyranose 320 E-nose system from Smiths Detection.	18
Figure 9: Dependence of success rate of VOC complex identification on the number of VOCs in the complex, using a Cyranose 320 E-nose.	19
Figure 10: A schematic diagram of the “bio-sniffer” stick built based on the enzyme catalytic reaction	22
Figure 11: An experimental set-up using a “bio-sniffer” to detect the malodor from a piece of building material	22
Figure 12: A schematic diagram of the Model 2100 GCO from Microanalytics	24
Figure 13: A schematic demonstration of the MS ² operational mechanism.....	25
Figure 14: SEM photomicrographs of the spiral GC micro-column on a 3-inch wide silicon wafer.	30
Figure 15: General architecture of the gas chromatographic hybrid system	30
Figure 16: An electronic nose that mimics the action of the mucus in the natural nose for odor sensing, developed by Professor Julian Gardner at University of Warwick	32
Figure 17: Conceptual design of an integrated system for odor detection	33

List of Tables

Table 1: Success Rate for Individual VOC Identification Using the Cyranose 320.....	19
Table 2: Summary of VOC Detection Time and Sensitivity for Different Methods	28

1.0 Introduction

The purpose of this report is to review sensor systems and other field deployable detection systems with respect to their potential application for human odor detection and identification. Over the past few years there has been a growing interest, especially in the areas of defense and national security, in the possibility of using human odor signatures as biometric identifiers. For many decades, dogs have been used by law enforcement personnel to identify or track individuals by their odor signatures. The significant successes of these highly trained animals provide some proof-of-principal evidence that humans can be associated with a distinctive odor signature. As yet, however, there is no instrument that can substitute for the nose of a well-trained dog. This report presents an overview on the current status of odor detection technologies and their potential for identifying humans by their odor in air matrices. First, human odor production and emission is briefly reviewed. Then, a variety of sensor and detection systems are examined based on their odor detection capability, field deployable and operational capabilities. Finally, their potential application for human odor detection and identification is discussed. The sensor and detection systems examined in this report include chemical sensors, biosensors, electronic noses, mass spectrometer (MS), differential optical absorption spectrometer (DOAS), and other field deployable analytical instrument. Hybrid systems, such as gas chromatograph – mass spectrometer and gas chromatograph – chemical sensor will also be discussed.

2.0 Odor

Odor, which refers to smells, can be utilized as a marker to identify certain problems or sources of interest. These include air pollution, environmental contamination, disease diagnostics, and as noted above, human identification in crime investigations. Odor consists of volatile organic compounds (VOCs) that typically have relative molecular masses between 30 and 300 g/mole. Heavier molecules do not occur as VOCs because they generally have a vapor pressure at room temperature that is too low to be active odorants. The volatility of molecules is determined by both their molecular weight and their intermolecular interaction, with non-polar molecules in general being more volatile than polar ones. As a consequence the most odorous molecules tend to have one or two polar functional groups. More functional groups in general result in molecules that are much less volatile [1, 2].

2.1 Human Odor Emission

There are hundreds of VOCs in human odor. It was reported that most human odor VOCs are C₆-C₁₀ straight-chain or branched unsaturated acids [3]. Terminally unsaturated acids, such as 2-methyl C₆-C₁₀ acids, and 4-ethyl C₅-C₁₁ acids, are other important odor contributors. It was also discovered that short-chain fatty acids are odorants from feet [3]. These VOCs are emitted from the human body to the surrounding environment through a mechanism described below.

Human skin, typically at 33°C under normal activity levels, is about 9°C warmer than the surrounding air at room temperature [4]. This causes a steady thermal convection process that transfers heat from the body to the surrounding atmosphere to form a current of warm air that surrounds the human body [5]. The current of warm air is approximately one-third to one-half inch thick. It travels up and over the body at a rate of 125 feet each minute, according to Archimedes' Principle, generating a free-convection boundary layer about the body and a thermal plume above it. This process is illustrated by the Schlieren image shown in Figure 1 [6, 7]. This natural boundary layer grows to approximately 15 - 20 cm thick around the head. The air in contact with the human body can never be stagnant, but rather, is in a constant state of upward motion [8]. This motion is such that every location on the body contributes chemical traces to the human thermal boundary layer. These chemical traces include hundreds of bioeffluents and millions of skin flakes [8]. The skin flakes contain rafts, each of which is composed of one or more dead cells carrying approximately four microbial bacteria. Each raft is also said to be surrounded by a minute vapor cloud that results from the bacteria acting upon the cells [9]. All components of the raft are characteristic to a person [3]. When skin flakes are shed from the human body, large ones fall down to the ground, but smaller ones are drawn up into the warm current. These warm air currents can also be visualized through clothing, and they carry the rafts from the body into the surrounding area. Since it is commonly thought that human odor is produced through bacterial action on dead skin cells and secretions [3], the movement of the warm air currents allows for the emission of human odor to the environment [8].



Figure 1: Schlieren image of the thermal boundary layer and plume of an 11 year-old girl.

The circular field-of-view is 1 m in diameter [6,7].

2.2 Human Odor VOC Detection

It is well known that there are hundreds of VOCs in human odor. However, there are no reports regarding human odor VOC concentrations in the warm current around the human body. However, if close enough, the human olfactory system is able to smell out the human body odor with a sensitivity of 1 ppm to sub ppb level [10]. Therefore we use the sensitivity of a human olfactory system as a reference for human odor detection in air matrices. It needs to be pointed out that this sensitivity level could be considered as a minimum requirement for human odor detection in air matrices. This is because, in many cases of human identification, it is still necessary to use the more sensitive dog nose to smell out the odors. It is believed that the limit of detection (LOD) of the dog nose in detecting VOCs in air matrices can be as low as ppt level.

Natural noses have both high sensitivity and specificity for “smell” out odors, and they are used as a model for E-nose design and development. Figure 2 shows the different components in a human olfactory system and their functionalities in smelling out odors [11]. It indicates that the natural biological olfactory system is a very complex sensory system. Although the primary receptor mechanism, biological transduction, and information storage are still not well understood, the performance demonstrated by the biological nose indicates that it is just these processes that provide the natural biological nose its exceptional capability for sensitive and specific detection. Regarding specificity, biological noses are able not only to distinguish different objectives (group to group), but also to identify different subjects (individual to individual). Such capability in detection specificity is necessary and required for human odor VOC identification.

In addition, biological noses also have many operational capabilities that ensure detection sensitivity and specificity. Temperature and humidity are well controlled to ensure reliable performance of the mucus layer for sample collection, molecule selective binding, analyte preconcentrating, and sorting. Air sampling is steady and reliable. All biological components are self-refreshed and self-calibrated to ensure consistency in performance.

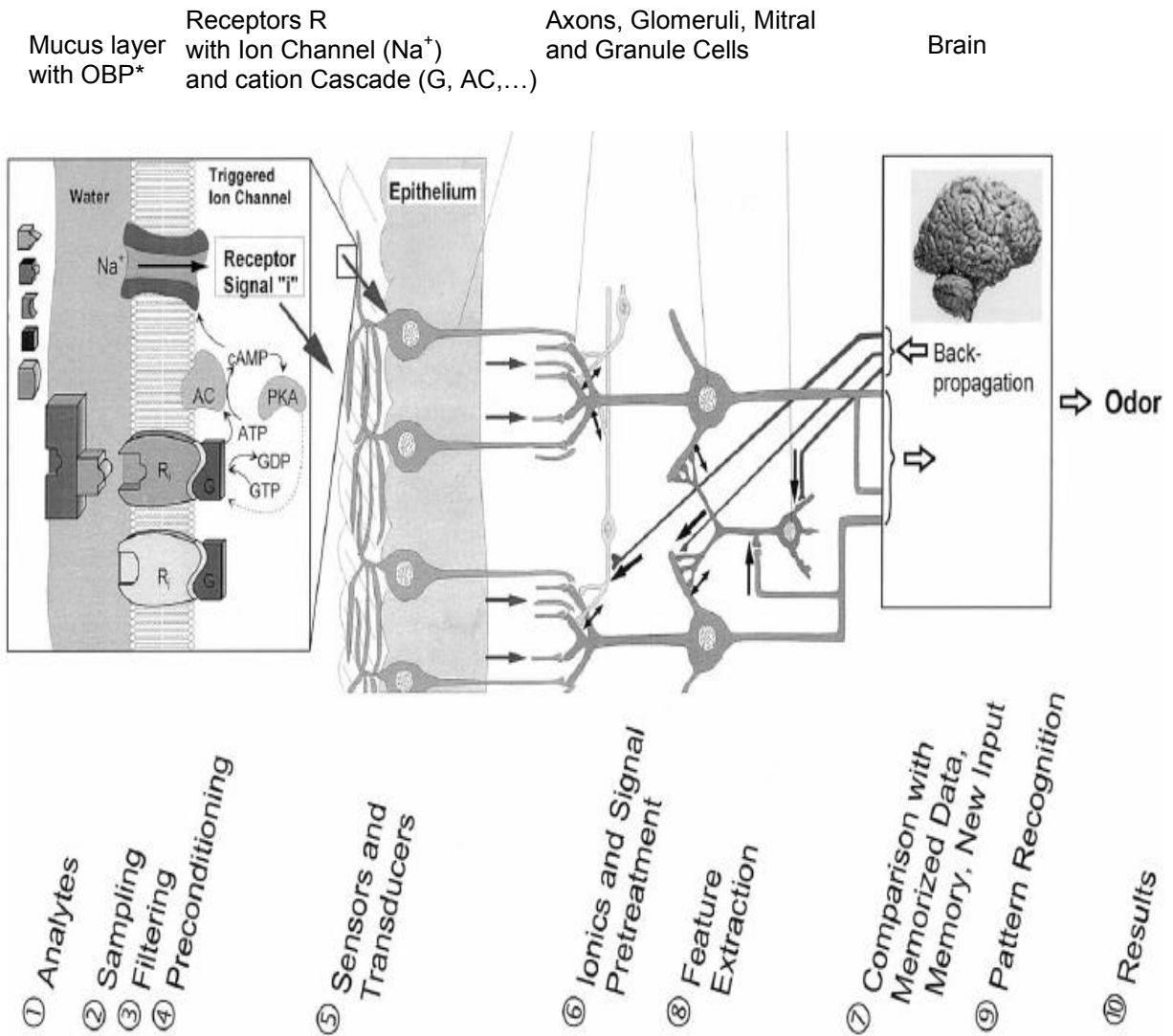

Figure 2: A schematic representation of different components of human nose and their functionalities for odor smelling [11].

3.0 Current Status of Instrumentation for Odor Detection

The current state-of-the-art method for detecting odor emissions is via classical olfactometry. By this method, odor assessment is based on a sensory panel consisting of a group of selected people (panelists) with a 95% probability of average odor sensitivity. However, physiological differences in the smelling abilities of the panel members can lead to subjective results. In addition, the olfactometry method is very costly and requires an exact undertaking in an experienced odor laboratory in order to achieve reliable results. Moreover, a system based on the human sensory system is not feasible for continuous monitoring [1].

This motivates the need to develop odor detection instruments that can provide unambiguous and reproducible detection of odorous substances, and correctly identify the odor source (e.g. a human body, an animal body, or a contamination source). Conventional analytical instruments such as the gas chromatograph (GC) and mass spectrometer (MS) have been utilized for VOC detection and identification, especially at the trace level, but the analysis is typically not performed in real time. The challenge is to develop technology for real-time VOC detection and identification.

The need for rapid detection has driven the tendency to develop real-time or near real-time systems for VOC detection. Application of such systems in detecting malodor in the environment and for monitoring gas leaks requires that the detection system be a simple and quick on-line monitoring system rather than employing time-consuming processing and analysis methods. Progress has been made in the past decade in developing sensor systems which show promise for creating simple and rapid on-line monitoring systems. However, robust instruments that can provide reliable real-time detection still remain a technical challenge.

Although there have been publications on environmental pollution detection and abatement methods [12-17], there has been a noticeable absence of work in odor detection for human identification using instrumentation, especially real-time detection in air matrices. Since human odor detection is very useful for crime investigation we attempt to remedy this deficiency by reviewing the current state of the relevant sensor and detection technologies. Furthermore, we will assess their potential for human odor VOC detection and identification in air matrices. This overview of the sensor and other detection technologies will focus on the operating principal, system detection capabilities, and operational reliabilities of the instrument systems. Most of the systems covered in the paper are either prototype or commercialized systems.

Systems that are still in laboratory development are mentioned but are not a focus of attention in this paper. Regarding detection of human odor VOCs, our discussion will focus on detection directly from air.

A number of odor detection systems have already been developed, and on-going efforts are being devoted to further improving their performance [7-16, 19-24, 36-47, 53-55, 71, 84]. Based on their detection mechanisms, these systems can be classified into several categories, including chemical sensors, biosensors, GC-detector systems, MS-based detectors, and hybrid GC/chemical sensors. In this report, each category of systems will be discussed with a concentration on the operating principle, system capability and performance.

3.1 Chemical Sensors

Chemical sensors detect odor molecules based on the reaction between the odor molecules and the target sensing materials on the sensor surface. This reaction triggers a certain change in mass, volume, or other physical properties. The change is then converted to an electronic signal by a transducer. There are different types of transducers for chemical sensors: optical, electrochemical, heat-sensitive, and mass-sensitive. In this report, several of the most common chemical sensors will be reviewed: surface acoustic wave sensor, quartz crystal microbalance sensor, metal oxide semiconductor sensor, and polymer composite-based sensor. E-noses, which are a sensor array, have drawn much attention since it is the most promising approach so far for mimicking the biological nose for sensing. Therefore, it will be discussed as well.

3.1.1 Surface Acoustic Wave (SAW) Sensors

The SAW sensor transducer is mass sensitive. The sensor is composed of a substrate of quartz that is cut at a crystalline angle to support a surface wave, as well as a chemically sensitive thin film that is coated on the quartz surface. Since the quartz is a piezoelectric material, it converts surface acoustic waves to electric signals. When the chemically sensitive thin film adsorbs specific molecules, the mass of the film increases, thus causing the acoustic waves to travel more slowly. This change can be detected by the sensor microelectronics once the acoustic wave is converted to an electric signal [18].

Since the oscillation frequency of a quartz substrate typically falls within a certain range, it is expected that the sensor will only be able to detect very limited numbers of target molecules. As shown in Figure 3 [18], the SAW mini-CAD from MSA is a portable sensor system that can be designed for chemical warfare agent detection. The system was developed and calibrated to detect a few target chemicals, and thus appears limited in its use for detecting other VOCs.



Figure 3: The SAW mini-CAD system from MSA [18].

To enhance the capability of identifying VOCs, the Department of Energy's (DOE) Sandia National Laboratories developed a SAW sensor array that can identify 18 different VOCs over a wide range of concentrations with a 95-percent success rate [19]. However, the system needs to be operated in a temperature-controlled environment to ensure identification accuracy.

3.1.2 Quartz Crystal Microbalance (QCM) Sensors

Quartz crystal microbalance (QCM) is another type of microbalance mass sensor. Similar to the SAW sensor, the transducer for the QCM sensor is also mass-sensitive. The major difference between SAW and QCM is that the former employs a surface acoustic wave sensor while the latter uses a bulk acoustic wave sensor. Its sensing mechanism is based on the shift in the quartz crystal (QC) resonant frequency due to the adsorption of gas molecules onto the sensing films. Film-coated QCM sensors have enabled the detection of a variety of individual pollutants [20-22] and the sensing of VOCs [23-26]. The sensors used for the latter are typically coated with PVC blended lipids [23], syndiotactic polystyrene (s-PS) semicrystalline [24], carbon nanotubes [25], and molecular imprinted polymers [26]. These films can collect target

VOC molecules and trigger a shift in the QC resonance frequency. Recently, modifications in film composition have been reported to improve the sensitivity and specificity in gas identification [27, 28].

Figure 4 shows a diagram of gas detection using a QCM system [27]. The operation of the sensor requires temperature and humidity control because the QC resonant frequency is affected by variation in temperature and humidity, and thus affects how the frequency shifts during gas molecule collection. Therefore the robustness of QCM sensor systems could be an issue for real-time detection of VOCs.

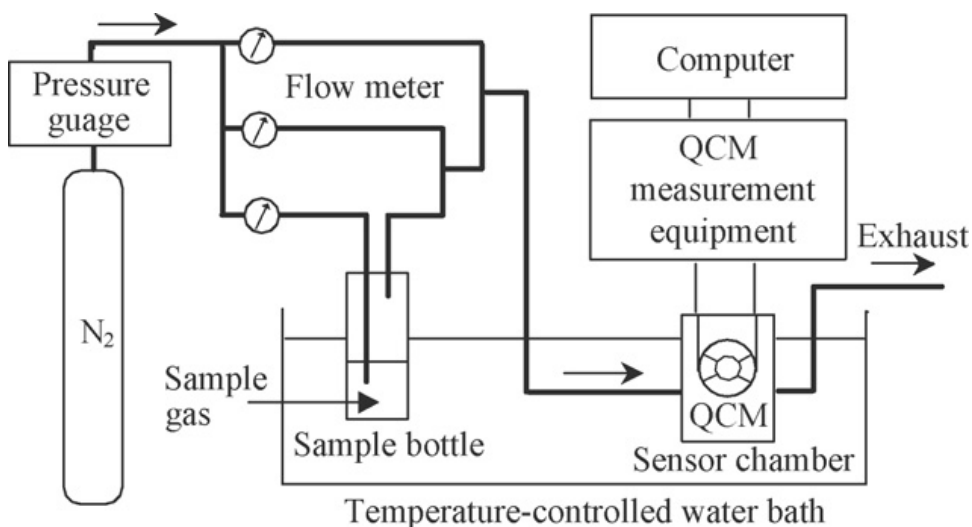

Figure 4: Schematic diagram of the gas testing system for VOCs [27].

There have been commercial QCM sensor systems out on the market. Most of them are for moisture and inorganic gas detection; for example, the Model 3050 Moisture Analyzer from Ametek is for moisture trace detection. There are some reports demonstrating the detection of VOCs using QCM sensor systems [28, 29]. The detection sensitivity for VOCs typically falls in the range of 10 to 10³ ppm, which is not high enough for trace level detection.

3.1.3 Metal Oxide Sensors

Metal oxide sensors are devices that translate a change in the concentration of chemical vapors into electrical signals. As shown in Figure 5, the device has a metal oxide semiconductor sensing surface with an insulating layer underneath, a heater, and a circuit for measuring the resistance of the metal oxide sensor. When VOC molecules are collected on the metal oxide

surface, they are oxidized by the metal oxide at an elevated temperature, typically 250 to 450°C. The reaction results in electron transfer from the VOC molecules to the metal oxide structure. A change in the conductivity is registered as a consequence.

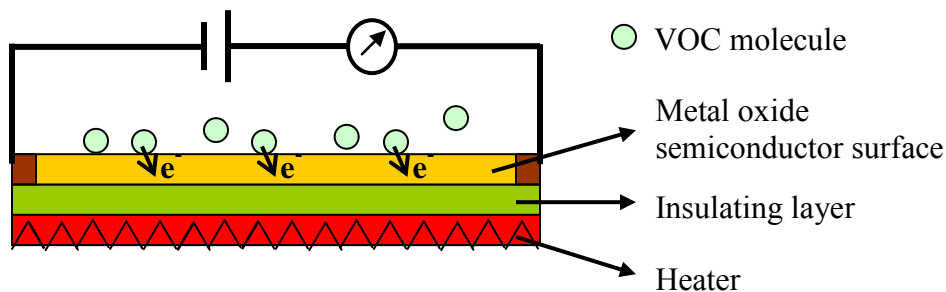

Figure 5: A schematic diagram of metal oxide sensor for VOC detection.

Since detection occurs at high temperature the environmental humidity and temperature are not interfering factors. However, the power consumption caused by the high operating temperatures is a challenge, especially for hand-held and portable systems. To address this issue, work has been undertaken within the last decade to develop systems with lower power consumption. Several types of micro-machined hotplates have been adopted to reduce the power consumption down to a range of a few hundred to tens of mW, for a typical operating temperature of 400°C [30-32]. Recently, the development of ultra-low-power consumption metal oxide sensors with micro-machined hotplates have been reported [33]. These sensors are also able to detect VOCs at the ppb-level, and thus has the capability for VOC trace detection [33].

During the last few decades, one major effort in metal oxide sensor development has been in developing suitable sensor fabrication technologies to increase VOC detection sensitivity [34-39]. Another major focus during the past decade has been in improving VOC detection specificity using an array of metal oxide sensors [40-45]. Such a microarray system is also referred to as an E-nose, as described below.

3.1.4 E-nose

An electronic nose (E-nose) is an instrument that is designed to mimic the function of the natural nose. By definition, it uses a sensor array to not only detect but also discriminate among complex odors [10, 11, 46-48]. The sensor array typically consists of a group of non-specific

chemical sensors that respond to odors. The detection and identification of a particular odorant is based on a unique combined response pattern from all sensors rather than a response pattern from a particular sensor. In addition to the sensor array, the response pattern recognition algorithm is another key component in an E-nose system that determines how well the E-nose identifies VOCs.

Metal oxide sensors and polymer composite-based sensors are two major types of chemical sensors used in different E-nose systems [36-41, 49-53]. Two representative commercial systems based on these two types of sensor will be reviewed below.

3.1.4.1 E-nose Based on Metal Oxide Sensor Array

An E-nose system named KAMINA was developed by Goschnick [36-40] and has been commercialized by Systems and Services for Chemical Analysis (SYSCA). The system operates on a unique, fingernail-sized gas sensor chip with a microarray consisting of 38 tin oxide (SnO_2) or tungsten oxide (WO_3) gradient gas sensors. The architecture of the gradient microarray shown in Figure 6 depicts how the thickness of sensing film and operating temperature changes across the array [41]. Figure 7 shows the chip in its housing [36]. At higher temperatures (approx. 300°C), the electrical conductivity of the metal oxide depends on the composition of the ambient gas, and thus can be utilized to detect gases. Furthermore, each sensor is heated to a slightly different temperature and its membrane thickness differs from those of its neighboring sensors. As a consequence, the individual sensors have a different sensitivity spectrum to gases, and all sensors have a different response to a single gas. Discrimination capability can be obtained by using pattern recognition techniques [38].

The KAMINA system has been used for VOC detection related to consumer products such as cloth smell, exhaust gas control and air conditioning in automobiles, household food processing, and private care diagnostics [36, 37, 39, 40]. The operating temperature varies from 200 to 400°C . The microarray and the operating electronics can be housed within a space as small as a mobile phone. The sensitivity for detecting individual gases could be as low as sub-ppm level, and it is claimed that the sensor can recognize certain smells without identifying individual gases [41]. However, the manufacturer calibrates the microarray using a group of target analytes, and the users are not allowed to train or calibrate the sensor array to detect new analytes of interest.

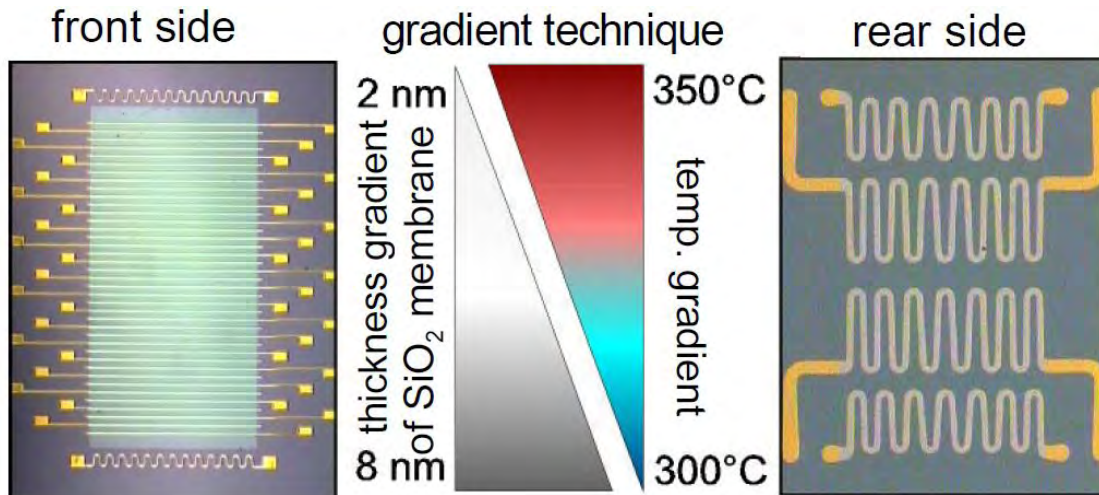

Figure 6: Karlsruhe gradient metal oxide semiconductor array.

Left: front side with 38 sensor segments by 39 electrode strips and two temperature sensors, one above and one below the array. Right: rear side with four heating meanders. The gradient technique is depicted at the center: A temperature gradient and a thickness gradient are applied across the array, allowing each sensor segment to receive a gradually different gas sensitivity spectrum compared to adjacent segments [41].

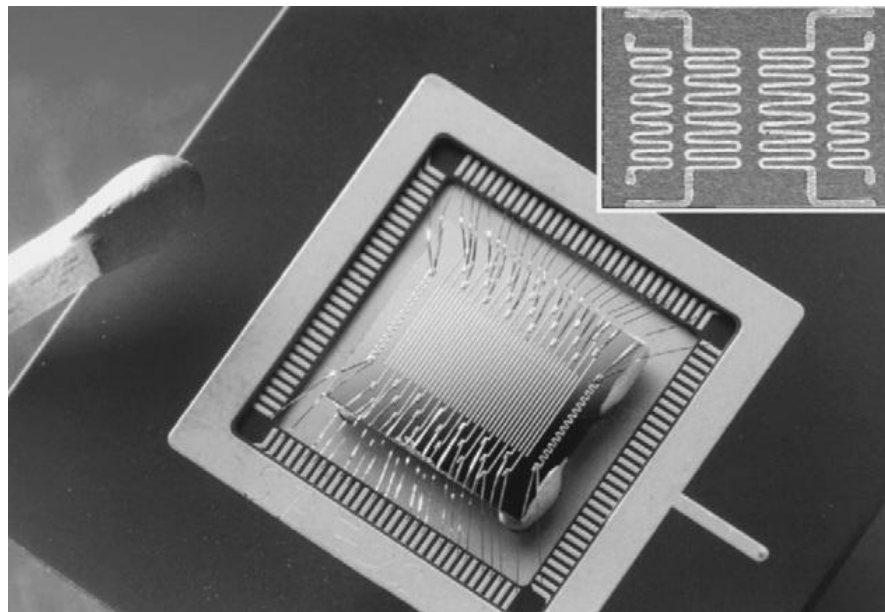

Figure 7: KAMINA gas sensing chip with gradient microarray mounted in its housing.

Electrical contacts are provided by gold wire bonds. The rear side of the chip (upper right) carries 4 meander-shaped heating elements made of platinum to allow controlled inhomogeneous heating of the chip [36].

3.1.4.2 E-nose Based on Polymer Composite Sensor Array

Another commercialized E-nose system is the Cyranose 320 E-nose system from Smiths Detection [53]. It detects and identifies VOCs based on the change in electrical resistance due to absorption of VOCs. We have evaluated the Cyranose E-nose to understand its capabilities for detecting and discriminating between complex VOCs.

Figure 8 (a) shows a Cyranose 320 E-nose system [53]. It is a handheld system consisting of an array of 32 chemical sensors, a VOC sampler, and an on-board data processor. The sensing surface is a polymer network with a 3-dimensional continuous porous structure filled with conducting carbon black. When VOC molecules land on the sensing surface, the reaction between the VOC molecules and the functional group(s) at the polymers cause a volume expansion in the polymer network. As a consequence, the connection between carbon black blocks filling in the polymer network structure becomes loose, and the conductivity decreases. The type and the density of the functional group(s) at the macromolecules are tailored for each sensor type, with the aim that each sensor will respond to a particular VOC in a different way. To identify a particular VOC, the sensor system must be trained using target VOCs with concentrations within the expected range. The training data are used as known “smellprints” to which the blind test data will be compared for prediction. Figure 8 (b) shows a conceptual smellprint comparison.

In order to understand the identification capability of the Cyranose for VOCs, we first tested the system using individual VOCs: isopropanol, 1-pentanol, cyclohexane, 1-hexene, p-xylene, and mesitylene. As shown in Table 1, the identification of individual VOCs is quite successful when the concentration of blind samples is lower than the training concentration. We further tested the system using mixtures of these VOCs containing one, three, four, and five components. As indicated in Figure 9, the prediction success rate decreases dramatically when the number of components in the mixture is larger than 3. This reveals that the Cyranose E-nose does not have sufficient capability to identify either a VOC complex or a VOC from a VOC complex.

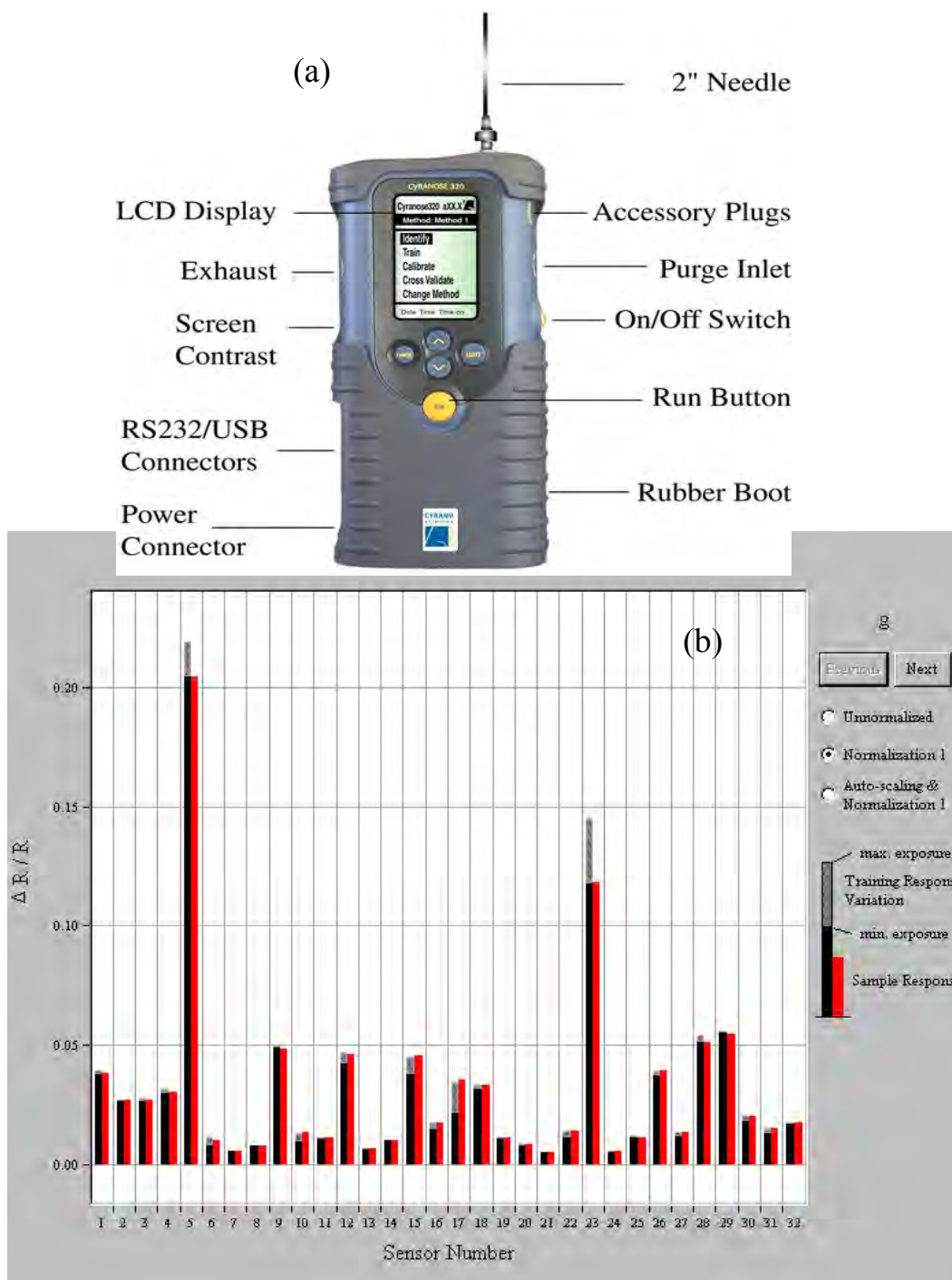

Figure 8: A Cyranose 320 E-nose system from Smiths Detection.

(a) A picture of the system. (b) A comparison of a new smellprint (in red) with stored smellprints (in black) previously obtained from a control experiment. The vertical axis represents sensor response or $\Delta R/R$, where ΔR is the change in resistance [53].

Table 1: Success Rate for Individual VOC Identification Using the Cyranose 320

Training Concentration	Blind Test Concentration		
	High	Medium	Low
High	97%	100%	83%
Medium	61%	83%	83%
Low	22%	83%	100%

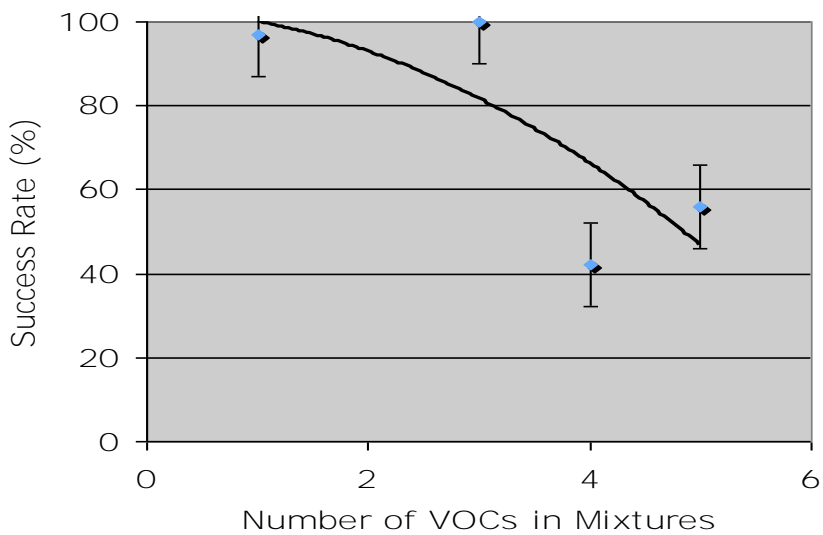

Figure 9: Dependence of success rate of VOC complex identification on the number of VOCs in the complex, using a Cyranose 320 E-nose.

E-nose systems have been much more widely exploited for VOC detection and identification than other chemical sensor systems. Applications include food quality control [49, 51, 54, 55], classification of aromatic species [56], and prediction of human percepts of odor quality [50]. E-noses have also been integrated into an intelligent system where it is utilized for odor recognition [52]. However, E-nose systems must be trained prior to a blind test, and this may pose some limitations. For instance, the training dataset and blind data need to be collected under the same operational conditions. Although most E-nose systems can build a training model with a small number of standard samples, they can only discriminate a VOC from among a small group of VOCs. Therefore the capability for VOC complex detection and identification is limited.

3.1.5 Current R&D Efforts

In recent years, new sensing mechanisms have been explored to increase the detection sensitivity or specificity. J. Pons showed for the first time that a pulsed digital oscillator-based structure can detect a fairly small frequency shift and thus possibly be used for sensitive VOC detection [57]. A thin film consisting of metal oxide nanoparticles has been explored to enhance the sensitivity as well as the range of the dynamic response of the chemical sensors [58]. Thin films with novel compositions, such as organic-inorganic hybrid structures [59-61], chemical modified copolymers [62], and metal doped semiconductors [63], have been studied and proven to increase the sensitivity. The best detection sensitivity reported is at the level of several tens of ppb [59]. For specificity, molecularly imprinted polymers have been used for selective sensing of small molecules [64]. Newly developed detection technologies such as a surface plasmon resonance spectrum has also been explored for VOC sensing [65].

In summary, chemical sensors for VOC detection and identification have been in existence for decades. The most common chemical sensor types include SAW, QCM, metal oxide semiconductor sensors, and polymer composite-based semiconductor sensors. Commercial product systems have been developed based on these sensing mechanisms, and they have demonstrated certain capabilities for VOC detection. However, each type of sensor system has some limitations. While the majority of efforts have been devoted to increasing the detection

sensitivity, the system operational robustness and identification specificity are still major challenges for the developers.

3.2 Biosensors

The gold standard for odor detection is the mammalian nose that displays detection with both high sensitivity and specificity. The olfactory receptors make these properties possible, as they support combinatorial detection of odors [66] at trace levels, e.g. 10^{-7} to 10^{-11} M in humans [67, 68]. Efforts have been devoted to exploiting these receptors in association with some electronic devices to develop biosensors that truly mimic biological noses [69-75].

The rat (or mouse) nose has widely been used as a model for VOC sensor development. Rats are capable of identifying food smell and location very quickly, being three orders of magnitude quicker than the human nose [76, 77]. This makes them the prime alternative to “sniffer” dogs [78]. Developing biosensors for VOC detection using rat olfactory receptors has been reported [70-75]. The detection mechanism of these biosensors is based on the specific interaction between olfactory receptors and odorant molecules. The sensors demonstrate better detection selectivity than chemical sensors. However, the majority of the work done so far has focused on development using a single olfactory receptor. Future development must focus on an olfactory receptor array for multiple target detection. Stability of such biosensors will also be a challenge. Hopefully advances in bio-nanotechnology will make this a reality, and lead to robust, label free, sensitive, and specific odor detection [69].

Another type of biosensor developed for VOC detection is based on biochemical reactions between a VOC and a biomolecule, or a chemical reaction catalyzed by biomolecules. An example of this is the “bio-sniffer”; it uses an enzyme catalytic reaction for conventional and quick measurement of VOCs from building materials for environmental monitoring [79-82]. Figure 10 shows a stick type bio-sniffer, and Figure 11 shows how the sensor sniffs the malodor (formaldehyde) of a piece of building material [82]. Compared to commercially available semiconductor gas sensors, the bio-sniffer has better overall performance in sensitivity, calibration behavior, and selectivity [82].

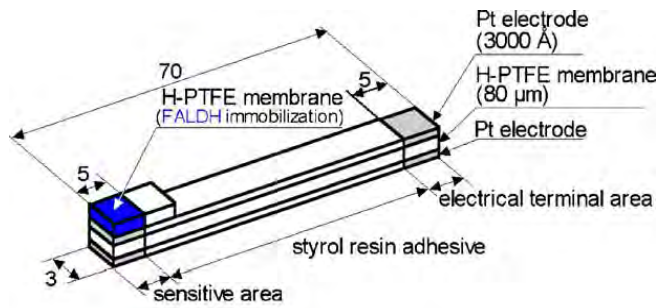

enzymatic reaction



electrochemical reaction

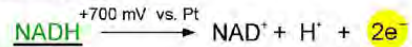

Figure 10: A schematic diagram of the “bio-sniffer” stick built based on the enzyme catalytic reaction [82].

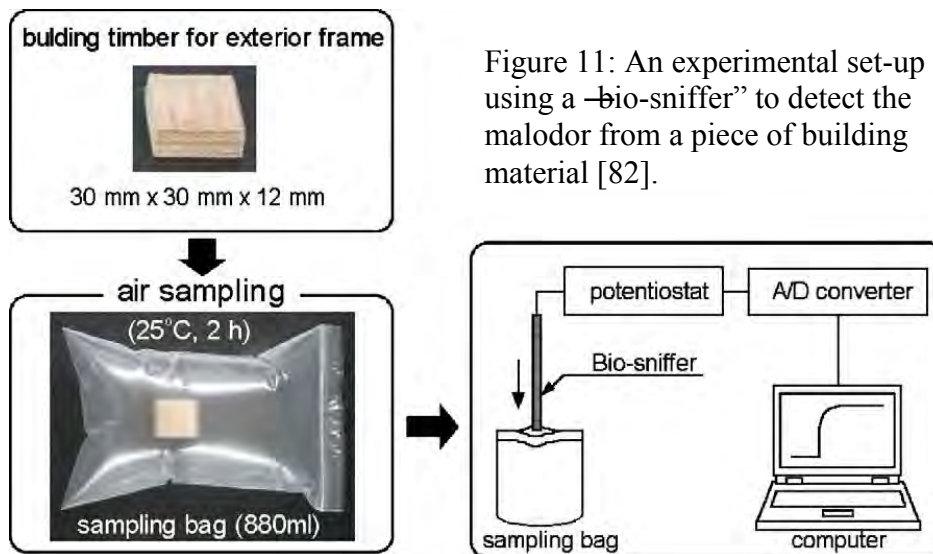

Figure 11: An experimental set-up using a “bio-sniffer” to detect the malodor from a piece of building material [82].

3.3 Gas Chromatography (GC) system

Traditional analytical methods have been utilized for VOC detection using a combination of gas chromatography (GC) with a certain detection approach such as flame ionization detection (GC/FID), photoionization (GC/PID) or mass spectrometry (GC/MS) [83, 84]. The gas chromatograph is used for separating analytes, while the detectors are for measuring the individual analytes.

A multidimensional GC/MS olfactometry system has been developed for highly sensitive VOC identification among a mixture with a large group of VOC components [85]. Tobacco, chocolate, coffee, etc., contain over 1,000 components in the headspace (air above or surrounding the material). Analyzing such materials is often a difficult challenge, due to both the large number of components contained within the sample, as well as the huge variation in the concentrations of all components. Also, in most cases, only a small subset of components are of interest and used as markers for identification. A solution for removing the interference effect from the non-target components can be achieved using the multidimensional GC/MS olfactometry system. The system enables the users to separate the components of interest, identify the “character defining” compounds, and identify those components using conventional mass spectral techniques [85]. In parallel, an ergonomically designed olfactory port, in conjunction with a conventional quadrupole mass spectrometer, allows the user to quickly assign aroma/odor significance to regions of the chromatogram and subsequently identify those peaks of interest [85]. This multidimensional GC olfactometry (GCO) system has been widely utilized in the food industry for sensitive food flavor or odor identification [86, 87]. Figure 12 shows a schematic diagram of the configuration of a multidimensional GC-olfactory instrument developed by Microanalytics [85]. The GC system houses two columns of which one is more efficient for polar VOC separation, while the other is for non-polar VOCs. The sample, after being eluted through the GC columns, is split to both a MS detector and an olfactory detector. The latter is typically a panel of human noses. The technology has been in use by a number of companies to fully resolve and identify the critical, “character defining” aroma and odor compounds in a variety of matrices [85].

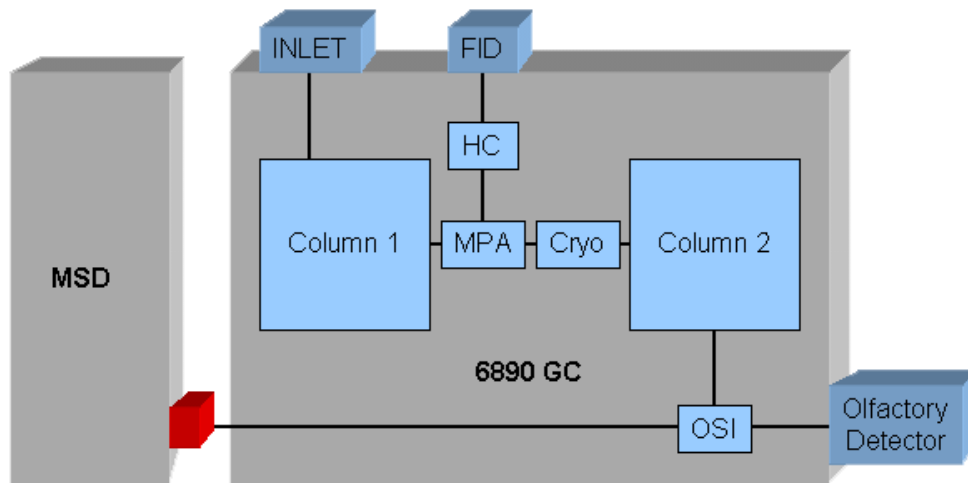

Figure 12: A schematic diagram of the Model 2100 GCO from Microanalytics [85].

These GC-related methods typically employ batch detection that involves separate analytical steps, including VOC sampling, sample transportation, analyte pre-concentration, separation via chromatography, detection, data transmission, and post-data analysis. Although these methods are very useful for VOC trace detection [88], they are quite time-consuming. The users are required to be well trained before they can utilize the instrument for VOC analysis. Also, the concentration detected from such analysis is the average or accumulated level rather than spatial variations over the sampling time period. In addition, VOC sample loss could occur during sample transportation and thus may affect the concentration measurement. Since the sample loss rate is different for different VOCs, any results that are related to a differential concentration among different VOC components in a mixture could be affected by sample transportation.

3.4 Real-time Detection Systems

In order to handle emergent situations such as a chemical leak or spill, some real-time detection approaches have been developed to perform continuous on-site monitoring of VOCs in the environment.

3.4.1 Mass Spectrometer-based Systems

3.4.1.1 Detection Method

The most powerful real-time VOC detection systems utilize a mass spectrometer as the detector with a continuously operated air sampler. To insure the sensitivity required to identify VOCs at trace levels, a coupling of two stages of mass analysis (MS/MS or MS²) is typically used. As shown in Figure 13 [89], ions of a particular mass to charge ratio (m/z value) are selected at the first stage, and sent to the second stage where they are further fragmented. The resultant fragments at the second stage are then analyzed without interference from a large amount of unrelated fragments. MS² can be very useful in identifying compounds in complex mixtures and in determining the structures of unknown substances.

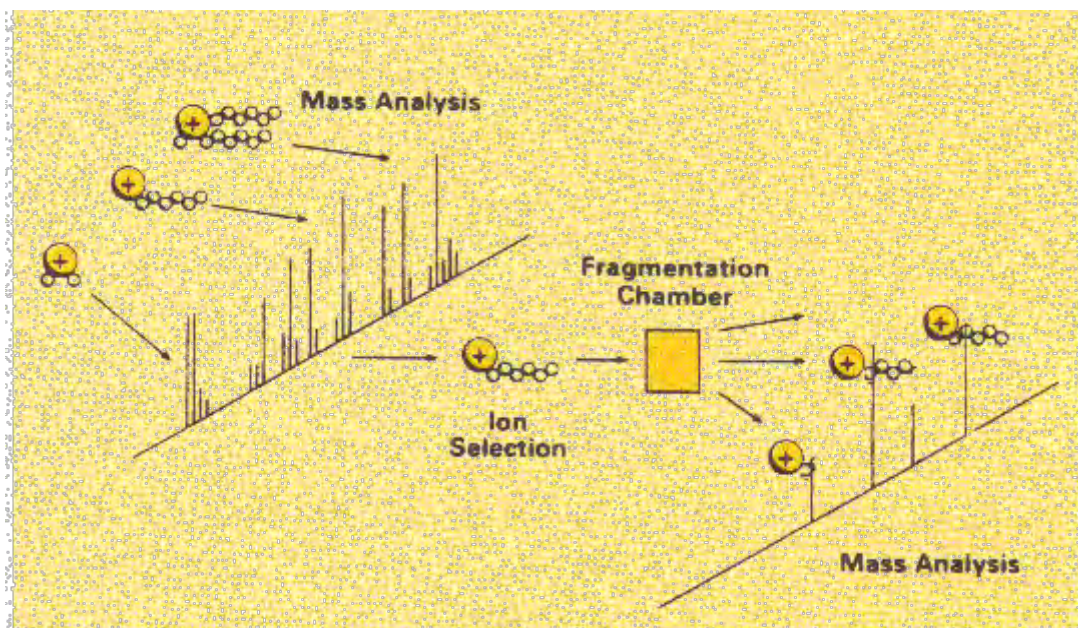

Figure 13: A schematic demonstration of the MS² operational mechanism

In MS², the first mass spectrometer selects ions of one m/z value for fragmentation, and the second one produces the mass spectrum of the fragments from the selected ions [89].

Systems based on mass spectrometers with various ionization methods have been utilized for real-time VOC monitoring. They include atmospheric pressure chemical ionization/MS² (APCI-MS²) [90, 91], low pressure chemical ionization/MS² (LPCI-MS²) [88, 92, 93], and

proton-transfer reaction MS (PTR-MS) [94, 95]. Beside the difference in ionization method, APCI-MS² is based on the principles of MS² using a triple quadrupole mass spectrometer [90] or an ion trap (IT) mass spectrometer, while LPCI-MS² is based on the principles of MS² using a triple quadrupole mass spectrometer. LPCI-MS² gives low background levels and lower method limits of detection (LOD) than APCI-MS² [93]. However, LPCI-MS² instruments are expensive and are not yet able to achieve very low LOD. Therefore, they do not conclusively measure VOCs, particularly benzene, toluene, ethylbenzene, and xylenes (BTEX), in ambient air at the concentration levels (low- $\mu\text{g}/\text{m}^3$) widely set by regulatory authorities in environmental and occupational health areas. The PTR-MS technique provides rapid, sensitive measurement of VOCs in ambient air with a very low limit of detection. However, isomeric and isobaric compounds are not separated and measured individually by PTR-MS instruments, so only the sum of isomeric or isobaric compounds is determined by PTR-MS.

3.4.1.2 Commercial Systems

One commercialized real-time VOC monitoring system is TAGA (trace atmospheric gas analyzer) manufactured by Sciex [96]. This is a very powerful, field deployable, analytical instrument. The TAGA operation is based on coupling two stages of mass analysis. It is a mobile unit designed for monitoring of airborne pollutants in real time. It can also track down emission sources and identify odors, and thus is capable of supporting environmental emergencies (e.g., chemical spills and fires) [15]. Different models of mobile TAGA have been developed since 1980 and have been used for monitoring ambient-air VOCs in several situations [97].

Because of their high sensitivity, selectivity, speed and broad applicability, MS systems, particularly those that rely on MS², would be excellent candidates for portable instruments aimed at real-time airborne VOC analysis. Nevertheless, such an MS² system would still need to be reduced in dimension and energy consumption. Development of portable mass spectrometers started in the 1960s [98]. Much effort has gone into miniaturization of mass analyzers, especially the ITs [99-101]. Several commercial portable instruments have been developed for on-site chemical hazard identification. Griffin Analytical Technologies Inc. has released a field-ready portable GC-MS instrument using a miniature cylindrical IT (CIT) mass analyzer. A portable GC-MS instrument based on a miniature linear quadrupole array has also been

developed by Infico. Few miniature direct-sampling mass spectrometers have been developed in recent years which are capable of performing real-time continuous monitoring of VOCs in ambient air [91, 101]. MKS Instruments has developed a portable CIT mass spectrometer based on a helium leak detector. Portable instruments based on a miniature IT yield low limits of detection (LODs) (e.g., 38.3 $\mu\text{g}/\text{m}^3$ for benzene), short analysis time (<5 seconds), a mass range of about 450 m/z , and thus are very suitable for monitoring airborne VOCs [91]. The main limitation of miniature portable IT spectrometers, when compared to full-sized IT analyzers, is the loss in performance as a trade-off for the reduced size. In general, as the trap depth is reduced, mass resolution degrades [101, 102], sensitivity for the lower masses decreases, and the dynamic range is shown to be reduced [103].

3.4.2 Optical Spectroscopy

One of the most commonly used on-site methods for continuous monitoring of airborne VOCs is differential optical absorption spectroscopy (DOAS) [12-14, 104-107]. DOAS has been applied widely in a number of field studies of VOCs in ambient air all over the world. DOAS instruments have been used for near real-time continuous monitoring of monoaromatic hydrocarbons (BTEX) in urban air in Germany by Volkamer et al. [108], Korea by Lee et al. [109], Italy by Brocco et al. [110], Greece by Kourtidis et al. [111], USA by Trost et al. [112], and Sweden by Axelsson et al. [113].

The principle of the DOAS technique is based on the differential absorption of light by chemical compounds at specific wavelengths, following Lambert-Beer's Law. The DOAS equipment has three major parts: an emitter, a receiver, and an analyzer. The emitter (a xenon lamp) sends to the receiver a light beam containing a range of wavelengths from ultraviolet to visible. Different VOC molecules absorb light at specific wavelengths along the path between the emitter and the receiver. The analyzer (spectrophotometer) continuously measures the light absorbance within the wavelength interval of interest (250–290 nm for the aromatic hydrocarbons), with a scan time of around 10 ms. Differential absorption spectra are produced in the wavelength range and are stored in memory with up to 1000 channels. Each compound is identified by comparing its specific fingerprint in the measured spectrum with the reference spectra that have been prerecorded from pure standard gases. A computer converts the differential absorbance into concentrations for each of the VOCs monitored.

DOAS combines the advantages of fast response time (60 sec) and low method LODs (LOD = 2.6 $\mu\text{g}/\text{m}^3$ for benzene). Disadvantages include optical interference from oxygen, ozone, and several hydrocarbons [84, 113].

3.4.3 Comparison of Detection Capability among Different Methods

Table 2 summarizes the VOC detection time and sensitivity of each method described in Section 3.4 [97]. The comparison is based on data collected from real-time measurement of VOCs (e.g. BETX) in ambient air. The TAGA LPCI-MS² is quite sensitive, and the system is simple, reliable, and relatively maintenance-free. However, it is expensive. The portable APCI-MS² has good selectivity, higher sensitivity for only several VOCs, and allows direct air sampling, but is also expensive. Obviously, the PTR-MS has the highest sensitivity and shortest detection time. However, it can not separate isomeric and isobaric compounds and measure them individually. The DOAS can measure mixing ratio variations for a short-term period, and requires no processing for data acquisition. However, the accuracy of the measurement depends on the correctness of absorption cross-sections, and the sensitivity decreases under low-visibility conditions. Oxygen, ozone, and hydrocarbons in the air are interferents for this system.

Table 2: Summary of VOC Detection Time and Sensitivity for Different Methods [90].

Methods	Detection Time (Sec.)	Limit of Detection ($\mu\text{g}/\text{m}^3$)
TAGA LPCI-MS ²	5	2.0
Portable APCI- MS ²	< 5	38.3
PTR-MS	1	0.3
DOAS	60	2.6

3.5 Hybrid GC/Chemical Sensor System

Powerful VOC detection using analytical instruments, including a GC-detector, has been discussed above. Although these systems indicate better sensitivity and selectivity than sensor systems, their relatively larger dimensions and much higher manufacturing costs are still

obstacles for some applications that require miniature, low cost, and easily deployed devices. As discussed above, sensitivity and specificity requirements for VOC trace detection still remain a great challenge if sensors are used as detectors, especially for detection of VOCs in a complex background. If the individual VOCs can be separated prior to detection, the sensitivity would be enhanced since there is much less interference from other VOCs in the complex background. This leads to the idea of integrating a GC column and a sensor for VOC detection. The former allows the separation of VOC components in a mixture while the latter provides detection for different VOC components when they are eluted out of the GC column. The separation of VOC components in a GC column is typically carried out at an elevated temperature and thus it requires that the sensor can be operated at elevated temperatures. The metal oxide semiconductor gas sensor has good stability, is sensitive to a broad range of VOCs, and can be made reproducible among common batches. It also operates at a temperature between 200 to 400 °C, and thus is a great candidate for a detector in such a system.

Development of a miniature device with a GC micro-column and a gas sensor has been reported [16, 114-118]. One of the development challenges is how to manufacture the GC micro-column. Development remained in a laboratory stage until 2006, when Sanchez et al. [16] reported their successful development of a GC micro-column on a silicon chip using micro-fabrication technology. Figure 14 shows a picture of such a GC micro-column made by etching micro-channels on a chip, and then coating the internal walls with a stationary phase for VOC separation. A prototype of the architecture shown in Figure 15 was fabricated by Sanchez [16], by integrating a GC micro-column and a SnO₂ gas sensor. The system was tested with a gas mixture of benzene, toluene and two isomers of xylene eluted in synthetic air. The test results indicate that all four VOCs were identified including the isomers at low ppm level. It is expected the sensitivity could be lowered to sub ppm level after the system is calibrated. This prototype system, beyond its small size and its great chemical discrimination, provides fast response and offers the best results with very low temperatures (303 to 343 K) of the GC micro-column [16].

A commercialized portable GC-SAW system was developed by Amerasia (Electronic Sensor Technology) in 1999 [17]. The system contains a down-sized conventional GC column and a SAW sensor tuned to detect a couple dozen common VOCs in air. The detection time is less than 2 minutes and the sensitivity is at ppb level. The column setting is fast (5 seconds).

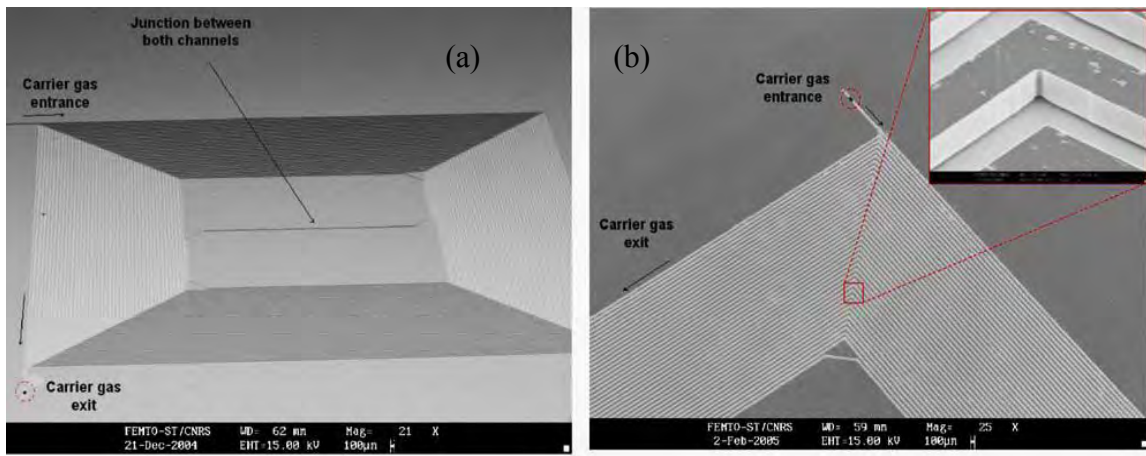

Figure 14: SEM photomicrographs of the spiral GC micro-column on a 3-inch wide silicon wafer.

(a) General view of the completely etched micro-column; (b) zoom on the internal wall of the spiral GC micro-column [16].

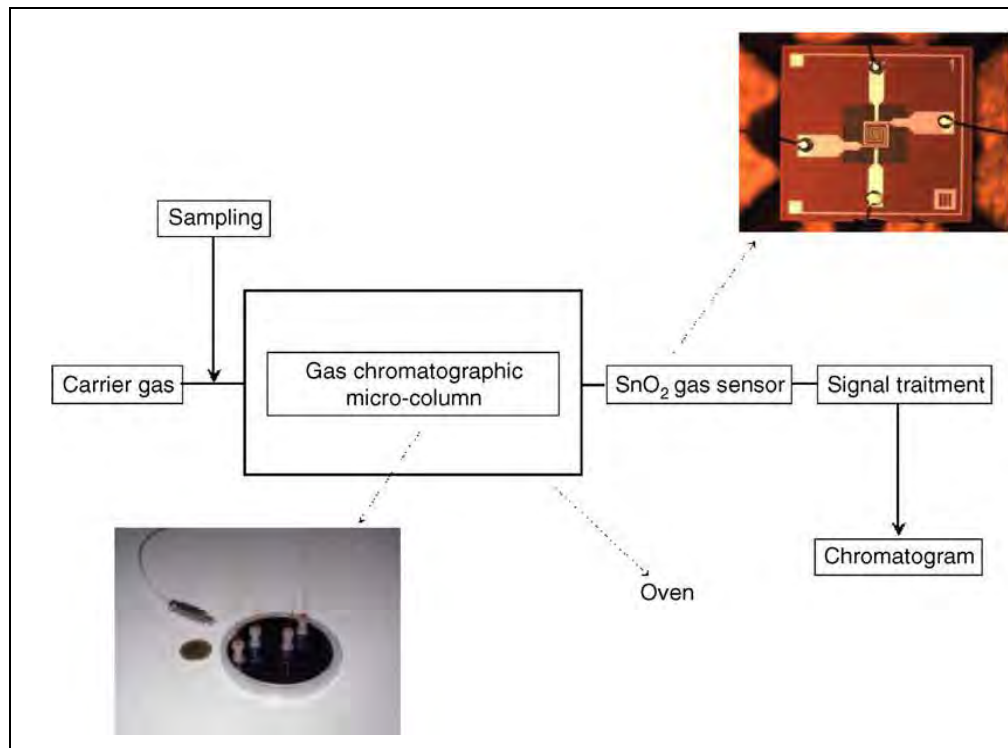

Figure 15: General architecture of the gas chromatographic hybrid system [16].

The dimensions are 14 by 20 by 10 inches and the weight is 35 lb. The system can also be configured for stand alone use or integrated with other systems. It is a field deployable system.

4.0 Instrumentation for Human Odor Detection in Air Matrices

Detection of trace VOCs for human odor is important for investigative law enforcement, forensic analyses, health monitoring, and disease diagnosis. Canines have been trained specifically to remember odor on human subjects and have demonstrated a strong capability in matching criminal suspects to proffered odor evidence. However, because there are no regulatory qualification standards for human odor-discriminating canines, odor detection is not currently accepted as evidence in U.S. court systems [8], although positive responses are generally accepted as corroborative evidence. For human odor detection in support of canine determinations, it would therefore be beneficial for law enforcement to mimic the canine to detect trace-level VOCs from air in near real time, using certain sensor and/or detection technologies to determine target VOCs and their respective concentrations [119]. Therefore, there is a pressing need to develop such technology. Below, we first provide our opinions on the current instrumentation limitations for human odor detection and identification, then propose some recommendations for future development.

4.1 Instrumentation Limitation

Currently, the most powerful detection system for VOCs, the GC/MS, has a LOD at the ppm level to detect a VOC in a complex background. This LOD is obtained based on the amount of concentrated sample injected into the GC column for each analysis. However, some VOCs in human odor occur in such low concentrations that direct sampling and detection in air matrices is not possible. For these VOCs, specific sample collection and concentrating processes, such as trapping and concentrating the VOC sample using solid phase microextraction (SPME) technique, need to be implemented to enable detection. However, the tradeoff is that the analysis is not available in real time due to the time delay caused by the concentrating process. Also, the VOC complex sample collected through such a process is not necessarily chemically identical to its source, because the dispersion rates of different VOCs in air are different depending on the molecular mass and structure of each VOC [10].

For direct detection of human odor VOCs from air matrices, E-nose technology could be a more promising candidate. As discussed earlier, sensitivity is still an issue for trace VOC detection and specificity is also a huge challenge. This is because today's E-nose technology only mimics part of the functionality of the human olfactory system, mainly sensing and signal processing as described in steps 5 to 10 shown in Figure 2. There are no components in the E-nose that play a role that mimics the action of the mucus in the natural nose. Some E-nose designs seem to mimic the molecular recognition mechanism performed by the odor protein binding process in the olfactory system. However, they still lack good molecule sorting mechanisms. Control of reliable operating conditions (temperature and humidity) is critical for the molecular recognition process, but is still left out of the current E-nose system. The sampling techniques used affect odor delivery and collection, but very limited efforts have been devoted to development and optimization of this area.

Recently, researchers at the University of Warwick have coated the sensors in an E-nose with a mix of polymers that mimics the action of the mucus in the natural nose. It was reported that this greatly improves the performance of the electronic devices allowing them to pick out a more diverse range of smells [120]. The artificial mucus offers not only improved odor discrimination for electronic noses, but also much shorter analysis times than conventional techniques. As shown in Figure 16, the final device with both sensors and artificial mucus can be housed within a piece of plastic just a few centimeters wide, at a cost of less than five British pounds (£) to produce [120].

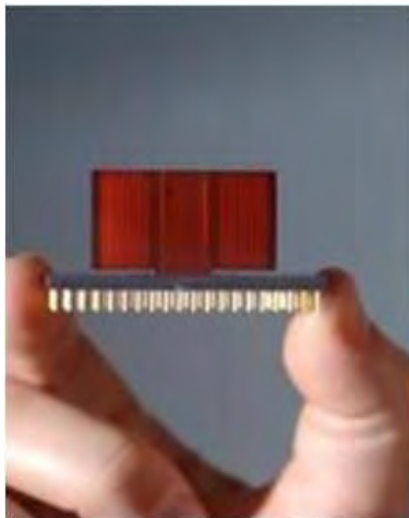

Figure 16: An electronic nose that mimics the action of the mucus in the natural nose for odor sensing, developed by Professor Julian Gardner at University of Warwick [120].

4.2 Recommendations

Recognizing that there is still a long journey until a truly artificial nose is developed, the best strategy for current development would be to integrate a system that is composed of a variety of different components with the following functionalities: VOC sampling in air matrices, a filter to exclude non-target chemicals, VOC separation, and detection. Figure 17 is a schematic illustration of a conceptual design for such a system. An air sampler at the front end intakes air from the environment and delivers it to a filter, where target VOCs will pass through and some interferences will be blocked. The filtered sample is then released to a gas chromatograph (GC) where the mixture of VOCs will be separated into individual VOCs that are eluted out of the GC column at different times. The incorporation of the filter and the GC unit will eliminate interference for individual VOC detection, and thus enhance the detection sensitivity and specificity. An E-nose can be utilized to detect the individual VOC. If necessary, both an E-nose and a MS detector can be integrated into the system at the same time, in which case the former serves as a trigger to report the presence of VOCs and to initiate the latter to perform confirming identification of the individual VOC. As mentioned above, miniature GC and down-sized MS systems are now prototyped. Therefore, developing a portable field deployable system based on this conceptual design could be possible.

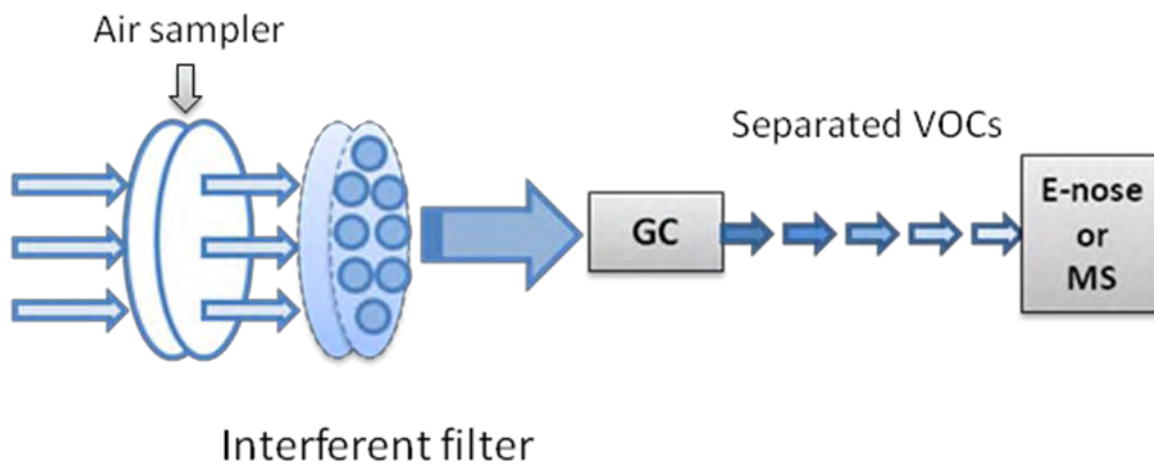

Figure 17: Conceptual design of an integrated system for odor detection

The system has the following components: an air sampler, an interferent filter to exclude non-target chemicals, a gas chromatograph for VOC separation, and an E-nose or MS for VOC detection

5.0 Summary

The use of human odor as a biometric identifier would be a significant step forward for the nation's defense and security. In this report, we have examined human odor, its component VOCs, and its emission from the body. Instruments that are potentially applicable for detecting and identifying human odor were discussed. Finally, a recommendation was presented for an integrated system to refine and enhance current detection capabilities.

Both sensor systems and analytical instruments have been developed and exploited for VOC trace detection and identification. A variety of sensors, including chemical sensors, biosensors, and E-noses that are basically chemical sensor arrays, have demonstrated the feasibility of VOC detection in air matrices, as well as a certain capability for VOC detection and identification. While a considerable amount of work has been done to improve the sensitivity from high to low ppm levels, the specificity of identification still remains a huge challenge. Future efforts devoted to developing a truly artificial nose must focus on implementing those functionalities in the natural nose that currently have not been adopted. This includes enhancing the VOC molecule recognition capability, developing and incorporating a molecule sorting mechanism that mimics the mucus action in the natural nose, stabilizing the operating conditions (temperature and humidity) to ensure the molecule recognition capability, as well as developing an appropriate air sampling mechanism to enhance VOC collection efficiency.

Analytical instruments based on GC/MS have excellent detection sensitivity and specificity, and are thus the best candidates for VOC trace detection and identification. However, real-time direct detection from air matrices could pose a challenge for this type of detection system. Furthermore, the requirement of concentrating samples may be a constraint for real-time detection. Finally, the instrument operators require extensive training for detection method development and data interpretation.

Application of current VOC detection technologies for human odor VOC detection and identification in air matrices is still a challenge. An integrated system could now be considered to efficiently assemble and optimally exploit the advantages of various methods and approaches for odor VOC sampling, interferent filtering, VOC separation and detection, and thus to mimic the functionalities of the human nose for odor VOC detection. Although it will be many years before we can come close to truly simulating the dog's nose, judicious research in certain areas will help make significant advances in E-noses for human odor detection and identification.

6.0 Acknowledgement

The author would like to express her gratitude to Ms. Brigitte Rolfe, for her thoughtful review of the report and helpful discussions and suggestions. Work for this report was supported by funding from the MITRE MIP program and the U.S. Government Nano-Enabled Technology Initiative.

7.0 Glossary

APCI-MS ²	Atmospheric Pressure Chemical Ionization/MS ²
BTEX,	Benzene, Toluene, Ethylbenzene, and Xylenes
CIT	Cylindrical Ion Trap
DOAS	Differential Optical Absorption Spectroscopy
FID	Flame Ionization Detection
GC	Gas Chromatographer
GCO	GC olfactometry
IT	Ion Trap
LOD	Limit of Detection
LPCI-MS ²	Low Pressure Chemical Ionization/MS ²
MOX	Metal Oxide
MS	Mass Spectrometer
MS/MS (MS ²)	a coupling of two stages of mass analysis
m/z	mass-to-charge ratio
PID	Photoionization Detection
Polar molecule	molecule with a electric polar moment
ppb	Parts-Per-Billion
ppm	Parts-Per-Million
ppt	Parts Per Trillion
PTRMS	Proton-Transfer Reaction MS
QCM	Quartz Crystal Microbalance
SAW	Surface Acoustic Wave
SEM	Scanning Electronic Microscope
SYSCA	Systems and Services for Chemical Analysis
TAGA	Trace Atmospheric Gas Analyzer
VOC	Volatile Organic Compound

8.0 References

- [1] A. Yuwono and P. S. Lammers, Odor Pollution in the Environment and the Detection Instrumentation, *Agricultural Engineering International: the CIGR Journal of Scientific Research and Development* VI (2004).
- [2] J. W. Gardner and P. N. Bartlett, *Electronic Noses Principles and Applications* Oxford University Press, Oxford, UK, 1999.
- [3] A. M. Curran, S. I. Rabin and K. G. Furton, Analysis of the Uniqueness and Persistence of Human Scents, *Forensic Science Communications* 7 (2005) 2.
- [4] R. P. Clark and O. G. Edholm, *Man and His Thermal Environment*, New York, 1985.
- [5] C. Doyle, Secret Cloud that Surrounds Us, *Family Health*, 1970, January 1970, pp. 32-35.
- [6] G. S. Settles and W. J. McGann, Potential for portal detection of human chemical and biological contamination, *SPIE Aerosense* 4378 (2001).
- [7] G. S. Settles, *Schlieren and Shadowgraph Techniques*, Springer-Verlag, Heidelberg, 2001.
- [8] R. A. Stockham, D. Slavin and W. Kift, Survivability of Human Scents, *Forensic Science Communications* 6 (2004).
- [9] W. G. Syrotuck, *Scents and the Scentsing Dog*, Canastota: Arner Publication, New York, 1972.
- [10] T. C. Pearce, Computational parallels between the biological olfactory pathway and its analogue 'The Electronic Nose': Part II. Sensor-based machine olfaction, *BioSystems* 41 (1997) 69–90.
- [11] W. Gopel, Chemical imaging: I. Concepts and visions for electronic and bioelectronic noses, *Sensors and Actuators B* 52 (1998) 125–142.
- [12] M. Johansson, B. Galle, T. Yu, L. Tang, D. Chen, H. Li, J. X. Li and Y. Zhang, Quantification of total emission of air pollutants from Beijing using mobile mini-DOAS, *Atmospheric Environment* 42 (2008) 6926-6933.
- [13] S.-W. Kim, S.-C. Yoon, J.-G. Won and S.-C. Choi, Ground-based remote sensing measurements of aerosol and ozone in an urban area: A case study of mixing height evolution and its effect on ground-level ozone concentrations, *Atmospheric Environment* 41 (2007) 7069-7081.
- [14] S. Zoras, A. G. Triantafyllou and V. Evangelopoulos, Aspects of year-long differential optical absorption spectroscopy and ground station measurements in an urban street canyon near industrial pollution sources, *Atmospheric Environment* 42 (2008) 4293-4303.
- [15] Ontario Ministry of Environment, Brief PIBS 3662E (1998) 1.
- [16] J. Sanchez, F. Berger, M. Fromm and M. Nadal, A selective gas detection micro-device for monitoring the volatile organic compounds pollution, *Sensors and Actuators B* 119 (2006) 227–233.
- [17] SAW/GC System for Field Portable Detection of VOCs, Office of Science and Technology, Federal Energy Technology Center, 1999.
- [18] SAW MiniCAD mk II™ Miniature Chemical Agent Detector, <http://www.msanorthamerica.com/catalog/product500650.html>.
- [19] <http://www.sandia.gov/media/NewsRel/NR2000/sawsensor.htm>
- [20] J. F. Alder, Piezoelectric crystals for mass and chemical measurements, *Analyst* 108 (1983) 1169–1189.

- [21] G. G. Guilbault and J. Jordan, Analytical uses of piezoelectric crystals: a review, *CRC Critical Reviews of Analytical Chemistry* 19 (1988) 1-28.
- [22] A. Mierzwinski and Z. Witkiewicz, The application of piezoelectric detectors for investigations of environmental pollution, *Environmental Pollution* 57 (1989) 181-198.
- [23] A. K. M. Shafiqul Islam, Z. Ismail, M. N. Ahmad, B. Saad, A. R. Othman, A. Y. M. Shakaff, A. Daud and Z. Ishak, Transient parameters of a coated quartz crystal microbalance sensor for the detection of volatile organic compounds (VOCs), *Sensors and Actuators B* 109 (2005) 238–243.
- [24] G. Mensitieri, V. Venditto and G. Guerra, Polymeric sensing films absorbing organic guests into a nanoporous host crystalline phase, *Sensors and Actuators B* 92 (2003) 255–261.
- [25] M. Penza, G. Cassano, P. Aversa, F. Antolini, A. Cusano, M. Consales, M. Giordano and L. Nicolais, Carbon nanotubes-coated multi-transducing sensors for VOCs detection, *Sensors and Actuators B* 111–112 (2005) 171–180.
- [26] M. Matsuguchi and T. Uno, Molecular imprinting strategy for solvent molecules and its application for QCM-based VOC vapor sensing, *Sensors and Actuators B* 113 (2006) 94–99.
- [27] S. Ichinohe, H. Tanaka and Y. Kanno, Gas sensing by AT-cut quartz crystal oscillator coated with mixed-lipid film, *Sensors and Actuators B* 123 (2007) 306–312.
- [28] P. Si, J. Mortensen, A. Komolov, J. Denborg and P. J. Møller, Polymer coated quartz crystal microbalance sensors for detection of volatile organic compounds in gas mixtures, *Analytica Chimica Acta* 597 (2007) 223–230.
- [29] A. Yuwono and P. S. Lammers, Performance Test of a Sensor Array - Based Odor Detection Instrument, *Agricultural Engineering International: the CIGR Journal of Scientific Research and Development* BC 03 009 (2004).
- [30] S. Semancik, Microhotplate platform for chemical sensors research, *Sensors and Actuators B* 77 (2001) 579–591.
- [31] P. C. H. Chan, G. Yan, L. Sheng, R. K. Sharma, Z. Tang, J. K. O. Sin, I.-M. Hsing and Y. Wang, An integrated gas sensor technology using surface micromachining, *Sensors and Actuators B* 82 (2002) 277–283.
- [32] J. Wollenstein, J. A. Plaza, C. Canè, Y. Min, H. Bottner and H. L. Tuller, A novel single chip thin film metal oxide array, *Sensors and Actuators B* 93 (2003) 350–355.
- [33] I. Elmi, S. Zampolli, E. Cozzani, F. Mancarella and G. C. Cardinali, Development of ultra-low-power consumption MOX sensors with ppb-level VOC detection capabilities for emerging applications, *Sensors and Actuators B* in press (2008).
- [34] K. Kanda and T. Maekawa, Development of a WO₃ thick-film-based sensor for the detection of VOC, *Sensors and Actuators B* 108 (2005) 97–101.
- [35] E. J. Wolfrum, R. M. Meglen, D. Peterson and J. Sluiter, Metal oxide sensor arrays for the detection, differentiation, and quantification of volatile organic compounds at sub-parts-per-million concentration levels, *Sensors and Actuators B* 115 (2006) 322–329.
- [36] D.-S. Lee, J.-K. Jung, J.-W. Lim, J. S. Huh and D.-D. Lee, Recognition of volatile organic compounds using SnO₂ sensors array and pattern recognition analysis, *Sensors and Actuators B* 77 (2001) 228–236.
- [37] A. T. Hodgson and H. Levin, Volatile Organic Compounds in Indoor Air: A Review of Concentrations Measured in North America Since 1990, Lawrence Berkeley National Laboratory, 2003, p. 31.

- [38] P. Wolkoff and G. D. Nielsen, Organic compounds in indoor air—their relevance for perceived indoor air quality, *Atmospheric Environment* 35 (2001) 4407–4417.
- [39] T. Itoh, J. Wang, I. Matsubara, W. Shin, N. Izu, M. Nishibori and N. Murayama, VOCs sensing properties of layered organic–inorganic hybrid thin films: MoO₃ with various interlayer organic components, *Materials Letters* 62 (2008) 3021–3023.
- [40] D. Haeringer and J. Goschnick, Characterization of smelling contaminations on textiles using a gradient microarray as an electronic nose, *Sensors and Actuators B* 132 (2008) 644–649.
- [41] R. Gmür, J. Goschnick, T. Hocker, H. Schwarzenbach and M. Sommer, Impact of sensor packaging on analytical performance and power consumption of metal oxide based gas sensor microarrays, *Sensors and Actuators B* 127 (2007) 107–111.
- [42] J. Goschnick, V. Magapu, I. Kiselev and I. Koroncz, New normalization procedure to improve signal pattern discrimination power in case of different concentration dependencies of the gas sensors in an array, *Sensors and Actuators B* 116 (2006) 85–89.
- [43] C. Arnold, D. Haeringer, I. Kiselev and J. Goschnick, Sub-surface probe module equipped with the Karlsruhe Micronose KAMINA using a hierarchical LDA for the recognition of volatile soil pollutants, *Sensors and Actuators B* 116 (2006) 90–94.
- [44] J. Goschnick, I. Koroncz, M. Frietsch and I. Kiselev, Water pollution recognition with the electronic nose KAMINA, *Sensors and Actuators B* 106 (2005) 182–186.
- [45] The Karlsruhe Micronose KAMINA: Novel technology for intelligent systems, *Systems and Services for Chemical Analysis*, Product Manual.
- [46] J. Gardner and P. Bartlett, A Brief History of Electronic Noses, *Sensors and Actuators B* 18 (1994) 211–220.
- [47] T. C. Pearce, Computational parallels between the biological olfactory pathway and its analogue ‘The Electronic Nose’: Part I. Biological olfaction, *BioSystems* 41 (1997) 43–67.
- [48] T. C. Pearce, S. S. Schiffman, H. T. Nagle and J. W. Gardner, *Handbook of Machine Olfaction: Electronic Nose Technology*, Chapter 1, Wiley-VCH, Weinheim, Germany, 2003, p. 592.
- [49] J. Lozano, T. Arroyo, J. P. Santos, J. M. Cabellos and M. C. Horrillo, Electronic nose for wine aging detection, *Sensors and Actuators B* 133 (2008) 180–186.
- [50] M. C. Burl, B. J. Doleman, A. Schaffer and N. S. Lewis, Assessing the ability to predict human percepts of odor quality from the detector responses of a conducting polymer composite-based electronic nose, *Sensors and Actuators B* 72 (2001) 149–159.
- [51] M. Santonico, P. Pittia, G. Pennazza, E. Martinelli, M. Bernabei, R. Paolesse, A. D’Amico, D. Compagnone and C. Di Natale, Study of the aroma of artificially flavoured custards by chemical sensor array fingerprinting, *Sensors and Actuators B* 133 (2008) 345–351.
- [52] A. Loutfi and S. Coradeschi, *Odor Recognition for Intelligent Systems*, 2008, p. 41–48, www.computer.org/intelligent.
- [53] The Cyranose 320 E-nose User Manual, Smiths Detection, User Manual.
- [54] S. Balasubramaniana, S. Panigrahib, B. Kottapallic and C. E. Wolf-Halld, Evaluation of an artificial olfactory system for grain quality discrimination, *LWT* 40 (2007) 1815–1825.

- [55] S. Balasubramanian, S. Panigrahi, C. M. Logue, H. Gub and M. Marchello, Neural networks-integrated metal oxide-based artificial olfactory system for meat spoilage identification, *Journal of Food Engineering* in press (2008).
- [56] J. Brezmes, B. Ferreras, E. Llobet, X. Vilanova and X. Correig, Neural network based electronic nose for the classification of aromatic species, *Analytica Chimica Acta* 348 (1997) 503-509.
- [57] J. Ricart, J. Ponsa, M. Domínguez, A. Rodríguez, E. Figueras, M. C. Horrillo, J. Gutiérrez and I. Sayago, Application of pulsed digital oscillators to volatile organic compounds sensing, *Sensors and Actuators B* 134 (2008) 773–779.
- [58] Rella, J. Spadavecchia, M. G. Manera, S. Capone, A. Taurino, M. Martino, A. P. Caricato and T. Tunno, Acetone and ethanol solid-state gas sensors based on TiO₂ nanoparticles thin film deposited by matrix assisted pulsed laser evaporation, *Sensors and Actuators B* 127 (2007) 426–431.
- [59] T. Itoh, I. M. Woosuck, S. N. Izu and M. Nishibori, Preparation of layered organic inorganic nanohybrid thin films of molybdenum trioxide with polyaniline derivatives for aldehyde gases sensors of several tens ppb level, *Sensors and Actuators B* 128 (2008) 512–520.
- [60] K. Lubert, N. Bari' e and M. Rapp, Sensing layers for mass sensitive sensors prepared from tetraethoxysilane and organic modifiers for the detection of volatile organic compounds, *Sensors and Actuators B* 123 (2007) 218–226.
- [61] T. Itoh, I. Matsubara, W. Shin and N. Izu, Synthesis and characterization of layered organic/inorganic hybrid thin films based on molybdenum trioxide with poly(N-methylaniline) for VOC sensor, *Materials Letters* 61 (2007) 4031–4034.
- [62] M. Matsuguchi, T. Uno, T. Aoki and M. Yoshida, Chemically modified copolymer coatings for mass-sensitive toluene vapor sensors, *Sensors and Actuators B* 131 (2008) 652–659.
- [63] J. J. Vijay, L. J. Kennedy, G. S. M. Bayhanc and M. A. M. A. William, Preparation and VOC gas sensing properties of Sr(II)-added copper aluminate spinel composite, *Sensors and Actuators B* 134 (2008) 604–612.
- [64] M. Ávila, M. Zougagh, A. Escarpa and Á. Ríos, Molecularly imprinted polymers for selective piezoelectric sensing of small molecules, *Trends in Analytical Chemistry* 27 (2008).
- [65] C. Cheng, Y. Chen and C. Lu, Organic vapour sensing using localized surface plasmon resonance spectrum of metallic nanoparticles self assemble monolayer, *Talanta* 73 (2007) 358–365.
- [66] B. Malnic, J. Hirono, T. Sato and L. B. Buck, Combinatorial Receptor Codes for Odors, *Cell* 96 (1999) 713–723.
- [67] C. H. Wetzel, M. Oles, C. Wellerdieck, M. Kuczkowiak, G. Gisselmann and H. J. Hatt, Specificity and sensitivity of a human olfactory receptor functionally expressed in human embryonic kidney 293 cells and *Xenopus laevis* oocytes *Journal of Neuroscience* 19 (1999) 7426–7433.
- [68] G. Levasseur, M. A. Persuy, D. Grebert, J. J. Remy, R. Salesse and E. Pajot-Augy, Ligand-specific dose–response of heterologously expressed olfactory receptors, *European Journal of Biochemistry* 270 (2003) 2905–2912.
- [69] Y. Hou, N. Jaffrezic-Renault, C. Martelet, A. Zhang, J. Minic-Vidic, T. Gorojankina, M. Persuy, E. Pajot-Augy, R. Salesse, V. Akimov, L. Reggiani, C. Pennetta, E. Alfinito, O.

- Ruiz, G. Gomila, J. Samitier and A. Errachid, A novel detection strategy for odorant molecules based on controlled bioengineering of rat olfactory receptor I7, *Biosensors and Bioelectronics* 22 (2007) 1550–1555.
- [70] H. J. Ko and T. H. Park, Piezoelectric olfactory biosensor: ligand specificity and dose-dependence of an olfactory receptor expressed in a heterologous cell system, *Biosensors and Bioelectronics* 20 (2005) 1327–1332.
- [71] H. J. Ko and T. H. Park, Dual signal transduction mediated by a single type of olfactory receptor expressed in a heterologous system, *Biological Chemistry* 387 (2006) 59–68.
- [72] C.-S. Lee, S.-H. Lee, Y.-G. Kim, C.-H. Choi, Y.-K. Kim and B.-G. K. Kim, Biochemical reactions on a microfluidic chip based on a precise fluidic handling method at the nanoliter scale, *Biotechnology and Bioprocess Engineering* 11 (2006) 146–153.
- [73] J. Y. Lee, H. J. Ko, S. H. Lee and T. H. Park, Cell-based measurement of odorant molecules using surface plasmon resonance, *Enzyme and Microbial Technology* 39 (2006) 375–380.
- [74] J. H. Sung, H. J. Ko and T. H. Park, Piezoelectric biosensor using olfactory receptor protein expressed in *Escherichia coli* *Biosensors and Bioelectronics* 21 (2006) 1981–1986.
- [75] H. J. Ko and T. H. Park, Enhancement of odorant detection sensitivity by the expression of odorant-binding protein, *Biosensors and Bioelectronics* 23 (2008) 1017–1023.
- [76] C. C. Burn, What is it like to be a rat? Rat sensory perception and its implications for experimental design and rat welfare, *Applied Animal Behaviour Science* 112 (2008) 1–32.
- [77] R. Rajan, J. P. Clement and Bhalla, Rats smell in stereo, *Science* 311 (2006) 666–670.
- [78] J. Otto, M. F. Brown and W. Long, Training rats to search and alert on contraband odors, *Appl. Anim. Behav. Sci.* 77 (2008) 217–232.
- [79] K. Mitsubayashi, K. Yokoyama, T. Takeuchi and I. Karube, Gas-phase biosensor for ethanol, *Anal. Chem.* 66 (1994) 3297–3302.
- [80] K. Mitsubayashi and Y. Hashimoto, Bioelectronic nose for methyl mercaptan vapor using xenobiotic metabolizing enzyme: flavin-containing monooxygenase, *Sens. Actuators B* 83 (2002) 35–40.
- [81] K. Mitsubayashi and Y. Hashimoto, Bioelectronic sniffer device for trimethylamine vapor using flavin containing monooxygenase, *IEEE Sensors Journal* 2 (2002) 133–139.
- [82] K. Mitsubayashi, G. Nishio, M. Sawai, T. Saito, H. Kudo, H. Saito, K. Otsuka, T. Noguier and J. Marty, A bio-sniffer stick with FALDH (formaldehyde dehydrogenase) for convenient analysis of gaseous formaldehyde, *Sensors and Actuators B* 130 (2008) 32–37.
- [83] X.-L. Cao and C. N. Hewitt, Detection methods for the analysis of biogenic non-methane hydrocarbons in air *Journal of Chromatography A* 710 (1995) 39-50.
- [84] H. Skov, A. Lindskog, F. Palmgren and C. S. Christensen, An overview of commonly used methods for measuring benzene in ambient air, *Atmospheric Environment* 35 (2001) 141-148.
- [85] Model 2100 Multidimensional GC/MS Olfactometry System, Microanalytics, Product Brochure.
- [86] E. O. Afoakwa, A. Paterson, M. Fowler and A. Ryan, Matrix effects on flavour volatiles release in dark chocolates varying in particle size distribution and fat content using GC-mass spectrometry and GC-olfactometry, *Food Chemistry* 113 (2009) 208-215.

- [87] S. Selli, C. Prost and T. Serot, Odour-active and off-odour components in rainbow trout (*Oncorhynchus mykiss*) extracts obtained by microwave assisted distillation-solvent extraction, *Food Chemistry* 114 (2009) 317-322.
- [88] Q. F. Chen, R. K. Milburn and N. S. Karellas, Real time monitoring of hazardous airborne chemicals: A styrene investigation, *Journal of Hazardous Materials* 132 (2006) 261.
- [89] <http://www.asms.org/whatisms/p15.html>
- [90] J. Sunner, M. G. Ikononou and P. Kebarle, Sensitivity enhancements obtained at high temperatures in atmospheric pressure ionization mass spectrometry, *Analytical Chemistry* 60 (1988) 1308-1313.
- [91] C. C. Mulligan, D. R. Justes, R. J. Noll, N. L. Sanders, B. C. Laughlin and R. G. Cooks, Direct monitoring of toxic compounds in air using a portable mass spectrometer, *Analyst* 131 (2006) 556.
- [92] Q.-F. Chen, R. K. Milburn, G. B. DeBrou and N. S. Karellas, Air monitoring of a coal tar cleanup using a mobile TAGA LPCI-MS/MS *Journal of Hazardous Materials* 91 (2002) 271-284.
- [93] S. A. McLuckey, G. L. Glish, K. G. Asano and B. C. Grant, Atmospheric sampling glow discharge ionization source for the determination of trace organic compounds in ambient air, *Analytical Chemistry* 60 (1988) 2220-2227.
- [94] W. Lindinger, A. Hansel and A. Jordan, *International Journal of Mass Spectrometry* 173 (1998) 191.
- [95] W. Lindinger, A. Hansel and A. Jordan, Proton-transfer-reaction mass spectrometry (PTR-MS): on-line monitoring of volatile organic compounds at pptv levels, *Chemical Society Review* 27 (1998) 347 - 375.
- [96] A. J. Taylor, R. S. T. Linforth, B. A. Harvey and A. Blake, Atmospheric pressure chemical ionisation mass spectrometry for in vivo analysis of volatile flavour release, *Food Chemistry* 71 (2000) 327-338.
- [97] K. Badjagbo, S. Moore and S. Sauve, Real-time continuous monitoring methods for airborne VOCs, *Trends in Analytical Chemistry* 26 (2007) 931-940.
- [98] T. Kotiaho, On-site environmental and in situ process analysis by mass spectrometry, *Journal of Mass Spectrometry* 31 (1996) 1-15.
- [99] L. Gao, Q. Song, G. E. Patterson, R. G. Cooks and Z. Ouyang, Handheld Rectilinear Ion Trap Mass Spectrometer, *Analytical Chemistry* 78 (2006) 5994-6002.
- [100] A. M. Tabert, M. P. Goodwin, J. S. Duncan, C. D. Fico and R. G. Cooks, Multiplexed Rectilinear Ion Trap Mass Spectrometer for High-Throughput Analysis, *Analytical Chemistry* 78 (2006) 4830-4838.
- [101] O. Kornienko, P. T. A. Reilly, W. B. Whitten and J. M. Ramsey, Micro ion trap mass spectrometry, *Rapid Communications in Mass Spectrometry* 13 (1999) 50-53.
- [102] J. Moxom, P. T. A. Reilly, W. B. Whitten and J. M. Ramsey, Double resonance ejection in a micro ion trap mass spectrometer, *Rapid Communications in Mass Spectrometry* 16 (2002) 755-760.
- [103] O. Kornienko, P. T. A. Reilly, W. B. Whitten and J. M. Ramsey, Electron impact ionization in a microion trap mass spectrometer, *Review of Scientific Instruments* 70 (1999) 3907-3909.

- [104] R. K. Stevens, R. J. Drago and Y. Mamane, A long path differential optical absorption spectrometer and epa-approved fixed-point methods intercomparison, *Atmospheric Environment* 27 (1993) 231-236.
- [105] U. Platt, D. Perner and H. W. Patz, Simultaneous Measurement of Atmospheric CH₂O, O₃, and NO₂ by Differential Optical Absorption *Journal of Geophysical Research* 84 (1979) 6329-6335.
- [106] P. Avino and M. Manigrasso, Ten-year measurements of gaseous pollutants in urban air by an open-path analyzer, *Atmospheric Environment* 42 (2008) 4138-4148.
- [107] D. Ciaparra, E. Aries, M.-J. Booth, D. R. Anderson, S. M. Almeida and S. Harrad, Characterisation of Volatile Organic Compounds and Polycyclic Aromatic Hydrocarbons in the Ambient Air of Steelworks in the UK, *Atmospheric Environment* In Press (2008).
- [108] R. Volkamer, T. Etzkorn, A. Geyer and U. Platt, Correction of the oxygen interference with UV spectroscopic (DOAS) measurements of monocyclic aromatic hydrocarbons in the atmosphere, *Atmospheric Environment* 32 (1998) 3731-3747.
- [109] C. Lee, Y. J. Choi, J. S. Jung, J. S. Lee, K. H. Kim and Y. J. Kim, *Atmos. Environ.* 39 (2005) 2225.
- [110] D. Brocco, R. Fratarcangeli, L. Lepore, M. Petricca and I. Ventrone, Determination of aromatic hydrocarbons in urban air of Rome, *Atmospheric Environment* 31 (1997) 557-566.
- [111] K. Kourtidis, I. Ziomas, C. Zerefos, A. Gousopoulos, D. Balis and P. Tzoumaka, Benzene and toluene levels measured with a commercial DOAS system in Thessaloniki, Greece *Atmospheric Environment* 34 (2000) 1471-1480.
- [112] B. Trost, J. Stutz and U. Platt, UV-absorption cross sections of a series of monocyclic aromatic compounds, *Atmospheric Environment* 31 (1997) 3999-4008.
- [113] H. Axelsson, A. Eilard, A. Emanuelsson, B. Galle, H. Edner, P. Ragnarson and H. Kloo, Measurement of Aromatic Hydrocarbons with the DOAS Technique *Applied Spectroscopy* 49 (1995) 1254-1260.
- [114] J.-B. Sanchez, F. Berger, M. Fromm and M.-H. Nadal, Use of a chromatographic column to improve the selectivity of the SnO₂ gas sensors: first approach towards a miniaturised device and selective with hydrogen fluoride vapours, *Sensors and Actuators B* 106 (2004) 823-831.
- [115] S. C. Terry, J. H. Jerman and J. B. Angell, A gas chromatographic air analyzer fabricated on a silicon wafer, *IEEE Transactions on Electron Devices* 26 (1979) 1880-1886.
- [116] R. R. Reston and E. S. Kolesar, Silicon-micromachined gas chromatography system used to separate and detect ammonia and nitrogen dioxide. Part I. Design, fabrication, and integration of the gas chromatography system, *J. Microelectromech. Syst.* 3 (1994) 134-146.
- [117] C. M. Matzke, Microfabricated silicon gas chromatographic microchannels: fabrication and performance, in: *SPIE Conference on Micromachining and Microfabrication Process Technology IV*, Santa Clara, California, 1998, pp. 262-268.
- [118] M. R. Haskard, D. E. Mulcahy, D. E. Davey and E. F. Dawes, Microengineered open tubular columns for GC analysis, in: *SPIE Conference on Electronics and Structures for MEMS*, Royal Pines Resort, Queensland, Australia, 1999, pp. 168-177.
- [119] S. Ramsey, M. Sc. Thesis, Michigan State University, East Lansing, MI, 2004.
- [120] Artificial 'Snot' Enhances Electronic Nose, *ScienceDaily*, 2007, April, 30.

