

UNCLASSIFIED

Defense Technical Information Center
Compilation Part Notice

ADP011843

TITLE: Readout Characteristics and Mechanism of Light-Scattering-Mode Super-RENS Disks

DISTRIBUTION: Approved for public release, distribution unlimited

This paper is part of the following report:

TITLE: Optical Storage and Optical Information Held in Taipei, Taiwan on 26-27 July 2000

To order the complete compilation report, use: ADA399082

The component part is provided here to allow users access to individually authored sections of proceedings, annals, symposia, etc. However, the component should be considered within the context of the overall compilation report and not as a stand-alone technical report.

The following component part numbers comprise the compilation report:

ADP011833 thru ADP011864

UNCLASSIFIED

Readout characteristics and mechanism of light-scattering-mode Super-RENS disks

Junji Tominaga, Dorothea Buechel, Takashi Nakano, *Hiroshi Fuji,
Toshio Fukaya and Nobufumi Atoda

Optical Memory Group
National Institute for Advanced Interdisciplinary Research
1-1-4 Higashi, Tsukuba 305-8562, JAPAN
*Advanced Technology Research Laboratories, Sharp Co.
2631-1 Ichinomoto-cho, Tenri 632-8567, JAPAN

ABSTRACT

Readout characteristics of light-scattering-mode super-resolution near-field structure (super-RENS) disks are described in detail. Readout intensities in reflected and transmitted signals are compared. Both signals showed mostly the same carrier-to-noise ratios (CNRs) using objective lenses with NA of 0.6. The formation mechanism of light scattering centers in the super-RENS disks is also described in comparison with several different disks. As increasing oxygen ratio during the deposition of silver oxide (AgOx) layers, two different chemical reactions were identified. It was found that the super-RENS disks with oxygen-rich AgOx films have both characteristics of transparent and light-scattering apertures in one disk. Further study also revealed that the AgOx dynamic nonlinearity is not so high and less than 6% by the film itself; however, it is enhanced to 12% in super-RENS. It is supposed that the imaginary refractive index k of the films is less than 0.1; therefore, it is hard to heat itself to the decomposition temperature without a heat source (GeSbTe film) underneath. This result would be a hint to further increase CNRs in a light-scattering-mode super-RENS disks

Keywords: optical memory, super-RENS, silver oxide, optical nonlinearity

1. INTRODUCTION

A gate of optical data storage with terabyte (TB) capacity has long been closed by the diffraction limit. However, Re-discovery of the importance of optical near-field and the development of scanning probe microscopes (SPMs) may make it realize such systems.^{1,2} Since optical near-field recording (ONFR) was first carried out, a variety of ideas have been proposed and demonstrated theoretically and experimentally.¹⁻⁴ One of the difficulties to overcome is to control a space between a recording head and a medium surface carefully and precisely with few 10's nm at very high speeds. Up to date, specially designed optical fiber heads, planner flying heads with the same design as current hard disk heads, solid immersion lens (SILs) and mirrors (SIMs) have been developed.⁵⁻⁸ One the other hand, our group proposed another idea to fabricate a near-field aperture into an optical disk, in order to avoid a contact or a head crash to the medium surface. We named the disk structure " super-resolution near-field structure (super-RENS)." The principle and characteristics of super-RENS were refereed elsewhere.⁹⁻¹¹ We have developed two different types of super-RENS disks: generating a transparent aperture (TA-super-RENS) with an Sb film and a light scattering center (LSC-super-RENS) with a silver oxide (AgOx) film.^{10,11} The resolution of TA-super-RENS disks is superior to that of LSC-super-RENS disks; however, LSC-super-RENS is more attractive and more promising on the point of view of utilizing surface plasmon that further enhances signal intensity.¹² The mechanism of LSC-super-RENS, unfortunately, has not been well identified. The objectives of this paper are to reveal the reaction mechanism of AgOx films in LSC-super-RENS disks statically and dynamically. Especially, we carefully re-estimate the dynamic optical nonlinearities of the films, applying one-dc laser beams to LSC-super-RENS disks and estimating the output

Further author information -

E-mail: tominaga@nair.go.jp

Telephone:81-298-61-2924, Fax:81-298-61-2939

reflections by a storage oscilloscope. We also describe the reflected and transmitted signal characteristics of LSC-super-RENS disks in detail.

2. EXPERIMENTAL

All AgOx films in this work were produced by r.f. reactive magnetron sputtering with a high purity Ag target and gas mixture of Ar and oxygen. The composition of the films can be controlled by changing the gas ratio, and the refractive index is also changed.¹¹ We used two different substrates: glass plates and polycarbonate disks. In some cases, ZnS-SiO₂ dielectric films were covered on the AgOx films. A Ge₂Sb₂Te₅ target was used as a recording film for LSC-super-RENS disks. The disk structures were referred in other papers.¹¹

Optical transmission of the films was measured by LIMKAM LK-600PM micro-heating stage at a ramp rate of 30°C/min under an optical microscope, which is connected to a multichannel-photodetector (Hamamatsu Photonics, PMA-11) through an optical fiber.

The dynamic optical nonlinearities were estimated by DDU-1000 disk drive tester (Pulstech Indust. Co. Ltd.) with a laser wavelength of 635 nm, and an objective lens numerical aperture of 0.6. Dynamic optical nonlinearities of Sb and AgOx films have already been observed by our group.¹¹ However, the evaluation of the nonlinearities includes quite large errors because the nonlinearities are gradually increasing or decreasing during measurement in many cases. In order to avoid and evaluate more precisely, we applied one dc laser power on a disk during only one rotation. The reflection change was monitored with a storage oscilloscope synchronizing it to a tracking jump signal. The system configuration was depicted in Figs. 1 and 2.

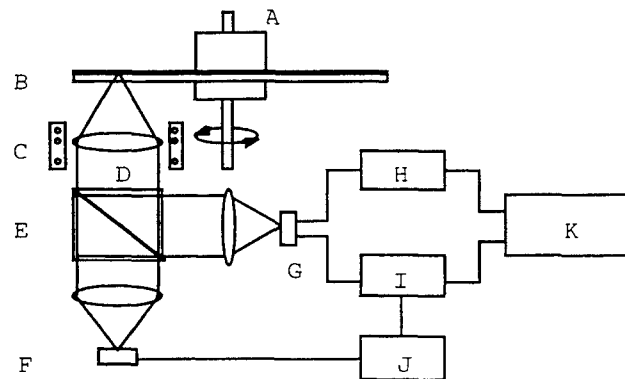

Fig. 1 Schematic diagram of synchronized dynamic disk tester.

A: Spindle motor, B: Test disk, C: voice control optical head, D: focus lens (NA:0.6), E: beam splitter, F: semiconductor laser (635 nm), G: photodetector, H: focusing unit, I: tracking unit, J: frequency & laser power modulator and K: storage oscilloscope.

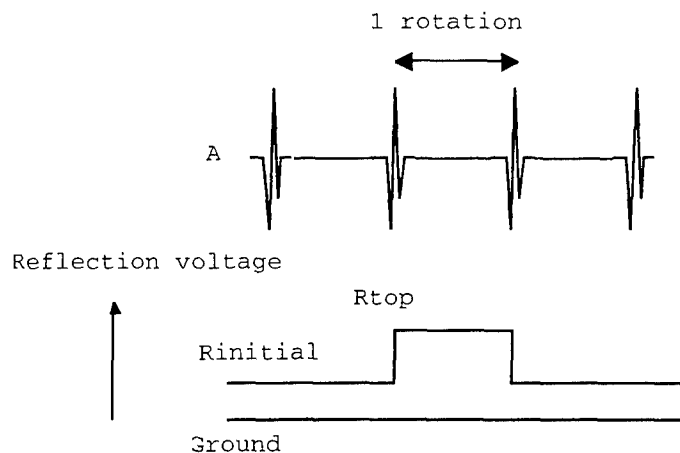

Fig. 2 Evaluation method of dynamic optical nonlinearity.

A: Tracking-jump signals, R_{top} : reflection output by a high readout power during one rotation of the disk, $R_{initial}$: reflection of the initial readout power and G: ground level.

3. RESULTS AND DISCUSSION

3.1. Formation Mechanism and Dynamic Optical Nonlinearity of LSC-super-RENS Disks

It is well known that $AgOx$ is easily decomposed into Ag and oxygen at temperatures of less than $200^{\circ}C$. Fig.3 shows optical transmission changes in three different $AgOx$ films (thickness: 100 nm) deposited on glass plates under different mixture gas ratios. The film produced at a ratio of 0.35 shows that the transmittance gradually decreases as the temperature increases. The curve becomes steeper at temperatures of more than $150^{\circ}C$. The films produced with further high gas ratios: 0.5 and 0.6, on the other hand, show maximums at around the same temperature. Interestingly, the transmittance once increases, until the temperature reaches the maximum. As a reference, the refractive indices depending on the gas mixture ratio are shown in Fig.4. In comparison with two figures, it is noticed that the high-transmitted region exists in the vicinity of the gas ratio of 0.4. The composition of the film was already determined as Ag_2O .¹³ In higher temperature region in both cases, the transmission monotonically decreases. Therefore, it is supposed that as-deposited $AgOx$ films usually do not exist as a single phase, but mixture phases with Ag_2O , AgO and Ag_2O_3 .

The optical change or phase change from the as-deposited state to the stable state or phase was also confirmed under dynamical conditions. Fig.5 shows reflection outputs from the disk drive tester with the disk samples, whose structure is composed of $ZnS-SiO_2(170\text{ nm})/AgOx(15\text{ nm})/ZnS-SiO_2(20\text{ nm})$. At the initial laser power (1.0 mW) to obtain a focus for readout, the reflection was 1.17 V. Applying dc laser powers to the disk, the reflection once drops and then is gradually recovered toward the initial. As increasing the dc power, the recovery speed becomes faster. This first reflection drops correspond to those observed in the static measurements. The initial reflection drop seems to appear even with powers of less than 1.5 mW, and at lower disk rotation speeds of less than 6 m/s. It is, therefore, supposed that the initial transition of $AgOx$ films deposited by r.f. sputtering occurs by both thermal and photochemical mechanisms, and Ag_2O rich composition is produced.

It is interesting to confirm if the two different chemical states are actually identified in usual LSC-super-RENS disks. Fig.6 shows carrier to noise ratio (CNR) of 300-nm-sized marks against the increase of readout power. As increasing the power from 1.0 to 2.0 mW, the CNR once gradually increases. As further increasing the power, however, it suddenly drops to a

minimum (12.0 dB) and then it is rapidly improved at powers of more than 2.6 mW. The results are good in agreement with the static and the dynamic nonlinear characteristics.

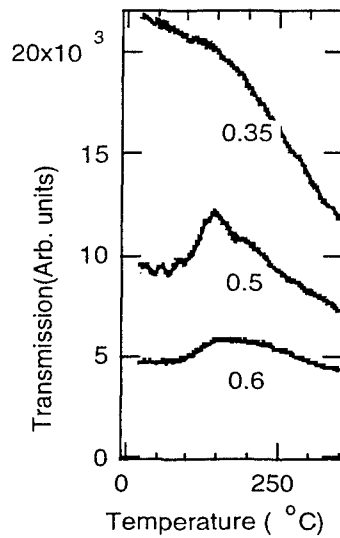

Fig.3 Optical transmission changes of AgOx films by temperature increasing. Each value marked on the lines shows a deposition gas mixture ratio ($O_2/(Ar+O_2)$). The AgOx films with a 100-nm thickness were all deposited on glass plate by r.f. magnetron sputtering.

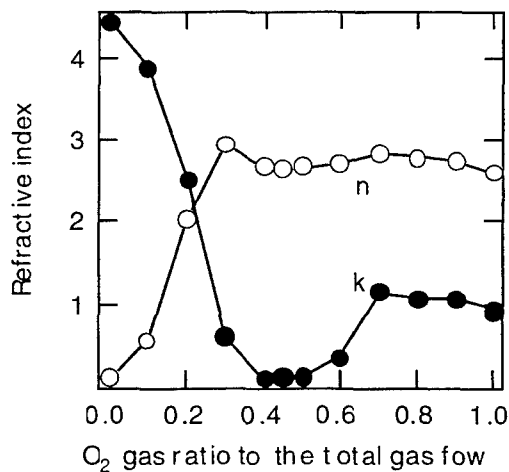

Fig.4 Refractive indices of AgOx sputtered films with different gas mixture ratios. n and k show real and imaginal refractive parts.

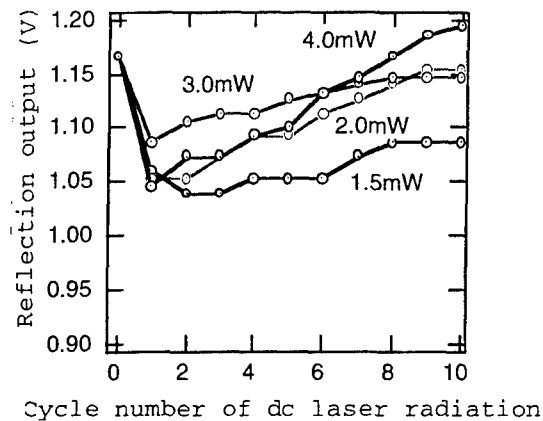

Fig.5 Dynamic reflection change by applying dc laser radiation. The disk structure was composed of polycarbonate disk/ZnS-SiO₂ (170 nm)/AgOx (15 nm)/ZnS-SiO₂ (20 nm). The disk was rotated at a constant linear velocity of 6.0 m/s.

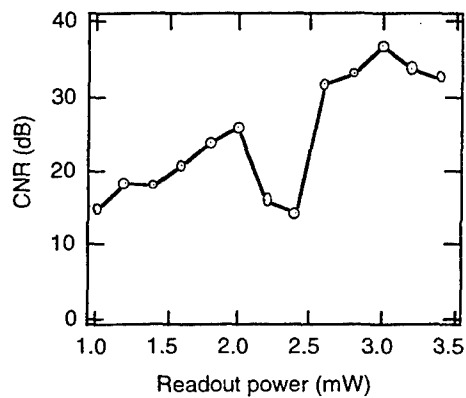

Fig.6 CNR change of 300-nm sized marks of a LSC-super-RENS disk against readout power. The AgOx film was produced at O₂ gas ratio of 0.5.

Optical dynamic nonlinearity is one of the most important properties of super-RENS disks. However, the precise evaluation is a very hard work because the nonlinearity gradually changes for the time being. In order to avoid the time-shift, we synchronized one pulse dc laser radiation with a tracking jump signal during one disk rotation. The reflection output was monitored by a storage oscilloscope. Fig. 7 shows a display of the monitor, when one pulse dc laser is irradiated on a sample

disk. The reflection output was measured against the ground level (G). As shown in Fig.7, the reflection after the laser radiation (C) slightly drops in comparison with that of the initial (A) in case of LSC-super-RENS disks. This is due to the thermally and photochemically produced Ag_2O rich phase, which was above mentioned. As increasing the dc laser power on the same track, One can draw a nonlinear curve at each disk rotation speed (here, we use a constant linear velocity (CLV)).

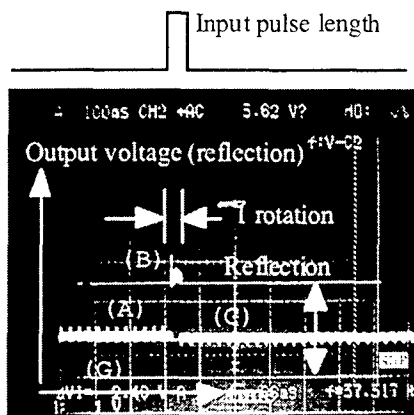

Fig.7 Synchronized one-rotation reflection measurement of dynamic optical nonlinearity.

Fig.8-(a) show the results. As it was already mentioned, the dynamic optical nonlinearity is gradually saturated to a linear relationship by increasing CLV.¹⁴ This is because a special region generating a strong optical nonlinearity gradually shifts to the backward of the laser spot center by the time duration. The nonlinear shifts in this work against reference values obtained at the highest CLV (9.0 m/s) were smaller than those observed previously by our group.¹¹ It is important to estimate nonlinear ratios against the reference observed at the highest speed because the magnitude of the nonlinearities may become big or small in aid of the optical interference in the multilayers. The nonlinear ratios at CLVs of 2.0 and 6.0 m/s was evaluated to the reference at 9.0 m/s. The results are shown in Fig.8-(b). The nonlinearity is only about 6% at a maximum of 2.5 mW. As further increasing the power, the nonlinearity gradually drops. It is interesting to compare the results with the nonlinearities obtained from an actual LSC-super-RENS disk. The results are very intriguing and the nonlinear ratio is improved up to 12%. This is shown in Fig.9. The LSC-super-RENS disk has large nonlinearities at CLV = 6.0 m/s, on the other hand, a maximum appears at 2.0 m/s in the disk without the recording layer. The nonlinearity of the LSC-super-RENS disk at a slow speed (2.0 m/s) once increases: thus reflection increases, then rapidly drops, as increasing the dc power. The irreversible power corresponds to a dc power of 2.5 mW at the speed. As further increasing the power, therefore, AgOx cannot return to the stable phase. As increasing the disk rotation speed (6.0 m/s), on the other hand, such a property is improved up to powers around 3.5 mW. The initial drop that appears in the curve of 6.0 m/s is due to the generation of the stable phase mentioned previously.

In comparison with Figs. 8 and 9, we can reach a conclusion of the mechanism of LSC-super-RENS disks. The large nonlinear characteristics strongly depend on the recording layer deposited on the AgOx layer. As shown in Fig.4, the imaginary part of the refractive index k in normal LSC-super-RENS disks using a AgOx layer, which is deposited at the mixture gas ratio of 0.4 to 0.5, is very small and 0.08. Therefore, the 15-nm thick film does not sufficiently absorb an incident laser beam itself, and it can decompose into Ag and O_2 in aid of a light absorbing layer: that is the recording layer. As a result, it is thought that the mechanism generating a light scattering center in LSC-super-RENS disks is little due to a light-mode, but mostly heat-mode. Additionally, the chemical reaction in LSC-super-RENS disks is more complicate than what we thought previously. However, some important questions have not been revealed yet in this work. The condition of

decomposed oxygen atoms and how the oxygen and Ag return to AgOx again are our further studies. We are now engaging in the research and we will be able to make them clear in the near future.

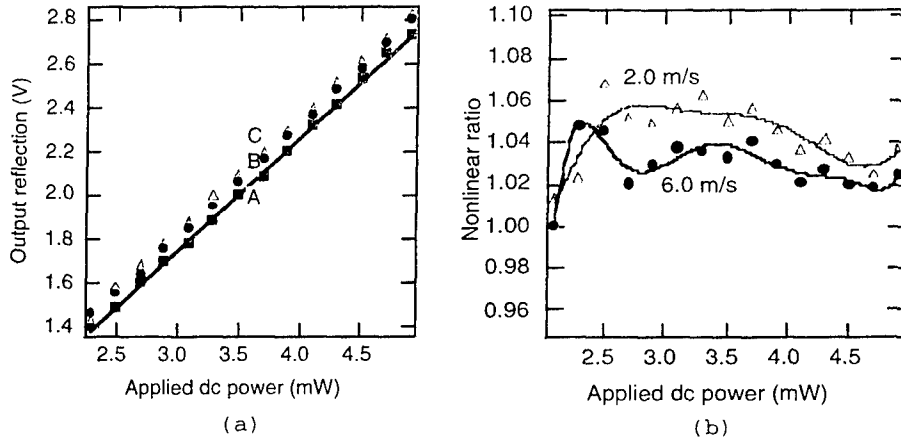

Fig.8 The dynamic optical nonlinearity and the ratios of a AgOx film. (a):the actually observed nonlinearities. A: CLV=9.0 m/s, B: 6.0 m/s and C: 2.0 m/s, and (b): the ratios against the data obtained at CLV = 9.0 m/s. The disk structure is PC.-sub/ZnS-SiO₂(170 nm)/AgOx(15 nm)/ZnS-SiO₂(20 nm)

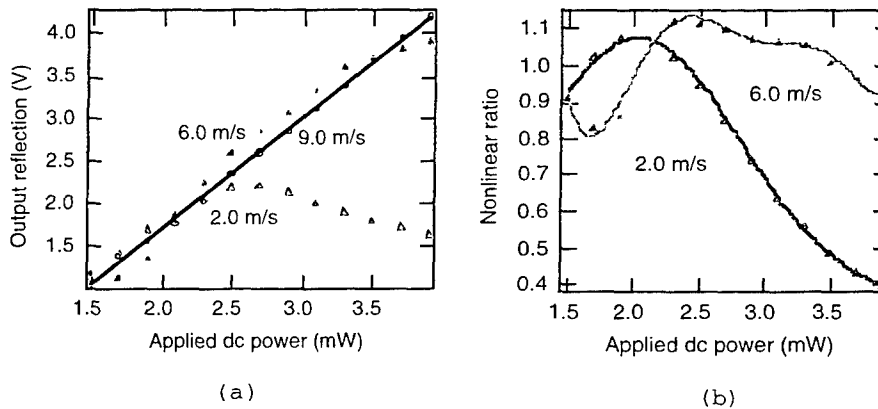

Fig.9 The dynamic optical nonlinearities of a LSC-super-RENS disk. (a): observed nonlinearities, and (b): the ratios against the data obtained at CLV = 9.0 m/s. The disk structure is PC.-sub/ZnS-SiO₂(130 nm)/AgOx(15 nm)/ZnS-SiO₂(40 nm)/Ge₂Sb₂Te₅(20 nm)/ZnS-SiO₂(20 nm).

3.2 Readout Characteristics of LSC-Super-RENS Disks

LSC-super-RENS disks are usually more transparent than TA-super-RENS disks. The transmitted near-field signals of a TA-super-RENS disk were already obtained.¹⁴ It is also important to estimate transmitted signals from LSC-super-RENS disks. A sample disk was produced on a polycarbonate disk with the structure of ZnS-SiO₂(147 nm)/AgOx(15 nm)/ ZnS-SiO₂

(40 nm)/Ge₂Sb₂Te₅ (20 nm)/ ZnS-SiO₂ (20 nm). Fig. 10-(a) shows the readout intensities of both reflected and transmitted signals of 200-nm-sized marks. The recording was carried out on a land at a CLV of 6.0 m/s with the power of 10.0 mW. The system configuration for transmitted signal detection was the same as the previous work.¹⁴ At a readout power of less than 2.0 mW, both signals are little detectable. As further increasing the power, the CNRs gradually increase and are saturated at around 2.4 mW. As shown in Fig. 10, the transmitted intensity is 5 dB higher than the reflected intensity. The tendency did not change in several different disks with different thicknesses. The resolutions are also compared in Fig. 10-(b).

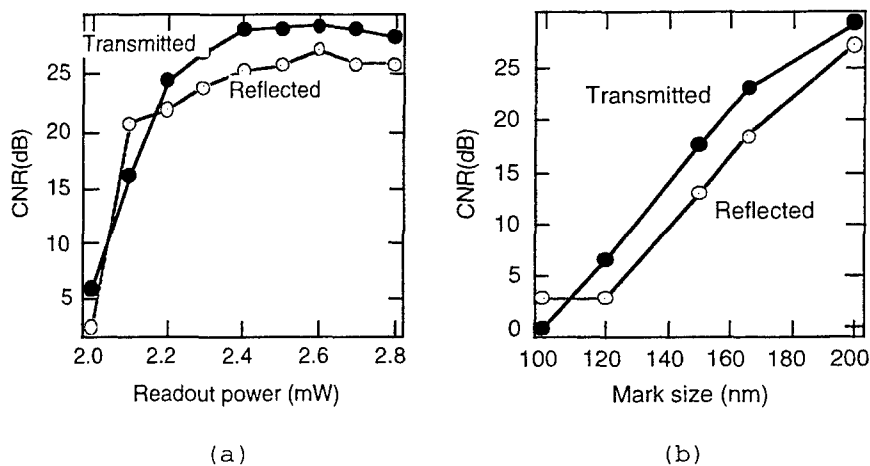

Fig. 10 Comparison of transmitted and reflected signals of 200-nm sized marks of a LSC-super-RENS disk. (a):readout power dependence of CNR, and (b):mark resolution.

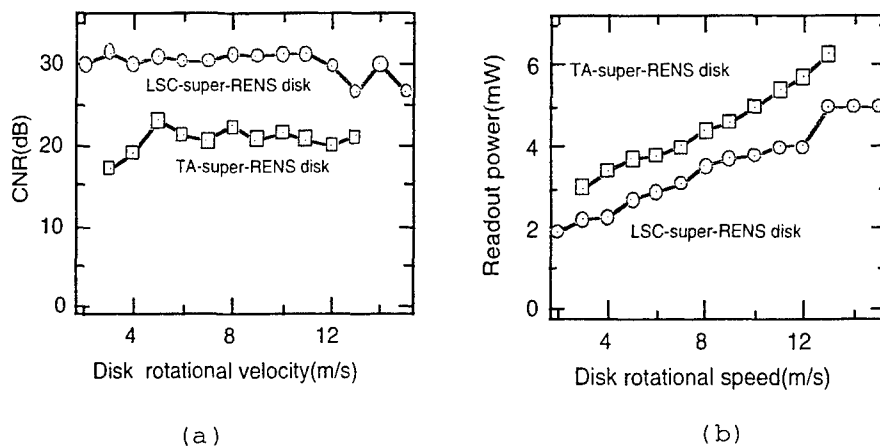

Fig. 11 CNR and optimum readout power dependence of disk rotation speed. (a): CNR, and (b):readout power. Recorded mark size is 200 nm.

As decreasing mark size, the transmitted signal is higher than the reflected one until 120 nm. The limit was mostly the same and around 100 nm.

CNR dependence of disk rotation speed is also important characteristics in future data storage to increase data transfer rate. Fig. 11 shows the CNR change and the optimum readout power against disk rotation speed in comparison with a TA-super-RENS disk with a structure described in the reference.⁹ As shown in Fig.11, CNR of 200-nm marks does not decrease in the LSC-super-RENS disk until CLV of 14.0 m/s, which is the limit of our disk drive tester. Additionally, the optimum readout power is less than 4 mW, even at 12.0 m/s. These characteristics are very important to further increase data transfer rate in future optical storage.

4. CONCLUSIONS

We described the formation mechanism of a light scattering center in LSC-super-RENS disks and some specific characteristics of the disks in detail. It is found that chemical reaction generated in the AgOx films are more complicated than what we have already described. By one-dc laser radiation method synchronized with the tracking jump signal, it was also revealed that the recording layer once absorbs the incident laser beam and produce heat; then it propagates to the AgOx film. The reaction is heat-mode process, rather than light-mode. Additionally, the transmitted signal is stronger than the reflected signal in LSC-super-RENS disks, and the disk can be readable even at a very high speed of more than 10 m/s. This will be very much important in the future optical data storage.

5. REFERENCES

1. E.Betzig, J.K.Trautman, "Near-field optics: Microscopy, spectroscopy, and surface modification beyond the diffraction limit", *Science*, **257**,pp.189-195,1992.
2. S.Hosaka, T.Shintani, M.Miyamoto, A.Hirotsume, M.Terao, M.Yoshida, K.Fujita, S.Kammer," Nanometer-Sized Phase Change Recording Using a Scanning Near-Field Optical Microscope with a Laser Diode", *Jpn. J. Appl. Phys.* **35B**, pp.443-447, 1996.
3. B.D.Terris, H.J.Mamin, D.Roger, W.R.Studenmund and G.S.Kino, "Near-field optical data storage using a solid immersion lens," *Appl. Phys. Lett.*, **65**, pp.388-390, 1994.
4. M. Ohtsu, "High speed near-field optical technology for ultrahigh density storage," *Tech. Digest of the joint MORIS/ISOM Symp.*, pp.180-181, 1997.
5. Y.Yatsui, M.Kouroggi and M.Ohtsu, "Highly efficient excitation of optical near-field on an apertured fiber probe with an asymmetric structure," *Appl. Phys. Lett.*, **71**, pp.1756-1758, 1997.
6. M.Kouroggi, T.Yatsui, S.Ishimura, M.B.Lee, N.Atoda, K.Tsutsui and M.Ohtsu, "A Near-field planar apertured probe array for optical near-field memory," *Proc. SPIE*, vol. 3467, pp.258-267, 1998.
7. K.Kishima, I.Ichimura, K.Yamamoto, K.Osato, Y.Kuroda and K.Saito, "Near-field phase change optical recording over 1.2-numerical-aperture," *Tech. Digest of the joint ISOM/ODS Symp.*, pp.355-357, 1999.
8. C.W.Lee, S.T.Jung, J.E.Seo, Y.G.Kim and D.H.Shin, "Signal characteristics from a catadioptric system for near-field application," *Tech. Digest of the joint ISOM/ODS Symp.*, pp.367-369, 1999.
9. J.Tominaga, T.Nakano and N.Atoda, "Super-resolution structure for optical data storage by near-field optics," *Proc. SPIE*, vol. 3467, pp.282-286, 1998.
10. J.Tominaga, T.Nakano and N.Atoda, "An approach for recording and readout beyond the diffraction limit with an Sb thin film" *Appl. Phys. Lett.*, **73**, pp.2078-2080, 1998
11. J.Tominaga, H.Fuji, T.Nakano, L.Men and N.Atoda, " Reflection-mode super-resolution near-field structure (super-RENS) for super-density data storage," The 2nd. Asia-Pacific Workshop on Near-field Optics, Oct. 20-23, Peking, China, 1999.
12. D.P.Tsai, C.W.Yang, W.C.Lin, F.H.Ho and W.Y.Lin, "Super-resolution surface plasmon near-field optical data storage," The 2nd. Asia-Pacific Workshop on Near-field Optics, Oct. 20-23, Peking, China, 1999.
13. A.A.Schmidt, J.Offermann and R.Anton, "The role of neutral oxygen radicals in the oxidation of AgO films," *Thin Solid Films*, **281-282**, pp.105-107, 1996.
14. J.Tominaga and T.Fukaya, "Thermal nano-phase change of an antimony thin films and the application for optical near-field data storage," *Adv. in Solid State Phys.*, **39**, pp.37-45, 1999.