

DEC 27 1946

copy 1

ARR No. E5A29

NATIONAL ADVISORY COMMITTEE FOR AERONAUTICS

WARTIME REPORT

ORIGINALLY ISSUED

February 1945 as
Advance Restricted Report E5A29

A COOLING CORRELATION OF THE WRIGHT R-2600-8 ENGINE SHOWING

THE EFFECT OF WATER AS AN INTERNAL COOLANT

By Robert J. Koenig and Helmuth W. Engelman

Aircraft Engine Research Laboratory
Cleveland, Ohio

NACA

WASHINGTON

NACA LIBRARY
LANGLEY MEMORIAL AERONAUTICAL
LABORATORY

NACA WARTIME REPORTS are reprints of papers originally issued to provide rapid distribution of advance research results to an authorized group requiring them for the war effort. They were previously held under a security status but are now unclassified. Some of these reports were not technically edited. All have been reproduced without change in order to expedite general distribution.

NACA ARR No. E5A29

NATIONAL ADVISORY COMMITTEE FOR AERONAUTICS

ADVANCE RESTRICTED REPORT

A COOLING CORRELATION OF THE WRIGHT R-2600-8 ENGINE SHOWING
THE EFFECT OF WATER AS AN INTERNAL COOLANT

By Robert J. Koenig and Helmuth W. Engelman

SUMMARY

Object. - To establish a correlation of the cooling characteristics of the Wright R-2600-8 engine with water as an internal coolant and to investigate methods of introducing the water.

Scope. - Tests were conducted at powers ranging from 60 to 137 percent of normal rated power. The fuel-air ratio was varied from 0.053 to 0.116, and water was added to a water-fuel ratio of 1.0 by two methods: (1) by injection into the carburetor spray bar with the fuel and (2) by continuous injection to the individual cylinders through nozzles located in the primer-plug openings. Estimates are made of the temperature-limited power with and without water.

Summary of results. - A cooling correlation, including the effect of water as an internal coolant, was established by use of the NACA cooling-correlation method. A substantial increase in temperature-limited power was obtained by use of water injection; however, at constant charge-air flow and fuel-air ratio, a power loss was noted. This loss did not exceed 4 percent except at fuel-air ratios greater than 0.10 or water-fuel ratios greater than 0.25. When water was injected through nozzles located in individual primer-plug openings, the power loss was less than when injected through the carburetor spray bar with the fuel. The spread of temperatures among the various cylinders increased when water was injected, even when equal amounts of water were injected to each cylinder.

INTRODUCTION

It has been known for some time that the addition of water to the mixture charge of a spark-ignition engine raises the knock-limited power and also has an internal-cooling effect. Considerable work

has been done, particularly in recent years, toward evaluating the effect of internal coolants on knock and cooling. Both effects were investigated in reference 1 in single-cylinder tests of a G200 cylinder from a Wright R-1820 engine. The effect of water as an internal coolant was determined in a Pratt & Whitney R-2800 engine and was presented by use of the NACA cooling-correlation method in reference 2. In both reference 3 and reference 4, the use of water injection in place of enrichment of the fuel-air mixture is discussed as a means of improving fuel economy at high cruising powers.

The object of the tests reported herein was to establish a cooling correlation with and without water injection for the Wright R-2600-5 engine, by means of which cooling requirements could be calculated. The tests were conducted at the NACA Cleveland laboratory during June and July of 1943.

APPARATUS

Some of the pertinent characteristics of the Wright R-2600-8 engine used for the tests are as follows:

Type	14-cylinder, 2-row, air-cooled radial
Bore, inches	6.125
Stroke, inches	6.312
Compression ratio	6.85
Supercharger: low gear ratio	7.06:1
high gear ratio	10.06:1
Impeller diameter, inches	11.00
Grade of fuel required	95-octane

The engine was fitted with standard baffles. A Bendix-Stromberg PT-13E2 injection-type carburetor and a Hamilton Standard constant-speed propeller were used for the tests. The propeller was a three-blade test club having the same general blade profile as a flight propeller but with the tips cut off. Cooling air was drawn across the engine by an exhaust fan. Figures 1 and 2 show the engine installation.

Two separate systems for injecting water were provided: one for feeding the water into the carburetor spray bar and the other for injecting the water in continuous sprays to the individual cylinders through simple nozzles located in the primer-plug openings. The total flow of water injected by either method was measured by a rotameter, and individual flows to each cylinder were measured by orifices. Control was entirely manual. The pressure at the water-supply tank was maintained at approximately 50 pounds per square inch gage.

The charge-air flow was measured with a standard flange-tap orifice installation (reference 5) with interchangeable 6-inch and 11-inch orifice plates. A means of controlling engine charge-air temperature was provided and a separately driven auxiliary blower was available to supply additional supercharging when required.

The pressure drop across the engine was measured by pressure tubes located as shown in figure 3. Shielded total-pressure tubes were located on cylinders 2, 6, 8, and 12 and static-pressure tubes on cylinders 1, 5, 7, and 11. The pressure drop across the heads was taken as the difference A - B (fig. 3) and the pressure drop across the middle barrel as C - D (fig. 3). Figure 4 is a sketch of the type of spark-plug-gasket thermocouple assembly used for the tests. Thermocouples were also spot-welded to the middle of the barrel and to the base flange at the rear of each cylinder.

The usual instruments and controls were used for the engine. In addition, several refinements were incorporated. An air bleed added to the carburetor metering system permitted a vernier adjustment of fuel flow and allowed the setting of fuel-air ratios lower than the normal automatic-lean setting. A barometric-type mercury manometer and a flight instrument indicated manifold pressure. Engine speed was measured by an electric counter and a tachometer. The torque was measured by a Wright torque indicator in which oil pressure on a piston is balanced against the reaction on the stationary element of the nose reduction gear train.

ANALYSIS

The NACA cooling-correlation method is used to present the cooling characteristics of the Wright R-2600 engine as determined by these tests. The development of this method is given in references 6, 7, and 8.

The correlation equation is of the form

$$\frac{T - T_a}{T_g - T} = C \frac{M_e^m}{(\sigma \Delta p)^x} = C \left(\frac{M_e^{m/x}}{\sigma \Delta p} \right)^x \quad (1)$$

where

T reference cylinder temperature, °F

T_h is used for average indication of 14 rear spark-plug-gasket thermocouples and T_b is used for average indication of 14 rear middle-barrel thermocouples.

- T_a stagnation temperature of cooling air in front of engine, °F
- T_g mean effective gas temperature, °F
- C constant
- W_e weight flow of engine charge air, pounds per second
- σ ratio of density of cooling air in front of engine to density of standard sea-level air
- Δp cooling-air pressure drop, inches of water
 Pressure difference between mean total pressure at face of engine and mean static pressure at rear of rear-row cylinders (fig. 3). Pressure drop across cylinder heads is equal to A - B; pressure drop across cylinder barrels is equal to C - D.

The mean effective gas temperature T_g represents the average gas temperature effective in the transfer of heat from the gases within the cylinder chamber to the cylinder walls. For engines operating with a fixed spark advance, the quantity T_g is principally dependent on the fuel-air ratio and the temperature of the charge entering the cylinder.

The method of handling the T_g quantity, which has been successfully used in the correlation of numerous data obtained for a large number of air-cooled engines, is as follows:

$$T_g = T_{g80} + \Delta T_g$$

where T_{g80} is the mean effective gas temperature for 80° F charge-air temperature without supercharger.

(a) A reference T_{g80} value of 1150° F for the cylinder heads and of 600° F for the cylinder barrels is chosen for a fuel-air ratio of 0.08 and a manifold temperature T_m of 80° F from previous correlation work. Small differences in the choice of this reference T_{g80} value do not seriously affect the accuracy of the correlation. Instead, it is much more important once the standard value has been adopted that an accurate establishment of the T_g variation with the pertinent variables be determined.

(b) The variation in T_{g80} for the heads and the barrels with fuel-air ratio must either be determined in individual cooling tests or must be known from previous tests on the same engine.

(c) The variation in T_g with T_m , which was determined for a Wright 1820-G engine and which has since been used with good results on many current air-cooled engines, is given simply by the relation

$$\Delta T_g = 0.8 \Delta T_m = 0.8(T_m - 80) \quad (2)$$

for the cylinder heads and for the cylinder barrels in low blower gear ratio, and by the relation

$$\Delta T_g = 0.5 \Delta T_m = 0.5(T_m - 80) \quad (3)$$

for the cylinder barrels in high blower gear ratio.

The manifold temperature T_m is calculated from the carburetor inlet-air temperature T_c and the theoretical blower temperature rise, assuming no fuel vaporization. This relation is given as follows:

$$T_m = T_c + \frac{U^2}{c_p J g}$$

where

U blower tip speed, feet per second

c_p specific heat of air at constant pressure, 0.24, Btu per pound per $^{\circ}F$

J mechanical equivalent of heat, 778, foot pounds per Btu

g acceleration due to gravity, 32.2, feet per second per second

that reduces to

$$T_m = T_c + 19 \left(\frac{N}{1000} \right)^2 \quad (4)$$

for low blower gear ratio (where N is engine speed in rpm) and

$$T_m = T_c + 38.2 \left(\frac{N}{1000} \right)^2 \quad (5)$$

for high blower gear ratio.

TEST PROCEDURE

In order to establish the cooling correlation, three types of run were made:

1. External cooling was varied, with fuel-air ratio, engine speed, carburetor-air temperature (the factors affecting T_g) and charge-air flow held constant, to determine the response of engine temperatures to the external flow of cooling fluid.

2. Charge-air flow was varied, with fuel-air ratio, engine speed, carburetor-air temperature, and cooling-air flow held constant, to determine the response of engine temperatures to the internal flow of heating fluid.

3. Fuel-air ratio was varied, with charge-air flow, cooling-air flow, engine speed, and carburetor-air temperature held constant, to determine the effect of fuel-air ratio on mean effective gas temperature and on engine temperatures.

In addition to the correlation on the basis of head temperatures, a correlation made on the basis of rear middle-barrel temperatures is included. It is believed that the rear middle-barrel temperature is a criterion of piston, piston ring, and cylinder-wall temperatures. The relation between average middle-barrel temperatures and average base temperatures was inconsistent, but a practically constant difference of 20° F existed between the hottest base temperature and the hottest middle-barrel temperature. This relation makes it possible to use the base-temperature specifications of the engine manufacturer in the correlation.

The cooling-correlation tests were only a part of the water-injection test program but, after the correlation runs, all additional tests with or without water injection could be correlated.

In most of the water-injection runs fuel flow, charge-air flow, cooling-air pressure drop, and engine speed were held constant with water flow as the primary variable and power and cylinder temperatures as the dependent variables. Values of T_g for various water-fuel ratios were calculated from the cylinder temperatures. Water-fuel ratio was increased to the point where a cylinder began to drown out (as noted from the exhaust flames) for all carburetor-injection runs and in most cases for equal individual cylinder-injection runs.

Other tests were made to determine power limits at constant fuel-air ratio and cooling-air flow. The power was increased as the water was added to maintain the engine at its temperature limits.

RESULTS AND DISCUSSION

Cooling Correlation

Figure 5 is a construction curve used to determine the relation between cylinder-head temperature and the external flow of cooling air; the slope establishes the value of the exponent x in the equation

$$\frac{T - T_a}{T_g - T} = C \frac{M_e^m}{\sigma \Delta p^x} \quad (6)$$

where M_e and T_g are constant.

The construction curve used to determine the relation between cylinder-head temperatures and charge-air flow is shown in figure 6; the slope establishes the value of the exponent m in equation (6) with $\sigma \Delta p$ and T_g held constant.

Figures 7 and 8 are similar construction curves for the correlation of cylinder-barrel temperatures with cooling-air flow and charge-air flow. The equation

$$\frac{T - T_a}{T_g - T} = C \left(\frac{M_e^{m/x}}{\sigma \Delta p} \right)^x \quad (7)$$

has been plotted in figure 9 for both cylinder-head and rear middle-barrel temperatures. The numerical evaluation of the equation for the cylinder heads (fig. 9(a)) is

$$\frac{T_h - T_a}{T_g - T_h} = 0.52 \left(\frac{M_e^{1.73}}{\sigma \Delta p} \right)^{0.3133} \quad (8)$$

and for the barrels (fig. 9(b)) is

$$\frac{T_b - T_a}{T_g - T_b} = 0.74 \left(\frac{M_e^{2.35}}{\sigma \Delta p} \right)^{0.2500} \quad (9)$$

Figure 10 shows the variation of mean effective gas temperature with fuel-air ratio. The effect of water upon mean effective gas temperature is given for the heads and the barrels in figures 11(a) and 11(b), respectively, over the range of fuel-air ratios tested.

The figures were obtained by cross-plotting from figure 12. The actual test points are shown in figure 12 by a plot of mean effective gas temperature against water-fuel ratio for constant fuel-air ratios. Figure 11(a) shows that the change in T_g for the cylinder heads is a linear function of the quantity of water injected for water-fuel ratios less than 0.6. Additional amounts of water cause progressively less change of T_g . Figure 11(b) shows that for the cylinder barrels, as the water-fuel ratio is increased, each additional equal amount of water causes a progressively greater change of T_g . The calculated curves of figure 11(a) were obtained by the method presented in appendix A.

In figure 13, indicated specific air consumption has been plotted against fuel-air ratio. The curves for the various water-fuel ratios were cross-plotted from figure 14. The indicated horsepower was computed from the brake horsepower by a method fully described in a later part of the report. Figure 14 shows that the loss of power at the high water-fuel ratios is much less with individual cylinder injection than with carburetor injection. The drop in power is also less at lean mixtures than at rich, as indicated by the slope of the curves. The high-power runs are labeled on figure 13 to show that the relation M_e/ihp is a function of fuel-air ratio and water-fuel ratio and independent of power.

The temperature pattern (rear spark-plug-gasket thermocouples) of the cylinders for a wide range of fuel-air ratios, engine speeds, and powers without water injection is shown in figure 15. The temperature spread does not appreciably increase at high powers and rich mixtures.

Figure 16(a) shows the variation of the hottest rear spark-plug-gasket temperature and the hottest rear middle-barrel temperature with the average temperature for the heads and the barrels. This curve must be used when calculating a cooling condition without water injection because the correlation is based upon average temperatures. Figures 16(b) and 16(c) give the relation of the hottest to the average temperature for heads and barrels for the two methods of water injection used. The difference between the hottest and the average temperature is greater with water injection than without.

Cooling-Performance Predictions

The curves presented in this report give a cooling correlation for the Wright R-2600-8 engine including the effect of water injection as an internal coolant. From the correlation it is possible to calculate the cooling performance of the engine at any power, with or without water, or to calculate the temperature-limited power at various conditions.

Operating conditions as specified by the Wright Aeronautical Corporation for the R-2600-8 engine are:

Power condition	Brake horsepower	Limiting cylinder-head temperature (°F)	Limiting cylinder-base temperature (°F)	Carburetor-mixture setting
Take-off	1700	475	325	Automatic rich
Normal-rated	1500	425	300	Do.
75-percent cruise	1125	400	275	Do.

The pressure drop required to cool to limiting head temperatures is given in table 1 for four power conditions: take-off power, maximum engine temperature-limited power with water injection, and 75 percent cruise power with and without water injection. The fuel-air ratios given in table 1 for take-off power and for the cruise condition without water injection were obtained by operating the engine at the specified conditions. The cooling-air pressure drop required for take-off power without water injection was used in the calculation involving water injection. These calculations are for the engine without any alterations.

Supercharger capacity is the principal limitation on the maximum power available and, for this reason, the charge-air flow corresponding to wide-open throttle was used. The limiting value of T_g was then calculated and the combination of fuel-air ratio and water-fuel ratio was selected to give the lowest possible indicated specific air consumption at that value of T_g . The calculation is given in appendix B. The cruising-power condition at a fuel-air ratio of 0.06 and a water-fuel ratio of 0.3 was calculated on the basis of extrapolated values of the data of figure 11. A saving of 25 percent in fuel consumption is indicated without an increase in total liquid consumption. The cruise condition is further discussed in reference 3.

The capacity of the supercharger provided on the Wright R-2600-8 engine is given in figure 17 in terms of charge-air flow and manifold pressure at NACA standard altitude conditions. These curves were plotted from data on the calibration of the Wright R-2600-8 engine obtained by Sanwald and Strong at the Aircraft Engine Laboratory of the Naval Air Materiel Center, Naval Air Experimental Station (Philadelphia, Pa.). The curve for sea level was obtained by extrapolation.

In order to use the correlation, it is necessary to know the charge-air flow M_e for various operating conditions. Because charge-air flow is not usually specified, a simple method involving the relation of charge-air flow and indicated horsepower can be used to obtain a close approximation of charge-air flow for use in conjunction with the following equation:

$$\text{ihp} = \text{bhp} + \left[A + B \left(\frac{M_e}{1000} \right) \right] \left(\frac{N}{1000} \right)^2 - C (p_{sl} - p_{alt}) \left(\frac{N}{1000} \right) \quad (10)$$

where

ihp indicated horsepower

bhp brake horsepower

A constant proportional to engine friction

B constant proportional to blower power

p_{sl} barometric pressure at sea level, inches of mercury absolute

p_{alt} barometric pressure at altitude, inches of mercury absolute

The coefficient of friction power A in equation (10) has been calculated for the Wright R-2600-3 engine on the basis that the engine friction, without charge air and blower, absorbs 144 horsepower at 2400 rpm. It is assumed that all the friction is laminar fluid friction within the oil film between moving parts and that the friction power therefore varies as the square of the engine speed:

$$A = \frac{144}{(2.4)^2} = 25 \quad (11)$$

The coefficient of blower power B was calculated by equating blower power and the rate of energy input to the charge air. The gear-drive efficiency was taken as 85 percent.

$$\begin{aligned} \text{Blower hp} &= \frac{1}{(0.85)(550)} \left[N \frac{\pi(\text{impeller diam.})(\text{blower gear ratio})}{60} \right]^2 \frac{M_e}{3600g} \\ &= B M_e \left(\frac{N}{1000} \right)^2 \end{aligned} \quad (12)$$

with B equal to 2.12 for low blower gear ratio and 4.31 for high blower gear ratio.

The constant C is used in connection with the variation of power due to changes in exhaust back pressure with altitude

$$\text{hp} = \frac{(70.7)(\text{engine displacement})}{(1728)(33)} (p_{s1} - p_{alt}) N \quad (13)$$

$$C = 1.61$$

where

70.7 constant converting inches of mercury to pounds per square foot

The constants in equation (10) are not intended to be used individually for the calculation of friction and blower power or the power gained from decreased exhaust back pressure. The variation of M_e/ihp with fuel-air ratio is shown in figure 13. The curves of figure 13 were calculated from measured values of charge air and values of indicated horsepower computed by use of equation (10). In the calculation of cooling and power performance from other cooling and power data, errors in the constants of the indicated-horsepower equation tend to be nullified although the computed value of indicated horsepower may not be exact.

Useful values of indicated specific air consumption may also be calculated on the basis of equation (10). The values used in the present report apply only to the Wright R-2600-8 engine.

Charge-air flow may be estimated in four steps by means of equation (10):

1. Indicated horsepower is computed from the known brake horsepower at an assumed mechanical efficiency of 85 percent.

2. A value of M_e is calculated from the estimated indicated horsepower and the value of M_e/ihp at the known fuel-air ratio.

3. From the estimated value of M_e , indicated horsepower is calculated from equation (10).

4. From this more exact estimate of indicated horsepower, the charge-air flow is computed. If the discrepancy between the first and the recomputed values of charge-air flow is large, steps 3 and 4 are repeated. Usually, recalculation is not necessary.

This method of estimating engine charge-air flow can be used with reasonable accuracy for conditions of 2000 rpm or above,

1000 brake horsepower or above, and altitudes to 15,000 feet. The values of charge-air flow for powers ranging from 1000 to 1500 brake horsepower and altitudes to 11,000 feet in low blower are from 0 to 2 percent lower than those obtained in altitude-chamber tests made at the Naval Air Materiel Center, Naval Air Experimental Station. For air flows above rated power and for high-blower operation, the charge-air flows as calculated are from 1 to 3 percent lower than those obtained in the altitude-chamber tests; however, there was some inconsistency in the data for the altitude-chamber tests at high powers. For low powers and high altitudes this method will not give reliable estimates.

In order to solve for the pressure drop required to cool an engine at a specified operating condition, the following steps are taken:

1. A value of T_g is obtained from equations (2) to (5) and figure 10.

2. From the specified T_h and T_g , $(T_h - T_a)/(T_g - T_h)$ is calculated.

3. From figure 9, a value of $M_e^{m/x}/\sigma\Delta p$ is determined.

4. The value of M_e is calculated by use of equation (10) and $\sigma\Delta p$ is obtained from the value of $M_e^{m/x}/\sigma\Delta p$.

5. The Δp required can then be found by correcting for the density.

Figure 18 presents temperature-limited powers calculated by use of the cooling correlation as functions of fuel-air ratio for a series of water-fuel ratios. These estimates are to be considered only as an indication of the cooling possibilities with water injection. In the calculations, the temperature limits given in the manufacturer's operating recommendations were assumed to be an indication of satisfactory cooling. It is recognized that at power outputs in excess of the manufacturer's ratings these temperature limits may not be satisfactory.

Engine Condition

During the test program the engine was operated at 1600 brake horsepower or above for considerable lengths of time. The conditions for these test runs are given in table 2. No effects of overheating were apparent when the engine was dismantled. The valves and the valve guides were found to be in good condition, as

were the pistons, the piston rings, and the cylinder bores. During the course of the tests no knock was apparent from observation of the exhaust flames.

SUMMARY OF RESULTS

From an investigation to establish a correlation of the cooling characteristics of the Wright R-2600-8 engine with water as an internal coolant, the following results were obtained:

1. A cooling correlation, including the effect of water as an internal coolant, was established by use of the NACA cooling-correlation method.

2. A substantial increase in temperature-limited power was obtained by use of water injection; however, at constant charge-air flow and fuel-air ratio, a power loss was noted. This loss did not exceed 4 percent except at fuel-air ratios greater than 0.10 or water-fuel ratios greater than 0.25.

3. When water was injected through nozzles located in individual primer-plug openings, the power loss was less than when injected through the carburetor spray bar with the fuel.

4. The spread of temperatures among the various cylinders increased when water was injected, even when equal amounts of water were injected to each cylinder.

Aircraft Engine Research Laboratory,
National Advisory Committee for Aeronautics,
Cleveland, Ohio.

APPENDIX A

CALCULATION OF THE COOLING EFFECT OF WATER

Several simplifying assumptions made possible a conservative calculation of the cooling effect of water. Dissociation phenomena and interference in the combustion process are neglected. The calculation is made on the basis of internal energy. The cooling effect of the water is accounted for as a lowering of the mean effective gas temperature.

The loss of internal energy of the dry charge as it is cooled by the water is equated to the gain in internal energy of the water, in which the internal energy of evaporation is included.

The thermal capacity of the dry charge is taken as that of the products of combustion, assuming octane as fuel. Values of specific heat at constant volume c_v were computed from values of the gas constant R and the ratio of specific heats γ given in reference 9, from the relation

$$c_v = \frac{R}{\gamma - 1}$$

The values for specific heat of superheated steam were derived by the relation

$$c_v = \frac{c_p}{\gamma}$$

from values of specific heat at constant pressure c_p and γ given in reference 10.

The calculation was made in two steps: the cooling of the dry charge due to the vaporization of the water was first computed, and the equilibrium temperature was then calculated on the basis of the specific heats.

The following table gives values of the constant K for the expression

$$T_g - T_{g_w} = K \frac{W}{F}$$

where

T_g mean effective gas temperature without water injection

T_{g_w} mean effective gas temperature with water injection

$\frac{W}{F}$ water-fuel weight ratio

Fuel-air ratio	0.06	0.066	0.07	0.08	0.09	0.10	0.11
K	331	368	386	419	445	463	482

The values were used in plotting the calculated curves of figure 11.

APPENDIX B

CALCULATION OF PERMISSIBLE TAKE-OFF POWER FROM COOLING
AND SUPERCHARGER-CAPACITY CONSIDERATIONS

This sample calculation of permissible take-off power is presented to illustrate the use of equations found in the present report. The maximum temperature-limited power of the Wright R-260C-8 engine is calculated here on the basis of certain assumed conditions. These conditions are:

Supercharger gear ratio	low
Rear spark-plug-gasket temperature limit, °F	475
Carburetor-air temperature, °F	90
Cooling-air temperature, °F	90

The cooling-air pressure drop is the same as that required for normal take-off.

(a) Cooling required for normal take-off:

$$\text{Fuel-air ratio} = 0.105$$

$$\text{ihp} = \text{bhp} + A \left(\frac{N}{1000} \right)^2 + B \frac{M_e}{1000} \left(\frac{N}{1000} \right)^2 \quad (\text{equation (10)})$$

where

$$\begin{aligned} \text{bhp} &= 1700 \\ M &= 2600 \text{ rpm} \\ A &= 25 \\ B &= 2.12 \end{aligned}$$

$$M_e = 12,107 \text{ lb/hr}$$

$$\text{ihp} = 2040$$

T_{g80} at 0.105 fuel-air ratio = 931° F from figure 10.

$$\begin{aligned} \Delta T_g &= 0.8 \left[(T_c - 80) + 19 \left(\frac{N}{1000} \right)^2 \right] \\ &= 0.8 \left[(90 - 80) + 19 (2.6)^2 \right] \\ &= 110^\circ \text{ F} \end{aligned}$$

$$T_g = 931 + 110 = 1041$$

From figure 16(a) for limit of 475° F,

$$T_h = 450^\circ \text{ F}$$

Then

$$\begin{aligned} \frac{T_h - T_a}{T_g - T_h} &= \frac{450 - 90}{1041 - 450} \\ &= 0.609 \end{aligned}$$

From figure 9(a),

$$\begin{aligned} \frac{M_e^{1.73}}{\sigma \Delta p} &= 1.65 \\ M_e &= 3.365 \text{ lb/sec} \\ M_e^{1.73} &= 8.18 \end{aligned}$$

Then

$$\sigma \Delta p = 5 \text{ in. water}$$

(b) For maximum power (assume wide-open throttle):

Air flow at 2600 rpm from figure 17, corrected to an inlet-air temperature at 90° F,

$$\begin{aligned} M_e &= 13,000 \text{ lb/hr} \\ &= 3.61 \text{ lb/sec} \end{aligned}$$

$$M_e^{1.73} = 9.2$$

$$\frac{M_e^{1.73}}{\sigma \Delta p} = 1.84$$

Then

$$\frac{T_h - T_a}{T_g - T_h} = 0.63$$

From figure 16(c),

$$T_h = 425^\circ \text{ F}$$

$$\frac{425 - 90}{0.63} = T_g - 425 = 532$$

$$T_g = 957^\circ \text{ F}$$

$$\Delta T_g = 110^\circ \text{ F}$$

$$T_{g80} = 847^\circ \text{ F}$$

The combinations of water-fuel ratio and fuel-air ratio for T_{g80} of 847° F are:

Water-fuel ratio	0	0.2	0.4	0.6
Fuel-air ratio	0.115	0.102	0.091	0.0825

From figure 13, the minimum specific air consumption occurs at a water-fuel ratio of 0.4 and a fuel-air ratio of 0.091 and its value is 5.82 lb/ihp-hr.

$$\text{ihp} = \frac{13,000}{5.82}$$

$$= 2235$$

From equation (10),

$$2235 = \text{bhp} + 25 \left(\frac{N}{1000} \right)^2 + 2.12 \left(\frac{M_e}{1000} \right) \left(\frac{N}{1000} \right)^2$$

$$\text{bhp} = 2235 - 25 (2.6)^2 + 2.12 (13) (2.6)^2$$

$$\text{bhp} = 1890$$

REFERENCES

1. Rothrock, Addison M., Krsek, Alois, Jr., and Jones, Anthony W.: Summary Report on the Induction of Water to the Inlet Air as a Means of Internal Cooling in Aircraft Engine Cylinders. NACA ARR, Aug. 1942.
2. Koenig, Robert J., and Hieser, Gerald: The Effect of Water Injection on the Cooling Characteristics of a Pratt & Whitney R-2800 Engine. NACA ARR No. 3K09, 1943.
3. Engelman, Helmut W., and White, H. Jack: Use of Water Injection to Decrease Gasoline Consumption in an Aircraft Engine Cruising at High Power. NACA RB No. E4H12, 1944.
4. Bell, Arthur H.: Continuous Use of Internal Cooling to Suppress Knock in Aircraft Engines Cruising at High Power. NACA ARR No. E4H15, 1944.
5. Anon.: Fluid Meters - Their Theory and Application. Pt. 1, 4th ed., A.S.M.E., 1937.
6. Pinkel, Benjamin: Heat-Transfer Processes in Air-Cooled Engine Cylinders. NACA Rep. No. 612, 1938.
7. Schey, Oscar W., Pinkel, Benjamin, and Ellerbrock, Herman H., Jr.: Correction of Temperatures of Air-Cooled Engine Cylinders for Variation in Engine and Cooling Conditions. NACA Rep. No. 645, 1938.
8. Pinkel, Benjamin, and Ellerbrock, Herman H., Jr.: Correlation of Cooling Data from an Air-Cooled Cylinder and Several Multi-cylinder Engines. NACA Rep. No. 683, 1940.
9. Pinkel, Benjamin, and Turner, L. Richard: Thermodynamic Data for the Computation of the Performance of Exhaust-Gas Turbines. NACA ARR No. 4B25, 1944.
10. Keenan, Joseph H., and Keyes, Frederick G.: Thermodynamic Properties of Steam. John Wiley & Sons, Inc., 1936.

TABLE 1. -- COOLING-PERFORMANCE PREDICTIONS (NO KNOCK)

Power condition	Brake horsepower	Engine speed (rpm)	Rear spark-plug-gasket temperature limit (°F)	Fuel-air ratio	Water-fuel ratio	Required Δp (in. water)	Fuel flow (lb/hr)	Water flow (lb/hr)
Take-off	1700	2600	475	0.105	0	5	1270	0
Maximum	1890	2600	475	.091	.4	5	1230	492
75 percent cruise	1125	2100	400	.090	0	9.4	670	0
75 percent cruise ^a	1125	2100	400	.060	.3	9.4	495	150

^aCalculated by extrapolating test curves.

TABLE 2. -- ENGINE CONDITIONS FOR TEST RUNS
OF 1600 BRAKE HORSEPOWER OR ABOVE

Flower gear ratio	Brake horsepower	Engine speed (rpm)	Manifold pressure (in. Hg absolute)	Brake mean effective pressure	Fuel-air ratio	M_e (lb/hr)	Water-fuel ratio
Low	1839	2400	^a 48.9	233	0.092	12,395	0.35
High	1669	2400	54.9	212	.093	13,067	.53
Low	1929	2400	^a 50.8	245	.090	13,474	.43
Low	1744	2400	^a 47.2	221	.090	11,807	.33
Low	1943	2400	^a 51.8	245	.100	13,053	.35
Low	1670	2600	44.15	196	.100	11,844	0
Low	1607	2600	43.7	189.5	.100	11,886	.29
Low	2060	2600	^a 53.4	242	.101	14,242	.285

^aAuxiliary boost used.

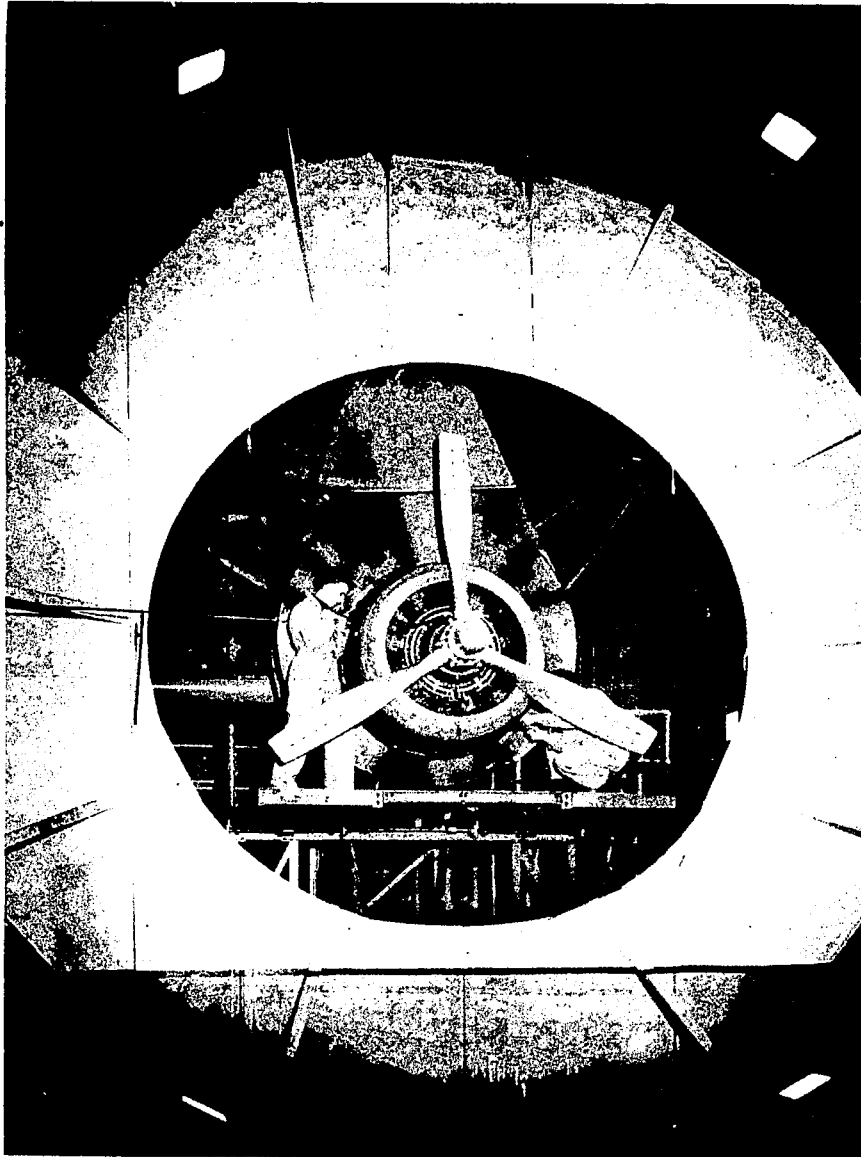

NACA
C-1379

Figure 1. - Front view of Wright R-2600-8 engine installation.

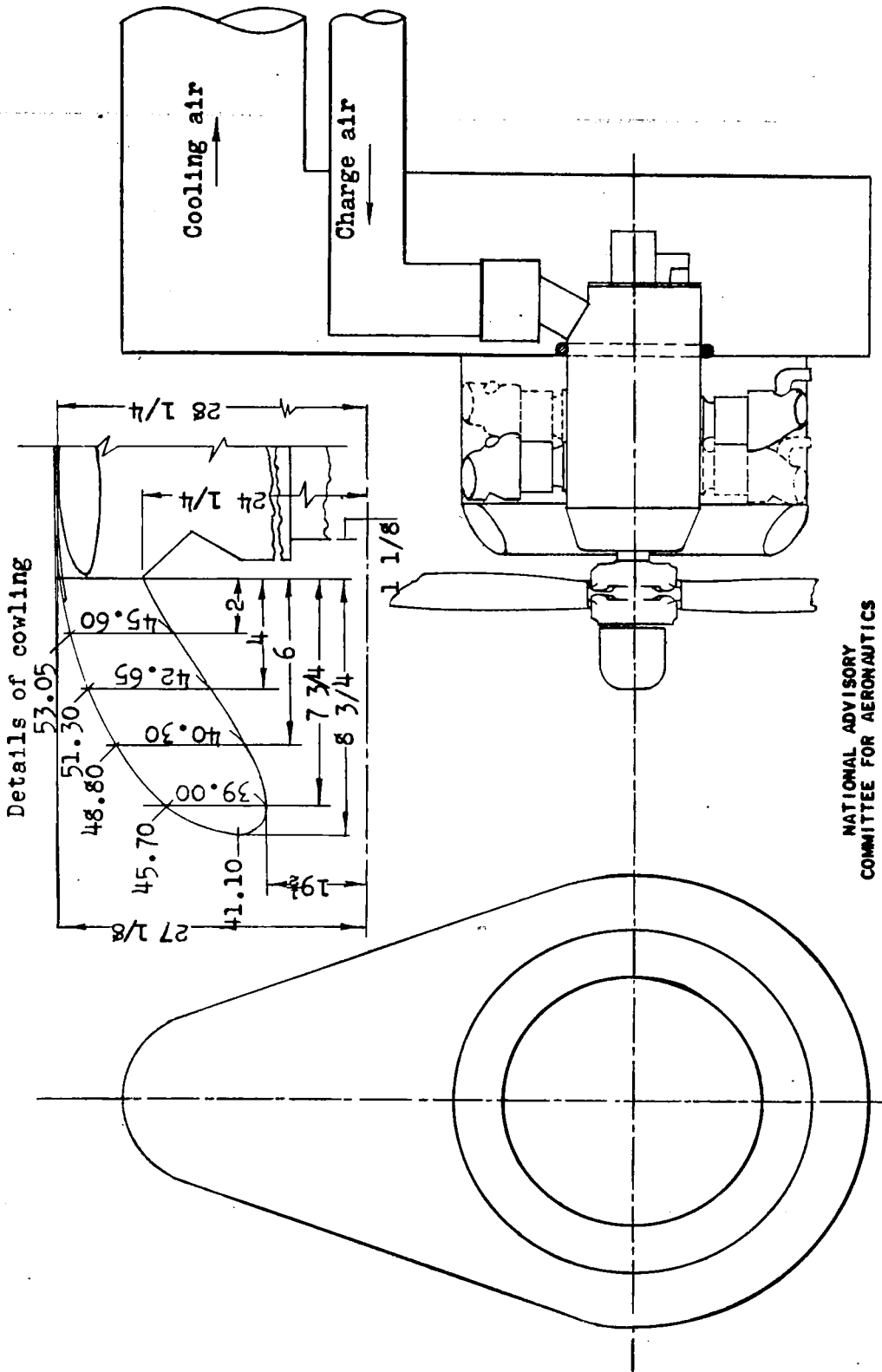

NATIONAL ADVISORY
COMMITTEE FOR AERONAUTICS

Figure 2. - Sketch of Wright R-2600-8 engine installation, including cowl details. All dimensions in inches.

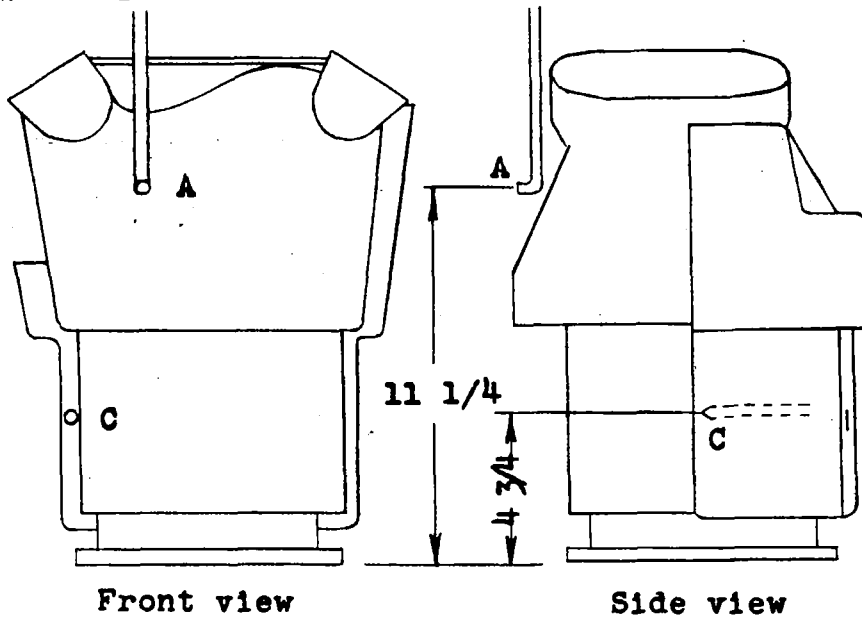

Front view

Side view

Front-row cylinder

NATIONAL ADVISORY
COMMITTEE FOR AERONAUTICS

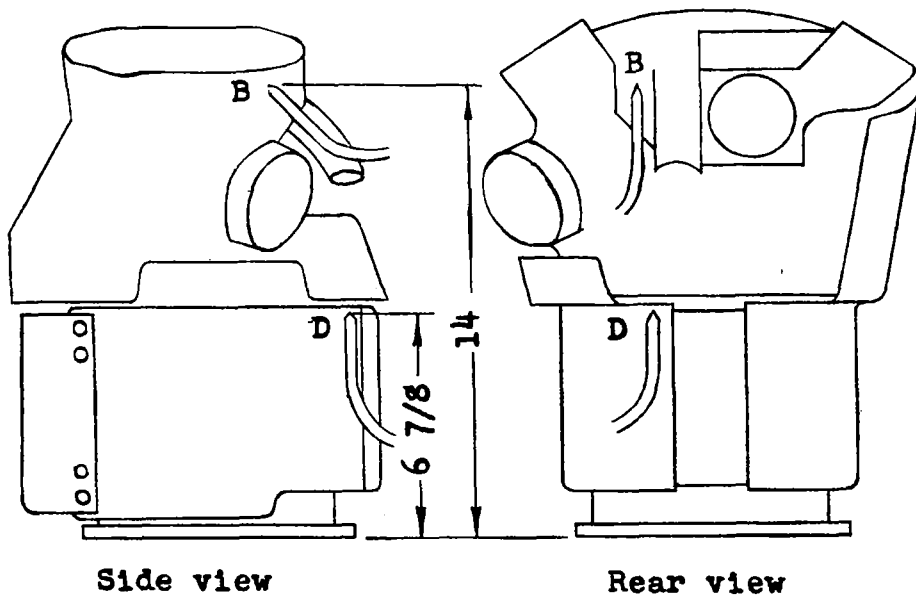

Side view

Rear view

Rear-row cylinder

Figure 3. - Location of pressure tubes used in measuring cooling-air pressure drop across Wright R-2600-8 engine. All dimensions in inches.

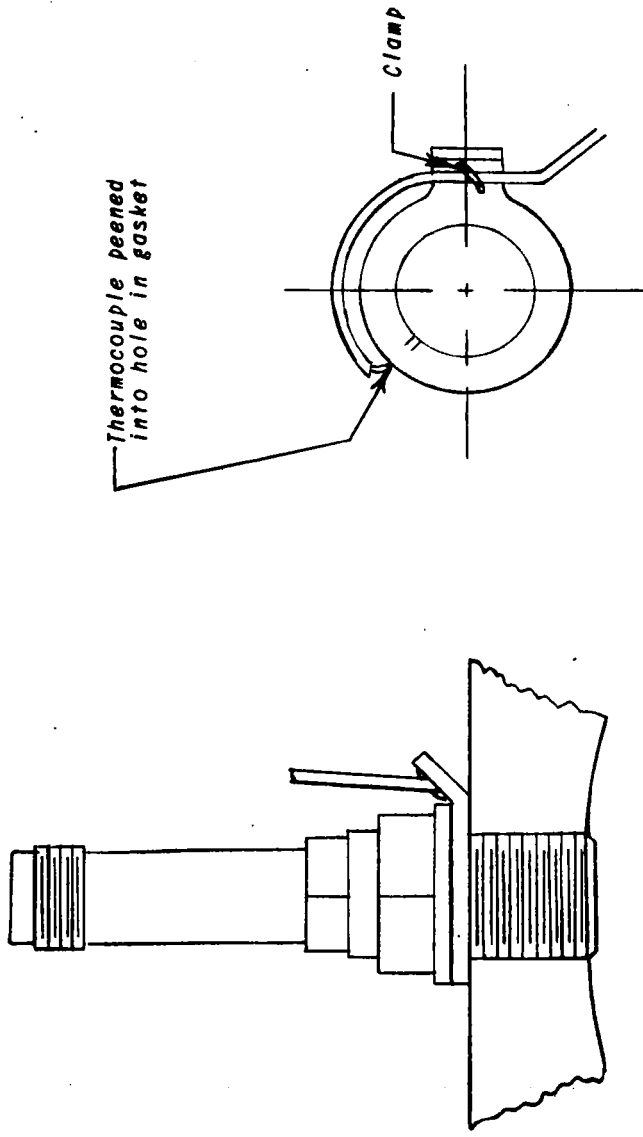

NATIONAL ADVISORY
COMMITTEE FOR AERONAUTICS

Figure 4. - Spark-plug-gasket-thermocouple detail.

NATIONAL ADVISORY
COMMITTEE FOR AERONAUTICS

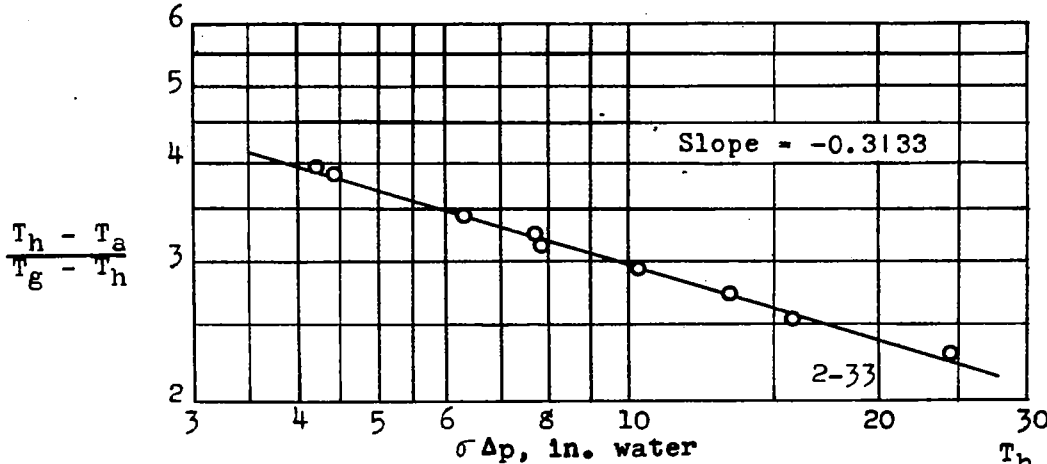

Figure 5. - Variation of cooling-temperature differential $\frac{T_h - T_a}{T_g - T_h}$ with sea-level cooling-air pressure drop for cylinder heads.

M_e , 5000 pounds per hour; fuel-air ratio, 0.08; Wright R-2600-8 engine.

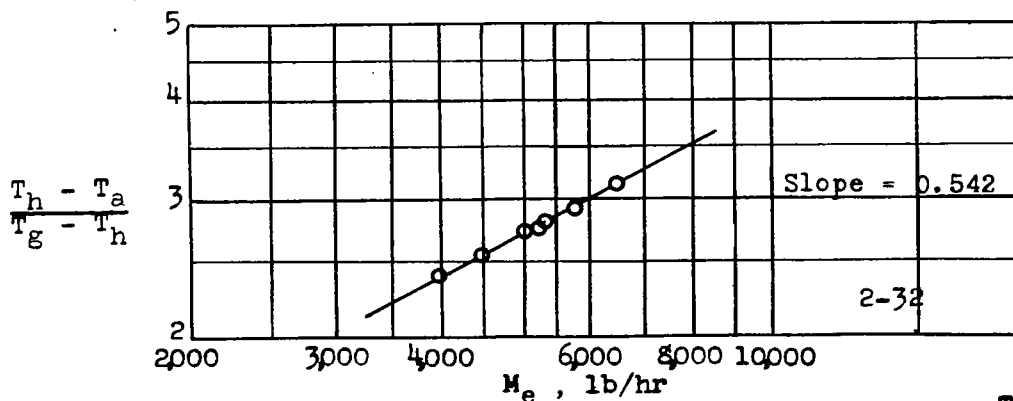

Figure 6. - Variation of cooling-temperature differential $\frac{T_h - T_a}{T_g - T_h}$ with charge-air flow for cylinder heads. $\sigma \Delta p$, 13.7 inches water; fuel-air ratio, 0.08; Wright R-2600-8 engine.

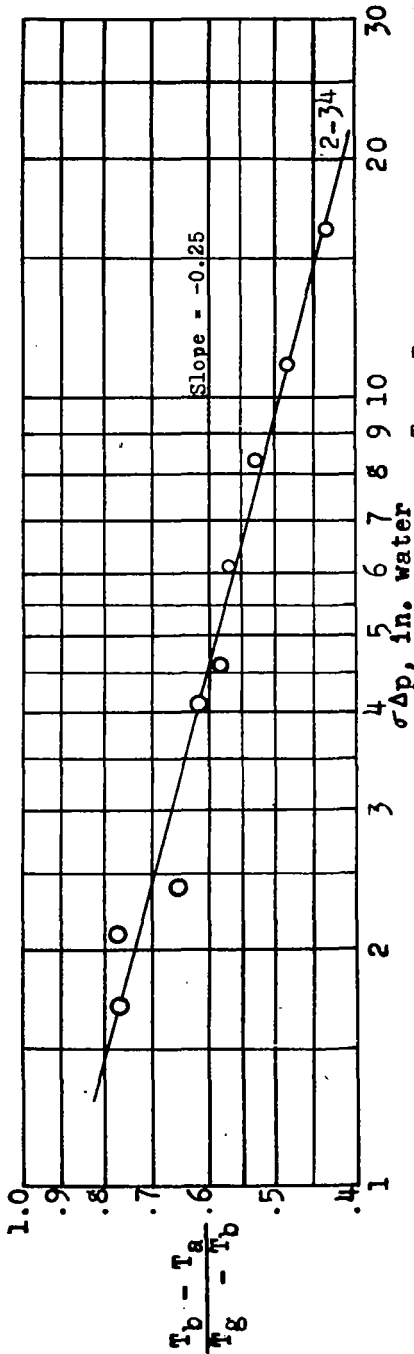

Figure 7. - Variation of cooling-temperature differential $\frac{T_b - T_a}{T_g - T_b}$ with sea-level cooling-air pressure drop for cylinder barrels. $\sigma \Delta p$, 8.6 inches water; fuel-air ratio, 0.08; Wright R-2600-8 engine.

NATIONAL ADVISORY
COMMITTEE FOR AERONAUTICS

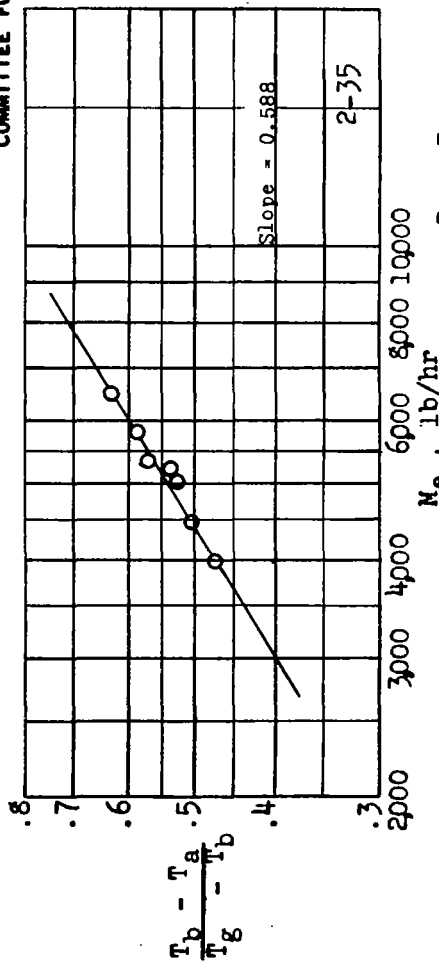

Figure 8. - Variation of cooling-temperature differential $\frac{T_b - T_a}{T_g - T_b}$ with charge-air flow for cylinder barrels. M_e , 5000 pounds per hour; fuel-air ratio, 0.08; Wright R-2600-8 engine.

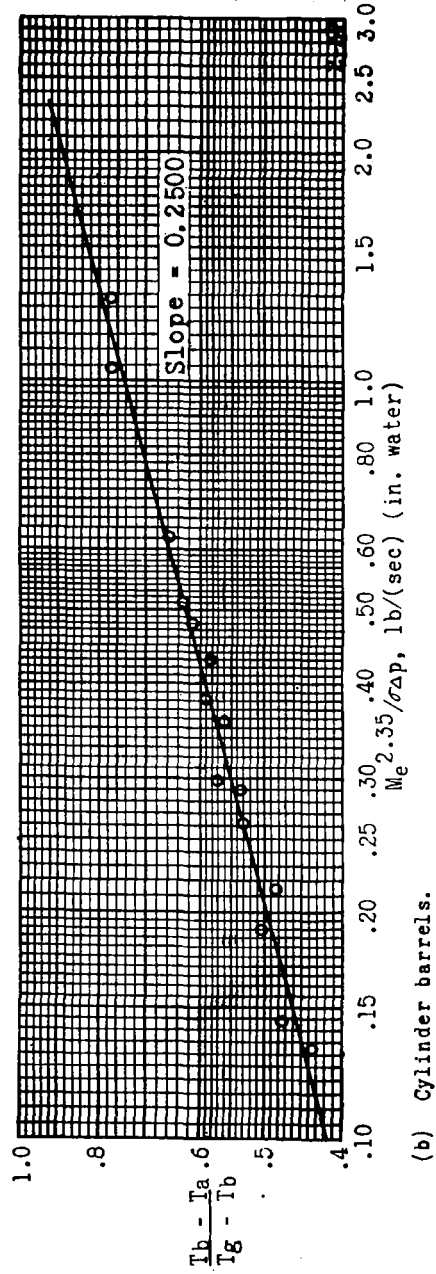
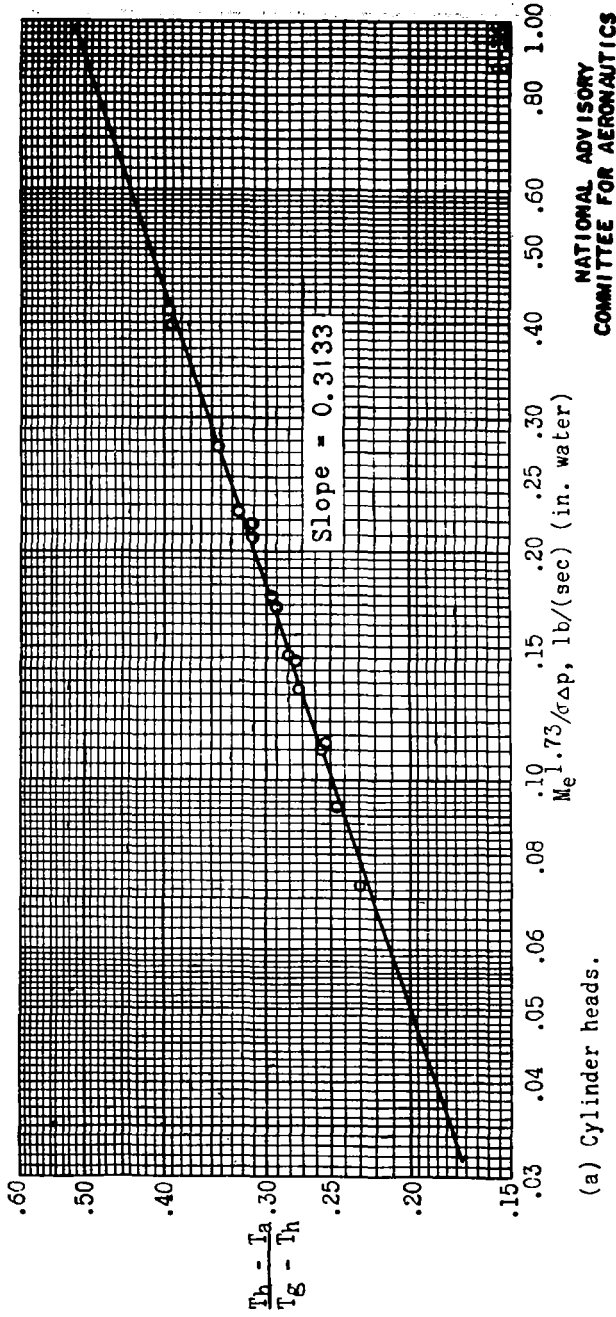

Figure 9. - Variation of cooling-temperature differential with ratio of charge-air flow and cooling-air pressure drop. Wright R-2600-8 engine.

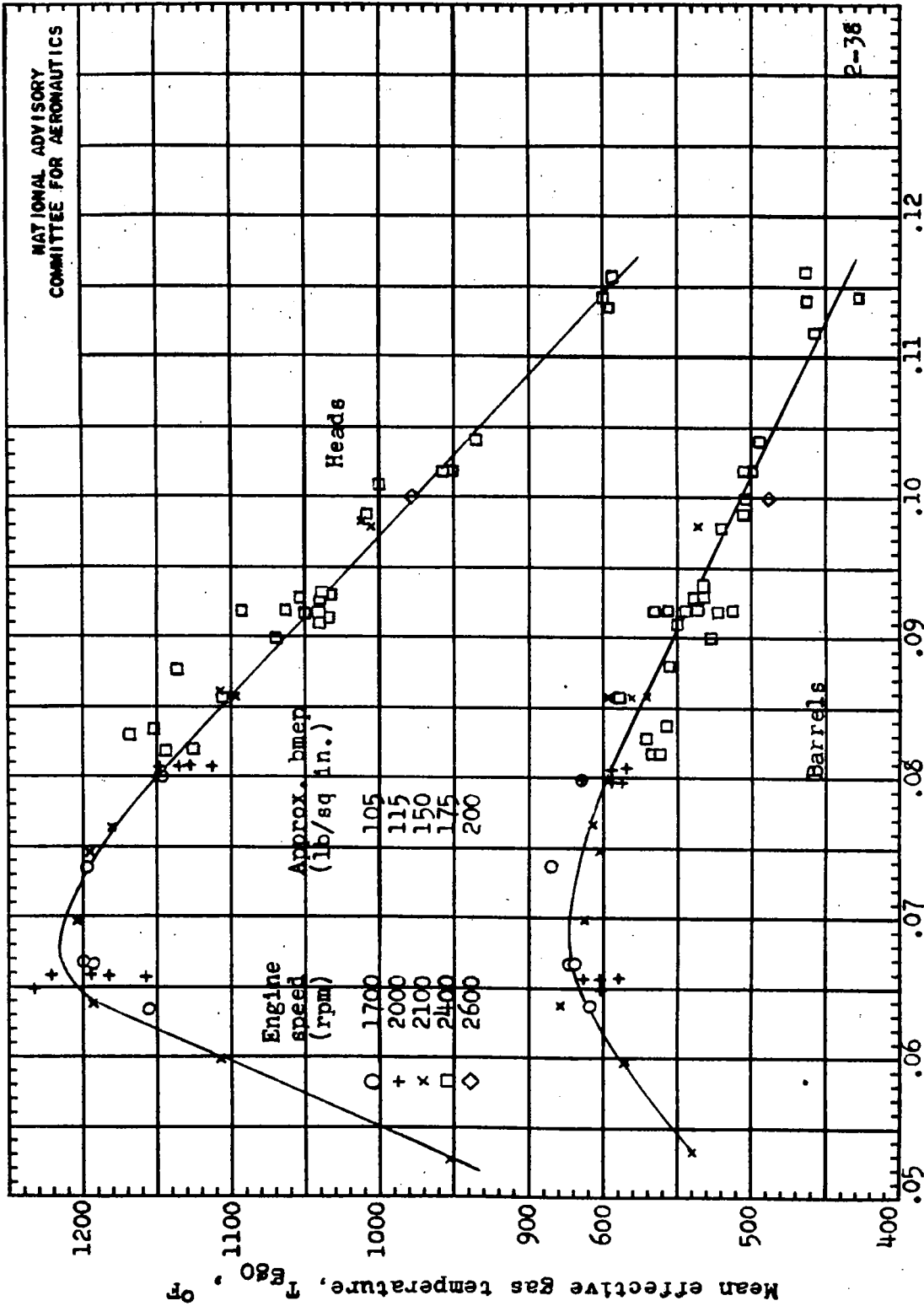
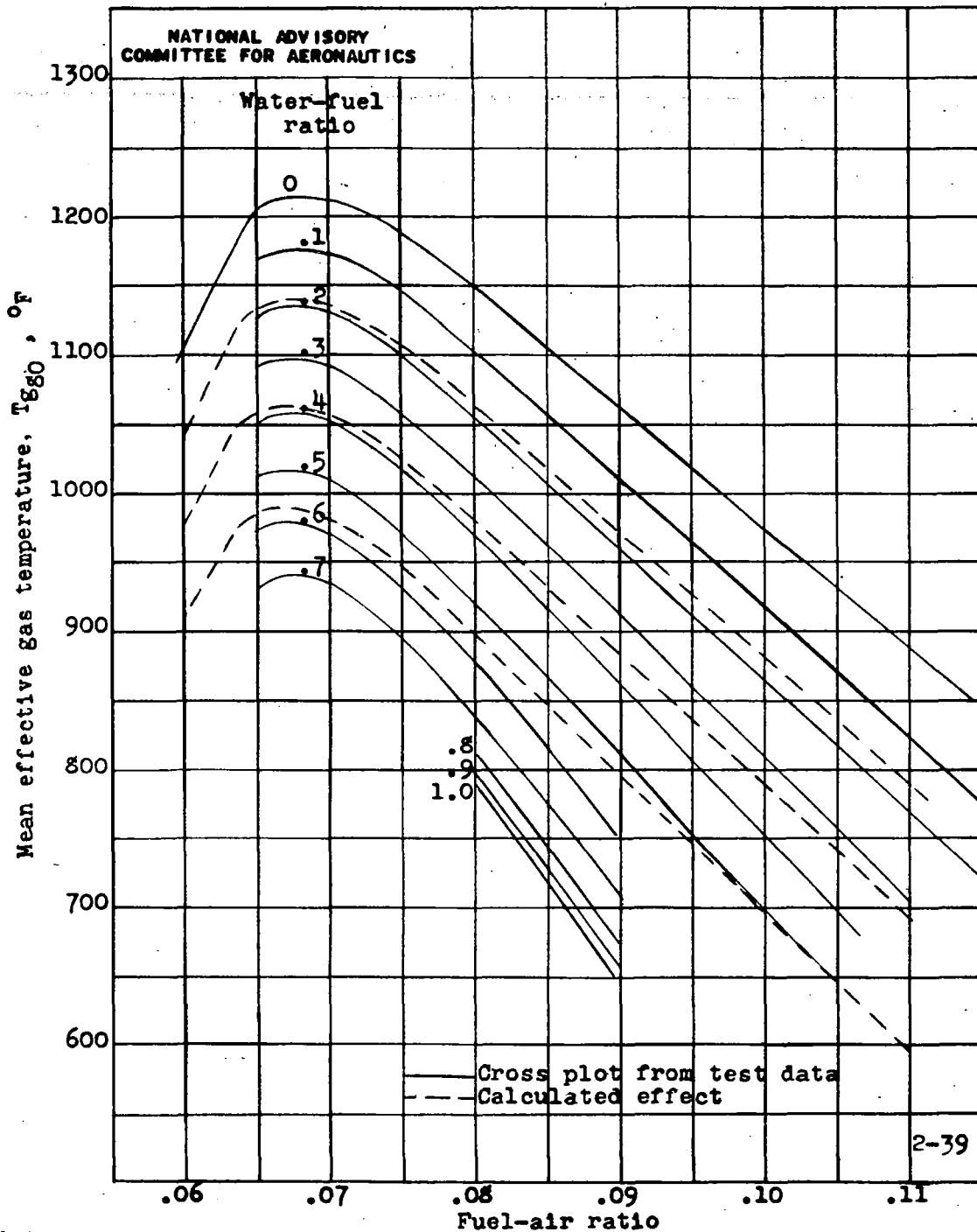
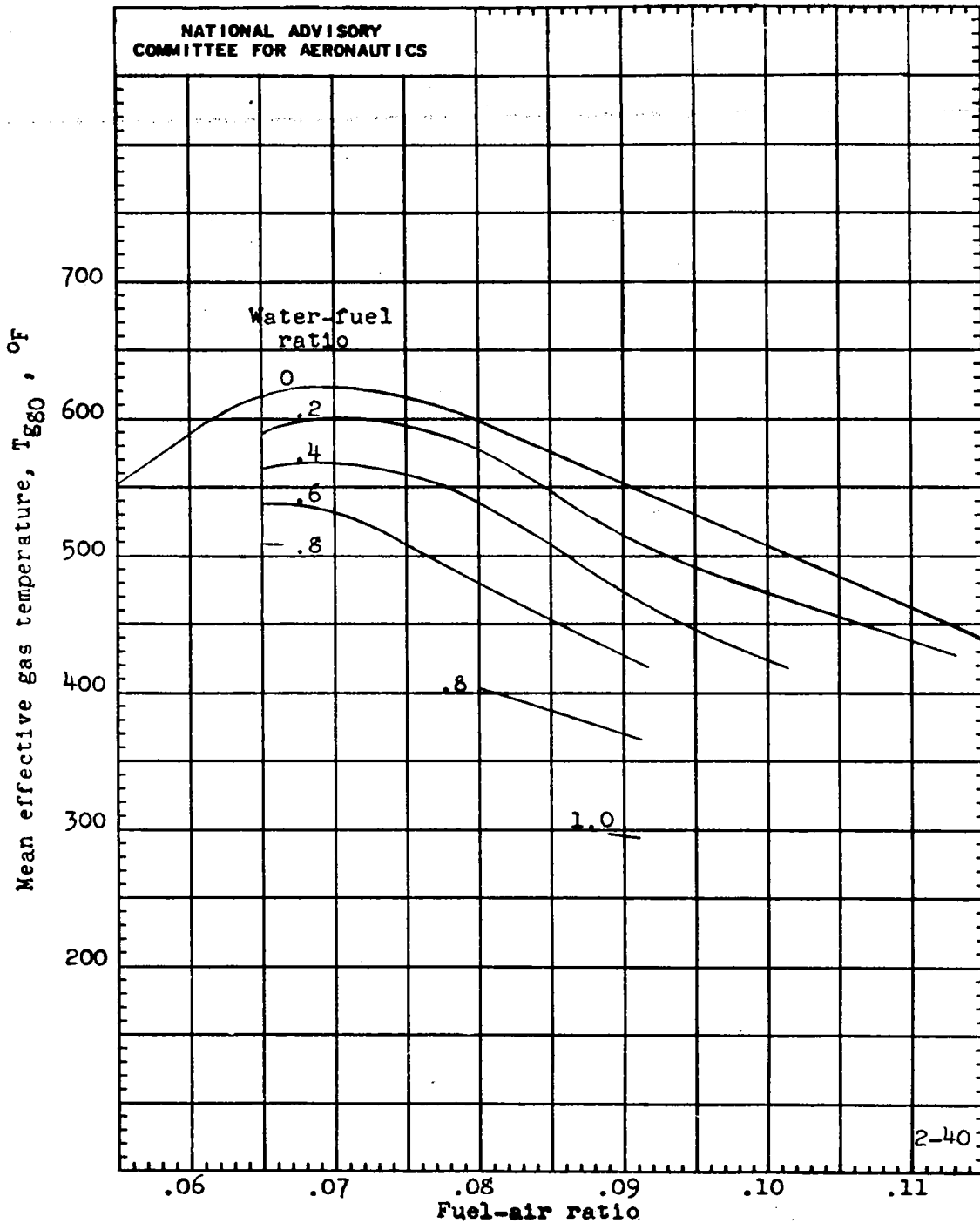

Figure 10. - Variation of mean effective gas temperature T_{860} with fuel-air ratio for cylinder heads and barrels. Wright R-2600-8 engine; fuel, AN-F-26, Amendment-1.



(a) Heads.

Figure 11. - Variation of mean effective gas temperature T_{EgO} with fuel-air ratio for water-fuel ratios indicated. Wright R-2600-8 engine.



(b) Barrels.

Figure 11. - Concluded.

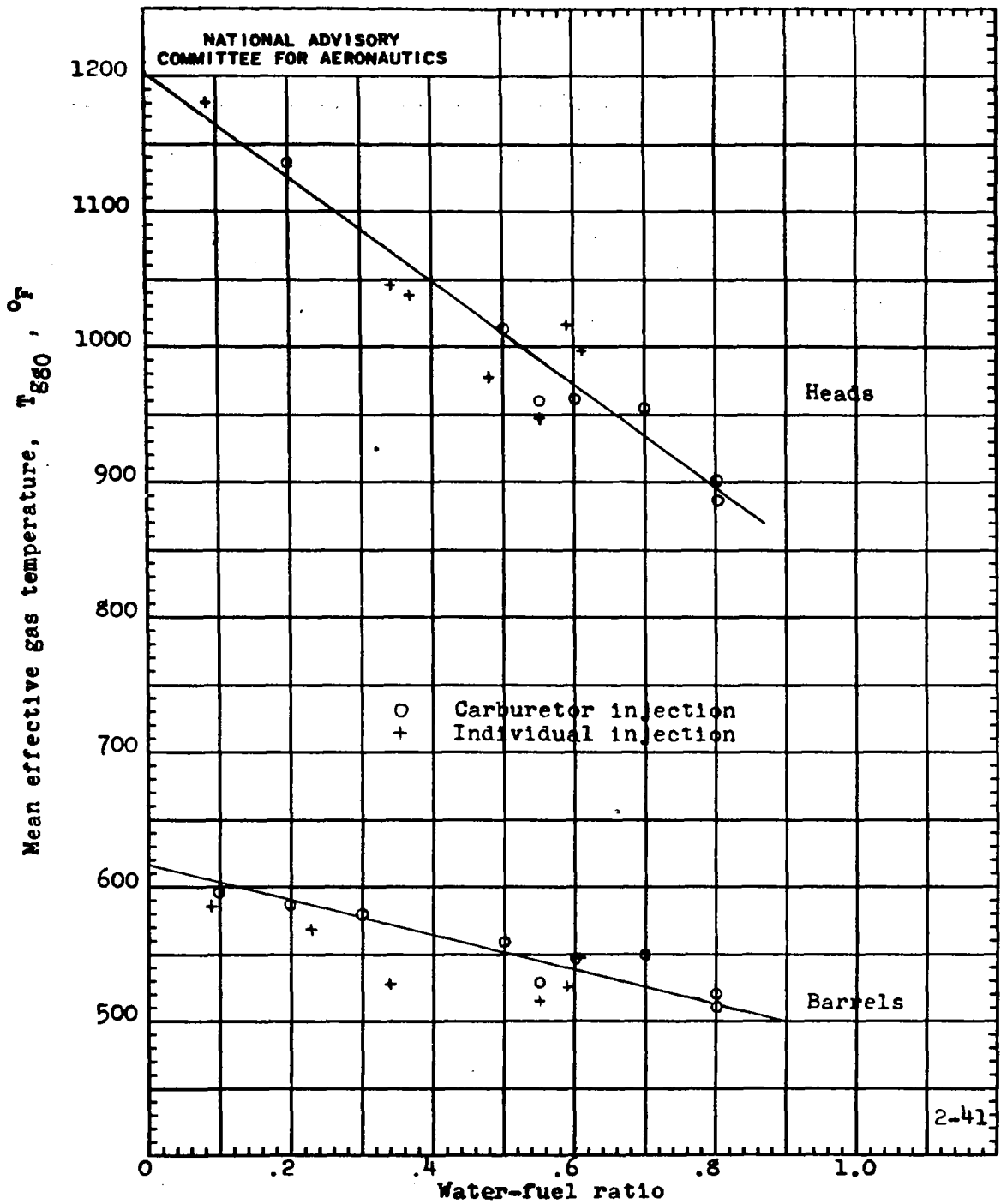

(a) Fuel-air ratio, 0.065.

Figure 12. - Variation of mean effective gas temperature T_{gg0} with water-fuel ratio for cylinder heads and barrels. Wright R-2600-8 engine.

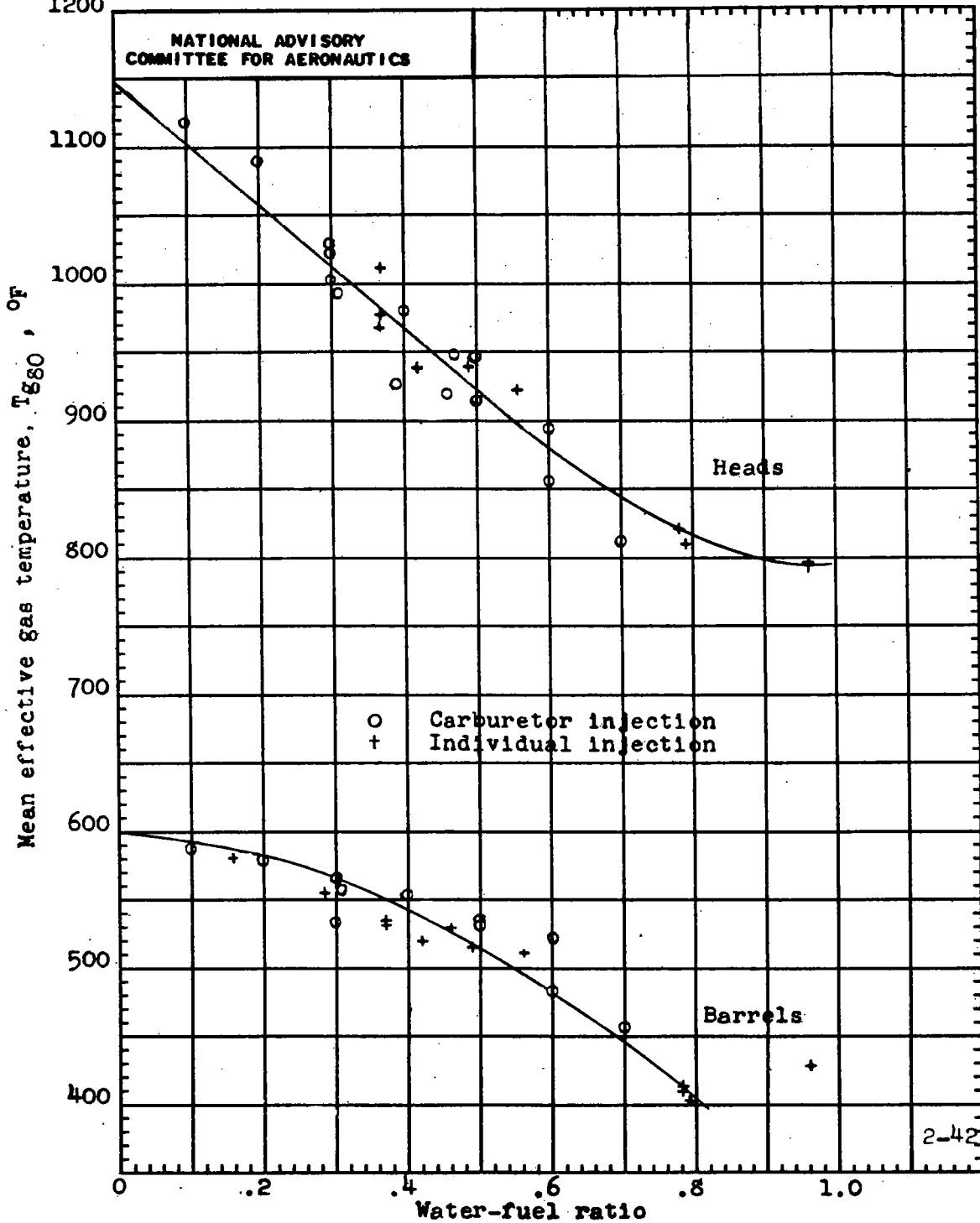

(b) Fuel-air ratio, 0.05.

Figure 12. - Continued.

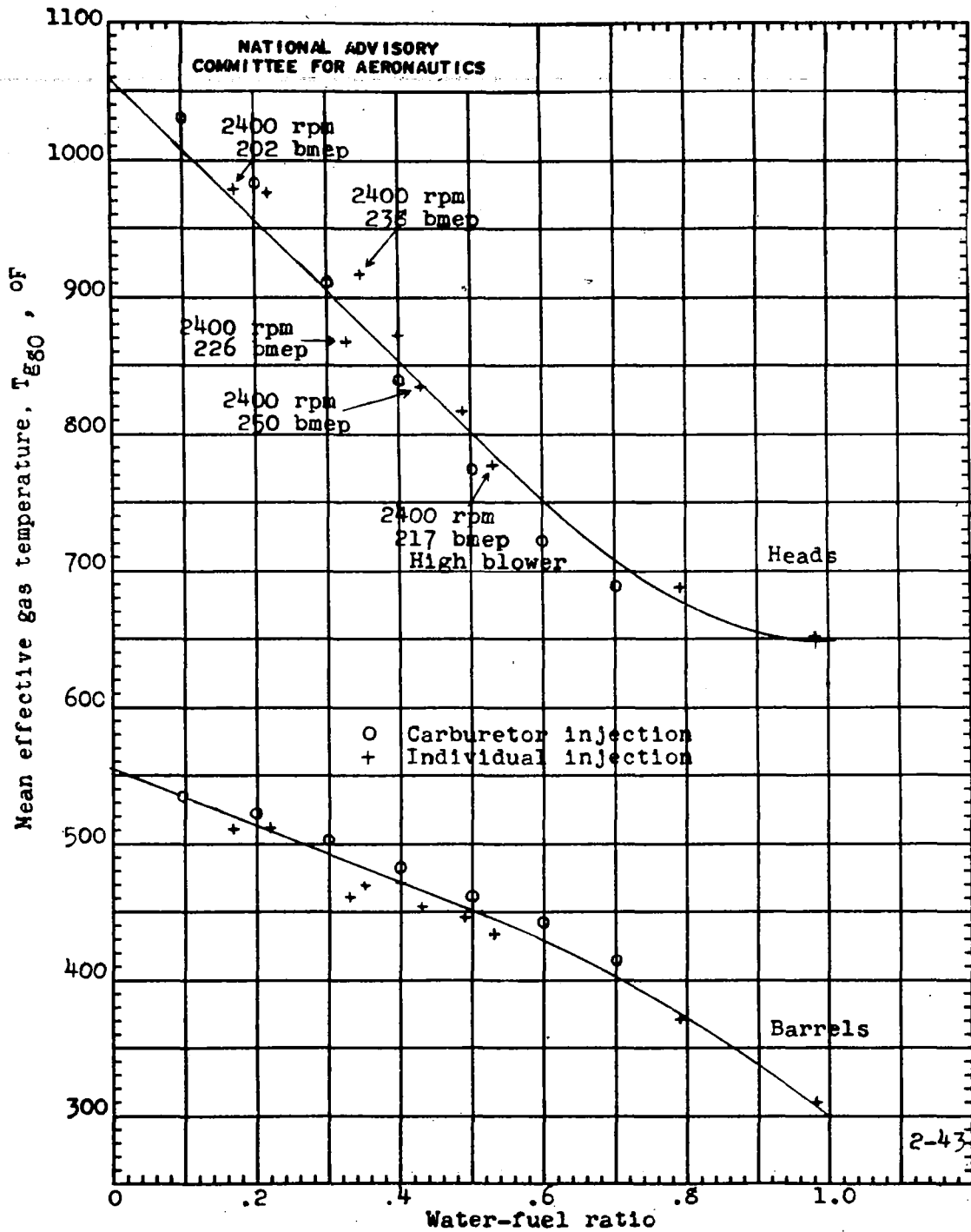

(c) Fuel-air ratio, 0.09.

Figure 12. - Continued.

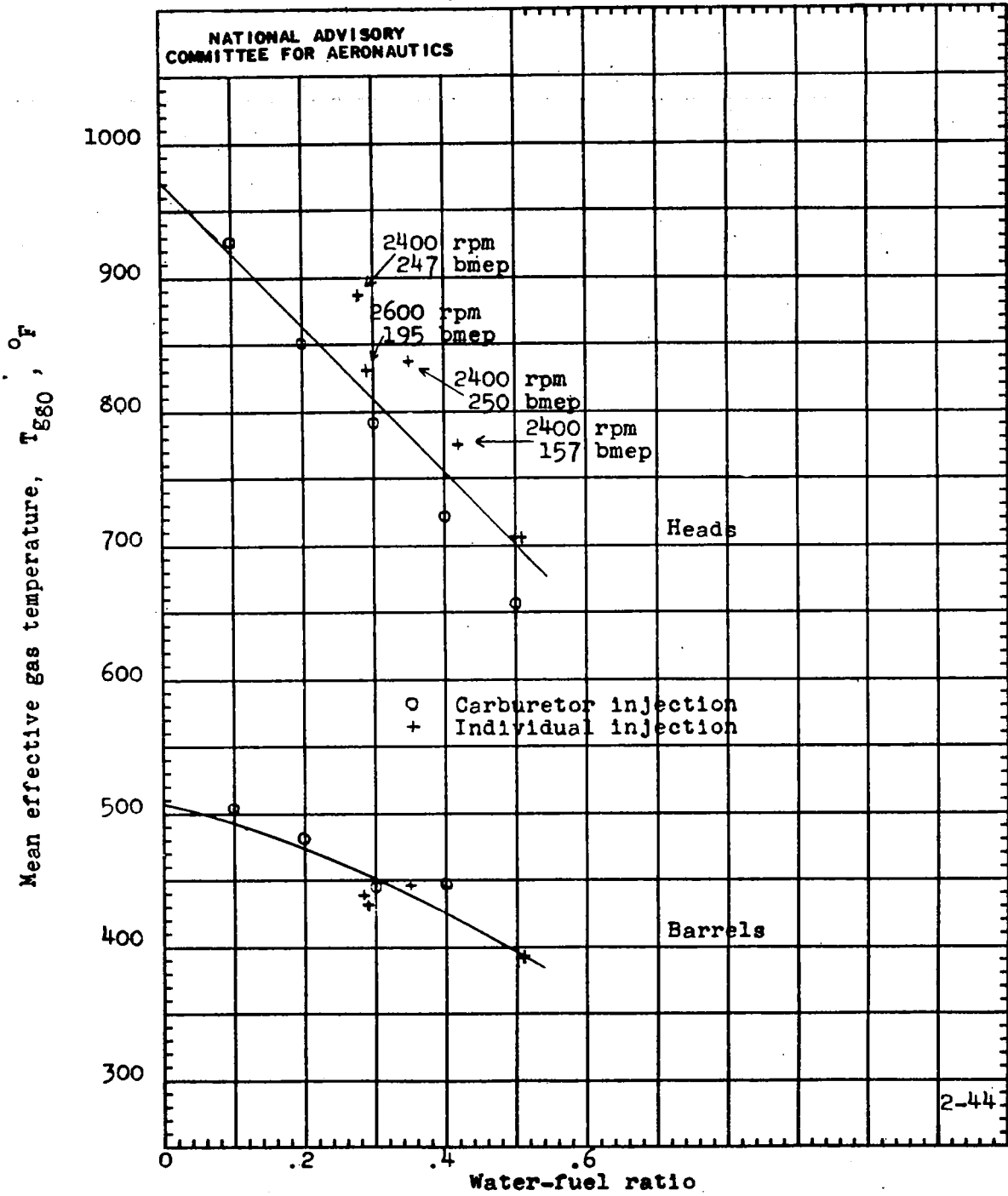

(d) Fuel-air ratio, 0.10.

Figure 12. - Continued.

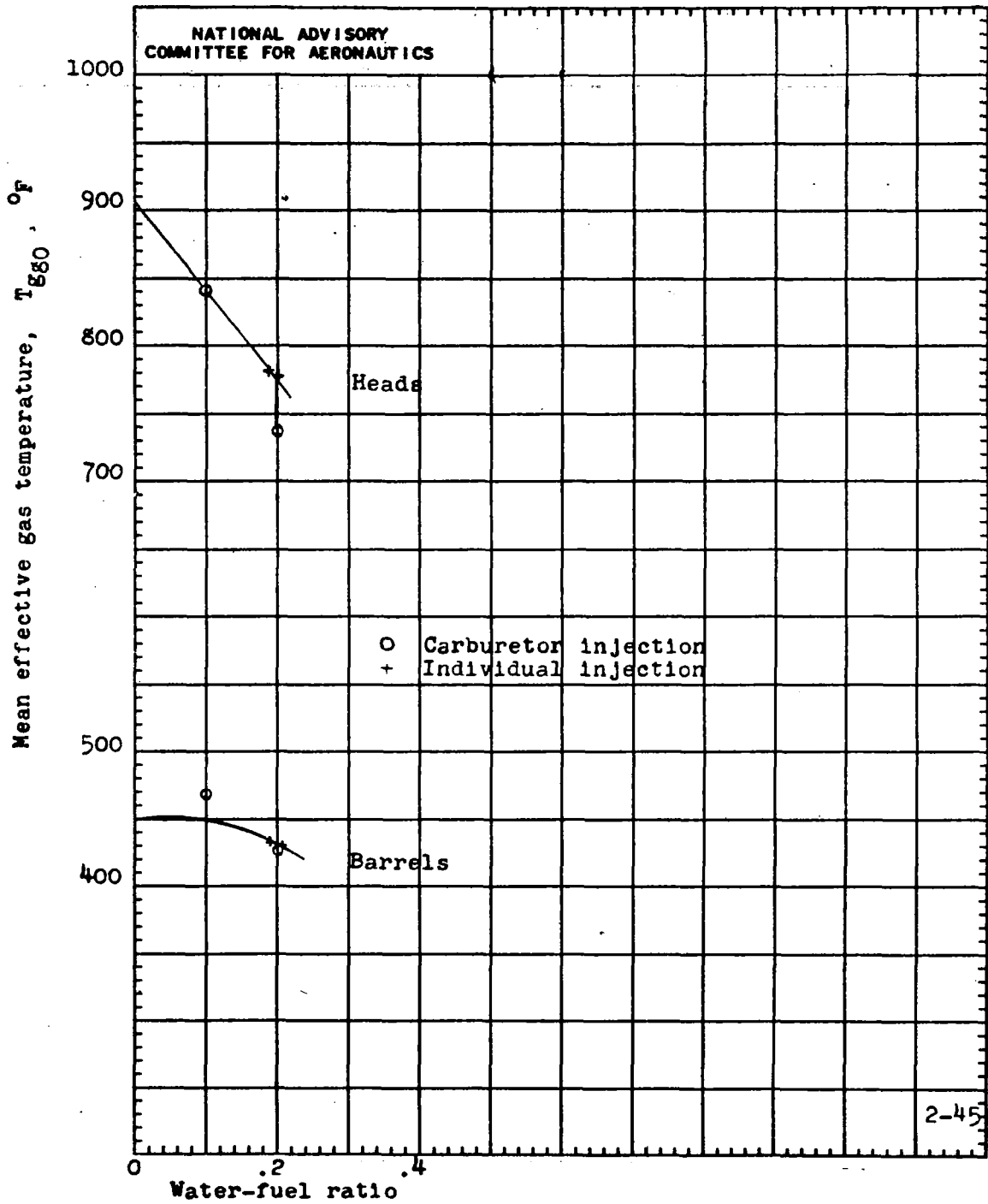

(e) Fuel-air ratio, 0.113.

Figure 12. - Concluded.

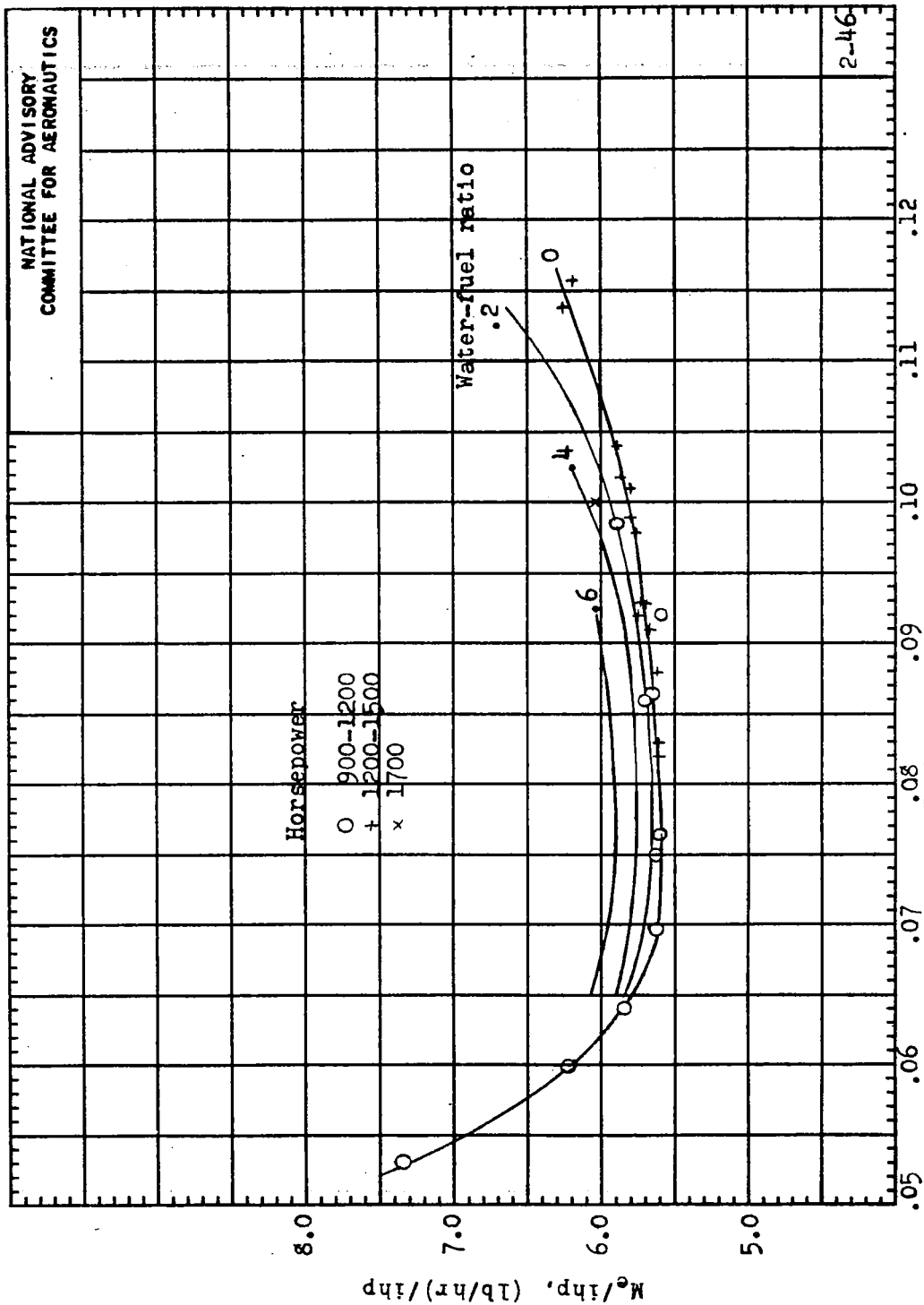

Figure 13. - Variation of indicated specific air consumption M_e /ihp with fuel-air ratio. Wright R-2600-8 engine; water injection to individual cylinders; indicated horsepower calculated by equation (10).

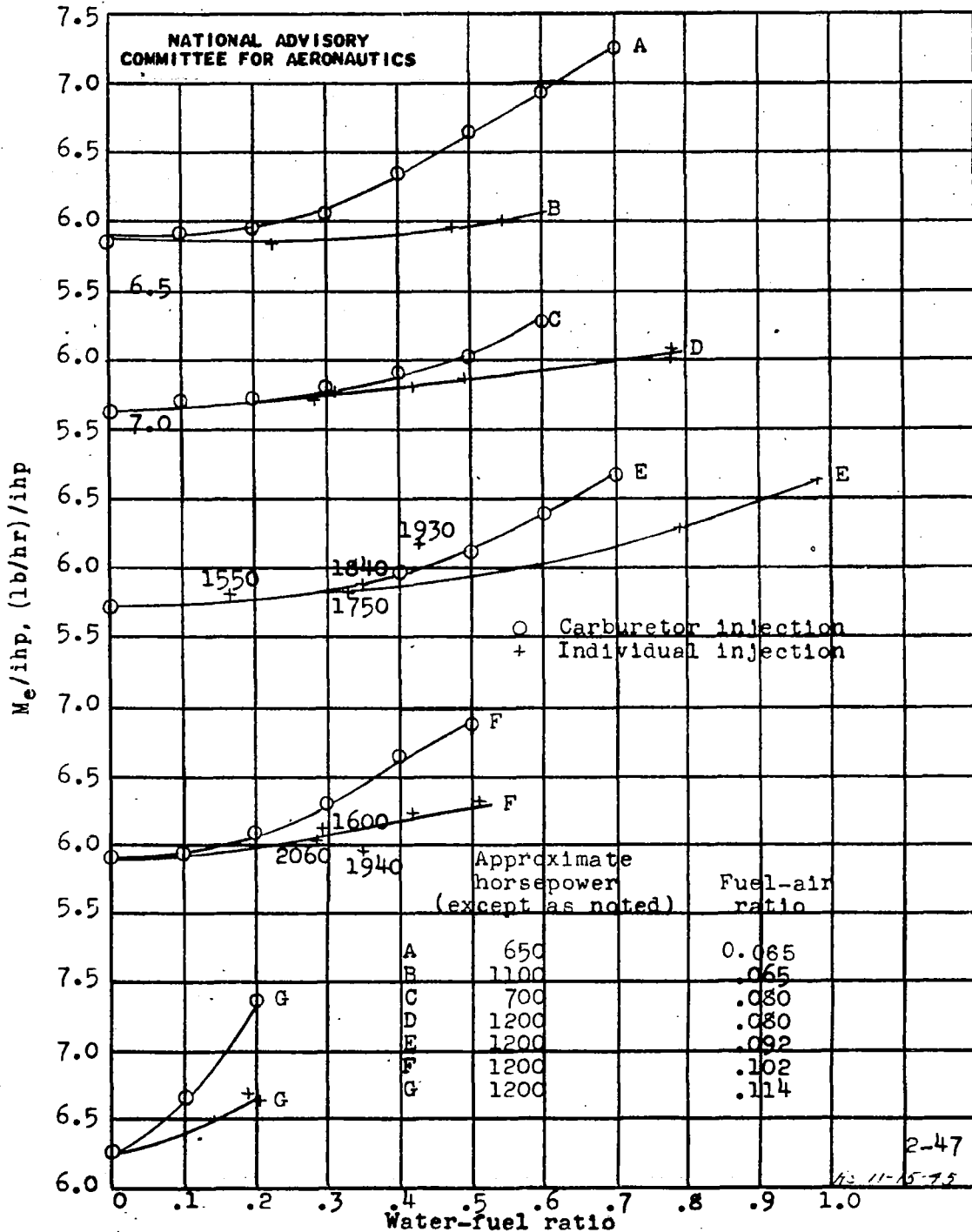

Figure 14. - Variation of indicated specific air consumption M_e/ihp with water-fuel ratio. Wright R-2600-8 engine.

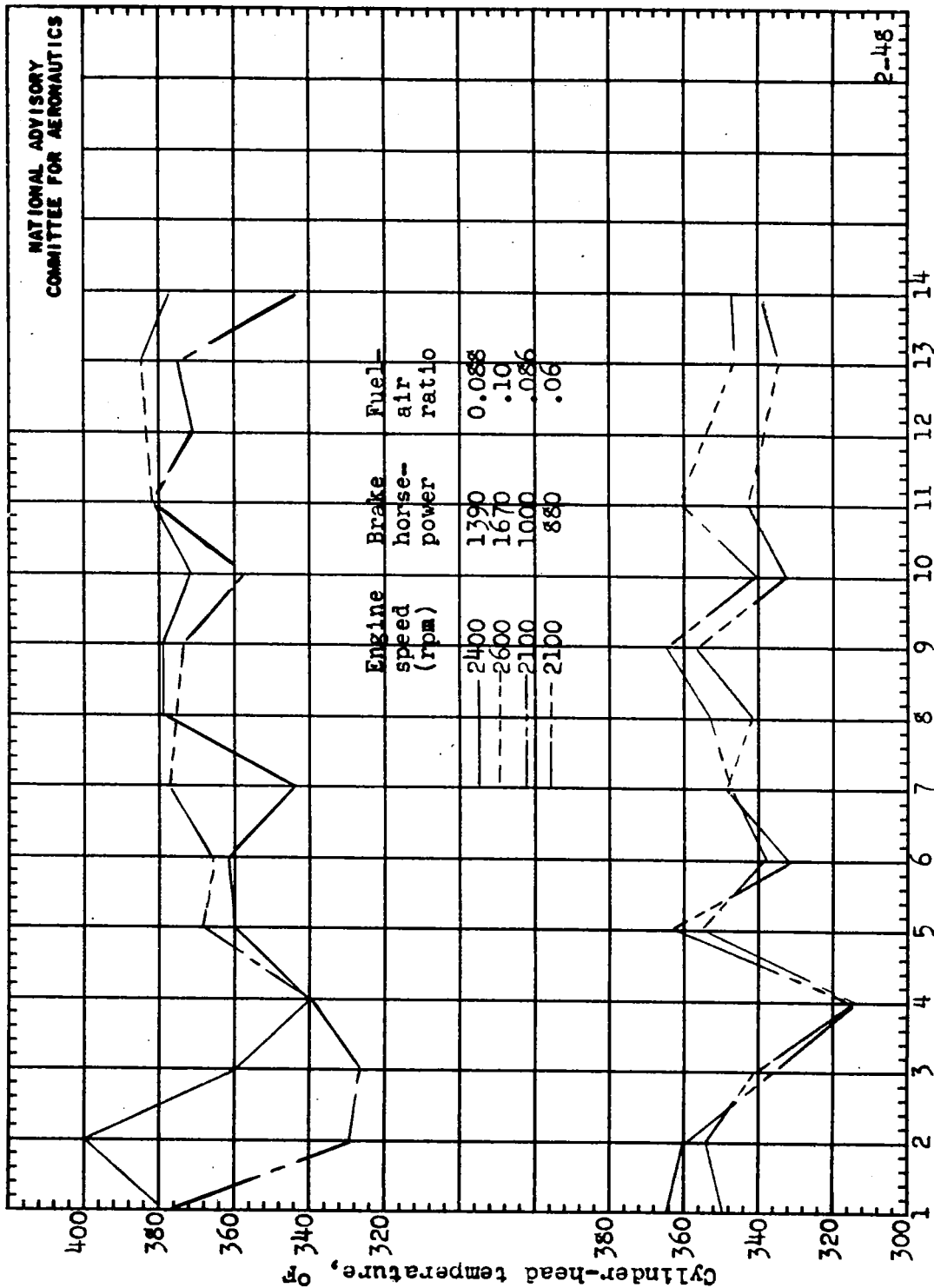
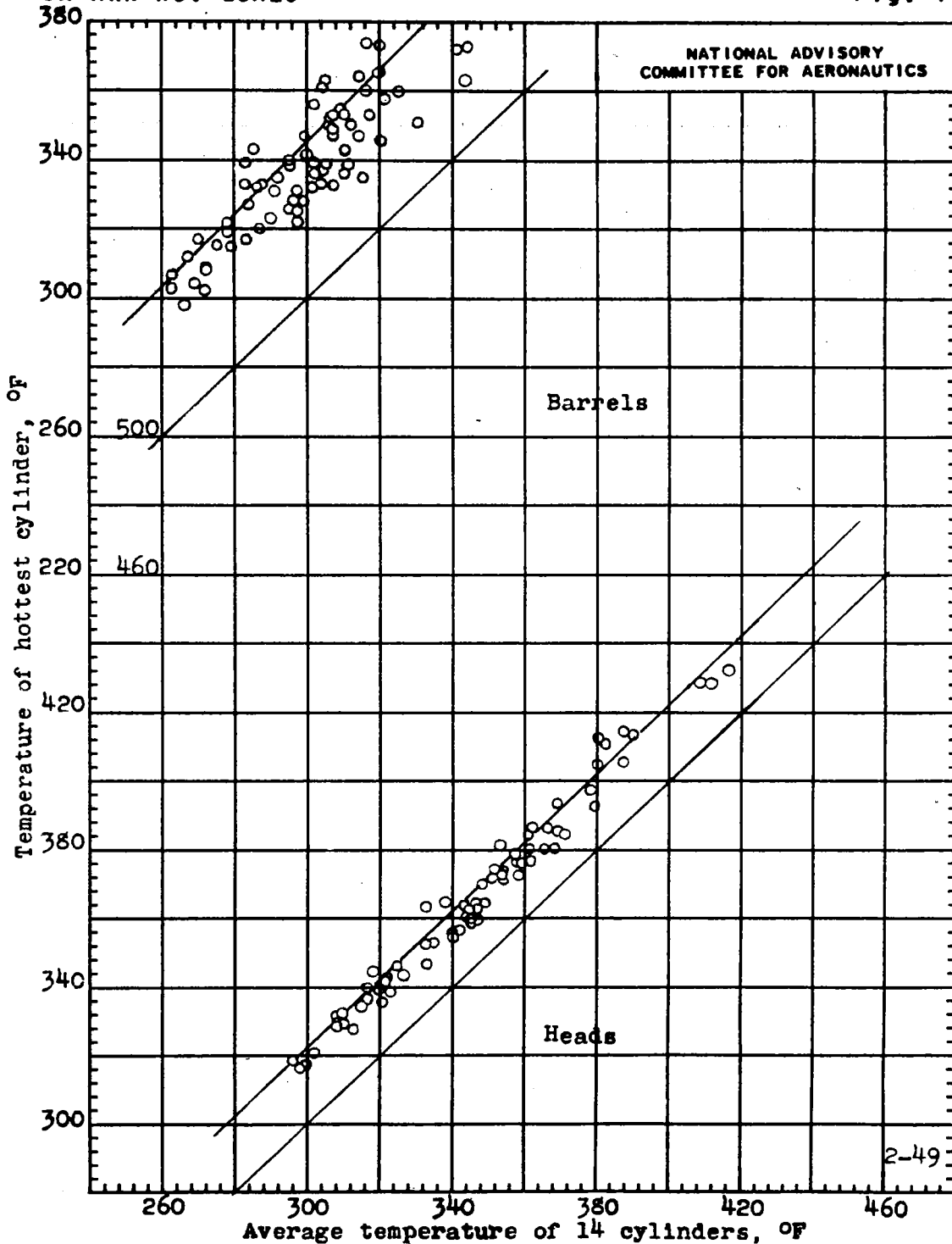
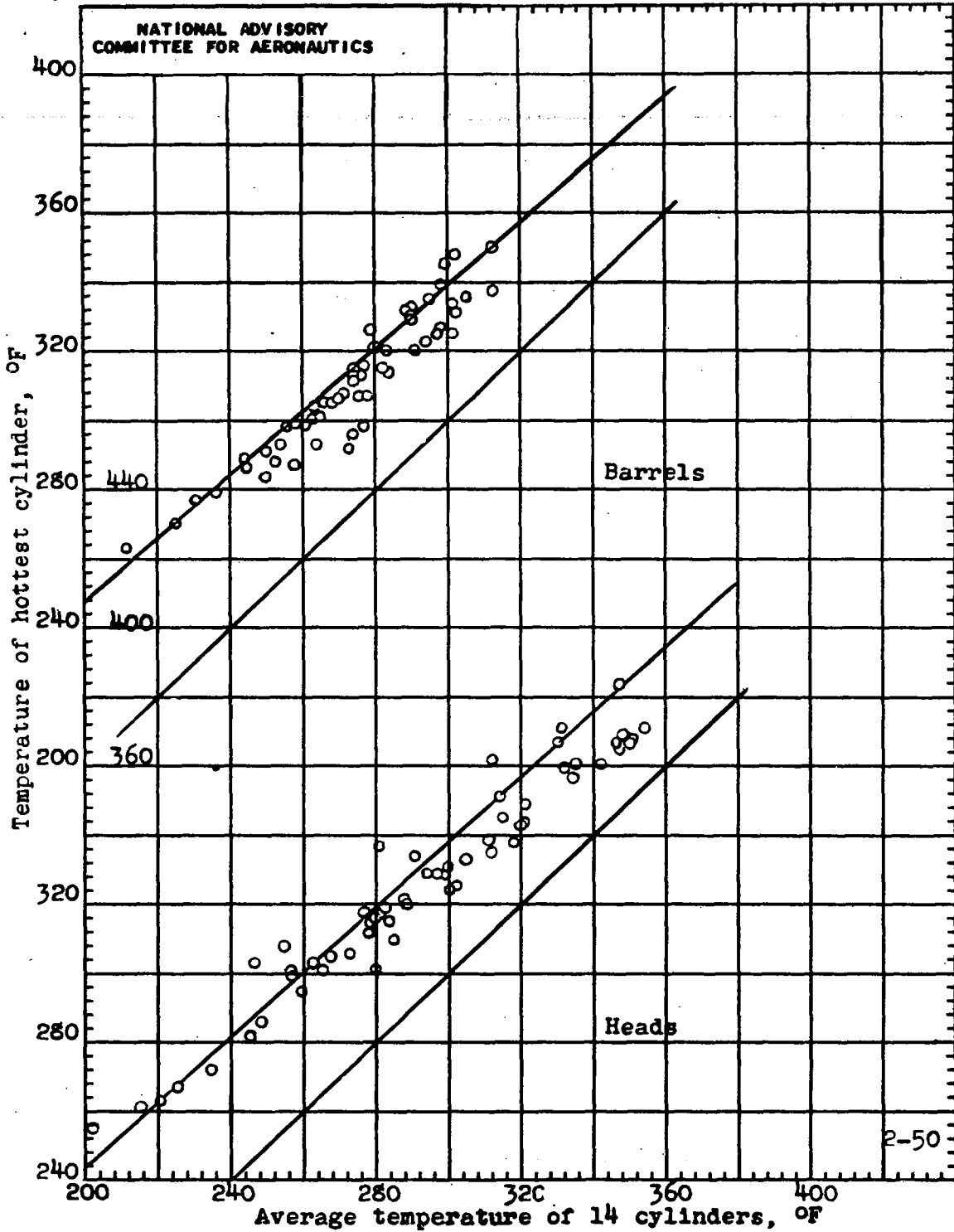

Figure 15. - Temperature pattern of rear spark-plug-gasket thermocouples. Wright R-2600. 8 engine; Bendix-Stromberg PT-13E2 injection carburetor; no water injection.



(a) No water injection.

Figure 16.- Variation of hottest cylinder temperatures with average temperatures of 14 cylinders. Wright R-2600-8 engine.



(b) Water injection through carburetor.

Figure 16. - Continued.

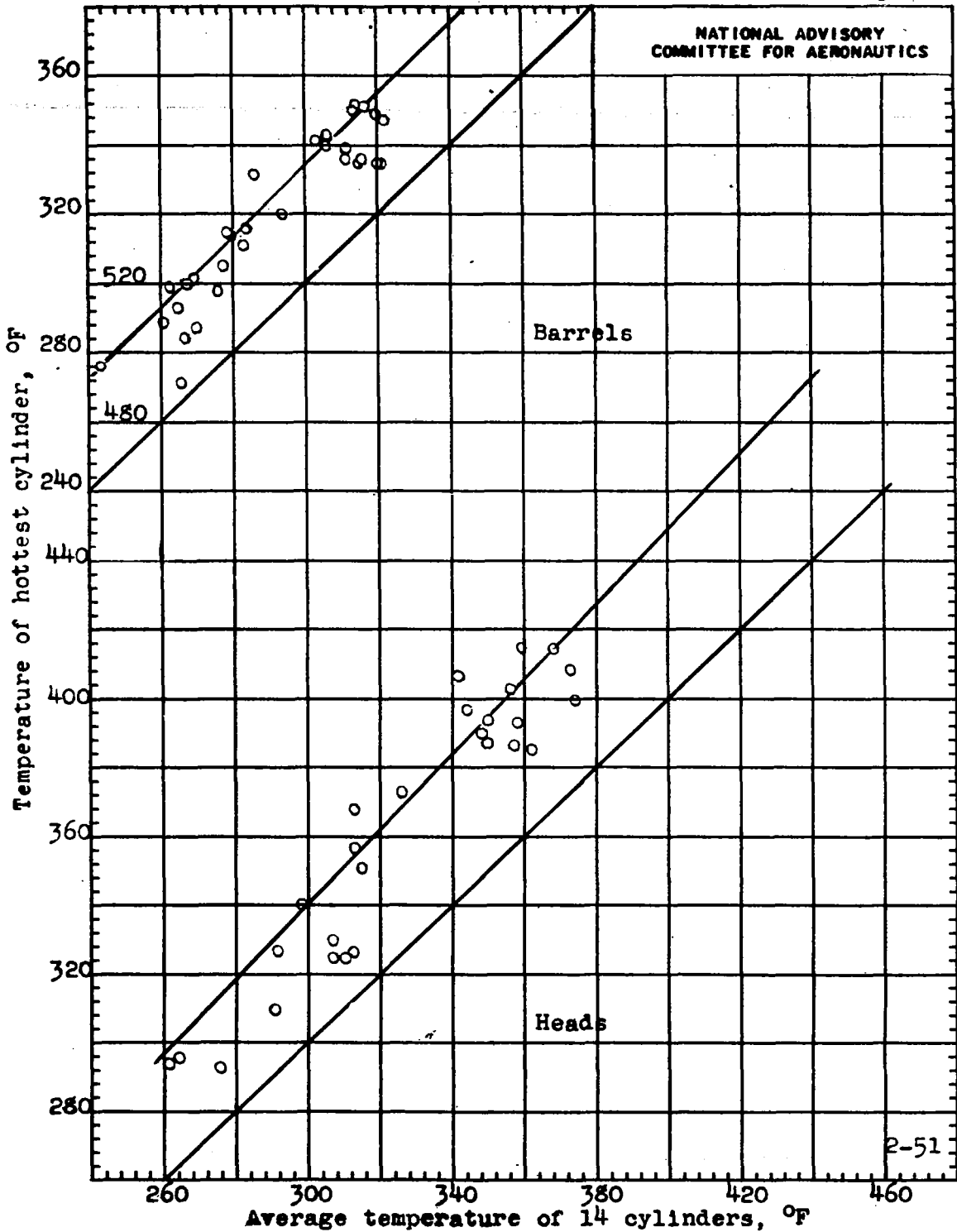

(c) Water injection to individual cylinders.

Figure 16. - Concluded.

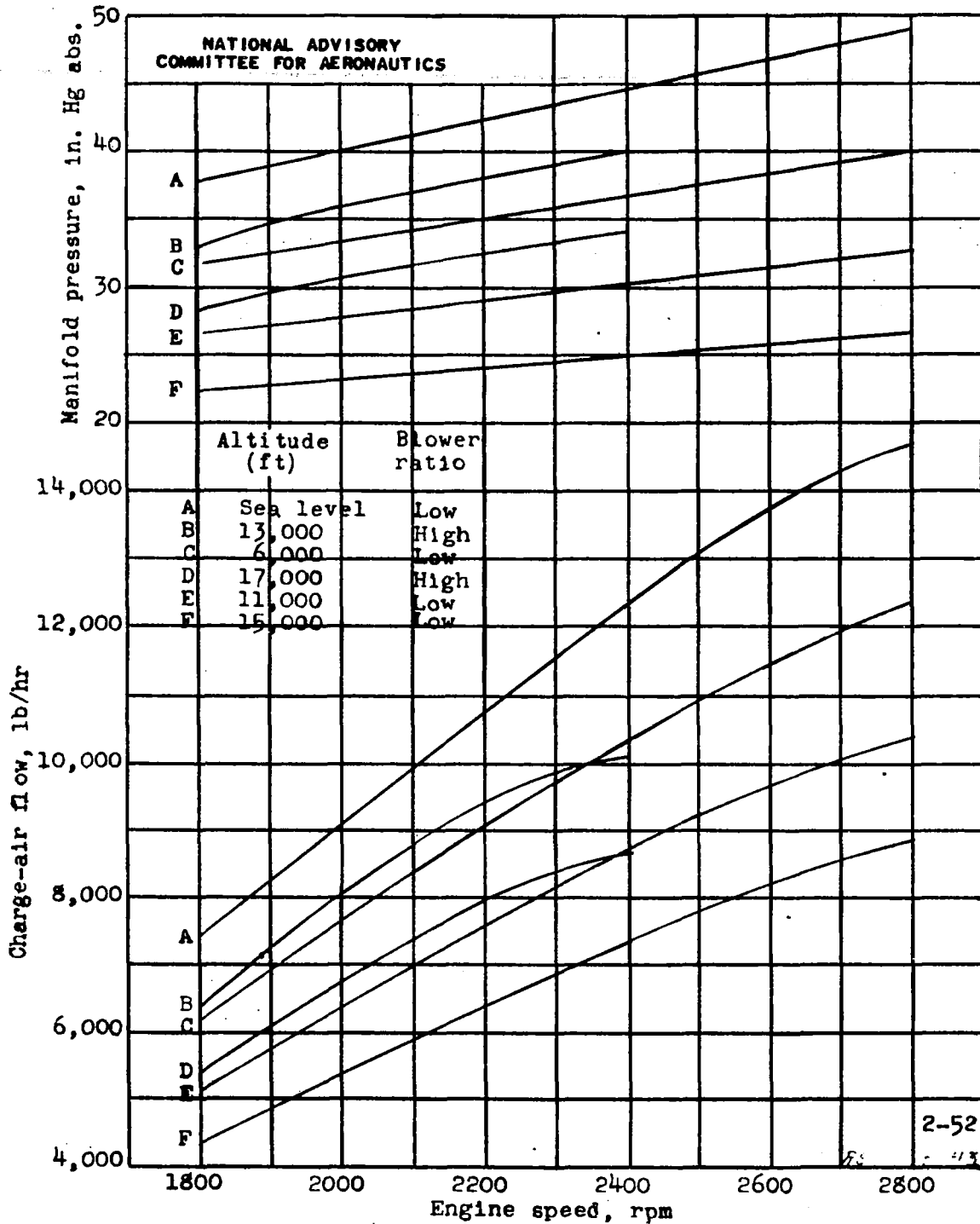

Figure 17. - Capacity of supercharger of Wright R-2600-8 engine in terms of air flow and manifold pressure at standard altitude. Data from Naval Air Materiel Center, Naval Air Experimental Station.

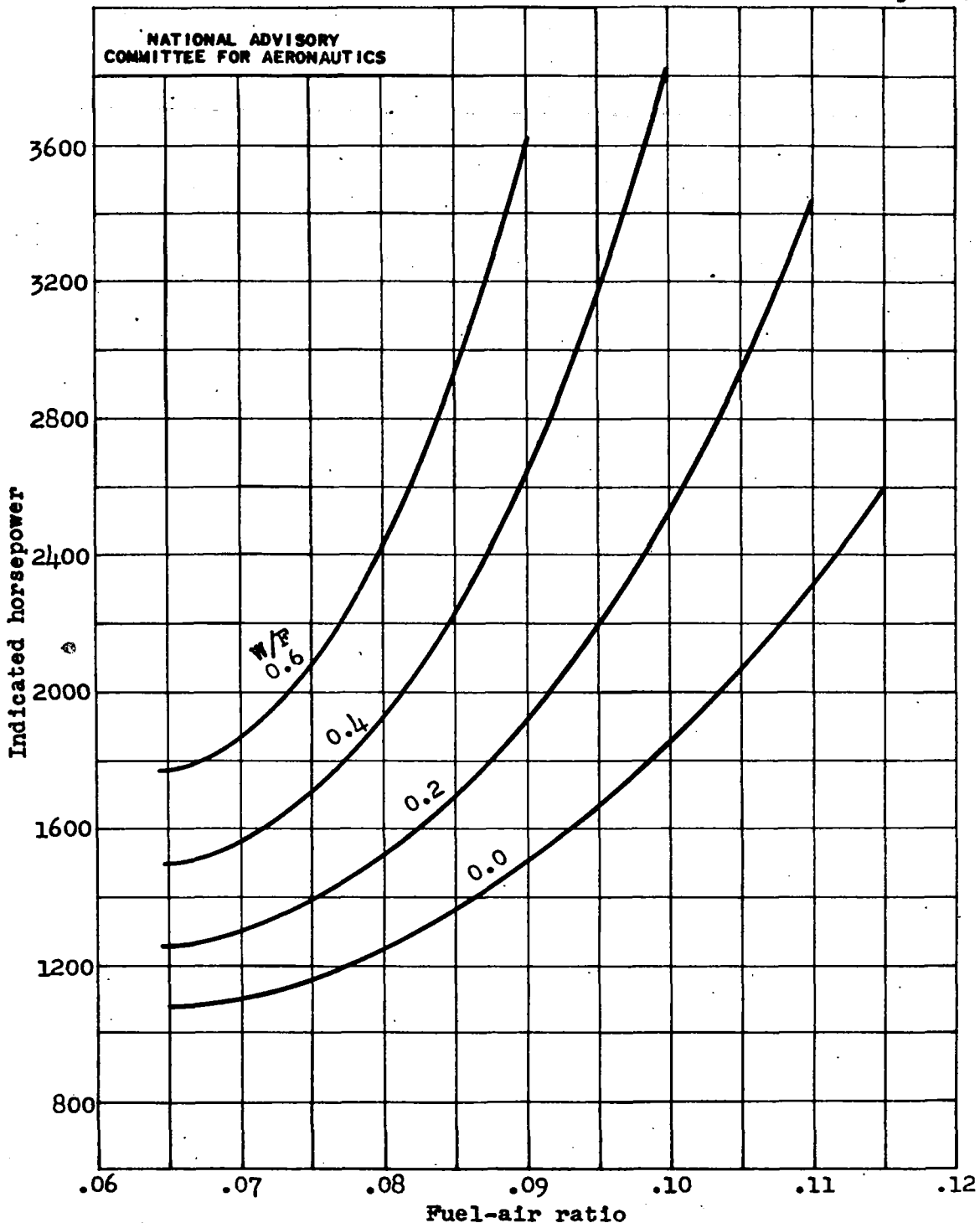

Figure 18. - Relation between fuel-air ratio and temperature-limited horsepower at different water-fuel ratios. Wright R-2600-8 engine; cooling-air pressure drop, 7 inches of water; average rear spark-plug-gasket temperature, 425° F; carburetor-air temperature, 90° F; cooling-air temperature, 90° F; engine speed, 2600 rpm.