

L-40

NATIONAL ADVISORY COMMITTEE FOR AERONAUTICS

WARTIME REPORT

ORIGINALLY ISSUED

October 1945 as

██████████ Bulletin L5H08

FLIGHT TESTS OF TWO AIRPLANES HAVING MODERATELY HIGH
EFFECTIVE DIHEDRAL AND DIFFERENT DIRECTIONAL
STABILITY AND CONTROL CHARACTERISTICS

By S. A. Sjoberg

Langley Memorial Aeronautical Laboratory
Langley Field, Va.



NACA

WASHINGTON

NACA WARTIME REPORTS are reprints of papers originally issued to provide rapid distribution of advance research results to an authorized group requiring them for the war effort. They were previously held under a security status but are now unclassified. Some of these reports were not technically edited. All have been reproduced without change in order to expedite general distribution.

NATIONAL ADVISORY COMMITTEE FOR AERONAUTICS

BULLETIN

FLIGHT TESTS OF TWO AIRPLANES HAVING MODERATELY HIGH
EFFECTIVE DIHEDRAL AND DIFFERENT DIRECTIONAL
STABILITY AND CONTROL CHARACTERISTICS

By S. A. Sjoberg

SUMMARY

Flight tests of a twin-engine midwing attack bomber and a single-engine low-wing fighter airplane showed both airplanes to have moderately high effective dihedral but different directional stability and control characteristics.

The attack bomber had a high degree of directional stability and the variation of rudder force required for trim with speed was small. The fighter had considerably less directional stability than the attack bomber and the rudder forces required for trim as the speed and engine power were varied were relatively high. In flying the attack bomber, pilots did not observe any unusual or undesirable lateral control characteristics. On the other hand pilots reported control coordination was difficult with the fighter when changing speed or power, with the result that inadvertent sideslipping occurred. When this motion occurred the airplane tended to roll and the pilot was required to apply aileron forces continually. Pilots also considered the rough-air control characteristics objectionable because of the aileron forces that were required when inadvertent sideslipping occurred. When the rudder forces were reduced with a spring-tab rudder, pilots noted a marked improvement in the lateral and directional control characteristics.

INTRODUCTION

In the course of flight tests made at the Langley Laboratory of the NACA to determine the flying qualities of an attack bomber and a fighter airplane, both airplanes

were found to have moderately high effective dihedral at moderate and high speeds but different directional stability and control characteristics. Unpublished tests in which high effective dihedral was found to be objectionable have been reported at the Ames Laboratory of the NACA. The present report gives a discussion of the effects of differences in the directional stability and control characteristics on the lateral control characteristics of a fighter and an attack bomber having approximately the same moderately high effective dihedral. The fighter airplane was tested with both the standard rudder and an experimental spring-tab rudder.

TEST RESULTS AND DISCUSSION

Figures 1 and 2 are three-view drawings of the two airplanes that were tested. Pertinent dimensions are given in the figures.

The effective dihedral was calculated from flight measurements of the variation of aileron angle with sideslip angle in steady sideslips and the variation of helix angle $pb/2V$ with aileron deflection in rudder-fixed aileron rolls. The effective-dihedral angle in degrees is given by the formula

$$\Gamma_e = (57.3)^2 \frac{C_{l_p} \left(\frac{d \frac{pb}{2V}}{d\delta_a} \right) \left(\frac{d\delta_a}{d\beta} \right)}{\frac{C_{l_\beta}}{\Gamma}}$$

where

Γ_e effective-dihedral angle, degrees

C_{l_p} variation of rolling-moment coefficient C_l with helix angle $pb/2V$ in radians (obtained from reference 1)

$\frac{d \frac{pb}{2V}}{d\delta_a}$ variation of helix angle $pb/2V$ in radians with aileron angle δ_a in degrees (obtained from rudder-fixed aileron rolls in flight)

$d\delta_a/d\beta$ variation of aileron angle δ_a in degrees with sideslip angle β in degrees (obtained from steady sideslips in flight)

$C_{l\beta}/\Gamma$ variation of rolling-moment coefficient C_l with sideslip angle β in radians per unit dihedral angle Γ in radians (obtained from reference 1)

In the rated-power clean condition at an indicated air-speed of 250 miles per hour, the effective dihedral was calculated to be 5.6° for the attack bomber and 5.4° for the fighter.

An indication of the degree of directional stability of the two airplanes is shown in figures 3 and 4 by the maximum change in sideslip angle due to abrupt full aileron deflection. These figures are time histories of rudder-fixed full-aileron rolls out of turns. These maneuvers were started at a lift coefficient of 1.35 for the fighter and 1.13 for the attack bomber. The maximum value of helix angle $p\beta/2V$ reached was 0.062 radian for both airplanes. Figures 3 and 4 show that the attack bomber had considerably more directional stability than the fighter; the maximum change in sideslip angle was 12° for the attack bomber and 21° for the fighter.

Figures 5 and 6 give the steady sideslip characteristics of the two airplanes. The curves of rudder angle and rudder force plotted against sideslip angle in these figures are also a measure of the directional stability of the airplanes. Inspection of the rudder-angle curves shows the greater directional stability of the attack bomber that was pointed out previously. The data for the fighter show a further decrease in directional stability at small sideslip angles, especially in left sideslips. The decrease in directional stability at small sideslip angles was even more apparent in flight at lower speeds.

In flying the fighter airplane, pilots reported that control coordination was difficult during changes in speed and power and that use of the controls to maintain steady flight in rough air resulted in objectionable rolling motions. Because of the relatively large variation of rudder trim force with speed and power with this airplane, pilots experienced difficulty in maintaining zero or negligible sideslip angles when the speed or power was changed. When appreciable sideslip angles developed, the airplane tended to roll and the pilot was required to

apply aileron forces continually to overcome the rolling moment due to sideslip. Because of the low directional stability, pilots also considered the lateral control characteristics unsatisfactory when flying at constant speed. In this case inadvertent sideslipping caused the objectionable tendency of the airplane to roll. When flying in rough air, if a gust caused the initial motion, pilots reported that it was especially difficult to return the airplane to steady flight.

In flying the attack bomber, pilots did not observe any unusual or undesirable lateral control characteristics. With the high directional stability and the small variation of rudder trim force with speed, the airplane was not as likely to reach angles of sideslip sufficient to cause rolling.

The effect of reducing the rudder forces of the fighter was investigated by equipping the airplane with an experimental spring-tab rudder. Figure 7 shows a comparison of the variation of rudder angle and rudder force with sideslip angle in steady sideslips for this airplane when equipped with the original rudder and the spring-tab rudder. With the spring-tab rudder the rudder force required to produce a given sideslip angle and the rudder forces required for trim were considerably reduced. Pilots noted that with the lighter rudder forces it was easier to maintain negligible sideslip angles and the lateral control characteristics were improved. The fact that improved lateral control characteristics resulted when the rudder forces were reduced is not consistent with various requirements based on the relation between rudder forces and the rolling response that have been proposed to set an upper limit on the allowable effective dihedral. For example, a tentative requirement has been proposed at the Ames laboratory which states that the angle of bank reached in 2 seconds should be less than 0.0035 or 0.0040 radian per pound of rudder force. From aileron-fixed rudder kicks made at 200 miles per hour in the clean, power-on condition, the angle of bank reached in 2 seconds was found to be 0.0026 radian per pound of rudder force for the attack bomber and 0.0048 radian per pound of rudder force for the fighter with the original rudder. The angle of bank that would be reached in 2 seconds with the fighter equipped with the spring-tab rudder was estimated to be 0.0082 radian per pound of rudder force at 200 miles per hour. Since the spring tab becomes more effective as the speed is increased, the

difference between the angles of bank reached in 2 seconds per pound of rudder force with the original rudder and the spring-tab rudder will be even greater at higher speeds. The data show that the attack bomber satisfied the proposed requirement and that the fighter with either the original rudder or the spring-tab rudder did not satisfy the proposed requirement. The fighter with the original rudder came much closer to satisfying the requirement than the same airplane with the spring-tab rudder, but the lateral control characteristics were better with the spring-tab rudder. A criterion for the upper limit of effective dihedral based on the angle of bank reached in 2 seconds with a given rudder force therefore appears unsatisfactory and such a criterion should take into account other factors such as the directional stability of the airplane.

The use of high effective dihedral in conjunction with light rudder forces has been suggested as a means of increasing the rolling performance of an airplane. Figures 8 and 9 show that considerable rolling velocity can be obtained by use of the rudder with both airplanes, but these figures also show that there is an appreciable time lag between application of the rudder and the resultant rolling motion. For this reason, pilots considered this means of obtaining a high rolling velocity to be unsatisfactory.

CONCLUSIONS

Flight tests of two airplanes, a fighter airplane and an attack bomber, which had different directional stability and control characteristics and approximately the same moderately high effective dihedral, led to the following conclusions concerning the effects of the different directional stability and control characteristics on the flying qualities of the two airplanes:

With the fighter, which had low directional stability and a large variation of rudder trim force with speed and power, pilots reported control coordination was difficult when changing speed or power, with the result that inadvertent sideslipping occurred. When this motion occurred, the airplane tended to roll and the pilot was required to apply aileron forces continually. Pilots also considered the rough-air control characteristics



objectionable because of the aileron forces that were required when inadvertent sideslipping occurred. When the rudder forces were reduced with a spring-tab rudder, pilots noted a marked improvement in the lateral and directional control characteristics.

With the high degree of directional stability and low directional trim forces of the attack bomber, pilots observed no unusual or undesirable lateral control characteristics.

Langley Memorial Aeronautical Laboratory
National Advisory Committee for Aeronautics
Langley Field, Va.

REFERENCE

1. Pearson, Henry A., and Jones, Robert T.: Theoretical Stability and Control Characteristics of Wings with Various Amounts of Taper and Twist. NACA Rep. No. 635, 1938.

[REDACTED]

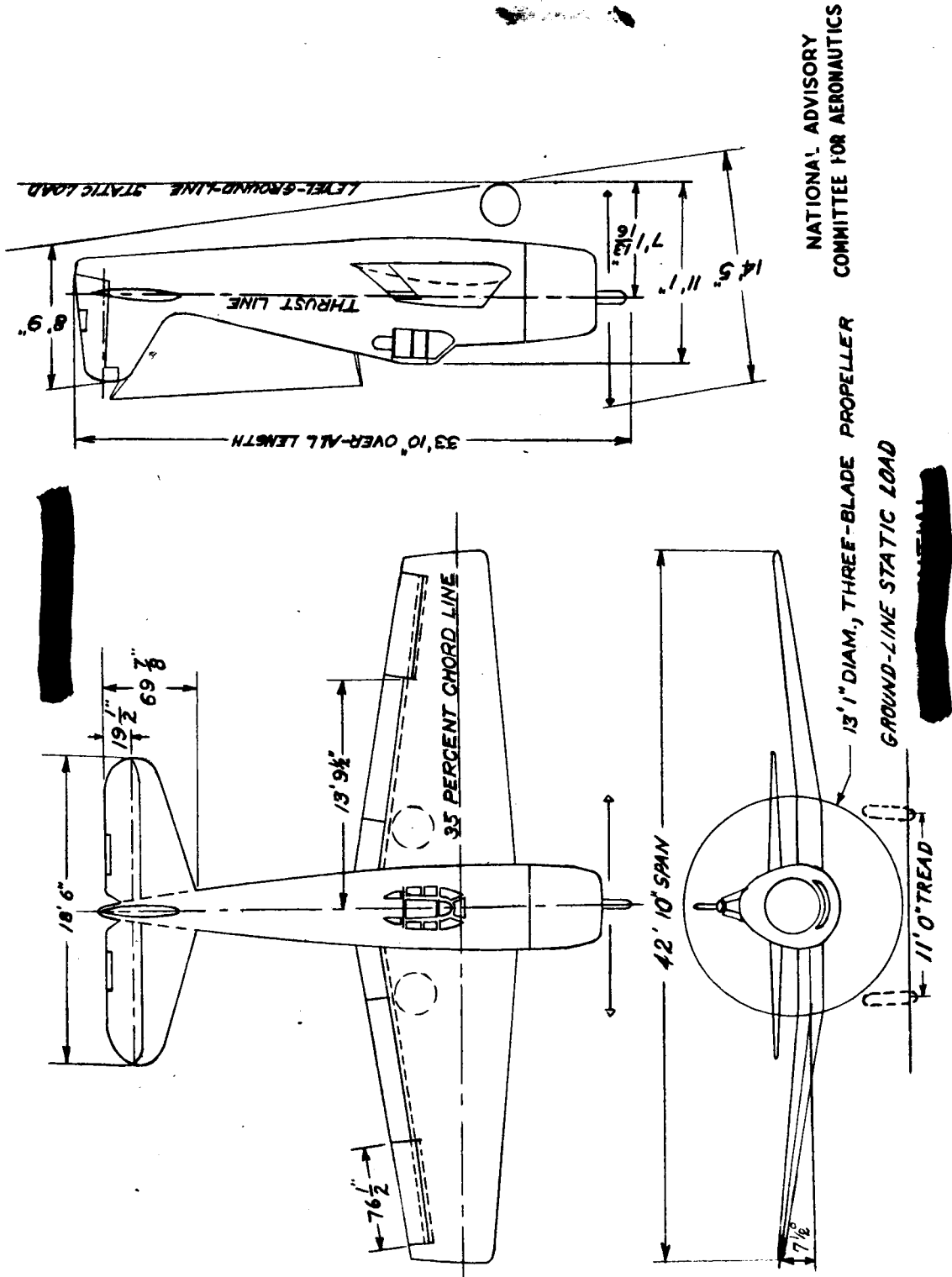

Figure 1.- Three-view drawing of fighter airplane tested.

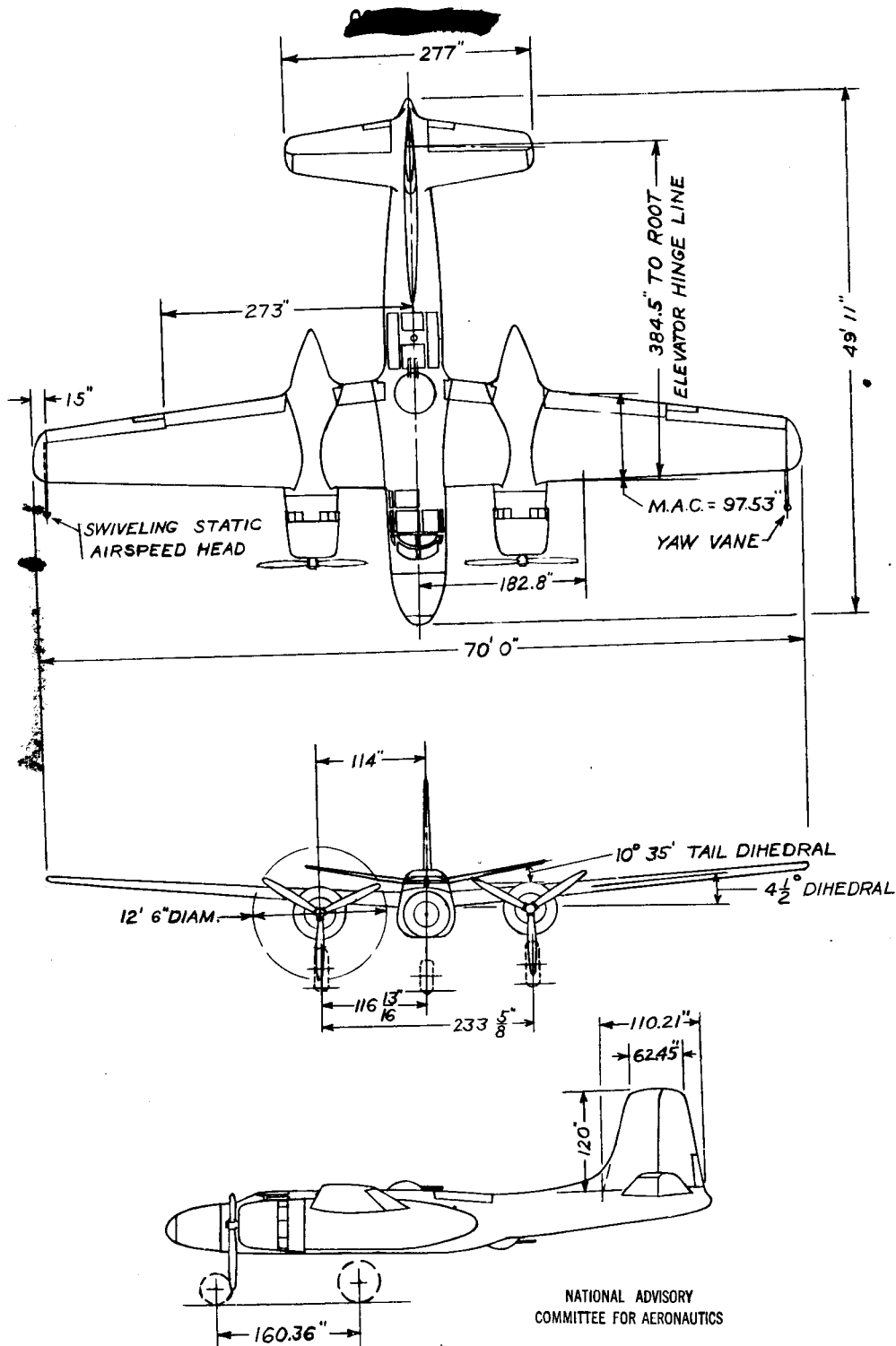

Figure 2.- Three-view drawing of attack bomber tested.

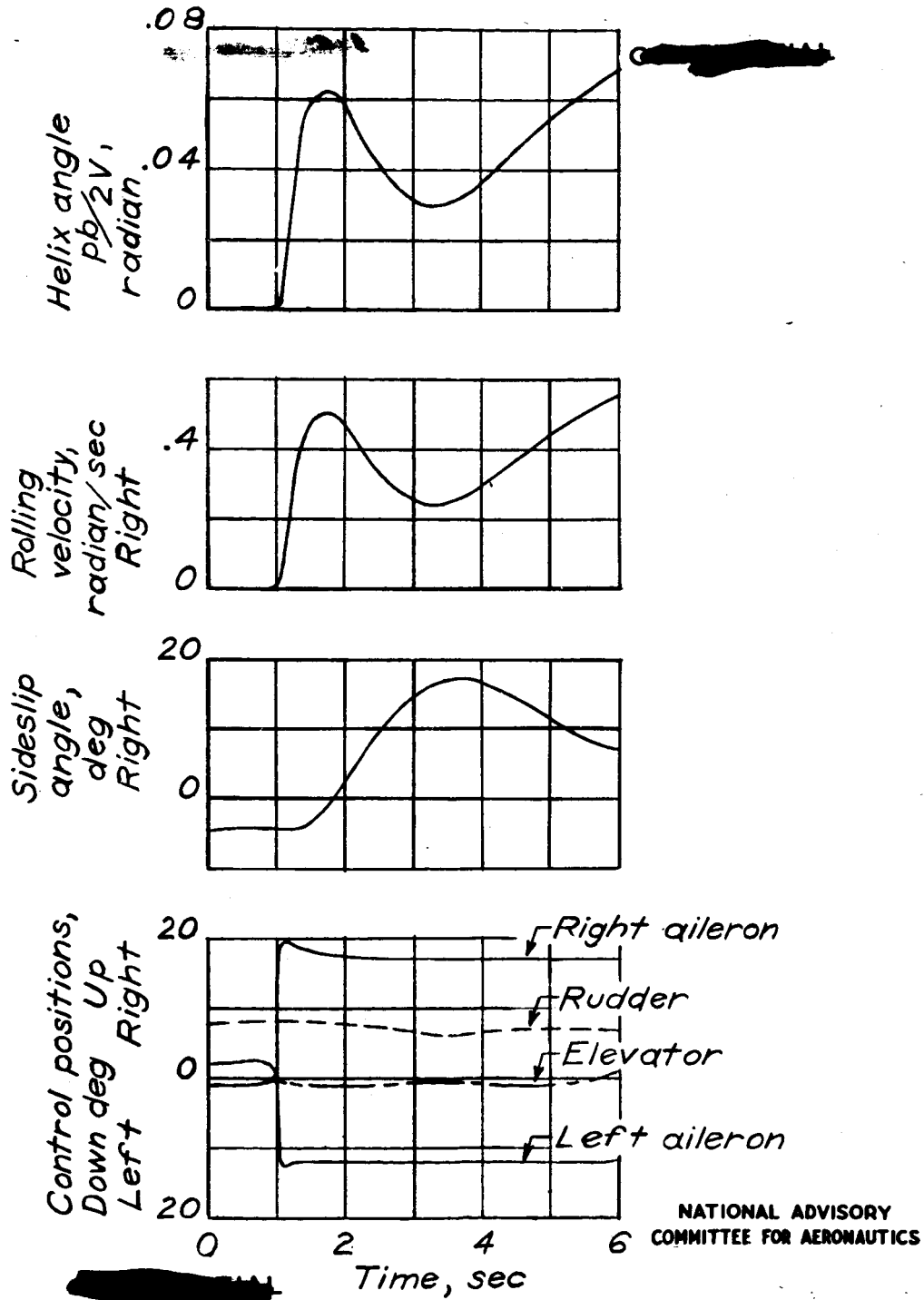
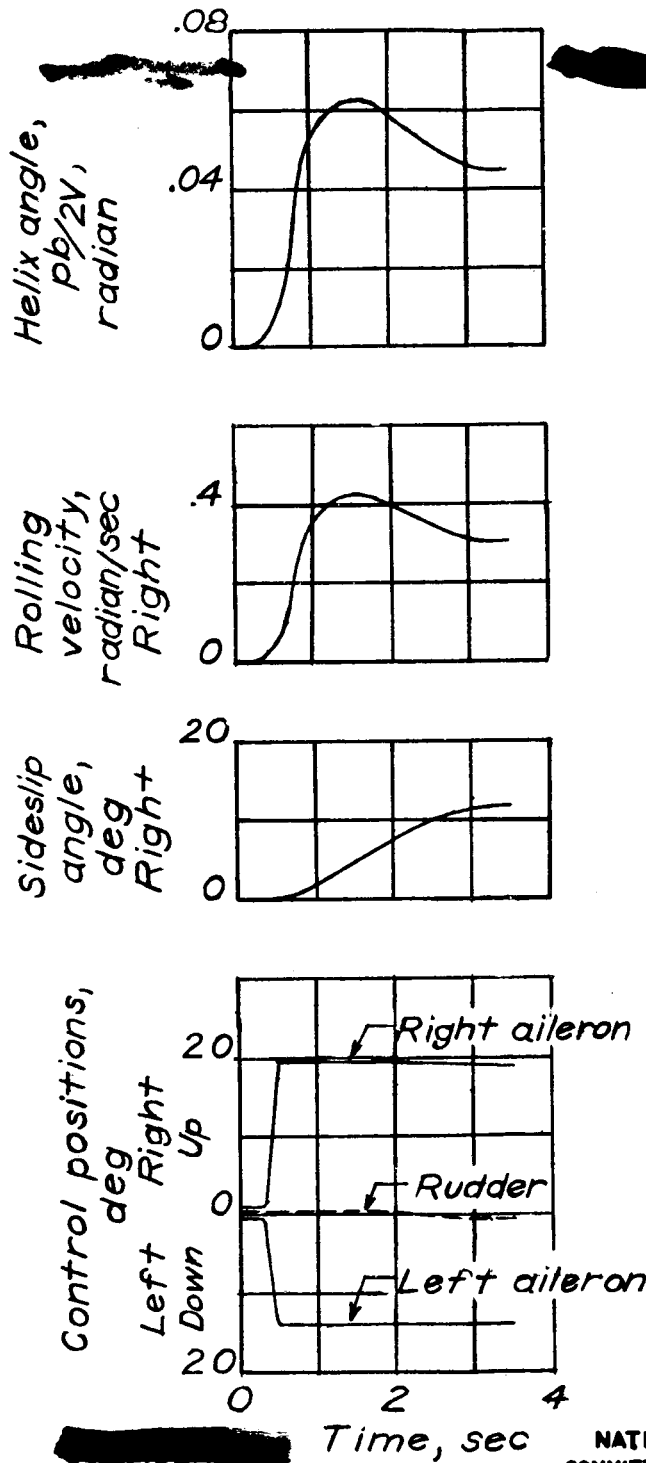
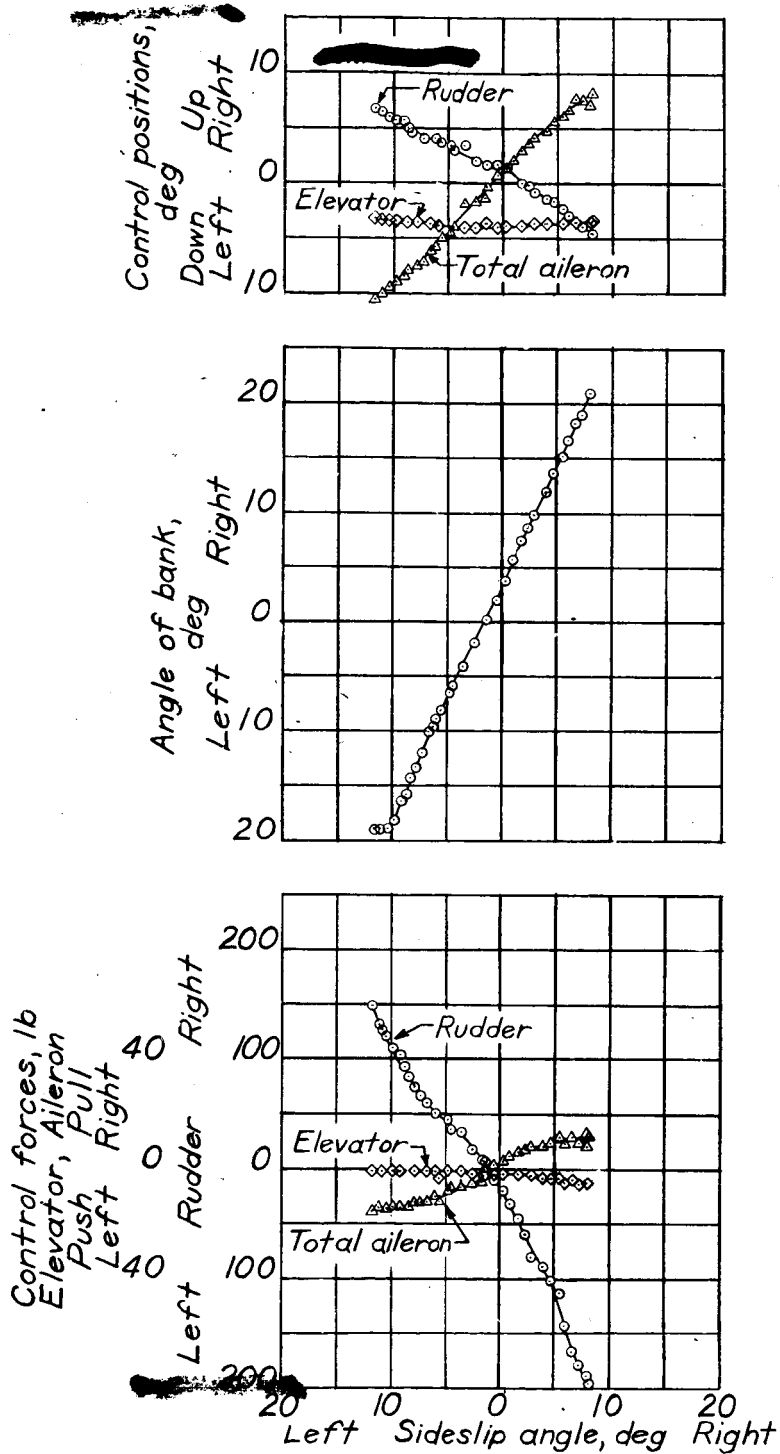

Figure 3.- Time history of a full-deflection aileron roll out of a left turn with rudder held fixed for fighter airplane. Clean condition; power for level flight; indicated air-speed, $V_i = 104$ miles per hour; lift coefficient, $C_L = 1.35$ at start of maneuver.



NATIONAL ADVISORY
COMMITTEE FOR AERONAUTICS

Figure 4.- Time history of a full-deflection aileron roll out of a left turn with rudder held fixed for attack bomber. Clean condition; power for level flight; indicated airspeed, $V_1 = 145$ miles per hour; lift coefficient, $C_L = 1.13$ (approx.) at start of maneuver.



NATIONAL ADVISORY
COMMITTEE FOR AERONAUTICS

Figure 5.- Steady sideslip characteristics for fighter airplane. Clean condition; rated power; indicated airspeed, $V_1 = 252$ miles per hour.

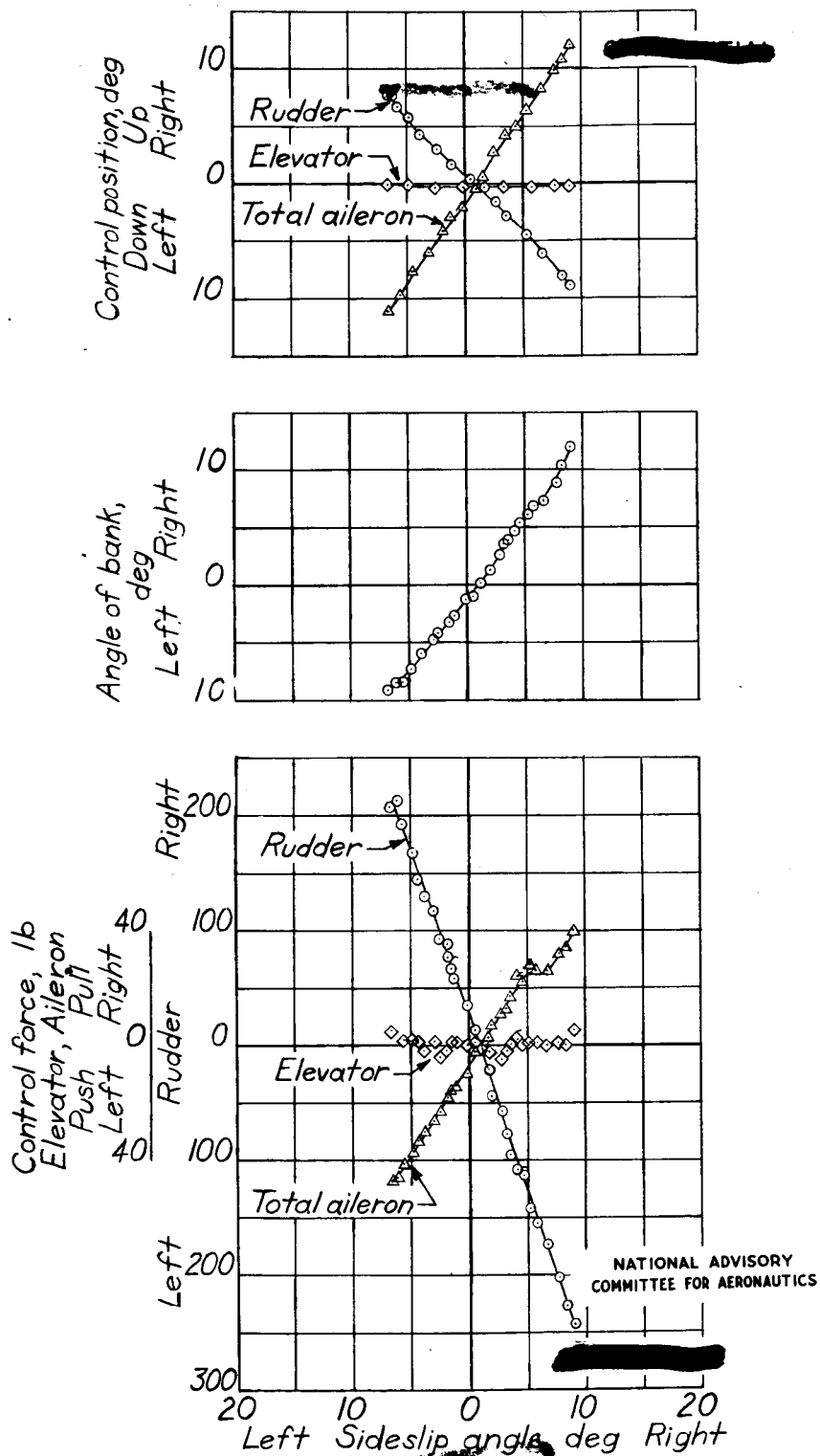

Figure 6.- Steady sideslip characteristics for attack bomber. Clean condition; rated power; indicated airspeed, $V_1 = 252$ miles per hour.

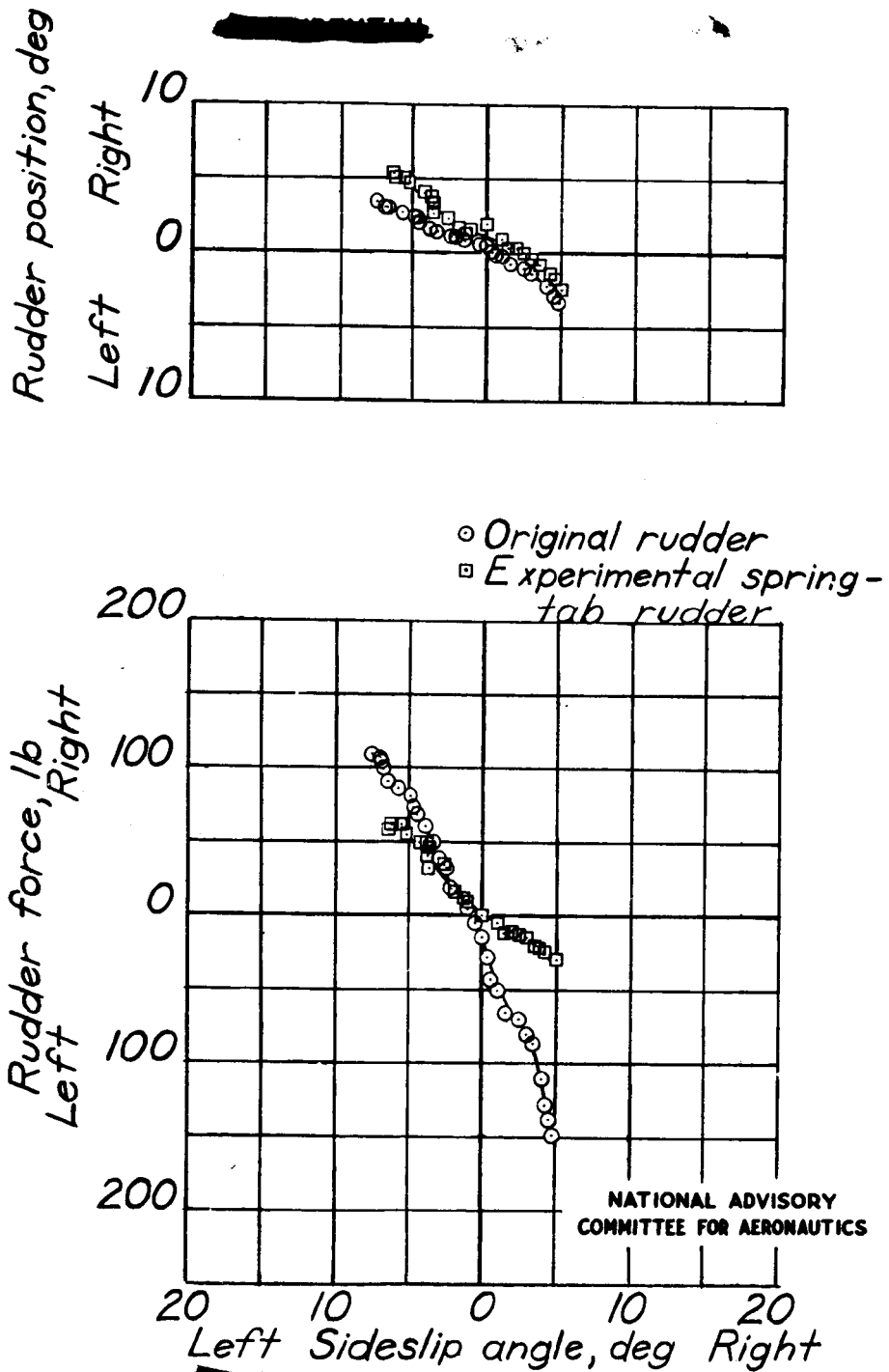

Figure 7.- Variation of rudder angle and rudder force with sideslip angle for fighter airplane with original rudder and experimental spring-tab rudder with 5-pound preload. Clean condition; rated power; indicated airspeed, $V_1 = 300$ miles per hour.

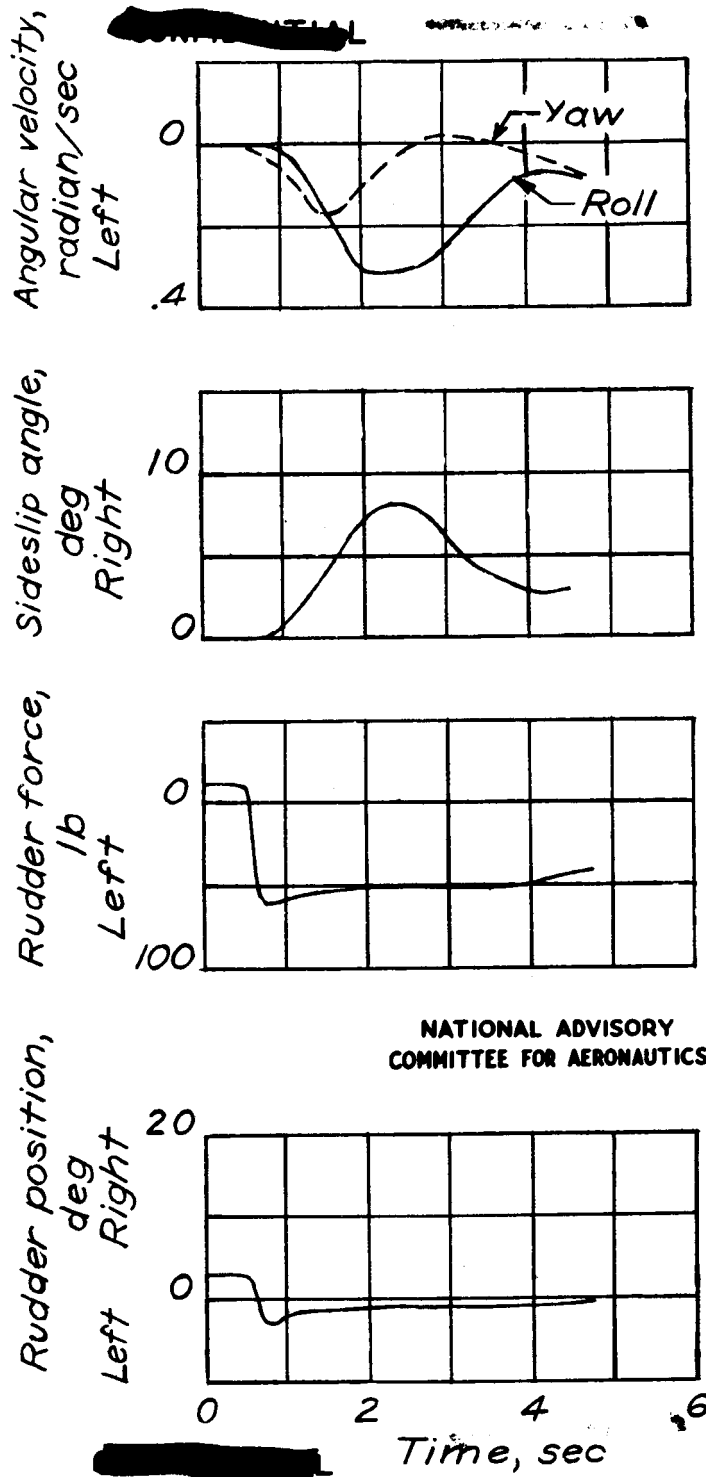

Figure 8.- Time history of a rudder kick with ailerons held fixed for fighter airplane. Clean condition; level-flight power; indicated airspeed, $V_i = 197$ miles per hour.

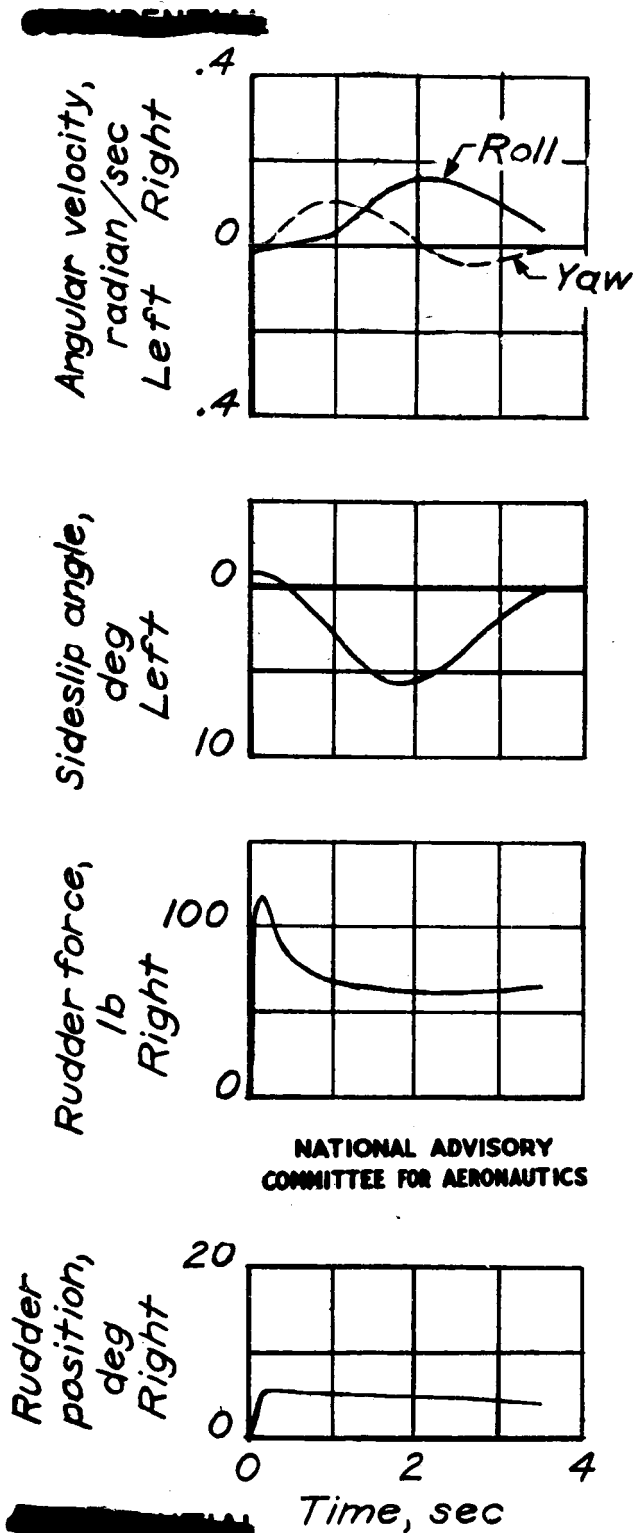

Figure 9.- Time history of a rudder kick with ailerons held fixed for attack bomber. Clean condition; rated power; indicated airspeed, $V_1 = 200$ miles per hour.

TITLE: Flight Tests of Two Airplanes Having Moderately High Effective Dihedral and Different Directional Stability and Control Characteristics

AUTHOR(S): Sjoberg, S. A.

ORIGINATING AGENCY: National Advisory Committee for Aeronautics, Washington, D. C.

PUBLISHED BY: (Same)

ATI- 13891

REVISION none

ORIG. AGENCY NO.

CB-L5H08

PUBLISHING AGENCY NO.

DATE	DOC. CLASS.	COUNTRY	LANGUAGE	PAGES	ILLUSTRATIONS
Oct '45	Unclass.	U.S.	Eng.	15	graphs, drwgs

ABSTRACT:

A twin-engine attack bomber, the A-27, and single-engine fighter, the P-47, were tested to determine the effects that the different directional and control characteristics had on flying qualities. The fighter showed that control coordination was difficult when changing speed or power, with the result that inadvertent sideslipping occurred. No unusual or undesirable lateral control characteristics were noted in flight testing the bomber.

DISTRIBUTION: Request copies of this report only from Originating Agency

DIVISION: Aerodynamics (2)

SECTION: Stability and Control (1)

SUBJECT HEADINGS: Airplanes - Stability (08487); Airplanes - Flight characteristics (08443); Airplanes - Control characteristics (08393); A-27 (08487); P-47 (08487) (08443)

ATI SHEET NO.: R-2-1-30

Air Documents Division, Intelligence Department
Air Materiel Command

AIR TECHNICAL INDEX

Wright-Patterson Air Force Base
Dayton, Ohio