

# Failure Mechanisms of Polymer-Reinforced Concrete Masonry Walls Subjected to Blast

James S. Davidson<sup>1</sup>; Jeff W. Fisher<sup>2</sup>; Michael I. Hammons<sup>3</sup>; Jonathan R. Porter<sup>4</sup>; and Robert J. Dinan<sup>5</sup>

**Abstract:** Recent terrorist attacks indicate the improvised explosive device as the choice terror tactic. Over the past decade, the U.S. Department of Defense has encouraged and sponsored research toward developing methods of reinforcing structures to protect building occupants from the effects of external explosion. The focus of wall reinforcement research has recently shifted from applying stiff fiber-reinforced composites to using lower-strength higher-elongation elastomeric polymers that can be easily applied to the wall interior. This paper presents recent efforts that have demonstrated an innovative use of thin-membrane elastomeric polymers to prevent breaching and collapse of unreinforced masonry walls subjected to blast. The complex array of failure mechanisms observed from recent explosive tests is discussed. Effects of structural and nonstructural parameters are described with the aid of finite-element simulations. Finally, the needs and direction of future blast reinforcement developments are outlined.

**DOI:** 10.1061/(ASCE)0733-9445(2005)131:8(1194)

**CE Database subject headings:** Blast loads; Masonry; Failures; Finite elements; Polymers; Terrorism; Concrete, reinforced.

## Introduction

Terrorist bomb attacks commonly target populated facilities, such as residential buildings, office buildings, and restaurants, not to mention military and diplomatic facilities. Most casualties and injuries sustained during external explosions are not caused by the pressure, heat, or container fragments resulting from a bomb detonation. Rather, most injuries are blunt trauma and penetration injuries caused by the disintegration and fragmentation of walls, the shattering of windows, and by nonsecured objects that are propelled at high velocities by the blast. Ensuring that the exterior walls of a structure are able to withstand a blast without producing deadly fragments is a critical part of minimizing injuries to building occupants.

Most existing buildings were not designed to withstand blast loading. Therefore, existing exterior walls of high risk facilities must be strengthened to improve blast resistance. The resistance of a wall to blast loads can be enhanced by increasing the mass and ductility of the wall with additional concrete and steel reinforcement, which can be time consuming and expensive. For this

reason among others, a need has arisen for cost effective methods of reinforcing existing concrete and masonry walls.

Since 1995, the Air Force Research Laboratory (AFRL) at Tyndall Air Force Base, Fla., has conducted research toward developing lightweight, expedient methods of retrofit-strengthening structures for blast loading. One focus over recent years has been on strengthening unreinforced, nonload bearing concrete masonry walls. This focus is due to: (1) The frequent use of concrete masonry in building construction typically occupied by a high density of occupants and (2) the susceptibility of these structures to fragmentation under relatively low blast pressure.

A wide range of potential external reinforcement materials, including carbon and glass fiber-reinforced composites, aramid and geotextile fabrics, etc., were investigated by AFRL engineers and other agencies involved in blast reinforcement technology development (Barbero et al. 1997; Crawford et al. 1997a,b; Slawson et al. 1999). Their methods demonstrated the ability to protect against blast, however the feasibility of widespread application was challenged by difficulties in developing cost and time efficient methods of applying the reinforcement to the structure.

In 1999, AFRL began experimenting with other classes of "neat" (no fiber reinforcement) polymers. A total of 21 prospective polymers were evaluated in the initial phases of the project. Seven of the materials were extruded thermoplastic sheet materials, 13 were spray-on polymers, and one was a brush-on polymer. As a group, the initial polymer candidates possessed ultraviolet and temperature stability, flame resistance, and could be purchased at acceptable cost. While all were reportedly nontoxic once in place and cured, the spray-on and brush-on polymers were considered toxic during application, requiring special handling equipment, such as protective clothing, gloves, masks, and respirators (Knox et al. 2000; Davidson et al. 2004).

Mechanical properties were evaluated for all of the candidate polymers. The extruded thermoplastics were stiffer and stronger [secant modulus: 113,000 kPa (164,000 psi); maximum tensile strength: 55,800 kPa (8,100 psi)] than the other classes of materials. However, the extruded thermoplastics were eliminated from the initial phase of the investigation due to constructability chal-

<sup>1</sup>Associate Professor, Dept. of Civil and Environmental Engineering, The Univ. of Alabama at Birmingham, Birmingham, AL 35294.

<sup>2</sup>Senior Engineer, Applied Research Associates, Inc., P.O. Box 40128, Tyndall Air Force Base, FL 32403.

<sup>3</sup>Principal Engineer, Applied Research Associates, Inc., 5000 NW 27th Ct. Suite E, Gainesville, FL 32606.

<sup>4</sup>Senior Research Engineer, Air Force Research Laboratory, 139 Barnes Dr., Suite 2, Tyndall Air Force Base, FL 32403.

<sup>5</sup>Senior Research Engineer, Air Force Research Laboratory, 139 Barnes Dr. Suite 2, Tyndall Air Force Base, FL 32403.

Note. Associate Editor: Barry Thomas Rosson. Discussion open until January 1, 2006. Separate discussions must be submitted for individual papers. To extend the closing date by one month, a written request must be filed with the ASCE Managing Editor. The manuscript for this paper was submitted for review and possible publication on January 29, 2004; approved on November 19, 2004. This paper is part of the *Journal of Structural Engineering*, Vol. 131, No. 8, August 1, 2005. ©ASCE, ISSN 0733-9445/2005/8-1194-1205/\$25.00.

# Report Documentation Page

*Form Approved  
OMB No. 0704-0188*

Public reporting burden for the collection of information is estimated to average 1 hour per response, including the time for reviewing instructions, searching existing data sources, gathering and maintaining the data needed, and completing and reviewing the collection of information. Send comments regarding this burden estimate or any other aspect of this collection of information, including suggestions for reducing this burden, to Washington Headquarters Services, Directorate for Information Operations and Reports, 1215 Jefferson Davis Highway, Suite 1204, Arlington VA 22202-4302. Respondents should be aware that notwithstanding any other provision of law, no person shall be subject to a penalty for failing to comply with a collection of information if it does not display a currently valid OMB control number.

1. REPORT DATE <b>AUG 2005</b>	2. REPORT TYPE	3. DATES COVERED <b>00-00-2005 to 00-00-2005</b>			
4. TITLE AND SUBTITLE <b>Failure Mechanisms of Polymer-Reinforced Concrete Masonry Walls Subjected to Blast</b>		5a. CONTRACT NUMBER			
		5b. GRANT NUMBER			
		5c. PROGRAM ELEMENT NUMBER			
6. AUTHOR(S)		5d. PROJECT NUMBER			
		5e. TASK NUMBER			
		5f. WORK UNIT NUMBER			
7. PERFORMING ORGANIZATION NAME(S) AND ADDRESS(ES) <b>Senior Research Engineer, Air Force Research Laboratory, 139 Barnes Dr. Suite 2, Tyndall Air Force Base, FL, 32403</b>		8. PERFORMING ORGANIZATION REPORT NUMBER			
9. SPONSORING/MONITORING AGENCY NAME(S) AND ADDRESS(ES)		10. SPONSOR/MONITOR'S ACRONYM(S)			
		11. SPONSOR/MONITOR'S REPORT NUMBER(S)			
12. DISTRIBUTION/AVAILABILITY STATEMENT <b>Approved for public release; distribution unlimited</b>					
13. SUPPLEMENTARY NOTES <b>JOURNAL OF STRUCTURAL ENGINEERING, August 2005</b>					
14. ABSTRACT					
15. SUBJECT TERMS					
16. SECURITY CLASSIFICATION OF:			17. LIMITATION OF ABSTRACT <b>Same as Report (SAR)</b>	18. NUMBER OF PAGES <b>14</b>	19a. NAME OF RESPONSIBLE PERSON
a. REPORT <b>unclassified</b>	b. ABSTRACT <b>unclassified</b>	c. THIS PAGE <b>unclassified</b>			

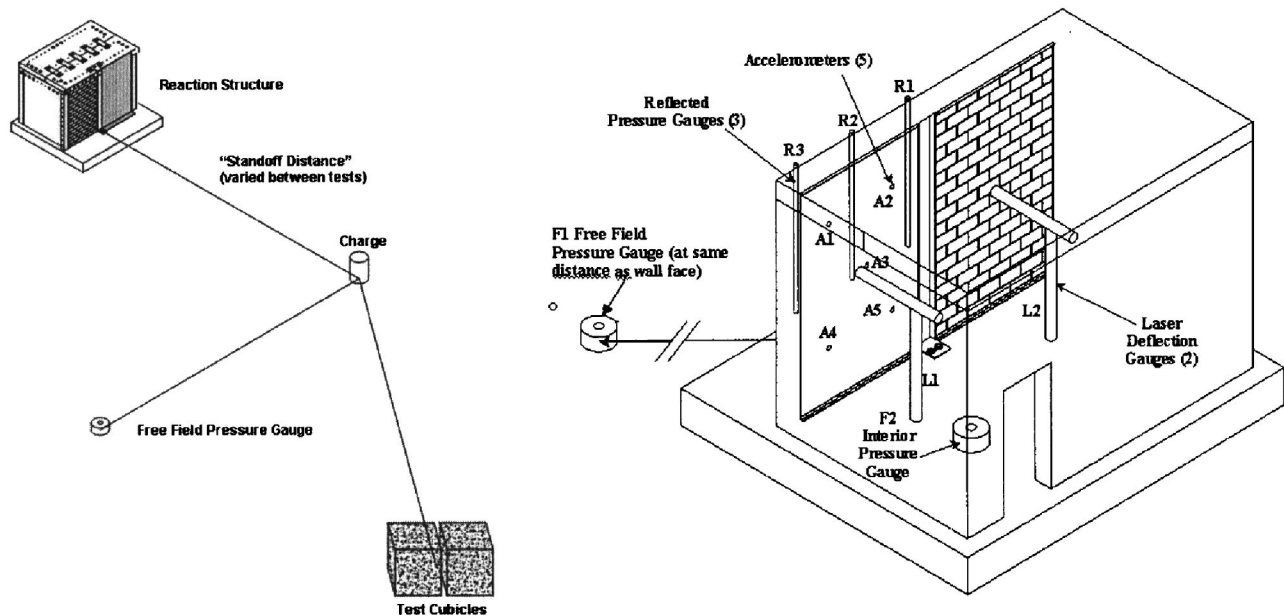

Fig. 1. Full-scale explosive test setup and enlargement of reaction structure illustrating instrumentation setup

Challenges associated with using extruded panels for large-scale applications. The brush-on polymer was weak, brittle, and required long cure times, which eliminated it from consideration in the first phase of the program (Knox et al. 2000; Davidson et al. 2004).

The 13 spray-on polymers were comprised of seven polyurethanes, one polyurea, and five polyurea/urethanes. The polymers considered have fast gel and cure times, making application to vertical and overhead surfaces feasible. The polyureas are typically stiffer than polyurethanes but have less elongation capacity. As a result, urethanes are often combined with ureas to increase elongation capacity. Based primarily on stiffness and elongation characteristics, the spray-on polyureas were selected for further evaluation as a blast reinforcement material. A pure polyurea was chosen over the polyurethanes for the first phase of explosive tests due to secondary considerations such as availability, flammability characteristics, and cost. These polymers have many commercial applications ranging from marine applications to linings for feed and storage tanks. The spray-on polymer that was chosen for explosive test evaluation has an initial modulus of approximately 234,000 kPa (34,000 psi), a clearly discernable yield point at approximately 12,000 kPa (1,700 psi), an ultimate tensile strength of approximately 14,000 kPa (2,000 psi), and an elongation capacity of approximately 90%.

In December 2000, three full-scale explosive tests were planned toward determining the effectiveness of the polymers to improve the blast resistance of unreinforced masonry walls (Connell 2002; Davidson et al. 2004). The overall objectives of the first three tests were to assess the general effectiveness and level of protection provided by the elastomeric polymer coating. Although the walls sustained significant damage, the first three tests demonstrated that a thin coating [approximately 3.2 mm (1/8 in.)] of the elastomeric polymer on the interior of unreinforced masonry walls can reduce the distance to an explosion that would cause catastrophic failure resulting in occupant injury or death by as much as 80% (Dinan et al. 2003; Davidson et al. 2004).

Based on this successful proof-of-concept testing, additional research and testing was undertaken by AFRL. A recent paper by

the writers (Davidson et al. 2004) summarized test methods and general results of the first three proof-of-concept masonry wall tests. Four additional explosive tests were subsequently conducted with the goal of understanding the causes and influence of localized fracture on the progression and overall failure of polymer-reinforced concrete masonry walls. An understanding of failure mechanisms would then lead to the development of design-oriented analytical models that can be used to predict maximum wall deflection and collapse of polymer-reinforced masonry walls exposed to a specified threat. This paper discusses the damage and failure mechanisms observed from 12 polymer-reinforced masonry walls during seven explosive tests designed to establish the limits of blast resistance effectiveness of polymer-reinforced masonry walls.

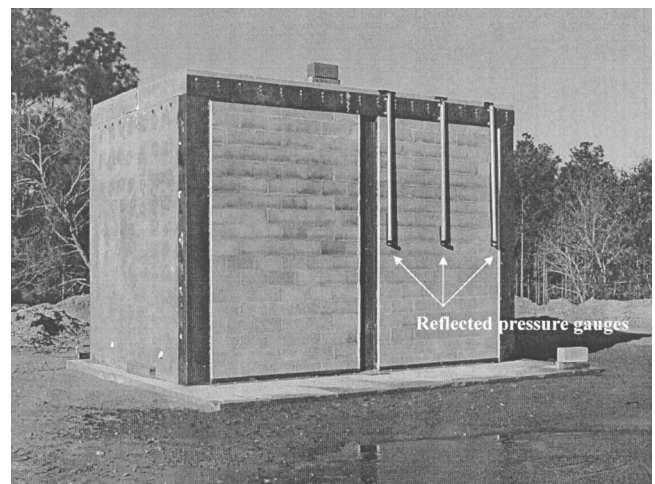

Fig. 2. Reaction structure with masonry walls ready for testing

**Table 1.** Description of Polymer Reinforced Masonry Wall Tests

Wall	Component description	Data objective	Peak pressure/impulse	Maximum displacement	Failure characterization
1	3.7 m by 2.3 m wall of 200 mm CMU block with 3 mm thick polymer reinforcement on the interior face, 15 cm overlap onto supports over angles.	Measure reflective pressures, wall acceleration, wall deflection, and capture video of wall response. Side by side comparison to control wall.	393 kPa/1,460 kPa ms	184 mm	Control wall severely fragmented and collapsed. Upper three courses front face shell fracture entire wall width. Flexural hinge formed at top, bottom, and height wise center. No tearing of the polymer.
2	3.7 m by 2.3 m wall of 200 mm CMU block with 3 mm thick polymer reinforcement on the interior face, 15 cm overlap onto supports over angles.	Measure reflective pressures, wall acceleration, deflection, and capture video of wall response. Exploring polymer reinforcement limitations.	1,640 kPa/2,740 kPa ms	Collapse	Wall was severely overloaded and collapsed. Polymer torn at top and bottom connection to frame and height wise center. Polymer provided some effectiveness at holding fragments together.
3	3.7 m by 2.3 m wall of 200 mm CMU block with 6 mm thick polymer reinforcement on the interior face, 30 cm overlap onto supports over angles.	Measure reflective pressures, wall deflection, and capture video of wall response. Investigate advantages of increased polymer thickness.	409 kPa/1,560 kPa ms	239 mm	Upper three courses front face fracture entire wall width. Mortar joint cracked at midheight. Flexural hinge formed under the third course from the top. Polymer reinforcement torn in two places under the third course near the width-wise center of the wall. No breach of block fragments.
4	3.7 m by 2.3 m wall of 200 mm CMU block with 3 mm thick polymer reinforcement on interior and exterior faces, 30 cm overlap onto supports over angles.	Measure reflective pressures, wall deflection, and capture video of wall response. Investigate advantages of polymer coating on both sides.	446 kPa/1,650 kPa ms	198 mm	Similar flexural mechanism as Wall 3. Polymer reinforcement torn under the third course at one side of the wall. No breach of block fragments.
5	2.4 m by 2.4 m wall of 200 mm CMU block with 3 mm thick polymer reinforcement on the interior face, 15 cm overlap onto supports.	Measure reflective pressures, wall deflection, and capture video of wall response. Side by side comparison with Wall 6.	442 kPa/1,490 kPa ms	125 mm	Front face fracture over the top and bottom third of the wall. Small tear of the polymer at one side above the bottom course. No breach of block fragments.
6	2.4 m by 2.4 m wall of 200 mm CMU block with 3 mm thick polymer reinforcement on the interior face, 30 cm overlap onto supports.	Measure reflective pressures, wall deflection, and capture video of wall response.	476 kPa/1,500 kPa ms	150 mm	Front face fracture over the top and bottom third of the wall. No tearing of the polymer. No breach of block fragments.
7	3.0 m by 2.3 m wall of 200 mm CMU block with 3 mm thick polymer reinforcement on the interior face, standard window opening centered, 30 cm overlap onto supports.	Measure reflective pressures, wall deflection, and capture video of wall response. Target impact of window opening on wall response and polymer effectiveness.	366 kPa/1,340 kPa ms	196 mm	Approximately one-half of the blocks incurred front face shell fracture. More mortar joint cracks than similar tests without window frames. Small polymer tear at one corner of the window frame. No breach of block fragments.

**Table 1.** (Continued.)

Wall	Component description	Data objective	Peak pressure/impulse	Maximum displacement	Failure characterization
8	3.0 m by 2.3 m wall of 200 mm CMU block with 3 mm thick polymer reinforcement on the interior face, standard door opening centered, 30 cm overlap onto supports.	Measure reflective pressures, wall deflection, and capture video of wall response. Target impact of door opening on wall response and polymer effectiveness.	366 kPa/1,340 kPa ms	143 mm	Approximately one-quarter of the blocks incurred front face shell fracture. Three mortar joint cracks on the left side of the door frame formed flexural hinge. The polymer tore at the bottom connection to the frame and the bottom three courses breached. The wall was separated from the door frame.
9	3.7 m by 4.9 m wall of 200 mm CMU block with 3 mm thick polymer reinforcement on the interior face, stiffened frame door opening centered, 30 cm overlap onto supports.	Measure reflective pressures, wall deflection, and capture video of wall response. Target impact of door opening with stiffened door on wall response. Using larger wall area to minimize edge effects.	299 kPa/1,300 kPa ms	241 mm	Front face shell fracture along the top three courses and second and third course from the bottom on the right side of the door. The polymer tore from both sides to the approximately the door edge, at the mortar joint one course above the door frame.
10	3.7 m by 4.9 m wall of 200 mm CMU block with 3 mm thick polymer reinforcement on the interior face, large heavily anchored window opening centered with polymer overlap, 30 cm overlap onto supports.	Measure reflective pressures, wall deflection, and capture video of wall response. Target impact of large window tied to the polymer on wall response. Using larger wall area to minimize edge effects.	263 kPa/1,260 kPa ms	158 mm	The bottom third of the blocks and blocks around the rigid window frame incurred front face shell fracture. Some polymer tears occurred along the mortar joint above the second course from the bottom. No breach of block fragments.
11	3.7 m by 2.3 m wall of 200 cm CMU block WITHOUT mortar with 3 mm thick polymer reinforcement on the interior face, 30 cm overlap onto supports.	Measure reflective pressures, wall deflection, and capture video of wall response. Looking to understand influence of mortar strength on response. Side by side comparison to identical wall without polymer bonded to block (Wall 12).	289 kPa/1,280 kPa ms	96.8 mm	The bottom three courses of blocks and a few other blocks sporadically distributed incurred front face shell fracture. Polymer tears of approximately 30 cm from both sides at the height-wise center of the walls. No breach of block fragments.
12	3.7 m by 2.3 m wall of 200 cm CMU block WITHOUT mortar, 3 mm polymer reinforcement isolated from block (i.e., no bond) with plastic membrane on the interior face, 30 cm overlap onto supports.	Measure reflective pressures, wall deflection, and capture video of wall response. Investigate effectiveness and failure mechanism of unbonded catcher membrane. Side by side comparison to identical wall with polymer bonded to block (Wall 11).	279 kPa/1,280 kPa ms	863.6 mm (collapse)	The polymer connection to the top support tore and the wall collapsed.

Note: CMU=Concrete masonry unit.

## Explosive Tests

Seven explosive tests were conducted that involved a total of 12 polymer-reinforced masonry walls. In each of the tests, the walls were constructed and tested in reusable reaction structures designed to withstand repeated blast loads. Illustrations of the test setup and instrumentation are provided in Fig. 1, and an image of a structure ready for testing is provided in Fig. 2. Additional details of explosive test methodology are provided in Davidson et al. (2004).

Some wall panels were coated with polymer, while other walls were not coated (control walls) for a direct evaluation of polymer reinforcement effectiveness. "Effectiveness" or "success" is defined as the ability of the reinforcement to prevent catastrophic breaching or collapse of the wall that would cause harm to the occupants. The walls were constructed by masonry contractors using standard construction materials and following standard construction practice for unreinforced infill concrete masonry. A 9.5 mm (3/8 in.) thick layer of mortar was applied only along the front and back faces of the block (no mortar over the webs). The walls were laterally restrained at the top and bottom only, and allowed to translate along vertical edges, thereby enforcing a one-way flexural response. Although the space between the roof and the top of the walls was also tuck point filled with mortar, the walls supported no vertical load except self-weight. Blast loads were then applied by detonating explosive charges at designed standoff distances. Table 1 provides a synopsis of the objectives for each test. Note that some of the walls included door and window openings.

Pressures, accelerations, and deflections experienced by the walls were measured using pressure gauges, single-axis accelerometers, and deflection gauges, respectively (Fig. 1). Prior to each of the tests, predictions were made for each gauge using blast and wall analysis software (Thornburg 2004). Reflected pressure gauges were mounted in pipes in front of the test panels, and suspended from the top of the reaction structure (Fig. 2). The accelerometers were attached to the interior face of the polymer-reinforced wall panels and deflection gauges were mounted at the center of the test walls. High-speed cameras [1,000 frames per second (fps)] were used to capture wall response, primarily from outside the reaction structure. Lower-speed (30 fps) cameras were directed at wall segments to capture local effects from inside the reaction structure.

## Failure Mechanisms

Failure description of the system under blast loading is complex and highly sensitive to the peak pressure, impulse, and support conditions. It is crucial, however, to develop an engineering description of the resistance to lateral pressure, provided by the wall system up to its ultimate load carrying capacity, so that design and analysis methodology can be developed for the use of polymer reinforcement. Traditional beam and yield line methods used for static analysis of unreinforced concrete masonry unit (CMU) walls for out-of-plane loads give conservative results for walls subjected to low pressures. Walls subjected to lateral loads can develop additional resistance through arching mechanisms if the necessary boundary conditions exist and the shear capacity is not exceeded (Drysdale et al. 1994). However, complexity is added when the loading is the result of blast reflective pressure. The engineering basis used with methods of static analysis disappears as components of the wall fracture and overall geometry breaks

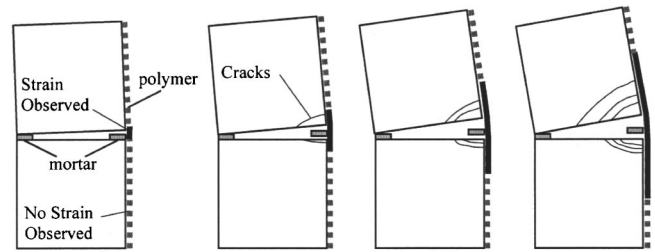

Fig. 3. Progressive failure of polymer reinforced mortar joint in flexure

down. It is difficult to precisely control an explosive test event. Furthermore, predicting the lateral blast pressure that can be resisted by a polymer-reinforced wall is complicated by: (1) The variability in mortar joint flexural bond strength, (2) inconsistencies in polymer thickness or continuity over surface irregularities, and (3) fracture of the front face shell of the masonry blocks in early stages of the response.

Overall, the behavior of the polymer-reinforced masonry wall subjected to blast is characterized by: (1) A stress wave that propagates through the wall that may fracture or weaken parts of the system, (2) fracture of the front face shell of some of the masonry blocks in the first few milliseconds of the response due directly to shock load pressure, (3) high localized stresses at the block/mortar interfaces closest to the supports, which may result in tearing of the polymer coating, (4) fracture of the front face shell of some of the masonry blocks due to flexural compression of the front face of the wall, (5) tearing of the polymer reinforcement in tension as the wall flexes and mortar joints expand, and (6) tearing or loss of adhesion of the polymer at the connection to the roof of the host structure that results in collapse of the system. An overall characterization of the failure mechanism of each polymer-reinforced wall is provided in Table 1. All control walls failed catastrophically and provided little additional failure mechanism data.

Several static tests were performed in the laboratory to help one understand the interaction between the spray-on polymer reinforcement and the masonry. Flexural bond strength tests on CMU prisms (two blocks stacked) with and without polymer reinforcement were conducted according to ASTM C1072. The overall goal of these tests was to understand the static flexural capacity of polymer-reinforced sections and observe polymer

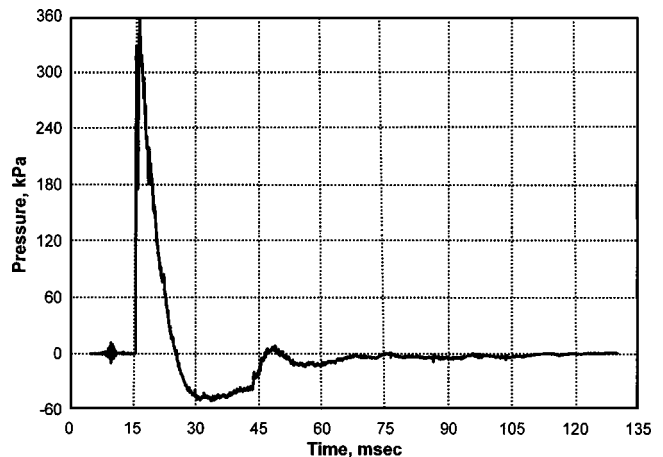
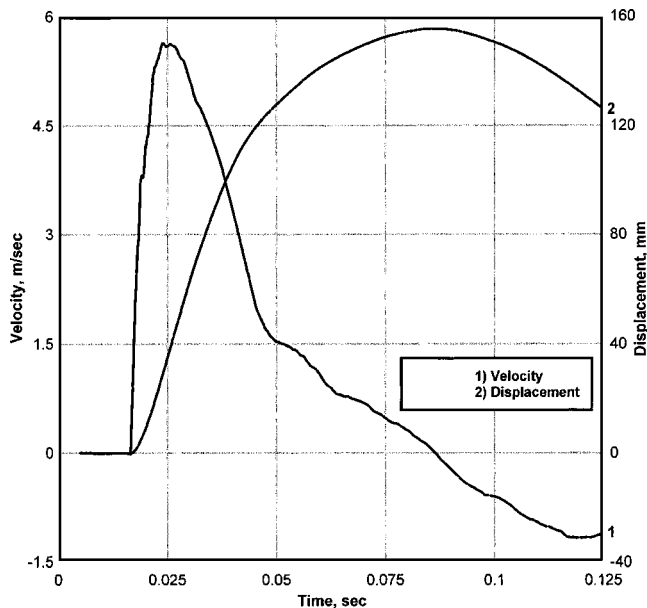

Fig. 4. Wall 1 reflected pressure



**Fig. 5.** Velocity and displacement: Wall 1, Gauge A2

strain behavior. Also, adhesion tests were conducted with various substrates (steel, dry concrete, and wet concrete) using various priming/preparation processes (Dinan et al. 2003).

The spray-on polymer treatment demonstrated an excellent bond between the polymer and the masonry. Fig. 3 illustrates the progression of failure of a polymer-reinforced mortar joint in flexure. The extent of strained polymer increases as the blocks separate. It is important to realize that the tensile bond between the mortar and the masonry is only 50–150 psi. Furthermore, the compressive strength of the concrete used in hollow concrete masonry blocks can be as little as 1,500 psi (10 MPa) based on net area and the tensile strength is only approximately 10% of the compressive strength (Drysdale et al. 1994). Once the polymer begins to strain, the length of polymer being strained extends across the mortar joint for slightly more than one-half of the block height in each direction. The bond between block and polymer is stronger in shear than the tensile strength of the concrete. Consequently, the polymer cracks the concrete as strain progresses.

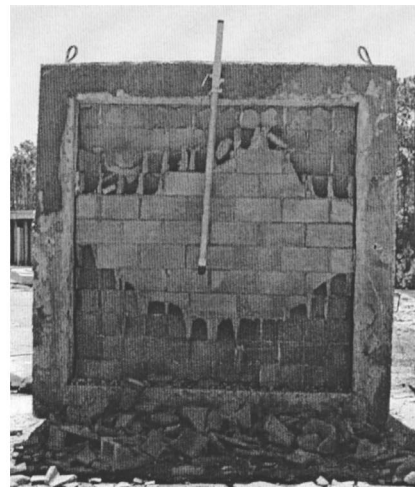
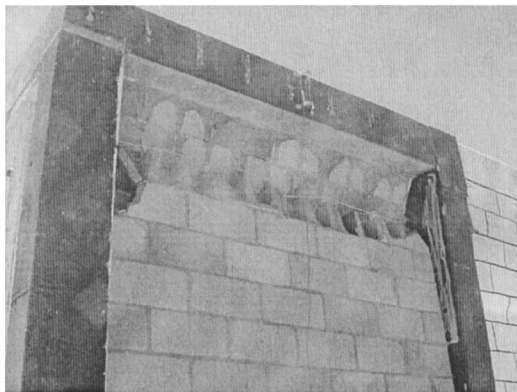

**Fig. 6.** Front face shell fracture

For the charge sizes and distances considered in this investigation, the forward pressure on the wall (positive phase) lasts only about 10 ms: An example of the loading to the structure measured by a reflected pressure gauge on Wall 1 is provided in Fig. 4. Although the peak pressure varied between tests (provided in Table 1), the shape and duration of the load curve did not vary substantially. Some damage to the system may result from the initial stress wave that travels through the depth of the masonry, however, due to the mass involved, the flexural response of the system is spread over a broader time frame of approximately 60 ms and a velocity of approximately 7.6 m/s (300 in/s) is imparted to the wall. A plot of deflection over time of Wall 1, accelerometer A2 is shown in Fig. 5.

Front face fracture of the masonry units has been consistently observed. The term front face fracture describes the condition depicted in Fig. 6, where the face shell of the concrete block facing the blast is fractured. The block is often broken into several pieces, but sometimes the front face shears from the webs and survives as one piece. A causation and timing description of this phenomenon is important because it reduces the stiffness of the system as the wall flexes inward, and will affect the capacity definition of the wall. Note that the fracture tends to be concentrated closest to the supporting edges. It has also been observed that the fracture point within the block is deepest nearest to the supports.

There are two plausible explanations for the front face fracture phenomenon. The first explanation is based on local loading and fracture phenomena. The front face of the blocks is fractured by the peak pressure in the first few milliseconds of the loading. Resistance to lateral displacement varies over the wall height, with the greatest resistance nearest the supports. The masonry blocks with the stiffest lateral resistance will have a greater tendency for front face shell fracture, which provides a reasonable explanation why front face fracture is consistently observed near the supports. Shock wave propagation in the front face also creates tension and possibly spalling on the interior free surface of the forward face of the masonry, which would also weaken the front face shell.

The second explanation is that fracture results from compression of the front side of the wall as flexure occurs. Compression membrane action of masonry walls, referred to as “arching,” has been well established in static tests and can be considered in

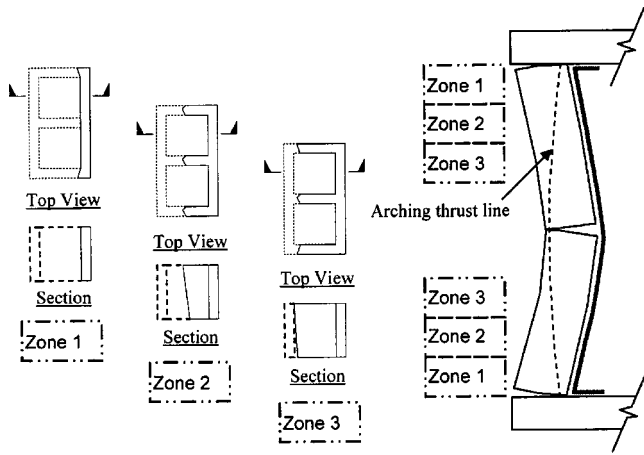

**Fig. 7.** Web vertical shear failures (arching collapse)

design resistance of masonry walls (Drysdale et al. 1994). Arching compressive forces can increase the lateral cracking load by a factor of about 2.5 if the end supports are completely rigid (Gabrielsen et al. 1975). A close posttest inspection of front face fracture conditions, observed from the full-scale explosive tests, indicates that arching is developed. The existence of intact front face pieces is evidence that something more than independent block behavior is occurring. It is not possible to observe the front face block fracture during the explosive test due to the short-time duration and debris carried by the blast wave. It is only revealed if the wall remains standing. Consequently, block face shell failures have only been verified on polymer-reinforced walls. In general, the point of fracture within the web measured from the front face appears to be related to the slope of the deflected shape during the blast response. The fracture pattern observed in some tests loosely mirrored the arching thrust line of a wall with large deflection, as described in Fig. 7.

To address some of the failure mechanism questions, two exploratory tests were conducted. Walls 11 and 12 were constructed without mortar, i.e., the blocks were simply stacked on top of each other in a typical running bond pattern. At the top of the wall, the space between block and structure was tuck pointed with mortar. For Wall 11, a polymer coating was applied directly to the interior of the wall in the same way as the other tests. For Wall 12, polymer coating was sprayed onto a plastic membrane liner so that there was no bond between the masonry and the polymer reinforcement.

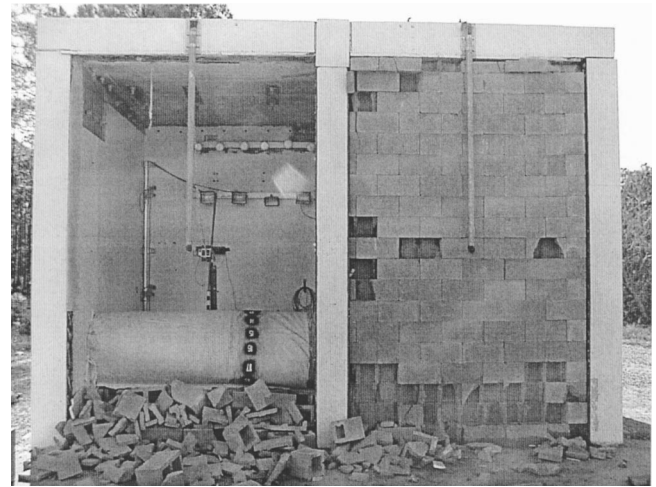

**Fig. 8.** Posttest configuration for Walls 11 (right) and 12 (left)

Wall 11 withstood the blast without collapse. Front face fracture occurred over the lower three courses of block and was sporadically distributed over several other blocks (Fig. 8). Polymer tearing initiated for several inches from both sides at approximately the height-wise center of the wall. Also, it appears from careful posttest analysis of the reaction frame and high-speed videos that flexural rotation lifted the roof of the reaction frame. This indicates a dramatic increase in the arching forces as compared to a standard mortared wall, and that the mortar joints provide freedom of movement that reduces arching forces. The polymer of Wall 12 tore at the top support attachment and collapsed. The lack of an integrated masonry-polymer system (no bond between the blocks and polymer) resulted in the polymer coating acting as a “catcher” membrane and thus a higher concentration of force at the connection of the polymer to the reaction frame. Although collapse occurred, the rubble was contained to the forward part of the structure and, compared to a masonry wall without polymer reinforcement, a high level of occupant protection would have been provided.

Three of the tests involved window and door openings (Walls 7 through 10, Fig. 9). The overall objectives of these tests were to examine the influence of typical window and door frame openings on polymer reinforcement effectiveness and failure mechanisms. These tests also involved a 3.2 mm (1/8 in.) coating with a 30 cm (12 in.) overlap onto the reaction structure. Walls 7, 8, and 9 did not include overlap of the polymer coating onto the window or door frame. Walls 9 and 10 involved a wider wall structure

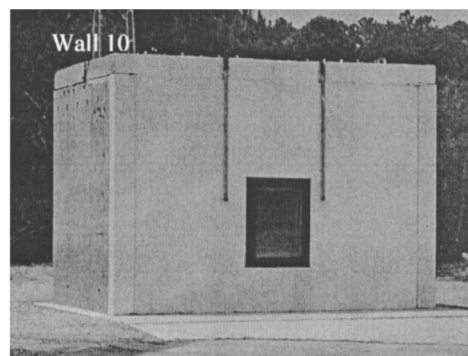
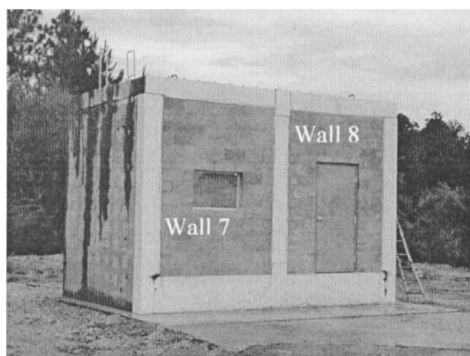

**Fig. 9.** Walls 7, 8, and 10 with window and door openings



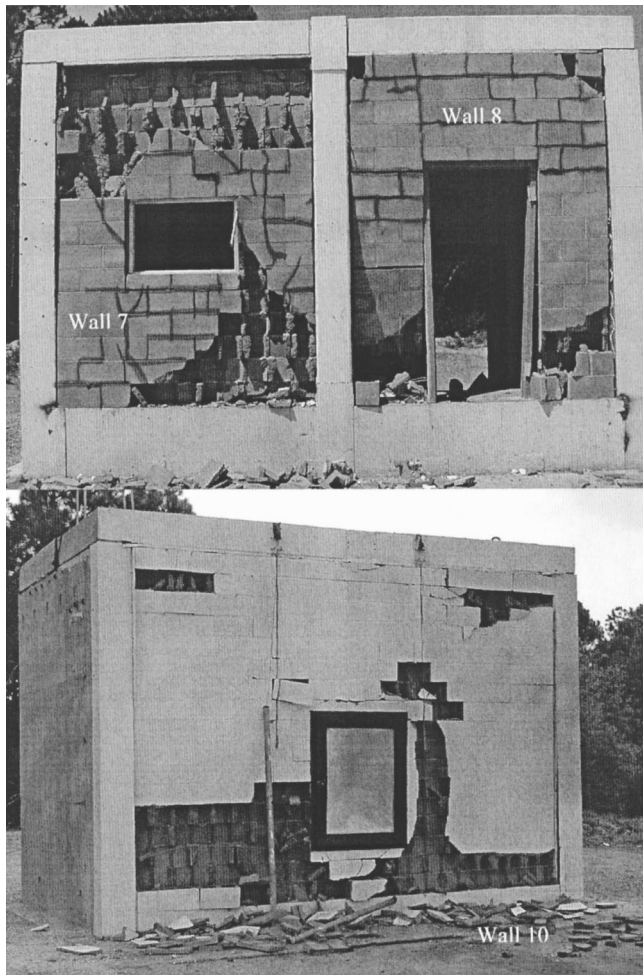

**Fig. 10.** Posttest configuration of Walls 7, 8, and 10

than the other walls (4.9 m versus 2.3 m) to eliminate edge condition effects on walls with openings. Wall 10 involved a heavily anchored window frame with polymer overlap onto the frame.

Overall, the polymer provided the same level of effectiveness for walls with the openings as walls without openings. Front face shell fracture occurred, with an evident tendency for fracture around the stiff window or door frames. There was evidence of an increased tendency for mortar joint fracture compared to walls of the same test and construction parameters without door or window openings (Fig. 10). A large lower portion of Wall 8 (containing a door frame) was breached. There was also evidence of a tendency for tear initiation of the polymer coating at the corners of the window frames.

Flexural wall response dissipates as cross-sectional structural integrity is lost. The two primary causes for the loss of structural integrity under blast loads are: (1) Mortar joint separation due to bond, flexure, or shear failure, and (2) failure of the front face shell of individual blocks. In some of the tests, large areas maintained integrity with mortar failure limited to three or less joints. Some of the observed failure mechanisms are illustrated in Fig. 11. Careful posttest analyses reveal that wall behavior involves some or all of these mechanisms at different stages of the wall response. The order of these failure mechanisms can vary. If slope change at the critical stress area is severe, then shear may develop in the polymer coating at rough block edges. The polymer tears sooner in these situations than in those where the polymer is

predominantly subjected to tension. The areas indicated by dark lines in Fig. 11 illustrate primary polymer strain areas for the different failure points.

## Finite Element Modeling

Use of advanced computer modeling techniques is essential to understanding the behavior of structures subjected to blast. The short duration of loading and response, plus the destructive result of the testing, eliminates the opportunity for a thorough understanding of structural response being gained exclusively from explosive tests. Furthermore, full-scale explosive tests are too expensive to be used to examine every important parameter. The objectives of the modeling aspects of this effort were to: (1) Provide insight into the distribution of strain over the response time interval and thus to better understand failure mechanisms, (2) complement data taken during a minimum number of explosive tests with parametric analyses involving a wide range of variables, and (3) thoroughly investigate and adopt modeling techniques that could be used to explore the feasibility of other masonry reinforcement concepts prior to explosive testing. The modeling effort is ongoing, but the following discussion summarizes simulation methodology and important knowledge gained thus far.

An implicitly formulated finite element solver, *LS-DYNA-3D* (LSTC 1998, 1999), was used to model the polymer reinforced masonry walls subjected to blast loading. *DYNA-3D* is known for its capabilities and efficiency in solving highly nonlinear dynamic problems, such as penetration mechanics, response of structures subjected to blast, and motor vehicle crash. It has a wide range of material property options developed to simulate materials in high strain rate environments, as well as the ability to simulate contact interfaces and separation of discrete components.

Many models have been developed. To determine the *DYNA* material model that would best simulate the concrete masonry units and to calibrate the material models used in full wall models, single CMU blocks were subjected to blast loading and high-fidelity models constructed. Blocks were positioned at varying distances away from the explosive charge in several tests as illustrated in Fig. 12. Five material models developed for brittle fracture applications were initially considered. A simple material model developed for crushable foam behavior, *MAT\_SOIL\_AND\_FOAM*, provided the best correlation between fracture occurring during explosive tests and prediction of fracture using the high-fidelity single-block finite element model

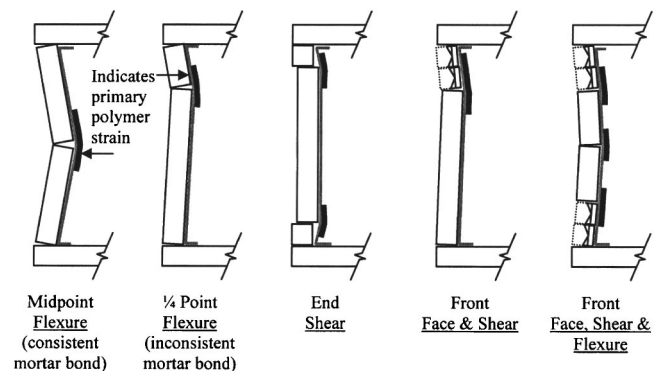

**Fig. 11.** Observed failure mechanisms in full-scale blast tests

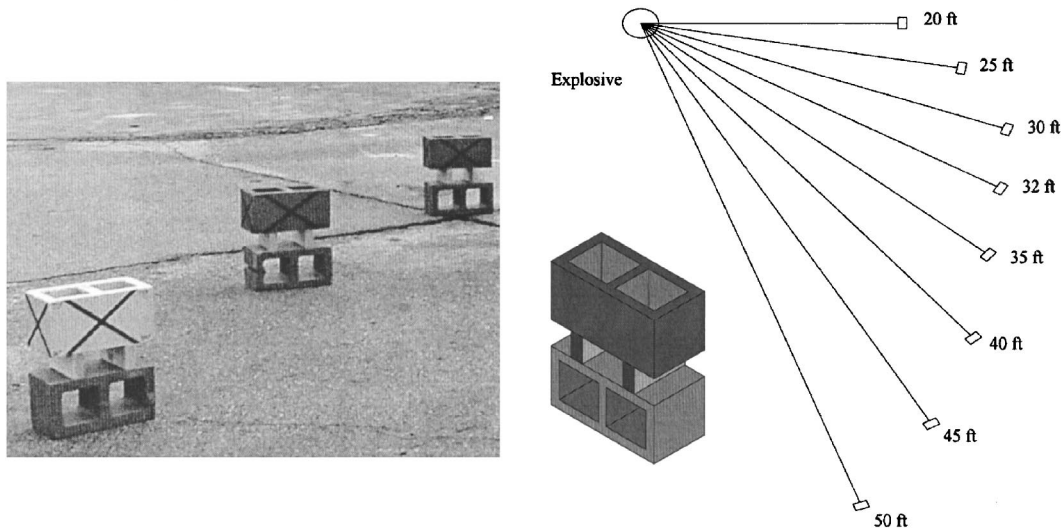

Fig. 12. Single-block fracture test setup

(Moradi and Davidson 2003). The single-block tests and the finite element modeling verified that, for certain pressure/impulse environments, local failure may occur prior to the development of momentum of the block and thus prior to the development of flexure in the walls. The sensitivity to standoff distance is noteworthy. A block—just 24 in. closer to the blast origin—resulted in much greater fragmentation, whereas a block positioned just a few inches farther from the blast—resulted in no fracture.

Accurate simulation of the polymer-reinforced walls subjected to blast loads is challenging. One-way flexure models were constructed. A highly refined mesh was required to simulate the fracture patterns observed in the tests. The highest fidelity models were comprised of over 100,000 elements. Model development challenges included simulating the interaction with supports (arching effects), incorporating gravity preload effects, modeling the block/polymer interface, choosing material models capable of simulating the behavior of the polymer subjected to high shear and tension under high strain rates, and simulating interface separation at mortar joints. The one-way flexure model illustrated in Fig. 13 uses a concrete constitutive model for the CMU blocks and mortar joints, and uses tied-node features of *DYNA-3D* to simulate the discrete component interaction between the blocks and the mortar joints. The interaction of the wall structure with the supports was simulated with rigid contact surfaces. The constraining effect of the wall/supports interaction has a significant effect on the stiffness of the system as the wall undergoes flexure, so the space between the upper edge of the wall and the rigid supports was varied to study arching effects. An acceleration was imparted to implement the effects of gravity preload. The elastomeric coating was modeled with shell elements. A study of the applicability and stability of *LS-DYNA* material models developed for rubber and plastic behaviors resulted in the *MAT\_PIECEWISE\_LINEAR\_PLASTICITY* chosen to represent the polymer used in the explosive tests (Sudame 2004). The material characteristics (Fig. 14), including strain rate effects, were taken from strain rate-dependent tensile tests conducted by the University of Dayton Research Institute (Hill 2003). The polymer shell elements were tied to the block and mortar elements using contact interface capabilities and tied-node failure rules so that the effect of bond strength between the masonry block and polymer on the system behavior could be studied.

An excellent agreement between the *DYNA-3D* models and the accelerometer and deflection gauge results from the blast tests was achieved and several behavioral observations were noted. Fig. 15 illustrates a deflection comparison to Wall 1 using several of the material models considered for the concrete masonry. The finite element modeling approach was also used to conduct an input parameter sensitivity study. Parameters considered included: Elongation capacity of the polymer reinforcement, thickness of the polymer reinforcement, initial modulus of the polymer reinforcement, yield strength of the polymer reinforcement, gap between the top of the wall and the support frame, bond strength

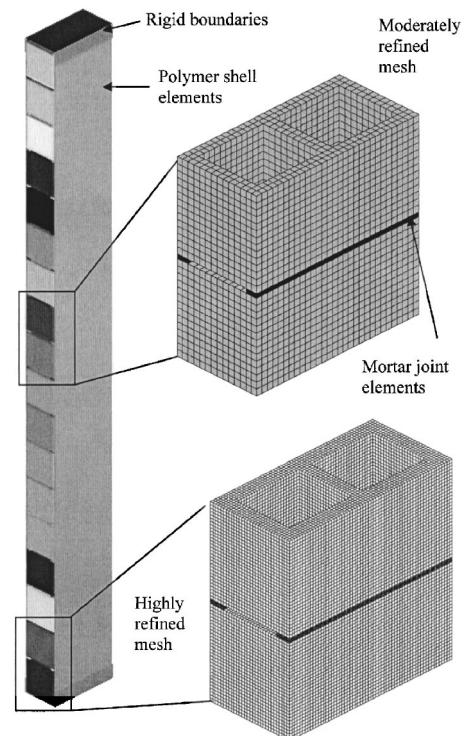

Fig. 13. One-way flexure finite element model

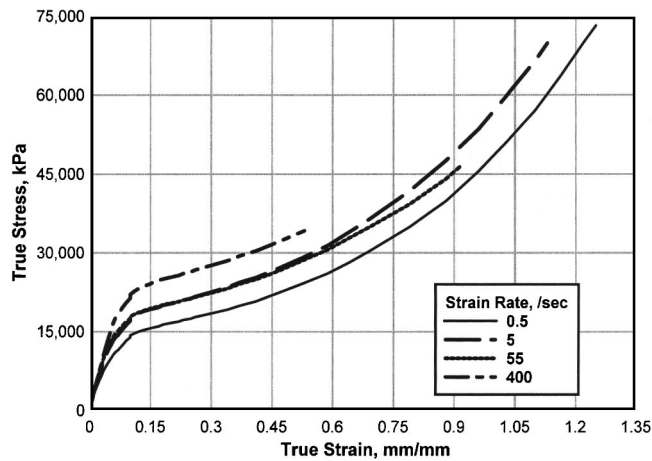

Fig. 14. Material property input used in the finite element analyses resulting from strain rate varied tension tests

between the mortar joints and masonry, and bond strength between the polymer reinforcement and masonry.

One important observation was that high localized stresses at the upper and/or lower second or third mortar joints occurs prior to significant tension strains at the height-wise center of the wall (Fig. 16). This agrees with tear failures observed in some of the explosive tests. The finite element simulations have also helped provide an understanding of the rates of strain incurred under the load regimes considered during these tests. Many polymeric materials that may be appropriate for structural reinforcement purposes stiffen significantly and become brittle under high strain rates (Blazynski 1987). So far, results from the finite element study indicate that the rate of strain in the polymer reinforcement due to the flexural response is moderate, less than 100 s. Furthermore, although the polymers used in this study have as much as 90% elongation ability under static loading, the finite element models indicate that most of the polymer reinforcement is only slightly strained. Since the polymer coating is strongly bonded to the concrete block substrate, significant strains in the polymer occur only where cracks occur. Highest strains are less than 20% and occur at mortar joint interfaces due to relative displacement between blocks. The parameter study illustrates that polymer strength parameters, such as initial modulus and yield point, have less effect on the maximum wall displacement than parameters

that largely influence strain energy absorption potential, such as polymer coating thickness and elongation capacity. A comprehensive description of the finite element methodology and results is provided in Sudame (2004).

## Observations

General observations and conclusions from both the testing and finite element modeling include:

1. A thin elastomeric coating on the interior of the wall can be effective at minimizing the deadly secondary fragmentation and potential for collapse of unreinforced concrete masonry walls resulting from blast.
2. A simple spray overlap of 15 cm (6 in.) of the polymer to the host reaction structure provided enough connection strength to transfer loads resulting from the blast to the structural frame and prevent collapse of polymer-reinforced masonry walls.
3. Although an effective balance between stiffness and elongation ability is required, the elongation capacity is more important for this purpose than having a high stiffness. The material used in this series of tests had an elongation capacity of approximately 90%; finite element results indicate that less than 20% would suffice for this application and loading, and that a better balance between stiffness, shear tearing resistance, strength, and strain capacity should result in a more effective reinforcement.
4. The spray-on polymer used in this test series bonded well to the masonry. Static tests indicate that the bond is stronger than the tensile strength of the concrete. Although a strong bond has some advantages, it precludes use of the full strain energy absorption potential of the polymer membrane. High localized strains are concentrated at a few mortar joints; most of the polymer reinforcement is minimally strained. An optimized balance between bond strength, strain energy absorption, and overlap strength may result in a more effective reinforcement system.
5. Front face shell fracture of the masonry of polymer-reinforced walls is common when the peak load is close to the loading capacity of the polymer-reinforced wall. This phenomenon may be local and driven by peak pressure, or may be a result of arching compression of the wall front face

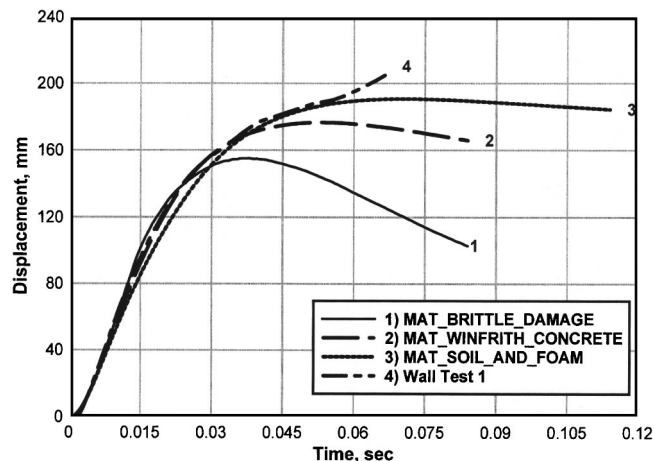
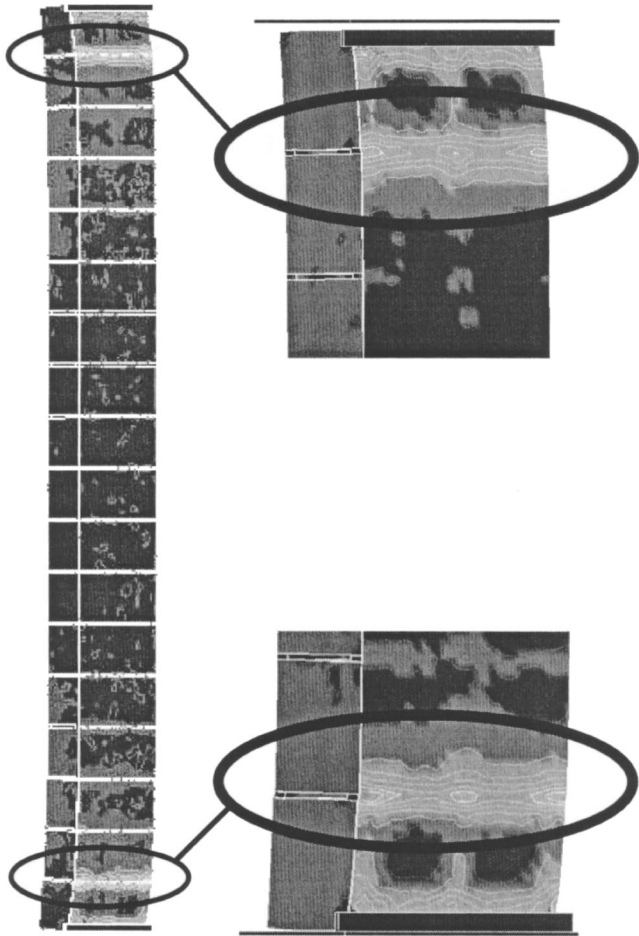

Fig. 15. Deflection comparison to Wall 1 using several of the material models considered for the concrete masonry



**Fig. 16.** Finite element results illustrating areas of high local strain in early stages of the flexural response

as the structure flexes inward. This behavior is important and should be better defined so that it can be considered during the development of resistance functions.

6. Significant arching effects were evident in some of the tests. Finite element results indicate that a tight fit of the wall into the host frame is necessary for significant arching stiffening to occur. An explosive test on concrete masonry walls without mortar indicated that the finite thickness of the mortar joint provides freedom of movement that diminishes arching effects.
7. The strong bond between the polymer and masonry was critical for the effectiveness demonstrated in the tests conducted during this program. A catcher membrane approach using this low-stiffness/low-strength material resulted in tearing at the connection of the polymer coating to the host structure and collapse of the wall. However, a catcher membrane approach offers the potential advantage of more-efficiently absorbing strain energy over a greater reinforcement volume, as well as the potential for use of a wide range of more cost effective reinforcement materials.
8. Both finite element results and posttest analyses indicate that the mortar bonds at the upper-most mortar joints fracture at early stages of flexure, resulting in relative displacement between the two courses of block and high shear strains in the polymer coating at the upper-most mortar joint. This emphasizes the importance of shear tearing resistance in an external reinforcement product.

9. For the masonry structures considered in this study, the rate of strain encountered by the polymer reinforcement is significant, but not high. Finite element results indicate that the maximum strain rate is below  $100 \text{ s}^{-1}$ .
10. For walls with window or door openings, some detrimental effects were noted. A larger area of front face shell fracture, a tendency for tearing to initiate at the door or window frame, and additional breaching was observed. However, the overall effectiveness of the polymer coating remained high.

## Conclusions

The masonry wall tests conducted by the Air Force Research Laboratory at Tyndall AFB indicate that a paint-on polymer-reinforcement approach can be effective in reducing the vulnerability of unreinforced nonload bearing CMU walls subjected to blast loading. The application options are not overly burdensome and the explosive tests indicate that a 10-fold increase in peak pressures can be resisted without catastrophic collapse by polymer-reinforced one-way flexure walls compared to unreinforced concrete masonry walls. Although the reinforced walls are of little economic value after the blast event, they reduce the risk to building inhabitants. This paper presents an overview of the failure mechanisms observed in a series of explosive tests involving 12 polymer-reinforced masonry walls plus insight from on-going finite element work.

The success of this project could have significant implications for the design of blast resistant buildings and facilities. A wide range of stiff composite materials, such as woven aramid fabrics and carbon fiber composites, were investigated for their effectiveness toward preventing the fragmentation of wall structures at the beginning of blast reinforcement research. However, the stiff composite materials were deemed a poor choice for widespread use, not because of ineffectiveness in preventing fragmentation and collapse, but rather because of high material costs, challenges in bonding the material to the wall, and difficulties in anchoring the material to the host structure. The spray-on polymer approach overcame these issues. However, improvements are still needed. The materials and application procedures used were off-the-shelf products designed for other purposes. The polymer materials investigated thus far emit hazardous volatiles during application, and therefore require protective clothing. Expensive and cumbersome spraying equipment is also required. This work emphasizes the importance of ductility through the ability of reinforcement to absorb strain energy, and that a polymeric material with a better balance of stiffness, strength, and elongation capacity may result in an external reinforcement technique with a broader range of applications.

AFRL is continuing to investigate and develop cost effective methodologies for protecting building occupants from the effects of blast. Ongoing efforts include: (1) Optimizing materials and application procedures for strengthening wall structures against blast, (2) investigating the effectiveness of polymeric materials for reinforcing wall structures other than masonry walls, (3) developing high-fidelity finite element models that accurately simulate such structures subjected to blast loads, (4) developing non-explosive laboratory test procedures that predict the energy absorbing effectiveness of a given reinforcement material candidate, (5) developing performance criteria for elastomeric coatings to be used for blast reinforcement, (6) developing innovative hybrid wall systems for blast resistance, and (7) developing engi-

neering design tools and guidelines for polymeric blast reinforcement methodology.

## Acknowledgments

The tests described herein were conducted by the Force Protection Branch of the Air Force Research Laboratory (AFRL) at Tyndall Air Force Base, Fla. The contributions of other team members, especially the assistance of Kenneth J. Knox, Principal Engineer and Joseph B. Jordan, Senior Engineer, of Applied Research Associates, Inc. (ARA), are gratefully acknowledged. The test synthesis was done by James D. Connell and Danica Thornburg as part of their MSCE thesis requirements at the University of Alabama at Birmingham (UAB) and finite element analyses conducted by James D. Connell, Lee Moradi, and Sushant Sudame as part of their MSCE requirements at UAB. UAB team members are extremely grateful for the sponsorship and for the opportunity to collaborate with AFRL and ARA engineers.

## References

- Barbero, E. J., Davalos, J. F., Kiger, S. A., and Shore, J. S. (1997). "Reinforcement with advanced composite materials for blast loads." *Proc., Structures Congress XV*.
- Blazynski, T. Z. (1987). *Materials at high strain rates*, Elsevier Science, N.Y.
- Connell, J. D. (2002). "Evaluation of elastomeric polymers for retrofit of unreinforced masonry walls subjected to blast." M.S. thesis, The Univ. of Alabama at Birmingham, Birmingham, Ala.
- Crawford, J. E., Bogosian, D. D., and Wesevich, J. W. (1997a). "Evaluation of the effects of explosive loads on masonry walls and an assessment of retrofit techniques for increasing their strength." *Proc., 8th Int. Symp. on Interaction of the Effects of Munitions with Structures*.
- Crawford, J. E., Malvar, L. J., Wesevich, J. W., Valancius, J., and Reynolds, A. D. (1997b). "Retrofit of reinforced concrete structures to resist blast effects." *ACI Struct. J.*, 94(4), 371–377.
- Davidson J. S., Porter, J. R., Dinan, R. J., Hammons, M. I., Connell J. D. (2004). "Explosive testing of polymer retrofit masonry walls." *J. Perform. Constr. Facil.*, 18(2), 100–106.
- Dinan R. J., Fisher J. W., Hammons M. I., and Porter J. R. (2003). "Failure mechanisms In unreinforced concrete masonry walls retrofitted with polymer coatings." *Proc., 11th Int. Symp. on Interaction of the Effects of Munitions with Structures*.
- Drysdale, R. G., Hamid, A. A., and Baker, L. R. (1994). *Masonry structures - Behavior and design*, Prentice-Hall, Englewood Cliffs, N.J.
- Gabrielsen, B. L., Kaplan, K., and Wilton, C. (1975). "A study of arching in Nonreinforced masonry walls." *SSI 748-1*, Scientific Services, Inc., Redwood City, Calif.
- Hill, S. (2003). "High rate tensile tests of 2003HSD001 polyurea." *Evaluation Report UDR-TR-2003-00130*. Report submitted to the Air Force Research Laboratory, Tyndall AFB, Florida by Structural Test Group, Univ. of Dayton Research Institute, Dayton, Ohio.
- Knox, K. J., Hammons, M. I., Lewis, T. T., and Porter, J. R. (2000). "Polymer materials for structural retrofit." Force Protection Branch, Air Expeditionary Forces Technology Division, Air Force Research Laboratory, Tyndall AFB, Fla.
- Livermore Software Technology Corporation (LSTC). (1998). *LS-DYNA theoretical manual: Nonlinear dynamic analysis of structures*, Livermore, Calif.
- Livermore Software Technology Corporation (LSTC). (1999). *LS-DYNA keyword user's manual: Nonlinear dynamic analysis of structures*, Livermore, Calif.
- Moradi, L., and Davidson, J. S. (2003). "Constitutive properties for a single concrete masonry unit (CMU) subjected to blast." Report submitted to the Air Force Research Laboratory, Tyndall AFB, Fla.
- Slawson, T. R., Coltharp, D. R., Dennis, S. T., and Mosher, R. (1999). "Evaluation of anchored fabric retrofits for reducing masonry wall debris hazard." *Proc., 9th Int. Symp. on Interaction of the Effects of Munitions with Structures*.
- Sudame S. (2004). "Development of high-fidelity computational models and input sensitive study of masonry walls subjected to blast." M.S. thesis, The Univ. of Alabama at Birmingham, Birmingham, Ala.
- Thornburg D. L. (2004). "Evaluation of elastomeric polymers used for external reinforcement of masonry walls subjected to blast." M.S. thesis, The Univ. of Alabama at Birmingham, Birmingham, Ala.

Copyright of Journal of Structural Engineering is the property of American Society of Civil Engineers. The copyright in an individual article may be maintained by the author in certain cases. Content may not be copied or emailed to multiple sites or posted to a listserv without the copyright holder's express written permission. However, users may print, download, or email articles for individual use.