

~~CONFIDENTIAL~~
UNCLASSIFIED

COPY NO. _____

ARMY BALLISTIC MISSILE AGENCY

3-422

HISTORICAL MONOGRAPH NO. 4

DEVELOPMENT OF THE CORPORAL:
THE EMBRYO OF THE ARMY MISSILE PROGRAM

~~CONFIDENTIAL~~

CPH 99
APRIL 1961 C. Wall

UNCLASSIFIED

Authority *CS*
UPL-Iom # *751-69-42*

Date
8-71

By
*Marguerite
McCauley*

VOLUME I OF II

NARRATIVE

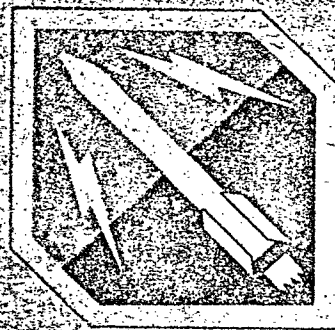

REDSTONE ARSENAL, ALABAMA

~~CONFIDENTIAL~~
~~CONFIDENTIAL~~

DOD DIR 5200.10

Revised April 64

UNCLASSIFIED

~~CONFIDENTIAL~~

C 775-695/4

A

B

M

A

FORM 484, RE

Report Documentation Page

Form Approved
OMB No. 0704-0188

Public reporting burden for the collection of information is estimated to average 1 hour per response, including the time for reviewing instructions, searching existing data sources, gathering and maintaining the data needed, and completing and reviewing the collection of information. Send comments regarding this burden estimate or any other aspect of this collection of information, including suggestions for reducing this burden, to Washington Headquarters Services, Directorate for Information Operations and Reports, 1215 Jefferson Davis Highway, Suite 1204, Arlington VA 22202-4302. Respondents should be aware that notwithstanding any other provision of law, no person shall be subject to a penalty for failing to comply with a collection of information if it does not display a currently valid OMB control number.

1. REPORT DATE 30 APR 1961		2. REPORT TYPE N/A		3. DATES COVERED -	
4. TITLE AND SUBTITLE Development of the Corporal: the Embryo of the Army Missile Program: Volume 1, Narrative.				5a. CONTRACT NUMBER	
				5b. GRANT NUMBER	
				5c. PROGRAM ELEMENT NUMBER	
6. AUTHOR(S) James W. Bragg				5d. PROJECT NUMBER	
				5e. TASK NUMBER	
				5f. WORK UNIT NUMBER	
7. PERFORMING ORGANIZATION NAME(S) AND ADDRESS(ES) Army Ballistic Missile Agency				8. PERFORMING ORGANIZATION REPORT NUMBER	
9. SPONSORING/MONITORING AGENCY NAME(S) AND ADDRESS(ES) Army Ballistic Missile Agency				10. SPONSOR/MONITOR'S ACRONYM(S)	
				11. SPONSOR/MONITOR'S REPORT NUMBER(S)	
12. DISTRIBUTION/AVAILABILITY STATEMENT Approved for public release, distribution unlimited					
13. SUPPLEMENTARY NOTES					
14. ABSTRACT					
15. SUBJECT TERMS					
16. SECURITY CLASSIFICATION OF:			17. LIMITATION OF ABSTRACT UU	18. NUMBER OF PAGES 316	19a. NAME OF RESPONSIBLE PERSON
a. REPORT unclassified	b. ABSTRACT unclassified	c. THIS PAGE unclassified			

~~CONFIDENTIAL~~

UNCLASSIFIED

S E C U R I T Y

This document contains information affecting the National Defense of the United States within the meaning of the espionage laws, Title 18, U.S.C., Sections 793 and 794. The transmission or the revelation of its contents in any manner to an unauthorized person is prohibited by law.

~~TOP SECRET~~

UNCLASSIFIED

~~CONFIDENTIAL~~

C-715698/10061

~~CONFIDENTIAL~~

UNCLASSIFIED

HISTORICAL MONOGRAPH No. 4

DEVELOPMENT OF THE CORPORAL: THE EMBRYO

OF THE ARMY MISSILE PROGRAM

Classification Changed to	
JPL-IOM # 751-1A-42 (8-27-69)	
Authority	
Date	By

APRIL 1961

90

James W. Bragg

Classification Changed to	
UNCLASSIFIED	
Authority	
JPL-IOM # 751-69-42 (8-27-69)	
Date	By
1-8-71	Marquette McCauley

J. H. Douglas
 GERVASE L. BARNHILL
 Colonel, GS
 Chief, Control Office

Richard M. Hurst
 RICHARD M. HURST
 Brigadier General, USA
 Commander, ABMA

James M. Grimwood
 JAMES M. GRIMWOOD
 Chief Historian

Robert A. Smith, III
 ROBERT A. SMITH, III
 Chief, Reports and Historical Branch
 Control Office

Prepared by

Reports and Historical Branch
 Control Office
 Army Ballistic Missile Agency
 Army Ordnance Missile Command
 Redstone Arsenal, Alabama

Volume I of II

v

UNCLASSIFIED
~~CONFIDENTIAL~~

~~CONFIDENTIAL~~

UNCLASSIFIED

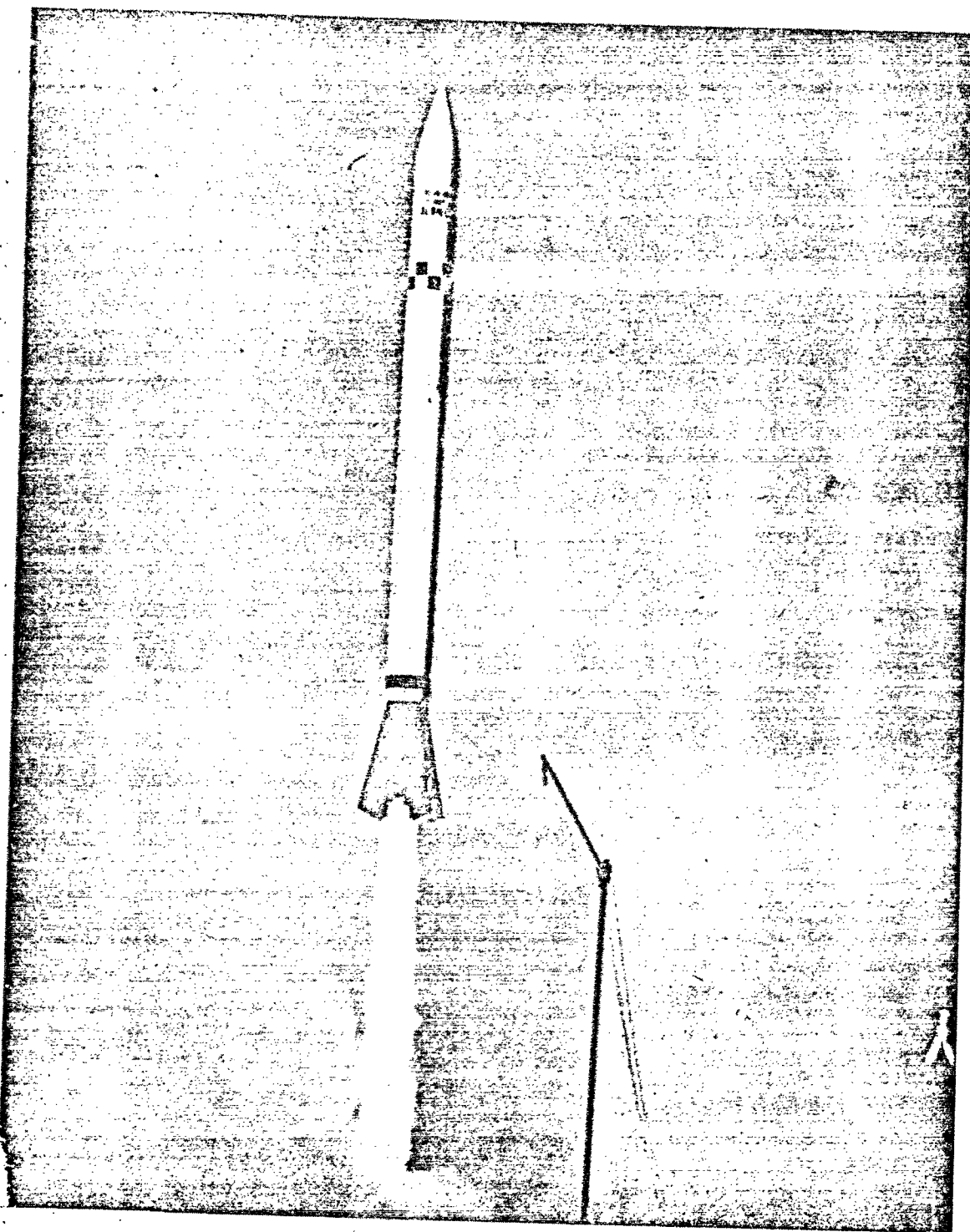

CORPORAL MISSILE IN FLIGHT

vii

UNCLASSIFIED

UNCLASSIFIED

PREFACE

A small group of rocket enthusiasts at the California Institute of Technology in 1936 requested and received permission to organize at the Institute's Guggenheim Aeronautical Laboratory the GALCIT Research Project to investigate rocketry and its related aspects. The Project began as a private endeavor, and one of its own members financed the initial studies with a gift of \$1,000.

From such a modest beginning has expanded the 1961 Jet Propulsion Laboratory, California Institute of Technology. And under the sponsorship of the U.S. Army Ordnance Department, the original GALCIT group, considerably augmented since 1936, in 1944 undertook the research and development of a succession of rocket test vehicles, one of which became the first, the pioneer U.S. Army tactical guided missile--CORPORAL--American-developed from drawing board to deployment in Europe.

The story of CORPORAL's birth, growth, and development into a full-fledged guided missile system is one of trial and error, a pattern of devoted human endeavor studded with many failures and fewer heartening successes, acknowledging each failure and profiting from it, and striving toward the goal of providing the Army Field Forces with an efficient deterrent to aggression. This story is one of improvisations, of making do what was available in materials and components, and of feeling the way as explorers into the unknown, uncharted realm of rocketry.

In the language of CORPORAL's sponsor, the Ordnance Department initiated its guided missile program with full realization that it was pioneering in a new field and that, before guided missiles could be produced, it was mandatory that competent scientific staffs be built up; a comprehensive and long-range research program be initiated; adequate test facilities be established.

The prime objective of the Ordnance Department in the development of guided missiles from the program's initiation was to provide for the United States Armed Forces weapons whose performance in combat would be second to none. In attaining this objective, the basic policies of Ordnance have always been and will continue to be:

UNCLASSIFIED

1. Maximum utilization of the talent available in the most capable scientific and commercial institutions of the United States.
2. Establishment of integrated projects designed to develop in a step-by-step procedure effective missiles, control equipment, and launching gear for use in surface-to-surface and surface-to-air applications.
3. Utilization to the fullest of all Government arsenals and laboratories to promote the most efficient and economical development of suitable guided missile weapons.
4. Full and free cooperation with all other agencies engaged in guided missile development, since such cooperation will benefit the national guided missile effort.

This was Ordnance's objective and policy as announced in April 1949. Ready at hand, with eight years basic research in rocket propulsion and propellants behind the group, the initiation of Ordnance's guided missile program had in 1944 found the GALCIT Research Project, whose desire back in 1936 had been to launch a sounding rocket into the upper reaches.

Let it not be forgotten, too, that the somewhat rude, rough, uncouth pioneer CORPORAL blazed the trail through a wilderness of dynamics, aerodynamics, and electronics, as applied to guided missiles, pointing out the path for manufacturers and military personnel to follow with the designing, fabrication, and operation of more refined, sophisticated second and third generations of such missile weapon systems.

The following chronology documents the progressive milestones, clearly indicating the "firsts" that made the CORPORAL development program a dramatic one, indeed.

UNCLASSIFIED

ORDCIT PROJECT AND CORPORAL PROGRAM FIRSTS,
TOGETHER WITH OTHER PERTINENT INFORMATION

Extracted From

"Chronology of Significant Events in the CORPORAL Program," a type-written document located in the SERGEANT-CORPORAL Projects Office, R&D Operations, ABMA.

Department of the Army Pamphlet Nr. 70-10, "Chronological History of Army Activities in the Missile/Satellite Field, 1943-1958," Headquarters, Department of the Army, 17 September 1958.

Summarizations from various documents other than those listed.

"Surface-to-Surface Reference Book," Section II: "Chronology of the CORPORAL Missile System," U.S. Army Ordnance Missile Command, Redstone Arsenal, Alabama, December 1959.

Technical Report, "Ordnance Guided Missile & Rocket Programs," Vol. III, "CORPORAL Field Artillery Guided Missile System, Inception Through 30 June 1955."

~~CONFIDENTIAL~~
UNCLASSIFIED

ORDCIT PROJECT AND CORPORAL PROGRAM FIRSTS,
TOGETHER WITH OTHER PERTINENT INFORMATION

1936

A group of California Institute of Technology (CIT) graduate students, guided by Dr. Theodore von Karman, Director of Guggenheim Aeronautical Laboratories (GAL), organized themselves for the first unified investigation of rockets and related fields in the United States, with initial research financed by a private gift of \$1,000. Out of this organization grew Jet Propulsion Laboratory (JPL).

May 1944

ORDCIT Project, first of U.S. Army Ordnance integrated missiles projects, planned to progress from test vehicle to guided missile, was initiated at CIT, and Jet Propulsion Laboratory was soon thereafter organized--JPL/GALCIT, CIT.

24 May 1944

First interim contract was entered into for research and development leading to long-range rocket missiles.

26 May 1944

First tentative military characteristics were established for pilot models.

22 Jun 1944

First definitive contract for U.S. missiles research was placed with JPL/CIT, providing for orderly development of rocket test vehicles and all related fields, leading eventually to tactical CORPORAL, by way of PRIVATE A, PRIVATE F, WAC CORPORALS A & B, BUMPER WAC, and CORPORAL E.

1 Jul 1944

R&D Service Sub-Office (Rocket) was established at CIT.

Nov 1944

Studies, theoretical calculations (including trajectories), and drawings of a tentative CORPORAL had already begun to take form.

Dec 1944

First firings of a test vehicle as part of the first integrated development program designed to lead to a guided missile occurred at the Leach Lake, Leach Springs, California, area--PRIVATE A, first U.S. step-rocket--crude but a step-rocket nevertheless.

2 Jan 1945

Establishment of the first large-thrust rocket motor test station, together with all related facilities, was approved. Location: Muroc, California; motor to be tested: the 20,000-pound-thrust CORPORAL motor, the first motor of such high thrust to be designed and built in the United States.

~~CONFIDENTIAL~~
UNCLASSIFIED

Feb-Apr
1945

PRIVATES A & F and crude CORPORAL rocket models were subjected to supersonic wind-tunnel tests at Aberdeen Proving Ground--the first such Army Ordnance tests of rocket models.

Apr 1945

PRIVATE F firings were the first to prove that winged ballistic missiles required guidance control to effect stability in flight.

25 Jun 1945

Work was begun on construction of facilities of the newly acquired White Sands Proving Ground (WSPG), an acquisition necessitated by development of ORDCIT Project.

26 Sep 1945

TINY TIM, WAC CORPORAL's booster, became the first rocket to be test-fired at WSPG.

1 Oct 1945

WAC CORPORAL A (quarter-charged), first U.S. high-altitude test rocket and first U.S. two-stage rocket to demonstrate successful separation of first from second stage in free flight (outside launcher), was also first to carry a nose release recovery system, though its operation was unsuccessful.

11 Oct 1945

WAC A Round 5 was the first U.S. missile to carry radiosonde equipment, although it failed to function. Round 5 reached a 235,000-foot altitude, a record for a U.S. test vehicle at that date. The 1st Guided Missile Battalion was activated at Fort Bliss, Texas.

12 Oct 1945

WAC A Round 6 was the first U.S. missile to carry a "radar window," or beacon.

19 Oct 1945

JPL deeded to the U.S. 31.5 acres and facilities occupying the land tract, making the U.S. Government owner of JET PROPULSION LABORATORY land and facilities.

Late 1945

The first U.S. large-thrust rocket motor was tested at the new Muroc test stand--the 20,000-pound-thrust CORPORAL aniline-red fuming nitric acid (RFNA) liquid propellant motor.

6 Dec 1946

Round 12 of the WAC firings at WSPG was the first WAC B, with a newly designed, much lighter motor, and was the first U.S. missile to carry oxidizer and fuel burst-diaphragms. Burst-diaphragms proved their value during WAC B and BUMPER firings and persisted throughout CORPORAL development and deployment. Round 12 had the first successful parachute operation. The entire missile was recovered. WAC B's air and propellant tanks were individual instead of a single partitioned cylinder, and the air tank was moved forward of the two propellant tanks.

~~CONFIDENTIAL~~
UNCLASSIFIED

12 Dec 1946

WAC B Round 14 was first to demonstrate successful recovery of instrumentation--telemetry.

22 May 1947

CORPORAL E, first U.S. surface-to-surface guided ballistic missile, accepted guidance corrections, and attained a range of 63.5 miles and an altitude of 129,000 feet; it was powered by the first U.S. developed and tested large-thrust rocket motor, essentially a scaled-up WAC motor, and having a 20,000-pound thrust, burning RFNA-aniline-furfuryl alcohol propellant combination.

Spring 1947

Battery D, 1st Guided Missile Battalion, furnished the first all-soldier crew ever to fire a missile in the United States--a WAC CORPORAL B.

20 Jun 1947

Ordnance established as a part of HERMES Project (General Electric Company) development of a two-stage research vehicle--BUMPER--to consist of WAC B mated to the German V-2 (or A-4)

13 May 1948

BUMPER Round 1, with a partially charged, solid-propellant second stage (Dummy WAC), was successfully fired at WSPG. This was the first large, two-stage rocket to be launched in the Western Hemisphere. In-flight separation was proved. The first U.S. spin rocket, first used on this first round (Dummy WAC), was developed especially for the BUMPER Program to provide aerodynamic stabilization for second-stage WAC after separation from V-2. This spin rocket demonstrated its own success during those firings which were themselves successful.

1 Nov 1948

BUMPER WAC Round 4 was the first U.S. missile to have a burst-diaphragm over the exhaust nozzle, designed to insure proper motor starting conditions at high altitudes by preserving ground-atmospheric conditions for second-stage start.

24 Feb 1949

BUMPER WAC CORPORAL Round 5 was the first missile to be used to measure temperatures at extreme altitudes, carried telemetry which transmitted to ground stations technical information concerning conditions encountered during flight, and demonstrated feasibility of separation of two-stage rockets at very high altitudes. This was the first time radio equipment had ever been operated at such extreme altitudes. Round 5 attained a speed of 5,150 miles per hour and an altitude of about 244 miles, the greatest velocity and highest altitude ever reached by a man-made object, with the latter record awaiting WAC's lineal descendant, AEROBEE, to break the altitude record at a much later date.

UNCLASSIFIED
~~CONFIDENTIAL~~

- 21 Apr 1949 BUMPER WAC Round 6 was the first U.S. test vehicle designed to obtain cosmic ray data at altitudes unattainable by other rockets, although first stage V-2 failed.
- 7 June 1949 CORPORAL E Round 4 proved CORPORAL's modified propulsion system, including newly designed, axially cooled, 125-pound motor, basically the same system persisting all the way to tactical CORPORAL. Round 4 also carried diaphragm modified for the axially cooled motor.
- 22 Sep 1949 Review by Ordnance of U.S. missile programs resulted in selection of CORPORAL E to be developed into the first U.S. tactical guided missile.
- 1949 Seven CORPORAL E airframes were produced by Douglas Aircraft Company to be used in R&D firings, JPL installing guidance and control components.
- 18 Jan 1950 JPL was directed by Chief of Ordnance to expedite CORPORAL development toward the goal of interim tactical guided missile.
- Jun-Jul 1950 The 1st Guided Missile Group participated in preparation for the firing and the firing of BUMPER Rounds 7 and 8 at Long Range Proving Ground (LRPG), Cocoa, Florida.
- 11 Jul 1950 CORPORAL E Round 5 was the first to carry JPL's electronic autopilot, together with certain elements of a modified ground guidance system (including modified SCR-584 radar) to expedite early operational status of CORPORAL as an interim tactical missile, since, as directed by Ordnance, existing components were to be used as far as practicable.
- 29 Jul 1950 BUMPER WAC CORPORAL Round 7 broke WAC's previous record in velocity, attaining 8,213 feet per second--Mach 9--at LRPG, Cocoa, Florida, and that was in the dense atmosphere of a low altitude.
- 9 Oct 1950 Douglas received a contract for fabricating 20 CORPORAL rounds to be used in JPL's R&D firings.
- Dec 1950 CORPORAL was the first U.S. missile to be approved as an atomic warhead carrier.
- 2 Jan 1951 Ordnance placed with JPL the first definitive contract calling for development of a complete missile system--CORPORAL.

~~CONFIDENTIAL~~
UNCLASSIFIED

- Jan 1951 CORPORAL E Round 7 was the first of the series to carry the newly developed inflight shutoff.
- Jan 1951 CORPORAL authority was assigned to Redstone Arsenal, Alabama.
- Feb 1951 JPL formed the first publications group to document technical data for use in manuals for CORPORAL--the first such program in the U.S. missile field.
- 30 Mar 1951 Implementation of recommendation for production of 200 missiles and prototype ground equipment resulted in first production order of tactical guided missiles. An additional increase of 120 missiles was later made.
- 6 Jun 1951 D/A, at request of Ordnance, authorized expenditure of FY 1951 funds amounting to \$9 million to expedite missile procurement.
- 29 Jun 1951 Firestone Tire and Rubber Company became production contractor for the first 200 missiles through selection by Board of Awards in meeting at Redstone Arsenal, Alabama.
- 17 Jul 1951 A letter order amounting to \$6,888,796 was placed with Firestone.
- 1951 JPL's Hydraulics Laboratory was modified to accommodate a 45-foot missile in a vertical position for hydraulic and pneumatic checkout--another first for the sake of CORPORAL.
- 1951 A 12-inch supersonic (to Mach 3.5) wind tunnel and one of 20 inches (to Mach 4.8), both among the first in the United States, were completed.
- Jul 1951 JPL's CORPORAL School prepared to get under way, with 5 Ordnance and 5 Field Forces personnel taking part--the first officially initiated school for purely missile training--CORPORAL, that is. Two classes were graduated and went out to become instructors.
- 10 Oct 1951 CORPORAL E Round 11 (Round 10 not flown) was first to carry the delta fin configuration, basic pattern of future tactical CORPORAL.
- 6 Dec 1951 CORPORAL E Flight 11 was the second U.S. missile to have the delta fin configuration and first to carry elements of the warhead equipment. Prototype radar, Doppler, and computer equipment were employed in Flight 11.

UNCLASSIFIED

~~CONFIDENTIAL~~

~~CONFIDENTIAL~~

~~CONFIDENTIAL~~
UNCLASSIFIED

10 Dec 1951

Contract for 200 Type I CORPORAL missiles, spare parts, and documentation was placed with Firestone--the first such contract executed in the United States (Cf above for contract developments), replacing letter order of 17 July 1951.

Jan 1952

A combined NIKE and CORPORAL Direct Support Company was approved. CORPORAL Section was later designated 96th Ordnance Direct Support Company, CORPORAL and became the first Direct Support Company to go overseas.

20, 27 Feb
25 Jun 1952

Study was made by JPL as to feasibility of CORPORAL's becoming an antiaircraft missile. A conditionally favorable report was made.

Mar 1952

The Provisional Redstone Guided Missile School was established at Redstone Arsenal, Alabama.

Mar 1952

Three CORPORAL battalions were activated--the first ballistic missiles units to be activated in the United States.

10 Mar 1952

CORPORAL and NIKE shared honors in the initiation of the first guided missile training program begun at Redstone Arsenal, with 7 officers enrolled for the very broad, general course.

19 Dec 1952

Defense Department approved procurement of 465 missiles to arm 6 battalions, each with 2 firing batteries. These improved CORPORALS were to be designated as Type II.

30 Jan 1953
to
22 Jan 1954

Engineer-User (E-U) program of firing 14 CORPORAL I missiles was completed--the first such program and a pattern for those to follow in missile development.

3 Feb 1953

Military personnel fired their first CORPORAL missile.

16 Feb 1953

OGMS, Redstone Arsenal, Alabama, was designated as a D/A service school and a Class II activity.

11 Jun 1953

Gilfillan Brothers, Inc., contracted with Ordnance to redesign the CORPORAL guidance system--later to be known as CORPORAL IIA--and to continue component improvement to eventuate in CORPORAL III.

7 Jul 1953

The first CORPORAL I tactical equipment was used in firing a CORPORAL missile.

UNCLASSIFIED
~~CONFIDENTIAL~~

~~SECRET~~

~~CONFIDENTIAL~~

UNCLASSIFIED

23 Sep 1953

First Maintenance Plan for guided missiles and associated equipment was published and distributed to the Army--another CORPORAL first.

19 Oct 1953

A supplemental agreement provided for development and fabrication of prototype models of improved ground and missile guidance and control equipment to be known as Type III CORPORAL, Gilfillan contract.

Late 1954

An agreement was reached between the United States and the United Kingdom (UK) in which the United States agreed to furnish UK 113 Type II missiles and associated ground equipment--the first U.S. guided missiles destined for service in a foreign country to be used by a foreign power. Later, British Army personnel underwent training at OGMS, Fort Bliss, and WSPG as a cadre to set up missile training in a planned service school in Britain.

10 Oct 1954

Specialist courses and "Unit Commanders" courses were approved for instruction at OGMS.

4 Nov 1954

Unit Training Center was established at OGMS for activating, organizing, and training direct support companies.

1 Jan 1955

Office, Chief of Ordnance, took over CORPORAL atomic warhead development from Atomic Energy Commission.

Jan 1955

A heavy maintenance team was activated to provide back-up support of a direct support company overseas.

Feb 1955

The first CORPORAL battalion--the 259th--and 96th Direct Support Company, with Type I equipment, were deployed to Europe--the first U.S. missile unit to be deployed overseas. The 246th and 247th Battalions remained at Fort Bliss, Texas.

Spring 1955

A contract was executed for the UK 113 CORPORAL missiles (Type IIA) and associated equipment (Cf previous mention of the U.S.-UK agreement).

28 Sep 1955

A Redstone Arsenal study recommended a plan for integrating Type III CORPORAL system into the CORPORAL.

20 Dec 1955

Modification of Gilfillan Contract ORD-681 provided for incorporation of Type IIA guidance components on all missile production beginning January 1957.

UNCLASSIFIED

xviii

~~CONFIDENTIAL~~

~~CONFIDENTIAL~~
UNCLASSIFIED

17 Jan 1956 Chief of Ordnance directed Commanding General, Redstone Arsenal, to continue the CORPORAL Type III program to provide an "on-the-shelf" item.

28 Mar 1956 Redstone Arsenal presented a plan for a "shelf-item" program for Type III CORPORAL.

Spring 1956 The 259th CORPORAL Battalion was replaced in Europe by units equipped with Type II CORPORAL systems.

25 Apr 1956 Chief of Ordnance recommended continued development of Type III CORPORAL system with FY 1956 and FY 1957 funds and production with FY 1958 funds.

30 Jun 1956 Contractor had completed fabrication of one tactical prototype model of Type III ground guidance equipment and missile test truck and was conducting system tests at contractor's plant.

30 Jun 1956 A total of 12 CORPORAL battalions had been activated and provided with Type II equipment, with 6 battalions (single-fire unit) deployed to Europe and 2 others scheduled to deploy in September 1956. System reliability had improved to 74 per cent. All R&D activities relating to Types I and II CORPORAL systems were terminated. As of this date, 358 CORPORAL Type II missiles and 19 sets of ground equipment had been delivered.

23 May 1957 CORPORAL Type III R&D program was terminated.

Oct 1958 Industrial Engineering Flight Test Program was terminated.

During 1958 Troop-test inflight reliability of 82 per cent was attained.

1958 - 1959 CORPORAL IIB was being produced.

1961 CORPORAL is still standing on guard.

UNCLASSIFIED

~~CONFIDENTIAL~~

UNCLASSIFIED

C O N T E N T S

<u>CHAPTER</u>		<u>PAGE</u>
	FRONTISPIECES	vii
	PREFACE	ix
	CHRONOLOGY	xi
	LIST OF APPENDICES	xxvi.
I	INITIATION OF THE ORDCIT PROJECT	1
	HISTORICAL DEVELOPMENT OF THE JET PROPULSION LABORATORY (JPL)	1
	The GALCIT Rocket Research Project	1
	Reports of German Missiles	4
	Feasibility Studies of Developing U.S. Jet Pro- pelled Missiles	4
	The Development Program Proposed by Dr. Von Karman and Associates	5
	ORDCIT Project Initiated	7
II	PRIVATE A	17
	PROGRESS DURING THE NINETY-DAY INTERIM CONTRACT ...	17
	FINAL DESIGN OF PRIVATE A	18
	WIND-TUNNEL TESTS	31
	FIRING TESTS	32
III	PRIVATE F	36
	PURPOSE OF PRIVATE F	36
	DESCRIPTION OF THE PRIVATE F AND LAUNCHER	36
	WIND-TUNNEL TESTS	37
	FIRING TESTS	37
	Results of Tests	38
	Conclusions	39
	SCALED-DOWN-MODEL TESTS CONSIDERED	41
IV	WAC CORPORAL A	42
	STUDY OF A HIGH-ALTITUDE SOUNDING ROCKET PROPOSED .	42

UNCLASSIFIED

CONTENTS (Continued)

CHAPTER

PAGE

IV WAC CORPORAL A (Cont)

PARTICULAR DECISIONS DURING THE PLANNING STAGE AND FINAL DESIGN (Cont)

Propellants, Propulsion, and Propulsion Systems ..	43
Some Final Specifications of the WAC Summarized ..	50
The Booster	50
The Launcher	51
The WAC's Nose and Its Release Mechanism	53

V TRANSITION TO WAC CORPORAL B

BABY WAC	55
Reasons for BABY WAC	55
Construction and Tests of the BABY WAC	55
Results of Tests and Conclusions	56

FIRING PROGRAM AT WSPG, 26 SEPTEMBER-25 OCTOBER

1945 - WAC A	56
Phase 1: TINY TIM Alone	56
Phase 2: Dummy WAC CORPORAL, Rounds 1 and 2	57
Phase 3: Partial-Charge WAC CORPORAL, Rounds 3 and 4	57
Phase 4: Full-Charge WAC CORPORAL, Rounds 5, 6, 7, 8, 9, 10	57
Results of the Tests	59
Conclusions and Recommendations	60

WAC CORPORAL B	61
Changes in Design and Construction Appearing in WAC B	61
Propulsion System	61
Aft Section and Fins	63
Nose Cone	66
Prototype Static Firing	67

THE BOOSTER	67
-------------------	----

FIRING TESTS, WSPG, 2-13 DECEMBER 1946	68
--	----

MODIFICATIONS BECAUSE OF TEST RESULTS	68
Propulsion System	68
Miscellaneous	71

THE BOOSTER ROCKET	71
--------------------------	----

UNCLASSIFIED

CONTENTS (Continued)

<u>CHAPTER</u>		<u>PAGE</u>
V	TRANSITION TO WAC CORPORAL B (Cont)	
	FIRING TESTS, WSPG, 17 FEBRUARY-3 MARCH 1947	73
	RECOMMENDATIONS IN VIEW OF TEST RESULTS	74
VI	BUMPER WAC	76
	INTRODUCTION	76
	INITIATION OF THE BUMPER WAC PROJECT	76
	The Fort Bliss, Texas, Study	80
	Geometric Considerations	87
	The DAUGHTER	87
	Summary of the BUMPER Program	88
	PROBLEMS AND THEIR SOLUTIONS	89
	Separation and Second-Stage Ignition	89
	Stabilization of the BUMPER WAC	92
	Aerodynamic Stability	92
	Correcting the Effects of Asymmetric Thrust	98
	GENERAL DESCRIPTION OF THE A-2 AND THE BUMPER WAC COMBINATION	98
	FIRINGS AT WSPG	105
	TEST RESULTS	106
	FIRINGS AT JOINT LONG RANGE PROVING GROUND, FLORIDA	106
VII	MISSILE XF30L20,000 - CORPORAL E	108
	INTRODUCTION	108
	THE CONTROL SYSTEM	109
	TELEMETERING	111
	PROPULSION SYSTEMS	112
	CORPORAL E FIRINGS AT WSPG	113
	INTERIM DEVELOPMENT BEFORE THE FIRING OF ROUND 4 ...	116
	The Rocket Motor	116
	Other Modifications in Design	118

UNCLASSIFIED

CONTENTS (Continued)

<u>CHAPTER</u>		<u>PAGE</u>
VII	MISSILE XF30L20,000 - CORPORAL E (Cont)	
	INTERIM DEVELOPMENT BEFORE THE FIRING OF ROUND 4 (Cont)	
	Launching and Handling	118
	FIRINGS RESUMED	119
	FIRINGS AGAIN INTERRUPTED	121
	DEVELOPMENTS IN WASHINGTON	121
	FIRING RESUMED	123
VIII	CORPORAL I	127
	INTRODUCTION	127
	WARHEAD	129
	SYSTEM DESCRIPTION	130
	RESUME OF CORPORAL I	131
	Propulsion	133
	Airframe	133
	Guidance	137
	Telemetry	139
	COUNTERMEASURES	140
	Study of CORPORAL E's Susceptibility to Countermeasures	140
	ACM Group Established; Findings	141
	HANDLING AND LAUNCHING	142
	TYPE I CONTRACTORS	146
	TYPE I EVALUATION PROGRAM	147
	Static Testing	147
	Firing Tests	151
	TYPE I ENGINEER-USER PROGRAM	155
	EVALUATION OF THE E-U TESTS	159
	TRAINING PROGRAM	160

UNCLASSIFIED

CONTENTS (Continued)

<u>CHAPTER</u>		<u>PAGE</u>
VIII	CORPORAL I (Cont)	
	FIELD FORCE PROGRAM	162
	TESTS CONTINUED	163
IX	CORPORALS II, IIA, AND IIB	165
	TRANSITION FROM TYPE I TO TYPE II CORPORAL	165
	Changes in the Type II CORPORAL System	167
	Propulsion System	168
	TEST FIRING OF CORPORAL TYPE II	170
	ARMING THE CORPORAL	174
	COST OF THE CORPORAL PROGRAM	175
	CONCLUSIONS AND RECOMMENDATIONS	186
	RESULTS, CONCLUSIONS, AND RECOMMENDATIONS	189
	CRITERIA USED IN THE EVALUATION	201
	CONCLUSIONS	202
	E-U Rounds	202
	Training Rounds	203
	E-U and Training Rounds Combined	204
	RECOMMENDATIONS	205
	GENERAL DESCRIPTION OF THE CORPORAL SYSTEM	206
X	CORPORAL TYPE III, AN "ON-THE-SHELF ITEM"	225
	RESUME	225
	COMPARISON OF TYPE III GROUND GUIDANCE EQUIPMENT WITH THAT OF TYPE II	228
	TEST AND CHECKOUT EQUIPMENT	231
	GROUND HANDLING EQUIPMENT	232
	THE TYPE III MISSILE AS PLANNED	232

CONTENTS (Continued)

<u>CHAPTER</u>		<u>PAGE</u>
X	CORPORAL TYPE III, AN "ON-THE-SHELF ITEM" (Cont)	
	REDSTONE ARSENAL'S STUDY OF THE CORPORAL TYPE III SYSTEM	233
	ANALYSIS OF TYPE II FIRING TESTS	234
	FUNDING	236
XI	TRAINING, DEPLOYMENT, AND PRESENT STATUS OF THE CORPORAL	243
	JPL TRAINING MISSION FOR THE CORPORAL	243
	Beginning of Organized Training	250
	DEPLOYMENT OF THE CORPORAL MISSILE SYSTEM	259
	PRESENT STATUS OF THE CORPORAL SYSTEM, AS OF 31 DECEMBER 1961	263
XII	SUMMARIZED CONCLUSIONS	269
	BIBLIOGRAPHY	275
	GLOSSARY	287
	DISTRIBUTION LIST	292

UNCLASSIFIED

A P P E N D I X

<u>DOCUMENT</u>	<u>DESCRIPTION</u>	<u>NUMBER</u>
	Initiation of the Jet Propulsion Laboratory	1
	Acquisition of Land for ORDCIT Project Range Facilities Designated White Sands Proving Ground, Later Redesignated White Sands Missile Range	2
	ORDCIT Project	3
	Statistical Summary of PRIVATE A	4
	Wind Tunnel Tests of ORDCIT Models	5
	Results of PRIVATE A Firings	6
	Statistical Summary of PRIVATE F	7
	Results of PRIVATE F Firings	8
	Statistical Summary of WAC CORPORAL Missile and TINY TIM Booster	9
	Results of WAC CORPORAL Firings	10
	Theoretical Calculations of Trajectories for the Proposed V-2/WAC CORPORAL Missile	11
	BUMPER (V-2/WAC CORPORAL Combination) Firings at White Sands Proving Ground, New Mexico, and at Long Range Proving Ground, Cocoa, Florida	12
	Detailed Launching Accounts, BUMPER Round 5	13
	BUMPER Missiles No. 7 and 8	14
	Early Military Characteristics Expected of the Drawing- Board CORPORAL and the Estimated Performance of the ORDCIT CORPORAL Series of Guided Missiles	15
	Research Program for the Second Type of Long-Range Jet Pro- pelled Missile (XF30L20,000)	16
	Initial Development of the Control System of CORPORAL E by Sperry Gyroscope Company, Inc.	17
	Early Troubles Encountered by the Outside Fabrication Department, JPL/GALCIT, CIT, and Their Solution	18

UNCLASSIFIED

APPENDIX (Continued)

<u>DOCUMENT</u>	<u>DESCRIPTION</u>	<u>NUMBER</u>
	Results of CORPORAL E Firings	19
	Tabulation of ORDCIT Test Vehicle and CORPORAL Firings	20
	The CORPORAL Missile Arming Philosophy	21
	Military Characteristics, Status of CORPORAL and CORPORAL I Firings to 22 September 1952 and Addenda Concerning CORPORAL Type I Firings to 30 June 1955 and Additional Military Characteristics	22
	Anticountermeasures	23
	Development of CORPORAL's Ground Handling Equipment	24
	Fiscal History of CORPORAL	25
	Flight Analysis of First Fourteen Rounds of CORPORAL Type I Fired in E-U Program	26
	Charts of CORPORAL Firings	27
	CORPORAL's Propulsion System	28
	CORPORAL Training--Individual and Unit	29
	CORPORAL Presentation, White Sands Proving Ground, 22 March 1956	30
	Statistical Information Concerning CORPORAL Development	31

~~CONFIDENTIAL~~
UNCLASSIFIED
CHAPTER I

INITIATION OF THE ORDCIT PROJECT

HISTORICAL DEVELOPMENT OF THE JET PROPULSION LABORATORY (JPL)

The GALCIT Rocket Research Project

(C) In 1936, after obtaining approval from Dr. Theodore von Karman, Director of the Guggenheim Aeronautical Laboratory, California Institute of Technology (GALCIT), a group of rocket enthusiasts formed the GALCIT Research Project at the Institute. Really, the Project was privately initiated by the following research group: Frank J. Malina, Hsue-Shen Tsien, A. M. O. Smith, John W. Parsons, Edward S. Forman, and Weld Arnold. Early research phases were financed by a fund of \$1,000 from Weld Arnold.

(C) Initial investigations of the group included a broad study involving rocket propulsion aspects, including theoretical studies of the flight performance of a sounding rocket, since the development of a high-altitude vehicle of this nature was of primary interest. Included, too, were studies of rocket motor designs and of both solid- and liquid-propellants. In the course of these investigations, several members of the group wrote papers.

(C) By 1938, under the sponsorship of the National Academy of Sciences and the Army Air Forces (AAF), activities of the rocket group were centered on developing liquid- and solid-propellant-type rocket propulsion systems suitable for auxiliary propulsion of aircraft. On 1 July 1939 the Air Corps Jet Propulsion Research Project--GALCIT Project Nr. 1--was initiated under the direction of Dr. von Karman. Basically concerned was fundamental research on the application of rockets and jet propulsion.

(C) The Army Air Corps by the spring of 1941 decided to eliminate the National Academy and to negotiate a contract directly with CIT. Effective on 25 June 1941 and extended by periodic renewals until

UNCLASSIFIED
~~CONFIDENTIAL~~

~~CONFIDENTIAL~~
UNCLASSIFIED

30 June 1946, this contract became known as JPL-1. The primary objectives and accomplishments of JPL-1 embraced the following:

1. Performance of the first take-off in the United States of an aircraft assisted by restricted-burning solid-propellant units, 12 August 1941, March Field, California.
2. Development of the asphalt-potassium perchlorate restricted-burning propellant known as GALCIT 61-C, the only successful restricted-burning propellant then in service use--used in Navy jet-assist-take-off (JATO) units.
3. Development of the first satisfactory theory on the operation of a restricted-burning solid-propellant unit.
4. Performance of the first take-off in the United States of an aircraft assisted by liquid-propellant rocket units, 15 April 1942, Muroc, California.
5. Development of the red fuming nitric acid (RFNA)-aniline liquid-propellant rocket unit.
6. Design and test of the first high-performance liquid-propellant rocket motor to operate at thermal equilibrium for a period exceeding 30 minutes.
7. Design and test of the first regeneratively cooled mono-propellant-type (nitromethane) motor.
8. Design and test of the largest thrust motor (as of 1946) operated in the United States (20,000-pound thrust).¹

(C) Lack of space and facilities had hindered the work of the GALCIT group from the time of its formation. Commencing in 1938 with the expansion of its research activities, the GALCIT group found that land holdings and facilities must likewise be expanded to provide space and equipment for carrying on investigations. The declaration of war on

1. Miles, Capt. R. C., compiler, "The History of the ORDCIT Project up to 30 June 1946, pp. 1-10, Research and Development Service Sub-Office (Rocket), CIT, Pasadena, California, n.d.; Malina, F. J., Report Nr. 4-18, "Development and Flight Performance of a High-Altitude Sounding Rocket, the 'WAC CORPORAL,'" p. 1, JPL/GALCIT, CIT, 24 January 1946.

UNCLASSIFIED
~~CONFIDENTIAL~~

UNCLASSIFIED

8 December 1941 increased the importance of the project and entailed the assumption of additional research experimentation. Moreover, during the ensuing years, land holdings and facilities were increased until the final purchase on 1 February 1944 brought the total acreage held by the GALCIT Project to approximately 65.415 acres, including 4.435 acres leased from the City of Pasadena.

(C) CIT's willingness to sell to the U. S. Government the property devoted to the GALCIT Project resulted on 19 October 1945 in the sale of 31.5 acres at the nominal cost of \$164 per acre, for practically all facilities had been financed by the Government. The U. S. Engineers negotiated a lease of the acreage belonging to the City of Pasadena, with 30 June 1970 as the lease's expiration date. By March 1946 the JPL, GALCIT, together with all its installations, was valued at approximately \$3,000,000 and owned entirely by the Federal Government, insofar as CIT was concerned.²

(S) Closely allied with matters concerning land and facilities were the requirements for test-firing. In that relation, it became evident in the early fall of 1944 that the accelerated missile development program would require a land-range over which missiles could be test-fired and after impact recovered for further study. Such studies would inevitably make available data to aid in the development of future missiles for military application.

(S) Criteria for the selection of a missile-firing range were established, and a group of specially selected officers representing the War Department and the Corps of Engineers visited the few sites considered "possible" and chose the area soon thereafter acquired and designated White Sands Proving Ground (WSPG), later renamed White Sands Missile Range (WSMR). While this tract of land was not so large as was desired, being approximately 100 miles long and 40 miles wide, it was chosen as most suitable for testing purposes.³

2. Miles, compiler, op. cit., pp. 16-19, 44. See Document 1 for additional information concerning the beginning and growth of JPL.
3. Brown et. al., "Development & Testing of Rockets & Missile at White Sands Proving Ground, 1945-1955," pp. 14-16, Historical Information Branch, WSMR, New Mexico, 1 October 1959. See Document 2 for additional information concerning land acquisition to create WSPG.

UNCLASSIFIED

UNCLASSIFIED

Reports of German Missiles

(U) World War II was, of course, responsible for the increased interest in jet propulsion research. During the early part of 1943, British Intelligence reports, forwarded to Dr. von Karman by the Experimental Engineering Division, Air Materiel Command, credited the Germans with perfection of large jet-propelled projectiles capable of ranges in excess of 100 miles. Information contained in these reports was usually sketchy and often contradictory. Dr. von Karman was asked for study and comment concerning these reports, which he provided in a letter dated 2 August 1943.

Feasibility Studies of Developing U. S. Jet-Propelled Missiles

(U) Progress in the field of jet propulsion by the Army Air Corps Jet Propulsion Research Project, the National Defense Research Committee (NDRC), and the Aerojet Engineering Corporation had indicated that the development of a long-range rocket projectile was within engineering feasibility. At the suggestion of Col. W. H. Joiner, AAF, Materiel Command Liaison Officer at CIT, von Karman and two of his associates, Drs. Malina and Tsien, prepared theoretical studies analyzing performance and design of long-range missiles. An attempt was also made to reconstruct--on the drawing board--the German type of long-range projectile. Inasmuch as the data secured from prisoners of war generally indicated that those projectiles were of the ramjet type, the reconstruction studies were concerned primarily with rocket-boosted ramjet projectiles.

(U) Results of these studies showed that ranges in excess of 100 miles could not be realized with propulsive equipment then (November 1943) in the United States. With the equipment already developed for aircraft superperformance,* however, rocket projectiles could be constructed having a greater range and carrying a much larger explosive load than those currently employed by the Armed Forces. Furthermore,

* The rocket used as a JATO for conventional aircraft resulted in "superperformance" in that the aircraft became airborne without the customary very long run preceding flight. Moreover, JATO enabled bombers to become airborne with heavier payloads.

UNCLASSIFIED

by developing a special type of propulsive equipment of the "athodyd"* type, ranges comparable to those claimed by the Germans might be achieved.

The Development Program Proposed by Dr. von Karman and Associates

(U) Admittedly, the solution of the engineering problems connected with that type jet unit required considerable time. On the other hand, a large amount of immediately useful information was to be accumulated by experimentation with projectiles utilizing aircraft superperformance equipment. Dr. von Karman, appraising the situation, set forth several coordinated phases as necessary to a development program.

(U) First, firing tests of a projectile propelled by a restricted-burning solid-propellant unit produced by the Aerojet Engineering Corporation and boosted during launching by unrestricted-burning solid-propellant rockets developed by NDRC. This projectile was to weigh approximately 350 pounds and to carry a 50-pound payload for a distance of 10 to 12 miles. Firing tests were to provide information on problems of launching, stability, and control, and for verification of performance calculations.

(U) Second, the design of a 2,000-pound rocket projectile propelled by a liquid-propellant jet unit developed by the Air Corps Jet Propulsion Research Project and manufactured by Aerojet. This projectile was to carry a 200-pound explosive load for approximately 12 miles. This phase needed starting as soon as sufficient information had been obtained from Phase 1 on the design of the projectile shape, stabilizing fins, and launching technique. At this point, von Karman's expressed opinion was that the program under Phase 1 should initiate experiments on the effect of adding wings to the missiles.

(U) Third, von Karman considered it desirable to make a study of design and characteristics of the athodyd-type propulsion unit

* The "athodyd" (or aerodynamic duct jet unit) is similar to other thermal jet units, with the exception that pressure in the combustion chamber is obtained directly from the dynamic air pressure resulting from the velocity of flight. This jet engine consists essentially of a continuous duct, or tube, of varying diameters, admitting air at the forward end, adding heat to it by the combustion of fuel, and discharging it from the after end. The ramjet engine is an example of athodyd.

UNCLASSIFIED

simultaneously with the first and second phases of the projectile development. This type jet unit was expected to be more efficient than others at velocities exceeding the velocity of sound. Von Karman considered the best means of this investigation would be to make a ground installation in which tests could be carried out by using a compressor unit capable of blowing a considerable quantity of air through a duct and combustion chamber system. He considered the development of the athodyd-type unit important for both the long-range projectile and the general propulsion of aircraft at very high speeds.

(U) Fourth, upon obtaining design information from the first two phases on projectile development and the results of the special jet unit development under Phase 3, the design and construction of a projectile weighing 10,000 pounds or more and having a range of the order of 75 miles was to be undertaken.

(U) Dr. von Karman believed that the projectiles developed in the first two phases would possess immediate military usefulness, thereby justifying the effort expended independently of the general development program. Furthermore, the knowledge gained on the behavior of wings and the control surfaces at supersonic velocities was expected to prove very valuable to the designer of high-speed aircraft and remotely controlled unmanned missiles. Perhaps missiles such as glide bombs then being developed could be equipped with jet propulsion units. These studies were expected to yield information on the possibilities of accelerating such devices up to and beyond sonic velocities. On the other hand, the results collected from the ground launching tests should yield important data for the case of launching rocket-propelled devices from aircraft and from surface vessels. In fact, the absence of recoil forces opened up a wide field for application of jet propulsion to large-caliber and long-range missiles.⁴

4. von Karman, Theodore, Memorandum Nr. 1, "Memorandum on the Possibilities of Long-Range Rocket Projectiles," pp. 1-4; Tsien, H. S., and Malina, F. J., "A Review and Preliminary Analysis of Long-Range Projectiles, passim, JPL/GALCIT, CIT, 20 November 1943.

UNCLASSIFIED

~~SECRET~~ ~~CONFIDENTIAL~~
UNCLASSIFIED

ORDCIT Project Initiated

7

(S) As a result of these studies and recommendations, Maj. Gen. G. M. Barnes, Army Ordnance Department, in January 1944 requested that CIT undertake a research and development program on long-range, jet-propelled vehicles. This request led to the ORDCIT Project, the first of its kind in the United States.

(S) The first contract between the Ordnance Department and CIT--Contract Nr. W-04-200-ORD-396--was for an interim period of 90 days following 24 May 1944 and was allocated \$25,000 to initiate the program. During the interim period, on 22 June 1944, a second and larger contract was executed--Contract Nr. DA-04-200-ORD-455. The ORDCIT Project was in business. In the interest of more efficient administration, the GALCIT Research Project was reorganized and designated as the Jet Propulsion Laboratory, Guggenheim Aeronautical Laboratory, California Institute of Technology--JPL/GALCIT.⁵

(C) The definitive contract was finally accomplished on 16 January 1945, or several months after the ORDCIT Project had gotten under way. Officially, it was Contract Nr. W-04-200-ORD-455, but was usually identified as JPL-4. Facilities for the research called for under JPL-4 were covered by a separate contract, Nr. W-04-200-ORD-703, and known as JPL-5.⁶

(C) JPL-4's primary purpose was to execute the development of a long-range guided missile. However, the contract encompassed such additional projects as fundamental research on propellants; matters involved in rockets and ramjet units, on remote control equipment, and on high-speed aerodynamic problems; materials; and provision for the engineering, design, and fabrication of prototype missiles suitable for firing tests.

5. Millikan, Clark B., "Final Report ORDCIT Project, Contract Nr. W-04-200-ORD-396," *passim*, JPL/GALCIT, 1 November 1944.

6. Miles, *op. cit.*, pp. 32, 87.

UNCLASSIFIED

~~SECRET~~ ~~CONFIDENTIAL~~

~~CONFIDENTIAL~~
UNCLASSIFIED

(C) As to objectives, the ORDCIT Program was to increase progressively the size and the range of the various missiles, commencing with the PRIVATE A and extending through the SERGEANT. At the termination of hostilities, however, the program was immediately revised, and the SERGEANT missile was eliminated.⁷

7. Miles, op. cit., p. 34. For additional information concerning the extent of the ORDCIT Program, see Document 3.

UNCLASSIFIED

~~CONFIDENTIAL~~

UNCLASSIFIED

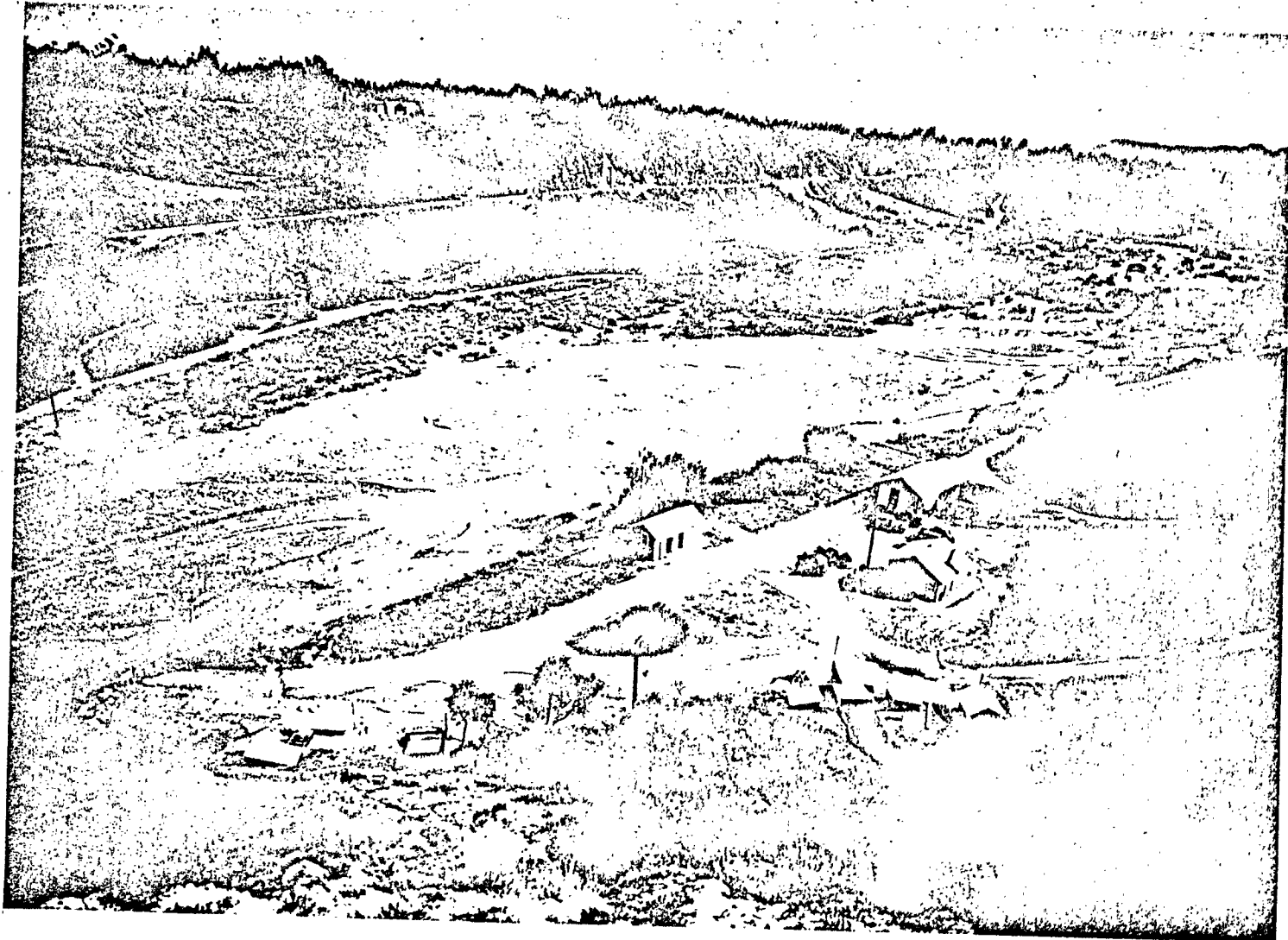

UNCLASSIFIED

PANAROMIC VIEW OF JPL IN 1941

UNCLASSIFIED

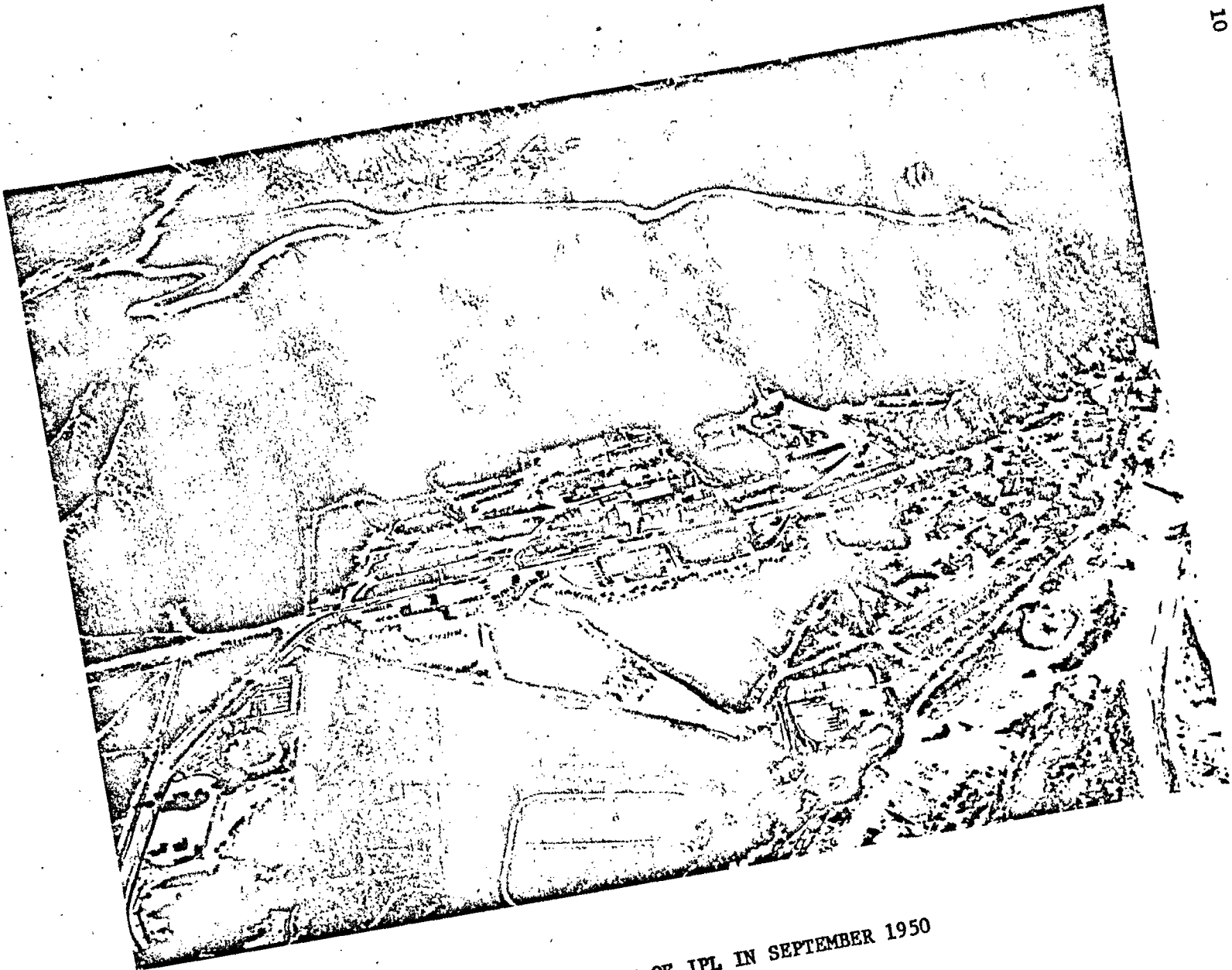

UNCLASSIFIED

AERIAL VIEW OF JPL IN SEPTEMBER 1950

UNCLASSIFIED

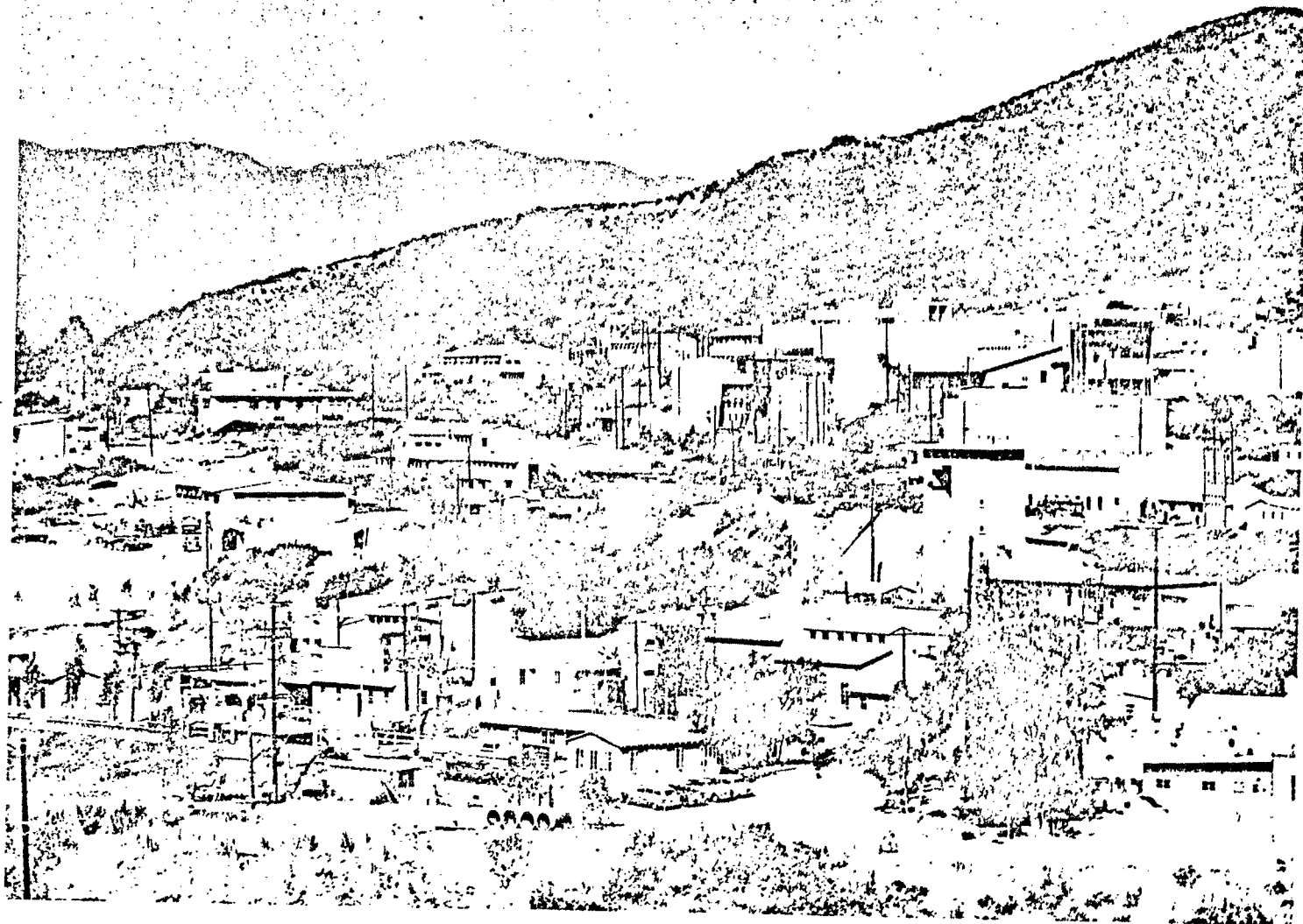

UNCLASSIFIED

PANAROMIC VIEW OF JPL IN 1952

UNCLASSIFIED

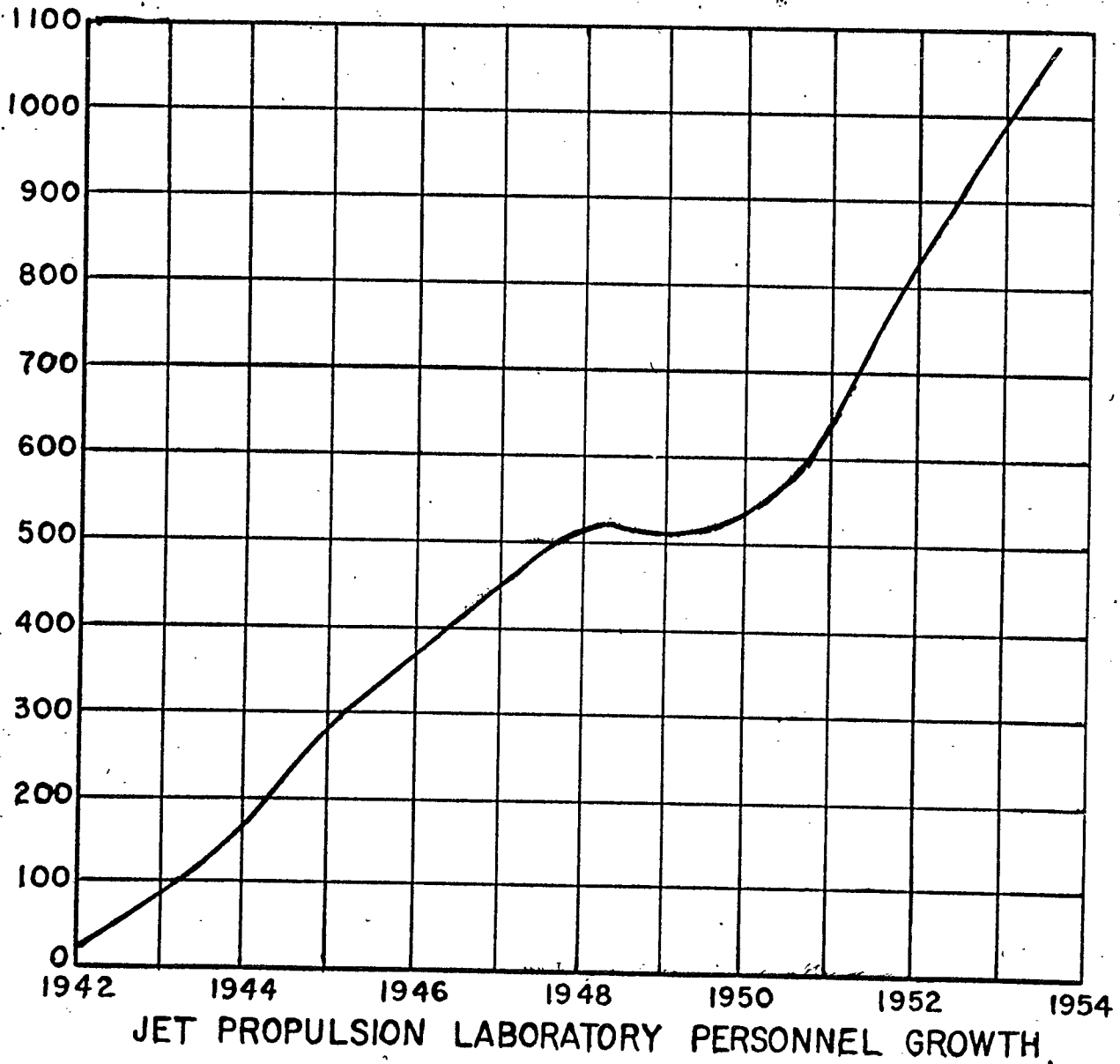

UNCLASSIFIED

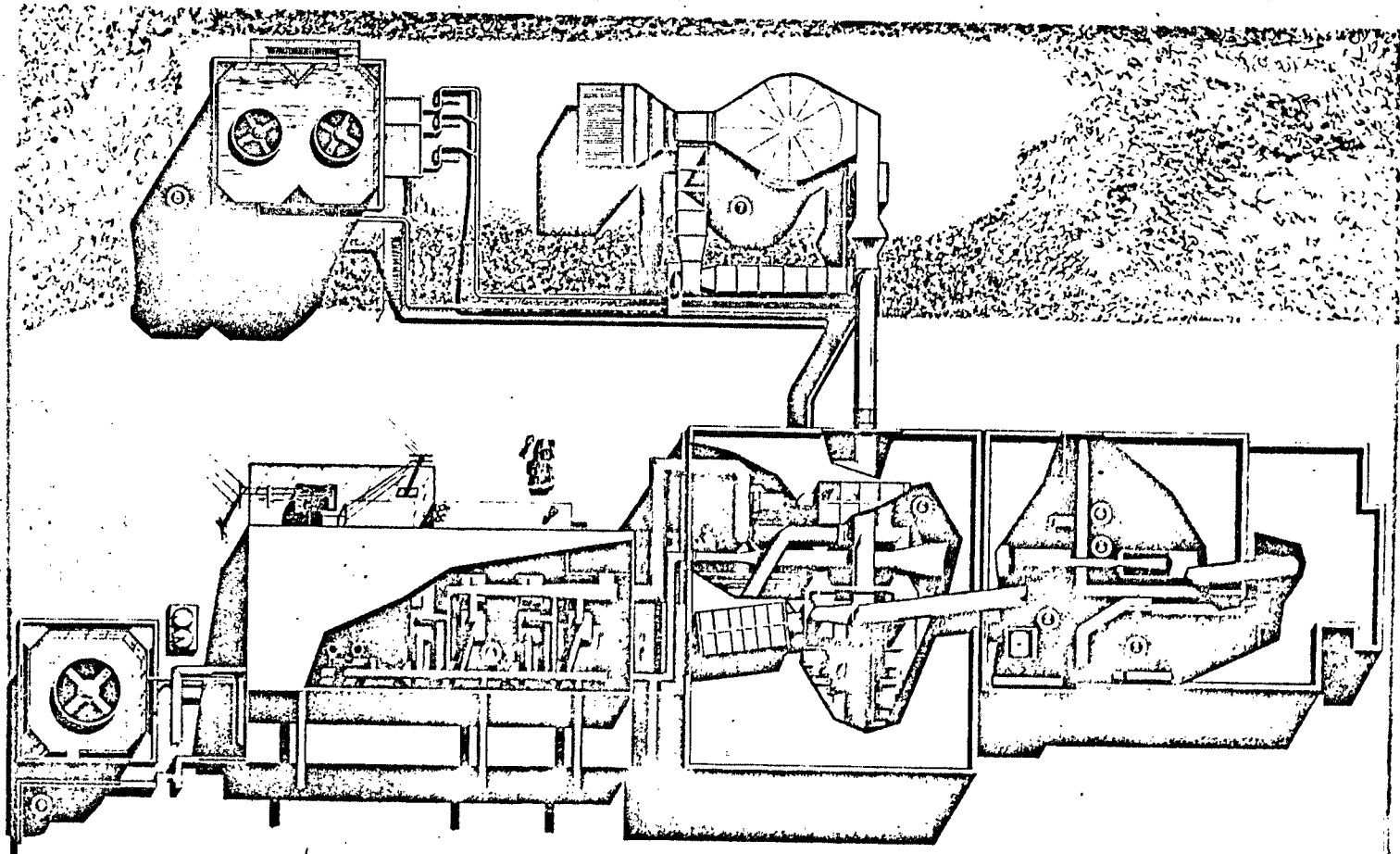

UNCLASSIFIED

- ① CONTROL ROOM
- ② CAM DATA UNIT
- ③ TEST SECTION
- ④ SCHLIEREN LIGHT
- ⑤ COMPRESSOR ROOM
- ⑥ SMALL COMPRESSOR
- ⑦ AIR INTAKE SYSTEM
- ⑧ MAIN COOLING TOWER
- ⑨ SMALL COOLING TOWER

PLAN VIEW OF JPL 20-INCH WIND TUNNELL in 1953

UNCLASSIFIED

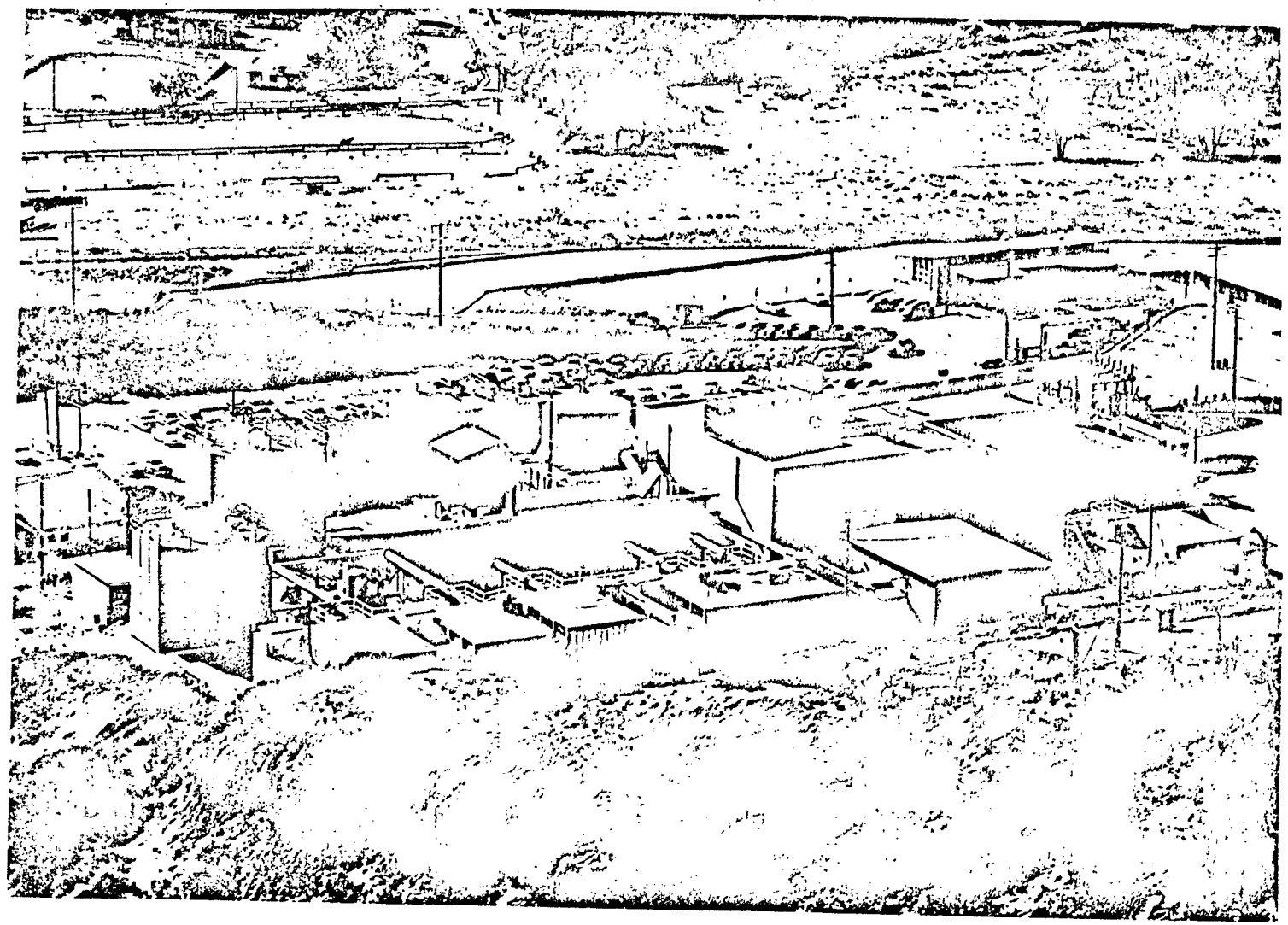

UNCLASSIFIED

PERSPECTIVE PHOTOGRAPH OF JPL 20-INCH WIND TUNNEL IN 1953

UNCLASSIFIED

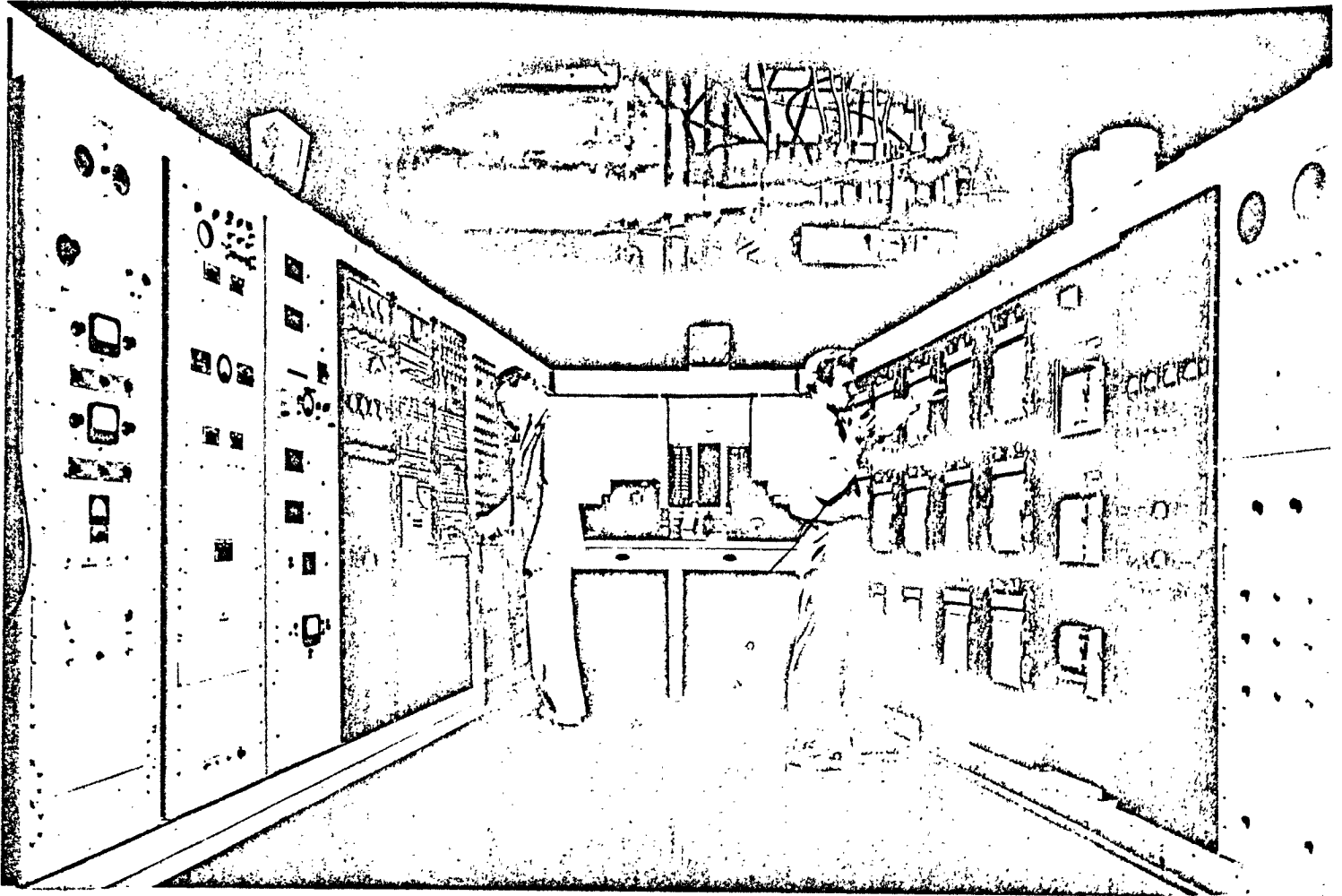

INSTRUMENTATION: CENTRAL DATA RECORDING CENTER IN 1953

UNCLASSIFIED

UNCLASSIFIED

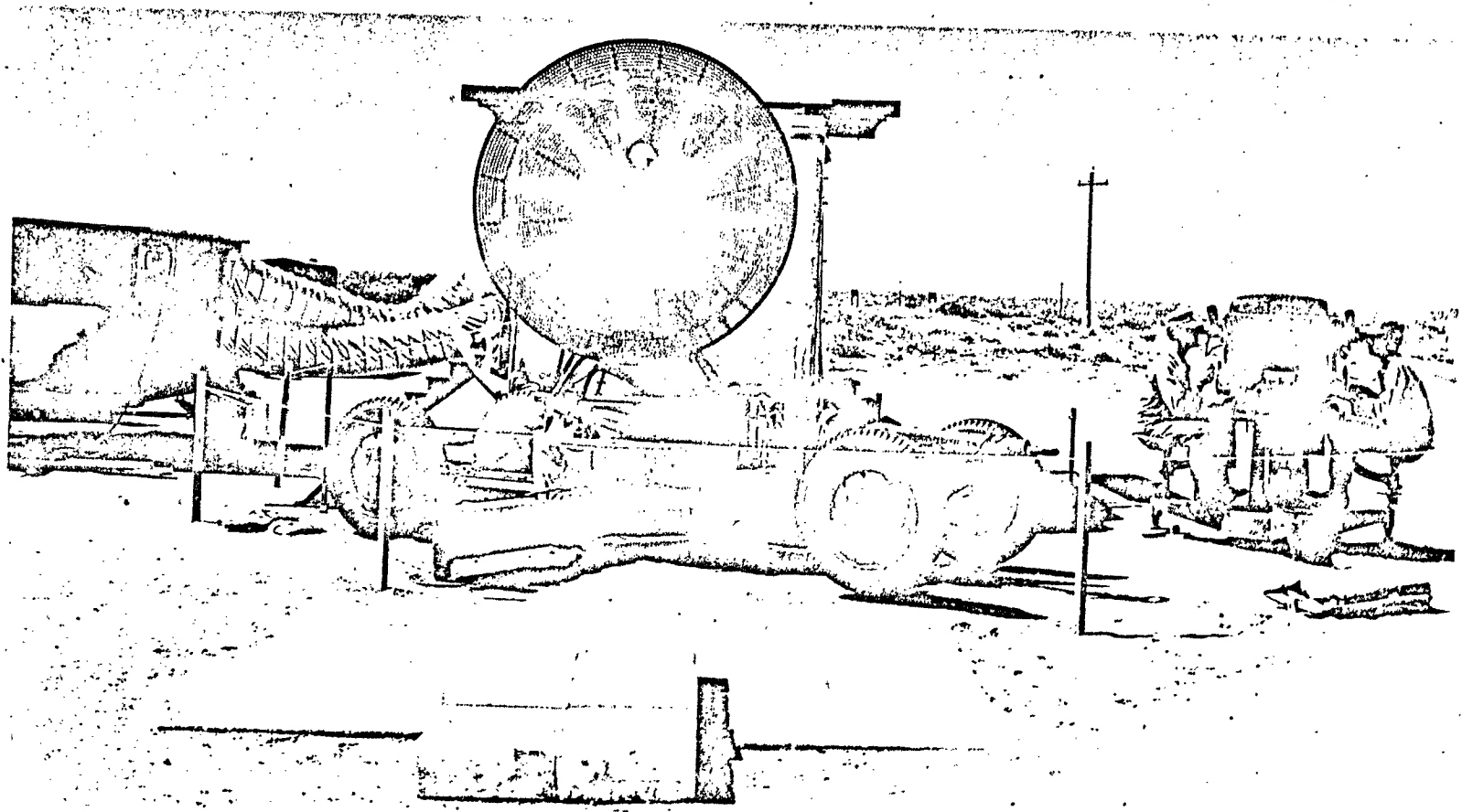

UNCLASSIFIED

GUIDANCE: RADAR DISH ON STABLE PEDESTAL IN 1953

PRIVATE A

PROGRESS DURING THE NINETY-DAY INTERIM CONTRACT

(S) The know-how gained by JPL's staff during their earlier research provided a logical foundation for the extensive program confronting them. A carefully planned, step-by-step progression was immediately laid out for solving innumerable engineering problems involved in harnessing this untried form of power to practical missile application. Objectives of the original 90-day contract were ambitious and comprehensive but were apparently in all cases met or exceeded. The ORDCIT Project's organization was practically completed, and progress was made on the most urgent aspects of the problem. Achievement of the Project's objectives is indicated as follows:

1. Considerable progress was made in theoretical calculations of trajectories, performances, stability, and general characteristics of missiles, but no calculations were completed.
2. In the development of appropriate rocket motors, JPL/CIT occupied a stronger initial position. Data already available at JPL were applied to two specific missiles being designed for the ORDCIT Project. These data were furnished the design section and served as the basis for the engineering design of these two missiles. A number of solid propellants had been investigated in connection with rocket motors.
3. Practically all the work connected with the development of ramjet propulsive systems consisted in designs of facilities and equipment for laboratory tests of such systems. As of 1 November 1944, work was continuing on ramjet development.
4. Work in connection with remote control systems consisted largely in recruiting personnel and in conferring with representatives from the Ordnance Department and potential sub-contractors. The initial 90-day period witnessed no tangible results.

~~CONFIDENTIAL~~

UNCLASSIFIED

5. In connection with the design and construction of actual missiles and launching gear for field test, practically all the effort was expended on the design of Missile XF10S1000,* called the PRIVATE, and its associated launching equipment. During the 90-day period, subcontracts were let, and construction was started on practically all the elements connected with the PRIVATE. Preliminary design of a much larger missile was initiated but did not progress to the stage of finished drawings.
6. Work of the field test section did not begin until shortly after the expiration of the interim 90-day period.¹

FINAL DESIGN OF PRIVATE A

(U) Although two models--A and B--of Missile XF10S1000 (the PRIVATE) were designed, PRIVATE B progressed no further than the drawing-board stage. The tail fin assembly of PRIVATE B was to have consisted of a ring encircling four blades, with the ring's outside diameter slightly less than the maximum diameter of the missile, whose general design followed the then current pattern of aircraft bombs.²

(U) The final configuration of PRIVATE A followed closely the theoretical design. As fabricated, the missile's over-all length was approximately 92 inches and its diameter 10 inches. Its four fins were spaced at ninety degrees and extended 12 inches from the body. Constituting the missile's power plant, as planned in the original design, was a 1,000-pound-thrust, 30-second-duration Aerojet 30AS1000 motor.** A

* This designation meant: X, experimental; F, fin tail for stability; 10 diameter in inches; S, solid-propellant rocket unit; A, first model of the type. The first model, was called PRIVATE A; PRIVATE B was contemplated but not built; and the winged PRIVATE F was constructed.

1. Millikan, Clark B., "Final Report, ORDCIT Project, Contract Nr. W-04-200-ORD-396," passim, JPL/GALCIT, CIT, 1 November 1944.
2. ORDCIT Memorandum Nr. 1, "Research Program for the First Type of Long-Range, Jet-Propelled Missile (XF10S1000-A and XF10S1000-B)," passim, JPL/GALCIT, CIT, 2 August 1944.

** This motor was a JATO for aircraft and officially designated Aerojet Model 30AS1000 Jet Motor.

UNCLASSIFIED

~~CONFIDENTIAL~~

AEROJET SOLID PROPELLANT JET MOTOR

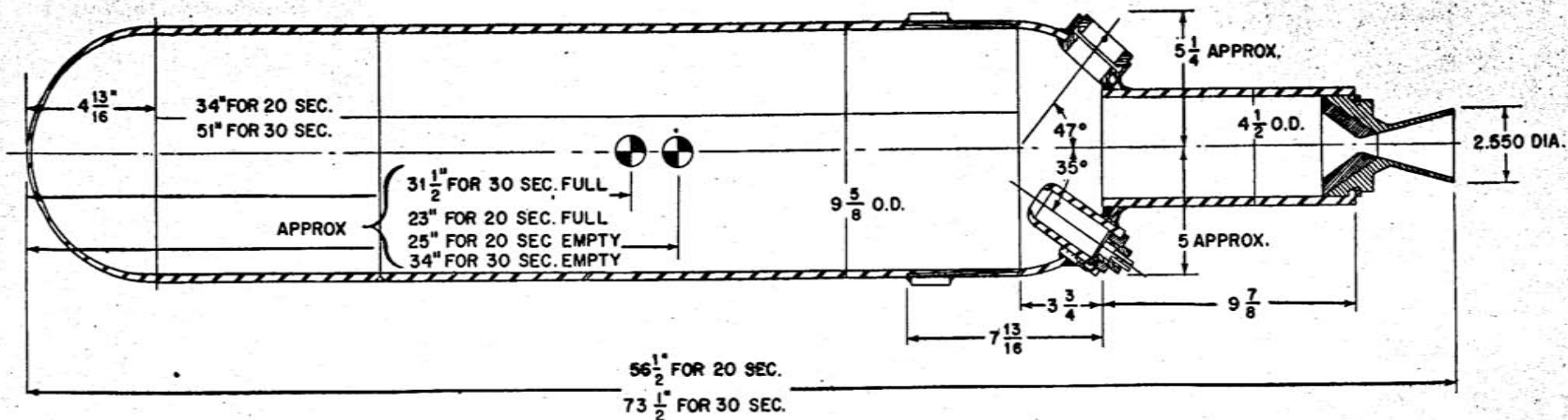

UNCLASSIFIED

UNCLASSIFIED

	<u>MODEL X20A5 1000</u>	<u>MODEL X30A5 1000</u>
RATED THRUST	1000 LBS	1000 LBS
RATED DURATION	20 SEC	30 SEC
WEIGHT LOADED	270 LBS	385 LBS
WEIGHT EMPTY	140 LBS	190 LBS

20-degree, sharply pointed, hollow, conical nose was mounted on the forward end of the motor. The initial weight and center of gravity of the missile were adjustable by varying the lead weights to be carried in the hollow nose. Depending on the amount of lead carried, PRIVATE A's gross weight ranged from approximately 500 to 550 pounds.³

(U) The booster consisted of four unrestricted-burning, solid-propellant Army 4.5-inch Type T-22 Artillery Rocket motors, with their noses removed and their forward ends manifolded together to insure simultaneous firing. This booster assembly delivered approximately 22,000 pounds of thrust for 0.18-second duration. A forward cone, hollow in order to permit passage of the missile blast, was attached to the assembly in such a manner as to provide bearing on the large external nut threaded on the exhaust nozzle of the missile. When launched from the 36-foot-long, four-rail, box-type launcher, PRIVATE A and its booster, thus loosely mated, actually constituted a crude step-rocket--the first in the United States.⁴

(U) With the advent of PRIVATE A, the restricted-burning solid-propellant rocket made its debut in the ordnance field. In this missile the 192-pound charge of the solid-propellant GALCIT 61-C, in the form of a right-circular cylinder, was ignited at one end and burned away in parallel layers, which were perpendicular to the axis of the charge. GALCIT 61-C consisted of 76 per cent pulverulent potassium chlorate and 24 per cent of an asphalt-oil mixture acting dually as fuel and binder.⁵

-
3. Ibid.; Mills, M. M., Report Nr. 4-2, "Thrust and Anertial Characteristics of Rocket Missile XF10S1000-A, PRIVATE A," pp. 1-2, 7-8, 17, JPL/GALCIT, CIT, 19 March 1945; Sandberg, W. A., Barry, W. B., and McLean, R. S., Report Nr. 4-1, "Design of 'PRIVATE A,' Facilities for Handling the Missile, and Launcher," passim, JPL/GALCIT, CIT, 8 May 1945.
 4. Sandberg and McLean, Report Nr. 1, op. cit.
 5. Ibid. See Document 4 for tabular statistics of PRIVATE A, booster, and launcher.

DIMENSIONS OF PRIVATE A WITH BOOSTER

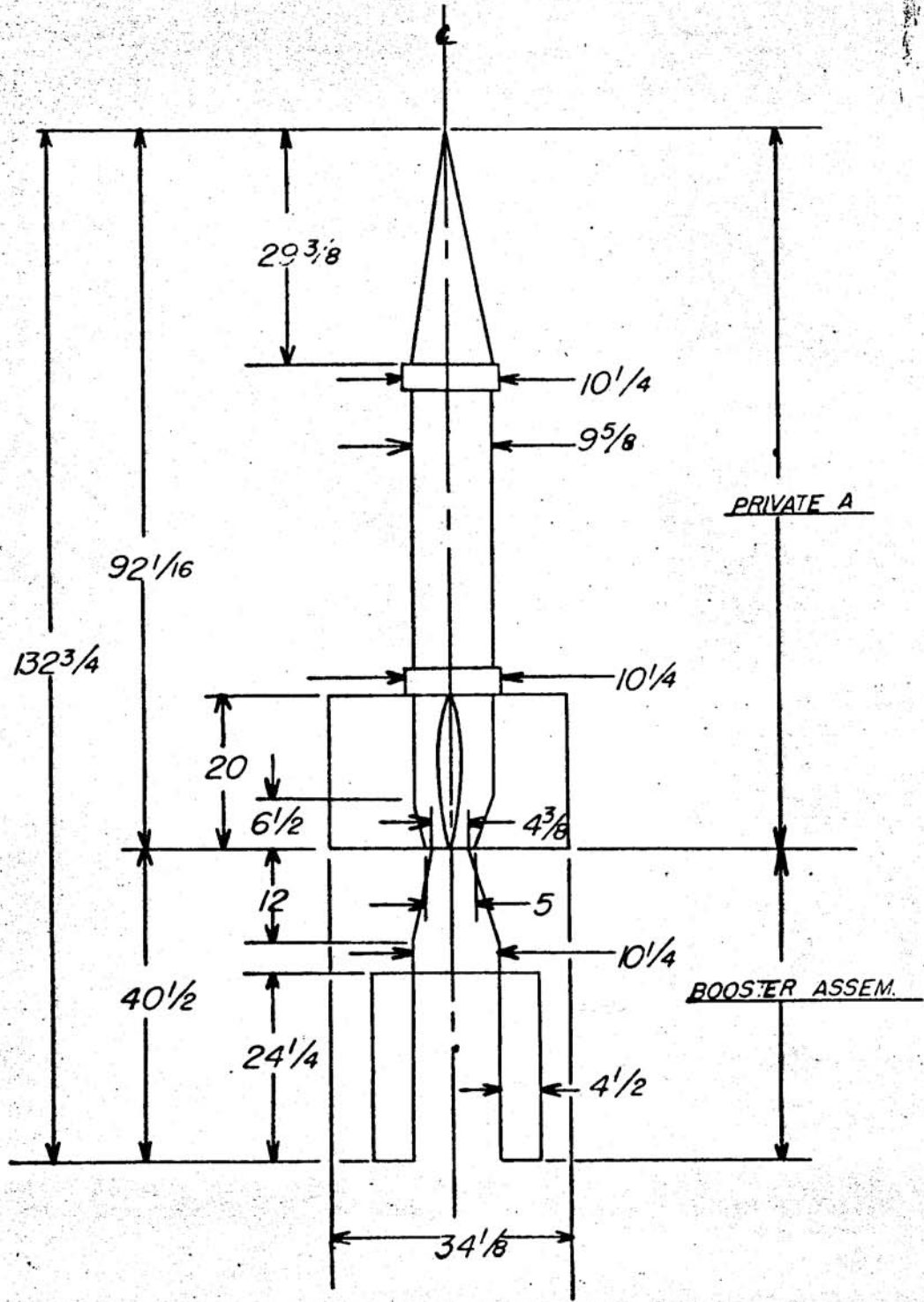

UNCLASSIFIED

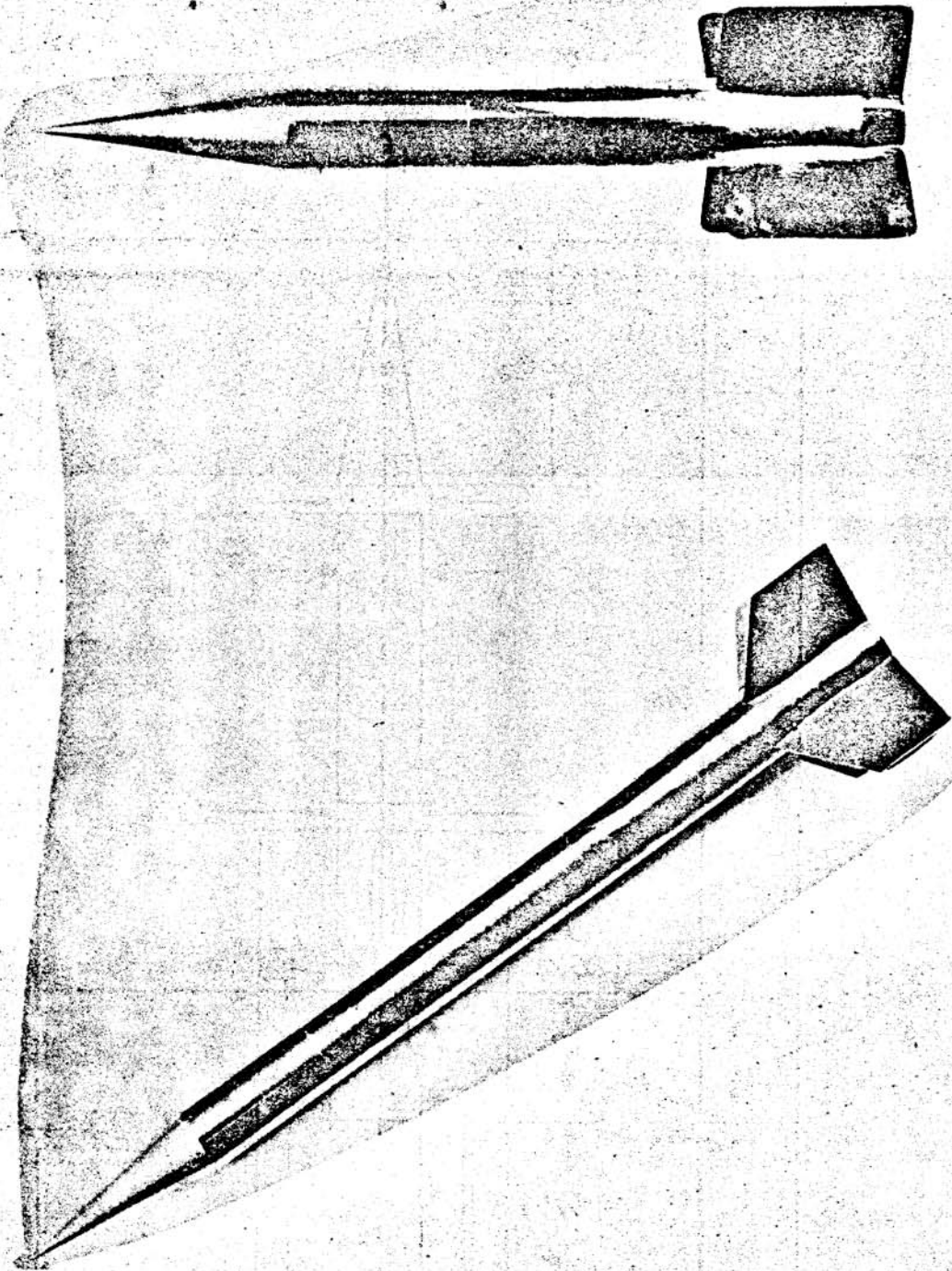

BRL/APG, Supersonic Wind Tunnel Test Laboratory (SSWTL) Tests of ORDCIT models. TOP: Basic PRIVATE A; BOTTOM: Basic CORPORAL: Photograph dated 5 June 1945.

UNCLASSIFIED

UNCLASSIFIED

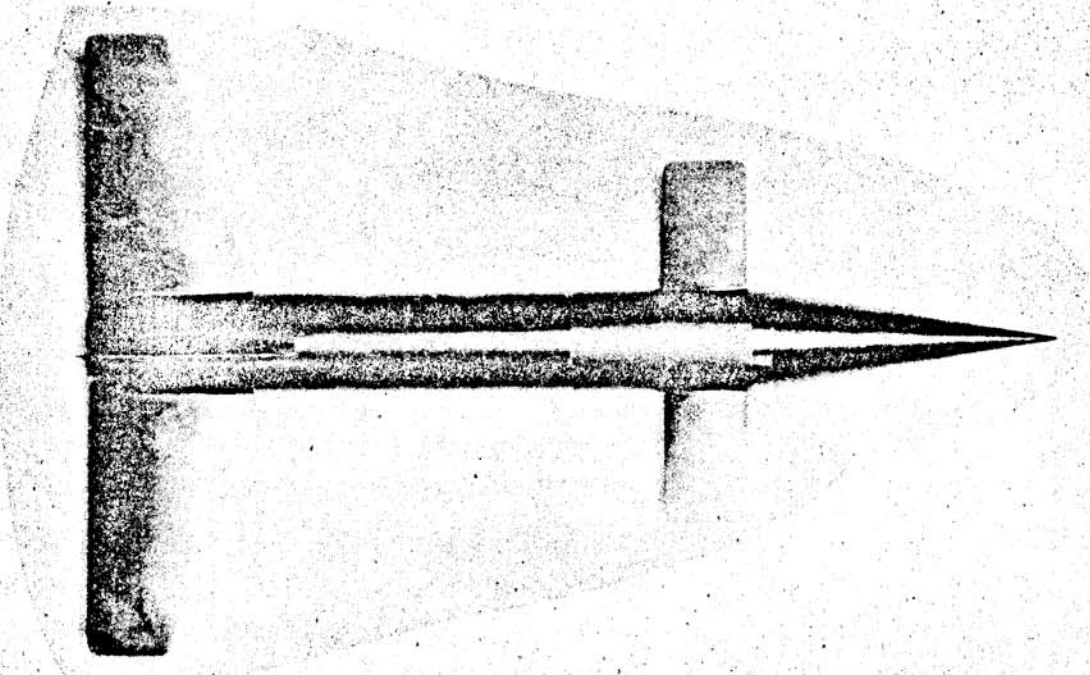

UNCLASSIFIED

BRL/APG SSWTL Tests of ORDCIT Models at Mach 1.72, PRIVATE F - top view
Photograph dated 12 March 1945

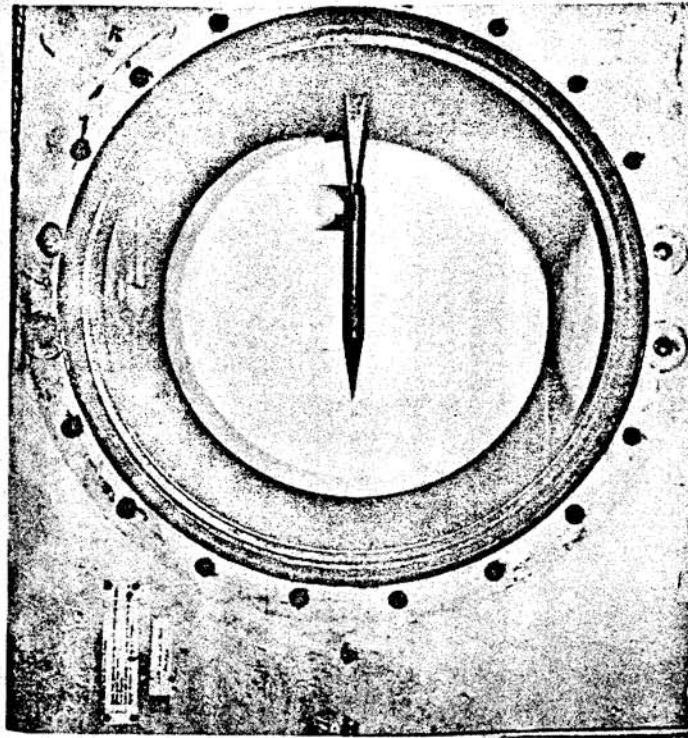

BRL/AFG SSWTL Tests of ORDCIT Models at Mach 1.72 - Model Installation in Test Section
Photograph dated 26 March 1945

UNCLASSIFIED

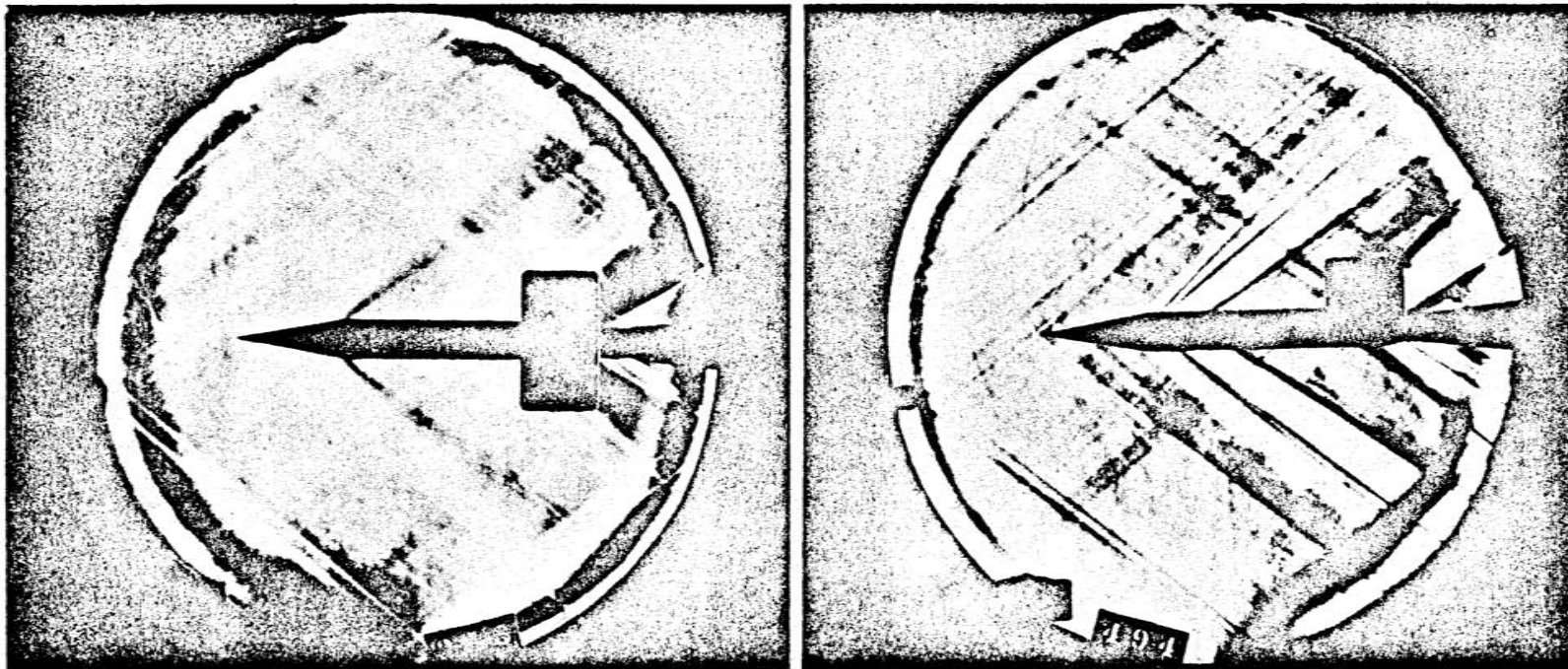

UNCLASSIFIED

BRL/APG SSWTL Tests of ORDCIT Models at Mach 1.72

LEFT: MR 18, PRIVATE A; Angle of Attack = 0° ; Knife Edge at 0° ; Photograph dated 9 February 1945
RIGHT: MR 20, PRIVATE F; Angle of Attack = 0° ; Knife Edge at 180° ; Photograph dated 1 March 1945

UNCLASSIFIED

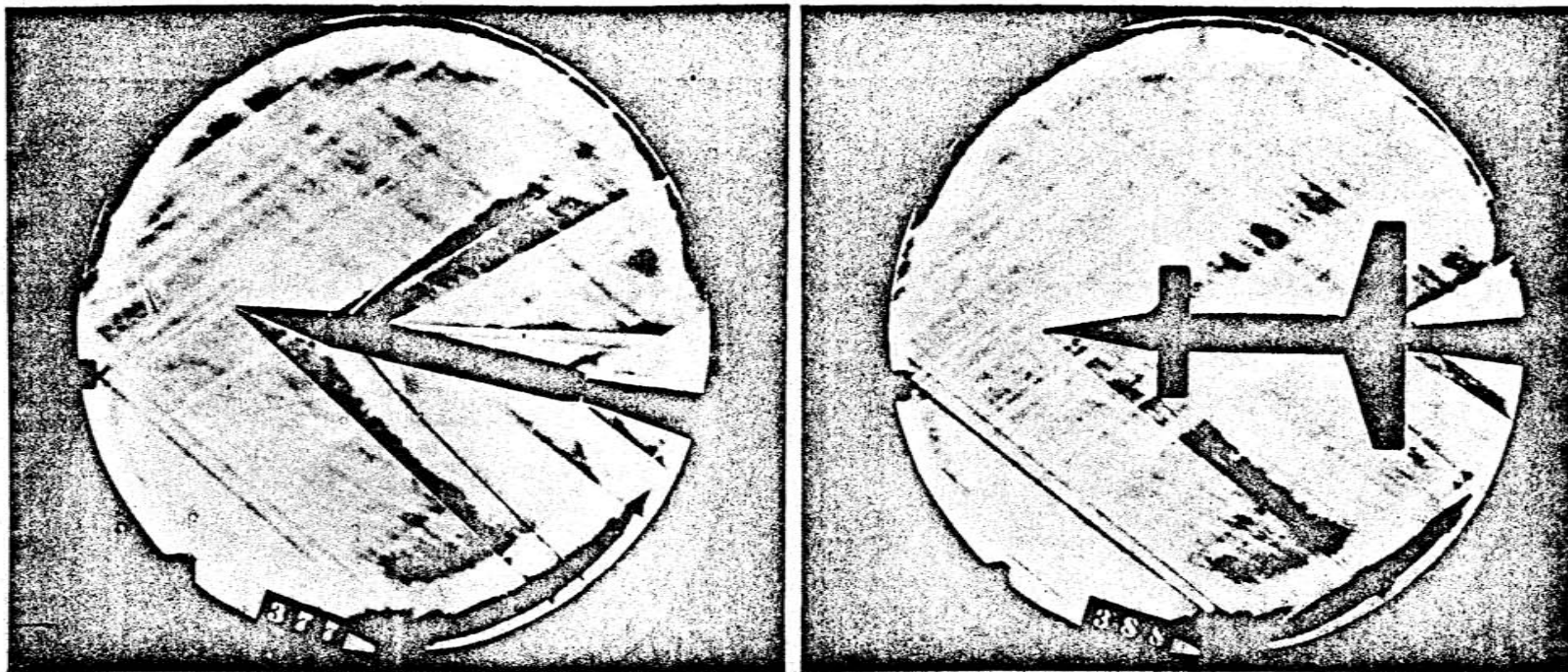

UNCLASSIFIED

BRL/APG SSWT Tests of ORDCIT Models at Mach 1.72. LEFT: MR22, PRIVATE F Minus Tail; Angle of Attack = 10° ; Knife Edge at 270° , Photograph dated 20 February 1945. RIGHT: MR20, PRIVATE F; Angle of Attack = 0° ; Knife Edge at 270° , Photograph dated 21 February 1945.

UNCLASSIFIED

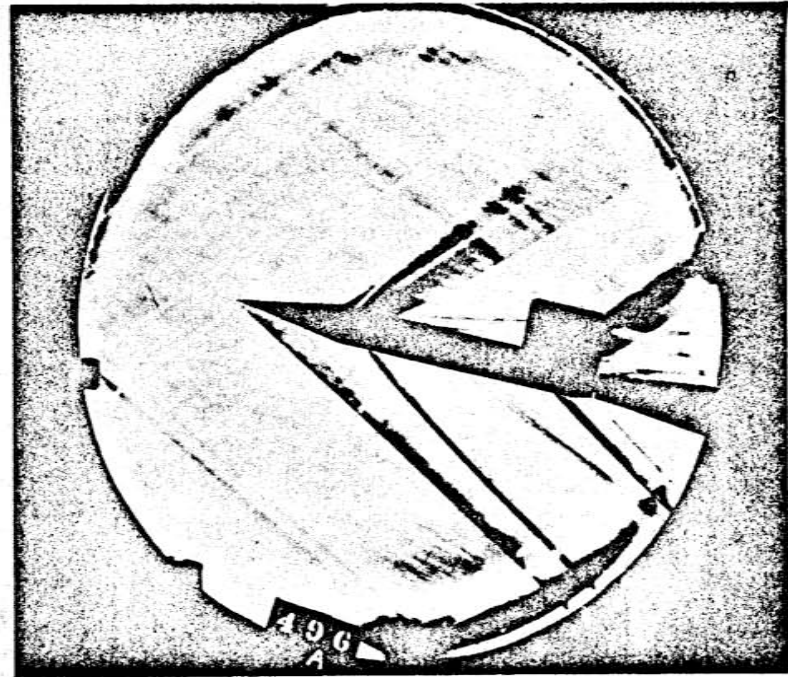
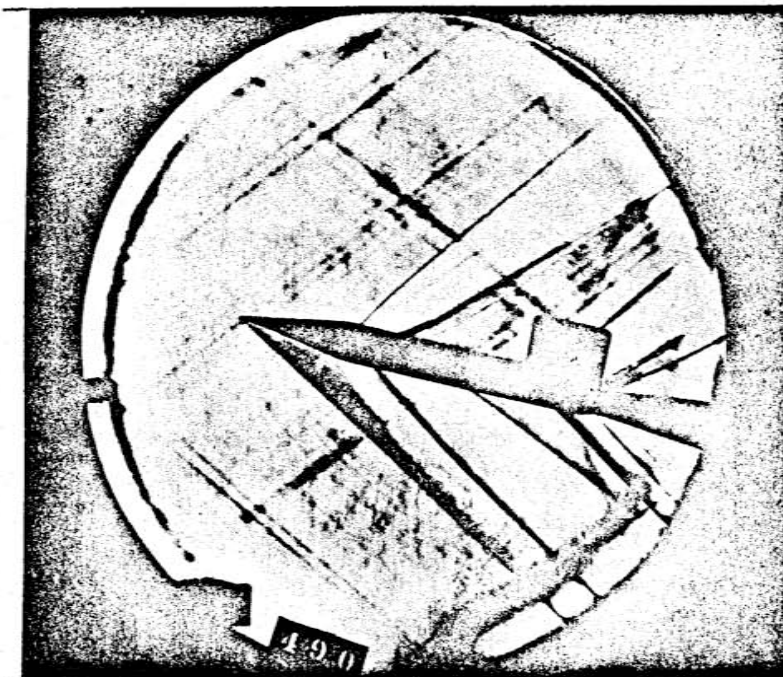

UNCLASSIFIED

BRL/APG SSWTL Tests of ORDCIT Models at Mach 1.72.
LEFT: MR20, PRIVATE F; Angle of Attack = 10° ; Knife Edge at 180° , Photograph dated 1 March 1945.
RIGHT: MR20, PRIVATE F; Angle of Attack = 10° ; Knife Edge at 270° , Photograph dated 1 March 1945.

UNCLASSIFIED

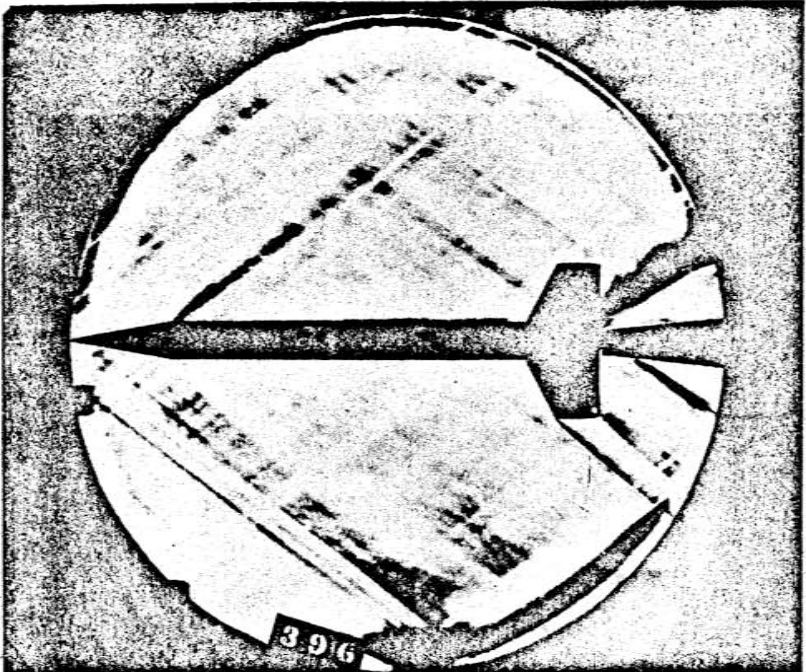
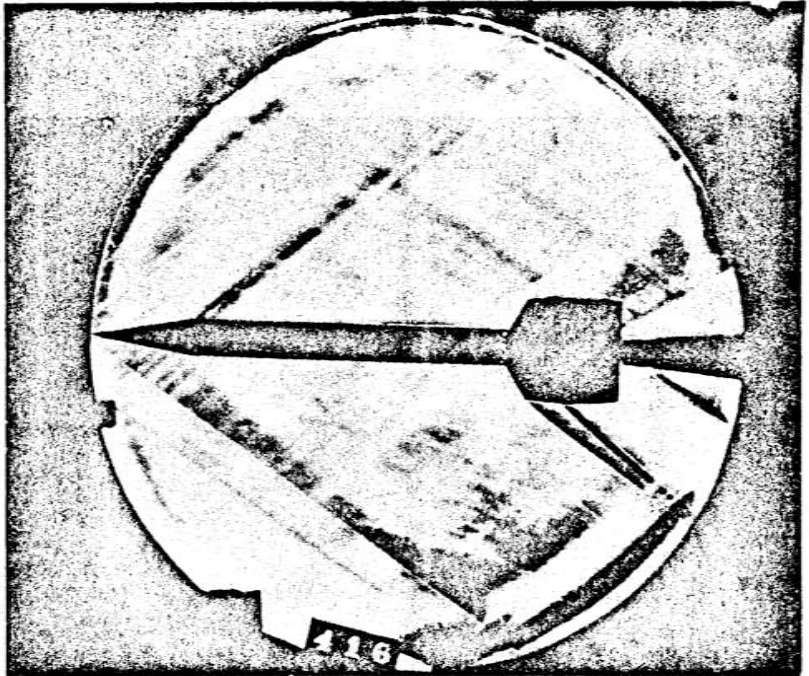

UNCLASSIFIED

UNCLASSIFIED

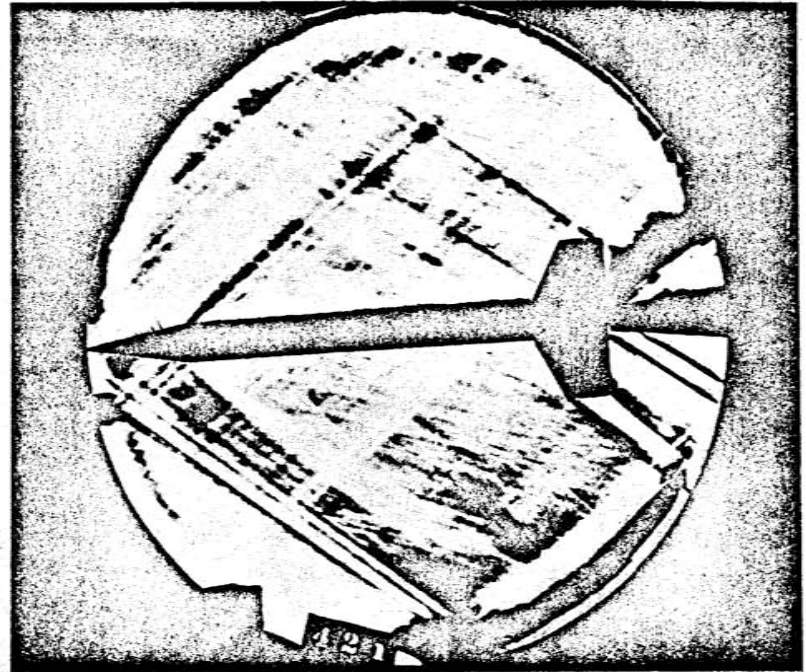
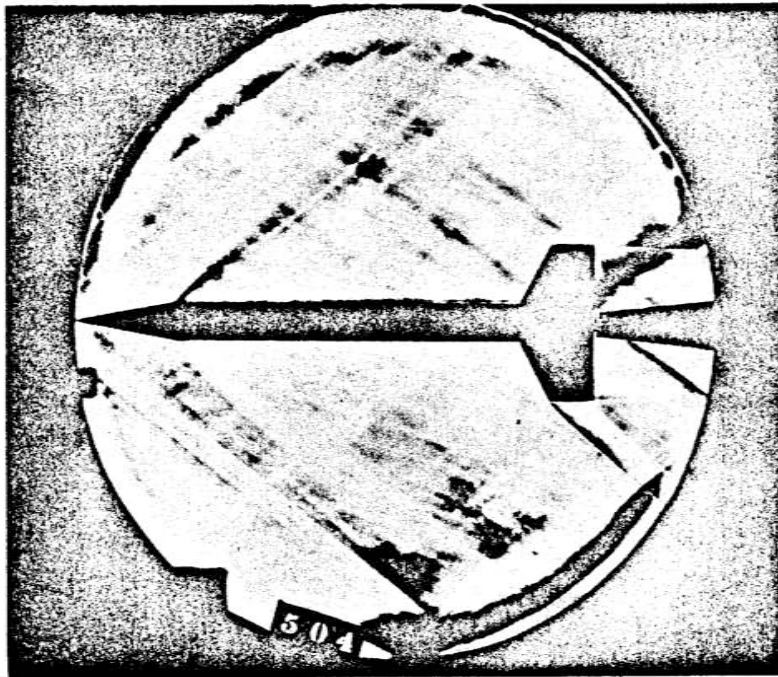

UNCLASSIFIED

BRL/APG SSWTL Tests of ORDCIT Models at Mach 1.72. LEFT: MR32, Basic CORPORAL; Angle of Yaw- 10° ; Knife Edge at 270° , Photograph dated 2 March 1945. RIGHT: MR32, Basic CORPORAL; Angle of Attack- 0° ; Knife Edge at 270° , Photograph dated 23 February 1945.

UNCLASSIFIED

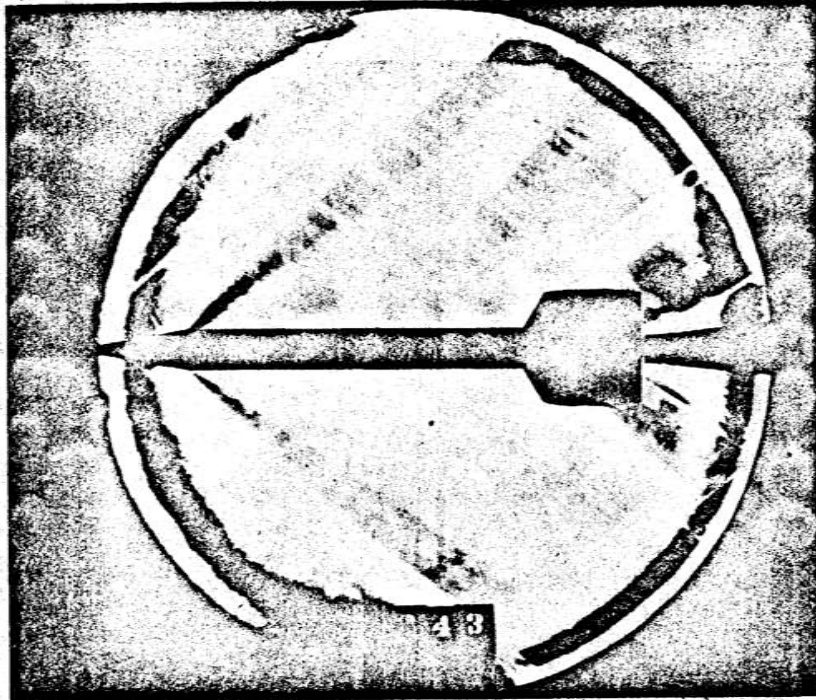

UNCLASSIFIED

BRL/APG SSWTL Tests of ORDCIT Models at Mach 1.72. MR55, CONFIDENTIAL. (low aspect ratio tail, elevators 8° down); Angle of Attack 0° ; Knife Edge at 0° , Photograph dated 4 April 1945.

~~CONFIDENTIAL~~
~~SECRET~~
UNCLASSIFIED

31

WIND-TUNNEL TESTS

(S) In October 1944 wind-tunnel tests were carried out in the ten-foot subsonic wind tunnel at GALCIT on a model which was essentially a full-scale version of PRIVATE A. To obtain test results with a model approximating the contemplated CORPORAL, extensions of the cylindrical section were used. All configurations tested had conical noses and rectangular planform fins.⁶

(U) Also, a series of models of jet-propelled missiles developed under the ORDCIT Project underwent wind-tunnel tests at sub-sonic and supersonic speeds in the bomb tunnel at Ballistic Research Laboratory, Aberdeen Proving Ground (BRL/APG) between 9 February 1945 and 2 March 1945. The schedule included approximately 30 configurations tested at all speeds, the results of these tests being designed to determine the aerodynamic coefficients on the three basic models (PRIVATE A, PRIVATE F, and CORPORAL) and the effect of removing or changing various components such as tail surfaces, body lengths, and nose angles. In addition to the PRIVATE A and PRIVATE F models tested, CORPORAL configurations with boattail, three different cylindrical body lengths, three different conical noses, and two fin planforms were tested, none of which configurations corresponded exactly to those of the CORPORAL vehicles later field-tested.⁷

(U) The aerodynamic forces on this series of models, at Mach 1.72, conformed generally to those which might have been expected from a calculation based on the simple theories then available. Lifting surfaces of aspect ratio above two were observed to develop lift equal to or in excess of that predicted. In particular, it appeared that an airfoil attached to a body might cause the center section of the body to develop

6. Pickering W. H., Report Nr. 20-100, "The CORPORAL, A Surface-to-Surface Guided Ballistic Missile," p. 19, JPL/CIT, 17 March 1958. "Planform" refers to a completely flat, or plane surface.
7. Puckett, Allen E., BRL Report Nr. 548, Laboratory Problem Nr. SS-2, "Wind Tunnel Tests of ORDCIT Models," passim, Ordnance Research & Development Center, APG, 25 May 1945.

UNCLASSIFIED

~~CONFIDENTIAL~~

~~SECRET~~

UNCLASSIFIED

some lift. The lift coefficient of the one low aspect ratio surface tested was considerably below that predicted.⁸

(U) The wave drag, that is, that part of the drag associated uniquely with supersonic flow, constituted a large part of the total drag on the models tested.

(U) Tail surfaces provided on this model series furnished satisfactory longitudinal stability. Trim characteristics of the PRIVATE F indicated that, at one supersonic speed, the lift-drag ratio was improved by using a wing at 2 degrees incidence.

(U) Lateral stability could not be computed from the force coefficients determined in this series of tests.⁹

FIRING TESTS

(U) Firing tests on PRIVATE A were carried out prior to the APG wind-tunnel tests. Between 1 and 16 December 1944, launchings occurred at the Leach Spring-Leach Lake area of the Camp Irwin Reservation, near Bartow, California. This site was chosen because it afforded an unrestricted view of the impact area. The firing program was conducted by representatives of Ordnance Liaison at CIT, of APG, and of JPL.¹⁰

(U) The test program was successfully carried out, and it yielded the desired technical information. A total of 24 rounds was fired, including 4 rounds of dummy PRIVATE A's to test the operation of the launcher and the boosters, 2 rounds of one-third-duration charged PRIVATE A's to test the launching procedure and the stability of the missiles, and 18 rounds of fully charged PRIVATE A's for record test data.

(U) During the test program the firing elevation of the launcher, which was adjustable in elevation only, varied from 50 degrees to 80.5 degrees, with 76 degrees considered normal. The average range obtained

8. Ibid.

9. Ibid. See Document 5 for tables of ORDCIT models tested and their respective configurations.

10. Goldberg, S. J., Report Nr. 4-3, "Firing Tests of 'PRIVATE A' at Leach Spring, Camp Irwin, California," pp. 1-3, JPL/GALCIT, CIT, 14 March 1945.

UNCLASSIFIED

by the fully charged missiles was approximately 18,000 yards, with a total included dispersion of 3,200 yards. Maximum range attained was over 20,000 yards.¹¹

(U) A study of test and theoretical results led to several conclusions:

1. Deviation of the trajectories from round to round was considerable, and it appeared that reasonable accuracy of a rocket missile having extended range could be attained only with proper control mechanism, especially during the burning period.
2. A chief uncertainty in the drag calculations seemed to be in that of thrust, but the results apparently indicated that the values of the drag coefficient near sonic speeds were higher than those estimated before and used for theoretical trajectory calculations. One cause of the increase was thought possible to be the yaw of the missile, the effect of the yaw upon its drag appearing to be considerable. A decision was made that study of the differential corrections was required to ascertain whether such an increase in drag would cause an appreciable difference in the range. It did seem undesirable to have a missile operate mainly in the transonic range, as happened to be the case with PRIVATE A. Analysis of the results showed no conclusive difference in the drag coefficient between jet-on and jet-off.

(U) The following points were emphasized as being necessary in order to get more reliable determination of the drag coefficient:

1. Direct measurements of the velocity of the missile would greatly increase the accuracy of test results.
2. Data in the post-burning period would be better for drag calculations, because these finds would be free from the

11. Ibid., passim. See Document 6 for round-by-round summary of firings.

12. Lin, C. C., Report Nr. 4-4, "The Exterior Ballistics of 'PRIVATE A' from Analyses of Firing Tests," pp. 1-2, passim, JPL/GALCIT, CIT, 27 April 1945.

uncertainties in the thrust. It appeared desirable, therefore, to obtain more extensive data during this period of the trajectory.¹³

13. Ibid.

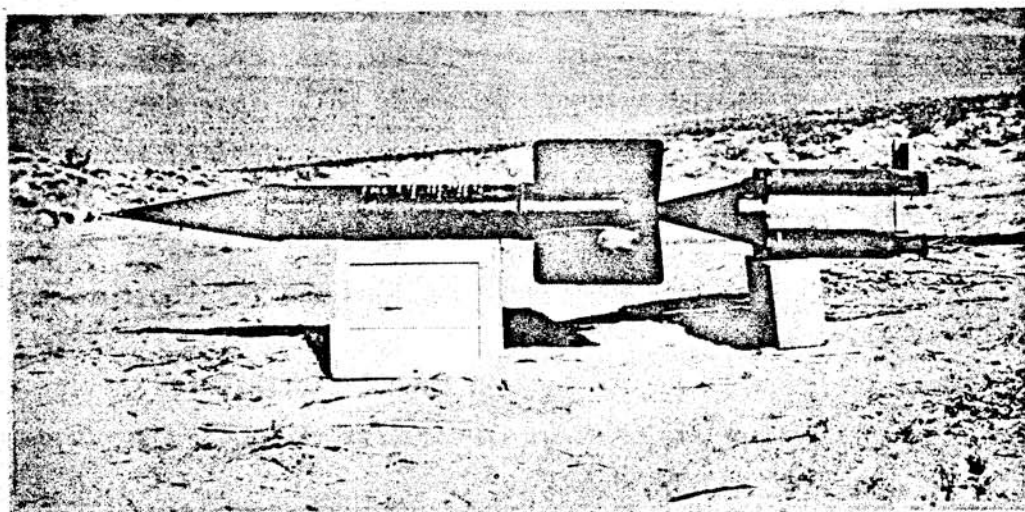
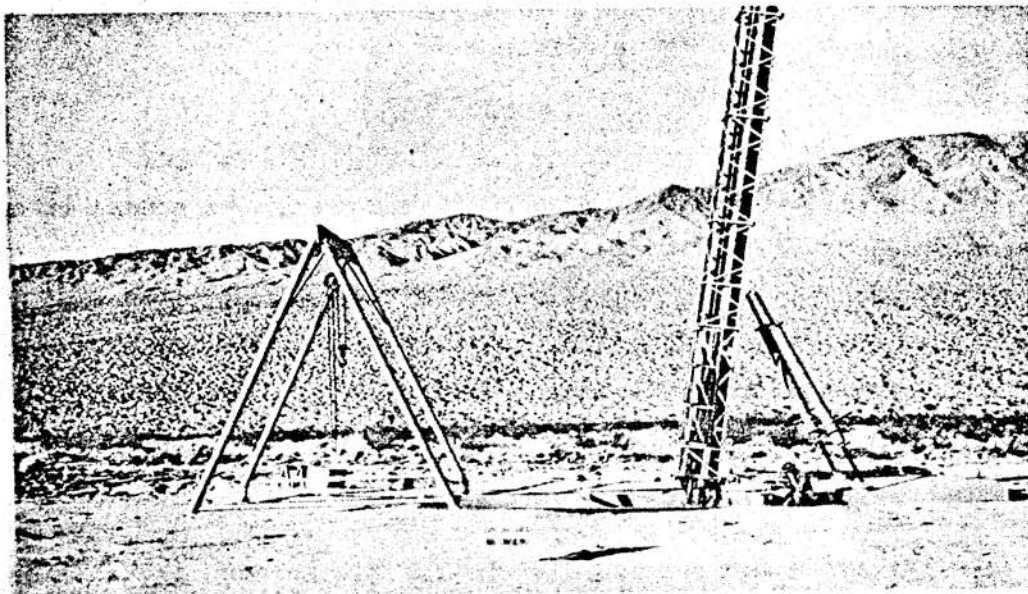

PRIVATE A 4-Rail Box Launcher and PRIVATE A With Booster

Specifications:

Range - 18,000 yds.
 Speed - 1300 ft/sec.
 Guidance - Free Flight
 Weights: -
 Overall - 529 lbs.
 Fuel - 192 lbs.
 Warhead)
 or) - 60 lbs.
 Payload) dummy weight

Dimensions:

Length - 92 Ins.
 Diameter - 9.6 Ins
 Diameter
 Over Fins - 33½ Ins.
 Booster - 4 - 4.5 Ins.
 Solid Propellant
 Rockets

UNCLASSIFIED

CHAPTER III

PRIVATE F

PURPOSE OF PRIVATE F

(U) The investigation of PRIVATE F (second of the series of test vehicles being developed by the ORDCIT Project) was an attempt to determine the behavior of a noncontrolled rocket missile provided with lifting surfaces, or wings. Calculated trajectories indicated that a range about twice that of PRIVATE A could be attained provided stable flight could be achieved.¹

DESCRIPTION OF THE PRIVATE F AND LAUNCHER

(U) PRIVATE F was essentially the PRIVATE A; that is, it consisted of the Aerojet Model 30AS1000 Jet Motor modified to receive nose and fin structures. No single description fitted the configuration of the PRIVATE F, however, since its stabilizing surfaces were altered from time to time during firing tests in attempts to achieve aerodynamic stability in trajectory. Basically, the four symmetrical fins of the PRIVATE A were replaced with a single fin and two horizontal lifting surfaces which spanned approximately five feet. Two forward horizontal fins, spanning about three feet, were added to control the fore-and-aft trim of the missile.

(U) As in the case of the PRIVATE A and similarly modified, four 4.5-inch Type T-22 Artillery Rocket units were manifolded together to serve as booster for the PRIVATE F.

(U) The launching boom had two instead of four rails, with the rails located above the steel framework. This launcher was 32 feet long and was adjustable in elevation only.²

1. Sandberg, W. A., and Barry, W. B., Report Nr. 4-5, "Design of 'PRIVATE F,' Facilities for Handling the Missile, and Launcher," pp. 1-2, JPL/GALCIT, CIT, 14 July 1945.
2. Sandberg & Barry, Rpt Nr. 4-5, *op. cit.*, *passim*; Mills, M. M., Rpt Nr. 4-6, "Thrust and Inertail Characteristics of Rocket Missile XF10S1000-F, 'PRIVATE F,'" pp. 1-2, 7, JPL/GALCIT, CIT, 8 May 1945. See Document 7 for tabular statistics concerning PRIVATE F.

WIND-TUNNEL TESTS

(U) In the wind-tunnel tests conducted at the BRL/APG, models of the PRIVATE F had made a poor showing (Ref. notes 7, 8, and 9, and photographs of PRIVATE F models, Chapter II). ORDCIT Project analyzed the problem thus:

(U) A winged missile must be stabilized in roll by an automatic pilot or by gravity through the action of dihedral in the wing system. A vehicle stabilized by gravity could not be considered as a prototype for a long-range vehicle, since the trajectory would not be in a plane of constant azimuth but would be of a circling nature. Since the development of an autopilot stabilization system would have required considerable time, it was determined that an attempt should be made to stabilize the test vehicle by means of gravity. The belief was that a simple vehicle of this type would permit a study of some of the aerodynamic problems of stability and drag at high speeds and could afford an experimental check on the feasibility of attempting to extend the range of the vehicle by the use of wings.³

(U) In pursuance of this reasoning and in advance preparation for firing tests, a full-size, wind-tunnel model of the PRIVATE F was fabricated and tested in the GALCIT 10-foot wind tunnel at speeds approximating 150 miles per hour. During these tests it was noted that the model asymmetry due to manufacturing variations was rather serious. An attempt was then made to increase the accuracy employed in building the field-test models.⁴

FIRING TESTS

(U) The firing tests on the PRIVATE F were carried out at the Hueco Firing Range* of Fort Bliss, Texas, between 1 April and 13 April

3. Stewart, S. J., and Chien, W. Z., Report Nr. 4-8, "Flight Characteristics of the PRIVATE F," pp. 2, 30, JPL/GALCIT, CIT, 19 November 1945; Dunn, L. G., and Meeks, P. J., "A Brief Resume of the CORPORALE Program," pp. 2-3, JPL/CIT, 17 February 1948.

4. Ibid.

* A member of the field-testing team mentioned that "the test site was in an extremely exposed situation. Sand storms with winds having velocities as high as 80 mph, rain, extreme cold, and snow

UNCLASSIFIED

1945 and were conducted by the same group that had supervised the PRIVATE A launchings.

(U) This test program consisted of 17 rounds, including two rounds of concrete-filled dummy PRIVATE F's to test the operation of the launcher and the boosters, two rounds of one-third-duration charged PRIVATE F's to test the launching procedure, 12 rounds of fully charged PRIVATE F's, and one round of a PRIVATE A with $1\frac{1}{2}$ inch removed from the tip of each fin to permit the missile to fit the launcher. The last-named vehicle was called PRIVATE A-1.⁵

(U) PRIVATE F was charged with the solid propellant GALCIT 61-C, as was PRIVATE A; however, PRIVATE F's charge was reduced from 191 to 175 pounds to allow the installation of about 20 pounds of a slow-burning charge at the forward end of the combustion chamber. The purpose of this charge was to supply a continuous smoke trail to aid in observing the missile, even after the burning of the main propellant charge. In addition, PRIVATE F carried in its nose a 12-pound charge of black powder, designed to be detonated by two inertia fuzes upon the missile's impact. Fully charged, PRIVATE F's nominal weight (its weight varied from round to round) was 505 pounds. Thrust was of 28-second duration at 1,100 pounds.⁶

(U) The booster delivered approximately 22,000 pounds of thrust for 0.18 second and weighed 163 pounds, including its charge of 19 pounds of ballistite.⁷

Results of Tests

(U) With two exceptions, the performance of the PRIVATE F rockets, the booster rockets, and the explosive spotting charge was satisfactory.

delayed the test preparations for a week." S. J. Goldberg, JPL Report Nr. 4-7.

5. Mills, Rpt Nr 4-6, op. cit., pp. 1, 7-9, 11; Goldberg, S. J., Rpt Nr. 4-7, "Firing Tests of 'PRIVATE F' at Hueco Range, Fort Bliss, Texas, April 1 to April 13, 1945," pp. 1, 8, 12-13, JPL/GALCIT, CIT, 10 May 1945. See Document 8 for round-by-round summary of PRIVATE F firings.

6. Ibid.

7. Ibid.

UNCLASSIFIED

(U) Most of the rounds fired at the Hueco Range exhibited aerodynamic instability, which produced an irregular trajectory of the missile, causing several of the PRIVATES to strike the ground before the propelling charge had completely burned. It was noteworthy, however, that the rocket unit seemed to function in a normal manner even after a round struck the ground and set off the black-powder explosive charge in the nose cone.

(U) In all firings an undesirable rolling motion developed about 10 seconds after launching. Numerous small changes in the vertical fin area and in the stabilizer dihedral were made during the test program, but no really satisfactory results were obtained.⁸

Conclusions

(U) As a result of these tests, extensive theoretical studies were made. These studies showed that the tolerances in missiles having lifting surfaces had to be very small to provide the required stability necessary to handle the aerodynamic moments produced by asymmetries in the wing and tail construction. Extraordinary precision in construction was an impracticable remedy for such asymmetries. It further appeared that it was impossible to meet the requirements over the entire speed range of the PRIVATE F, even though the center of gravity movement in trajectory was relatively small. General conclusions were therefore drawn that small high-speed vehicles, although theoretically stable, were too sensitive to minor asymmetries to be stabilized in roll by gravity and that roll stabilization was practical only with an automatic pilot.⁹

8. Goldberg, Report Nr. 4-7, op. cit., pp. 20-26 (description of firing of each round); Dunn & Meeks, Report Nr. 4-45, op. cit., pp. 2-3; Ordway, Frederick I., III, and Wakeford, Ronald C., "International Missile and Spacecraft Guide," p. 190, New York, 1960; Stewart & Chien, Report Nr. 4-8, op. cit. pp. 1-4, 25, 28, 30-32. In addition to giving general summaries, Stewart & Chien analyzed PRIVATE F's performance technically in minute detail.

9. Ibid.

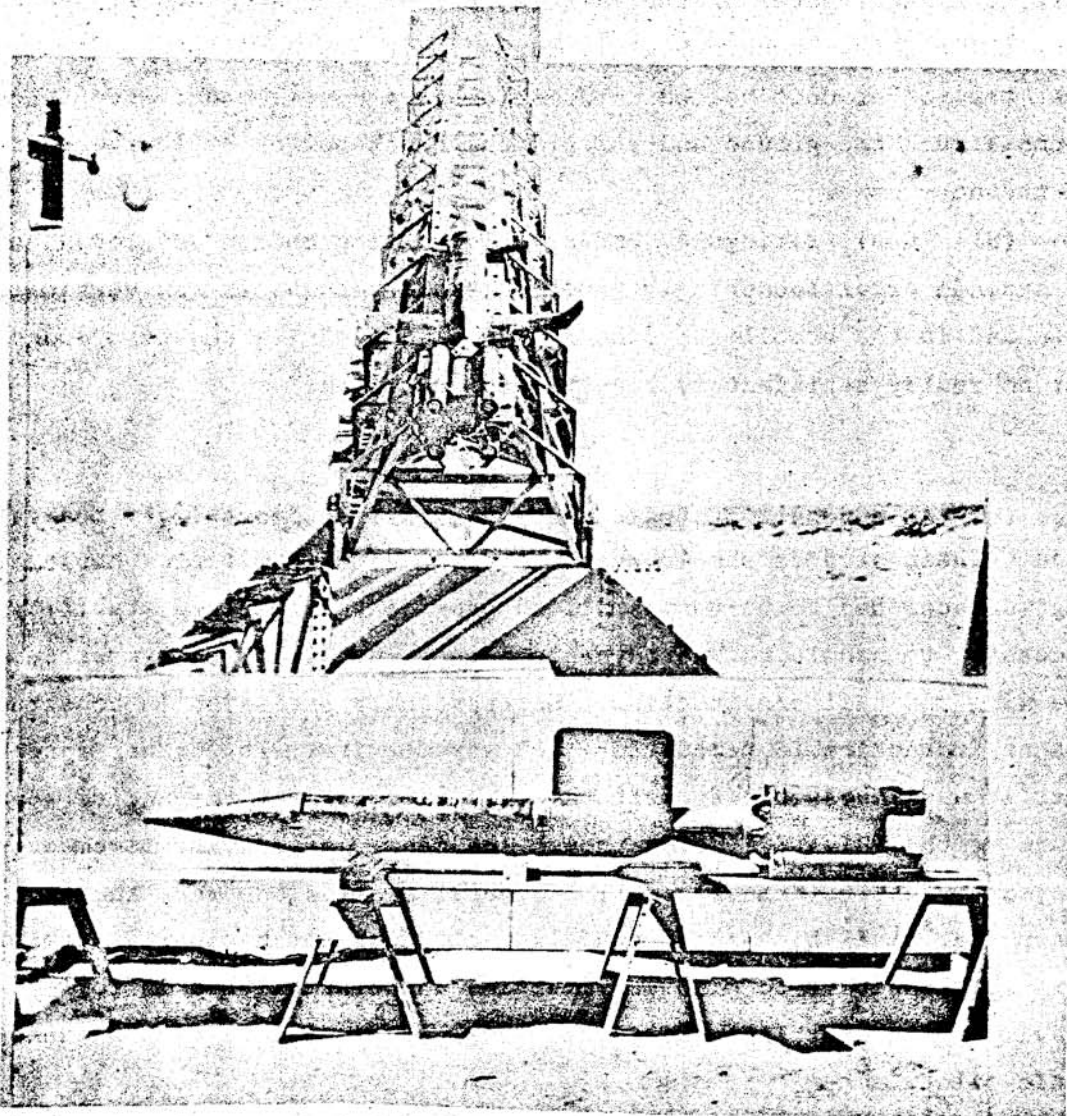

PRIVATE F With Launcher in Launching Position and PRIVATE F With Booster

Specifications:

Range - 5,000 yds.
 Speed - 1200 ft/sec.
 Guidance - Free Flight
 Weights: -
 Overall - 506 lbs.
 Fuel - 175 lbs.
 Warhead)
 or) - 60 lbs.
 Payload) dummy weight

Dimensions:

Length - 92 Ins.
 Diameter - 9.6 Ins.
 Diameter
 Over Fins - 33½ Ins.
 Booster - 4 - 4.5 Ins.
 Solid Propellant
 Rocket

SCALED-DOWN-MODEL TESTS CONSIDERED

(U) As C. B. Millikan* said, the tests on the PRIVATE F at Hueco Range had indicated that the problem of stability for missiles of this type was a serious and difficult one. Since the problem was dynamical, ordinary wind-tunnel tests were inadequate. JPL considered it highly desirable to investigate the possibility of flight tests on relatively inexpensive, small-scale, rocket-powered models launched by boosters from a launcher scaled down in proportion to the model.¹⁰

(U) It was desired that aerodynamic, inertia, and gravity forces retain their full-scale relations in this scaling down, both aerodynamic and dynamic similarity being necessary for a study of the problems involved.

(U) It was proposed that the model and the full-scale tests be made in air, starting from ground levels, with conditions the same throughout for both the model and the full-scale vehicle.¹¹ Nothing apparently came of this proposal, since development of both the PRIVATE F and the PRIVATE A ended with the test firings.

* Millikan was a JPL staff member. He later became chairman of the Jet Propulsion Laboratory Board of CIT.

10. Millikan, C. B., Memorandum Nr. 4-6, "Scale Model Tests for ORDCIT Winged Missiles," p. 1. JPL/GALCIT, CIT, 8 April 1945.

11. Ibid.

UNCLASSIFIED

CHAPTER IV

WAC CORPORAL A

STUDY OF A HIGH-ALTITUDE SOUNDING ROCKET PROPOSED

(U) The firings of the PRIVATES A and F satisfactorily completed the first phase of the program; that is, these firings had furnished necessary experimental data to complement theoretical calculations on trajectories and aerodynamic forces as well as launching techniques and propellants. The second phase was to have been the design and construction of a 2,000-pound thrust rocket powered by a liquid-propellant motor. In December 1944, however, while the design of the 2,000-pound test vehicle was still in the study stage and the firings of the PRIVATE A were still in progress, the Army Ordnance Department itself revived the idea of the sounding rocket.*

(U) There had arisen a requirement of the Signal Corps for a high-altitude sounding rocket to carry 25 pounds of meteorological instruments to an altitude of 100,000 feet or more. Col. G. W. Trichel requested that a feasibility study be made of developing such a test vehicle for the Rocket R&D Division, Ordnance Department. This vehicle, it was decided, would provide opportunity to study a liquid-propelled rocket, while the Signal Corps could at the same time be supplied with a useful research tool. The originally planned Phase 2 was thereupon shunted aside in favor of this new development.¹

* Cf footnote 4, Chapter I.

1. Malina, F. J., Report Nr. 4-18, "Development and Flight Performance of a High-Altitude Sounding Rocket, The 'WAC CORPORAL'," p. 1, JPL/GALCIT, CIT, 24 January 1946 (WAC meaning "without altitude control"); von Karman, Memo Nr. 1, op. cit., pp. 1-4 (Cf Chapter I); Tsien & Malina, "A Review and Preliminary Analysis," op. cit., passim (Cf Chapter I); Malina, F. J., and Stewart, H. J. Memorandum Nr. 4-4, "Considerations of the Feasibility of Developing a 100,000-foot Altitude Rocket," p. 1, JPL/GALCIT, CIT, 16 January 1945; Seifert, Howard S., JPL Publication Nr. 22, "History of Ordnance Research at the Jet Propulsion Laboratory, 1945-1953," pp. 1-19, JPL/CIT, 29 July 1953.

(U) In addition to the specific requirements of the Signal Corps, it was concluded during the course of the preliminary study that a rocket of this type would also provide a wide usefulness in the over-all ORDCIT rocket development program: First, the proposed rocket would serve as a scaled-down model of the CORPORAL already under development (as of 16 January 1945). For this reason the designation "WAC CORPORAL" was chosen. Second, the WAC CORPORAL would represent a logical first step in the development of a guided antiaircraft projectile. Interestingly enough, the specifications for the WAC CORPORAL were similar in many respects to those set up by the British for their first liquid-propellant model in the Guided Antiaircraft Projectile (GAP) Program.²

(U) Results of a preliminary study indicated that a liquid-propellant rocket weighing about 700 pounds at launching would reach an altitude of 100,000 feet. Propulsion would be accomplished by a motor delivering a 1,500-pound thrust for a period of 40 to 50 seconds and imparting an initial velocity of about 400 feet per second (ft/sec) by short-duration, solid-propellant booster rockets. The launcher was to be approximately 100 feet high, and the rocket was to have no remote control after launching.³

PARTICULAR DECISIONS DURING THE PLANNING STAGE AND FINAL DESIGN

Propellants, Propulsion, and Propulsion Systems

(U) Both the solid propellants ballistite and GALCIT 61-C were rejected as propellants for the WAC CORPORAL, and the final decision was to make it a two-stage rather than a single-stage rocket. Turning to liquid propellants, JPL's planners decided against both the liquid oxygen-alcohol mixture--used by the Germans--and a monopropellant such as nitromethane, which admittedly possessed certain advantages from the standpoint of rocket design and servicing. Insufficient experimentation with the use of a monopropellant, however, prohibited its use. On the other hand, the nitric acid-aniline rocket unit utilizing

2. Malina & Stewart, Memo Nr. 4-4, op. cit., p. 1.

3. Ibid., pp. 1-2.

a gas-pressure feed system had been highly developed, and its use was well understood. For this reason, it appeared feasible to consider this unit for use in the prototype of the high-altitude rocket. A further advantage was that the engineering development of the CORPORAL could be used as the basis for designing the high-altitude rocket.⁴

(U) The final decision was against using a gas-pressurized feed system and favored employing compressed air instead of nitrogen to pressurize the missile's propellants, a decision largely influenced by the relative ease in providing compressed air in the field.

(U) After considering several methods for starting the propulsion system, it was decided to utilize an inertia valve in the compressed air circuit, the valve opening with the acceleration of the missile out of the launcher by the booster rocket.

(U) The propellant combination finally chosen consisted of RFNA as oxidizer and aniline containing 20 per cent furfuryl alcohol as fuel, with the appropriate weight ratio of oxidizer to fuel being 2.65.⁵

(U) An Aerojet liquid-propellant rocket motor was redesigned to burn the RFNA-aniline propellant combination and to produce a minimum effective exhaust velocity of 6,200 ft/sec, a performance which was later measured experimentally in static tests of the motor. It was to be regeneratively cooled, utilizing the fuel as coolant.⁶

(U) To check the over-all rocket propulsion system, a prototype model was constructed. Propellant tanks and the propellant circuit duplicated the final missile layout. Static tests were carried out on the prototype model at the ORDCIT Test Section, Muroc, California, and showed the design of the propulsion system to be satisfactory.⁷

4. Malina & Stewart, Memo Nr. 4-4, op. cit., pp. 2-5; Malina, Report Nr. 4-18, op. cit., pp. 4, 6-7.

5. Sandberg, W. A., and Barry, W. B., Report Nr. 4-21, "Design and Fabrication of the WAC CORPORAL Missile, Launcher, and Handling Facilities," pp. 1-4, JPL/GALCIT, CIT, 19 February 1946; Malina, Report Nr. 4-18, op. cit., pp. 6, 8.

6. Malina, Report Nr. 4-18, op. cit., pp. 6-7.

7. Ibid., p. 8. (Actually, the WAC was a scaled-down (0.4 scale) model of the projected CORPORAL. The drawing-board CORPORAL influenced the development of the WAC. Knowledge gained through experience with the WAC; in turn, influenced development of the

UNCLASSIFIED

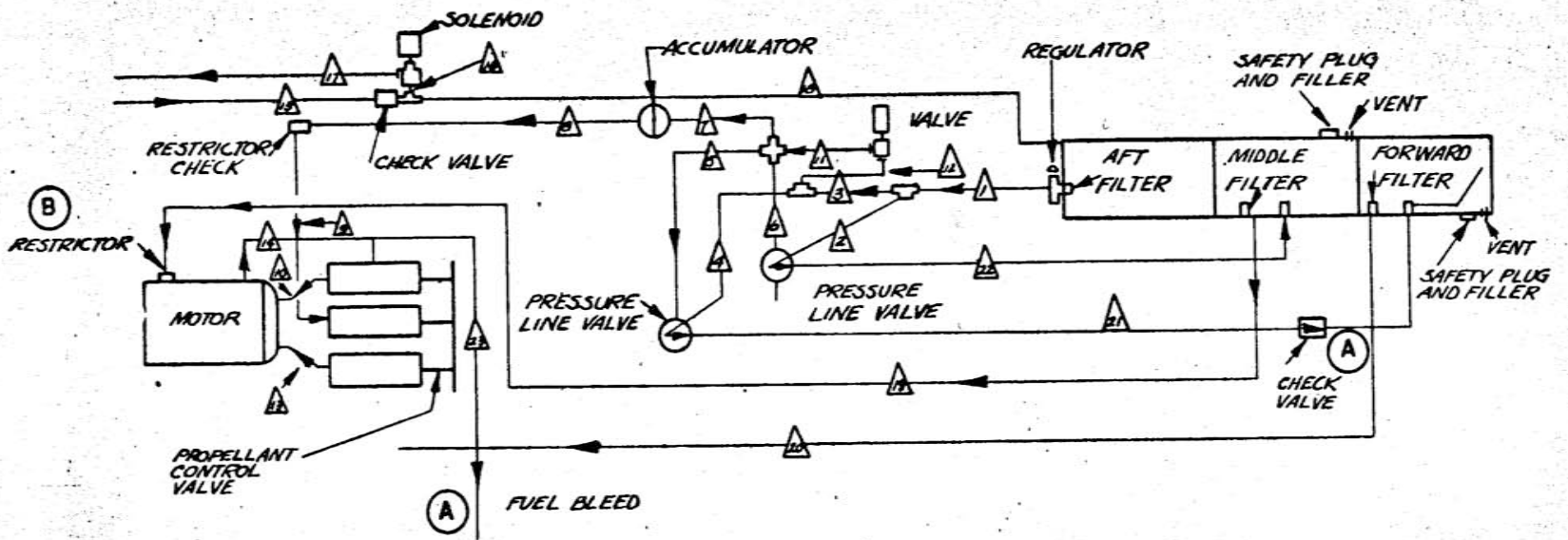

FLOW DIAGRAM OF THE WAC CORPORAL

UNCLASSIFIED

UNCLASSIFIED

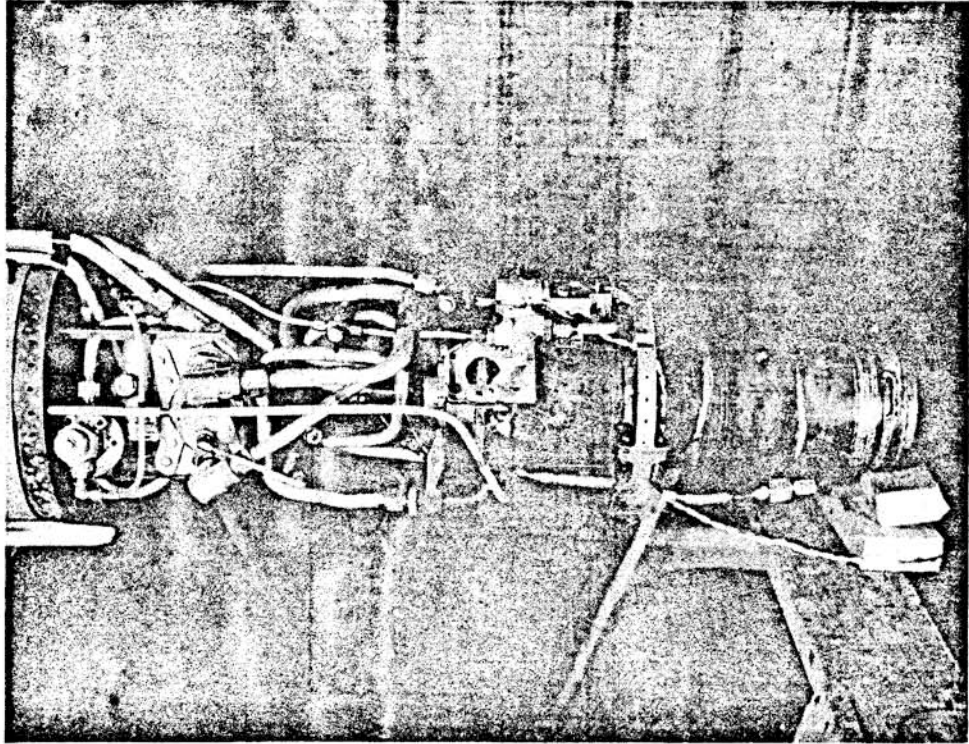

MOTOR AND PIPING OF THE WAC CORPORAL

UNCLASSIFIED

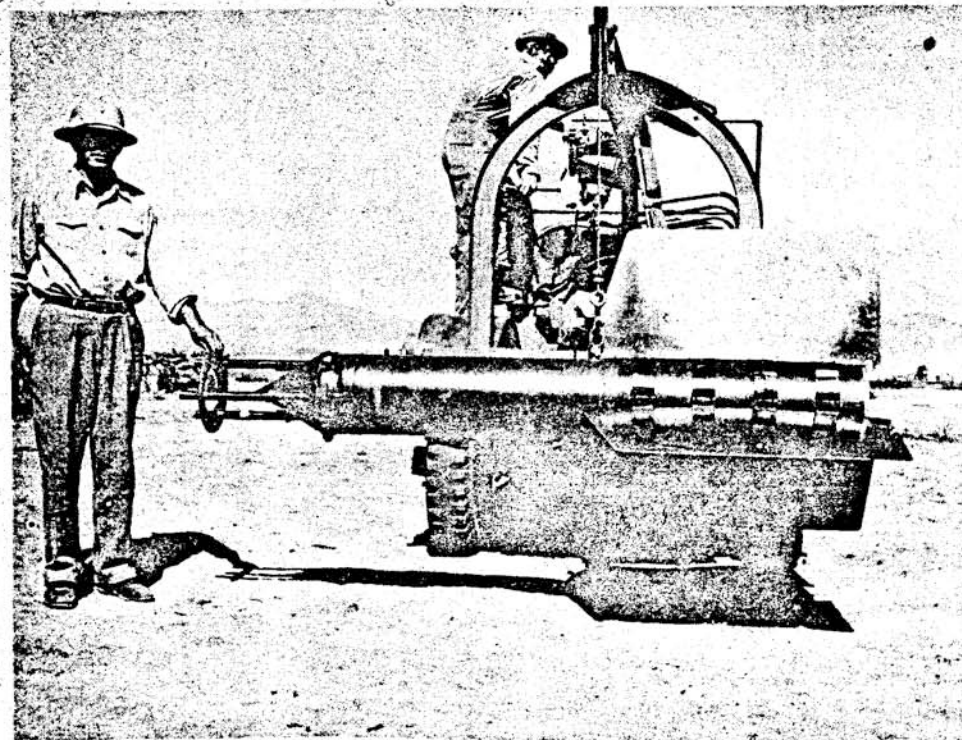

BOOSTER

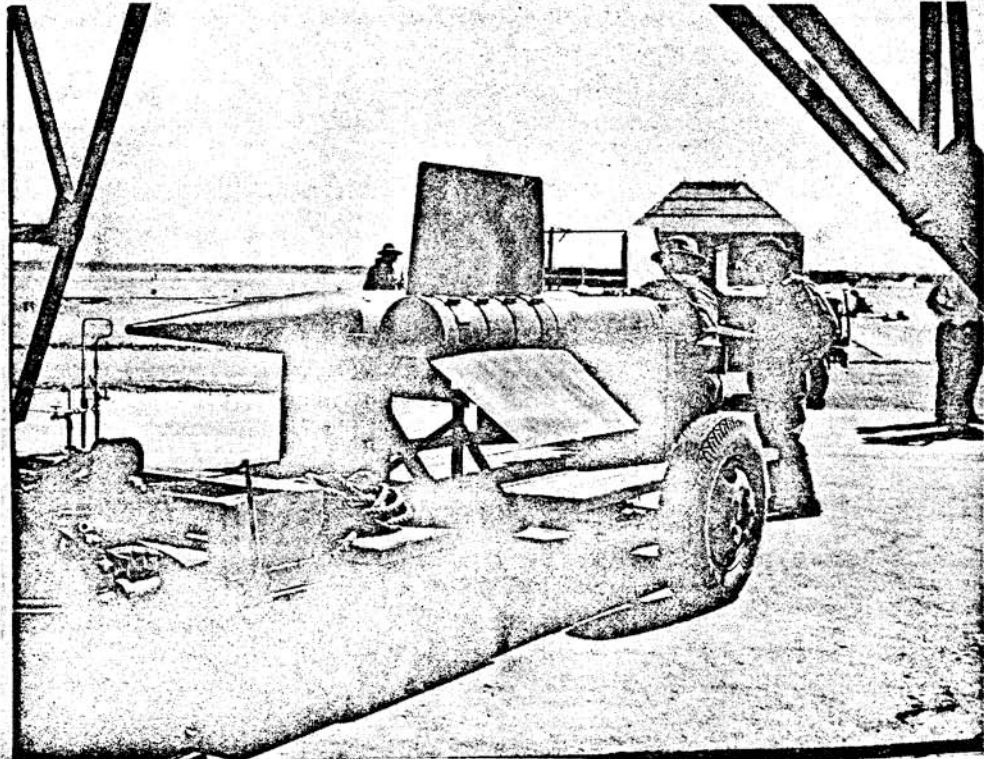

M-5 BOMB TRUCK ALTERATIONS

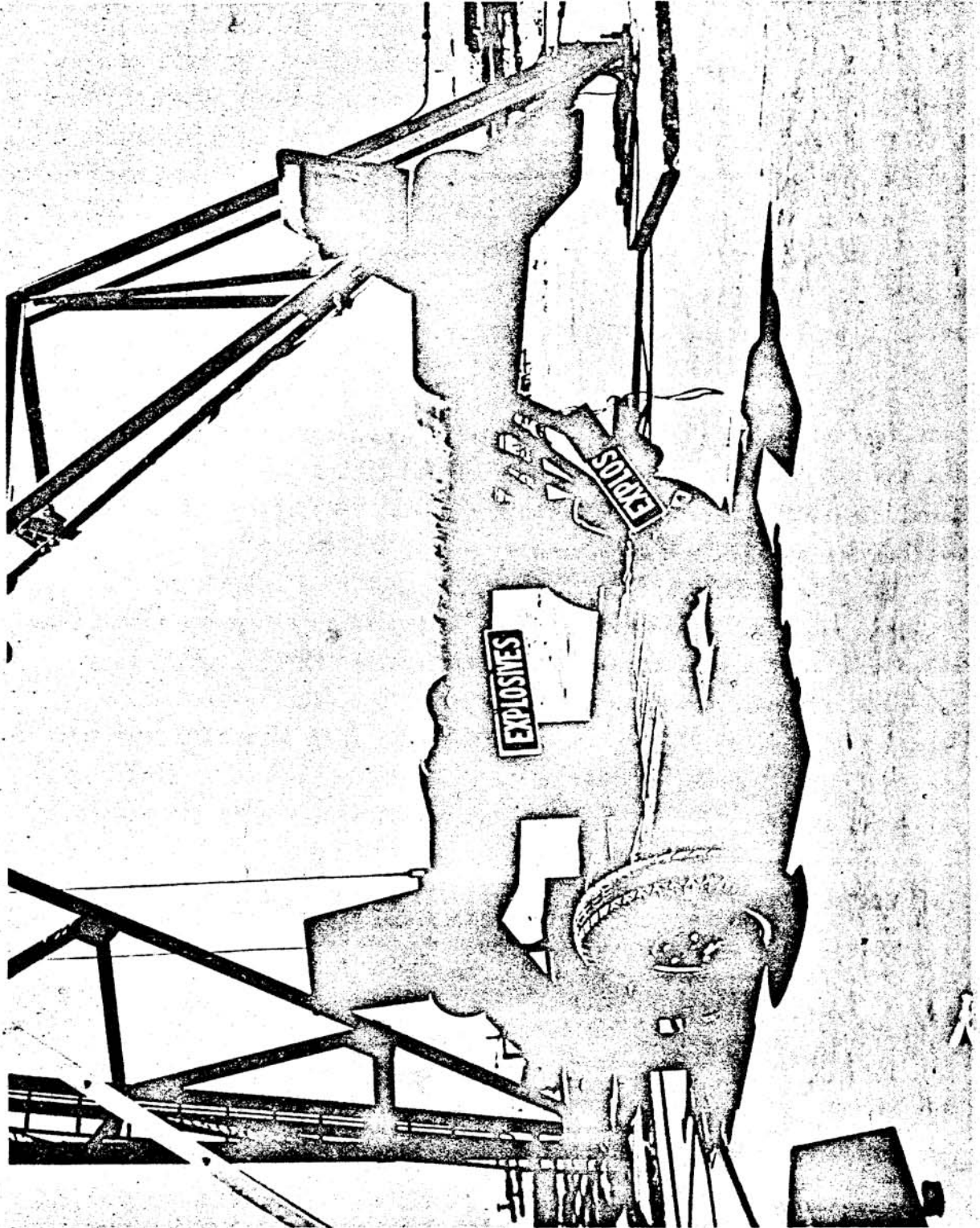

CORPORAL A AND TINY TIM BOOSTER AT LAUNCHER

UNCLASSIFIED

Some Final Specifications of the WAC Summarized

(U) When fabricated for its firing program, the missile had an over-all length of 194 inches, a maximum body diameter of 12.2 inches, three tail fins spaced at 120 degrees and having a total effective area of 7.17 square feet, a conical nose of 7-degree angle of generation, a gross weight of 665 pounds, an empty weight of 296.7 pounds, a thrust at launching point of 1,500 pounds, and a thrust duration of 45 seconds. Also, 1.83 cubic feet of air at 2,100 psi was required to pressurize the propulsion system.⁸ This unrefined prototype test vehicle was later to be designated as WAC CORPORAL A.

The Booster

(U) Since this 0.4-scale model of the drawing-board CORPORAL called the WAC CORPORAL was not to be equipped with flight-control equipment, the stability of the vehicle's vertical trajectory had to depend entirely on the WAC's high launching speed, set at 400 ft/sec.

(U) Chosen over the T-22 aircraft rocket as a booster for the WAC CORPORAL was another aircraft rocket, the ballistite-burning TINY TIM, which was, with comparatively little difficulty, modified to deliver approximately 50,000 pounds of thrust for 0.6 second instead of its normal thrust of 30,000 pounds for 1 second. When modified, TINY TIM was expected to impart to the WAC CORPORAL an average acceleration of approximately 37.3 g's and a launching velocity of around 720 ft/sec,

CORPORAL to the extent that the basic design of the propellant system became fixed, although JPL researchers reluctantly surrendered the idea of a gas-pressurized feed system rather than the compressed air system incorporated in the CORPORAL design. Throughout the whole development from the PRIVATE A to the final version of the tactical CORPORAL, there was a progression. In the WAC and the drawing board CORPORAL, there was an interplay of influence.)

8. Malina, Report Nr. 4-18, op. cit., p. 12; Sandberg & Barry, Report Nr. 4-21, op. cit., p. 1. (The latter for a 47-second duration at 101 pounds of aniline-furfuryl alcohol and 273 pounds of nitric acid. Because of differing payloads during the firing tests, loaded weights of WAC CORPORAL varied from 683 to 704 pounds, and empty weights from 289 to 310 pounds, an obvious discrepancy in description, as will be noted.)

UNCLASSIFIED

both values having been considered acceptable. The long burning time would, however, have required a tower about 216 feet high, if the missile were to ride on rails during the entire boosting period. It was decided to retain the originally calculated launcher height of approximately 100 feet, with rails 82 feet long, and to allow part of the missile's boosting to continue in free flight. Upon leaving the launcher, the missile-booster combination would have a velocity of approximately 400 ft/sec.⁹

(U) TINY TIM's warhead was replaced by a blast deflector provided with three rods designed to fit into recesses in the aft ring of the WAC CORPORAL, thereby, mating missile and booster.

(U) The normal four fins were removed from the booster and replaced by three fins spaced at 120 degrees to permit passage through the launcher. These fins were made of steel because of its availability and strength and the relative unimportance of weight.

(U) As modified, TINY TIM had a gross weight of 759.2 pounds, of which 148.7 pounds was propellant. The booster had an over-all length of 96 inches and a body diameter of 11.75 inches.¹⁰

The Launcher

(U) As finally designed and constructed, the launcher consisted of a 77-foot, triangular, self-supporting structural-steel tower, 6 feet on a side, resting on a tripod 25 feet high, with a 26-foot base, giving an over-all height of 102 feet. Inside this tower were three launching rails having an effective length of 82 feet and set at 120 degrees apart to guide the missile-booster combination. The ORDCIT Project carried out the design, fabrication, and erection of the launcher.¹¹

9. Malina & Stewart, Memo Nr. 4-4, op. cit., pp. 10-11; Sandberg & Barry, Report Nr. 4-21, op. cit., pp. 1, 7; Malina, Report Nr. 4-18, op. cit., pp. 4-5, 8, 14.

10. Ibid.

11. Malina & Stewart, Memo Nr. 4-4, op. cit., pp. 9-10; Sandberg & Barry, Report Nr. 4-21, op. cit., pp. 1, 7-9; Malina, Report Nr. 4-18, op. cit., p. 15.

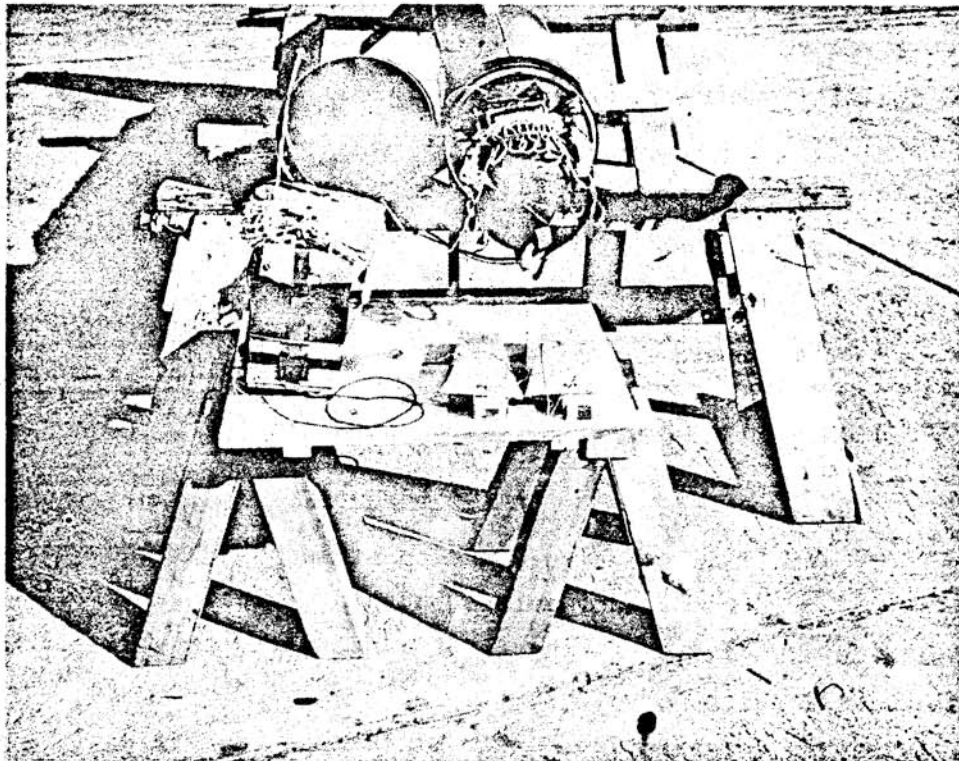

CONTENTS OF NOSE OF THE WAC CORPORAL.

The WAC's Nose and Its Release Mechanism

(U) Since the expected use of the WAC CORPORAL was as a meteorological sounding rocket in various locations, some near populated areas, it was desirable to investigate the feasibility of utilizing a parachute to lower the missile to the ground at a reasonable velocity. The release of the parachute at the zenith of the vertical trajectory posed many hitherto uninvestigated problems and proved difficult of achievement. No information was available on the behavior of a parachute when falling through the high stratosphere with its extremely low but gradually increasing density. Despite the difficulty of the problem, however, a somewhat complicated nose-release mechanism was devised for the first experimental rounds of the WAC CORPORAL. Tests conducted at JPL under simulated conditions indicated that the mechanism should function satisfactorily, although firing tests were later to disprove that conclusion.¹²

(U) Space was available in the WAC's nose for the Signal Corps to send aloft radiosonde units, and several rounds were fired with the sets installed. Suspended from its own parachute, the radiosonde set was to be released at the same time as the main parachute to lower the missile.¹³

12. Malina & Stewart, Memo Nr. 4-4, op. cit., p. 11; Sandberg & Barry, Report Nr. 4-21, op. cit., pp. 1, 4-6; Malina, Report Nr. 4-18, op. cit., pp. 8-11. See Document 9 for Statistical Summary of WAC and TINY TIM Characteristics.

13. Ibid. (It will be noted that this was a pioneer effort to recover instrumentation ejected from a missile during its trajectory.)

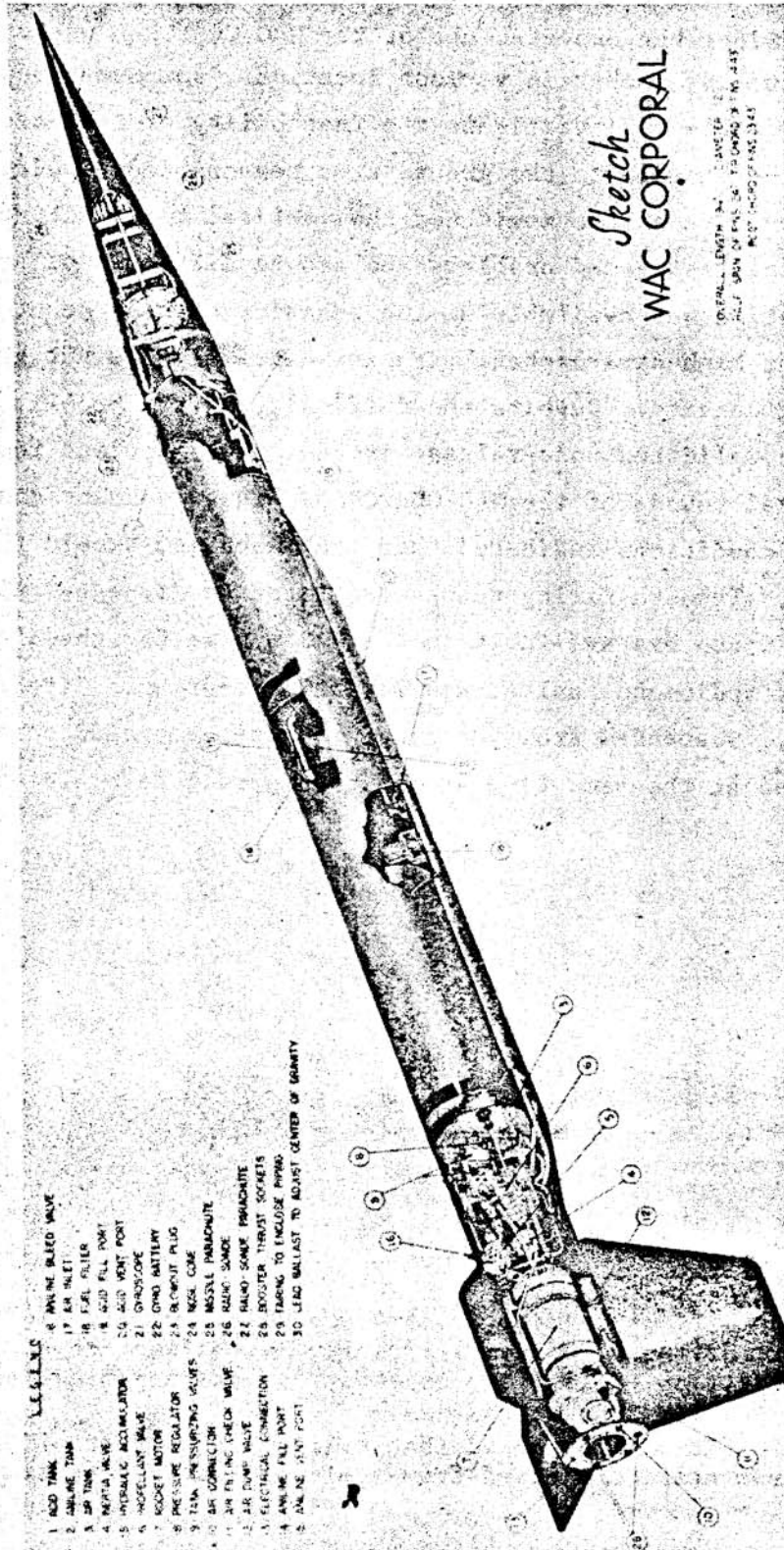

UNCLASSIFIED

CHAPTER V

TRANSITION TO WAC CORPORAL B

BABY WAC

Reasons for BABY WAC

(U) It was pointed out (Ref. note 9, Chapter IV) that the most suitable booster rocket available required that a part of the WAC CORPORAL's trajectory take place outside the launcher, with booster thrust still acting. Questions therefore arose regarding the general stability characteristics of the missile-booster combination after leaving the launcher and the action of the booster on the missile at separation. Moreover, there was also some questioning in regard to using three tail fins on the booster and the missile instead of the usual four. In order to study these problems, it was decided to make tests with dynamically similar scale models of the WAC CORPORAL, its booster, and the launcher.

Construction and Tests of the BABY WAC

(U) And so BABY WAC was born. Ten 1/5-scale models of the WAC CORPORAL and its booster were constructed. To accommodate these models, a scaled-down launcher was built. A special solid propellant was developed by JPL--a propellant which permitted the dynamic conditions of the full-scale launching to be simulated. Various center-of-gravity positions were to be experienced by the WAC CORPORAL. An external longitudinal protuberance for housing the propellant lines was also tested to scale on the models. The BABY WAC's were fired from their 1/5-scale launcher at Goldstone Ridge, California, on 3-4 July 1945.

-
1. Malina, Report Nr. 4-18, op. cit., pp. 11-12; Ordway & Wakeford, op. cit., pp. 208-210

UNCLASSIFIED

Results of Tests and Conclusions

(U) Tests disclosed that the models behaved satisfactorily throughout the trajectory to its zenith, no difficulty being encountered with launching, booster disengagement, or flight under power. Models with the most rearward center-of-gravity position, however, tended to become unstable after passing the zenith, and three out of four developed flat spins which continued to the ground. This characteristic was not observed during the ascent and was thought to be of minor importance in the WAC CORPORAL program as planned. The BABY WAC's reached an altitude of approximately 3,000 feet.

(U) These tests indicated that the general dynamics of the WAC CORPORAL's three-finned design, including the method of launching by means of a three-finned booster, were satisfactory. Thus, full-scale tests could be undertaken with the assurance that the above characteristic would offer no difficulties.²

FIRING PROGRAM AT WSPG, 26 SEPTEMBER-25 OCTOBER 1945 - WAC A

(U) With the BABY WAC firings successfully concluded, the newly activated WSPG began test firing full-scale WAC CORPORALS. Development of this test vehicle as furthered through firing tests at WSPG was divided into four phases, but several firings were made before the WAC CORPORAL firing program. A modified TINY TIM was the first rocket tested at WSPG; the firing occurred at 1000 hours, 26 September 1945, to test the rocket's use as a potential booster for the WAC CORPORAL. A second TINY Tim was fired the same day and a third the following day.³

Phase 1: TINY TIM Alone

(U) For checking the launcher and firing controls and for tracking practice for the radar and camera crews, four rounds of the booster alone were fired (Rounds A, B, C, and D). Normal tail fins were utilized, but the TINY Tim was fitted with a sharp-pointed nose and

2. Ibid.

3. Malina, Report Nr. 4-18, op. cit., pp. 18-19; Sandberg & Barry, Report Nr. 4-21, op. cit., pp. 19-22.

weighted with approximately 250 pounds of lead. The launcher proved satisfactory, and the booster operated as planned.⁴

Phase 2: Dummy WAC CORPORAL, Rounds 1 and 2

(U) Normal booster rockets launched two dummy rounds of the WAC to test the launcher, launching velocity, and booster-missile separation. Each dummy WAC was constructed of steel tubing, had practically identical dimensions as those of the final full-charge missile, and was filled with concrete to duplicate the WAC CORPORAL's estimated gross weight. Except for a tendency for radar tracking to lock on the booster after separation, the results were satisfactory.⁵

Phase 3: Partial-Charge WAC CORPORAL, Rounds 3 and 4

(U) On 1 October a quarter-charge WAC CORPORAL was fired, to be followed the next day by the second quarter-charge missile. Ballast in the propellant tanks supplied the lack in the initial gross weight and provided the normal center-of-gravity position of the full-charge missile. This modified test was in the nature of a dress rehearsal of normal operational procedures and differed from the full-scale test only in the duration of the propellant charge, that is, approximately 12 seconds. Launching and flight were satisfactory for both rounds, but the nose release mechanism failed in both. Radar tracking was unsatisfactory. Over-all missile operation was, however, very satisfactory.⁶

Phase 4: Full-Charge WAC CORPORAL, Rounds 5, 6, 7, 8, 9, 10

(U) Six full-charge WAC CORPORAL rounds were fired. The design and specifications of the missile have already been discussed in Chapter IV.⁷

4. Ibid.

5. Ibid.

6. Ibid.

7. Ibid. See Document 10 for summary of TINY TIM booster and WAC CORPORAL A and B firings.

UNCLASSIFIED

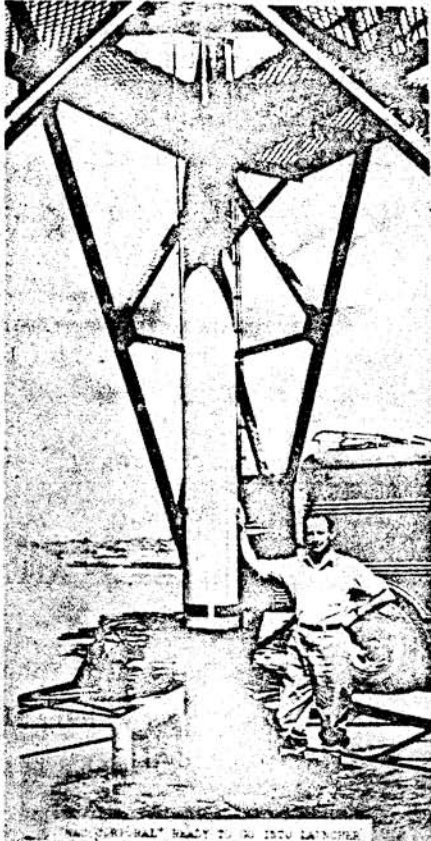

WAC CORPORAL READY TO BE INTO LAUNCHER

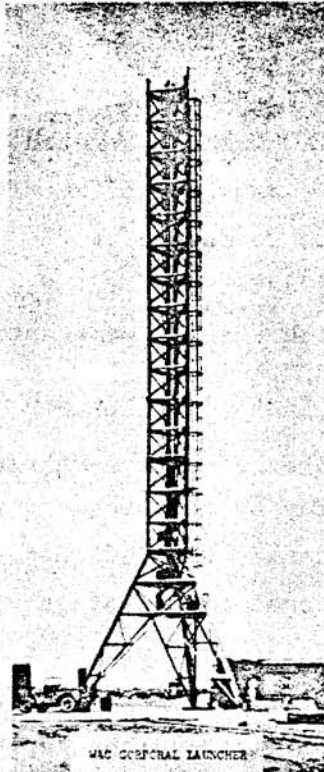

WAC CORPORAL LAUNCHER



FIRING OF WAC CORPORAL

WAC CORPORAL

Altitude:	240,000 ft.
Speed:	3,000 ft/sec.
Fins:	3 tail stabilization fins
Fuel:	Nitric Acid & Aniline
Thrust:	1,500 lbs.
Burning Time:	50 sec.
Guidance:	Free flight
Launching:	100 ft. vertical launcher
Weight:	
Overall	660 lbs.
Fuel	360 lbs.
Payload	25 to 60 lbs.
Dimensions:	
Length	12 ft 6 ins.
Diameter	12 ins.
Diameter	
over fin	52 ins.
Booster:	Tiny Tim

UNCLASSIFIED

Results of the Tests

(U) Flight performance of the missile was satisfactory in all cases in which the center of gravity was moved sufficiently forward. When it was too far aft, a tendency toward instability developed nearest the highest flight Mach number (Mach number approximating 3) during the ascending portion of the trajectory, and a number of rounds went into a flat spin during descent.⁸

(U) Over-all, the mechanical design of the liquid-propellant rocket propulsion system proved to be acceptable. The use of an inertia valve for automatically starting the operation of the propulsion system at the missile's acceleration by the booster was highly satisfactory. No major difficulties were encountered in servicing the missile with propellants and compressed air. The booster rocket functioned reliably in all firings. Separation of the booster from the missile during flight was excellent in every launching. No damage was done to the launcher structure or to the launching rails by any of the rounds fired. The nose release mechanism was found to be unreliable, and the missile parachute attachment was of insufficient strength. Tracking of the missile by radar was found to be difficult without the use of manual trackers, and the radar signal received at an altitude above approximately 90,000 feet was too weak to be picked up. Satisfactory signals were not received from the radiosonde equipment.⁹

8. Malina, Report Nr. 4-18, op. cit., pp. 24-26; Sandberg & Barry, Report Nr. 4-21, op. cit., pp. 22-26.

9. Ibid. (On 13 May 1946, Captain Richard C. Miles, a Liaison Officer assigned to the Sub-Office, CIT, made a trip to APG and to Picatinny Arsenal, Dover, New Jersey, to determine the feasibility of optical tracking of the WAC CORPORAL to an altitude of 100 miles and also the practicability of developing a mechanical time fuze which would operate in a vacuum up to a duration of 200 seconds. Immediate interest was professed by both installations, for the problems involved research in theretofore unexplored fields. As a result of Captain Miles' trip, it was decided that both programs would be initiated at once, even though it was quite improbable that such research could be completed prior to the scheduled WAC CORPORAL firings in August 1946. /Firings were deferred until December 1946./ From a long-range standpoint, however, it was considered that such research had definite applications to future missiles

UNCLASSIFIED

Conclusions and Recommendations

(U) The WAC CORPORAL as used in these tests was capable of reaching an altitude of about 230,000 feet in vertical trajectory. This great increase in altitude which surpassed that indicated by preliminary estimates, was achieved primarily through reduction in the empty weight of the missile and availability of additional impulse from the TINY TIM booster rocket.

(U) Firing tests demonstrated that acceptable vertical flight of a missile could be obtained without the use of flight-control equipment provided the missiles were launched at velocities around 400 ft/sec.¹⁰

(U) Based on the results of the firing tests, the following recommendations on major items were made:

1. That the compressed air tank be placed at the top of the propellant tanks instead of at the bottom, in order to shift the missile's center of gravity forward.
2. That alternate construction materials for propellant and air tanks be investigated with a view of minimizing fabrication difficulties and reducing weight.
3. That a study be made of the valves in the propulsion system with a view of achieving more compact and lighter weight parts.
4. That development of the liquid-propellant rocket motor be continued to reduce its weight.
5. That a reliable nose release mechanism be designed.
6. That the missile parachute attachment be greatly strengthened.
7. That a radar beacon be provided on the missile to assure radar tracking throughout the trajectory.
8. That the possibility of improving the impulse-weight ratio of the booster rocket be analyzed.¹¹

under development of The Ordnance Department and also the future WAC CORPORAL program. Miles, Capt. R. C., compiler, "Hist. ORDCIT Project," op. cit., p. 103.)

10. Ibid.

11. Ibid.

WAC CORPORAL B

(U) Round 10 of the WAC CORPORAL A was fired on 25 October 1945. One round was left over from the September-October 1945 tests. It was modified to incorporate newly designed fins and nose blowoff system, and a Signal Corps remitter was installed for the purpose of tracking. When a new series of firings commenced in December 1946, the modified Round 11 WAC CORPORAL A was launched on 3 December 1946 as Round 22, counting from Round 1 of the preceding year.¹² This round was the WAC in transition from A to B.

Changes in Design and Construction Appearing in WAC B

(U) During the period of time between the firing of Rounds 10 and 11 of the WAC CORPORAL A, great progress was made toward achieving the recommended goals, and WAC CORPORAL B succeeded WAC A, whose basic design was only slightly modified for WAC B. Over-all length and fin circle diameter were each increased four inches, but the diameter of the rocket body remained unchanged. Propellant weight was decreased 40 pounds and gross weight 100 pounds in an effort to attain higher altitudes. Details of comparisons and changes follow:

Propulsion System

(U) The WAC CORPORAL B's rocket motor, as compared to that of the A model, was reduced in length from 73 to 61 inches and in weight from 50 to less than 12 pounds. The injector assembly was redesigned and its efficiency increased.

(U) In order to reduce the empty weight of the rocket still further, a development program was undertaken on the propellant and the air tanks. After considerable experimentation, it was decided to use X4130 chrome molybdenum steel (in the normalized condition) for the fuel and the air tanks. No difficulty was encountered in producing

12. Meeks, P. J., Denison, F. G., Jr., and Rose, R. F., Report Nr. 4-41, "Design, Development, and Field Tests of the WAC B Sounding Rocket," pp. 19-20, JPL/CIT, 15 December 1947.

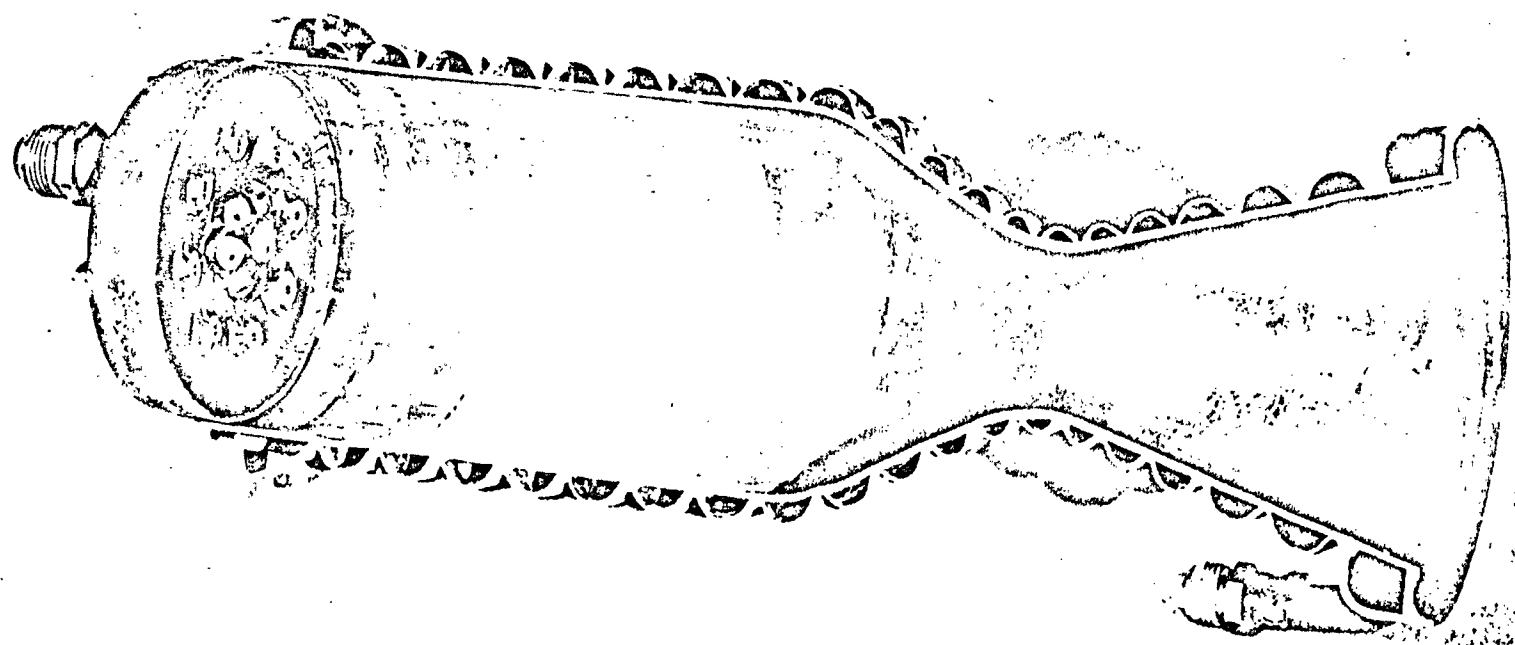

UNCLASSIFIED

SECTION OF WAC CORPORAL B COMBUSTION CHAMBER

SECTION OF WAC CORPORAL B COMBUSTION CHAMBER

these vessels. The new oxidizer tank, designed of 61ST aluminum, was readily fabricated to pass the required pressure test.

(U) The integral tank arrangement, (that is, a single, long tank partitioned into three compartments) of the WAC CORPORAL was abandoned for an arrangement of separate cells, with the air tank moved forward from its former aft position to ride on top of, or above, the propellant tanks. Besides lightening the weight of the total tank assembly, the new separate tank arrangement made possible the use of dissimilar materials in tank construction and also obviated the possible danger of explosions arising from intertank leakage.

(U) The flow system of the WAC CORPORAL B differed from that of the WAC A mainly in the system for air filling and in the elimination of a test-cell-type of propellant valve installation. Since the operation of a rocket is of a one-shot nature, the required functioning of many of the components could be simplified.¹³

Aft Section and Fins

(U) The aft section design was essentially the same as that employed in the WAC CORPORAL A. The basic structure was typical monocoque, with bulkhead rings to transfer into the sheet the fin and motor-thrust loads and the booster forces. The skin gage was lightened over the previous design, however, and static tests were performed to prove the lighter design's load-carrying ability.

(U) Fin circle diameter was increased four inches. To achieve weight saving, the skin gage was decreased from 0.081 to 0.051 inch, and the static tests apparently confirmed theoretical calculations.

(U) Provision was made to install the dipole antenna for the SC584 remitter in two of the three WAC B fins.¹⁴

13. Meeks, P. J., Denison, F. G., and Rose, R. F., Report Nr. 4-41, op. cit., pp. 1-5.

14. Ibid., p. 7.

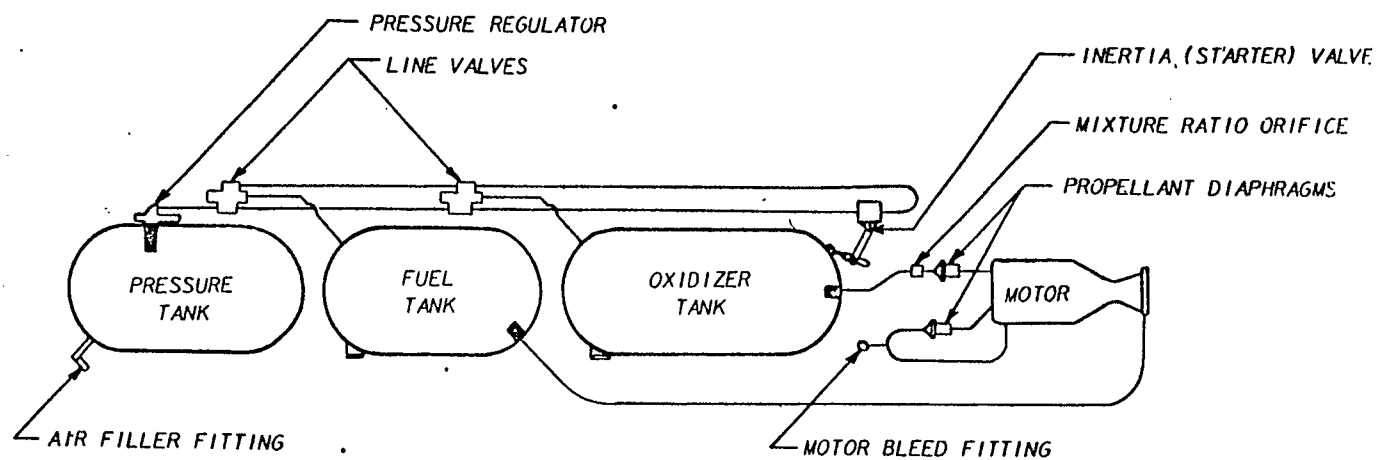

LINE SIZES

OXIDIZER	3/4 OD x .058	5250
FUEL	5/8 OD x .035	5250
AIR (FEED)	1/2 OD x .035	5250
AIR (TO LINE VALVES)	1/4 OD x .035	5250

PROPELLANT WEIGHTS

OXIDIZER	265 LB
FUEL	100 LB

REGULATED AIR PRESSURE	475 PSI
FUEL AND OXIDIZER DIAPHRAGM BURST PRESSURE	50-60 PSI
PROPELLANT MIXTURE RATIO	2.60 - 2.70
LINE VALVE ACTUATING PRESSURE	400 PSI

TANK VOLUMES

OXIDIZER	5030 CUBIC INCHES
FUEL	2750 CUBIC INCHES
AIR	3200 CUBIC INCHES

TANK OPERATING PRESSURES

OXIDIZER	475 PSI MAX.	600 TEST
FUEL	475 PSI MAX.	600 TEST
AIR	2100 PSI	2500 TEST

PROPULSION SYSTEM FLOW DIAGRAM OF WAC B

UNCLASSIFIED

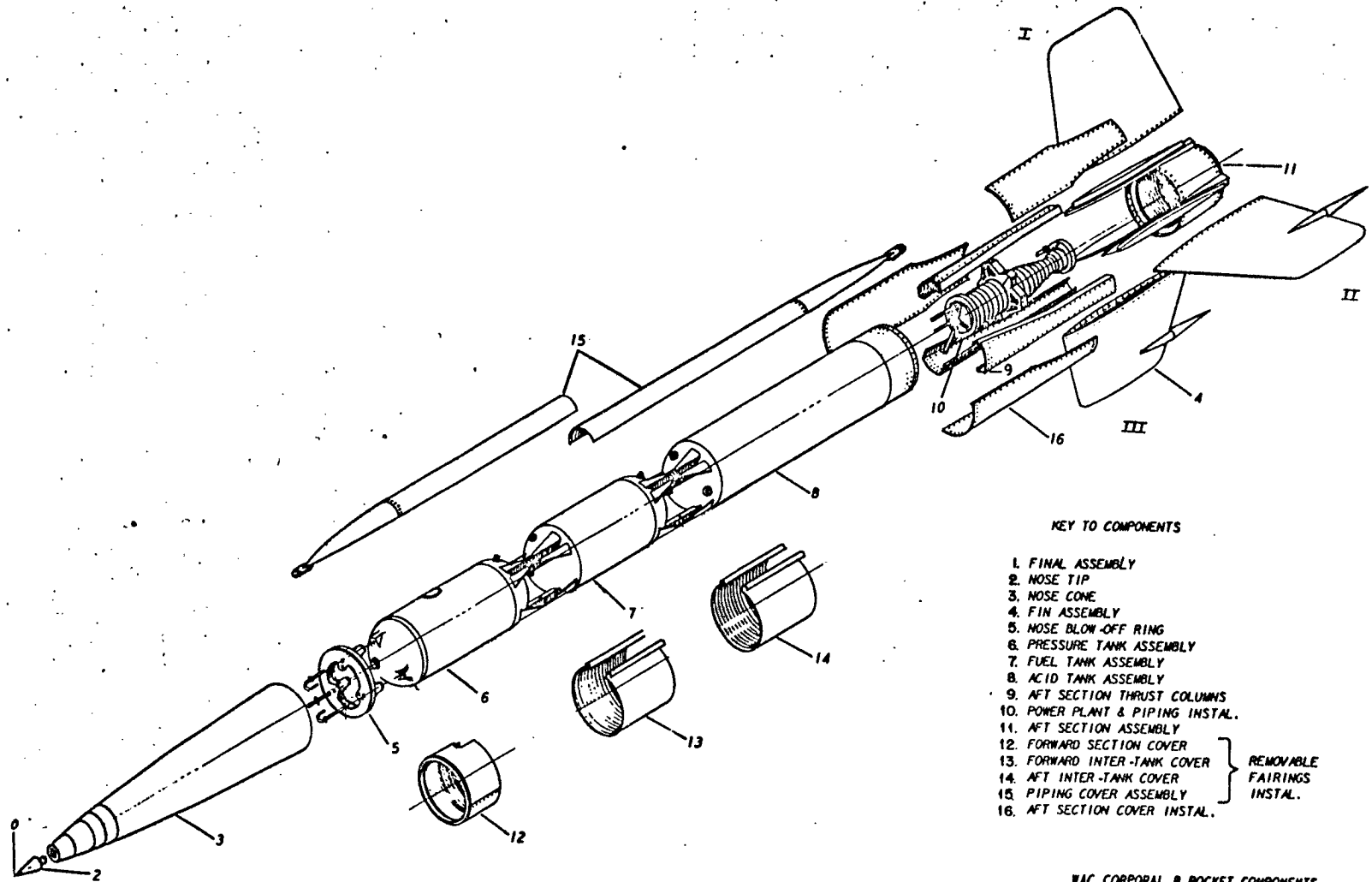

KEY TO COMPONENTS

1. FINAL ASSEMBLY
 2. NOSE TIP
 3. NOSE CONE
 4. FIN ASSEMBLY
 5. NOSE BLOW-OFF RING
 6. PRESSURE TANK ASSEMBLY
 7. FUEL TANK ASSEMBLY
 8. ACID TANK ASSEMBLY
 9. AFT SECTION THRUST COLUMNS
 10. POWER PLANT & PIPING INSTAL.
 11. AFT SECTION ASSEMBLY
 12. FORWARD SECTION COVER
 13. FORWARD INTER-TANK COVER
 14. AFT INTER-TANK COVER
 15. PIPING COVER ASSEMBLY
 16. AFT SECTION COVER INSTAL.
- REMOVABLE FAIRINGS INSTAL.

WAC CORPORAL B ROCKET COMPONENTS

UNCLASSIFIED

UNCLASSIFIED

Nose Cone

(U) For the first experimental models of the WAC CORPORAL A, the parachute was attached to the top of the propellant tanks, within the nose of the missile. Three explosive pins were used to attach the nose to the missile. These pins were inserted through the skirt of the nose into lugs welded on the forward end of the tank head. The nose skirt was seated on a rubber ring seal strip which was provided around the tank head. Atmospheric pressure at the launching point was thus sealed in the nose and provided a force to push off the nose at the zenith of trajectory, where the sealed-in atmospheric pressure would be essentially greater. Release of the nose was to be effected by electrically igniting the restraining explosive plugs, and the rip cord of the parachute was attached to the nose.¹⁵

(U) Modifications of the original WAC CORPORAL A nose blowoff system were made to insure controlled and dependable operation. Various arrangements were tried out in preliminary tests at WSPG, utilizing the missile's nose structure applied to a TINY TIM booster. The arrangement finally chosen involved a primacord ring inserted under a band of light magnesium sheet which fastened the nose to the vehicle proper. This primacord was detonated by a blasting cap which was actuated either by a signal from the remitter or by a fuze. Blowing off the nose by means of the remitter was accomplished by observing the trajectory of the rocket on the plotting board and transmitting a signal to the remitter to detonate the primacord at the peak. A fuze was installed so that the nose cone would be blown off and the parachute ejected even in the event of radio failure. When the nose cone was blown off, it was accelerated away from the vehicle, drawing out the parachute, which had been wedged into the nose cone.¹⁶

(U) Prior to the WAC B field tests, several TINY TIM solid-propellant rockets (tabulated on the firing chart as Rounds 13 to 20,

15. Malina, Report Nr. 4-18, op. cit., pp. 9-10.

16. Meeks, Denison, & Rose, Report 4-41, op. cit., pp. 5-6.

UNCLASSIFIED

inclusive) equipped with WAC B nose-cone assemblies were fired for the purpose of proving the parachute ejection mechanism. Although these rounds reached an altitude of only approximately 14,000 feet, which did not simulate the conditions for the ejection of the WAC CORPORAL B's parachute, the results of the test were considered quite satisfactory.

(U) Radio-telemetry equipment was developed, thereby making possible the transmission of instrument readings from the rocket to the ground receiving station. This equipment was installed in the nose cones of three WAC B's, and satisfactory signals were received.¹⁷

Prototype Static Firing

(U) The first of the WAC B test vehicles was initially assembled for prototype testing at the Muroc Test Station. This was the first static test of the complete rocket test vehicle employing burst-diaphragm starting valves ever conducted in the United States. The motor came up to 95 per cent chamber pressure in approximately 0.5 second. Both starting transient and cutoff at the end of burning were smooth. Post-firing examination of the motor showed it to be in perfect condition. After the prototype's testing, it was returned to the Douglas Aircraft Company for modification to flight configuration, and this assembly was later fired as Round 26.¹⁸

THE BOOSTER

(U) The booster employed in the December 1946 firings was identical with that used in the WAC CORPORAL A tests of the preceding year. Maximum burning time was still held between 0.60 and 0.65 second, which provided a maximum thrust of approximately 50,000 pounds.¹⁹

17. Ibid.

18. Ibid., pp. 17-19.

19. Ibid., p. 19. See Document 9 for Statistical Summary of WAC CORPORAL and TINY TIM.

UNCLASSIFIED

FIRING TESTS, WSPG, 2-13 DECEMBER 1946

(U) As mentioned above, eight rounds of the TINY TIM booster had already been fired to prove the parachute mechanism. In numerical order, then, the first launching of the December 1946 tests was that of Round 21, which was fired on 2 December and consisted of a TINY TIM booster rocket equipped with a WAC B nose cone and a 10-foot glass fabric parachute.

(U) Round 22 was the modified WAC A rocket left over from the 1945 firings, as mentioned before (Ref. note 12, above).

(U) Four rounds of the WAC CORPORAL B completed the December firing program. No round reached an altitude higher than 175,000 feet. (Ref. Document 10 for round-by-round summary of all TINY TIM and WAC CORPORAL firings).

MODIFICATIONS BECAUSE OF TEST RESULTS

Propulsion System

(U) Because no round had delivered the required impulse satisfactorily, it was decided to assemble three more vehicles in an attempt to obtain satisfactory propulsion system performance. Such assembly was easily accomplished, since two remitter rounds fired were recovered in good condition. Moreover, enough spare components had been constructed at the time of the original fabrication to form the basis of a third assembly.

(U) In redesigning the injector of the WAC B's motor, orifices had been drilled. For the scheduled February 1947 firing of the proposed three additional vehicles, their motor injectors were provided with cavitation-free,* screwed-in orifice inserts having rounded and polished entrances.

(U) Two of the February vehicles were provided with air tanks constructed of a lighter weight steel, thereby permitting in each case a

* "Cavitation," a gas-filled space in a liquid; or a partial vacuum in a fluid under certain conditions.

UNCLASSIFIED

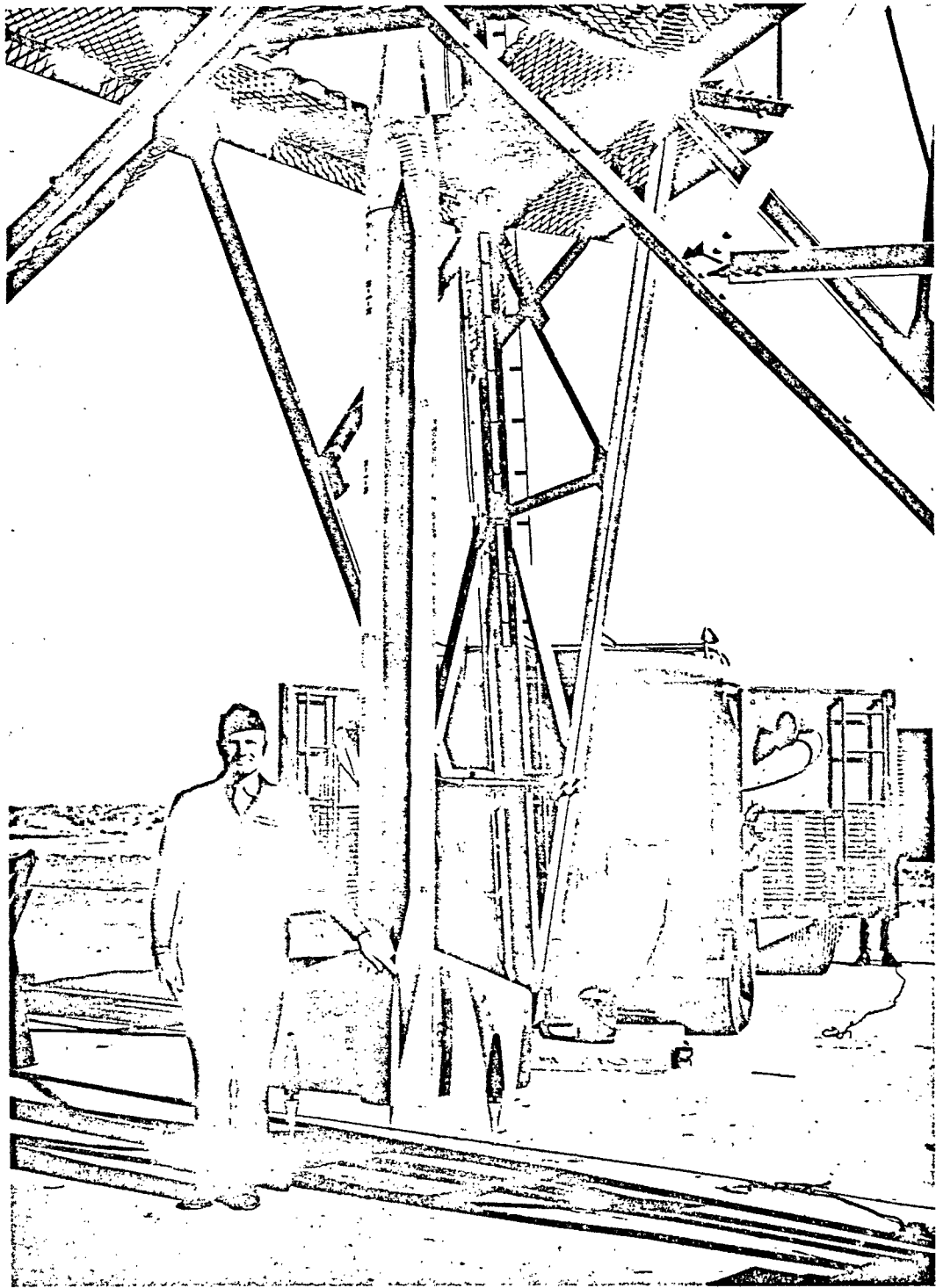

Col. B. S. Mesick, Chief, R&D Service Sub-Office (Rocket), CIT, Pasadena, California, standing at launcher beside WAC CORPORAL Round 23, the first WAC B round to be fired.

UNCLASSIFIED

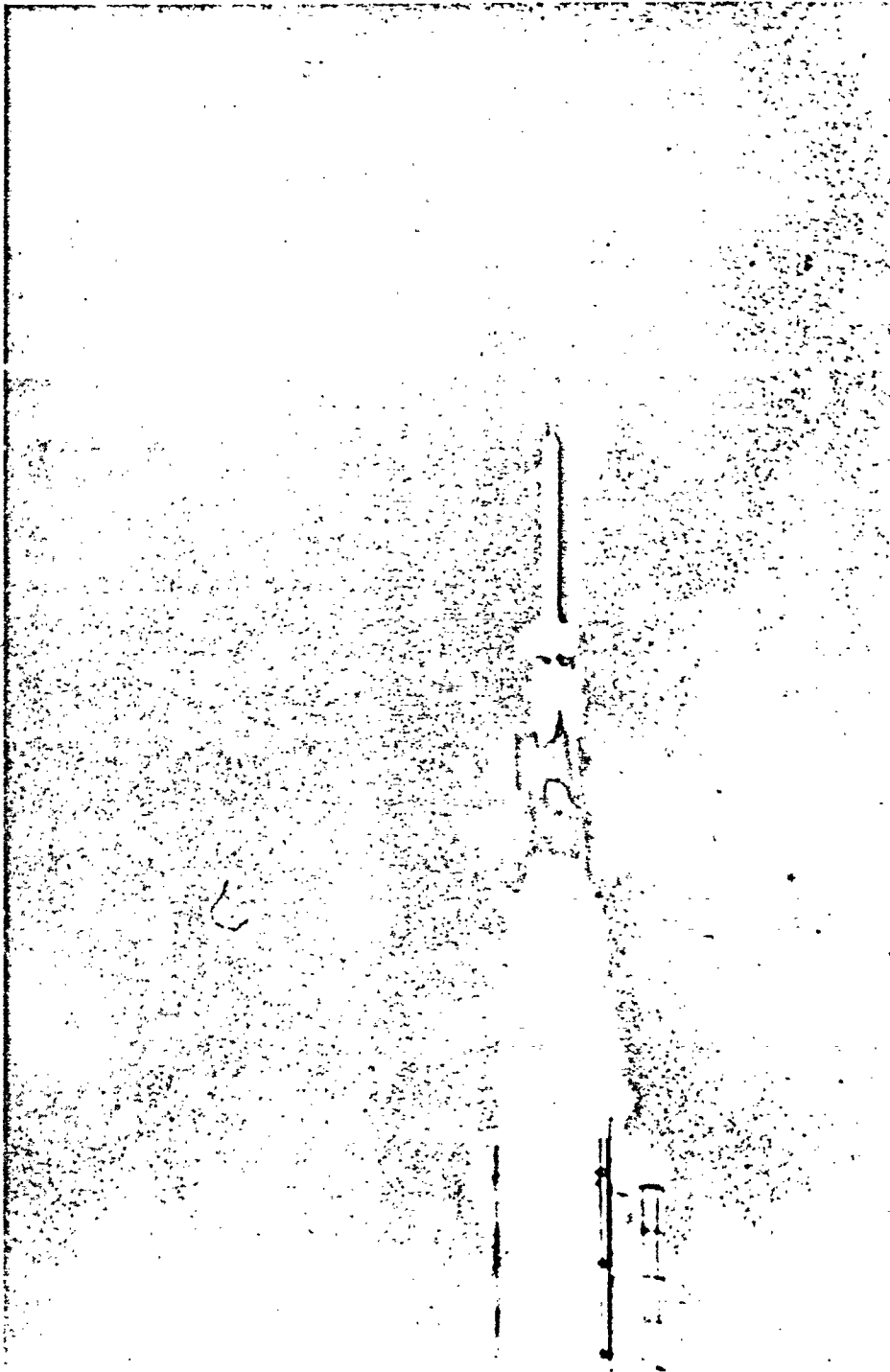

FIRING OF WAC CORPORAL-WAC AND TINY TIM BOOSTER CLEARING LAUNCHER

UNCLASSIFIED

weight of 75 instead of 91 pounds, a weight^h saving of 16 pounds for each tank.²⁰

Miscellaneous

(U) The nose blowoff arrangement required no change. Obtainable ribbon parachutes were very large (18 to 24 feet in diameter), requiring special nose cone shells having an extended cylindrical portion to provide the extra volume. The remitter installation remained unchanged, and each of the three rounds carried remitters to aid radar in obtaining complete flight data.²¹

(U) No changes were made in the aft section. Because of fin failures in the December 1946 firings, the fin skin gage was increased to 0.081 inch, the specification of the WAC CORPORAL A. In addition, a tip casting was employed to provide more stiffening against the type of failure which had occurred.²²

(U) The three WAC B vehicles to be fired at WSPG in February 1947 were subjected to hydraulic tests and were also statically fired at JPL before shipment to WSPG. The motor starting transients were smooth and extremely rapid. Combustion was clean throughout the test, and cutoff was quite satisfactory. After static firing, each vehicle was shipped to Douglas Aircraft Company for flight modification and shipment to WSPG.²³

THE BOOSTER ROCKET

(U) Only two of the modified TINY TIM motors were available for the scheduled tests; the supply had been exhausted during previous launchings. For the third firing it was necessary to obtain from the U. S. Navy stock the only similar rocket motor, the Mk I, Mod 1, a design employing the same propellant as the TINY TIM burned but having a body about 10 inches longer. Among other factors, the 150 pounds in increased weight resulted in a significantly lower boosted velocity

20. Ibid., pp. 19-24.

21. Ibid.

22. Ibid.

23. Ibid.

UNCLASSIFIED

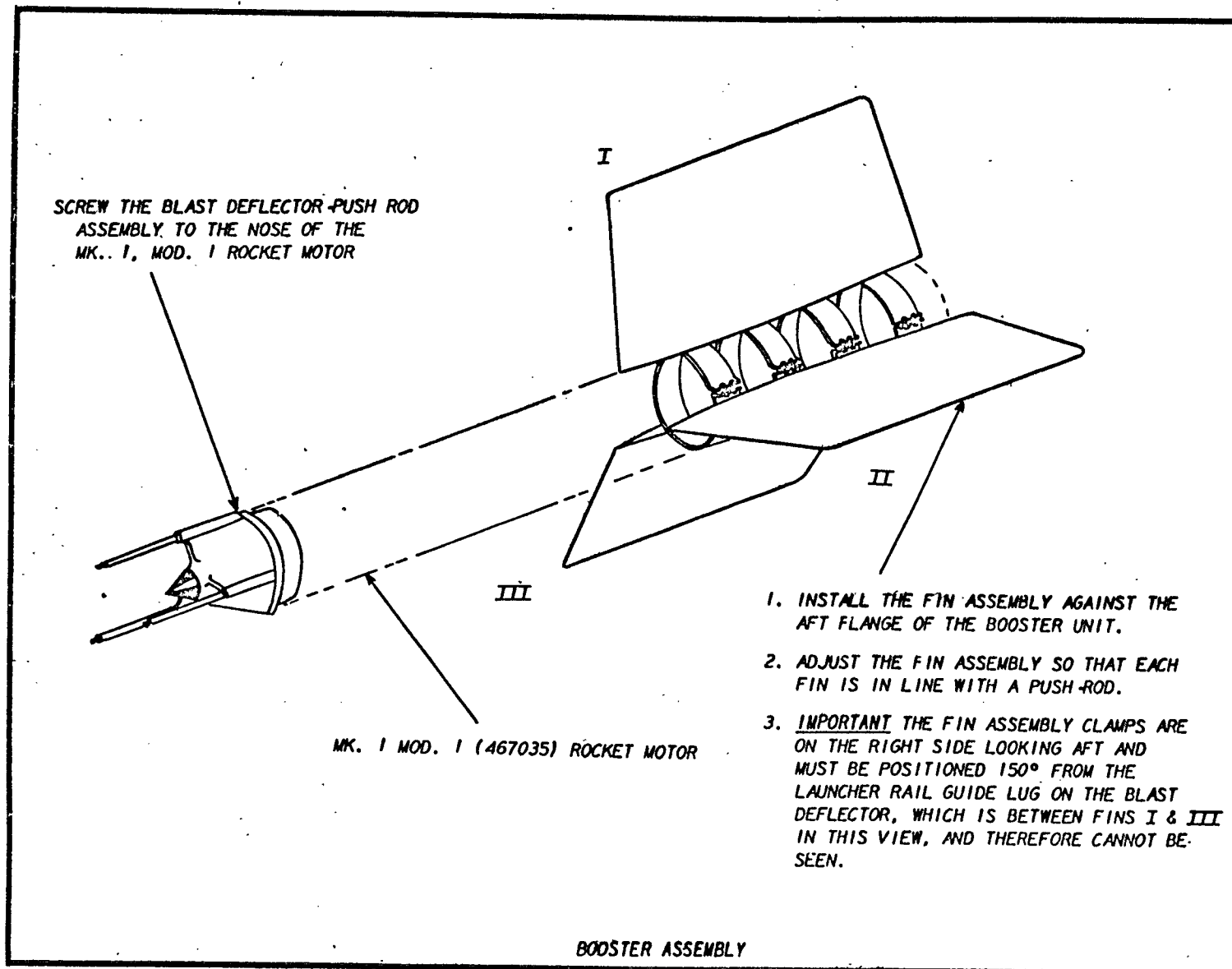

UNCLASSIFIED

on leaving the launching tower and consequently reduced the final altitude reached by the sounding rocket.²⁴

FIRING TESTS, WSPG, 17 FEBRUARY-3 MARCH 1947

(U) Round 27, launched on 17 February 1947, was a proof test of the new type of TINY TIM booster rocket. It carried 680 pounds of lead as ballast, was fired successfully, and provided burning time and acceleration data.

(U) Round 28's launching, on 18 February, was normal, but the 144,000-foot altitude reached was much less than expected. This round was equipped with a 21-foot (in diameter) silk ribbon parachute and a special nose cone. Instrumentation was good. The nose cone was blown off at the zenith by radar, and recovery of the missile by parachute was successful.

(U) At this point it was concluded that the reduced altitude obtained with Round 28 and other rounds fired during the December 1946 tests might have been due to malfunctioning of the air line disconnect coupling, thereby allowing air to escape into the atmosphere during flight. An additional check valve in the air-fill line aboard Rounds 29 and 30 corrected this condition, and altitudes comparable with theoretical estimates were obtained.

(U) Round 29, launched on 24 February 1947, was equipped with a 10-foot glass parachute, which failed to open; the round was lost and never recovered. Instrumentation was good. This WAC B was tracked by radar to peak, at which point the remitter failed (apparently because of the nose cone blowoff). Altitude reached was 240,000 feet.

(U) Equipped with a 10-foot glass parachute, Round 30 on 3 March 1947 reached a 206,000-foot altitude. The parachute opened, and the missile was recovered nearly intact.²⁵

24. Ibid.

25. Meeks, Denison, & Rose, Report Nr. 4-41, op. cit., pp. 24-25. (Brown & Others, "Development & Testing of Rockets & Missiles at WSPG, 1945-1955," mentions another WAC B firing as having occurred on 12 June 1947. This round, equipped with a 10-foot glass parachute, reached an altitude of 198,000 feet. The nose-cone blowoff and parachute operation were good, but the missile was not recovered. (Appendix, p. 71.) See Document 10 for summary of firings.

RECOMMENDATIONS IN VIEW OF TEST RESULTS

(U) Rounds 29 and 30 showed acceptable performance, and, in the light of the minor modifications necessary to achieve this result, it was concluded that the vehicle was ready for release for limited production. Design was turned over to the Ordnance Department, together with suggestions for a number of design improvements, the necessity for which had become apparent through experience gained in the field.*

(U) At a predicted weight saving of six pounds, pull-out fittings were recommended for installation near the nose, with leads to the ground being lengthened accordingly. A different material was recommended for the aniline tank, with the prospect of saving 15 pounds in its weight.²⁶

(U) It was recommended that the nose cone assembly be made a quick-detachable unit, thereby permitting its final installations and adjustments to be made on the ground. Another proposal was that a section of the launching rail be made removable so that the nose and its gear complete could then be attached to the rocket body in the launcher, with no weight increase deemed necessary to achieve this improvement.²⁷

(U) In view of later development of the CORPORAL missile, one recommendation was of considerable significance: Field experience had shown that the stressed skin construction universally employed in the WAC CORPORAL B (and A) limited the access to the propulsion system

* The AEROBEE rocket was a direct lineal descendant of WAC CORPORAL. It was developed under a Bureau of Ordnance Contract awarded in May 1946 to Aerojet Engineering Corporation and to Douglas Aircraft Corporation, with technical supervision from Johns Hopkins University. The proposal was to pattern the new rocket generally on the lines of the successful WAC CORPORAL, but with instrument volume and altitude specifications more suited to high-altitude research requirements. Like WAC CORPORAL, AEROBEE was unguided but possessed arrow stability by virtue of its three fins and proper location of its center of mass. Its trajectory was controlled simply by tilting the 140-foot launching tower in accordance with wind data obtained from meteorological balloons. WAC CORPORAL was phased out. Gatland, Kenneth, W., "Development of Guided Missiles," pp. 67-69, New York, 1952.

26. Ibid., pp. 24-25.

27. Ibid.

compartments inordinately. It was recommended that the aft section and the intertank connections be modified to truss-type structures, and that the skin carry none, or at least only a small part, of the load. Easily removed skin panels could thus be opened for servicing without jeopardizing the structural strength of the vehicle. Moreover, it was believed that this type of design would lend itself more readily to quantity production, where interchangeable components would be almost a necessity. By modifying the boost rod locations so as to line up with the aft section truss members, it was believed that an improvement in the loading of the aft section could be achieved. It seemed possible that the combination of these changes could provide the desired accessibility with no increase in weight.²⁸

28. Ibid.

~~CONFIDENTIAL~~

UNCLASSIFIED
CHAPTER VI

BUMPER WAC

INTRODUCTION

(U) In regard to designing vehicles for probing the unexplored upper reaches, JPL's W. Z. Chien posed two basic questions:¹

In designing rocket missiles, two basic questions arose: How high could a rocket missile be sent vertically upward, and how far could a rocket missile be projected along the earth's surface? Or conversely, as might be even more frequently asked, what would be the basic design parameters of a rocket missile capable of reaching a given altitude or a given horizontal?

(U) These two questions arose during the designing of the WAC CORPORAL and were but partially answered when round after round of that vehicle soared aloft. BUMPER WAC was to answer those questions a little more fully.

INITIATION OF THE BUMPER WAC PROJECT

(C) At the time of the 13 June 1946 V-2* firing at WSPG, the possibility of using a V-2 as the first step of a combined V-2/WAC step-rocket was discussed at some length by Col. H. N. Toftoy,** Lt. Col. H. R. Turner, Dr. R. W. Porter, and Dr. C. B. Millikan. Following his return to CIT, Dr. Millikan initiated studies at JPL of the feasibility of this project and of the performance that might be expected if such a missile were constructed. In pursuance of Colonel Toftoy's suggestion, members of the Peenemunde group at Fort Bliss, Texas, including Ludwig Roth and Wernher von Braun, likewise undertook a preliminary study of

1. Chien, W. Z., Report Nr. 4-11, "Vertical Flight Performance of Rocket Missiles and an Estimation of their Horizontal Ranges, p. 1, JPL/GALGIT, CIT, 28 June 1945.

* The German V-2 missile was frequently designated as A-4. Both terms refer to the same missile.

** Major General H. N. Toftoy was at the time mentioned Colonel Toftoy, Chief of the Rocket Development Division, OCO.

UNCLASSIFIED
76

~~CONFIDENTIAL~~

UNCLASSIFIED

the problem, considering the following aspects of such a combination: (1) geometric, (2) stability, (3) performance, and (4) terminal trajectory.²

(U) In pursuance of achieving the mating of V-2 and WAC CORPORAL as a step-rocket, in October 1946, some months after the preliminary studies discussed below had been undertaken, but before these studies and theoretical calculations had been completed, the Army Ordnance Department authorized the BUMPER Project. Design work was started in May 1947, and the first BUMPER missile was launched on 13 May 1948 at WSPG. The eighth (and last) was fired on 29 July 1950 at Long Range Proving Ground (LRPG), Florida.³

(U) It seemed geometrically possible to mount the WAC in the nose of the V-2. However, three stability problems had to be solved: (1) the stability of the combined missile during the V-2 burning period; (2) the stability of the WAC during its launching period; and (3) the stability of the WAC near the end of its burning period.⁴

(U) Since the WAC's nose cone would project forward of the V-2's nose, a small destabilizing moment would be introduced, especially near the end of the V-2's burning period. This instability could be prevented by ballasting the V-2 nose compartment with lead or instruments weighing enough to restore the normal stability or by increasing the V-2 fin area to shift the center of pressure aft. This latter solution could be accomplished by four small fixed fins (of about eight square

-
2. Stewart, H. J. Memorandum Nr. 4-16, "Preliminary Considerations Regarding the Proposed V-2 WAC Missile," p. 1, JPL/GALCIT, CIT, 16 August 1946; Roth, Ludwig, and von Braun, Wernher, Technical Report Nr. 18, "The Combination of V-2 and WAC CORPORAL as a Two-Stage Rocket," p. 1, War Department, OCO, R&D Suboffice (Rocket), Fort Bliss, Texas, July 1946; Crawford, Jane E., Report Nr. 55227, "Trajectory Calculations for the A-4 BUMPER WAC Missile," pp. 2-3, Marine & Aeronautic Engineering Division, General Electric Company, Schenectady, New York, 3 November 1947.
 3. White, L. D., Report Nr. R52A0510, "Final Report, Project HERMES V-2 Missile Program," p. 24, Guided Missiles Department, Aeronautic and Ordnance Systems Divisions, Defense Product Group, General Electric Company, Schenectady, New York, September 1952.
 4. Stewart, Memo Nr. 4-16, op. cit., pp. 1-2.

UNCLASSIFIED

feet each) interleaved between the normal fins. The first appeared the simpler of the two solutions, however.⁵

(U) The normal fins of the WAC B were large enough to stabilize the missile up to approximately Mach 5, the speed at which the WAC was to be launched from the V-2. It was necessary to increase the WAC fin area in order to assure a satisfactory launching. That could be done most simply by changing from a three-fin to a four-fin arrangement, affording a 33 per cent fin area increase. Furthermore, with the WAC set back into the normal instrument section, leaving only about a 1-inch clearance at the fin tips, rearrangement of the V-2 instruments became necessary.⁶

(U) During the latter portion of the WAC burning period, the air density would be so low that air forces would be almost insignificant. The primary stability factor in this region would be the jet-thrust asymmetry. If the jet thrust failed to act through the missile's center of gravity, the resulting moment would cause the missile to tumble. Since the air forces are so small in this region, a theoretical solution indicated that a very small rate of spin, about 500 rpm, would be sufficient to produce stability. This spin, it was thought at this time, could be easily produced by small fixed jet vanes.⁷

(U) The maximum performance of the WAC indicated that it be launched immediately after the end of the burning of the V-2. At this time, for the high-elevation trajectories being currently used for the WSPG V-2 firings, the altitude was 124,000 feet and the speed was 5,047 ft/sec. For these initial conditions, the trajectories of the WAC were computed for three initial gross weights varying from 700 pounds (WAC A) to 570 pounds (WAC B with magnesium tanks), with no calculations for air drag included. For Case 3 (the 570-pound WAC B), the estimated horizontal range in this trajectory was 275 miles, with a maximum altitude

5. Ibid., pp. 1-6

6. Ibid.; Crawford, Report Nr. 55227, op. cit., pp. 2-3.

7. Ibid.

UNCLASSIFIED

PROPOSED HIGH ALTITUDE WAC LAUNCHING
ORDCIT PROJECT JPL GALCIT

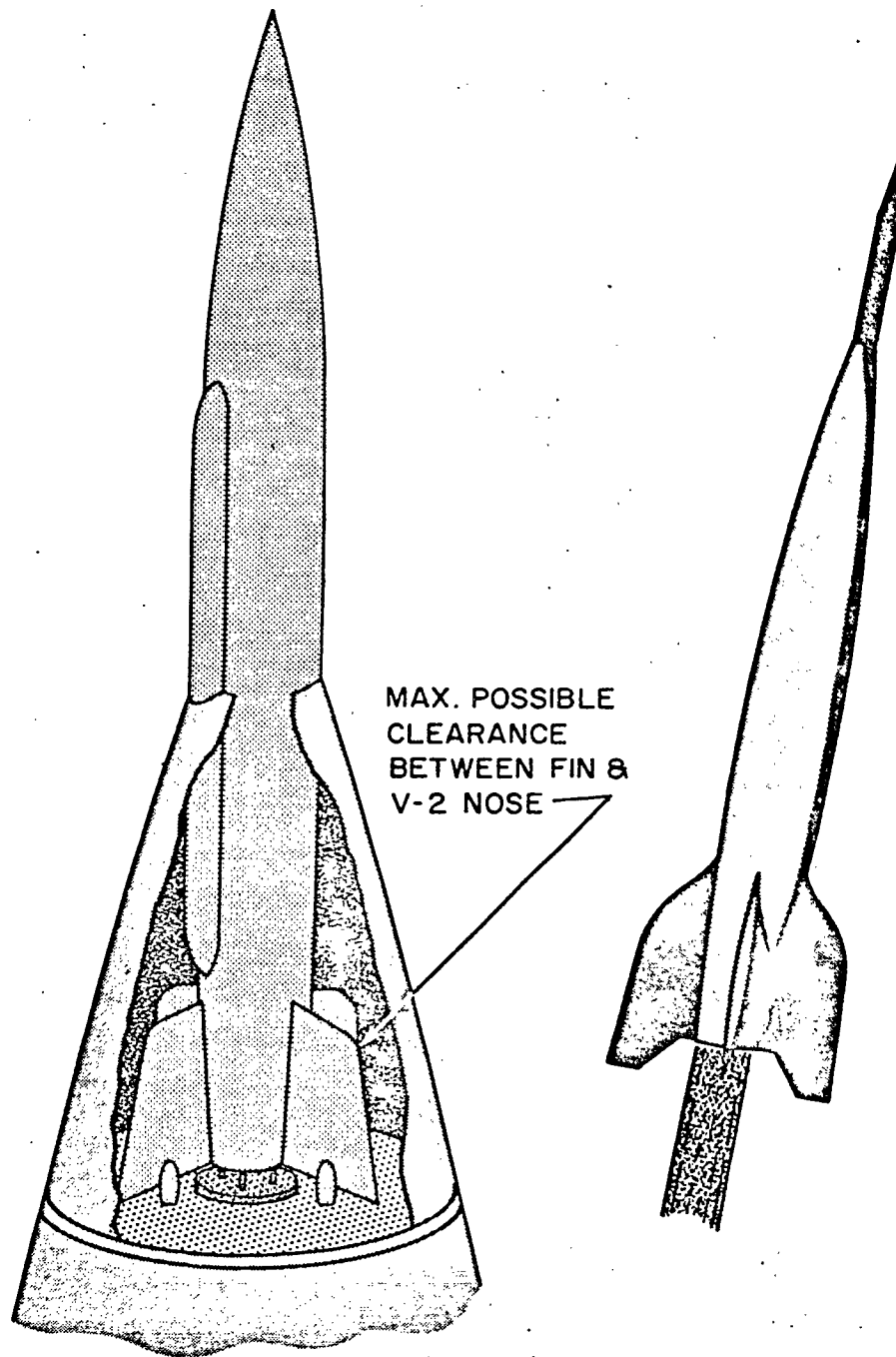

DETAIL OF WAC CORPORAL ROCKET
INSTALLED IN NOSE OF V-2 ROCKET

~~CONFIDENTIAL~~
UNCLASSIFIED

of approximately 400 miles. The maximum horizontal range at the optimum elevation was estimated at 800 miles.⁸

(U) The WAC was expected to reenter the dense low layers of the atmosphere unstable and at high velocity, with the resulting air forces destroying the fin structure. The tank structure, however, was expected to spin down to the earth's surface fairly intact, after having survived the viscous heating from atmospheric friction.⁹

(U) Since the probable error in the impact point of the combined missile could be expected to be about five times that of the V-2 alone, the danger area around the expected impact point would be so large that it appeared necessary to consider an over-water firing range for such a missile.¹⁰

The Fort Bliss, Texas, Study

(C) The German rocket experts at Fort Bliss, Texas, found data of the WAC available to the project group there very poor. Much of the data, especially concerning the performance of the WAC, was determined by calculations based upon a few known dimensions and performance values. They recognized two of the problems and associated difficulties as being of serious import and expressed them in the form of questions:

1. Was the structural strength of the WAC sufficient for the high stagnation pressures occurring during the powered trajectory of the V-2 booster, considering the fact that only the lower part of the WAC would be fixed with the V-2 booster?
2. Would the skin of the WAC withstand the high boundary-layer temperatures occurring at the high velocities that were to be expected? If not, which parts of the WAC would have to be substituted by parts made of a higher-melting alloy?¹¹

8. Crawford, Report Nr. 55227, op. cit., pp 2-3; Stewart, Memo Nr. 4-16, op. cit., pp. 1-6. See Document 11: "Theoretical Calculations of Trajectories for the Proposed V-2/WAC CORPORAL Missile."

9. Ibid.

10. Ibid.

11. Roth, Ludwig, and von Braun, Wernher, Technical Report Nr. 18, op. cit., p. 1.

UNCLASSIFIED
~~CONFIDENTIAL~~

UNCLASSIFIED

COMBINATION V-2 & WAC-CORPORAL

4 DIFFERENT ASSEMBLY METHODS

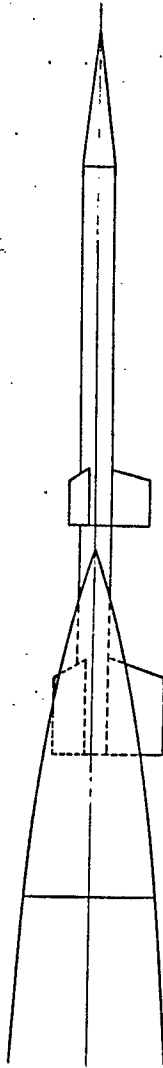

A WAC + POWDER ROCKET BOOSTER USING SPACE OF V-2 WARHEAD ONLY.

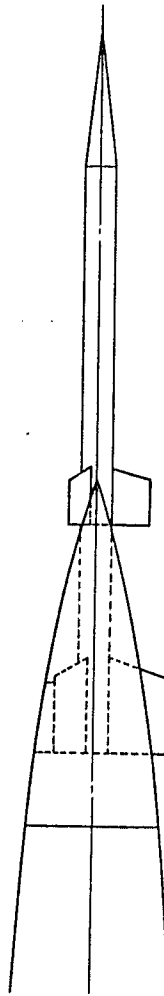

B WAC + POWDER ROCKET BOOSTER USING SPACE OF WARHEAD + HALF THE LENGTH OF INSTRUMENT COMPARTMENT OF V-2.

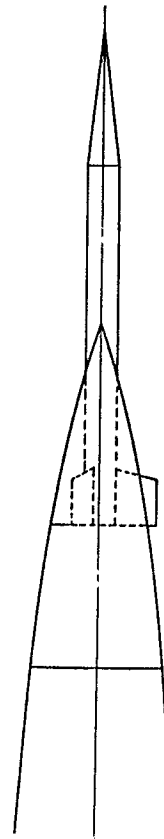

C WAC WITHOUT POWDER ROCKET BOOSTER USING SPACE OF V-2 WARHEAD ONLY.

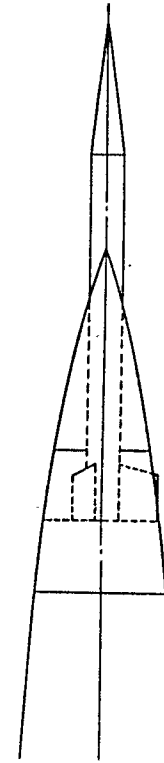

D WAC WITHOUT POWDER ROCKET BOOSTER, USING SPACE OF WARHEAD AND HALF THE LENGTH OF INSTRUMENT COMPARTMENT OF V-2.

UNCLASSIFIED

V-2 WITH WAC CORPORAL

SCALE 1=50

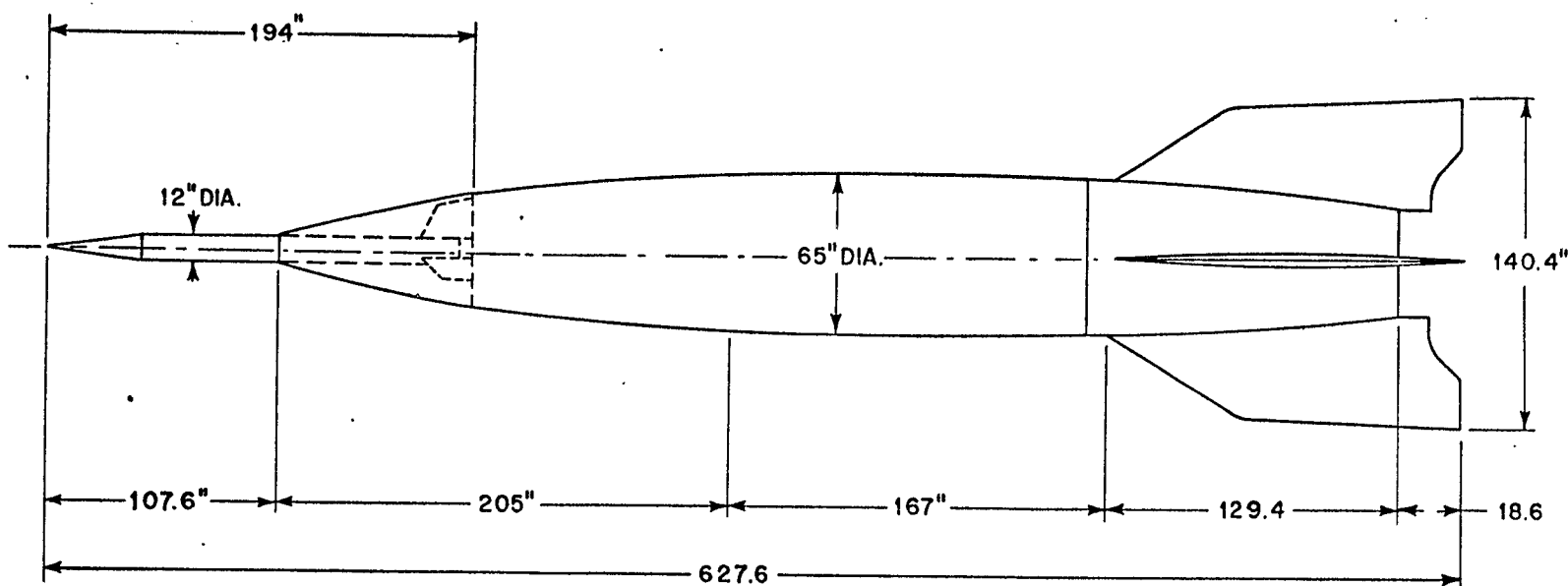

UNCLASSIFIED

UNCLASSIFIED

V2 (A4) WITH WAC-CORPORAL

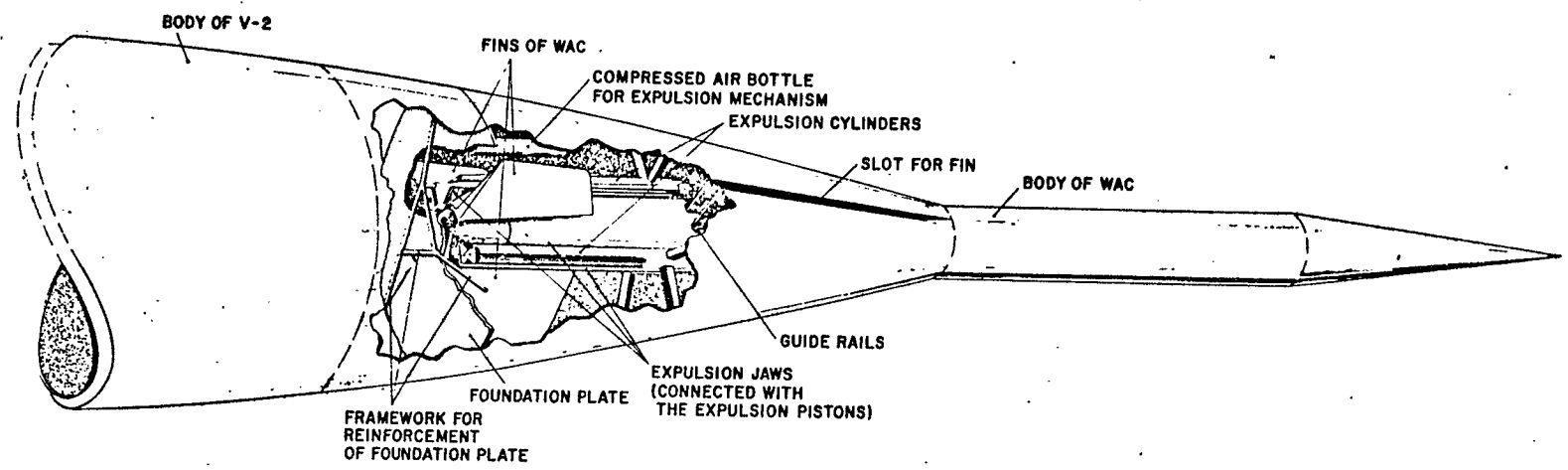

UNCLASSIFIED

UNCLASSIFIED

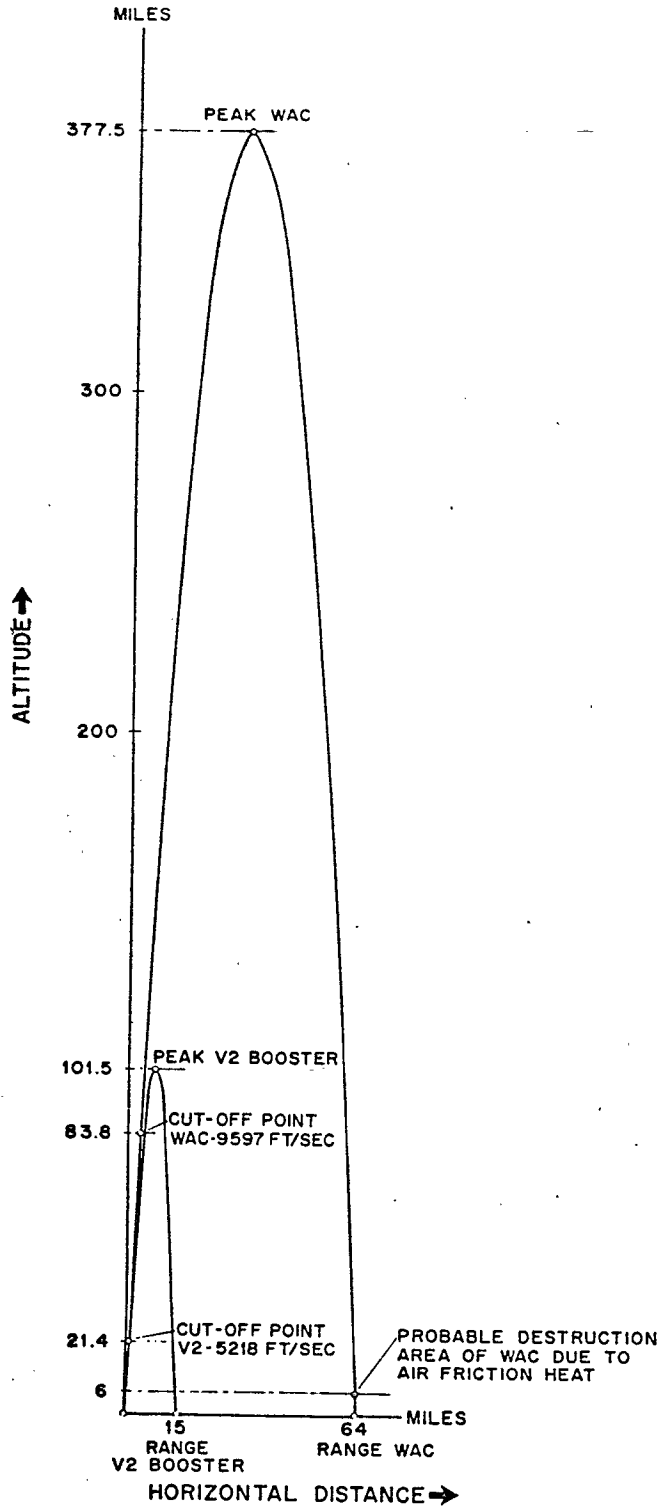

TRAJECTORY OF WAC-V2 COMBINATION

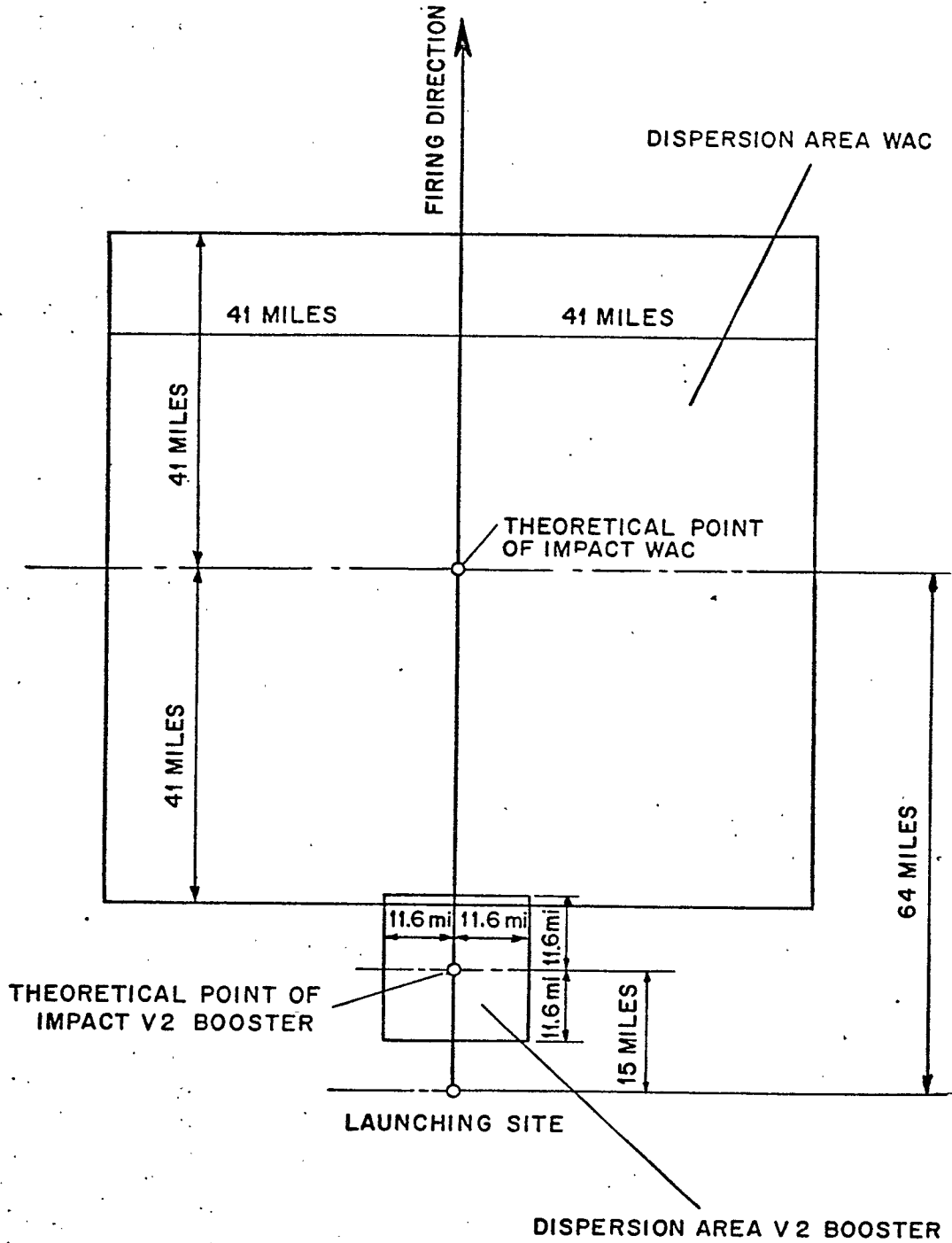

DISPERSION DIAGRAM

DAUGHTER

UNCLASSIFIED

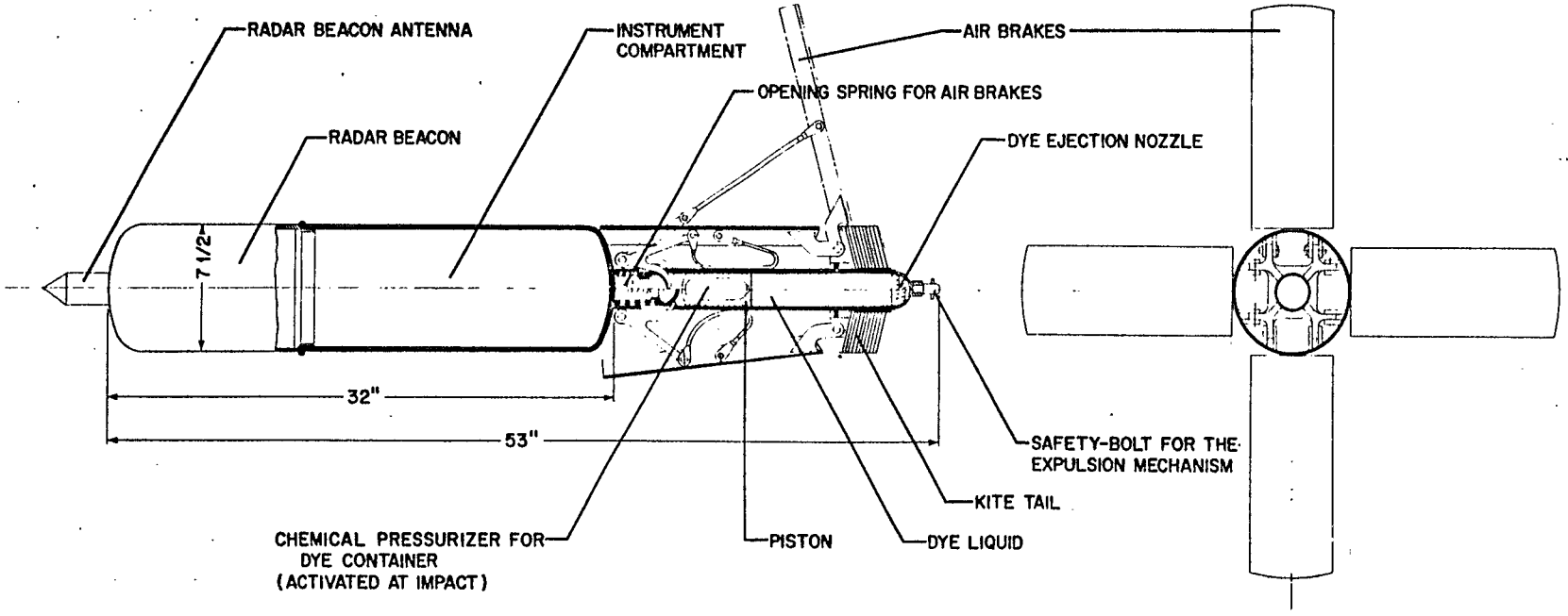

UNCLASSIFIED

UNCLASSIFIED

(C) Geometric Considerations. Four proposals for the assembly of the WAC and the V-2 were considered, with the WAC retaining its original three-fin tail assembly in each instance: (1) an assembly of the V-2, the WAC, and the solid-propellant booster, with the fins of both the WAC and the booster protruding beyond the contour of the V-2 and the entire WAC mounted outside the V-2; (2) the same three-step unit, but with half the length of the V-2's instrument compartment occupied by the WAC's booster, leaving the lower part of the compartment available for housing the guiding equipment; (3) the WAC alone, fixed in a launcher substituted for the V-2's warhead, with the WAC's fins still protruding beyond the contour of the V-2; and (4) the WAC alone, merged as deeply in the V-2 body as possible, but with only half the length of the instrument chamber occupied by the WAC and with the WAC's fins almost entirely merged in the body of the V-2. In this fourth proposal, the fins of the WAC were designed to slide out of three slots provided in the upper part of the warhead-shaped launcher.¹²

(C) The suggested combination of the V-2 with a WAC CORPORAL seemed in the thinking of the Fort Bliss group to be practicable, but the launching of the WAC by its booster rocket did not appear so. It was decided that the explosion of the WAC from the V-2 would have to be achieved by means of pneumatically operated ejection pistons.¹³

(C) THE DAUGHTER. The chance of getting the WAC down to the ground undestroyed was considered very poor, but it was believed that salvaging an instrument container protected against heat transfer might be achieved. A so-called DAUGHTER was to salvage recording instruments for atmospherical measurements in the vicinity of the peak of the V-2 trajectory, being expelled from the V-2 at its point of zero velocity. The DAUGHTER's velocity of descent was to be slowed by a species of air brakes and a kite tail, with impact velocity at sea level being as low as 155 ft/sec, a rate which could be withstood by suitably prepared instruments or records. Equipped with a radar beacon, the DAUGHTER

12. Ibid., pp. 1-4.

13. Ibid., pp. 3-4.

UNCLASSIFIED~~CONFIDENTIAL~~

~~CONFIDENTIAL~~**UNCLASSIFIED**

could be tracked down electrically to the point of impact. Upon impact, a special dye container was to eject a liquid dye for coloring the surroundings of the impact point, making easy the discovery of the spot by a search plane.¹⁴ V-2's DAUGHTER never survived but was buried in the archives among the thousands of other abortive, premature, visionary brain children, to be forgotten until a later date. (Ref. note 14, below.)

Summary of the BUMPER Program

(U) The BUMPER program, when finally inaugurated, consisted of firing tests of eight missiles utilizing V-2 booster having such structural modifications in the forward portion as would serve to launch modified WAC CORPORAL B second-stage rockets before the end of the V-2 powered trajectory. The V-2 booster was designated as BUMPER, and BUMPER WAC identified the modified WAC CORPORAL B. As a two-stage rocket, the two were referred to as the BUMPER missile.

(U) Initiated at the behest of the Ordnance Department, BUMPER was a phase of the HERMES Project, with General Electric Company exercising prime cognizance, being responsible for (1) proper coordination among the participating agencies, and (2) assembly, pre-flight checkout tests, and actual launching of the missile at WSPG.* JPL/CIT was assigned responsibility for the theoretical investigations required, the design of the second stage, and the basic design of the separation system.

14. Roth & von Braun, Technical Report Nr. 18, op. cit., pp. 6-8. (Col. B. S. Mesick, Ordnance Sub-Office Chief, CIT, visited the HERMES Project at General Electric and discovered that a helicopter device had been developed which might be applicable to the ORDCIT problem of lowering the WAC CORPORAL from high altitudes. This visit was long prior to initiation of the BUMPER Project. Miles, Capt. Richard C., compiler, "Hist. ORDCIT Project," op. cit., p. 103. DAUGHTER was a pioneer in the recovery of records and instrumentation from space explorations. The air brakes employed the helicopter principle for slowing the rate of descent and also a sort of kite tail. The helicopter concept has been resurrected for further study and experimentation.)

* Since GE had been given the responsibility of assembly, testing, and firing of V-2's at WSPG, responsibility for the two-stage missile was also assigned to GE and included in the HERMES Project, another Ordnance Department missile development program then in progress.

UNCLASSIFIED~~CONFIDENTIAL~~

UNCLASSIFIED

The Douglas Aircraft Company fabricated the second stage and was responsible for the detail design and fabrication of the special parts required for V-2 modifications.¹⁵

(C) The BUMPER was a test vehicle to investigate the feasibility of separation at high velocity of a two-stage missile; to obtain missile velocities and altitudes higher than those attainable by other means; and to conduct limited investigations of high speed, high altitude phenomena such as missile skin temperature rise. Employing the already existing V-2 and the uncontrolled WAC CORPORAL (without undertaking major design changes) was conceived as the least expensive and time consuming approach to such two-stage missile development.¹⁶

PROBLEMS AND THEIR SOLUTIONS

Separation and Second-Stage Ignition

(C) It was decided to submerge the BUMPER WAC in the nose of the V-2 for these reasons: (1) This would reduce the lift on the WAC body and fins and hold the destabilizing moment of the combined missile to a minimum. (2) Such arrangement would also allow a greater distance between the supports which transmitted the shear* and bending loads to the V-2 nose. (3) A third consideration was the possibility of developing a large angle of yaw between the BUMPER WAC and the V-2 during the short interval of time in which they were still attached in shear, but not in bending. During this interval the combined missile would behave

-
15. White, L. D., Report Nr. R52A0510, Final Report, op. cit., p. 24; Shafer, John I., Progress Report Nr. 4-69, "Spin Rocket Development Tests for the BUMPER WAC," p. 1, JPL/CIT, 8 June 1959.
 16. Haviland, R. P., Report Nr. R50A0501 (Project HERMES, "Progress Report on BUMPER Vehicle--A Two-Stage, Rocket-Powered Test Vehicle," pp. 2, 4, General Electric Company, Schenectady, New York, February 1950; White, Report Nr. R52A0510, op. cit., p. 1; "Semi-Annual Progress Report of the Guided Missile Program, Department of the Army," p. 36, 30 April 1949.

* "Shear": (a) Internal force tangential to the section on which it acts; shearing force. (b) An action or stress resulting from applied forces, which causes or tends to cause two contiguous parts of a body to slide relatively to each other in a direction parallel to their plane of contact.

UNCLASSIFIED
~~CONFIDENTIAL~~

~~CONFIDENTIAL~~**UNCLASSIFIED**

as though hinged between the WAC and the V-2 and might be highly unstable. This possibility indicated the desirability of keeping the separation interval short, an operation requiring high separation velocity.¹⁷

(C) The simplest method of separation was adopted--that of using thrust from the second-stage WAC motor to provide separation impulse. The necessity of starting the WAC's motor while the WAC was still being positively accelerated forward by the V-2 indicated this solution. This decision required a means of escape from the WAC's jet without injury to the V-2. A ducting system was provided. Ducting provisions for the WAC rocket motor jet consisted of a conical pressure bulkhead located approximately eight inches behind the WAC motor exit and occupying part of the space originally devoted to the V-2 instrumentation compartment. The V-2's nose was divided into quadrants, and the duct exit locations were restricted to quadrants II and IV, since the Doppler antenna panels were located in quadrants I and III. Two doors were placed in each of the quadrants II and IV of the V-2 nose to seal the nose cavity during the V-2's ascent. These doors were to be opened before the firing of the WAC motor in order to avoid any pressure rise in the nose cavity due to exhaust gases.¹⁸

(C) Firing of the WAC motor had to occur while the BUMPER vehicle was accelerating in the direction of the launching in order to prevent the propellants from shifting to the forward end of the tanks. Firing, moreover, had to be accurately timed with the V-2 cutoff so that the launching time would be a minimum, with separation velocity a maximum. Otherwise, prolonged hovering of the BUMPER WAC in the nose of the V-2 while combustion was occurring could have damaged both vehicles. In addition, the tip-off yaw angle would have been directly affected by the separation velocity.¹⁹

-
17. Haviland, Report Nr. R50A0501, op. cit., p. 6; Bank, Herman, and Denison, Frank G., Jr., Progress Report Nr. 4-96, "Preliminary Design Considerations for the BUMPER Program," p. 1, JPL/CIT, 13 April 1949.
 18. Haviland, Report Nr. R50A0501, op. cit., pp. 6-7; Bank & Denison, Report Nr. 4-96, op. cit., pp. 5-10.
 19. Ibid.

UNCLASSIFIED~~CONFIDENTIAL~~

UNCLASSIFIED

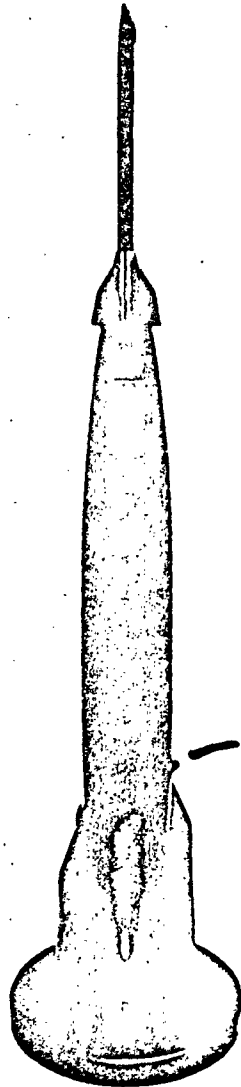

MODEL OF BUMPER.

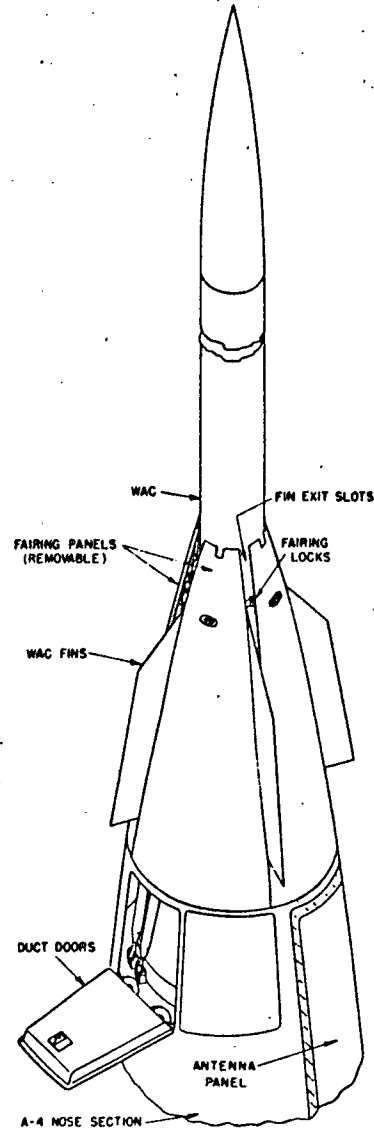

SKETCH OF ASSEMBLY.

UNCLASSIFIED

UNCLASSIFIED

~~CONFIDENTIAL~~
UNCLASSIFIED

(C) Since the velocity of the separation depended upon the difference in the acceleration of the two vehicles, the thrust program during the separation was of considerable importance. The operation sequence for separation was selected as follows:

1. The initial V-2 integrating accelerometer signal would actuate the V-2 motor control from the 28-ton to the 8-ton thrust stage.
2. The final V-2 integrating accelerometer signal (normally used for cutoff) would actuate the firing circuits for the duct-door operation (Cf above) and the start of the BUMPER WAC motor.
3. The jet of the BUMPER WAC motor would burn through a wire and thereby in turn actuate the cutoff of the V-2 thrust.
4. A limit switch would actuate the spin rocket ignition circuit within the BUMPER WAC upon separation of the two vehicles.²⁰

(C) Though comparatively simple, the mechanism providing a smooth exit of the BUMPER WAC under its own power from the nose of the V-2 was quite ingenious. Four channel-type tracks were symmetrically spaced between the fins of the WAC and supported at both ends by the V-2 structure. The WAC was guided by three self-aligning rollers engaged in each track and supporting the WAC tangentially. Radial deflection of the tracks during launching was likewise provided for.²¹

Stabilization of the BUMPER WAC

(C) Aerodynamic Stability. To provide control against aerodynamic instability, the fin area was increased about 50 per cent by using four instead of the WAC CORPORAL's three fins, with the area of each fin somewhat greater than formerly. The new sweptback (but still trapezoidal) fins were made of 24ST aluminum alloy instead of the J-1H magnesium alloy previously used. These fins were mounted at a small angle to the

-
20. Haviland, Report Nr. R50A0501, op. cit., pp. 6-7; Bank & Denison, Report Nr. 4-96, op. cit., pp. 7-10.
 21. Haviland, Report Nr. 50A0501, op. cit., p. 7; Bank & Denison, Report Nr. 4-96, op. cit., pp. 5-7; "Combined Bimonthly Summary, Nr. 3, 20 October 1947 to 20 December 1947, p. 35, JPL/CIT.

UNCLASSIFIED
~~CONFIDENTIAL~~

UNCLASSIFIED

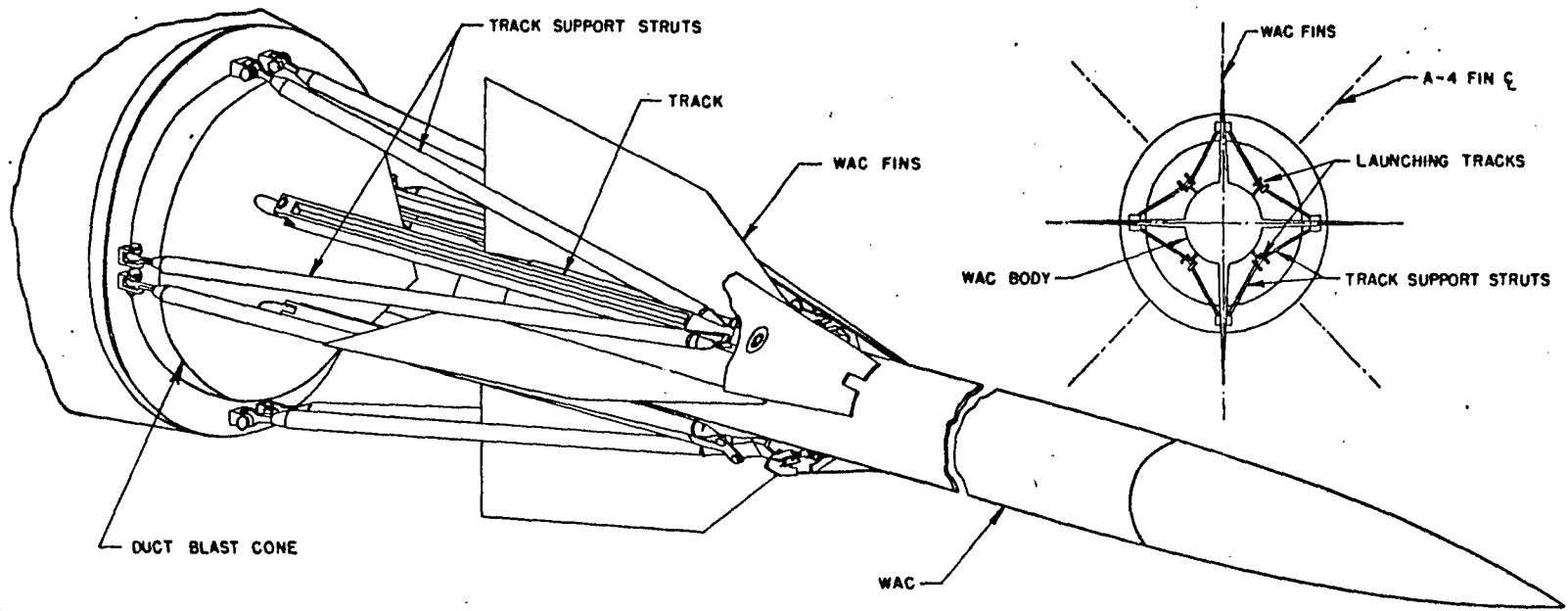

SUPPORT STRUCTURE OF LAUNCHING TRACK.

UNCLASSIFIED

UNCLASSIFIED

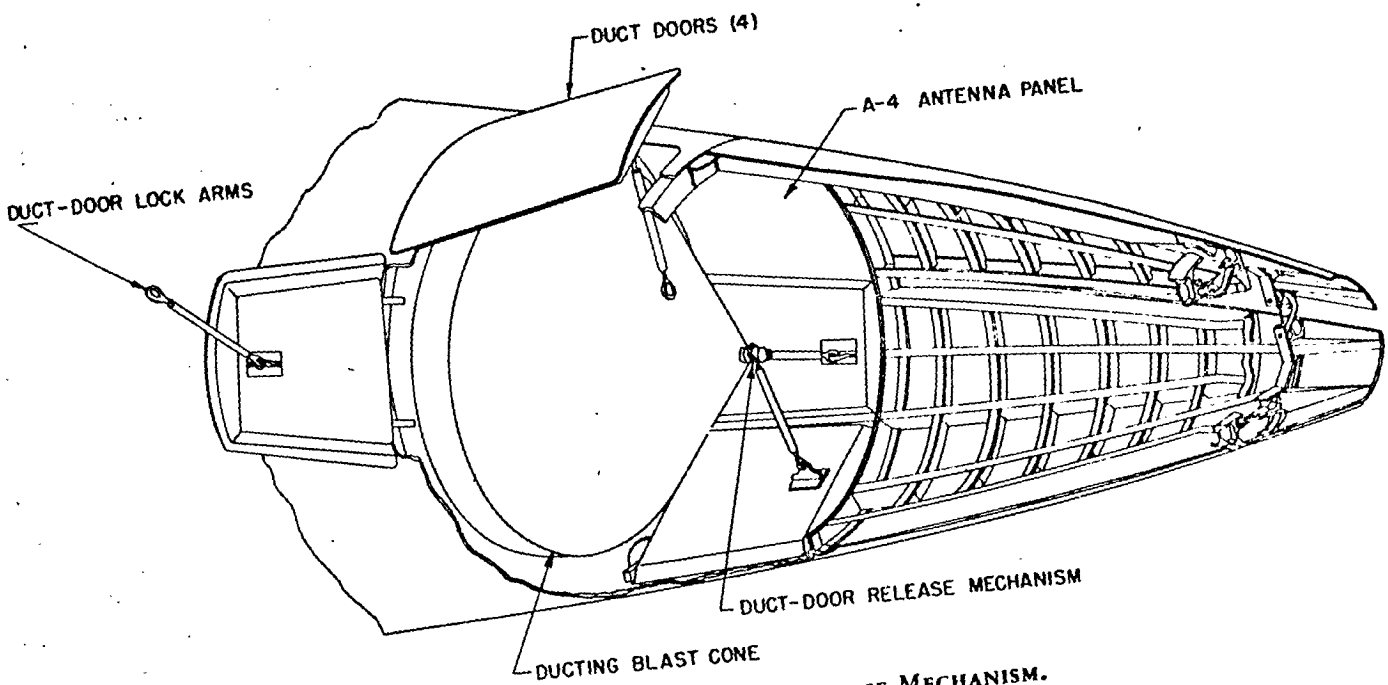

DUCT DOORS AND RELEASE MECHANISM.

UNCLASSIFIED

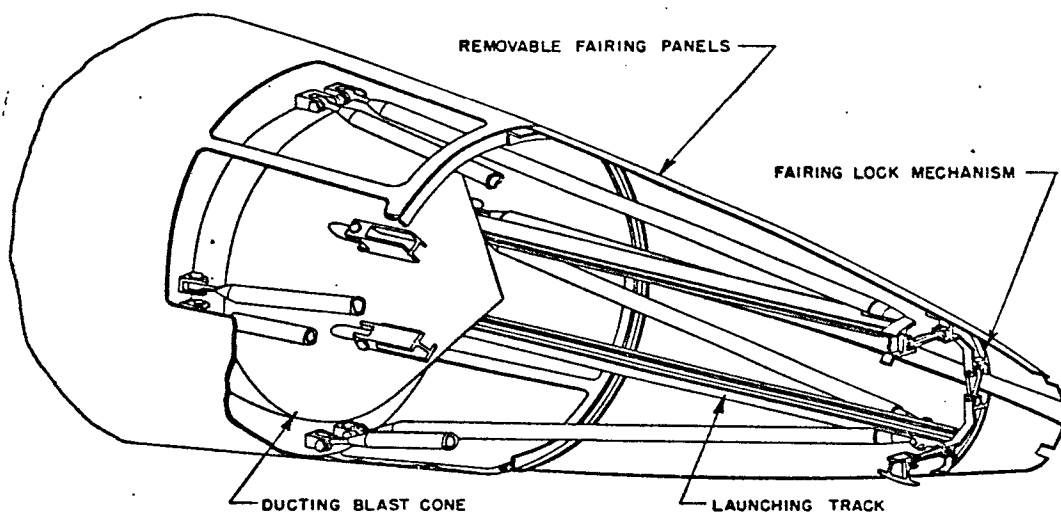

FAIRING AND TRACK INSTALLATION.

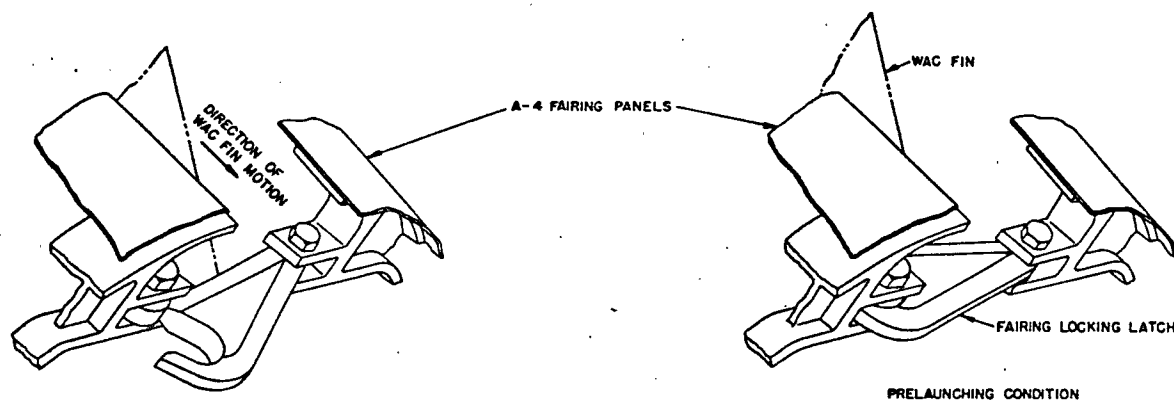

LAUNCHING CONDITION

PRELAUNCHING CONDITION

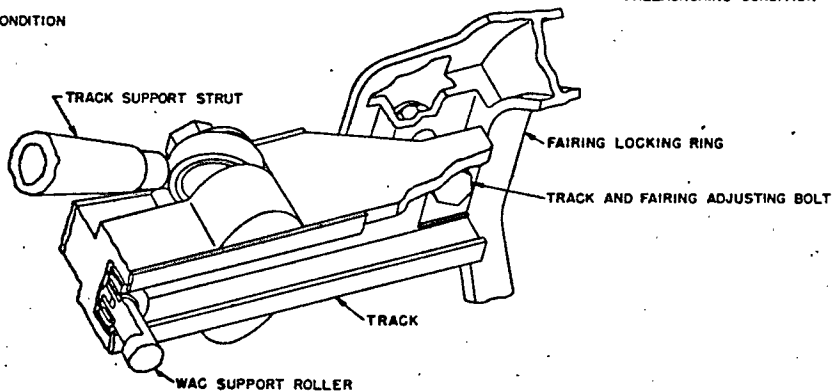

FAIRING LOCK MECHANISM

LOCKING MECHANISM OF FAIRING.

UNCLASSIFIED

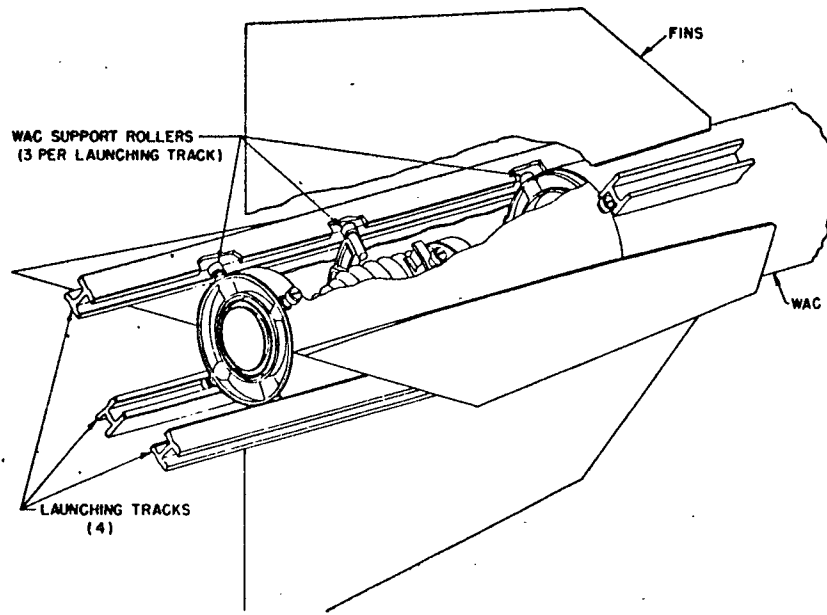

SUPPORT ROLLER INSTALLATION.

UNCLASSIFIED

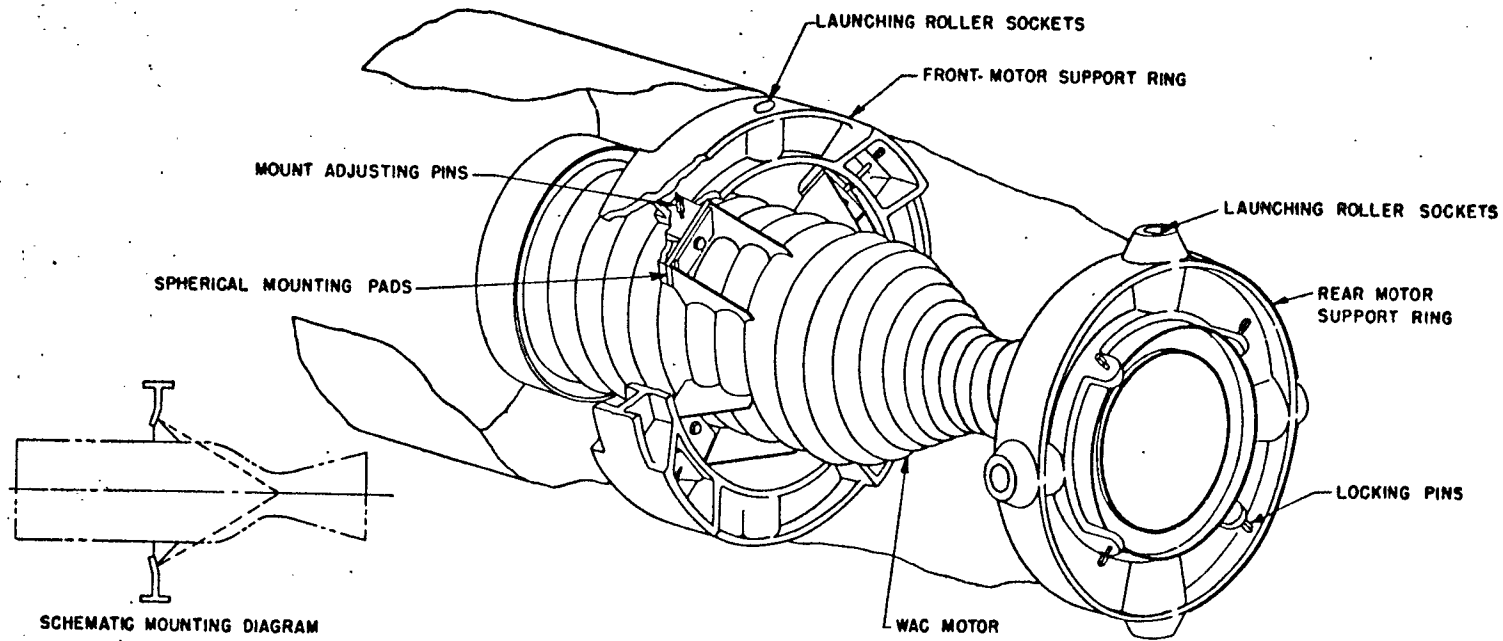

ADJUSTABLE MOTOR MOUNT.

UNCLASSIFIED

~~CONFIDENTIAL~~
UNCLASSIFIED

missile's longitudinal axis, to give zero angle of attack when the missile was spinning.²²

(C) Correcting the Effects of Asymmetric Thrust. As a result of theoretical studies and static motor firings by both JPL and other investigators, it was decided to spin the BUMPER WAC about its longitudinal axis after its launching from the V-2 in order to overcome the effects of asymmetric thrust during the WAC's trajectory above the sensible atmosphere.

(C) Slow spinning of the WAC was to be accomplished immediately after its separation from the V-2. Utilized for this purpose were dual solid-propellant rockets manifolded together and mounted within the WAC's shell between the fuel and the oxidizer tanks and in a plane perpendicular to the longitudinal axis, intersecting the axis at the center of gravity of the WAC. The nozzles of each rocket protruded slightly beyond the WAC shell and fired in opposite directions. As finally designed and tested, the spin rocket had an over-all length of 8 5/8 inches. Its propellant charge was a 2½-inch by 7-inch cartridge of JPL 117D, a polysulfide rubber base fuel admixed with finely ground potassium perchlorate as oxidizer. In a final test, however, FFFG* black powder was used instead of the pellet ignition. Ignition of both the spin rockets was effected in approximately 0.02 second. In tests, duration and velocity achieved were 540 rpm in 0.43 second, compared with 475 rpm in 0.38 second.²³

GENERAL DESCRIPTION OF THE A-2 AND THE BUMPER WAC COMBINATION

(S) Since the BUMPER WAC was a test vehicle, it was not fired at a target. Being uncontrolled after expulsion from the V-2, the WAC's accuracy was very poor, and the missile had a large dispersion compared to controlled missiles.

22. Haviland, Report Nr. 50A0501, op. cit., pp. 8-9; Bank & Denison, Report Nr. 4-96, op. cit., pp. 2, 5; CBS, Nr. 3, op. cit., p. 35.

* Designation for ignition powder.

23. Haviland, Report Nr. 50A0501, op. cit., pp. 7, 9, 10; Bank & Denison, Report Nr. 4-96, op. cit., pp. 10-13; Shafer, Progress Report Nr. 4-69, op. cit., pp. 1-8; CBS, Nr. 3, op. cit., p. 35.

UNCLASSIFIED

~~CONFIDENTIAL~~

UNCLASSIFIED

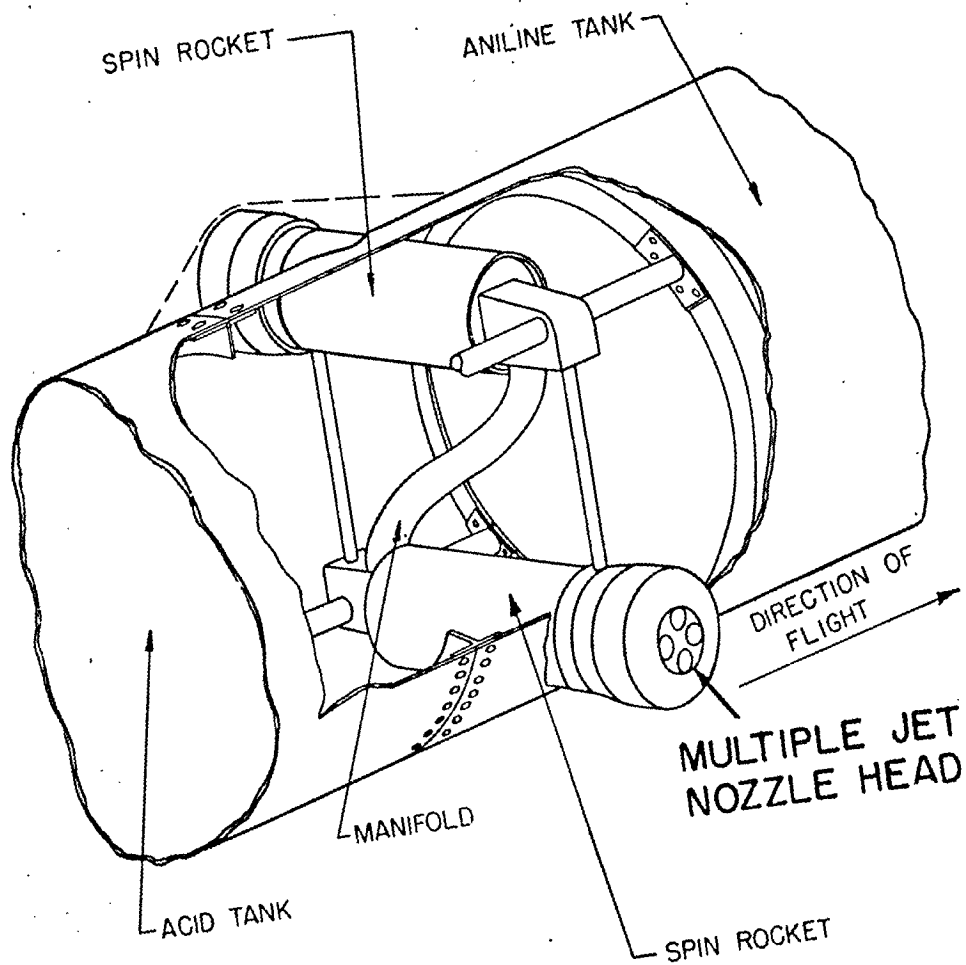

LOCATION OF SPIN ROCKET ASSEMBLY BETWEEN FUEL AND OXIDIZER TANKS OF BUMPER WAC

UNCLASSIFIED

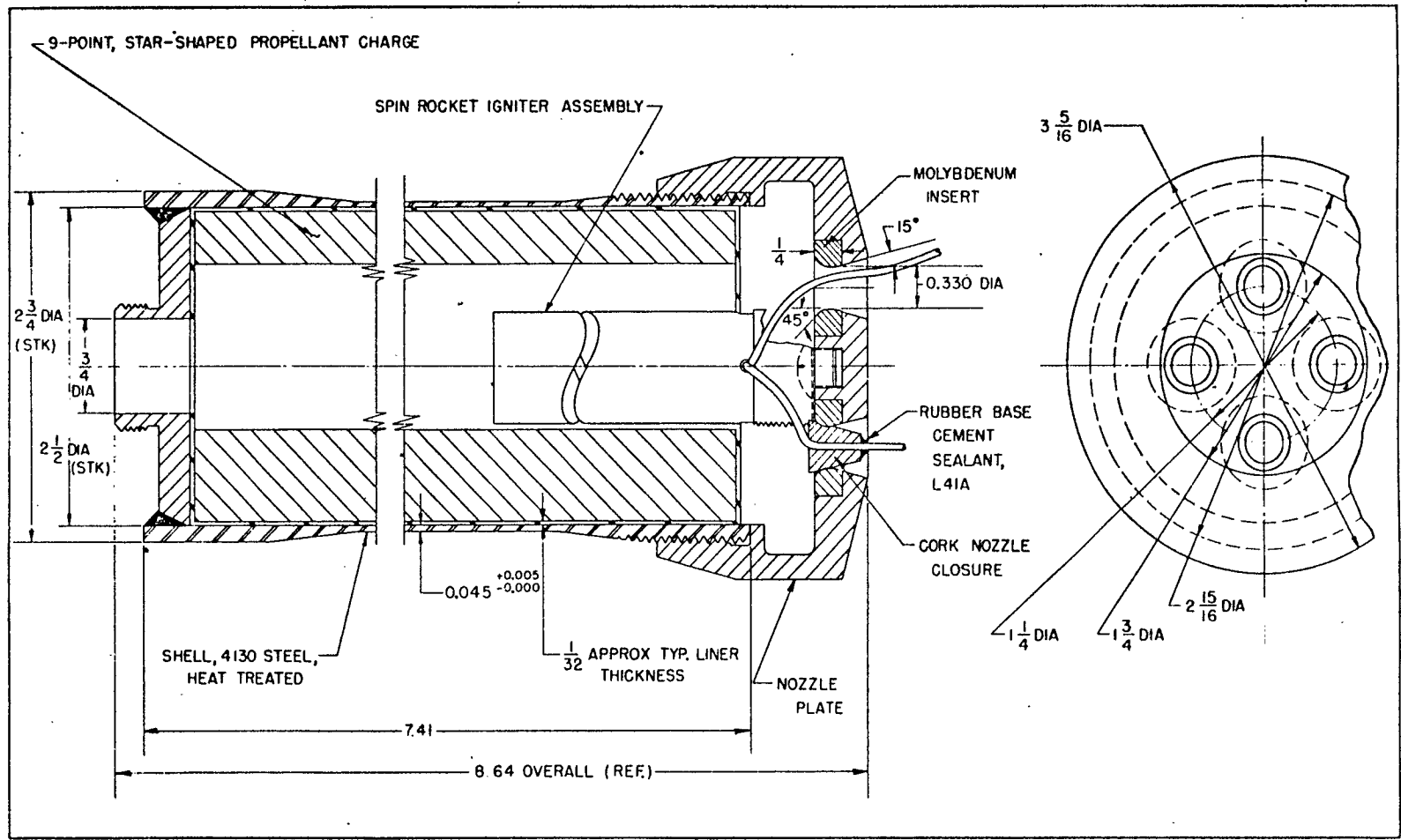

CROSS-SECTIONAL SKETCH OF SPIN ROCKET

UNCLASSIFIED

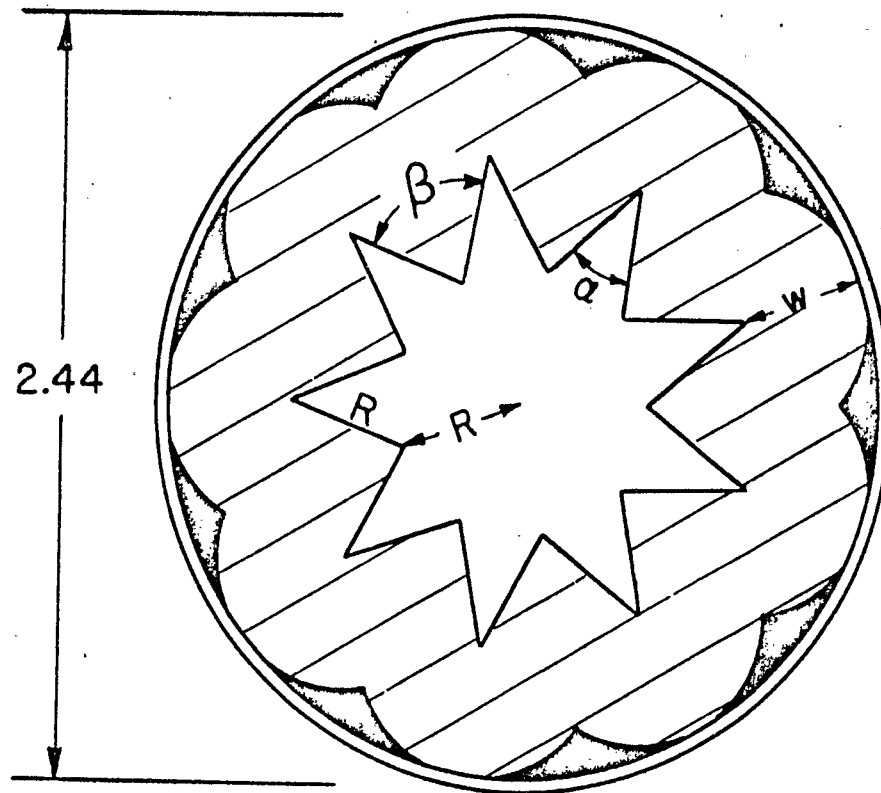

UNCLASSIFIED

Diameter of propellant (in.).....	2.44
Side of star R (in.).....	0.43
Restriction thickness (in.).....	0.03
Volumetric loading (%).....	77.2
Propellant residue, measured (%).....	5.0
Web w (in.).....	0.41
Angle α ($^{\circ}$).....	40
Angle β ($^{\circ}$).....	80

CROSS-SECTIONAL SKETCH OF PROPELLANT CHARGE
FOR SPIN ROCKET

~~CONFIDENTIAL~~
UNCLASSIFIED

(S) In order to keep the missile within the WSPG range, the fully tanked BUMPER first stage was fired vertically. It then maintained an angle of 2.5 degrees to the vertical, with the velocity component parallel to the earth directed north. When the first stage reached 4,150 ft/sec, the first stage thrust was reduced, and the second-stage motor started. The WAC, uncontrolled except for its built-in stabilizing features, then continued on its own independent trajectory.²⁴

(S) The ground-launcher used was the normal V-2 launching table without rails or guides. Four rails inside the V-2 nose acted as launcher for the WAC. Three rollers ran in each guide rail, and the rollers were free to move radially as the tracks deflected.²⁵

(C) The WAC structure consisted of the aluminum alloy tanks (air and propellant) joined by adapters, a laminated plastic ogival nose, and an aluminum alloy monocoque tail reinforced by heavy aluminum rings and carrying four swept-back fixed tail surfaces.²⁶

(C) The total payload which the WAC could carry was determined to be 50 pounds, which prohibited extensive instrumentation. The following elements were sent aloft in the WAC's nose cone, which was approximately 43 inches long, 12 inches in outside diameter at the large end, and 4 inches in outside diameter at the small end:

1. A Doppler receiver-transmitter (Verdoppler), designed and constructed by BRL/APG, thereby eliminating the V-2 Doppler installation.
2. A rudimentary telemetry system, formed by amplitude modulation of the doppler signal.
3. Provisions for telemetry of the received signal strength.
4. Provisions for the telemetry of the skin temperature of a metal cone on the nose of the WAC, such data being selected as the most important (from an engineering standpoint) that could be obtained with reasonable accuracy.²⁷

24. Semi-Annual Progress Report Guided Missiles Program, 30 April, 1947, op. cit., pp. 37-38

25. Ibid.

26. Ibid.

27. Ibid.

UNCLASSIFIED

~~CONFIDENTIAL~~

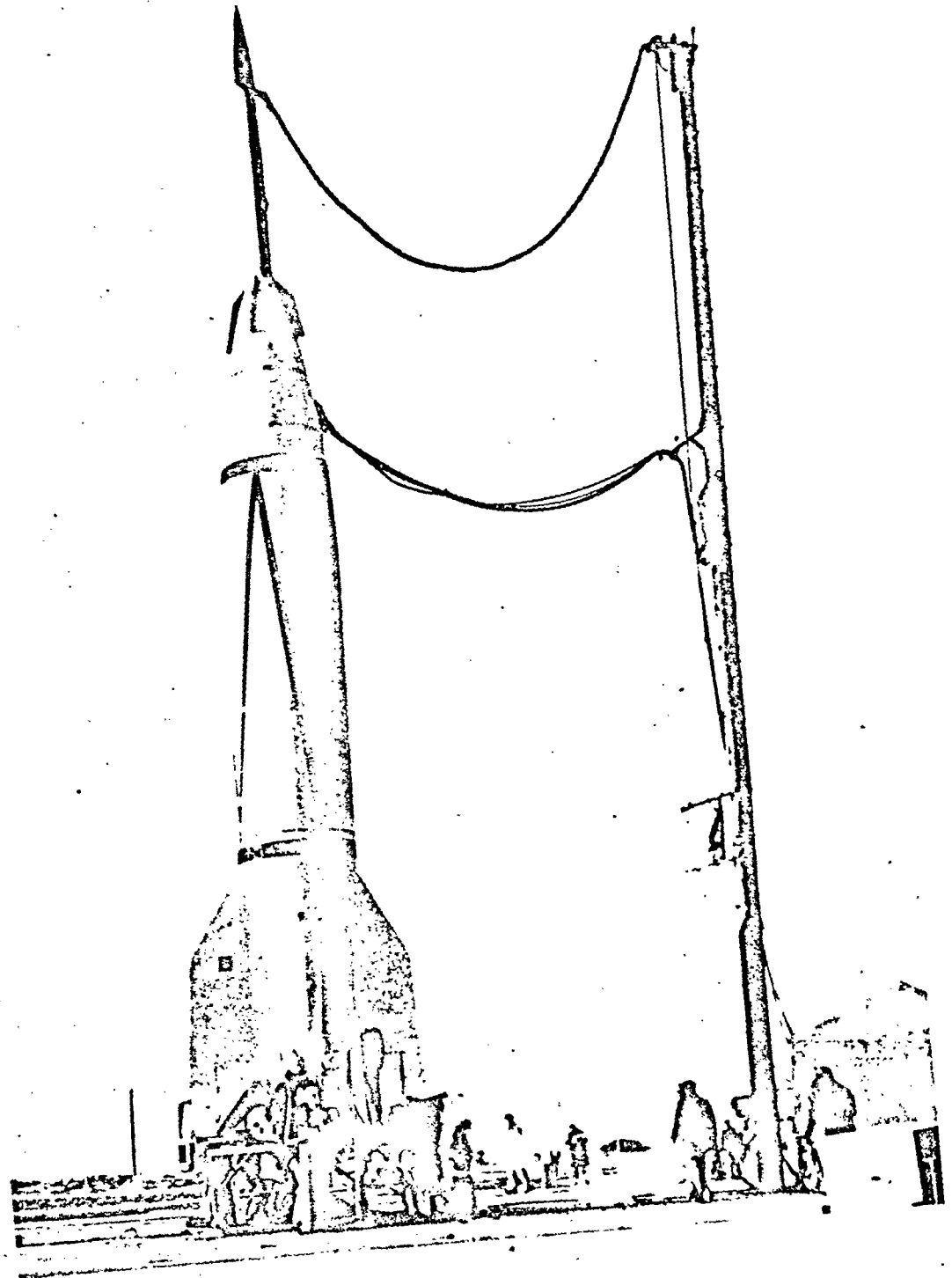

BUMPER/WAC READY FOR LAUNCHING

UNCLASSIFIED

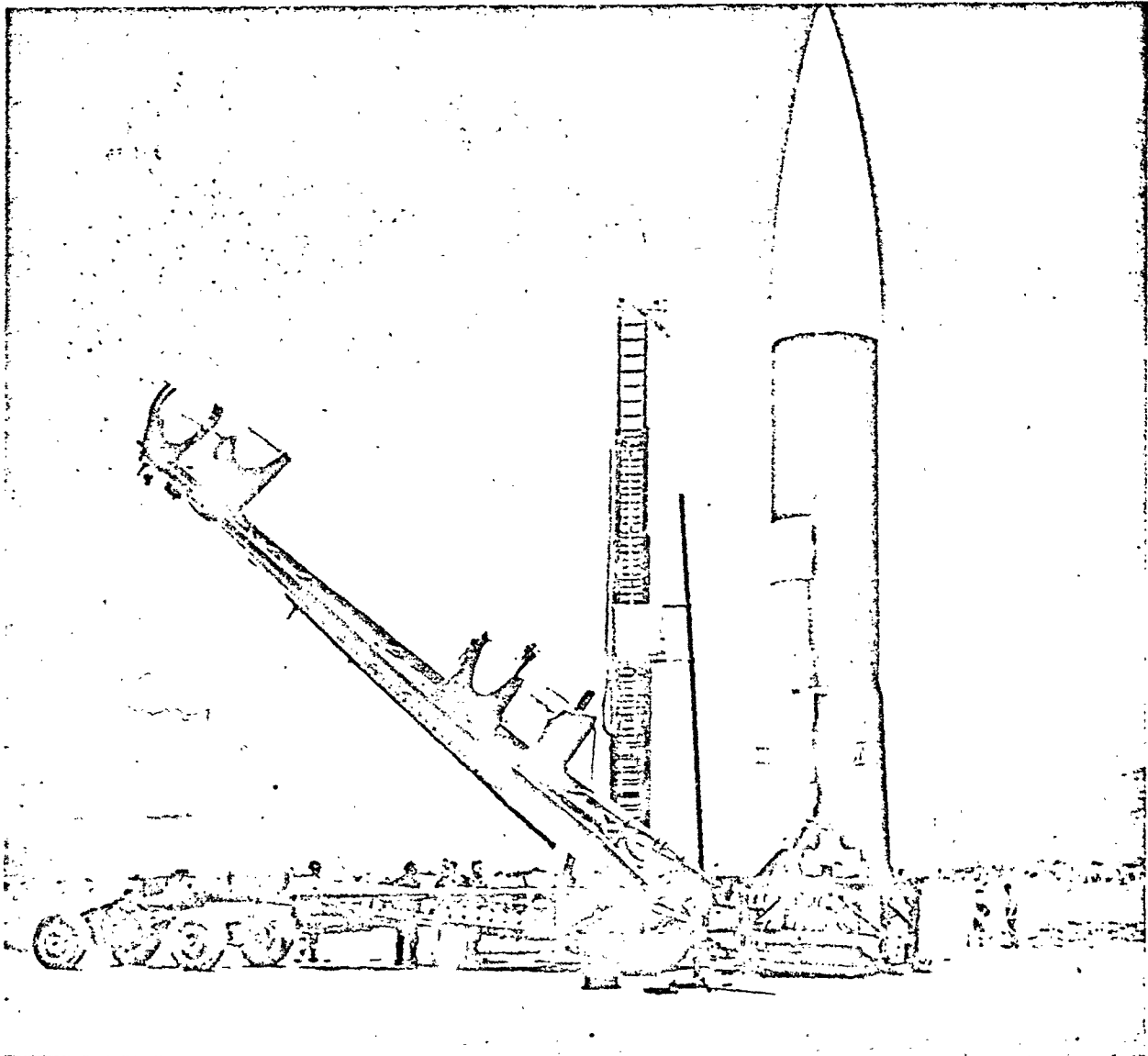

V-2 BEING PLACED IN FIRING POSITION
 U.S. Army Ordnance Proving Ground
 White Sands, New Mexico

General Characteristics

Measurements:

Overall	46.1 Ft.
Diameter (Center Section)	5.4 Ft.
Length External Fins	13.3 Ft.
Maximum Diameter Across Fins	11.8 Ft.
Diameter Venturi Opening at Base	2.4 Ft.

Weights:

Warhead	2,150 lbs.
Fuel (Total)	18,948 lbs.
Motor Unit	1,350 lbs.
Total Weight	27,376 lbs.

Maximum altitude reached during first twenty-four (24) firings at
 White Sands - 601,920 ft. - 114 miles.

UNCLASSIFIED

UNCLASSIFIED

(U) Due to the over-all complexity of the BUMPER missile, it appeared desirable to limit V-2 instrumentation to provide the three following types of information needed to evaluate over-all performance: (1) performance of the V-2; (2) effect of changes in center of gravity and pressure due to the addition of the WAC; (3) performance of the second-stage starting and separation components.²⁸

(C) To provide the information needed, the following quantities were telemetered from the V-2: (1) turbine speed and motor pressure; (2) four vane positions; (3) three component accelerations; (4) four vane control signals; (5) three gyro signals; (6) separation sequence.²⁹

FIRINGS AT WSPG

(C) BUMPER launching initially occurred on 13 May 1948, and the sixth on 21 April 1949. The first two rounds had short-duration solid-propellant rockets propelling the second stage, simulating the WAC in structure, weight, and center of gravity. Success in all details was recorded in the first round firing, but the second failed in the first stage.

(C) Third and fourth rounds had the liquid-fuel WAC B motors, with 32-second burning time. These rockets were ballasted to maintain normal weight and center of gravity. The third round failed because of an explosion of the second-stage motor just prior to separation, and the fourth round failed in the first stage.

(C) The last two rounds fired at WSPG had fully tanked second-stage WAC's of 45-second burning time. The sixth failed in the first stage, but the fifth was completely successful. This BUMPER WAC reached an altitude of 244 miles above the earth's surface and attained a maximum velocity of 7,553 feet per second, the highest altitude and greatest velocity ever attained by a rocket missile to that date.³⁰

28. Ibid.

29. Ibid. See Document 12: Chart, "BUMPER Firings at WSPG"; and Document 13: "Detailed Launching Accounts, BUMPER Round 5."

30. Haviland, Report Nr. 50A0501, op. cit., pp. 20-27 (preparations for firing); pp. 28-40 (the firings); pp. 38-39 (conclusions & recommendations); CBS, Nr. 5, 20 February 1948 to 20 April 1948, p. 31; CBS, Nr. 6, 20 April 1948 to 20 June 1948, pp. 36-38; CBS, Nr. 8,

UNCLASSIFIED~~CONFIDENTIAL~~

~~CONFIDENTIAL~~

TEST RESULTS

UNCLASSIFIED

(C) Through BUMPER firings, it was learned that the speed of a rocket or missile could be increased with each successive stage. A step-rocket, fired when the assistant rocket was at a maximum velocity, it was found, gave the final rocket a speed equal to that of all stages. Innumerable problems connected with rocket motor ignition at high altitude and attachment and separation of successive stages were solved satisfactorily, providing a sound basis for later missile designs, requiring similar experiments.³¹

(C) Constructing and firing these test vehicles were considered to have proven the stability of both stages up to approximately 7,500 ft/sec, stability during separation, and adequacy of structural design in both ground and firing tests. Skin-heating data were obtained at higher velocities than could have been obtained by other means. The insulated nose of the second stage allowed doppler transmission through maximum velocity and altitude. Doppler and telemetry data were obtained up to maximum altitude. Temperature data on the WAC nose were obtained up to Mach 6.³²

FIRINGS AT JOINT LONG RANGE PROVING GROUND, FLORIDA

(C) The remaining two rounds of the eight prepared for the BUMPER Project were to be launched on a nearly horizontal trajectory for aerodynamic research. The operation was scheduled for the Joint Long Range Proving Ground, Florida. For the low-angle trajectory, the vehicle was

20 August 1948 to 20 October 1948, pp. 35-36; Semi-Annual Progress Report Guided Missiles Program, 30 April 1949, op. cit., pp. 36, 38, 59, 91, 165; Ibid., 31 October 1949, p. 36; Brown et al., "Development & Testing at WSPG," op. cit., pp. 91-93; Patton, R. B. Jr., Report Nr. 504, "An Analysis of Spin Errors in the Dovap System From the Record of BUMPER Round Nr. 5," passim, Ordnance Department, BRL/APG, February 1950.

31. Brown et al., "Developing & Testing at WSPG," op. cit., pp. 94-95; Semi-Annual Progress Report Guided Missiles Program, 31 October 1949, pp. 36, 38; Ibid., 31 December 1950, p. 56.
32. See Note 30.

UNCLASSIFIED~~CONFIDENTIAL~~

UNCLASSIFIED

to be launched vertically and then at separation turned to an angle of 68 degrees from the vertical. Predetermined burnout altitude was set at 125,000 feet and peak altitude at 160,000 feet.

(C) The first attempt to launch BUMPER Round 7 was unsuccessful because of moisture collected within the missile. It was returned to the hangar, dried, rechecked, and successfully fired on 29 July 1950. Round 8 was fired on 24 July 1950 but was damaged on separation.

(C) The experiments to be carried out on these missiles called for a relatively low trajectory, with a separation angle somewhat greater than 20 degrees from the horizontal. Because of a precession of the pitch gyro, however, the program angle was increased. Round 7 separated at an angle of approximately 10 degrees from the horizontal, and Round 8 at about 13 degrees. Notwithstanding the error in trajectory, however, Round 7 attained a speed of Mach 9, the highest that had ever been reached in the earth's atmosphere.³³

(U) AEROBEE inherited knowledge gained through performance of the WAC, which had already successfully demonstrated step-rocket techniques, including launching and separation in a near vacuum during free flight. BUMPER proved the possibility of two-way communication beyond the D, E, and F layers of the upper atmosphere (ionosphere). As a test vehicle, BUMPER paved the way for later space probes and intermediate and inter-continental missiles. (Ref. explanatory note, p. 74, for further information concerning AEROBEE.)³⁴

-
33. Brown et al., op. cit., pp. 94-95; Semi-Annual Progress Report Guided Missiles Program, 31 October 1949, op. cit., pp. 36, 38; Ibid., 31 December 1950, p. 56; Haviland, Robert P., Project HERMES, "Minutes of BUMPER Conference at WSPG, Las Cruces, New Mexico, 24-25 October 1949," passim, Long Range Proving Ground Division (LRPGD), Patrick Air Force Base, Cocoa, Florida; LRPGD Technical Report Nr., "BUMPER Missiles No. 7 & 8," passim, LRPGD, Patrick Air Force Base, Cocoa, Florida. See Document 14 for detailed account of BUMPER Rounds 7 and 8 firings.
34. Ordway & Wakeford, op. cit., pp. 209-210; Gatland, K. W., op. cit., pp. 67-69. Other missiles drawing heavily upon design information first supplied by WAC CORPORAL were LARK, NATIV, and NIKE. Seifert, Howard S., JPI Publication Nr. 22, op. cit., p. 20.

UNCLASSIFIED~~CONFIDENTIAL~~

UNCLASSIFIED

CHAPTER VII

MISSILE XF30L20,000 - CORPORAL E

INTRODUCTION

(U) At the outset, as previously noted, the first type of experimental missile, propelled by a solid-propellant rocket, was formulated to enable the research staff at JPL to obtain pertinent aerodynamic and structural data. These data were to be used in solving stabilization and launching problems and to gain familiarity with the various other problems connected with the ORDCIT Project. When initiating the task, Dr. von Karman already envisioned a great forward step: "After the completion of this preliminary phase of research," he wrote, "the method of remote control of the missile (one of the central problems) should be tackled." He estimated that a missile having a range of 30 to 40 miles would be necessary for reproducing technical requirements of the prototype. In other words, such a missile was to be designed as a test unit and used as a means of carrying out basic development work on controls and launching.

(U) By utilizing the data included in the 20 November 1943 studies (Ref. note 4, Chapter I), on jet-propelled vehicles, Dr. von Karman estimated that a missile of approximately five tons gross weight would be necessary for achieving the desired range. This missile, he thought, would require a motor of a 60-second burning time and 20,000-pound thrust.

(U) From past experience, it was believed that the only developed type of rocket capable of meeting those specifications was the liquid-propellant rocket burning the RFNA-aniline propellant combination. Already exhaustively tested and proved reliable, that type rocket might easily be adapted to Model XF30L20,000 with the least expenditure of development work and time.¹

1. von Karman, Theodore, Memorandum Nr. 2, Research Program for the Second Type of Long-Range Jet-Propelled Missile, XF30L20,000, pp. 1-4, JPL/GALCIT, CIT, 20 August 1944. See Document 15 for discussion of estimated performance of CORPORAL.

(U) Preliminary study of feed systems for such large thrust likewise indicated that the most promising design consisted of turbine-driven centrifugal pumps,* the turbine being in turn driven by combustion gases from a combustion pot using a small fraction of the rocket propellant. Aerojet Engineering Corporation was already developing a "Turborocket", and JPL planned to utilize Aerojet's experience in adapting a similar device for the CORPORAL.

(U) Dr. von Kármán laid out a remarkably optimistic time schedule for Missile XF30L20,000, setting 1 March 1945 as the date firing tests were to begin.²

THE CONTROL SYSTEM

(U) Overriding considerations in JPL's search for a technique for controlling rocket missiles dictated the devising of equipment for acquiring as much information as possible regarding such control rather than a system capable of being used in the field for accurate control and freedom from enemy interference. Of like importance was measurement of the missile's behavior during flight; therefore, the telemetering equipment to be installed in the unit was expected to provide information of value in later designs, and its use was not, of course, contemplated in field equipment.³

(U) The CORPORAL's trajectory could be divided into three parts: (1) the vertical ascent, (2) powered trajectory at a decreasing elevation angle, and (3) parabolic path followed as a free projectile. Transition from (1) to (2) required the application of an appropriate control impulse, since the missile would be quite unstable during (1). Moreover, if any sort of accuracy were to be attained, maintaining tight control over the trajectory during both (1) and the transition period from (1) to (2) was obviously necessary. It was, therefore, necessary to design a control system operating on the three axes of the

* See Document 15 for discussion of further development of this design.
2. Ibid. See Document 16 for details of XF30L20,000 and time schedule.
3. Pickering, W. H., Progress Report Nr. 4-15, "Control and Telemetering for 'CORPORAL E,'" p. 1, JPL/GALCIT, CIT, 15 May 1945.

missile for at least this portion of the trajectory. Such a control system exercising control over yaw, pitch, and roll became a complete automatic pilot. Three techniques for operating the pilot were possible:

1. Establishment of a predetermined trajectory and setting the pitch angle as a function of time. The yaw axis would then be maintained in a fixed azimuth and the missile would be roll-stabilized.
2. Control of the pitch and the yaw by a radio signal from a ground station. Roll would be controlled by internal means.
3. A combination of 1 and 2.

The decision was that the third option be used.⁴

(U) Accurate mapping of the actual trajectory was to be accomplished by using two radar plotting boards, one showing the projection of the trajectory on the horizontal plane and the other the trajectory in the vertical plane. Short-period deviations from the mean trajectory were to be reported to the ground by radio signals from additional gyroscopes placed in the missile and such information suitably recorded.⁵

(U) German experience had demonstrated need for external velocity control near the target in order to attain accuracy. Accuracy was not one of the prime objectives of this model, however, and it was decided that the complication introduced with velocity control did not warrant its inclusion at the time.

(U) Details of the various units of the control system were, for the most part, to be supplied by Sperry Gyroscope Company, Inc.* To some extent it was necessary to assemble the autopilots for the first firings of the CORPORAL E from existing units because of the time element. For this reason, the first system was to be completely pneumatic.⁶

(U) At low speeds aerodynamic control was impossible with the fin structures necessary for high-speed flight. Hence, initial control was

4. Ibid., pp. 1-3.

5. Ibid., pp. 2-3.

* See Document 17 for details of Sperry's early research and fabrication of the CORPORAL autopilot. Also, note mentions of CORPORAL F Turborocket.

6. Ibid., pp. 3-7.

to be accomplished with vanes placed in the jet, mechanically connected to the control surfaces, and operated by the same servo motors.⁷

TELEMETERING

(U) A maximum of ten channels was planned for telemetering information to the ground station during flight. In operation, the system was to present the information on a series of graphic recorders and thus give the operator an intimate missile behavior picture.⁸

(U) Throughout the missile's trajectory, the operator would thus obtain information from two sources: radar plotting boards and telemetering recorders. From the first he would obtain the mean trajectory, and from the second the fluctuations about this mean trajectory. With this information, stability of flight (either with or without internal control), efficacy of the internal control, and effect of a given control signal, could be determined.

(U) Control signals were to be sent to the missile by a mechanism similar to an airplane stick, thereby affording the operator an opportunity to observe the flight records and to send control signals to the missile as necessary.⁹

(U) A switch was to be provided to disconnect a part, or all, of the internal control. Operation of this switch would place the control surfaces in neutral for observation of the stability of uncontrolled flight.

(U) During this planning stage, it was expected that the first few firings of the CORPORAL E would be entirely on internal control. Then was to come a definite program of study of the effects of yaw and pitch controls. Assuming satisfactory results, firings were planned with the operator attempting to hit a predetermined target.¹⁰

7. Ibid., pp. 4-5.

8. Ibid., p. 5.

9. Ibid., pp. 6-7.

10. Ibid., p. 10.

~~CONFIDENTIAL~~**UNCLASSIFIED**

PROPULSION SYSTEMS

(U) For reference, the third phase of the ORDCIT Project was to be a study of the ramjet type of propulsion unit. Information gained from the first three phases was to be used for the design and construction of a jet-propelled projectile weighing 10,000 pounds or more and having a range of approximately 75 statute miles. JPL investigated both the ramjet and the ducted rocket types but decided upon a liquid-propellant motor of the acid-aniline type as being more satisfactory than any other for immediate development. Selection of a suitable feed system seemed, however, to occasion some concern, even after the successful use of compressed air to pressurize the WAC CORPORAL's propellant tanks.¹¹

(U) In response to an Ordnance Department request--23 May 1945-- that all agencies engaged in guided missile development were to evaluate their programs, JPL undertook and subsequently reported its results. The ORDCIT group was developing one basic guided missile, the CORPORAL; however, several modifications of this basic missile's power plant were being considered:

1. CORPORAL E, which used a compressed-air propellant-pumping system, already was in an advanced stage of engineering design and fabrication of missiles was under way (as of November 1945).
2. CORPORAL F, which used a turborocket propellant-pumping system and was in an early stage of engineering design, with fabrication of some components already initiated.
3. CORPORAL G, which used a gas-generation propellant-pumping system and was to be carried only through a paper study by the ORDCIT Project.¹²

(S) After considering the propellant feed systems, it was finally decided that a liquid-propellant motor having an air-pressurized feed

-
11. Miles, *op. cit.*, pp. 55-56, 60-61; Brown et al, *op. cit.*, p. 55.
 12. Stewart, H. J., and Chien, W. Z., Memorandum Nr. 4-12, "The Estimated Performance of the ORDCIT CORPORAL Series of Guided Missiles," pp. 1-5, JPL/GALCIT, CIT, 30 November 1945. See Document 15 for discussion of further investigation of both gas-generation propellant-pumping system and the turbopump.

UNCLASSIFIED~~CONFIDENTIAL~~

UNCLASSIFIED

system and using an acid-aniline combination as propellant would comprise a more satisfactory propulsion system than any other of those investigated. CORPORAL E's motor was to have 20,000 pounds of thrust and a 60-second duration of burning time.

(S) Originally, the field-test program for CORPORAL E called for firing 10 rounds during the latter part of 1945 and early 1946. With the end of World War II in August 1945, however, a less stringent time schedule for the CORPORAL E program was decided upon. In the meanwhile the WAC CORPORAL was to be used to provide more information in order to improve the CORPORAL E design.¹³

(U) WAC CORPORAL's development, for example, demonstrated the soundness of the missile's propulsion system and the reliability of the acid-aniline-furfuryl alcohol combination as propellant. The air tank relocation forward of the propellant tanks in WAC B carried over to CORPORAL E. Individual tanks for air and propellants in WAC B were used in CORPORAL E. New materials, improved hardware, and more efficient manufacturing techniques in fabricating the propulsion system of WAC B contributed to CORPORAL E's development. An outstanding example was the burst-diaphragm starting valves, which persisted throughout CORPORAL development. Since WAC CORPORAL was a scaled-down version of the larger missile, WAC contributed considerable knowledge of aerodynamic forces and trajectories.¹⁴

CORPORAL E FIRINGS AT WSPG

(S) The ORDCIT Project had been a cooperative enterprise from its initiation. Airframes for the original CORPORAL E rounds were designed at JPL and fabricated by the Douglas Aircraft Company, Santa Monica, California. Rocket motors and certain other parts were designed and built at JPL. Sperry Gyroscope Company, Great Neck, Long Island, New York, supplied the autopilot. Army Ordnance, APG, furnished a Doppler Velocity and Position (DOVAP) transponder, and the Signal Corps

13. Brown et al, op. cit., pp. 55-56.
14. Ref. Chapters IV and V for WAC CORPORAL developments.

UNCLASSIFIED

~~CONFIDENTIAL~~
UNCLASSIFIED

Laboratories, of Fort Monmouth, New Jersey, provided a radar tracking beacon. JPL supplied the telemetry equipment. After checkout, the missiles and equipment were shipped to WSPG for field tests and firing.¹⁵

(S) The first CORPORAL E round was fired on 22 May 1947. This was the first ORDCIT test vehicle incorporating command guidance and the first American-designed, engineered, and fabricated surface-to-surface missile. Test results were completely satisfactory, and the missile performed above expectations. An altitude of 129,000 feet was reached and the missile impacted within 2 miles of a target range of 62.5 miles. After 160 seconds of flight, a radar control signal was given to deflect the missile to the left, and it responded to the command.¹⁶

(C) CORPORAL E Round 2 was fired at WSPG on 17 July 1947, at 1030 hours. The following summarizes JPL's report of the firing:¹⁷

...Since the assembly and handling proceeded in a manner similar to that of the first round and since no significant changes had been made in the design, it was expected that the firing would take place as previously. However, after the closing of the firing circuit, a starting delay of about 8 to 10 seconds was observed. The rocket motor then started, but insufficient thrust was developed, and the test vehicle stood burning in the launcher for about 90 seconds. At the end of that time, sufficient fuel had been exhausted to equalize weight of the vehicle to thrust. CORPORAL E then rose in a short trajectory, tilted over, and impacted a few hundred yards east of the launching area.

From the telemetered data of the air-tank pressure and rocket-motor chamber pressure, it was seen that the rocket-motor chamber pressure was of sufficient magnitude at the start of burning to be marginal for takeoff. There was, in fact, some evidence that the test vehicle left the launcher, rose into the air approximately $\frac{1}{2}$ inch, and then dropped back to the stand.

-
15. Brown et al, op. cit., p. 55. See Document 18 for "Early Troubles Encountered by the Outside Fabrication Department, JPL/GALCIT."
 16. Ibid., p. 56; Technical Bulletin, "Army Ordnance Department Guided Missile Program," 1 January 1948, p. 37. See Document 19 for CORPORAL E firings.
 17. Combined Bimonthly Summary (CBS), Nr. 1, 20 June 1947 to 20 August 1947, pp. 70-71, JPL/CIT, 15 September 1947; JPL Report Nr. 20-100, op. cit., pp. 2-4.

UNCLASSIFIED~~CONFIDENTIAL~~

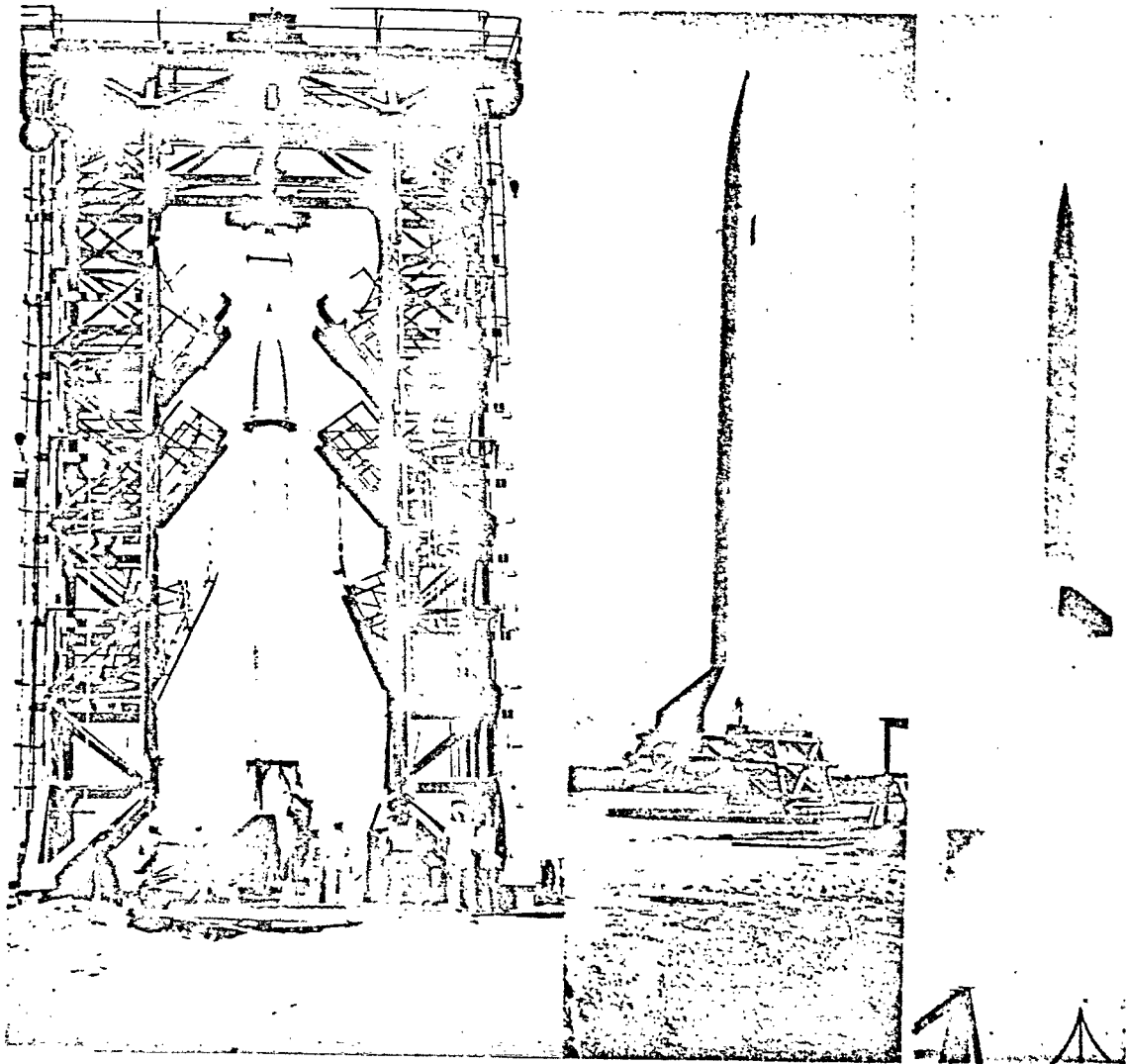

CORPORAL E ROUND NO. 1 BEING FIRED
 U.S. ARMY ORDNANCE PROVING GROUND
 WHITE SANDS, NEW MEXICO

General Characteristics

Type	Surface-to-Surface	Weight, over-all	11,700 lbs.
Range (Rnd. No. 1)	62½ miles	Length, over-all	39', 2-3/8"
Altitude (Rnd. No. 1)	24½ miles	Diameter, center sec.	30"
Maximum Velocity	2695 ft/sec	Payload	300 to 500 lbs.
Thrust	20,000 lb.	Weight, fuel	1768 lbs.
Burning Time	60 sec.	Oxidizer	4668 lbs.
		Air	256 lbs.

Guidance - Preset auto-pilot with overriding radar command control

~~CONFIDENTIAL~~**UNCLASSIFIED**

It was concluded that a major malfunctioning of the air-regulation system (i.e., the main air regulator) had occurred. Since not all parts of the air-regulation system were recovered intact following the impact, it was difficult to ascertain in detail the nature of the failure.

(C) The launching of CORPORAL E Round 3 on 4 November 1947 was partially successful. Up to 43 seconds after launching, performance was satisfactory. At that time the rocket motor suddenly ceased burning, and the missile's range was reduced to just over 14 miles from a predicted 60 miles, and the maximum altitude attained to 66,000 feet, as compared to Round 1's 129,000 feet. Telemetering records indicated violent fluctuations of high amplitude and high frequency in the motor chamber pressure after 10 seconds of flight.¹⁸

(C) At the completion of the third round, the Ordnance Department became interested in developing the design to serve as a pilot program for more extended construction or, at least, as an educational program in manufacturing methods and tooling. Also intended was that the construction would employ information gained in the development of the earlier rounds in order to improve performance and reliability. With these ideas in mind, the Ordnance Department let a contract to the Douglas Aircraft Company for the fabrication of seven additional rockets.¹⁹

INTERIM DEVELOPMENT BEFORE THE FIRING OF ROUND 4

The Rocket Motor

(C) CORPORAL E's first three rounds were powered by a regeneratively cooled motor weighing 650 pounds, a unit essentially consisting of a scaled-up version of the WAC CORPORAL B's motor to step up its 1,500-pound thrust to a thrust of 20,000 pounds. Helical passages outside the chamber wall circulated liquid fuel aniline-furfuryl alcohol as a coolant. Although the firing of Round 1 was successful beyond

-
18. CBS, Nr. 2, 20 August 1947 to 20 October 1947, p. 36; CBS, Nr. 3, 20 October 1947 to 20 December 1947, pp. 30-32, 39-40; Brown et al., op. cit., pp. 57-58; JPL Report Nr. 20-100, op. cit., p. 4.
19. Dunn, Louis G., Meeks, Paul J., and Denison, Frank G., Jr., ORDCIT Project Memorandum Nr. 4-59, "Present Status of the CORPORAL Development," p. 1, JPL/CIT, 17 March 1950.

UNCLASSIFIED~~CONFIDENTIAL~~

expectations, the next two rounds experienced difficulties in the propulsion system. Moreover, the motor was much too heavy, difficult to fabricate, and subject to burnout of its throat because of the failure of the helical cooling coils to cool the throat region. Designing a lightweight motor, therefore, became a prime JPL objective.²⁰

(C) Approximately one and a half years elapsed before the firing of Round 4. Prior to the development of the 650-pound motor, four scaled-up versions of WAC B's motor, weighing 200 pounds each, had been designed and fabricated. Due to their lightweight construction, however, none was satisfactory for vehicle use after proof firing. It was to overcome such failures that the heavy 650-pound version was designed. Several other rockets motors of a modified heavyweight design, weighing 450 pounds and combining features of the two basic designs mentioned above, also failed during static firings, in each instance from throat burnout.²¹

(C) While the 450-pound versions were undergoing proof tests, design of a completely new motor weighing but 125 pounds was completed, and it was first flown in Round 4. This motor used the same type of propellants and employed the same fuel combination as coolant, but the cooling passages provided axial flow. In addition, since the former injector was incompatible with the lightweight motor, the new motor's injector was of a completely new design. The redesigned injector, which became standard for the CORPORAL motor, had 52 pairs of impinging jets and gave a resultant momentum angle of the propellants of about 2.5 degrees toward the chamber wall.²²

20. Pickering, JPL Report Nr. 20-100, op. cit., pp. 57-58; Dunn, Meeks, & Denison, JPL Memo Nr. 4-59, op. cit., p. 1; Dunn & Meeks, JPL Report Nr. 4-45, op. cit., p. 5.

21. Ibid.

22. CBS, Nr. 6, 20 April 1948 to 20 June 1948, pp. 32-33; JPL Report Nr. 20-100, op. cit., pp. 4-5, 55-58; Dunn, Meeks & Denison, Memo Nr. 4-59, op. cit., pp. 1, 5-6; Brown & Others, op. cit., p. 58; Semi-Annual Progress Report of the Guided Missiles Program, D/A, 30 April 1949, pp. 69-70.

~~CONFIDENTIAL~~
UNCLASSIFIED

Other Modifications in Design

(S) The tail area was increased as a result of experience gained from the first three firings, and the boattail design was replaced by a straight cylindrical aft end. Jet vanes and holders were modified also. In the control system a pneumatic piston replaced the rotary air motor and the gear box. In the redesign, truss-type structures were used wherever possible to allow better access to the space wherein the payload, instrumentation, and propulsion system were housed. Additionally, a considerable advantage was obtained in the ease of assembling the vehicle, since, with such a method of construction, off-the-shelf, interchangeable assembly was made possible without any weight sacrifice. In the matter of weight reduction, the tanks were constructed of stronger, but lighter, materials.²³

Launching and Handling

(S) CORPORAL E rounds fired, that is, the first three, were launched from a vertical position on a platform having bearing surfaces engaging the extremities of the fins. Its platform rested over a pit designed to accommodate the jet stream at takeoff. A gantry crane was used to handle the missile. CIT had designed both pit and crane, and the Corps of Engineers had built both.

(S) Missile redesigns resulted in changes in launching technique: On the CORPORAL E redesign subsequent to the first three firings, a decrease in vehicle weight was expected to allow an increase in burnout velocity, which, in turn, required the provision of larger fins. This change demanded launcher modification and led to a review of launching techniques aimed at reducing the severe static loads imposed on the fins. Objectives were to achieve a decrease in fin weight per unit area, thereby conserving the assumed reduction in vehicle weight. A method of launching was developed involving four 10-foot-long struts spaced equidistantly about the missile and each set at an angle of approximately 39 degrees from the vertical, providing support at points

23. Brown et al, op. cit., p. 58; Semi-Annual Progress Report Guided Missiles Program, 30 April 1949, op. cit., pp. 49, 173-174; Dunn, Meeks, & Denison, Memo Nr. 4-59, op. cit., pp. 6-7.

UNCLASSIFIED

~~CONFIDENTIAL~~

UNCLASSIFIED

about one-fifth of the way up the missile's body. Virtually, then, these supports, which actuated by springs and swung backward after the missile had risen four inches, were to be left at the launcher instead of accompanying the vehicle in the form of over-strength fins. Furthermore, the skin of the aft body, not being stressed as formerly, could be provided with inspection covers, making the space accessible for servicing the equipment contained within. This launcher modification was complete prior to the firing of the first (Round 4 of the firing series) of the seven production type missiles being fabricated by Douglas Aircraft and scheduled for delivery in May 1949.²⁴

FIRINGS RESUMED

(S) CORPORAL E Round 4, or the first production round, was fired at WSPG on 7 June 1949 and veered to the left of vertical almost immediately after takeoff. It rolled at about 15 seconds, and at 23 seconds radio destruct was effected as a safety measure. Telemetering records showed that the control system's performance had differed radically from that anticipated. Later, at the ORDCIT Test Station at Muroc, California, a static test was made to check out the various autopilot components. This test proved conclusively that the system was marginal in its reliability and that its continued use in the remaining six rounds was not justified. Inasmuch as the development of the autopilot for the SERGEANT was well along, a decision was made to suspend further launchings of the CORPORAL E and to modify the SERGEANT device for use in the CORPORAL E program. In a static test of an aft section assembly exactly like that used in Round 4, it was found that the jet-vane movement was four times greater than expected. JPL personnel determined that the flame had entered the control mixer, burned away some of the pneumatic tubing, and softened the springs of the control system mixer bar. That

24. Semi-Annual Progress Report Guided Missiles Program, 30 April 1949, op. cit., pp 48, 95-97; Ibid., 31 October 1949, pp. 50, 109; Dunn, Meeks, & Denison, Memo Nr. 4-59, op. cit., pp. 7, 10. (This launching technique was refined and retained throughout CORPORAL system development and incorporated in the tactical CORPORAL's launcher.)

UNCLASSIFIED

UNCLASSIFIED

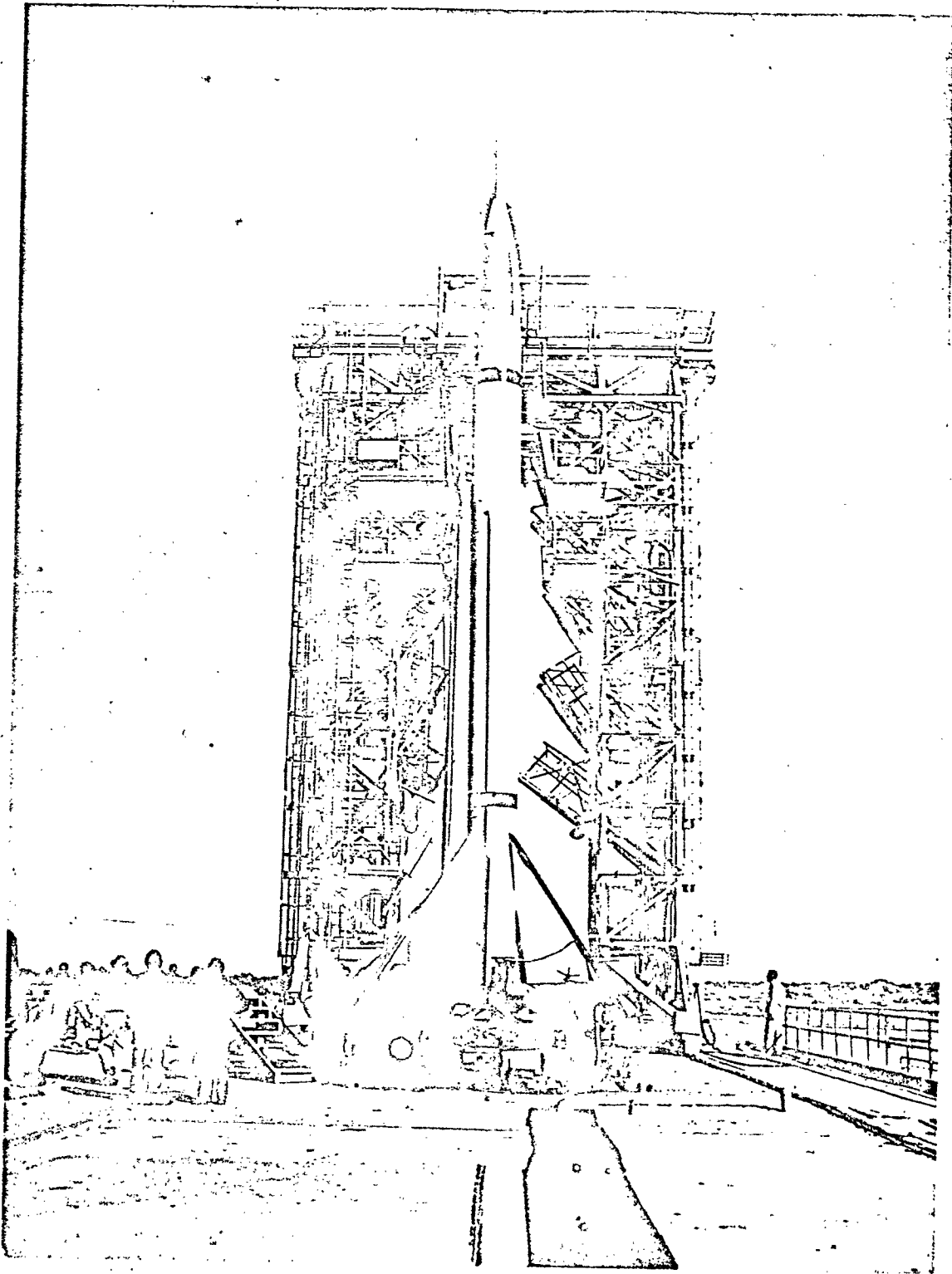

CORPORAL E ROUND 4 BEING READIED FOR LAUNCHING

UNCLASSIFIED

UNCLASSIFIED

a new jet-vane holder and a protective flame shield required on the aft end of the missile was plainly indicated.²⁵

FIRINGS AGAIN INTERRUPTED

(S) During the ensuing thirteen months, improvements were effected. The all-pneumatic control system, for instance, was abandoned for the electro-pneumatic autopilot designed at JPL. Because of the many changes to be incorporated in Round 5, a static test was conducted at WSPG in June 1950. Shortly after the motor ignited, an aniline line broke in the aft end of the missile and caused a fire which engulfed the missile briefly. This failure was attributed to vibration, and special precautions were taken in rebuilding Round 5 to obviate the possibility of a recurrence, although it was realized that vibration environment in flight would probably differ from that of the static test.²⁶

DEVELOPMENTS IN WASHINGTON

(S) In September 1949 Dr. Louis G. Dunn, JPL's Director, and some of his staff met with Major General (then Colonel) H. N. Toftoy of the Missiles and Rockets Branch, Office, Chief of Ordnance (OCO) at the Pentagon, Washington, D. C. General Toftoy expressed disappointment at the development progress of guided-missile weapon systems in this country, and, in view of the increasing international tension, the Army Ordnance Department desired JPL to undertake the development of a guidance system for the CORPORAL on a "crash program." He also stated that a Circular Probable Error (CPE) of 1/2 mile or less probably would be considered acceptable and stipulated that existing components and techniques should be used when and wherever possible in order to demonstrate the technical feasibility of these requirements at the earliest date.

(S) At the beginning of 1950, the Defense Department denied the Army Ordnance request that the CORPORAL E be listed as a weapon development program. Therefore, it was impossible to pursue such a program

25. Brown et al, op. cit., p. 58; JPL Report Nr. 20-100, op. cit., p. 6; Dunn, Meeks, & Denison, Memo Nr. 4-59, op. cit., pp. 1-2, 8.

26. Brown et al, op. cit., pp 58-59; JPL Report Nr. 20-100, op. cit., p. 6.

UNCLASSIFIED~~CONFIDENTIAL~~

~~CONFIDENTIAL~~
UNCLASSIFIED

with priority rating equal to that enjoyed by other missile programs; hence the technical development of the system was retarded during the next several months. General Toftoy and other Army Ordnance officers held to the belief that the CORPORAL system development should be continued actively and gave the program as much support as possible.²⁷

(S) In this September 1949 review of all Ordnance surface-to-surface missile programs, the intent was to determine the best approach to meet an operational capability by July 1954 for a system capable of carrying a 1,500-pound warhead to medium ranges, with probable error in both range and azimuth of less than 1,000 feet at maximum range. At this time, Ordnance had under way at the General Electric Company a development of a long-range surface-to-surface missile system known as the HERMES Project. The HERMES airframe and propulsion system were not as advanced as similar components of CORPORAL E, whose airframe and propulsion system had demonstrated reliability in four launchings and numerous static tests. Ordnance, therefore, concluded that the best possible approach for reaching the July 1954 operational capability was the modification of the CORPORAL E rocket to an interim guided system. Since time was a pressing factor, the developer of the CORPORAL E rocket was naturally selected to convert the test vehicle to a weapon system.²⁸

(S) Despite the somewhat negative attitude of the Defense Department, a letter from OCO to JPL/CIT, dated 18 January 1950, outlined an accelerated program for the development of the CORPORAL E rocket into a guided missile system. This project was to include a projected test firing program to demonstrate a satisfactory guidance system. The beginning of the Korean War (24 June 1950) increased the emphasis on the newly inaugurated development of the CORPORAL E into a lethal missile.²⁹

27. JPL Report Nr. 20-100, op. cit., p. 6.

28. Technical Report, "Ordnance Guided Missile & Rocket Programs, Vol. III, 'CORPORAL,' Inception Through 30 June 1955," pp. 1-2. (Development of the CORPORAL guided missile system was conducted by JPL under Contract Nr. DA-04-495-ORD-18, initiated by Letter Order (LO) dated 5 October 1950, with the definitive contract dated 2 January 1951.) (Ref. Ibid.)

29. Ibid.

UNCLASSIFIED

~~CONFIDENTIAL~~

FIRING RESUMED

UNCLASSIFIED

(S) Round 5 CORPORAL E was finally fired on 11 July 1950 to a range of 51.2 miles, 3.45 miles short of that expected. Reduced propellant flow rates after 30 seconds of flight cut down on over-all performance of the missile. This malfunction resulted from the failure of the disconnect air coupling designed to bleed air from the air tank. However, this round demonstrated the new JPL electronic autopilot. No ground guidance was provided for Round 5, although a Doppler transponder and an AN/DPW-1 radar beacon, modified in accordance with the HERMES A-1 missile requirements, were carried as passengers.³⁰

(S) JPL's recital of the misadventures of Round 6 is worthy of quoting.³¹

Round 6, fired on 2 November 1950, impacted at 35.9 miles, approximately 34 miles short. In later static tests it was demonstrated that both Rounds 5 and 6 apparently had dome-loader regulator failures, causing overrich mixture ratios; in addition, a failure of the air-line disconnect coupling had caused loss of air. In Round 6, the radar beacon was used to provide azimuth overriding guidance, which operated satisfactorily until the flight beacon transmitter failed at 36 seconds. The azimuth error was 126 feet east at impact. The Doppler beacon was provided to initiate shutoff of the flow propellants to the rocket motor when the missile had achieved a velocity calculated to carry it to the target in ballistic trajectory. However, the missile did not reach a velocity sufficient to effect shutoff of the propellants at the predetermined velocity. Furthermore, the Doppler beacon itself failed at 24 seconds. Finally, the telemetering equipment ceased operating at 48½ seconds. The most significant aspect of this round was the fact that all electronic equipment failed, apparently because of the extreme vibration inherent in the flight environment.

(S) A range of 63.85 miles, five miles short of its target, was reached by Round 7 in January 1951. This missile began to roll at 40 seconds because of failure of the connection from the central power supply to the autopilot. The ground radar furnished some erroneous

30. JPL Report Nr. 20-100, op. cit., p. 6; Brown et al, op. cit., p. 58 Technical Report, "Ordnance Guided Missiles, Vol. III, CORPORAL," op. cit., p. 2.

31. JPL Report Nr. 20-100, op. cit., pp. 6-7.

UNCLASSIFIED

~~CONFIDENTIAL~~**UNCLASSIFIED**

information to the guidance system, thereby accounting for two miles of the five-mile target shortage.³²

(S) During the ten months following the September 1949 Pentagon meeting, CORPORAL's guidance system was selected (Ref. notes 25, 26, 27, 28, and 29). Elements of the system were assembled, the all-pneumatic control system was abandoned, and an electro-pneumatic autopilot was designed at JPL. The only component retained in the new (JPL) autopilot was the pneumatic cylinder, which had been introduced in Round 4.

(S) By the time Round 7 was fired, CORPORAL's control and guidance system had, through vibration and flight tests, attained comparative reliability. Fundamental feasibility of CORPORAL's autopilot design for adequate stability, overriding radar guidance for azimuth accuracy, use of radar data in a computer to assist in calculating the critical shutoff velocity, and utilization of Doppler velocity as a means of determining the missile shutoff had been demonstrated. (Ref. note 38 for absence of propellant shutoff in Round 9).³³

(S) CORPORAL E Round 7 was the first to have the newly developed quick-shutoff propellant valve. A new multi-cell air tank plus a new air-disconnect coupling greatly improved the reliability of the propulsion system. (Ref. notes 17, 30, and 31 for failures of the air disconnect coupling.)³⁴

(S) The early shutoff propellant valve used a hydraulic operating cylinder instead of the later pneumatic cylinder. In this early valve, fuel under pressure was bled from the fuel circuit through a restrictor to the opening side of the operating cylinder at a controlled rate and opened the valve. This early valve was designed to close during flight in the event of a missile malfunction but was not designed to provide range control. Consequently, the valve did not include a quick-close feature.

32. JPL Report Nr. 20-100, op. cit., p. 7.

33. Ibid., pp. 6-7, 89-99, passim.

34. Ibid., p. 7.

UNCLASSIFIED~~CONFIDENTIAL~~

~~CONFIDENTIAL~~
UNCLASSIFIED

(S) For a period of about eight years the propellant tanks underwent a series of evolutionary changes, the first being that mentioned for the first time in discussing CORPORAL E Round 7.³⁵

(U) In regard to propellant tanks, WAC CORPORAL A had a single, long, heavy tank partitioned to provide separate cells for fuel, oxidizer, and air, the cell for the last being aft of the propellant tanks. This arrangement prohibited the use of different materials for the three containers and the danger of leakage was obvious. (Ref. Chapter IV: WAC CORPORAL A.)

(U) The first modifications were to remove such hazard, permit use of different and lighter materials, and to reduce the dead weight of the missile. Separate tanks were provided, with the air tank placed forward, above both propellant tanks. (Ref. Chapter V: Transition to CORPORAL B.)

(S) In the meantime, newly developed techniques for working aluminum were being developed, one being extrusion. CORPORAL E Round 7's air tank was the first to exploit this technique; the missile's new air tank consisted of nineteen extruded aluminum tubes manifolded in a bundle and was destined to be used in all future CORPORAL rounds. Since this tank was fabricated from commercially available aluminum tubing, such development simplified problems incident to fabrication.³⁶

(S) Despite improvements, however, the number of malfunctions indicated that over-all reliability of CORPORAL E remained a significant problem and that more information was needed concerning operating environment, for that factor was as yet little understood.³⁷

(S) Launched on 22 March 1951, Round 8 impacted approximately four miles short. On the other hand, on 12 July 1951, Round 9 landed about 20 miles beyond expected impact because of failure of the Doppler transponder and consequent absence of propellant shutoff.

35. Ibid., pp. 6-7, 66-68 (for discussion of "evolutionary changes").

36. JPL Report Nr. 20-100, op. cit., pp. 40, 51, 65-66; Semi-Annual Progress Report Guided Missiles, 31 December 1950, op. cit., p. 85; Brown et al, op. cit., p. 60; Ordnance Guided Missiles Program, Vol. III, CORPORAL, op. cit., p. 33.

37. JPL Report Nr. 20-100, op. cit., p. 7.

~~CONFIDENTIAL~~
UNCLASSIFIED

~~CONFIDENTIAL~~
UNCLASSIFIED

(S) JPL recognized the problem and had this to say about such failures:³⁸

With the high incidence of electronic in-flight failures, a concentrated effort was made to determine the vibration environment; an effort was also made to simulate the effects of the vibration environment through the use of vibration test tables for design improvement and for testing individual flight units before installation in the missile. Without any prior knowledge of such extreme environments, the educational process was naturally slow.

(S) Round 10 was not launched. Fired on 10 October 1951, Round 11 was actually the tenth (and final) test-firing in the CORPORAL E testing and development program. Besides being the last of the CORPORAL E firings, Round 11 comprised the basic configuration of the tactical CORPORAL missile subsequently developed. This final round had the new delta fins, carried a nose cone capable of containing a 1,500-pound warhead, and was structurally strong enough to withstand the re-entry conditions encountered during flight. At takeoff, the central power supply frequency regulator failed, thereby disrupting control loop stability and causing the missile to roll and to follow a trajectory that carried it over the Organ Mountains in a westward direction instead of northward as programmed. It was "cut down" by the range-safety radio link and made to impact between the WSPG headquarters and the City of Las Cruces, landing about 15 miles west of the launcher.³⁹

(S) In the two years since JPL had been asked to consider the technical feasibility of developing a guidance system for the CORPORAL, a total of seven rounds had been fired. After the firing of CORPORAL E Round 11, the CORPORAL Program was ready to enter a new phase.⁴⁰

38. JPL Report Nr. 20-100, op. cit., pp. 7, 11; Brown et al, op. cit., p. 61.

39. JPL Report Nr. 20-100, op. cit., p. 7; Brown et al, op. cit., p. 61; Ordnance Guided Missile Program, Vol. III, CORPORAL, op. cit., p.35.

40. Ibid. See Document 20 for tabulation of ORDCIT Test Vehicle & CORPORAL firings through 1955.

UNCLASSIFIED~~CONFIDENTIAL~~

~~CONFIDENTIAL~~
UNCLASSIFIED

CORPORAL I

INTRODUCTION

(U) CORPORAL was the first surface-to-surface ballistic guided missile to be produced and made available to Army Field Forces for tactical use in field operations. This missile system, which eventually demonstrated high performance and accuracy characteristics and good reliability, was developed in a natural progression commencing with the drafting board. PRIVATE A, PRIVATE F, WAC CORPORAL, and finally CORPORAL E each contributed knowledge, and the ORDCIT Project finally became a separate weapon system development program.

(U) For recall purposes, in September 1949, after the firing of CORPORAL E Round 4, the Missiles and Rockets Branch of the Office of the Chief of Ordnance requested JPL to develop a guidance system for the improved version of the CORPORAL missile. During the next two years, while work on this new guidance system was in progress, the remaining rounds of the seven Douglas production CORPORAL E's were fired at WSPG. Round 11, fired on 10 October 1951, was the last, and it comprised the basic configuration which thereafter persisted in the tactical version of the CORPORAL missile (Cf CHAPTER VII, passim).

(S) In the meantime, other events of considerable import to guided missile development in the United States were transpiring. Prior to the launching of CORPORAL E Round 6, Mr. K. T. Keller was appointed to the newly established Office of Director of Guided Missiles, Office, Secretary of Defense in October 1950. This appointment was significant due to the fact that the future of all guided missile programs was to be influenced by the Director, since this new Office coordinated the research and development and the production of all guided missiles.¹

1. Technical Report, "Ordnance Guided Missiles Program, Vol. III, CORPORAL," op. cit., p. 33.

UNCLASSIFIED~~CONFIDENTIAL~~

~~CONFIDENTIAL~~
UNCLASSIFIED

(S) Preceding the above occurrence, another event of significance to the future of guided missiles transpired: a Guided Missile Center was activated at Redstone Arsenal, near Huntsville, Alabama. The Ordnance Research and Development Suboffice (Rocket), Fort Bliss, Texas, had been established in 1946 to provide Ordnance Department guided missile specialists with facilities necessary for the development of the HERMES II missile. This installation had been self-supporting in that it had all necessary facilities and equipment to conduct a comprehensive guided missile research and development program. Facilities for testing ramjet configurations, fuel injection and combustion problems, and other problems relating to rocket development were located in mobile trailers. As a move of this installation to a permanent site had been long contemplated, all facilities had been kept as mobile as possible. On 15 April 1950, the Ordnance Department had officially activated the Ordnance Guided Missile Center (OGMC) at Redstone Arsenal and transferred all HERMES II Project activities and personnel to that Center. The move was scheduled for completion by 1 November 1950, at which time all research and development guided missile activities at Fort Bliss were to terminate.²

(S) It was planned that OGMC, Redstone Arsenal, would serve as the synthesizing agency of the Ordnance Corps in the formulation and execution of the R&D phases of the Ordnance Guided Missiles Program in addition to performing procurement and field service functions. As of 31 December 1950, there were approximately 700 military, civil service, and contractor personnel assigned to OGMC for the conduct of guided missile research and development alone. The majority of these specialists were organized on a functional basis, with few personnel being assigned to any one specific project. By this date, facilities for testing missile components, ramjet configurations, and combustion chambers had

2. Semi-Annual Progress Report Guided Missiles Program, D/A, 30 June 1950, p. 12. (As of 30 June 1950, facilities and equipment provided this project were valued at \$3,957,400; BRL/APG facilities were valued at \$9,920,000; and those at WSPG at \$31,550,000. By 31 October 1949, the government-owned JPL facilities were valued at \$4,834,000. Ref. Ibid., 31 October 1949, p. 6)

UNCLASSIFIED

~~CONFIDENTIAL~~

~~CONFIDENTIAL~~
UNCLASSIFIED

been installed in permanent structures and were in operation. In addition, chemical, mechanical, and electronic laboratories, and production and assembly shops had been established to support the development programs at OGMC.³

(U) Prior to 1950, there had been no Industrial budget as such for guided missiles. There had, of course, been no planned program for the development of the CORPORAL as a military weapon. As has been heretofore discussed, it had been planned as an "upper-atmospheric test vehicle only," and the "crash program" alluded to before resulted in the CORPORAL's designation for development as a missile system. It was specified that such components as were already available be adapted to the CORPORAL's development as a military weapon. The year 1951 saw the first formal Industrial budget in all the missile systems, the CORPORAL included.

(U) With activation of the OGMC at Redstone Arsenal, Redstone assumed cognizance of guided missile development, that of the CORPORAL included. OCO designated Captain E. B. Detchemendy, Special Weapon Unit, Ammunition Branch, Industrial Division, OCO, to manage the CORPORAL Project, since no organization existed at Redstone to do so.⁴

(S) To expedite the development being rushed to provide an interim tactical guided missile, the projected FY 1951 funds were \$2,189,000, and the FY 1952 funds were \$3,345,000.⁵

WARHEAD

(S) Warhead and fuze development were conducted by agencies other than JPL. The total allowable fuze and warhead weight was approximately 1,500 pounds. Picatinny Arsenal was (as of 31 December 1950) developing

3. Ibid., 31 December 1950, p. 19; D/A Pamphlet Nr. 70-10, op. cit., pp. 81-82.
4. Interview with Lt. Col. E. B. Detchemendy, Chief, Maintenance Division, FSO, ARGMA. (Captain Detchemendy was promoted to Major soon after his transfer to Redstone. As of 1 March 1961, he was on his second tour of duty there; Col. Carroll D. Hudson was at the time of OGMC's activation on his second tour of duty as Commanding Officer, Redstone Arsenal.)
5. D/A Pamphlet Nr. 70-10, op. cit., p. 82.

UNCLASSIFIED~~CONFIDENTIAL~~

~~UNCLASSIFIED~~

1,500-pound general purpose (GP) and the Cluster Fragmentation Warhead for the CORPORAL. Starting with the round following CORPORAL E Round 11, warhead agencies, such as Sandia Corporation, National Bureau of Standards (later the Diamond Ordnance Fuze Laboratory), Chemical Warfare, and APG, were provided warhead space. These organizations participated to varying degrees throughout the remaining CORPORAL firing-test program.⁶

SYSTEM DESCRIPTION

(S) CORPORAL I (XSSM-A-17) was a guided missile fired from a mobile ground installation at medium-range surface targets. It was designed to carry a 1,500-pound warhead at ranges of 50,000 to 120,000 meters with a CPE of 300 meters and to fly a series of standard trajectories. The range of the missile was primarily controlled by terminating thrust at a velocity (as determined by the shutoff computer) that would minimize the range error at impact. In order that the missile would be in the proper region of position-velocity space at shutoff,* an elevation computer system guided the missile along a predetermined trajectory from 22 seconds to shutoff. Range error was further reduced by determining (on the basis of measured position and velocity) the predicted impact error, near the peak of the trajectory, and by programming a terminal maneuver to compensate for this error. The azimuth error was controlled by commands calculated to keep the missile heading on target from 22 seconds to impact minus 10 seconds. The missile was controlled to fly close to the standard trajectory by means of yaw and pitch programs and by autopilot control. Deviations from this standard

6. JPL Report Nr. 20-100, op. cit., p. 7, 99-101; Semi-Annual Progress Report Guided Missiles Program, 31 December, op. cit., pp. 50, 164; "Ordnance Guided Missiles & Rocket Programs, Vol. III, CORPORAL," op. cit., pp. 7-12; "Research and Development Annual Guided Missile Report," D/A, 1 October 1957, pp. 154-173 (contains resumes of warhead development, including atomic warhead); Kautz, G. P., ORDCIT Project, Publication Nr. 64, "The CORPORAL Missile Arming Philosophy," passim, JPL/CIT, 16 February 1956. See Document 21 for extracts from Publication Nr. 64, including chart of impact area in relation to friendly troops.

* That is, CORPORAL's proper position in space at shutoff was determined by the missile's velocity.

UNCLASSIFIED

~~CONFIDENTIAL~~

UNCLASSIFIED

trajectory were determined by a combination of radar and Doppler data. These data were transmitted to the missile as commands.⁷

RESUME OF CORPORAL I

(C) The above depicts CORPORAL as it was during the first Engineer-User firings (30 January 1953-22 January 1954), a missile unreliable and unpredictable in behavior and especially susceptible to countermeasures. A somewhat detailed account of CORPORAL and progress of certain phases of its development follows:

(C) Chosen for development as a tactical missile before any decision had been reached as to the military characteristics it must possess, establishment of such characteristics remained in a constant state of flux. Among early military characteristics, tactical CORPORAL had +500-foot requirement in range error and \pm 100 feet in azimuth (+ referring in range to "over," and - to "under"; in azimuth, + meaning "right" deflection from target, and - designating "left" deflection). There was to be flexibility in range from 20 per cent of maximum up to maximum.

(C) As mentioned elsewhere, when the decision was made late in 1949 to add to CORPORAL an accurate guidance system, the missile was regarded as no more than an interim weapon. Its test results, however, had proved sufficiently encouraging to justify its being developed into a tactical weapon system.

(C) The philosophy determining choice of a guidance system was based on the following assumptions:

-
7. Technical Report Nr. 39, "Flight Analysis of First Fourteen Rounds of CORPORAL Type I Fired in E-U Program," p. 2, Technical Staff, WSPG, Released December 1954. (Radar guided the missile; the computer determined its position in space and supplied radar with corrective commands. The autopilot was the actual controlling factor. Radar overrode commands only when necessary. Doppler did not convey any guidance commands per se, but it did transmit the shutoff command when the missile had attained its proper velocity to attain its predetermined range. Mr. N. L. Cropp, ABMA Control Office.)
 8. Seifert, Howard S., JPL Publication Nr. 22, op. cit., p. 23; JPL Report Nr. 20-100, op. cit., p. 61.

UNCLASSIFIED~~CONFIDENTIAL~~

~~CONFIDENTIAL~~

UNCLASSIFIED

1. The guidance system was to use existing components for speed in development; hence the SCR-584 World War II radar was chosen for commands rather than an inertial system.
2. CORPORAL was to be "fail safe" and fall near the general area of the target in spite of ordinary malfunctions.
3. A "zero-lift," or nonmaneuvering, trajectory was to be employed for the purpose of reducing strength and weight requirements, as well as making it possible for radar to relinquish guidance early in the missile's flight, a definite tactical advantage.
4. CORPORAL's autopilot was to be electronic for flexibility, and all units were to be packaged for rapid interchangeability in the field, thereby greatly simplifying maintenance.⁹

(C) As shown above, emphasis was placed upon simplicity, reliability, and immediate availability. The system chosen was one in which velocity was measured by a Doppler radio link to one part in 10,000 and thrust terminated exactly (\pm 5 milliseconds) at the proper time and velocity to cause the missile to follow a ballistic trajectory to the target. A fortunate geometric feature of this trajectory was that impact would be rather insensitive to the velocity direction at the time of shutoff. CORPORAL was to be kept in a fixed azimuth plane connecting launcher and target by means of commands from a radar fixed in azimuth, tracking in elevation, and capable of 0.2-mil* angular resolution. A gyro-controlled autopilot stabilized the missile in roll to \pm 10 degrees and executed radar commands.¹⁰

(C) Accuracy requirements for CORPORAL were originally chosen to conform to the accuracy limits of the SCR-584 radar. Subsequent experience, however, showed that wind disturbances, and particularly unknown variations in air density, caused greater errors than the radar. This discovery resulted in the concept of post-shutoff guidance, carried out by a "range correction" system.¹¹

9. Seifert, Howard S., JPL Publication Nr. 22, *op. cit.*, p. 23.
 * "Mil": a unit of angular measurement, equal to $1/6400$ of 360 degrees, in the case above making $0.2\text{-mil} = 0.01125$ degree.

10. *Ibid.*, pp. 23-24.

11. *Ibid.*, p. 24.

UNCLASSIFIED
~~CONFIDENTIAL~~

~~CONFIDENTIAL~~
UNCLASSIFIED

133

(C) In the first dozen rounds, errors were measured in miles; however, this error steadily decreased. Occasional large errors, however, were experienced because of gross failure of some system component, and this reliability problem continued to be a matter of concern and investigation. With all components working properly, the CORPORAL system demonstrated its capability of functioning with the desired error of only a few hundred feet. For instance, on Flight 54, fired 23 July 1953, the radial error was 88 meters.¹²

(C) As originally conceived, and remaining thus, CORPORAL and its ground equipment constituted an exceedingly complex weapon system, which may be broken down into subsystems, each being of itself rather intricate, namely: propulsion, airframe, guidance, and telemetering.¹³

Propulsion

(C) Most of the major improvements in the propulsion system such as the lightweight motor and the cellular air tanks were completed before 1949 (Ref. Chapter VII: CORPORAL E). A new development required by the guidance scheme was a quick-shutoff valve capable of operating in a few milliseconds. This device was proof-tested by late 1950 and was chosen in lieu of throttling back the thrust, as had been done in the German V-2, or using auxiliary small motors for precise velocity control.¹⁴

Airframe

(C) Accessibility of the airframe was improved by the use of inter-tank trusses rather than heavy cylindrical skirts. Aerodynamic stability and ease of control were enhanced by replacing trapezoidal with delta

-
12. Ibid., p. 24; JPL "Status Report on CORPORAL," 22 September 1952, op. cit., pp. 3-5 (first JPL firings of CORPORAL I). See Document 22 for tabulation of those firings.
 13. JPL Report Nr. 20-59, "The CORPORAL Surface-to-Surface Missile, XSSM-G-7, passim, JPL/CIT, 30 June 1951; CORPORAL Handbook Nr. 1, "Principles of the CORPORAL XSSM-G-17 System," JPL/CIT, 15 January 1952.
 14. Ibid.; Seifert, Howard S., JPL Publication Nr. 22, op. cit., p. 25; see note 13 also.

UNCLASSIFIED

~~CONFIDENTIAL~~

UNCLASSIFIED

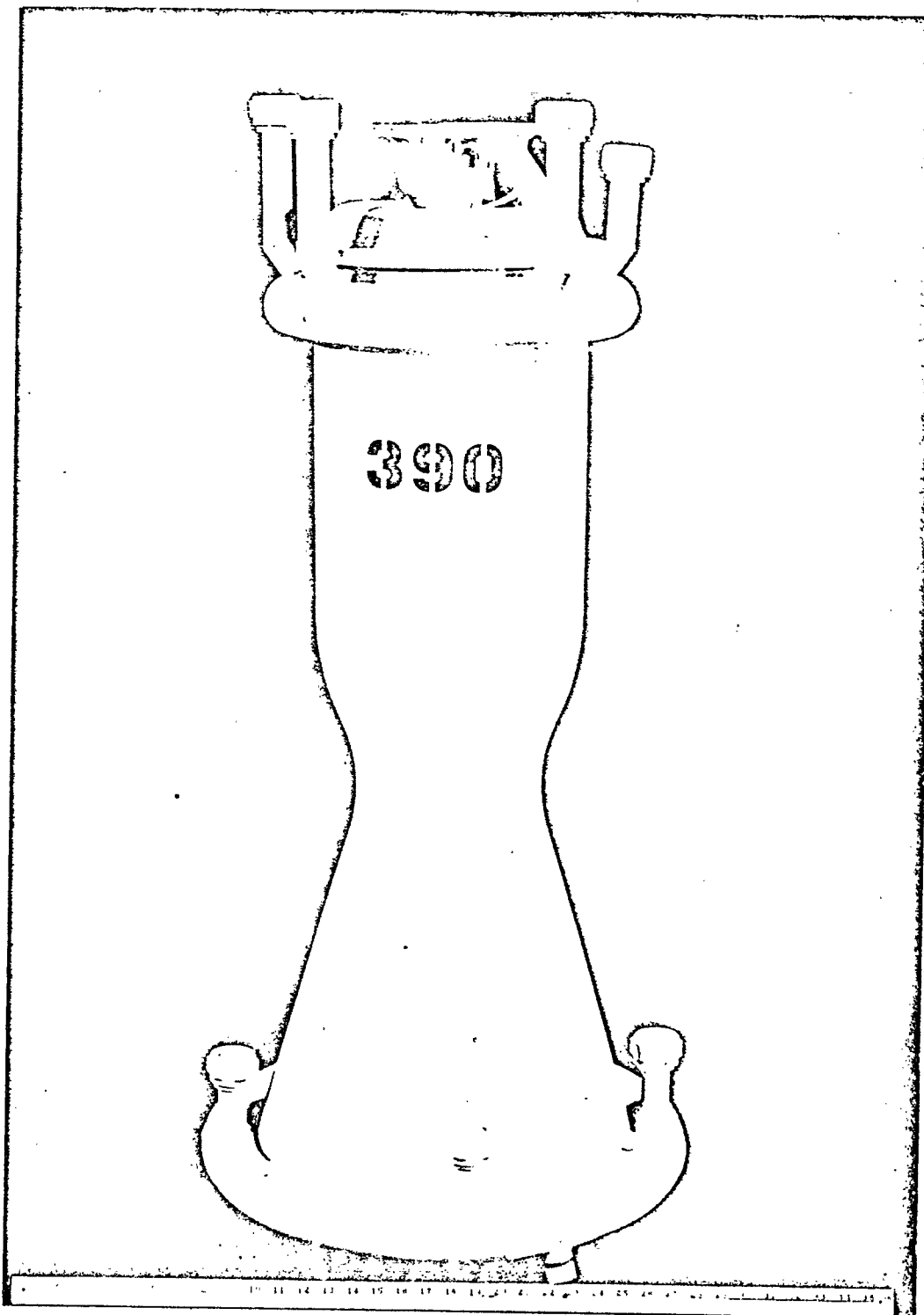

CORPORAL'S LIGHTWEIGHT MOTOR

UNCLASSIFIED

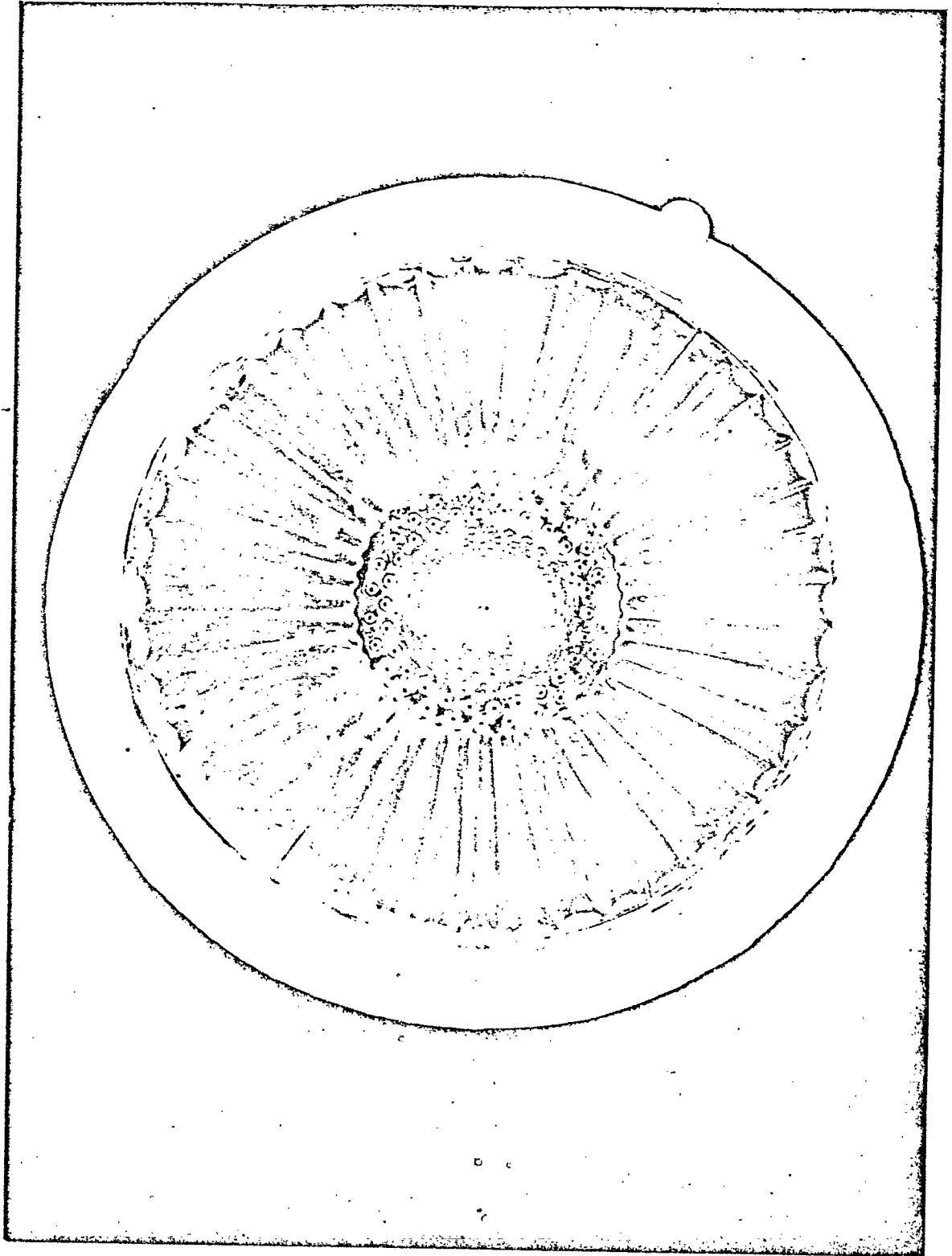

END VIEW OF THE CORPORAL MOTOR'S COMBUSTION CHAMBER, SHOWING INJECTOR

UNCLASSIFIED

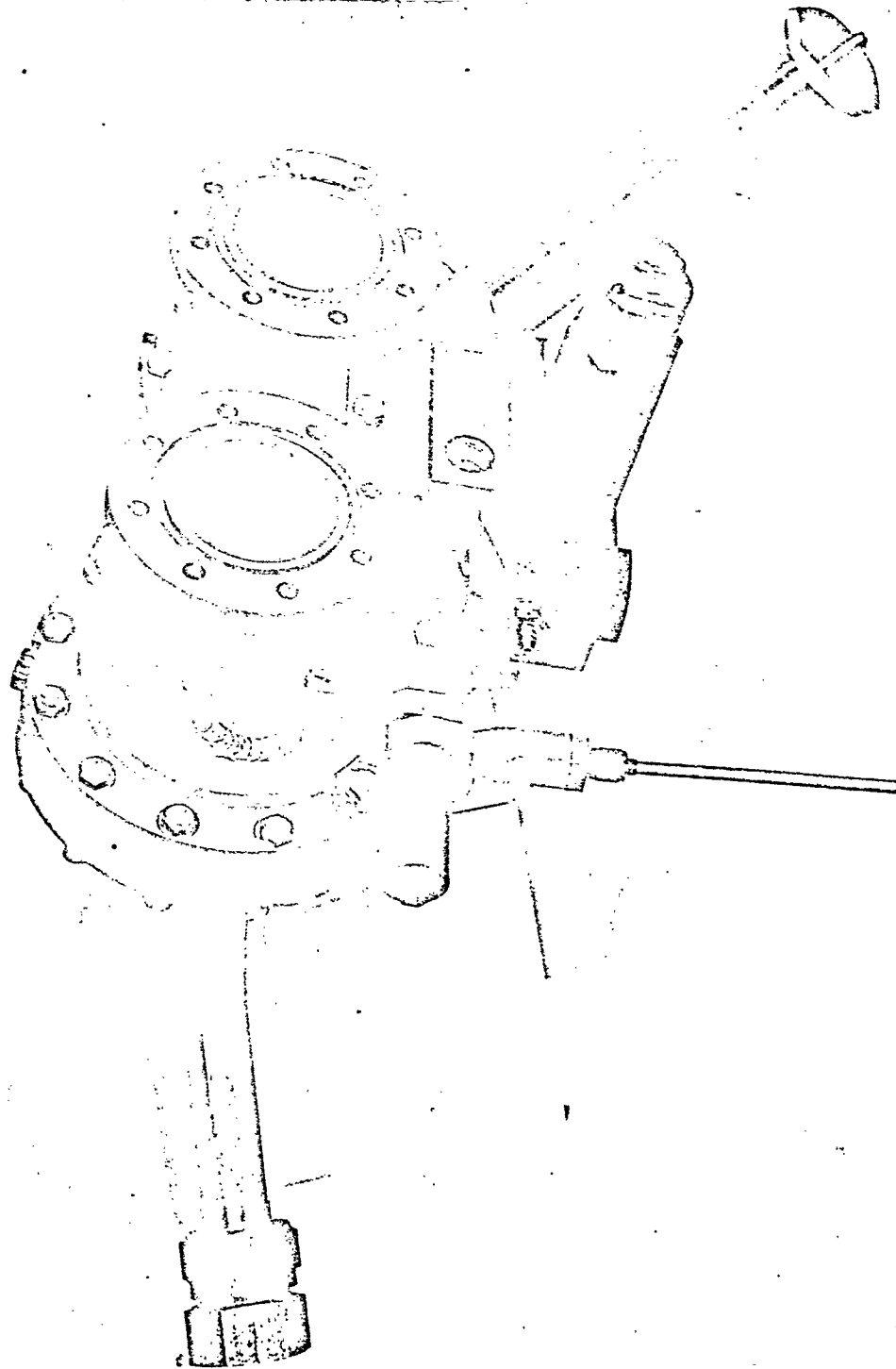

CORPORAL IMPROVED TYPE I QUICK CUT-OFF PROPELLANT VALVE

UNCLASSIFIED

UNCLASSIFIED

fins. Flight experience in 1952 indicated that aero-elastic bending on the missile's reentering the atmosphere during the downward leg of the trajectory tended to increase dispersion. Addition of accelerometers giving corrective commands, rather than stiffening the airframe, corrected that situation.¹⁵

Guidance

(C) Although guidance equipment may be correctly considered as a subsystem, it is of sufficient intricacy to be broken down still further into sub-subsystems, namely: autopilot, Doppler radio, radar and computer, and range correction.

(C) The autopilot of the 1953 CORPORAL consisted of gyroscopes (replaceable at certain times by accelerometers), which acted through an electronic amplifier to actuate a pneumatic fin-control servo system and thereby controlled missile attitude. Choice of a pneumatic servo system in 1949 was something of an innovation; at that time, only hydraulic systems were considered suitable. This decision required development of a precision air-control valve which would rotate very rapidly and proportionately to the weak direct current output of the amplifier. Development of this valve, essentially a phase-sensitive electro-pneumatic amplifier of high gain, by 1950 constituted a significant contribution toward solving guidance problems.

(C) The Doppler radio link comprised a stable ground transmitter which sent a sine wave to the missile, there to be redoubled in frequency and retransmitted by a transponder. On the ground, the frequency difference Δf of the received and locally generated signals (proportional to missile radial velocity) was monitored. At a specified Δf , the cutoff signal was sent. This system was adopted from the DOVAP instrumentation system at WSPG, which acquired the system from the Germans.

(C) Basically, the radar was a Signal Corps SCR-584 modified for precision tracking by the addition of a different dish and certain circuit refinements. It being necessary to send command information to

15. Ibid.

UNCLASSIFIED
~~CONFIDENTIAL~~

~~CONFIDENTIAL~~
UNCLASSIFIED

CORPORAL, a pulse-coding system developed by General Electric (GE) for HERMES was combined with this modified radar, designated MPQ-12. Coded pulses were interpreted in the missile by a "beacon," or radio command unit, which was also a GE development.

(C) After 1951, the beacon, which was rather vulnerable to vibration, was repackaged to withstand the missile mechanical frequency spectrum.* To provide additional rigidity and directional stability, the radar was mounted on a ground pedestal. Collimation** techniques were developed, making it possible to orient the radar quickly and accurately.

(C) Computers for processing data from both radar and Doppler, so that proper commands might be given the missile, were developed, using the Reeves GP analog computer as a starting point. The main purpose of a computer being to perform mathematical operations, precision is of the first importance. Any computer's heart is the operational amplifier, or integrator. In CORPORAL's special-purpose computer, a precision operational amplifier was developed which was an improvement over commercially available items and a definite contribution to computer development.

(C) Range correction involved making a careful measurement of CORPORAL's velocity and position at the zenith of its trajectory after most disturbances had already acted. A range-correction signal was then computed and sent to the missile, where it was to be stored until reentry into the atmosphere made corrective maneuvering possible. At a programmed instant, the autopilot began to execute the corrective maneuver, and its completion was sensed by doubly integrating the output of appropriate accelerometers. This system, a species of "fine adjustment" to the

* "Spectrum," in radio: the range of wave lengths of radio waves (from about 30,000 meters to 3 centimeters, or, in terms of frequencies, from 10 to 10,000,000 kilocycles), called also "radio spectrum," the application here being that vibration produced distortion, or scrambling, of frequencies, a mechanically produced malfunctioning resulting in varying frequencies.

** "Collimation": adjustment of line of sight, that is, the radar's line of "sight" in this particular application.

UNCLASSIFIED

~~CONFIDENTIAL~~

range, was capable of a maximum correction of 5,000 feet and for that reason could not be tested until late in the flight program, after the gross operation of major controls, such as Doppler, had been proved. As of 1953, the system was still in process of checkout.¹⁶

Telemetry

(C) Recovery of CORPORAL after firing having been an impossibility, it was recognized from the beginning that an effective telemetry system was vital to research and development, since this was the sole means of accumulating data from flight tests. The FM-FM system (audio-frequency and radio-frequency modulation) was begun as early as 1944 in connection with the Rocket Airfoil Tester (RAFT) vehicle and was developed simultaneously with, but independently of, similar work at the Applied Physics Laboratory of Johns Hopkins University.

(C) CORPORAL's system employed two radio-frequency channels, each capable of carrying fifteen audio-frequency channels of information. Thus, 30 continuous channels capable of an average band width of about 500 cycles could be used, and, by subcommutation of individual channels, an even greater variety of data could be sent. Typical quantities included fin positions, combustion pressure, skin temperatures, missile attitude, and critical voltages to the electronic gear. Certain data being always of interest for statistical evaluation of missile reliability, it was planned to fly a limited amount of telemetry in tactical missiles in addition to those devoted to research and development. This phase was designated "service evaluation telemetry" (SET).

(C) After 1951, substantial progress was made in repackaging and reducing the weight of telemetry components by using plug-in units. By 1953, "transistorized" telemetry had been flown, in which weight of equipment was reduced from 1/5 to 1/10 that of the vacuum tube system.¹⁷

-
16. Seifert, Howard S., JPL Publication Nr. 22, op. cit., pp. 25-27; see note 13 also.
 17. Seifert, Howard S., JPL Publication Nr. 22, op. cit., pp. 27-28; see note 13 also; Pickering, Progress Report Nr. 4-15, op. cit., passim.

~~CONFIDENTIAL~~
UNCLASSIFIED

COUNTERMEASURES

(S) Early in the development of CORPORAL's guidance system, it was recognized that electronic countermeasures (ECM) could threaten the success of the system. As previously discussed, however, the CORPORAL program was considered to be a "crash" project, and the philosophy of adapting readily available equipment and techniques, notably SCR-584 radar, dominated early system planning, with the objective of demonstrating a workable system of sufficient accuracy at the earliest possible date. In CORPORAL E Round 5 (fired on 11 July 1950), the basic radar and Doppler equipment was employed, and the pattern was set for the eventual CORPORAL radio-guidance system.¹⁸

Study of CORPORAL E's Susceptibility to Countermeasures

(S) On 11 December 1950, shortly after the firing of CORPORAL E Round 6 (2 November 1950), at the request of the Signal Corps, a new project was approved: a study of the susceptibility of the CORPORAL E to countermeasures. Results of the research were to be used to increase knowledge of countermeasuring such missile systems and to provide the Ordnance Corps with information on the susceptibility of their missile to countermeasures. As of 31 December 1950, the study program was being prepared by the Signal Engineering Laboratories (SEL).¹⁹

(C) A conference held at Redstone Arsenal on 24-25 November 1952 to discuss design improvement of the CORPORAL guidance equipment concluded that a study should be undertaken of the missile's guidance equipment suitable within the military characteristics. A specific objective was the replacement of the obsolete World War II SCR-584 radar in the CORPORAL system.

-
18. JPL Report 20-100, op. cit., pp. 6, 227; Technical Report, "Ordnance Guided Missile Programs," Vol. III, "CORPORAL," op. cit., pp. 2-3.
19. Semi-Annual Progress Report Guided Missiles, 31 December 1950, op. cit., p. 232.

UNCLASSIFIED
~~CONFIDENTIAL~~

[REDACTED]

UNCLASSIFIEDACM Group Established; Findings

(S) In late 1952, an anticountermeasures (ACM) group was established at JPL to study CORPORAL's methods of reducing the probability of effective enemy jamming. As a result, certain ECM vulnerability characteristics were improved. Other organizations participated in studying the problem. In general, however, the ACM evaluation program indicated that it would be technically practical, or under some assumptions rather easy, for a properly prepared enemy to jam the CORPORAL radio-guidance system, even as modified.

(S) Resistance to ECM, the group ascertained, was determined both by the fundamental design of the system and by the detailed performance of subsystems and individual circuits. By the time an active ACM effort was underway, however, CORPORAL system fundamentals had long been fixed, and an accelerated effort was underway to get the system into production. This situation made it difficult to incorporate other than relatively minor changes and the effectiveness of those changes was at times even problematical.

(S) Despite these facts, active research and development continued throughout the life of CORPORAL I, with each round fired incorporating more efficient equipment as it could be developed. As CORPORAL I lost its own original identity and merged into CORPORAL II, the total performance and reliability of the missile increased. Both ground guidance and missile equipment shared in this improvement.

(S) The most direct result of this research and development program as related to CORPORAL was the derivation of the theory and technique of phase-locked loops which were employed in the Doppler tracking filter. Later results included MICROLOCK for extreme range telemetering, the CODORAC system for JUPITER missile guidance, and phase-locked loop shutoff discriminators for telemetering.²⁰

20. JPL Report Nr. 20-100, op. cit., pp. 89-221 ("Guidance & Control," and complete discussion of development), pp. 227-233 (contain a detailed account of efforts at improvement of guidance and control equipment, including development of anticountermeasures); "Guided Missile Summary No. 46, 1 January 1955-1 March 1955," pp. 30-42, 44-45 (CORPORAL in particular), 46-55 (supporting investigation in

UNCLASSIFIED~~CONFIDENTIAL~~

~~CONFIDENTIAL~~**UNCLASSIFIED**

HANDLING AND LAUNCHING

(S) Firing tests to 31 December 1950 had utilized purely non-tactical launching and handling equipment, including large semitrailers, a gantry crane, and the nonportable launcher developed during the CORPORAL E program (Ref. Chapter VII: CORPORAL E). The story of the development of handling, launching and servicing equipment for the CORPORAL missile system was largely one of having to educate manufacturers in a new phase of the armament industry.

(S) On the date mentioned above, the basic problems incident to the design and development of tactical ground support equipment (GSE) was under study. A design subcontract having the purpose of obtaining definite designs for these items had been awarded to International Derrick and Equipment Company (IDECO), Torrance, California. Studies were expected to be available during March 1951, and prototype sets of equipment were expected for the firings scheduled during the third quarter of 1951.²¹

(S) IDECO's plans for the erector and launcher failed to satisfy JPL, which had over-all responsibility for the development of GSE for CORPORAL I, and the construction phases of the launch and erector contract were canceled. It was two years after the initiation of the equipment studies before prototypes of the remaining items developed under the IDECO subcontract were in operation in tests at WSPG.²²

communication techniques; jamming resistance, 46-48; phase-locked loop, 50-52), JPL/CIT, 15 March 1955; *Ibid.*, No. 47, 1 March 1955-1 May 1955, pp. 42-46, 49-53, 56-58, JPL/CIT, 15 May 1955; "Chronology of Significant Events in the CORPORAL Program," a typewritten manuscript located in the SERGEANT-CORPORAL Project Office, Building 4488, ABMA. See Document 23; Anticountermeasures, for full discussion of the subject. Telemetry is fully discussed in JPL Report Nr. 20-100, *op. cit.*, pp. 235-296.

21. JPL Report Nr. 20-100, *op. cit.*, pp. 299-310 (gives a detailed account of the problems involved); Technical Report, "Ordnance Guided Missile Programs, Vol. III, CORPORAL," *op. cit.*, *passim* (gives less detailed account); Semi-Annual Progress Report Guided Missiles Program, 31 December 1950, *op. cit.*, p. 105. See Document 24: "Ground Handling Equipment" for details of this development.
22. JPL Report Nr. 20-100, *op. cit.*, pp. 299-301.

UNCLASSIFIED~~CONFIDENTIAL~~

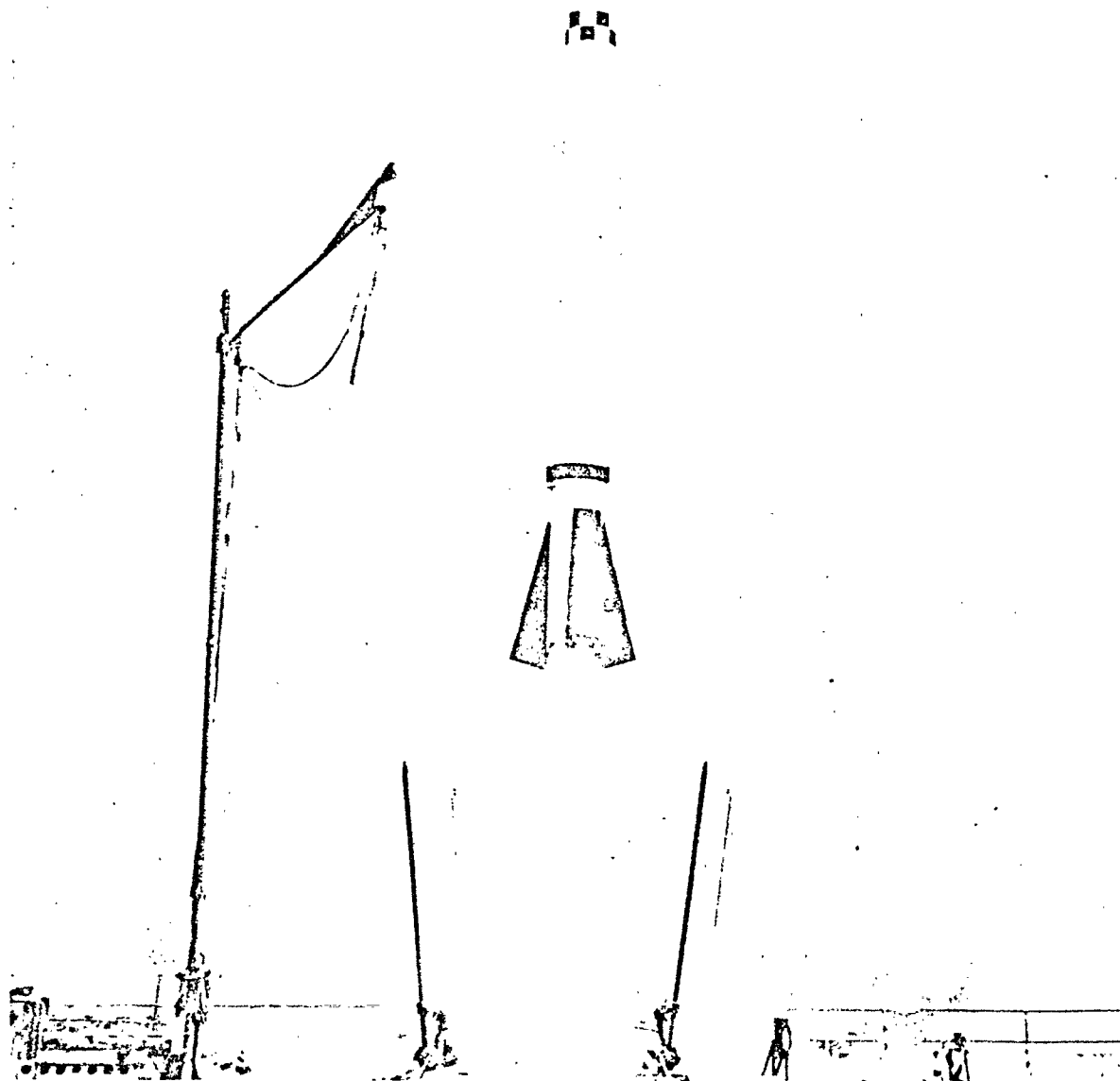

FIRING OF CORPORAL TYPE I FROM NONMOBILE LAUNCHER,
DEVELOPED DURING CORPORAL E PROGRAM

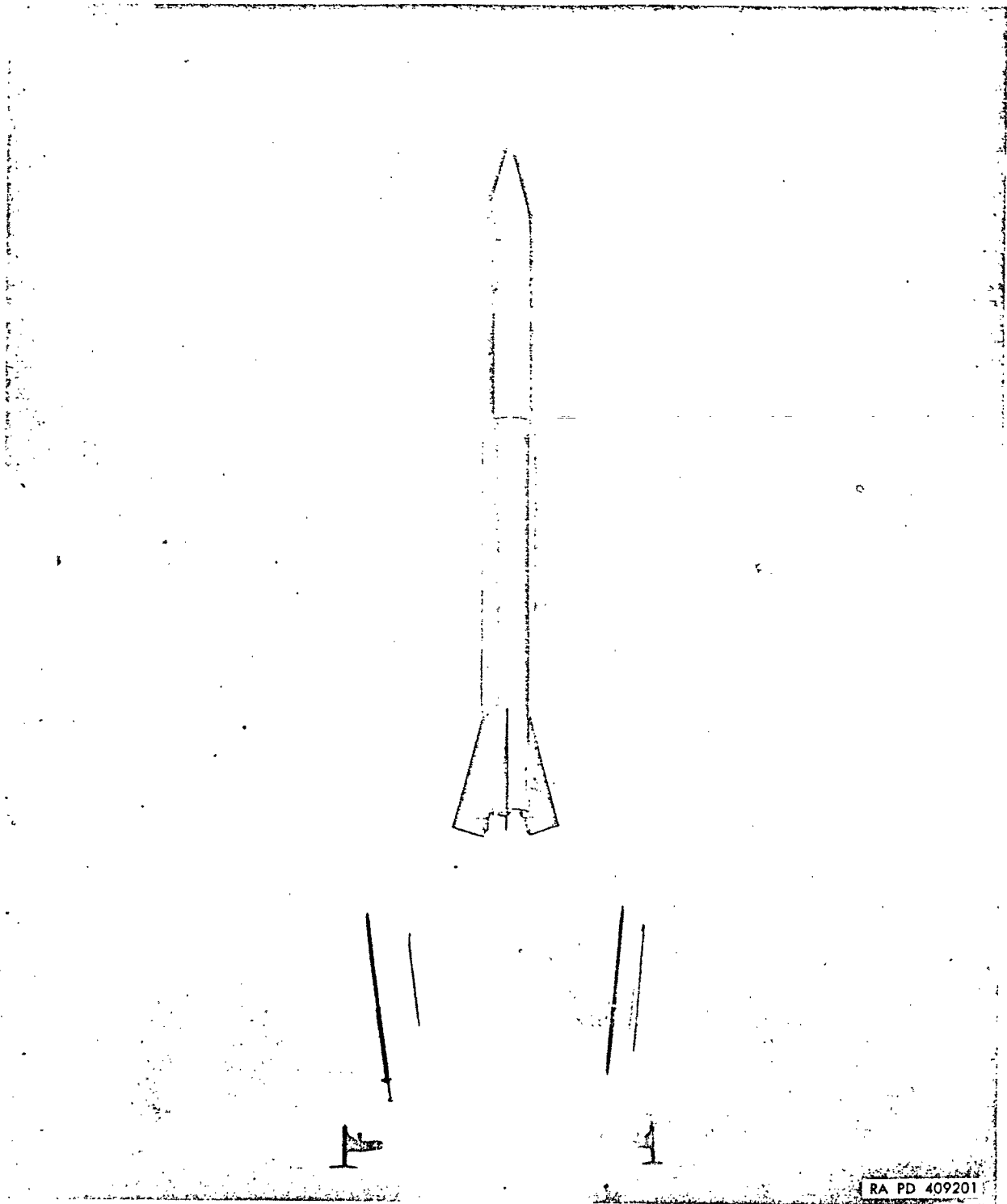

CORPORAL TYPE II BEING FIRED FROM CORPORAL TACTICAL LAUNCHER

~~CONFIDENTIAL~~
UNCLASSIFIED

145

(S) Le Tourneau succeeded IDECO in attempting to design a vehicle for transporting CORPORAL and erecting it on its launcher. The Le Tourneau easily controlled, electrical motor-driven erector was accepted for initial prototypes. Working with Firestone, Le Tourneau later extensively redesigned the Type I erector. Doubts arose as to Le Tourneau's proposed launcher, however, and JPL proceeded with a launcher design of its own. After the basic elements had been demonstrated in field tests, Firestone was awarded the contract to produce these elements and then to redesign launching equipment to correct deficiencies disclosed by these tests.²³

(S) In addition to a mobile erector and launcher, included in CORPORAL Type I ground handling equipment to be designed and fabricated were an air-supply truck, a truck-mounted air compressor, truck-mounted propellant servicers, a 40-foot device for servicing CORPORAL after erection, and a shipping container capable of protecting CORPORAL from damage in storage and during transit.²⁴

(S) In the matter of equipment thought capable of modification to serve as a servicing platform, Stemm Brothers, Inc., had on the market "Hi-tender," a device for work in apple orchards. "Hi-tender" was redesigned and mounted on a five-ton truck chassis as a servicing platform to enable an operator to reach the components in the nose of the erected missile. After the servicing platform collapsed during use at WSPG while being operated by Army personnel,* a Miller Orchard Spray unit was modified to service the erected missile.²⁵

(S) Design of a satisfactory CORPORAL shipping container likewise presented problems requiring time and effort to solve. Lyon Van and Storage Company submitted a study, but JPL rejected this proposed container as being entirely inadequate. A second container resulted from

23. Ibid., pp. 301-302, 304-305, 310.

24. Ibid., p. 299.

* The operator's cage fell approximately fifteen feet to the ground, and the men in the cage sustained slight injuries.

25. Ibid., p. 303.

UNCLASSIFIED

~~CONFIDENTIAL~~

~~CONFIDENTIAL~~
UNCLASSIFIED

design collaboration between Firestone and JPL but was considered as an interim shipping means only. This interim device was a large plywood box structure fitted with missile supports at the forward end and near the aft end of the missile-body aft section. Each support had four rubber shear mounts. CORPORAL was protected from the adverse effects of humidity by a composite plastic and aluminum foil bag designed by Firestone.²⁶

(S) Ordnance contracted with JPL to design and fabricate a reusable metal shipping container after a study by Rheem Manufacturing Company proved unacceptable. JPL fabricated three of the original, or prototype, containers and tested them. Because of manpower limitations in this field, however, JPL farmed out the designing and manufacture to Sandberg-Serrell Corporation and received an acceptable design within three months--a metal container alleviating the original objections to the wooden device.²⁷

(U) These examples suffice to emphasize the early lack of knowledge of missile-system equipment and the slow, halting educational process leading to such knowledge. Likewise, they demonstrate the peculiarly vital role played by JPL in this process and the fact that JPL personnel were also being educated. In the terminology of chemical experimentation, JPL acted simultaneously as catalyst, reagent, synthesizing agent, and substance being acted upon in this matter of learning how to convert equipment originally designed for peaceful pursuits into supporting accessories to a deadly weapon system.

TYPE I CONTRACTORS

(S) As discussed in Chapter VII, Douglas Aircraft Company during 1949 built 7 CORPORAL airframes (Contract Nr. W-04-200-ORD-1504), and JPL added propulsion and guidance. During 1950 and early 1951, Douglas built an additional 20 rounds (Rounds 12 through 31) under Contract Nr. DA-04-495-ORD-21. These 20 Douglas rounds were used in the R&D test

26. Ibid., pp. 305-306.

27. Ibid., pp. 305-307.

UNCLASSIFIED

~~CONFIDENTIAL~~

firing program. Production information was also generated under these contracts.

(S) Even before the demonstration of guidance feasibility, the Department of Defense ordered the CORPORAL into production. Several companies in the summer of 1951 were invited to submit bids for the initial Type I production contract.

(S) On 15 March 1951, the Department of the Army had recommended to the Director of Guided Missiles an industrial program calling for the procurement of CORPORAL missiles, spare parts, and ground equipment. Upon approval of the Secretary of Defense, bids for production of 200 missiles, plus spare parts and manuals, were solicited from several selected companies. A Board of Awards met at Redstone Arsenal on 29 June 1951 and selected the Firestone Tire and Rubber Company as the successful bidder. A letter order in the amount of \$6,888,796 was placed with the Firestone Company on 17 July 1951. When funds became available for the FY 1952 program, this letter order was replaced with Contract Nr. DA-04-495-ORD-159, dated 10 December 1951, in the amount of \$13,695,592. In June 1952, implementing another program approved by the Secretary of Defense, this contract was supplemented to provide for 120 additional missiles, at a cost of \$9,000,000, or \$75,000 per unit. This brought the total number of Type I CORPORAL missiles to be produced under the ORD-159 contract to 320.²⁸

TYPE I EVALUATION PROGRAM

Static Testing

(C) From their very first translation of theoretical calculations into experimental data, JPL personnel had subjected rocket components and propellants to exhaustive preflight tests before sending them aloft. Static testing at the Muroc test stand, which had been established to

28. "Ordnance Guided Missiles & Rocket Programs, Vol. III, CORPORAL," op. cit., pp. 3, 33-38; Brown & Others, Development & Testing...at WSPG, 1945-1955, op. cit., pp. 175-176. See Document 25 for tabulated fiscal history of CORPORAL, commencing with ORDCIT Project.

~~CONFIDENTIAL~~
UNCLASSIFIED

further the ORDCIT Project, resulted in development of the successful lightweight CORPORAL motor, first flown in CORPORAL E Round 4. Vibration tests provided information leading to designs to forestall failures caused by vibration. Static tests revealed that CORPORAL E Rounds 5 and 6 had been unsuccessful because of dome-loader regulator failures, causing overrich propellant mixture ratios, in addition to loss of air through failure of the air-line disconnect coupling (Ref. Chapter VII).

(S) At the conclusion of the JPL CORPORAL program, four primary sources of quantitative, experimental, CORPORAL aerodynamic data were available: subsonic free-flight of fractional scaled models, jet-vane force and movement data from motor static firings, supersonic wind-tunnel tests, and telemetered and ground-recorded data from CORPORAL firings.²⁹

(S) Model flight tests were carried out in October 1950 to determine the center-of-pressure location at subsonic speeds of 1/10-scale CORPORAL models with burning jet, both with and without control surfaces. Missiles tested were modeled after an early version of the redesigned CORPORAL E Round 11 and corresponded to a full-scale missile 520 inches long.³⁰

(S) The planforms, thickness distributions, and materials, used in early CORPORAL jet vane tests were selected on the basis of theoretical considerations, availability of appropriate materials, and available experimental results from other missile programs. Between April 1946 and February 1947, a series of eight tests were carried out on rectangular vanes at the ORDCIT Test Station, Muroc, California. A special vane tester was designed and built which permitted oscillating the vanes uniformly at a rate approximating 3.5 deg/sec within the desired angular limits.

(S) The normal force, hinge moment, and chord force of the vanes were measured by means of strain gauges cemented to the vane test shaft. Water circulating through a hole bored down its center maintained the shaft at constant temperature.³¹

29. JPL Report Nr. 20-100, op. cit., p. 24.

30. Ibid.

31. Ibid.

UNCLASSIFIED

~~CONFIDENTIAL~~

(S) The vane tester was revised and rebuilt between the fourth and fifth jet-vane tests, thereby greatly improving both the method of calibration and data reliability. Slight changes were made in vane design.³²

(S) It was the main purpose of these tests to determine whether or not the vane material and structural design were capable of withstanding the loads and erosive action produced by the exhaust jet of CORPORAL's motor, as revealed by such tests, vane damage was most severe at the inboard tip of the leading edge and at the point where the edge of the jet crossed the wedge leading edge.³³

(S) The structural redesign carried out prior to the firing of CORPORAL E Round 4 left the jet vane configuration unchanged from the aerodynamic point of view.

(S) Because of extensive aft-section damage occurring during Round 4's flight, additional jet vane tests preceded the launching of Round 5. These tests were conducted in conjunction with six static firings at Muroc between August and December 1949. As a result, a vane configuration was adopted having a 1½-inch greater span and attached 1½ inches farther outboard than previously. CORPORAL Type I inherited the basic jet vane configuration resulting from these static tests.³⁴

(S) In September 1950, the first of a series of supersonic wind-tunnel tests was undertaken to develop a CORPORAL configuration utilizing Delta-shaped wings and having a much smaller static stability margin than was the case with earlier configurations. These were 1/48-scale model tests, conducted in JPL's 12-inch supersonic windtunnel. The models did not incorporate the appropriate external pipe and wire fairings. Effects of deflecting the elevators at eight degrees were measured.³⁵

(S) Additional 1/48-scale model tests employing a more finely constructed model occurred in October 1950 in the same wind tunnel. Two fin designs were tested, the smaller corresponding in planform and

32. Ibid.

33. Ibid., pp. 24-25.

34. Ibid., p. 25. (Ref. Chapter VII and Document 19 for results of CORPORAL E firings.)

35. Ibid., p. 26.

~~UNCLASSIFIED~~
~~CONFIDENTIAL~~

thickness distribution to those used in the 1958 CORPORAL. Two nose sections, composed of a series of truncated cones, with full-scale maximum diameters of 34 and 31 inches, respectively, were also tested.³⁶

(S) In May 1951, further tests of a 1/48-scale model in the 12-inch supersonic wind tunnel were performed. This model had the smaller of the two segmented noses mentioned above and a fin planform and thickness distribution corresponding to those of the 1958 CORPORAL. The primary purpose was to determine the effects of local flow nonuniformities on test measurements. Results at least qualitatively resolved the incongruities of missile stability obtained at Mach 2.8 and Mach 3.0 in preceding tests.³⁷

(S) JPL in July 1951 conducted 1/30-scale model tests in the Laboratory's 20-inch supersonic wind tunnel to verify test results obtained in the 12-inch tunnel and to extend Mach number range to 3.6 per cent. Except for the absence of simulated external pipe and wire fairings, the model configuration tested corresponded to that of the 1958 tactical CORPORAL.³⁸

(S) The last and most complete of the wind-tunnel tests which could be considered an integral part of the CORPORAL development program occurred in January 1952 and were performed on a 1/30-scale model in the 20-inch supersonic wind tunnel. Again external pipe and wire fairings were omitted; otherwise it corresponded to tactical CORPORAL's configuration. These tests were performed in a Mach number range from 1.61 to 4.50.³⁹

(S) Further tests of a 1/30-inch scale CORPORAL were carried out in the 20-inch wind tunnel as a part of another development program at JPL. In September 1953, a CORPORAL model was tested, incorporating the external pipe and wire fairings used in Types I and II missiles, but excluding the Doppler antenna fairings used in Type I. Essentially the same CORPORAL model was tested in September 1954; it differed in having a cylindrical section 1.36 calibers longer (18.69 calibers total length).⁴⁰

36. Ibid.
37. Ibid.
38. Ibid.
39. Ibid.
40. Ibid.

~~UNCLASSIFIED~~

~~CONFIDENTIAL~~

UNCLASSIFIED

(S) The above supersonic wind-tunnel tests permitted estimation of center-of-pressure location and normal-force coefficient slope as functions of Mach number to a good accuracy. Control surface effectiveness was measured during only one of these tests and could not be reliably determined solely from data thus obtained. Hinge moments were not measured. The fore drag measurements made were of but limited usefulness, since determination of the drag component due to wave drag required estimation of viscous drag. Useful base drag could not be obtained at all. Presence of pipe and wire fairings in the pitch plane had a noticeable effect on the center-of-pressure location in the yaw plane (approximately 1/2 caliber destabilizing). Additional effects due to the presence of Doppler antenna fairings, however, could only be surmised, since no model tests including them were carried out.⁴¹

Firing Tests

(C) When the first firing tests of CORPORAL were made in 1947 to 1950, the JPL research staff personally supervised each launching. As such tests became more frequent, this was impracticable, since it interfered too much with regular research. Consequently, in 1951, a Field Operations and Test Section (FOTS) was formed to conduct research firings for JPL and to coordinate JPL activities with WSPG. This group became residents of WSPG early in 1952, after having been activated in August 1951.⁴²

(S) The first Firestone-manufactured CORPORAL, which incorporated all the significant features of CORPORAL E Round 11, was fired at WSPG on 7 August 1952. During that month, two more Firestone missiles were launched. These missiles were incomplete with reference to guidance equipment, since the radar command unit and the range correction unit had not yet reached a satisfactory production stage and could not be used in the production firing tests. All rounds manufactured by

41. Ibid. (These tests formed the pattern and laid the groundwork for the type of static testing later employed by ABMA for JUPITER and REDSTONE. Mr. N. L. Cropp, Publications Officer, Reports Branch, ABMA Control Office.)

42. Seifert, JPL Publication Nr. 22, op. cit., p. 30

UNCLASSIFIED

~~CONFIDENTIAL~~**UNCLASSIFIED**

Firestone were nevertheless delivered to JPL, where they were dismantled, inspected, reassembled, and preflight tested before shipment to WSPG for firing tests.⁴³

(C) The test-firing program under the auspices of FOTS included not only research launchings but also the evaluation of tactical field-handling equipment. Thus, the clumsy gantry crane was replaced by a missile erector truck, and separate vehicles for servicing, propellants, compressed air, and portable launcher were provided. The first full-scale field test using tactical ground equipment was held in September 1952, and the electronic ground equipment was repackaged into smaller, more mobile vans that year. Field tests began to acquire greater realism through the setting up of launchings under tactical conditions, by "off-set" firings, in which the missile was brought into the radar beam from a laterally displaced position by autopilot alone, and in numerous other ways. During the course of these field firings, simultaneous tests on various types of warhead were conducted by the warhead agencies.⁴⁴

(S) By June 1953, Firestone had delivered approximately 50 missiles to JPL. Gilfillan Brothers, Inc., the prime contractor for the ground guidance equipment, had already turned out 4 ground guidance centers. Changes and improvements were being introduced so rapidly that JPL had to set up a missile modification activity (Cf above) to modify these missiles coming directly from production before they were flight-worthy and compatible with the ground guidance equipment. JPL carried out extensive firing and laboratory tests of the Type I production system as well as tests of the system components. As a result of this rigid preflight evaluation program, JPL was able to submit suggestions

43. JPL Report Nr. 20-100, op. cit., pp. 8-10; Pickering, W. H., Publication Nr. 45, "History of Ordnance Research at the Jet Propulsion Laboratory 1 June 1953 through 31 December 1954," pp. 3-5, JPL/CIT, 1 May 1955. See Document 20 for tabulation of ORDCIT test vehicle and CORPORAL firings through 1955 and Document 22 for military characteristics and early firings of CORPORAL I.

44. Seifert, JPL Publication Nr. 22, op. cit., p. 30

UNCLASSIFIED~~CONFIDENTIAL~~

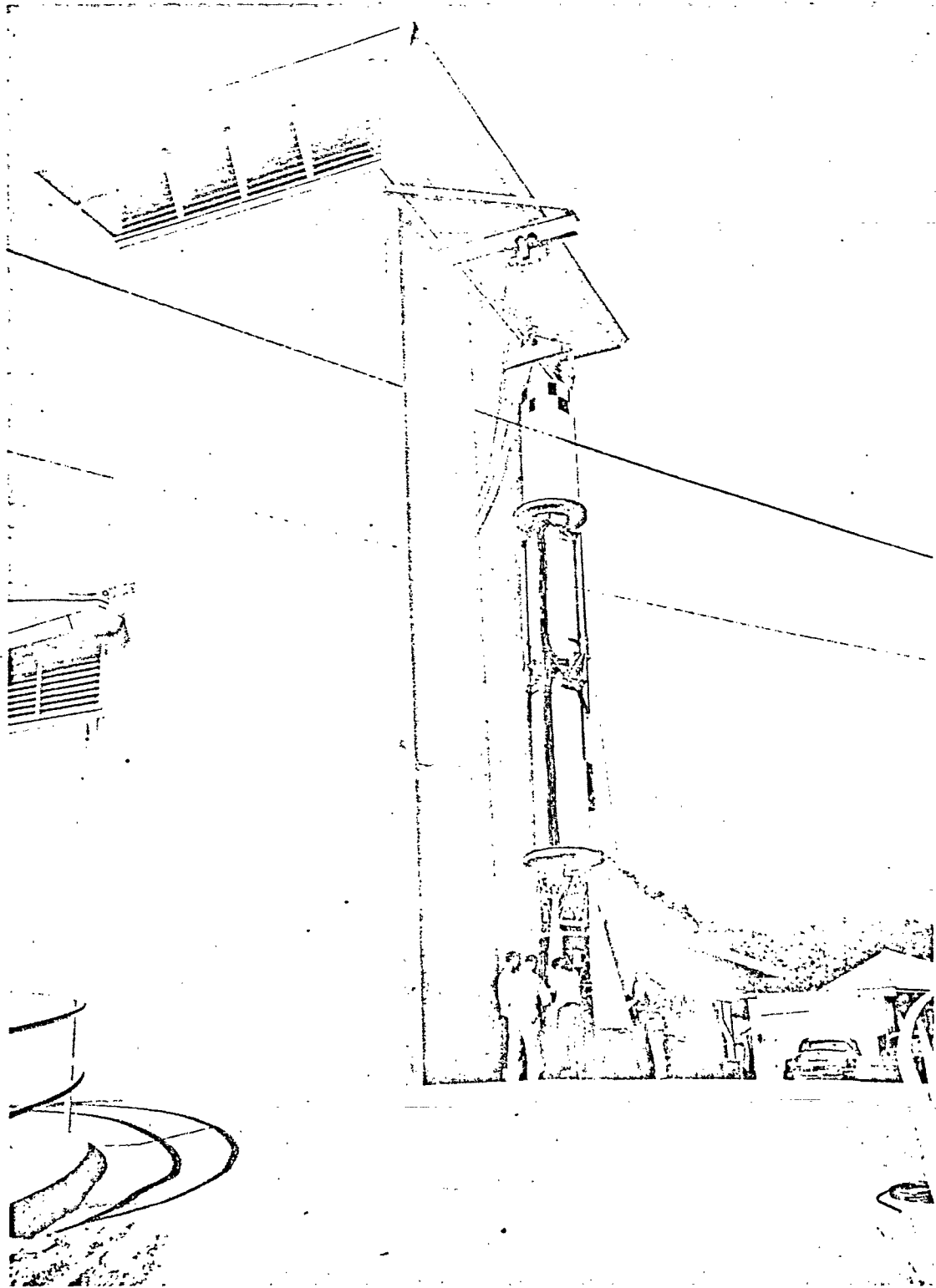

CORPORAL I ABOUT TO UNDERGO TEST AT JPL HYDRAULIC TEST FACILITY

UNCLASSIFIED



JPL MISSILE ASSEMBLY BUILDING WITH CORPORAL I
ROUNDS BEING DISMANTLED, INSPECTED, AND REASSEMBLED

UNCLASSIFIED

UNCLASSIFIED

to Firestone to assist in expediting factory production of acceptable rounds.⁴⁵

(S) Approximately 40 missiles were fired between 1 June 1953 and 31 December 1954, and various difficulties were encountered during this Type I evaluation program. The most flagrant of these involved the propellant shutoff circuit, which affected the range control mechanism. Missiles were fired at ranges of 30, 50, and 70 statute miles. CORPORAL showed a greater dispersion in range than in azimuth, and the Type I program demonstrated a CPE of approximately 500 meters. In view of the fact that many unique experiments were being conducted during this phase, this was considered satisfactory. Moreover, these experiments were more likely to cause errors or failures than would be the case in normal tactical operations. Such experimentation was necessary during the design and development of such a new weapon system, although these experiments themselves did not necessarily result in the over-all accuracy record of the Type I CORPORAL.⁴⁶

TYPE I ENGINEER-USER PROGRAM

(S) Planning was already under way for the Engineer-User (E-U) Program in the spring of 1952. The first E-U missile failed to arrive in September 1952 as scheduled and was delayed until early January 1953. A JPL report had the following to say concerning the E-U testing program:

Past conventions have usually dictated that any new weapon development be given engineering tests by that arm of the Army which has had responsibility for the particular weapon program. These tests have then been followed by tests of the weapon under operational conditions, as conducted by the using arm of the service. This practice was somewhat altered insofar as the CORPORAL was concerned. In the interests of saving time, money, and manpower, a joint team of Army Ordnance Corps and Field Forces personnel was formed as an Engineer-User Team for the CORPORAL missile.

45. JPL Report Nr. 20-100, op. cit., pp. 8-10; Pickering, W. H., Publication Nr. 45, op. cit., pp. 3-5.

46. Ibid. See Document 27 for Charts of Firings.

UNCLASSIFIED~~CONFIDENTIAL~~

UNCLASSIFIED



CORPORAL I MOTOR RECOVERED AFTER IMPACT

UNCLASSIFIED

~~CONFIDENTIAL~~
UNCLASSIFIED

157

(S) This team was organized at WSPG, the testing program initially used missiles which had been modified by the JPL preparatory to release to the E-U team. The group also used ground guidance and handling equipment which was obtained at this Laboratory and subjected to various modifications prior to release for E-U tests.⁴⁷

(U) Thus was CORPORAL research and development merged with actual use in the field, a practice mutually educational as well as economical, as mentioned above, and it was another CORPORAL first. Engineering personnel, during E-U firings, were able to see CORPORAL in action and note its faults and idiosyncrasies. From that fact, plus the perhaps caustic criticism and suggestions for improvement voiced by users, engineers gained an insight leading to improved reliability of the whole CORPORAL system, including ground handling equipment. In turn, users received instructions in proper preparation of CORPORAL for firing and in launching techniques as well as in caring for CORPORAL in storage.*

(S) Fourteen rounds were fired in the E-U Program from 30 January 1953 through 22 January 1954. CORPORAL EU-1 (Firestone Serial No. 1247), was fired on 30 January 1953. After 165.8 seconds of flight, it impacted 70.61 meters right and 6,629.6 meters short of the target. Propellant shutoff occurred four seconds prematurely, causing the range correction system to operate at an improper time. The trajectory was unusually high, thereby contributing to the range shortage. After 23 seconds, the missile was 200 meters above the standard trajectory. This was the largest deviation from a standard trajectory of any of the 14 rounds but was not considered excessive as the elevation system was capable of compensating for at least 600 meters.**

(S) CORPORAL EU-2 (Firestone 1251) was fired on 26 February 1953 and impacted 6,936 meters right and 84,072.3 meters long after 183.18 seconds of flight. The Doppler unit transmitted the fuel shutoff signal

47. JPL Report 17 or 20-100, op. cit., p. 10.

* This practice of joint engineer-firing, initiated as outlined above, has become fixed in missile development. Mr. N. L. Cropp, ABMA Control Office.

** See Document 26 for detailed flight analysis of this series of E-U firings.

UNCLASSIFIED

~~CONFIDENTIAL~~

~~CONFIDENTIAL~~**UNCLASSIFIED**

at the proper time--54.05 seconds, but the missile failed to respond. It burned until the fuel was exhausted, thereby accounting for the extremely long range. Evaluation of the flight data indicated that the Doppler shutoff signal from the ground was not acted upon by the shutoff circuitry of the missile Doppler transponder.

(S) Round (Firestone 1261), launched on 23 March 1953, impacted 3,606.94 meters right and 1,351.2 meters long after 171.59 seconds of flight. In this round, the missile responded properly to the shutoff signal. It achieved a satisfactory flight and flew a trajectory that deviated only slightly from the standard.⁴⁸

(S) Of the remaining 11 rounds fired during the E-U program for Type I CORPORAL, only Round 8 (on 13 August 1953) and Round 14 (on 22 January 1954) were evaluated as complete failures. Only Rounds 7, 12, and 13 (fired on 4 August 1953, 15 December 1953, and 12 January 1954, respectively) were, however, considered fully successful. These three rounds averaged approximately 170 seconds in flight and attained an average range of around 64 Kilometers (40 miles). Miss distances ranged from 25.6 meters right and 548.7 meters long for Rounds 7 to 12 and 960.7 meters left and 7,799.8 meters short for Round 13.

(S) Round 4 (on 14 May 1953) was shut off by Range Safety at 68 seconds because it entered a heavy overcast of clouds and was lost by radar and optical trackers. It traveled only 23.7 km.

(S) On 8 June 1953, Round 5 reached correction velocity at 170 seconds instead of the programmed 116 seconds. Its flight lasted for 183.5 seconds, and impact occurred 45.22 miles from the launcher.

(S) A large miss distance resulted from an error in the shutoff equation sent to Round 6 during its flight on 7 July 1953, but it flew for 205 seconds and achieved an 82.3 km range.

(S) After the firing of Round 8, the central power system failed. At 30.5 seconds the forward and aft sections of the missile broke apart,

48. Brown & Others, Development & Testing ... at WSPG, op. cit., p. 179; Technical Report Nr. 39, "Flight Analysis of First Fourteen Rounds of CORPORAL Type I fired in E-U Program," pp. 13-60, Technical Staff, WSPG, Released December 1954.

UNCLASSIFIED~~CONFIDENTIAL~~

terminating thrust. The aft section impacted 61.14 seconds later, 7.029 miles from the launcher. Having followed a shorter trajectory, the nose section impacted 2.34 miles from the launcher.⁴⁹

(S) Rounds 9 (1 October 1953), 10 (13 October 1953), and 11 (27 October 1953) all had large miss distances due to malfunctions in the range correction systems. Otherwise, the tests were satisfactory. Ranges averaged more than 52 km, with flight times averaging about 160 seconds.⁵⁰

(S) A dense cloud of smoke poured from the side of Round 14 just before takeoff (22 January 1954). Post-flight analysis indicated that an aniline leak probably caused this vaporization but that the leak had no apparent effect on the function of the propellant system. The missile yawed hard to the right at takeoff plus one second. It began to roll at nine seconds. For five more seconds, it continued in a northease direction and then impacted only 3,070.21 feet from the launcher, just 14.2 seconds after takeoff. Data indicated that a failure of the north servo system, due to intense vibration during the countdown and takeoff, caused the hard right yaw. The roll was caused by abrupt action of the south fin in response to the yaw-right error signal.⁵¹

EVALUATION OF THE E-U TESTS

(S) Summarized, the results of these tests indicated that (1) the accuracy of the azimuth system met military requirements; (2) the accuracy in range could not be determined; (3) 21 per cent of the rounds (Rounds 3, 4, and 7) had range errors attributable to random errors consistent with the equipment flown; (4) component malfunctions occurred approximately 54 per cent of the time, preventing the system from accomplishing its mission; (5) the majority of the malfunctions occurred in the missile; (6) malfunctions of components during the preparation for

49. Technical Staff Report Nr. 39, op. cit., pp. 65-153, 213-246; Brown et al, op. cit., pp. 179-180.

50. Technical Staff Report Nr. 39, op. cit., pp. 156-211; Brown et al, op. cit., pp. 180-181.

51. Technical Staff Report Nr. 39, op. cit., pp 249-260; Brown et al, op. cit., p. 181.

~~CONFIDENTIAL~~
UNCLASSIFIED

the mission caused excessive increases in preparation times (in this connection, while Rounds 2, 4, and 6 were being emplaced in the launcher, rain caused many components to malfunction. The missiles could not be fired until their interiors had thoroughly dried.); (7) one or more errors of personnel resulting from incomplete training accounted for 18 per cent of the failures, indicating that the operating personnel for this system had to be extremely well-trained; and (8) seven per cent of the failures were attributable to errors in determining the system's settings without firing tables.

(S) Since the firing tables (FT CORPORAL A-1) were not available, system settings had been calculated at WSPG on the basis of trajectories previously calculated at JPL, at BRL/APG, and at WSPG.⁵²

TRAINING PROGRAM

(C) In January 1954, Operation BONDOQUE was conducted by personnel from JPL, the Ordnance Corps, and the prime contractors to determine the tactical feasibility of the complete Type I CORPORAL system and to provide information to be used in writing operating and maintenance manuals. After the firing of E-U Round 14 on 22 January 1954, the E-U team suspended firings for a few months. In March 1954, JPL conducted a school on the CORPORAL system. It was attended by 14 E-U personnel, including officers, enlisted men, and civilians. The course continued for three months and covered all aspects of checkout and firing the missile.

(C) By the spring of 1954, it became evident that the introduction of the CORPORAL to the Army Field Forces (AFF) had posed many more problems than had been originally anticipated. There was consequently a great need for more complete and accurate technical information than was currently available in the field. To alleviate this situation, JPL was requested to assume a greater degree of over-all program coordination. The JPL Field Operations and Training Section at WSPG provided field consultation to various field agencies. During the summer of 1954,

52. Technical Report Nr. 39, op. cit., pp. 1, 1, 11. See Document 26 for detailed flight analysis of this series of E-U firings.

UNCLASSIFIED

~~CONFIDENTIAL~~

UNCLASSIFIED

Field Force, Ordnance, contractor, and laboratory personnel held joint meetings and determined a feasible set of operating procedures acceptable to all concerned. In addition, the CORPORAL Technical Consultants Office, composed of one representative each from JPL, Firestone, and Gilfillan, was established at Fort Bliss to aid the field units in conducting operations and to help keep current information flowing. JPL also inaugurated (in July 1954) a CORPORAL NEWS BULLETIN. This publication provided all agencies concerned with the CORPORAL system accurate, up-to-date information on equipment and procedural changes as soon as they were put into the system, as well as serving as a distribution medium for all Modification Work Orders.⁵³

53. Brown et al, op. cit., p. 182; Pickering, Publication Nr. 45, op. cit., pp. 6-7; Report, "Ordnance-Contractor Technical Committee Investigation of Type I CORPORAL System Operation and Support in the Fort Bliss, Texas, Area during the Period 21-26 June 1954," with penciled comments of the then Brig. Gen. H. N. Toftoy, Deputy Commanding General, Redstone Arsenal. (This extremely critical evaluation and the insistent drive of General Toftoy sparked the training and communication activities mentioned in the paragraph immediately above: "This report describes the findings and recommendations of a special group of technical personnel known as the 'Ordnance-Contractor Technical Committee for Type I CORPORAL,' organized by Brig. Gen. H. N. Toftoy, Deputy Commanding General, Redstone Arsenal, for the purpose of investigation of the technical problems which might limit the effective employment of the Type I CORPORAL.)

"The investigation was deemed necessary due to the difficulties encountered by the 2d GM Group, Fort Bliss, in accomplishing successful training flights, and due to the early deployment of an FA Missile Battalion (CORPORAL) and an Ordnance Support Company."

At a later date (6 October 1954), General Toftoy emphatically expressed his displeasure at Firestone's lack of progress after a visit of two Firestone representatives to discuss CORPORAL production:

"They were informed by the undersigned [HNT] that progress to date has been unsatisfactory and disappointing. They were told of necessity of concentrating on getting a satisfactory system in hands of the field forces--working closer as a team with JPL, Gilfillan, Ord; providing capable and experienced technical people to do the job right, not expanding into associated fields and getting over their heads."

UNCLASSIFIED~~CONFIDENTIAL~~

~~CONFIDENTIAL~~
UNCLASSIFIED

FIELD FORCE PROGRAM

(S) Late in 1953, after troops had been trained at the Guided Missile School, Fort Bliss, Texas, three CORPORAL Field Artillery Missile Battalions (the 246th, the 247th, and the 259th) were activated. These units were still receiving items of basic equipment as late as mid-1954, when field-firing operations were underway at Red Canyon Range Camp, WSPG.

In a lecture delivered by Dr. William H. Pickering, Director, JPL, at the Industrial College of the Armed Forces, Washington, D.C., 22 January 1958, he had much to say about missile production problems. After completion of the formal lecture, there was a question and answer period, with one of Dr. Pickering's answers alluding directly to CORPORAL:

QUESTION: (Speaking of development of missiles) "Even though you develop these things in Government plants, what about the problems of mass-producing them? Would not the Government have to have large mass-production plants? Do you think we would ever come to such a situation? Don't you think there are firms ... who can develop a whole weapon system?"

DR. PICKERING: "Yes, there are."

QUESTION: "In talking about having Government facilities develop our weapon systems, do you also envisage the Government having the capability of mass-producing them?"

DR. PICKERING: "That problem certainly exists. I would like to point out, however, ... that the production problem has been somewhat overemphasized. ... The problem is largely one of education and training. When one starts out, he wouldn't appreciate that in effect this [education and training] has to go into industry. Again, the education, ending up with planning to have the industrial group take over, will solve the problem."

"I will point out that in the case of CORPORAL I think the problem was a miserable mess; that the transition from the laboratory to production on CORPORAL was not at all satisfactory. Perhaps that is more representative of this sort of thing that one hears about."

Pickering, W. H., "Management Techniques for the management and Development of Weapon Systems," Publication Nr. L58-90, Industrial College of the Armed Forces, Washington, D.C., 22 January 1958.

UNCLASSIFIED

~~CONFIDENTIAL~~

UNCLASSIFIED

(S) Initial firing tests in the Field Forces program were considered unsatisfactory for a variety of reasons. A fact-finding conference was held at Fort Bliss during the latter half of June 1954. It was attended by representatives from WSPG, Fort Bliss, OCO, Redstone Arsenal, JPL, Firestone, and Gilfillan Brothers. A committee was appointed to establish the facts and to make recommendations to the agencies involved. This committee determined that supplies of spare parts were deficient and that usable information about the CORPORAL system was not being distributed freely to those having a need for it at the lowest operating levels. Over a period of time, these difficulties were rectified. JPL began publication of a biweekly newsletter for the exchange of pertinent information among the contractors, training schools, user troops, test agencies, and administrative organizations (Cf above). The committee produced detailed instructions concerning operating and maintenance procedures, resulting in standardization in all phases of the program. An office for technical consultants was opened and staffed at Fort Bliss to provide direct engineering field service and consultation for user units (Cf above and note 53).⁵⁴

(S) Late in 1954, the 259th Field Artillery Missile Battalion fired four successful training rounds in the Field Forces Program at Red Canyon Range Camp, WSPG. In January 1955, the 259th was deployed to Europe with full Type CORPORAL field equipment and accompanied by the 96th Ordnance Direct Support Company.⁵⁵

TESTS CONTINUED

(S) In the meantime, in May 1954, E-U Rounds 15 and 16 had been fired jointly by the E-U team and JPL personnel. In June 1954, a high-altitude shoot employing extensive instrumentation for the BRL/APG, was highly successful.

54. JPL Report Nr. 20-100, op. cit., pp. 8-16; Brown & Others, op. cit., pp. 183-184.

55. Ibid. (The 96th was formed at WSPG late in 1953 or early in 1954 and transferred to Fort Bliss. Mr. N. L. Cropp, ABMA Control Office.)

UNCLASSIFIED~~CONFIDENTIAL~~

~~CONFIDENTIAL~~
UNCLASSIFIED

(S) During 1954 JPL subjected new and critical missile components to severe vibrational environment tests as well as to environmental tests of extreme heat and cold. Both propellants and motor were subjected to these performance tests in environments varying from extreme heat to extreme cold.

(S) From August until November 1954, at the request of the Chief of Ordnance, the E-U team conducted various climatic tests with the CORPORAL missile. One phase involved temperatures ranging from 60 degrees below zero to 180 degrees above zero, Fahrenheit. Another test phase involved temperature variations and humidity tests. These E-U tests were conducted in addition to the JPL firing schedule and resulted in extra efforts on the part of the firing crews, who used the same checkout equipment for both regular firing and climatic tests.⁵⁶

56. Pickering, Publication Nr. 45, op. cit., p. 5; JPL Report Nr. 20-100, op. cit., pp. 359-360; Brown & Others, op. cit., p. 182. See Document 27 for Charts of CORPORAL Firings.

UNCLASSIFIED

~~CONFIDENTIAL~~

CORPORALS II, IIA, AND IIB

TRANSITION FROM TYPE I TO TYPE II CORPORAL

(C) A striking and noteworthy feature of CORPORAL development was the orderly progression from one phase to another, with two or more phases under theoretical and/or experimental investigation concurrently. CORPORAL was, for example, envisioned even before PRIVATE A was fabricated for firing, and models of both underwent wind tunnel tests on the same occasion (Cf Chapters I and II). Moreover, even as WAC CORPORAL A merged into WAC B, CORPORAL E had already progressed from drafting board to fabrication to firing (Cf Chapters IV, V, and VII). Knowledge pyramided through disproving or verifying by experimental testing theoretical calculations of propulsion systems* and propellants,** configurations, aerodynamic forces, trajectories, and environmental conditions, and CORPORAL E merged into CORPORAL I, the first phase of the CORPORAL tactical missile system (Cf Chapters VII and VIII).

(C) Although Type I equipment was deemed operable, it was recognized during production and firing tests that many system shortcomings existed, especially in the field of tactical useability (Cf Chapter VIII). Between production of the first order of Type I equipment*** and delivery of a second production order late in 1954, extensive engineering changes to correct obvious faults were made both in the missiles themselves and in ground equipment. These changes caused the second production order to be known as Type II.

* See Document 28 for Development of CORPORAL's Propulsion System.

** Discussed in footnote 9 below.

*** Douglas Aircraft Company fabricated the first 30 missiles. Firestone was awarded the initial Type I production contract for 200 missiles, later supplemented by another 120 missiles. Firestone also produced Type I ground handling equipment. Gilfillan Brothers, Inc., Los Angeles, California, contracted to furnish ground guidance equipment for the system. JPL Report Nr. 20-100, op. cit., p. 8. See Document 25 for Summarized Tables of CORPORAL's fiscal history.

~~CONFIDENTIAL~~
UNCLASSIFIED

(C) Because time allowed only those modifications in Type I equipment requiring no major redesign of system components, a contract* was initiated with Gilfillan Brothers, Inc., in 1953 for improving the reliability of electronic elements. This contract preserved the basic system guidance concept but allowed major component redesign for both missile-borne electronic components and ground guidance equipment. With JPL providing technical advice and consultation and performing evaluation in the field, Gilfillan continued to improve Type II CORPORAL's guidance equipment. These redesigned missile-borne electronic components were designated Type IIA and were compatible with Type II ground guidance. Gilfillan's contract was modified on 20 December 1955 to provide for incorporation of Type IIA guidance components in all missile production after 1 January 1957.¹

(C) Around the middle of 1953, JPL released to the Ordnance Corps initial design documentation for the Type II CORPORAL system (designated by JPL as CORPORAL XSSM-A-17a). Ordnance Contract Nr. DA-04-495-ORD-437 was awarded to Firestone for production of 465 of these newly designed CORPORAL missiles.** JPL had delivered most of the necessary information to the contractor.²

(C) In addition to providing this design information and consulting with contractors, JPL's work during 1953 and through the first half of 1954 consisted primarily of evaluating Type I production, Type II prototype equipment, and long-term missile system improvements, besides investigating system environments and continuing technical assistance to the Ordnance Corps. Starting in December 1953 and continuing through 1954, JPL completely rebuilt and launched certain Type I missiles as prototype vehicles for Type II electronic equipment.³

* Contract Nr. DA-04-495-ORD-468, dated 11 June 1953, for redesign of guidance equipment.

1. Pickering, JPL Publication Nr. 45, op. cit., pp. 3-4; JPL Report Nr. 20-100, op. cit., p. 11.

** CORPORAL II was known officially as XM2E-1. See Document 25 for tables summarizing contracts.

2. Ibid.

3. Ibid.

UNCLASSIFIED
~~CONFIDENTIAL~~

~~CONFIDENTIAL~~
UNCLASSIFIED

167

(C) In 1954, CORPORAL Type II missiles began to replace the Type I system among deliveries from Firestone's Los Angeles plant. Phasing this newer design into the flight-testing program began, although a number of Type I rounds still remained available. These were subsequently used by JPL, AFF, and Chemical Warfare Service as test vehicles for the new Type II program. The last Type I round was fired at WSPG in December 1954, except for those utilized for special tests and/or as "targets" for other missiles.⁴

(C) In addition to launching missiles for direct evaluation of the CORPORAL system, a few firings were conducted using specially modified missiles to determine the feasibility of radical design changes for future production runs and/or further missile systems. These flights included evaluation of an air-driven power supply as a possible substitute for the chemical batteries used in both the Type I and the Type II CORPORAL systems. Investigations were also initiated to evaluate the use of drag brakes on ballistic missiles as a means of controlling range. Two CORPORAL missiles were test fired with drag brakes; the first round contained fixed brakes, and the second, retractable brakes. Results of these tests were completely satisfactory.⁵

Changes in the Type II CORPORAL System

(S) A significant change from the Type I system was in the Doppler unit. Operating frequency was increased from the fixed-tuned DOVAP instrumentation frequency of 38 megacycles to the ultra high frequency (UHF) region, using a tunable missile transponder with an input frequency range of 450 to 480 megacycles. Other minor improvements were incorporated in the radio link to provide better tactical operation.⁶

-
4. Ibid. (Information as to the last Type I rounds fired was furnished by Field Support Operations, ABMA.
 5. Pickering, JPL Publication Nr. 45, op. cit., pp. 3-4; JPL Publication Nr. 99, op. cit., p. 4. The drag-brake experiments occurred in 1954, with both firings employing standard Type I CORPORAL and ground guidance. Flight 76 fired at a 37-km range, had fixed drag brakes. Flight 88, fired at a 122-km range, had retractable brakes.
 6. JPL Report Nr. 20-100, op. cit., p. 11.

UNCLASSIFIED

~~CONFIDENTIAL~~

UNCLASSIFIED ~~CONFIDENTIAL~~

(S) Launcher, erector, and servicing platform were also redesigned for the Type II system.⁷

(S) It should be constantly kept in mind that the CORPORAL missile was originally intended as a general test vehicle for the study of guided missile problems. Its design was undertaken at a time when most phases of the science of missile aerodynamics were relatively unknown. CORPORAL progressed through a series of configurations, and with each configuration the accuracy with which aerodynamic data could be predicted showed improvement. CORPORAL missiles fired after Round 11 (10 October 1951) all had essentially the same aerodynamic configuration. The two "standard" versions, Type I and Type II, differed principally in that Type I carried four DOVAP antenna spikes mounted on two fairings in the yaw plane of the missile. As a part of the redesign for Round 11, the 96-inch-long nose shape used in the earlier CORPORAL rounds was abandoned and a 65.5-inch-long shape was adopted, a change effected to reduce the over-all missile length. Type I generally included a 26-inch-long telemetering compartment, and the standard missile length with that compartment was 554 inches; without it, length was 527 inches.⁸

Propulsion System

(S) The Type II motor differed little, if any at all, from that of Type I. Weighing 122 pounds,* CORPORAL's motor developed 20,000 pounds of thrust for durations up to 64 seconds. CORPORAL utilized compressed air to pump a propellant combination of stabilized fuming nitric acid (SFNA) as the oxidizer and an aniline-furfuryl alcohol-hydrazine mixture as the fuel to the axially cooled motor, with the fuel serving as coolant.⁹ The tanks (propellant and air) had not

7. JPL Report Nr. 20-100, op. cit., p. 11.

8. JPL Report Nr. 20-100, op. cit., pp. 20-27.

* Weight is frequently listed as 125 pounds.

9. JPL Report Nr. 20-100, op. cit., pp. 59-61. (CORPORAL E propellants consisted of aniline (80 per cent) combined with furfuryl alcohol (20 per cent) as fuel. Oxidizer was RFNA, containing 6 per cent NO₂ by weight.)

UNCLASSIFIED~~CONFIDENTIAL~~

changed in design since the firing of Round 11 CORPORAL E (December 1951). As lighter, stronger, corrosion-resisting materials had become available, however, the tanks reflected such development.* Throughout the CORPORAL development, valves had undergone constant improvement making for certainty and efficiency of operations. Selection and development of this propellant system and development of the axially cooled rocket motor eventually proved to be one of the major achievements of the CORPORAL program. Motors used in all Firestone rounds were static-tested

For Rounds 1 through 10, the propellant tanks were designed to give a mixture ratio of 2.65, with the first three rounds operating at or near that design mixture ratio. With the advent of the light-weight axially cooled motor of Round 4, the actual operating mixture ratio dropped first to 2.45 and then to 2.2.

After Round 11, the propellant tanks were designed for an operating mixture ratio of 2.2 for the propulsion system-RFNA (6.5 per cent NO₂) as oxidizer and aniline (80 per cent) combined with furfuryl alcohol (20 per cent as fuel). This propellant combination had several tactical disadvantages. When stored in closed containers at the desired upper temperature limit of 160°F, the oxidizer developed excessively high pressures due to decomposition of HNO₃ into oxygen, NO₂, and water. A starting slug of two parts furfuryl alcohol and one part aniline had been used, but use of a separate starting fuel was undesirable from a tactical standpoint, requiring supply of two fuels and complicating missile fueling procedure. Moreover, the running fuel had too high a freezing point (0°F) for field use.

Numerous experiments with propellant combinations finally resulted in the combination in use as of 1958. The propellant mixture as of that date consisted of 46.5 per cent aniline, 46.5 per cent furfuryl alcohol, and 7 per cent hydrazine. SFNA having a nominal composition of 14 per cent NO₂, 2.5 per cent H₂O, 0.6 per cent HF, and the remainder HNO₃ constituted the oxidizer. Due to changes in density of the propellants, the operating mixture ratio of the missile became 2.13.

R/

quote from where? all glossary RFNA & SFNA

"Stabilization" referred to inhibition of decomposition of the oxidizer under certain conditions. The term in use as of May 1960 was "inhibited red fuming nitric acid (IRFNA)", the two designations apparently having the same meaning when employed in reference to the oxidizing component of CORPORAL's propellant combination. See D/A Technical Manual TM 9-5038-12, "WARNING," 5 May 1960.

* See Document 28 for Development of CORPORAL's Propulsion System.

~~CONFIDENTIAL~~
UNCLASSIFIED

on facilities at WSPG before becoming flight-tested with the other missile components.¹⁰

TEST FIRING OF CORPORAL TYPE II

(S) The first Type II prototype round was flown on 8 October 1953. This missile was Type I with components modified by JPL. This round impacted 234 meters short and 116 meters right, well within the CPE of 300 meters.

(S) The first ORD-437 missile manufactured by Firestone was fired on 28 October 1954, just 1 year after the first prototype operation. This round impacted 43 meters short and 169 meters right of the target. During the interval between the prototype and the production Type II firings, most of the launchers were Type I rounds containing nearly complete Type II modifications. These rounds used electronic components manufactured by Gilfillan, whereas, in Type I, Firestone had contracted directly with various electronic manufacturers for flight electronic equipment. In Type II production, all the missile electronic units were procured through Gilfillan. On an ORD-468 contract, Gilfillan also undertook improvement of both the ground and the flight electronic equipment. JPL provided technical advice and consultation and performed evaluation testing in the field.¹¹

(S) JPL fired 57 Type II rounds between the first ORD-437 firing on 28 October 1954 and the end of CY 1955. This contractor program was scheduled to continue in 1956. The E-U team fired 21 Type II rounds between February and December 1955; this firing program was also incomplete as of the end of CY 1955 and was scheduled to continue during 1956. Meanwhile, both CORPORAL R&D rounds and CORPORAL Test Vehicle rounds were being fired by project personnel at WSPG.

(S) In the fall of 1954, the E-U team and JPL worked together on four missile firings which comprised Operation SANDSPIT. This program was both an evaluation of Type II procedures testing and checkout equipment and a training exercise on the Type II missile. After a limited amount of training, the E-U team members in turn instructed other E-U

-
10. JPL Report Nr. 20-100, pp. 53-88 (dealing with propulsion in all its aspects); Pickering, JPL Publication Nr. 45, op. cit., p. 5; Brown & Others, op. cit., p. 187.
 11. JPL Report Nr. 20-100, op. cit., p. 11.

UNCLASSIFIED~~CONFIDENTIAL~~

~~CONFIDENTIAL~~
UNCLASSIFIED

personnel in Type II operational procedures. A complete Type II system arrived in February 1955, and the E-U team then proceeded with thorough proof tests of the Type II equipment. The team also undertook the check-out of three Type II rounds which had been scheduled by WSPG Electro-Mechanical Laboratories for climatic experimentation. After having completed five Type II CORPORAL firings by mid-July 1955, the E-U team continued a regular schedule of firings, which were still underway in 1957. Although some formal classroom training was conducted, new E-U crews learned mostly through actual work on missiles. The Type II evaluation program was essentially completed by mid-1957, when Type IIA tests began.¹²

(S) The aggregate CPE for all production (Type II) rounds fired by JPL was 350 meters, as compared with the desired CPE of 300 meters. Other rounds were fired for special experiments, but no attempt was made to record such flights for accuracy, since accuracy was only incidental to these operations. While all aborted flights would be considered as penalties in tactical operations, one evaluation was made with aborts not counted. The same Type II rounds calculated without aborts showed a CPE of 150 meters. A combination of results of all JPL firings (Types I and II), including aborted flights, gave a CPE of approximately 570 meters. With aborts eliminated for these same rounds, the resultant CPE was approximately 330 meters.¹³

(S) In the meantime, JPL was playing a decreasingly important role in CORPORAL affairs, although production and delivery in 1955 of the production Type II missile to the Army and to testing agencies did find JPL retaining technical control of the CORPORAL program through that year. Although most of JPL's technical control was relinquished by 1956, the Laboratory continued throughout that year to render technical assistance to Firestone and Gilfillan in executing Ordnance prime contracts, but on a reduced scale compared to that provided during 1955.

12. JPL Report Nr. 20-100, op. cit., pp. 314, 360-361; Brown et al, op. cit., pp. 188-189.

13. JPL Report Nr. 20-100, op. cit., p. 11; Brown et al, op. cit., p. 189. See Document 27 for Charts of CORPORAL Firings mentioned above.

UNCLASSIFIED

~~CONFIDENTIAL~~

UNCLASSIFIED

(S) The CORPORAL phase of JPL program 56 consisted primarily in evaluating new CORPORAL missile and ground components produced by Gilfillan under ORD-468. Representative of the type of improvements already introduced into ground equipment of Type I was a single elevation program for all ranges in the computer, thereby eliminating the need for eight potentiometers in the computer section. This resulted in simplification of firing table settings for Type II.¹⁴

(S) JPL had completed all CORPORAL research and development tasks by the end of 1955. The 1955 programs included development of the anti-countermeasures locked-loop filter for the Type II Doppler, the transistorized service-evaluation telemetry, the control-monitor group (tactical scorer, ground-guidance loop tester, and trainer), the protective missile cover, and so forth. No new CORPORAL development was carried out by JPL during 1956.¹⁵

(S) During 1955, JPL continued the recording of ground guidance signals and the analysis of these and other data (telemetry and trajectory, for instance) to evaluate the operation of JPL CORPORAL firings. These firings were primarily tests of Type II CORPORAL equipment and served to check and confirm the revised drag coefficient and improved procedures used in the calculation of the Type II firing tables, the revised seasonal density variations for WSPG, the technique used for compensating for the slightly longer-than-anticipated shutoff delay of the CORPORAL rocket motor, and the general operation of the Type II equipment.¹⁶

(S) Three CORPORAL Type IIA evaluation flight tests were conducted during 1956. The five major electronic components fabricated by

14. JPL Publication Nr. 99, "History of Ordnance Research at the Jet Propulsion Laboratory, 1 January 1955 through 31 December 1956," pp. 1, 22, JPL/GIT, 10 May 1957; Pickering, JPL Publication Nr. 45, op. cit., p. 4; "Research and Development Annual Guided Missiles Report," 1 October 1957, pp. 156-157. Department of the Army Pamphlet; Nr. 70-10, Chronological, History of Army Activities in the Missile/Satellite Field, 1943-1958, p. 86, Headquarters, Department of the Army, September 1958.

15. Ibid.

16. Ibid.

UNCLASSIFIED~~CONFIDENTIAL~~

Gilfillan--electronic control amplifier, automatic pilot flight controller, signal data converter, transponder set, and radio beacon--were environmentally tested at JPL and then flown for flight evaluation purposes in CORPORAL Type IIA. Gilfillan also undertook major redesign of the ground guidance service checkout and certain missile components. JPL supplied assistance in the form of consulting and advisory personnel during the three firings. With the completion of the CORPORAL IIA flight evaluation tests in July 1956 and the cancellation of the handbook requirement in August 1956, the CORPORAL project had no further contractual requirements of JPL.¹⁷

(C) The Type I CORPORAL system was issued to troops in 1954, only to be replaced in two years by Type II. By OTCM 36374, dated 15 November 1956, Type II CORPORAL (Guided Missile Artillery, M2 [XM2E1]) was classified as standard type. CORPORAL Type II Ground Guidance and Control Equipment and Ground Handling and Launching Equipment were classified as limited standard type.¹⁸

(U) Although development of CORPORAL III is discussed more fully in Chapter X, because of continuing research progressing from Types II and IIA to Type III, a brief summary is given here.

(C) Fabrication and assembly of Type III Ground Equipment was completed in August 1956. System part-assembly checkout was completed in February 1957, and the system was shipped to WSPG for flight evaluation tests. The completely redesigned guidance system incorporating all design changes, was designated Type III. As between CORPORAL II and CORPORAL III, the difference was largely in the ground guidance system. This effort's objective was to produce an increase in component and system reliability, accuracy, tactical useability, and maintainability.¹⁹

17. Ibid. (This was Contract Nr. DA-04-495-ORD-18.)

18. "R&D Annual Guided Missiles Report, 1 October 1957, op. cit., pp. 156-158; Department of the Army Pamphlet Nr. 70-10, "Chronological History of Army Activities in the Missile/Satellite Field, 1943-1958," p. 86, Headquarters, D/A, September 1958; Technical Information Report CD-3, OCO, August 1960, p. 24.

19. Ibid.

UNCLASSIFIED~~CONFIDENTIAL~~

(S) The Chief of Ordnance on 17 January 1956 had already directed the Commanding General, Redstone Arsenal, to continue the CORPORAL Type III program to provide an "on-the-shelf" item, which had a lower priority than that of other missile projects.

(C) Because of a limited research and development budget and the development progress on the SERGEANT system, a staff directive on 23 May 1957 cancelled the CORPORAL Type III program. After that date, program efforts were directed toward an orderly termination of the Gilfillan ORD-468 contract, with the terminal objectives of procuring completed prototype equipment and limited documentation. In July 1958 CORPORAL II was reclassified standard B.²⁰

ARMING THE CORPORAL

(S) As early as 11 August 1950, as a phase of the "crash" program for CORPORAL, the Deputy Chief of Staff, G-4, for R&D proposed to G-3 that CORPORAL I be provided the capability of delivering the ELSIE, THOR, or conventional warheads. Then, on 30 December 1950, the CORPORAL missile was approved as an atomic warhead carrier of the XW-7 warhead, and the Atomic Energy Commission (AEC) was given responsibility for warhead development. The end of the year 1950 found the CORPORAL missile being developed for a range of 26 to 75 nautical miles, with a 1500-pound warhead.²¹

(S) On 15 March 1951, the Secretary of the Army informed the Director of Guided Missiles that he was recommending acceleration of the CORPORAL program "to provide an expedient weapon capable of carrying the XW-7 atomic warhead to a range approximately 75 nautical miles with an accuracy compatible with the radius of such a warhead." An XW-7/CORPORAL Ad Hoc Working Group was formed with representation from Sandia Corporation, Armed Forces Special Weapons Project (AFSWP), Army Ordnance, Army Field Forces, Chemical Corps, Redstone Arsenal, and National Bureau of Standards. Among the original recommendations were that

20. Ibid.

21. D/A Pamphlet Nr. 70-10, op. cit., pp. 81-82, 85, 86; R&D Annual Guided Missile Report, D/A, op. cit., pp. 161-164, 168-173. See Document 21 for extracts from CORPORAL Arming Philosophy.

UNCLASSIFIED~~CONFIDENTIAL~~

(1) Sandia Corporation be responsible for development of the Model 0 fuzing system for XW-7/CORPORAL; (2) Army Ordnance be responsible for the arming system; (3) Sandia Corporation be responsible for picking up the arming signal at the point of reception in the missile; (4) Sandia Corporation start development work on improved arming systems.²²

(S) Responsibility for the CORPORAL atomic warhead adaption kit was, on 1 January 1955, transferred from AEC to the Office, Chief of Ordnance. In October 1955 the XW-7 atomic warhead installation improvement program was temporarily suspended because of lack of funds. It was 24 June 1956 before the Chief of R&D directed reactivation of an improved adaption kit (XM56E1)* for the XW-7 atomic warhead for the CORPORAL.²³

(S) During the same period devoted to perfecting an atomic warhead for the CORPORAL, Picatinny Arsenal, APG, Army Ordnance, Department of the Navy and Rheem Manufacturing Company (with Picatinny Arsenal the directing agency) were cooperating in developing fragmentation warheads. Diamond Ordnance Fuze Laboratories, with the Ordnance Corps as cognizant agency, were at the same time developing proximity fuzes for both chemical and fragmentation warheads. The proximity fuze was to "offer an accurate burst height at a selected altitude ... to achieve the maximum effect of the ... warhead."²⁴

COST OF THE CORPORAL PROGRAM

(S) By the end of FY 1955, the total dollar value of all CORPORAL contracts which had been executed was \$199,423,694. This included \$39,470,388 in the R&D program, \$159,248,719 in the Industrial program, and \$704,587 in the Field Service program. Even though the contracts had been executed by 30 June 1955, actual delivery of many items contracted for in the Industrial and the Field Service programs was not scheduled until CY 1956. Completion of some contracts in the R&D program was also scheduled for 1956 or later. The Department of Army

22. Ibid.

* XM56E1 Adaption Kit was developed as a shelf item only. XM56 was the latest production model as of 15 March 1961. Col. O. M. Herch, Ordnance Corps, Director, ABMA Industrial Operations. *Herch*

23. Ibid.

24. Ibid.

considered the CORPORAL program as a "very economical" one. At the end of 1957, CORPORAL's total funding for FY 1957 and prior was \$42 million for R&D and \$216.88 million for P&P.* The budget for FY 1958 called for \$10.3 million for P&P.²⁵

(S) Approximately 900 CORPORAL missiles had been produced by the end of CY 1957. These included both Type I and Type II missiles and also those produced for the British. It was expected that the end of FY 1958 would find approximately 190 missiles available for U.S. stockpile.²⁶

(S) Approximately 400 CORPORAL missiles had been fired by the end of CY 1957. The recent firings had demonstrated that the system had a CPE of less than 300 meters,** and an in-flight reliability of approximately 75 per cent as compared to less than 50 per cent in 1955.²⁷

(U) Many references have been made in regard to reliability of CORPORAL's various components, particularly those relating to guidance and control and even more particularly to ground guidance, as well as CORPORAL's reliability as an entity. The following section will summarize some of the test results and conclusions.

(S) According to a JPL status report on the CORPORAL system (dated 22 September 1952), 22 rounds had been fired to that date, including Round 11 (the final CORPORAL E) and 4 Firestone missiles. JPL spent two months checking, modifying, and reworking the production rounds from Douglas and Firestone. Nevertheless, field tests indicated about one failure per flight.

* P&P: Procurement and production - this designation was changed to PEMA.

25. Brown & Others, op. cit., pp. 189-190; DA Pamphlet Nr. 70-10, op. cit., p. 87; "Ordnance Guided Missiles & Rocket Programs, Vol. III, CORPORAL," op. cit., pp. 169-201. See Document 25 for Fiscal History of CORPORAL.

26. DA Pamphlet Nr. 70-10, op. cit., p. 87. See Document 25 for tabulations of funding and procurement.

** Ordnance and AFF desired a CPE of 150 meters, though a 300-meter CPE was acceptable.

27. Ibid.

~~CONFIDENTIAL~~
UNCLASSIFIED

(S) "The satisfactory performance of a system as complex as a guided missile requires that all components of the system have an exceedingly high reliability," the report said. "In practice the desired reliability is still not attained. Field tests to date indicate about one failure per flight. Fortunately, because of the CORPORAL system, most of these failures still permit the missile to impact in the target area.

(S) "The Laboratory is placing a great deal of emphasis on its reliability program and significant improvements in component performance can be expected."

(S) There was, indeed, great effort expended by JPL to achieve both component and missile system reliability, and on the date of the report (22 September 1952) JPL's plans called for the firing of 70 missiles at WSPG.²⁸

(S) In a study of a projected Army surface-to-surface missile family, CORPORAL's susceptibility to countermeasures was pointed out. Moreover, the system required many items of ground equipment and a correspondingly large number of personnel. Furthermore, mobility of the system left much to be desired, and time required for going into and out of action was excessive. In addition, many parts of the system had to be "peaked" for proper system performance and lacked ruggedness needed for a "workhorse" missile.

(S) It was, however, undoubtedly true that:²⁹

Development of the CORPORAL system was authorized and justified despite these shortcomings in recognition of the urgent need for a tactical support guided missile ... to be considered, however, only as an interim solution for the short-range missile. As such it has definitely contributed to the Army family of missiles, not only by making a guided missile weapon available in the shortest possible time but also by clearly pointing out all the mechanical and operational shortcomings to be avoided in "second generation" short-range missile design.

-
28. JPL Status Report on CORPORAL Guided Missiles, JPL/CIT, pp. 3, 5, 6-7, 10, 22 September 1952. See Document 22 for military characteristics and charted results of early CORPORAL I firings.
29. Army Surface-to-Surface Guided Missile Family (A Recommendation Based on a Study Survey of Military Requirements, Technical Capabilities, and Available Manpower and Funds) 17 Nov 1954, pp. 13-15.

~~CONFIDENTIAL~~
UNCLASSIFIED

~~CONFIDENTIAL~~
UNCLASSIFIED

(S) This criticism of the CORPORAL system substantiated the "Report of the SERGEANT Evaluation Committee," August 1954. Type II ground guidance was in process of production, and Type III was being projected. The latter was expected to result in a substantial reduction in equipment, improved radar data and circuits, some simplification in operation, training, and handling, and greater immunity to countermeasures--all of which would have resulted in greater reliability. Despite such improvements, however, the same old criticisms were valid: (1) The CORPORAL system failed to meet the desired dispersal of 300 to 8,000 meters distance between ground control station and launcher. (2) Countermeasure susceptibility was considered to be one of CORPORAL's principal weaknesses, as compared to the immunity that could be built into a new system. (3) Necessary ground equipment required high numbers of personnel to handle it and yet would not permit the required rate of cyclic firing. (4) CORPORAL required too much time to go into and out of action. (5) Many components had to be "peaked" for proper system performance, and testing was difficult. (6) For this same reason, the system was not rugged and failed to meet environmental criteria.³⁰

(S) In the fall of 1957, at WSPG, there were 37 firings of CORPORAL II missiles at nominal ranges of 55, 83, and 111 kilometers from the launcher. Analysis of data obtained from six flights revealed no statistical evidence that any significant difference in the six azimuth miss distance means (averages) was caused by varying the nominal range of the target or early termination of azimuth guidance. In addition, there was no statistical evidence that a bias, that is, to left, right, over, or under, existed in the over-all mean, or average, when compared to an expected value of zero, that is, the target itself.

(S) On the other hand, there was a definite increase in azimuth dispersion (variance) of the azimuth miss distance caused by terminating azimuth guidance early. The really large dispersion was at the long target-range with azimuth terminated early. The fact that early guidance

30. "Report of the SERGEANT Evaluation Committee," August 1954. (Committee members were W. W. Berning, W. S. Carlson, C. M. Hudson, P. W. Newton, W. H. Pickering, and A. K. Thiel.)

~~CONFIDENTIAL~~
UNCLASSIFIED

XSSM-A-17 CORPORAL TYPE II

MAIN CHARACTERISTICS

TAKEOFF WEIGHT	11,247 LB
EMPTY WEIGHT (INC. WARHEAD)	2,961 LB
OVERALL LENGTH	552 IN
BODY DIAMETER	30 IN
RANGE	26-70 NMI
SPEED, MACH NO	3.8 MAX

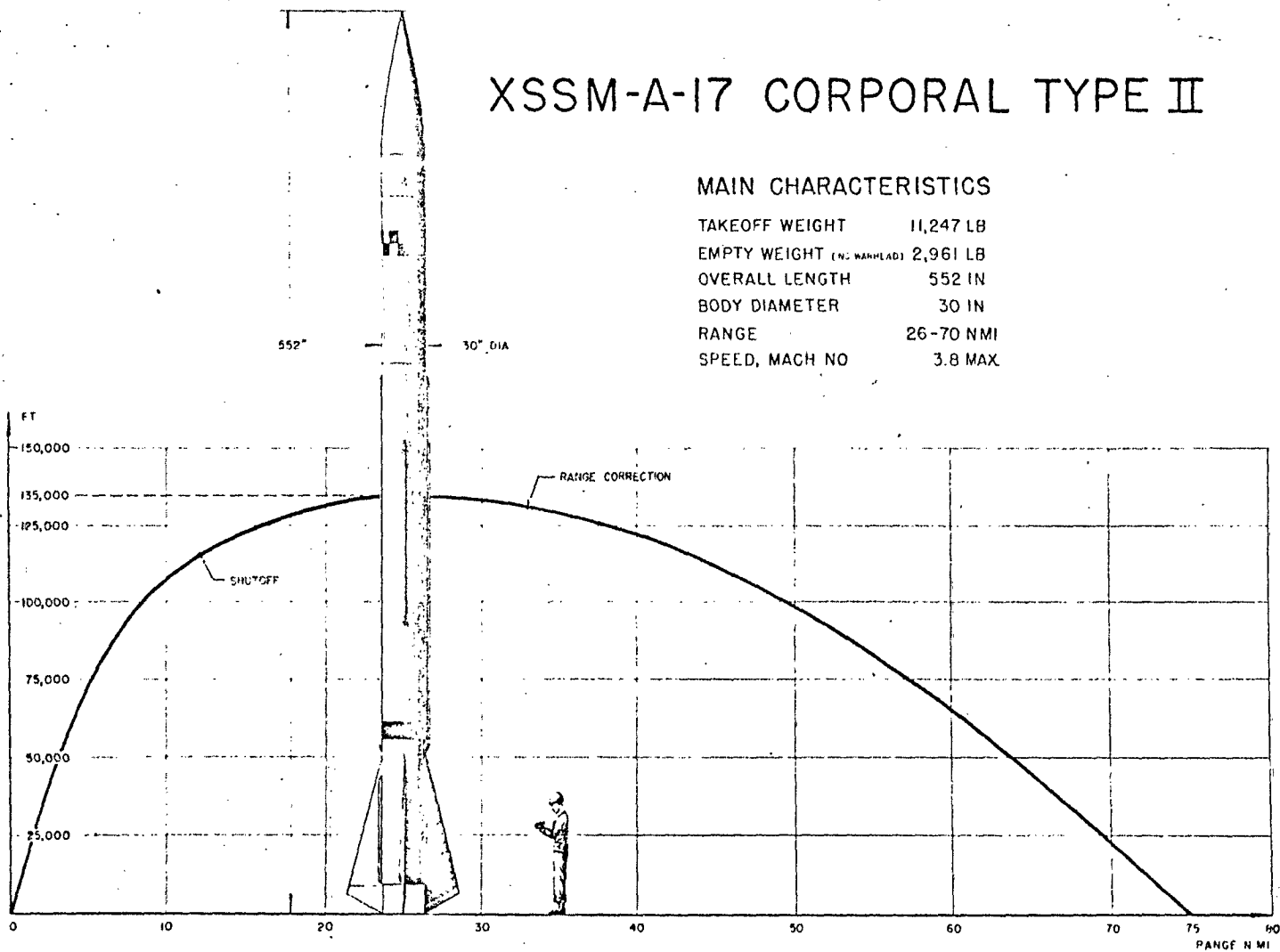

SECRET

CORPORAL TYPE II MAIN CHARACTERISTICS

35-1

UNCLASSIFIED

~~CONFIDENTIAL~~

UNCLASSIFIED

CORPORAL TYPE II

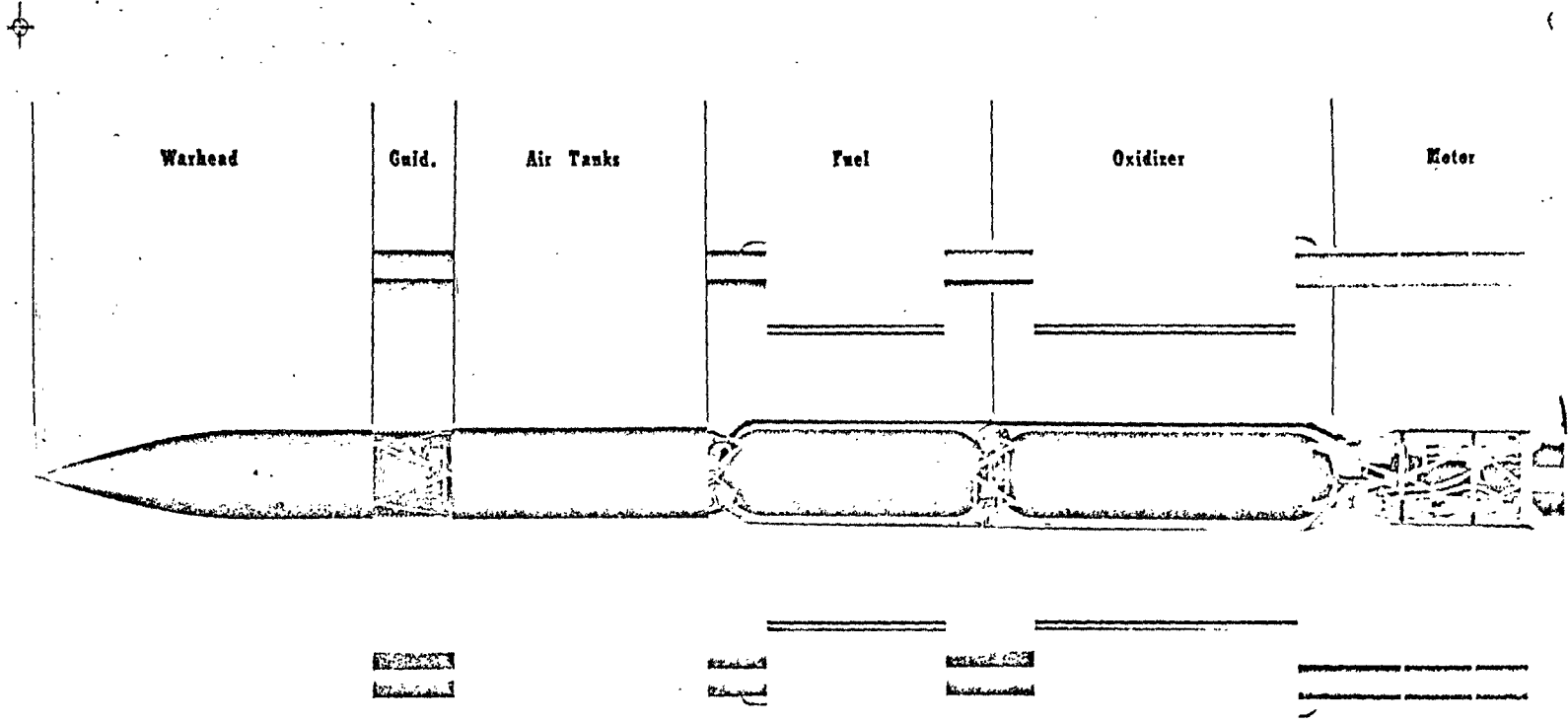

UNCLASSIFIED

CORPORAL MISSILE CUTAWAY

UNCLASSIFIED

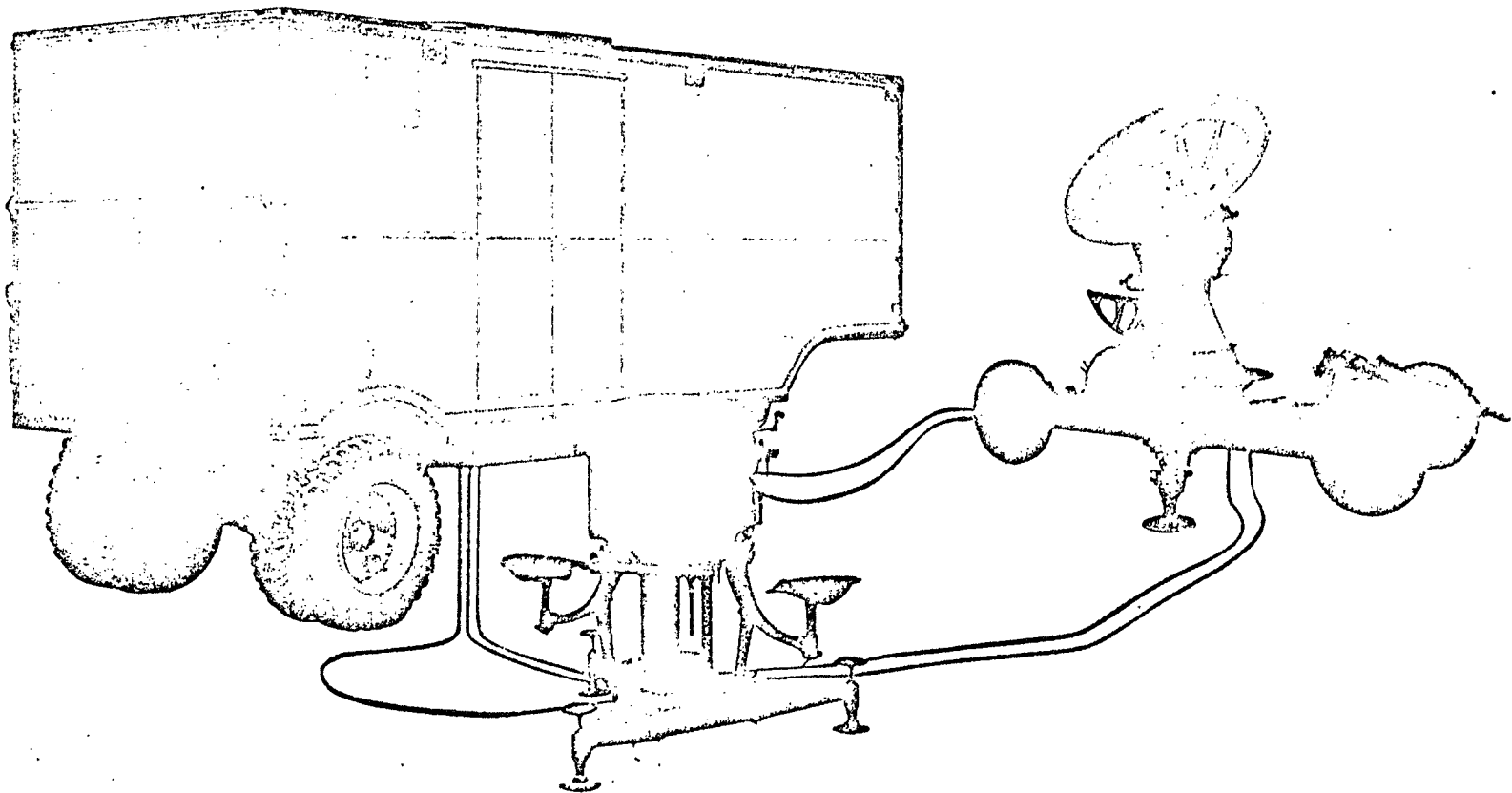

CORPORAL MISSILE RADAR SET

UNCLASSIFIED



CORPORAL MISSILE OPTICAL TRACKER

termination did not significantly increase the azimuth mean indicating that early azimuth termination could be used in case of anticipatedoming, with little or no expected bias in the miss-distance at the target jet.³¹

(S) With the then present condition existing in firing table settings, there was "a tendency to saturate the range system with 'go short' commands" because of overshooting the target.

(S) The over-all inflight reliability estimate for the 37 flights was approximately 51 per cent. This estimate was obtained by counting as successful those flights for which the miss-distance was less than 600 yards from the target. This 600-yard figure represented twice the design intent CPE of 300 yards.* It was felt that this was a conservative estimate of reliability, even though some of the missiles hitting within 600 yards of the target had a malfunction. The estimate of 51 per cent was comparable to the results for the E-U firings of the year before (1956).** There was no statistical evidence that range of the target influenced flight success, although there was a trend toward decreasing success as target range was increased. Likewise, there was no statistical evidence that azimuth offset affected success of the missiles' flight.³²

(C) During the period 1 January 1957 to 10 April 1959, 87 Type component failures were subjected to laboratory analysis at WSMR. Included in the report summarizing laboratory investigations of these failures was "a summary of unsatisfactory conditions found on the

31. WSPG Technical Memorandum Nr. 472, "Accuracy and Dispersion Estimates for CORPORAL II Missile under Varied Flight Conditions," pp. 1-8, Systems Test Division, WSPG, New Mexico, November 1957.

* It will be noted that an apparent inconsistency exists in the matter of CPE, which is sometimes listed as 300 meters and at other times as 300 yards. Such is the way CPE's were reported, with apparent changes from time to time in military characteristics regarding CPE.

** WSPG Technical Memorandum Nr. 387, "CORPORAL II Accuracy and Inflight Reliability Estimates," WSPG, N.M., November 1956.

32. Ibid.

~~CONFIDENTIAL~~
UNCLASSIFIED

CORPORAL Type II missile from 2 April 1956 to 4 November 1958 ... to disclose the degree of susceptibility of the system's major functional areas."

(C) Investigations included: control compartment, 40 (45.5 per cent), 14 of which were in the autopilot flight controller, 3 in the control assembly gyro, 10 in the electronic control amplifier, 5 in the command unit, 7 in the accelerometer, and 1 in the signal data converter; aft airframe, 46 (52.2 per cent), 8 of which were in the motor generator, 1 in the interconnecting box, 37 in the electro-pneumatic servocylinder, but only 2 in the propulsion unit.³³

(C) Eight flight controller starting assembly failures were due to faulty cam activation of the microswitch lever, redesigned to use roller bearings which impinged on the working face of the cam.

(C) One additional laboratory finding was concluded on the servocylinders. An improper feedback voltage was noted in the pressure transducer. The pressure feedback control was found to be out of adjustment. It was recommended that the manufacturer be informed that this was the twenty-fifth failure of this type.

(C) Another Laboratory Report (LAR) concerned the motor generator. As in the previous 6, this unfavorable LAR was due to the incorrect fit of the bearing to the motor shaft, resulting in the bearing burning out. Redstone Arsenal was advised that 7 of these failures were due to undersized shafts.³⁴

(C) There were 3 LAR's concerning excessively high minimum resistance of yaw command and changeover potentiometers, resulting in loss of signal. This was due to the presence of foreign material between the contact and the wiping arm and was caused by deterioration of lubricating material used by the manufacturer. ARGMA* was advised of this failure and asked to determine the feasibility of substituting

33. McBride, Samuel, and Culpepper, Gideon, Army Missile Test Center (AMTC) Technical Report Nr. 79, Final Summary of Component Reliability of CORPORAL Type II and IIA, pp. iii, 1, 12-13, and passim.

34. Ibid.

* ARGMA was the agency responsible for CORPORAL during the period under discussion.

UNCLASSIFIED
~~CONFIDENTIAL~~

'Quietrole' (which had been tested at WSPG) or some other product that could retain its original lubricating qualities.³⁵

(C) Underlying causes of failure by number of items and per cent were: design deficiency, 53 (60.2 per cent); handling, 2 (2.3 per cent); manufacturing, assembly, or inspection, 25 (28.4 per cent); and unknown, 8 (9.1 per cent).³⁶

(U) An analysis of the LAR's showed that increased component reliability could be achieved by, (1) substituting presently available materials which were more suitable, (2) more adequate inspection procedure, (3) improved workmanship, and (4) continuing laboratory investigation of subsequent failures to determine causes of failure in those areas wherein specific causes had not yet been disclosed.

(U) It was recommended that the contractor be advised to take corrective action in those areas over which he exercised control, that is, inspection, design, and calibration.

(U) As expressed by the LAR, much had been learned from work on CORPORAL, and this information was being incorporated into other systems which had been initiated.³⁷

(C) Between January and May 1958 Systems Test Division, WSMR, subjected production prototypes of CORPORAL Type IIA guidance components to a series of tests including bench, checkout, limits of adjustments, temperature effects, and field handling. These components were automatic pilot flight controller, transponder set, radio beacon, signal data converter, and electronic control amplifier. The tests were to evaluate functional stability of these components and to determine adequacy of current checkout procedures used for the CORPORAL Type IIA missile.

(C) Severity of the road test was of special interest because of previous criticisms of the CORPORAL system's inability to withstand the physical punishment to be expected in field service (Cf above). The test report portrayed a far more rugged CORPORAL:

35. Ibid.

36. Ibid.

37. Ibid.

~~CONFIDENTIAL~~
UNCLASSIFIED

The five special test guidance components were subjected to a "go-no-go" road test which simulated possible field transportation conditions. This road test was performed with the components placed in the cargo bed of a 3/4-ton, 4-foot by 4-foot cargo truck. Components were not crated, and the only care taken was to prevent damage to cable connectors. No effort was exerted to minimize the amount of shock and vibration encountered in this test.

This road test was performed on the approved WSMR road test area, which is an unimproved road with terrain similar to conditions which may be encountered in the field. The test was performed at speeds between 5 and 10 miles per hour and consisted of 1 mile over the road test area. The units were subjected to treatment rougher than would normally occur in field handling and were observed to bounce approximately 12 inches off the bed of the vehicle

Except for the receive frequency of the transponder set, the functional and operational adjustments of the guidance components were not affected by the road test. Receive frequency was found to have dropped 18 megacycles. Comparison of the data of the component checkout test prior to the road test with that of the road test itself indicate that the Type IIA guidance components are rugged and well constructed and are not affected appreciably by rough handling.³⁸

CONCLUSIONS AND RECOMMENDATIONS

(C) Though conceding that electronic limits and operational characteristics accorded with the engineering handbooks, general conclusions were somewhat critical of Type IIA components evaluated. One comment was that duration modulation* necessary to cause shutoff relay operation in the radio beacon was too great. CORPORAL's radio beacon, moreover, was not proof against such enemy countermeasures as the use of properly modulated frequencies to cause premature shutoff operation.³⁹

(C) The transponder set became stable after a 10-minute warm-up, except for an automatic gain control (AGC) delay. AGC level instability,

38. Deans, J. L., AMTC Technical Memorandum Nr. 597, Functional Evaluation of CORPORAL Type IIA Components (Test Plan II-C-28), passim, Systems Test Division, WSMR, New Mexico, January 1959.

* "Modulation": alteration of amplitude or frequency of a wave in accordance with a signal.

39. Ibid.

UNCLASSIFIED
~~CONFIDENTIAL~~

together with a variation in "full-firing sensitivity," caused this AGC delay to be out of tolerance. During the first 10 minutes of operation, transponder set transmit-frequency drifted down 13 megacycles. Cathode* line presentation failed to provide the operator with a reliable means of repeating corresponding adjustment. Change in the transponder set's receive-frequency was the only significant one resulting from the rough treatment, and normal adjustments were able to correct this change. On the positive side, a definite improvement was shown by Type IIA's electronic control amplifier in repeatability and stability of performance over that of Type II.⁴⁰

(C) Instead of a reduction in time required to remove Type IIA guidance components for repair or replacement, however, approximately 50 per cent more time was expended than in Type II. Removal was not only time-consuming but was difficult and required the use of special wrenches "unavailable in normal supply channels." Autopilot flight controller and electronic control amplifier likewise came in for severe criticism.⁴¹

(C) Moreover, the Missile Checkout Station's Command indicator panel was incompatible when used to measure cathode-to-ground voltages on azimuth and elevation discriminators, with the meter being deflected off the scale when so used. Also, the panel markings of bias voltage** were incorrect.⁴²

(C) Among the recommendations to correct faults of Type IIA's electronic components were further improvement of the radio beacon to render CORPORAL less susceptible to any other than its own frequency and also a redesign of the transponder set AGC circuit. Relocation of subassemblies to improve ease of access was advised, as was a reduction in the number of bolts and screws and their standardization, so as to require fewer tools to remove all guidance components. Likewise

* "Cathode": negative pole, or electrode, of a vacuum tube.

40. Ibid.

** "Bias voltage": direct voltage in the grid circuit of an electron tube.

41. Ibid.

~~CONFIDENTIAL~~
UNCLASSIFIED

recommended was replacement of the voltmeter for measuring cathode-to-ground voltages on the azimuth and elevation discriminators, employing a meter of higher scale.

(C) To improve compatibility with Type IIA's transponder set, the command unit indicator panel needed modification, and labeling of the bias voltage on the panel needed changing to 250 rather than 150 volts.⁴³ Gilfillan was being "educated."

(U) During the period between 22 September 1958 and 10 November 1958, the Guidance and Control Laboratory, WSMR, subjected one set of the CORPORAL IIA missile-borne electronic guidance system to operational and environmental tests. As in the immediately preceding test, the components consisted of electronic control amplifier, automatic pilot flight controller, signal data converter, transponder set, and radio beacon. These tests, the operational (go-no-go) type, were carried out while subjecting the components to laboratory-controlled high-temperature, low-temperature, high-altitude, and vibrational environments. Results of these environmental tests indicated that a system composed of the five components tested would have malfunctioned in any of the extreme environmental conditions outlined in the pertinent specifications, which follow.

(U) Each component was subjected to an operational checkout test under the five following environments: (1) acceptance test (ambient test); (2) low-temperature test, $- 25^{\circ} \text{F}$ ($\pm 5^{\circ} \text{F}$); (3) high-temperature test, $+ 150^{\circ} \text{F}$ ($\pm 5^{\circ} \text{F}$); (4) high-altitude test, 100,000 feet; and (5) vibrational test, 6 g and 12 g levels.⁴⁴

43. Ibid.

44. AMTC Technical Memorandum Nr. 619, Electro-Mechanical Laboratories, (EML) Task Nr. 269A, "Go-No-Go Test of CORPORAL Type IIA Missile-Borne Electronic Guidance Components Under Extreme Environmental Conditions (Test Plan 11B28)," passim, Guidance and Control Laboratory, Electro-Mechanical Laboratories, WSMR, N.M. March 1959.

UNCLASSIFIED

~~CONFIDENTIAL~~

RESULTS, CONCLUSIONS, AND RECOMMENDATIONS

(U) In the course of these environmental tests, all components in the CORPORAL IIA missile-borne electronic guidance systems failed while in one or another simulated environment. Since this was a go-no-go type of test, no evaluation of failures was carried out. It was apparent that each component failed and, if combined into a system, would fail under any extreme environment.

(U) It was found that some units which had failed rectified themselves upon returning to ambient operating conditions. This held true in the case of the automatic flight controller, which failed during the -25°F test, the signal data converter during the $+150^{\circ}\text{F}$ test, the transponder set during the $+150^{\circ}\text{F}$ test, and the radio beacon during the vibrational test in the Z plane. Further tests were required to determine at which temperature or which point in the environment these discrepancies would appear.⁴⁵

(U) Also apparent was the fact that some of these failures resulted from multiple exposure to various environments and might not have occurred in a single exposure to one extreme environment.

(U) As should be noted, only one set of components was tested, and the probability of all these failures existing in all identical components could not be determined. Upon study of actual firing charts and JPL's Publication Nr. 73, Evaluation of Type IIA CORPORAL Guidance Components, dated 13 August 1956, it could be stated that the results of this test were inconclusive and that further studies were indicated on an evaluation basis with more than one component of each type.

(U) As a result of the tests that were conducted on the single samples provided, however, it was concluded that the CORPORAL IIA missile-borne electronic guidance system appeared to be unreliable under extreme environmental conditions.

(U) It was recommended that all cognizant agencies be advised of these results and that further tests be conducted, so that a more

45. Ibid.

UNCLASSIFIED

accurate conclusion concerning this system's reliability might be reached.⁴⁶

(U) In September 1959, the Ordnance Mission at WSMR published the final evaluation report on the CORPORAL II and IIA systems. Compiled during the termination phase of the CORPORAL II and IIA program at WSMR, this report presented the final evaluation of all data obtained on significant areas of the CORPORAL Missile System during the testing and evaluation period of April 1956 through April 1959 and included the following:

1. Analysis of the reliability of 224 CORPORAL Type II and IIA rounds, including training rounds.
2. Inflight analysis of E-U CORPORAL rounds fired at WSMR. These firings revealed several system biases, one concerning range correction command.
3. Resume of field tests on the mechanical and electronic units of the CORPORAL missile system, with recommendations for obtaining optimum performance of the system. The proposed air turbine alternator (ATA)^{*} was given thorough and prolonged acceptance and laboratory tests.
4. Abstracts of all pertinent technical memorandums and data reports previously published, including those on laboratory tests.⁴⁷

(U) The various components comprising the handling equipment, including missile erector, launcher, component containers, fuel and oxidizer equipment, and servicing platform, underwent a total of 43 field tests at WSMR from April 1956 to March 1959.

(U) General areas of concern of the five extensive tests conducted on the CORPORAL II erector were its electrical drive and control elements and human engineering pertinent to the erector's employment. The evaluation and missile flight support operation conducted at WSMR with the

46. Ibid.

* ATA was not a Type IIA component, however.

47. AMTC Technical Report Nr. 86, "CORPORAL: CORPORAL Type II and IIA System Final Evaluation Report," pp. iii, 8, Ordnance Mission, WSMR, n.m., September 1959.

UNCLASSIFIED

CORPORAL Erector M-2 required continual correction of malfunctions occurring in its electrical and structural systems. Modifications applied to the erector during its utilization in flight support corrected some of the inadequacies.

(U) CORPORAL's launcher was found to be satisfactory with the exception of a few minor defects which could be circumvented by properly training personnel.

(U) Under such environmental tests of the CORPORAL missile containers as climate and rough handling, using actual missile components inside the containers, several defects were discovered in the containers during the rough-handling tests.

(U) Propellant servicing trucks--fuel and oxidizer--were found adequate for performing the normal operations of fueling and defueling the CORPORAL missile and were capable of limited transportation of fuel or oxidizer. During all phases of operation at WSMR, it was indicated that the propellant trucks were suitable for field usage provided special training in handling fuel and oxidizer was given operating personnel. A prototype oxidizer vehicle failed to prove itself an improvement over the original equipment.

(U) Both the air compressor truck and the air-servicer-bottle truck showed various inadequacies.

(U) As initially received at WSMR, CORPORAL's servicing platform proved unsuitable for operation with the CORPORAL missile system, as manifested by both malfunctions and design deficiencies. After modifications, the servicing platform performed all missile operations satisfactorily. The conclusion was that it would be satisfactory for field usage provided there were proper maintenance and operator-training.⁴⁸

(U) Flight testing of the CORPORAL II and IIA consisted of checkouts and preparation for firing, followed by actual firing tests. This report included both E-U and industrial flight-test programs. Failures listed were only those malfunctions within a unit classifiable as the failure of a production line item. Any malfunction of a modification

48. Ibid., passim.

UNCLASSIFIED

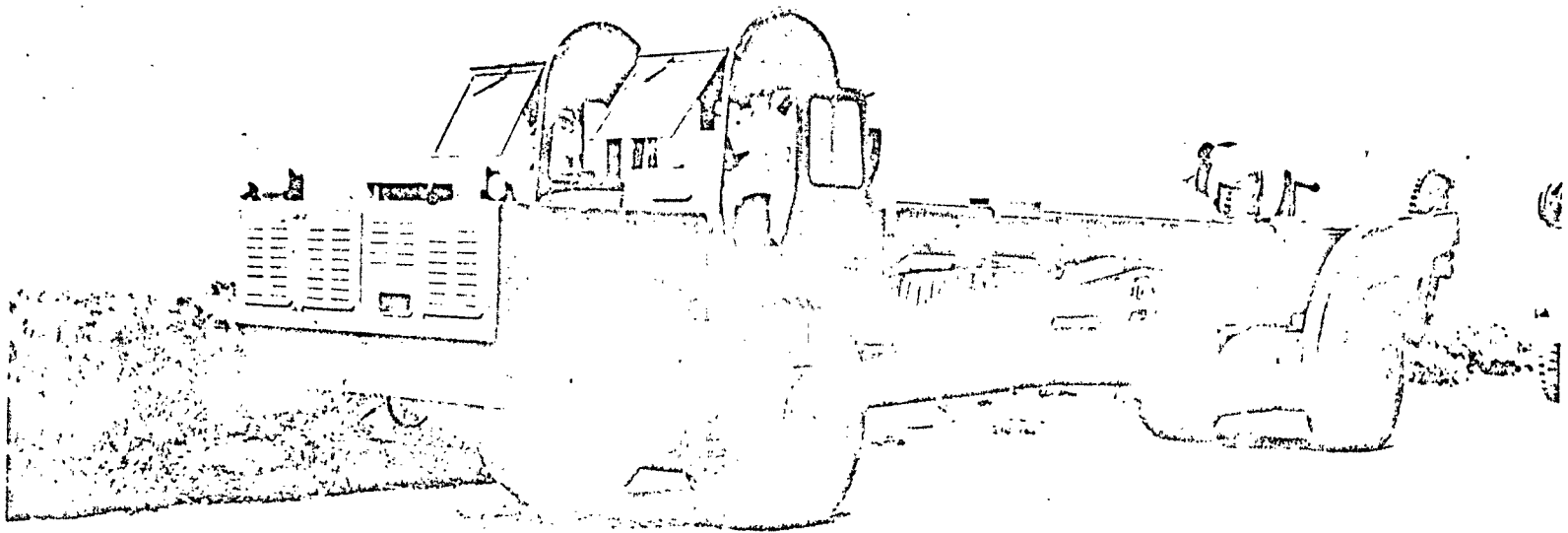

CORPORAL MISSILE ERECTOR

UNCLASSIFIED

UNCLASSIFIED

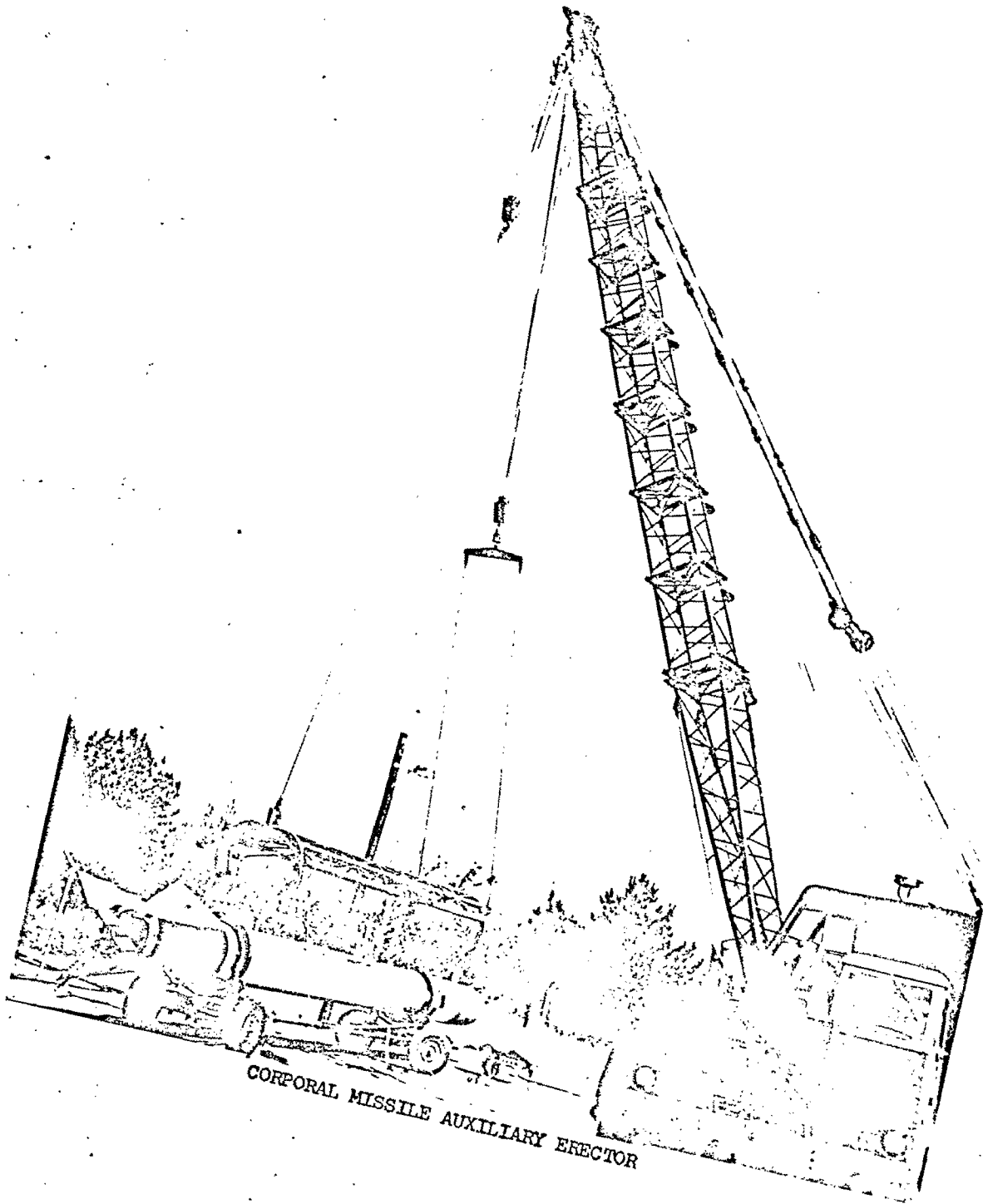

CORPORAL MISSILE AUXILIARY ERECTOR

UNCLASSIFIED

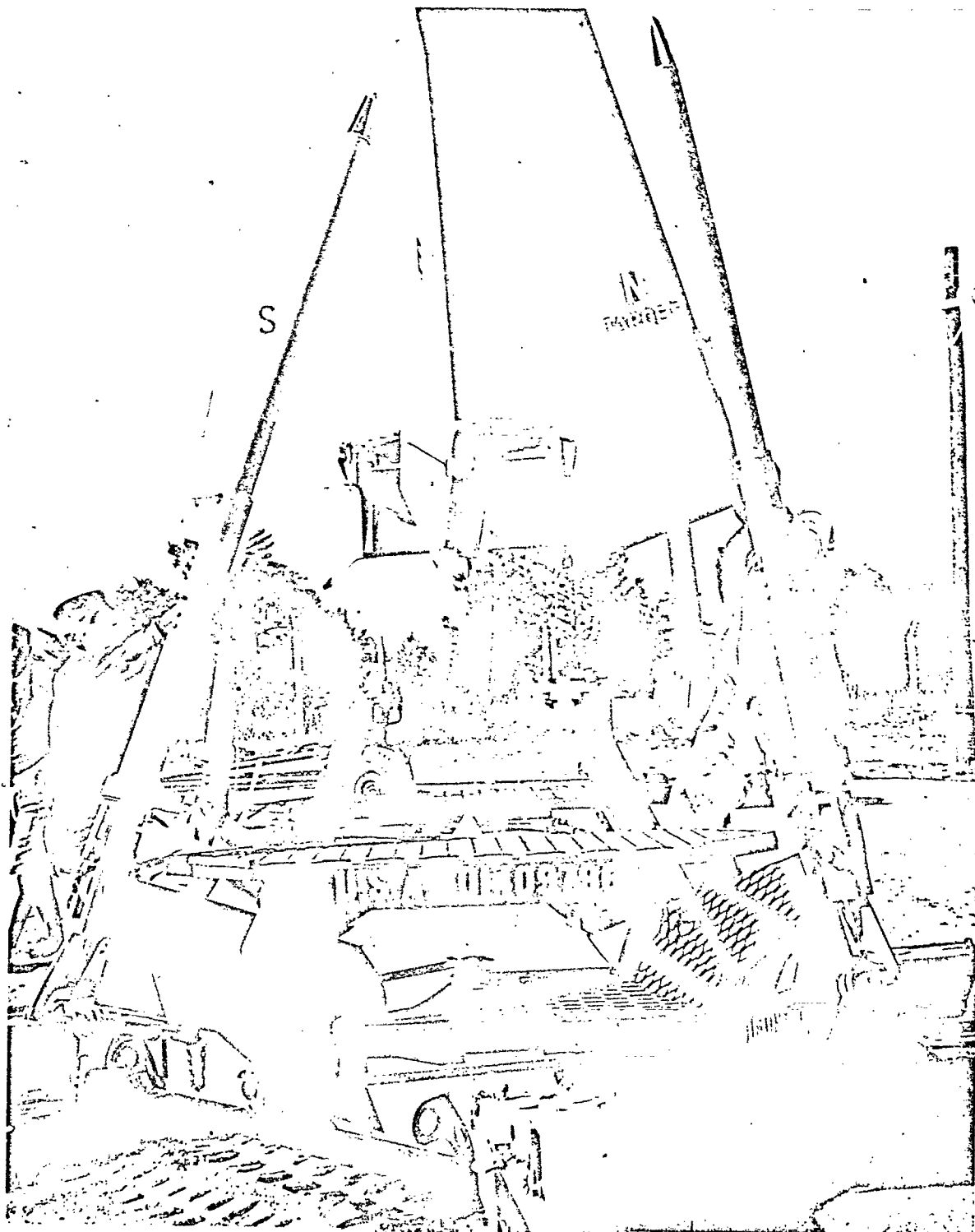

CORPORAL MISSILE LAUNCHER

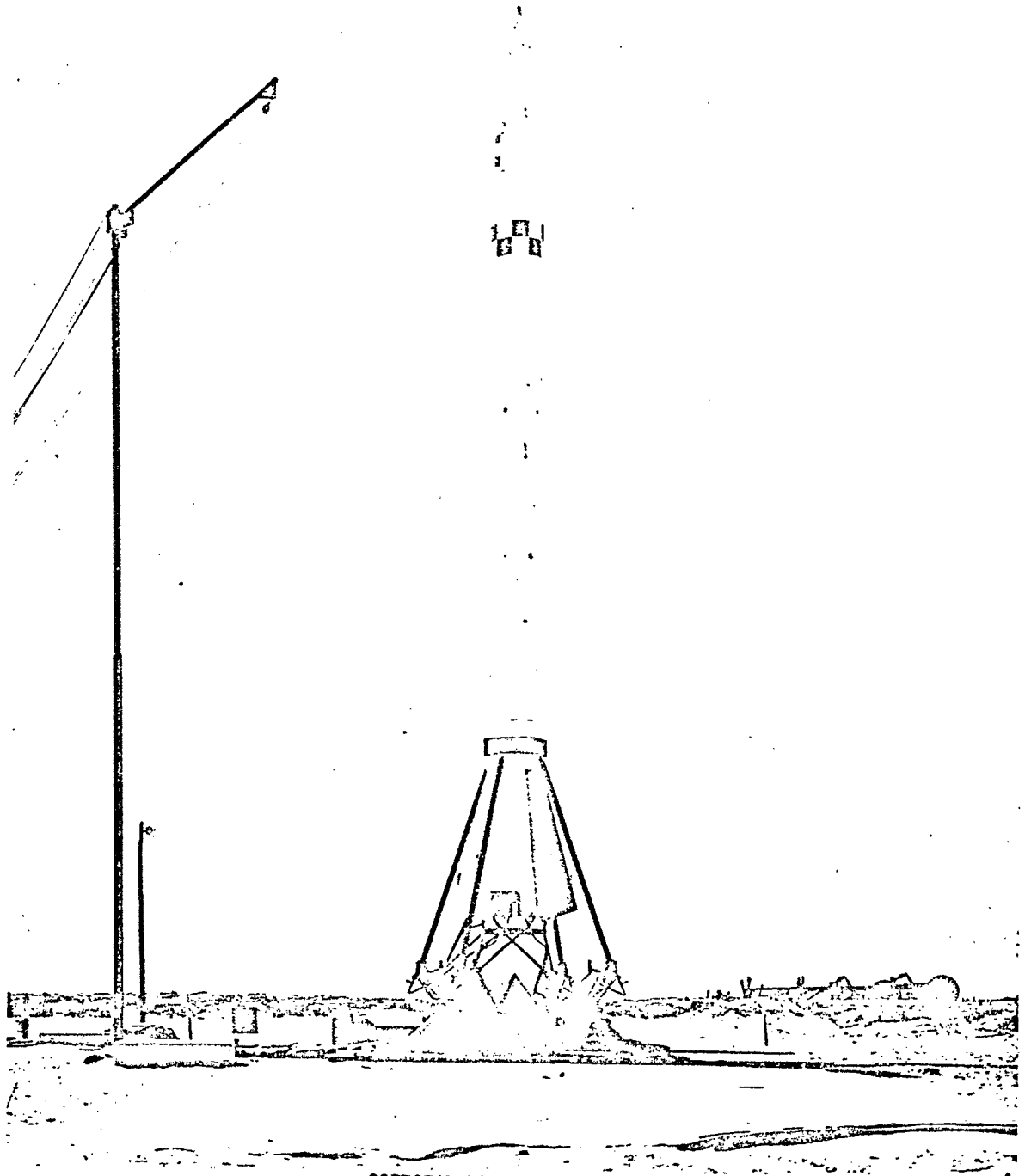

CORPORAL MISSILE ON LAUNCHER

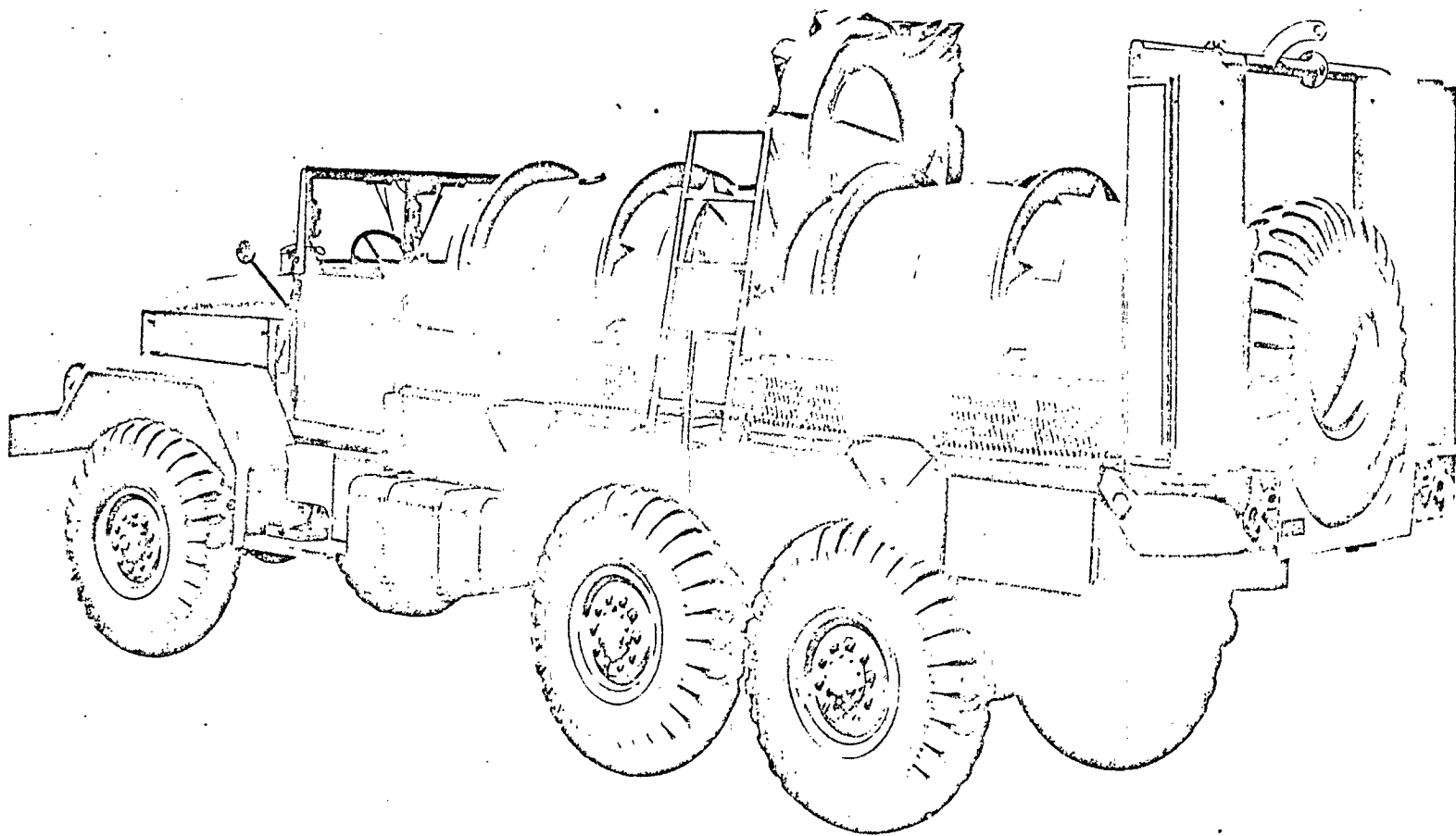

CORPORAL MISSILE PROPPELLANT SERVICING TRUCK

UNCLASSIFIED

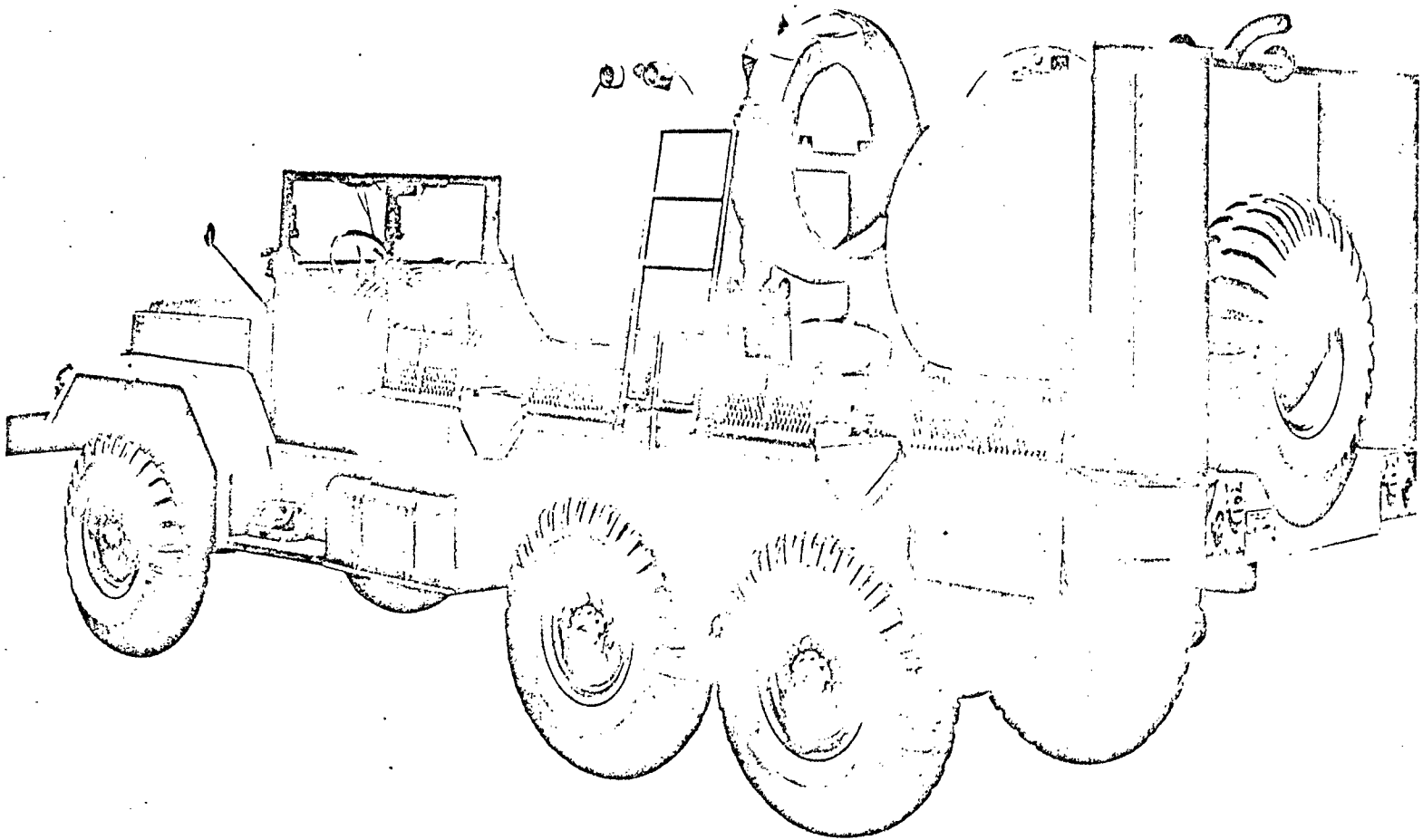

CORPORAL MISSILE PROPELLANT SERVICING TRUCK (ACID TANKS)

UNCLASSIFIED

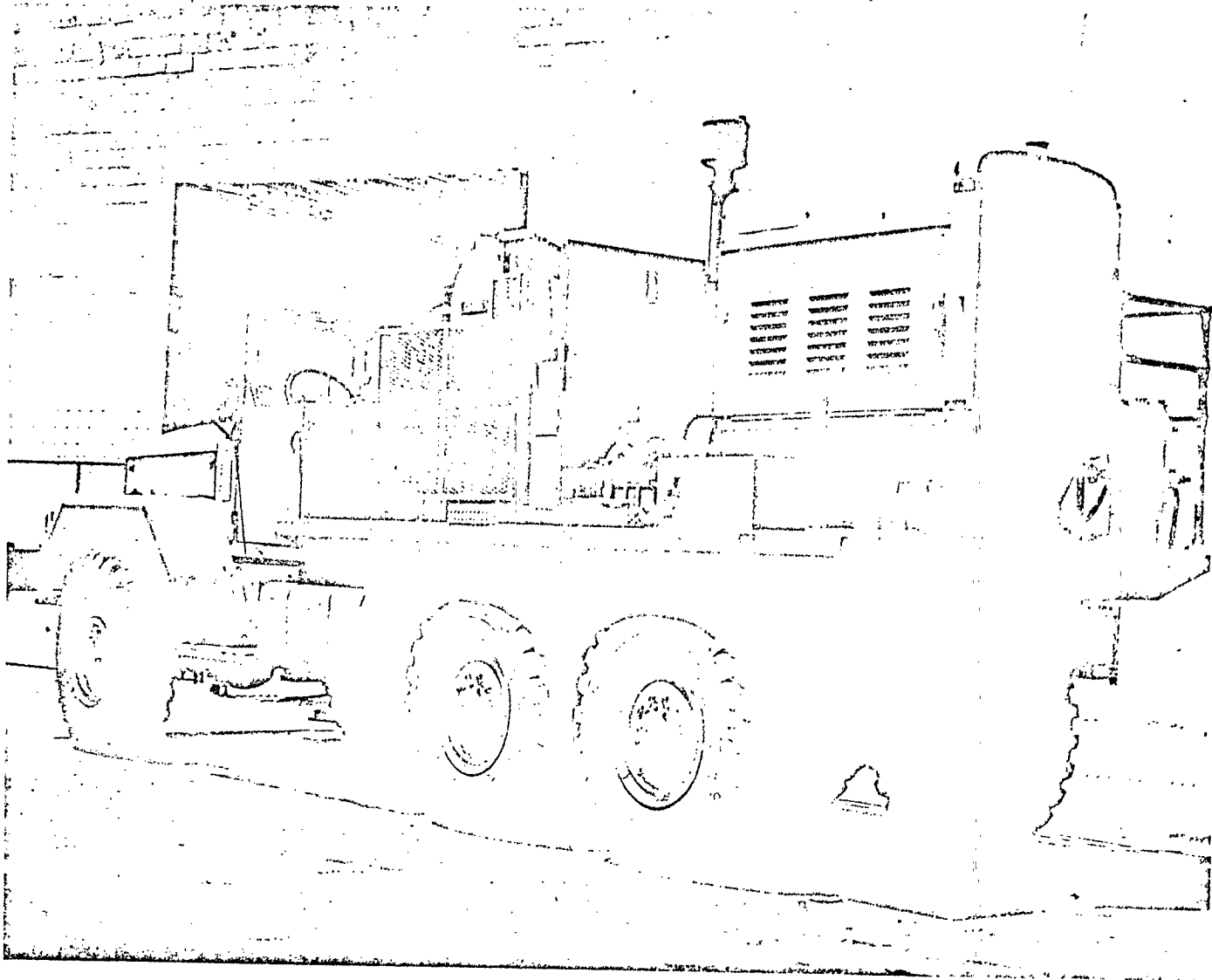

UNCLASSIFIED

CORPORAL MISSILE RECIPROCATING COMPRESSOR

UNCLASSIFIED

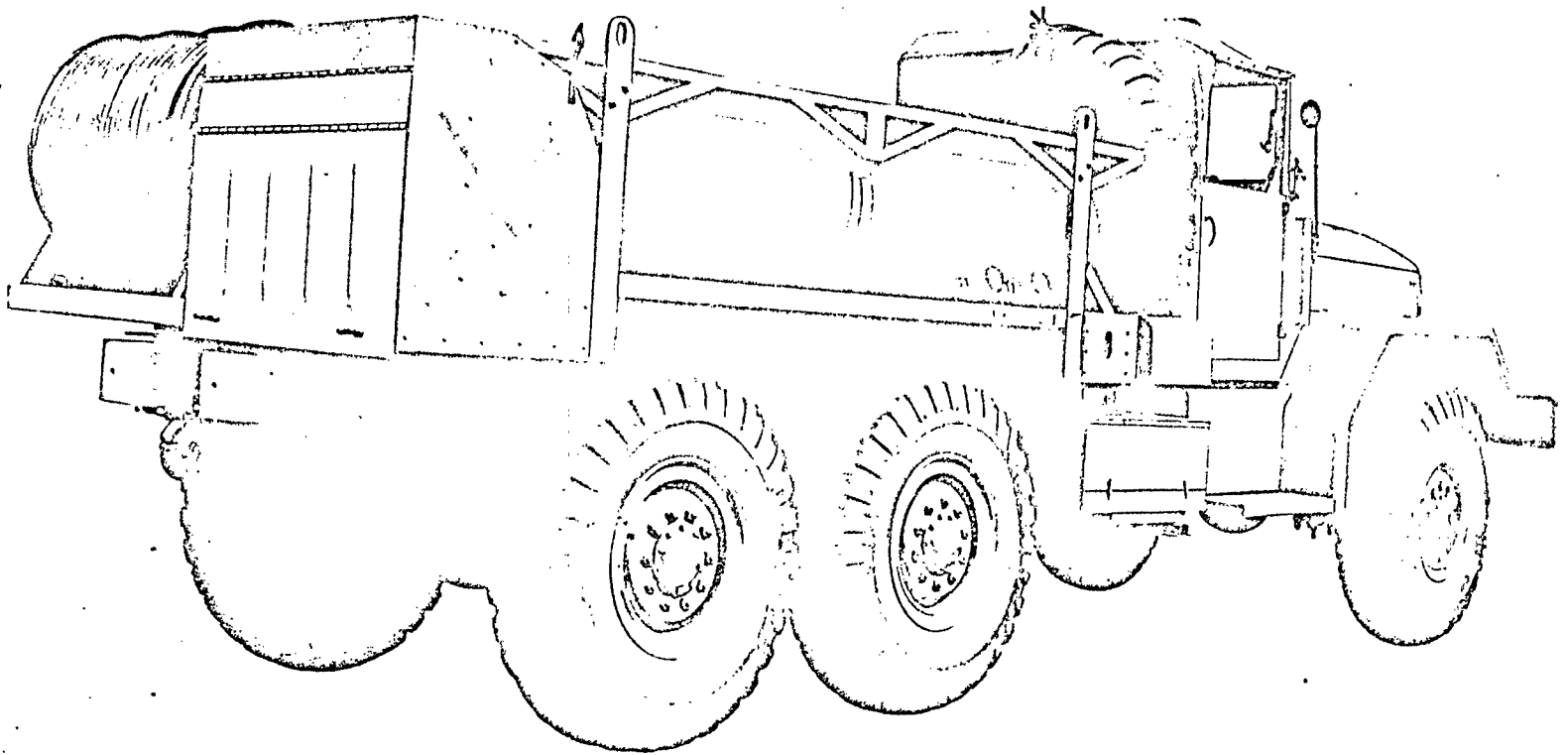

CORPORAL MISSILE AIR SERVICER TRUCK

UNCLASSIFIED

UNCLASSIFIED

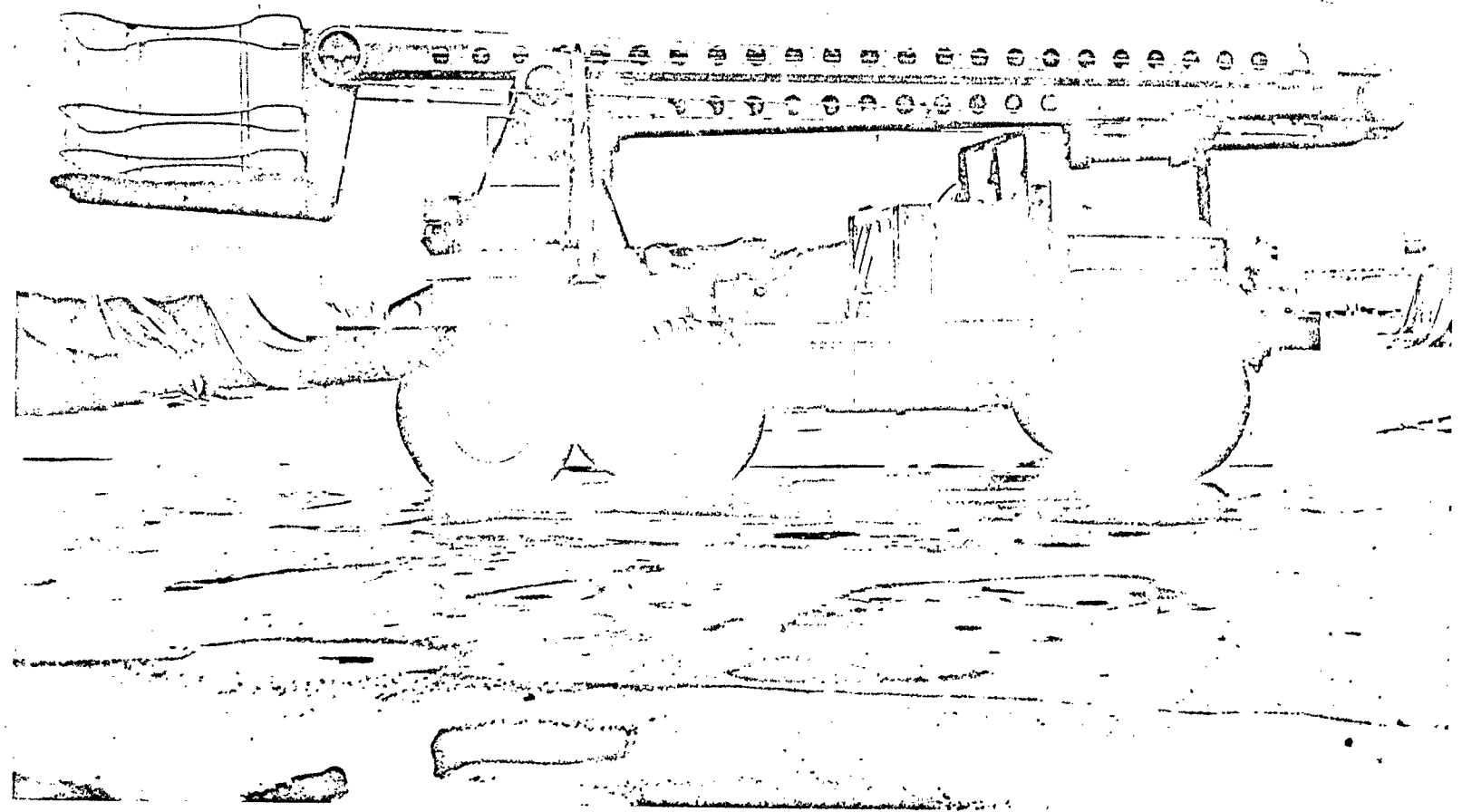

CORPORAL MISSILE SERVICING PLATFORM

UNCLASSIFIED

to a unit was not listed. The data given below were derived from results based on a total of 57 missiles flown to test electronics components.

(U) Missile electronic system records indicated that there were approximately 30 per cent prefiring failures of 14 items. Missile batteries were undependable in the first 25 rounds fired. Investigation disclosed that procedures used to prepare batteries for flight were inadequate. Excessive electrolyte in the cells leaked and created a short to ground. Dependability increased when the method for adjusting the level changed. The motor generator was dependable during the first 40 rounds, but dependability decreased during the last 17.

(U) It was thought possible to remedy difficulties encountered with the missile batteries and motor generator by replacing them with the ATA, which had been tested in three firings during the Industrial phase and proved satisfactory. Servocylinder failure reflected a high recurrence rate (53). An improvement was brought about by the use of a different servocylinder, however, since a new manufacturer supplied a more reliable unit than had been available previously.

(C) The final statistical and reliability analysis included 224 CORPORAL II rounds which were fired during the period 28 October 1954 to 11 February 1959 by the following agencies: WSMR E-U personnel (65 rounds) and Field Artillery (FA) training personnel (159 rounds). Included in the 65 E-U rounds were those JPL rounds which were sufficiently similar to the others to justify their inclusion in the E-U analysis. Also, 16 rounds fired by CONARC Board Nr 4 were included in the 159 training rounds.⁴⁹

CRITERIA USED IN THE EVALUATION

(U) The following military characteristics and assumptions were used for purposes of evaluation:

1. A military design intent CPE of 300 yards (275 meters).
2. Ninety-five per cent of those rounds passing preflight check-out to be launched within one minute of X-time.

49. Ibid., p. 48.

UNCLASSIFIED ~~CONFIDENTIAL~~

3. Ninety-five per cent of those rounds launched within one minute of X-time to be successful; that is, to impact within 1,097 meters of the target.

(S) It was assumed that the specification of a CPE of 275 meters would be equivalent to a requirement that 95 per cent of all successfully launched rounds must impact within 1,200 yards (1,097 meters) of the target. Furthermore, range and deflection components of radical miss distance were to be normally distributed.

(U) Three nominal firing ranges were used: short (50-69 km), medium (70-99 km), and long (100 or more km).⁵⁰

(C) Of the 65 E-U rounds fired between 28 October 1954 and 18 February 1959, 11 rounds having no pitch guidance and two having non-tactical failures (that is, range safety errors) were rejected from the analysis. Of the remaining 52 rounds to be evaluated, 32 were successful. (A successful round was defined as one in which impact data were corrected for certain personnel errors such as launcher misalignment and so forth, and also impacts within a circle of 1,097 meters radius, with the target being at the center of the circle.)⁵¹

CONCLUSIONS

E-U Rounds

(S) E-U rounds launched at short and medium nominal firing ranges impacted within the military design CPE of 275 meters. Long-range successful shots did not (CPE = 354 meters). If, however, all the firing ranges were combined, the 32 successful missiles had an estimated CPE of 277 meters, which was very close to that desired.

(S) In all three firing ranges, the rounds tended to impact beyond and to the right of the target, but these two biases were not considered important.

(S) Dispersion in the range miss distance was significantly larger than that of deflection for all ranges except that of the medium one.

50. Ibid., pp. 48-51. (It will be noted that CPE is here specified as 300 yards, not meters.)

51. Ibid., p. 50.

UNCLASSIFIED~~CONFIDENTIAL~~

(S) Estimated in-flight reliability of the E-U rounds was 62 per cent.

(S) Of all the 26 scheduled rounds fired within the prescribed time, 62 per cent of them (16) were successes, compared to the 95 per cent required by Military Characteristics.

(S) The third Military Characteristic, whereby 95 per cent of those rounds passing the preflight checkout were to launch within the prescribed time, was not satisfied. Only 26 of the 52 rounds (50 per cent) that passed the preflight checkout were launched within one minute of X-time.⁵²

Training Rounds

(S) The CPE of the successful training rounds launched at short and medium nominal firing ranges was less than the military design intent CPE of 275 meters. The CPE of the long-range successful shoots was 329 meters. An over-all CPE of 322 meters was obtained from combining the three firing ranges. This was a lower impact accuracy than that exhibited by the E-U rounds having an over-all CPE of 277 meters.

(S) Rangemiss distances were significantly different between the three firing ranges. In particular, CORPORAL training rounds fired at medium range consistently overshot* the target, while those fired at long range consistently undershot the target.

(U) There was no indication of a significant bias either in the range or the deflection component of the miss-distance.

(U) For all three ranges, the standard range miss distance was something like three times as great as that of deflection. The standard deviation in the range component of the miss distance was of the order of three times as great as that of the deflection component for all three ranges.

(S) Estimated in-flight reliability of the training rounds was 60 per cent.

52. Ibid., pp. 50-61, 68-69.

* Ref. WSRG Technical Memo Nr. 472, dated November 1957, pp. 5, 7, for this overshooting.

~~CONFIDENTIAL~~**UNCLASSIFIED**

(U) There was a decided upward trend in the reliability of those rounds fired in the second half of the program over those fired in the first half.

(S) Of all the 65 rounds known to have been fired within the prescribed time, 69 per cent of them (45) were successful; this failed to meet the Military Characteristic of 95 per cent.

(S) Of the 154 rounds that passed the preflight checkout, 95 per cent (or 146 rounds) were required to launch within one minute of X-time. Sixty-five, or 42 per cent, did launch within the prescribed time, and this value was far below the one called for by the Military Characteristic.⁵³

E-U and Training Rounds Combined

(S) The estimated CPE for rounds fired at the short and medium nominal ranges fell within the design intent CPE. Although the estimated CPE for the long-range firings exceeded the required value by about 70 meters, if all the firing ranges were considered, the CPE estimated from this combination was compatible with the 275 meters called for in the Military Characteristics.

(S) The mean, or average, values of range component of the miss distances were significantly different among the three ranges, and the value of 222 meters for the medium range was significantly different from zero.* All of the successful CORPORAL Type II rounds tended to impact beyond the target.

(U) Dispersion in range miss distance was significantly larger than that of deflection for all three firing ranges.

(U) E-U rounds impacted closer to the target than did training rounds.

(S) Over-all mean values of the radial miss distances for the three firing ranges--261, 348, and 420 meters--were different from one another. The firing range, then, had a real effect on the radial miss distance.

53. Ibid., pp. 62-66.

* "Zero" refers to a direct hit on the target.

UNCLASSIFIED~~CONFIDENTIAL~~

(S) Estimated in-flight reliability of the combined E-U and training rounds was 61 per cent.

(U) For both E-U and training rounds, there appeared to be a definite correlation between the number of malfunctions detected during hangar checkout and the likelihood of CORPORAL's failure. No similar statement could be made about preflight checkout, nor was any attempt made to explain the cause of this first relationship or the lack of relationship in the second instance.

(S) Of all the 91 rounds fired within the prescribed time, 68 per cent of them (61) were successful.

(S) Forty-three per cent of all those rounds passing the preflight inspection and eventually fired were launched within one minute of X-time. Once again the Military Characteristic of 95 per cent was not satisfied.⁵⁴

RECOMMENDATIONS

(S) It was recommended that further investigation be made into the possibility of reducing the tendency of CORPORAL Type II to impact beyond the target on medium-range and short of the target on long-range firings.

(U) Review of the Military Characteristic requirements was recommended in an effort to make them more realistic in terms of the tactical requirements of the missile system.

(U) A further recommendation was that these modified requirements be compared with actual missile performance and all indicated measures for improvement be taken.

(U) Indubitably, reliability of the CORPORAL Type II missile needed to be improved upon in those areas where the Military Characteristics were affected the most.⁵⁵

54. Ibid., pp. 66-70.

55. Ibid., p. 71.

~~CONFIDENTIAL~~
UNCLASSIFIED

GENERAL DESCRIPTION OF THE CORPORAL SYSTEM

(C) As previously mentioned, development of the CORPORAL III missile system, which was to have redesigned guidance equipment was terminated in June 1958 because of advances made in other missile systems, primarily in that of SERGEANT, and that CORPORAL II was reclassified standard B in July 1958.

(C) Since improved electronic equipment was incorporated internally, but with no exterior changes, to modify Type II into Type IIA, the following general description is applicable to both types, as of 1 January 1961.

(C) CORPORAL II (or IIA) is a cylindrical missile, 45 feet 4 inches long and 30 inches in diameter. When loaded with propellants and a warhead, the missile weighs slightly over 11,000 pounds. Dry weight is approximately 4,400 pounds. CORPORAL delivers a 1,500-pound conventional or nuclear warhead, over a modified ballistic trajectory, to a distance of 25 to 80* nautical miles, with a CPE of 300 yards. Four fixed, delta-shaped fin assemblies at the after end of the missile stabilizes it in flight. Comprising each fin assembly is a fixed stabilizer, a servo-actuated rudder, and a graphite jet vane having its leading edge of molybdenum and moving with its associated rudder. Placed in the jet exhaust, these vanes, by deflecting the exhaust gases, stabilize the missile early in its flight, until air speed is enough for the external rudders to become effective.⁵⁶

-
- * Range maximum as given by Industrial Operations, ABMA. Ranges cited vary from 70 to 80 nautical miles.
56. D/A Technical Manual TM 9-5036, Description, "CORPORAL II Artillery Guided Missile System," passim, Washington 25, D.C., Headquarters, Department of the Army, 29 October 1947; D/A Technical Manual TM 9-5038-12, Operator and Organizational Maintenance Manual: "Artillery Guided Missile M2 (Equipped with Type-II and IIA Components)," (CORPORAL II Artillery Guided Missile System), passim, Washington 25, D.C., Headquarters, Department of the Army, 5 May 1960; Technical Information Report CD-3, "Development of Surface-to-Surface Guided Missiles and Large Rockets," pp. 24-27, Washington 25, D.C., Office, Chief of Ordnance, August 1960; WSPG, "Requirements for Work and Resources," Revision Nr. 1, pp. 2-3, Mission Plans & Operations, WSPG, N.M., 1 April 1958; information furnished by ABMA FSO.

UNCLASSIFIED~~CONFIDENTIAL~~

CORPORAL

WARGAMES

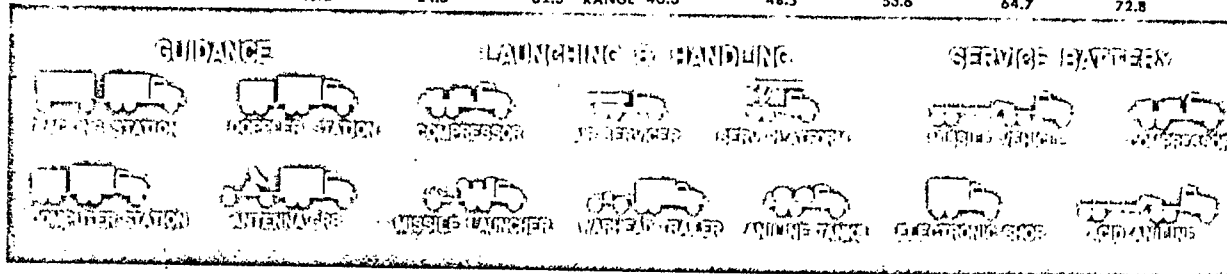
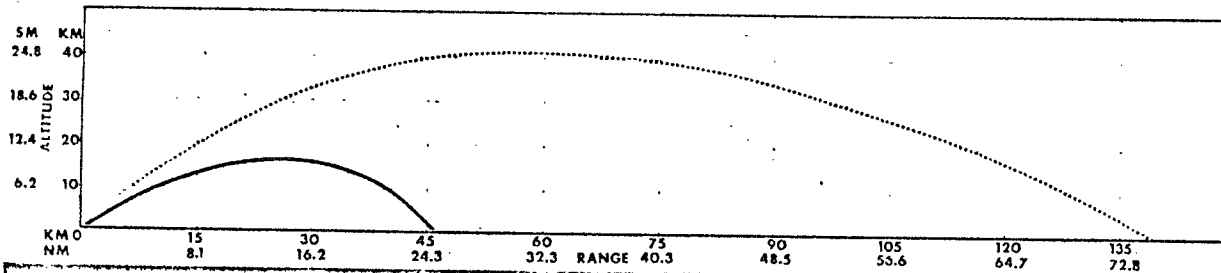
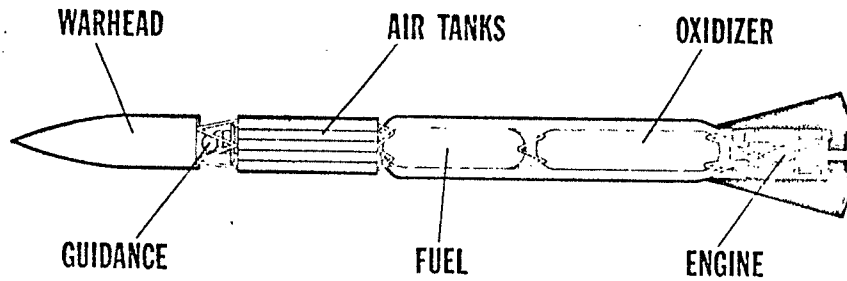

TAKEOFF WT	11,250 LB
EMPTY WT	4,461 LB
PAYLOAD WT	1,500 LB
LENGTH	45 FT 3 IN
BODY DIAMETER	30 IN
SPEED, MACH NO	3.8

ARMY ROCKET & MISSILE AGENCY
 DA C-172
 REV C
 DATE 11/19/53

UNCLASSIFIED

UNCLASSIFIED

~~CONFIDENTIAL~~
UNCLASSIFIED

(C) CORPORAL's axially cooled rocket engine weighs 122 pounds* and burns an aniline-furfuryl alcohol-hydrazine liquid-fuel mixture with IRFNA** as an oxidizer. The oxidizer tank is immediately forward of the engine, with the fuel tank next, and the air tank just forward of it. Air pressure from the air tank forces fuel and oxidizer from their tanks through the propellant valve of the engine. Since this propellant combination comprises a hypergolic*** mixture, combustion is spontaneous, and the engine requires no ignition system. The combustion gases leave the engine-exhaust nozzle at about 4,500 feet per second to impart 20,000 pounds of thrust and drive CORPORAL at speeds up to 2,250 miles per hour.⁵⁷

(C) After being fired vertically, CORPORAL is guided through a two-phase, modified-ballistic trajectory by a combination of an auto-pilot-and-command guidance system for controlling the missile's path and altitude. Continuous powered flight--first phase--starts with four seconds of vertical takeoff. During the powered phase, CORPORAL is stabilized by its autopilot system, which uses gyroscopes to sense instability or deviation, and plastic, formerly molybdenum-shielded graphite, vanes in the exhaust stream to exert correcting movements.⁵⁸

(C) Between 23 and 31 seconds after takeoff, CORPORAL's autopilot system, preset in azimuth, moves the missile laterally into the beam of a ground-based radar. After approximately four seconds of flight, a cam initiates a series of events which begins to program the pitch. During this phase of the flight, CORPORAL's position is measured by the radar--a modified SCR-584. Missile velocity is measured by a Doppler system. This information is fed into a ground-based computer which computes the appropriate time for missile thrust termination. When, after from 48 to 65 seconds of flight, the ground-based Doppler and the missile-borne Doppler transponder have determined that CORPORAL has attained a

* Often listed as 125 pounds.

** Reference note 9 above.

*** "Hypergolic": self-igniting - a chemically induced combustion produced merely by bringing fuel and oxidizer into contact.

57. Ibid.

58. Ibid.

UNCLASSIFIED

~~CONFIDENTIAL~~

predetermined radial velocity depending on the range of the target, the ground-based Doppler transmitter sends a propellant-shutoff command to the missile. The second, or unpowered, phase then commences, with CORPORAL at an altitude of about 14 miles and a speed of 2,250 miles per hour when fired at its maximum range.⁵⁹

(C) Elevation command signals to the CORPORAL are stopped at the start of the unpowered phase of flight, and the missile, subject to the effects of atmospheric disturbances, follows a ballistic trajectory. The ground guidance equipment, however, continues to signal azimuth corrections throughout flight, ceasing to transmit them shortly before the missile's impact. In the vertical plane of the trajectory one additional correction is applied, by which the guidance system causes the missile to make an adjustment in range approximately 20 seconds before impact. Calculations for this final pitch correction are made by the guidance system just before the missile reaches the zenith of its trajectory; the data are transmitted to the missile and stored in its memory device; and the servo control of the missile applies the adjustment at the proper time.⁶⁰

(C) When deployed in the field, the CORPORAL system can be conveniently divided into three areas of operation: the firing position, the checkout area, and the guidance position. The firing position has a number of special vehicles for handling and firing the missile, including: truck-mounted compressed-air equipment, the firing station, the launcher, the self-propelled guided missile erector, propellant-servicing trucks, the missile-servicing platform, and the warhead trailer. The missile test station, a generating unit, and compressed air equipment are in the checkout area. At the guidance position are the radar and radio sets, computing devices, and associated communicating and generating equipment.⁶¹

59. Ibid.

60. Ibid.

61. Ibid.

UNCLASSIFIED

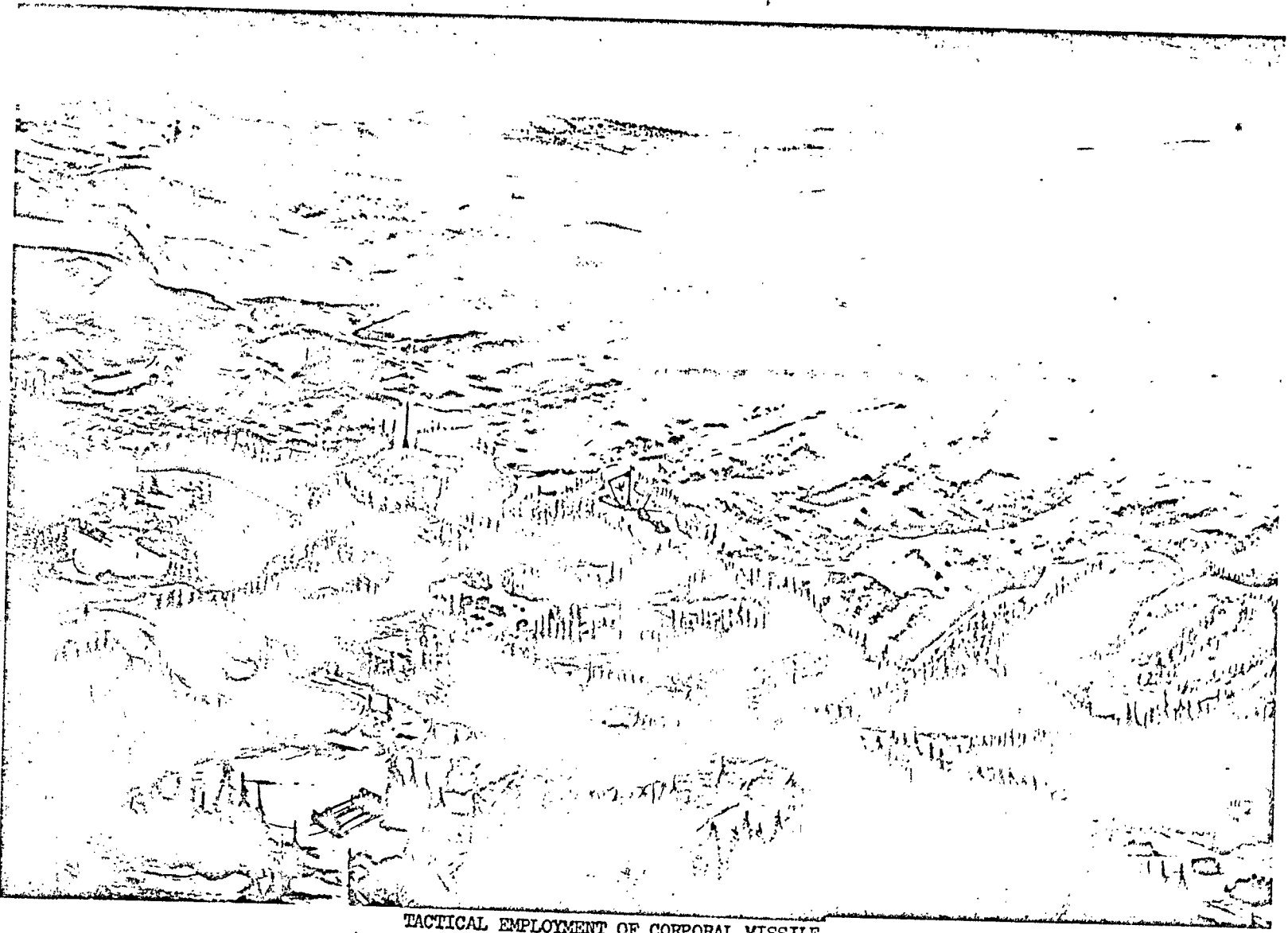

TACTICAL EMPLOYMENT OF CORPORAL MISSILE

UNCLASSIFIED

UNCLASSIFIED

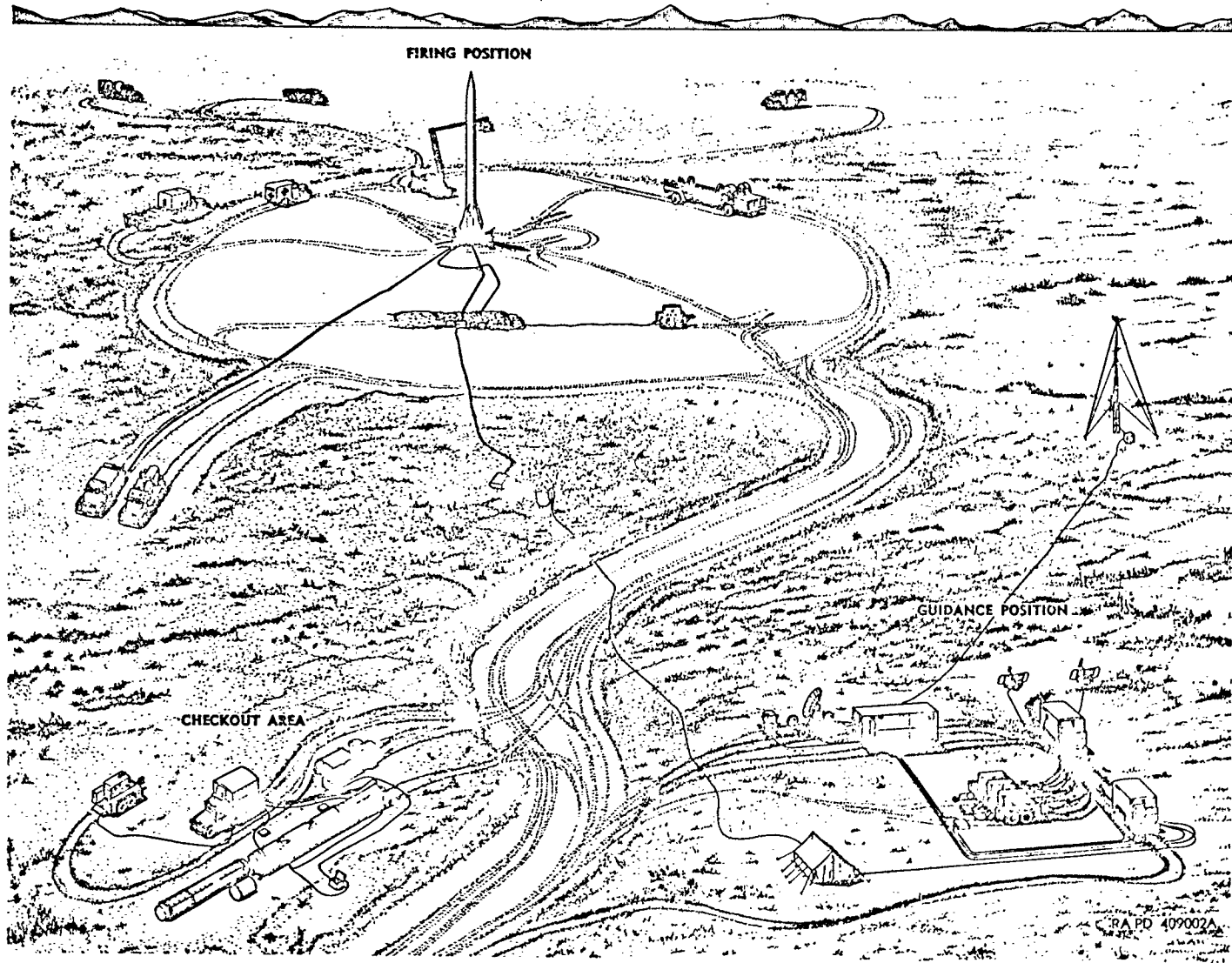

UNCLASSIFIED

CORPORAL II SYSTEM EMPLACED

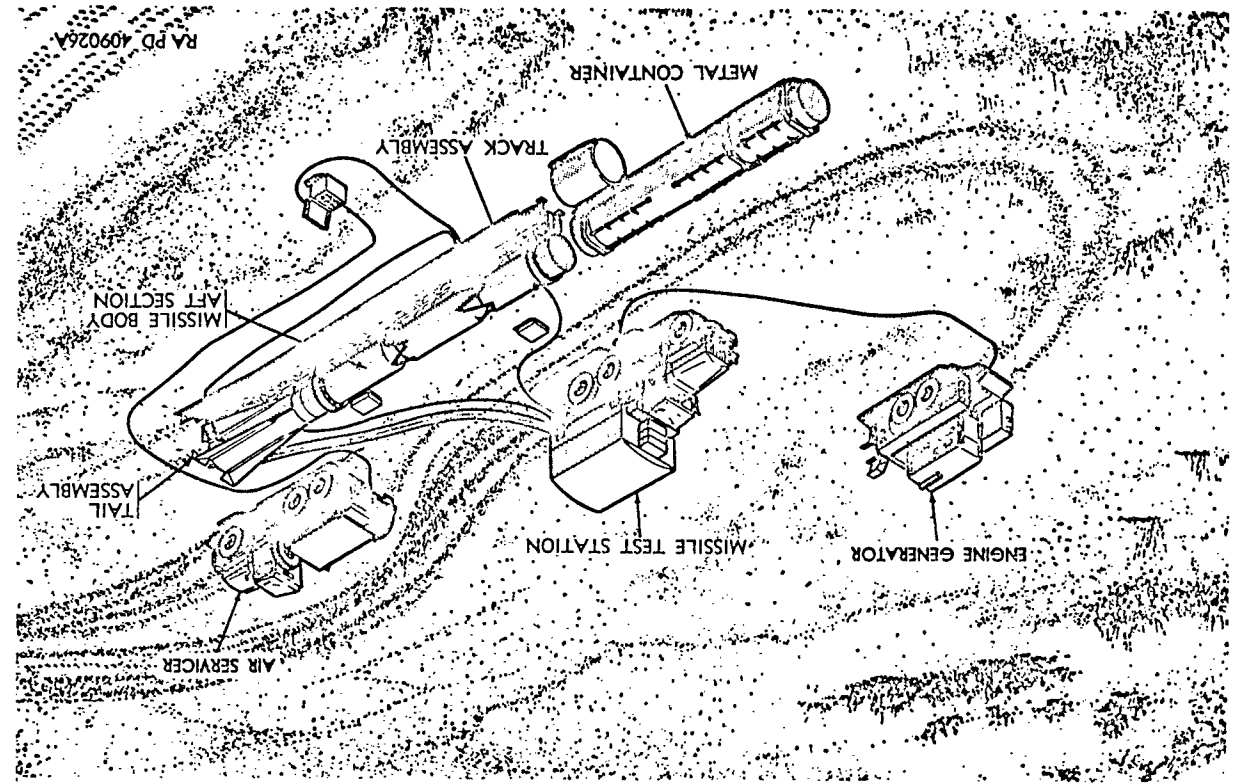

CHECKOUT AREA EQUIPMENT EMPLACED

UNCLASSIFIED

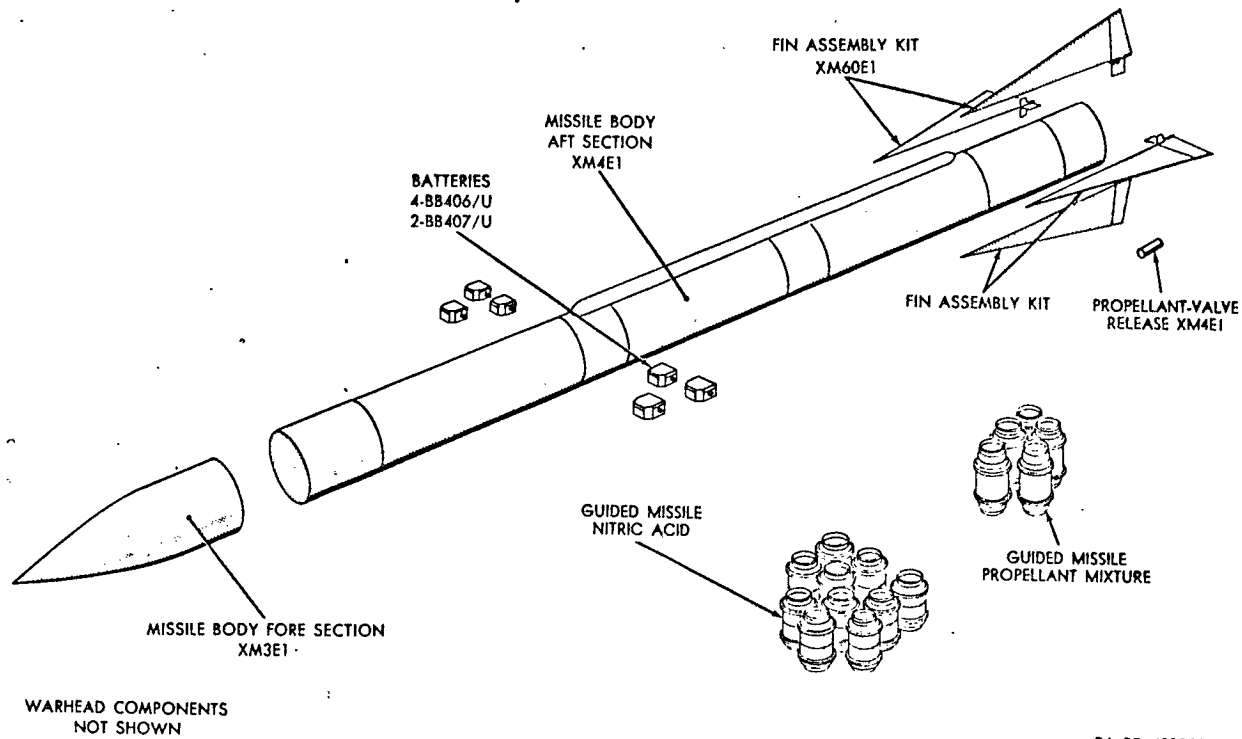

RA PD 409003

COMPLETE ROUND, CORPORAL GUIDED MISSILE M2

UNCLASSIFIED

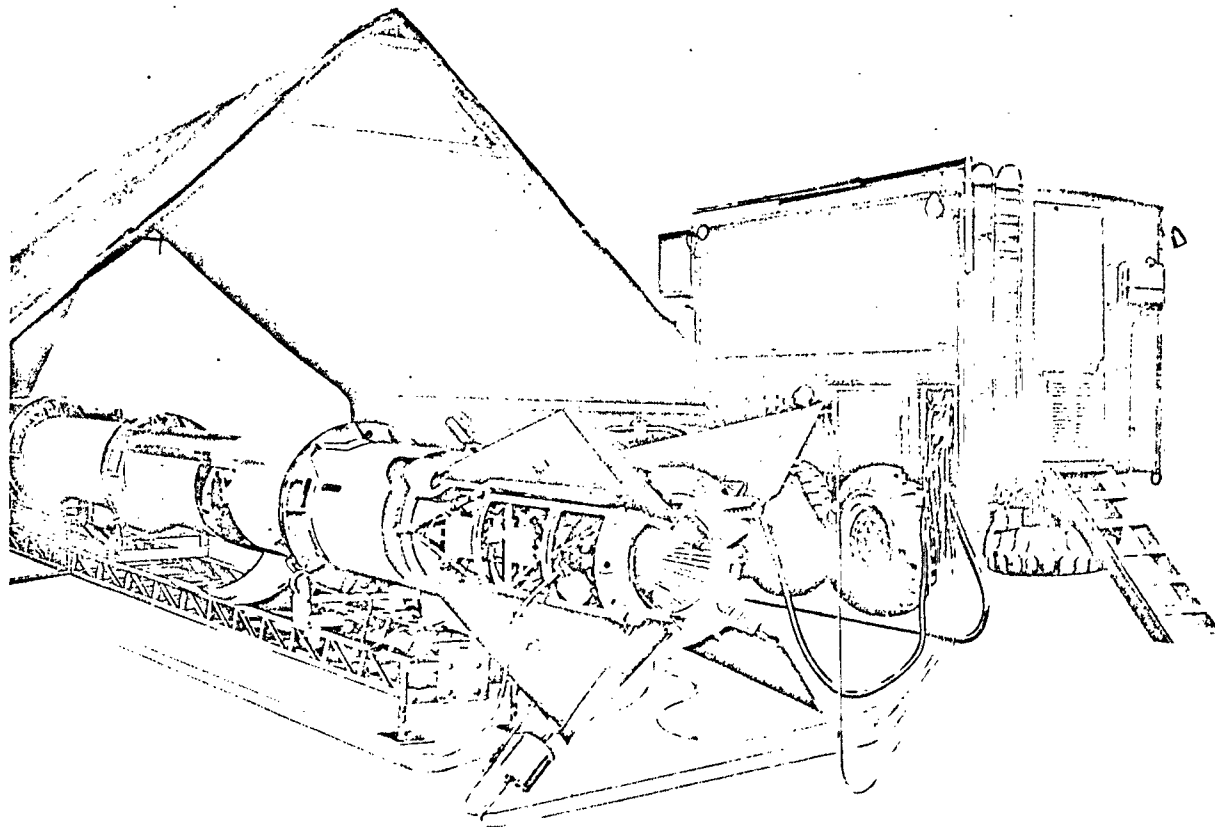

RA PD 409092

MISSILE TEST STATION CABLING CONNECTED TO MISSILE FOR CORPORAL CHECKOUT

UNCLASSIFIED

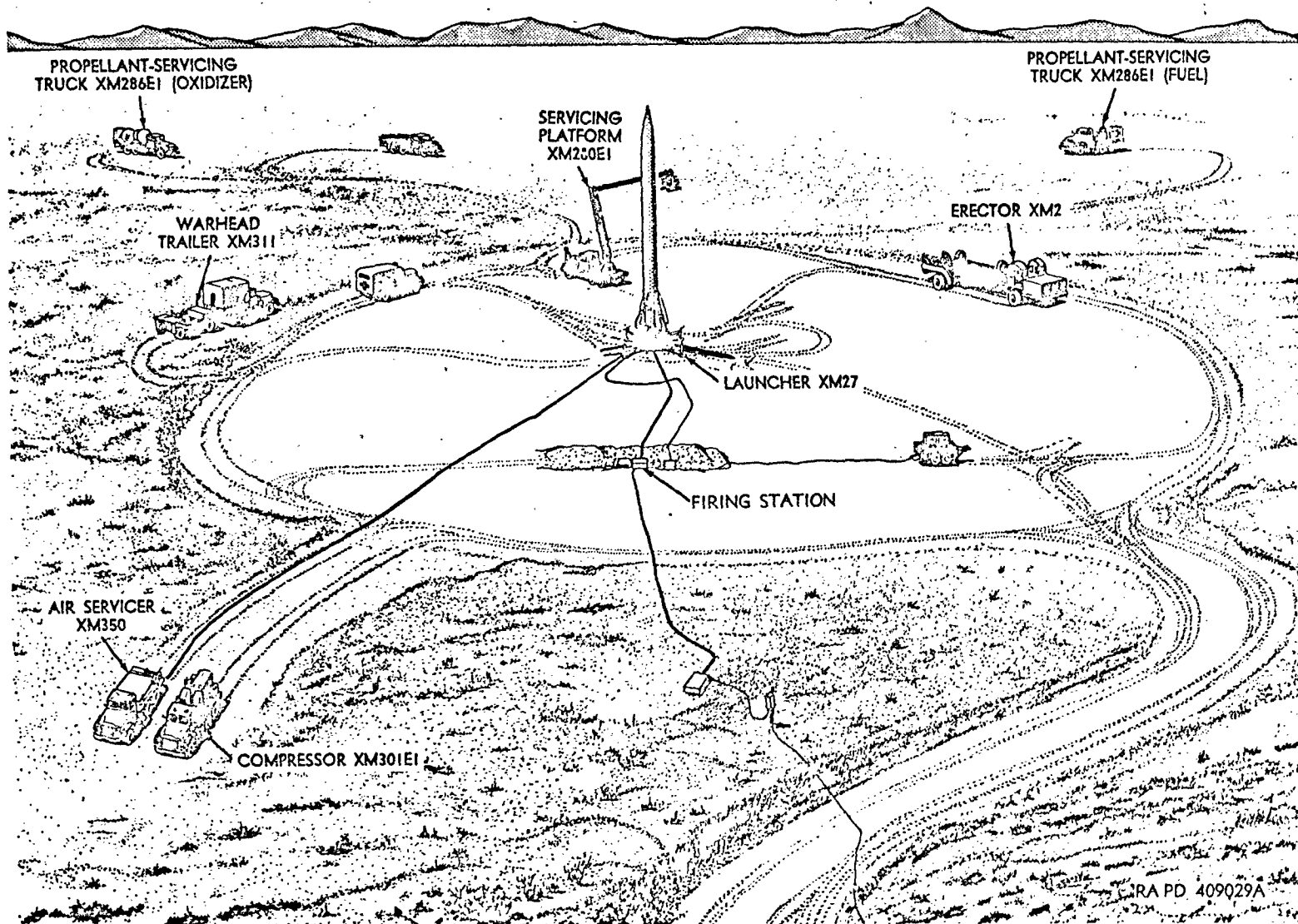

UNCLASSIFIED

FIRING POSITION EQUIPMENT EMPLACED

UNCLASSIFIED

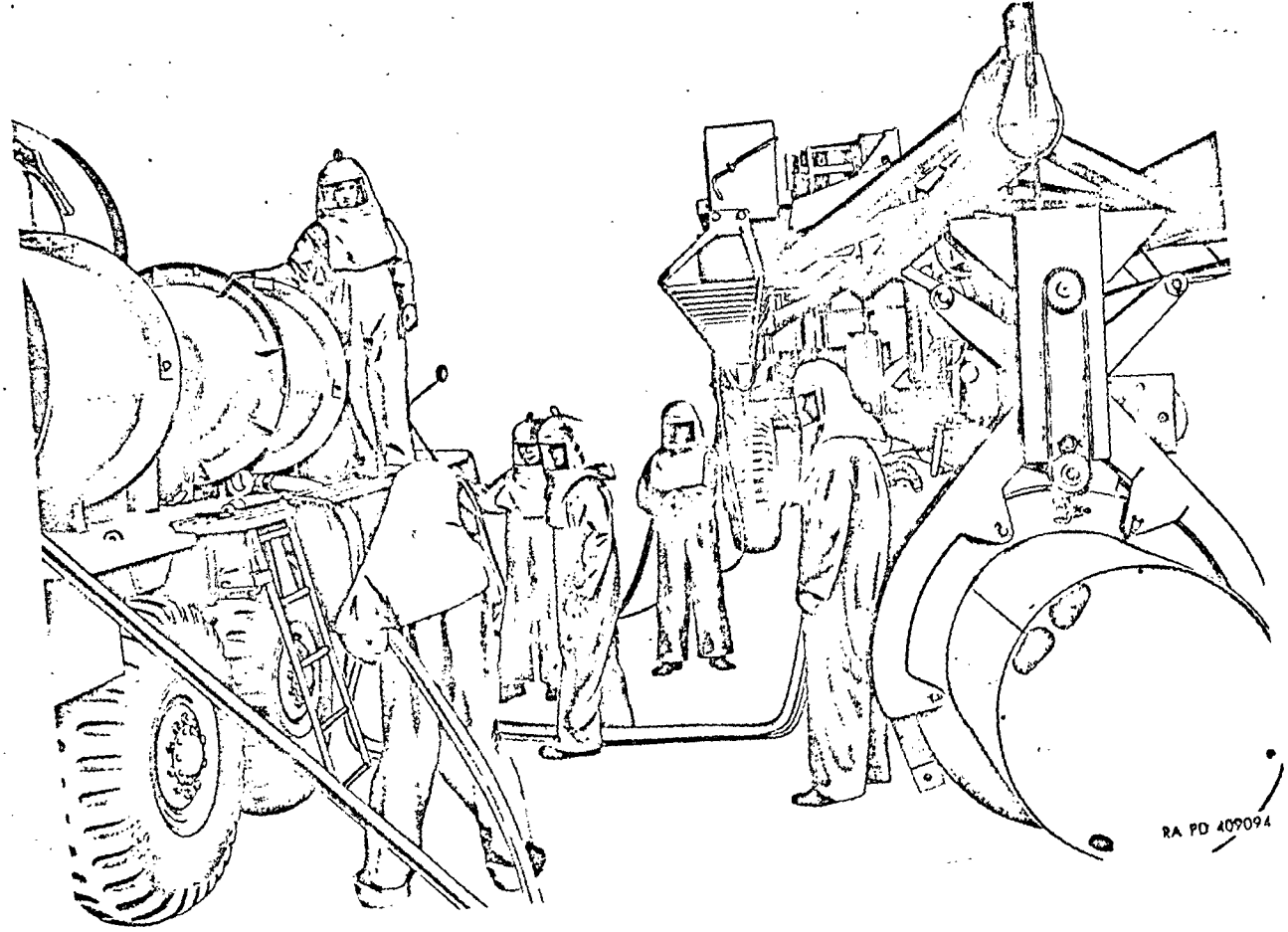

RA PD 409094

FUELING CORPORAL

UNCLASSIFIED

UNCLASSIFIED

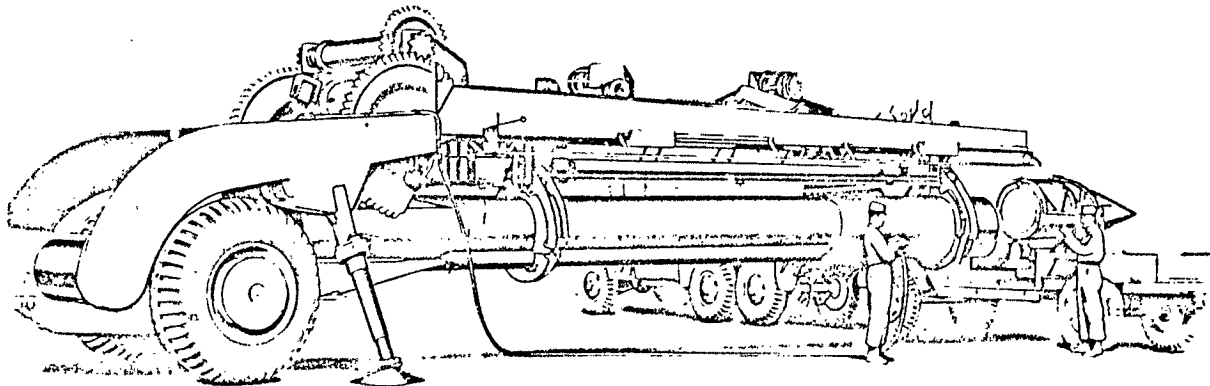

RA PD 409095

MATING WARHEAD TO MISSILE BODY

UNCLASSIFIED

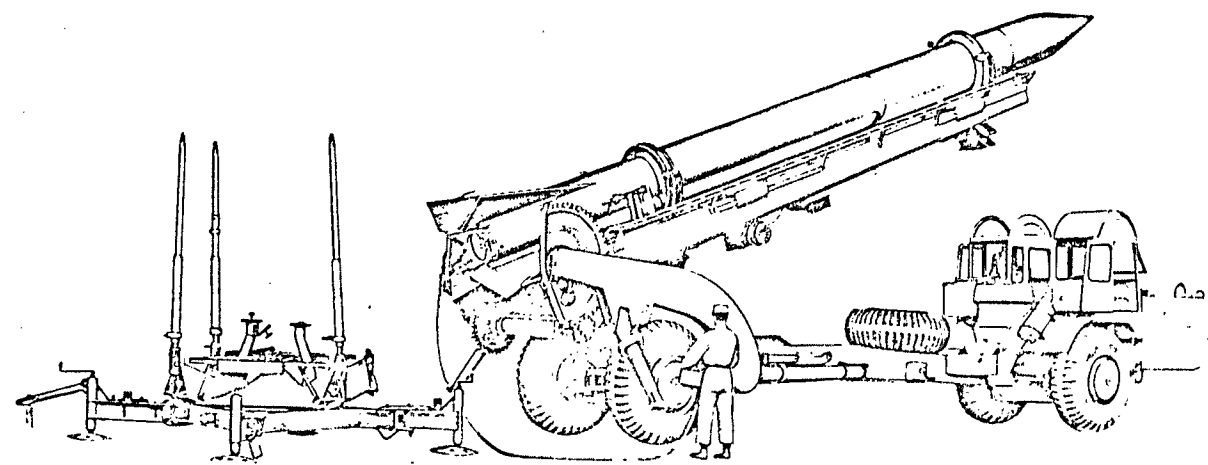

RA PD 409096

ERECTING CORPORAL

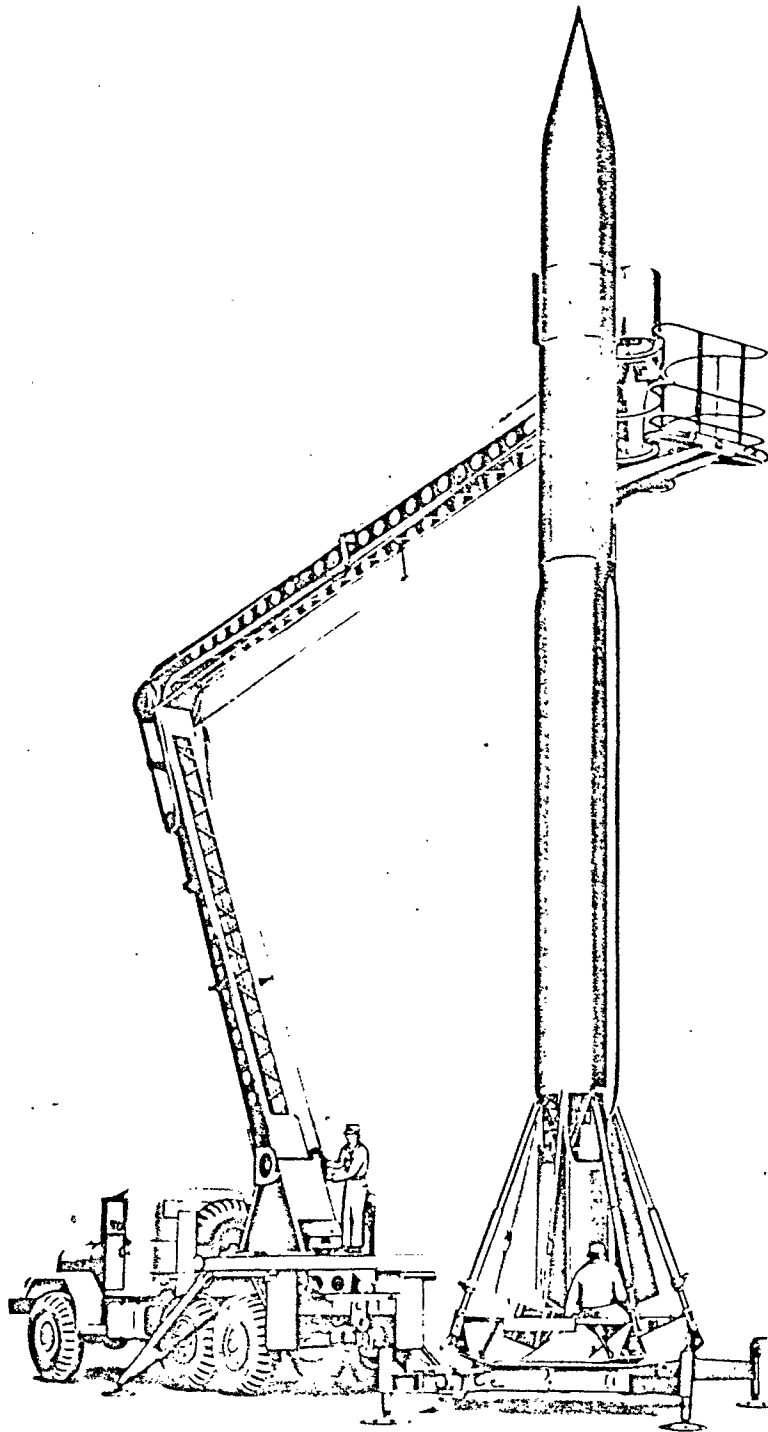

RA PD 409095

SERVICING PLATFORM IN USE

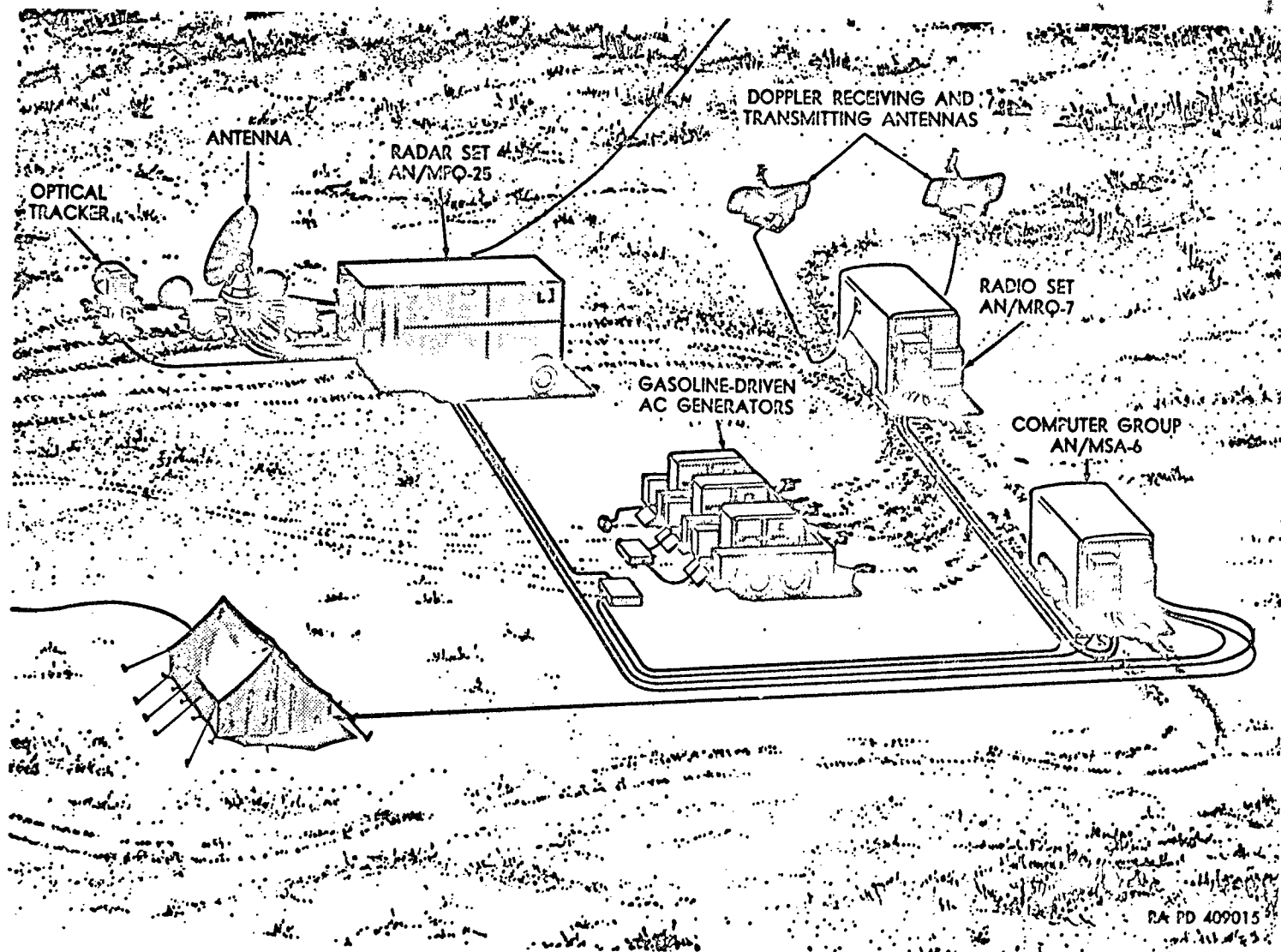

UNCLASSIFIED

GUIDANCE POSITION EQUIPMENT EMPLACED

RA PD 409015

CONFIDENTIAL

CORPORAL TRAJECTORY

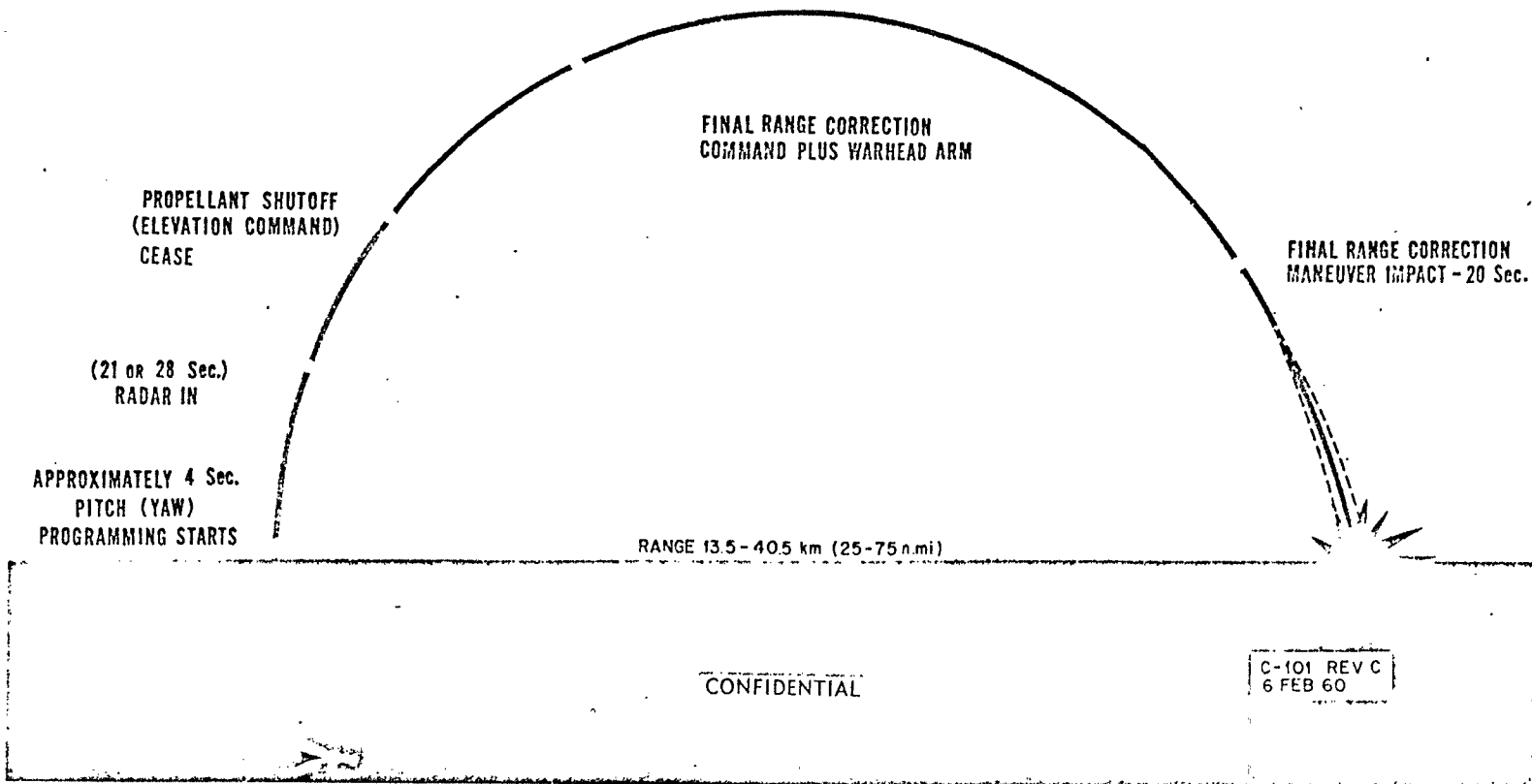

~~CONFIDENTIAL~~
UNCLASSIFIED

~~CONFIDENTIAL~~
UNCLASSIFIED

~~CONFIDENTIAL~~
UNCLASSIFIED

(U) A brief summary of events is necessary for understanding further development of the fielded tactical CORPORAL, since there was such development beyond Type IIA.

(C) In January 1951, CORPORAL was among the missile systems coming under the cognizance of OGMC, Redstone Arsenal, with the Center's function chiefly one of funding. JPL, as has been heretofore described, from the initiation of the CORPORAL program, exercised technical supervision in developing and producing the missile's components and the missile as a whole. In 1955 and 1956, however, JPL phased out of CORPORAL development.

(C) When JPL relinquished technical supervision, Redstone Arsenal assumed complete control of the CORPORAL, in a sense becoming prime contractor as well as technical supervisor of the system. Redstone retained the funding function and, although nominally exercising technical supervision, in actuality farmed it out to Firestone Tire and Rubber Company and Gilfillan Brothers, Incorporated. Gilfillan was assigned responsibility for further development of ground guidance and missile-borne electronics and test equipment for both. Moreover, Gilfillan was to keep an eye on Firestone for system compatibility and was to review all specifications. In addition, Gilfillan was to furnish test equipment for CORPORAL's propulsion system. Production of the CORPORAL system was divided in this manner:

Firestone

Missile

1. Airframe
2. Propulsion
3. Central power
4. Cabling

Ground equipment

1. Launching and handling
2. Test equipment

Gilfillan

Air-borne guidance

1. Electronic control amplifier
2. Automatic pilot flight controller
3. Signal data converter
4. Transponder set
5. Radio beacon

Ground guidance

1. Radar
2. Computer
3. Doppler (radio set)
4. Firing set

Test equipment for electronic components and also for propulsion system.

UNCLASSIFIED
~~CONFIDENTIAL~~

~~CONFIDENTIAL~~
UNCLASSIFIED

223

(S) When the Guided Missile Development Division of Redstone Arsenal on 1 February 1956 became the Army Ballistic Missile Agency (ABMA), Redstone retained responsibility for the CORPORAL system. With the establishment of the Army Rocket and Guided Missile Agency (ARGMA) on 1 April 1958, CORPORAL was one of the missile systems transferred to the new agency, while Redstone Arsenal became the housekeeping agency for the entire RSA complex.

(S) Cessation of JPL's responsibility for technical development of CORPORAL did not, however, mean a cessation of modifications of CORPORAL to improve its reliability. The missile as described above was of Type IIA as it was in the latter part of 1957. From time to time important modifications were incorporated. One such was the substitution of phenolic resin (a plastic) for graphite in the manufacture of jet vanes.* Manufacturing difficulties in the use of graphite resulted in the breaking of approximately two vanes for each unbroken one--a considerable waste. Moreover, precision machining was necessary in order to fit the leading edge of each vane with a molybdenum protective cover against the jet blast. As opposed to the care and waste involved in making the jet vanes of molybdenum-shielded graphite, plastic vanes could be readily molded. This vane was incorporated in CORPORAL Type IIA.

(S) As demonstrated in test firings, CORPORAL's batteries were a source of trouble, and an ATA had been developed to replace the batteries. This ATA was to be powered by compressed air from the missile's air tank. ATA was incorporated in a CORPORAL modified to receive it, and this modified CORPORAL later became Type IIB.

(S) A second major difference between Type IIA and Type IIB was the development of quick-disconnect fins for the IIB. This development permitted more rapid assembly of the missile in the field when going into action and more rapid disassembly when going out of action.

(S) There was a change in the main air regulator, but that modification was itself, in its turn, later modified. There were, in fact, several minor changes, but the two important modifications were the ATA and the

* Cf note 58.

~~CONFIDENTIAL~~
UNCLASSIFIED

~~CONFIDENTIAL~~

UNCLASSIFIED~~CONFIDENTIAL~~

quick-disconnect fins. Type IIB went into production in 1959, with ARGMA as the responsible agency.

(S) There had been some talk of efforts being made to introduce Type III after it had been laid on the shelf. In order to forestall any accusation that such surreptitious substitutions were being made, the CORPORAL modified to carry the ATA and the improved fins was deliberately designated Type IIB.⁶²

-
62. The above is the composite result of interviews with the following personnel on 10, 13-14 February 1961: Lt. Peter J. Marrero, CORPORAL Project Officer, FSO, ABMA; Mr. Robert W. Fleagle, Chief, Special Weapons Branch, R&D, ABMA; Mr. Amos G. Bogel, Asst. Engr. for CORPORAL, Engr. Div., Industrial Operations, ABMA.

UNCLASSIFIED~~CONFIDENTIAL~~

UNCLASSIFIED

CORPORAL TYPE III, AN "ON-THE-SHELF ITEM"

RESUME

(U) It has been mentioned before and indicated by tracing CORPORAL's development that the story of the CORPORAL System is one of progression; that is, as new discoveries were made, new materials (including alloys) developed, and electronic components improved and made more efficient through increased resistance to countermeasures, CORPORAL was modified in accordance with such advances. Its developmental history indicates that it has been a missile peculiarly adapted to improvement through the relative ease of incorporating more efficient components and at the same time maintaining over-all system compatibility. The program for improving CORPORAL reliability began before the fielding of Type I and continued thereafter until research and development was halted and Type III was designated as an "on-the-shelf item."

(U) That characteristic of relative ease of modification was manifested in WAC CORPORAL A, which became WAC B. Moreover, illustrative of CORPORAL's inherent versatility, WAC B lent itself readily to modification of its three-finned tail structure to one of four fins to help stabilize the vehicle as the second stage of BUMPER.

(S) As a further illustration, on 20 February 1952, the Deputy Assistant Chief of Staff, G-4, "suggested to the Chief of Ordnance that a study be made of the possibility of marrying the CORPORAL missile to an existing homing-all-the-way guidance system." It was thought that such a weapon might fulfill a surface-to-air role with both conventional and atomic warheads.

(S) Dr. L. G. Dunn, Director of JPL, on 27 February 1952 agreed to undertake preliminary studies, including changes necessary to adapt the CORPORAL to this role. JPL on 25 June 1952 reported that CORPORAL could function as an antiaircraft weapon under certain conditions. Effectiveness of the missile as an antiaircraft weapon would, according to the report, be greatly increased by making certain design changes to increase

UNCLASSIFIED
CONFIDENTIAL

UNCLASSIFIED~~CONFIDENTIAL~~

its maneuverability. From the point of time, the greatest obstacle was the necessity of designing and developing a new computer. Although the NIKE radar could be used, the NIKE computer could not.¹ This phase of CORPORAL development was apparently pursued no further thereafter.

(S) To recapitulate briefly, CORPORAL E was designed as a liquid-propellant test vehicle having a 20,000-pound thrust and an 80-mile range. The first CORPORAL E round was launched at WSPG on 22 May 1947 and was successful, achieving a range of 63.5 miles as compared to an aim point of 62 miles. After a missile redesign, Round 4 was fired on 7 June 1949. This round was over 1,000 pounds lighter than the previous model, largely due to its newly designed rocket engine, which weighed 125 pounds, or approximately one-fourth the weight of its predecessor. Round 4 proved positively the satisfactory performance of the revised propulsion system and negatively that the mechanical autopilot being used was adversely affected by vibration. On 11 July 1950, CORPORAL Round 5 was fired at WSPG, demonstrating the new JPL electronic autopilot and some elements of the guidance system. In September 1949, a review had been made of all Ordnance surface-to-surface missile programs to determine the best approach to meet an operational capability by July 1954 for a system capable of carrying a 1,500-pound warhead to medium ranges, with a probable error in both range and azimuth of less than 1,000 feet at maximum range. The CORPORAL E test vehicle was selected for modification to an interim guided missile weapon system. Commencement of the Korean War (24 June 1950) increased the emphasis on the development program, and the firing of CORPORAL E Round 5 marked the end of the CORPORAL test vehicle development. A greatly accelerated program gathered momentum to develop a guided missile weapon system. Round 11 carried the basic configuration for succeeding CORPORAL missiles and was the last CORPORAL E round.

(S) Since CORPORAL was to become an interim guided missile weapon system to meet an early operational requirement, a limitation was placed

1. D/A Pamphlet Nr. 70-10, op. cit., pp. 83-84.

UNCLASSIFIED~~CONFIDENTIAL~~

~~CONFIDENTIAL~~
UNCLASSIFIED

227

on JPL to use existing components insofar as practicable, with emphasis placed on early availability.²

(S) With time as the urgent factor, early operational availability became the goal of both the Type I and Type II CORPORAL systems. As early as 1952, it was recognized that this system, which was telescoped into production to meet the operational requirement, had many limitations, the nature of which was such that a large-scale redesign was required to overcome them. Engineering effort made for Type II CORPORAL was limited by the fact that it had to be of short duration in order to meet delivery dates to troops; consequently, only relatively minor design changes could be made.

(S) A conference was held at Redstone Arsenal on 24-25 November 1952 to discuss design improvement of the CORPORAL guidance equipment. It was concluded that a study should be undertaken with the objective of making the missile's guidance equipment tactically suitable within the military characteristics. The replacement of the obsolete SCR-584 radar was a specific objective.³

(S) Ordnance executed the ORD-468 contract with Gilfillan Brothers, Incorporated, on 11 June 1953, to conduct a redesign study of the CORPORAL guidance equipment (Ref. Chapter IX). A subsequent supplemental agreement (19 October 1953) expanded the scope of the contract to provide for development and fabrication of prototype models of improved guidance and control equipment, later designated as Type III. This supplement also made provision for two steps in design improvement of missile guidance components for early incorporation with Type II missile production. Increased costs, lack of funds, and a slip in the contractor's schedule,

-
2. Ibid., pp. 80-82; "Chronology of Significant Events in the CORPORAL Program," op. cit., pp. 7-11; Ordnance Guided Missile & Rocket Programs, Vol. III, CORPORAL," op. cit., pp. 1-3. Reference also to Chapters VII and VIII.
 3. "Ordnance Guided Missile & Rocket Programs, Vol. III, CORPORAL," op. cit., p. 105; Minutes, Conference on CORPORAL Ground Electronic Equipment, Redstone Arsenal, 24-25 November 1952, cited in "Chronology of Significant Events in the CORPORAL Program," op. cit., p. 38. See Document 15 for information concerning military characteristics.

UNCLASSIFIED
~~CONFIDENTIAL~~

UNCLASSIFIED ~~CONFIDENTIAL~~

however, delayed delivery of the prototype models of Type III guidance equipment until July 1956.

(S) Improvements in the missile, other than its guidance equipment, were made through development conducted by JPL and production engineering by Firestone.

(S) Redstone Arsenal developed a new method of warhead handling and also modified a standard 20-ton Corps of Engineers crane for erecting and servicing CORPORAL. After fabrication of this modified equipment, it was tested at WSPG but was not recommended as a replacement for the existing erector and servicer.⁴

COMPARISON OF TYPE III GROUND GUIDANCE EQUIPMENT WITH THAT OF TYPE II

(S) Without changing the basic system concept, the primary objective of the Type III development was improvement of the CORPORAL system's tactical useability and reliability. Other objectives were to "increase maintainability and produceability of the system."

(S) Type III ground guidance equipment (radar, Doppler, and computer) were to be condensed into one trailer the size of the Type II radar trailers, as contrasted to the three trailers and extensive interconnecting cabling required by Type II. This consolidation meant (1) greatly reduced communication and coordination requirements, (2) reduced setup and moveout times due to reduced interconnecting cabling, and (3) reduction of the number of operators by a three to one ratio.

(S) In the Type II system, the radar was locked in azimuth prior to launch; upon launch, the missile was internally programmed into the radar beam.* An optical tracker** was employed to track the missile from launch and to aid in positioning the radar in elevation. This reliance on the optical tracker hampered all-weather usefulness of the system.

4. "Ordnance Guided Missiles & Rocket Programs, Vol. III, CORPORAL," op. cit., pp. 106-107; "Chronology of Significant Events in the CORPORAL Program," op. cit., pp. 49, 54; D/A Pamphlet Nr. 70-10 op. cit., p. 86.

* Cf launching and flight sequence in Chapter IX.

** The optical tracker was deleted from the CORPORAL system in 1957. ABMA Industrial Operations.

UNCLASSIFIED ~~CONFIDENTIAL~~

~~CONFIDENTIAL~~
UNCLASSIFIED

~~CONFIDENTIAL~~

229

On the other hand, in the Type III system, the missile was to be tracked by radar from launch and programmed into the radar-to-target line, where the radar antenna was then to be automatically locked in azimuth, a feature designed to increase all-weather useability and CORPORAL's reliability.⁵

(S) A radome covering of lightweight fabric was proposed for use with Type III's radar antenna. Suspended separately from the antenna, this covering was expected to insure satisfactory radar operation in high winds, that is, winds of a velocity up to 60 mph. Such protection was also designed to preserve equipment from damage incident to solar radiation, snow, rain, and other weather extremes, as well as to protect operators from such weather extremes when making antenna adjustments.⁶

(S) In pursuance of the long-time, continuing goal, considerable effort was expended in Type III guidance equipment to reduce its vulnerability to electronic countermeasures.* Furthering achievement of this goal, Type III's antenna pattern was narrower in beam width than that of Type II and had much lower amplitude side lobes. As for Type III's Doppler, its "on" time was reduced. It used a selective amplifier instead of the former null network. The newly designed ground Doppler also incorporated an acceleration discriminator. This feature was for preventing any rapid, sweeping countermeasures signal from affecting such Doppler operations as those involving fuel shutoff, such a signal being one sweeping at a rate higher than the frequency corresponding to missile

5. "Ordnance Guided Missile & Rocket Programs, Vol. III, CORPORAL," op. cit., pp. 106-119. (Reference to Chapter IX will show development of Type II, Type IIA, and Type IIB missiles. The five redesigned major missile-borne electronic components were incorporated in Type II to convert it to Type IIA. ATA and quick-detach fins were included in Type IIB. On 20 December 1955, a contract modification was placed providing for incorporation of Type IIA guidance components in all missile production after January 1957. D/A Pamphlet Nr. 70-10, op. cit., p. 86.

6. "Ordnance Guided Missile & Rocket Programs, Vol. III, CORPORAL," op. cit., pp. 108-111.

* See Document 23 for studies concerning development of anticountermeasures.

UNCLASSIFIED

~~CONFIDENTIAL~~

UNCLASSIFIED~~CONFIDENTIAL~~

acceleration. Type III's radar transmitter was tunable instead of using five fixed frequency magnetrons.* Furthermore, radar repetition rate was noise-jittered. Finally, higher gain and more directional missile radar antennas were used.**

(S) In addition to the increase in reliability afforded by these improved characteristics, reliability was to be further improved by reducing prelaunch operator functions. The computer had been redesigned to enable all range dependent settings to be inserted by a prepunched card, thereby eliminating the setting of 23 individual potentiometers, as in the Type II system. Elimination of the operator required in two of the Type II trailers and the two optical tracker operators has been previously mentioned. After missile takeoff, the Type III ground guidance system operation was to be completely automatic. On the contrary, in Type II system operation, several operations had to be performed manually during the missile's flight. It was thought that Type III guidance equipment would virtually eliminate changes for operator errors.⁷

* "Magnetron:" a vacuum tube containing an anode (positive pole, or electrode, of a vacuum tube) and a heated cathode (negative pole), the flow of electrons from cathode to anode being controlled by an externally applied magnetic field.

** In addition to the general description in Chapter IX, further detailed information concerning operation of electronic elements is given here from RFWAR, WSPG, Revision Nr. 1, op. cit.: "The ground based Doppler transmitter is used to transmit the fuel shut-off command to the missile at the critical velocity for the desired range. This command is received by the missile-borne Doppler transponder and is used to activate an explosive cartridge, which releases a latch and allows the propellant valve to effect fuel shut-off. By means of the programmed pitch commands and precise thrust termination, the missile is directed into a ballistic trajectory toward the target. Immediately after thrust termination, missile-borne accelerometers are activated. These accelerometers and the ground-based radar are used to measure any variations in missile position from the desired ballistic trajectory. During this phase of flight, range correction commands are transmitted to the missile by means of coded radar pulses and are stored until the missile enters an atmosphere sufficiently dense for fin control to be effective. The missile executes a terminal maneuver (utilizing the commands previously stored) during the last 20 seconds of flight to compensate for any deviation observed in missile position from the desired ballistic trajectory."

7. Ibid., pp. 111-112.

UNCLASSIFIED~~CONFIDENTIAL~~

(S) Type II ground guidance equipment employed the obsolete, though modified, World War II SCR-584 radar and the M-2 optical tracker,* in 1955 already 12 years old. Major items and replacement components were no longer in production, making maintenance of this equipment extremely difficult. Further aggravating the situation, production drawings of the items were incomplete. A limited supply of SCR-584 radars remained, but their condition was in most cases poor, and availability of spares was decreasing. Conversely, the Type III system was modern and was expected to alleviate this problem. Moreover, the Type III system was designed to be more easily maintained, since extensive use was made of small plug-in assemblies, which could be easily removed and replaced. In addition, provisions were made for storing in the trailer at least one spare of each type of the plug-in subminiature card assemblies used in the ground control center.⁸

TEST AND CHECKOUT EQUIPMENT

(S) The design of the Type III missile test truck permitted orderly and rapid missile checkout. A go-no-go simulated flight check of the missile materially reduced checkout time, a feature considered a major improvement since the Type II system did not incorporate this feature. Redesign and simplification of test equipment had likewise contributed to improvement of missile checkout. Inclusion of all checkout controls on one control console was expected to reduce operator checkout errors materially. Setup and moveout time for Type III missile checkout was expected to be less than for Type II because of the addition of cable booms, thereby reducing cable handling problems. In designing the Type III missile test truck, human engineering of equipment arrangement and controls was considered.

(S) Checkout of the ground guidance equipment was to be accomplished with integral test facilities, since the designing of integral test equipment functions into the guidance system offered several advantages. Foremost was the functional simplicity achieved by

* Eliminated in 1957.

8. Ibid., pp. 112-113.

UNCLASSIFIED~~CONFIDENTIAL~~

providing only those controls and test functions required for the alignment operations. Moreover, by packaging the test equipment as a part of the guidance system, it could be afforded the same environmental protection as that provided the equipment. Maximum practical usage was made of standard military test equipment.⁹

GROUND HANDLING EQUIPMENT

(S) Although Type II ground handling equipment had remedied many of the deficiencies present in that of Type I, Type II was still deficient in many respects. For example, the hazardous feature of multiple handling of propellants was to be remedied in Type III by the use of a bulk propellant handling and transfer system, thereby streamlining the propellant supply and servicing system. A dangerous and time consuming gravity-feed system for transferring propellants to the missile was to be remedied by a flow-metered pump-fill system.¹⁰

(S) Remaining unsolved was the problem of an expensive, economically impractical, highly specialized erector which required considerable logistical support. As previously mentioned, the Redstone Arsenal-developed erector had proved unsatisfactory during WSPG tests conducted 30 June 1956.¹¹

(S) Time-consuming and suspending all but remote checks and adjustments because of safety reasons, the pressurizing operation for the Type II missile system remained a problem apparently defying solution.¹²

THE TYPE III MISSILE AS PLANNED

(S) Basically, Type II and Type III missiles were the same. To convert Type II to Type III required only replacement of the Type II S-band radar beacon with a new X-band beacon and the substitution of a newly designed controller for that of Type II.¹³

9. Ibid.

10. Ibid., pp. 113-114.

11. Ibid., p. 114.

12. Ibid., p. 113.

13. Ibid., p. 114.

UNCLASSIFIED~~CONFIDENTIAL~~

(S) Reliability of Type II missiles was being improved by a re-design of all the missile electronic components under contract with Gilfillan. At the same time, Firestone was improving the remainder of the missile. Several new designs of missile components as of 30 June 1955 had already been released by or were in process by JPL. Many of these improvements were to be incorporated in Type II as well as in Type III missiles. Planned improvements contemplated more reliable electronic components, requiring less maintenance. An ATA was scheduled to replace troublesome batteries and motor generator as CORPORAL's primary electrical power source, thereby greatly reducing maintenance and logistical support. Likewise, besides this missile-borne electric and electronic equipment, improved, but functionally equivalent, components being engineered by Firestone were to be incorporated.¹⁴

REDSTONE ARSENAL'S STUDY OF THE CORPORAL TYPE III SYSTEM

(S) A study of the Type III CORPORAL system conducted by Redstone Arsenal on 28 September 1955 concluded that:

1. The logistical support of the Type I and Type II CORPORAL systems was not practicable for an extended period because of the difficulties in supporting the obsolete SCR-584 radar used in these systems.
2. Although from a tactical standpoint the Type II CORPORAL system was more useable than the Type I, it had deficiencies inherent in the design that could not be eliminated by product improvement, even if the total amount of \$7,960,000 allocated to development of the CORPORAL were spent in the effort.
3. The Type III CORPORAL system, which was (as of 28 September 1955) nearing completion of the development phase, eliminated or minimized the inherent design deficiencies of the Type I and Type II systems.
4. Funds spent on the Type III CORPORAL system would buy more tactical useability, reliability, maintainability, and producibility per dollar than funds spent on the Type II system.

14. Ibid., pp. 115-119.

UNCLASSIFIED ~~CONFIDENTIAL~~

5. The Type III system could be delivered to users in July 1958 provided:
 - a. A program was approved prior to January 1956 and funds made available as required to implement the program.
 - b. To the maximum extent practicable personnel trained on Type I and Type II systems were given additional training and employed on the Type III systems.¹⁵

(S) The scheduled availability date for the SERGEANT system was the third quarter of 1963. This date was based on the schedule of the SERGEANT program prior to the recent orientation to an all-inertial guidance system in lieu of the dual approach of a radio and an all-inertial guidance system. In view of the SERGEANT availability date and the conclusions arrived at during the Redstone Arsenal study of CORPORAL Type III, the following recommendations were made:

1. That the Type I equipment in the hands of the user be replaced with Type III equipment beginning in the third quarter of 1958.
2. That no additional Type II equipment be procured to meet troop requirements.
3. That Type II equipment in the hands of the user be replaced with Type III equipment beginning in the first quarter of 1959.
4. That only Type III equipment be procured to meet additional troop requirements for CORPORAL capabilities until the availability of the SERGEANT system.¹⁶

ANALYSIS OF TYPE II FIRING TESTS

(S) As CY 1955 drew to a close, an analysis of 31 firing tests of Type II production missiles prepared by WSPG disclosed the following (Reference Teletype dated 31 October 1955):

1. Inflight reliability, that is, per cent of launchings with no system malfunctions during flight, was as follows:

-
15. "A Study of Type III CORPORAL System and Recommended Plan for Integration of Type III System into CORPORAL Program," Ordnance Corps, Redstone Arsenal, 28 September 1955, cited in "Chronology of Significant Events in the CORPORAL Program," op. cit., p. 93.
 16. Ibid., p. 94.

UNCLASSIFIED~~CONFIDENTIAL~~

~~CONFIDENTIAL~~
UNCLASSIFIED

235

- a. R&D (JPL) fired 14 missiles, with 8 successful for reliability of 57 per cent.
 - b. E-U (WSPG) fired 10, with 6 successful for reliability of 60 per cent.
 - c. AFF fired 7, with 2 successful for reliability of 28 per cent.
2. Inherent accuracy of the system demonstrated in the 31 launchings (discounting rounds having system malfunctions) was as follows:
- a. For R&D test firings the mean range miss-distance was short 134 meters \pm 163 meters at 95 per cent Confidence Level. The mean azimuth miss-distance was right 51 meters \pm 133 at 95 per cent Confidence Level. The standard deviation in range was 195 meters and in azimuth 160 meters.
 - b. In E-U test firings the mean range miss-distance was short 133 meters \pm 225 at 95 per cent Confidence Level. The mean azimuth miss-distance was right 19 meters. Standard deviation in range was 195 meters and in azimuth 160 meters.
 - c. Mean range miss-distance for AFF launchings was 86 meters long, and the mean azimuth miss-distance was right 66 meters. (Confidence Level in the AFF accuracy results was zero because of the small sample.)
 - d. For the combined firings of the three agencies the mean range miss-distance was short 98 meters \pm 107 meters. The mean azimuth miss-distance was right 41 meters \pm 74 meters. Standard deviation in range was 201 meters and in azimuth 139 meters.¹⁷

(S) On 5 December 1955 the Director of R&D, commenting on a review of the guided missile program, informed the Assistant Secretary of Defense that one prototype of the CORPORAL III would be delivered to the Ordnance Corps during the period July 1956 - January 1957. The difference

17. Ibid., p. 96, citing Teletype Nr. 6706, WSPG to Redstone Arsenal, DTG 311630Z, Oct 55, subj: CORPORAL Type II Results of R&D Program to date.

UNCLASSIFIED

~~CONFIDENTIAL~~

~~CONFIDENTIAL~~
UNCLASSIFIED~~CONFIDENTIAL~~

between CORPORAL II and CORPORAL III, the Director said, was largely in the ground guidance system.

FUNDING

(S) Funding entered the picture when, in December 1955, OCO rescheduled \$200,000 of the \$1,722,000 initially provided for CORPORAL R&D efforts for FY 1956 to Supporting Research Office. Total funds then available for the Type III CORPORAL effort were \$1,522,000. Gilfillan Brothers, Inc., notified the Los Angeles Ordnance District (LAOD) of an increase of \$2,695,184 in cost of the scope of the work. Approximately \$700,000 of the increase was for ORD-6 equipment, the cost of which was increased as a result of a change in concept for ORD-6 equipment. (As mentioned above, on 20 December 1955, contract modification was placed providing for incorporation of Type IIA guidance components on all missile production beginning January 1957.)*

(S) Redstone Arsenal advised OCO on 23 December 1955 in regard to Gilfillan's ORD-468 contract that additional funds of \$2,695,184 would be required in FY 1956 to cover cost increases, including that of ORD-6, together with \$500,000 to initiate work on a firing-test program.

(S) FY 1956 funds amounting to \$639,103 were available at Redstone Arsenal to offset the requirement, leaving a balance of \$2,456,081 additional funds required to fund the Type III program on an optimum schedule basis. OCO decided to defer the \$500,000 for initiation of firing tests and \$700,000 for ORD-6 equipment to FY 1957. FY 1956 funds amounting to \$1,231,471 were provided on 16 March 1956 to complete the scope of the work less ORD-6 equipment.¹⁸

(S) By 1st endorsement from OCO to CG, Redstone Arsenal, on 17 January 1956, the following guide lines for the Type III CORPORAL program were presented by OCO:

-
- * Modification 5 to Contract DA-04-495-ORD-681 and Modification 6 to Contract DA-04-495-ORD-468, both dated 20 December 1955.
18. "Chronology of Significant Events in the CORPORAL Program," op. cit., pp. 98-101, citing Revision to Technical Report, Vol. III, "CORPORAL, Ordnance Guided Missile & Rocket Program."

UNCLASSIFIED~~CONFIDENTIAL~~

1. System development and testing were to be continued with the view toward providing an "on-the-shelf" item.
2. Additional requirements for the CORPORAL system were to be fulfilled by the procurement of the latest production type.
3. No decision was to be made with respect to substitution of Type III for Type II equipment until after evaluation of scheduled field tests. Results of these tests, additional performance data then available on Type III, and progress of the SERGEANT program at that time were "then to provide a basis for a sound decision."¹⁹

(S) In a letter from CG, Redstone Arsenal, to OCO, subj: "Type III CORPORAL Planning," dated 28 March 1956, Redstone Arsenal presented a "shelf-item" program, which included the following:

1. Completion of development and firing test of 20 missiles.
2. Key personnel training.
3. Preproduction engineering and fabrication of 3 pilot models of ground equipments and conversion of 40 Type II missiles to Type III.
4. Ordnance Engineering and Product evaluation testing.

(S) This recommended "shelf-item" program, so Redstone stated, would bring the project to the point where the only time required to equip troops, in the event of a production decision, would be the lead-time required for missile production and training of troops, both running concurrently.²⁰

(C) In the meantime, a Program Execution Directive had already released funds for engineering and production of ORD-6 test equipment (7 February 1956) and resulted in the following program:²¹

-
19. "Chronology of Significant Events in the CORPORAL Program," op. cit., p. 102, citing 1st Ind from ORDTU to RSA, subj: "Type III CORPORAL Planning," dated 17 January 1956.
 20. "Chronology of Significant Events in the CORPORAL Program," p. 104.
 21. Ibid., p. 103, citing Program Execution Directive 60304121-13-40014-00-0-321, dated 7 February 1956.

UNCLASSIFIED~~CONFIDENTIAL~~ContractorORD-6 Test Set

Firestone Tire & Rubber Co.

Missile Mechanical Heavy Maintenance,
1 prototype (delivery scheduled 1
December 1957), 5 production models

Firestone Tire & Rubber Co.

Ground Handling Heavy Maintenance,
1 prototype (delivery scheduled 1
December 1957) 5 production models

Gilfillan Brothers, Inc.

Ground Guidance Direct Support, 2
prototypes (delivered), 18 production
models.

Gilfillan Brothers, Inc.

Missile Electronic Direct Support,
2 prototypes (delivered), 18 produc-
tion models.

Gilfillan Brothers, Inc.

Ground Guidance Heavy Maintenance,
1 prototype (delivery scheduled Feb-
ruary 1958), 6 production models.

Gilfillan Brothers, Inc.

Missile Electronics Heavy Maintenance,
1 prototype (delivery scheduled March
1958), 5 production models.

(S) The Chief of Ordnance, on 25 April 1956, recommended to the Deputy Chief of Staff for Logistics the continued development of the Type III CORPORAL system with FY 1956 and FY 1957 funds and production with FY 1958 funds.²²

(C) Office, Deputy Chief of Staff for R&D, on 7 May 1956, requested that the Chief of Ordnance, on 18 May 1956, present a briefing of the CORPORAL Type III Program, to include the following:

1. Scope of the CORPORAL Type III development to include all changes from Type II in both missile and ground equipment.
2. Status of the program at that time.
3. Alternatives in the planned program for future development and testing to produce a "shelf-item."
4. Cost in terms of time, R&D, and Procurement and Production (P&P) funds, and amount of equipment required for development for each of the various alternatives.

22. Ibid., p. 106, citing DF from COFORD to DCSLOG, subj: "CORPORAL Program," dated 25 April 1956.

UNCLASSIFIED~~CONFIDENTIAL~~

~~CONFIDENTIAL~~
UNCLASSIFIED

239

(C) As requested, on 18 May 1956, representatives of OCO and Redstone Arsenal presented the briefing in the Pentagon to representatives of the Offices of the Deputy Chief of Staff for Logistics and the Deputy Chief of Staff for R&D. It was stated in this meeting that any program less than that outlined above (Cf text preceeding note 20) and on the chart entitled "Type III, CORPORAL Shelf-Item Program"* would not be a true "shelf-item" program.

(C) As of 30 June 1956, no official decision by the Deputy Chief of Staff for Logistics relative to the Type III CORPORAL Program had been received by Ordnance. The schedule presented in the Chart (Cf above) slipped because of unavailability of funds in FY 1956 to initiate the planned firing-test program.²³

(S) FY 1956 funds amounting to \$1,722,000 were provided for the CORPORAL FY 1956 R&D efforts (17 May 1956). Of this amount, \$1,177,000 was used to cover a deficit carried over from FY 1955 in the funding of Contract ORD-468. The scope of work of this contract called for fabrication of one set each of Type III prototype ground guidance equipment, missile test truck and ORD-6 equipment, and 10 sets of Type III missile guidance components. Of the \$1,722,000 initially provided, \$157,653 was used to provide for JPL assistance in the R&D evaluation of Type III equipment. This activity included conversion of five Type II missiles to Type III, assistance in firing tests of the five missiles, and laboratory testing of the Type III missile components.²⁴

(S) Rising costs had been upsetting funding programs, and the upward spiral continued. Gilfillan in June 1956 notified LAOD of an increase in cost of \$655,000, a result of the following unforeseen expenditures:

1. Difficulties not anticipated in producing 10 Type IIA missile electronic components, also a part of contract ORD-468, \$64,000.

* This chart is unavailable.

23. Ibid., pp. 107, 109, citing Revision to Technical Report, Vol. III, "CORPORAL, Ordnance Guided Missile & Rocket Programs."

24. Ibid., p. 108.

UNCLASSIFIED

~~CONFIDENTIAL~~

UNCLASSIFIED~~CONFIDENTIAL~~

2. Unanticipated cost of production drawings for Type III prototype equipment, \$401,000.
3. Increase in cost of development of Type III missile-borne radar beacon, \$150,000.
4. Expenditures in planning for Type III R&D firing tests, which were not adequately covered in the contract, \$40,000.

(S) Redstone Arsenal had on hand \$186,000--\$22,000 R&D and \$164,000 P&P funds which were placed in the contract on 21 June 1956 to offset partially this increase in cost, leaving a balance of \$469,000 deficit in FY 1956.²⁵

(S) By 30 June 1956 all R&D activities relating to the Types I and II CORPORAL systems had been terminated except that pertaining to E-U testing. JPL, the developer of Types I and II, was phased out of the CORPORAL program during this period. JPL had been assisting the Ordnance Corps and the production contractors in solving problems encountered in the production and the field use of the CORPORAL system. Because of the increase of JPL activities in the SERGEANT and JUPITER programs, however, it was necessary to terminate the CORPORAL activities at JPL. The work done by JPL during the period 1 July 1955 to 30 June 1956 included the completion of development of the Control Monitor Group, laboratory evaluation and flight testing of missile components redesigned by the production contractors, and consultation provided to Ordnance and the production contractors.

(C) It was 16 July 1956, however, before JPL completed the testing of the five missile-borne electronic components redesigned by Gilfillan and designated as Type IIA.²⁶

(C) By 30 June 1956, too, the contractor had completed one tactical prototype model of Type III ground guidance equipment and the missile test truck and was conducting system tests at the contractor's plant. Fabrication and assembly of the Type III ground guidance and missile test station were completed. By concentrating the funds in the contract on the completion of prototype equipment at the expense of certain items

25. Ibid., p. 110.

26. Ibid., pp. 116, 121. Cf Chapter IX for details.

UNCLASSIFIED~~CONFIDENTIAL~~

of documentation, the contractor was able to complete fabrication of this tactical prototype set of ground guidance equipment and missile test station. This equipment was statically demonstrated at the contractor's plant to representatives of Office, Deputy Chief of Staff for R&D; OCO; Headquarters, CONARC; Antiaircraft Artillery and Guided Missiles Center (AAA & GM Center), Fort Bliss, Texas, and the Artillery and Guided Missile Center, Fort Sill, Oklahoma.²⁷

(C) A meeting was held on 10 August 1956 at OCO to discuss and determine whether the CORPORAL Type III Program could be accelerated, at a decrease in cost, if the major responsibilities for the firing-test program were shifted from Gilfillan to WSPG. The general consensus of opinion of Redstone Arsenal, Gilfillan Brothers, Inc., and WSPG was that any changes in the existing program would be detrimental.²⁸

(S) The Deputy Chief of R&D on 4 December 1956 informed the AAA & GM Center, Fort Bliss, Texas, that the CORPORAL program had been under study for some time and that "the Army position was to continue CORPORAL III through a very limited development program, thus making CORPORAL III available for production should additional CORPORAL units be required before completion of SERGEANT." CORPORAL III development "was to be on a very austere basis, so as not to interfere with that of SERGEANT."²⁹

(C) Modification Nr. 16 to Contract ORD-468 in the amount of \$695,000 was signed 15 May 1957, providing for Gilfillan to develop one prototype set of ORD-6 Test Equipment for the Type III CORPORAL system.³⁰

(S) On that same day (15 May 1957), the Chief of R&D approved for the Chief of Staff, Army, termination of the CORPORAL Type III development program. The reason assigned was that support for SERGEANT and

-
27. "Chronology of Significant Events in the CORPORAL Program," op. cit., pp. 118, 123-125, citing Revision to Technical Report, Vol. III, "CORPORAL, Ordnance Guided Missile & Rocket Programs;" Semi-Annual. CORPORAL R&D Historical Summary, ORD Project TUI-2; Monthly Activity Report, "CORPORAL Field Artillery Guided Missile System, ORD Project TUI-2, August 1956."
28. Ibid.
29. D/A Pamphlet Nr. 70-10, op. cit., p. 86.
30. "Chronology of Significant Events in the CORPORAL Program," op. cit. p. 127.

UNCLASSIFIED~~CONFIDENTIAL~~

other missiles was underfunded in the FY 1958 budget. CORPORAL III, being a "shelf-item," had lower priority than these other missile projects.

(C) The axe finally fell on 23 May 1957 when the CORPORAL Type III Program was terminated in compliance with a Staff Directive. Objectives listed in the termination action were completed prototype equipment, contractor's manufacturing-type drawings to include brief Engineering Level Handbooks, and a final report.

(U) As a reminder that CORPORAL was still considered as a lethal weapon, however, on 26 June 1957, a contract was signed with Lyons Van and Storage Company of Burbank, California, for development of a CORPORAL warhead container.³¹

31. Ibid., pp. 128-129; D/A Pamphlet Nr. 70-10, op. cit., p. 86.

UNCLASSIFIED~~CONFIDENTIAL~~

UNCLASSIFIED

~~CONFIDENTIAL~~

CHAPTER XI

TRAINING, DEPLOYMENT, AND PRESENT STATUS OF THE CORPORAL

(U) Although not precisely pertinent to a study of the development of the CORPORAL Missile System, a summarization of training incident to its development, the system's deployment, and its present (1 January 1961) status nevertheless seems apropos.

JPL TRAINING MISSION FOR THE CORPORAL

(U) For two years or more before 30 June 1946, at the request of the Air Technical Service Command, a course on jet propulsion had been conducted at CIT by the staffs of the Guggenheim Aeronautical Laboratory and the Jet Propulsion Laboratory. This course had been limited to officer personnel of the Army and the Navy assigned for graduate study at CIT.

(S) When, therefore, the Ordnance Corps early in 1951 requested JPL to operate a formal training program for Army personnel, the request found JPL already prepared to undertake the task. The mission of the projected new CORPORAL Military Training School was to train instructors for the Army Ordnance Corps and the AFF.¹

(S) A supplemental agreement to the basic contract--ORD-18--required JPL to furnish necessary personnel, equipment, facilities, and training documents to teach the operation and maintenance of the CORPORAL missile and its associated equipment. JPL was responsible for the technical content of the curriculum. Ordnance Corps and AFF each provided five officers to assist in preparation and operation of the program. Also, the Ordnance Corps assigned a military school-coordinating officer. In addition to the original ten military instructors, JPL employed seven civilian specialists and provided two research engineers to serve as instructors. Moreover, JPL's CORPORAL research and development engineers

1. Seifert, "Hist Ord Research at JPL," op. cit., pp. 30-31; JPL Report Nr. 20-100, op. cit., p. 355; "Ordnance Guided Missile & Rocket Programs, Vol. III, CORPORAL," op. cit., p. 152.

UNCLASSIFIED

~~CONFIDENTIAL~~

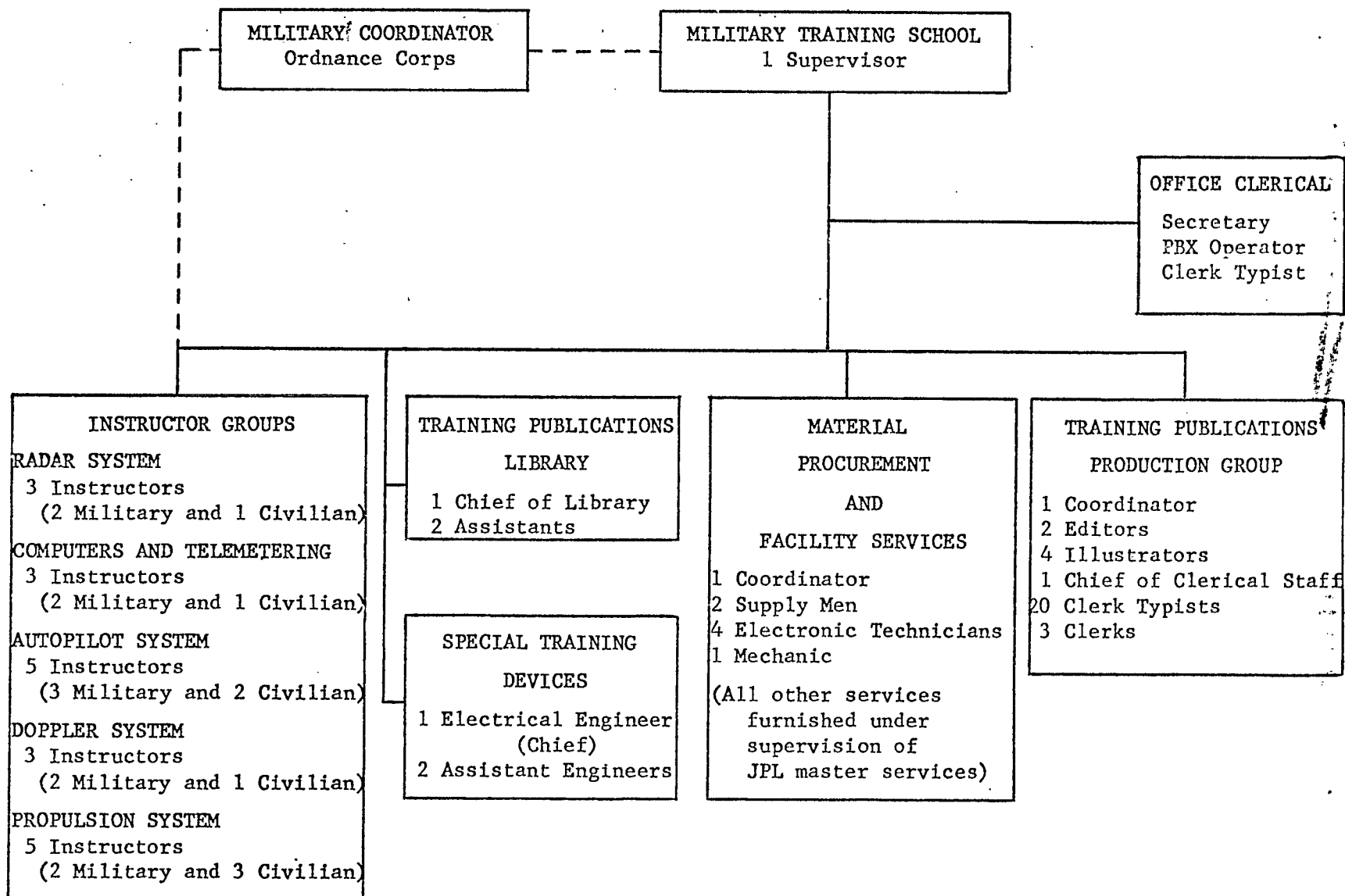

UNCLASSIFIED

Organization of JPL CORPORAL Training School

and specialists were asked to assist the instructor group in determining technical content of the course.²

(S) In April 1952, after about six months of preparation for the school's opening, the first class convened. The CORPORAL system was broken into three basic sections for instruction: internal, external, and mechanical. Internal covered missile and test station; external covered ground-guidance equipment; and mechanical covered nuts-and-bolts aspects of the whole system. The only technical manual available in the beginning was Handbook I, which covered the operation of the over-all prototype CORPORAL system. Instructors, therefore, had to prepare reference materials for both their own and student use. Material for these information sheets was obtained from technical reports, as well as from conferences with JPL's research and development engineers.³

(S) Since there were no ready-prepared teaching materials, staff instructors were responsible for the general outline of the courses. Included in lesson plans were an outline of each lecture or laboratory period and a list of training aids and materials required for the class. These instructors prepared a total of 540 lesson plans for the CORPORAL school courses and, in addition, two types of supplementary information sheets: worksheets for the class, and instructor notes containing more complete information than that included in the lesson plan outlines. Moreover, three types of training aids were devised: charts, overhead projection transparencies, and special devices and simulators. To meet training requirements, a total of 450 finalized training aids were produced, of which 165 were 3-foot X 4-foot wall charts and the remainder were overhead projection transparencies.

(S) Two classes of military students completed each 14-week CORPORAL course, which was divided into 1 week of orientation lectures, 11 weeks of training on their specific assignments, and 2 weeks for the third and

2. Ibid.

3. JPL Report Nr. 20-100, op. cit., pp. 357-358; "Ordnance Guided Missile & Rocket Programs, Vol. III, CORPORAL," op. cit., pp. 152-153.

4. JPL Report Nr. 20-100, op. cit., pp. 356-357.

UNCLASSIFIED ~~CONFIDENTIAL~~

final phase of training--a trip to WSPG to observe checkout and firing of a CORPORAL missile.

(S) The first class graduated 12 students in propulsion, 20 in internal, and 20 in external guidance. Having started at the school on 14 April 1952, this class completed the course on 6 July 1952 and then traveled to WSPG to witness CORPORAL firings. Starting training on 11 August 1952, the second class graduated 12 students in propulsion, 23 in internal, and 23 in external guidance. These propulsion students graduated on 24 October 1952 and returned directly to their stations. Internal and external guidance students graduated on 7 November 1952 and continued to WSPG to observe checkout and firing of the missile.⁵

(S) Officers and enlisted men from the Army Ordnance Corps comprised the majority of these students, and some were from the AFF. Several civilian employees from Ordnance depots attended the school along with the military students. A high percentage of the second class's students were found to have insufficient technical background for the course. Those assigned to ground radar were particularly weak because they had not been trained on the SCR-584 radar set, as had been specified by JPL. As a consequence, although all students completed the course, approximately one-third failed to receive diplomas, since diplomas were awarded to only those who had maintained a predetermined minimum grade average.⁶

(S) As a result of a conference held at Fort Bliss, Texas, in June 1954, with Ordnance Field Forces, production contractors, and JPL represented, a CORPORAL coordinator was established at Redstone Arsenal to centralize the whole CORPORAL program. At the same time, a CORPORAL Technical Consultants (CTC) Office was established at Fort Bliss, with one representative each chosen from JPL, Gilfillan, and Firestone to act as technical consultants for the service of equipment supplied by their respective organizations. The JPL representative was the senior member of the CTC, whose function (broadly speaking) was chiefly educational. An illustration of this function was the publication and circulation by

5. Ibid., p. 358.

6. Ibid.

UNCLASSIFIED~~CONFIDENTIAL~~

JPL (under the cognizance of Field Service Division of Redstone Arsenal) of a biweekly CORPORAL News Bulletin, containing accurate information consistent with official procedures, specifications, characteristics, and handling techniques. All personnel working on CORPORAL were responsible for insuring that all pertinent technical information reached the News Bulletin editor. Because of its wide and frequent distribution, the CORPORAL News Bulletin was also used for dissemination of any urgent CORPORAL information when the situation so required. In 1956, responsibility for the News Bulletin was assigned to Gilfillan, who continued its publication until early in 1957 (Cf Training Program, Chapter VIII).⁷

(S) Commencing on 30 January 1953 and ending in January 1954, an E-U team fired 14 CORPORAL rounds. No formal training program was established within E-U, although JPL was frequently consulted on various problems. With no written operating procedures, the firing crews learned chiefly through on-the-job training; techniques evolved with experience (Cf Type I Engineer-User Program, Chapter VIII). After three unsuccessful launchings, of which the causes of the failures were unknown, E-U suspended firings for a few months. In March 1954, JPL conducted a school on the CORPORAL missile.* In addition to representatives from other CORPORAL units, 14 E-U personnel attended, including enlisted men, officers, and civilians. This school continued for three months and covered all aspects of checkout and firing of the missile. Procedures for all operations were written during this period. In reference to the CTC Office, it is probable that its greatest single contribution to improved results in the military firings was the preparation of standard operating procedures.⁸

(S) When the decision was made to put CORPORAL into production, JPL established a group of engineers to assist Redstone Arsenal in the transition of the missile system from research and development to production status. Specifically, although not all existed from the outset, the principal duties of the group were as follows:

7. Ibid., pp. 360-362.

* Note that this is not the CORPORAL school already alluded to.

8. Ibid., pp. 359-360.

UNCLASSIFIED ~~CONFIDENTIAL~~

1. Maintenance of liaison between JPL and the R&D Division of Redstone Arsenal.
2. Provision of contract specifications and drawings for production of both missile and ground equipment.
3. Rendering of technical assistance to Redstone Arsenal's Industrial Division and to the LAOD in their supervision of CORPORAL production.
4. Provision of technical assistance to production contractors.
5. Preparation for Field Service Division (FSD), Redstone Arsenal, a series of preliminary operators' and maintenance manuals, together with standard operating procedures.
6. Publication of the CORPORAL News Bulletin.⁹

(S) In the matter of documentation, both JPL and JPL's subcontractors published a series of manuals describing the missile and its associated equipment in sufficient detail to enable Army personnel to operate and maintain all elements of the CORPORAL system. JPL also published a series of operating and preventive maintenance procedures for the use of Army personnel, who, because of lack of training, unfamiliarity with the equipment, or similar reasons, had difficulty in accomplishing the necessary procedural requirements for successfully firing the missile. This documentation covered both Type I and Type II CORPORAL and handling equipment.¹⁰

(S) Throughout the CORPORAL program, representatives of JPL acted as technical consultants in field operations both of the military and of the production contractors. In the latter relationship, a system of integrating Firestone personnel into the JPL firing team was initiated. About 12 Firestone representatives and engineers were trained in this mutually beneficial program which began in December 1953. JPL early in 1954 also initiated a system of integrating Gilfillan personnel into the JPL firing team. Under this plan, three Gilfillan technicians were

9. Ibid., p. 361.

10. Ibid., pp. 363-370.

UNCLASSIFIED ~~CONFIDENTIAL~~

assigned to JPL's team for on-the-job training in using elements of the system produced by Gilfillan.¹¹

(U) As early as 11 October 1945, the 1st Guided Missile Battalion was activated at Fort Bliss, Texas, to insure that trained troops would be available to place guided missiles in operational use as soon as such weapons might become available. On 26 September 1945, the first rocket to be tested at WSPG was TINY TIM.

(U) Battery D of the 1st Guided Missile Battalion in the spring of 1947 furnished the first all-soldier crew ever to fire a rocket missile in the United States--a WAC CORPORAL B.

(C) In a letter (15 November 1947) to the President of the Manpower Board, Army, the Commanding General, Army Ground Forces (AGF), requested an increase in the AGF bulk space allotment in order to expand the existing 1st Guided Missile Battalion into a regiment.

(S) As of 18 November 1948, the civilian schooling program for the combat arms had graduated 65 officers with masters degrees; 86 were currently enrolled; and 56 were to be enrolled in FY 1949. A 37-week officer guided missile course had been established at the Antiaircraft Artillery and Guided Missile School in 1946, from which school 70 Army and 20 Navy officers had graduated, with 37 Army and 18 Navy officers in attendance as of 18 November 1948. On the operational side, the newly formed 1st Guided Missile Regiment had been undergoing training.

(C) The Chief of Staff on 13 February 1950 approved an Organization and Training Division for organization of the 1st Guided Missile Brigade. Organization of one group headquarters and a headquarters company and three missile battalions was to proceed without further approval of the Chief of Staff.

(C) In April 1950, the 1st Guided Missile Group obtained 66 JB-2's--buzz bombs--from the Air Force for use in training. This group adopted the Navy guidance system and named the JB-2's the ARMY LOON.

11. Ibid., pp. 361-363. (JPL's participation as technical consultant in military field operations will be discussed later in the text.)

UNCLASSIFIED ~~CONFIDENTIAL~~

(C) The 1st Guided Missile Group in June 1950 assisted in firing the two BUMPER rockets at LRPG, Cocoa, Florida.¹²

Beginning of Organized Training

(S) In an effort to centralize responsibility for the Ordnance Training Mission, the Army Chief of Ordnance established the Ordnance Training Command (OTC) at APG in October 1950. The Command's mission was established as the "continuous coordination, direction, guidance, and surveillance of the entire Ordnance Training Program." With the advent of guided missiles into the Army weapon system, training of all Ordnance military and selected civilian personnel required for the support of the new missile system became the responsibility of OTC.¹³

(S) OTC in June 1951 established the Guided Missile Branch of the Ordnance School at APG, having as its mission the planning and preparation for training of Ordnance personnel on the new missile systems then under development. To centralize and accelerate this planning, the Guided Missile Branch was transferred to OTC headquarters in July 1951 to become a staff division there.

(S) During this period, efforts were also underway at Fort Bliss and WSPG to prepare for activation of the first guided missile units. Since no firm commitments had yet been made as to which missile system would be the first to be adopted, all planning had to be on a broad scale to include all missiles then under development. As soon as specific information was received from AFF, tentative Tables of Organization and Equipment (T/O&E) were developed. In January 1954, a combined NIKE and CORPORAL Ordnance Guided Missile Direct Support Company, T/O&E 9-227, was approved. This unit had the responsibility of providing Ordnance direct support for both the NIKE and the CORPORAL systems in the field.

-
12. D/A Pamphlet Nr. 70-10, "Chronological History of Army Activities in the Missile/Satellite Field, 1943-1958," pp. 11, 16, 18, 20, 23, Headquarters, Department of the Army, September 1958.
 13. *Ibid.*, p. 28; "Ordnance Guided Missile & Rocket Programs, Vol. III, CORPORAL," *op. cit.*, p. 151.

UNCLASSIFIED~~CONFIDENTIAL~~

CORPORAL's section of this unit was later designated as the 96th Ordnance Direct Support Company, CORPORAL.¹⁴

(S) Meanwhile, personnel to be assigned to prospective units were undergoing extensive operator training on NIKE and CORPORAL at the AAA & GM Center, Fort Bliss. At WSPG, personnel who later became the nucleus of the CORPORAL Direct Support companies were gathering field experience from the V-2 firings being conducted there. Upon activation of such companies, their personnel conducted on-the-job training for incoming personnel.*

(S) When it soon became apparent that space requirements at APG were inadequate for the activities of the Guided Missile Branch, OTC, search for a new site for Ordnance Guided Missile Training led to the establishment in March 1952 of the Provisional Redstone Guided Missile Branch, OTC, were transferred to Redstone to form the nucleus of the new school.¹⁵

(S) Seven officers were enrolled in the Guided Missile Officers Course when the first Ordnance Guided Missile Training Program at Redstone began on 10 March 1952. Four additional courses were added for enlisted personnel and civilians during the next four months. Training on both the CORPORAL and the NIKE systems was given in all courses. The first courses offered included calculus, differential equations, Laplace transforms, supersonic aerodynamics, high frequency electronics, radar, and thermodynamics. Such broad theoretical knowledge was necessary because of the state of flux in missile development.¹⁶ Changes were made in resident courses at Redstone as new information became available. Graduates of the JPL course bolstered the school's knowledge of the CORPORAL, and the instruction became more specifically related to that system (Reference note 14).

14. "Ordnance Guided Missile & Rocket Programs, Vol. III, CORPORAL," op. cit., pp. 152-153.

* One such company was the 137th, which was formed at Fort Bliss but was not deployed overseas. It supported firings and served more or less as a trouble-shooting unit. Mr. N. L. Cropp, ABMA Control Office.

15. Ibid.

16. Ibid.

~~UNCLASSIFIED~~ ~~CONFIDENTIAL~~

(S) The too heavy electronic teaching load for Ordnance personnel allocated to the school resulted in October 1952 in the establishment at Redstone of the 9615th TU, with a contingent of Signal Corps officers and enlisted men to assist in the training program. Civilian contractors with experience in electronic training contracted to aid in the teaching job.

(S) Department of the Army General Order Nr. 17, dated 16 February 1953, stated that the Ordnance Guided Missile School (OGMS), Redstone Arsenal, effective as of 1 December 1952, was established as a Department of the Army service school and designated it as a Class II activity under the jurisdiction of the Chief of Ordnance.

(S) Activation of OGMS as a Class II activity witnessed increased emphasis on gearing missile training more closely to needs of units in the field. In May 1953, for example, the new course "Guided Missile Propellant Explosive Specialist" was initiated. Selected students were trained in the receipt, storage, maintenance, and issue of guided missile fuels and explosive components.¹⁷

(S) In relation to JPL's role as complementing the Ordnance training program, both prior to and following the completion of the classes in its own CORPORAL school, JPL supplied the following training aids to both APG and Redstone Arsenal.

1. A total of 165 master charts for reproduction by silk-screen process as colored charts.
2. A total of 450 master negatives of all artwork for reproduction of overhead projection transparencies.
3. Forty copies of each of the 540 lesson plans finally transmitted to Ordnance and AFF training schools. Included with each copy of the lesson plans was one 8½-inch X 11-inch copy of the training aids referenced in the lesson plan.
4. Three copies of film positives, reproduced from each master negative of the training aids, to provide these organizations with advance copies of overhead projections for immediate use

17. Ibid., pp. 153-154.

~~UNCLASSIFIED~~ ~~CONFIDENTIAL~~

~~CONFIDENTIAL~~
UNCLASSIFIED

253

in training. One copy of each was forwarded to Fort Bliss, to OGMS, Redstone Arsenal, and to the JPL Field Test Operations and Training Section at WSPG.

5. Two CORPORAL propulsion system demonstrators and two missile electronic demonstrators. These units were designed and fabricated, and one of each was shipped to OGMS, Redstone Arsenal, and to the Field Forces school at Fort Bliss.

In addition to JPL's providing training aids, three JPL representatives visited Redstone Arsenal in mid-1953 as advisors to the CORPORAL School on the use of training equipment.¹⁸

(S) Satisfying field requirements was the continuing concern of OGMS. Early in 1954, therefore, the highly specialized repair concept for CORPORAL was adopted, and work was begun to prepare new courses to cover each major combination in the CORPORAL system. Enlisted courses then included CORPORAL Radar, CORPORAL Doppler, CORPORAL Computer, CORPORAL Internal, and CORPORAL Mechanical. A two-fold function was thereby accomplished: first, specialist training was given on only one system, and second, specialist training was given on only one particular portion of the system. Among the advantages hoped for from such a plan were these: less confusion would result in training on only one system; training times would be reduced; more of the personnel's productive time would therefore be available to the service; and more qualified and highly specialized men would be available to the using units.¹⁹

(S) Officer courses were separated into NIKE and CORPORAL courses. These covered the same material as formerly, but, as in the case of those newly instituted for enlisted personnel, practical work with the actual system was emphasized, thereby increasing the ability of graduates to maintain and service CORPORAL equipment.

(S) In addition to this new specialist training, two new officer courses were developed and later adopted, the "Unit Commander's Course" and "Guided Missile Maintenance and Supply Management." The former was

18. JPL Report Nr. 20-100, op. cit., pp. 357, 363.

19. "Ordnance Guided Missile & Rocket Programs, Vol. III, CORPORAL," op. cit., pp. 154-156.

.bdl .OS
.ERI .IS

UNCLASSIFIED

UNCLASSIFIED~~CONFIDENTIAL~~

designed to give selected officers anticipating assignment to guided missile units a thorough orientation on all the missile systems they were likely to encounter in the field. Coverage was also given on the types of organizations used for NIKE and CORPORAL. The second was two weeks in length, with about one week devoted to CORPORAL, and was designed to orient key personnel in the entire field of guided missiles.²⁰

(S) It was determined that incentive must be given for enlisted personnel to choose the Ordnance Guided Missile as a career field, with the desired result for the Army of better personnel stabilization. This led to the "union" concept of apprentice, journeyman, and master mechanic. In accord with this concept, an enlisted man starting in the guided missile field, specifically CORPORAL, would, for instance, begin as a CORPORAL electronic helper after basic electronic training. Then, either through on-the-job training or a CORPORAL specialist course, he would become a specialist, or journeyman. Through work in the field or the CORPORAL supervisor's course, he would become a warrant officer, or master mechanic, on the entire system. This warrant officer would thus be trained in over-all system maintenance. As a result, company officers could be given a more generalized CORPORAL course dealing with management aspects and leave system technical problems to the warrant officer.

(S) CONARC--formerly Office, Chief of AFF--on 10 September 1954 approved the CORPORAL specialist courses and the "Unit Commander's Course." Interim authority to begin instruction in the CORPORAL Warrant Officer Course was granted in August 1954, and it was officially approved on 20 July 1955. Refined versions of these CORPORAL courses continued to be taught.²¹

(S) In July 1955, resident CORPORAL courses were revised to incorporate CORPORAL Type II and also to conform to the new Army-wide military occupational specialty (MOS) concept. Changes in the major items of the Type II system, however, were of no great magnitude. Moreover, experience

20. Ibid.
21. Ibid.

UNCLASSIFIED~~CONFIDENTIAL~~

gained by the school in implementing Type I training proved very valuable in gathering information and initiating training on Type II.²²

(U) On 21 June 1955, a proposed field maintenance training program for CORPORAL Type II ground handling equipment was forwarded to the OTC, and Redstone Arsenal was subsequently instructed to initiate such a training course. On 10 January 1956, "when all reasonable efforts failed to locate equipment and hardware to be used in the ground handling equipment, field maintenance course," Redstone Arsenal recommended to OTC that OGMS incorporate field maintenance training into CORPORAL courses being currently conducted. The OTC approved this plan and directed OGMS "to revise appropriate CORPORAL courses to include adequate coverage of CORPORAL Type II ground handling equipment." That no conflict of jurisdiction or mission might ensue, OTC specified that "training at OGMS would not duplicate or infringe upon training which was the responsibility of the Engineer School." OGMS immediately initiated preparation of a new program of instruction for the "Surface-to-Surface Missile (SSM) Mechanical Repair Course" to provide field maintenance capability to the field.²³

(S) OGMS in late 1954 assumed unit training for CORPORAL. A letter from OTC (dated 4 November 1954) established the Unit Training Center (later Command) at OGMS, effective 1 January 1955. This new mission, transferred to OGMS from WSPG, was to activate, organize, train, and administer Ordnance Guided Missile Direct Support companies.

(S) Department of the Army evolved a schedule for activating sufficient CORPORAL companies to satisfy field requirements, and inputs were obtained from resident courses at OGMS. The 26th Ordnance Direct Support Company (CORPORAL) activated on 15 February 1955, was the first unit to be activated at OGMS. On 15 May following, the 543rd was formed.

22. Ibid., pp. 156-157, 158, 161; "Chronology of Significant Events in the CORPORAL Program," a typewritten manuscript located in the SERGEANT-CORPORAL Projects Office, Building 4488, ABMA; interview, 14 February 1961, with Captain Daniel L. Cunningham, Deputy Commander, Unit Training Command, Building 3200, OGMS, Redstone Arsenal. See Document 29 for training tables-individual and unit.

23. Ibid., passim.

UNCLASSIFIED

The 26th on 15 September 1955 and the 543rd on 18 November 1955 left Redstone Arsenal for Fort Bliss, Texas. The 515th was activated on 15 August 1955 and was sent to Fort Sill, Oklahoma, on 27 February 1956. Organized on 14 November 1955, the 7th left Fort Bliss, Texas, on 15 May 1956. The 205th Ordnance Platoon, Guided Missile Direct Support (GMDS), CORPORAL, became a unit on 15 November 1957 and departed for Leghorn, Italy, on 25 June 1958. Originally organized as a platoon, the 228th Ordnance Detachment, Guided Missile Heavy Maintenance (GMHM), SSM, was activated on 25 September 1958. As of 15 February 1961, this detachment, comprising one officer, one warrant officer, and 31 enlisted men, was still stationed at Redstone Arsenal in support of the school.²⁴

(S) These CORPORAL units were given on-the-job training as such and were as nearly as possible brought up to a level commensurate with those operating in the field. They were then (except for the 228th Ordnance Detachment as noted above) deployed, each in support of an Artillery Firing Battalion, CORPORAL.²⁵

(S) Throughout the history of the CORPORAL training program, the problem of personnel has been foremost. By the time the two-year inductees into the Army have completed electronic courses, little time has remained before their discharge. Moreover, civilian industry has hired away many of the school-trained Regular Army personnel. Consequently, building a "hard core" of career maintenance personnel has proved impossible. Shortened, practical-type courses, plus improvements in the guided missile career field, however, notably aided the CORPORAL training program. The enlisting of high school graduates for three years, with a direct commitment to the service school courses of their respective choices, has helped alleviate the problem. Not all these direct commitment personnel, however, have been fully qualified for guided missile courses, and they have rather consistently left the service at the end of their three-year tour.²⁶

24. Ibid.

25. Ibid.

26. "Ordnance Guided Missile & Rocket Programs, Vol. III, CORPORAL," op. cit., pp. 156-166, passim.

UNCLASSIFIED~~CONFIDENTIAL~~

~~CONFIDENTIAL~~
UNCLASSIFIED

257

(S) Lack of qualified Regular Army officer personnel, particularly field grade, has likewise hampered the CORPORAL training program. Ordnance has resorted to the use of reservists, who have been separated with the completion of commitments. The "tried-and-true" concepts of the older fields in Ordnance have failed to solve this problem of retaining trained personnel. Its solution must be realized through extensive research and study of the intricacies of guided missile system.²⁷

(S) In regard to equipment, the major problem encountered initially was that of providing sufficient quantities of complete CORPORAL system components, together with test equipment and tools. Literally no equipment was available when the first CORPORAL courses were begun. Instruction had to be given on the SCR-584 radar system, inadequate help that it was. Prototype equipment, not identical to production equipment, alleviated but failed to remedy the situation. Eventually, of course, sets of production equipment arrived at OGMS but not in sufficient numbers. Finally, nearly adequate amounts were received, and fully qualified graduates became a reality.

(S) Lack of training aids, engineering drawings, and handbooks further hampered training, and complete publications were still unavailable after the CORPORAL system had been in the field approximately five years.²⁸

(S) Obtaining funds and approval for new construction far enough in advance to assure adequate facilities for increased training demands presented a major problem in providing training facilities. In the case of the CORPORAL training program, for example, requirements for facilities were submitted for approval during FY 1952. Funds were, however, not made available for the necessary construction lead-time of approximately 18 months, and that lack considerably delayed completion of the required facilities.²⁹

(S) It is revealing to note that, despite such obstacles as lack of documentation, teaching aids, and various facilities, the Ordnance

27. Ibid., pp. 164-165.

28. Ibid., pp. 163-166.

29. Ibid., p. 166.

UNCLASSIFIED

~~CONFIDENTIAL~~

UNCLASSIFIED~~CONFIDENTIAL~~

Guided Missile Training Program at Redstone Arsenal had expanded from the 10 March 1952 class of 7 officers to training requirements of FY 1956 for a total of 76 inputs. Of this total, the "Guided Missile Unit Commander Course" accounted for 48; "Guided Missile Systems Maintenance, SSM," 71; and Ordnance "Guided Missile Maintenance and Supply Management, CORPORAL Phase," 290. Courses for enlisted personnel included "Doppler Repair Course, SSM," 47 inputs; "Computer Repair Course, SSM," 28; "Radar Repair Course, SSM," 44; "Internal Repair Course, SSM" 96; and "Mechanical System Repair Course, SSM," 136.³⁰

(S) During the years between 1956 and 1960, both the course numbers and the descriptive nomenclature of course titles, for both officers and enlisted personnel, underwent several changes. The most recent course numbers and titles are used herein. As of FY 1961, officers' courses included 9-G-F1, "Ordnance Guided Missile Management Orientation" (2 weeks), inputs programmed, 287; 9-A-4801, "Ordnance Guided Missile Officers Course, Field Artillery, Guided Missile (FAGM)," (19 weeks, 4 days), inputs programmed, 35; and 9-A-4513, "Ordnance Staff Officer, Guided Missile and Nuclear Weapons Course" (18 weeks), inputs programmed, 9. No inputs were programmed for FY 1961 for the Warrant Officer Course Nr. 9-N-4812, "CORPORAL Maintenance Supervision."³¹

(S) In regard to the enlisted men's courses, experience in the field indicated that the concept of specialization had been carried too far and that broader knowledge of the interrelationship existing among the various missile components was necessary for efficient operation. Those courses pertaining to ground guidance, missile-borne electronics, and missile propulsion were therefore rearranged and combined. Instead of the former five CORPORAL courses for enlisted men, three remained:

30. Ibid., pp. 153, 158-159, 163.

31. USA OGMS Program of Instruction for 9-R-245.1, "CORPORAL Ground Guidance Repair;" ibid., 9-R-249.1, "CORPORAL Missile Repair;" ibid., 9-R-437.1, "CORPORAL Ground Handling Equipment Repair;" ibid., "Detailed Schedule of Classes, Fiscal Year 1961," 22 July 1960; ibid., Unnumbered Memorandum, dated 8 October 1957; interview 14 February 1961, Mr. John M. Gullick, Assistant Chief, CORPORAL Branch, FAM Division, Department of Individual Training, USA OGMS, Redstone Arsenal; interview, 14 February 1961, Lt. R. W. Guillory, Chief, CORPORAL Branch, FAM Division, OGMS. Further information on both individual and unit training will be found in Document 29.

UNCLASSIFIED~~CONFIDENTIAL~~

9-R-245.1, "CORPORAL Ground Guidance Repair" (23 weeks); 9-R-249.1, "CORPORAL Missile Repair" (17 weeks); and 9-R-437.1, "CORPORAL Ground Handling Equipment Repair" (9 weeks). In the matter of statistics pertaining to OGMS inputs and graduations in the CORPORAL enlisted men's courses, it will be understood that there have been of necessity carryovers from one year to the next and that discrepancies between the numbers of inputs and graduations are only apparent. During FY 1958, for instance, there were 394 inputs and 364 graduations, with 98 carryovers to FY 1959; during FY 1959, 426 inputs and 384 graduation, with 131 carryovers to FY 1960; during FY 1960, 256 inputs and 334 graduations, with 37 carryovers to FY 1961. During FY 1959 a total of 7 and during FY 1960 a total of 17 completed Course Nr. 9-N-4812, the Warrant Officer Course. Although there were eight programmed as inputs for the Warrant Officer Course for FY 1960, there were no enrollments. The 17 graduates of FY 1960 were carryovers from FY 1959. As of 10 February 1961, FY 1961 inputs for the enlisted men courses totaled 65, and 61 had graduated. A total of 99 for the "CORPORAL Ground Guidance Repair Course" and 16 for the "CORPORAL Ground Handling Equipment Repair Course" had been programmed for FY 1961, with no inputs programmed for the "CORPORAL Missile Repair Course."³²

(S) Although students have of recent years been programmed to enroll at OGMS for the various CORPORAL courses and adequate preparations made for their reception and training, for some reason, or reasons, actual input has fallen far short of that programmed. A total input of 346 was, for example, programmed for FY 1960, but the actual input was but 256.³³

DEPLOYMENT OF THE CORPORAL MISSILE SYSTEM

(S) Troop training in the firing of CORPORAL and the system's deployment of necessity ran concurrently. AFF personnel from Fort Bliss provided assistance and took training from the JPL firing team as early

32. Ibid.

33. Ibid.

UNCLASSIFIED

as January 1952. Fort Bliss trainees covered all phases of activity, including ground-guidance elements, missile electronics, propulsion, and ground-handling equipment.

(S) The first CORPORAL rounds were fired by AFF personnel when the 246th FA Battalion, 2nd GM Group, started its training in March 1953, in anticipation of participation in the FLASHBURN exercises at Fort Bragg, North Carolina. Also, JPL participated for the first time with the 246th FA Battalion to provide technical advice to AFF at Oro Grande, New Mexico.³⁴

(S) The 247th FA Battalion, 2nd GM Group, succeeded the 246th FA Battalion in active training in the Oro Grande area. This battalion fired several CORPORAL rounds, again under the advice and supervision of the JPL field-test group, who acted as technical assistants in the field.

(S) Three members of JPL joined the Operation FLASHBURN exercises at Fort Bragg in April 1954. This small group provided technical advice to AFF Board Nr. 4, to the technical evaluation team, to the advisory teams, and for the second time to the 246th FA Battalion.

(S) During April 1954, three JPL field engineers accompanied the 247th FA Battalion, 2nd GM Group, in the first CORPORAL Type I rounds fired in the field tests at Red Canyon, New Mexico.

(S) JPL personnel acted as observers and unofficial advisers at the Operation SAGEBRUSH maneuvers held in Louisiana in November and December 1955 and at the Louisiana-located Operation KING COLE in March and April 1957.³⁵

(S) Following troop training at the Guided Missile School, Fort Bliss, Texas, three Field Artillery Missile Battalions had been activated late in 1953:^{*} the 246th, 247th, and 259th. These battalions and the school were initially staffed by cadres that had been trained at the

34. JPL Report Nr. 20-100, op. cit., pp. 10, 363.

35. Ibid.

* D/A Pamphlet Nr. 70-10, op. cit., p. 84, has this to say concerning the date of activation of these battalions: "Mar 52 Three CORPORAL battalions were activated. These were the first ballistic missile units to be activated in the U.S."

UNCLASSIFIED

~~CONFIDENTIAL~~
UNCLASSIFIED

261

JPL-operated CORPORAL School previously mentioned. Field units were hampered in their training program, since much of the basic equipment was still arriving as late mid-1954, when field-firing operations were under way.³⁶

(S) The CORPORAL program's original objective was to provide an operational capability of 16 battalions in combat readiness by July 1954. That ambitious goal was not achieved. In spite of the extremely short time available for development and production of equipment and the training of Field Artillery and Ordnance Support personnel, however, the three battalions, mentioned above--each having two firing batteries--were organized and equipped with Type I equipment by July 1954. A total of 320 missiles and 11 sets of ground equipment had been delivered. As of 30 June 1955, 79 Type II missiles and 14 sets of ground equipment had also been delivered. Ten battalions--single fire units--had been organized and equipped with Type II systems: the 246th (reequipped with Type II equipment), 515th, 530th, 531st, 543rd, 557th, 559th, 570th, and 601st Field Artillery Missile Battalions, CORPORAL. Six of these battalions were scheduled for deployment to Europe during the first quarter of 1956. At the conclusion of the Korean conflict, the original objective of 16 battalions was reduced.³⁷

(S) In October 1954, the Army Chief of Staff G-3 had recommended to the Chief of Staff that one Type I CORPORAL battalion be deployed to the European Theatre, primarily for training and logistic shakedown. Accompanied by the 96th Ordnance Direct Support Company, the 259th FA Battalion with Type I field equipment completed the overseas movement in the first quarter of 1955. Having fired four CORPORAL rounds at Red Canyon, New Mexico, prior to deployment, the 259th was considered as a valuable addition to North Atlantic Treaty Organization (NATO) armament in Western Europe. More important, this battalion acquainted U.S. Army commanders overseas and NATO allies with the CORPORAL missile system. Of necessity, European field training was limited to simulated firings

36. Ibid.

37. "Ordnance Guided Missile & Rocket Programs, Vol. III, CORPORAL," op. cit., pp. 62, 64, 65, and 67.

UNCLASSIFIED

~~CONFIDENTIAL~~

~~CONFIDENTIAL~~
UNCLASSIFIED

as part of command post exercises.* Nevertheless, tactical field use and combat requirements of the weapon system were effectively demonstrated. It is of interest to note that these missile units were battalions, organized under the command of lieutenant colonels.

(S) The relatively rapid turnover in personnel soon made it apparent that the 259th had lost its firing capability as a unit. Consequently, it was replaced in 1956 by Type II battalions (Cf note 37, above), of which there were eight in Europe as of July 1957. Army policy was initiated in 1957 to rotate battalion firing teams from Europe to the United States for Annual Service Practice (ASP) firings at WSPG.

(S) In 1957, two Type II CORPORAL battalions and one Type I were stationed in the United States. Personnel for these units were trained at the Guided Missile School, which had been moved in 1956 from Fort Bliss, Texas, to Fort Sill, Oklahoma, thus placing all surface-to-surface Army artillery training agencies under one command.³⁸

(S) Objective evaluation of Army progress in missile-firing capability is difficult to assess. It is however, noteworthy that some Type II battalions demonstrated better firing accuracy in training than either the JPL or the E-U groups could show, even by selecting the best of their rounds. A 1958 report of troop firing, for instance, cited such precision as to result in a CORPORAL reliability rating of 82 per cent. Consensus of Army commanders was that strict adherence to good teamwork was responsible for these results.³⁹

(S) In the latter part of 1954, an agreement was reached by the governments of the United States and of the United Kingdom (UK) for the United States to furnish the latter 113 Type IIA CORPORAL missiles, together with 10 sets of ground-guidance and handling equipment and 3

* Note below the later development of a device designed for at least a partial solution of this deficiency in training on European soil.

38. Ibid., p. 60; JPL Report Nr. 20-100, op. cit., p. 16.

39. "Surface-to-Surface Missiles Reference Book," op. cit., p. II-19; JPL Report Nr. 20-100, op. cit., p. 16.

UNCLASSIFIED~~CONFIDENTIAL~~

sets of Type IV test equipment,* and with missile delivery scheduled to begin in June 1956. The British Government had decided to integrate CORPORAL into the UK's military system, thereby providing a missile potential until such time as its own weapon systems could be designed and tested. British troops were sent to Fort Bliss and to Redstone Arsenal for schooling. They obtained field-firing experience in late 1956 at WSPG. A CORPORAL training school, patterned somewhat after U.S. Army operations, was readied in England to commence operation in 1957.⁴⁰

PRESENT STATUS OF THE CORPORAL SYSTEM, AS OF 31 DECEMBER 1961

(C) The year 1960 saw the transfer of the CORPORAL Missile System from ARGMA to ABMA as a phase of the realignment of responsibilities and missions following separation of Marshall Space Flight Center (MSFC) from ABMA. R&D and Industrial functions transferred on 1 August 1960, but Field Support Maintenance and Technical Assistance functions were not assumed by ABMA until 3 October 1960. Supply functions transferred in early February 1961.

(C) As of 31 December 1960, there were 12 active CORPORAL tactical units, designated and deployed as follows:

Battalions located in USAREUR **

<u>Former Designation</u>	<u>Present Designation</u>
601st	2nd Missile Battalion, 40th Artillery
530th	1st Missile Battalion, 39th Artillery
558th	2nd Missile Battalion, 82nd Artillery
531st	1st Missile Battalion, 38th Artillery
559th	2nd Missile Battalion, 84th Artillery
557th	2nd Missile Battalion, 81st Artillery

* Information as to respective divisions in the UK allocation was furnished by Mr. Paul R. Collier, ABMA Missile System Industrial Management Officer.

40. JPL Report Nr. 20-100, op. cit., p. 16; "Ordnance Guided Missile & Rocket Programs, Vol. III, CORPORAL," op. cit., pp. 62-63; D/A Pamphlet Nr. 70-10, op. cit., pp. 85-86. (The 113 UK missiles were to cost \$7,739,287.98; ground launching & handling equipment, \$2,253,354.95; ground guidance & control equipment, \$2,682,267.00; total, \$12,674,909.93. Reference Vol. III CORPORAL, pp. 62-63.) Further training information will be found in Document 29.

** United States (7th Army, Europe (Germany)).

~~CONFIDENTIAL~~
UNCLASSIFIEDBattalions located in SETAF*Former DesignationPresent Designation543rd
570th1st Missile Battalion, 82nd Artillery
1st Missile Battalion, 80th ArtilleryBattalions located in CONUS**Former DesignationPresent Designation523rd
259th
246th
526th1st Missile Battalion, 81st Artillery,
Fort Carson, Colorado
1st Missile Battalion, 40th Artillery,
Fort Bliss, Texas
2nd Missile Battalion, 80th Artillery,
Fort Sill, Oklahoma
1st Missile Battalion, 84th Artillery,
Fort Sill, Oklahoma.⁴¹

(C) Because of slippage in the SERGEANT development program, the CORPORAL system was subjected to reexamination and reappraisal, since the date of replacement of CORPORAL by SERGEANT was unavoidably deferred. It was found that the CORPORAL system, as indicated by ASP firings, had deteriorated in reliability. For the period 1957-1960, 7th Army units maintained an average rate of 69 per cent successful firings; SETAF units dropped far below with 52.9 per cent; and CONUS units 53.6 per cent was but little better. There was considerable variation among the units, ranging from 87.5 per cent for the highest down to 47.0 for the lowest, with 7th Army units consistently maintaining an excellent rate, while SETAF and CONUS scores were as consistently low.⁴²

(C) During 1960, a total of 48 rounds was fired at WSMR during CORPORAL ASP firings conducted for 8 overseas and 4 state-side battalions. One round was not considered for reliability purposes. Of the

* Southern European Task Force (Italy).

** Continental United States.

41. ABMA Report, CORPORAL, "An Interim CORPORAL Reliability Report," pp. 3-4, 10, ABMA, USAOMC, Redstone Arsenal, Alabama, 26 January 1961; interview with Lt. Peter J. Marrero, CORPORAL Project Officer, FSO, ABMA, 3 February 1961. Each battalion had 250 men in two batteries - a firing battery and a Headquarters Service battery. There were two operational CORPORAL launchers assigned to a battalion.

42. ABMA Interim Report, CORPORAL, op. cit., passim.

UNCLASSIFIED
~~CONFIDENTIAL~~

remaining 47 rounds, 21 were successful and 26 unsuccessful, for an average reliability of 45 per cent. Close analysis of firing results indicated that personnel failures might have accounted for some failures, manifested as component malfunctions. Investigations and tests were initiated to prove out the indicated storage deterioration problem, believed to be connected with some component malfunctions.⁴³

(C) Initiated as a result of a command letter in December 1959 from the CG, AOMC, to United States Continental Army Command (USCONARC), "expressing AOMC's concern in regard to the degradation in firing results, and offering assistance in any manner that would contribute to correcting this downward trend," a number of CORPORAL Reliability Conferences were held. These conferences resulted in detailed analyses of the causes behind decreasing reliability of the CORPORAL system as indicated by ASP firings and also a detailed program for correcting the situation.

(C) The 45 per cent reliability figure for 1960 ASP firings failed to tell the whole truth. The low point in reliability for the period 1957-1960 was reached in May 1960. Of the first 20 missiles fired, only 5 were successful, for a reliability of 25 per cent. With no significant changes in hardware or procedures, but with added emphasis on the program mentioned above and monitoring its actual employment, 16 of the remaining 27 missiles fired in 1960--discounting the one missile destroyed prematurely by Range Safety--were successful for a reliability of 59.3 per cent. The 1st Missile Battalion, 39th Artillery, and the 2nd Missile Battalion, 40th Artillery, both of the 7th U.S. Army, in June and August, respectively, fired 4 missiles each, for a score of 100 per cent successful. In connection with these 1960 ASP firings, it is noteworthy that the percentages of success in 1960 declined alarmingly below the averages of the period 1957-1959.⁴⁴

(C) By way of comparison and as a matter of information, it is interesting to note that the UK success percentages did not differ

43. Ibid.
44. Ibid.

UNCLASSIFIED

materially from those of the U.S. CORPORAL units. Firings for CY 1959 showed 46 per cent success. Whereas U.S. successes declined from 1959 to 1960, however, UK experience was the opposite, with CY 1960 firings showing a success percentage of 61. Of particular interest is the fact that the UK effort to pinpoint suspected hardware malfunctions closely paralleled that of the U.S.⁴⁵

(C) This, the most recent of CORPORAL reliability reports, emphasized the human factor, including morale, training, and teamwork; the results of organized efforts to improve reliability of the CORPORAL are reminiscent of a report dated 26 July 1956, summarized below.⁴⁶

(S) Concerning user, or troop, testing of the CORPORAL Type II system during the period 1 July 1955 to 30 June 1956, a letter report from Headquarters, Guided Missile Brigade, to CG, AAA & GM Center, subject: "CORPORAL Accuracy and Reliability Report," was quite optimistic. An analysis of 19 firings conducted in 1955 showed a system reliability of 32 per cent, the report read. An analysis of 19 firings during the period 1 January to 30 June 1956, on the other hand, showed a system reliability of 74 per cent. Moreover, CORPORAL's inflight reliability was constantly improving,⁴⁷ to attain the 1958 level of 82 per cent, as already noted (Cf note 39).

(U) A comparatively recently developed training item was devised to enhance reliability of the CORPORAL system's human element and thereby increase reliability of the missile itself. Brig. Gen. J. G. Shinkle professed expectations that the device would "improve user training."

(U) The Electronic Checkout Trainer--renamed Simulator, Guided Missile Prelaunch Signals*--was originally developed by Naval Training Devices Center for use in schools to train CORPORAL firing station operators. As of 18 December 1958, 27 Simulators had been delivered, with no further production scheduled. Deliveries were made to Fort

45. Ibid.

46. Ibid.

47. "Chronology of Significant Events in the CORPORAL Program," a type-written manuscript located in the SERGEANT-CORPORAL Project Office, ABMA, Building 4488.

* SM-200/T, formerly the 3G11 Trainer.

UNCLASSIFIED~~CONFIDENTIAL~~

Sill, Oklahoma; Fort Bliss, Texas; Camp Carson, Colorado; and OGMS, Redstone Arsenal. USAREUR, however, declined to accept the training device on the ground that no system of logistical support had been provided. As a result, trainers destined for overseas use were delivered to USCONARC and held pending solution of that problem.

(U) As cognizant agency of CORPORAL, though the missile was scheduled for transfer to ABMA, ARGMA considered the Simulator "an ARGMA-controlled major item of the CORPORAL System." Logistical support was to "be available on that basis," with tentative readiness of such support "established as of 1 November 1960." Due to the nature of the Simulator, it was "deemed most feasible to include it as a T/O&E line item of the CORPORAL Battalion rather than a component of some other T/O&E line item." A proposal was made to change T/O&E-545 (Cf note 18) to reflect one Simulator per CORPORAL Battalion for both full and reduced strength.⁴⁸

(U) In the meantime, after extensive use for training firing station operators in schools, it was decided that the device would also be beneficial for localizing malfunctions in the Firing Station and in field training of firing station operators. In pursuance of that decision, Ordnance officially assumed logistical responsibility for Simulator SM-200/T as of 1 October 1960. Prior to that date, supply and technical manuals for support of the Simulator had already been printed for distribution.⁴⁹

-
48. Discussion in "Simulator, Guided Missile Prelaunch Signals," with suggested listing on T/O&E 6-545 (CPL) in paragraph 21 (Firing Section), approved by J. G. Shinkle, Brig. Gen., USA, CG, ARGMA; letter, From: ORDXM-X (signed by Thomas W. Cooke, Colonel, GS, Chief of Staff, AOMC), dated 22 April 1960. To: CG, USCONARC, Fort Monroe, Virginia, Subject: Change to T/O&E 6-545 (CPL).
49. Ibid.; "Logistic Support Plan for Simulator, Guided Missile, Prelaunch Signals - SM-200/T (formerly the 3G11 Trainer, FSN 4935-789-1143) passim, Drafted 19 August 1960; additional information furnished by ABMA FSO. (The Simulator was designed to simulate actual checkout and firing procedures, thereby preparing operators for actual field firings. With the reduced number of inputs for CORPORAL training, however, two units were turned in by OGMS as surplus and one retained as of 15 February 1961 for employment in the CORPORAL Training Program of OGMS. Mr. John M. Gullick, Jr., Assistant Chief, Individual Training Division, CORPORAL Branch, OGMS.)

UNCLASSIFIED

(U) Funds had been made available for this project in early January 1960, and, in view of the contemplated transfer of CORPORAL to ABMA, OCO instructed that agency to initiate action to assume logistical responsibility of Simulator SM-200/T. ABMA, soon after CORPORAL's transfer, proceeded to develop a Field Service Package for the Simulator, consisting of technical and supply manuals, repair parts, and a support concept.

(U) With adequate support assured, 12 Simulators were located in USAREUR, as of 1 April 1961. Of the remaining 15 units, OGMS received 3; Forts Carson and Sill, 1 each; and Fort Bliss, 2. The remaining Simulators were to be used for "maintenance float."⁵⁰

50. "Logistic Support Plan for Simulator," op. cit., passim.

UNCLASSIFIED

UNCLASSIFIED

CHAPTER XII

SUMMARIZED CONCLUSIONS

(U) Educators, with unanswerable logic, declare this truism: "Education must begin where the student is." Viewed in that light, the ORDCIT Project at its initiation by Army Ordnance in 1944 was in the early kindergarten stage, even after eight years of basic research conducted by the GALCIT group. In keeping with its traditional role of furnishing United States forces with the most efficient weapons available, realizing that the rumored German long-range rocket missiles were about to usher in a new type of warfare, Ordnance had scrutinized the scientific field in search of some agency or institution capable of starting from scratch and developing a guided missile. The scientific field as related to rocketry was singularly barren except for the GALCIT group. As a result of this Ordnance survey, ORDCIT Project and Jet Propulsion Laboratory came into being to undertake "a comprehensive and long-range research program," to eventuate in a guided missile. As a result of Ordnance's decision, the CORPORAL Missile System finally took its place among other weapon systems sponsored by Ordnance--the first all-American guided missile system. The veteran "work-horse" CORPORAL in the year 1961 still stands on guard, while awaiting replacement by the more sophisticated SERGEANT.

(U) CORPORAL was not a product of wishful thinking. "Competent scientific staffs [had to] be built up," with the original GALCIT group, plus personnel accretions during the 1936-1944 interval, serving as a hard-core nucleus. "Adequate test facilities [had to] be established." Manufacturers had to be educated in research and development and fabrication of missile components, with the final goal of component assembly into effective, reliable missiles. The major role of ORDCIT Project, therefore, was one of self-education, progressing concurrently with the education of those in other areas contributing to missile development.

(U) CORPORAL continued in the role of educator from CORPORAL E through successive developmental stages until CORPORAL III's relegation to the innocuous desuetude of a passive "on-the-shelf item."

UNCLASSIFIED

(U) In undertaking the program outlined by Ordnance, JPL had little to build upon. Environment to be encountered by the missile after its launching was unknown. Trajectory studies were theoretical in nature. Aerodynamic forces were a mystery to be solved. Experimental data on ballistics were confined to conventional projectiles. Included among available theoretical studies were those of the Russian K. E. Ziolkowsky, the German Hermann Oberth, and the American Robert H. Goddard, whose rocket on 31 May 1935 had attained an altitude of 7,500 feet. The U.S. Signal Corps claimed a height of 72,395 feet for a weather balloon on 11 November 1935, but about 60,000 feet was the usual maximum altitude reached by weather balloons. Supplementing these and other sources of information were the various GALCIT theoretical studies and calculations, actual experimental data on propellants, and development of jet-assisted-take-off (JATO) rockets, the result of collaboration with Aerojet.

(U) Practical training in relation to a ballistic rocket began with PRIVATES A and F, which were planned to prove theoretical trajectories, launching techniques, and related matters. Modification of the Aerojet solid-propellant motor to provide fins, nose cone, booster connection, and blast cone, despite the simplicity of the problem, failed to achieve altogether satisfactory results. Small local machine shops did the necessary fabrication, with JPL supervising. JPL commented about asymmetries in both full-size and wind-tunnel test models of the PRIVATES and of CORPORAL.

(U) Detailed accounts of educational progression are unnecessary, since that phase of CORPORAL development is implicit in the textual material. Illustrating the rapid expansion of missile knowledge, however, mention should be made of Douglas Aircraft Company, manufacturer of conventional airplanes, and participant in WAC CORPORAL development, as well as contractor for early CORPORAL I rounds. Sperry, whose modified autopilot performed unsatisfactorily in CORPORAL E, gained sufficient know-how to assume responsibility for SERGEANT. Firestone Tire and Rubber Company, through experience with CORPORAL, became adept in missile production, a field utterly foreign to that of rubber goods.

UNCLASSIFIED

Gilfillan Brothers, Inc., finally became capable of going it alone in developing reliable electronic components, after an extended period of guidance from JPL. Manufacturers of storage tanks, orchard equipment, and heavy-duty dirt-moving equipment became skilled at turning out ground handling equipment.

(U) The axially cooled CORPORAL motor provides a specific example of the spread of know-how among manufacturers. Briefly, JPL fabricated motors used in early rounds. Those employed in early Douglas and Firestone rounds were manufactured by Ryan Aeronautical Company, but Firestone established a second source by tooling and installing other facilities for making CORPORAL motors. Motors used in Douglas flight rounds were proof-fired by Aerojet-General Corporation, while Firestone flight rounds were tested at WSPG.

(U) In a lecture delivered on 22 January 1958, Dr. William H. Pickering, Director, JPL/CIT, who had been a member of ORDCIT Project and participated as a chief actor in the subsequent CORPORAL development program, had considerable to say about the transition from research and development to production. The problem, he stated, is "largely one of education on training." Quite often, he declared, the fact that a missile system "has to go into industry" is not fully appreciated. "Again," Dr. Pickering said, "the education, ending up with planning to have the industrial group take over, will solve the [production] problem." He thought that in the case of CORPORAL "the problem was a miserable mess and that the transition from the laboratory to production on CORPORAL was not at all satisfactory."

(U) As considered in some detail in the text, training, and education extended to WSPG personnel, E-U teams, troop firings, and the various Government installations such as Aberdeen Proving Ground, Maryland, and Redstone Arsenal, Alabama.

(U) Out of his experience with CORPORAL, Dr. Pickering, in the matter of planning new missile systems, advised the establishment of "some tentative objectives," with the caution that "the original design must not take off too far into the wild blue yonder with new physical principles and unsolved design problems." After this first step would

UNCLASSIFIED

come a research program, during which phase care was to be taken that "fundamental problems" be solved. "Coming on through development to production," with a "properly conducted" development program preceding production, as explained by Dr. Pickering, this sequence of events should follow:

The weapon should be ready for production, completely documented, properly designed, consistent with all the requirements of the weapon system, training programs ready to go, maintenance programs established, manuals written, and supply channels activated; so that when the first production devices come off the line, a complete weapon system is in being. Experience will inevitably show the necessity of some changes, but these will in fact be minor and probably of such a nature as to be possible to effect in the field.

(U) Leveling criticism at contrary practices, Dr. Pickering in 1958 found that, "in many of our weapon systems ... currently in development, ... production frequently starts too early by these criteria; moreover, some production will be started even though it is obvious that the development program is not complete." Such procedure he considered unwise "on purely logical technical grounds, ... because it is obviously more difficult to make the modifications and more costly to make the modifications once a production program has been established." On the other hand, he emphasized, "In the developmental phase modification becomes easy and, of course, in the research phase easier still." In reiteration, he stressed that "from the very beginning there must be a clear concept of what the weapon system is supposed to do, what are the real constraints put on by that requirement. The research people then must be aware of these constraints and must actively design with these in mind."

(U) So much had the "crash" CORPORAL program taught Dr. Pickering.

(U) Dr. Pickering likewise criticized the blunderbuss, scatter-gun approach to missile planning, as have professional Army users and informed Army-employed civilian personnel. As opposed to that approach, they have advanced the logical concept of a missile family, with each member assigned a certain task and developed to that end. Moreover, each missile would be adaptable; that is, as improved materials should become available and more reliable components developed, they would replace the

UNCLASSIFIED

inferior, less reliable elements both on the ground and in the missile with a minimum of modification otherwise. CORPORAL demonstrated the feasibility of this constant improvement and replacement of components, with consequent increase in system reliability. Improvement of electronics in a steadily progressing effectiveness against countermeasures and development of the propulsion system, the air turbine alternator, and the quick-detach fins illustrate this concept in action. Moreover, the consensus of opinion held by those acquainted with the CORPORAL system is that CORPORAL III represented a great stride forward in development and would have fully justified its production for employment in the field.

(U) CORPORAL was truly a pioneer and as such was worth far more than its cost in money and effort, a fact apparently not fully appreciated by many civilians closely associated with the missile's development. As to Army users, as testified by those who deployed with CORPORAL, Army personnel experienced keen resentment at playing the role of "guinea pigs" trying to learn how to control the erratic, temperamental, unpredictable CORPORAL--also a "guinea pig." One incident, witnessed by one of these human "guinea pigs," is to this effect: A very important personage paid a visit to WSPG, and a CORPORAL firing was planned for him. Countdown had proceeded without interruption until the instant before pressing the firing button, when the excited command came, "Hold!" The "hold" signal was too late, however, as the operator had almost simultaneously pressed the button. CORPORAL made an almost perfect flight--erratic, temperamental, unpredicable CORPORAL.

(U) CORPORAL was, indeed, a pioneer, but, according to available information, field officers failed to sell that idea to their men, since the officers themselves apparently failed to understand that they were ushering in the missile age, push-button warfare.

(U) The "guinea-pig" complex apparently infected replacements assigned to missile battalions, with consequent lowered morale. The "guinea-pig" complex became the "obsolete-weapon" obsession and morale reached the nadir in some units, as demonstrated by ASP firings during

UNCLASSIFIED

the period 1957-1960. There, too, CORPORAL experience had taught a lesson, for, with a buildup of morale, ASP firing results responded dramatically.

(U) In the meantime, rough, uncouth, much maligned CORPORAL still stands as a sentinel on guard. Lessons learned during its development have transferred to other missile systems, and an armament industry has come into being to produce them--all dating back to 1944 and the initiation of ORDCIT Project.

(U) CORPORAL might well be cited as an outstanding example of "a kind of evolutionary process by which new weapons 'grow out' of old ones," as expressed in the Report of the Military Operations Subcommittee (the Holifield Committee). Admittedly, scientific "breakthroughs often cause sudden spurts in growth or radical change in the line of development." Who, however, may possess such prescience as to declare unequivocally of any member of the weapon family or generation, "This can be discarded ..."?

Budgetary limitations impose their toll, of course, and weapons may go into discard because short funds compel a choice among those of greater and lesser promise. ... Discarding weapons in which large investments already have been made saves today's money but wastes yesterdays. ...

UNCLASSIFIED

UNCLASSIFIED

B I B L I O G R A P H Y

275
UNCLASSIFIED

UNCLASSIFIED

B I B L I O G R A P H Y

- ABMA Report, CORPORAL, AN INTERIM REPORT ON CORPORAL RELIABILITY, Army Ballistic Missile Agency, U.S. Army Ordnance Missile Command, Redstone Arsenal, Alabama, 26 January 1961, ABMA Historical Files.
- AMTC Technical Report Nr. 86, CORPORAL: CORPORAL TYPE II AND IIA SYSTEM FINAL EVALUATION REPORT, Ordnance Mission, Army Missile Test Center, White Sands Missile Range, New Mexico, September 1959, Technical Documents Library, ABMA.
- AMTC Technical Memorandum Nr. 619, CORPORAL: GO-NO-GO TEST OF CORPORAL TYPE IIA MISSILE-BORNE ELECTRONIC GUIDANCE COMPONENTS UNDER EXTREME ENVIRONMENTAL CONDITIONS (Test Plan II B28), Guidance and Control Laboratory, Electro-Mechanical Laboratories, White Sands Missile Range, New Mexico, March 1959, Technical Documents Library, ABMA.
- ARMY SURFACE-TO-SURFACE GUIDED MISSILE FAMILY (A RECOMMENDATION BASED ON A STUDY SURVEY OF MILITARY REQUIREMENTS, TECHNICAL CAPABILITIES, AND AVAILABLE MANPOWER AND FUNDS), n.p., 17 November 1954, Technical Documents Library, ABMA.
- Bank, Herman, and Denison, Frank G., Jr., ORDCIT Progress Report Nr. 4-96, PRELIMINARY DESIGN CONSIDERATIONS FOR THE BUMPER PROGRAM, Jet Propulsion Laboratory, California Institute of Technology, 13 April 1949, Technical Documents Library, ARGMA.
- Brown, Eunice H., Robertson, James A., Kroehnke, John W., Poisall, Charles R., Cross, E. D., 1st Lieut., U.S.A., DEVELOPMENT & TESTING OF ROCKETS & MISSILES AT WHITE SANDS PROVING GROUND, 1945-1955, Historical Information Branch, White Sands Missile Range, New Mexico, 1 October 1959, U.S. AOMC Historical Office Files.
- Cagle, Mary T., HISTORY OF REDSTONE ARSENAL, Public Information Office, Redstone Arsenal, Huntsville, Alabama, n.d., but ca early 1955, ABMA Historical Files.
- Chien, W. Z., ORDCIT Progress Report Nr. 4-7, THE TRAJECTORIES OF THE MISSILE XF30L20,000 (CORPORAL), Jet Propulsion Laboratory, GALCIT, California Institute of Technology, 19 January 1945, Technical Documents Library, ARGMA.
- Chien, W. Z., ORDCIT Report Nr. 4-11, VERTICAL FLIGHT PERFORMANCE OF ROCKET MISSILES AND AN ESTIMATION OF THEIR HORIZONTAL RANGES, JPL/ GALCIT, CIT, 28 June 1945, Technical Documents Library, ARGMA.

UNCLASSIFIED

CHRONOLOGY OF SIGNIFICANT EVENTS IN THE CORPORAL PROGRAM, a typewritten document located in the SERGEANT-CORPORAL Projects Office, R&D Operations, ABMA Building 4488. (A Xerox reproduction is in ABMA Historical Files.) *revised*

CORPORAL Handbook Nr. 1, PRINCIPLES OF THE CORPORAL XSSM-G-17 SYSTEM, JPL/CIT, 15 January 1952.

CORPORAL TEST PLAN II-A-1, AND APPLICABLE ADDENDUMS, WSPG, N.M., December 1954, Technical Documents Library, ARGMA.

Crawford, Jane E., Report Nr. R55227, Project HERMES, TRAJECTORY CALCULATIONS FOR THE A-4 BUMPER WAC MISSILE, Schenectady, New York: Marine and Aeronautic Engineering Division, General Electric Company, 3 November 1947, Technical Documents Library, ARGMA.

Deans, J. L., AMTC Technical Memorandum Nr. 597, CORPORAL: FUNCTIONAL EVALUATION OF CORPORAL TYPE II COMPONENTS (Test Plan II-C-28), Systems Test Division, White Sands Missile Range, New Mexico, January 1959, Technical Documents Library, ABMA. *ordered*

Department of the Army Pamphlet Nr. 70-10, CHRONOLOGICAL HISTORY OF ARMY ACTIVITIES IN THE MISSILE/SATELLITE FIELD, 1943-1958, Washington 25, D.C.: Headquarters, Department of the Army, 17 September 1958, Technical Documents Library, ARGMA.

Department of the Army Technical Manual, TM 9-5036, DESCRIPTION: CORPORAL II ARTILLERY GUIDED MISSILE SYSTEM, Washington 25, D.C.: Headquarters, Department of the Army, 29 October 1957, Technical Documents Library, ARGMA.

Department of the Army Technical Manual, TM 9-5038-12, OPERATOR AND ORGANIZATIONAL MAINTENANCE MANUAL: ARTILLERY GUIDED MISSILE M2 (EQUIPPED WITH TYPE II AND IIA COMPONENTS), CORPORAL II ARTILLERY GUIDED MISSILE SYSTEM, Washington 25, D.C.: Headquarters, Department of the Army, 5 May 1960, ABMA Historical Files.

Department of the Army RESEARCH AND DEVELOPMENT ANNUAL GUIDED MISSILE REPORT, Department of the Army, 1 October 1957, Technical Documents Library, ABMA.

Dunn, Louis G., Meeks, Paul J., and Denison, Frank G., Jr., ORDCIT Memorandum Nr. 4-59, PRESENT STATUS OF THE CORPORAL DEVELOPMENT, JPL/CIT, 17 March 1950, Technical Documents Library, ARGMA.

UNCLASSIFIED

Dunn, Louis G., and Maeks, Paul J., JPL Report Nr. 4-45, A BRIEF RESUME OF THE CORPORAL E PROGRAM, JPL/CIT, 17 February 1948, Technical Documents Library, ARGMA.

Fischer, W. W., Report Nr. R50A0523, Project HERMES, SKIN TEMPERATURE MEASUREMENTS DURING BUMPER No. 5 FLIGHT, Schenectady, New York: General Electric Company, Technical Documents Library, ARGMA.

Furnas, Dr. Clifford C., ICAF Publication Nr. L58-76, RESEARCH AND DEVELOPMENT IN THE ARMED FORCES, lecture delivered 20 December 1957, Industrial College of the Armed Forces, Washington, D.C., 1957-1958.

Gatland, Kenneth W., DEVELOPMENT OF THE GUIDED MISSILE, New York: Philosophical Library, 1952, Technical Documents Library, ARGMA.

Goldberg, S. J., ORDCIT Report Nr. 4-3, FIRING TESTS OF "PRIVATE A" AT LEACH SPRING, CAMP IRWIN, CALIFORNIA, JPL/GALCIT, CIT, 14 March 1945, Technical Documents Library, ARGMA.

Goldberg, S. J., ORDCIT Report Nr. 4-7, FIRING TESTS OF "PRIVATE F" AT HUECO RANGE, FORT BLISS, TEXAS, APRIL 1 TO APRIL 13, 1945, JPL/GALCIT, CIT, 10 May 1945, Technical Documents Library, ARGMA.

GUIDED MISSILE SUMMARY NO. 46 FOR THE PERIOD JANUARY 1, 1955, TO MARCH 1, 1955, JPL/CIT, 15 March 1955, Technical Documents Library, ARGMA.

GUIDED MISSILE SUMMARY NO. 47 FOR THE PERIOD MARCH 1, 1955, TO MAY 1, 1955, JPL/CIT, 15 May 1955, Technical Documents Library, ARGMA.

HANDBOOK OF GUIDED MISSILES, Prepared by Guided Missiles Committee of the Joint Committee on New Weapons and Equipment, Joint Chiefs of Staff, 1 July 1945.

Haviland, R. P., Progress Report Nr. R50A0501, Project HERMES, PROGRESS REPORT ON BUMPER VEHICLE--A TWO-STAGE ROCKET-POWERED TEST VEHICLE, Schenectady, New York: General Electric Company, Apparatus Department, Special Projects Division, February 1950, Technical Documents Library, ARGMA.

Haviland, Robert P., Project HERMES, MINUTES OF BUMPER CONFERENCE AT WHITE SANDS PROVING GROUND, LAS CRUCES, NEW MEXICO, 24-25 OCTOBER 1949, 11 November 1949, Technical Documents Library, ARGMA.

JPL Report, STATUS REPORT ON CORPORAL GUIDED MISSILES, JPL/CIT, 22 September 1952, Technical Documents Library, ARGMA.

JPL Report Nr. 20-59, THE CORPORAL SURFACE-TO-SURFACE MISSILE XSSM-G-17, JPL/CIT, 30 June 1951, Technical Documents Library, ARGMA.

UNCLASSIFIED

JPL COMBINED BIMONTHLY SUMMARY NO. 1, JUNE 20, 1947, TO AUGUST 20, 1947, JPL/CIT, 15 September 1947; NO. 2, AUGUST 20, 1947, TO OCTOBER 20, 1947, ibid., 15 November 1947; NO. 3, OCTOBER 20, 1947, TO DECEMBER 20, 1947, ibid., 15 January 1948; NO. 4, DECEMBER 20, 1947, TO FEBRUARY 20, 1948, ibid., 15 March 1948; NO. 5, FEBRUARY 20, 1948, TO APRIL 20, 1948, ibid., 15 May 1948; NO. 6, APRIL 20, 1948, TO JUNE 20, 1948, ibid., 15 July 1948; NO. 7, JUNE 20, 1948, TO AUGUST 20, 1948, ibid., 15 September 1948; NO. 8, AUGUST 20, 1948, TO OCTOBER 20, 1948, ibid., 15 November 1948, Technical Documents Library, ARGMA.

JPL COMBINED BIMONTHLY SUMMARY NO. 50, FOR THE PERIOD OCTOBER 1, 1955, TO DECEMBER 1, 1955, JPL/CIT, 15 December 1955; NO. 51, ... DECEMBER 1, 1955, TO FEBRUARY 1, 1956, ibid., 15 February 1956; NO. 52, ... FEBRUARY 1, 1956, TO APRIL 1, 1956, ibid., 15 April 1956; NO. 53, ... APRIL 1, 1956, TO JUNE 1, 1956, ibid., 15 June, 1956; NO. 54, ... JUNE 1, 1956, TO AUGUST 1, 1956, ibid., 15 August 1956; NO. 55, ... AUGUST 1, 1956, TO OCTOBER 1, 1956, ibid., 15 October 1956, Technical Documents Library, ARGMA.

JPL Publication Nr. 99, HISTORY OF ORDNANCE RESEARCH AT THE JET PROPULSION LABORATORY 1 JANUARY 1955 THROUGH 31 DECEMBER 1956, JPL/CIT, 10 May 1957, Technical Documents Library, ABMA.

Kautz, G. P., ORDCIT Publication Nr. 64, THE CORPORAL MISSILE ARMING PHILOSOPHY, JPL/CIT, 16 February 1956, Technical Documents Library, ARGMA.

Letter, From: Col. Harold R. Turner, Ordnance, Commanding, Advance Headquarters, Joint Long-Range Proving Ground, Cocoa, Florida, Subject: "BUMPER Coordination Policy," To: Col. H. N. Toftoy, Armed Forces Missile Section, Pentagon, Washington 25, D. C., and Others, dated 29 September 1949, Technical Documents Library, ARGMA.

Letter, From: ORDXM-X (signed Thomas W. Cooke, Colonel, Chief of Staff, AOMC, Subject: "Change to TOE 6-545 (CPL), To, CG, USCONARC, dated 22 April 1960, together with a discussion of Simulator, Guided Missile Prelaunch Signals SM-200/T, dated 18 April 1960.

Lin, C. C., ORDCIT Report Nr. 4-4, THE EXTERIOR BALLISTICS OF "PRIVATE A" FROM ANALYSES OF FIRING TESTS, JPL/GALCIT, CIT, 27 April 1945, Technical Documents Library, ARGMA.

Long Range Proving Ground Division Technical Report Nr. 1, "BUMPER" MISSILES 7 & 8, Long Range Proving Ground Division, Patrick Air Force Base, Cocoa, Florida.

Malina, F. J., and Stewart, H. J., ORDCIT Memorandum Nr. 4-4, CONSIDERATIONS OF THE FEASIBILITY OF DEVELOPING A 100,000 FT. ALTITUDE ROCKET, (THE "WAC CORPORAL"), JPL/GALCIT, CIT, 16 January 1945, Technical Documents Library, ARGMA.

UNCLASSIFIED

Malina, F. J., ORDCIT Report Nr. 4-18, DEVELOPMENT AND FLIGHT PERFORMANCE OF A HIGH-ALTITUDE SOUNDING ROCKET, THE "WAC CORPORAL," JPL/GALCIT, CIT, 24 January 1946, Technical Documents Library, ARGMA.

Meeks, P. J., Denison, F. G., Jr., and Rose, F. F., ORDCIT Report Nr. 4-41, DESIGN, DEVELOPMENT, AND FIELD TESTS OF THE WAC B SOUNDING ROCKET, JPL/CIT, 15 December 1957, Technical Documents Library, ARGMA.

abstract
 Miles, Capt. R. C., compiler, THE HISTORY OF THE ORDCIT PROJECT UP TO 30 JUNE 1946, Pasadena, California; Research and Development Service Sub-Office (Rocket), California Institute of Technology, n.d., Technical Documents Library, ARGMA.

Millikan, Clark B., FINAL REPORT, CONTRACT W-04-200-ORD-396, JPL/GALCIT, CIT, 1 November 1944, Technical Documents Library, ARGMA.

Millikan, C. B., ORDCIT Memorandum Nr. 4-6, SCALE MODEL TESTS FOR ORDCIT WINGED MISSILES, JPL/GALCIT, CIT, 8 April 1945, Technical Documents Library, ARGMA.

Mills, M. M., ORDCIT Report Nr. 4-2, THRUST AND INERTIAL CHARACTERISTICS OF ROCKET MISSILE XF10S1000-A, PRIVATE A, JPL/GALCIT, CIT, 19 March 1945, Technical Documents Library, ARGMA.

Mills, M. M., ORDCIT Report Nr. 4-6, THRUST AND INERTIAL CHARACTERISTICS OF ROCKET MISSILE XF10S1000-F, "PRIVATE F," JPL/GALCIT, 8 May 1945, Technical Documents Library, ARGMA.

McBride, Samuel, and Culpepper, Gideon, AMTC Technical Report Nr. 79, CORPORAL: FINAL SUMMARY OF COMPONENT RELIABILITY OF CORPORAL TYPE II AND IIIA, (Test Plan IIB-17), Ordnance Mission, White Sands Missile Range, New Mexico, June 1959, Technical Documents Library, ABMA.

✓ NOTES ON MATERIEL PERTAINING TO THE WAC CORPORAL B ROCKET, Prepared under the direction of the Office, Chief of Ordnance, by the Douglas Aircraft Company, Inc., Santa Monica, California, 31 March 1959. (This document was prepared for the purpose of acquainting Ordnance and Service personnel with the Douglas Aircraft version of the WAC CORPORAL B high-altitude sounding rocket and was intended to be used as a guide in the final assembly, testing, servicing, and launching of these rockets.) Technical Documents Library, ARGMA.

✓ ORDCIT Memorandum Nr. 4-1, RESEARCH PROGRAM FOR THE FIRST TYPE OF LONG-RANGE JET-PROPELLED MISSILE (XF10S1000-A and XF10S1000-B), JPL/GALCIT, CIT, 2 August 1944.

Ordnance Technical Report, ORDNANCE GUIDED MISSILE & ROCKET PROGRAMS, Vol. III, CORPORAL FIELD ARTILLERY GUIDED MISSILE SYSTEM, INCEPTION THROUGH 30 JUNE 1955; ibid., Vol. X, "HERMES," INCEPTION THROUGH 30 June 1955.

UNCLASSIFIED

- Ordway, Frederick J., III, and Wakeford, Ronald C., INTERNATIONAL MISSILE AND SPACECRAFT GUIDE, New York, Toronto, and London: McGraw-Hill Book Company, Inc., 1960, Marshall Space Flight Center History Office Files.
- Patton, R. B., Jr., Ballistic Research Laboratories Memorandum Report Nr. 504, AN ANALYSIS OF SPIN ERRORS IN THE DOVAP SYSTEM FROM THE RECORD OF BUMPER ROUND NO. 5, Ordnance Department, Ballistic Research Laboratories, Aberdeen Proving Ground, Maryland, February 1950, Technical Documents Library, ARGMA.
- Pickering, W. H., Publication Nr. 45, HISTORY OF ORDNANCE RESEARCH AT THE JET PROPULSION LABORATORY 1 JUNE 1953 THROUGH 31 DECEMBER 1954, JPL/CIT, 1 May 1955, Technical Documents Library, ARGMA.
- Pickering, W. H., ORDCIT Progress Report Nr. 4-15, CONTROL AND TELEMETERING FOR "CORPORAL E," JPL/GALCIT, CIT, 15 May 1945, Technical Documents Library, ARGMA.
- Pickering, W. H., ORDCIT Report Nr. 20-100, THE CORPORAL: A SURFACE-TO-SURFACE GUIDED BALLISTIC MISSILE, JPL/CIT, 17 March 1958. Technical Documents Library, ABMA.
- Pickering, William H., ICAF Publication Nr. L58-90, MANAGEMENT TECHNIQUES FOR THE MANAGEMENT AND DEVELOPMENT OF WEAPON SYSTEMS, a lecture delivered 22 January 1958, Industrial College of The Armed Forces, Washington, D. C., 1957-1958.
- Puckett, Allen E., Ballistic Research Laboratories Report Nr. 548, Supersonic Wind Tunnels Laboratory Problem Nr. SS-2, WIND TUNNEL TESTS OF ORDCIT MODELS, Ordnance Research and Development Center, Aberdeen Proving Ground, Maryland, 25 May 1945.
- Reehl, G. H., Report Nr. R55145, Project HERMES, DYNAMIC STABILITY OF A-4 WAC CORPORAL COMBINATION MISSILE, General Electric Company, Technical Documents Library, ARGMA.
- Report of the Military Operations Subcommittee (the Holifield Committee, ORGANIZATION AND MANAGEMENT OF MISSILE PROGRAMS, X. MISSILES AND MISSIONS, Extracted by ABMA, Redstone Arsenal, Alabama. n.d.
- REPORT OF THE SERGEANT EVALUATION COMMITTEE (W. W. Berning, W. S. Carlson, C. M. Hudson, P. W. Newton, W. H. Pickering, and A. K. Thiel), August 1954, Technical Documents Library, ARGMA.
- Report GM 113/32, SHORT-RANGE SURFACE-TO-SURFACE MISSILES, to Committee on Guided Missiles, Research and Development Board, Department of Defense, Presented 25 and 26 January 1951 and 7 June 1951, n.d., Technical Documents Library, ARGMA.

UNCLASSIFIED

Report, ORDNANCE-CONTRACTOR TECHNICAL COMMITTEE INVESTIGATION OF TYPE I CORPORAL SYSTEM OPERATION AND SUPPORT IN THE FORT BLISS, TEXAS, AREA DURING THE PERIOD 21-26 June 1954, with penciled comments of Brigadier General (as of that date) H. N. Toftoy, Deputy Commanding General, Redstone Arsenal (as of that date). (This report is a draft copy and is located at the Technical Documents Library, ARGMA.)

Roth, Ludwig, and von Braun, Wernher, Technical Report Nr. 18, THE COMBINATION OF V-2 AND WAC CORPORAL AS A TWO-STAGE ROCKET, War Department, Office, Chief of Ordnance, Research and Development Service Sub-Office (Rocket), Fort Bliss, Texas, n.d., Technical Documents Library, ARGMA.

Sandberg, W. A., Barry, W. B., and McLean R. S., ORDCIT Report Nr. 4-1, DESIGN OF "PRIVATE A," FACILITIES FOR HANDLING THE MISSILE AND LAUNCHER, JPL/GALCIT, CIT, 8 May 1945, Technical Documents Library, ARGMA.

Sandberg, W. A., and Barry, W. B., ORDCIT Report Nr. 4-5, DESIGN OF "PRIVATE F," FACILITIES FOR HANDLING THE MISSILE, AND LAUNCHER, JPL/GALCIT, CIT, 14 July 1945, Technical Documents Library, ARGMA.

Sandberg, W. A., and Barry, W. B., ORDCIT Report Nr. 4-21, DESIGN AND FABRICATION OF THE WAC CORPORAL MISSILE, BOOSTER, LAUNCHER, AND HANDLING FACILITIES, JPL/GALCIT, CIT, 19 February 1946, Technical Documents Library, ARGMA.

Seifert, Howard S., JPL Publication Nr. 22, HISTORY OF ORDNANCE RESEARCH AT THE JET PROPULSION LABORATORY, 1945-1953, JPL/CIT, 29 July 1953, Technical Documents Library, ARGMA.

SEMI-ANNUAL PROGRESS REPORT OF THE GUIDED MISSILES PROGRAM, Department of the Army, 30 April 1949; *ibid.*, 31 October 1949; *ibid.*, 31 December 1950, Technical Documents Library, ARGMA.

Shafer, John I., ORDCIT Progress Report Nr. 4-69, SPIN ROCKET DEVELOPMENT TESTS FOR THE BUMPER WAC, JPL/CIT, 8 June 1949, Technical Documents Library, ARGMA.

Snodgrass, R. J., ORDNANCE GUIDED MISSILE PROGRAM, 1944-1954, Historical Branch, Office, Chief of Ordnance, 1954. (This is a draft copy and is located at ARGMA Technical Library, Redstone Arsenal.)

Stewart, H. J., and Chien, W. Z., ORDCIT Report Nr. 4-8, FLIGHT CHARACTERISTICS OF THE PRIVATE F, JPL/GALCIT, CIT, 19 November 1945, Technical Documents Library, ARGMA.

Stewart, H. J., ORDCIT Memorandum Nr. 4-16, PRELIMINARY CONSIDERATIONS REGARDING THE PROPOSED V-2 WAC MISSILE, JPL/GALCIT, CIT, 16 August 1946, Technical Documents Library, ARGMA.

UNCLASSIFIED

- Stewart, Homer J., and Nagamatsu, Henry T., ORDCIT Progress Report Nr. 4-54, BALLISTIC FORM FACTOR AND FLIGHT PERFORMANCE OF WAC B, JPL/CIT, 22 April 1949, Technical Documents Library, ARGMA.
- Stewart, H. J., and Chien W. Z., ORDCIT Memorandum Nr. 4-12, THE ESTIMATED PERFORMANCE OF THE ORDCIT SERIES OF GUIDED MISSILES, JPL/GALCIT, CIT, 30 November 1945, Technical Documents Library, ARGMA.
- SURFACE-TO-SURFACE MISSILES REFERENCE BOOK, Section II; "The CORPORAL Missile System," pages II-1 through II-25, U.S. Army Ordnance Missile Command, ca. December 1959, Technical Documents Library, ARGMA.
- Technical Bulletin, ARMY ORDNANCE DEPARTMENT GUIDED MISSILES PROGRAM, Rocket Development Division, Research and Development Service, Office, Chief of Ordnance, 13 March 1947; ibid., 1 January 1958, ibid., Technical Documents Library, ARGMA.
- Technical Information Report 10-1, DEVELOPMENT OF FIELD ARTILLERY GUIDED MISSILES SYSTEMS, Office, Chief of Ordnance, March 1956, Technical Documents Library, ARGMA.
- Technical Information Report 10-1-1, DEVELOPMENT OF FIELD ARTILLERY MISSILE SYSTEM, CORPORAL II, Office, Chief of Ordnance, October 1955.
- Technical Information Report CD-3, DEVELOPMENT OF SURFACE-TO-SURFACE GUIDED MISSILES AND LARGE ROCKETS, Office, Chief of Ordnance, August 1960, Technical Documents Library, ARGMA.
- Tsien, H. S., and Malina, F. J., A REVIEW AND PRELIMINARY ANALYSIS OF LONG-RANGE PROJECTILES, JPL/GALCIT, CIT, 20 November 1943. Technical Documents Library, ARGMA.
- United States Army Ordnance Guided Missile School (USA OGMS), PROGRAM OF INSTRUCTION FOR 9-R-F19 (renumbered 9-R-245.1): CORPORAL GROUND GUIDANCE REPAIR, Redstone Arsenal, Alabama, July, 1959, ABMA Historical Files.
- USA OGMS, PROGRAM OF INSTRUCTION FOR 9-R-F21 (renumbered 9-R-249.1): CORPORAL MISSILE REPAIR RSA, Alabama, July 1959, ABMA Historical Files.
- USA OGMS, PROGRAM OF INSTRUCTION FOR 9-R-F22 (renumbered 9-R-437.1): CORPORAL GROUND HANDLING EQUIPMENT REPAIR, RSA, Alabama, July 1959, ABMA Historical Files.
- USA OGMS, PROGRAM OF INSTRUCTION FOR 9-N-4812: CORPORAL MAINTENANCE SUPERVISION, RSA, Alabama, July 1959, ABMA Historical Files.
- USA OGMS, UNNUMBERED MEMORANDUM: "Course Redesignation", dated 8 October 1957.

UNCLASSIFIED

USA OGMS, DETAILED SCHEDULE OF CLASSES, 1st, 2nd, 3rd, and 4th QUARTERS, FISCAL YEAR 1961, RSA, Alabama, 22 July 1960, ABMA Historical Files.

USA OGMS, UNIT TRAINING CENTER FUNCTION MANUAL, RSA, Alabama, 1 March 1959, Unit Training Command Files, OGMS, Building 3200.

von Karman, Theodore, JPL Memorandum Nr. JPL-1, MEMORANDUM ON THE POSSIBILITIES OF LONG-RANGE ROCKET PROJECTILES, JPL/GALCIT, CIT, 20 November 1943. Technical Documents Library, ARGMA.

von Karman, Theodore, Tsien, Hsue-shen, and Canright, Richard B., Jet Propulsion Research, GALCIT Project Nr. 1 (Air Corps), Progress Report Nr. 7, A STUDY OF THE POSSIBILITY OF USING THE EJECTOR ACTION OF THE JET AS A SOURCE OF POWER FOR DRIVING PROPELLANT PUMPS, Pasadena, California: California Institute of Technology, 27 July 1943. Technical Documents Library, ARGMA.

von Karman, Theodore, ORDCIT Memorandum Nr. 2, RESEARCH PROGRAM FOR THE SECOND TYPE OF LONG-RANGE JET-PROPELLED MISSILE (XF30L20,000), JPL/GALCIT, CIT, 20 August 1944. Technical Documents Library, ARGMA.

White, L. D., Report Nr. R52A0510, FINAL REPORT, PROJECT HERMES V-2 MISSILE PROGRAM, Schenectady, New York: Guided Missiles Department, Aeronautic and Ordnance Systems Divisions, Defense Products Group, General Electric Company, Technical Documents Library, ARGMA.

WHITE SANDS PROVING GROUND, REQUIREMENTS FOR WORK AND RESOURCES, Revision Nr. 1, Mission Plans & Operations, WSPG, New Mexico, 1 April 1958, Technical Documents Library, ARGMA.

White Sands Proving Ground Technical Memorandum Nr. 387, CORPORAL II ACCURACY AND INFLIGHT RELIABILITY ESTIMATES, White Sands Proving Ground, New Mexico, November 1956, Technical Documents Library, ARGMA.

White Sands Proving Ground Technical Memorandum Nr. 472, ACCURACY AND DISPERSION ESTIMATES FOR CORPORAL II MISSILES UNDER VARIED FLIGHT CONDITIONS, Systems Test Division, White Sands Proving Ground, New Mexico, November 1957, Technical Documents Library, ABMA.

INTERVIEWS WITH

Bogel, Mr. Amos G., Assistant Engineer for CORPORAL, Engineering Division, Industrial Operations, ABMA, Building 3737, Tin Village, 13 February 1961.

Collier, Mr. Paul R., Missile System Industrial Management Officer, ABMA, Building 4488, 10, 14, and 24 February 1961.

UNCLASSIFIED

INTERVIEWS WITH (Continued)

- Cropp, Mr. N. L., Publications Officer, Reports Branch, ABMA Control Office
- Cunningham, Captain Daniel L., USA, Deputy Commander, Unit Training Command, USA OGMS, RSA, Alabama, Building 3200, 14 February 1961.
- Detchemendy, Lieut. Col. Ed. B., USA, Chief, Maintenance Division, Field Service Operations, ARGMA, Building 5681, 13 February and 2 March 1961.
- Fleagle, Mr. Robert W., Chief, Special Weapons Branch, Research and Development, ABMA, Building 4488, 10 February 1961.
- Fredericks, Sergeant First Class Russell M., USA, Administrative Specialist, Programming Branch, Office of Operations, USA OGMS, RSA, Alabama, Building 3300, 1 March 1961.
- Guillory, 1st Lieut. R. W., USA, Chief, CORPORAL Branch, FAM Division, Department of Individual Training, USA OGMS, RSA, Alabama, Building 3305, 14 February and 1 March 1961.
- Gullick, Mr. John M., Assistant Chief, CORPORAL Branch, FAM Division, Department of Individual Training, USA OGMS, RSA, Alabama, Building 3305, 14 February and 1 March 1961.
- Mancini, Master Sergeant James D., USA, Non-Commissioned Officer in Charge of Office of Operations, USA OGMS, RSA, Alabama, Building 3300, 14 February and 1 March 1961.
- Smith, Mr. Robert A., III, Chief, Reports Branch, ABMA Control Office.

ADDITIONAL INFORMATION AND ASSISTANCE FURNISHED
AFTER CRITICAL REVIEW OF MANUSCRIPT

- Field Support Operations, ABMA.
- Industrial Operations, ABMA.
- Reports Branch, ABMA Control Office.

UNCLASSIFIED

COOPERATING ELEMENTS

ABMA Technical Documents Library.

ARGMA Technical Documents Library.

Graphics Section, Control Room Operations Branch, ABMA Control Office

Reports and Historical Branch, ABMA Control Office, Redstone Arsenal, Alabama (especially in advising, editing, procuring pictorial materials, and typing).

Still Photographic Section, Pictorial Branch, Signal Division, Redstone Arsenal, Alabama.

UNCLASSIFIED

UNCLASSIFIED

G L O S S A R Y

287
UNCLASSIFIED

UNCLASSIFIED

GLOSSARY

-A-

AAA & GM Center--Antiaircraft Artillery and Guided Missile Center
ABMA--Army Ballistic Missile Agency
ACM--anticounter measures
AEC--Atomic Energy Commission
AFF--Army Field Forces
AFSWP--Armed Forces Special Weapons Project
AGC--automatic gain control
AGF--Army Ground Forces
AMTC--Army Missile Test Center
APG--Aberdeen Proving Grounds
ARGMA--Army Rocket and Guided Missile Agency
ASP--annual service practice
ATA--air turbine alternator

-B-

BRL/APG--Ballistic Research Laboratory, Aberdeen Proving Ground

-C-

CBS--Combined Bimonthly Summary
CIT--California Institute of Technology
CONUS--Continental United States
CPE--Circular Probable Error
CTC--CORPORAL Technical Consultants

-D-

D/A--Department of the Army
DOVAP--Doppler Velocity and Position
DS--Direct Support

-E-

ECM--electronic countermeasures
EML--Electro-Mechanical Laboratories
E-U--Engineer-User

UNCLASSIFIED

-F-

FA--Field Artillery
FAGM--Field Artillery, Guided Missile
FOTS--Field Operations and Test Station
FM-FM--audio-frequency and radio-frequency modulation
FSD--Field Service Division
ft/sec--feet per second

-G-

GALCIT--Guggenheim Aeronautical Laboratory, California Institute of
Technology
GAP--Guided Antiaircraft Projectile
GE--General Electric
GSE--ground support equipment
GMDS--Guided Missile Direct Support
GMHM--Guided Missile Heavy Maintenance
GP--general purpose

-I-

IDECO--Internation Derrick and Equipment Company
IRFNA--inhibited red fuming nitric acid

-J-

JATO--jet-assist-take-off
JPL--Jet Propulsion Laboratory

-L-

LAOD--Los Angeles Ordnance District
LAR--Laboratory Report
LO--letter order
LRPG--Long Range Proving Ground, Cocoa, Florida
LRPGD--Long Range Proving Ground Division

UNCLASSIFIED

-M-

MOS--military occupational specialty
MSFC--Marshall Space Flight Center

-N-

NATO--North Atlantic Treaty Organization
NDRC--National Defense Research Committee

-O-

OCO--Office, Chief of Ordnance
OGMC--Ordnance Guided Missile Center
OGMS--Ordnance Guided Missile School
OTC--Ordnance Training Command

-P-

P&P--Procurement and Production

-R-

RAFT--Rocket Airfoil Tester
RFNA--red fuming nitric acid

-S-

SEL--Signal Engineering Laboratories
SET--service evaluation telemetering
SETAF--Southern European Task Force (Italy)
SFNA--stabilized fuming nitric acid
SSM--Surface-to-Surface Missile
SSWTL--Supersonic Wind Tunnel Test Laboratory

-T-

T/O&E--Table of Organization and Equipment

-U-

UHF--ultra high frequency
UK--United Kingdom
USAREUR--United States Army, (7th) Europe (Germany)

UNCLASSIFIED

USCONARC--United States Continental Army Command

-W-

WAC--without altitude control

WSMR--White Sands Missile Range

WSPG--White Sands Proving Ground

UNCLASSIFIED

D I S T R I B U T I O N L I S T

<u>Addressee</u>	<u>No. of Copies</u>
Chief of Ordnance Department of the Army Washington 25, D. C. ATTN: ORDGX-H	1
Office, Chief of Military History Department of the Army Second & R Streets, S. W. Washington 25, D. C.	1
Commanding General Army Combat Surveillance Agency 1124 North Highland Street Arlington 1, Virginia	1
Commanding General U. S. Army Ordnance Missile Command Redstone Arsenal, Alabama ATTN: ORDXM-AH	1
ORDAB-X	1
ORDAB-C	1
ORDAB-R	1
ORDAB-E	1
ORDAB-F	1
ORDAB-HT	3
ORDAB-I	2
ORDAB-J	1
ORDAB-L	1
ORDAB-M	1
ORDAB-P	1
ORDAB-S	4
ORDAB-CRR (file)	6

UNCLASSIFIED

~~CONFIDENTIAL~~

~~CONFIDENTIAL~~

UNCLASSIFIED

~~CONFIDENTIAL~~

~~CONFIDENTIAL~~