



EXCERPT FROM THE
PROCEEDINGS

OF THE
NINTH ANNUAL ACQUISITION
RESEARCH SYMPOSIUM
WEDNESDAY SESSIONS
VOLUME I

Data-Driven Monetization of Acquisition Risk

Katherine Morse and David L. Drake
The John Hopkins University Applied Physics Laboratory

Published April 30, 2012

Report Documentation Page

Form Approved
OMB No. 0704-0188

Public reporting burden for the collection of information is estimated to average 1 hour per response, including the time for reviewing instructions, searching existing data sources, gathering and maintaining the data needed, and completing and reviewing the collection of information. Send comments regarding this burden estimate or any other aspect of this collection of information, including suggestions for reducing this burden, to Washington Headquarters Services, Directorate for Information Operations and Reports, 1215 Jefferson Davis Highway, Suite 1204, Arlington VA 22202-4302. Respondents should be aware that notwithstanding any other provision of law, no person shall be subject to a penalty for failing to comply with a collection of information if it does not display a currently valid OMB control number.

1. REPORT DATE 30 APR 2012	2. REPORT TYPE	3. DATES COVERED 00-00-2012 to 00-00-2012	
4. TITLE AND SUBTITLE Data-Driven Monetization of Acquisition Risk		5a. CONTRACT NUMBER	
6. AUTHOR(S)		5b. GRANT NUMBER	
7. PERFORMING ORGANIZATION NAME(S) AND ADDRESS(ES) John Hopkins University, Applied Physics Laboratory, 11100 Johns Hopkins Road, Laurel, MD, 20723		5c. PROGRAM ELEMENT NUMBER	
9. SPONSORING/MONITORING AGENCY NAME(S) AND ADDRESS(ES)		5d. PROJECT NUMBER	
12. DISTRIBUTION/AVAILABILITY STATEMENT Approved for public release; distribution unlimited		5e. TASK NUMBER	
13. SUPPLEMENTARY NOTES		5f. WORK UNIT NUMBER	
14. ABSTRACT The current state of practice in program risk assessment relies on the best judgment of program management and systems engineering to identify and qualitatively assess the nature and probability of risks. While there are best practices and lessons learned upon which the risk assessment process can rely, the process is still heavily qualitative and is performed by program management and systems engineering staff that are inherently optimistic about program success. As a result, risks and their consequences are frequently underestimated. We propose a methodology that actively collects, and continuously and quantitatively analyzes, metrics that are earlier indicators of risk than cost and schedule slips. This methodology includes the application of web-based technologies for collection and analysis; a quantified risk cloud and monetized risk thresholds; establishing a readily accessible knowledge base of previous program failures, and new metrics to be collected closer to the source of risk.		8. PERFORMING ORGANIZATION REPORT NUMBER	
15. SUBJECT TERMS		10. SPONSOR/MONITOR'S ACRONYM(S)	
16. SECURITY CLASSIFICATION OF:		11. SPONSOR/MONITOR'S REPORT NUMBER(S)	
a. REPORT unclassified	b. ABSTRACT unclassified	c. THIS PAGE unclassified	17. LIMITATION OF ABSTRACT Same as Report (SAR)
18. NUMBER OF PAGES 38			19a. NAME OF RESPONSIBLE PERSON

The research presented at the symposium was supported by the acquisition chair of the Graduate School of Business & Public Policy at the Naval Postgraduate School.

To request defense acquisition research or to become a research sponsor, please contact:

NPS Acquisition Research Program
Attn: James B. Greene, RADM, USN, (Ret.)
Acquisition Chair
Graduate School of Business and Public Policy
Naval Postgraduate School
Monterey, CA 93943-5103
Tel: (831) 656-2092
Fax: (831) 656-2253
E-mail: jbgreene@nps.edu

Copies of the Acquisition Research Program's sponsored research reports may be printed from our website (www.acquisitionresearch.net).



ACQUISITION RESEARCH PROGRAM
GRADUATE SCHOOL OF BUSINESS & PUBLIC POLICY
NAVAL POSTGRADUATE SCHOOL

Preface & Acknowledgements

Welcome to our Ninth Annual Acquisition Research Symposium! This event is the highlight of the year for the Acquisition Research Program (ARP) here at the Naval Postgraduate School (NPS) because it showcases the findings of recently completed research projects—and that research activity has been prolific! Since the ARP's founding in 2003, over 800 original research reports have been added to the acquisition body of knowledge. We continue to add to that library, located online at www.acquisitionresearch.net, at a rate of roughly 140 reports per year. This activity has engaged researchers at over 60 universities and other institutions, greatly enhancing the diversity of thought brought to bear on the business activities of the DoD.

We generate this level of activity in three ways. First, we solicit research topics from academia and other institutions through an annual Broad Agency Announcement, sponsored by the USD(AT&L). Second, we issue an annual internal call for proposals to seek NPS faculty research supporting the interests of our program sponsors. Finally, we serve as a “broker” to market specific research topics identified by our sponsors to NPS graduate students. This three-pronged approach provides for a rich and broad diversity of scholarly rigor mixed with a good blend of practitioner experience in the field of acquisition. We are grateful to those of you who have contributed to our research program in the past and hope this symposium will spark even more participation.

We encourage you to be active participants at the symposium. Indeed, active participation has been the hallmark of previous symposia. We purposely limit attendance to 350 people to encourage just that. In addition, this forum is unique in its effort to bring scholars and practitioners together around acquisition research that is both relevant in application and rigorous in method. Seldom will you get the opportunity to interact with so many top DoD acquisition officials and acquisition researchers. We encourage dialogue both in the formal panel sessions and in the many opportunities we make available at meals, breaks, and the day-ending socials. Many of our researchers use these occasions to establish new teaming arrangements for future research work. In the words of one senior government official, “I would not miss this symposium for the world as it is the best forum I've found for catching up on acquisition issues and learning from the great presenters.”

We expect affordability to be a major focus at this year's event. It is a central tenet of the DoD's Better Buying Power initiatives, and budget projections indicate it will continue to be important as the nation works its way out of the recession. This suggests that research with a focus on affordability will be of great interest to the DoD leadership in the year to come. Whether you're a practitioner or scholar, we invite you to participate in that research.

We gratefully acknowledge the ongoing support and leadership of our sponsors, whose foresight and vision have assured the continuing success of the ARP:

- Office of the Under Secretary of Defense (Acquisition, Technology, & Logistics)
- Director, Acquisition Career Management, ASN (RD&A)
- Program Executive Officer, SHIPS
- Commander, Naval Sea Systems Command
- Program Executive Officer, Integrated Warfare Systems
- Army Contracting Command, U.S. Army Materiel Command
- Office of the Assistant Secretary of the Air Force (Acquisition)



- Office of the Assistant Secretary of the Army (Acquisition, Logistics, & Technology)
- Deputy Director, Acquisition Career Management, U.S. Army
- Office of Procurement and Assistance Management Headquarters, Department of Energy
- Director, Defense Security Cooperation Agency
- Deputy Assistant Secretary of the Navy, Research, Development, Test & Evaluation
- Program Executive Officer, Tactical Aircraft
- Director, Office of Small Business Programs, Department of the Navy
- Director, Office of Acquisition Resources and Analysis (ARA)
- Deputy Assistant Secretary of the Navy, Acquisition & Procurement
- Director of Open Architecture, DASN (RDT&E)
- Program Executive Officer, Littoral Combat Ships

We also thank the Naval Postgraduate School Foundation and acknowledge its generous contributions in support of this symposium.

James B. Greene Jr.
Rear Admiral, U.S. Navy (Ret.)

Keith F. Snider, PhD
Associate Professor



Panel 3. New Approaches to Reducing Risk in Acquisition Programs

Wednesday, May 16, 2012	
11:15 a.m. – 12:45 p.m.	<p>Chair: Dr. Jomana Amara, Associate Professor, Naval Postgraduate School</p> <p><i>Data-Driven Monetization of Acquisition Risk</i> Katherine Morse and David L. Drake <i>The John Hopkins University Applied Physics Laboratory</i></p> <p><i>Capability and Development Risk Management in System-of-Systems Architectures: A Portfolio Approach to Decision-Making</i> Navindran Davendralingam, Muharrem Mane, and Daniel DeLaurentis <i>Purdue University</i></p> <p><i>Addressing Risk in the Acquisition Lifecycle With Enterprise Simulation</i> Doug Bodner, <i>Georgia Institute of Technology</i></p>

Jomana Amara—Dr. Amara, PhD, PE, is an associate professor of economics at the Defense Resources Management Institute at the Naval Postgraduate School in Monterey, California and a Fulbright Scholar. Dr. Amara worked with Shell Oil before joining the Naval Postgraduate School. She currently researches and publishes on international economics, defense economics, health economics, and the economics of the public sector. She has addressed various national and international academic organizations, institutions and conferences. Dr. Amara is the author of the forthcoming book *Economic Development and Post Conflict Reconstruction* and co-editor of *Military Medicine: From Pre-Deployment to Post-Separation*. She has published in numerous peer-reviewed journals. Dr. Amara is a member of the American Economic Association (AEA) and the International Institute of Strategic Studies (IISS). [jhamara@nps.edu]



Data-Driven Monetization of Acquisition Risk

Katherine L. Morse—Dr. Morse is a member of the Senior Professional Staff at JHU/APL. She received her BS in mathematics (1982), BA in Russian (1983), and MS in computer science (1986) from the University of Arizona; in addition, she received an MS (1995) and PhD (2000) in information and computer science from the University of California, Irvine. Dr. Morse has worked in the computer industry for over 25 years, specializing in the areas of simulation, computer security, compilers, operating systems, neural networks, speech recognition, image processing, and engineering process development. She is a member of Phi Beta Kappa, Dobro Slovo, ACM, and SISO, and a senior member of IEEE. [katherine.morse@jhuapl.edu]

David L. Drake—Mr. Drake is a member of the Senior Professional Staff at JHU/APL. He performs research and development in the area of modeling and simulation supporting the U.S. government and military. Mr. Drake has 10 years of experience in modeling and simulation design, development, and standards, and 24 years as a computer security professional in computer security design, implementation, and evaluation. Mr. Drake received his bachelor's degree in mathematics from State University of New York at Buffalo. He has published in the areas of simulation, service-oriented architecture, grid computing, security, and risk assessment, and has a patent on the process for enterprise-wide intrusion detection. [david.drake@jhuapl.edu]

Abstract

The current state of practice in program risk assessment relies on the best judgment of program management and systems engineering to identify and qualitatively assess the nature and probability of risks. While there are best practices and lessons learned upon which the risk assessment process can rely, the process is still heavily qualitative and is performed by program management and systems engineering staff that are inherently optimistic about program success. As a result, risks and their consequences are frequently underestimated. We propose a methodology that actively collects, and continuously and quantitatively analyzes, metrics that are earlier indicators of risk than cost and schedule slips. This methodology includes

- the application of web-based technologies for collection and analysis,
- a quantified risk cloud and monetized risk thresholds,
- establishing a readily accessible knowledge base of previous program failures, and
- new metrics to be collected closer to the source of risk.

Background

The Government Accountability Office (GAO) estimated that FY2008 acquisition costs for major defense programs grew by \$296 billion, an increase of 25% over initial estimates (GAO, 2009). The 2011 version of this same report (GAO, 2011) found that

the total acquisition cost of the programs in DOD's 2010 portfolio has increased by \$135 billion over the past 2 years, of which \$70 billion cannot be attributed to quantity changes. A small number of programs are driving most of this cost growth; however, half of DOD's major defense acquisition programs do not meet cost performance goals agreed to by DOD, the Office of Management and Budget, and GAO.

The goal of this paper is to provide a better approach to early detection of program failure, allowing early program termination or course correction. Based on our experience on multiple programs of various sizes, we conclude that, despite programmatic assertions to the contrary, risk management is often static and superficial. It is one of the areas of program management that is not well supported by tools that produce quantitative,



repeatable results. And such tools are only possible if they are supported by a knowledge base of previous program failures and lessons learned. Our thesis is that technology and collaborative techniques have evolved to the point that a quantitative, data-driven approach is now more feasible than it has been in the past. This data should come from two sources:

1. data captured from previous program failures, and
2. crowd-sourced data from program performers.

We believe that such a knowledge base and tool would improve the process of understanding and evaluating risk within acquisition programs to

- reduce program failures, cost and schedule overruns, and unanticipated technical and managerial roadblocks;
- better anticipate the full program undertaking;
- prevent repeating historical lessons learned; and
- provide a more accurate risk analysis to existing programs to have a clearer understanding of its areas of predictability and unpredictability.

Current Risk Management

Figure 1 and Table 1 illustrate a traditional Continuous Risk Management (CRM) process for acquisition (NASA, 2000).¹ Unfortunately, this process is often more theoretical than actual. We believe our proposed approach will make it more feasible to realize this process.



Figure 1. Continuous Risk Management Process

¹ *The Risk Management Guide for DoD Acquisition* (2006) advocates a process that is only slightly different, placing risk mitigation plan implementation (control) before tracking.

Table 1. Continuous Risk Management Activities

Activity	Description
Identify	State the risk in terms of condition and consequences; capture the context of the risk (e.g., what, when, where, how, and why).
Analyze	Evaluate risk probability, impact/severity, and time-frame (when action needs to be taken); classify/group with similar/related risks; and prioritize.
Plan	Assign responsibility, determine approach (research, accept, mitigate, or monitor); if risk will be mitigated, define mitigation level (e.g., action item list or more detailed task plan) and goal; execute plan.
Track	Acquire/update, compile, analyze, and organize risk data; report tracking results; and verify and validate mitigation actions.
Control	Analyze tracking results, decide how to proceed (re-plan, close the risk, invoke contingency plans, continue tracking); execute the control decisions.
Communication and Documentation	These are present in all of the preceding functions and are essential for the management of risks. A system for documentation and tracking of risk decisions shall be implemented.

Current Tools

Many of the commercial risk analysis/assessment tools available are focused on an enterprise’s information technology (IT; including information security) and facilities, for example, Central Computing and Telecommunications Agency (CCTA, n.d.) Risk Analysis and Management Method (CRAMM), Cost of Risk Analysis (CORA, n.d.), and Countermeasures (n.d.). This is not surprising since a commercial tool must demonstrate immediate value, which argues for focusing on risk domains where large data sets of discrete, identifiable risks exist.

The Defense Acquisition Portal (n.d.) lists several risk assessment tools:

- ACEIT (Automated Cost Estimating Integrated Tools) RI\$K is one of a family of applications that support project managers and cost/financial analysts during all phases of a program’s life cycle that permits the user to conduct detailed cost-risk analysis. It provides risk-adjusted, phased cost estimates, and performs risk calculations using eight probability functions to model uncertainty (beta, lognormal, log-*t*, normal, student’s *t*, triangular, uniform, and Weibull).
- Army Cost Analysis Strategy Assessment (CASA) is a Life Cycle Cost (LCC)/Total Ownership Cost (TOC) decision support tool that includes risk and uncertainty analysis as a capability.
- Cost/Risk Identification & Management System (CRIMS) is a system for identifying, tracking, and storing cost-risk information.²
- Formal Risk Analysis (FRISK 4.00) supports cost-risk analysis by allowing the user to statistically sum Work Breakdown Structure (WBS)-element costs, represented by probability distributions, to obtain a probability distribution of total cost. This appears to indicate monetization of risk, but the most current version is from 2000.

² Current information on this tool was unavailable.



- NetIDEAS Inc.—Risk Manager supports the suggestions made in this paper in terms of using an online environment for team members to collaborate on risk identification, assessment, mitigation, and contingency planning.
- Technical Risk Identification and Mitigation System (TRIMS) purports to have a knowledge base. However, information on its source was unavailable, and it does not appear to allow for collaboration outside the program using it.

Our key observations about these tools are as follows:

1. They are focused mostly on methodology rather than data.
2. Many are not maintained actively, suggesting that they have established an initial methodology and have no impetus to evolve past that methodology. By extension, the tool that implements it does not evolve because the tool is not integrated with a risk management enterprise that tracks project results.

Shortcomings of Current Practice

In practice, we have observed the following shortcomings of risk assessments on actual programs:

- Senior acquisition team members, especially management, have a vested interest in underestimating risk. This is not only because of their desire for continuity of the program, but because their role requires an optimistic attitude to lead their program team to success.
- Engineers often recognize technical and programmatic risks, but cannot/will not risk raising concern for fear of retaliation or working at cross-purposes with their leaders' success-oriented optimism.
- Engineers are rarely included in the risk assessment process.
- All acquisition team members are limited by their collective knowledge of risk. No matter how experienced the team is, team members cannot be expected to know or recognize all the risks that have ever resulted in acquisition failures or their indicators.
- Risks are usually assessed qualitatively rather than quantitatively because team members lack the data to produce useful and realistic metrics.
- Methodologies that look at cost and schedule (e.g., Earned Value Management [EVM]) are assessing symptoms, not causes.
- Well-defined metrics are needed that are causally closer to symptoms or program risk.
- The potential causal relationships between individual risks are often overlooked (i.e., a failure in one aspect of a program may have a cascade effect).

Proposed Risk Analysis Snapshot for Acquisition Program Cost Projection

A well-managed program can sustain some number of unexpected events and stay within budget. The question to be answered is, how many unexpected events, and of what magnitude, can be tolerated before program recovery is not achievable? By monetizing program risks, a probabilistic risk “cloud” can be calculated that permits understanding of the additional costs that unexpected events will incur for the program. Figure 2 provides a conceptual illustration of this risk cloud. When the risk cloud is added to the top of the expected costs, a clearer picture of the possible overall costs that a program may incur are seen. The challenge with this simple picture is that early in a project, when the current expended funds are low, the project budget has quite a bit of capability to absorb future



project changes due to unexpected decisions and project direction. The risk cloud above the project budget should be small at that time. As the project matures, and more funds have been expended, the size of the probabilistic risk cloud changes.

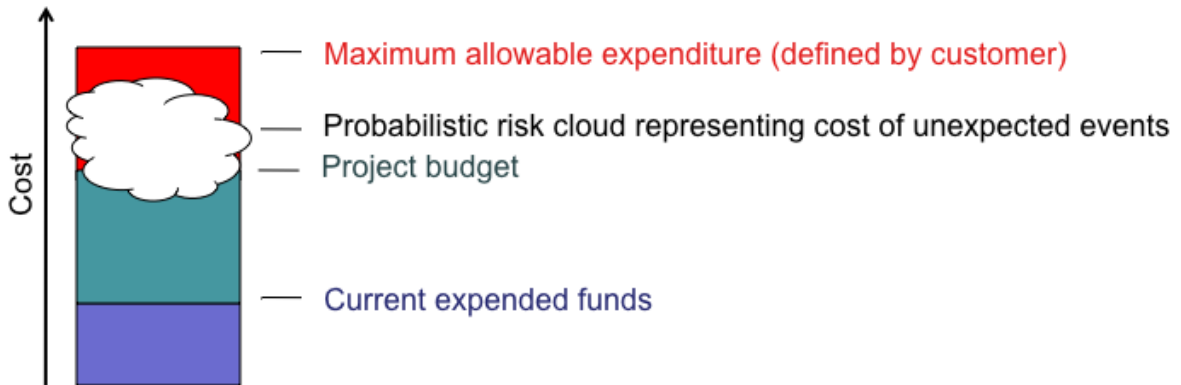

Figure 2. Risk Cloud

By conceptualizing the cost of a program in this manner, the upper financial limit that would be allowed, even through an overrun, can be defined. That limit can be called the Maximum Allowable Expenditure (MAE). If an overrun were borne by the customer, then the customer would define the MAE. In that case, the customer may justifiably terminate or significantly reorganize a program if the estimated average of unexpected events will drive costs above the MAE. If the contract were firm fixed price, then the MAE would be defined by the contractor, who would bear the cost of an overrun. In both cases, the customer, program manager, and contractor are very concerned with a risk cloud that approaches or surpasses the MAE.

The project manager might also set the MAE low enough to prevent loss of incentives such as award fees. However, cost elasticity is not out of the question as the enactment of Nunn-McCurdy (§ 2433) so strongly demonstrates. One of the primary reasons to implement the recommendations in this paper is to avoid the type of visibility associated with program cost overruns and a required explanation to Congress.

The MAE should vary over the lifetime of a program. Although uncertainty may be high, the risk of program failure should be low at the beginning of a program since there is greater time and budget to recover. Figure 3 illustrates the concept and projected evolution of the average and maximum of the risk cloud over the course of a program.

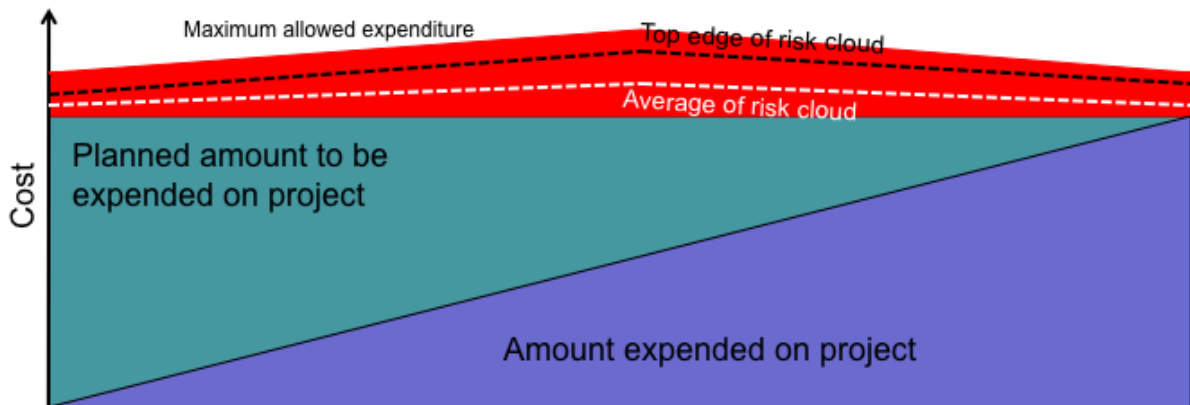

Figure 3. Projected Risk Evolution Over Time

Notice that the MAE is rising until the “middle” or risk peak of the program and falling toward the end. Figure 3 clearly reflects perfect knowledge of how risk will evolve on the program, the type of knowledge a project manager (PM) almost never has in reality. The two key points about this profile are the following:

- The change over time reflects the fact that the PM is anticipating there is a knee in the risk curve while keeping a close rein on the risk.
- Any time the top edge of the risk cloud crosses or is about to cross the MAE, it should trigger a Program Scrub Decision (PSD) to cancel or reorganize the program.

For this approach to be effective, the MAE profile needs to anticipate rising and falling risk. If the MAE were flat across the program timeline, and it were set too high initially, the program could get into trouble early without triggering a PSD.

Figure 4 illustrates what could happen if the MAE were flat, but set too low initially. As the risk rises early in the program, a PSD is triggered. If the PM concludes that the risk is still manageable, the MAE is raised. But if the MAE profile is still flat, risk could continue to rise toward the end of the program rather than falling as expected without triggering another PSD.

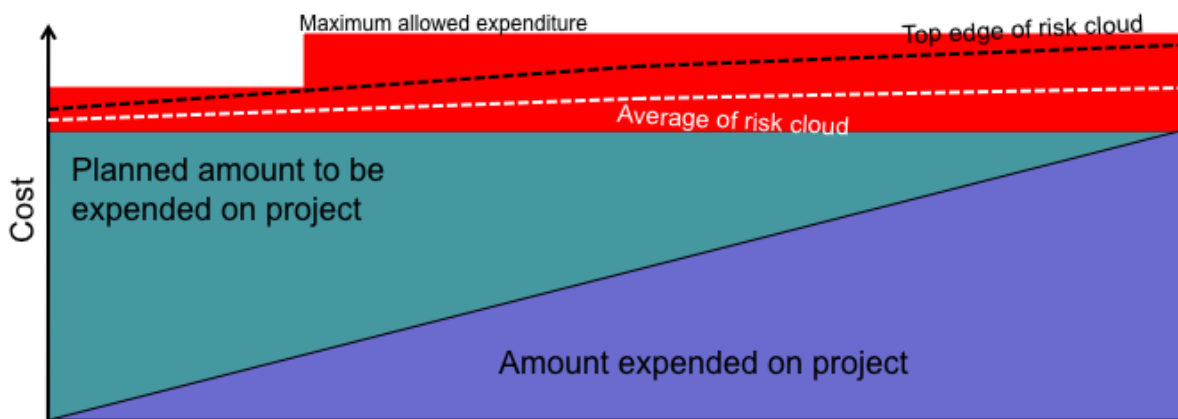

Figure 4. Program Scrub Decision Point

A concept that needs to be better understood is where the knee of the curve exists (as shown in Figure 3; i.e., where to allow the greatest risk). This may be related to the Technical Readiness Level (TRL; DoD, 2011) of the program.

Recommendations for a “Living” Risk Management Capability

The *quantitative process* described in the following subsection is only feasible with the support of *data* and the *infrastructure* to make it *usable* and *accessible* by programs.

Quantitative Process

The quantitative process helps determine the type of data that need to be gathered. The process is as follows:

- Identify an initial set of discrete risk elements.
- Monetize the identified set of discrete risk elements based on their negative impact to project resources (duration/schedule, personnel, and materials) multiplied against the likelihood of occurrence (based on past acquisition project histories).



- Determine the mathematics of unifying the monetized risk across the project by determining the causal relationships between the discrete risk elements, based on the Eight-Stage Risk Assessment Methodology (Drake & Morse, 1994):
 - If there is no causal relationship, then a simple summation across the monetized risk elements is sufficient.
 - If risk elements are mutually exclusive, then selecting the maximum of the risk is sufficient.
 - If risk elements are causally chained together, then the Eight-Stage Risk Assessment Methodology (or a similar calculation) applies, where the causal elements will raise the monetized value due to the likelihood of the combined probability of occurrence.
- Continually track, update, and plan against risks.
- Compare their risks to a substantial knowledge base of risks from previous programs.
- Collect metrics to support quantitative risk adjustments.

Data

The portal should be backed by a knowledge base of previous acquisition successes and failures detailing

- types of failures;
- indicators of failures;
- probability of failure based on indicators;
- loss percentages based on failures; and
- applicable risk treatments (remedies), including success and failure metrics.

Infrastructure

The web portal that supports the process in the Quantitative Process section will need the following functionality:

- knowledge base of individual risks searchable on multiple criteria (e.g., phase technical/programmatic, technologies, drivers);
- management tools for continually tracking, updating, and planning against risks;
- metrics collection tools; and
- open APIs for importing and exporting data.

Usability

The portal should have the following features:

- Present potential risks from which the risk assessor can choose, reducing the effort to “think up” all potential risks, but still allow the assessor to specify new risks.
- Provide recommendations and guidance on techniques that apply to assessing individual risks: for example,
 - Failure Modes and Effects Analysis (FMEA),
 - Fault Tree Analysis (FTA),



- Probabilistic Risk Assessment (PRA), and
- Probability distributions appropriate for individual risks.
- Integrate tools for collecting metrics, including anonymous polling of team members.³

The portal should provide the following key outputs:

- Cloud of probable cost based on risk and comparison of the risk cloud to
 - target cost,
 - actual cost,
 - MAE,
 - average risk, and
 - monetized risk.
- Tracking and adjustment of risk probabilities based on previous program performance.
 - If the program has consistently underestimated risks, then future risk probabilities should be increased accordingly.
- Versioning and tracking to enable rapid assessment of risk management success over time.

Accessibility

The portal should have role-based access control for

- management,
- engineers,
- government program managers,
- auditors, and
- portal maintenance staff.

Deploying and Employing the Portal

While the application of this portal is technically outside the scope of our effort to improve the process of monetizing risk, the broad adoption of the proposed process and portal could factor into contracts in the form of specified government remedies (e.g., cancellation or re-bid) tied to specific risk metrics.

Some Proposed (and Potentially Unpopular) Risk Metrics

At the end of the subsection Current Risk Management, we asserted the need for metrics that are causally closer to symptoms rather than those that capture and record their impact later, such as EVM. Table 2 presents some proposed metrics from our personal experiences on programs of various sizes.

³ Engineers are often aware of technical risks before PMs, since they are “closer” to the fault, and it is usually the engineers that have to relay the technical issue to the manager.



Table 2. Proposed New Risk Metrics

Metric	Description
Work-to-noise ratio = work/(work + noise)	<ul style="list-style-type: none"> • What percentage of time do engineers spend actually performing engineering tasks vs. engaging in non-productive tasks (e.g., sitting in meetings/telecons to which they are not contributing nor from which they are getting actionable information)? • This metric can be collected anonymously through the proposed web portal.
Task coupling	<ul style="list-style-type: none"> • To what degree does completion of tasks depend on coordination between tasks? • This metric is related to a Gantt chart of the schedule, but cannot be seen on the Gantt chart. • Task coupling not only runs the risk of making both tasks late because they are interdependent, but simply trying to arrange the coordination often delays the tasks because schedules are hard to synchronize.
Resource gapping	<ul style="list-style-type: none"> • A delay in one task delays a dependent task, causing a gap in tasking for some resources. <ul style="list-style-type: none"> ○ This could be observed as resource underutilization in the schedule. • Unlike machinery, engineers cannot just sit idle; they have to be retained and paid, so they have to perform work. <ul style="list-style-type: none"> ○ It must be value-adding or the costs are wasted. ○ They cannot be shifted to other, productive tasks because other resources have already been allocated, and putting them on other programs risks losing them and their expertise altogether.
Engineering skill loss	<ul style="list-style-type: none"> • This includes not just the loss of engineers, but the loss of the most knowledgeable and skilled engineers. • Engineers are not interchangeable resources. <ul style="list-style-type: none"> ○ When rumors of cuts start, the better engineers find new jobs and leave. ○ The loss of engineering skill is disproportionately larger than the loss of engineers.
Energy drains	<ul style="list-style-type: none"> • These are individuals who have psychological and substantive negative impacts on otherwise productive members of the team. <ul style="list-style-type: none"> ○ Leaders who demoralize subordinates to the point that they waste time complaining to each other rather than working ○ Team members who perform “negative work” (i.e., whose work is so poor that it takes more time to correct than it would have taken a productive team member to do it in the first place). These individuals also negatively affect morale because productive team members resent having to work harder to make up for the counter-productivity.

Next Steps and Challenges

We cannot switch from qualitative analysis to quantitative analysis without quantitative data. Central to the success of this approach is the collection and maintenance of data on previous acquisition risks and failures. While some of this data may be available,



it will need to be evaluated to determine if it is sufficiently detailed and quantified to be transformed into failure records as described in the Data subsection. There are a number of potential sources coordinated by USD(AT&L). The data for major programs are collected in the Defense Acquisition Executive Summary (DAES, n.d.), a multi-part document reporting program information and assessments that provides an early-warning report to USD(AT&L). The DAES describes actual program problems, warns of potential program problems, and describes mitigating actions taken or planned. Another potential source is AT&L's Performance Assessment and Root Cause Analyses (PARCA) office (PARCA, n.d.), the central office for major defense authorization performance assessment, root cause analysis, and EVM.

The success of the proposed portal is reliant upon continuous acquisition of new data that is a key challenge of any such enterprise. Program personnel must be incentivized to share experiences and may require anonymity to do so. New metrics should be solicited from the community. Acceptable values for some of the new metrics and their impact on risk (e.g., work-to-noise ratio) cannot be determined without data collection from multiple programs.

Finally, this type of community effort succeeds and thrives when the community continuously rates the value of the elements of the enterprise. In this case, the applicability of identified risks and the accuracy of their associated metrics should be continuously evaluated and adjusted based on community feedback, improving accuracy over time.

References

- Central Computing and Telecommunications Agency (CCTA). (n.d.). Risk analysis and management method (CRAMM). Retrieved from <http://www.cramm.com>
- Cost of risk analysis. (n.d.). Retrieved from <http://www.softscout.com/software/Project-and-Business-Management/Risk-Management/CORA--Cost-of-Risk-Analysis.html>
- Countermeasures. (n.d.). Retrieved from <http://www.countermeasures.com>
- Defense acquisition executive summary. (n.d.). Retrieved from [https://acc.dau.mil/adl/en-US/24422/file/2852/Defense%20Acquisition%20Executive%20Summary%20\(DAES\).doc](https://acc.dau.mil/adl/en-US/24422/file/2852/Defense%20Acquisition%20Executive%20Summary%20(DAES).doc)
- Defense acquisition portal. (n.d.). Retrieved from <https://dap.dau.mil/aphome/das/Lists/Software%20Tools/All.aspx?sgroup=All>
- DoD. (2011, July 29). *Defense acquisition guidebook*. Washington, DC: Author.
- DoD Authorization Act of 1983, Pub. L. No. 97-252.
- Drake, D. L., & Morse, K. L. (1994). The security-specific eight stage risk assessment methodology. In *Proceedings of the 17th National Computer Security Conference*.
- GAO. (2009, March 30). *Assessments of selected weapon programs* (GAO-09-326SP). Washington, DC: Author.
- GAO. (2011, March 30). *Assessments of selected weapon programs* (GAO-11-233SP). Washington, DC: Author.
- NASA. (2000, July 27). Risk-based acquisition management (R-BAM).
- Nunn-McCurdy Act, 10 U.S.C. § 2433.
- Performance assessment and root cause analyses. (n.d.). Retrieved from <http://www.acq.osd.mil/parca/about.shtml>
- The risk management guide for DoD acquisition* (6th ed.). (2006, August).





ACQUISITION RESEARCH PROGRAM
GRADUATE SCHOOL OF BUSINESS & PUBLIC POLICY
NAVAL POSTGRADUATE SCHOOL
555 DYER ROAD, INGERSOLL HALL
MONTEREY, CA 93943

www.acquisitionresearch.net

Data-Driven Monetization of Acquisition Risk

Katherine L. Morse, Ph.D., NSAD/JMS

David L. Drake, FPD/KVD

Summary Proposal

We propose a methodology that actively collects and continuously, quantitatively analyzes metrics that are earlier indicators of risk than cost and schedule slip. This methodology includes:

- **The application of web-based technologies to collection and analysis**
- **A quantified risk cloud and monetized risk thresholds**
- **Establishing a readily-accessible knowledge base of previous program failures**
- **New metrics to be collected closer to the source of risk**

Traditional Continuous Risk Management (CRM) Process for Acquisition

- **Identify:** State the risk in terms of condition and consequences; capture the context of the risk; e.g., what, when, where, how, and why.
- **Analyze:** Evaluate risk probability, impact/severity, and time-frame (when action needs to be taken); classify/group with similar/related risks; and prioritize.
- **Plan:** Assign responsibility, determine approach (research, accept, mitigate, or monitor); if risk will be mitigated, define mitigation level (e.g., action item list or more detailed task plan) and goal; execute plan.
- **Track:** Acquire/update, compile, analyze, and organize risk data; report tracking results; and verify and validate mitigation actions.
- **Control:** Analyze tracking results, decide how to proceed (re-plan, close the risk, invoke contingency plans, continue tracking); execute the control decisions.
- **Communication and documentation:** These are present in all of the preceding functions and are essential for the management of risks. A system for documentation and tracking of risk decisions shall be implemented.

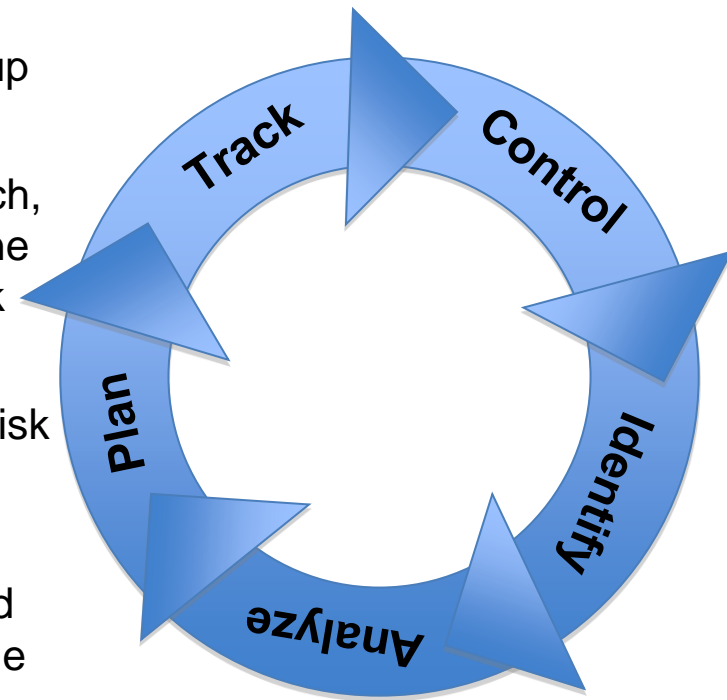

Observations About Existing Risk Assessment Approaches

- **Team members tend toward optimism, consequently underestimating risk.**
- **Engineers often recognize technical and programmatic risks, but can't/won't risk raising concern for fear of retaliation.**
 - **Engineers are rarely included in risk assessment.**
- **All acquisition team members are limited by their collective knowledge of risk.**
 - **They can't be expected to know or recognize all the risks that have ever resulted in acquisition failures.**
- **Risks are usually assessed qualitatively rather than quantitatively because they lack the data to produce useful and realistic metrics.**
- **Methodologies that look at cost and schedule, e.g. EVMS, are assessing symptoms, not causes.**
 - **We need metrics that are causally closer to symptoms.**
- **The potential causal relationships between individual risks are often overlooked, i.e. a failure in one aspect of a program may have a cascade effect.**

Proposed Risk Analysis Snapshot for Acquisition Project Cost Projection

- By monetizing project risks, a probabilistic risk “cloud” can be calculated that permits understanding of the additional costs unexpected events will incur for the project.
- A well-managed project can sustain a set of unexpected events and stay within budget.
- A sponsor may justifiably terminate (or significantly reorganize) a project if an average of unexpected events will drive costs above the maximum allowable expenditure.
- The performer might also set the maximum expenditure to prevent loss of incentives such as award fees.

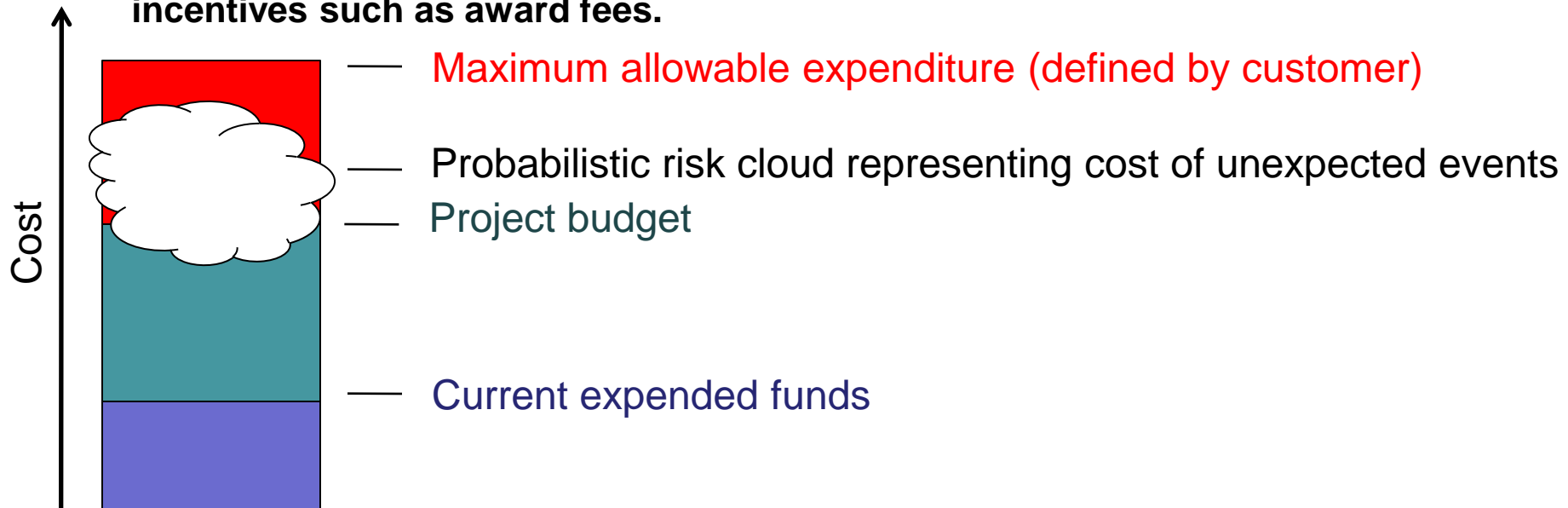

Proposed Risk Analysis for Acquisition Project Cost Projection Over the Acquisition Lifecycle

- Risk level should be low at the beginning of the project since there is greater room to recover.
- A concept that needs to be better understood is where the knee of the curve exists, i.e. where to allow the greatest risk.
 - This may be related to the Technical Readiness Level (TRL) of the project.

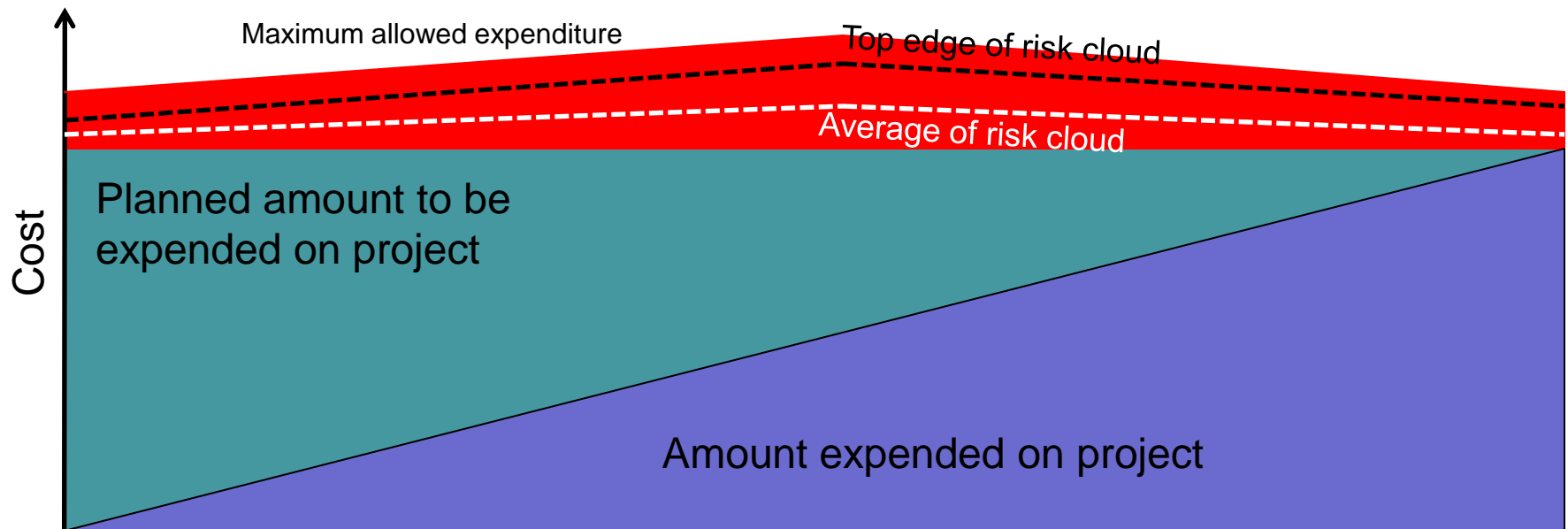

Project Scrub Decision Point

- At any time, if the risk cloud is projected to cross the maximum allowed expenditure, there is a critical decision point:
 - Raise the maximum allowed expenditure or
 - Cancel or reorganize the program

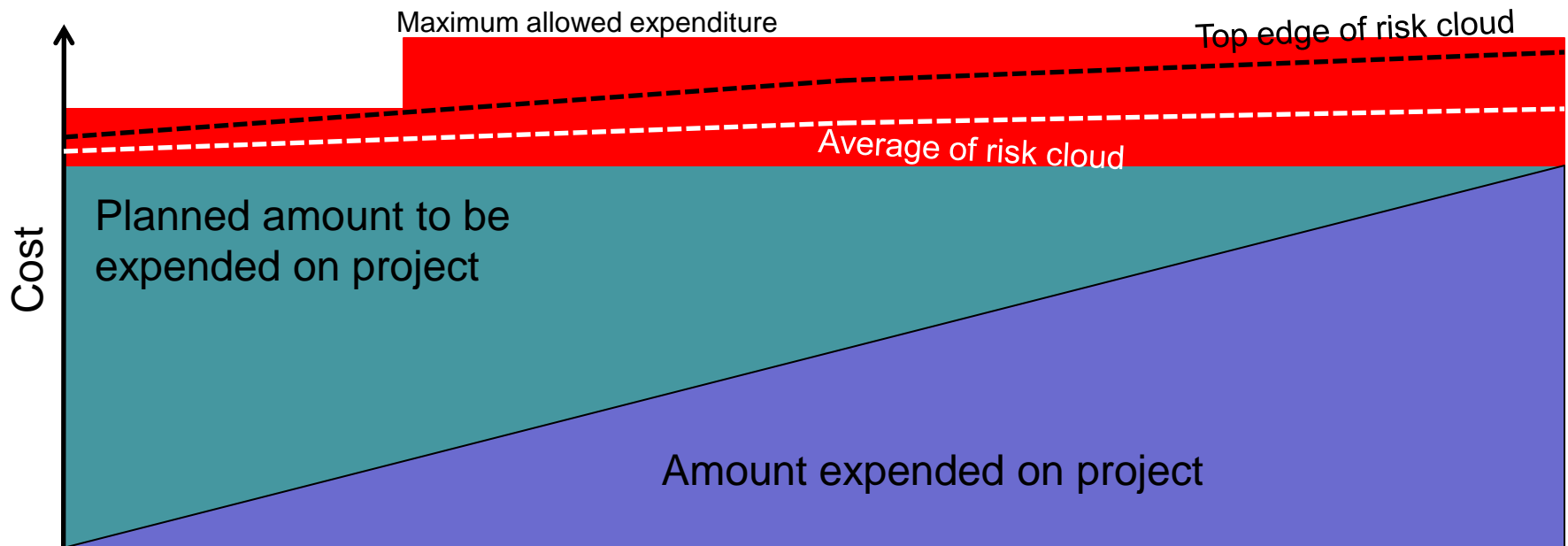

Recommendations for a “Living” Risk Management Capability

- A *quantitative process* as previously described is only feasible with the support of *data* and the *infrastructure* to make it *usable* and *accessible* by programs.

- **Identify an initial set of discrete risk elements**
- **Monetize the identified set of discrete risk elements based on their negative impact to project resources multiplied against the likelihood of occurrence**
- **Determine the mathematics of unifying the monetized risk across the project by determining the causal relationships between the discrete risk elements**
- **Continually track, update, and plan against risks**
- **Compare their risks to a substantial knowledge base of risks from previous programs**
- **Collect metrics to support quantitative risk adjustments**

- **Types of failures**
- **Indicators of failures**
- **Probability of failure based on indicators**
- **Loss percentages based on failures**
- **Applicable risk treatments (remedies) including success and failure metrics**

Infrastructure

- Knowledge base of individual risks searchable on multiple criteria, e.g. phase technical/programmatic, technologies, drivers
- Management tools for continually tracking, updating, and planning against risks
- Metrics collection tools
- Open APIs for importing and exporting data

- **Portal features:**
 - **Present potential risks from which the risk assessor can choose, reducing the effort to “think up” all potential risks, but still allow the assessor to specify new risks.**
 - **Provide recommendations and guidance on techniques that apply to assessing individual risks**
 - **Integrate tools for collecting metrics including anonymous polling of team members**
- **Outputs:**
 - **Cloud of probable cost based on risk and comparison of the risk cloud**
 - **Tracking and adjustment of risk probabilities based on previous program performance.**
 - **Versioning and tracking to enable rapid assessment of risk management success over time**

- **Role-based access control for:**
 - **Management**
 - **Engineers**
 - **Government program managers**
 - **Auditors**
 - **Portal maintenance staff**

Deploying and Employing the Portal

- **While the application of this tool is technically outside the scope of our effort to improve the process of monetizing risk, the broad adoption of the proposed process and tool could factor into contracts in the form of specified government remedies, e.g. cancellation or re-bid, tied to specific risk metrics.**

Some Proposed (and Potentially Unpopular) Risk Metrics (1 of 2)

- **Work to noise ratio = work / (work + noise)**
 - **What percentage of time do engineers spend actually performing engineering tasks vs engaging in non-productive tasks, e.g. sitting in meetings/telecons to which they're not contributing nor from which they're getting actionable information?**
 - **This metric can be collected anonymously through the proposed web portal.**
- **Task coupling**
 - **To what degree does completion of tasks depend on coordination between tasks?**
 - **This metric is related to a Gantt chart of the schedule, but can't be seen on the Gantt chart.**
 - **Task coupling not only runs the risk of making both tasks late because they're interdependent, but simply trying to arrange the coordination often delays the tasks because schedules are hard to synchronize.**

Some Proposed (and Potentially Unpopular) Risk Metrics (2 of 2)

- **Resource gapping**
 - **A delay in one task delays a dependent task, causing a gap in tasking for some resources.**
 - **This could be observed as resource underutilization in the schedule.**
 - **Unlike machinery, engineers can't just sit idle; they have to be retained and paid, so they have to perform work.**
 - **It must be value-adding or the costs are wasted.**
 - **They can't be shifted to other, productive tasks because other resources have already been allocated, and putting them on other programs risks losing them and their expertise altogether.**
- **Engineering skill loss**
 - **Not just the loss of engineers, but the loss of the most knowledgeable and skilled engineers.**
 - **Engineers are not interchangeable parts.**
 - **When rumors of cuts start, the better engineers find new jobs and leave.**
 - **The loss of engineering skill is disproportionately larger than the loss of engineers.**
- **Energy drains**
 - **Individuals who have psychological and substantive negative impacts on otherwise productive members of the team**

- **We can't switch from qualitative analysis to quantitative analysis without quantitative data.**
- **Central to the success of this approach is the collection and maintenance of data on previous acquisition risks and failures.**
- **New metrics should be solicited from the community.**
 - **Acceptable values for some of the new metrics and their impact on risk, e.g. work to noise ratio, cannot be determined without data collection from multiple programs.**
- **This type of community effort succeeds and thrives when the community continuously rates the value of the elements of the enterprise.**
 - **In this case, the applicability of identified risks and the accuracy of their associated metrics should be continuously evaluated and adjusted based on community feedback, improving accuracy over time.**

References

1. U.S. Government Accountability Office, Assessments of Selected Weapon Programs, GAO-09-326SP, March 30, 2009, p. Highlights.
2. U.S. Government Accountability Office, Assessments of Selected Weapon Programs, GAO-11-233SP, March 30, 2011, p. Highlights.
3. NASA, Risk-Based Acquisition Management (R-BAM), July 27, 2000.
4. The Risk Management Guide for DoD Acquisition, Sixth Edition, August 2006.
5. Central Computing and Telecommunications Agency (CCTA) Risk Analysis and Management Method (CRAMM), <http://www.cramm.com>.
6. Cost of Risk Analysis, <http://www.softscout.com/software/Project-and-Business-Management/Risk-Management/CORA--Cost-of-Risk-Analysis.html>.
7. Countermeasures, <http://www.countermeasures.com>.
8. <https://dap.dau.mil/aphome/das/Lists/Software%20Tools/All.aspx?sgroup=All>
9. DoD Authorization Act, 1983 (P.L. 97-252), Nunn-McCurdy Act (10 U.S.C. § 2433)
10. Defense Acquisition Guidebook, DoD 7/29/2011, Chapter 10.5.2.2.
11. David L. Drake and Katherine L. Morse, "The Security-Specific Eight Stage Risk Assessment Methodology," Proceedings of the 17th National Computer Security Conference, 1994.
12. Defense Acquisition Executive Summary, [https://acc.dau.mil/adl/en-US/24422/file/2852/Defense%20Acquisition%20Executive%20Summary%20\(DAES\).doc](https://acc.dau.mil/adl/en-US/24422/file/2852/Defense%20Acquisition%20Executive%20Summary%20(DAES).doc)
13. Performance Assessment and Root Cause Analyses, <http://www.acq.osd.mil/parca/about.shtml>

BACKUPS

Graphics

- **Improve the process of understanding and evaluating risk within acquisition projects to:**
 - **Reduce project failures, cost and schedule overruns, and unanticipated technical and managerial roadblocks**
 - **Better anticipate the full project undertaking**
 - **Prevent repeating historical lessons learned**
 - **Provide a more accurate risk analysis to existing projects to have a clearer understanding of its areas of predictability and unpredictability**

Task Coupling

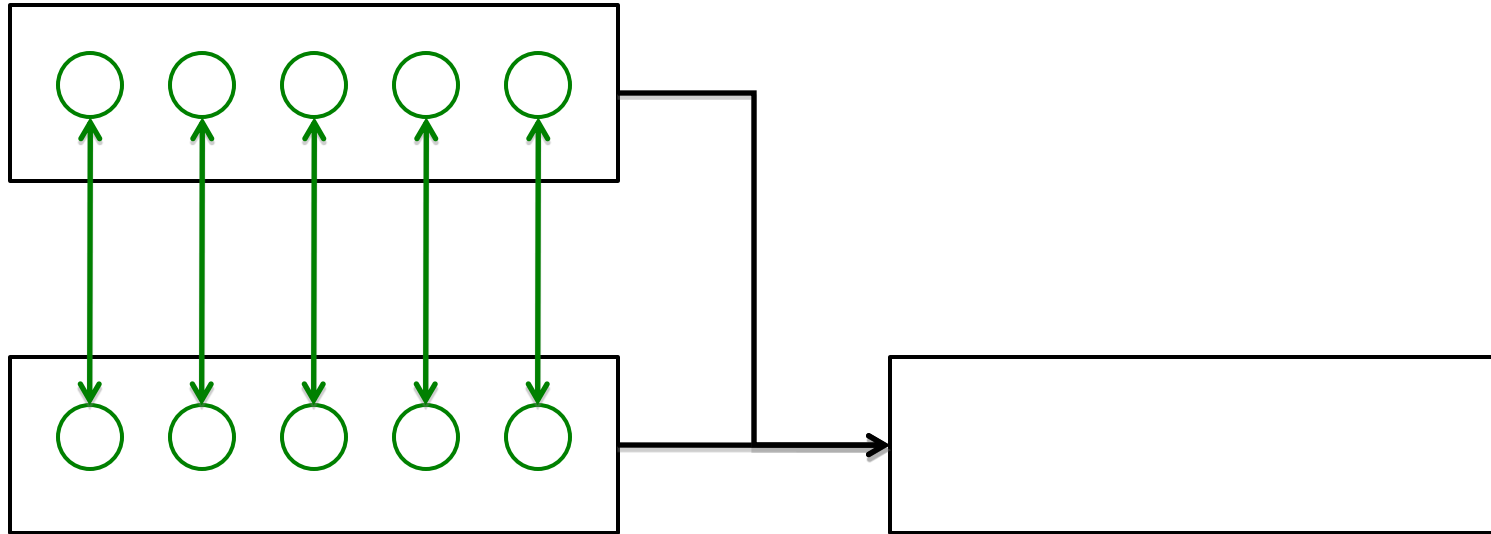

Resource Gapping

