



**AFRL-RY-WP-TM-2012-0108**

**AIR FORCE RESEARCH LABORATORY SENSORS  
DIRECTORATE COMMUNICATIONS BRANCH HISTORY  
FROM 1960-2011**

**Allen L. Johnson – Editor**

**SelectTech Services Corp**

**DECEMBER 2011  
Final Report**

**Approved for public release; distribution unlimited.**

*See additional restrictions described on inside pages*

**STINFO COPY**

**AIR FORCE RESEARCH LABORATORY  
SENSORS DIRECTORATE  
WRIGHT-PATTERSON AIR FORCE BASE, OH 45433-7320  
AIR FORCE MATERIEL COMMAND  
UNITED STATES AIR FORCE**

## NOTICE AND SIGNATURE PAGE

Using Government drawings, specifications, or other data included in this document for any purpose other than Government procurement does not in any way obligate the U.S. Government. The fact that the Government formulated or supplied the drawings, specifications, or other data does not license the holder or any other person or corporation; or convey any rights or permission to manufacture, use, or sell any patented invention that may relate to them.

This report was cleared for public release by the Wright-Patterson Air Force Base (WPAFB) Public Affairs Office, Case Number: 88ABW 2012- 0344, approved 1 February 2012 and is available to the general public, including foreign nationals. Copies may be obtained from the Defense Technical Information Center (DTIC) (<http://www.dtic.mil>).

AFRL-RY-WP-TM-2012-0108 HAS BEEN REVIEWED AND IS APPROVED FOR PUBLICATION IN ACCORDANCE WITH THE ASSIGNED DISTRIBUTION STATEMENT.

//signed//

---

WALTER B. HARTMAN, Chief  
Trusted Avionics Systems Network Branch  
Sensors Directorate

//signed//

---

TODD A. KASTLE, Chief  
Integrated Electronic and Net-Centric Warfare Division  
Sensors Directorate

This report is published in the interest of scientific and technical information exchange, and its publication does not constitute the Government's approval or disapproval of its ideas or findings.

\*Disseminated copies will show “//signed//” stamped or typed above the signature blocks.



<b>REPORT DOCUMENTATION PAGE</b>				<i>Form Approved OMB No. 0704-0188</i>	
<p>The public reporting burden for this collection of information is estimated to average 1 hour per response, including the time for reviewing instructions, searching existing data sources, gathering and maintaining the data needed, and completing and reviewing the collection of information. Send comments regarding this burden estimate or any other aspect of this collection of information, including suggestions for reducing this burden, to Department of Defense, Washington Headquarters Services, Directorate for Information Operations and Reports (0704-0188), 1215 Jefferson Davis Highway, Suite 1204, Arlington, VA 22202-4302. Respondents should be aware that notwithstanding any other provision of law, no person shall be subject to any penalty for failing to comply with a collection of information if it does not display a currently valid OMB control number. <b>PLEASE DO NOT RETURN YOUR FORM TO THE ABOVE ADDRESS.</b></p>					
<b>1. REPORT DATE (DD-MM-YY)</b> December 2011		<b>2. REPORT TYPE</b> Final		<b>3. DATES COVERED (From - To)</b> 1 January 1960 – 7 March 2011	
<b>4. TITLE AND SUBTITLE</b> AIR FORCE RESEARCH LABORATORY SENSORS DIRECTORATE COMMUNICATIONS BRANCH HISTORY FROM 1960-2011				<b>5a. CONTRACT NUMBER</b> In-house	
				<b>5b. GRANT NUMBER</b>	
				<b>5c. PROGRAM ELEMENT NUMBER</b> N/A	
<b>6. AUTHOR(S)</b> Allen L. Johnson – Editor				<b>5d. PROJECT NUMBER</b> N/A	
				<b>5e. TASK NUMBER</b> N/A	
				<b>5f. WORK UNIT NUMBER</b> In-house	
<b>7. PERFORMING ORGANIZATION NAME(S) AND ADDRESS(ES)</b> SelectTech Services Corporation 8045 Washington Village Drive Centerville OH 45458-1847				<b>8. PERFORMING ORGANIZATION REPORT NUMBER</b>	
<b>9. SPONSORING/MONITORING AGENCY NAME(S) AND ADDRESS(ES)</b>  Air Force Research Laboratory Sensors Directorate Wright-Patterson Air Force Base, OH 45433-7320 Air Force Materiel Command United States Air Force				<b>10. SPONSORING/MONITORING AGENCY ACRONYM(S)</b> AFRL/RYSWB	
				<b>11. SPONSORING/MONITORING AGENCY REPORT NUMBER(S)</b> AFRL-RY-WP-TM-2012-0108	
<b>12. DISTRIBUTION/AVAILABILITY STATEMENT</b> Approved for public release; distribution unlimited.					
<b>13. SUPPLEMENTARY NOTES</b>					
<b>14. ABSTRACT</b>  This text is a brief history of the Communications Branch's research and development projects accomplished since it was formed as part of the Air Force Avionics Laboratory in 1960 up until the present date. It covers the highlights of the Branch's activities, but is not totally inclusive of the hundreds of individual tasks and work units accomplished by the Branch personnel.					
<b>15. SUBJECT TERMS</b> History, AF Avionics Laboratory history, AF Wright Aeronautical Laboratory, Wright Research & Development Center, Wright Laboratory, Air Force Research Laboratory, Steer, Leap Frog, MARCOM Relay, Airborne SATCOM, ICNIA, LPI Comm, HAVE QUICK, CSEL, HAVE LACE, ABIT, Milstar, Predator, Silver Bullet, Viper, Steel Eagle, TacSat-3.					
<b>16. SECURITY CLASSIFICATION OF:</b>			<b>17. LIMITATION OF ABSTRACT:</b> SAR	<b>18. NUMBER OF PAGES</b> 277	<b>19a. NAME OF RESPONSIBLE PERSON (Monitor)</b> Walter Hartman <b>19b. TELEPHONE NUMBER (Include Area Code)</b> 937-528-8143
<b>a. REPORT</b> Unclassified	<b>b. ABSTRACT</b> Unclassified	<b>c. THIS PAGE</b> Unclassified			

This Page intentionally left blank

## Table of Content - Alphabetical

<u>Title</u>	<u>Dates</u>	<u>Page</u>
AirBorne Imagery Transmission	(1984-1995)	1
Airborne Infrared Radio Set for Senior Crown	(1960-1964)	5
Airborne Strategic SATCOM System – Project 698-AQ	(1969-1975)	12
Air Force One Communications Improvement	(1973-1975)	21
Coloured Bubbles Ionospheric Modifications Project	(1982)	27
Communications System Evaluation Laboratory	(1977-1996)	34
Expert Communications Link Manager	(1994-2003)	47
Fade Resistant Modem	(1975-1977)	51
GBS Airborne Antenna	(1999-2001)	56
Grid Sphere Passive Communications Satellite	(1960-1966)	62
HAVE LACE – Laser Airborne Communications Experiment	(1983-1987)	66
HAVE QUICK - Jam-Resistant Voice Radio	(1976-1990)	75
Helicopter Communications via SHF Satellite Relay	(1969-1971)	76
Helicopter Communications via UHF Satellite Relay	(1967-1970)	82
Helicopter Communications via VHF Satellite Relay	(1966-1967)	86
Integrated Communications, Navigation and Identifications Avionics	(1972-1996)	91
Ionospheric Scintillation Fading Mitigation	(1972-1996)	99
Lens-Sphere Passive communications Satellite	(1960-1964)	105
Low Probability of Intercept Communications	(1969-2011)	112
MARCOM Relay	(1962-1967)	114
Milstar Support	(1985-2004)	116
Navy Vulnerability Test Support	(1996)	122
Nuclear Testing of Airborne Communications System	(1962)	128
One Kilowatt UHF Solid State Amplifier AN/ASC-31	(1976-1982)	132
On-Orbit Evaluation of DSCS III Satellite	(1982-1983)	135
Predator SATCOM Support	(1993-2011)	144
Project HAVE LEAP FROG	(1960-1969)	146
Project STEER – Polar UHF Satellite	(1958-1960)	160
Project 1227 – Advanced Microwave Communications	(1973-1990)	167
Quint Network Technology	(2005-2008)	182
Rooftop Facility Building 620	(1972-2011)	184
Same Frequency Repeater AN/ZRC-1	(1966-1974)	188
Scattered-Light Test Airborne Receiver	(1984-1987)	199
SHF Satellite Communications Transition to Senior Year TR-1 Aircraft	(1981-1982)	210
Silver Bullet	(1995-2005)	212
SKYNET-4 Satellite Antenna Null Investigation	(1985-1989)	215
Steel Eagle	(2005-2011)	218
TacSat-3 Tracking and Downlink Reception	(2006-2011)	220

Tactical Satellite Communications – Project 591	(1965-1968)	222
Tactical Satellite Communications – Project 687-J	(1960-1973)	236
Tactical Targeting Network Technology	(2001-2008)	242
UHF Airborne Antenna Diversity Combiner	(1971-1974)	246
UHF Dual Modem MD-1034B/A	(1974-1978)	250
UHF Paratune Filter	(1980-1984)	255
Ultra Reliable UHF Radio Set AN/ARC-144 and AN/ARC-145	(1967-1974)	260
Viper Roll-On-Roll-Off SATCOM	(2004-2006)	263
Wide Band UHF Radio AN/ARC-50	(1958-1970)	266
Weapon Data Link	(2002-2008)	273

## Table of Content by Start Date

<u>Title</u>	<u>Dates</u>	<u>Page</u>
Project STEER – Polar UHF Satellite	(1958-1960)	160
Wide Band UHF Radio AN/ARC-50	(1958-1970)	266
Airborne Infrared Radio Set for Senior Crown	(1960-1964)	5
Lens-Sphere Passive communications Satellite	(1960-1964)	105
Grid Sphere Passive Communications Satellite	(1960-1966)	62
Project HAVE LEAP FROG	(1960-1969)	146
Tactical Satellite Communications – Project 687-J	(1960-1973)	236
Nuclear Testing of Airborne Communications System	(1962)	128
MARCOM Relay	(1962-1967)	114
Tactical Satellite Communications – Project 591	(1965-1968)	222
Helicopter Communications via VHF Satellite Relay	(1966-1967)	86
Same Frequency Repeater AN/ZRC-1	(1966-1974)	188
Helicopter Communications via UHF Satellite Relay	(1967-1970)	82
Ultra Reliable UHF Radio Set AN/ARC-144 and AN/ARC-145	(1967-1974)	260
Helicopter Communications via SHF Satellite Relay	(1969-1971)	76
Airborne Strategic SATCOM System – Project 698-AQ	(1969-1975)	12
Low Probability of Intercept Communications	(1969-2011)	112
UHF Airborne Antenna Diversity Combiner	(1971-1974)	246
Integrated Communications, Navigation and Identifications Avionics	(1972-1996)	91
Ionospheric Scintillation Fading Mitigation	(1972-1996)	99
Rooftop Facility Building 620	(1972-2011)	184
Air Force One Communications Improvement	(1973-1975)	21
Project 1227 – Advanced Microwave Communications	(1973-1990)	167
UHF Dual Modem MD-1034B/A	(1974-1978)	250
Fade Resistant Modem	(1975-1977)	51
One Kilowatt UHF Solid State Amplifier AN/ASC-31	(1976-1982)	132
HAVE QUICK - Jam-Resistant Voice Radio	(1976-1990)	75
Communications System Evaluation Laboratory	(1977-1996)	34
UHF Paratune Filter	(1980-1984)	255
SHF Satellite Communications Transition to Senior Year TR-1 Aircraft	(1981-1982)	210
Coloured Bubbles Ionospheric Modifications Project	(1982)	27
On-Orbit Evaluation of DSCS III Satellite	(1982-1983)	135
HAVE LACE – Laser Airborne Communications Experiment	(1983-1987)	66
Scattered-Light Test Airborne Receiver	(1984-1987)	199
AirBorne Imagery Transmission	(1984-1995)	1
SKYNET-4 Satellite Antenna Null Investigation	(1985-1989)	215
Milstar Support	(1985-2004)	116
Predator SATCOM Support	(1993-2011)	144
Expert Communications Link Manager	(1994-2003)	47

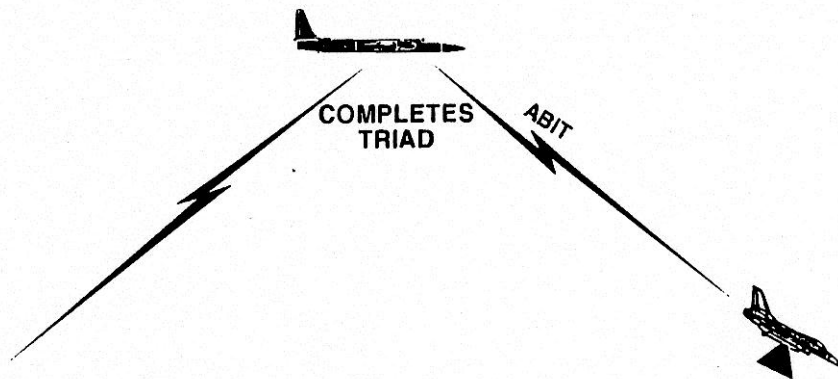
Silver Bullet	(1995-2005)	212
Navy Vulnerability Test Support	(1996)	122
GBS Airborne Antenna	(1999-2001)	56
Tactical Targeting Network Technology	(2001-2008)	242
Weapon Data Link	(2002-2008)	273
Viper Roll-On-Roll-Off SATCOM	(2004-2006)	263
Quint Network Technology	(2005-2008)	182
Steel Eagle	(2005-2011)	218
TacSat-3 Tracking and Downlink Reception	(2006-2011)	222

## AirBorne Imagery Transmission (1984-1995)

**Background:** The military has been utilizing aerial reconnaissance since the Civil War when they took photos from balloons. Until the middle of the 20<sup>th</sup> century, the recovery of the images involved landing or dropping a pod with the film. In the 1950s the military started investigating scanning the images and transmitting them to the ground. In 1979, the Department of Defense (DOD) initiated the Interoperable Data Link (IDL) to transmit reconnaissance images from the U-2 aircraft to the ground. At that time, each reconnaissance platform used its own unique data link system. In the late 1980s, the DOD decided to standardize the reconnaissance data link systems so they could be interoperable and the Common Data Link (CDL) came into being.

**AirBorne Imagery Transmission (ABIT) Development:** In 1984, the Defense Advanced Research Project Agency (DARPA) funded the Air Force Wright Aeronautical Laboratory (AFWAL) at WPAFB OH to develop a prototype airborne terminal to relay reconnaissance data from the sensor aircraft to the relay aircraft and to a ground station. AFWAL awarded an Advanced Development Model (ADM) contract F33615-84-C-1555 to the Paramax Systems, the military division of the Unisys Corporation of Salt Lake City UT in April 1985 for two Ku-Band (14-15 GHz) airborne terminals which could operate with a variety of data rates up to 274 Mbps.

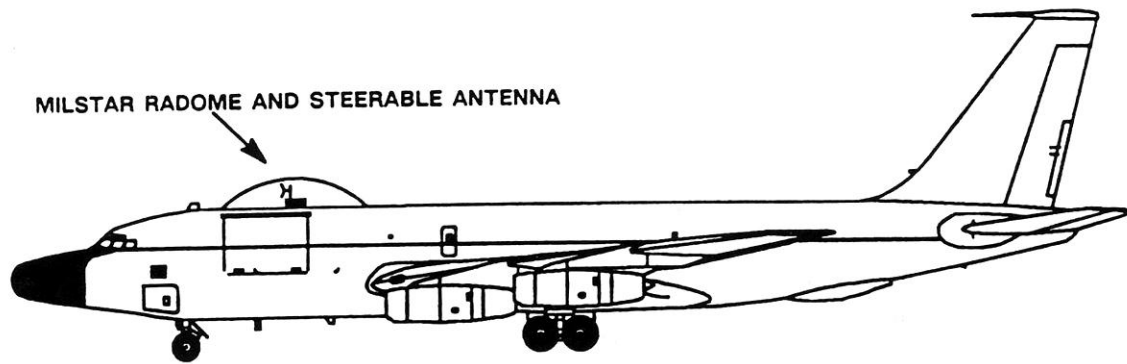
The ABIT operational scenario consists of the Air-to-Air (A/A) Data Link (DL) and involves a sensor equipped low altitude penetrating reconnaissance vehicle (sensor aircraft; e.g. a fighter) and a high altitude standoff surveillance vehicle (relay aircraft; e.g. an Airborne Warning and Control System - AWACS), Figure 1. The Sensor aircraft will penetrate the Forward Edge of the Battle Area (FEBA), acquire digital Imagery, and transmit via the A/A DL to the Relay aircraft.



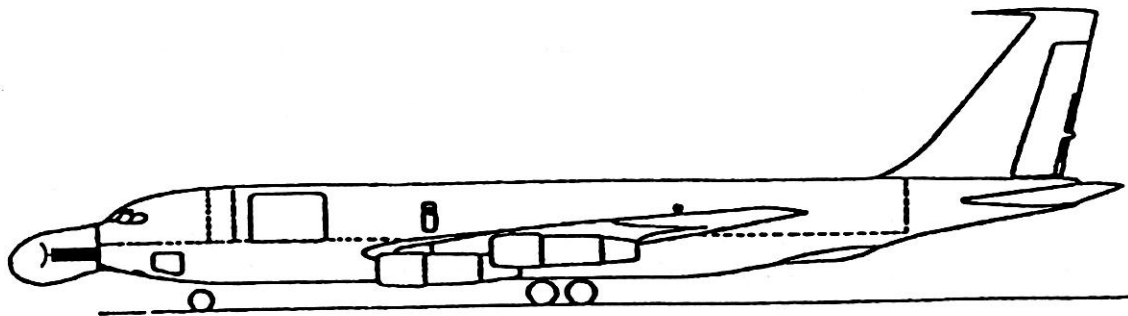
**Figure 1 ABIT Concept**

Paramax developed the ADM hardware and delivered it to WPAFB in 1991 for installation into the flight test aircraft. The 4950<sup>th</sup> Test Wing installed the equipment in two test aircraft: NKC-135/55-3122, Figure 2, mounted with a Milstar radome, designated as the sensor aircraft and EC-18B/81-0896, Figure 3, mounted with an Advanced Range Instrumentation Aircraft (ARIA) radome, as the relay aircraft.

The ABIT system is an advanced development model of a line-of-sight, two-way data link between a sensor-equipped platform and a relay aircraft. The ABIT system utilizes spread spectrum modulation, adaptive transmit power control, adaptive data rate, and narrow beam antennas to provide jam resistance and low probability of intercept data communication. Each ABIT terminal consists of ADM



**Figure 2 The ABIT Relay Aircraft NKC-135/122**



**Figure 3 The ABIT Sensor Aircraft C-18B/896**

equipment mounted in one 42 inch high, 19 inch wide bay of a shock mounted rack, as well as a remote receiver/transmitter (RF), a dish antenna and an inertial navigation unit.

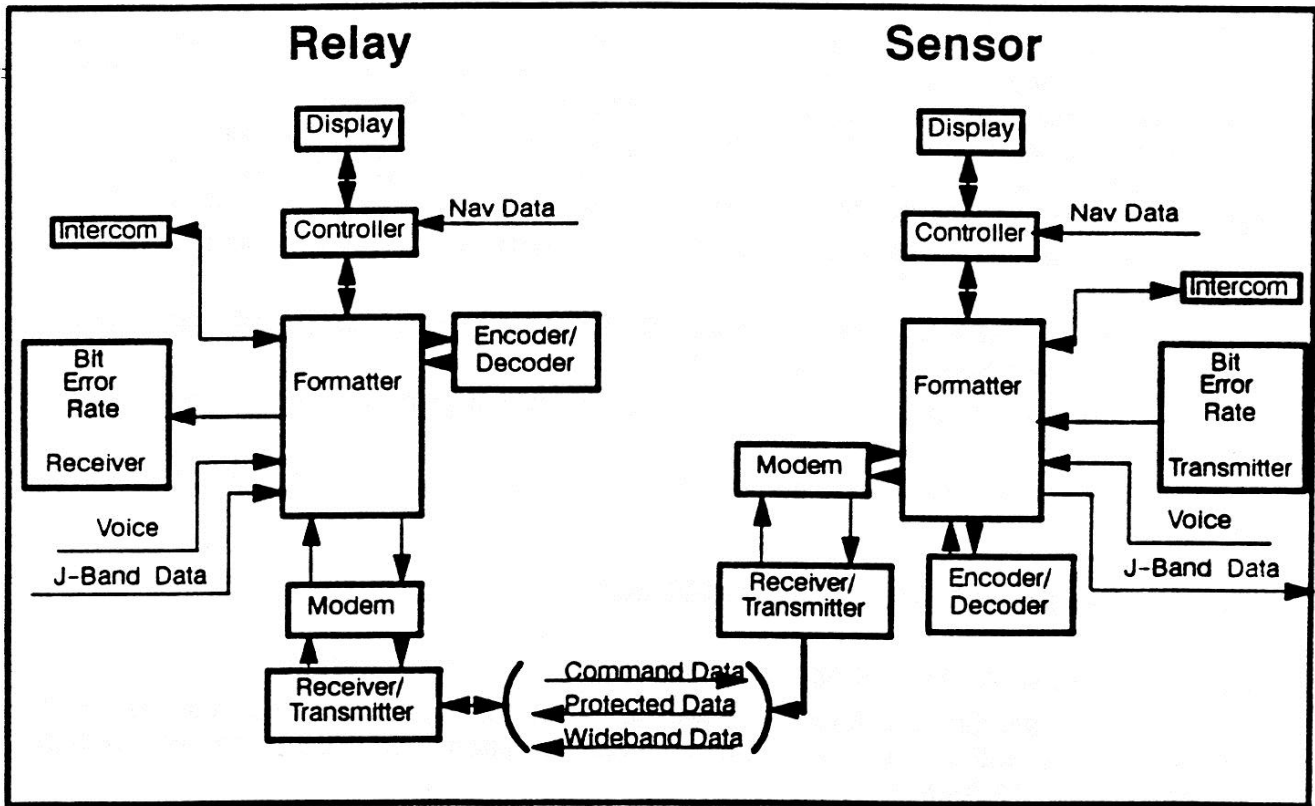
The ABIT subsystem searches for the other terminal's signal, acquires the signal, establishes the link, begins data transmission, and adjusts transmit power and data rate as necessary. The data rates range from a maximum of 274 Mbit/sec down to 133 Kbit.

The relay terminal sends command data to the sensor terminal over a X-band spread spectrum link and receives from the sensor, via a Ku-band spread spectrum link, both sensor protected data and the sensor's wideband imagery data.

The command data stream is assembled by the relay controller/formatter from the inertial navigation unit, the controller commands, and the digitized voice. This combined data is error correction encoded and sent to the modem. The modem modulates this data onto the 1700 MHz IF signal which is sent to the receiver/transmitter which up-converts this command data link to its X-band frequency. This signal is routed to the widebeam acquisition horn antenna for transmission to the sensor terminal.

At the sensor terminal, the command data is received by the 12" antenna, downconverted by the receiver/transmitter to a 1700 MHz IF signal. This IF signal is despread by the modem, demodulated, decoded and sent to the formatter. In the formatter the command data is routed to the controller and voice decoder.





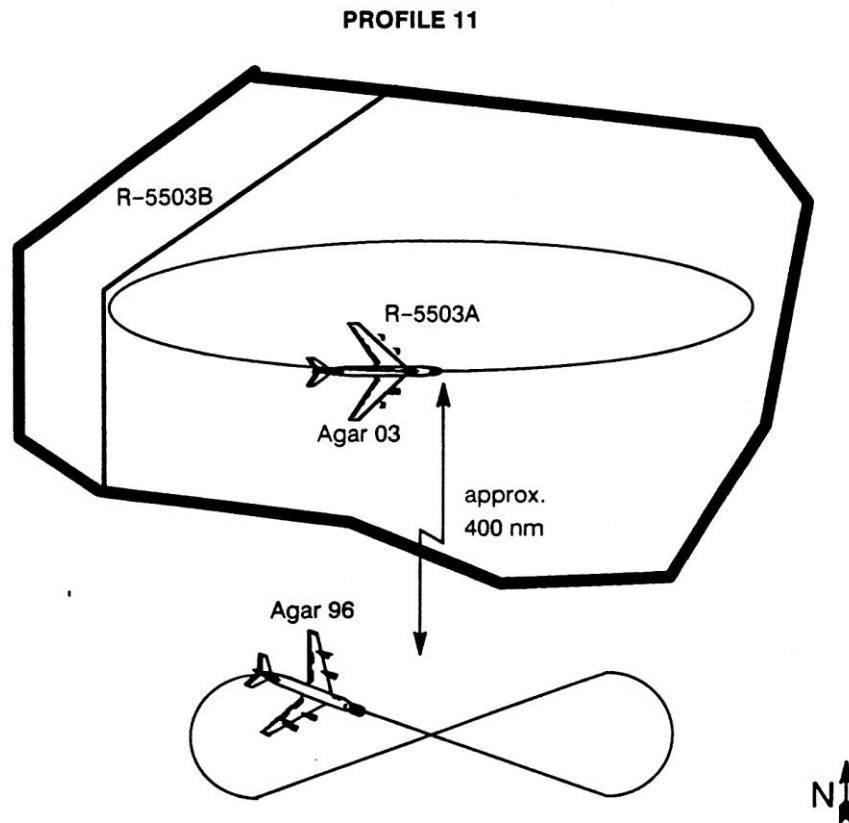
**Figure 4 ABIT ADM Hardware Block Diagram**

Upon receiving the relay location on the command data link, the sensor terminal points the sensor antennas and turns on the protected data link and wideband data imagery data link. Sensor navigation data, voice data, and sensor status data are assembled by the formatter, and sent to the modem where the data is modulated as the quadrature component of 3000 MHz IF signal. In the modem, the IF signal is also in-phase modulated by the wideband imagery data which has been assembled by the formatter with error correction coding supplied by the encoder. This spread 3000 MHz IF signal is upconverted to Ku-band by the receiver/transmitter and sent to the 10" antenna which sends the signal towards the relay aircraft.

Upon receiving the sensor's protected data via the acquisition horn antenna, the relay terminal will switch to the narrowbeam dish antenna and point the dish antenna towards the sensor terminal. This completes the acquisition sequence and wideband imagery is continuously passed from sensor to relay. The command link and the protected data link continuously update each terminal with the navigation data from the other terminal thus continuously pointing the antennas toward each other.

**Flight Test:** An extensive flight test evaluation was conducted by Wright Laboratory and 4950<sup>th</sup> Test Wing personnel in 1992-93. After a through ground checkout of the equipment, an air to ground test was conducted with the sensor aircraft on the ground. Following the successful acquisition and operation air to ground, an air to air flight test was conducted in the WPAFB area, Figure 4.

After several months of ABIT flight testing in the local area, the two aircraft flew to Eglin AFB FL and conducted a series of flight tests over the Gulf of Mexico to determine the effect of multipath reflection from water on the acquisition process and on the bit error rate once acquisition was complete. The ABIT flight test was successfully completed in 1993.



**Figure 5 One of the ABIT Local Flight Test Profiles**

**ABIT II:** In 1994, following the successful advanced development and flight test of the rack sized ABIT I hardware, the Defense Airborne Reconnaissance Office (DARO) requested Wright Laboratory (WL) initiate procurement of the Engineering Development Model (EDM) ABIT II hardware to fit in a U-2 relay aircraft. WL prepared the EDM specifications and awarded a contract to Paramax Systems Corp for the development. Shortly after the contract award, DARO decided to move the management of the ABIT II contract to the Reconnaissance System Program Office at WPAFB. WL continued to consult on the development until it was cancelled in 1995 when the decision was made to remove the U-2 aircraft from active service.

**Transition:** The results of the ABIT development and flight test were transitioned to the Defense Airborne Reconnaissance Office (DARO) and in 1997 DARO awarded three competitive Tactical Common Data Link (TCDL) contracts to Harris Corp, Lockheed Martin and Motorola to develop a family of CDL interoperable digital data links to support unmanned and manned airborne reconnaissance platforms including Outrider, Predator, Reef Point, Rivet Joint, Joint STARS, Airborne Reconnaissance Low and others. The CDL program was successful and DARO went on to develop Multi-Platform Common Data Link to allow networks of aircraft to interconnect at high data rates to share reconnaissance type data. The Paramax Systems' ABIT I experience allowed them to become a major competitor in the CDL hardware market. In 1995 Unisys sold Paramax to Loral Corp, who sold it to Lockheed Martin in 1996. In 1997, Paramax was sold to the newly formed L-3 Corporation of Salt Lake City. L-3 Corp is now one of the largest suppliers of CDL type hardware for the not only the U.S. DOD, but also for foreign military sales.

## **Airborne Infrared Radio Set for Senior Crown (1960-64)**

**Background:** As the Strategic Air Command (SAC) began planning for the operation of the A-12 (SR-71) spy plane in the early 1950s, they identified the need for a stealthy and secure means of communicating between the A-12 and the KC-135Q tankers that would refuel them. Communications research involving InfraRed (IR) communications and Radio Frequency (RF) spread spectrum techniques were considered. In 1960, the Air Force Avionics Laboratory (AFAL) awarded research and development contract AF-33616-7111 to Raytheon Missile and Space Division at Santa Barbara CA for an Airborne Infrared Frequency Radio Set.

**Infrared Frequency Radio Set Development:** The object of the AFAL contract was to investigate the feasibility of providing secure, stealthy voice communications between the SR-71 and the KC-135Q tanker during rendezvous and refueling. Since the infrared wavelengths are attenuated by the atmosphere, they offered low attenuation between two aircraft at altitude, but high attenuation between the aircraft and a ground observer. The probability of detecting or jamming a high-altitude IR signal from the ground was unlikely.

The Infrared Frequency Radio Set was designed to operate in the near infrared band (0.7-2.5 micrometers). This choice was governed by available transmitters (incandescent lamps), and receivers (lead sulfide cells). Higher powers and narrower spectrum can be obtained from some of the more exotic pulsed gas discharge lamps; but for continuous voice type operation, an incandescent lamp is adequate. Lead sulfide cells were selected as receiving detectors because of their good sensitivity in an uncooled condition. Better sensitivity can be obtained with a cooled detector but the maintenance problems are unduly increased.

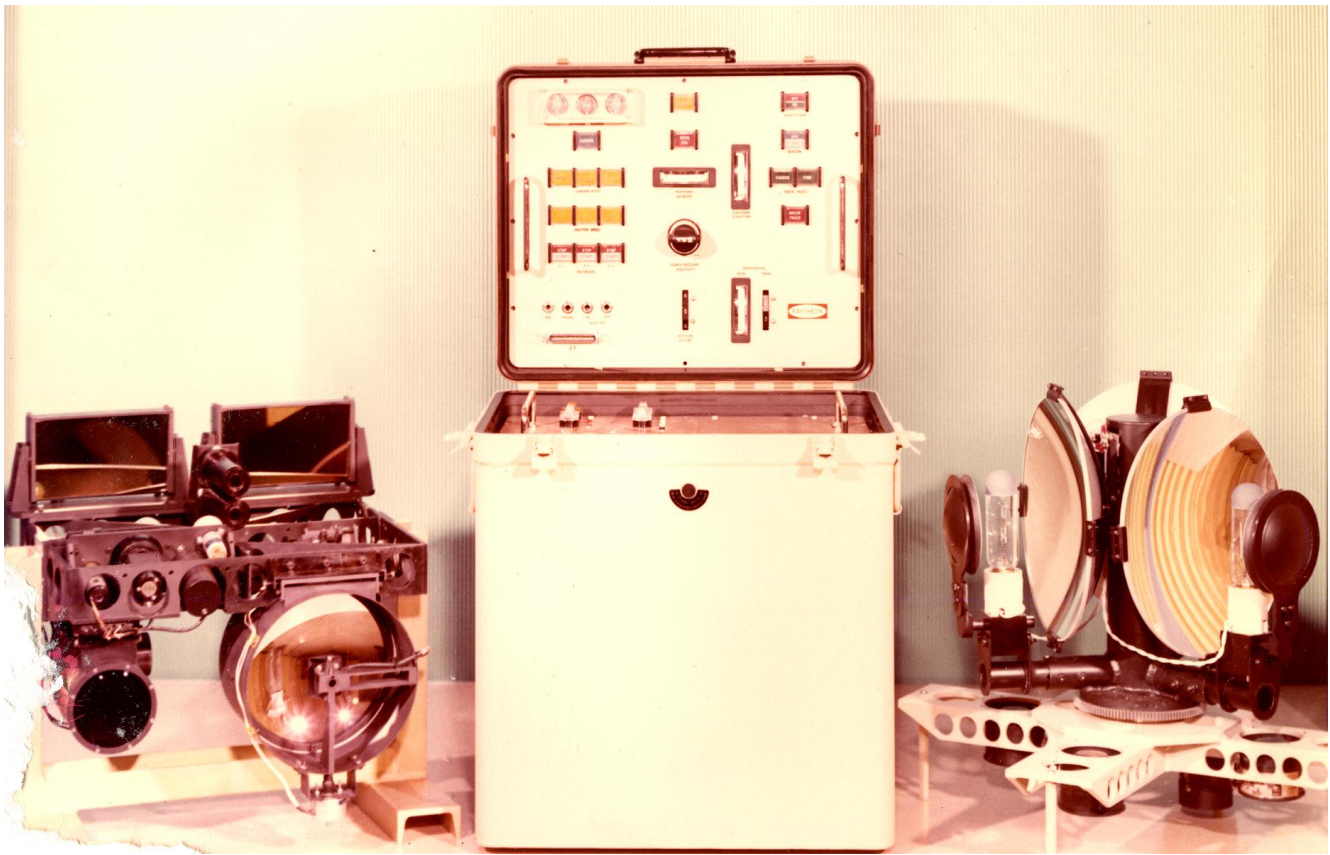
The infrared communication set consists of three separate transmitter-receivers systems. These were the search system, tracking system, and communications system.

**Search:** The search transmitter consists of three 1200 Watt projection lamps, each of which is focused by a 12" parabolic mirror into a 6° conical beam. These mirrors are equally spaced on a platform and staggered in elevation so as to give a total of 15° scan in the vertical direction with slight overlapping. The unit rotates at 180 RPM producing three pulses at infrared energy at a point within a beam and 6 pulses in the region of overlap. The pulse length is approximately 6 milliseconds.

In order to block the bright visible light from the projection lamps, sheets of black Carrara glass, made by Pittsburgh Plate Glass, were installed in the radome covering the beacon assembly. The Carrara glass blocked the visible light but was transparent at infrared wavelengths.

The search receiver is an array of four lead sulfide cells having a field of view, 15° vertical by 2° horizontal. The receiver is located on a platform which rotates at 1 RPM when the system is turned on. This receiver sees the cooperating transmitter as an infrared pulse with 6 milliseconds duration and a 180 RPM repetition rate. A logic circuit uses these characteristics to discriminate extraneous signals, i.e., cloud edges, and aircraft engines.

The search servo system uses the pulse information from the search cell array to position the tracking communication system to within one degree of the cooperating aircraft. When an infrared signal is detected by the called aircraft, it automatically turns on its search beacon and allows the originating aircraft to lock on through a similar procedure.



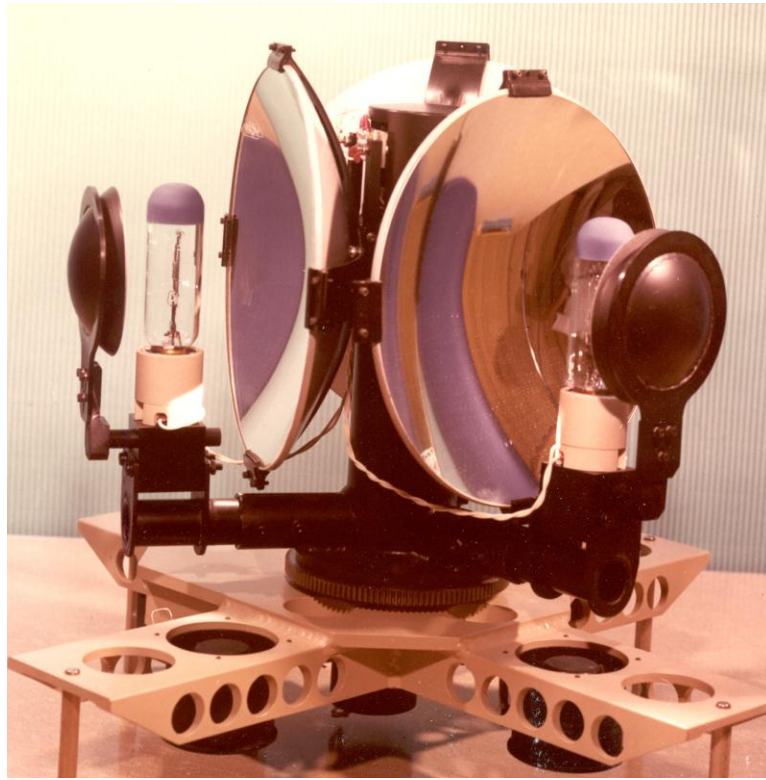
### **Airborne Infrared Communications System**

**Tracking:** The tracking transmitter uses a 300 Watt lamp which is amplitude modulated with a mechanical chopper at 200 Hz. and transmitted in a one degree conical beam. It is automatically turned on when infrared energy is detected by the search receiver.

The track receiver amplitude modulates the 200 Hz carrier at 20 Hz with a chopper which also drives a commutator. It is the phasing between the chopped signal and the commutator pulse that gives target position information. Once both aircraft have acquired the tracking signal, voice can begin immediately.

**Communications:** The communications transmitter utilizes an 18 Watt lamp which is focused on the mirror of a galvanometer being modulated at rates up to 6 KHz by an amplified microphone signal. The galvanometer output is then focused on a 4 inch by 6 inch segment of a parabolic mirror to deliver a high intensity infrared beam. The narrowness of the beam is illustrated by the fact that its diameter is only 500 feet at a range of 50 miles.

The communications receiver uses the same optics as the tracking receiver. Its detecting cell (PbS) is physically located behind a hole (.5 mm X .5 mm) in the center of the tracking cell. The field of view of the communications receiver is .1° X .1°.



**IR Beacon**



**IR Transmitter, Receiver and Tracker**

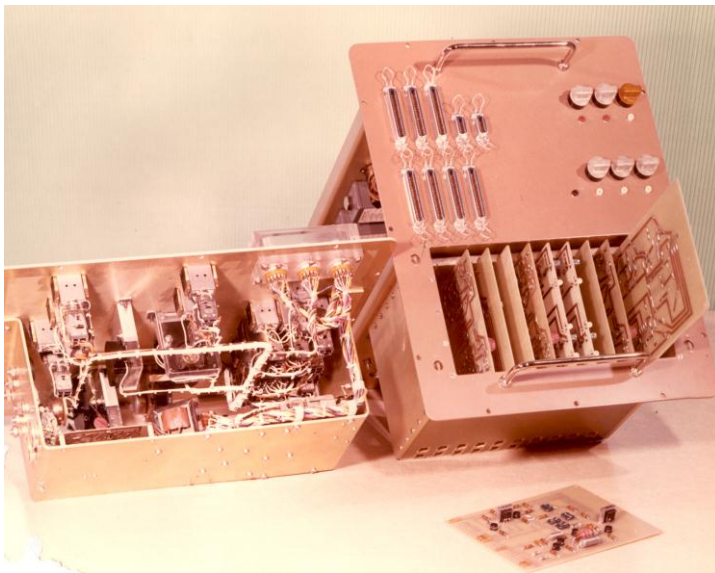


**Sun Receivers:** Special sun receivers are provided in order to protect the receiving cells against damage due to aiming directly at the sun. Their function is to provide a continuous pulse to a logic circuit when activated, which responds by moving a metal shutter in front of the receiving cells until the danger is removed. The pulse is then discontinued and the shutter returns to its normal open position

**Ideal Sequence of Operation:** Both aircraft must have their equipment turned on to establish the scan mode. This energizes all receivers and starts the platform assembly rotating at one revolution per minute.

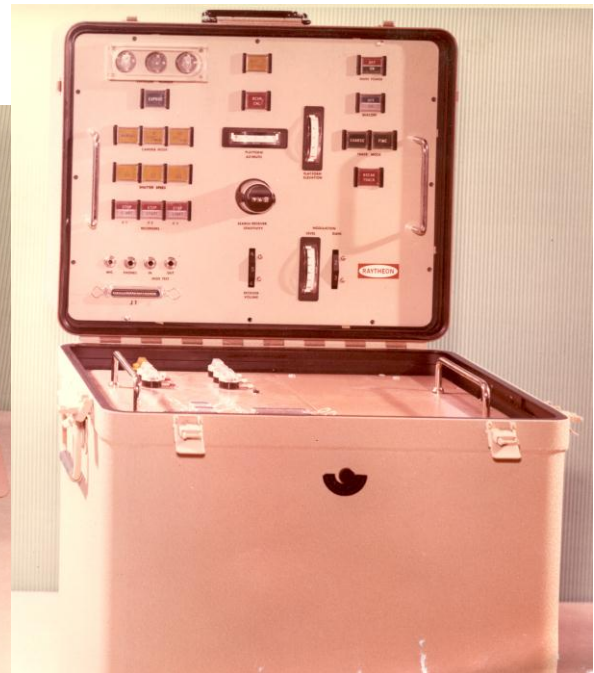
The aircraft desiring to initiate communications turns its search transmitter on. This places the system in the search mode, transmitting three pulses of infrared energy per second. It remains in this mode until the second aircraft detects the 3 Hz signal in its search receiver. The received signal automatically puts the second aircraft in the coarse track mode. This breaks the scan mode and turns on all of its transmitters. The X and Y servos go into a bang-bang operation, maintaining rough alignment of the platform on the incoming pulse.

When the first aircraft detects the 3 Hz signal, it too goes into the coarse track mode, resulting in the same sequence of events as described above. After both aircraft have established coarse track, fine track will be initiated within a few seconds by the 200 Hz signal that both aircraft are transmitting. Voice communications can then begin.



**IR System Electronics**

**Laboratory Testing and Ground Check-out:**



**IR System Controls**

**Dark Tunnel Test:** While the IR radio set was under development at Raytheon Santa Barbara, it underwent various range tests in their dark tunnel. These tests demonstrated that the detection and coarse tracking range was from 10 to 85 miles night vacuum range (NVR). At ranges less than 10

miles, the apparent blur spot became so large that position information was lost. Between 85 and 100 miles a pointing error of .25 degrees occurred and at ranges greater than 100 miles, the communications error rate became excessive. Subsequent test were made with a complete mock up system including the IR domes. Acquisition and lock-on was accomplished at reasonably satisfactorily at a NVR of 10-85 miles.

**Laboratory:** After the equipment was delivered to WPAFB, a brief demonstration was given in the Electronic Technical Laboratory optics room. The platforms were separated by 65 feet. At one end, lower power simulated transmitters and one platform was used in stationary positions. While the second platform was allowed to scan in its normal operation, acquisition and lock-on were performed automatically and voice could be heard over the set quite well.

**Gun Range:** The IR communications system was tested extensively in the Indoor Gun Range next to Building 22 on the flight line at Wright Field. The tests showed the delivered equipment was ready for installation into the test aircraft.

**Installation:** Following the laboratory testing, preparations were made to install the system in two 4950<sup>th</sup> Test Wing C-131 aircraft for flight testing. The equipment racks, optics and radomes were installed on C-131/823 and C-131/795. The beacons were placed on top of the aircraft fuselage just behind the wing. The communications modules were mounted in a clear glass radome on the bottom of the fuselage 15 feet behind the wings. The top and bottom installations were necessary to keep the receivers from seeing their own IR beacons.



**C-131 Test Aircraft with Top and Bottom IR Radomes**

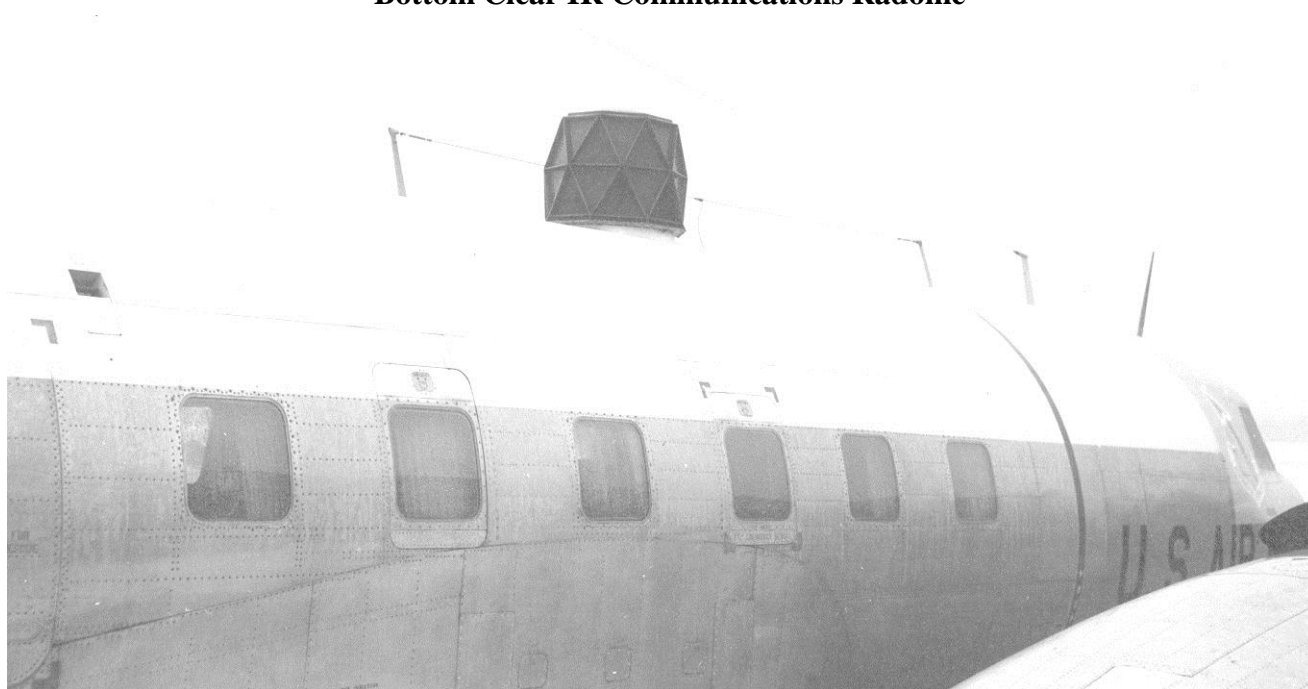
### **Preparation for Flight Testing:**

By December 1962, installation of the radomes on aircraft 823 was completed. An aerodynamic flight test was conducted on 19 December 1962 to check the rigidity of the radomes before installing the IR equipment. The rigidity of the domes was accepted. However, a buffet condition occurred and had to be solved before the flight testing of the IR equipment could begin. During the period from December 1962 to January 1963, thirteen flights were made using various modifications in an effort to eliminate

the buffeting. Bob Wheaton, the 4950<sup>th</sup> mechanical designer, redesigned the radomes to bring the glass out flush with the frame. He also designed a teardrop fairing to attach behind the radome to smooth out the air flow passing around the radome.



**Bottom Clear IR Communications Radome**



**Top Black Carrara-Glass Beacon Radome**





### **The Two IR Equipped Test Aircraft on the Ramp at WPAFB ready for Flight Testing**

**Ground Checkout:** After installations were completed in November 1963, efforts were continually made to optimize the systems performance on the ground. This involved reducing noise levels, replacing burned-out components and optimizing potentiometer settings on several circuits.

Attempts were made to operate the equipment with the aircraft parked on the flight line at a 1 mile separation. A reduction in search transmitter power allowed coarse track acquisition fairly well, however, at this range, the blur spot from the track transmitter is so large that positive information is lost. By removing the servo amplifiers and manually aligning the two platforms, garbled voice could be heard through the set. The garble was an effect of close range.

**Flight Testing:** Because of the radome buffet condition, the 4950<sup>th</sup> Test Wing placed a limit of 10 flight hours on each aircraft. This was to determine whether the equipment showed sufficient promise to warrant additional aircraft modifications for further flight testing.

Five flights were conducted between 9 April 1964 and 13 July 1964. The two aircraft flew parallel tracks at ranges of 10, 20 and 30 miles. It was observed at all ranges that the platform continually stopped in its coarse track mode of operation on what appeared to be false optical signals. Upon acquiring coarse track, the unit would immediately go into fine track and remain there until the break track switch was activated. This problem was apparently due to the excessive noise level on the communications and track channels causing the Schmitt Trigger, located on the 180-220 Hz filter circuit board, to trigger and thus energize the fine track relay. Several unsuccessful attempts were made to solve this problem, but it was not solved within the 10-hour flight test limit.

**Program Termination:** In addition to the IR equipment and radome buffet problems, in mid-1964 the Senior Crown program office made a decision to proceed with the AN/ARC-50 wideband UHF terminals development for their communications link with the tankers and the Airborne IR Radio Set development program was terminated.

### **References:**

**Airborne Infrared Frequency Radio Set – Instruction Manual:** Raytheon Space & Missile Co.: Santa Barbara CA; 10 April 1962.

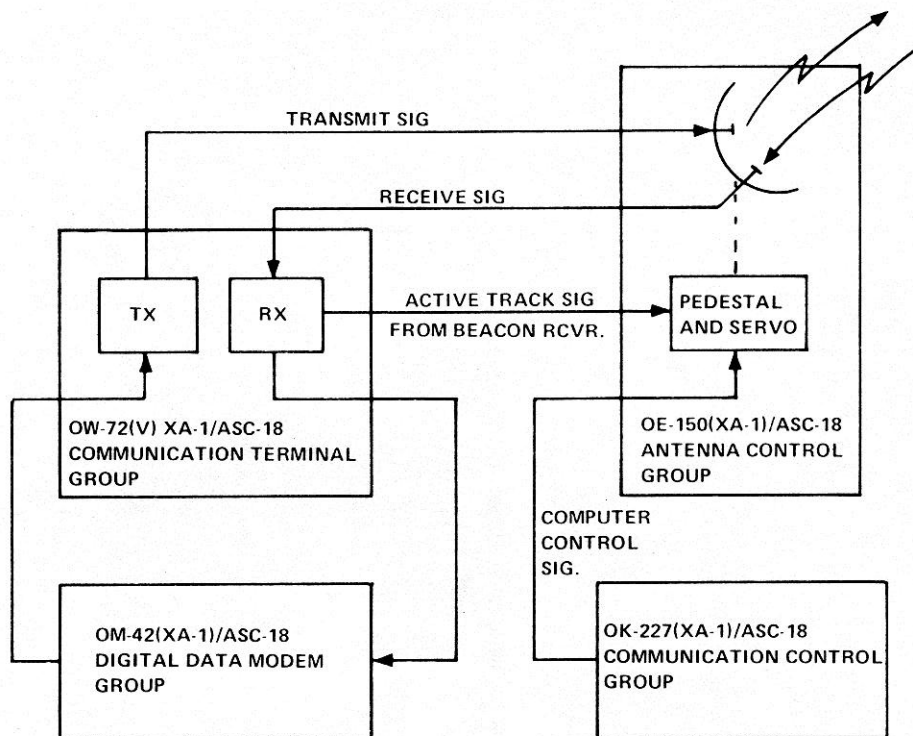
Hutson, Frank; **Airborne Infrared Frequency Radio Set – Draft Final Report:** Air Force Avionics Laboratory: AFAL/AVWC; WPAFB OH: August 1964.

## Airborne Strategic SATCOM System – Project 698-AQ (1969-75)

**Background:** In the 1960 the Strategic Air Command (SAC) installed the AFSATCOM system on their bombers and airborne command post to send and receive the Emergency Action Message (EAM) to the nuclear-capable bombers orbiting in the polar region. Because of the limited anti-jam protection offered by the AFSATCOM system, SAC expressed the need for a more robust system to pass the Single Integrated Operations Plan (SIOP) messages from their ground command post to the airborne command post. At the directions of the Air Force Systems Command (AFSC), the Air Force Avionics Laboratory (AFAL) initiated the Airborne Strategic SATCOM System effort under Program 698-AQ, Project 1227.

**Airborne Strategic SATCOM System Development:** In 1969 AFAL awarded the following Advanced Development contracts for the SHF System development:

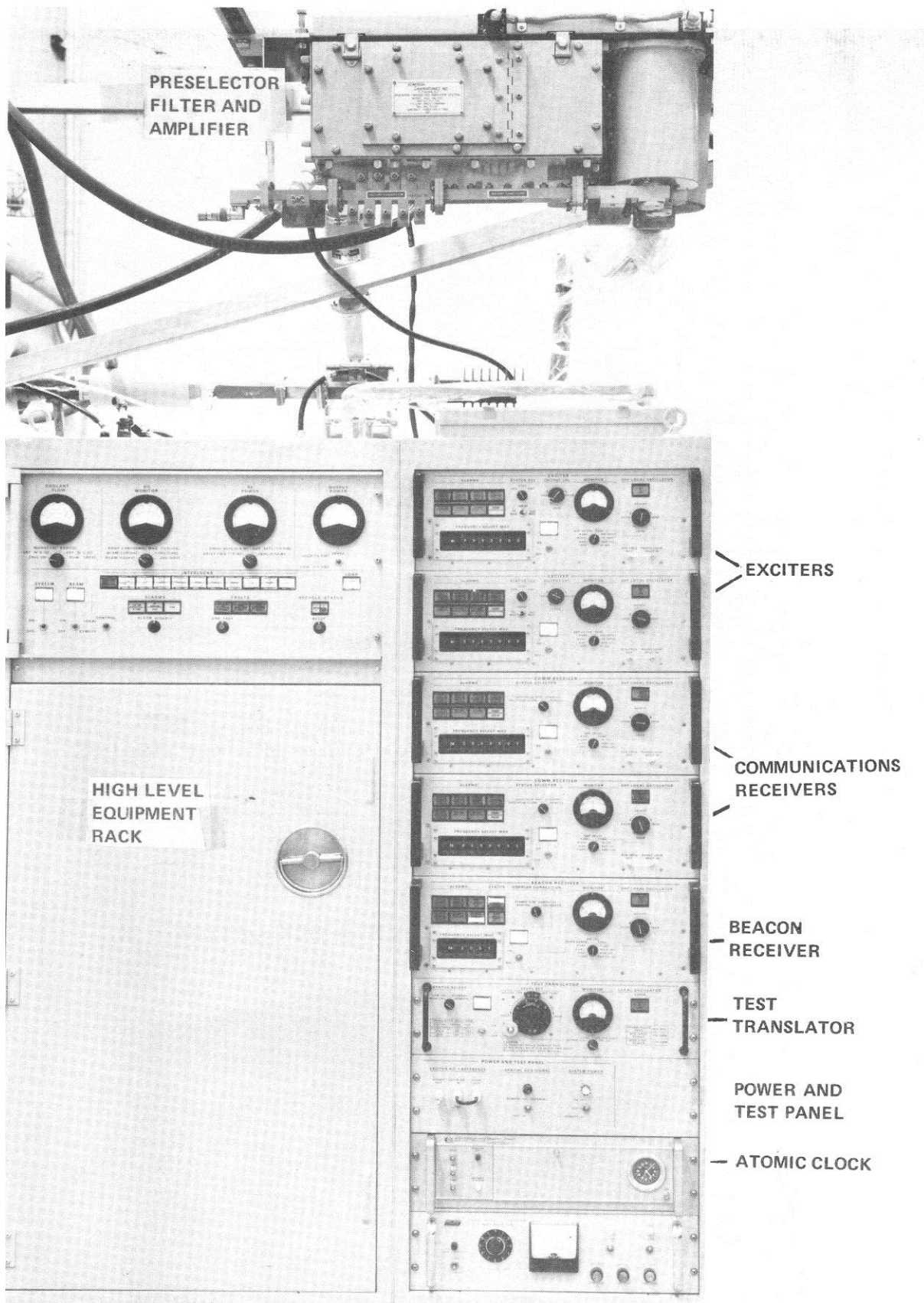
- 1 An 11 kW SHF Terminal to Collins Radio Co in Richardson TX
- 2 A 33 dB gain SHF Airborne Antenna and Computer Augmented Pointing System to RCA, Corp in Moorestown NJ
- 3 A Wide-Band, Anti-Jam Modem to Sylvania Electronic Systems in Buffalo NY.



**Block Diagram of AN/ASC-18 SHF SATCOM System**

In addition, a heat exchanger, radome, and instrumentation system were designed and built at Wright Patterson AFB. The SHF System was integrated and installed in a 4950<sup>th</sup> Test Wing C-135 aircraft.

The 11 kW SHF Terminal accepts one or two modulated input signals at the 70 or 700 MHz input, up-converts these through separate exciters, and amplifies the signals through a linear power amplifier to a



**AN/ASC-18/OW-72 SHF SATCOM Terminal and Preamplifier**

total power output of 11 kW. The frequencies of the terminal are controlled by a rubidium atomic frequency standard. The receiving system consists of a pre-selector filter, low noise parametric amplifier, and dual down-converter receivers. The received signal's output is at 70 or 700 MHz.

The instantaneous bandwidth of the transmitters and receivers is 100 MHz, tunable in 10 Hertz steps over a 500 MHz band. Noise figure of the receiving system is approximately 400°K including the contribution of the antenna and sky temperature. The low noise preamplifier has approximately a 135°K noise temperature.

A third receiver receives the RF signal from the satellite beacon, compares it with the atomic frequency standard, and derives the received Doppler. There are three methods of deriving the local oscillator frequencies. In the first method, the atomic mode, the terminal operates as a fixed down-converter and up-converter. In the second, the beacon mode, the receiving system is corrected for the measured received Doppler; the transmitting system is corrected for the inverse of the received Doppler. In the third mode the Computer Augmented Pointing System is used to calculate and predict the Doppler.

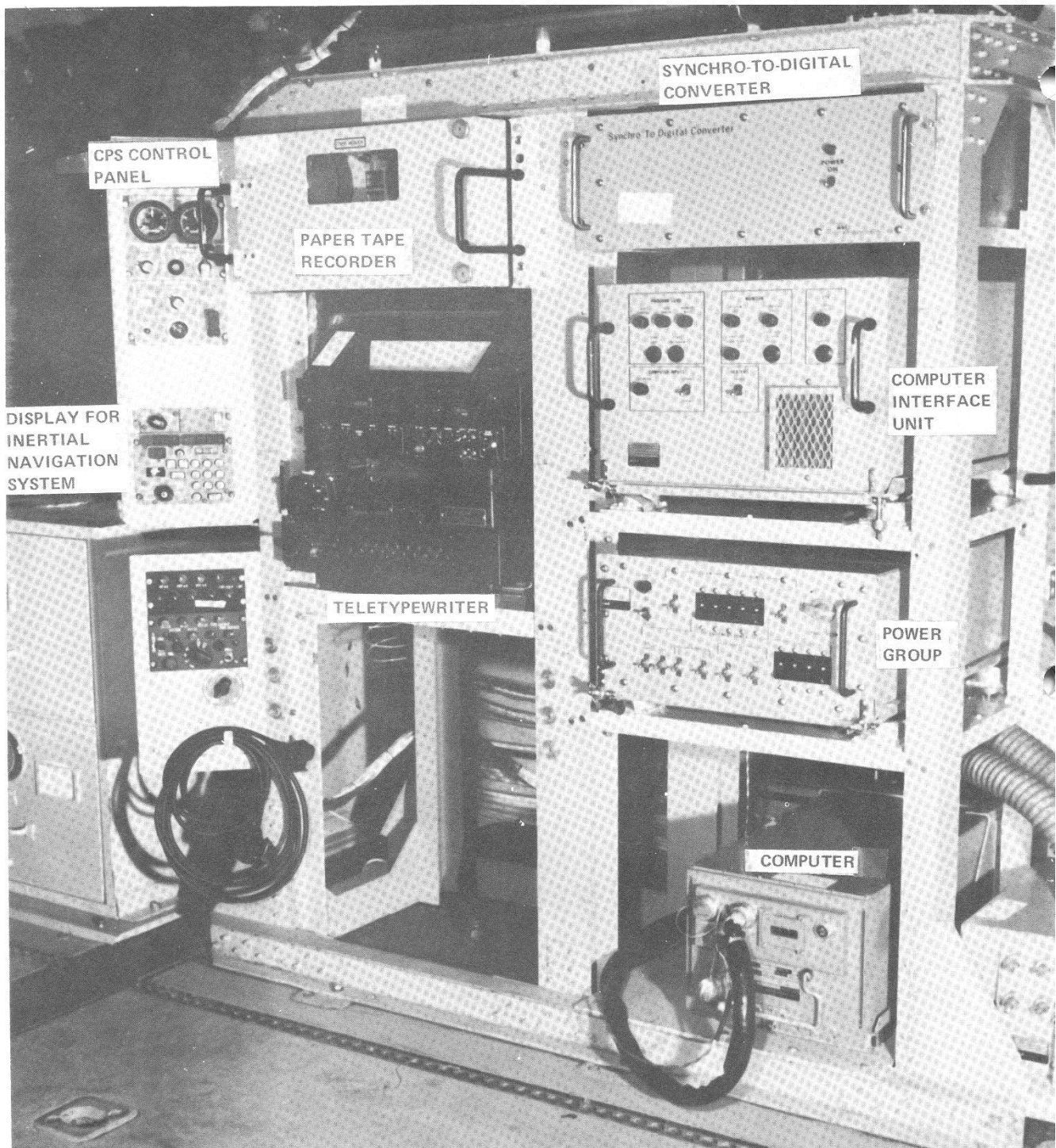
The terminal also contains a loop test capability which samples the transmit signal, converts it to the receive frequency, and inserts the signal into the receiver. The loop translator allows checkout of the entire terminal, exclusive of the antenna, without going through the satellite.

The SHF Antenna System utilizes a 33-inch parabolic dish with a Cassegrain feed system. The antenna pedestal provides 360° azimuth coverage and a -5° to 87° elevation coverage within the beamwidth of the antenna.



**AN/ASC-18/OE-150 SHF Antenna**





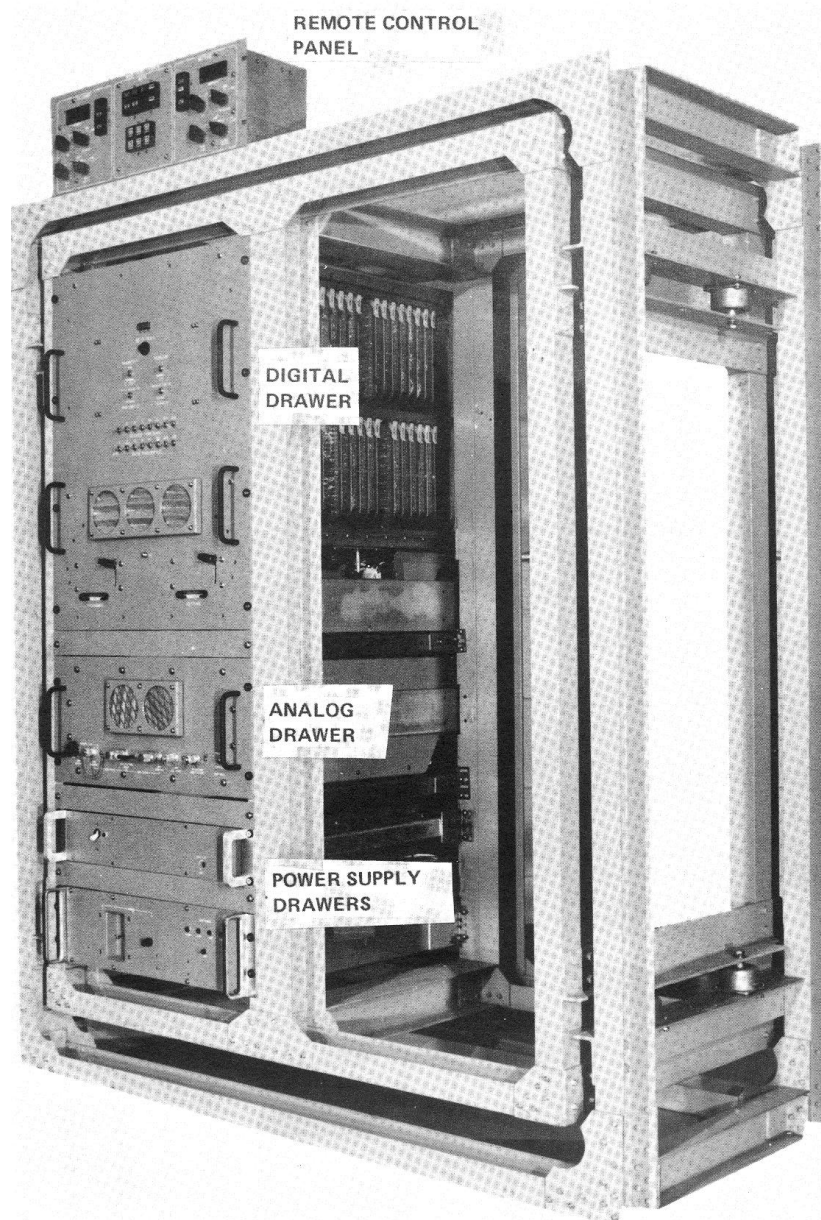
### **AN/ASC-18/OK-227 Computer Augmented Antenna Pointing System**

The antenna system covers the entire 500 MHz receive and 500 MHz transmit band but with opposite sense circular polarization. Dual rotary joints and an antenna diplexer provide isolation between the transmit and receive subsystems. An inertially stabilized platform is mounted on the rear of the antenna to remove the motion of the aircraft during flight. Initial acquisition of the satellite can be accomplished by manually searching for the received signal. If the antenna is positioned within 10° of the satellite, the automatic search mode will cause it to search in a raster scan pattern which covers a 20° by 20° area. When energy is detected during the raster scan, the antenna system will stop its scan

pattern and begin a 10 square figure eight tracking pattern. In this mode the antenna system continues to track the beacon energy of the satellite and update the inertial package to correct for long term gyro drift.

When the antenna is positioned through the use of the Computer Augmented Pointing System, the pointing is passive and does not require the beacon signal from the satellite. The computer is fed satellite orbit ephemeris data along with aircraft attitude and position from an inertial navigation system. From this information the pointing angles are calculated and the antenna is commanded to point toward the satellite. The pointing angles are recalculated ten times a second.

The computer also calculates range and range-rate to the satellite. The range-rate information is used to derive Doppler. This information is supplied to the SHF Terminal in either an analog or digital format to correct the local oscillators for Doppler.

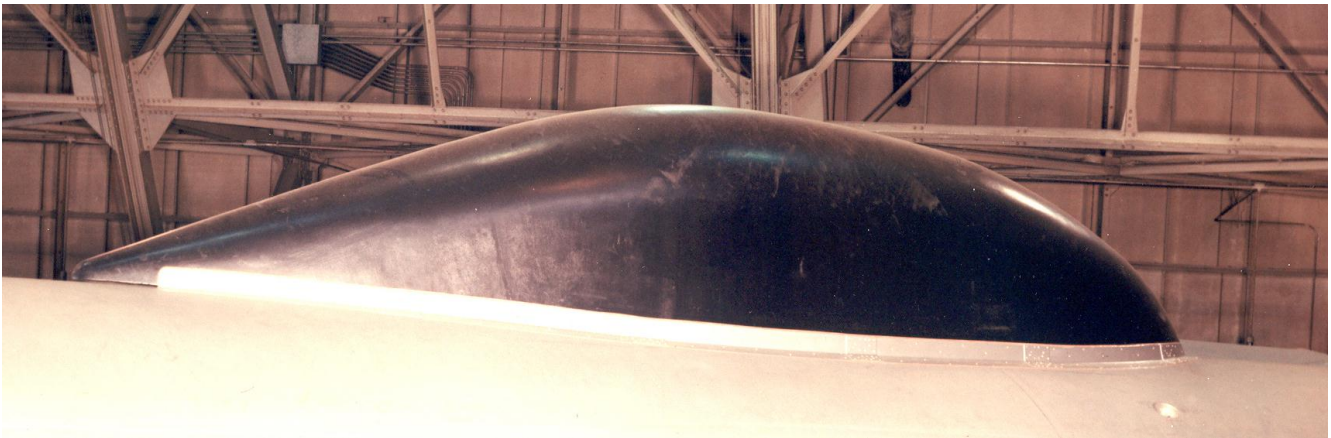


**AN/ASC-18/OM-42 Wideband AJ Modem**

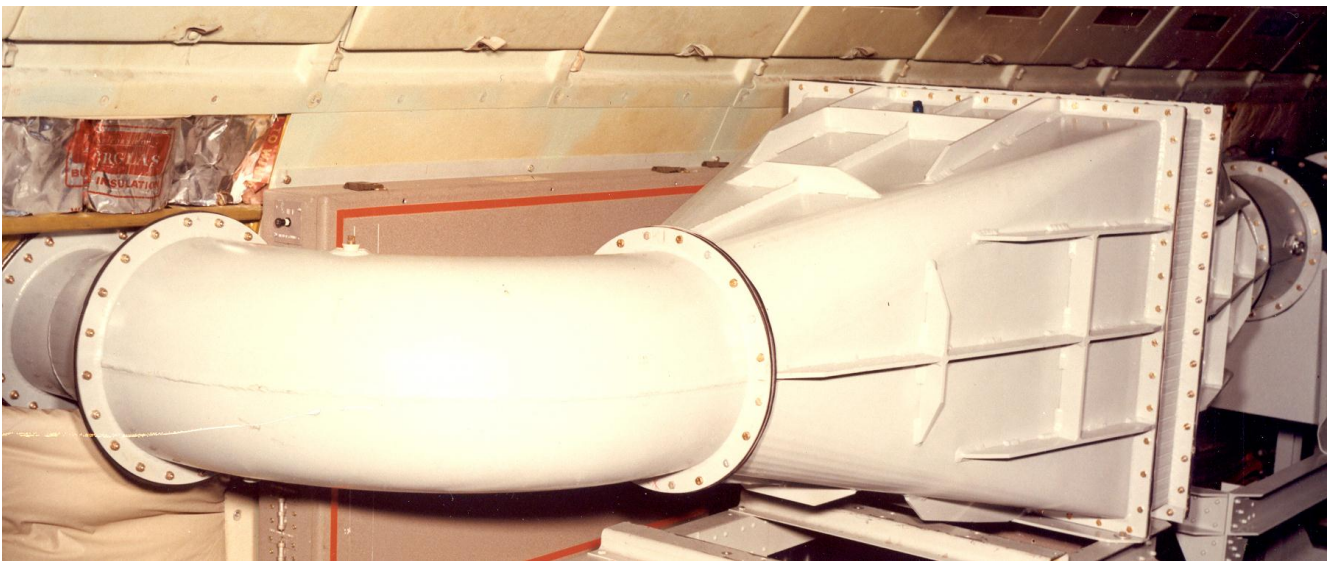


The Wide-Band AJ Modem is designed to interface with the transmitter/receiver at either 70 or 700 MHz. The modem utilizes a Reed-Solomon encoding to derive a multiple frequency shift keyed signal. This signal is then band spread by frequency hopping to provide anti-jam protection. The modem operates in a full duplex mode at several spread bandwidths and at several data rates. Initial synchronization of the modem is achieved by using either the satellite beacon signal or the atomic time standard as the reference. The modem has a capability of radar ranging to the satellite to determine the approximate range and minimize the search time. The Reed-Solomon encoding employed in the modem and the maximum likelihood detection provide error correction for the output data.

The Aeronautical System Division's 4950<sup>th</sup> Test Wing designed and built a fiberglass radome to house the SHF antenna. They also designed and built a ram air heat exchanger to remove the 50 kW of heat generated by the SHF terminal. The heat exchanger contains a blower for use during ground operation.



**Fiberglass Radome to House the SHF Antenna**



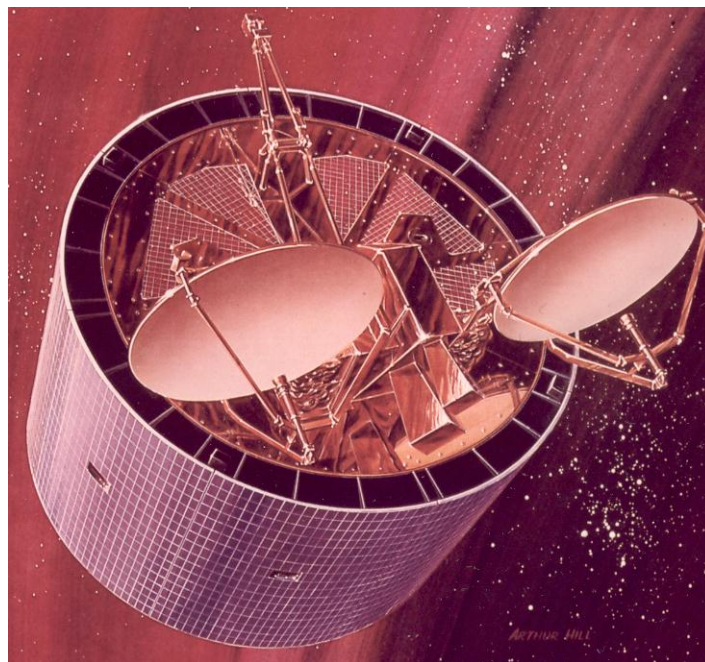
**Fifty Kilowatt Ram Air Heat Exchanger used to Cool the AN/ASC-18 Electronics**

The four SHF subsystems were integrated and installed in 4950th Test Wing's C-135/662 aircraft. A test instrumentation system was installed to record the test data. Prime power for the entire system was supplied by the aircraft's three 40 KVA generators.



**4950<sup>th</sup> Test Wing Aircraft C-135/662 used to Test the AN/ASC-18 System**

The SHF Terminal is designed to operate through the Defense Communication Agency's DSCS II satellite. This SHF transponder satellite has a total bandwidth of 500 MHz divided into four channels. The satellite has both earth coverage antennas and high gain spot beam antennas. The four satellite channels provide earth coverage to earth coverage mode, earth coverage to narrow beam mode, a narrow beam to earth coverage mode, and a narrow beam to narrow beam mode. The channel bandwidths vary from 50 to 185 MHz. The satellite amplifiers are normally operated in their linear gain region to minimize intermodulation distortion. The DSCS II has approximately 55 dBm ERP in the earth coverage mode and approximately 70 dBm ERP in the narrow beam mode. Beacon signals are provided in both the earth coverage and the narrow beam modes.



**DSCS II SHF Satellite used in System Tests**

Approximately 300 hours of airborne flight testing and 700 hours of ground testing were accomplished on the SHF ASC-18 System. The results of these tests indicate that the Transmitter, Receiver, Antenna



System, Computer Augmented Antenna Pointing System, and Modern meet the basic requirements for which they were designed. With additional design effort put into reliability improvement, utilization of modular construction techniques, and built-in fault isolation circuits it appears that the terminal reliability can be improved to a desirable level.

Following the flight test, the Advanced Development Model was at a point where it could be transitioned into an Engineering Development Model.

**Transition and Application:** Following AFAL's successful development and flight test evaluation of the AN/ASC-18, the Electronic Systems Division (ESD) contracted for a number of Engineering Development Models (EDM) and worked with Boeing to install the upgraded terminal, designated AN/ASC-24, on four E-4B (Boeing 747-200) airframes to provide secure, survivable communications for the National Airborne Operations Center (NAOC), the Presidential support aircraft. Boeing requested AFAL's input on the design of the radome to house the ASC-24 SHF antenna and on installation details. AFAL also provided a blockage table identifying the antenna pointing angles where the antenna beam would just grazed the aircraft's nose, wings and tail surfaces. The blockage table was used to avoid transmitting into the aircraft surfaces.



**The Radome Forward of the Wing on the E-4B Houses the AN/ASC-24 SHF Antenna**

#### **References:**

Allison, K., J. Iwaniec, T. Holmes; **Airborne SHF Satellite Terminal Test**; Electronics Communications Ins. St. Petersburg FL; AFAL-TR-73-299; December 1973.

Davis Major Leroy L.; **Wideband AJ Modem**; 4950<sup>th</sup> Test Wing WPAFB OH; FTR 4950/ENE-73-21; 20 September 1973.

Davis Major Leroy L.; **Airborne Satellite Communications Terminal – Strategic**; 4950<sup>th</sup> Test Wing WPAFB OH; FTR 4950/ENE-73-30; 18 October 1973.

Johnson, Allen L. and Ted Grizinski; **Executive Summary of Airborne SHF Satellite Communications System Terminal Flight Test**; Air Force Avionics Laboratory; WPAFB OH; AFAL-TR-73-392; October 1973.

Kellow, Robert S. and Kenneth R. Marshall; **SHF Airborne Communications Terminal**; Collins Radio Co; Richardson TX; AFAL-TR-72-123; August 1972.

Stander, Leonard; **SHF High-Power Airborne Antenna**; RCA Corp; Moorestown NJ; AFAL-TR-71-112; July 1971.

**Wideband AJ Modem Final Report**; Sylvania Electronic Systems; Buffalo NY; AFAL-TR-72; January 1972.

## Air Force One Communications Improvement (1973-1975)

**Background:** In the early 1970s, the Presidential VC-137 Special Air Mission (SAM) aircraft fleet was equipped with Air Force Avionics Laboratory (AFAL) developed UHF SATCOM systems that provided a reliable low data rate secure teletype communications link. However, the downlink signal margin was insufficient for the higher data rates of digitized secure voice. The 89<sup>th</sup> Airlift Wing that operates and maintains the SAM fleet contacted the AFAL to discuss options for improving the link margin so it would support a secure voice network. AFAL engineers visited Andrews AFB MD to tour Air Force One aircraft, Figure 1, observe the current SATCOM installation and discuss options with the 89<sup>th</sup> Airlift Wing engineers. The AFAL engineers also met with the Presidential pilot, Colonel Ralph Albertazzie, to discuss the project. Col Albertazzie made it clear that any change to Air Force One's external appearance, such as installing new external antennas, had to be done so that aircraft didn't look like a spy plane. The use of a large radome was out of the question. The AFAL study into the improvement of Air Force One's SATCOM link was accomplished under Project 687-J, Tactical Satellite Communications.



**Figure 1 Presidential aircraft VC-137-27000**

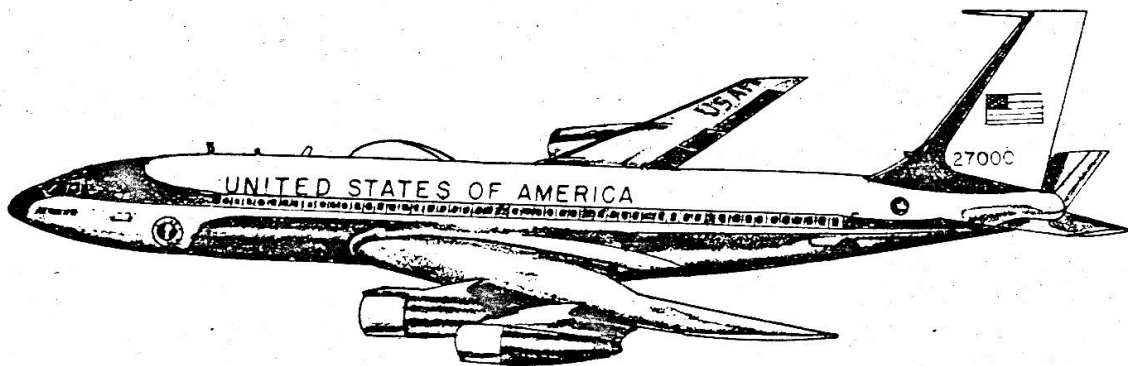
**SATCOM Improvement Study:** The Presidential aircraft fleet was equipped with AN/ARC-146 UHF SATCOM systems, including 1 KW transmitters. They utilized a blade antenna for coverage on the horizon and a crossed dipole antenna for overhead coverage. In the early 1970s, the systems operated through the TACSAT and LES 6 satellites to provide a reliable teletype communication link for the Presidential fleet when the aircraft is out of line-of-sight from normal ground entry points or relay aircraft. With the planned launch of the Gap-Filler satellite in early 1975 and the FLTSAT/AFSAT satellite systems in 1976, it seem desirable to upgrade the present UHF SATCOM system in the Presidential aircraft to provide additional link margin for the reception of digitized secure voice. Because of the limited RF power available from the satellite, the weakest portion of the communication path was the downlink from the satellite to the aircraft. On the uplink the AN/ARC-146 transmitted 1,000 watts ERP providing a reasonable signal level at the satellite. A ground station receiving the signal from the aircraft via the satellite utilized a directional antenna and therefore received the satellite signal with ample margin. The return link from the ground station to the satellite also provided a reasonable signal level at the satellite. However, the path from the satellite back to the aircraft was the limit of the link. Using the existing airborne antenna system, the received signal from the satellite was adequate for normal communications under ideal conditions. However, the existing antenna system had numerous nulls in the pattern, especially at low elevation angles to the satellite. This problem was particularly noticeable during maneuvers at these low elevation angles, such as approaches and landings where shadowing of the antenna occurs from the aircraft wingtips, tail, and nose. Such maneuvering usually causes loss of even the low data rate teletype signal.

Using AFAL's extensive UHF SATCOM antenna flight test experience, AFAL engineers proposed further study of three feasible approaches to antenna gain improvement. These are: (1) a mechanically steerable UHF antenna; (2) an antenna combiner which phases the inputs from four antennas; and (3) a switched array of antennas.

**Mechanically Steerable UHF Antenna:** A mechanically steerable UHF SATCOM antenna can provide a peak gain of approximately 9 dB with a minimum gain of approximately 5 dB. Such an antenna would be mounted on top of the fuselage as far forward as possible to minimize the blockage of the tail. The Boeing Company designed a mechanically steerable UHF antenna which was to be used on the Advanced Airborne Command Post aircraft. It was approximately 30 inches in diameter and 15 inches deep. It was steered 360 degrees in azimuth and had two elevation positions. One position covers the horizon up to 45 degrees and the other covers from 45 degrees to 90 degrees. The antenna would be housed in a radome approximately 3 feet high and 3 feet wide at the base, 15 feet in length. Based on the measured performance on AFAL's test aircraft with a 20 foot long, 5 foot high SHF radome, no more than 1% range degradation would be expected from the increased drag of such a radome. Steering for the antenna would have to be provided by the autopilot. The operator would have to calculate the initial antenna pointing coordinates. The flight director or automatic pilot output would then be used to keep the antenna correctly pointed.

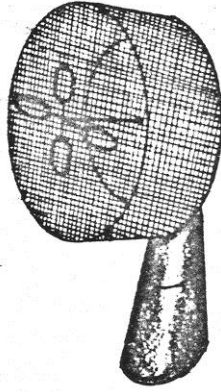
The beam width of this steerable antenna is approximately 80 degrees at the 3 dB point. Therefore, good performance is provided even at low elevation angles and during banks of up to 30 degrees. Some outages might occur at low elevation angles in a bank due to shadowing.

A drawing of the Presidential aircraft with a radome is shown in Figure 2. A sketch of the antenna is provided in Figure 3. The top-mounted antenna would require approximately 10 inches of room inside the aircraft for the antenna drive and control mechanisms.



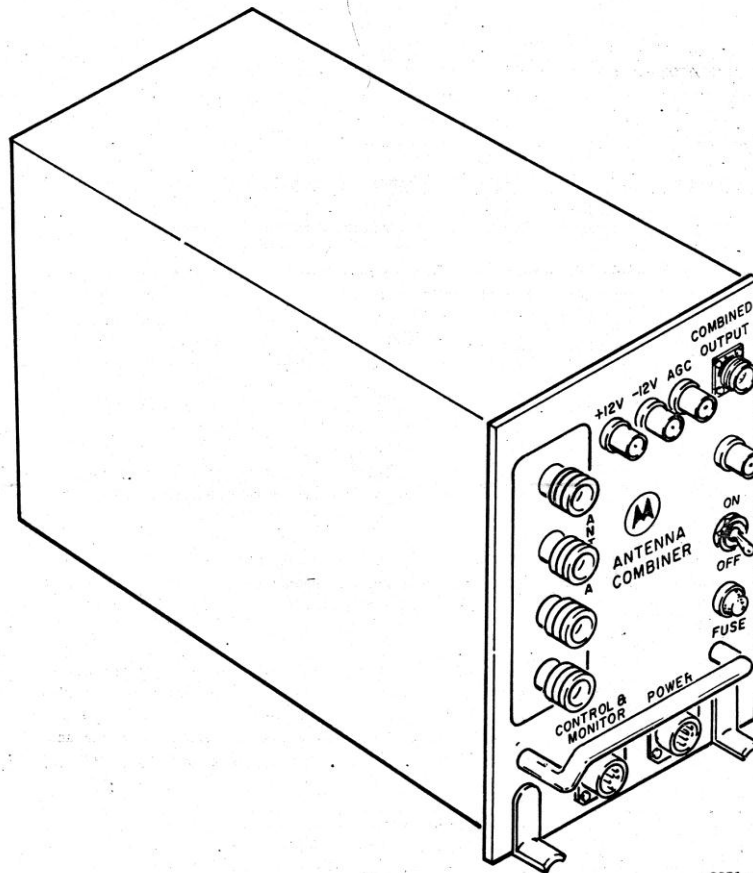
**Figure 2 Presidential Aircraft with Radome for Mechanically Steered Antenna**

**Antenna Combiner:** The second approach considered was the use of an antenna combiner which matches up the signals from four separate antennas and provides gain equal to the sum of the four antennas. Motorola had built such an antenna predetection combiner and AFAL flight tested it in 1972 showing it worked as advertised.



**Figure 3 Mechanically Steered Antenna**

The antenna combiner is packaged in a 1/2 ATR configuration as shown in Figure 4. Each of the inputs from four separate antennas is amplified and then the four signals are combined in a maximal ratio predetection combiner. The phase differences of these signals are resolved in the combiner to produce an intermediate frequency signal which is the sum of the four individual signals. The inputs are combined according to the square of the amplitudes such that the stronger antenna will be emphasized and the weaker, or shadowed antenna, will be minimized. Likewise, the noise from the various antennas adds incoherently resulting in a signal-to-noise improvement.



**Figure 4 Motorola Antenna Combiner**

2871-1



The only control required for the combiner is the selection of a local oscillator frequency which is determined by the satellites to be used. Three crystal controlled local oscillator frequencies are available. These could be set, for example, to the LES 6 satellite, the Gap-Filler satellite, and the wideband channel of the FLTSAT satellite.

Use of the antenna combiner not only provides increased gain, but it can also reduce the effect of nose, tail and wing shadowing. Since the individual antennas would be spaced along the top of the fuselage, one near the front of the aircraft, two in the middle and one in the rear of the aircraft, the angles at which each antenna would be shadowed are different. Therefore, the combining effect would minimize the contribution of those antennas which might be shadowed. Similarly, the spacing of the antenna provides a multipath protection at low elevation angles since the signal arriving at each antenna will not fade coherently. The normal 5 to 10 dB fading margin required for low elevation angles over water could be reduced to 1 to 2 dB using the antenna combiner. Various types of antennas have been considered for use with the combiner. Different antennas could be used with the combiner including the Dorne Margolin blade/turnstile dual mode antenna, the Collins AFSAT antenna, the Motorola spiral antenna or a standard UHF blade antenna.

**Switched Antenna Array:** The third system considered was the switched antenna array consisting of Motorola spiral antennas arranged in a pyramid. These spiral antennas could be switched using an antenna pointing arrangement similar to that being proposed for the mechanically steerable antenna system. Initially, the operator would calculate the satellite direction to determine which antenna was pointed in the proper direction.

Once the proper antenna had been selected, the steering could be accomplished from the autopilot or flight director information for the remainder of the mission.

The antennas are broad enough that accurate pointing would not be required. If the aircraft turned, the pointing system would switch from one spiral element to the next spiral element. Such a system could provide a minimum of 3 to 4 dB of gain except at angles where blockage occurs due to the wings or tail. The antenna element could be mounted in a low pyramid structure on top of the aircraft.

**Proposed Solution:** After a thorough review of the various alternatives, AFAL proposed the antenna combiner and four Dorne Margolin antennas to solve the low gain problem on Air Force One. Such a system would provide improved link margin through reduced antenna shadowing and reduced multipath fading. The expected gain would be 10 dB at high elevation angles, and a minimum of 3 dB on the horizon. The prime considerations for the selection of this approach were cost, complexity, overall gain performance, space requirements and appearance, Figure 5.

A block diagram of the proposed UHF SATCOM antenna system is shown in Figure 6. In this configuration only the forward-most antenna would be used for transmit since the margin on transmit is much greater than for receive. The existing antenna diplexer would be used to allow the transmit antenna to also be utilized for receive. The receive portion of the diplexer would be combined with the other three antennas in the antenna combiner. The resulting signal would be routed to the receive portion of the modem. It would be desirable to locate the antenna combiner as close to the antennas as possible, such as in the top of the aircraft above the drop ceiling. However, on those aircraft where the antenna diplexer is located in the equipment compartment in the belly of the airplane, the antenna combiner could also be located in the compartment.

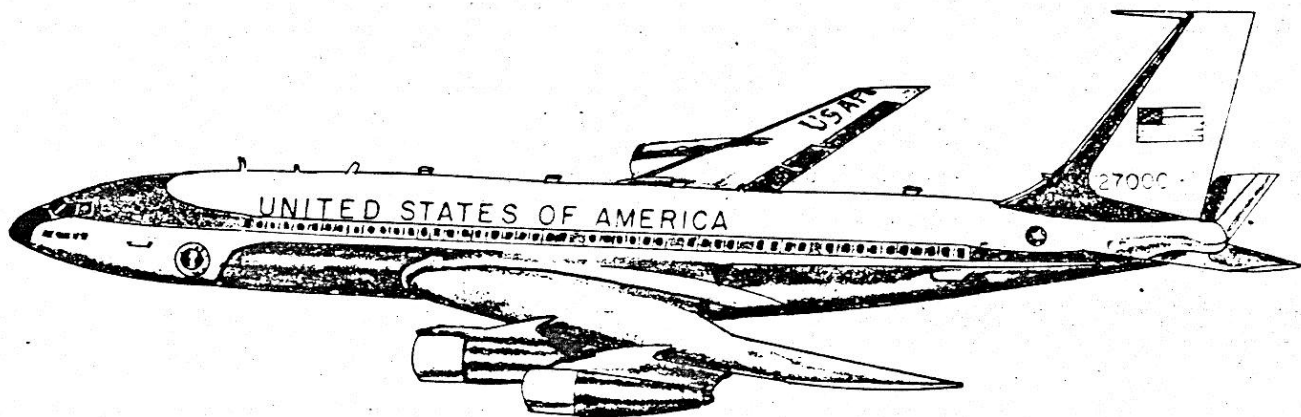


Figure 5 Proposed Installation with Dorne Margolin Antennas and Combiner

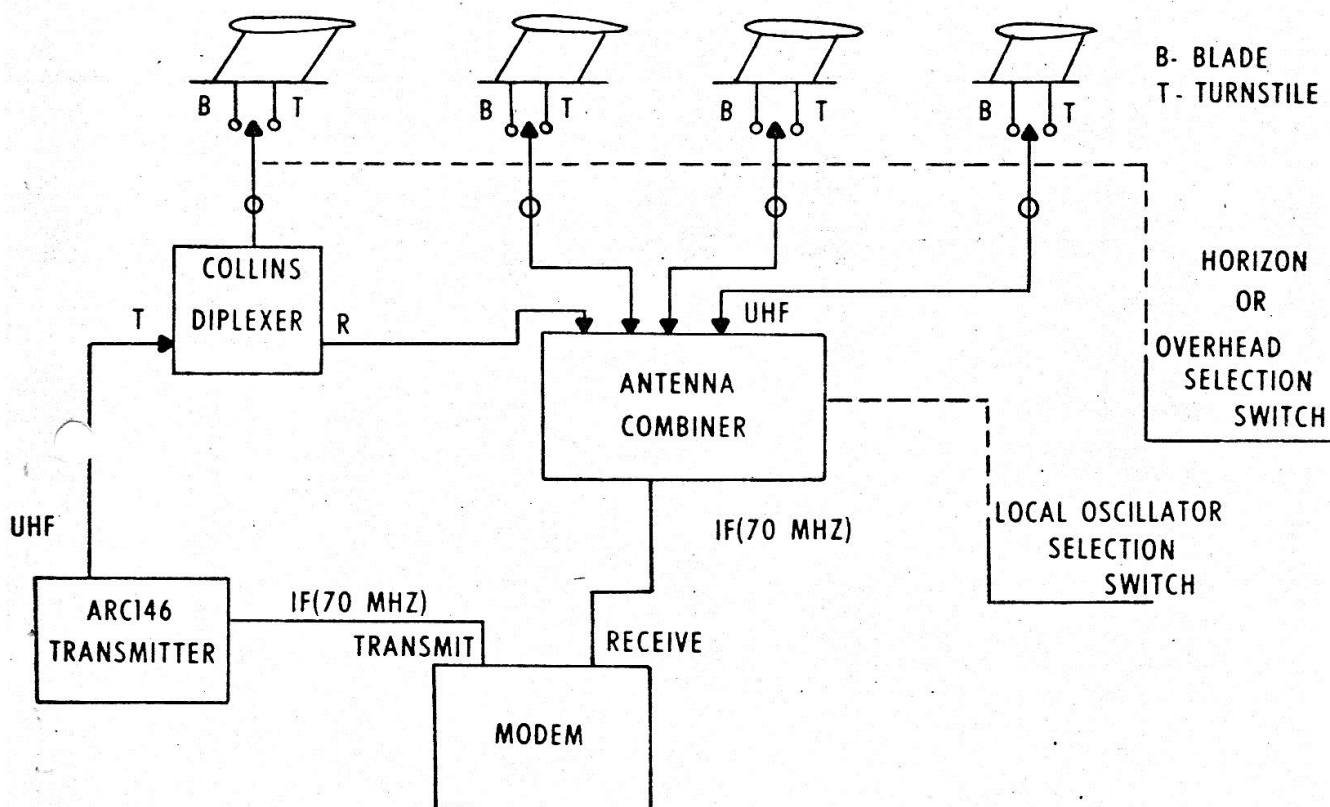


Figure 6 Block Diagram of Proposed Antenna System

The operator controls for the proposed antenna system would be an on/off power switch for the antenna combiner, a satellite-select switch and a two-position switch for horizon or overhead operation. The latter switch would be identical to the present AN/ARC-146 antenna-select switch.

**Conclusions:** Following the AFAL feasibility study, the proposed solution was briefed to the 89<sup>th</sup> Airlift Wing. They decided to go ahead with the AFAL recommendations. The antenna combiner and Dorne Margolin antennas were procured by the 89<sup>th</sup>, installed on one of the SAM fleet aircraft and

tested. The flight test proved successful, providing a workable solution to the improvement of the Presidential satellite communications link.

**References:**

Johnson, Allen L.; **Proposal for an Improved UHF SATCOM Antenna System for Air Force One**; Air Force Avionics Laboratory; 21 October 1974.

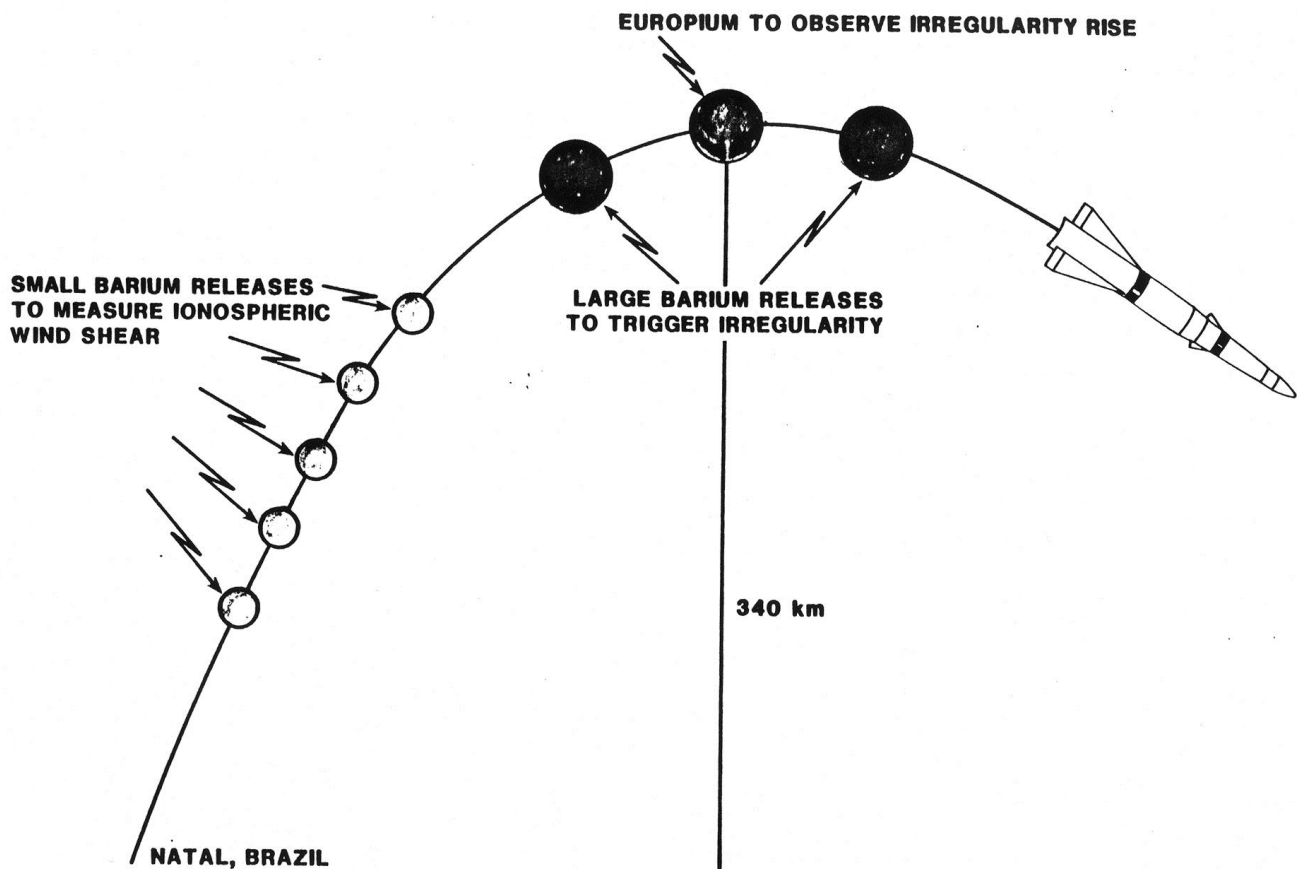
terHorst, J.F. and Col Ralph Albertazzie; **The Flying White House**; Coward, McCann & Geoghegan Inc; New York NY; ISBN 0-698-10930-9; 1979.



## Coloured Bubbles Ionspheric Modifications Project 1982)

**Background:** In an ongoing effort to understand the effects of the earth's ionosphere on satellite communications, a series of ionospheric modification experiments were accomplished in Brazil by a group of U.S., West German, and Brazilian organizations during September 1982. The background of the experiment, a list of the participants, and a description of the ground/airborne measurements are contained in the Brazil Ionospheric Modification Experiment test plan (Narcisi-1982). A part of the experiment, Coloured Bubbles, involved the injection of a barium chemical into the unstable ionosphere around sunset to trigger an irregularity (Haerendel-1982).

**Description of Coloured Bubbles Experiment:** The Coloured Bubbles experiment was designed by Dr Haerendel of the Max Planck Institute to investigate the trigger mechanism for equatorial ionospheric irregularities. The experiment consisted of 8 chemical packages launched on a Sonda III rocket from Natal, Brazil. The first five chemical packages were small barium charges released at 20 km intervals from 220 km to 300 km to investigate ionospheric wind shear in that region, Figure 1.



**Figure 1 Coloured Bubbles Launch Sequence**

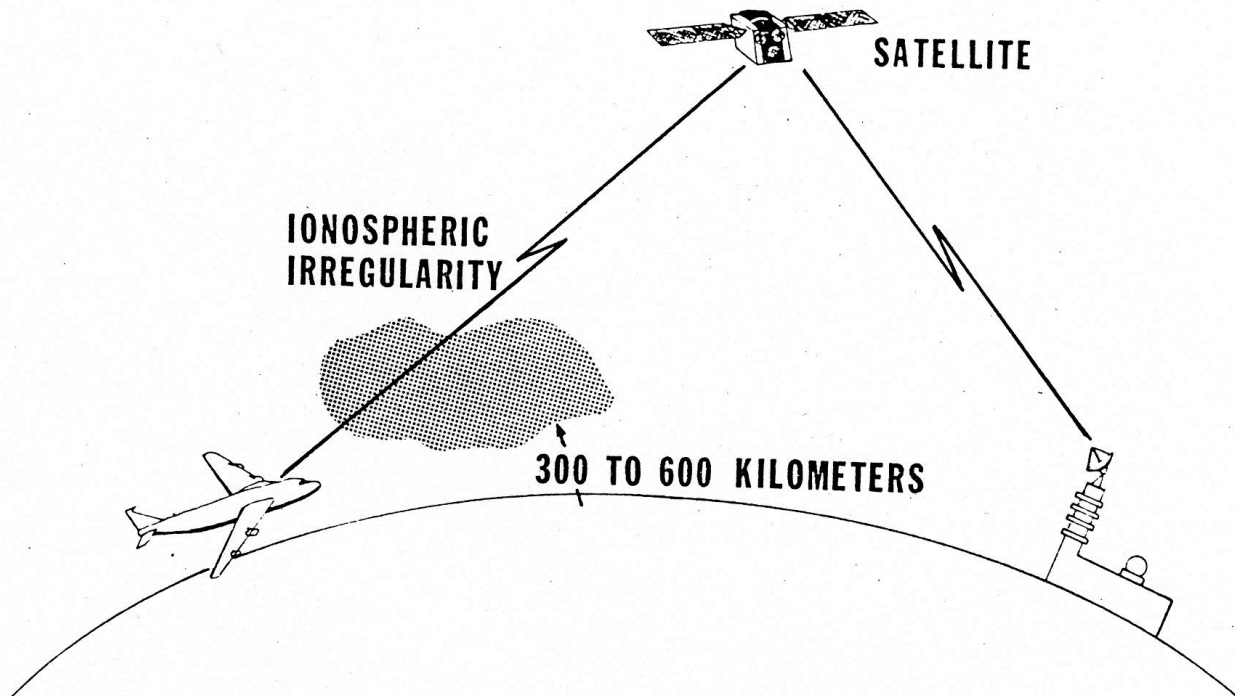
Two 40 kg barium packages, separated by a europium charges were detonated at 320 km where the ion density gradient was steepest. Haerendel (1982) postulated that as the barium ionizes, it enhances the plasma content of the ionospheric flux tubes. These flux tubes will be forced down with respect to the ambient undisturbed plasma. The incompressible nature of this convection motion, along with the electric field established between the two barium clouds, forces the plasma region between the barium upward. The upward motion of the low density plasma will grow exponentially if the barium is

injected into the steep slope of the post-sunset F region density, near 350 km altitude. Strong plasma density gradients will be set up by the rising low density region. These regions or bubbles will be subject to secondary instabilities forming small scale (1 meter to 10 kilometer) irregularities. The growth time and temporal development of the small scale irregularities are the physical properties of interest. The europium charge was used to monitor the rise of the irregularity clouds.

The Avionics Laboratory (AFWAL) equipped C-135/372 aircraft, Figure 2, flew off the coast of Natal, Brazil in the shadow of the barium clouds, receiving a UHF signal from the FLTSATCOM satellite at 23° West longitude (Johnson, 1982). The phase and amplitude of the UHF CW signal were recorded while the aircraft line-of-sight to the satellite swept in and out of the area where the effects of the barium-induced irregularity were expected to be, Figure 3.



**Figure 2 AFWAL Equipped C-135 Test Aircraft**



**Figure 3 Ionospheric Scintillation Experiment Geometry**

**Data from Coloured Bubbles #1:** On 17 September 1982 the first Coloured Bubbles rocket was launched from Natal, Brazil at 2056 UT. The first two of five small barium wind sheer measurement packages went off on schedule; then the timer malfunctioned. The major barium package, the europium package and the second major barium package went off on schedule. The other small barium packages detonated well above their planned release altitude. The time and location of each release is given in Table 1. The sequence of releases was photographed from the AFWAL aircraft and is shown in Figure 4.

TABLE 1 BARIUM RELEASE TIMES AND LOCATIONS

<u>TIME</u>	<u>EVENT</u>	<u>HEIGHT</u>	<u>LONGITUDE</u>	<u>LATITUDE</u>
<u>17 Sept 82</u>				
20:56:00 UT	Launch	0		
20:58:16	1st Small Ba	216 km	34.51°W	6.06°S
20:58:30	2nd Small Ba	235	34.45°W	6.07°S
21:00:04	1st Main Ba	322	33.93°W	6.17°S
21:01:04	Europium	336	33.60°W	6.24°S
21:01:18	3rd Small Ba	335	33.52°W	6.26°S
21:01:34	4th Small Ba	322	33.44°W	6.27°S
21:02:04	2nd Main Ba	320	33.28°W	6.31°S
<u>18 Sept 82</u>				
20:45:00	Launch	0		
20:47:16	1st Small Ba	218 km	34.60°W	6.04°S
20:47:30	2nd Small Ba	239	34.53°W	6.06°S
20:47:48	3rd Small Ba	262	34.44°W	6.07°S
20:48:04	4th Small Ba	281	34.36°W	6.09°S
20:48:28	5th Small Ba	303	34.25°W	6.12°S
20:49:04	1st Main Ba	330	34.09°W	6.15°S
20:50:04	Europium	347	33.83°W	6.21°S
20:51:04	2nd Main Ba	334	33.56°W	6.26°S

At the time of the europium release (2101:04 UT) the AFWAL aircraft was looking through the region of the release toward the FLTSATCOM satellite. A one dB signal enhancement was recorded from the 250 MHz downlink CW signal from FLTSATCOM. As the AFWAL aircraft passed back beneath the release area at 2111 UT approximately 10 seconds of 1 dB signal variation was recorded. After another turn, the aircraft took 19 minutes to catch up with the eastward drifting irregularity. By then, the ionospheric irregularity had become well structured. As the 250 MHz FLTSATCOM signal received on the AFWAL aircraft passed through the western edge of the irregularity, a 1 dB focus (enhancement) and 5 dB defocus (fade) were encountered followed by 2 minutes of 10 dB peak-to-peak fading, Figure 5. After the signal exited the irregularity the aircraft turned around, re-entering the shadow of the irregularity at 2137:30 UT. Approximately 20 dB peak-to-peak fading was encountered



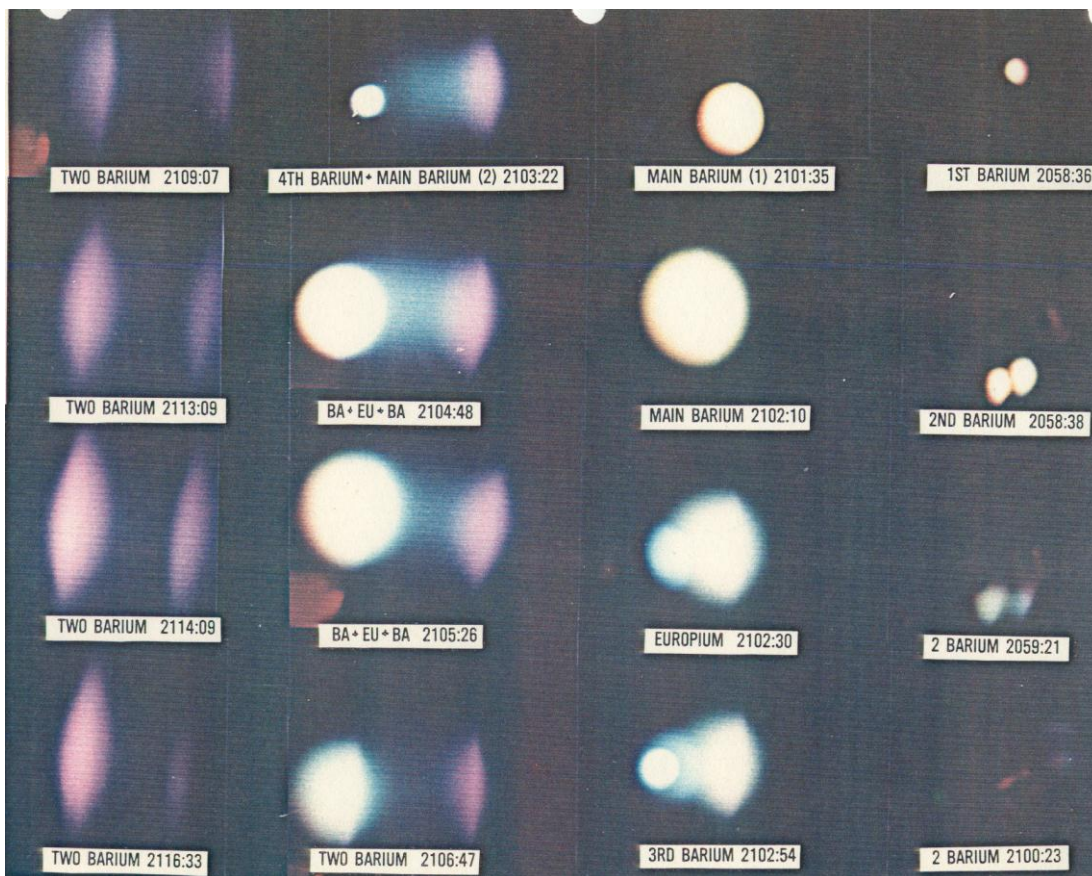


Figure 4 Growth of Irregularities Following Chemical Release of Coloured Bubbles 1

17 SEPTEMBER 1982  
 AIRCRAFT C-135/372  
 BRAZIL

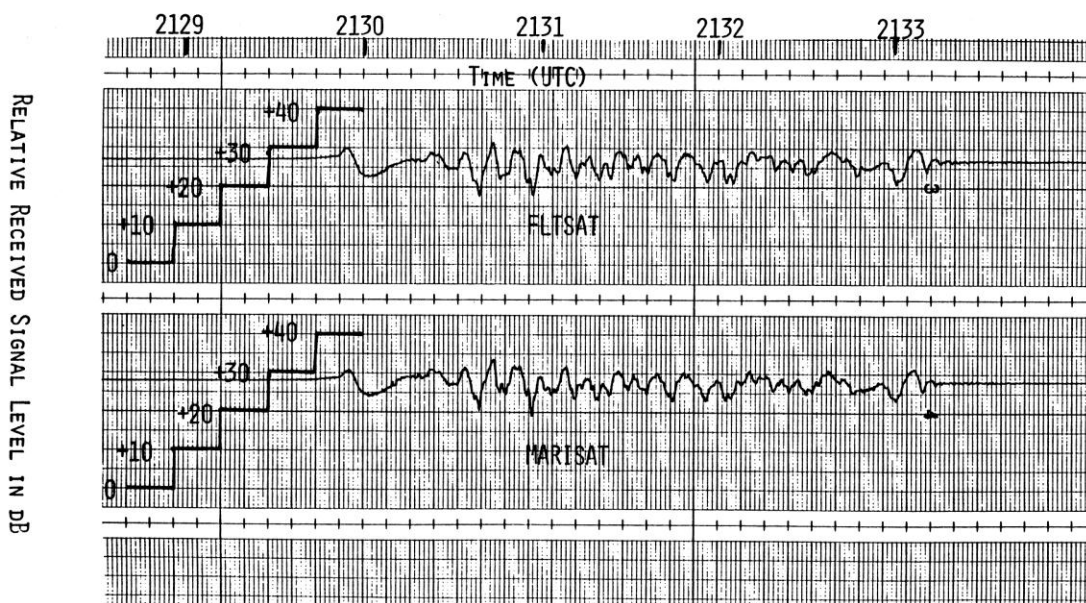


Figure 5 Received Satellite Signal Fading Caused by Ionospheric Irregularities

on this westward pass. After flying approximately 30 miles either side of the initial barium release point it became apparent that the only irregularity in the vicinity of the release was between the two barium clouds in the area of the europium release. At 2140 UT the AFWAL aircraft again turned east to catch the drifting irregularity. The AFWAL aircraft caught up with the irregularity at 2146 UT and flew almost 300 km east without finding the eastern edge.

The flight track of the AFWAL aircraft is shown in Figure 6. The track of the intersection of the received FLTSATCOM signal with a 350 km ionospheric altitude is plotted on each figure with an indication of the peak-to-peak scintillation fading encountered. During an early pass, the slight eastward drift of the initial irregularity is visible. On later passes, the well developed irregularity is drifting more rapidly to the east. On Figure 6 it is apparent that the locally generated irregularity has become embedded in a larger naturally irregularity.

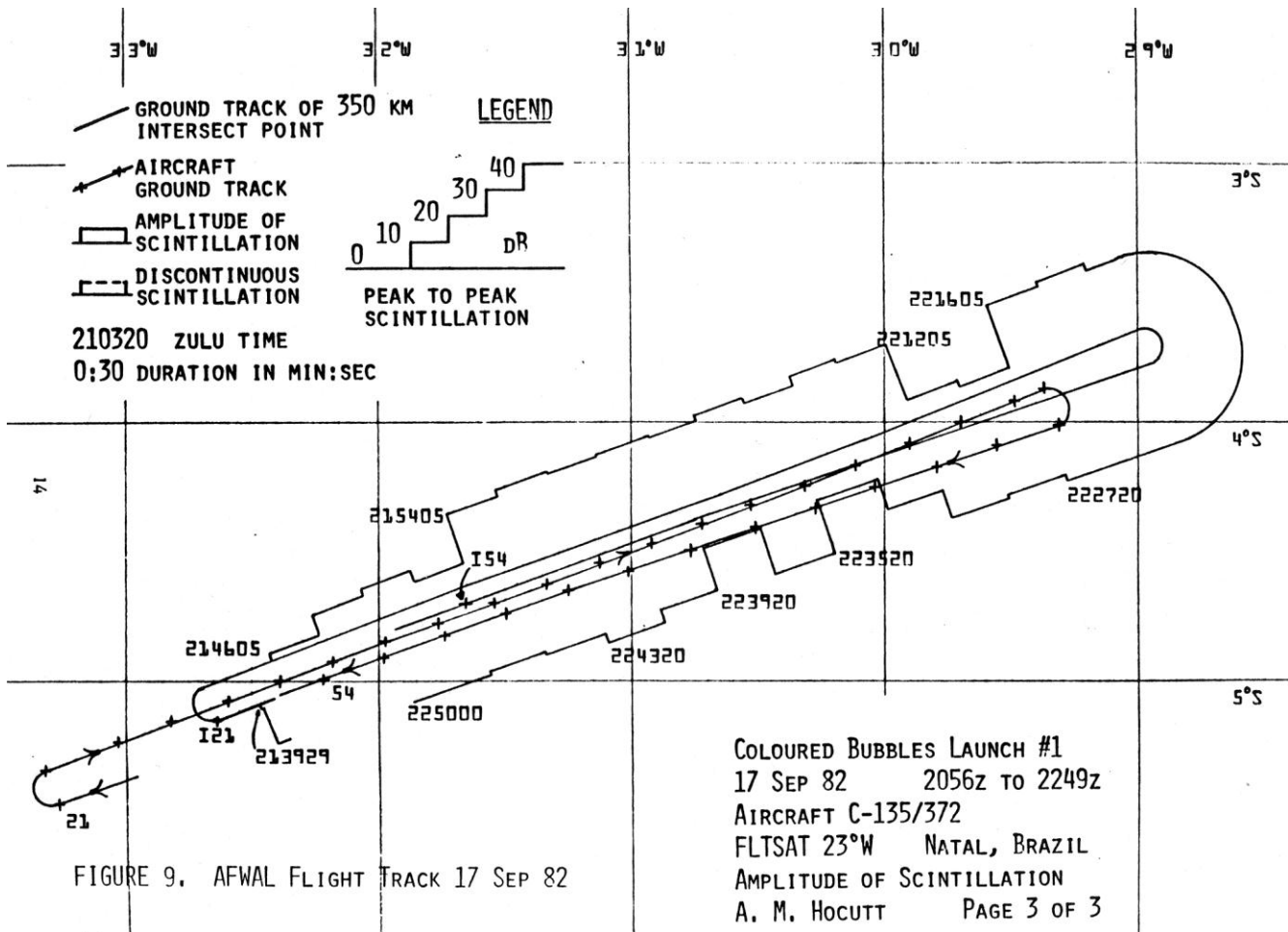


FIGURE 9. AFWAL FLIGHT TRACK 17 SEP 82

By measuring the position and time when the aircraft encountered the shadows of the irregularity edge, the velocities of the eastern and western edges of the irregularity and its width were calculated. Shortly after release, the western edge velocity was approximately 10 m/s to the east; the eastern edge velocity was approximately 30 m/s. Approximately 30 minutes after release the velocities had increased to 70 m/s for the western edge and 90 m/s for the eastern edge. An hour after release the velocities were over 100 m/s. The width of the irregularity grew from 1 km wide when first encountered to 5 km wide 10 minutes later. The growth continued in a nearly linear fashion to 30 km wide at 30 minutes after release and 40 km wide at 40 minutes from release.



**Data from Coloured Bubbles #2:** On 18 September 1982, the second Coloured Bubbles rocket was launched at 2045 UT. The first five barium packages went off on schedule as did the two main barium and the europium packages, Figure 7.



**Figure 7 Growth of Irregularities Following Chemical Release of Coloured Bubbles 2**

A small enhancement was recorded on the AFWAL aircraft at 2049:20 UT from FLTSATCOM. At 2057:30 UT, a 10 second long 1 dB disturbance was encountered. The irregularity continued to grow in width and intensity as the aircraft passed back and forth beneath it. Approximately 15 minutes after release the irregularity caused 5 dB peak-to-peak fading. It continued to grow in width and fading level. Forty minutes after release the fading was greater than 10 dB peak-to-peak on the FLTSATCOM signal. Fifty-five minutes after release, the fading was 25 dB peak-to-peak.

The irregularity width grew from 1 km wide, one minute after release to 60 km wide 40 minutes after release.

**Conclusions:** The Coloured Bubbles experiment showed that it is possible to trigger an irregularity in an unstable ionosphere by releasing barium packages at the critical gradient altitude. The irregularities grew from a seed to a hundred kilometer width and exhibited 25 dB peak-to-peak fading identical to that encountered with natural equatorial irregularities.

**Acknowledgements:** The AFWAL participation in the BIME and Coloured Bubbles experiments was accomplished with much assistance from Dr Ed Weber, Jurgen Buchau, and Jim Moore of AFGL. The AFWAL test team put in many hours of contributed overtime to get the equipment ready for the trip and to man the aircraft for 14 flights in a 19 day period. The efforts of Roger Swanson, Wayne Fischbach, Allen Johnson, Capt. Anne Hocutt, Ed Humphreys, Bill Brown, Claude Begin, Roy Foster, Bill Rembacz, Jim Sheets, Jerry Barcus, Lt Bob Duffer, TSgt Jim Cary, and Sgt Ron Hitchcock were instrumental in accomplishing the mission. The 4950th Test Wing flight and ground crews did an outstanding job of keeping the aircraft flying. Many thanks to LTC Chris Hopkins, Capt Bill Baker, Capt Larry Cummings, Capt Bill Ploetner, Capt Kevin McCartney, SMSgt Dave Lawrence, TSgt John Bartley, Ron Byrd, and A1C Keith Barrett. The data reduction was accomplished by Ray Chin, Don McPhillips and Mark Bough.

**References:**

Haerendel, G. and A. Valenzuela; **Coloured Bubbles Natal/Brazil**, Max Planck Inst Internal Report 38; Munchen, West Germany; September 1982.

Johnson, Allen L.; **Brazil Flight Test Plan**, Avionics Laboratory, WPAFB, Ohio, 14 June 1982.

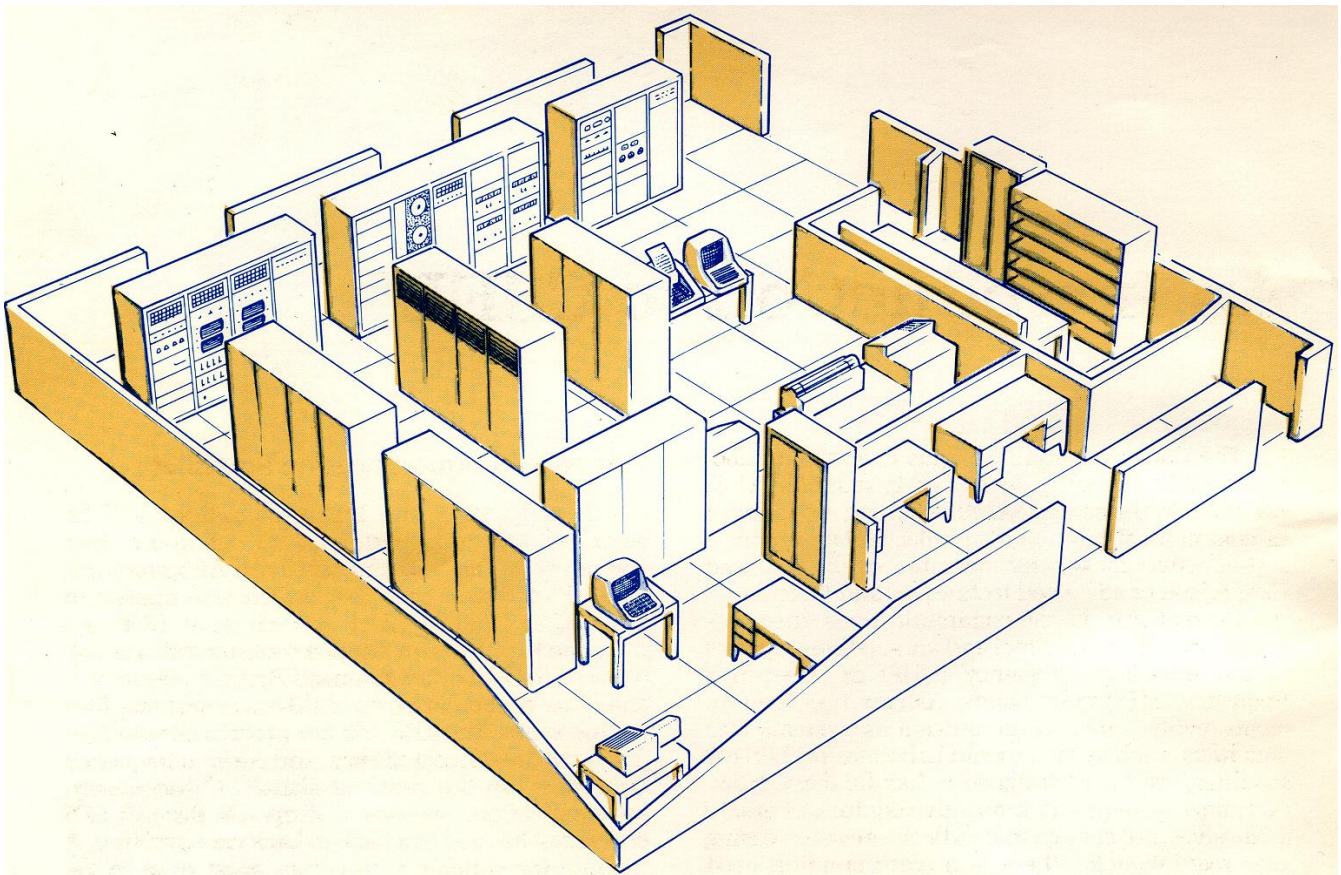
Johnson, Allen L., Capt. Anne Hocutt; **Preliminary Analysis of Coloured Bubbles Data**; Avionics Laboratory, WPAFB OH; 27 February 1983.

Narcisi, R.S.; **Project BIME Compiled Participant Submission and General Information**; Air Force Geophysics Laboratory; Hanscom AFB, MA; 7 June 1982.

## Communications Systems Evaluation Laboratory (1977-1996)

**Background:** In 1977, the Air Force Avionics Laboratory's System Avionics Division (AFAL/AAA) established the Communications System Evaluation Laboratory (CSEL) on the third floor of Building 620 at Wright Patterson Air Force Base, Ohio. CSEL was developed to assist the U. S. Air Force in the analysis, synthesis, and modeling of its communications and data links, and to provide a cost-effective means for dynamic evaluation and comparison of advanced techniques and systems.

**Communications Systems Evaluation Laboratory (CSEL)** Current Air Force communications links between aircraft, both direct and via satellite, operate in the ultra-high frequency (UHF) or super-high frequency (SHF) radio bands. As new user requirements evolve, new communications systems and data links, such as the Lincoln Laboratories' LES8/9 satellites, are being designed to handle them. However, new systems and innovative equipment are, in themselves, not enough to handle the ever-increasing user requirements, there is a corresponding need for change in such related areas as frequency bands of operation, signal structures, and modulation techniques. The CSEL, by providing the proper computer hardware/software mix, offers a dynamic evaluation tool that will provide the capability to observe and evaluate the performance of such advanced communications and data systems.



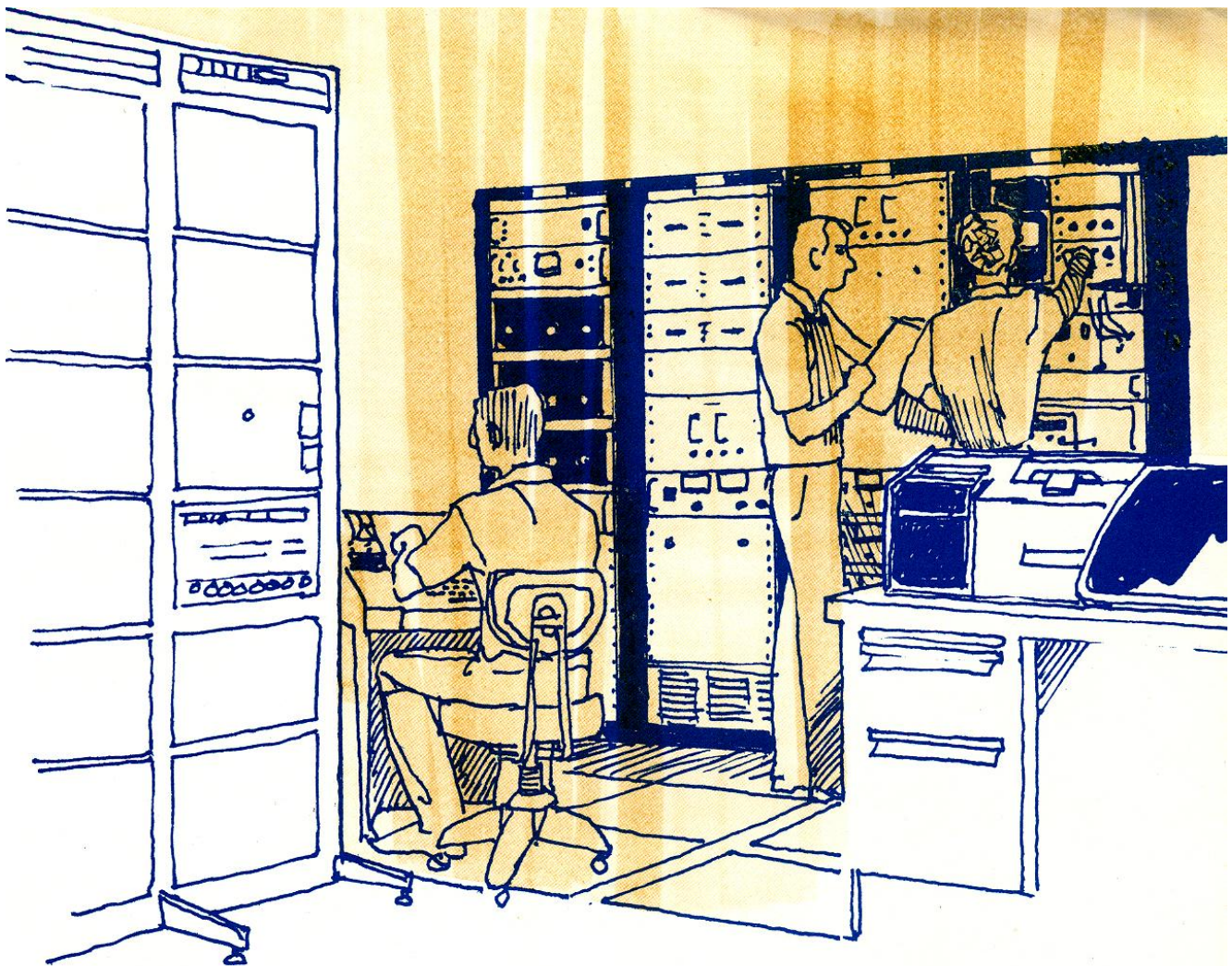
**CSEL's Equipment Layout**

**Advanced Communication Satellites:** In early 1975, the LES 8/9 satellites will be launched and tests performed to determine their suitability for use with the Advanced Airborne Command Post. These satellites, which will operate in the Ka-Band (36-38 GHz) as well as at UHF, are intended to provide



an anti-jam communications link between the Airborne Command Post, force elements, and other command posts. Unlike previous satellites in this series, the LES 8/9 are processing satellites that demodulate, remodulate, and perform frequency translation on the received signals. Consequently, communications systems that operate through LES 8/9 cannot be used in a back-to-back configuration. A satellite (or suitable simulation) must exist in the transmission path. This poses enormous problems in the prelaunch testing of the overall system.

Once the satellite is in orbit, several other factors must be considered. For example, it becomes more difficult to ascertain whether malfunctions are due to the terminals or to the satellites. To properly troubleshoot his equipment, each user will require "satellite time", time which is in great demand and which may be unobtainable for this purpose when the user needs it. In addition, the susceptibility of the satellites to various types of jamming can be predicted, but tests are required to ascertain vulnerability and communications performance in a jamming environment.



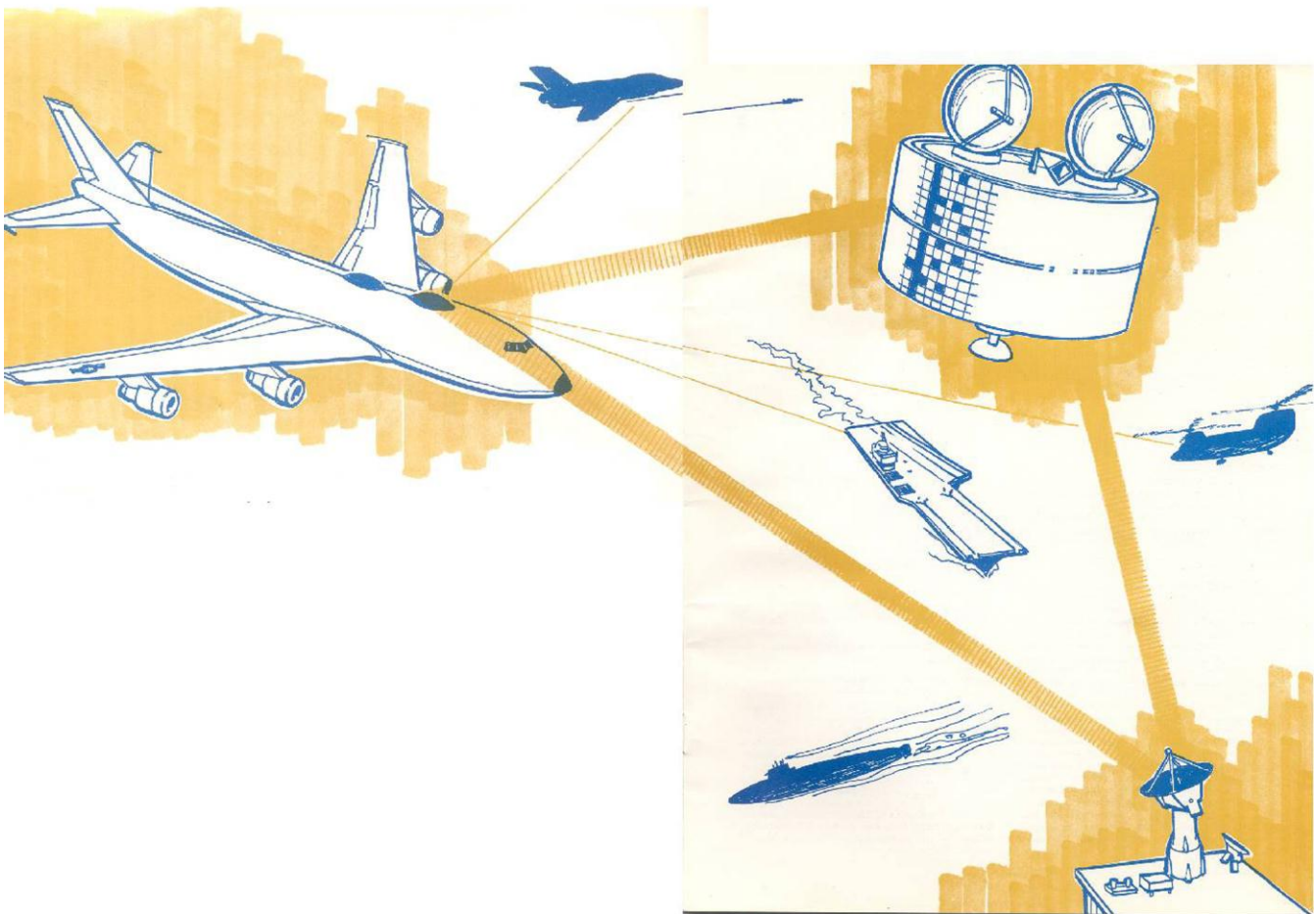
**Weapons Systems:** Advanced weapon systems, many of which will likely use a form of RPV, are currently under development. Many of these systems utilize a data link between the RPV and an airborne or ground-based receiver, and their successful performance will depend upon this link. CSEL provides an economical means of evaluating the system and link performance in a realistic environment- a task which has previously been both difficult and expensive to accomplish.

**Navigations Systems:** Advanced navigation techniques will also rely on satellite systems. These techniques apply to fast tactical aircraft as well as larger aircraft such as the Advanced Airborne Command Post and AWACS. Advanced modulation techniques will be used to provide antijam performance and to prevent unfriendly forces from using these satellites. CSEL will provide an economical means of evaluating these systems while simulating, with a high degree of accuracy, such effects as aircraft motion and Doppler.

**Total Armed Services Applicability:** Although the CSEL is being developed by the Air Force, for direct application to Air Force systems, its use is not restricted to that branch of the Armed Forces. The U. S. Navy, Marine Corps, and Army will all have requirements for similar systems. For example:

- The Navy will use LES 8/9 for communications with the Polaris fleet.
- Marine, Navy , and Army aircraft will utilize satellite navigation systems.
- Naval aircraft will rely on data links between aircraft-launched weapons and the aircraft.
- Naval forces at sea will rely upon satellite communications systems.
- The Army will rely on data links between ground bases and small aircraft and helicopters.

The Air Force's CSEL can accommodate all of these applications, as well as many others currently operational or in development stages within the various Armed Services.





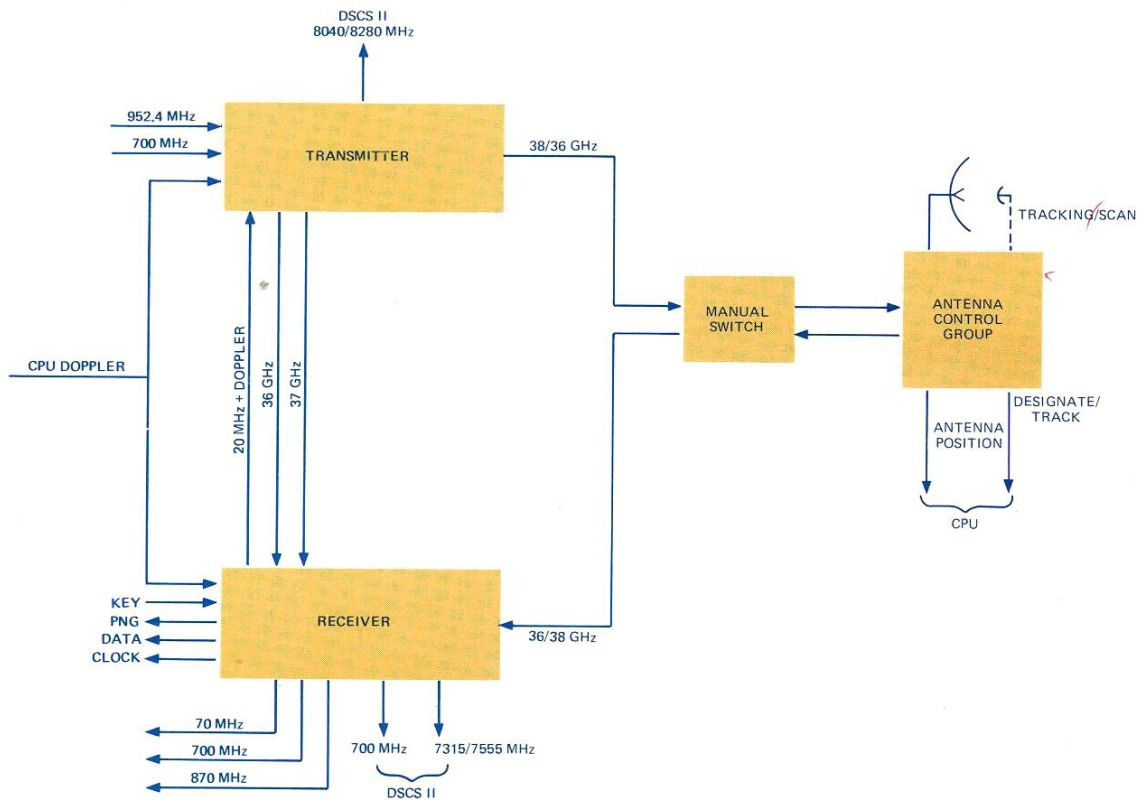


Figure 1. Simplified Block Diagram of the Ka-Band Terminal

## The Ka-Band Airborne Communications Terminal

The satellite communications set AN/ASC is an airborne terminal designed to provide communications from aircraft through the LES 8/9 satellites. The terminal comprises three major elements—uplink transmitter, downlink receiver, and antenna system. A simplified block diagram of this terminal is shown in Figure 1.

The transmitter consists primarily of upconverters and power amplifiers. Inputs at intermediate frequencies of 700 and 952.4 MHz are upconverted (one at a time) to the receive frequencies for LES 8/9. In addition, the 700-MHz input is upconverted to a low-level output suitable for the DSCS II satellite system. The output power at K-Band is variable between 0 and 30 dBW.

A unique feature of this terminal is its ability to precompensate the output carrier derived from the 700-MHz input for any doppler shift incurred on the uplink. This compensation is based on a measurement of the doppler frequency derived from the downlink carrier or a prediction received from the on-board computer.

The receiver front end includes an uncooled parametric amplifier which provides 17 dB of gain. Receiver outputs are provided at 870, 700, and 70 MHz. The receiver and antenna system are designed for conical scan operation to detect and acquire a signal from the LES satellites.

The antenna system consists of a 3-foot parabolic reflector with a cassegrain feed (utilized for conical scan). The antenna is mounted on a pedestal to provide azimuth and elevation steering, and the system is enclosed in a high-transmittance radome. The RF circuits utilize low-loss circular waveguide to radiate and receive circularly polarized waves. A polarizer mounted on the pedestal has two rectangular waveguide inputs to interface with the transmitter and receiver. This dual-mode polarizer allows the transmission of right-hand circularly polarized waves and the reception of left-hand polarized waves for communications with LES 8. By transposing input ports, the polarization sense is reversed for use with LES 9.

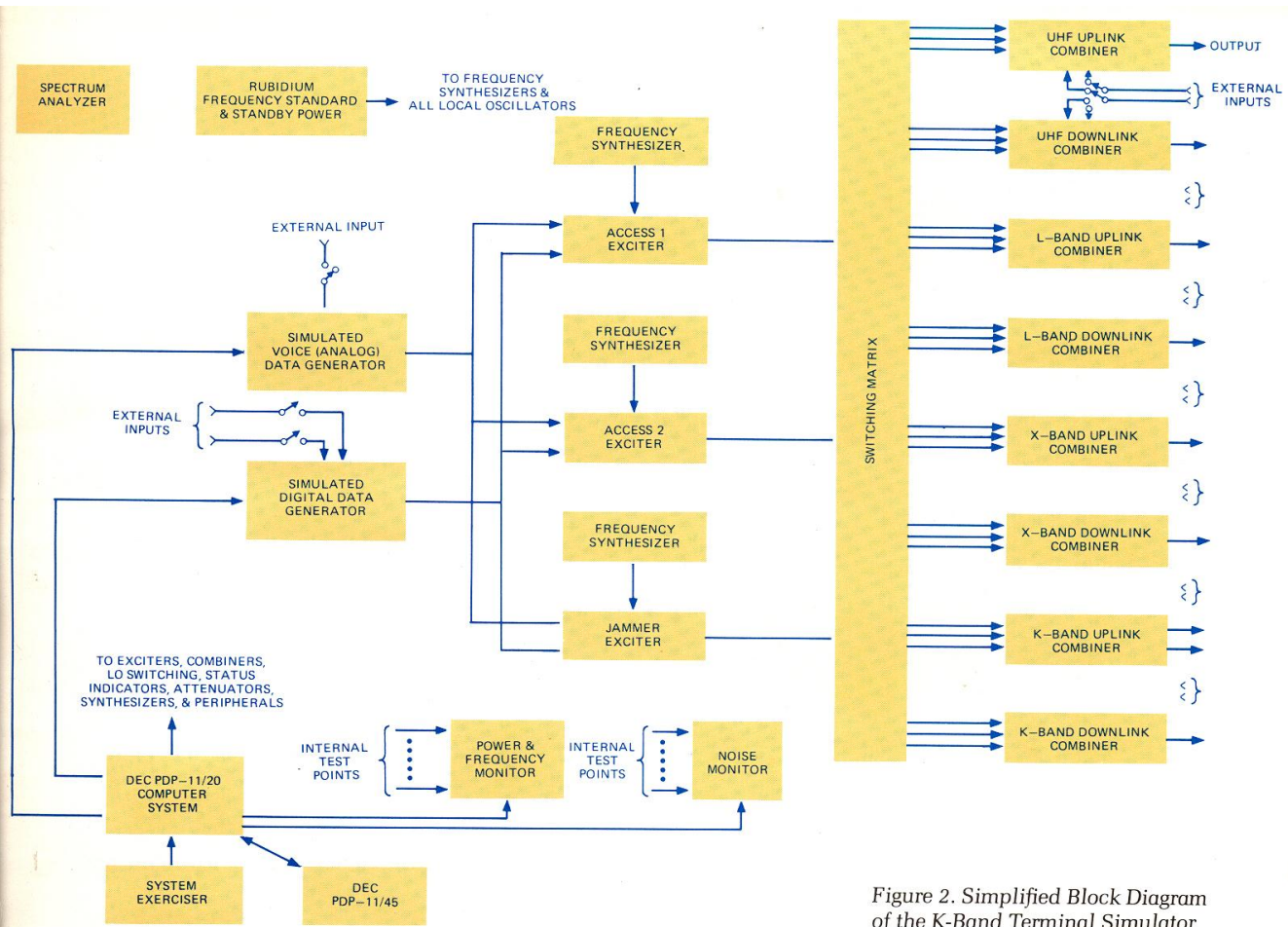


Figure 2. Simplified Block Diagram of the K-Band Terminal Simulator

## The K-Band Terminal Simulator

This equipment was designed by Computer Sciences Corporation to provide an Air Force capability for the analysis, synthesis, and modeling of typical satellite relay communications and navigation links. In addition, the system has been designed so that air-air and air-ground communications links can be evaluated.

The K-Band Terminal Simulator consists of four major components:

- Spectrum and interference generator which provides two simulated communications accesses plus an interference source.
- Grouping of signal combiners which provide the capability of adding two Air Force communications signals with the signals from the spectrum and interference generator.
- Digital controller complex to operate the hardware and indicate its operating status.
- Computer software to support the system.

A simplified block diagram of this equipment is shown in Figure 2.

The two accesses and the jammer are provided in the following frequency bands: 240-400 MHz (UHF), 1200-1600 MHz (L-Band), 7250-8400 MHz (X-Band), and 36.64-37.04 GHz and 37.84-38.24 GHz (K-Band). In each case, the basic signal frequency is obtained by means of a frequency synthesizer which is controlled by a digital computer (DEC PDP-11/20) and synchronized with the output from a Rubidium Atomic Frequency Standard. Since the synthesizers can be controlled to 1-Hz increments, but the output of the synthesizer is multiplied by 16, the minimum tuning increment, 16 Hz, is obtainable in each frequency band.

Each access can be provided as a CW signal, an FM modulated signal, and either a PSK or QSK signal. The FM modulation is computer selectable at a Gaussian noise equivalent of 1, 3, 5, 12, 36, and 60 voice channels. PSK and QSK rates can be chosen by the computer as  $75 \times 2^n$  bps, where n is any integer between 0 and 20 (75 bps to 78.6 Mbps). The jammer



signal can be pulse modulated with the pulse on and off times independently variable from 0.5 to 32,767.5 microseconds. The output power for each access and the jammer in each band is controlled by motorized attenuators driven from the computer. The maximum output power in the UHF band is approximately 0 dBm; in L-Band, approximately -12 dBm; and in X-Band and K-Band, approximately -20 dBm. In all of the bands except K-Band, 99.0 dB of attenuation can be controlled by the computer. In K-Band this value is 50 dB, with an additional 60 dB of attenuation provided by a manually controlled attenuator.

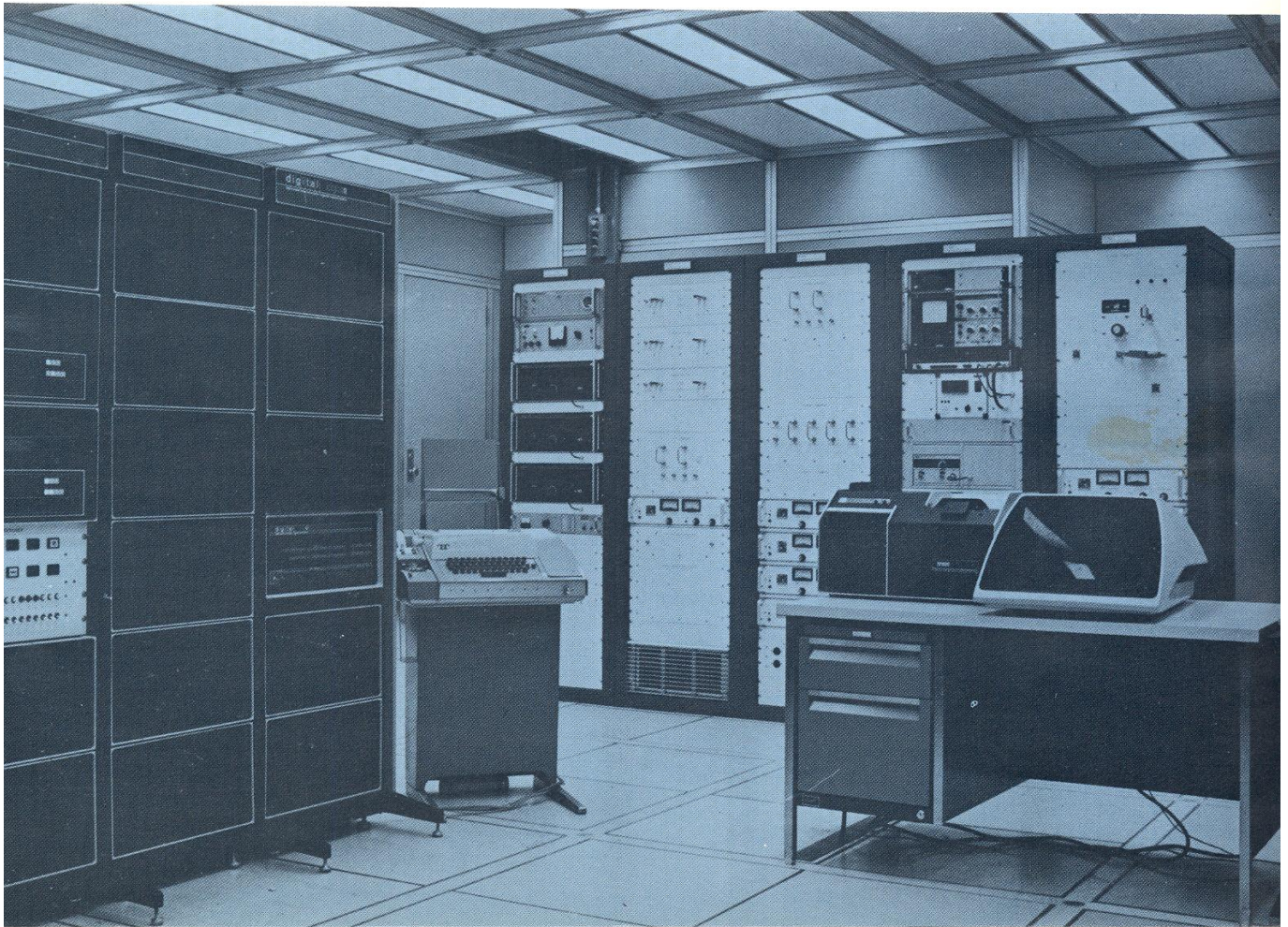
Indicating devices, automatically controlled by the computer, have been included in this system. These devices include a power meter which reads the output power, a digital meter which reads the frequency and the digital modulation bit rate, and a digital meter which reads the noise level into the FM modulator. In addition, a manually operated spectrum analyzer has been included so that spectrum occupancy effects can be observed.

Each access and the jammer has been provided with a fade attenuator which is capable of at least 25 dB of attenuation. These attenuators are controlled by the computer and by a fade pattern entered

into the computer. Each access is also capable of MFSK and frequency hop. In both instances, these effects are real-time changes in the carrier frequency, with the MFSK shifts in frequency usually smaller than the frequency hop. The m-ary FSK signal steps can be controlled by a pattern entered into the system. As many as 32 discrete changes in frequency can be chosen in either MFSK or frequency hop, and the interval between changes in frequency can be as short as 5 milliseconds or as long as several minutes. The change in frequency with each step in MFSK or hop can be as small as 16 Hz or as large as 400 MHz. This system also provides for doppler on both accesses and the jammer. The doppler change in frequency can be programmed in a pattern similar to the fade pattern. Doppler patterns may contain as many as 1008 points and fade patterns as many as 1016 points per pattern. The doppler rate achievable is much greater than known aircraft or rocket capabilities.

The computer central processor is a PDP 11/20 with 4K 16-bit words of 950-nanosecond core and 40K 16-bit words of 800-nanosecond interleaved core memory. All core is byte addressable through the use of eight general-purpose, 16-bit registers. Extended arithmetic functions of multiply, divide,

Figure 3. K-Band Terminal Simulator





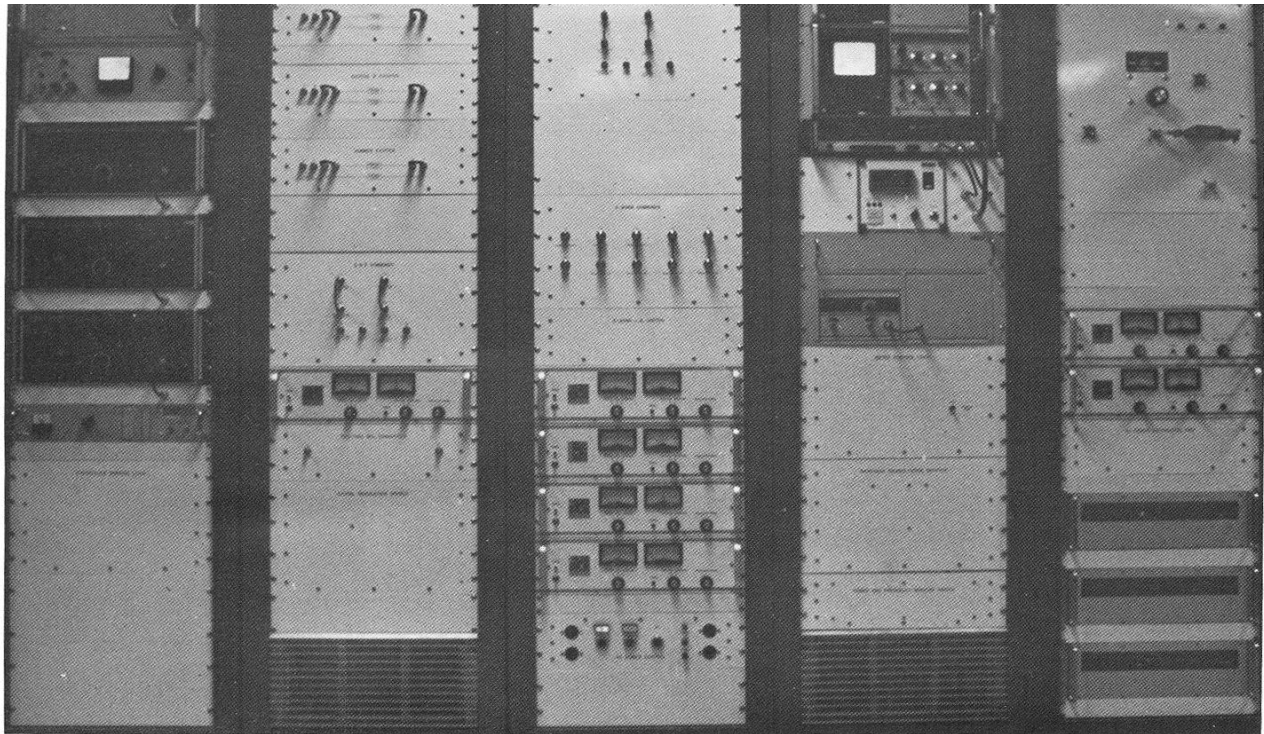


Figure 4. K-Band Terminal Simulator Hardware Racks

normalize, and multiple shifts are provided by a KE 11-A unit. A programmable real-time clock is also included. Fast bulk storage is provided by two 1.2-million-word disk drives. One disk holds all of the operating system while the other stores data patterns, job files, and other user-generated data. One nine-track magnetic tape transport and controller is also provided for additional bulk storage. Interactive input/output (I/O) peripherals include a standard ASR-33 TTY; two alphanumeric video display screens with a display capability of 20 lines of 72 characters each; a card reader that reads 80-column punched cards at 300 cards per minute; a paper tape unit; a 132-column line printer which provides hard copy output of programs and data using a 96-character print set; and an X/Y plotter. The system also provides an analog-to-digital conversion input module for signal inputs utilizing a four-channel high-level input (expandable to 32 channels).

The software subsystem provides the interface between the user and the hardware, the means by which hardware elements are addressed and controlled, and a language designed to be of maximum benefit to the communications engineer. The system parameters used are a simplified English language set of names and values utilizing engineering units such as dBm, MHz, bps, etc.

One of the special interfaces designed into the K-Band Terminal Simulator is the System Exerciser. Through its control panel all addressable devices on the Unibus may be written into or read from and displayed. The list of addressable devices includes all standard peripherals and all core memory. Thus,

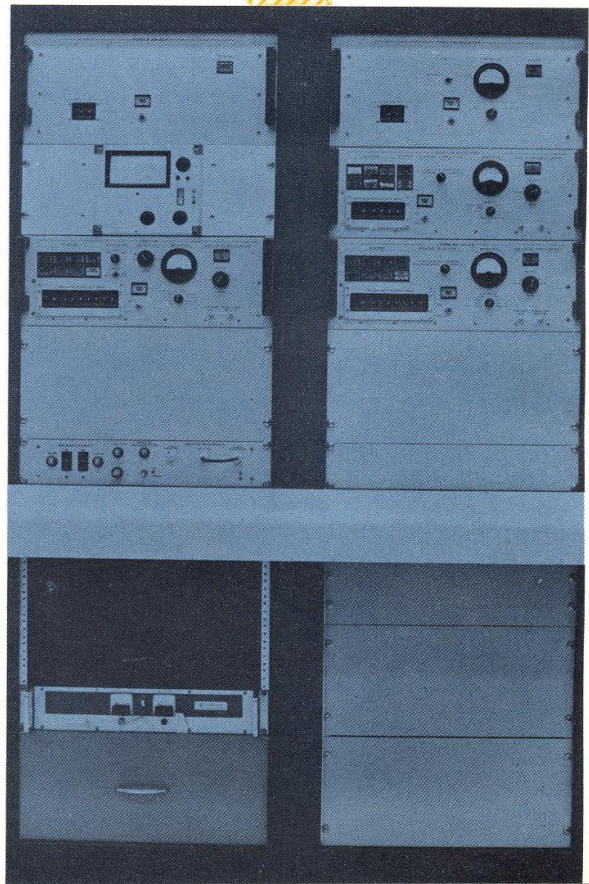
the Exerciser is an invaluable maintenance and debugging device which allows devices and their interfaces to be checked out manually and exercised in the same manner as program I/O instructions, but without the usual programming effort.

Figure 3 shows the K-Band Terminal Simulator as installed at the Air Force Avionics Laboratory. The digital processor is located on the left side. In the center are three means of entering data or conducting a test—teletypewriter, card reader, and CRT keyboard. The white panel on the computer is the System Exerciser. The hardware racks, shown in more detail in Figure 4, are positioned in the background. The first rack on the left contains the three frequency synthesizers, frequency standard, and digital interface between the processor and the synthesizers. The second rack contains the exciters for the two accesses and jammer, UHF combiner, locked oscillator for this combiner, and digital modulation generator. The center rack contains the L-Band and X-Band combiners, four locked oscillators for the X-Band, and the ac power control. The upper half of the next rack contains the measuring equipment—a manually operated spectrum analyzer and computer controlled frequency meter and power meter. The digital voltmeter used to set the modulation is below the power meter. The lower three units contain the necessary logic to interface these devices with the digital processor. The last rack contains the K-Band combiner, its two locked oscillators, and the system dc power supplies and distribution chassis. To the left of the digital processor, and not shown on these photographs, are the high-speed printer and plotter.



8

Figure 5. SHF Airborne Terminal





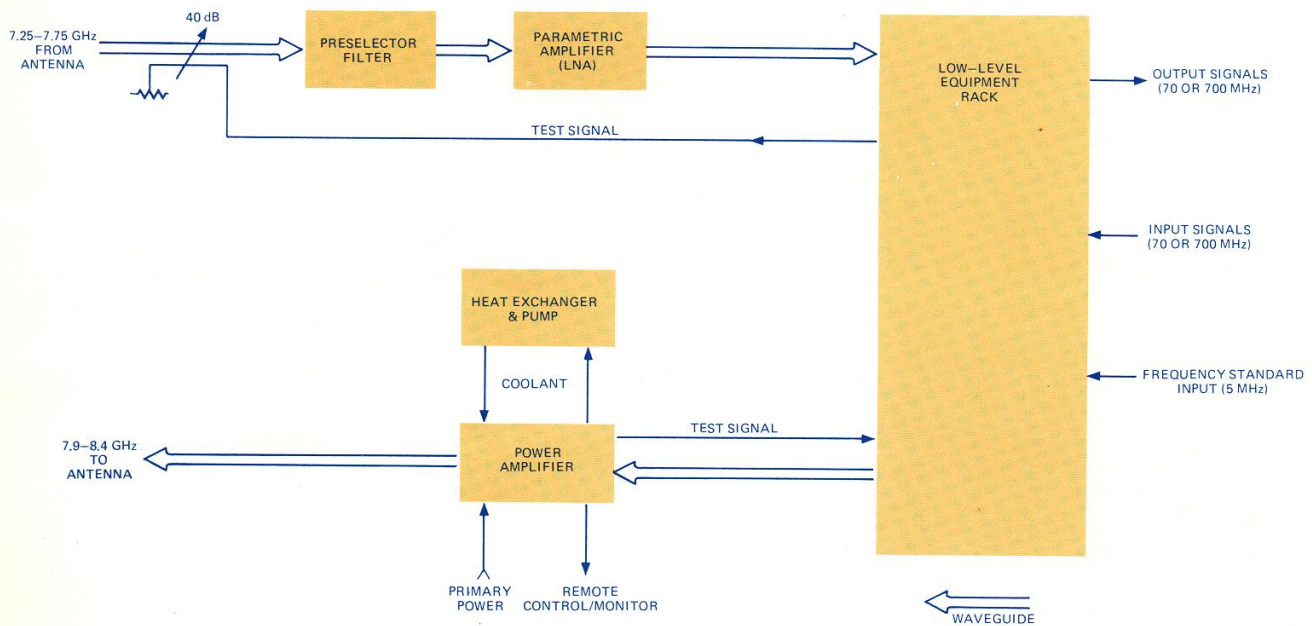


Figure 6. Simplified Block Diagram of the SHF Airborne Terminal

## The SHF Airborne Communications Terminal

The SHF Airborne Terminal, a major component of CSEL, has been designed to cover the frequency range of the DSCS Phase II satellite. Figure 5, a front panel view of this equipment, shows the entire terminal except for the transmitter heat exchanger and pump. For convenience of operation, the equipment has been mounted in a standard laboratory-type equipment rack.

Figure 6 is a simplified block diagram of the SHF Airborne Terminal. As shown, this system is comprised of a receiver and transmitter. The receiver chain consists of a preselector filter, low-noise parametric amplifier, communications receiver, and beacon receiver. The input level to the filter is expected to be in the range of -70 to -140 dBm. A 40-dB directional coupler provides a convenient point for the introduction of test signals without disturbing the noise figure of the receiver. The insertion loss of this coupler, which is less than 0.03 dB, has a negligible effect on the overall system noise temperature. The preselector filter also has a very low loss.

The parametric amplifier is fixed tuned and covers the entire 7.25- to 7.75-GHz receiving band. This unit provides about 30 dB of gain and has a noise temperature of less than 135°K. The output signal from the amplifier is applied to the low-level receiving equipment in the low-level rack, where it is further processed to provide the required outputs.

In the transmit direction, the input signals to the low-level rack are translated to the desired transmitting frequency band for application to the power amplifier. Six preset channels, each 100 MHz wide, are provided by the transmitting amplifier. The final output of the power amplifier can be adjusted from a maximum of 11 kW down to approximately 900 W.

The operating frequency of the communications receiver is controlled by an integral frequency synthesizer. Frequency selection can be made either at the front panel or remotely, with a minimum tuning increment of 10 Hz. This frequency synthesizer is slaved to a remote atomic frequency standard in the K-Band Terminal Simulator.

The beacon receiver serves two primary functions—it provides a 0.5-MHz signal to the tracking receiver for spatial acquisition, and it provides direct and inverted doppler-corrected 5-MHz reference signals to the communications receiver and exciters.

The center frequency about which the beacon receiver operates is controlled by a frequency synthesizer identical to the receiver synthesizer except that the minimum tuning increment is 10 kHz.

Included in this terminal is a test translator which accepts signals in the 7.5- to 8.4-GHz range and translates them to 7.25 to 7.75 GHz. This translator has a 1-dB bandwidth of at least 500 MHz and is flat within  $\pm 0.25$  dB over any 100-MHz segment of the passband.



# Rooftop Antenna Systems

To fulfill its function, CSEL must be able to transmit and receive signals from satellites designed to carry military traffic. To accomplish this, an antenna subsystem is being designed for the Air Force Avionics Laboratory. As shown in the photograph of the antenna mockup (Figure 7), two antennas will be in place at all times. The larger antenna, which has a diameter of 10 feet, is designed to operate in the K-Band. One of two smaller antennas (approximately 3 feet in diameter) will be mounted near the large antenna. The small antennas will operate at either X-Band or K-Band, and will be designed to reproduce the performance of aircraft antennas. The antennas will be enclosed in an inflatable radome (not shown in Figure 7), which is being designed to survive wind gusts up to 100 mph and will allow continuous operations in winds of up to 40 mph.

The large antenna, which is a typical cassegrain feed antenna, utilizes an 11-inch-diameter hyperbolic subreflector with a design goal of 59 dB gain (67 percent efficiency at 34 GHz). By rotating the subreflector, the main beam can be nutated at 65 Hz and the squint angle will be adjusted to yield a 0.5-dB crossover loss for conical scan tracking.

The antenna is mounted on a modified Scien-

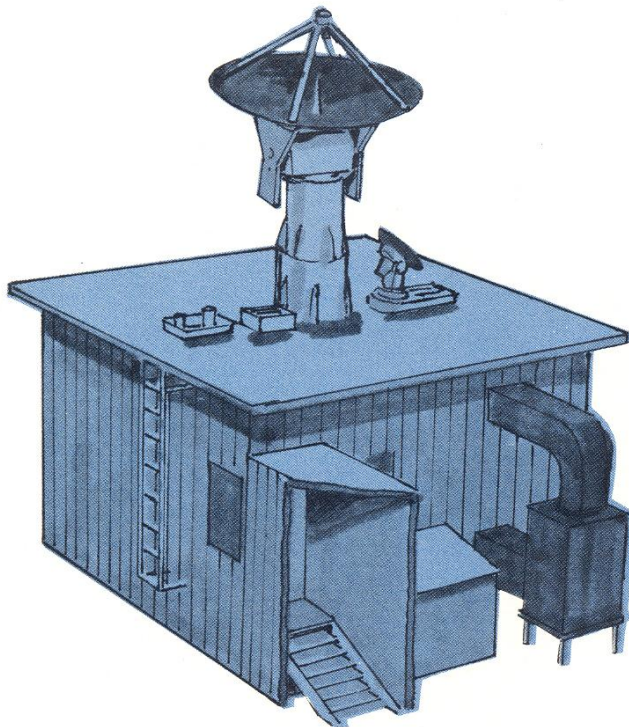


Figure 7. Mockup of the CSEL Antenna System

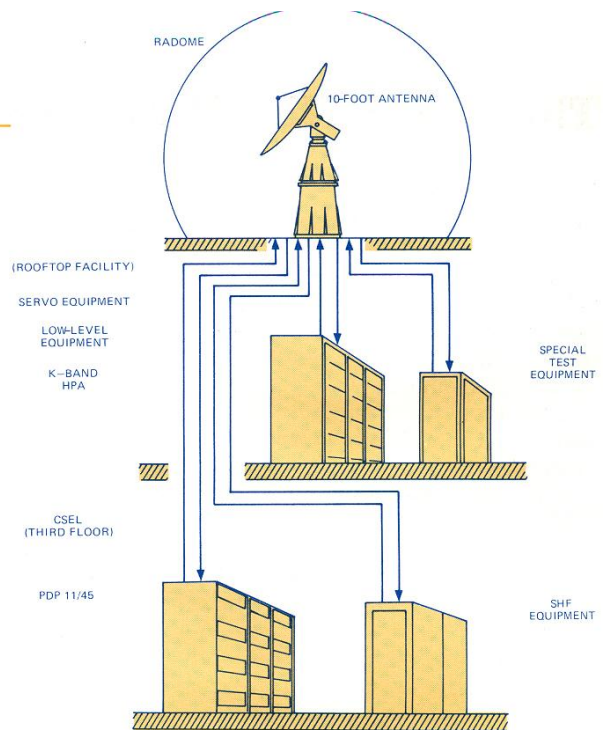


Figure 8. Antenna System Component Relationships

tific Atlanta pedestal. The pedestal servo system will provide variable-speed operation through 360° of azimuth and 90° of elevation. Circular waveguide is used within the pedestal, and the entire RF transmission line loss within the pedestal is designed to be less than 2 dB. The pedestal also includes a low-noise amplifier/down converter, polarizer and polarization switches, filters, and various antenna interfaces.

The antenna pointing system can operate in either an active or a passive mode. In the active mode the antenna is scanned over a circular sector centered around the angular position designated by the operator. When the received signal exceeds a preset threshold the scanning action ceases. In the passive mode, the tracking command for the antenna pointing is derived from a computer using the satellite ephemeris data.

Figure 8 is a drawing of the antenna system showing the relationships between the rooftop antennas, special test equipment, high-power K-Band amplifier, and CSEL located beneath the rooftop system. The figure also shows the system's connection to the PDP 11/45, which will be used for antenna pointing. Included in this rooftop facility are a number of safety features that will protect personnel in the vicinity of the antennas.

The 10-foot antenna has a beamwidth of 0.2° and will be capable of reception and transmission over the 34- to 40-GHz band. This bandwidth will be more than adequate for the anticipated use of this antenna with the LES-8/9 satellites.



# The PSP-FFH/PN Modem

If CSEL were totally dependent upon existing satellites its use would be severely restricted. Since satellite systems are so expensive, they provide only a limited amount of time for users to evaluate the performance of new terrestrial equipments. Furthermore, it would be impossible to test and evaluate airborne terminals before the satellites are launched, thus severely hampering the orderly development of equipment that should be in place when the satellite is launched.

To overcome these problems, CSEL includes the PSP-FFH/PN data terminal which can replicate the performance of a future or existing satellite. This terminal consists of a programmable signal processor (PSP) and the flexible frequency hopping/Pseudo noise (FFH/PN) modem developed for the Air Force Avionics Laboratory by GTE Sylvania. Figure 9 shows a front panel view of the PSP and its associated card reader, and Figure 10 shows the modem.

Each R-F drawer of the FFH/PN modem consists of a transmit and receive wideband frequency synthesizer, transmit/auxiliary generator, and receiver. The transmit/wideband frequency synthesizer, in conjunction with the transmit/auxiliary generator, is capable of producing any one of  $2^{24}$  possible output frequencies centered about a nominal frequency of 70 or 700 MHz. The selection of each frequency is accomplished by a binary controlled, 24-bit parallel input. The frequency synthesizer has

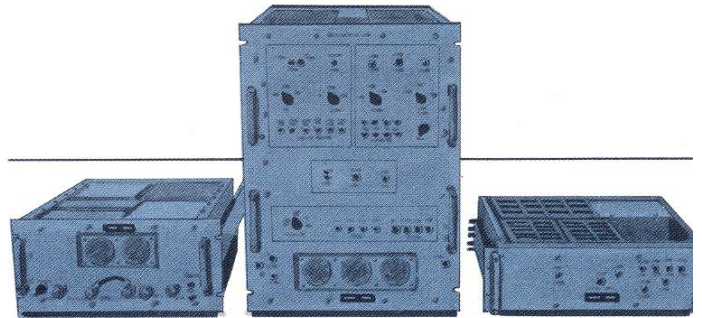


Figure 10. FFH/PN Modem

a settling time of less than 1.5 microseconds. By direct control of two parallel inputs to the transmit auxiliary generator, any selectable output frequency may be PSK or QSK modulated at a rate up to 1.28 MHz. The receive frequency synthesizer, in conjunction with the receiver, is capable of converting a received signal to baseband (i.e., inphase and quadrature components) using as a reference any of the  $2^{24}$  possible frequencies as specified by the transmitter in the 70- or 700-MHz mode. As in the transmit case, the receiver frequency synthesizer is controlled by a 24-bit binary parallel input and has the same specifications as the transmit frequency synthesizer.

To achieve the programmable data terminal, the PSP will interface with the two RF drawers via the transmit and receive frequency synthesizers and the PSP will directly control the 24-bit parallel synthesizer command inputs by programmed logic generated within the computer. The interface also enables the PSP to PSK or QPSK modulate the 70- or 700-MHz output of the transmit generator.

The flexibility of the programmable data terminal to implement, in real-time, various communications functions and techniques is limited only by the basic complexity and bandwidths (i.e., processing rates required) specified by the system that is to be implemented. Since this system will be an invaluable aid in the evaluation of new equipments, an extensive program for its use has been planned.

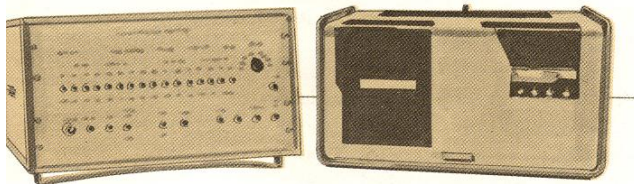


Figure 9. Programmable Signal Processor and Card Reader

# Computers

---

Three minicomputers—Digital Equipment Corporation's (DEC) PDP-11/45 and PDP-11/20 and a PSP built by GTE Sylvania—are used as digital controllers in CSEL.

The PDP-11/20, an integral part of the K-Band Terminal Simulator, provides the means by which the user controls the signal environment. The PDP-11/20 contains 4K 16-bit words of 950-nanosecond core and 40 K 16-bit words of 800-nanosecond interleaved core memory. All core is byte addressable through the use of eight general-purpose, 16-bit registers. Extended arithmetic functions of multiply, divide, normalize, and multiple shifts are provided by a KE 11-A unit. A programmable real-time clock (KW 11-P) generates hardware interrupts for real-time operation.

The PDP-11/45 provides the tracking commands for pointing the rooftop antenna subsystem and loads programs and data into the PSP controller. The PDP-11/45 is a major upward expansion of the PDP-11 family of minicomputers. It is a dual-bus system which allows for connection of semiconductor (MOS or bipolar) memory attaining cycle times of up to 300 nanoseconds per 16-bit word. Sixteen general purpose registers are available for use. Three of these are used as hardware stack pointers for the three different processor operating modes. Multiply, divide, normalize, and multiple shift instructions are standard. A programmable real-time clock (KW 11-P) is also provided.

The PSP computer provides control for the FFH/PN modem. The PSP is a small, high-speed digital computer designed specifically to perform real-time digital signal processing. The computer structure consists of two integrated circuit memory sections (a program memory which utilizes 32-bit words and a data memory which utilizes 16-bit words), an arithmetic section, an address modification section, a control section, and an input/output section. Multiply times of 750 nanoseconds can be attained in the direct addressing mode.

Computer-to-computer communications is provided between the PDP-11/45 and PDP-11/20 and

between the PDP-11/45 and the PSP (see Figures 11 and 12). The link between the PDP-11/45 and the PDP-11/20 is a full-duplex, 9600-baud asynchronous line connected to the bus of each computer. The PDP-11/45 to PSP link is a parallel 16-bit interface with interrupt control.

Bulk storage peripherals are provided for storage of programs and data. Both the PDP-11/45 and PDP-11/20 contain two fast-access disk drives (RK05s) which provide 1.2 million words of storage per drive. One nine-track magnetic tape transport provides additional bulk storage capacity on the PDP-11/45.

A standard ASR-33 TTY and a VT05 alphanumeric video display screen, each having a display capability of 20 72-character lines and each equipped with a keyboard, are provided for both the PDP-11/45 and PDP-11/20. These peripherals provide the user with the capability for interactive communication with the CSEL software.

Both DEC computers contain a high-speed paper tape reader and punch. The reader is an optical unit operating at speeds up to 300 cards per minute and the punch has a maximum rate of 50 cards per minute.

An LP 11-KA 132-column line printer provides quick hard copy output of programs and data using a 96-character print set. A CR11 tabletop card reader that reads 80-column punched cards at 300 cards per minute provides easy program and data entry. Both of these peripherals can be switched between the PDP-11/45 and PDP-11/20 by means of two controller switches connected to each computer's bus.

A Calcomp Model 563 29-inch incremental plotter provides hard copy for graphical outputs using a 0.005-inch step size in both X and Y directions.

The PDP-11/20 contains an analog-to-digital conversion input module for signal inputs using a four-channel (expandable to 32) high-level input with program-selectable input ranges of 0 to 2.5 volts, 5.0 volts, or 10.0 volts unipolar and ranges of 0 to  $\pm 1.25$  volts or  $\pm 10.0$  volts bipolar. The digital output is 10 bits plus a sign bit.

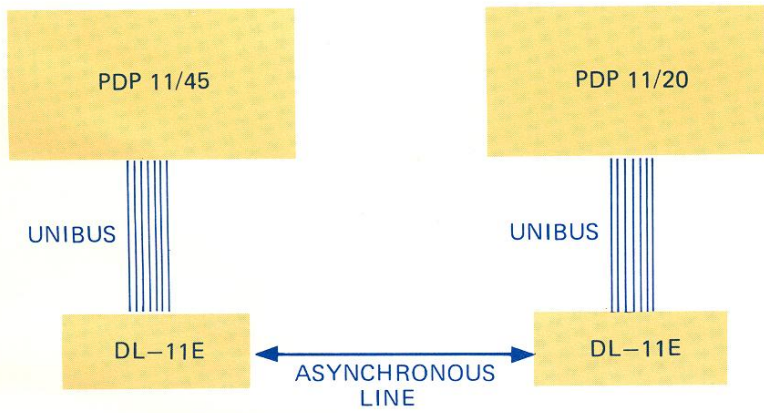


Figure 11. Computer Interface

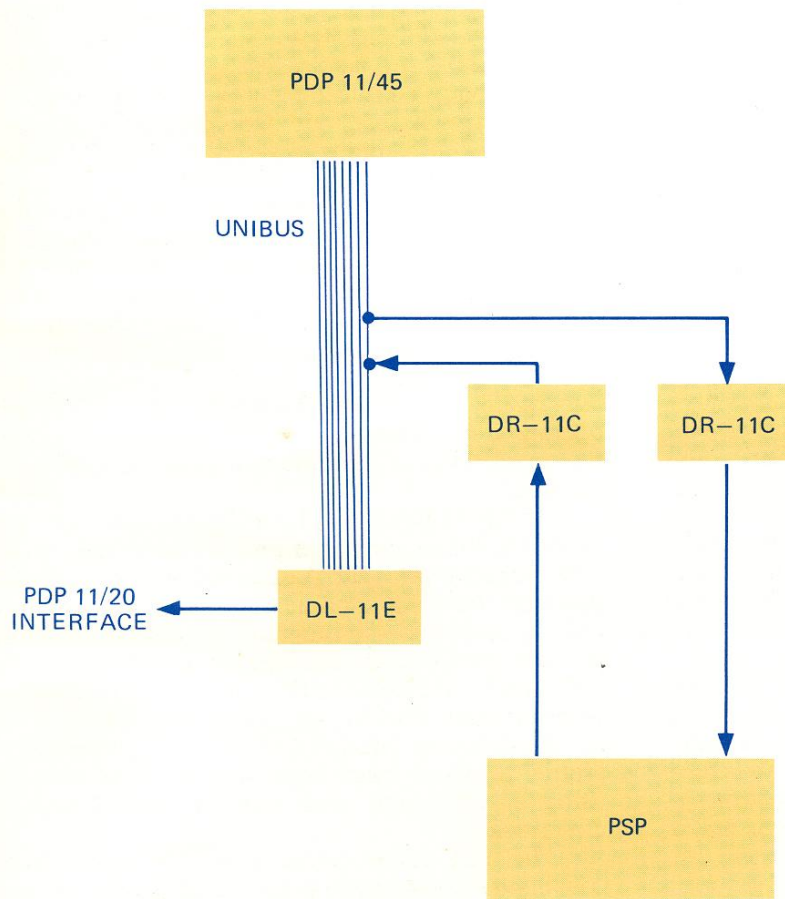


Figure 12. PDP 11/45-PSP Interface



## **Expert Communications Link Manager (1994-2003)**

**Background:** Today's "high-tech" aircraft have more equipment than ever before. Pilots are expected to know not only the purpose of each switch and control, but also its location almost without looking. To maintain air superiority, pilots must fly faster and more precise than the other guy. Even a few seconds diversion to look for a radio switch can spell disaster.

One solution is to have an assistant on board to share the flying duties. The assistant wouldn't be a human, but an electronic device such as "R2D2" from "STAR WARS" fame. The pilot would simply give a voice command and his "assistant" would immediately configure a communications link. For example, if the pilot wanted to talk on the tower frequency, he would give the command "tower". The "assistant" would decode the command into "give me the nearest tower frequency," find the nearest airfield based on the INS or GPS location of the aircraft, find the tower frequency for that airfield in the database, determine which radio to use, configure the radio and tell the pilot that the radio is ready.

**Expert Communications Link Manager (ECLM) Development:** The Air Force Wright Laboratory (AFWL) began the ECLM program during the summer of 1994 as an In-House Effort. Reserve Major Anne Hocutt was assigned to conduct a study to gather information on research projects where voice recognition was used. The results of the study provided the background information necessary to begin the In House program.

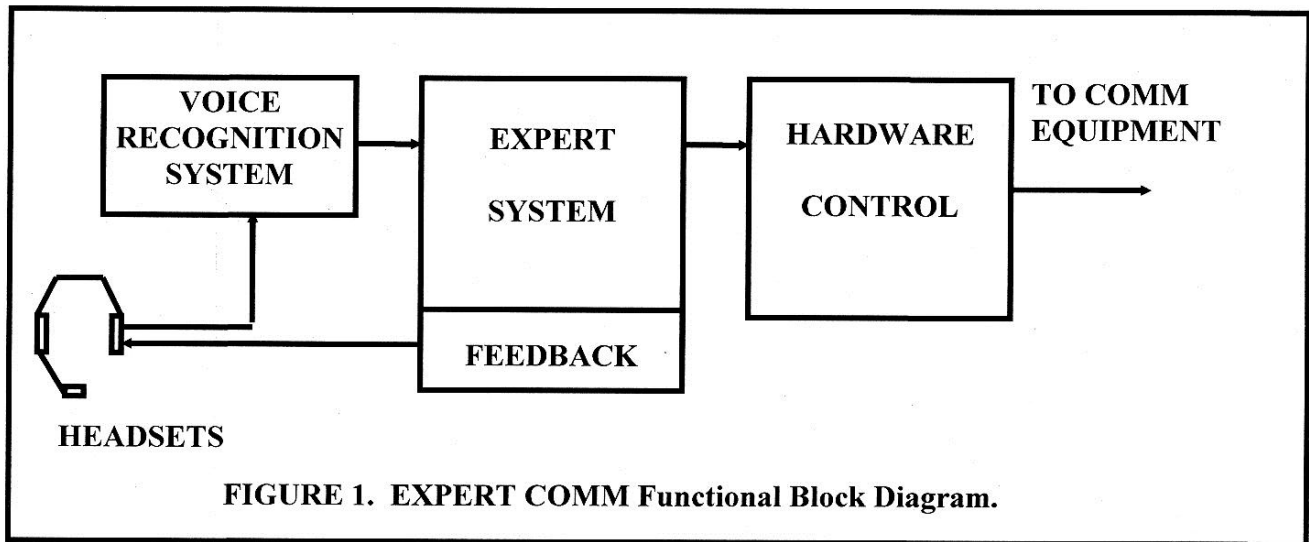
In January 1995, AFWL began the active In-House phase of the program with Larry Minor as the principle investigator. To expand the ECLM knowledge base, volunteers were gathered as a panel of "experts" specifically in cockpit communications. Pilots with various aircraft experiences were chosen. In addition, four engineers with voice recognition experience were also asked to participate. The make-up of the expert panel is shown below:

### # People and Expertise

- 1 KC-135 pilot
- 1 F-16 pilot
- 1 AC-130 pilot
- 2 C-21 pilots
- 2 F-15 pilots
- 4 engineers

The members of the expert panel answering questionnaires and telephone queries on different aspects of the program.

**Equipment Configuration:** The ECLM system consisted of four parts: Voice recognition system, expert system, hardware control and audio feedback, Figure 1. The voice recognition system converts voice commands into binary commands. The expert system acts on the commands from the voice recognition system by taking into account current aircraft location (from INS), radio capabilities and a database of frequencies to decide which radio and frequency to select. The expert system then executes the pilot's request by sending the appropriate command to the hardware control equipment. The hardware control tunes the radio frequency and connects the proper audio signals between the radio and headsets. When the hardware is properly configured, an audio feedback message is generated by the Expert System to inform the pilot that the command was executed.



**Voice Recognition System:** The voice recognition hardware consisted of the VRS1290 Voice Recognizer Synthesizer board from ITT Aerospace/Communications Division. The VRS 1290 was designed to be inserted into a full-size 8 bit internal PC card slot. This particular voice recognition card had demonstrated a high recognition rate in noisy environments.

**Expert System:** The Expert System consisted of a Pentium microprocessor (100 MHz), a General Purpose Interface Bus (GPIB) card and a sound card (used for the feedback system). The software program, APP1.EXE, runs under windows version 3.1 and was the software driver for the system.

The expert screen was made up of windows that display status of the major software modules (Inputs, GPIB Outputs, Expert Controller, Comm1, Comm2, Comm3, Comm4 and Feedback). There were three window control buttons: Run/Stop, Test and Exit and a Running Mode Indicator located in the bottom right corner.

**Hardware Control Equipment:** The hardware control consisted of two HP3488 IEEE-488 to digital control units, an audio switch and three laboratory control boxes. The expert microcontroller passed commands over the IEEE 488 (GPIB) BUS to the HP3488 units. The HP 3488s set the appropriate digital output lines in the addressed slot to control the radios. The radio's mode and frequency were set by passing four 8-bit words to the Lab Control Boxes. The Lab Control Box then rotated the 32-bits to the radio to complete the command. The microphone audio, received audio and push to talk (PTT) signals also needs to be properly routed. This is accomplished by passing a command to the Audio Switch Unit via HP3488, address #2, slot four. The digital lines controlled the signals by switching relays within the Audio Switch Unit. LED lights on the front of the Audio Switch Unit indicated the status of the relays.

The SATCOM frequencies were selected from twenty channels which are manually preset to the desired frequencies. An IEEE 488 command from the expert system sets digital lines in the Audio Switch Unit which were routed to the SATCOM receiver to select the desired channel.

**Audio Feedback:** Everything done in the everyday world requires some sort of feedback so that the operator knows the action requested was, in fact, accomplished. For example, take the case of turning on a light. In addition to the light coming on, an audio click is often heard when the switch changes from the "off" to "on" position. Even if the light is located outside our field of view, it is assumed that

the light came on because of the audible click. Things are more complex within the airborne environment. The pilot's main focus is on the mission, which is most likely outside the cockpit, making visual confirmations inside the cockpit undesirable. In addition to the workload, the pilot needs to know that two things happened correctly. First, that the speech recognition system correctly heard the command and secondly, that EXPERT COMM correctly configured the communications equipment. The feedback system was designed to provide the pilot with both, without interfering with his other activities.

Two types of audio feedback were employed. First, a single tone, (approx. 500 Hz for 1/4 second), was used to signal the pilot that the speech recognition system was *not able* to process his last voice command to a valid syntax. To recover, the pilot would simply repeat the command. The second type of audio feedback was voice, (a WAV file), heard over the headphones. Each feedback word was recorded in a separate WAV file and stored on the hard drive. A female voice is used because research has shown that the female's voice is better understood in stressful environments, probably due to the higher frequency components. Major Anne Hocutt volunteered to be EXPERT COMM's voice. The WAV files selected and the order played was determined by the information in the four variables; comm, frequency, airfield and contact.

**Conclusions from Phase I:** The EXPERT COMM program not only demonstrated that it was possible to use voice commands to activate communications equipment, but at a higher level. With only a one or two word command, the pilot could instantly have any frequency within the expert system's database. The pilot no longer needed scraps of paper to keep track of frequencies or memorize which frequency was loaded in which channel. The pilot no longer needed to calculate his location when choosing which frequency to use. The "electronic flying assistant" could do this and more.

The hardware showed no unacceptable delays in any of the following areas:

- command recognition
- command decode
- airfield search
- frequency search.
- link configuration
- feedback execution

In every case the software completed all of the tasks above in less than a second from the time the command was given.

**Phase II:** In May 1996, following the successful completion of Phase I, AFWL awarded contract F33615-96-C-1845 to Magnavox Electronic Systems in Fort Wayne IN for the development of flight hardware to demonstrate the ECLM concept. Magnavox Electronic Systems was subsequently purchased by Hughes Defence Communications and the Hughes Division bought by Raytheon Systems. Raytheon went on to develop flight hardware and deliver it in 1999.

**Phase III:** In 1999 the Air Force Research Laboratory (AFRL) formerly AFWL, contracted with SelectTech Corp of Centerville OH to flight test the ECLM. Following an extensive ground test checkout of the system, the ECLM hardware was installed in the 4950<sup>th</sup> Test Wing SATCOM aircraft, C-135/372 at WPAFB. In February 2002 airborne tests were conducted aboard the aircraft enroute to Gander Newfoundland and on the return flight.

On the test flights, the voice recognition system provided inconsistent results, due to the high background noise level in the aircraft in flight. The mapping function worked well and provided the operator an accurate indication of the aircraft's location during the entire flight. The ECLM UHF terminal was able to transmit to the Rooftop UHF radios at WPAFB out to 160 nautical miles in the manual selection mode.

**Transition:** AFRL's ECLM program demonstrated the potential of a pilot assistant to reduce the workload of current pilots. The technology of voice recognition has improved dramatically since the 1990s and offers solutions for even noisy environments like an aircraft cockpit. The technology developed by the ECLM program was shared with the US Army at Fort Monmouth who worked on a similar program for Army helicopters, and with the Air Force Human Research Laboratory which is conducting voice recognition and expert systems projects.

### **References:**

Beckett, P., **Voice Control of Cockpit Systems**: British Aerospace P.L.C.; AD-PO05 601; 1987.

Dunkelberger, Kirk A.; **Expert Communications Link Manager Overview and Progress**; Raytheon Systems Co.; Proceeding of the SPIE Vol.3393, pp 144-153; Digitization of the Battlespace III.

Dzugan, Michael; **Design Alternatives for an Expert Communications Link Manager**; Flight Information Systems Division; US Army; Ft. Monmouth NY; Contract DAAB07-90-G-H007 with ARINC Research Corp.; March 1993.

Miner, Lawrence A.; **Expert Cockpit Communications Link Manager**; Air Force Wright Laboratory; WPAFB OH; WL-TM-96-1058; 15 March 1996.

Riffle, T. and Heddings, C., **ARC 164 LABORATORY CONTROL BOX (ALCB)**, Air Force Wright Aeronautical Laboratory; WPAFB OH; AFWAL-TM-88-12-AAAI; 31 May 88.

Suntharalingam, P., **A Test on the Reliability and Performance of the Verbex 4000 Voice Recognizer**; Princeton University report number ARO 20155.6-MA; DITC No. A169066; September 1985.

Williamson, D.; **Flight Test Results of the AFTI/F-16 Voice Interactive Avionics Program**; Proceedings of the Voice I/O Systems Application Conference (pp. 335-345). Alexandria, VA; October 1987.

Williamson, D. and McDowell, J.; **The Implementation of a Voice Actuated Radio Management System in a C-135 Aircraft**; Proceedings of the Voice I/O Systems Application Conference (pp. 144-151). Alexandria, VA; September 1986.



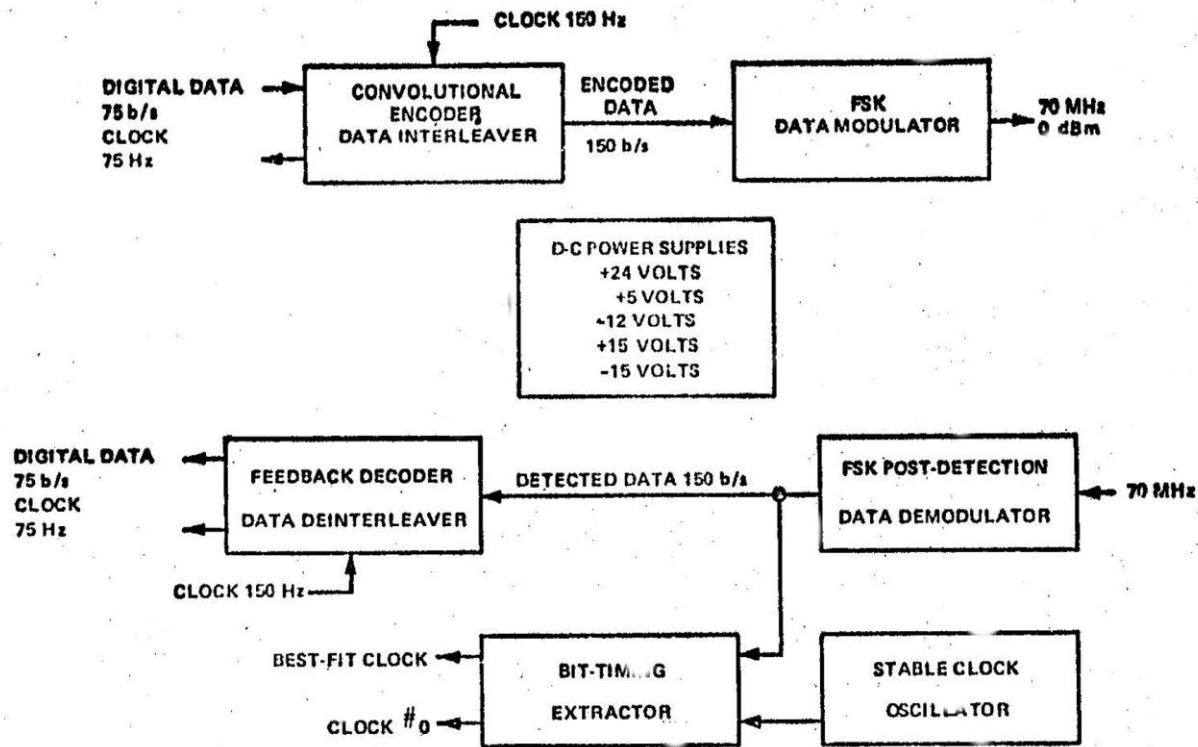
## Fade-Resistant Modem (1975-77)

**Background:** With the fielding of the AFSATCOM UHF SATCOM system it became apparent that due to the low link margins, unacceptable message error rates could occur when the operational aircraft encountered deep multipath fading, or equatorial/polar ionospheric scintillation fading. In an attempt to improve the communications link performance, the Air Force Avionics Laboratory (AFAL) undertook the in-house development of a fade-resistant modem under Project 1227, Advanced Microwave Communications.

**Fade-Resistant Modem Development:** The Fade-Resistant Modem design utilized a simple modulation-encoding scheme to improve the bit-error-rate (BER) performance of a low rate digital UHF satellite communications system operating with mobile terminals, such as aircraft, and where signal fading due to multipath and/or ionospheric scintillation is a system design consideration and the traditional diversity techniques fail to adequately improve system performance.

**Modulation and Encoding Scheme:** There are a number of basic performance requirements of a modulation-encoding scheme (a modem) utilized in a UHF satellite communications system where signal fading due to multipath and/or ionospheric scintillation are considerations in system design. In general, the modem should have a rapid signal acquisition time without a substantial tradeoff in BER performance. This rapid acquisition time is necessary because the received signal level from the satellite would be intermittently dropping below threshold due to the effects of signal fading and the system would be constantly reacquiring the signal. Second, the modem should have the power to correct "burst" errors caused by fading. This is required because of the duration of the signal fade. Consequently, digital errors often occur in bursts. Third, the modem should be capable of deriving a stable clock which can be adequately maintained during signal fades. This requirement is due to a scheme normally utilized in error-correction codes where the ordinal location of a bit in a digital sequence is important to the error correction process. Therefore, the digital bits must be accurately counted even though some of the bits may be in error due to a signal fade.

Figure 1 shows a block diagram of the Fade-Resistant Modem (FRM), which meets the basic performance requirements described above. The modem contains a simple binary frequency-shift keyed (FSK) modulator with a post-detection demodulator. The modulator section of the FRM consists of two stable crystal oscillators separated in frequency by 2500 Hertz (Hz), with one oscillator frequency 1250 Hz above 70 Megahertz (MHz) and the other oscillator 1250 Hz below 70 MHz, and a solid state switch. The digital sequence controls the solid state switch with the lower frequency oscillator representing one binary state (mark) and the higher frequency oscillator representing the other binary state (space). The output of the solid state switch feeds the associated system up/converter. The associated system down/converter feeds the FSK demodulator. In the demodulator the signal is amplified and converted to the 10.7 MHz frequency spectrum. The 10.7 MHz signal is fed through a 5 kilohertz (kHz) bandwidth channel filter and through an amplifier-limiter. The output of the limiter is split, with one output fed to the mark channel and the other output fed to the space channel. Each channel has a 2 kHz bandwidth filter with the center of the frequency passband of each of the two filters separated by 2500 Hz. The energy in each channel is detected and fed to an integrator. The outputs of the two integrators are compared to determine mark and space information. The output of the demodulator is a binary signal indicating which channel has the greater amount of energy.



**Figure 1 Fade Resistant Modem Block Diagram**

The general scheme of an error-correction code is to add additional bits to the digital information in such a way that certain digital patterns, or sequences, are expected at the receiving end of the system. If the received sequence is incorrect, the incorrect bit in the sequence can be identified and corrected. The encoder-decoder section of the FRM utilizes convolutional encoding with feedback decoding, with a code rate of one-half. For a code rate of one-half the encoder adds one parity bit for each information bit. This results in a change in the input data rate to the encoder of 75 bits-per-second (b/s) to 150 b/s at the output of the encoder. This decoding algorithm is capable of correcting any three errors out of twenty-two consecutive symbols, where symbol refers to a bit in the binary sequence, either information or parity. The approximate BER performance of the encoder-decoder is given by the following expression:

$$P_{out} \approx 2000 P_{in}^4$$

where  $P_{in}$  is the channel BER at the decoder input and  $P_{out}$  is the decoder output BER. This expression is a good approximation of BER performance as long as  $P_{in}$  does not exceed .05.

Because the FRM was conceived to operate with "burst" errors, data interleaving is used to spread adjacent symbols after the data has been encoded. Then at the receiver end of the system, and before the symbols are decoded, the deinterleaving of the symbols tends to spread the errors that may have occurred in bursts and the power of the decoding algorithm can be utilized to correct the errors.

If the separation of adjacent symbols at the output of the interleaver is 256 (this separation is called the interleaving depth), the system could withstand a fade in signal strength of up to a minimum of 5.12 seconds and yet correct all the errors caused by the signal fade. Since adjacent symbols are separated in time by approximately 1.71 seconds (256 times 1/150) and at least three symbols must be in error, the

fade in signal strength must last more than 5.12 seconds to affect three symbols. Since the time required for a twenty-two consecutive symbol block to be transmitted is approximately 37.5 seconds (22 times  $1/150$  times 256), if another signal fade occurs, in addition to a 5.12 second fade, during a 37.5 second time interval, the decoder may not be capable of correcting all the errors that were caused by the combination of the signal fades. In general, the combination of encoding and interleaving gives the system the power to withstand various combinations of signal fades over a 37.5 second time interval of up to 5 seconds and yet pass essentially error-free data.

There are basically two problems, among other considerations, associated with the error-correction scheme described above. First of all, the interleaving of the encoded symbols causes a time delay in data transfer. Because adjacent symbols at the output of the encoder are separated in time by the interleaving process there is a time delay. The time delay is a function of the interleaving depth and the data rate. If the time delay is reduced by reducing the interleaving depth, the time duration of a signal fade which the system can tolerate by correcting the errors which occur as a result of the fade, is also reduced. For example, with an interleaving depth of 256 the system can tolerate a signal fade of up to 5.12 seconds but with an interleaving depth of 128 the system can tolerate a signal fade of up to 2.56 seconds.

The second problem associated with the error-correction code is in the timing in the decoder. Although the system can tolerate fades in signal strength the system must maintain an adequate timing at the receiving end of the system. Even though errors are generated as a result of the signal fade, the ordinal location of the symbols must be maintained. If a symbol is added or deleted because of inaccurate timing at the receiving end of the system, a large number of errors will result. Therefore, the accuracy of the timing at the receiving end of the system must be maintained even during signal fading conditions.

One technique that is often used to derive bit-timing at the receiving end of the system with modulation schemes similar to that used in this modem is the phase-lock loop. With the phase-lock loop, the phase relationship between the detected output of the demodulator and a local frequency standard are compared. The output of the comparator (phase detector) is used to derive a clock which is in phase with the digital output of the demodulator. Due to the structure of the signal fading which can occur as a result of ionospheric scintillation or multipath, and primarily the duration of the signal fades, the phase-lock loop is not necessarily the ideal technique for deriving bit-timing under these conditions.

Another approach for deriving bit-timing from a binary sequence where fading due to ionospheric scintillation is a problem would be to extract timing when there is a sufficiently strong signal and make no changes in the timing during fades. Digital systems are normally designed so that transitions in the binary sequence occur at multiples of a fixed time interval. Transitions in the binary sequence other than at these fixed time intervals are generally due to disturbances in the transmission channel. These disturbances may be the result of a number of factors including signal fading and/or interference.

By analyzing the time relationships of transitions in the binary sequence, switching of the binary sequence which occurred due to fading in the channel (invalid data) can be distinguished from the proper binary sequence which resulted from a sufficiently strong signal (valid data). Bit-timing could then be derived during a valid data time interval and updated only during valid data time intervals which follow. One problem with this technique is in the stability of the clock selected for use as the system clock. This clock must remain stable during the invalid data interval.

A novel bit-timing extraction technique is used in the FRM to derive a stable clock for use in the receiving end of the system. The clock is derived directly from a stable frequency source (the standard) so that the derived clock has essentially the same stability as the standard. Eight distinct clocks are derived from the standard, with all eight clocks of the same frequency but displaced in phase by a difference of 45 degrees from adjacent clocks. At least one of these clocks can be used as the clock for processing. Since the phase relationship between the binary sequence and the clock is normally not required to be perfect, the selected clock should be sufficient for use in the deinterleaver-decoder at the receiving end of the system. Under these conditions the clock would be selected, or updated, during a valid data sequence and would hold during an invalid data sequence.

Data interleaving is only required when the system operates with "burst" errors. When the system operates with random errors the interleaving depth could be reduced, thus reducing the time delay. Even with no data interleaving the encoding process provides a differential improvement in performance over a channel with no encoding. In addition, the extent of error-correction occurring in the decoder could be used to authenticate data where there is automatic processing of the received information.

**Fade Resistant Modem Test:** The fade resistant modem was installed in AFAL airborne testbed, C-135 662. The AFAL ground station at Wright-Patterson AFB, Ohio transmitted binary frequency-shift keyed (FSK) teletype test format via the Atlantic Gapfiller (UHF transponder type) satellite. This uplink signal was transmitted at 100 watts to ensure that the quality of the received messages was a function of the downlink signal. The downlink signal was received on Aircraft C135/662 located near the equator in Peru, using the AFAL antenna combiner (UHF to 70 MHz down-converter), Fade Resistant modem and TGC-14 teletype system.

The equatorial ionospheric disturbance (scintillation) varies as the ion clouds drifts between the aircraft and satellite. The fade frequency and fade depth of the signal was dependent upon the speed and density of the ion clouds. The scintillation predominantly occurs around dusk and travels in an easterly direction.

The receive capability of the fade resistant modem was tested during both ground and airborne testing. The ground test was accomplished with the aircraft parked at the Lima, Peru International Airport, and the natural drift of the ionospheric disturbances passing between the aircraft and the satellite. The airborne portion of the test was accomplished during the flight to Lima, Peru from Wright-Patterson AFB OH and the return flight. There were also two local flight tests flown. The first was over two local ground stations that were also measuring the scintillation levels for further correlation with our data. The second was an elongated figure-eight pattern with the long legs calculated to be within the same direction and speed as the ion cloud movement. This was to allow for a nulling effect upon the scintillation fading.

**Test Results:** The threshold ( $10^{-3}$ ) BER of the fade-resistant modem was measured at Pr/No of 41 dBm. The modem utilizes a 150 bps coded data stream and a post detection filter detection technique. The modem operated with 100% copy with a 4 dB margin thru 15 dB fades with a fade duration of up to 5 to 6 seconds. It operated with a 3 dB margin thru 18 dB fades and a fade duration of up to 4 seconds. At the 2 and 1 dB margin points the modem operated with 100% copy thru fade depths of 15 db with up to 3 seconds and 2 seconds fade duration, respectively. With 4 dB margin and 15 db fades for 8 to 10 seconds, the modem will not hold lock and, consequently did not copy. When the unit had a 2 dB margin with 18 db fades lasting 2to 3 seconds in duration, the modem copied approximately 60% of the messages error free.

**Conclusions:** The fade resistant modem worked as designed. The unit will work thru 12 to 15 dB fades with 3 second duration. With a 2 dB margin, when the depth of fade decreases, it will still operate even though the fade duration increase up to 5 seconds in duration with the margin remaining constant. The fade resistant modem is capable of correcting errors caused by fade durations of greater than 5 seconds with fade depths of greater than 15 dB.

**Technology Transition:** The technology proven in the Fade Resistant Modem was transitioned to the UHF Dual modem which went into production as the MD1034. Over 1,000 units were produced and installed in SAC aircraft.

**References:**

Fischbach, Wayne O.; **Fade Resistant Modem Operation with Ionospheric Scintillation**: Air Force Avionics Laboratory; WPAFB OH; AFAL-TM-77-40-AAD; 1 July 1977.

Foshee, James J.; **Operation and Maintenance Manual for Fade Resistant Modem**: Air Force Avionics Laboratory; WPAFB OH; AFAL-TM-76-7-AAD; 22 January 1976.

Foshee, James J.; **A Bit-Timing Extraction Technique**: Air Force Avionics Laboratory; WPAFB OH; AFAL-TR-76-149; June 1976.

Foshee, James J.; **A Bit-Timing Extraction for Use in a UHF Satellite Communications Channel Disturbed by Ionospheric Scintillation**: Wright State University; Dayton OH; Masters Thesis; June 1976.

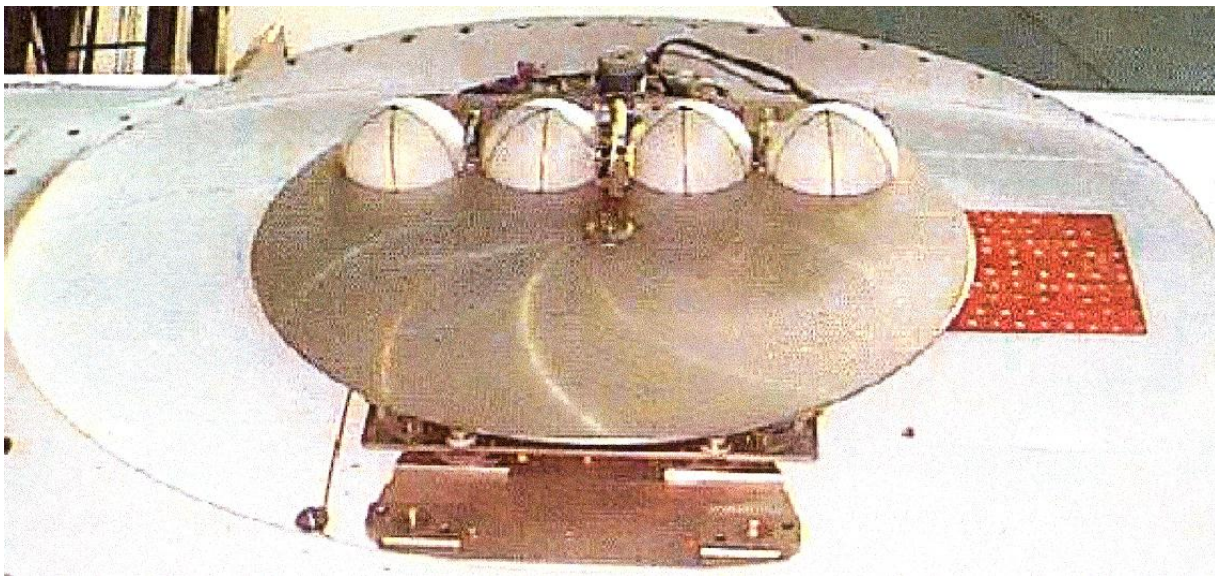
Foshee, James J.; **Fade Resistant Modem Interim Test Report**: Air Force Avionics Laboratory; WPAFB OH; AFAL-TM-76-53-AAD; 1 December 1976.

## GBS Airborne Antenna (1999-2001)

**Background:** Airborne microwave satellite communications systems require a high gain antenna on the aircraft to close the link. Historically, parabolic dish antennas have been used on the aircraft and these tend to be big, requiring an expensive radome installation (typically over \$1 million) to cover the dish. Phased array antennas have a much lower profile and don't require a large radome, but the arrays tend to be expensive to produce and have limited spherical coverage. A novel low-profile antenna was developed by the Datron Corp based on the Luneberg lens for commercial applications. With the advent of the Global Broadcast Satellites (GBS), the Datron antenna was considered for some military applications.

**GBS Airborne Antenna Development:** The military community began using the Milstar satellite system in the late 1990s for low data rate (i.e. 75 to 2400 bps) two-way communications. Milstar systems are deployed in ground, shipboard, and airborne applications and use the 44 and 20 GHz frequency bands, respectively, for uplink and downlink communications. Development and installation of the Global Broadcast Service (GBS) began in the late 1990s with transponders on three UHF Follow-On (UFO) satellites to provide high data rate (i.e. up to 23.5 Mbps) broadcast service to ground and shipboard users. The GBS uplink/downlink frequency bands are 30/20 GHz, respectively. Interest has been expressed by the DOD in demonstrating an airborne capability that will allow non-simultaneous reception of the Right Hand Circular Polarized (RHCP) signals of Milstar and the Left Hand Circular Polarized (LHCP) signals of GBS on a single antenna. Transmission to the Milstar satellite was planned to remain via the Milstar dish antenna for the initial phase of the effort.

In 1999, the Air Force Research Laboratory (AFRL/IFGC) at Rome NY awarded a development contract to Datron/Transco Systems Inc. of Simi Valley CA to develop a 20 GHz receive antenna and radome used for an airborne demonstration of their Luneberg Lens Antenna System. The



**Figure 1 Luneberg Lens Antenna installed on AFRL Test Aircraft**

prototype low-profile antenna, shown in Figure 1, consists of four lens hemispheres mounted on a ground plane. The lenses are phase combined to produce a beam. The beam is varied in elevation by movement of the feed assembly and in azimuth by rotation of the ground plane. Descriptive characteristics for the antenna and radome are summarized below:



Type Luneberg 4-Lens Array  
Frequency 19.2-21.2 GHz  
G/T 9.3 dB/°K (minimum)  
Polarization LHCP or RHCP, selectable  
Beamwidth (nominal) 2° (AZ), 5° (EL)  
Azimuth Range 360° continuous  
Elevation Range 10° to 90° continuous  
AZ Rate, Acceleration > 15°/second, 20°/sec<sup>2</sup>  
EL Rate, Acceleration > 10°/second, 20°/sec<sup>2</sup>  
Drive Mechanical  
Diameter 30 inches  
Height 6 inches  
Weight ≈55 pounds  
Aircraft skin access hole diameter 1 inch (2 each)  
LNA Noise Figure < 1.5 dB  
Receive Frequency 19.2 -21.2 GHz  
Receive Insertion Loss < 1.5 dB  
Receive Polarization LHCP or RHCP  
Radome Size 49"(W), 58"(L), 8.37' (H)  
Including adapter ring 59"(W), 63"(L), 8.7" (H)  
Radome Weight < 50 pounds  
Radome Material Electro Vu 581 Quartz Solid laminate  
Radome Thickness 0.180" (nominal)

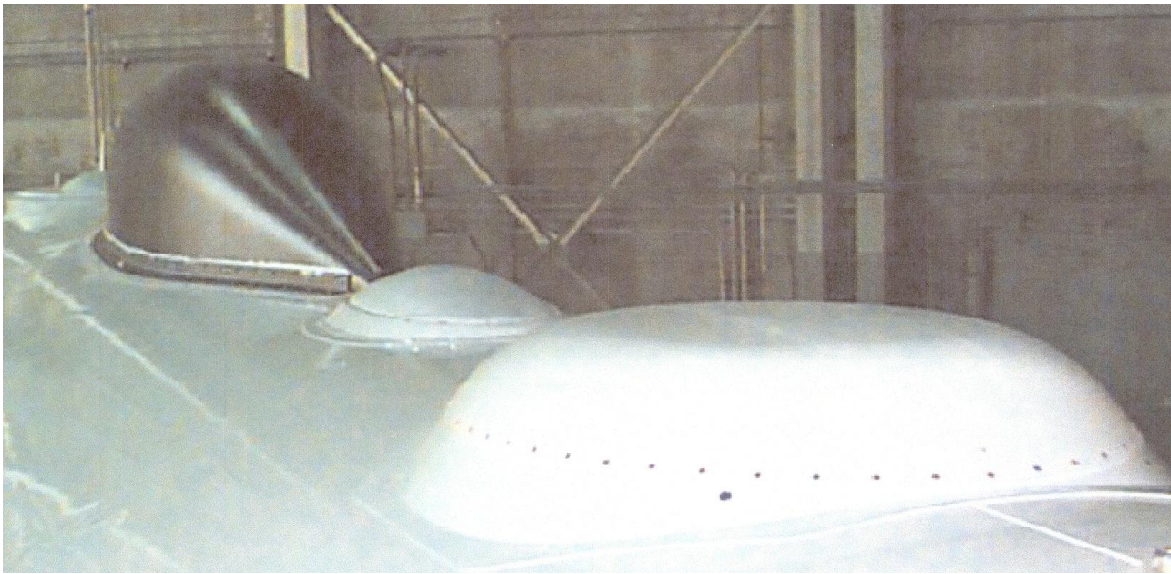
**Aircraft Installation and Test:** The AFRL/IFGD ACAT test aircraft at Wright Patterson Air Force Base (WPAFB) was used for the antenna flight demonstration, Figure 2. The equipment normally



**Figure 2 AFRL SATCOM Test Aircraft with Luneberg Lens Antenna under White Radome**

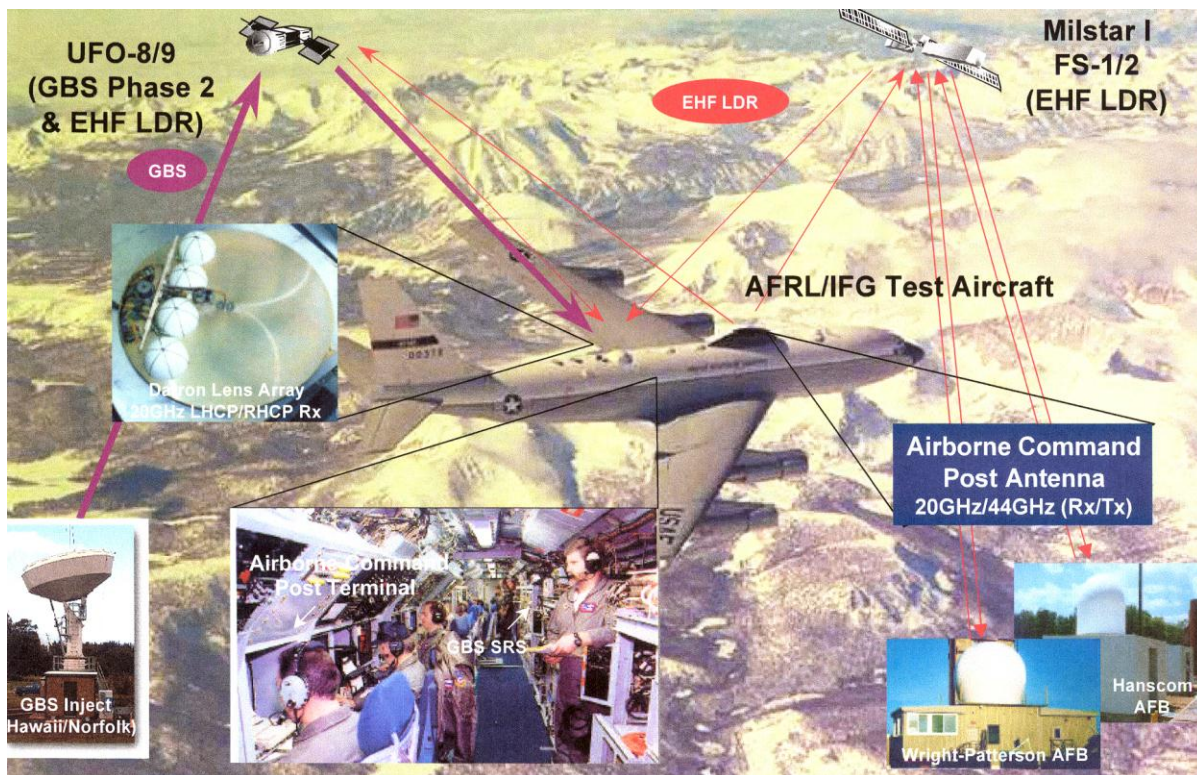
onboard the test aircraft includes a Milstar terminal. For the demonstration, the Luneberg lens antenna and radome were installed on the top of the test aircraft aft of the Milstar reflector antenna and radome as shown in Figures 2 and 3. The GBS equipment and antenna controls were installed in racks inside the test aircraft. The GBS equipment and Milstar receive equipment were integrated with the Luneberg lens antenna. The Milstar transmit functionality was retained with the Milstar parabolic dish antenna. The Luneberg Lens antenna and Milstar antenna were pointed to the respective GBS and Milstar

satellites by means of open loop commands derived from the onboard Inertial Navigation System (INS). The installation of the Luneberg lens antenna and radome was performed by 418<sup>th</sup> Test Wing at Edwards Air Force Base CA. The integration of the antenna with the GBS and Milstar equipment, and development of the pointing software, was performed by AFRL/IFGD.



**Figure 3 Radome housing the Luneberg Lens Antenna**

**Test Flights:** A series of test flights occurred in 1999 over a six-month period included destinations in Bermuda, various locations in CONUS and Puerto Rico, Figure 4. The flights demonstrated



**Figure 4 Flight Test Scenario**



simultaneous reception of GBS unclassified video/audio (2.2 or 3.0 Mbps), classified (6.0 Mbps) and unclassified data (6.0 Mbps) with the aircraft as the planned subscriber. The links typically were with the GBS narrow spot beam, but upon occasion were with the wide area beam. The video typically consisted of news rebroadcasts, taped programming, or live video feeds from the Primary Injection Point (PIP) at Norfolk VA. The data typically consisted of web pages (i.e. weather or map information) or a test file. The test file consisted of 200 linked and uniquely identified pages of text with each page approximately 825 K in size. This allowed real-time monitoring of the received data. The flights also demonstrated Milstar operation with transmission at 44 GHz using the Milstar parabolic dish antenna and reception at 20 GHz using the Luneberg Lens antenna. The Milstar system was also used as a reach-back channel to Norfolk to request changes in the test sequence.



## UFO GBS HOSTED PACKAGE

2-uplinks {1-fixed & 1-steerable} with 3-steerable downlink spots

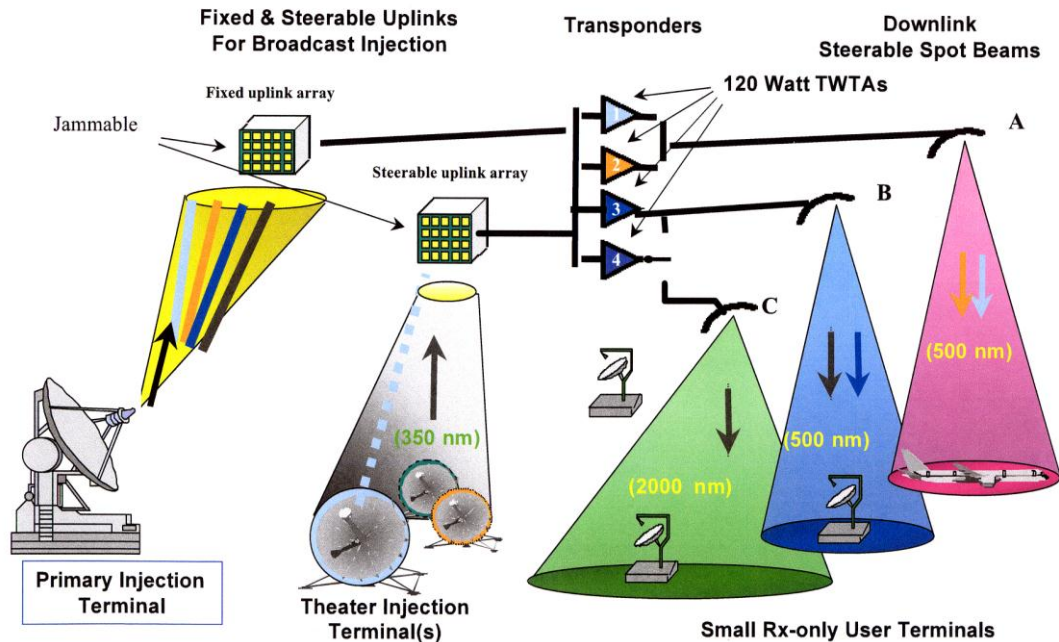


Figure 5 UFO Satellite with GBS Package

The flight from Bermuda to WPAFB was a typical flight, included both racetrack and 20°, 25°, and 35° circular roll patterns. A video signal was transmitted from the PIP in Norfolk. The GBS downlink patterns for the narrow beam pointed at Bermuda and the wide beam pointed at Norfolk. Expected GBS link performance is as follows:

- Frequency - 20.475 GHz (typical)
- Satellite EIRP - 53.2 dBW
- Satellite Margin - 3 dB
- Slant Angle - 15° nominal
- Free Space Loss -210.8 dB
- Antenna Pointing Loss -0.2 dB
- Polarization Loss -0.2 dB

Radome Loss -1.5 dB  
Atmospheric Loss -0.5 dB  
Weather Loss 0 dB  
Receive Power at Terminal -158 dBW  
Temperature of Environment - 275°K  
Receiver Noise Figure 2 dB  
Antenna gain 32.3 dB  
Receive G/T 9.3 dB/K  
Boltzmann's Constant 228.6 dBW/K-Hz  
Downlink Pr/No 79.9 dB-Hz  
FEC Coding 2/3  
Symbol Rate 17.625 Msps  
Noise Bandwidth 72.5 dB-Hz  
Pr/No 7.3 dB  
Eb/No (including implementation losses) 6.2 dB  
Margin 2.1 dB

As can be seen, with all system parameters optimal, up to a 17.625 Msps transmission stream from the PIP is supportable on the narrow beam. This stream included the 3.0 Mbps video signal intended for the test aircraft. The video was received continuously with disruption only in high roll turns which exceeded the mechanical elevation limits of the Luneberg lens antenna.

Data recording on the various flights was accomplished through a combination of methods. A strip chart recorder was connected to a spectrum analyzer which continuously monitored the GBS L-band receive signal. This provided a record of GBS signal strength for later correlation with aircraft maneuvers. Visual observation of the video signal provided a real-time assessment of relative quality of that signal and a VCR provided a permanent record. Both classified and unclassified GBS data files were saved in the PC with time identifiers. The test file software allowed continuous monitoring of incoming GBS data for comparison with aircraft dynamics. Bit Error Rate (BER) was displayed for the Milstar receive signal. Summary results for GBS from the various demonstration flights are shown below:

Transponder Beam - Narrow Spot  
Transmitted Symbol Rates - 10 and 17.625 Msps  
FEC Coding Rates –  $\frac{1}{2}$  and  $\frac{2}{3}$ , respectively  
Video Products - news, tape, live  
Video Rates - 2.2 or 3.0 Mbps  
Video Quality - Generally high quality. Some visual imperfections noted at close viewing distance. Video continuously received (within limits of aircraft dynamics and ground atmospheric conditions)  
Eb/No  $\approx$  8.5 dB  
Data Products - Web pages, test software  
Data Rates - 6.0 Mbps (Classified and unclassified)  
Performance - Files continuously received (within limits of aircraft dynamics and ground atmospheric conditions)  
Aircraft Roll - 20° typical; with elevation blockage to 35°

**Test Summary:** Activities accomplished include characterization of reception of unclassified video and both classified and unclassified data from GBS and non-simultaneous data from Milstar satellites using a single antenna. Milstar links were established using a combination of the Luneberg Lens antenna for reception and Milstar parabolic dish antenna for transmission. A reach-back channel was established to the PIP via Milstar. Results indicate satisfaction of all performance objectives.

References:

Cook, William G.; **Global Connectivity to Aerospace Forces Via SATCOM**; Air Force Research Laboratory; Rome NY; DTIC ADA458568; 1999.

Oleski, Paul J.; **GBS/Milstar Airborne Antenna**; Air Force Research Laboratory; Rome NY; Antenna Briefing; 2001.

Raponi, Daniel J., Paul J. Oleski, Capt Kevin Loucks, Dave J. Cobb; **Airborne Demonstration of Milstar and GBS Receive Capability Using a Single Antenna**; Air Force Research Laboratory; MILCOM 2000; Los Angeles CA; October 2000.



## **Grid Sphere Passive Communications Satellite (1960-1966)**

**Background:** Following the Soviet's launch of Sputnik I in 1957, the United States began a crash effort to catch up with the Soviets in space. Early attempts to launch an active communications satellite were frustrated by the lack of reliable electronics that could withstand the launch environment and operated reliably in space. The Wright Air Development Division's Communications and Navigation Laboratory (the predecessor to the Air Force Avionics Laboratory) began investigating passive communications satellites in 1960.

Rapid, versatile and reliable global communications is becoming more essential and vital each year. In the late 1950s, the US employed wire connections and a variety of radio links, but neither of them were capable of keeping pace with the ever growing demands either they were not economical, not flexible or not dependable enough. Therefore new approaches to this problem were needed.

Reflected electromagnetic waves have been used for communications since before Christ, when people communicated using light or the sun and optical mirrors. However, the weather, clouds, and the day-night cycle limited its usefulness.

Radio relay station high above the earth's surface, such as orbiting satellites would provide the necessary intercontinental line-of-sight distance. The extra-terrestrial relaying points may be active stations i.e. satellites with built-in receivers and transmitters, or pure orbiting reflectors, called passive satellites. The latter yield several advantageous features.

- (1) They do not need electronic devices of questionable reliability;
- (2) They do not clutter the radio frequency spectrum by continuously transmitting radio signals;
- (3) They permit change of the communication system and frequency. They represent silent servant, ready for use when required, but not disturbing by their sole presence.

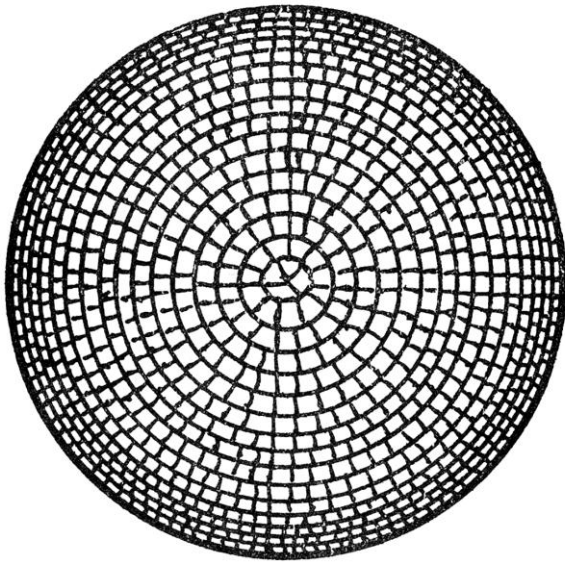
**Types of Passive Satellites:** Types of passive satellites include the following:

- a. Spherical reflectors, such as aluminumized balloons (Echo).
- b. Distributed material forming reflecting clouds or belts of randomly dispersed dipoles (Needles).
- c. Plane reflector, such as Flat Plates.

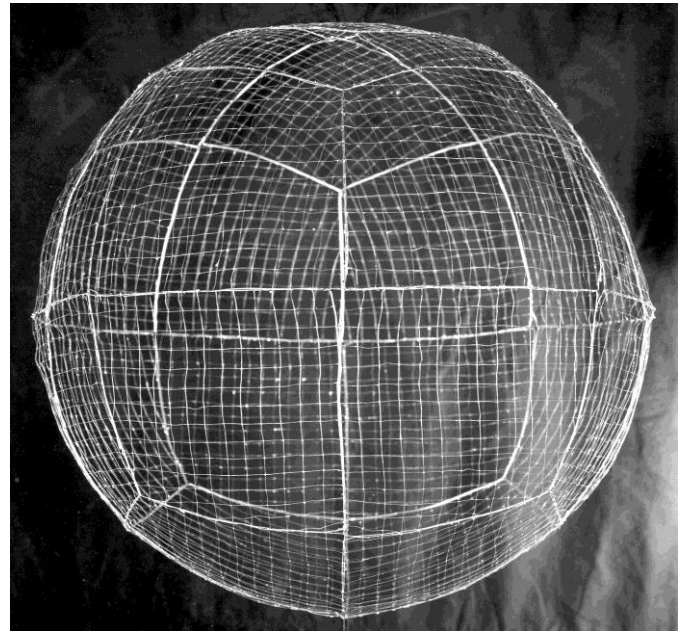
**Spherical Reflectors:** This project investigated spherical reflectors for use as passive communications satellites. On 12 August 1960, NASA launch Echo I, a 100-foot diameter Mylar balloon into a 1,000-mile altitude circular orbit. Ground stations at Holmdel NJ, Goldstone CA and Stump Neck VA relayed two-way telephone transmissions by reflecting their signals off the passive satellite. While the communications experiments were successful, solar pressure on the huge, light-weight balloon pushed it out of orbit and its orbit soon became so elliptical that it entered the earth's atmosphere during its perigee and burned up. To overcome this problem, the Wright Air Development Division's Communications and Navigation Laboratory began working on a grid sphere which would have an area-to-weight ratio 1,000 times less than a solid balloon and therefore be less affected by solar pressure.

**Grid Sphere Tests:** To decrease the area/weight ratio and minimizing the influence of solar pressure on the satellite, WADD developed two potential spherical reflector designs whose surface would consist of: (1) a metalized plastic grid, and (2) a wire mesh that could be erected by inflatable ribs.

The Laboratory simulated the first case by painting a grid of conductive silver paint on a plastic hull, and the second by constructing a sphere out of 24 spherical segments of wire mesh as illustrated in Figure 1a and 1b respectively, both with mesh dimensions of 1.5 cm by 1.5 cm.

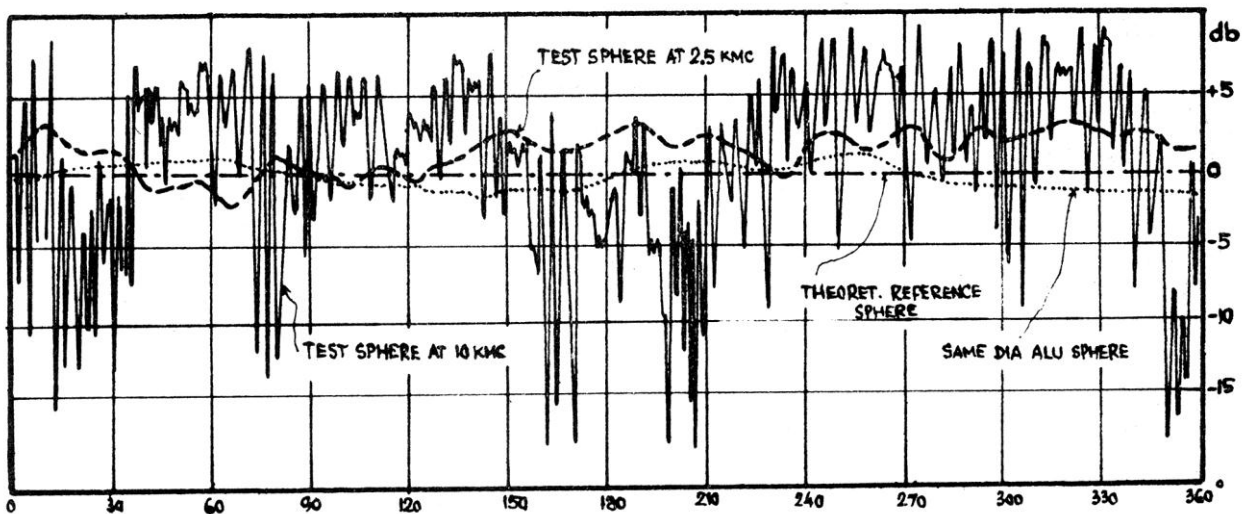


**Figure 1a Painted Test Grid Sphere**

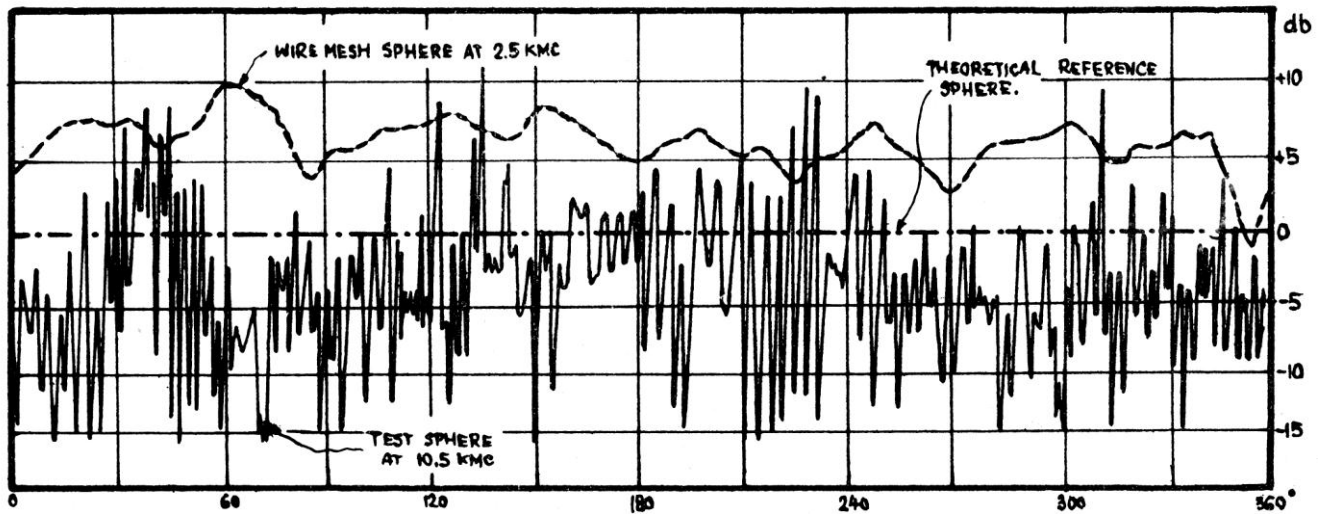


**Figure 1b Wire Mesh Test Grid Sphere**

The grid spheres were tested on a radio range to measure their reflectivity. The test frequencies were chosen in such a way that the wavelength varied from ten times to two times the mesh dimensions (2.5 GHz to 10 GHz). Figure 2 depicts the reflection patterns of the painted grid sphere at the upper and lower frequencies and Figure 3 depicts the patterns for the wire grid sphere.



**Figure 2 Reflection Patterns of Painted Grid Sphere**



**Figure 3 Reflection Patterns of Wire Grid Sphere**

The same tests were run for frequencies between the marginal wavelengths and the results show a gradual degradation from the rather uniform reflection at the longer wavelengths.

**Laboratory Test Conclusions:** Grid spheres, in general, may be used for frequencies whose wavelengths exceed ten times the mesh dimensions. Spheres with a flat grid represent equally good reflectors as entirely metalized spheres. Wire grid spheres reflect approximately 7 dB more energy than a plain sphere.

**Orbital Tests of Grid Sphere:** Following the successful laboratory grid sphere tests, WADD contracted with Goodyear Aerospace Corp for a launchable grid sphere. Goodyear developed a 30-foot diameter soft aluminum wire grid imbedded in a special plastic film designed to dissolve in space under the sun's strong ultraviolet rays. On 13 July 1966, the grid-sphere payload was launched from



**Figure 4 Thirty-foot Diameter Grid Sphere Similar to One Launched into Orbit**

Vandenberg Air Force Base CA atop an Atlas booster. The payload went into a circular orbit 620 miles above the earth and was automatically inflated with helium. The sphere inflated properly, stretching the aluminum wire grid into a perfectly spherical shape. The plastic film evaporated over the following 60-day period, leaving only the thin wire grid orbiting the earth. The initial orbital perturbations of the 30-foot diameter grid sphere shortly after the plastic film evaporated indicated the satellite would remain in orbit for approximately 11 years. Reflectivity test showed that the wire grid sphere reflected radio waves power about five times greater than from an equal sized solid sphere.

#### **References:**

Stahler, Ylo E. and Lt. Allen L Johnson, **Directive Non-Oriented Reflectors as Passive Satellites in Long Distance Communications**; Wright Air Development Division; Communication and Navigation Laboratory; WPAFB OH; WADD TM-60-100, March 1961.

Stahler, Ylo E., **A Hypothesis of the Time Dependence of Gravity Fields as Derived from Observations of an Orbiting Grid Sphere**; Air Force Avionics Laboratory book; WPAFB OH; 1968.

**Study, Fabrication, and Testing of Passive Satellite Models, Grid-Sphere Type**; Goodyear Aerospace Corp, Akron Ohio; DTIC AD0607273; August 1964.

## **HAVE LACE – Laser Airborne Communications Experiment (1983-1987)**

**Background:** During the Cold War, the Air Force began looking for an air-to-air communications system that could provide secure, anti-jam, low probability of intercept communications for applications such as the ELINT operations off Russia's Kamchatka Peninsula for passing large amounts of data as the aircraft leaving the orbit passed the aircraft taking up the patrol. The HAVE LACE program was designed to investigate the feasibility of laser communications between the two aircraft and study problems of the initial acquisition and bit error rate caused by communicating through a turbinate atmosphere. In 1983 the Air Force Wright Avionics Laboratory's (AFWAL) Communications Branch contracted with GTE for the laser communications hardware, installed it on two 4950<sup>th</sup> Test Wing C-135 aircraft and conducted a year-long in-house flight test.

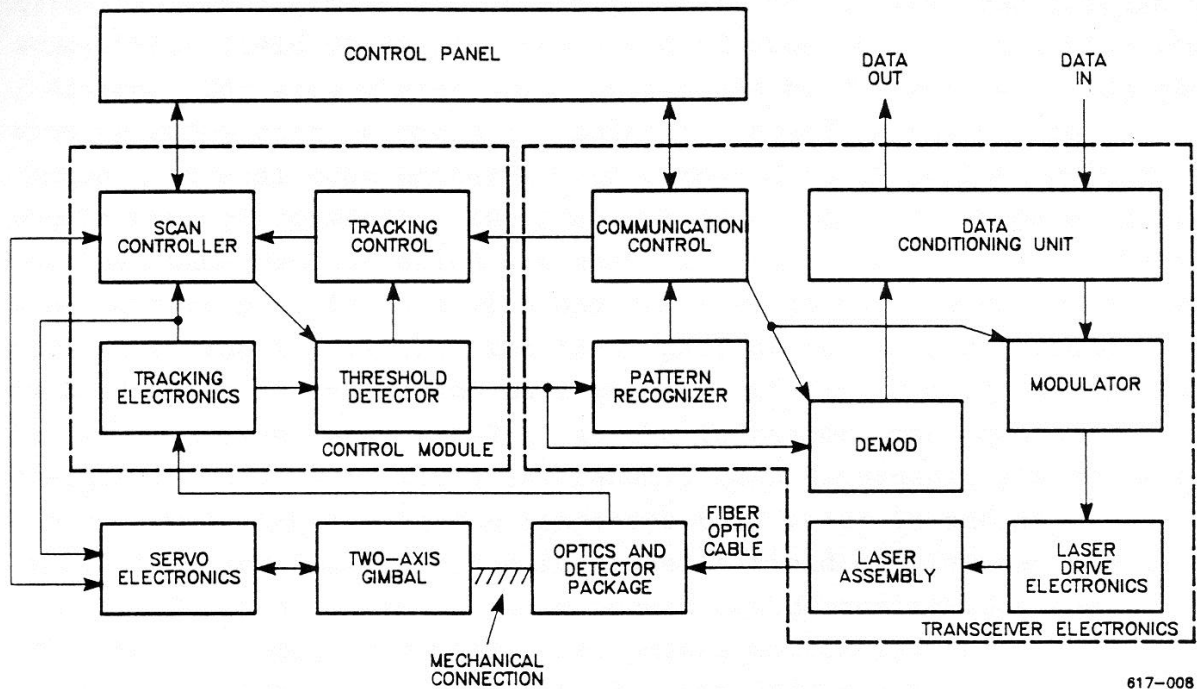
**Introduction:** Laser communications has the potential to provide secure, anti-jam, and low probability of intercept communications for airborne applications. The objective of the Laser Airborne Communications Experiment (HAVE LACE) program is to demonstrate acquisition, tracking and communications between airborne platforms up to 100 miles apart. This paper provides an overview of the HAVE LACE program, a description of the HAVE LACE terminal and a discussion of the test portion of the program. The major test areas discussed are acquisition, tracking, and communication system performance tests, along with attenuation and scintillation tests.

**Program Overview:** The Air Force Wright Aeronautical Laboratories at Wright-Patterson Air Force Base started the Laser Airborne Communications Experiment (HAVE LACE) program in 1982. The technology for laser communications using small solid state packages has been in existence for some time. Optical acquisition and tracking systems have been developed in the past for a wide variety of applications. Early in 1983, the Air Force established a contract with GTE Government Systems to develop two airborne laser communications terminals and furnish these terminals to the Air Force for a flight test program. These terminals are not advanced development models. They were designed using basically "off the shelf" technology to quickly provide the Air Force with equipment for the HAVE LACE demonstration and test program.

The objective of the HAVE LACE program is to demonstrate acquisition, tracking, and communications using a narrow laser beam between airborne platforms up to 100 miles apart. The HAVE LACE program is divided into three major areas: design and development of the HAVE LACE terminals, modification of the testbed aircraft and installation of the terminals, and the test program including ground and flight testing. The two HAVE LACE terminals furnished by GTE for use during the program consist of a laser transceiver and an acquisition/tracking system. GTE supported the aircraft modifications and terminal installation in two Air Force C-135 aircraft operated and maintained by the 4950th Test Wing. AFWAL conducted flight testing of the terminals and evaluated their performance. Flight test data is reduced after each flight and final results were compiled into a final report. Follow-on testing of an upgraded HAVE LACE terminal followed the initial flight tests. The upgrade included addition of a keypad for input of initial pointing angles, and a change in the acquisition algorithm. Information compiled during the initial flight tests and follow-on testing will aid in the decision making process leading to full scale development.

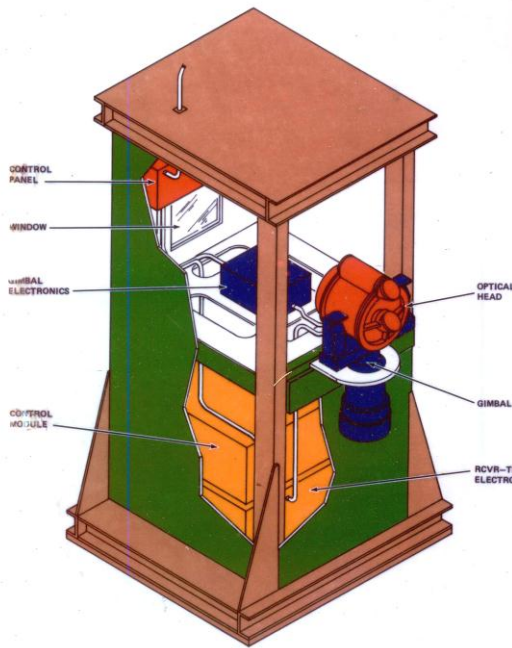
**HAVE LACE Terminal Description:** The HAVE LACE terminals are GTE equipment furnished to the Air Force for this test program. They each consist of transceiver electronics, a control module, an advanced transceiver head, associated controls, inputs, outputs and displays (Figure 1). These subsystems are installed in a single bay 19 inch rack with the transceiver head mounted in a two axis gimbal at the rear of the rack (Figure 2). The entire system is placed next to a side window in the aircraft.



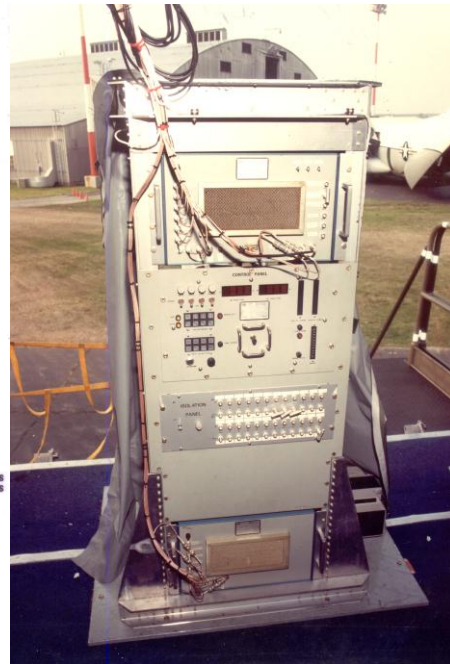


617-008

**Figure 1 HAVE LACE Block Diagram**



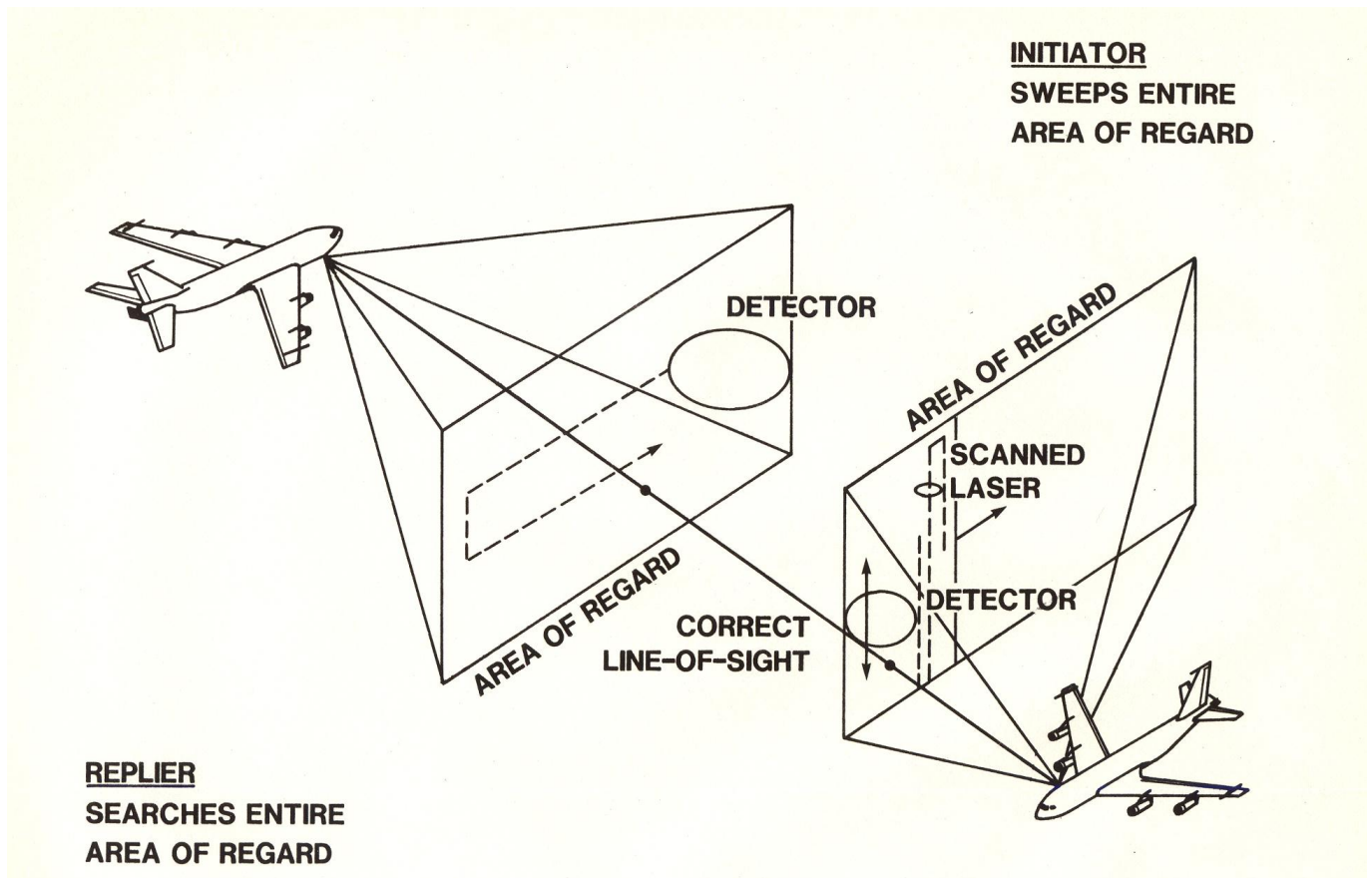
**Figure 2a Rack Drawing**



**Figure 2b Front of Equipment Rack**

System operation begins with initialization of the acquisition process (Figure 3). Each operator provides inputs to the terminal based on visual sighting, known flight paths or other navigation inputs designating the most probable location for the cooperating aircraft. This defines the center point for a 10 degree by 4 degree uncertainty region. The responding terminal slowly scans its uncertainty region

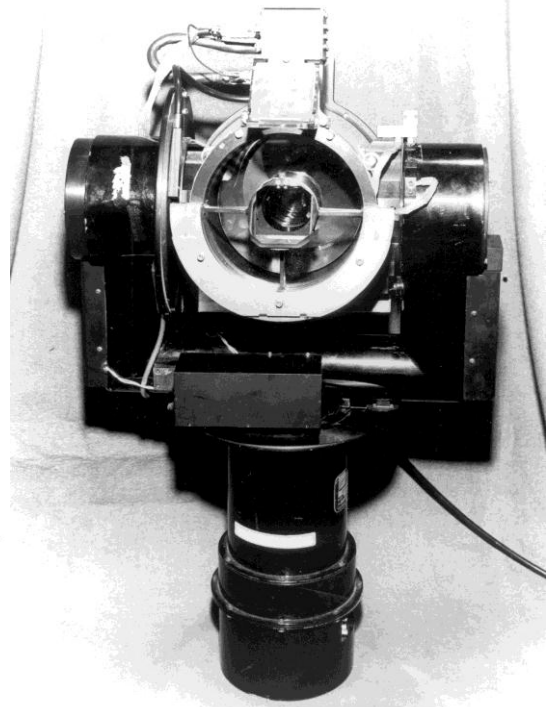
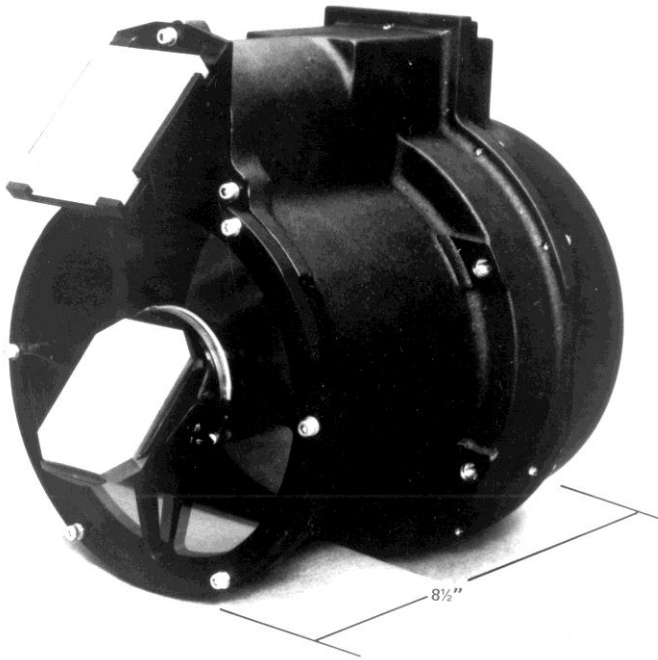
while the initiating terminal rapidly scans its uncertainty region until their fields of view are mutually aligned. The fast scan covers the initiator's entire scan pattern in less time than that taken for the field of view of the slow scan of the responder to pass across a point. Mutual alignment is thus assured to within the error allowed by the fields of view sometime before completion of one scan. By optimizing the scan patterns, quick acquisition can be accomplished. When the terminals are mutually aligned, an optical signal is detected by each terminal and a small scan pattern is used to refine alignment. After accurate tracking is established, timing synchronization is accomplished and full duplex communications are achieved using a time diversity technique. A side product of this timing synchronization is an accurate measurement of the transmission time delay and thus the range between the two communicating terminals. Tracking is maintained from this point using the communications beam. Should communications and tracking be interrupted, the terminals automatically go to a small scan. If they cannot reacquire, a large scan acquisition is started.



**Figure 3 Acquisition Scenario**

The transceiver electronics provides modulation, demodulation, encoding and decoding, and includes the laser diode source and its associated drive and cooling electronics. Pulse position modulation is used to provide data communications at 19.2, 9.6, 4.8, 2.4, and 1.2 kilobits per second along with digitized voice. Error correction is provided by interleaving and coding using a Hamming code. The laser source is a Laser Diode Labs semiconductor laser diode array. The 904 nanometer radiation is coupled to the advanced transceiver head (Figure 4) by a fiber optic cable. The laser is cooled using thermoelectric coolers. The advanced transceiver head is mounted in the gyro stabilized Two Axis Positioning System (TAPS) furnished to GTE by Ball Aerospace Systems Division. Separate transmit and receive optics are used. The transmitter beam divergence is 8.3 milliradians for normal operation and is opened to 18 milliradians during acquisition. The receiver field of view is 7 milliradians for

normal operation and 18 milliradians for acquisition. The receiver uses a quadrant arrangement of avalanche photodiodes to yield communications signals and the tracking error signals used by the control module.



**Figure 4a Advanced Transceiver Head      Figure 4b Gyro-stabilized Gimbal with Transceiver**

The control module includes TAPS, a microprocessor based scan controller and associated tracking electronics. TAPS uses outputs from the transceiver electronics to provide tracking over  $\pm 45$  degrees in azimuth and  $\pm 30$  degrees in elevation. The microprocessor based scan controller controls acquisition and other aspects of system operation.

**Test Program:** The HAVE LACE terminals are installed in two Air Force C-135 aircraft (Figure 5). The aircraft were modified to allow the terminals to be located on opposite sides for side by side testing. Optical quality windows have been located in front of the wings to avoid obstruction from the wings and to avoid operation through the turbulence behind the aircraft. After completion of integration of the HAVE LACE terminals into the testbed aircraft the Avionics Laboratory and the 4950th Test Wing began a ground and flight test program to evaluate the performance characteristics of the terminals and the effects of the environment on their performance. Ground tests were conducted over a 7.5 kilometer path from the Avionics Laboratory's twelfth floor Laser Communications Lab in the tower of Building 620 at Wright-Patterson to one of the test aircraft parked on the flight line (Figure 6). Air to ground flight tests followed and after several of these tests air to air flight tests began. The ground tests verified instrumentation and provided system operation and data reduction experience before starting flight tests. Air to ground flight tests provided data on low altitude operation and familiarization with airborne operation at lower cost than air to air tests. The core of the test program consisted of 40 hours of air to air testing under a variety of conditions. Most of these are local flights from Wright-Patterson and last about four hours each. To allow unrestricted flight paths some testing will be conducted over ocean areas.





**Figure 5a 4950<sup>th</sup> Test Aircraft C-135-372 With Optical Window**

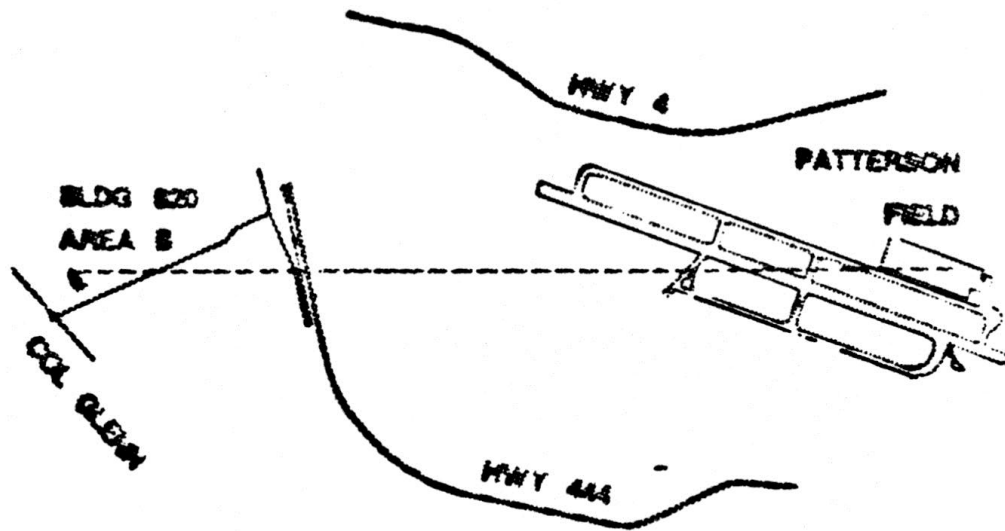


**Figure 5b 4950<sup>th</sup> Test Aircraft C-135-371 With Optical Window**

The test program demonstrated operation of laser communications in the airborne environment. Five major areas are being addressed concerning the system performance and the environment. System evaluation included acquisition, tracking, and communications' performance. Environmental effects on the system are being evaluated in terms of scintillation and attenuation.

The first test area is the performance of the acquisition portion of the terminals. Spatial acquisition is a challenging problem with airborne laser communications because of narrow beamwidths, high background light levels, the dynamic environment, and the limited knowledge of the other terminals location. For this test program, acquisition is attempted during parallel portions of the flight profile.

## WRIGHT-PATTERSON AFB, OH



**FIGURE 6 GROUND TEST SITE**

Information about aircraft locations needed to determine acquisition inputs is obtained from visual references, navigation aids such as INS, DNS or radar, and from an SHF link between the aircraft. The SHF link utilizes SATCOM equipment already onboard aircraft 372 to provide a permanent record of pointing angles to aid acquisition and as a reference for data reduction. As mentioned in the terminal description, the terminal accepts joystick inputs which direct the acquisition search to a particular 10 degree by 4 degree area.

The preliminary air to air test flights flown from Wright-Patterson AFB have shown the constantly changing relative positions of the aircraft to be the greatest hindrance to acquisition. Acquisition has tested at 3 and 25 nautical mile separations using inputs from all of the sources mentioned. The 3 nautical mile separation is the most difficult due to greater angular variations. Input angles from each of the sources have been good enough to permit acquisition.

The next logical area of testing after acquisition is the tracking performance of the HAVE LACE terminal. Accurate tracking is of course required at all times to provide optimum system performance. Ground testing in this area was limited because of the dynamics needed to exercise the tracking system. Flight profiles of particular interest for this area will use aircraft maneuvers to stress the tracking and will provide varying signal and background conditions.

The initial flight tests have shown very good tracking performance. GTE included in the design of the terminal a feature which causes it to begin a new reacquisition whenever the signal quality drops below a certain criteria. Operating the terminal normally, the tracking is not stressed a great deal because the criteria is set fairly high.

The core of the demonstration aspect of this program and the central test area is the communications performance of the HAVE LACE terminals over extended ranges and under various conditions. Basic system operation has been evaluated on the ground to predict airborne performance. Air to air flight tests will be conducted at altitudes from 4K feet to 37K feet and at ranges out to 100 miles. Results



from these tests will be compared with the tracking, scintillation, and attenuation test results to correlate communications losses with likely causes.

Hewlett Packard Data Error Analyzers are used to generate and check messages to detect errors in the data transfer. While the Hamming coding used in the system cannot be disabled the corrections being made by the code are detected and recorded.

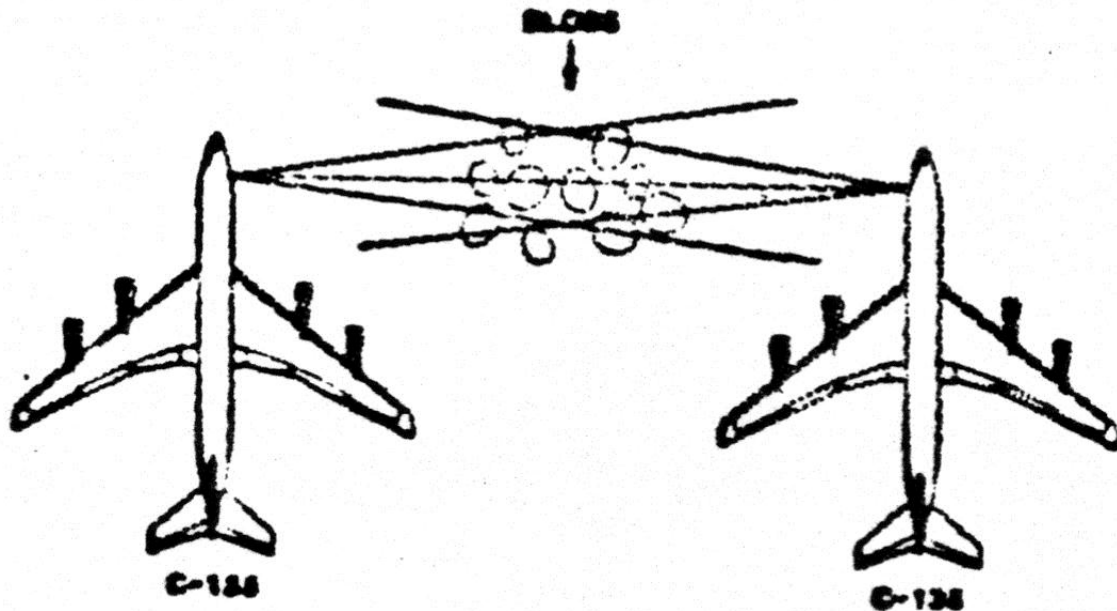
During the first flights, bit error rates as low as 1 error in  $10^6$  bits were observed at 25 nautical miles. Maximum communications range will be determined during later tests. The terminal provided voice communications using continuously variable sloped delta (CVSD) encoding. At 25 nautical miles, the voice was good quality and definitely recognizable.

A basic environmental effect on any atmospheric laser communications system in the atmosphere is attenuation. Throughout the HAVE LACE test program the attenuation encountered due to the atmosphere will be measured for various altitudes and ranges. Weather data is recorded along with received power and a comparison of this data with computer models for attenuation will be made. These measurements may include some bad weather measurements on the ground and some cloud measurement through thin ice clouds at higher altitudes.

During ground tests, we found that haze and ground fog were occasionally severe enough to keep the terminals from acquiring. In flight, we have maintained track through some thin cirrus clouds and haze, but clouds which block visual contact also cause dropout of the laser link.

Another environmental effect on atmospheric laser communications is scintillation (Figure 7). A laser beam propagating through dynamic non-homogeneous regions in the atmosphere ("blobs" of rising warm air) is degraded resulting in fluctuations in the optical power reaching the detectors. Over the long horizontal paths to be encountered in the HAVE LACE flight tests large fluctuations are expected. Theory to predict the magnitude of this effect exists. However there is very little data to verify the theory for high altitude horizontal paths. To accurately measure this scintillation, a special mode of operation was added to the terminals. In this mode one terminal will send a steady stream of pulses at about 11 kpps and the other terminal continuously receives these pulses and detects the peak levels of each pulse. Tracking during these measurements will be performed using only gyro stabilization, however measurements will be limited to several seconds so this is adequate. This sampling of the scintillation will provide information about fades and surges with frequencies up to about 5.5 kHz. The scintillation spectra are not expected to contain any components greater than this. A peak level detector followed by a sample and hold will allow the peak levels of the short pulses to be recorded on standard recording equipment. This terminal output simply tracks the fluctuations thus requiring a recording bandwidth of only 5.5 kHz.

Flight profiles for these tests are carefully controlled so that misalignment of the two systems will not induce fluctuations. Parallel paths will be maintained at the same altitude during all scintillation tests.



**FIGURE 7 SCINTILLATION TESTS**

Data reduction on the scintillation data will be extensive and include performing cross correlations, fast Fourier transforms, and statistical evaluation. Of particular interest will be the log variance and the power spectral density of the scintillation.

Significant scintillation effects were seen over the 7.5 km path used for ground tests. At times, the scintillation was strong enough to cause the signal to drop below the detection threshold quite frequently. The first air to air flights showed an up shift in the frequency of the scintillation and the strength of the scintillation varies considerably. The scintillation mode has been used and the results of the HAVE LACE program and follow on testing will be used to determine how best to use laser communications and what improvements and tradeoffs can be made on operational laser communications systems.

**Conclusions:** Development and testing of the HAVE LACE optical communications terminal demonstrated the feasibility and utility of air to air laser communications. The test program resulted in an understanding of the problems associated with integrating an optical communications system into an airborne testbed as well as providing data relating to the effects of the airborne environment on the performance of the terminals. The information obtained from the HAVE LACE tests will be used to help specify a system to fulfill operation requirements. Following the demonstration, a program to develop and deploy an optimized optical communication system for air to air applications will be undertaken.

**References:**

Feldman, Robert J., Capt Linden Mercer, Capt Steven K. Rogers, **Airborne Laser Communications Measurements**; NAECON-86; Dayton, Ohio, 30 April 1986

McCraw, @Lt Tammy L., **Laser Airborne Communications Experiment (HAVE LACE) Flight Test Report**; 4950-FTR-86-6; WPAFB, Ohio; May 1986

Mercer, Capt. Linden B., Lt John C. Holt, **HAVE LACE Communications Experiment**; TTCP Panel S-6; Malvern, England; 21 October 1985

Holt, John, Capt Linden Mercer, Capt Kirk Fisher, Helen Demers, Robert Feldman, **HAVE LACE Executive Summary**; Technical Memorandum AFWAL-TM-86-11, WPAFB OH, 10 June 1986

Sebald, Capt. Peter, Capt Kirk Fisher, Capt Linden Mercer, Capt John Holt, Robert Feldman, Helen Demers; **HAVE LACE Final Report**; AFWAL-TR-87-1128; WPAFB, Ohio; December 1987

Welles, C.G., P.T. Titterton, W.A. Seaman Jr, R.A. Lewis, K Maher, T.R. Johansen, **HAVE LACE Final Report**, AFWAL-TR-86-1102, WPAFB OH 21 July 1986

## **HAVE QUICK - Jam Resistant Voice Radio (1976-1990)**

**Background:** In 1940, movie star, Hedy Lamarr was talking to her Hollywood neighbor, George Antheil about the war in Europe and she suggested the Navy could use a frequency-hopping technique to guide a torpedo from a high-flying aircraft so the enemy couldn't jam the commands. Lamarr and Antheil worked on the idea for several months and then sent a description of it to the National Inventors Council. Charles F. Kettering was chairman of that council and he became interested in that idea. Kettering worked personally with Lamarr and Antheil to develop the patent application. In June 1941, Lamarr applied for a patent of a "Secret Communications System." The patent was granted in August 1942. The frequency hopping torpedo guidance never got into production, but the concept became general knowledge.

Since the end of World War II, U.S. and Allied military aircraft have used AM radios operating in the 225 to 400 MHz military UHF band for short range air-to-air and ground-to-air communications. These early UHF did not employ any features to secure communications for aircraft and helicopters from jamming. Progress in electronics in the late 1960s reached a point where anyone with an inexpensive radio frequency scanner or receiver set could intercept military communications. Once the target frequencies were identified, radio frequency jamming could easily be employed to degrade or completely disable communications.

**Jam-Resistant Voice Radio Development:** In the early 1970s, the Air Force Avionic Laboratory (AFAL) began developing concepts for a jam-resistant voice radio using a frequency-hopping technique. The early development primarily focused on how to synchronize the hopping sequence. In 1977, AFAL initiated a project under the HAVE QUICK program to develop a frequency hopping breadboard and transition the technology into the AN/ARC-164 UHF radio being installed in Air Force aircraft. AFAL engineers recognized that newer aircraft radios already included all-channel frequency synthesizers along with keyboards and displays for data entry. The only other system requirements to achieve the desired Anti-Jam functionality were an accurate clock (for timed synchronization) and a microprocessor to add frequency hopping to existing radios.

Aircraft and ground radios that employ HAVE QUICK must be initialized with accurate Time Of Day (TOD) (usually from a GPS receiver), a Word Of the Day (WOD) which serves as a key, and a NET number (providing mode selection and multiple networks to use the same word of the day). The word of the day, time of day and net number are input to a cryptographic pseudorandom number generator that controls the frequency changes. HAVE QUICK is not an encryption system, though many HAVE QUICK radios can be used with encryption, e.g. the KY-58 VINSON system.

The modified AN/ARC-146 radios with HAVE QUICK capability were flight tested in 1980 and the concept proven.

**Transition of HAVE QUICK:** In 1981, the Electronic Systems Division's (ESD's) HAVE QUICK System Program Office (SPO) let a \$21 million contract with Magnavox for 2,400 modification kits to upgrade the AN/ARC-164 radios to include a HAVE Quick capability. The HAVE QUICK capability was also added to other aircraft radios and adopted by NATO forces. By 2000, HAVE QUICK was installed in nearly all U.S. military aircraft use it. Improvements in the concept continue to be made and included HAVE QUICK II Phase 2 and a "Second generation Anti-Jam Tactical UHF Radio for NATO" called SATURN. The latter features more complex frequency hopping algorithm.

## Helicopter Communications via SHF Satellite Relay (1969-1971)

**Background:** Under the 698-AQ Satellite Communications Program, the Air Force Avionics Laboratory developed an airborne SHF satellite communications terminal for the Airborne Command Post EC-135 aircraft. Using that technology, AFAL joined in a cooperative development with the US Army's Satellite Communications Agency at Fort Monmouth NJ to develop a SHF satellite communications terminal for a helicopter. AFAL developed the SHF antenna under contract with Bell Aerospace Company in Buffalo NY and provided it to the Army to be mounted on the HU-1D helicopter. The Army developed the rest of the communications system and conducted the helicopter flight test, including establishing a communications link between the airborne helicopter and AFAL's SHF SATCOM terminal on aircraft C-135-662 through the Tactical Communications Satellite SHF system.

**Development and Testing:** The feasibility, practicability, and technical characteristics of satellite communications in rotary-wing aircraft have been evaluated in a special flight test program conducted by the US Army from December 1969 through October 1970. Tests were conducted at both ultra-high frequencies (UHF) and super-high frequencies (SHF-X band), using different antennas for each mounted atop the rotor mast on an Army/Bell UH-ID helicopter. The results of these tests have conclusively demonstrated the overall feasibility of UHF and SHF satellite voice communication in this unique environment and have provided much valuable information concerning the technical parameters of other modulation schemes. The tests included demonstrations of two-way voice communication between a UH-ID helicopter flying over Lakehurst, New Jersey, to remote terminals; In one case (UHF) to the USS Hornet on Apollo 12 recovery station near Guam, and the other (SHF) to an AFAL C-135 airborne testbed flying over the South Pacific.



**US Army Helicopter with SHF Satellite Communications Terminal**



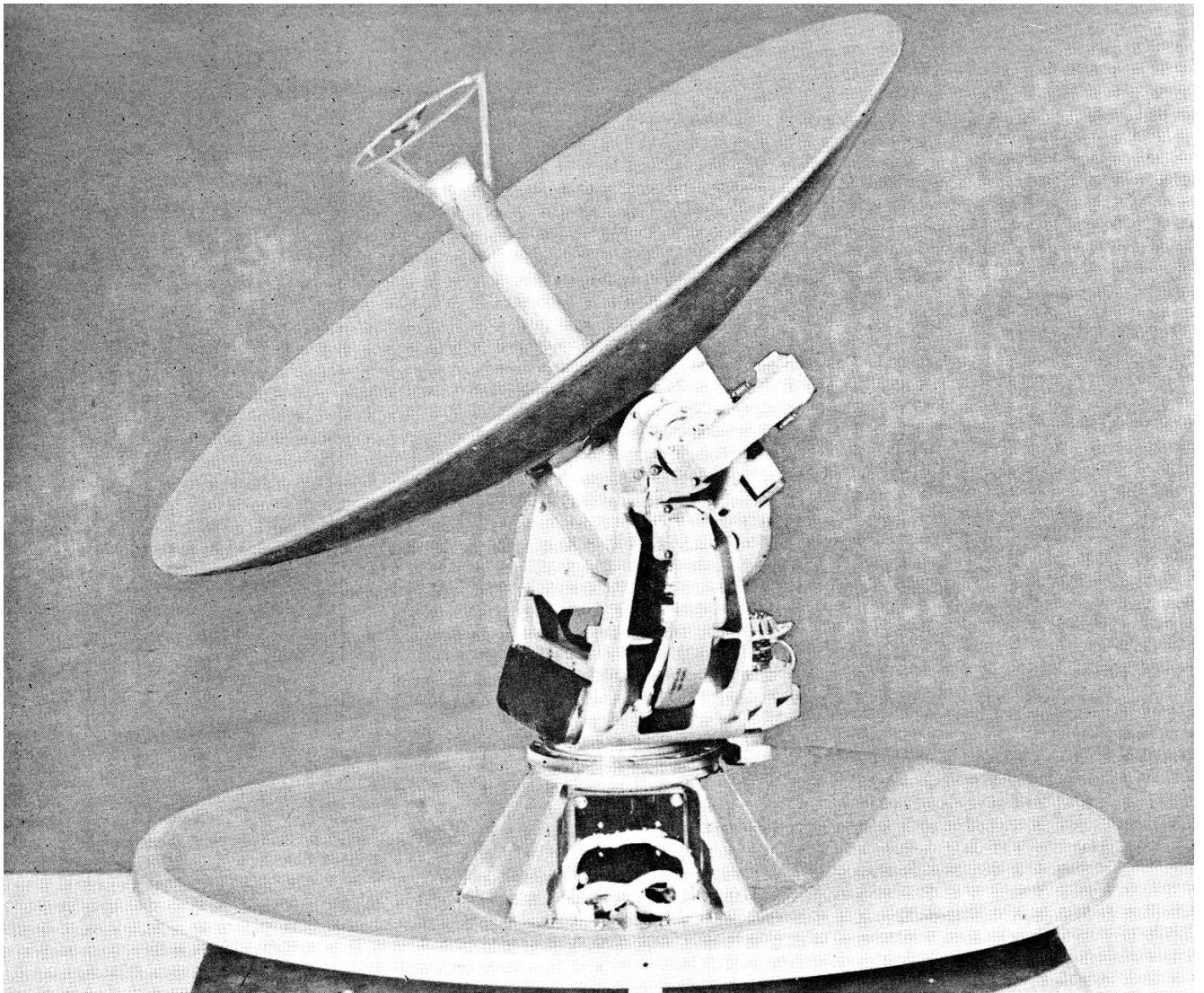
The overall conclusions of the program were:

- a. Both UHF and SHF satellite communications systems are feasible and practical in helicopters.
- b. Above-rotor antennas in both UHF and SHF systems are fundamental to successful application of satellite communications to helicopters.
- c. The UHF system appears to be the best choice for narrow-band traffic on few channels to many aircraft when jamming considerations permit because of the relatively low-cost antenna and communications equipment inherent in this system. An example of this type application is a voice air traffic control system requiring a few channels to cover all aircraft over a wide area.
- d. The SHF system appears to be the proper choice for:
  1. Broadband traffic, such as wideband sensor data, since the spectrum space is relatively more available in the SHF band.
  2. Application requiring superior resistance to jamming.
  3. Applications in which the aircraft must net with other SHF satellite communications terminals.

#### **SHF Test Results:**

**Antenna:** It was obvious from the outset that the practicability of an SHF Tactical Satellite Communications system in a helicopter was dependent upon finding a suitable high gain antenna system whose performance would not be heavily modulated by the blades. In a cooperative effort, the USAF (AFAL) and Army (SATCOMA) funded a contractual study and construction of a feasibility model of a SHF satellite antenna system. (Bell Aerospace Co., Buffalo, NY). The study included several multiple fuselage mounted antennas with switching and an above-rotor system. It was concluded that the latter system was superior and was the basis for the constructed feasibility model. The chosen design employs a 32 inch diameter (32 db) antenna mounted on an elevation-over-azimuth pedestal. The entire assembly is covered by a radome and mounted above the rotor on a fixed hollow tube mounted coaxially inside the rotating drive shaft. Waveguides and control Wiring are brought through the control support tube. The approximate 3 degrees wide antenna pattern is kept aimed at the satellite by an inertially controlled servo system using the normal pitch, roll and yaw gyros as references. The inertial track is aided by a supplemental auto track system using the satellite beacon radiation for which data are obtained by mechanically oscillating the antenna elevation and azimuth about  $\pm 1/2$  degree at a 1 Hertz rate about the satellite bore-sight errors in the initial pointing, and drift in gyros are biased out by a relatively long time constant electrical signal. Velocity feedback stabilization is obtained from angular rate gyros located on each axis. This method of feedback tends to degenerate any high rate angular motion of the pedestal as well as antenna motion relative to the pedestal. The servo system employs low gear ratio (4:1) DC torque motors driven from transistor power amplifiers.

**Air Worthiness Test:** The effect of the antenna on the aircraft system and its air worthiness were determined in a series of highly instrumented aircraft dynamics test flights under the direction of Army Aviation Systems Command. In summary, the principal effects were:



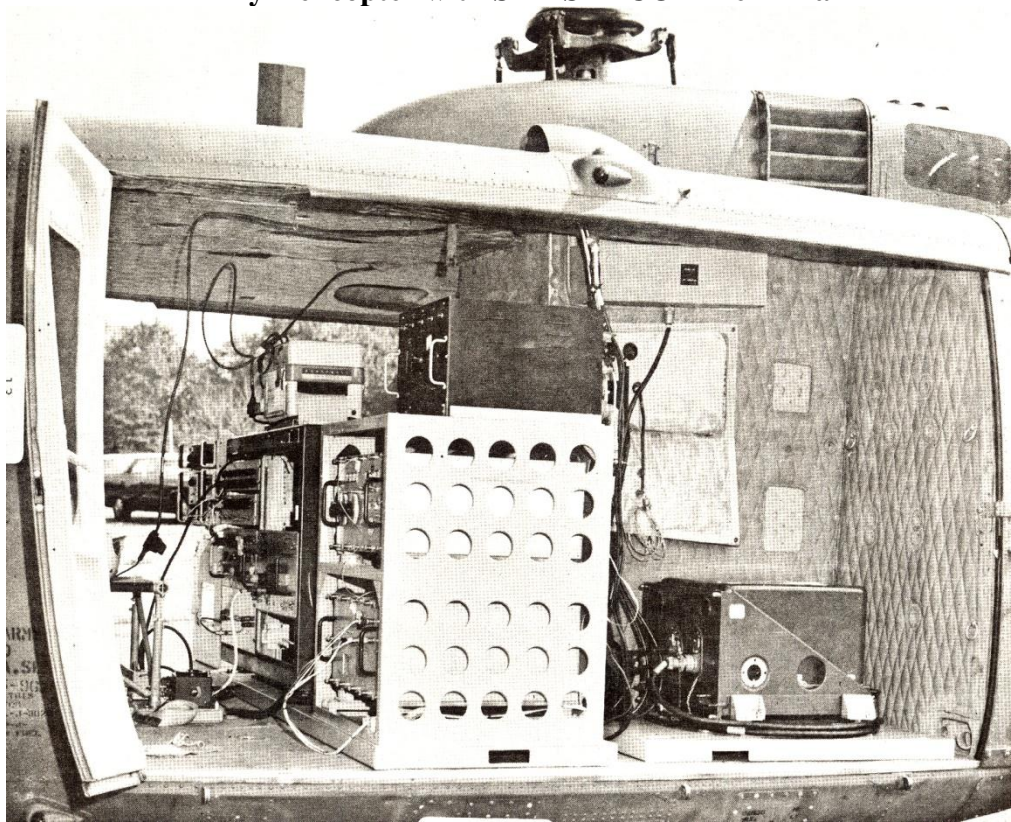
**SHF Airborne Helicopter Antenna Developed for AFAL by Bell Aerospace**

- (1) An increase of aircraft drag of about 6% at cruising speed.
- (2) An increase in aircraft stability as evidenced by a reduction in the number of pitch overshoots.
- (3) A slightly more forward position of the cyclic control for a given air speed due to drag above the rotor.

**Static Tests:** In addition to bench servo response tests and static antenna pattern tests, the antenna was subject to tests to evaluate the magnitude of amplitude and phase effects caused by the proximity of the rotor blades to the antenna. These tests were performed using a CW transmitter located in the opening of a large hangar with the aircraft positioned to provide a 5 degree and a 0 degree elevation angle. It is concluded that with more than 5 degrees relative angle above the rotor plane, no significant modulation occurred.



**Army Helicopter with SHF SATCOM Terminal**



**Army SHF SATCOM Terminal installed in HU-1D Helicopter**



**Dynamic Tests:** The performance of the antenna system was evaluated in a series of flight tests in which the signal strength received from the satellite beacon, and the elevation and azimuth error voltages were recorded as the aircraft was put through various maneuvers. Results indicated that the antenna would follow satisfactorily up to turn rates of about 18 degrees per second with potential of about 25 degrees per second.

A serious limitation of the tested design to operate with satellites at low elevation angles was verified during tests. Since the equipment provided an elevation angle coverage down to only zero degrees relative to the antenna azimuth plane, aircraft pitch or roll during maneuvers in excess of the satellite elevation angle could, at certain headings cause the antenna to "bottom" and lose track temporarily. This condition became especially troublesome at the end of the test period when satellite angles below 5 degrees were experienced. In combination with the normal roll and 5 degree nose-down attitude of the helicopter at cruising speed, it permitted no reliable contact to be maintained except when flying toward the satellite at such low satellite elevation angles.

Analysis of recorded data indicates that the antenna usually maintained an angular position within  $\pm 1/2$  degrees of the satellite during moderate maneuvers. Testing revealed the desirability of including a means for detecting the presence of loop offset in the auto-track system due to gyro drift or initial setting error. Such a means would permit resetting the look angle so that if "track" were lost, the system would start its reacquisition at the latest satellite angles. A loop error meter was added to the equipment so that the "satellite angle" dials could be manually adjusted for zero track loop stress. In future designs this follow up could be made automatic.

**Communications Equipment:** A vehicular SHF TACSAT terminal (AN/MS-57) was adapted to aircraft installation by providing (a) 400 Hz power capability, (b) shock mounting and (c) minor circuit modification to interface the Bell-developed antenna system. No provision was made for Doppler correction as provided on units. This terminal provides 100 Watts max output and provides features and interfaces necessary for operation in a frequency-hop spread spectrum mode in addition to FM voice.

**SHF System Tests:** Tests of the entire communications system using half duplex FM voice were made concurrent with antenna system flight tests. Tests showed that performance of the system were satisfactory as long as the antenna was not "bottomed" due to a combination of low satellite angle and aircraft angle, and as long as the aircraft angular turning rate was less than about 18 degrees per second.

A demonstration of the voice communications performance was made between the helicopter over Lakehurst, N. J. and an AFAL C-135 flying over the South Pacific. The helicopter employed about 70 watts of transmitter power through its 32 db antenna, while the EC-135 employed 300 watts through an antenna of nearly similar gain. These tests demonstrated that for the FM voice mode much of the equipment provided in the adapted vehicular equipment was not required and could be eliminated in any future FM voice equipment; thus reducing size and weight. For this mode, it appears practical to consider the normal UHF aircraft radio (AN/ARC-116) teamed with a UHF/SHF converter and amplifiers to be the driver for the SHF antenna system as a cost effective means for securing SHF satellite communications.

The last of the flight tests were performed with satellite elevation angles down to 1 degree. This permitted measurement of the magnitude of ground reflections received within the 3 degree beamwidth. To permit identification of this effect in the presence of other signal changes, the aircraft

flight pattern was adjusted to cause a carrier fluctuation of about 1 cycle every two seconds. At an elevation angle of approximately 1 degree, multipath modulation of about 5 dB were noted when the reflection point was over water. No identifiable multipath was noted over land.

The overall results of the tests of the SHF helicopter terminal indicate the following:

- a. It is entirely practical to place a high gain tracking antenna above the rotor of a helicopter without serious aerodynamic effects.
- b. Tests of the engineering model of the antenna showed that the performance was adequate for a satellite communications system; however, a number of design changes would improve its utility including operation to 15 degrees below the equipment horizon. If quantity requirements are sufficient, consideration should be given to design of a hybrid antenna in which the elevation plane is scanned by a phased array technique and azimuth by normal mechanical techniques. This would permit lowering the profile of the above-rotor radome and reducing aerodynamic drag by about 50% for equivalent gains.
- c. The use of inertial stabilization from aircraft instruments in conjunction with a simple long time constant auto-track system employing slow mechanical scans of the pedestal to overcome initial and cumulative gyro errors, appears to be a satisfactory and cost-effective method of keeping the antenna pointed to the satellite.
- d. Tests of the above-rotor SHF antenna show that rotor modulation is negligible except under very low angle conditions when the antenna beam actually passes through the tip of the rotor. This condition is encountered only during conditions of extreme maneuver at low satellite angles. The degree and type blade of modulation would probably not be objectionable for voice. However, some limitation on flight attitude might be necessary for data traffic.
- e. Vibrational motion of the above-rotor antenna due to periodic torque variations of the blades causes a phase modulation of system carriers of about  $\pm 90$  degrees at a predominant frequency of 11 Hz (blade passage frequency) which could cause problems with certain low rate data transmissions and modulation schemes.
- f. An SHF satellite FM voice communications system for helicopters is practical but requires redesign and repackaging of the employed transmitter/receiver to make them more specific for the mode and more reliable.
- g. Limitation on aircraft maneuvers and low angle multipath due to very low satellite angle indicate that the system should not be used with satellite angles less than about 10 degrees.

## **References:**

Todd, William, Capt. Robert A Wynsocki, 1Lt William Burling, **The Feasibility of Satellite Communications in Helicopters**; US Army Satellite Communications Agency; AMCPM-SC; Fort Monmouth NJ; August 1971.

Todd, William, **Satellite Communications For Helicopters**; Presented at 16 Meeting Military Space Communications; Sub-Group M; The Technical Cooperation Panel (TTCP); October 1970.



## Helicopter Communications via UHF Satellite Relay (1967-1970)

**Background:** Under the **Communications Technology for Satellite Relay** Project 4164, the Air Force Avionic Laboratory undertook an effort to demonstrate beyond-line-of-sight communication to a helicopter using UHF satellite relay. The effort was accomplished in-house between August 1967 and September 1969. The flight tests began on 21 May 1969 and were completed 19 September 1969.

**Test Results:** Tests to determine UHF teletype performance and antenna patterns on a UH-1F helicopter were conducted in an in-house program to study helicopter communications via satellite relay. Four configurations of special antenna designs were fabricated and tested in an effort to improve communications reliability by reducing the detrimental effects of the rotor blades shadowing the antennas intermittently during operational performance.

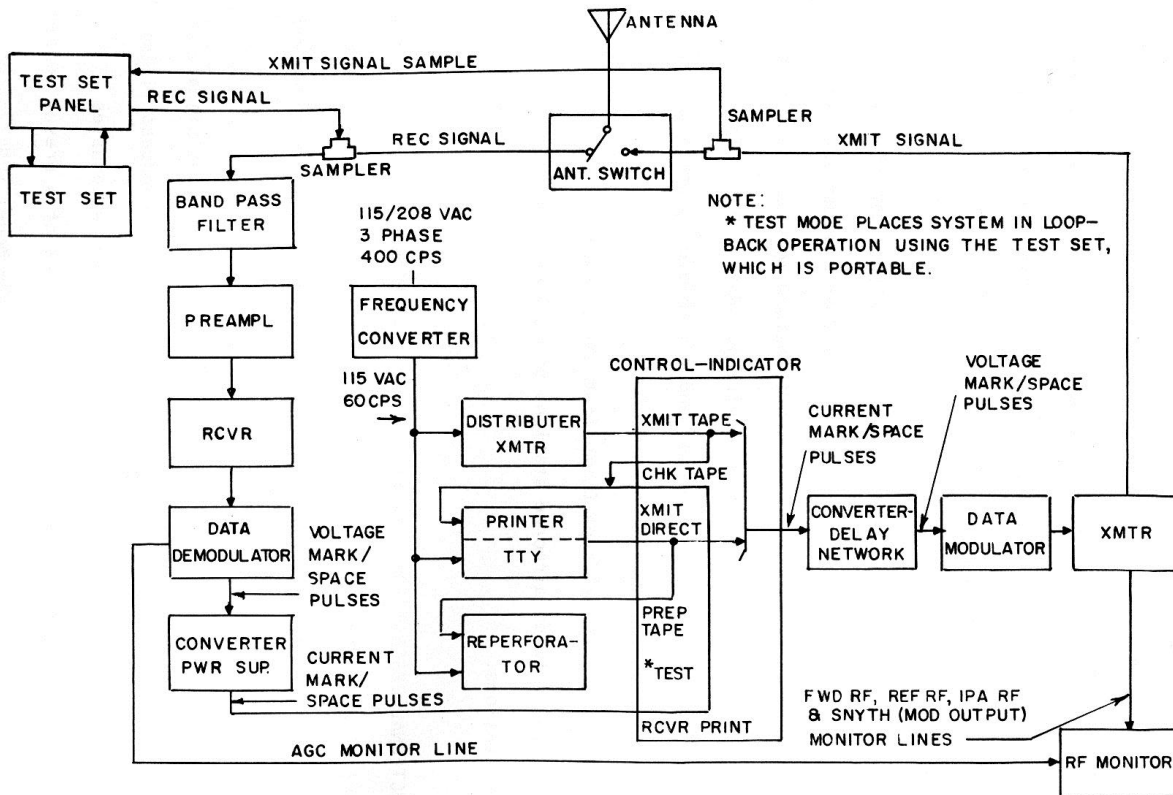


### UH-1F Helicopter used in UHF SATCOM Test

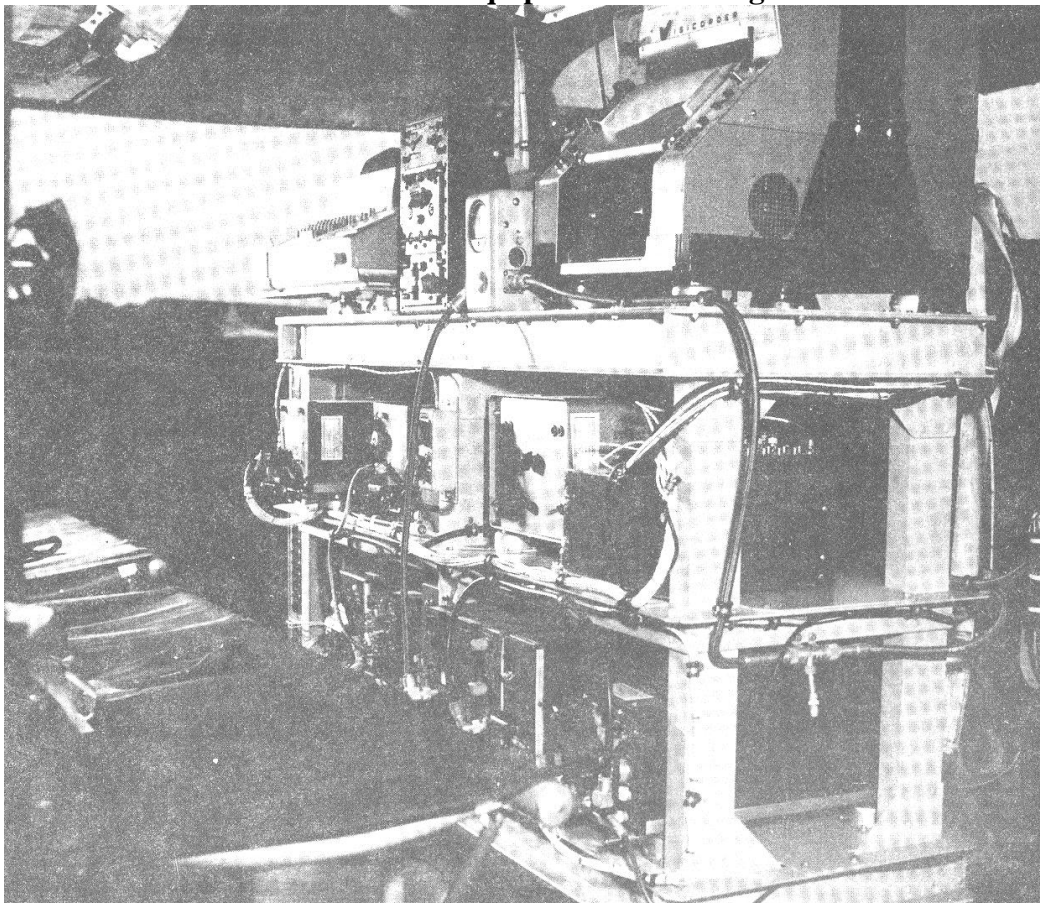
These tests were conducted using the LES-6 and TACSAT-1 satellites with a cooperating airborne terminal, Air Force C-135-662 aircraft, based at WPAFB, and ground-based terminals at Wright Patterson AFB, Ohio, and Electronic Communications, Inc. (ECI), St. Petersburg, Florida.

Results indicate that the antenna configuration consisting of a combination of a vertical dipole and a circularly polarized crossed dipole gave excellent teletype copy even under violent aircraft maneuvers. It is recommended that this configuration reconstructed as a single unit be considered for mounting on top of the rotor mast of operational helicopters.

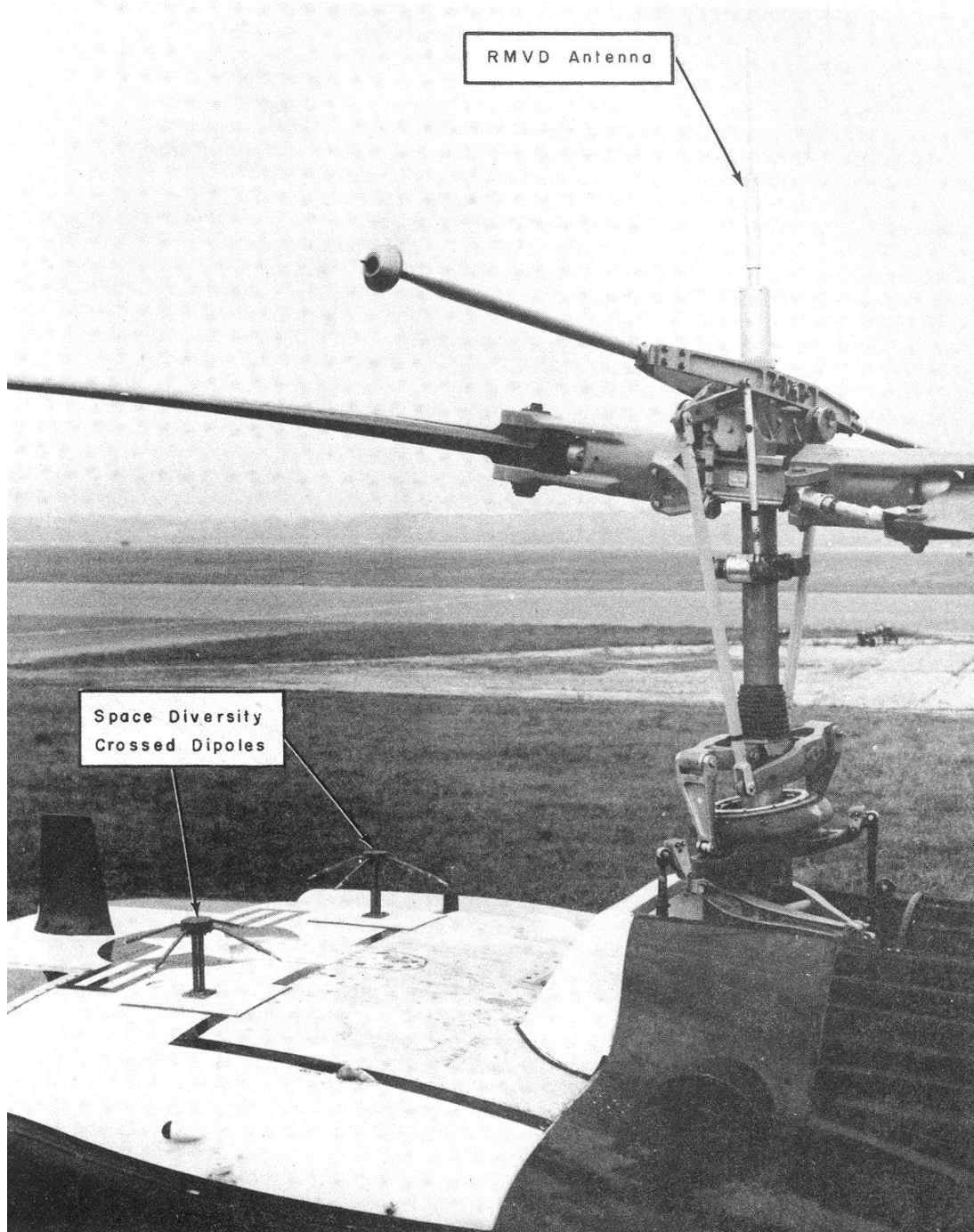
Four antenna configurations were conceived and tested in an effort to provide reliable satellite communications for the UH-1F helicopter by overcoming blade shadowing interference. The first two



**UHF SATCOM Equipment block Diagram**



**UHF SATCOM Equipment Mounted in Helicopter**



**Dipole Antenna on top of Mast and Crossed Dipoles Mounted on Top of Cabin**

antenna configurations were circularly polarized crossed dipoles, whose maximum radiation was directly overhead. The rotor-mounted antenna, the first antenna tested, was susceptible to blade modulation at low elevation angles, especially in the horizontal plane. The second antenna system, which was a two-element array, cabin-roof mounted, was more successful in reducing the blade modulation to acceptable limits, although blade modulation was severe when either element of the phased array was shadowed by the fixed structure of the helicopter. Adequate pattern coverage and





**Rotor-mounted Crossed Dipole Antenna**

performance would be provided by installing additional antenna elements toward the rear of the helicopter together with supporting phasing and switching components. This method was considered unsuitable, however, because it was too cumbersome. The third configuration, consisting of a vertical dipole, was more promising. It was mounted on the rotor mast and a built-in tuned choke section was used to electrically isolate it from the helicopter as well as the rotating blade. Blade modulation was thus eliminated or reduced to a very low level, and desirable pattern gain was obtained in the azimuth plane. This vertical dipole antenna, however, was deficient in overhead coverage. To correct this, a fourth configuration was constructed, consisting of a combination of the vertical dipole and one of the cabin-mounted crossed-dipole antennas fed in parallel. This combination, with its complementary patterns, provided hemispherical coverage. Since the two antenna elements have a polarization normal to each other, they generate no interference pattern. In flight tests, this antenna configuration gave excellent performance.

**Recommendations:** The antenna configuration consisting of a rotor-mounted vertical dipole and cabin-mounted horizontal crossed dipoles fed together represents an antenna system that provides upper hemispheric UHF satellite communications for a UH-IF helicopter. This configuration should be explored and the design refined to combine these two antenna functions into one physical unit for mounting on top the rotor mast. This type of antenna might also be considered for use on aircraft. One advantageous feature in the use of this antenna system on aircraft is that it permits the antenna system to occupy two antenna locations without causing an interference pattern.

**Reference:**

Yake, Capt. Terry J., Jerome W. Uhrig, **Helicopter Communications Via UHF Satellite Relay**; Air Force Avionics Laboratory; AFAL-TR-70-152; WPAFB OH; July 1970.



## Helicopter Communications via VHF Satellite Relay (1966-1967)

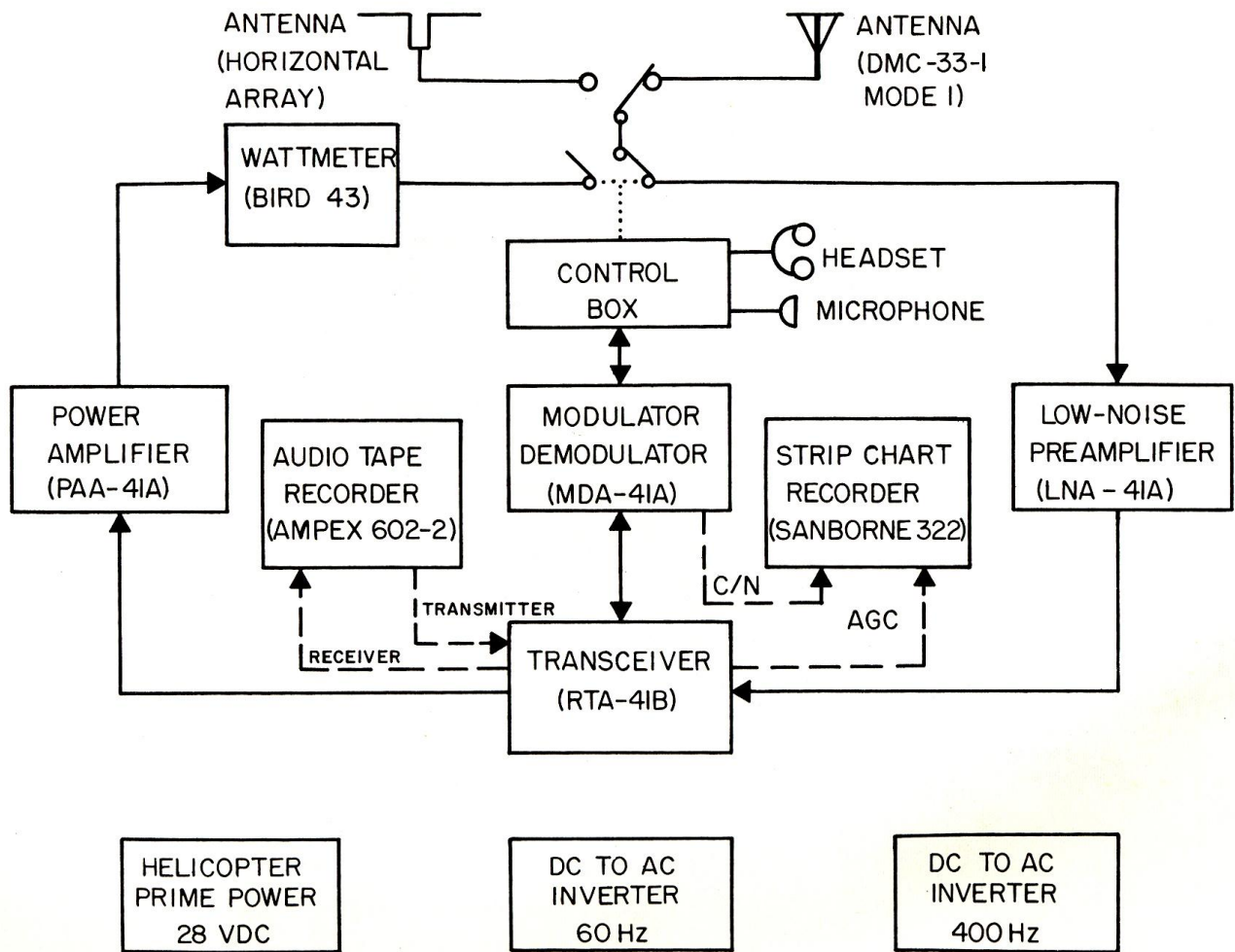
**Background:** Under the **Communications Technology for Satellite Relay** Project 4164, the Air Force Avionic Laboratory undertook an effort to demonstrate beyond-line-of-sight communication to a helicopter using VHF satellite relay. The initial effort involved a quick-reaction flight test program to be performed completely in-house and using available equipment, to demonstrate the feasibility of helicopter/satellite VHF-FM communications. That was to be followed by a contractual investigation of the various problem areas involved in specific helicopter/satellite communication links operating at UHF and SHF frequencies. The planning and helicopter modifications were accomplished between October 1966 and March 1967 with the flight tests conducted on 29 March 1967 and 11 May 1967.

**Test Results:** VHF-FM voice tests have been conducted to demonstrate the feasibility of continuous two-way helicopter/ground and helicopter/aircraft, beyond line-of-sight communications via satellite relay and to acquire operational information upon which future developments can be based, especially concerning antennas. These tests were conducted through the NASA ATS-1 satellite using an Air Force UH-1F helicopter and NASA ground stations based at Cooby Creek, Australia; Mojave, California; and Rosman, North Carolina. In addition, an Air Force JC-121 aircraft (Leap Frog) and a receive-only ground facility at Wright-Patterson AFB were employed as cooperating terminals. Results to date have demonstrated that helicopter/ground and helicopter/air links can be established for certain conditions. Effects due to rotor interference, ground plane deficiencies, and Faraday rotation were observed. In addition, future tests were recommended to complete the evaluation of communication-link rotor induced antenna problems for greater look angles and to determine link improvement for antennas installed on the helicopter in such a manner as to avoid or reduce the rotor effects.



**HU-1F Helicopter with Dorne Margolin VHF antenna atop cabin**

Based on the testing, several conclusions can be reached. First, VHF helicopter/ground and helicopter/aircraft voice communication links are feasible under certain conditions. These conditions concern parameters such as Faraday rotation, look angle, rotor blockage, and effective radiated power.

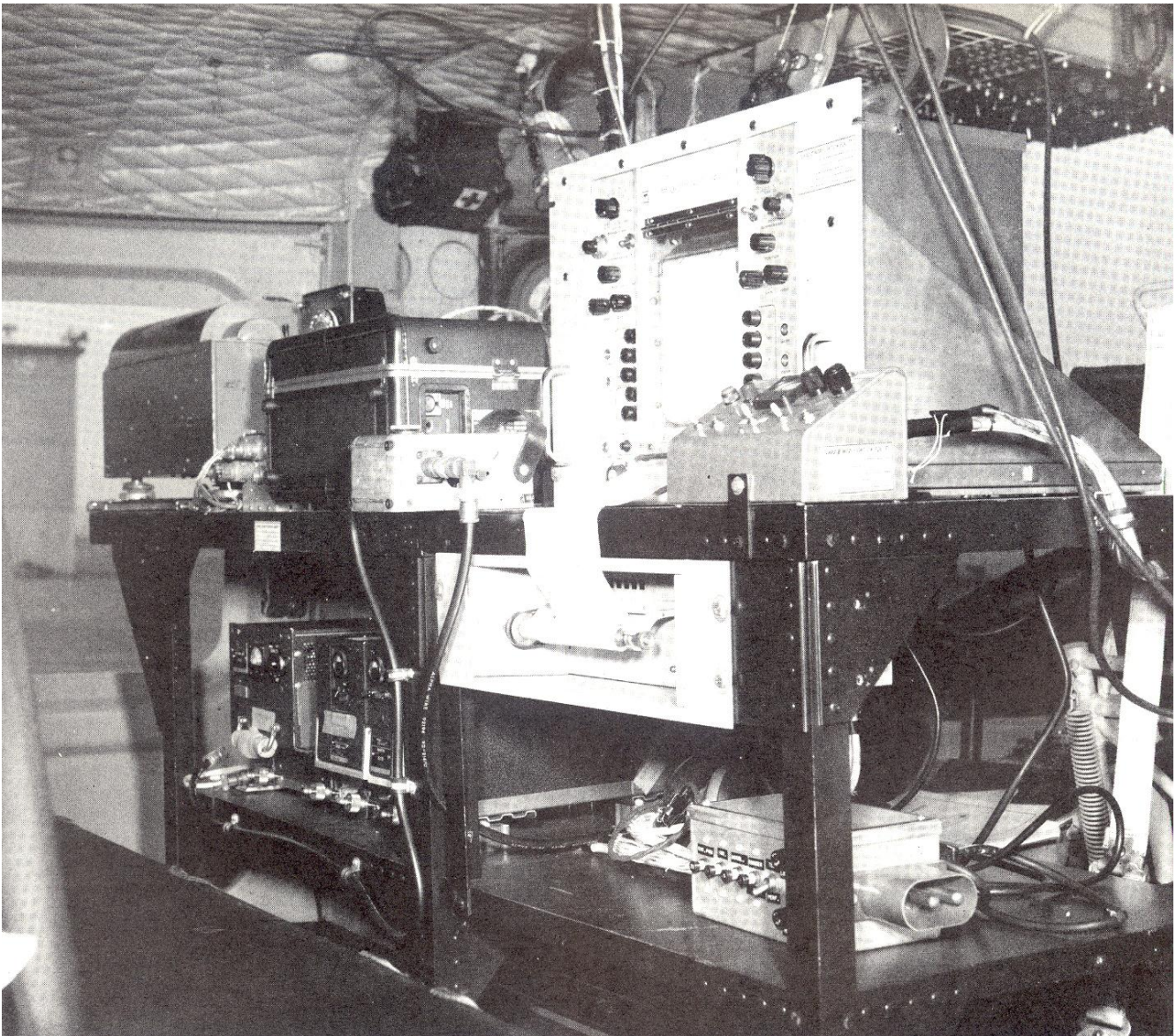


**Helicopter VHF Satellite Communication Equipment Block Diagram**

For these test, a circularly polarized antenna was required to assure continuous communications. In applications where no single antenna can provide the required polarization and antenna coverage, two or more antennas (or a single antenna with several modes) can be used and the operator, by means of a switch, can select the most satisfactory antenna (or mode) for each situation; however, this should be avoided if possible. Due to the much larger angular coverage required by the helicopter antenna, it would be more advantageous to have the circularly polarized antenna system on the satellite. Then the helicopter antenna could be either circularly or linearly polarized.

Since these tests were conducted in the vicinity of WPAFB (look angle to the satellite of about 7°), several points can be made concerning look angle effects. First, the relative importance of high- and low-level radiation has been analyzed by Cline and Martin. They determined that, for aircraft-to-satellite communications, "the satellite is nearly three times as likely to be found within a given solid angle near the horizon as within an equal elementary solid angle near the zenith." Therefore the helicopter antenna should provide near-horizon coverage for a single satellite system.





### **VHF Satellite Communications Equipment Mounted in Helicopter**

The second aspect of look angle which must be commented upon is that the effects of rotor modulation on the signal could not be fully determined because of the low elevation angle of these tests. Although some deleterious effects were discussed concerning the rotor-induced multipath signals, insufficient data were obtained from the pitch cuts to characterize either the DM Mode II operation or direct shadowing of the received signals by the rotor blades.

Based on the scale model information (which was verified experimentally for low look angles), it must be concluded that significant losses will be incurred when the line of sight from the helicopter to the satellite is directly through the path of the rotor blades (that is, when the look angle is greater than about  $10^\circ$ ).

As mentioned, the helicopter was able to receive signals from the satellite under adverse conditions whereas transmission through the satellite by the helicopter was only possible under optimum conditions. Therefore, a minimum of 500 watts should be available to the helicopter for VHF voice





**VHF Horizontally Polarized Antenna on Helicopter**



**VHF SATCOM Helicopter Operator**



communications via the ATS-1 satellite and possibly a kilowatt of RF power may be desirable to combat the effects of spin modulation.

**References:**

Falter, James W., Jerome W. Uhrig, **Helicopter Communications Test Program – VHF Communications Via ATS-1 Satellite Relay**; Air Force Avionics Laboratory; AFAL-TR-67-195; WPAGB OH; October 1967

## **Integrated Communications, Navigation and Identification Avionics (ICNIA) (1972-1996)**

**Background:** Communication, Navigation, and Identification (CNI) functions have historically comprised a major subset of military avionics systems—a subset that has expanded dramatically with the increasing complexity of the electronic battlefield. As these CNI systems have grown in number and sophistication over the past two decades, so have the attendant penalties in size, weight, and life cycle costs. Space limitations in the avionics bays and cockpits of current fighter aircraft coupled with high retrofit costs for avionics upgrades in the CNI area have forced us to make some significant compromises in the CNI capabilities of our front line fighters.

**ICNIA Development:** Today's communication, navigation, and identification (CNI) suite portrays an ubiquitous picture of technology and requirements rapidly outpacing the bureaucracy that produces and deploys operational systems. Current CNI systems have been implemented by a collection of equipment involving "radios" in different frequency bands that were implemented with diverse state-of-the-art electronic techniques and technologies. They perform satisfactorily in a benign environment, but offer little hope for success in the face of an expanding CNI threat. While tactical aircraft and missions increase in complexity and scope, equipment is uniquely developed to accomplish goals with little or no apparent interface with existing capabilities. As a result, the Air Force faces some major "inconveniences" in CNI systems: proliferation of unique, single function hardware; lack of central control and interface (which increases pilot workload); and a rather horrendous logistics problem of providing parts, maintenance training and technicians, and test equipment. To complicate matters even more, technology is booming at a rate that tends to make system technology obsolete by the time a full, operational capability is achieved, especially in the anti-jam arena.

Three new systems (JTIDS, GPS, and SEEK TALK) which will provide enhanced CNI performance capabilities are in the engineering development stage. As envisioned by the Air Force, these new jam-resistant systems are to become the foundation for tactical CNI avionics in the 1980s and beyond, in addition to the conventional systems already in use. Retention of the old radios may be necessary because of the prolonged transition period inherent in such a major system modification. The Air Force faces a serious problem because the combined impact of these existing and new CNI systems upon life cycle cost, volume, and weight is prohibitive.

A solution to the problems resulting from proliferation of CNI systems has taken shape in the Integrated Communication, Navigation, and Identification Avionics (ICNIA) program. ICNIA was a WL effort to integrate multiple CNI functions into a single, software intensive, reconfigurable, and fault tolerant architecture that will meet the needs of tactical aircraft beyond the year 2000. ICNIA uses a set of radical modular, reconfigurable components capable of selectively processing multiple, widely varying CNI signals. Some of these signals possess jam-resistant pseudo noise, frequency hopping, and time scrambling features; some are continuous while others are intermittent or pulsed. ICNIA is characterized by a modular design in which modules can be replaced at the flight line using no external diagnostic equipment. It includes extensive system built-in-test and software control for graceful degradation in the event of failures. From an operational viewpoint, ICNIA will give pilots a flexibility that does not exist today. The pilot will be able to decide the priority of CNI functions and program ICNIA accordingly. Only after multiple failures (e.g., battle damage) when redundant

resources are not longer available, will the pilot be advised of a problem. He will then be given the opportunity to reorder the prioritization of CNI functions. The system will drop lower priority functions as required to ensure that the pilot has available those functions he judges most critical to mission success. The ICNIA software intensive design will provide the reprogramming flexibility needed to support new CNI functions, changing platform/mission requirements and timely response to new CNI threats.

**HISTORICAL PERSPECTIVE:** The genesis of integrated avionics extends back almost three decades to technical thinking in the 1960's which recognized integrated systems to be potential solutions to size and weight bounds that certain tactical aircraft imposed on avionics plus solutions to pilot works loads, and a growing logistics support problem.

Several DOD-sponsored study efforts addressed the general CNI user equipment problem area. One Avionics Laboratory effort, entitled "L-Band Radio Architecture" (Contract F33615-72-C-1294), suggested that implementing the L-Band portion of CNI avionics as a unified, multifunction radio system would be more cost-effective than the usual collection of independent black boxes. Another study, entitled "Multifunction Avionics C-N System Study" (Contract F33615-72-C-2119), showed the feasibility of adding L-Band functions to the UHF Growth Radio and concluded that cost savings could result from such an approach. A third program entitled "Standard Avionics Modules for Existing Modems" (Contract F33615-76-C-1307), addressed the design and development of standard, common avionics modules for existing spread spectrum type CNI equipment, such as GPS and JTIDS. Although functional commonality was demonstrated, time sharing of common modules and processors between modem functions with minimum performance degradation was still considered to be of moderate risk. An ASD-funded study, entitled "L-Band Interrelationship" (contract F33657-75-C-0295), investigated the partitioning of L-Band radio functions to maximize the application of common modules across systems such as JTIDS, GPS and PLSS. This study, which agreed with and supported the aforementioned studies, illustrated that feasibility of partitioning these systems so that at least 60% of the modules are common to two or more systems.

During the 1970's, the major Service developmental program for integrated CNI was the Navy's Tactical Information Exchange System (TIES) that integrated signals in the HF, VHF, UHF, and L-band and which resulted in demonstration hardware. In 1975, the Naval Air Development Center in Warminster PA initiated an exploratory development program (TIES) to develop an integrated radio design to eliminate or reduce problems of proliferation of hardware, over redundancy, technological obsolescence, and cost. Upon termination of the system design contract in 1978, for convenience of the Government, the system design and integration was redirected as an in-house effort, resulting in the fabrication of a breadboard TIES. Laboratory demonstration of system performance was conducted in 1981, addressing the application of digital links, such as TADIL C, in Navy operations. The TIES architecture encompassed three major subsystems: frequency conversion, signal distribution, and signal conversion. The Frequency Conversion Subsystem served as the RF front end, which consisted of RF amplification, frequency synthesis, down conversion, and IF amplification. The system used an RF module unique to each particular frequency band but common to multiple channels within each band. Channel parameters such as frequency, bandwidth, and AGC were under digital control of the

Signal Distribution Subsystem. All IF channels were provided in accordance with the operational requirement and were fed to the Signal Distribution Subsystem. The Signal Distribution Subsystem function provided the flexibility in resource location for survivability. It was, in effect, an IF bus with a greater than 500MHz bandwidth to allow freedom in locating antennas and RF modules at locations separated from the signal conversion resources. Parallel IF channels were frequency division multiplexed onto the bus (similar to commercial cable television) through common hardware under digital controls that were also multiplexed onto the bus. The Signal Conversion Subsystem consisted of wideband and narrowband signal processors that performed functions such as modulation/demodulation, matched filtering, pulse detection, and signal parameter tracking in digital algorithms. Processing channels were connected to the bus as required. System availability was enhanced by both physical redundancy and reprogrammability; modern techniques were applied for built-in-test and expandability. The TIES architecture was a conventional superheterodyne radio approach using state-of-the-art technology. It did not include the Air Force SEEK TALK capability. A letter of understanding was coordinated between NADC and the Avionics Laboratory, designating levels of cooperation and technical interchange between the TIES and ICNIA program offices.

A General Officers' Steering Committee for Communications, Navigation, and Positioning Integration (CNPI) was established by the Vice Commander of AFSC in 1977 to determine how to fit GPS, JTIDS, and SEK TALK into tactical aircraft and integrate them with existing onboard systems. The study developed three integrated design alternatives using preferred packaging, advanced component technology, and various levels of integration. A low-level integration of the GPS, JTIDS, and INS systems was recommended as a near term solution to the problem. The SEEK TALK function was not integrated. The study indicated that further integration would result in greater cost savings as well as size and weight reductions.

The Multifunction Multiband Airborne Radio System (MFBARS) program was initiated by the Avionics Laboratory in 1977. It was originally a combined 6.2/6.3 effort, but was later separated to pursue exploratory development work only, with advanced development to be accomplished under the ICNIA program. The MFBARS effort developed a low cost radio terminal technology base that would satisfy the CNI needs of tactical aircraft in the 1990 time frame. It sought significant reductions in life cycle costs (LCC) through commonality of user equipment across new and existing CNI systems. In investigating full functional integration of CNI, four study contracts were awarded under Phase I to define possible architecture and project potential cost, size, and weight savings in light of standardized, modular system components. The following basic ground rules for the architectures were established: a) extrapolate technology into 1985 and design the architecture based upon that projection to insure an advanced, non-obsolete design for the 1990s; b) make the architecture compatible with a MIL-STD-1553B bus such as in the Digital Avionics Information System (DAIS) concept; and c) keep economic factors in mind for low, future production and support costs. Cost and design trade-off analyses were performed on all four architectures with projected savings of at least 30% in LCC, size, and weight. Two moderate-to-high risk/high potential pay-off architectures were selected for continuation into Phase II for conceptual design refinement and for identification of critical technologies. Additional analyses of the revised architectures projected the cost, size, and weight savings due to integration would be 50%, in addition to savings due to technology progression of single function equipment.



Phase II was extended through September 1980 to a) investigate the impact of adaptive antennas upon the MFBARS architectures, b) assess the applicability of the Laboratory-developed High Speed Micro Signal Processor to MFBARS, and c) to document in greater detail the system design tradeoffs and analyses. Phase III of the program validated the technological feasibility of two critical concepts, one from each architecture; namely, the agile bandpass filter (ABF) and radio frequency large scale integration (RFLSI) receiver. This phase extended through the end of FY82 to develop breadboard hardware to demonstrate the concepts of a programmable wideband transversal filter and a wideband, multifunction receiver on a chip.

A threat assessment was conducted by FTD in July 1978 for the MFBARS program. Susceptibility to existing threats to single function CNI equipment were scrutinized throughout the development of the ICNIA design.

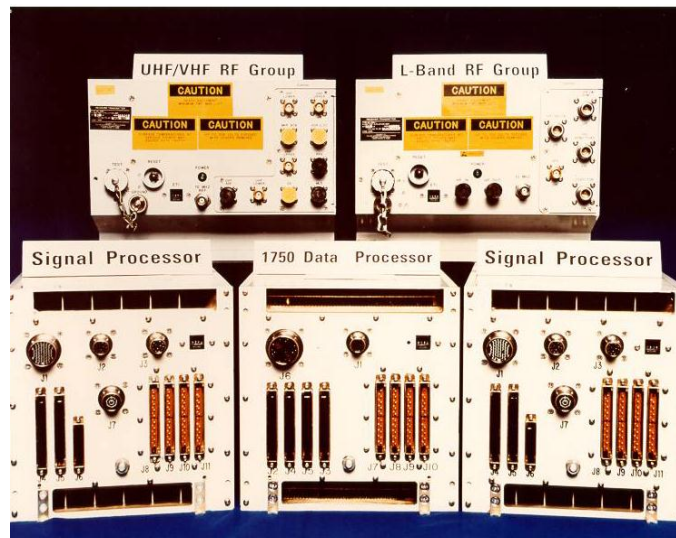
As mentioned above, the ICNIA program began with studies that the Air Force funded in 1978 aimed at exploring feasibility of Integrating CNI functions to obtain added space for developing CNI capabilities (such as JTIDS, GPS, SINGARS, and MARK XII) at an affordable life cycle cost. At that time, four contractors were funded to create generic architectures having the attributes of expandability and potential standardization around modules that could be used to accommodate new waveforms in the 2MHz to 2,000 MHz frequency range. Following these studies, which ended in January 1980, a dual award was made to develop conceptual architectures based on the best of the four ideas and their emerging technologies. Contract follow-ons, that lasted from March 1980 until August of 1983, represent the definitive efforts for the Air Force CNI avionics integration concepts, and serve as the baseline for the ICNIA program as it exists today.

Several related technology opportunities surfaced at about the same time to make ICNIA a timely program. The development of the Digital Avionics Information System (DAIS) concept of digital avionics information management opened the door to exploitation of the capabilities of an integrated CNI avionics system. Coupled with breakthroughs in digital technologies such as fiber optics, high speed microprocessors, more efficient navigational algorithms, and adaptive antennas, the ICNIA program will revolutionize radio development philosophies through the application of projected technology availabilities to advanced system design concepts. This can provide a design that will not be obsolete in production. Its architecture is readily adaptable to implementation of new technology as well as new requirements.

**TECHNOLOGY DESCRIPTION:** The ICNIA Program focuses upon the integration of CNI hardware and software into a single system architecture capable of receiving, processing, and transmitting any CNI RF signal between 2MHz and 2000MHz with the added capability of the Microwave Landing System at 5GHz. ICNIA is designed to have the same operational performance of as many as 16 discrete radios in a package that will eventually be 45 to 50 percent smaller and lighter in weight.

The system is characterized by a modular (28 module types) design in which modules can be replaced at the flight line using a minimum of supporting external diagnostic equipment, and by extensive system built-in-test and software control for graceful degradation in the event of failures.

Four different advanced development models (ADMs) of ICNIA were built, integrating from five to sixteen waveforms, with extreme hardware and software commonality across the different configurations. ICNIA ADMs were delivered to ATF SPO, demonstration/validation contractors in May and July of 1990.



**ICNIA Advanced Development Models (ADMs)**

**TECHNOLOGY TRANSITION INTO SYSTEM:** Following studies in the late 70's and early 80's, it was considered feasible to use emerging technology to integrate communication, navigation, and identification (CNI) functions within the 2-2000 MHz frequency band into a single system. Contracts were signed in October 1983 with TRW and a Joint Venture (JV) of ITT and TI to design, fabricate, test and evaluate advanced development model (ADM) ICNIA terminals. TRW formed subcontractor relationships with Rockwell-Collins, Singer-Kearfott, and General Dynamics.

The two independent designs were aimed at building radios capable of handling new anti-jam waveforms through software changes, with virtually no requirement for hardware modifications. A major thrust in the program was to develop fault tolerant architectures which incorporate functional redundancy, resource sharing, and through extensive built-in-test capability, fault detection/isolation and dynamic reconfiguration. The payoff is a flexible CNI system which can be tailored to meet different aircraft functional requirements and physical constraints in an affordable manner. Full modular designs, utilizing VHSIC technology, were incorporated, enabling the concept of 2-level maintenance to be evaluated. ICNIA ADM terminals were delivered to ATF SPOs demonstration/validation contractors in May and July of 1990.

**LABORATORY CONTRIBUTION:** The Laboratory's MFBARS/ICNIA programs began in 1978 when four study contracts (TRW, ITT, Sylvania, and General Dynamics) were awarded for development of competing architecture definitions under Program Element 62204F, Project 2003.

This resulted in two distinct approaches: one promising a “quantum leap” forward in radio system designs and potential performance, using GaAs “zero-IF” digital receivers; the other a “less risky” technical design based on developed techniques of superheterodyne radio engineering. These programs were followed by transitioning of the effort from Exploratory Development to Advanced Development under Program Element 63109F, Project 2538, and its name change to (ICNIA) which occurred in 1981. At that time, the Army became a partner in its development. Beginning with that transition, the program finalized two design architectures and construction began on the first modules for CNI avionics hardware and related software.

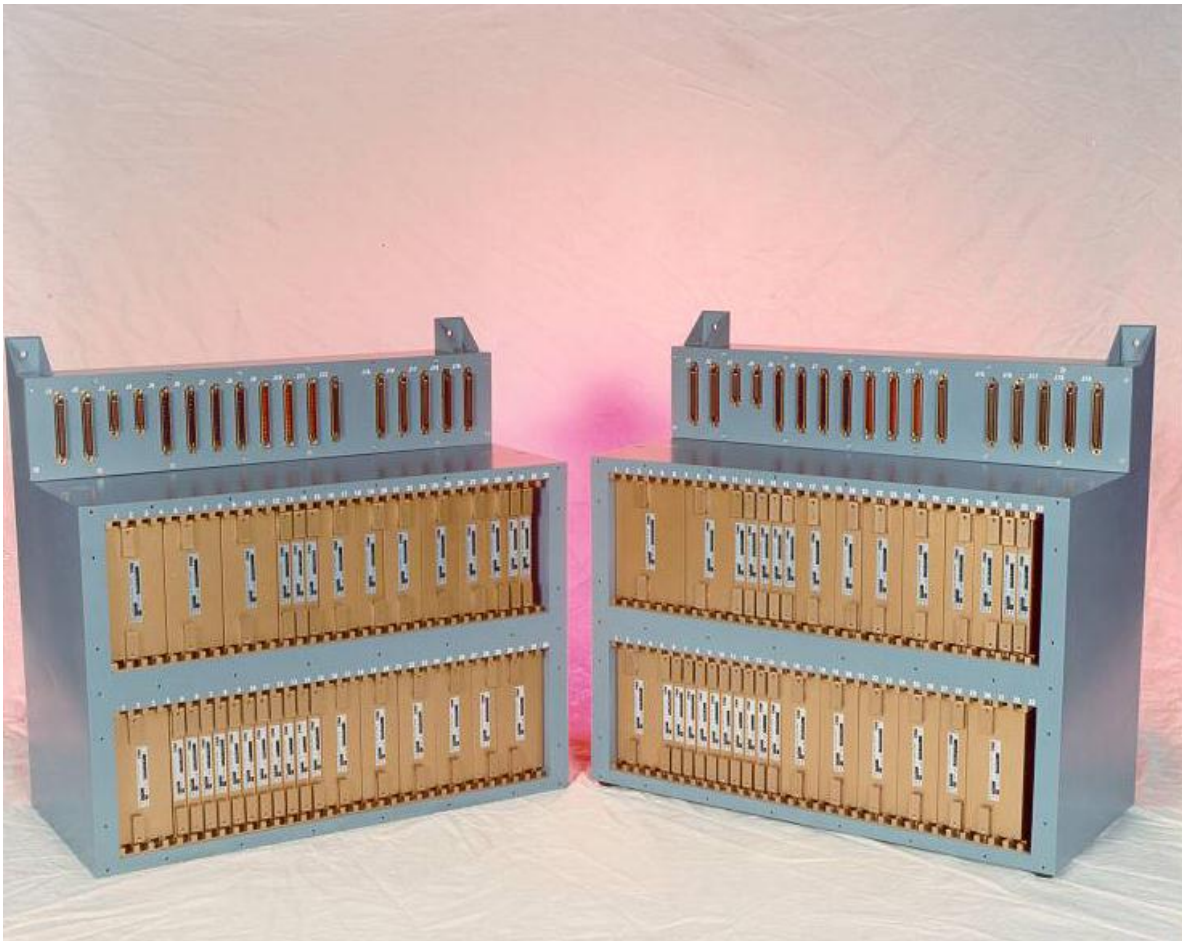
## **SUCCESSFUL MILESTONES AND USER PARTICIPATION:**

### Milestones

- Mar 81 - ICNIA System Definition Study Contracts awarded to TRW and ITT avionics
- Jan 82 - MOA signed with Army for joint ICNIA program
- Oct 83 - ICNIA ADM terminal contract awarded to TRW and ITT/TI (joint venture)
- Jun 85 - ICNIA CDRs held on Phase I design
- Sep 85 - Modular ICNIA Design Option implemented (contract amended)
- Oct 85 - PE63109F transferred to ATF SPO
- Apr 86 - Tri-Service MOA signed on ICNIA
- Apr 86 - Modular ICNIA CDR held (TRW)
- Jul 86 - Modular ICNIA CDR held (ITT/TI)
- Dec 86 - ITT/TI (Joint Venture) down selected
- Nov 87 - ICNIA Program Restructure ( Risk Reduction for ATF)
- Dec 87 - Navy requirements incorporated in ICNIA contract
- May/Jul 90 - ICNA ADM Terminals delivered to ATF SPO Dem/Val contractors
- Sep 90 - ADM #1 delivered to Army
- Feb 91 - Navy software Demonstration
- Mar 91 - Army Flight Demonstration in UH-60 Helicopter
- Mar 91 - ICNIA ADMs delivered to AF

In Oct 85, the ATF SPO was given control of PE63109F. The SPO worked closely with the Laboratory ICNIA development team to restructure the ICNIA program to provide risk reduction for the CNI portion of the ATF’s integrated avionics. The ICNIA ADM terminals delivered to the DEM/VAL contractor were a major element in ground base laboratory and flight demonstrations.

**PAYOFF ACHIEVED:** WL’s Avionics Directorate has successfully integrated a wide variety of CNI functions in the 2MHz to 5GHz frequency band into a single system. Advanced technologies, such as VHSIC, and extensive software programmability have been used to produce a fault tolerant radio system which significantly increases reliability and operational availability while reducing weight, size, and cost in comparison with discrete systems.



### **Integrated Avionics Modules for F-22 Aircraft**

As the very first modular integrated avionics system, ICNIA has had pervasive visibility, influence, and revolutionary effect on a wide segment of the aerospace electronics industry. It has spawned new ways of viewing avionics from the basic research through support of the complete system. Among its innovations are: functional integration, common modules, resource sharing, dynamic reconfiguration, and two level maintenance supportability.

As a result of this effort, knowledge gained during the design of the ADM terminals has been used to reduce the risks on the Integrated Electronic Warfare Systems (INEWS) program and the ATF Common Module Program. CNI terminals based on the ICNIA advanced development program were major factors in the timely completion by both contractors of the demonstration/validation phase of the ATF program. In addition, one of the ADM terminals will be installed in the Integrated Electromagnetic System Simulator (IESS) as a RF “hot bench” to support continuing evolutionary development of integrated CNI and other emerging CNI waveforms by software/firmware changes in the ICNIA architecture. Finally, the Light Helicopter (LH) for the Army will have an Integrated CNI suite based on ICNIA technology.



## **Applications: YF-22 AND YF-23 Programs**

### **Technology Demonstrations:**

- a. Brassboard-15 Sep 87
- b. ADM#1-2 Feb 90
- c. ADM#2-2 MAR 90
- d. ADM#3-6 Apr 90
- e. ADM#4-1 Jun 90

Estimated Air Force Investment: \$106M

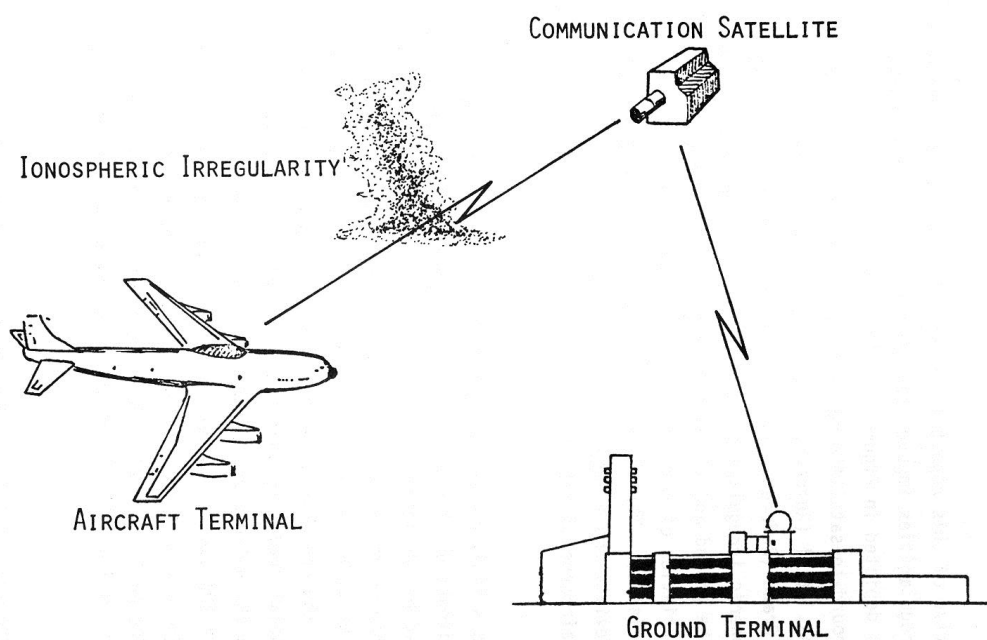
Estimated Army Investment: \$10M

Estimated Navy Investment: \$10M

## Ionospheric Scintillation Fade Mitigation (1972-2000)

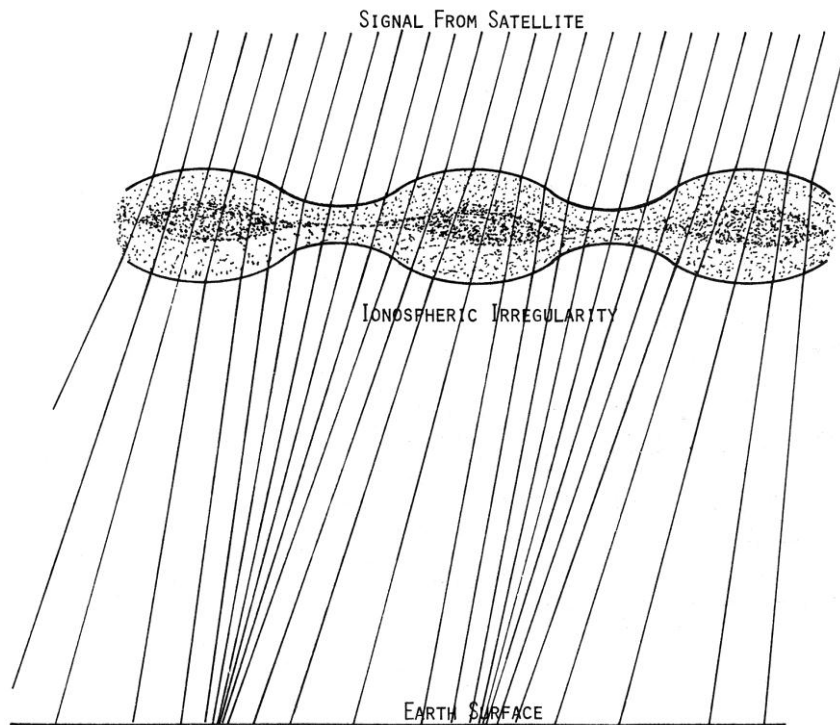
**Background:** The advent of UHF satellite communications in 1967 brought the promise of reliable, fade-free world-wide communications for aircraft and ship operators who had been living with the uncertainties of High Frequency (HF) communications since Marconi sent his first wireless signals in 1901. Since the HF had to bounce off the ionosphere to propagate beyond-line-of-sight, it was subject to ionospheric irregularities that often limited its range. By the early 1970s it became obvious the ionospheric irregularities could also caused problems with UHF satellite communications.

**Investigating the Ionospheric Scintillation Problem:** In the early 1970s, the Air Force Avionics Laboratory (AFAL) began to experience severe signal fading on their UHF satellite communications links when they operated in the polar or equatorial regions, Figure 1. AFRL joined up with the Air Force Cambridge Research Laboratory (AFCRL) at Hanscom AFB MA to investigate the cause of the problem and to develop methods to correct it.

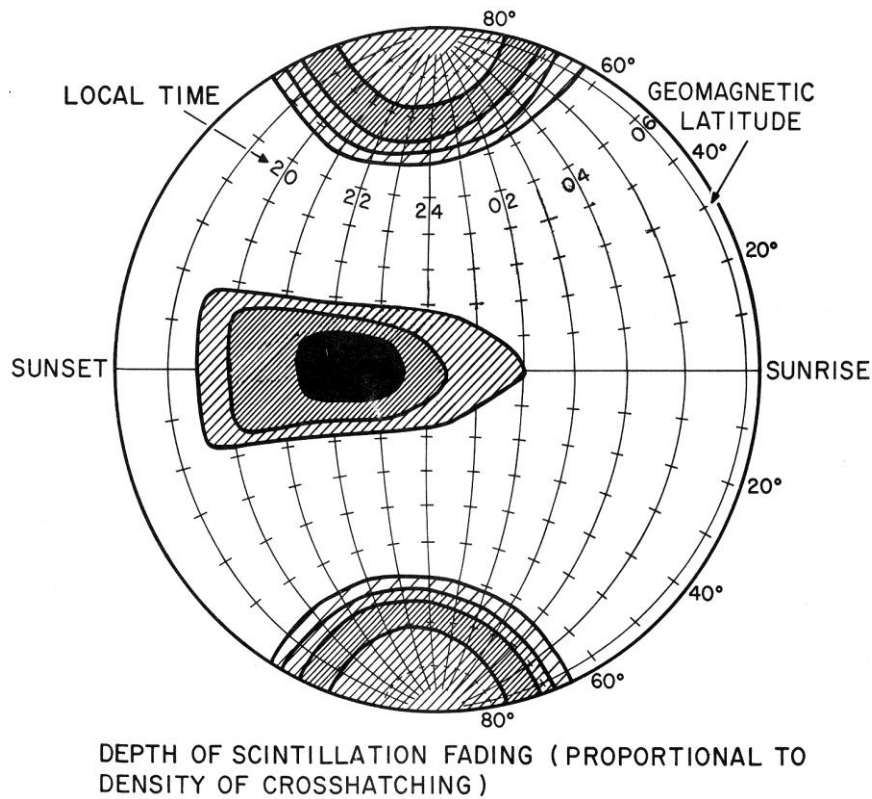


**Figure 1 Communications Path Through Ionospheric Scintillation**

Through the joint research effort, the Air Force team discovered that ionospheric scintillation fading occurs as a result of sharp ion or electron gradients which occur in the ionosphere. These sharp gradients are caused by the ionospheric irregularities which tend to refract or focus the radio waves as they pass from the earth's surface to the satellite, Figure 2. While the irregularities can occur anywhere over the earth's surface, the probability of occurrence is more likely in the polar and equatorial region as depicted in Figure 3. In the polar regions the occurrence is greatest near the auroral oval. In the equatorial region scintillation is predominantly a night-time effect, usually occurring one to two hours after local sunset and lasting past local midnight. In the mid-latitudes scintillation seldom occurs and usually is of short duration when it does occur.



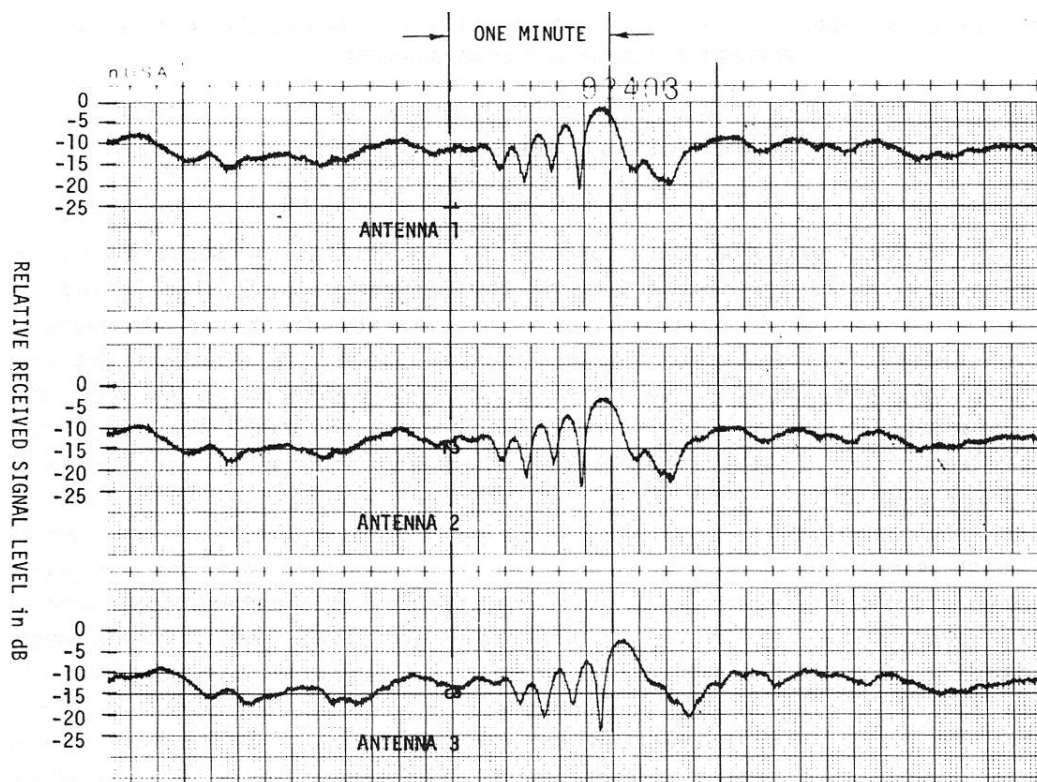
**Figure 2 Focusing Effect of Ionospheric Irregularities**



**Figure 3 Geographic Distribution of Ionospheric Scintillation Fading**

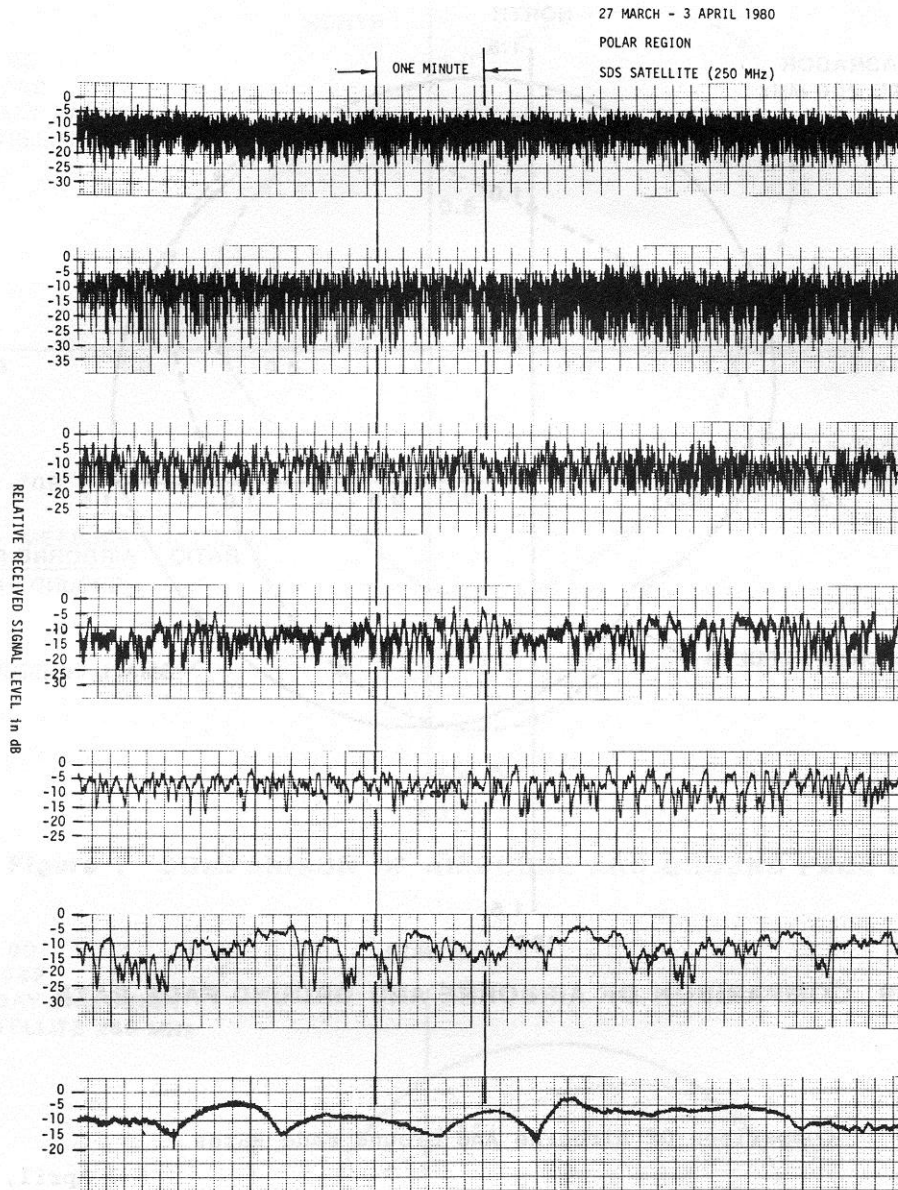
The development of ionospheric irregularities leading to scintillation is controlled by the earth's magnetic field. In the equatorial region the ionospheric irregularities are magnetic field aligned and extend  $\pm 15^\circ$  in latitude around the magnetic equator. In the high latitudes the magnetic field controls the location of the particle precipitation responsible for the formation of the irregularities. The scintillation regions are organized by L-shells or invariant geomagnetic latitudes. While the exact cause of the ionospheric irregularities is not completely understood, the resultant effects are clearly identifiable. The irregularities tend to form along the magnetic field lines between 200 to 1000 kilometer altitude. Instabilities in the ionosphere triggered by some natural phenomena tend to expand rapidly, forming high electron concentration or electron depletion regions which produce the observed scintillation. These irregularities, once formed, tend to cause a diffraction pattern effect on the earth's surface. The result is an irregular sequence of enhancements and null regions. The ionospheric irregularities are not stationary but tend to move due to electric field and/or neutral ionospheric winds and change in size and shape with time. The effect on earth-to-satellite communications is a signal amplitude and phase scintillation which is frequency dependent. The frequency dependence results in severe fading in the VHF and UHF bands with little fading above 1 GHz.

Once formed, the irregularities tend to remain frozen for several minutes. As the irregularities drift over spaced antennas, the same fade pattern will occur at each antenna with a time lag, Figure 4. By deploying three antennas in a triangular pattern, the correlation pattern allows the drift rate and direction to be determined. Depending upon the drift rate and the aircraft receiver velocity, the fading may be as fast as several fades per second or as slow as one fade per minute, Figure 5.



**Figure 4 Correlation of Ionospheric Scintillation Fading at Spaced Antennas**





**Figure 5 Variations in Scintillation Fade Rate**

**Scintillation Fade Mitigation:** After characterizing the scintillation fading, AFAL set about developing techniques to minimize the effect of the fading on airborne satellite communications reliability.

The modulation chosen for an airborne satellite communication system must be robust in order to minimize the phase and amplitude effects of polar fading. Calculations have shown that phase modulation, such as BPSK, would experience an irreducible bit-error-rate due to the severe phase variations of the polar fading. By contrast, a Frequency Shift Keyed (FSK) modulation such as binary FSK or 8-Ary FSK is less sensitive to phase variations and exhibits a more robust behavior in the fading environment.

Some type of diversity should be employed in the communications system to alleviate the burst errors caused by ionospheric fading. Fade depth changes very slowly with frequency, making frequency

diversity impractical. Antenna diversity, in general, requires antennas spaced hundreds of meters apart to get the necessary improvement. While this may be acceptable for ground stations, it is not practical for an airborne terminal. Time diversity, such as coding and interleaving provide the most practical solution for improving the performance of an airborne terminal. Most of the time, the fade duration is a fraction of a second. Interleaving over several seconds can successfully convert burst errors caused by the fading into random errors which can be corrected by a forward-error-correction decoder. Tests with 1/3 rate, 1/2 rate and 3/4 rate coding have shown that 1/2 rate or 3/4 rate coding is adequate to significantly improve the error rate during most ionospheric scintillation. The 1/3 rate coding provided only marginally better performance and reduces communications throughput rate.

AFAL built an experimental satellite communications terminal, the Fade Resistant Modem, using two-tone FSK with four-second interleaving and a 3/4 rate feedback decoder. Error-free message reception improved from 10 percent without coding/interleaving to 90 percent with coding/interleaving during polar ionospheric scintillation fading.

Another parameter available to the communications system designer is message length. When operating through polar ionospheric scintillation, it is desirable to keep the message length short, i.e. a few seconds. Under rapid fading conditions, the coding and interleaving will correct the burst errors and provide error-free messages. Under conditions of extremely slow fading, where the fade may last for several seconds, only one or two of the short messages would be lost per minute and these can be corrected by selective message repeating. Using longer messages might make it impossible to send a complete, error-free message under conditions of slow ionospheric scintillation fading.

**Transition of the Scintillation Fading Mitigation Technique:** AFAL's work on scintillation fading mitigation was employed in the design and development of the Command Post Modem Processor, UHF Dual Modem and other airborne satellite communications terminals.

#### **References:**

Aarons, J. (Ed); **A Survey of Scintillation Data and Its Relationship to Satellite Communications**; AFCRL-70-0053; Air Force Cambridge Research Laboratories; Hanscom AFB MA; January 1970.

Bernal, Dr. Robert; **Coding Techniques to Reduce Ionospheric Scintillation Effects on AFSATCOM Dual UHF Modem**; Linkabit Corp; San Diego CA; 27 December 1979.

Johnson, Allen L. and Paul K. Lee; Equatorial **Scintillation Test of Les 8/9**; Naval Research Laboratory Scintillation Symposium; Arlington VA; 24 January 1978.

Johnson, Allen L.; **The Effect of Ionospheric Scintillation Fading on Aircraft-to Satellite Communications**; Air Force Avionics Laboratory; WPAFB OH; AFAL-TR-78-171; February 1979.

Johnson, Allen L.; **Ionospheric Scintillation in the Polar Cap**; COSPAR Symposium; Warsaw Poland; 22 May 1980.

Johnson, Allen L.; **Influence of Ionospheric Irregularity Shape and Velocity on the Design of Airborne Satellite Communications Systems**; AGARD Symposium of the Electromagnetic Wave Propagation Panel; Fairbanks AK; 3 June 1985..

Prettie, Clifford W. and Allen Johnson; **Mitigation for Airborne Satellite Receiver Platforms of UHF Ionospheric Fading by Use of Spatial Diversity**; Naval Research Laboratory Scintillation Symposium; Arlington VA; 24 January 1978.

## Lens-Sphere Passive Communications Satellite (1960-1964)

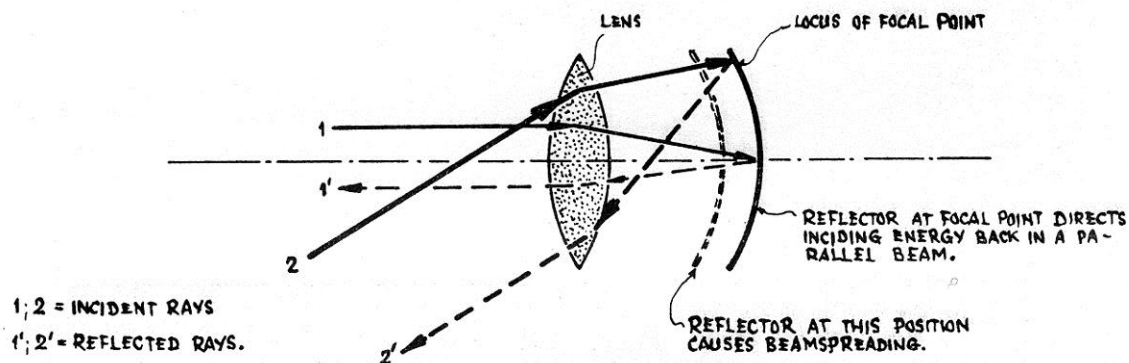
**Background:** Following the Soviet's launch of Sputnik I in 1957, the United States began a crash effort to catch up with the Soviets in space. Early attempts to launch an active communications satellite were frustrated by the lack of reliable electronics that could withstand the launch environment and operated reliably in space. The Wright Air Development Division's Communications and Navigation Laboratory (the predecessor to the Air Force Avionics Laboratory) began investigating passive communications satellites in 1960.

Relay station high above the earth's surface, such as orbiting satellites would provide the necessary intercontinental line-of-sight distance. The extra-terrestrial relaying points may be active stations i.e. satellites with built-in receivers and transmitters, or pure orbiting reflectors, called Passive Satellites. The latter yield several advantageous features.

- (1) They do not need electronic devices of questionable reliability;
- (2) They do not clutter the radio frequency spectrum by continuously transmitting radio signals;
- (3) They permit change of the communication system and frequency. They represent silent servant, ready for use when required, but not disturbing by their sole presence.

**Focused Reflectors:** Reflective balloons (Echo) or grid sphere represent the simplest type of passive satellite reflectors, but they have the disadvantage of reflecting the energy in all directions. This project investigated reflector which would scatter all the incident energy back into the desired spherical angle of that just covered the visible earth,  $17^\circ$  from synchronous orbit, and still not require any stabilization or attitude control. One solution is the Lens-Reflector arrangement explained in the following paragraphs.

**Basic Theory of Lens-Reflector Element:** Consider a lens and a reflecting surface at the focal locus, as depicted in Figure 1.



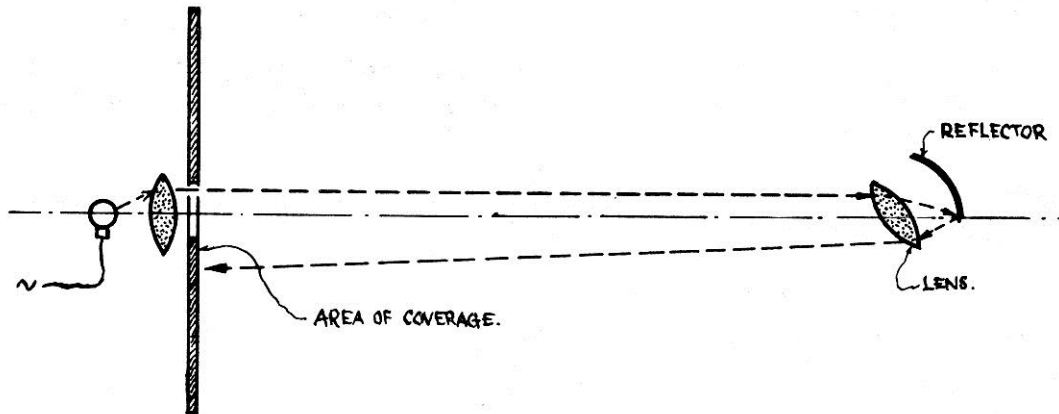
**Figure 1 Basic Optical Geometry of Lens-Reflector**

Evidently such a lens-reflector arrangement will reflect the energy back to the source, even if the incident beams form a considerable angle with the geometrical axis of the arrangement. If we rotate such a lens-reflector arrangement, the direction of the reflected beams remains the same for a considerable large angle of rotation.



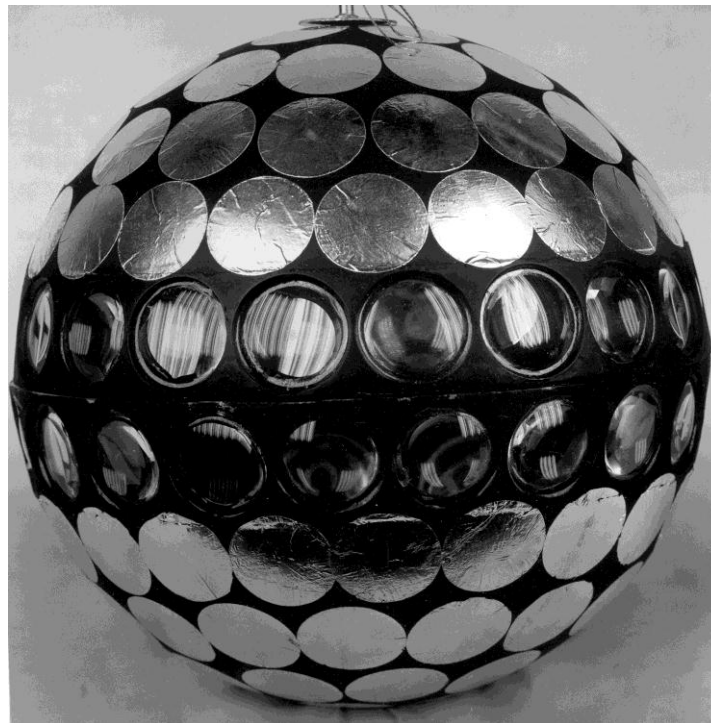
Such an arrangement acts as a flat plate perpendicular to the impinging beams regardless of attitude up to a rather large angle of incidence. In addition this arrangement permits one to spread the reflected energy into any desired angle by reducing the distance between reflector and lens.

A simple optical model, as shown in Figure 2, confirmed the theoretical considerations. This arrangement permitted incident angles up to  $30^\circ$  from the optical axis without causing any change of the reflected light pattern.



**Figure 2 Test Set-up for Optical Model**

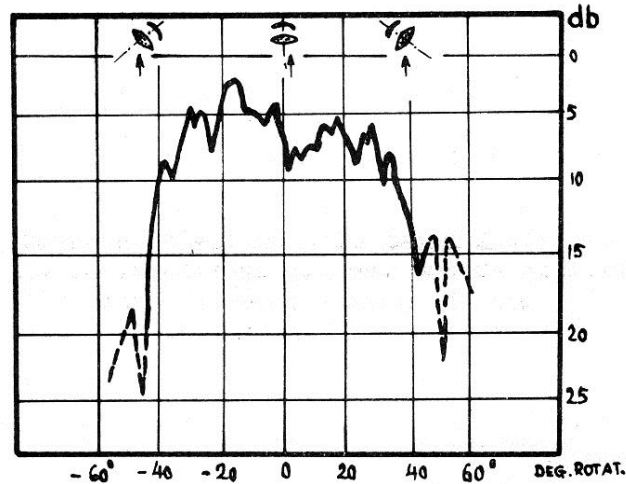
In addition, we constructed an optical model of a partially covered sphere by placing two rows of lens-reflectors around the circumference, Figure 3. This model allowed us to spin the sphere about its axis within a light beam at any speed without changing the area illuminated from the reflector. An actual satellite would be entirely covered with lenses and could rotate about any axis.



**Figure 3 Optical Model of Focused Reflector Sphere**

**Behavior at Radio Waves:** To prove that the basic theory may be applied for all electromagnetic waves, we constructed a model for radio waves using as lens material artificial dielectric (Styrofoam interspersed with aluminum chips). The diameter of the lens was made approximately 15 inches and the focal length approximately 12 inches.

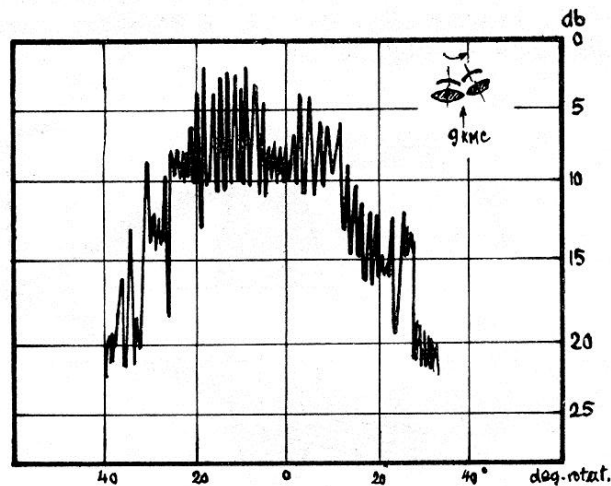
Although this material at the chosen test frequency (9 GHz) showed a rather high loss, we nevertheless could well demonstrate the feasibility of the basic idea. Figure 4 shows that the reflection remains rather constant over an angle of approximately 80°.



**Figure 4 Reflection Pattern of a Lens-Reflector Component**

Arranging such lens-reflector elements to form a spherical surface we may expect, because of the different path lengths, the reflected energy to return with a different phase from each element, but choosing the number of such elements large enough, the phase would add in a random fashion, decreasing somewhat the overall reflection gain.

We investigated the behavior of a pair of such components, and obtained the reflection pattern shown in Figure 5.

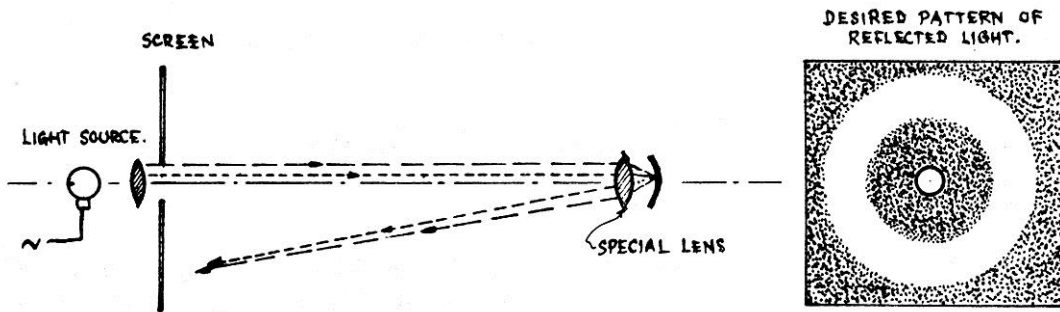


**Figure 5 Reflection Pattern of a Lens-Reflector Pair**

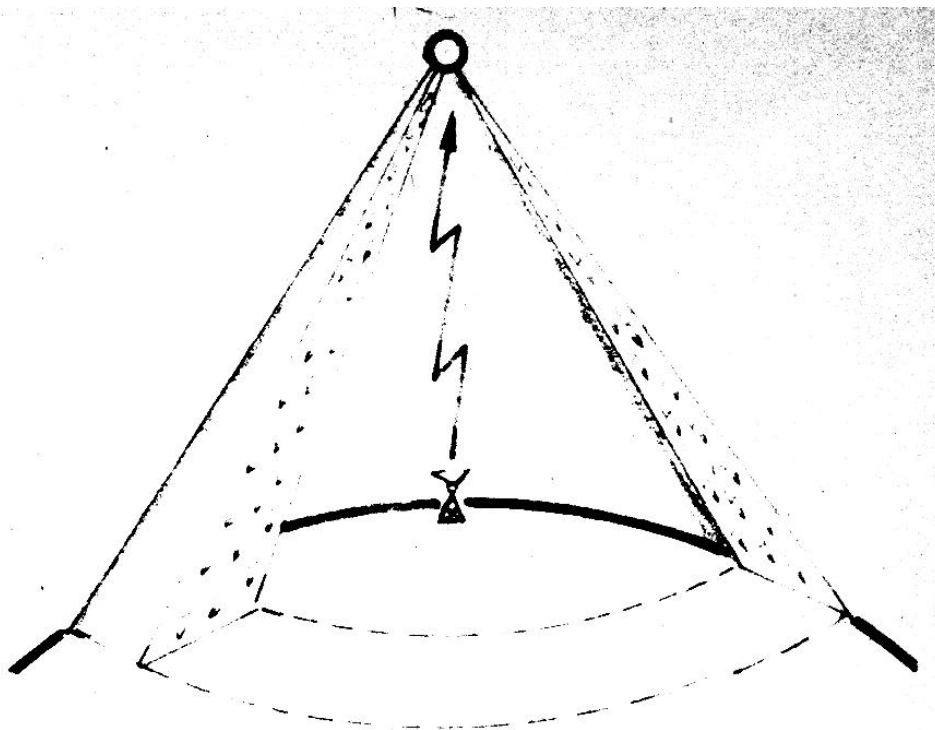
Although for two elements, the phase difference causes rather strong variations, we nevertheless expect considerable smoothing and leveling if many elements participate.

**Ring Shaped Reflection:** For global communications even a circle, uniformly illuminated from a stationary satellite, does not represent the ideal solution. An illuminated ring, leaving an area around the transmitter blank, appears as the most feasible reflection pattern, since near the transmitter simpler means than satellites can be used for communications.

Since the features of the lens and the position of the reflecting surface from the lens determine the beam-spreading, it appeared quite possible to construct a lens-reflector arrangement where the reflected energy would have a ring-shaped distribution as shown in Figures 6 and 7.

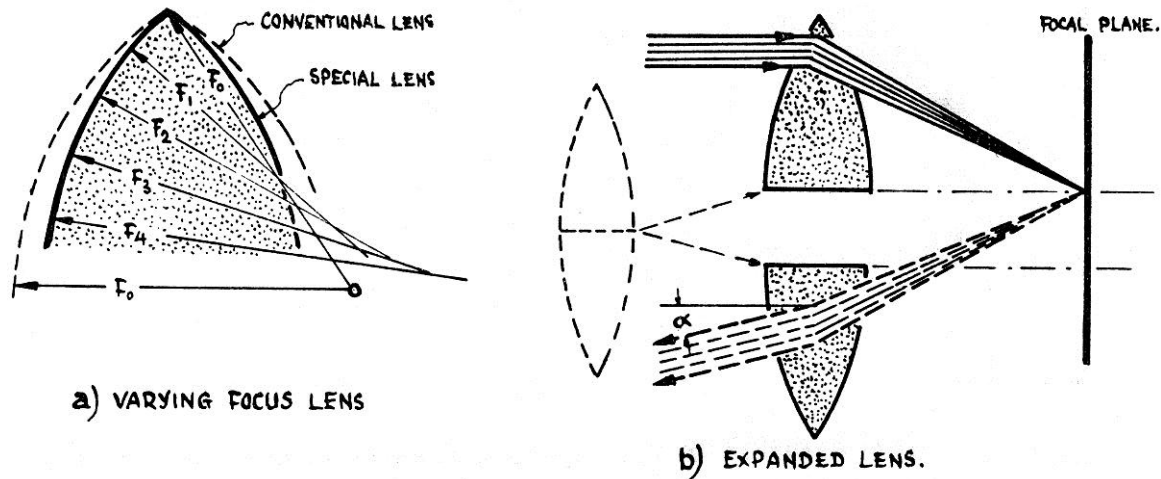


**Figure 6 Most Desirable Reflection Pattern of a Communications Satellite**



**Figure 7 Ring-Shaped Reflection Pattern**

A solution to achieve ring-shaped reflection is a specially shaped lens. Two approaches appear feasible: (1) a lens which instead of a constant focal length has one which varies as shown in Figure 8a; and (2) a regular lens with an expanded center area, as explained in Figure 8b.



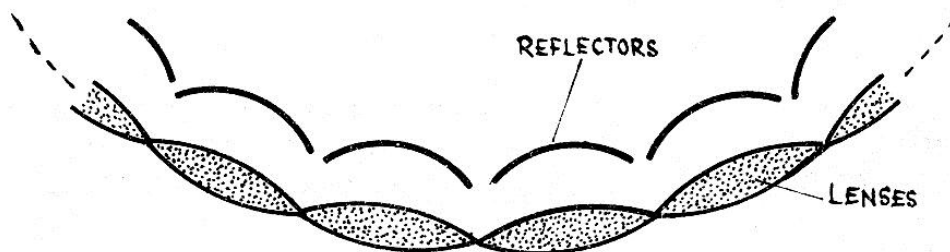
**Figure 8 Types of Special Lenses for Ring-Shaped Reflection**

A simple way to explain or construct this lens is with the two dimensional model shows in Figure 8b. Here we have taken a normal two dimensional lens and cut it in the center. The two halves are then separated. Now a parallel beam entering the top half will still focus at its focal point and, if reflected back, will now enter the bottom half at a point not diametrically opposite where the energy left the upper half. Therefore, it will be bent an amount different from the upper lens and will leave the lens at an angle different from the incoming beam. The amount of separation will determine the beam tilting.

At WADD we have made tests with such two dimensional and three dimensional lenses. It has been shown that one can indeed obtain a ring-shaped output from a parallel beam input. The diameter of the pattern can be adjusted to cover the desired area from any orbital altitude.

The US patent number 3,317,911, titled "Electromagnetic Lenses for Radiant Energy Communications Systems" describing the ring-shaped reflection was obtained by Y.E. Stahler and A.L. Johnson of WADD on 2 May 1967.

**Conclusions:** To exploit the lens reflector idea, we have to construct a sphere whose surface consists of many such reflecting elements as sketched in Figure 9. A considerable amount of the surface will act as a flat plate reflecting the entire impinging energy to the transmitting source.

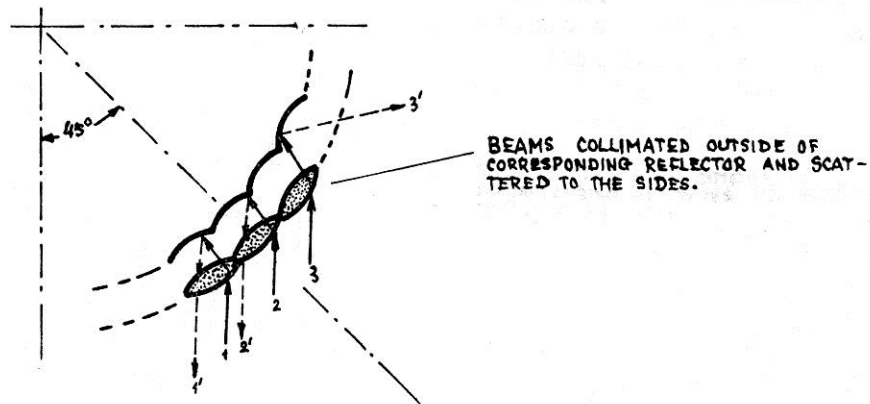


**Figure 9 Proposal of a Directional Spherical Reflector**



By changing the distance between the reflectors and lenses, the reflected beam may be widened to any desired angle, of course, decreasing at the same time the density of the reflected energy. Although this means a loss in power at any given point, coverage of large areas on the globe can be achieved only in this way.

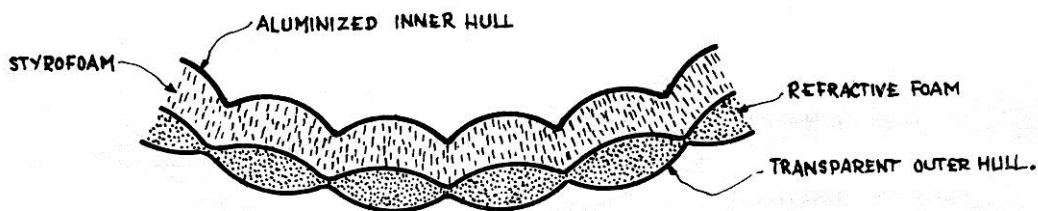
Practical considerations put a limit on the number of lenses along a circular surface which will reflect energy back to its source, because the reflectors can not be made to entirely enclose the lenses, nor will the lenses themselves collimate correctly beams far out from the sides. Starting from a certain angle, beams will be collimated outside of the reflecting surface, and hence, not reflected back to the source. Nevertheless, choosing a sufficient short focal length and shaping the reflecting surface accordingly, it appears reasonable to assume that lenses within a spherical segment, comprising an angle of  $90^\circ$ , could be effective, as illustrated in Figure 10.



**Figure 10 Limiting Conditions for Effective Reflecting Area**

In this case a sphere of a diameter  $D$  would equal a flat plate of a diameter  $\sqrt{2}/2 \times D$ . Indeed, a small difference, resulting in a power loss of only 3 dB.

Particularly, if we consider that such a reflector can be made for any desired beamwidth or circular pattern of the reflected energy, we obviously have an extremely useful tool at hand to establish space-bound relay stations at every required altitude without the need to employ transmitters of extreme high power. A serious problem will probably arise in implementing the previously described optical model for communication frequencies, i.e. the actual construction of the sphere, but considering that it would be possible to inject Styrofoam and special refractive dielectric foam between an inner and outer hull of a balloon as shown in Figure 11, this problem does not seem insolvable.



**Figure 11 A Possible Practical Construction Technique**

Such a balloon would have adequate rigidity to withstand the environmental influence of the outer space, and would represent a highly effective passive reflector.

**References:**

Stahler, Ylo E. and Lt. Allen L Johnson, **The Ring Focus Lens**; Wright Air Development Division; Communication and Navigation Laboratory; WPAFB OH; Technical Memo WWDPVT-2; October 1960.

Stahler, Ylo E. and Lt. Allen L Johnson, **Directive Non-Oriented Reflectors as Passive Satellites in Long Distance Communications**; Wright Air Development Division; Communication and Navigation Laboratory; WPAFB OH; WADD TM-60-100, March 1961.

Stahler, Ylo E. and Lt. Allen L Johnson, **Electromagnetic Lenses for Radiant Energy Communication Systems**; US Patent 3317911; 2 May 1967.

## **Low Probability of Intercept Communications (1969-2011)**

**Background:** At the end of World War II, the Soviets captured a lot of the Nazi's electronic equipment and research, including communications jamming equipment. When the Cold War started, the Soviets fielded communications jammers that could deny an adversary the ability to communicate in the vicinity of the Soviet borders. In the late 1950 and early 60s, the U.S. began developing small remotely piloted vehicles (RPVs) to carry surveillance cameras behind the Soviet front lines and the need developed for a communications link to guide the RPVs and retrieve the reconnaissance data that could not be detected or jammed.

**Low Probability of Intercept (LPI) Communications Development:** In the late 1960s, the Air Force Avionics Laboratory (AFAL) received funding from the Defense Advanced Research Project Agency (DARPA) to study a number of LPI techniques to apply to the control of RPVs and reception of their reconnaissance information. In 1995, AFAL awarded a contract to Harris Corp in Melbourne FL to develop a LPI Data Link. The objective was to remotely control 16 Mini-RPVs both enroute and in the terminal phase to perform strike/reconnaissance missions beyond the horizon. DARPA was the project lead organization with AFAL responsible for the relay aircraft High Gain Multi-Beam Null-Steering Antenna and the Rome Air Development Center (RADC) in Rome NY responsible for the Mini-RPV's Antenna and the Spread Spectrum Reconnaissance and Control Data Link Waveforms. The High Gain Multi-Beam Adaptive Null-Steering Antenna was designed and developed by Harris Corp. The antenna measured 8 feet long and 1.5 feet high, operating at Ku-band. It consisted of a horizontal array of 100 equally spaced vertical rectangular leaky waveguides. The leaky waveguides used non-linear element amplitude weighting to yield a cosecant-squared distribution on a pedestal vertical antenna pattern. This provided constant antenna gain toward the RPV independent of range. The gain of the 100 Horizontal Elements was horizontally tapered to provide low side lobes to limit detection. A six-way power divider was used at the output of each of the Horizontal Elements to provide inputs to six Adaptive Null Steering Antenna Phased Arrays (ANSAPA). These ANSAPA simultaneously receive a wide band (100 MHz) Pseudo Noise (PN) video reconnaissance signals from up to 4 RPVs. The system also transmit and receive Frequency Hopping (FH)/PN time-shared flight control signals for up to 16 RPVs and null out up to 50 interfering signals. The equipment was developed and flight tested in Arizona. Because of the limited display of location information on the prototype control panel, the RPV pilots had difficulties in controlling multiple RPV enroute. At that point, the program was simplified and cut in cost by replacing the ANSAPA by a simple gimbaled parabolic antenna. The technology for this program was made available to several classified programs and went on to become operational.



**Mini RPV similar to the Type Tested with the LPI Data Link**

AFAL continued to work on other classified LPI efforts up until the present. These technologies related to LPI Communication, Radar, and Intercept Receivers which all work together. The communication and radar signals can share the same waveform. The intercept receivers were used to determine the vulnerability of the LPI Communications and LPI Radars to detection and exploitation.

AFAL engineers developed MATHLAB computer programs which were used to evaluate different types of LPI Communication techniques against various types of Intercept Receiver Systems. An LPI Quality Factor was defined as  $20 \log (\text{Required Communication Range} / \text{Maximum Intercept Receiver Range})$ . Technologies identified in the LPI Quality Factor Analysis included: Adaptive Transmit Power Control, Adaptive Null Steering Antennas, Antenna Gains, Adaptive Interference Suppression, Antenna Sidelobes, Spread Spectrum Modulation, Time/Frequency Spreading, and Intercept Receiver Type, Bandwidth, Processor Speeds, Signal Sorting and Signal Identification. The LPI Quality Factor helped answer the questions of “How can we increase the efficiency of an invisible vehicle without making it vulnerable to detection?” and “How can we covertly communicate without increasing our vulnerability to detection and exploitation?”

In the 1980s, AFAL awarded a contract to Linkabit Corp. (which became Qualcomm in 1985) for an LPI Communications System using Code Division Multiple Access (CDMA) to spread and hide the signal. The Linkabit design included a Rake Filter consisting of a tapped delay line that could capture the energy arriving at the antenna later than the direct signal due to multipath reflections. By adaptively adjusting the tap delay, the reflected information could be added in phase with the direct signal to improve the signal to noise ratio (S/N). With the higher S/N, the transmitter power could be reduced, thereby making the communications signal less detectable by an enemy. The CDMA system with the Rake Filter worked so well that Linkabit patented it and it became the Interim Standard in 1995 (IS-95) for second generation cell phones. The system worked very well in urban environments like New York City, where tall buildings cause multipath delays which confuse the previous Time Division Multiple Access (TDMA) cell phones.

Odenwalder, Joseph P.; **Error Control Coding Handbook**, Contract F44620-76-C-0056; Linkabit Corporation, San Diego, CA; July 15, 1976.



### **MARCOM Relay (1962-1967)**

**Background:** MARCOM RELAY was a Program directed and funded by the Defense Communications Agency (DCA). The program originated in June, 1962, as a U. S. Army-Bell Telephone Laboratory effort. In December, 1963, it was reoriented as a U. S. Air Force program at Wright-Patterson AFB, Ohio. Collins Radio Company received a contract to provide over-all supervision of the engineering effort.

**Program Objectives:** The over-all objective of the MARCOM RELAY program was to answer system design questions for future airborne microwave links for the purpose of transferring wideband information and video. Specifically, these questions involve:

1. Basic path loss as a function of the flight variables.
2. Intermodulation noise resulting from anomalies in the propagation media.
3. Effect of multipath propagation and antenna shadowing on communication reliability.
4. Relative merits of frequency and space diversity.
5. Selective fading effects and resolution limits of TV transmission.
6. Reliability of variable-rate digital data.
7. Performance of the airborne inertially stabilized automatic tracking antenna system.
8. Effect of radio holes caused by a nonstandard atmosphere.

The information obtained in these tests will be applicable to numerous airborne applications, such as air-borne relay of trunk-type traffic, transmission or relay of reconnaissance data, advanced airborne command posts.

The RF system consists of Collins-built AN/TRC-90-type tropospheric scatter systems installed aboard two C-121 aircraft. Two 1-KW transmitters, four receivers and two antenna platforms in each aircraft provide for both frequency and space diversity.

The inertially stabilized automatic tracking antennas provide 23 db gain at 4.5 GHz. Simulated voice modulation of 250 KHz, digital data up to 1 megabit and 4 MHz video will be transmitted separately.

Computerized data reduction was employed for analyzing the test data. Magnetic tape data was digitalized; graphic recorder and photo panel data were manually programmed into a form acceptable to an IBM 7094 Computer. The computer processed this data and provided the following information:

1. Cumulative frequency distribution plots of the received signal power .
2. Path loss calculation, comparing predicted losses with measured losses.
3. Comparisons of nondiversity, dual frequency diversity, dual space diversity and quadruple diversity.
4. Effect of the terrain and meteorological conditions.

#### **Equipment Specifications**

Frequency Range: 4.4 to 5.0 GHz

Receiver Noise Figure: 9.0 db

Baseband Width: 60 telephone channel simulation - 250 KHz ; digital data - 6 MHz; video - 4.5 MHz

Antenna: 23 db gain parabolic section

Tracking: inertial stabilization, automatic signal tracking

Test Aircraft: two C-121 and one C-131 (Weather Aircraft)

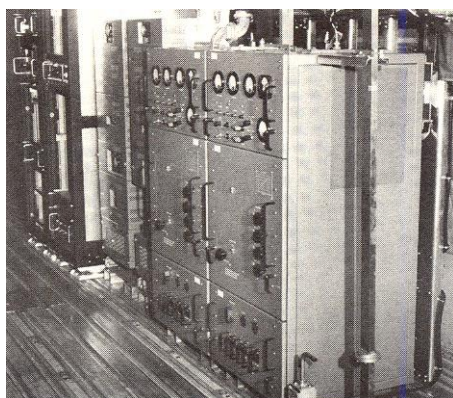
Transmitter Power: 1 KW CW

Diversity: quadruple frequency and space

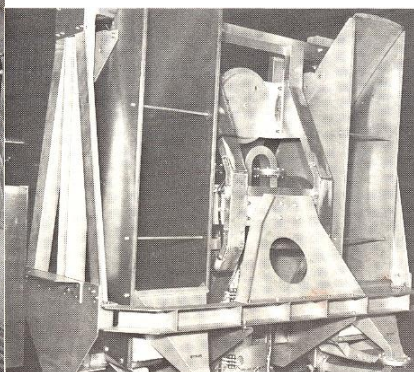
Meteorological Data: refractive index measurements  
Power Requirements: 30 KVA 400 cycle, 6 KVA 60 cycle, 5 KW DC  
Data Reduction: computerized on IBM 7094  
Weight : RF equipment and instrumentation 14,000 lbs.  
Magnetic Recorders: 14-channel Ampex AR214, 4-channel Norelco  
Graphic Recorders: three 18-channel CEC galvanometer recorders  
Photo Panels: two navigation panels, one TV monitor, two radar monitors  
Digital Printer: digital error counter and printer  
Flight Altitude: 20,000 feet maximum  
Maximum Range: 400 miles  
Approximate Number of Flights: 50  
Test Duration: 6 hours on station per flight  
Terrain: flat land, mountains, salt water



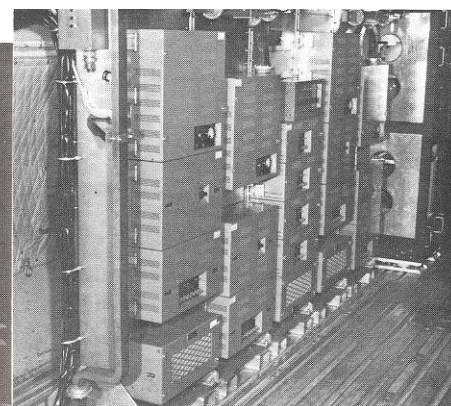
**MARCOM RELAY C-121-0160 and C-121-0170**



MICROWAVE TRANSMITTERS



ANTENNA

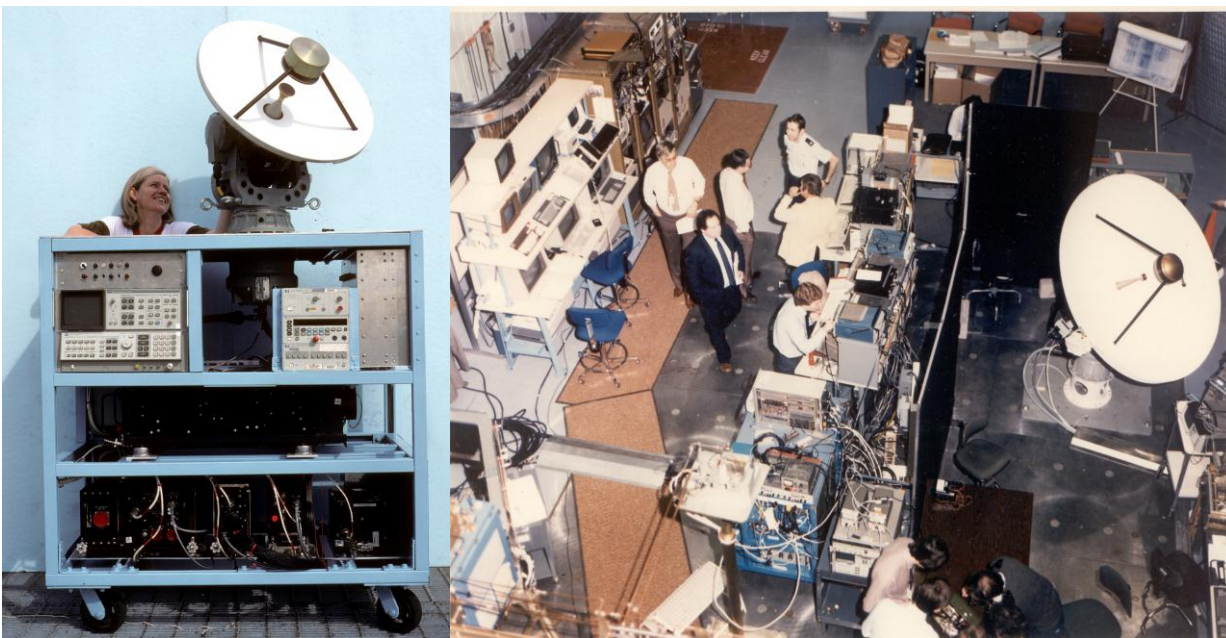


MICROWAVE RECEIVERS

## Milstar Support (1985-2001)

**Background:** The Air Force Avionics Laboratory (AFAL) began the development of an EHF Airborne SATCOM Terminal, the AN/ASC-22, in the early 1970s to operate through the LES-8/9 satellites. The success of that effort led to the development of the AN/ARC-208 Milstar Airborne Terminal and the Milstar satellites in the 1980s and 1990s.

**FLTSATCOM EHF Package (FEP) Checkout:** Following the development and testing of the EHF SATCOM concepts, the Air Force awarded dual development and production contracts for the AN/ARC-208 Milstar airborne terminal to Raytheon and Rockwell International. AFAL installed the development terminals in their C-135 test aircraft for initial flight testing and built a set of transportable racks (the Blue Carts, Figure 1) to house the AN/ARC-208 and act as a ground support station.



**Figure 1 AFAL Milstar Blue Carts**

**Figure 2 Blue Carts At Lincoln Lab for FEP Test**

MIT Lincoln Laboratory developed an EHF satellite package to test the proposed Milstar concept. Prior to launch, AFAL took the Blue Carts to Lincoln Laboratory to help check out the FEP satellite package and validate the operation of the AN/ARC-208 with it, Figure 2. After that successful ground test, the FEP was launched on the FLTSATCOM 7 satellite on 5 December 1986 and put into orbit over the Pacific Ocean. Because of its location, Lincoln Laboratory could not see the satellite to command the FEP from their main facility in Lexington MA. AFAL flew their C-135 test aircraft equipped with an AN/ARC-208 terminal to Hickam AFB HI on 7 December 1986 to establish an EHF link with the FEP. Using a leased land-line from Lexington MA to Hickam AFB, Lincoln Laboratory sent commands through AFAL's terminal to turn the FEP on and begin initial EHF operation. AFAL assisted in commanding and checking out the FEP for several weeks from the aircraft and then switched operation to an AFAL Blue Carts ground station set up at Hickam AFB for the next two



months. In February 1987, the satellite was moved east to a point where Lincoln Laboratory could command it from their Lexington site and the AFAL team returned to WPAFB OH.



**Figure 3 Blue Carts in Hawaii to Command FEP after Launch**

**AN/ARC-208 Checkout:** AFAL continued to fly the AN/ARC-208 against the FEP for several years to validate the terminal and satellite functions. Flights were made to the edge of satellite's northern coverage and to check the accuracy of the spot-beam pointing.

In the meantime, AFAL assisted in the checkout and evaluation of the Milstar satellite being built by Lockheed in San Jose CA. AFAL engineers took the Blue Carts to the Lockheed facility and helped conduct tests on the developmental satellite to demonstrate the satellite met the design objectives.

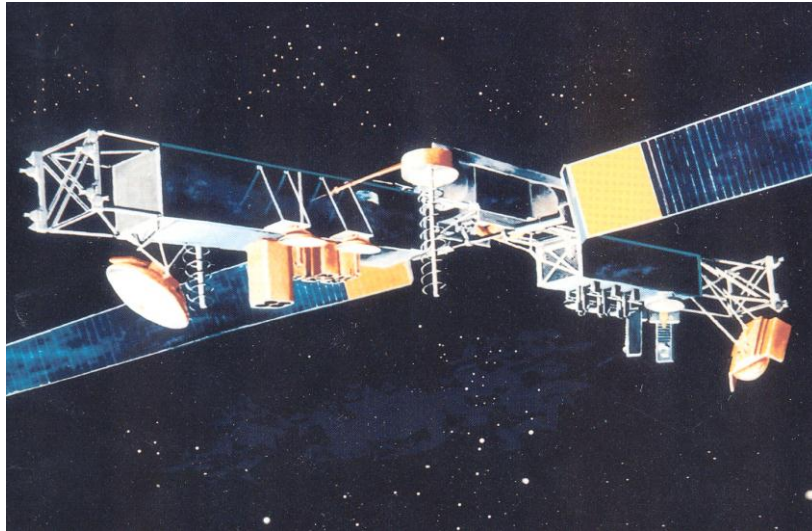


**Figure 4 AFAL's SATCOM Aircraft in Buenos Aires to Measure Milstar Antenna Pointing**

**Milstar Checkout:** After the first Milstar satellite was launch in 7 February 1994, AFAL flew missions with the AN/ARC-208 to help check out the operations of the satellite. In June 1994, AFAL flew the test aircraft to Buenos Aires, Argentina to help calibrate the Milstar antenna suite, Figure 4. While parked on the ramp at Buenos Aires International Airport, AFAL used the AN/ARC-208 and special AFAL developed software to command the Milstar spot-beam antennas, Figure 5, to move in a circle around the aircraft while recording the EHF received signal level. The received signal strength data was sent back to Lockheed for evaluation to see if the antenna parameters were properly adjusted



to allow the antenna to point where it was directed to point. In December 1995, AFAL returned to Buenos Aires with the test aircraft to help evaluate the antenna pointing of the second Milstar satellite, which was launched on 7 November 1995.



**Figure 5 Milstar Satellite contains over 100 antenna**

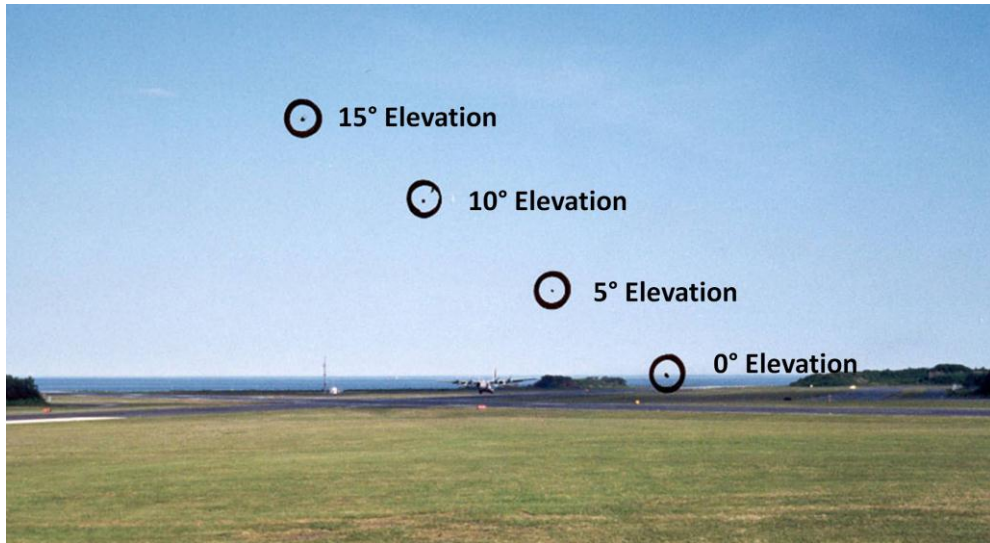
**Navy Low Angle Testing:** The Milstar Satellite is designed to provide communications coverage down to  $10^\circ$  above the horizon over almost half of the earth from its geosynchronous orbit. The Air Force Operational Test and Evaluation Center (AFOTEC) requested Wright Laboratory (WL) use an Air Force airborne command post Milstar terminal to emulate a Navy Milstar ship terminal and a Navy submarine terminal to demonstrate low angle link performance in far northern latitudes. The atmospheric attenuation increases dramatically at elevation angles around 1 or 2 degrees. The test would provide limits for low elevation angle operation of the Navy Milstar terminals.

The primary test objective was to demonstrate the minimum elevation angle that a Navy Milstar ship terminal and a Navy submarine terminal could operate error free. This information was required to define regions of connectivity for specific users and satellites.

To accomplish the test, WL's airborne SATCOM testbed equipped with the AN/ARC-208 airborne command post was flown from WPAFB OH to Kodiak, Alaska ( $57.75^\circ\text{N}$ ,  $152.5^\circ\text{W}$ ) on 3 July 1995. Kodiak was chosen for the ground test because it gave a clear view of the Milstar satellite as it rose or set, right down to zero degrees. The runway at Kodiak ends at the water's edge and is oriented basically in the azimuth direction of Milstar I orbiting at  $90^\circ$  degrees West.

The aircraft was parked on a taxiway with a clear view of the Milstar satellite from 0 degrees to its maximum elevation angle of 16 degrees, Figure 6.

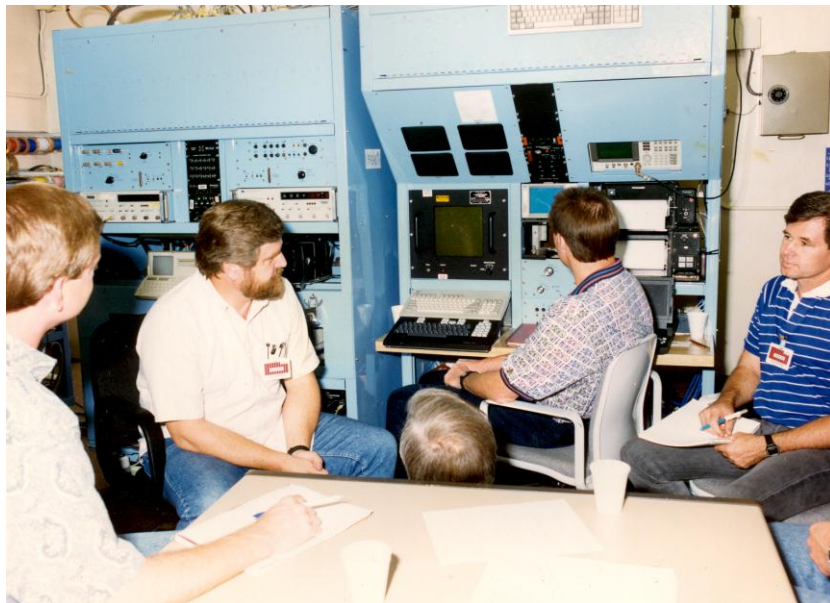
Raytheon's AF1 Milstar terminal at Sudbury MA and WL's AF8 Milstar Rooftop terminal at WPAFB acted as the cooperating terminals for the test. Raytheon and the Rooftop monitored their own downlinks to assure the links were error free and received the aircraft's transmissions to measure BER on the aircraft's uplinks. For the ship test, the aircraft terminal transmitted two uplinks from Alaska while monitoring both the Rooftop downlinks and the aircraft's own downlinks. For the sub test, the aircraft terminal transmitted one uplink while monitoring its downlink and the downlink of the net Raytheon was transmitting.



**Figure 6 Milstar's Elevation Angles from Kodiak Alaska**

To emulate a Navy ship terminal, the aircraft adjusted their AN/ARC-208 terminal's Effective Radiated Isotropic Power (EIRP) and Gain versus receiver noise Temperature (G/T) to that of the Navy terminal. Likewise, for the submarine test, the aircraft reconfigured its terminal by adjusting its EIRP and G/T to the submarine terminal values. The successful test provided valuable information and validated the Milstar coverage limits.

**United Kingdom (UK) EHF Satellite Simulator Support:** Through the NATO agreement, the UK was given permission to use portions of the Milstar satellite. The Royal Signals Research Establishment (RSRE) at Defford, England built an EHF satellite simulator to allow them to checkout their terminal hardware during development. To validate the UK EHF satellite simulator, AFAL flew their AN/ARC-208 equipped Blue Carts to England in August 1995 and spent several weeks working with RSRE personnel to validate the acquisition process and the different Milstar data rates and modes of operation, Figure 7.



**Figure 7 AFAL's Blue Carts at RSRE's Defford Facility**

**Milstar Nulling Antenna Test:** The Milstar II Medium Date Rate (MDR) satellites included a nulling function capable of placing a small null spot over a jammer's geographic position to reduce the uplink power from the jammer, Figure 8. To test this function, AFRL flew its SATCOM testbed through the null on 10 May 2001 to measure its depth.

The test technique involved establishing a known Bit-Error-Rate (BER) by attenuating the AN/ARC-208 transmit power on the aircraft while outside the null. Then the aircraft made a pass through the null while increasing the transmit power every 10 seconds to keep the BER at  $10^{-4}$ . The aircraft first flew through and measure the minor axis of the null ellipse and then flew through the major axis of the ellipse, Figure 9. The amount of attenuation increase in the null provided a measure of the null depth. The successful test verified that the nulling antenna worked as designed.

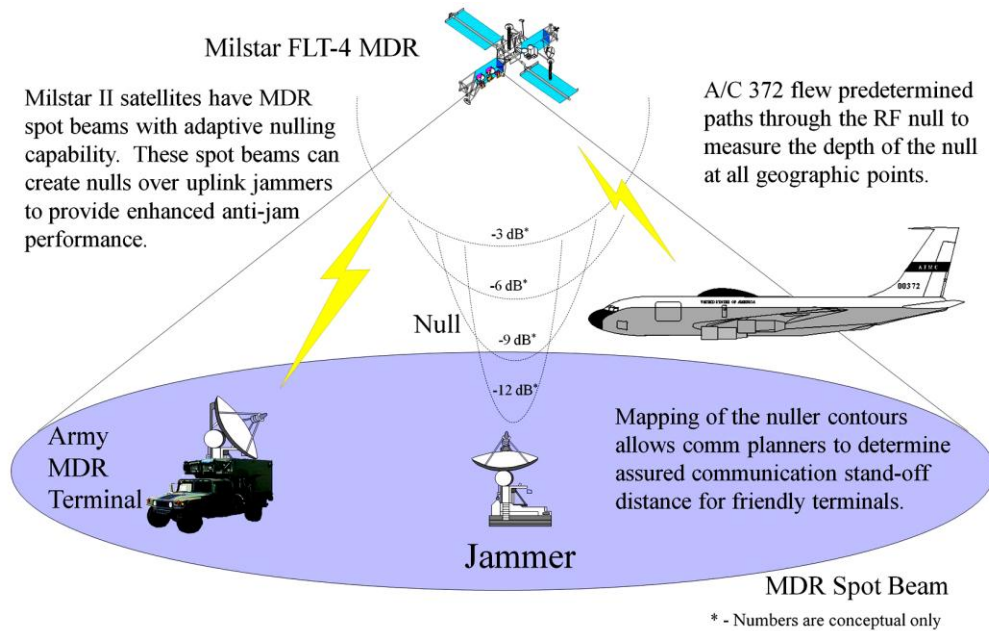


Figure 8 Milstar MDR Nuller Test Setup

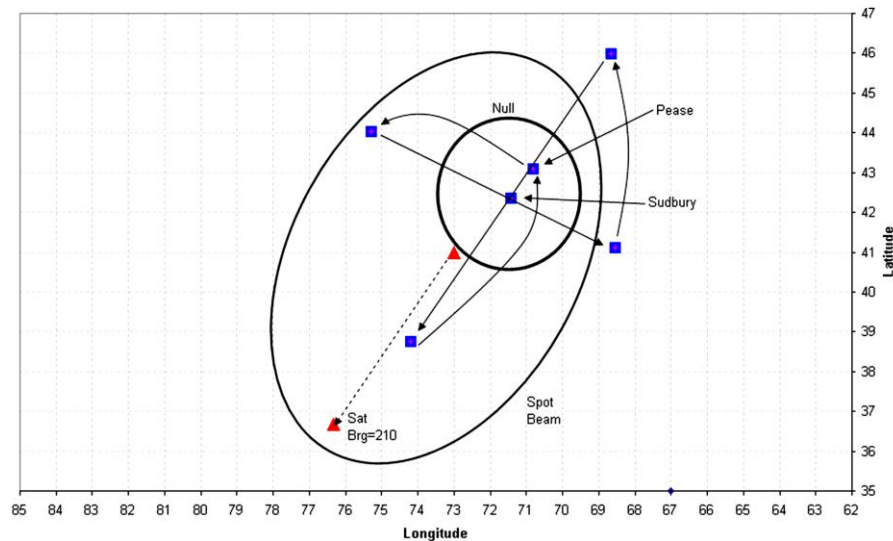


Figure 9 Flight Path for Nuller Test

**References:**

Cobb, James D.; **Milstar MDR Nuller Testing**; Air Force Research Laboratory; WPAFB OH; AFRL/IFGD Test Briefing; June 2001.

Johnson, Allen L.; **Early Post Launch FEP Operations Using the AN/ASC-30 EHF Terminal**; Air Force Wright Aeronautical Laboratory; WPAFB OH; AFWAL-TM-86-30, 29 December 1986.

Johnson, Allen L.; **Low Angle Milstar Testing in Alaska**; Air Force Wright Laboratory; TTCP Space Communications Panel Meeting; Dayton OH October 1995.



## Navy Vulnerability Test Support (1996)

**Background:** The Wright Laboratory (WL) developed an extensive and versatile test and analysis capability in connection with their flying laboratory in the 4950<sup>th</sup> C-135 SATCOM aircraft. When the Naval Research Laboratory (NRL) at Waldorf MD and their support contractor, the John Hopkins' Applied Physics Laboratory (APL) at Laurel MD began planning to evaluate the vulnerability of Naval satellite communications, they contacted WL early in 1996 to discuss the possibility of a joint vulnerability test effort.

**Aircraft Carrier Vulnerability Test:** The Navy's USS John C Stennis (CVN-74) Nimitz-class carrier was commissioned in December 1995. As part of the Navy's Final Operational Test and Evaluation (FOT&E), the vulnerability of the Milstar EHF satellite transmitter to intercept needed to be evaluated. WL agreed to support NRL in their evaluation of the carrier's Milstar vulnerability tests 8-19 June 1996 by flying WL's airborne SATCOM testbed as an interceptor and jammer against the USS John C. Stennis aircraft carrier sailing off the North Carolina coast. APL provided the intercept receiver and the jammer hardware which was interfaced with WL's EHF Milstar antenna pedestal. A special antenna pointing program was developed by WL to point the intercept antenna toward the carrier. The aircraft carrier transmitted their GPS coordinates to WL's aircraft via a Navy DAMA satellite channel. On the aircraft, the carrier's coordinates were fed into the pointing program to update the carrier's position every 10 seconds.

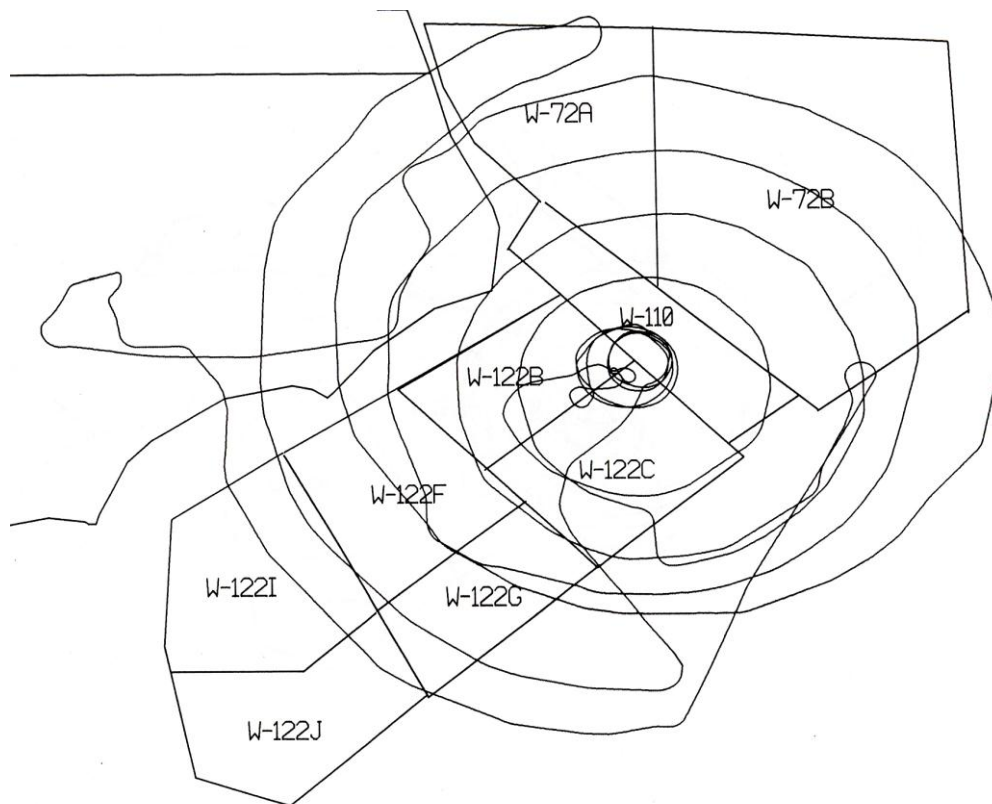


USS John C. Stennis Aircraft Carrier



### WL's SATCOM Testbed Aboard the 4950<sup>th</sup> C-135/372

For the intercept tests, the USS John C. Stennis transmitted their EHF signal to the DFS-1 Milstar satellite while WL flew the intercept receiver around the carrier at various ranges trying to intercept the EHF signal. WL's aircraft deployed from WPAFB OH to Seymour-Johnson AFB NC on 8 June 1996. A 10-hour test was flown on 13 June in cloudy weather. The test went well with the results about as expected. A second 5-hour intercept test was flown on 14 June with similar results.



**Flight Path around the USS Stennis For WL's Testbed on 14 June 1996**

Following the 14 June test, WL swapped the 44 GHz intercept horn and receiver for the 20 GHz jamming dish and jammer transmitter on the aircraft. The first jammer test was flown on 17 Jun. The aircraft first flew against an APL ground receiver on the Outer Banks to test the aircraft's antenna pointing accuracy. By conducting an elevation/azimuth scan it was determined that the aircraft antenna was pointing approximately 1/2 degree to the right of the desired point. The antenna pointing was shimmed in heading and retested. The APL ground station reported the aircraft's conscan provided a 2 dB ripple on the signal at the center of the scan which was considered good pointing.

After the antenna pointing test, the aircraft proceeded to the vicinity of the USS Stennis and conducted a 10-hour jamming test. The test was supported by a Navy EHF van at Charleston SC and WL's Rooftop Facility at WPAFB OH. The aircraft flew a circular pattern around the carrier, while radiating its jamming signal. The USS Stennis used communications networks of various robustness and watched for errors. As a control measure, the Navy's EHF van at Charleston copied the same networks to make sure that any errors received on the aircraft carrier were not also received at Charleston. The results of the jamming test were about what were expected based on calculations and previous ground tests.

On 18 Jun 96 the second jamming test was conducted. The aircraft took off from Seymour-Johnson AFB and flew toward the coast to conduct another antenna pointing test with the ground station on the Outer Banks. The ground antenna scan test conducted and the scans showed the antenna was pointing a little left of center in azimuth from the right side of the aircraft and a little high from the left side. The heading was shimmed to correct the pointing from the right side and the scan repeated to verify the shim corrected the pointing. It was decided to conduct all orbits clockwise so the antenna would point off the aircraft's right side where it was bore sighted.

Following the antenna pointing test with the ground station, the aircraft proceeded out to the aircraft carrier and attempted a figure-eight pattern across the radial where the carrier's EHF Milstar antenna was pointed, approximately 240 degrees azimuth. The aircraft was in such a steep bank for most of the figure-eight that the aircraft's jammer antenna was in blockage. Because of the blockage, it was decided to abandoned the figure-eight maneuver and proceed to the circular orbits originally planned for the test. Nine complete orbits were flown by the jammer aircraft while the USS Stennis changed the robustness of their Milstar communications networks and noted any increase in error-rate due the jamming.

The test went well with the results within the expected range. An absolute power measurement taken with an APL developed special propagation setup aboard the USS Stennis suggested the receive power from the jammer aircraft was slightly below the expected level.

**Submarine Vulnerability Tests:** The USS Albany (SSN-753), a Los Angeles Class Attack submarine was commissioned in April 1990. The submarine was fitted with a Milstar EHF SATCOM terminal including an EHF periscope antenna. WL supported the second phase of the Navy Milstar Vulnerability testing from 6-19 July 1996 by flying the airborne SATCOM testbed to intercept the Milstar EHF signals from the USS Albany attack submarine off the Virginia coast. The same test equipment complement used for the June 1996 test of the USS John C. Stennis was used in the USS Albany test.

For the intercept test, the USS Albany submarine operated at periscope depth and transmitted their EHF signal to Milstar DFS-1 while WL flew the JPL channelized intercept receiver around the submarine at various ranges trying to intercept the EHF signal. The initial test was flown on 10 July



1996 when the aircraft flew for 4.5 hours around the north side of the submarine. Thunderstorms directly over the submarine prevented the aircraft from circling the submarine as planned. The submarine transmitted a High Hop Rate (HHR) bit error rate sequence while the intercept aircraft probed for sidelobe energy. For a portion of the test the submarine sent Short Report-back (SRB) messages.

The intercept results appeared to be close to the pre-test predicted levels. There seemed to be some problem in the aircraft obtaining accurate submarine position information. In the previous vulnerability test with the USS Stennis, the carrier sent its GPS position to WL's aircraft every few seconds via the UHF DAMA SATCOM link. The submarine was unable to provide GPS data so this test was conducted with pre-planned way points and verbally updated of the submarine's position via UHF



**The USS Albany Attack Submarine**

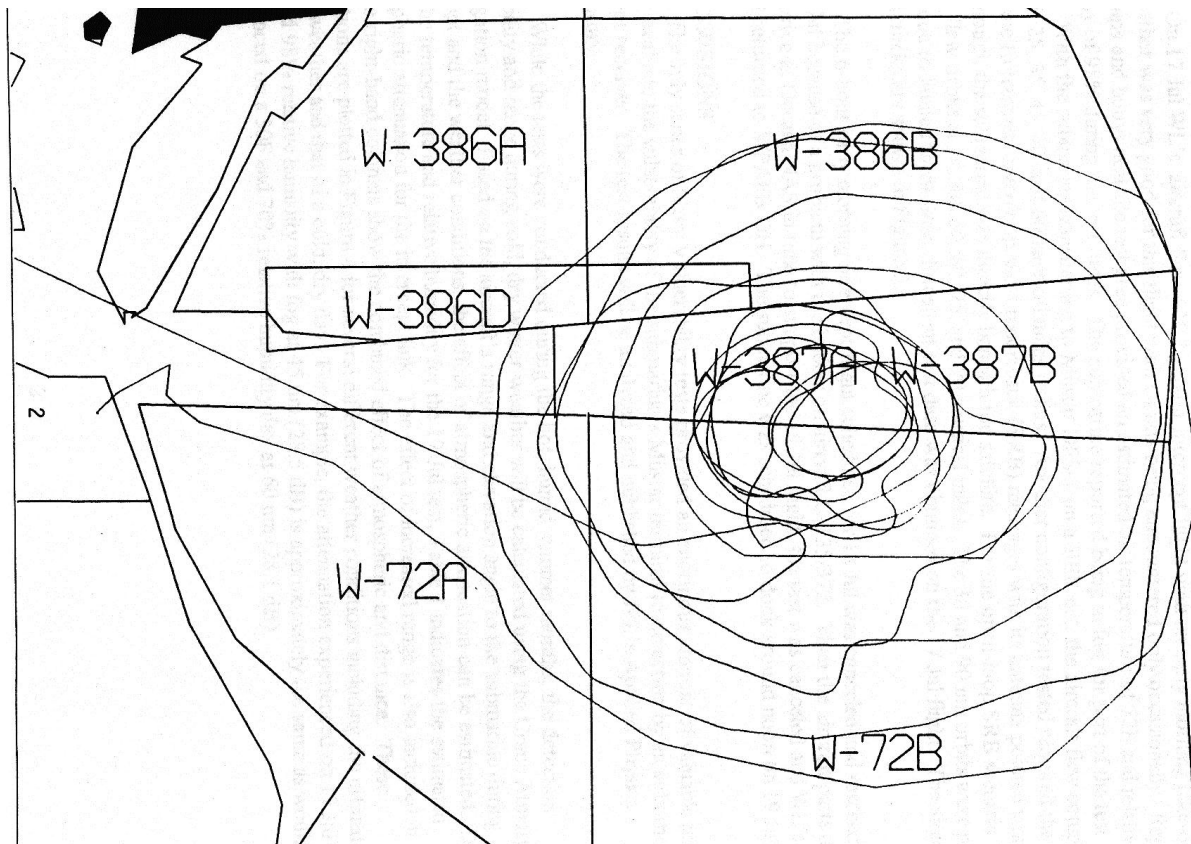
DAMA SATCOM voice. Several times the aircraft pointing was a mile or more off due to the submarine diverting from the pre-planned way points. The UHF DAMA SA TCOM net also proved to be marginal. Often the aircraft or the submarine would have to request 2 or 3 retransmissions of a message before it was intelligibly received by the other terminal. WL's Rooftop Facility at WP AFB indicated they received almost all DAMA messages on the first try. The primary difference in the various stations was their receive antenna gain. The Rooftop Facility used a 12-dB gain helix while most other stations used 0-dB gain antennas.

The intercept test scheduled for II Jul 96 was canceled due to the hurricane watch issued in the Virginia area for Hurricane Bertha and WL's aircraft was forced to evacuate to WP AFB OH.



On 14 Jul WL's airborne SATCOM testbed returned to the east coast and flew two missions against the USS Albany. The first 8-hour mission consisted of three 10-mile radius orbits around the submarine, one 15-mile orbit, two 20-mile orbits, two 30 mile orbits, one 40-mile orbit, one 50 mile orbit and one 60-mile orbit. The intercept data was very consistent for this test. There were still problems determining the submarine's position and problems with the reliability of the UHF DAMA order wire link.

After refueling, WL's aircraft flew a 3-hour mission late on 14 July. For that mission the submarine's elevation angle to Milstar DFS-1 was approximately 18 degrees and the aircraft passed near the main beam on its intercept orbits. Due to the short flight time, the aircraft was only able to accomplish two 10-mile radius orbits, one 15-mile orbit and one 25-mile orbit. Good intercept data was collected, consistent with the test earlier in the day.



**Flight Path around the USS Albany For WL's Testbed on 14 July 1996**

On 17 July 1996, WL's aircraft flew a 10 1/2 hour intercept flight with an early morning take-off. The weather was very good for this flight with clouds being encountered only occasionally. Reports from ships and buoys near the test area provided an estimated air temperature of 72°F and relative humidity of 98% during the test times. The submarine reported being in fog for part of the test period. With the submarine transmitting to Milstar DFS-1 on a BER net, the aircraft flew complete orbits at 25, 35, 45, 70, and 80 nautical miles radius. Another configuration tested required the submarine to transmit open-loop Short Report Back (SRB) messages with its antenna pointed straight up as though the submarine was directly beneath the satellite. For the open-loop SRB scenario WL's aircraft flew orbits at 30, 40, 50, 60, 75, and 90 nautical miles. The 30 and 90 nm orbits were partial circles due to limited flight time. Excellent test data was obtained on the 17 July flight.

**Conclusions:** The Navy Vulnerability tests provided an enormous amount of valuable test data to evaluate the vulnerability of the aircraft carrier's and submarine's Milstar terminal to detection by an airborne intercept receiver. The classified test results were analyzed and published by the Applied Physics Laboratory.

## **Nuclear Testing of Airborne Communications System (1962)**

**Background:** When the Russians launched the Sputnik in 1957, the US realized that we were behind in both the space race and the missile race. The Russians had bigger rockets than us and they had the technology to put an object into orbit. Instead of a communications satellite, supposed the Russians launched a nuclear weapon. The path of Sputnik passed right over the US several times a day.

To counter this perceived sneak-attack threat, the commander of the Strategic Air Command, General Curtis LeMay, tweaked the War Plan to place SAC's nuclear equipped B-52 bombers on orbit in the polar region, just a few hours from their pre-assigned targets in Russia. This gave the US President a quick strike retaliation option. The President had the technical means of sending an "ATTACK" or "RECALL" order by using a global network of powerful HF radio stations called "Giant Talk."

When SAC began continuous airborne alert of its airborne command post, "Looking Glass," in 1961, it addressed a survivability concern, but it did little to deal with the problem of how to communicate with bombers waiting to launch at a base with a dead (i.e., knocked out) communications system or with those, just launched and en route to their positive control stations. At that time, the command placed much reliance on its SAC Automated Command and Control System (SACCS) and Primary Alerting System (PAS) to issue the "go code," but when it became clear that an electromagnetic pulse would most likely disable these land-line systems with the first nuclear detonation (NUDET), engineers and analysts scrambled to ensure reliable redundancy.



**SAC's Looking Glass Command Post aircraft**

Satellite communications was still in its infancy and effective high-frequency (HF) propagation in an atmosphere ionized by NUDETs was problematic. Ultra-high frequency (UHF) radios provided the best insurance for reliable wartime communications, but UHF was only effective for line-of-sight links. That made altitude a primary factor for maximizing range, and multiple airborne platforms could expand the effective range considerably. The concept of "flying relay" stations received additional importance after explosives ruined a SAC radio relay station in Nevada in 1961. Contracts were let and two prototype B-47's were modified to serve as airborne relays. First step in making this plan operational came in July 1962 when the four support squadrons were activated with B-47s carrying 1,000 Watt AN/ARC-89 UHF radios. "Pipe Cleaner" was the nickname for these aircraft and

the relay link became known as “Noah’s Arc.” The “Pipe Cleaner” aircraft relayed communications between SAC’s main bases at Offutt AFB NE, Westover AFB MA and Barksdale AFB LA and the Looking Glass airborne command post.



### **SAC’s Pipe Cleaner B-47 Relay Aircraft**

Early in 1962, when the US began planning the Dominic I high altitude nuclear test in the Pacific, SAC requested a team of Air Force Avionics Laboratory (AFAL) and Aeronautical Systems Center (ASC) engineers help evaluate the effect of a nuclear blast on the Noah’s Arc relay communications.

#### **Effect of Nuclear Blast on Communications:**

In May 1962, a team of AFAL and ASD engineers flew to Hickam AFB Hawaii as part of Joint Task Force 8 (JTF-8) to assist SAC in evaluating the survivability of their Noah’s Arc communications. The team installed a UHF radio ground station in Battery Randolph at Hickam and another in a bunker on Johnston Island, 800 miles south of Hawaii. A SAC EC-135 Looking Glass Command post aircraft and two B-47 Pipe Cleaner aircraft and crews were deployed to Hickam. Practice airborne tests in June showed that phonetically balanced word lists simulating SAC’s Emergency Action Messages (EAMs) could be relayed from the Johnston Island ground station through the Pipe Cleaner aircraft to the Hawaii ground station with good clarity under ambient conditions.

On 8 July 1962, JTF-8 technicians mounted the nuclear warhead on the Thor rocket on Johnston Island and made it ready for launch. The SAC aircraft took off just before sunset and started receiving the test messages transmitted from the Johnston Island ground station and relaying them to our Hawaii ground station. At 10:45 p.m. Hawaii Time, the Thor rocket lifted off in a cloud of smoke and fire. At exactly 11:00 p.m., the one megaton warhead exploded at an altitude of approximately 250 miles. Less than a millionth of a second after the detonation of the weapon, the temperature in the bomb rose to 10-million degrees, as hot as the center of the sun. The uranium and bomb casing vaporized into an incandescent ball of gas. The flash for the blast was bright enough 50-miles away to fry unprotected human eyeballs. Since the air is so thin at 250 miles altitude, the fireball expanded as a perfect sphere reaching 100-mile diameter in less than a minute.

As predicted, the X-rays and radiation from the explosion disrupted the ionosphere and blacked out the high-frequency communications that relies on the ionosphere to reflect the signals. Commercial flights between California and Hawaii had been cancelled that night for safety reasons. The ionospheric disturbance from the blast would leave the aircraft without communications during their four-hour



2,000-mile journey. Ham operators in the Pacific Region who were listening to their short-wave radios heard the entire radio band go silent.



### **Nuclear Aurora Taken from Aircraft**

### **The Hawaiian Sky Lit up from Nuclear Burst**

Back at the Hickam AFB ground station, one of the AFAL engineers listened to the count down, started the instrumentation recorder and raced out the door of the bunker as the countdown approached zero. Looking north, away from the blast, the engineer watched the night sky light up as bright as day with a greenish-white glow. The one-megaton hydrogen bomb explosion set off a fireworks display that would travel halfway around the world. Even though the detonation point was 700 miles south of Hawaii, it turned the Waikiki night into day--bright enough at 11:00 p.m. to read a newspaper. The intense white light lasted for about five minutes before it faded to pink, then red and finally a deep purple.

Within seconds after the blast, an artificial Aurora developed near Johnston Island, triggered by the intense radiation. Less than a minute after the detonation, the radiation traveled out the magnetic field lines from the Northern Pacific and rushed back down those field lines at the conjugate point in the South Pacific. The high-energy electrons smashed into hydrogen, oxygen and nitrogen molecules in the upper atmosphere, expelling particles and generating a man-made Aurora display. In addition to the light show in the Southern Pacific between South America, New Zealand and Australia, the radiation disrupted the ionosphere and blacked out communications. Newspaper switchboards and the police stations were jammed with anxious callers who wondered why the sky turned bright red. The newspapers reported that many people on the islands of Fiji, Samoa and Tahiti wondered if the world was coming to an end.

As the light display faded in the Hawaiian sky, the AFAL engineer went back into the bunker to check the equipment. The experiment has gone well. The line-of-sight radio relay had worked perfectly through the nuclear event, giving SAC a reliable means of contacting their airborne command post and US bases in the event of a sneak attack.

The next scheduled launch a few weeks later did not go as smoothly. The ground station operator on Johnston Island peeked out of the ground station bunker to watch the liftoff of the Thor rocket that stood half a mile away. As the countdown reached zero, the rocket engines ignited, but the rocket didn't lift off. The ground station operator started relaying his eyewitness account of the event.

“Oh, my God! The rocket appears to be on fire,” he radioed in a high-pitch, excited narration. “The whole thing is starting to come apart. It looks like a giant Roman candle. Green, red and blue flashes are flying off in all directions. The rocket is blowing itself apart. There are clouds of smoke and fire everywhere!”

The fact that a megaton nuclear device was disintegrating half-a mile away from the operator never entered into his conversation. If the nuclear weapon had blown up, the entire coral island would have vaporized.

It took two months to clean up the mess, decontaminate the launch pad and get ready for the next launch. In October 1962, the JTF-8 team conducted more successful airborne communications tests as the technicians successfully launched three more nuclear devices. Late in October, the remaining Domatic tests were canceled due to the diplomatic flap over the Cuban missile crisis.

The tests showed that the Noah’s Arc communications relay could withstand the Electro-Magnetic Pulse (EMP) of a megaton detonation and that the disruption of the ionosphere did not cause harmful multipath or other disruptive effects on SAC’s important relay of communications.

## One Kilowatt UHF Solid State Amplifier AN/ASC-31 (1976-82)

**Background:** The AFSATCOM system became operational in the 1970s to provide the Strategic Air Command (SAC) with a reliable, secure, survivable means of disseminating the Emergency Action Message to the B-52 bombers. The system employed the AN/ARC-171 UHF SATCOM system with 100 Watts of transmit power. Since improvements in electronic technology with time allowed the jamming threat to increase, SAC requested the Air Force develop a more powerful transmitter to match or exceed the jamming threat. The Air Force Wright Aeronautical Laboratory's Avionic Laboratory initiated a development under Project 1227 for a one Kilowatt UHF Amplifier.

**One Kilowatt UHF Amplifier Program:** In order to increase the anti-jam capability of the UHF satellite communication (SATCOM) systems, a fast-tuning 1 kilowatt (kW) UHF airborne power amplifier was required. Current airborne UHF SATCOM systems utilized 100 Watt transceivers for their anti-jam SATCOM links. Several kW power amplifiers were in production; however, since they did not provide the tuning time required for a frequency hopping anti-jam UHF satellite system, development of an all solid state 1 kW power amplifier was undertaken. The Avionics Laboratory awarded the development contract to Motorola Inc. A major design goal of the development was the filtering of the output of the 1 kW amplifier so that it passed only the desired signal and excluded the broadband noise and spurious undesired signals.

While the previous generation of UHF transceivers utilized tune circuits in their transmitter and thereby minimized the broadband noise and spurious outputs, the present generation of solid state UHF transceivers generates high levels of broadband noise and spurious signals. If these noise levels are amplified by the 1 kW power amplifier, they cause considerable interference to other UHF systems on-board the using aircraft. For this reason, the 1 kW UHF power amplifier was designed with an integral tuning filter to clean up the input from the UHF transceiver and minimize the transmitted noise and spurious output. Thus the 1 kW UHF power amplifier (AN/ASC-31) not only increases the output level of the UHF driver, but actually reduces the broadband noise and spurious output, helping to solve RFI/EMI problems which were present in installations using UHF transceivers of modern design. The system is shown in Figure 1.

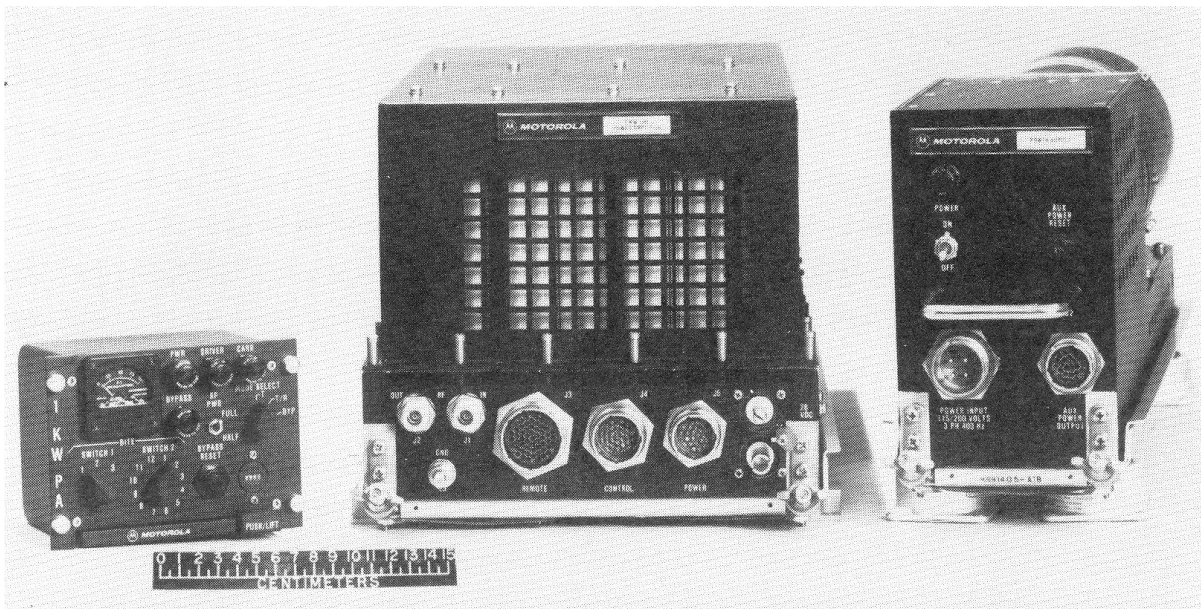


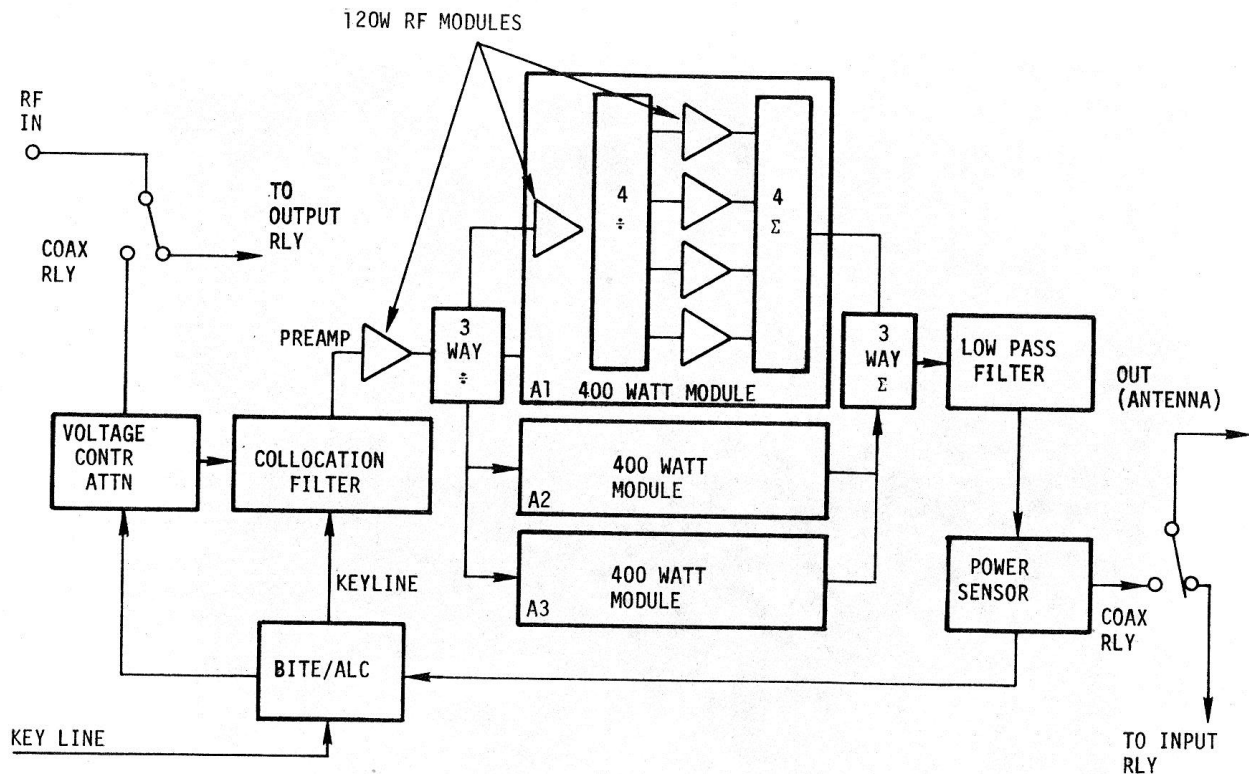
Figure 1 One Kilowatt UHF Solid State Power Amplifier (AN/ASC-31)

**Amplifier System Design:** The 1 kW UHF power amplifier (AN/ASC-31) was designed to provide 13-20 dB of power gain from an input UHF transceiver which operates anywhere in the 225-400 MHz frequency range. It will output 1000 watts of clean UHF power with harmonics down at least 60 dB and spurious down 80 dB. The system requires 4,000 Watts of primary 400 Hz power. The AN/ASC-31 system is comprised of three units: a power amplifier, a power supply and a remote control head as shown in Figure 1. These units are physically housed as follows:

- a. Power Amplifier: 1 ATR Type Case (10.12" x 8.5" x 19.56") Weight: 60 lbs.
- b. Power Supply: ½ ATR Case (5" x 7.62" x 19.56") Weight: 30 lbs.
- c. Remote Control Head: Cockpit Control Box Configuration (5¾" x 4⅛" x 4") Weight: 2 lbs.

The system has a calculated mean time between failures of approximately 4,000 hours. The power amplifier unit consists basically of the following modular shielded sub-assemblies, Figure 2:

- Three identical 400 Watt Power Modules
- Collocation Filter (Xetron)
- Built in Test (Bite)
- Voltage Controlled Attenuator (VCA)
- Low Pass Filter
- Power Sensor

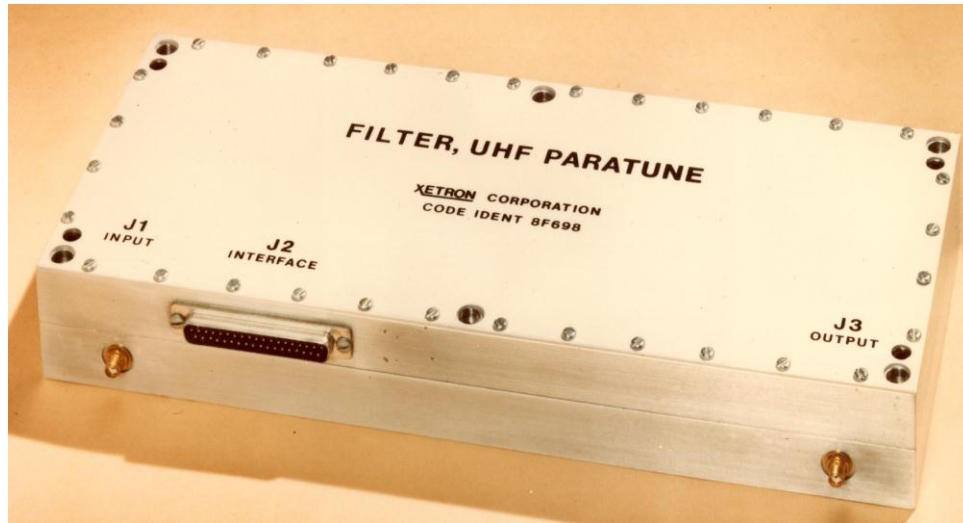


**Figure 2 Block Diagram of One Kilowatt Amplifier**

At the input to the power amplifier, the RF signal enters a coaxial bypass relay which, if not energized, will bypass the amplifier and pass the drive signal directly to the antenna. This will happen in receive,



or if the internal amplifier fault detection circuitry senses a problem. Once the relay is energized, the input signal is then controlled by a voltage-controlled attenuator to an output level of approximately 20 Watts maximum. The signal is then processed through a collocation Xetron filter (Figure 3) which reduces the broadband noise and spurious signals by approximately 60 dB while maintaining unity gain. This is an active rather than a passive filter, and through a digital tuning interface circuitry is capable of tuning to any frequency in the 225-400 MHz band in 300 microseconds. From the filter the "clean" signal enters the amplification stages of the power amplifier unit.



**Figure 3 Xetron Active Filter**

The amplifier is constructed of a series of RF power modules. These power modules are built up from two 100 Watt transistors, matched and derated for reliability to provide a power output of 120 Watts. Four of these units are combined to provide a 400 watt power module. Three of these 400 Watt power modules are combined through specially designed hybrids to provide the 1 kW power output. The RF signal is then fed through a low pass filter and is detected by a power sensor which drives the BITE/ALC (Automatic Level Control) circuitry, thus maintaining the desired 1 kW power output regardless of input gain variations

#### **References:**

Fischbach, Wayne O.; **One Kilowatt UHF Solid State Amplifier**; Air Force Wright Aeronautical Laboratory; AFWAL-TR-81-1152; February 1982.

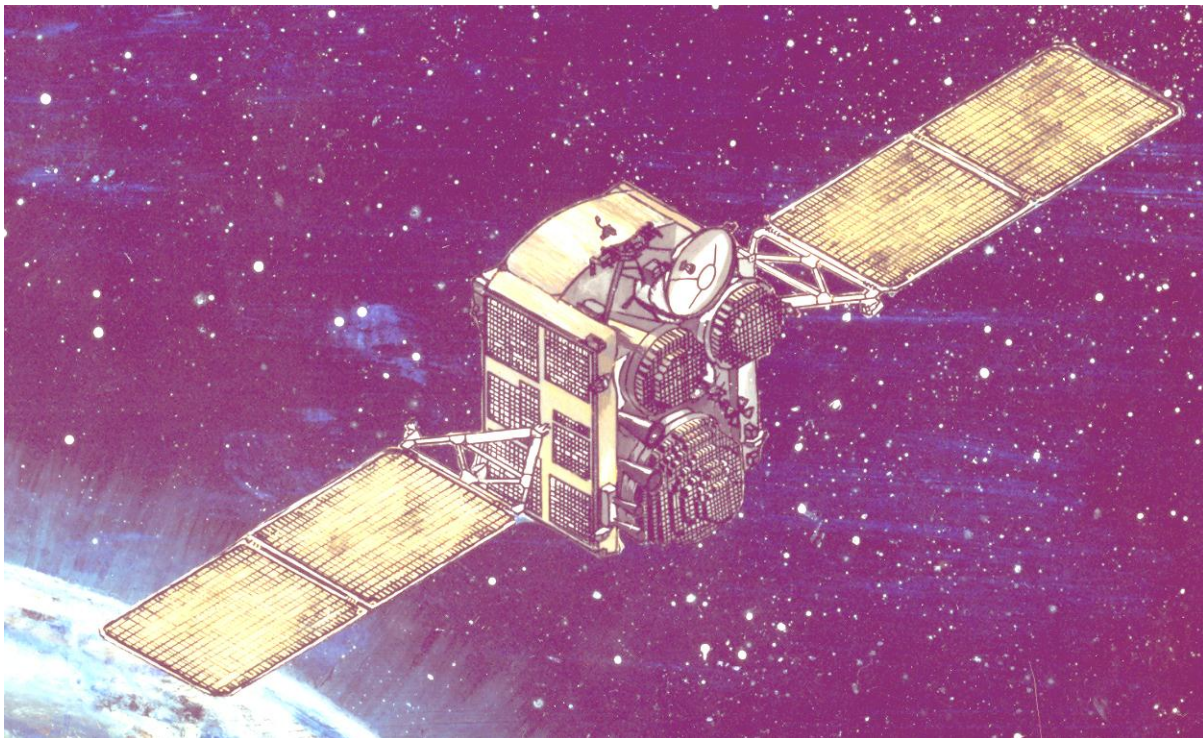
Fischbach, Wayne O. and Roger L. Swanson; **Motorola 1 KW Solid State Amplifier (AN/ASC-31) Intermod Test Results**; Air Force Wright Aeronautical Laboratory; AFWAL-TM-80-129-AAAD; 26 November 1980

Ney, R.; **One KW Power Amplifier Reliability Prediction**; Motorola Inc; DTIC AD0876444; 1 October 1980.

## On-Orbit Evaluation of DSCS III Satellite (1982-83)

**Background:** The Defense Communications Agency (DCA) was established in Arlington VA in 1960 to manage the Defense Communications System (DCS), a consolidation of the independent long-haul communications functions of the Army, Navy and Air Force. Part of the DCS included UHF and SHF satellites. In October 1982, the first Defense Satellite Communications System III (DSCS III) satellite was launched and placed into orbit over the Pacific Ocean at 105°W longitude. The satellite had a number of new antenna designs for both the SHF and UHF systems. DCS requested the Air Force Avionics Laboratory (AFAL) measure the signal strength and polarization on the SHF and UHF satellite antennas at low elevation angle around the Pacific Ocean coverage area to compare the on-orbit performance with the pre-launch antenna performance.

**SHF Satellite Antenna Evaluation:** The initial launch of the Defense Satellite Communication System satellite DSCS III, Figure 1, occurred on 30 Oct 82. During its initial checkout period the satellite was located in the vicinity of 105°W longitude. At the request of the Defense Communication Agency, the Avionics Laboratory measured the SHF earth coverage beacon signal strength (7600 MHz) within the DSCS III Pacific coverage area. The 4950th Test Wing aircraft C-135/372, Figure 2, equipped with the AFAL developed AN/ASC-30 SHF SATCOM System, Figure 3, made airborne measurements along the flight path shown in Figure 4 and ground measurements at six overseas locations. While on the ground a separate full-duplex test was run between the Army's USASATCOMA facility at Ft Monmouth, NJ and the aircraft over DSCS III channel 6 at 7925 and 7927 MHz.



**Figure 1 DSCS III Satellite**

**SHF Test Configuration:** The airborne and ground measurements of the DSCS III SHF signal were made with the AN/ASC-30 terminal installed on aircraft C-135/372 and the Army's MSC-61 terminal located at Ft Monmouth, New Jersey. The AN/ASC-30 has a G/T of 5 dB and during the ground



transmit tests provided an output power of 60 dBW EIRP. In flight the aircraft antenna tracked the DSCS III satellite by using a computer aided prediction system or by actively tracking on downlink energy.



Figure 2 4950<sup>th</sup> Test Wing C-135 Aircraft with AFAL's SATCOM Terminal

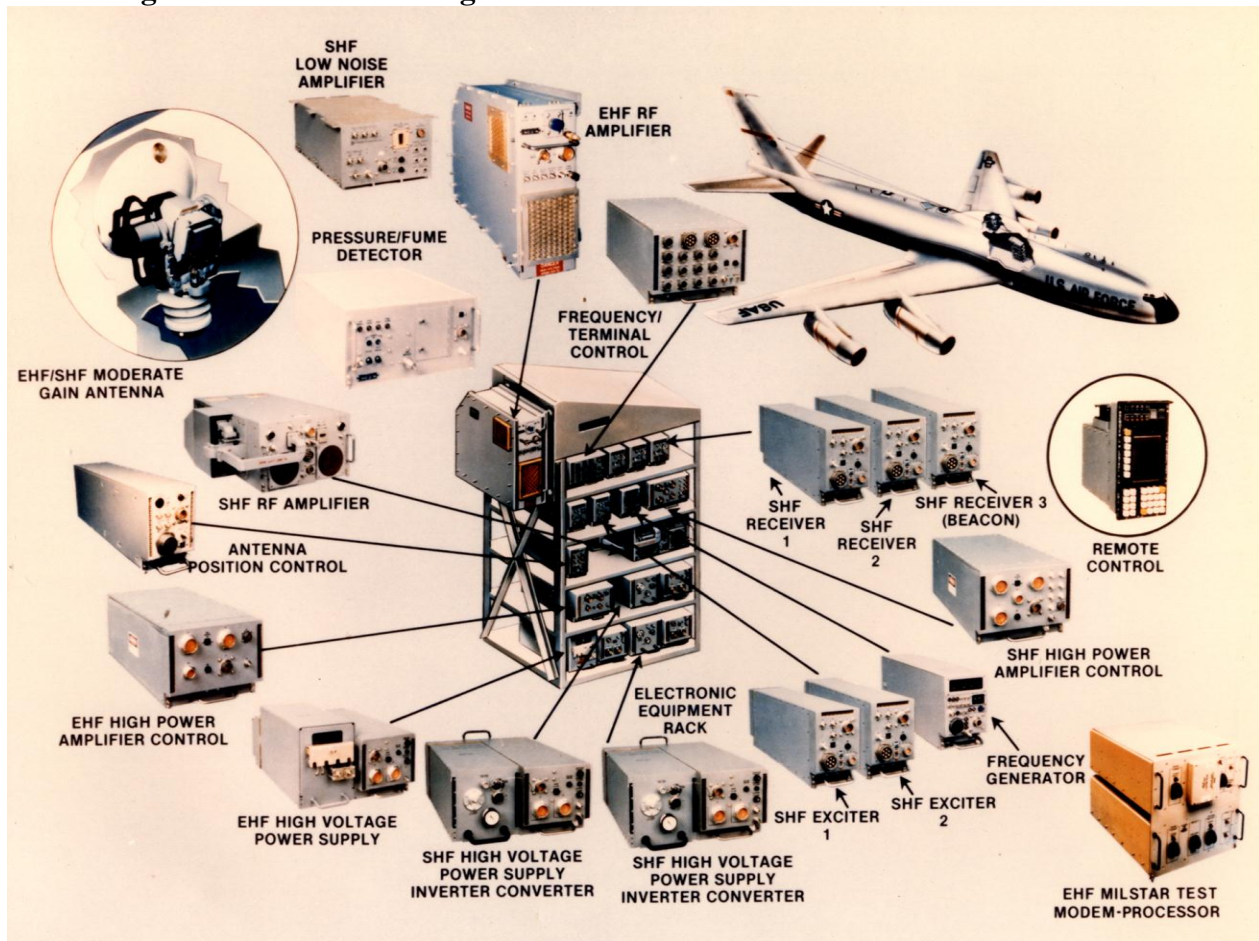
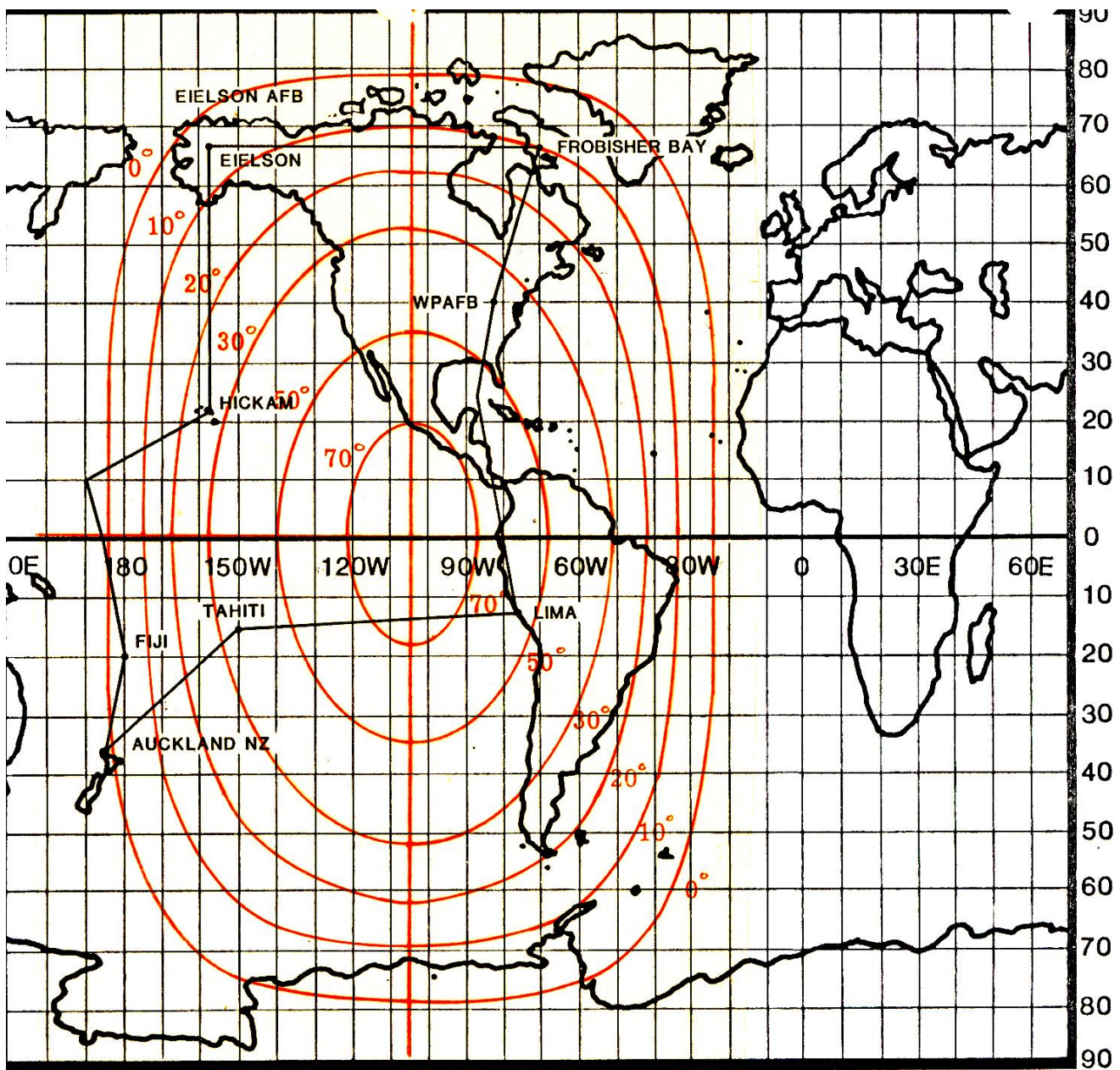


Figure 3 AN-ASC-30 SATCOM Terminal





**Figure 4 DSCS III Coverage Pattern and Aircraft Flight Path**

**SHF Test Results:** On the flight from WPAFB, Ohio to Frobisher Bay, NWT, Canada the elevation angle to DSCS III varied from  $24^{\circ}$  to  $7^{\circ}$  above the horizon. The SHF beacon signal level varied between 39 and 40 dB Pr/No. While on the ground at Frobisher Bay a 24 hour full-duplex test was run with Ft Monmouth, NJ over channel 6. The beacon and communication signals were constant with no multipath or atmospheric fading detected. The average received beacon signal was 39 to 40 dB Pr/No. The SHF communication signal transmitted by Ft Monmouth on 7927 MHz was received by the AN/ASC-30 at a Pr/No of 49 to 51 dB. No multipath or severe signal variations were seen at Frobisher Bay even with its low ( $7^{\circ}$ ) elevation angle. The weather was cloudy, windy, and the temperature  $-30^{\circ}\text{F}$ .

On 7 December the aircraft flew to Eielson AFB, Alaska. The SHF beacon signal was steady with an average level of 39 to 40 dB Pr/No. The elevation angle changed from  $7^{\circ}$  to  $15^{\circ}$  during the flight. On the ground at Eielson AFB ( $11^{\circ}$  elevation angle) a 5 hour test was conducted with Ft Monmouth. The



received beacon signal was 39 dB Pr/No and the communication signal was 50 dB Pr/No. No multipath was encountered.

The aircraft flew to Hickam AFB, Hawaii on 10 December. The SHF beacon signal increased from 40 to 41 dB Pr/No during the flight as the elevation angle increased from 15° to 30°. No multipath was experienced.

At Hickam AFB a 5 hour ground test was accomplished at an elevation angle of 28°. The SHF beacon signal was measured at 39 dB Pr/No and the SHF Comm signal at 49 dB Pr/No. No multipath was encountered.

On 13 December the aircraft flew to Nadi, Fiji in the South Pacific. The SHF beacon signal was near constant at 41 dB Pr/No as the elevation angle decreased from 31° to 2°. No multipath was seen on the receive signal.

At Fiji, the elevation angle to DSCS III was approximately 2°. The top of the 3,000 foot mountains in the direction of the satellite was 3° above the horizon. On 14 December a ground test was accomplished. Since the path from DSCS III to the ground station was obstructed, the downlink signal was diffracted by the mountains. The received SHF beacon and communications signal had 10 to 15 dB variations with a period of 10s of seconds to minutes.

On 15 December, the aircraft took off from Fiji and headed for Auckland, New Zealand. The elevation angle to the DSCS III satellite prior to take off varied from 3° to -1°. The SHF signal variations recorded on the ground at Fiji disappeared as the aircraft climbed above 1,000-foot altitude. The beacon signal remained steady at 39 dB Pr/No during the flight. As the aircraft descended to land at Auckland, the beacon signal began to experience multipath fading and finally dropped out as the aircraft descended below 5,000-foot altitude. The DSCS III SHF signal could not be received on the ground at Auckland. The -1° elevation angle and 3,000 feet mountains in the direction of the satellite blocked the signal.

On 17 December the aircraft flew on to Tahiti. The DSCS III SHF beacon signal was received shortly after takeoff from Auckland. A beacon signal of 40 to 41 dB Pr/No was recorded during the flight as the elevation angle increased from -1° to 36°. No multipath was recorded once the aircraft reached its 30,000 foot cruising altitude out of Auckland.

A ground test was conducted at Tahiti where the elevation angle was 36°. The SHF beacon was received with a 41 dB Pr/No and the SHF Comm signal at a 52 dB Pr/No. No multipath was experienced.

On 19 December the aircraft flew to Lima, Peru. The SHF beacon signal increased from 41 dB to 45 dB Pr/No as the elevation increased from 33° to 68°. On the ground at Lima the SHF beacon signal measured 43 dB and the SHF Comm signal measured 53 dB Pr/No at an elevation angle of 55°. No multipath was experienced.

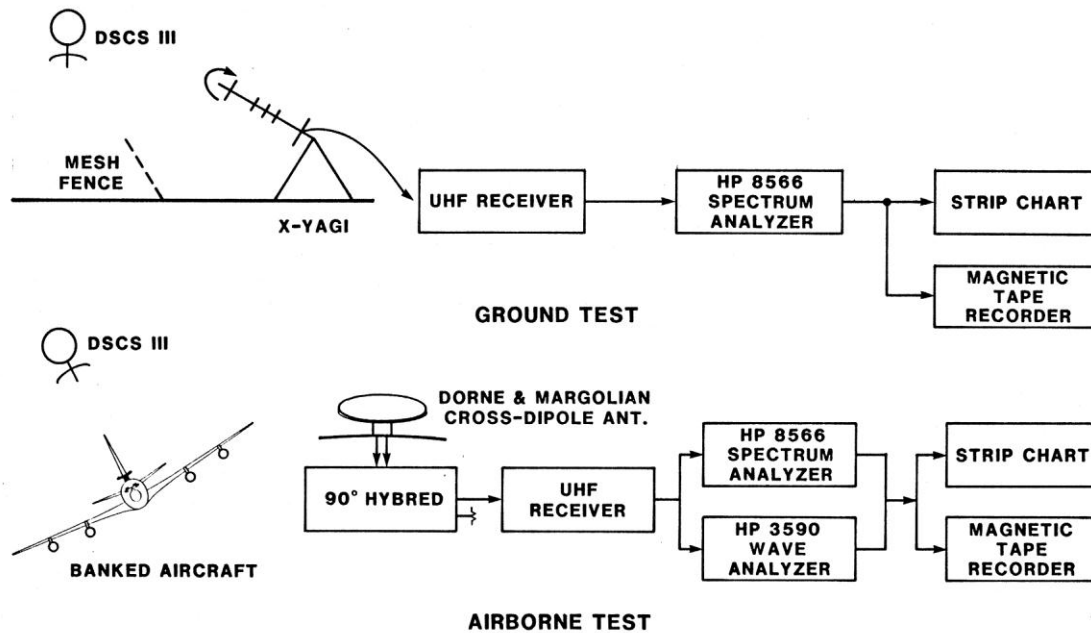
On 21 December the aircraft returned to WPAFB, Ohio. The beacon remained between 43 and 44 dB Pr/No as the elevation angle increased from 54° to 69° and then decreased to 47°.

**UHF Satellite Antenna Evaluation:** To characterize the DSCS III UHF communication system once the satellite was in orbit, the EIRP and the axial ratio of the downlink signal were measured. The EIRP of the signal directly affects the signal received by the ground antenna. To avoid terrestrial antenna

orientation problems most UHF satellites are equipped with circularly polarized antennas. Deviation from perfectly circular polarization reduces the power transfer into the ground antennas.

Measurements of downlink signal strength were recorded at six ground sites and at twenty locations while airborne between the ground sites. The flight path of the SATCOM test aircraft is shown in Figure 4 from Wright-Patterson AFB, Ohio, to Frobisher Bay, Canada; Eielson AFB, Alaska; Hickam AFB, Hawaii; Nadi, Fiji; Auckland, New Zealand; Papeete, Tahiti; Lima, Peru; and return to Wright-Patterson AFB, Ohio.

The UHF test configurations shown in Figure 5 for the airborne and ground measurements were similar. An UHF downconverter was interfaced with a spectrum analyzer as the signal strength indicator. The spectrum analyzer signal level was recorded on a strip chart and on magnetic tape.



**Figure 5 Ground and Aircraft UHF Received Signal Level Test Configuration**

The aircraft tests used a cross-dipole antenna mounted on top of the C-135 aircraft. Airborne measurements were made by banking the aircraft such that the top mounted RHCP cross-dipole antenna was pointed at the satellite. The intent was to receive the signal within the constant gain beamwidth of the aircraft antenna. For the airborne tests, the DSCS III elevation angle relative to the aircraft (horizontal) water line, DSCS III azimuth relative to the aircraft nose, time (UT), and signal strength were recorded. The relative angles to DSCS III during the banks were determined by pointing the AN/ASC-30 SHF antenna with the CPM/P computer pointing system and recording the analog angle readouts of the SHF antenna.

On the ground, the signal was received with a RHCP cross-Yagi antenna of known gain or a rotating linearly-polarized dipole, down converted from UHF to a low IF frequency. Then the IF signal was routed via a long (200 to 1000 ft.) cable to a spectrum analyzer in the aircraft to measure and record the downlink signal strength. The remote antenna and down converter were used to remove any aircraft

reflection effects. The output from the spectrum analyzer was recorded on a strip chart and on magnetic tape for later analysis.

To reduce multipath signals during the ground measurement, a wire mesh fence and blocks of radio-frequency absorbing material were appropriately located near the specular reflection point covering from one to five Fresnel zones, Figure 6.

**UHF Data Collection:** Propagation effects such as multipath fading and ionospheric scintillation fading interfered with the measurements at several locations. Two-ray multipath during airborne measurements occurred at some elevation angles. During the flight from Frobisher Bay, Canada to Eielson AFB, Alaska, at satellite elevation angles between  $5^{\circ}$  and  $15^{\circ}$ , multipath reflections from ground or ice complicated the measurement.

On the ground at Frobisher Bay, Canada, multiple reflections and ionospheric scintillation caused the data to become very irregular and difficult to analyze. In Fiji, the signal path was diffracted by a mountain range, which reduced the signal level. In New Zealand the test equipments was ferried by two New Zealand Royal Air Force helicopters, Figures 7 and 8, to a 2,500- foot high backbone ridge in order to get a clear line of sight to DSCS III.

During the airborne measurements the aircraft was banked so the overhead antenna pointed toward DSCS III and the UHF signal strength measured.



**Figure 6 UHF Signal Measurements At Frobisher Bay Canada with Fence and Absorber**





**Figure 7 New Zealand Helicopter and UHF Measurement Crew on Top of Mountain**



**Figure 8 UHF Antenna Set up On Top of New Zealand Mountain**



**UHF Data Analysis:** Measuring satellite EIRP using an antenna with known characteristics is a well known technique. With data recorded in dBm, one can compensate for the receiver gain, cable losses, measuring antenna gain, correction for axial ratio, and space loss giving the result of the satellite EIRP at the particular location.

The strip chart data was examined and the signal value of the spectrum analyzer was determined at the point of highest elevation angle relative to the aircraft water line. This method works well when the data obtained is very clean and unperturbed by a multipath signal or other spurious signals. However, multipath and other signal perturbation can make it difficult to clearly determine the direct signal level. To make use of all the data to compute the EIRP, the received data was smoothed with a curve which models the signal variation due to aircraft bank angle.

**Conclusions:** During the 18 day test period, measurements were made of the DSCS III SHF beacon and communication signal from elevation angles of  $-1^{\circ}$  to  $+69^{\circ}$ . There was approximately 6 dB difference between the minimum beacon signal of 39 dB Pr/No at low elevation angles of  $-1^{\circ}$  to  $20^{\circ}$  to the maximum of 45 dB Pr/No at a  $67^{\circ}$  elevation angle as the aircraft flew within 1,000 miles of the sub-satellite point. No multipath or signal variations were seen above a few degrees elevation angle. At Fiji where the satellite was partially blocked by the mountains, the SHF received signal varied 15 dB with a very slow period due to diffraction. On landing and takeoff at Auckland, New Zealand multipath and diffraction were also encountered as the satellite path went below the horizon.

The airborne UHF EIRP measurements showed a mean value of 25.24 dBW with a standard deviation of 0.73 from a point almost directly under the satellite to the edge of coverage. There appears to be a discrepancy of 1.5 dB between the ground measurements and the airborne results with the ground EIRP's being some what lower at a mean value of 23.74 dBW with a standard deviation of 0.84. Two data points are questionable and are not included in the mean. The data from Fiji is low due to diffraction by the mountain range and the data from New Zealand appears high.

The techniques used for the ground and airborne measurements worked well except when excessive multipath or ionospheric scintillation fading were encountered. Computer smoothing of the noisy fading data is required to extract meaning for results.

#### **References:**

Bell, J., R. Van Wagner; **DSCS III Low Elevation Angle Test**; Test Report 46-2336! US Army SATCOM Agency; Ft Monmouth NJ; 10 January 1983.

**Defense Satellite Communication System (DSCS) III Joint Test and Evaluation Plan**; DCA; Washington DC; May 1982.

**DSCS III Single-Channel Transponder On-Orbit Test Plan and Procedures**; Aerospace Report TOR 0082(2404-60)-4; Space Division; Los Angeles AFS CA; 30 September 1982.

**DSCS III MBA Control Performance Test**; DCA TWX 181837Z; November 1982.

**DSCS III Satellite Engineers Handbook**, General Electric, Contract 80SDS4219, CDRL Item A041, August 1980.

Dunham, P., C.K.H. Tsao, R.N. Jackson; **Small EHF/SHF Airborne SATCOM Terminal (AN/ASC-30)**; Air Force Avionics Laboratory; WPAFB, Ohio; January 1982.

Kraus, T. D., Antennas, McGraw Hill, 1950

Johnson, Allen. L.; DSCS III SCT Airborne Flight Test Plan; Air Force Avionics Laboratory; WPAFB OH; 1 November 1982.

Stutzman and Overstreet; Axial Ratio Measurement of Dual Circularly Polarized Antennas, Microwave Journal; October 1981.

Swanson, Roger, William Baker and Ted Grizinski; Axial Ratio Measurements of UHF Satellite Antennas; Proceeding of the Systems Space Communications Panel S-6, Technical Cooperative Program (TTCP), Ottawa, Canada, January 1983.

Swanson, Roger, William Baker and Ted Grizinski; On orbit Satellite UHF Axial Ratio Measurements, National Aerospace & Electronics Conference, (NAECON) Proceedings, IEEE, Dayton OH; May 1983.

## **Predator SATCOM support (1993-2011)**

**Background:** Until recently, Remotely Piloted Vehicles (RPVs) or Unmanned Aerial Vehicles (UAVs) were small unmanned airplanes that carried a camera and were controlled by a transmitter and operator in a truck a few miles away. That all changed in the 1990s. With the unacceptable loss of airplanes and pilots in the Vietnam War, the DOD started looking seriously at UAVs that could fly beyond line of sight.

**Predator SATCOM Support:** In 1993, the Aeronautical Systems Division's Reconnaissance System Program Office, who was responsible for the Predator development, contacted Wright Laboratory (WL) for assistance in preparing the specifications for the UHF and X-Band SATCOM systems necessary to command Predator and retrieve the surveillance information. A WL engineer worked with the Predator SPO to prepare the SATCOM specifications, evaluate the proposals and oversee the SATCOM developments.



### **Predator UAV with X-band SATCOM Dish under Radome**

In January 1994, the Air Force awarded a contract to General Atomics Aeronautical Systems to execute the Tier II, medium-altitude endurance Predator program to design a long-endurance, medium-altitude unmanned aircraft system for surveillance and reconnaissance missions. The Predator was designed to distribute surveillance imagery from synthetic aperture radar, video cameras and a forward-looking infrared (FLIR) in real-time both to the front line soldier and to the operational commander, or worldwide in real-time via satellite communication links.

The UHF SATCOM system consisted of an AN/ARC-210 SATCOM terminal used to control the Predator in flight. The Airborne X-band SATCOM System consists of both airborne and ground hardware with a forward command link and a return reconnaissance link. The airborne segment interfaces to the user's network via a user provided workstation PC. It provided interfaces include Ethernet for command and control, and RS-422 for voice, data and telemetry. The ground segment provides identical interfaces but also includes a local control PC. This can be used to control the system in the event the user-provided workstation PC is remotely located. The system also includes a Digital Gateway Unit to provide dial-up telephone connectivity to Public Switched Telephone Networks (PSTN's).

The airborne antenna is a 2-axis design employing a "splash plate" fed elliptical reflector and carbon fiber yoke. The elliptical reflector design is conducive to aircraft installations requiring a low profile to



### **X-Band SATCOM System**

minimize radome size and aerodynamic drag. The use of a carbon fiber yoke and composite reflector provide low-weight and high-dynamic response. Major components of the antenna include the yoke, reflector, feed, Microwave Power Module (MPM), LNA, diplexer and pedestal. The antenna is designed for fuselage mounting in a non-environmentally-controlled environment.

The ground segment consists of a Ground SATCOM Data Processor (GSDP) and a laptop PC. The GSDP is packaged in a standard 19" rack-mounted chassis. Primary components include the modem, multiplexer, IF converter, control processor, DGU and power supplies.

The environmental design is based on a standard office environment. The GSDP interfaces to the SATCOM ground station via a standard 70 or 700 MHz IF and to the user workstation via Ethernet and RS-422. The laptop PC provides direct control of the system from the SATCOM ground station.

The first prototype Predator flew in 1994. During April and May 1995, Predator, as a proof of concept demonstration, participated in Roving Sands '95, an annual air defense exercise held in the southwestern United States. The success of the Predator during this exercise played a substantial role in the decision to deploy it to the European theater in the summer of 1995.

The first European deployment, Nomad Vigil, was in support of Joint Task Force Provide Promise (JTF PP) with the Predator based in Gjader, Albania. A WL engineer accompanied the Air Force controllers and General Atomics engineers to Albania to assist in checking out the SATCOM systems and solve any SATCOM communications problems real time. Predator tasking was provided by the JTF PP headquarters through the Southern Region Joint Operations Intelligence Center (SR JOIC) in Naples, Italy. The required airspace coordination was performed at the NATO Combined Air Operations Center (CAOC) in Vicenza, Italy. The Predator deployment took place from July through November, 1995.

Engineers from WL, renamed the Air Force Research Laboratory (AFRL) in 1995, continued to support the Predator SPO as they upgraded the Predator to Ku-Band SATCOM systems in 2001 and worked to increase the transmission bandwidth and reliability of the communications data link up to the present day.



## Project HAVE Leap Frog (1960-1969)

**Background:** At the height of the Cold War in the late 1950s, all international communications were either sent through undersea cables or bounced off of the natural ionosphere. The United States military was concerned that the Soviets (or other "Hostile Actors") might cut those cables, forcing the unpredictable ionosphere to be the only means of communication with overseas forces. The Space Age had just begun, and the communications satellites we rely on today existed only in the sketches of futurists.

Nevertheless, the US Military looked to space to help solve their communications weakness. Their solution was to create an artificial ionosphere. In 1960 The Air Force funded a research effort with MIT Lincoln Laboratory called it Project West Ford. The effort envisioned creating an artificial ionosphere consisting of millions of thin copper dipoles to reflect the communications signal back to earth, like a passive satellite.



**Westford Concept**

**Copper Needles**

**Westford Ground Station**

In addition to ground communications stations at Millstone Hill MA and Camp Parks CA with large parabolic dishes, the Air Force directed the Air Force Avionics Laboratory (AFAL) to develop an airborne terminal, nick named Leap Frog, under Project 9168, capable of communicating with the ground stations.

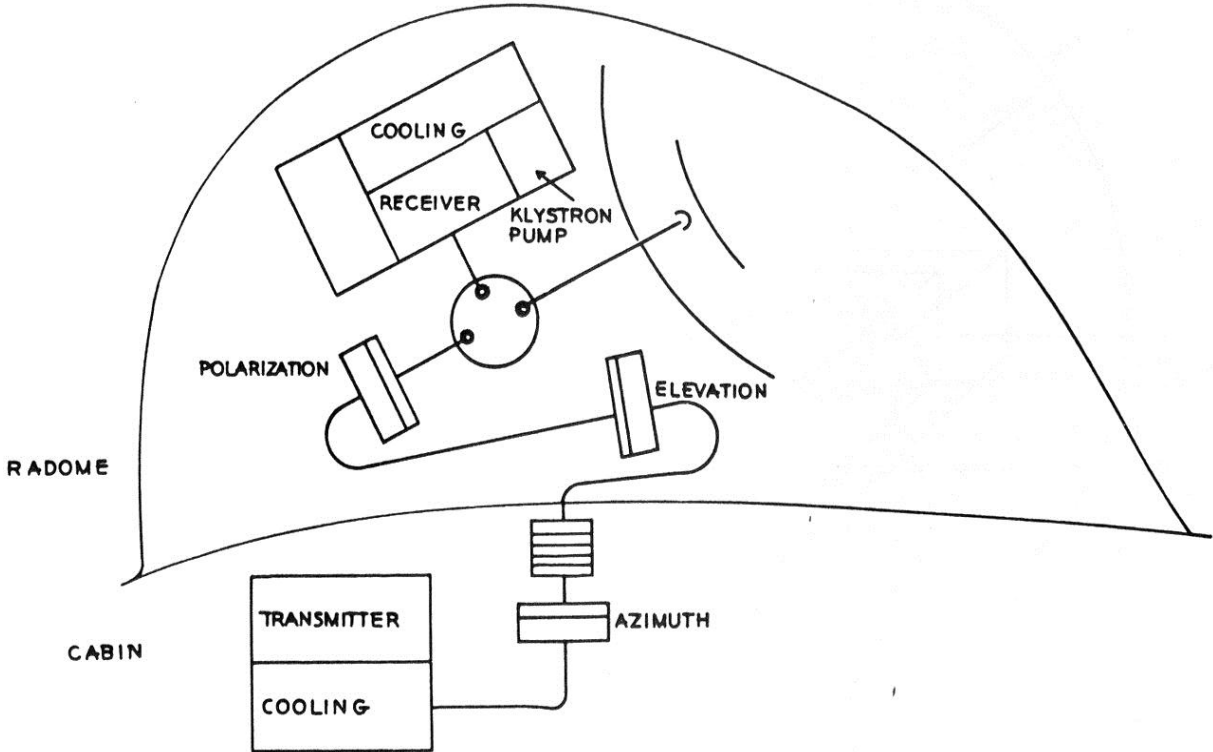
**Airborne Terminal Description:** The design study for the airborne antenna, transmitter and receiver was completed through contractual efforts initiated by the Air Force Cambridge Research Center (AFCRL). The airborne complex employed an open-cycle cooled maser receiver. The RF head of the maser operated at 7750 megacycles and had a gain of 20 dB, an instantaneous signal bandwidth of 10 MHz, and an effective noise temperature of 25°K. The maser amplifier, IF preamplifier, mixer, and local oscillator were mounted on the antenna structure.

The transmitter incorporates a Varian VA-863 klystron tube, which provides 10 KW of continuous RF power at 8350 megacycles. A liquid-cooled heat exchanger is provided for cooling the power amplifier and the high-power rotary joints of the antenna. An ethylene-glycol and water mixture was used as the coolant. The basic elements of the antenna were the radomes, reflector and feed, mount and servo system, and the computer pointing system. As mentioned previously, the antenna configuration includes provisions for mounting the maser receiver immediately behind the reflector to achieve an ultra low-loss receiving system. Overall receiving temperature is expected to be 100°K or less.

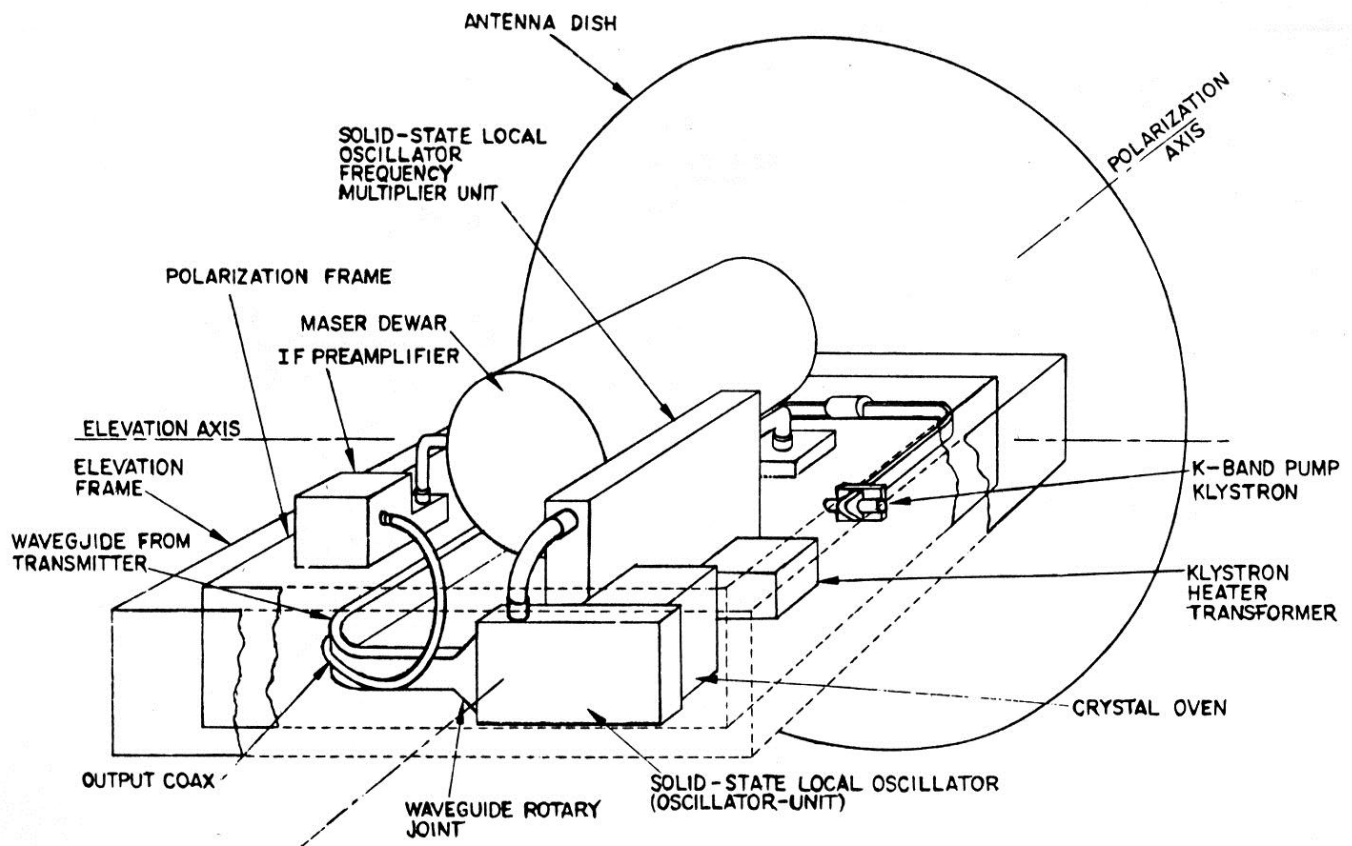
The airborne terminal was installed on test aircraft, JC-121- 51-3837 at Wright Patterson Air Force Base, Ohio in the early 1960s.



**Leap Frog Test Aircraft – C-121-3837**



**Airborne Communications Complex for Needles Experiment**



### Configuration of Airborne Receiver for Needles Project

The general performance characteristics of the antenna are as follows:

Reflector:	Paraboloid with Cassegrain feed
Frequency range:	7.7 to 8.4 GHz
Minimum gain:	30 db
Power capacity:	10-KW, C-W, 100-percent duty cycle
Polarization:	Linear, adjustable

The drive mechanism was capable of continuous 360 degrees motion in azimuth, minus 25 degrees to plus 120 degrees (30 degrees past vertical) motion in elevation, and a 180-degree change in polarization. Antenna pointing commands are supplied to the drive servo-motors by a computer, which computes the pointing angle from pre-programmed ephemeris of the orbiting belt and the position and altitude of the aircraft derived from the navigational system. Elevation and polarization commands are fed through a slip-ring assembly.

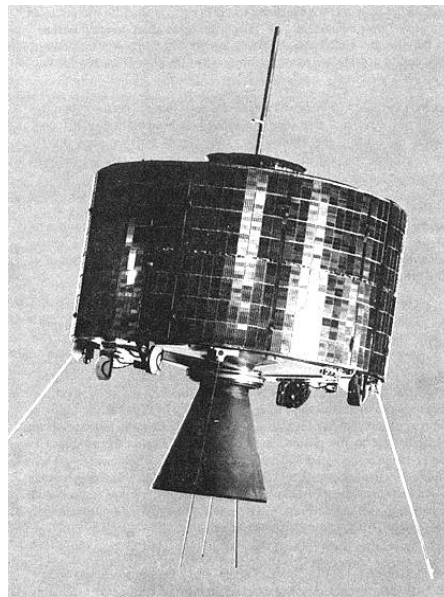
The modulator-demodulator design parameters provided a dual symbol Mark-Space output of the threshold detector fed to an information detector where the incoming data word was compared on a bit-per-bit basis with the reference. Generation of the Fielddata character was accomplished by means of a toggle-switch register. Recording of data was accomplished in suitable format for subsequent processing and analysis on the IBM 7090 computer.

In 1963, the Leap Frog equipment was installed in aircraft JC-121C-51-3837 at Wright Patterson AFB, Ohio. In May 1963, the US Air Force launched 480 million tiny copper needles that briefly created a

ring encircling the entire globe. Inside the West Ford spacecraft, the needles were packed densely together in blocks made of a naphthalene gel that would rapidly evaporate in space. This entire package of needles weighed only 20 kg. After being released, the hundreds of millions of copper needles gradually spread throughout their entire orbit over a period of two months. The final donut-shaped cloud was 15 km wide and 30 km thick and encircled the globe at an altitude of 3700 km.

The first attempt at remote communications using the West Ford belt was made on 14 May 1963, 4 days after the launch. At this point, the dipoles had not completely spread out to fill their entire orbit so they were much more densely spaced than in their final configuration. Using two 18.5 meter antenna, Project West Ford engineers were able to send voice transmissions between Camp Parks, CA and Millstone Hill, MA. The voice connection was described as "intelligible" and was transmitted at a data rate of approximately 20,000 bits per second- about the speed of a 1992-era telephone modem. But as the needles continued to disperse to their final cloud, the data rate dropped off significantly, so much so that by 18 June 1963 only 400 bits per second could be transmitted. On 2 July 1963, the West Ford experiment was terminated. At this time, the tiny needles were spaced about 400 meters from each other. The needle density was never sufficiently large to allow the Leap Frog airborne terminal to communicate with the ground stations.

**Syncom III Experiment:** With the demise of the West Fort Project, AFAL began looking for an alternate satellite to continue the research and development of a microwave air-to-ground link. NASA's Synchronous Communications Satellite (SYNCOM) program, which began in 1961, launched SYNCOM III into orbit on 19 August 1964. Syncom III was the first spin-stabilized satellite launched into synchronous orbit.



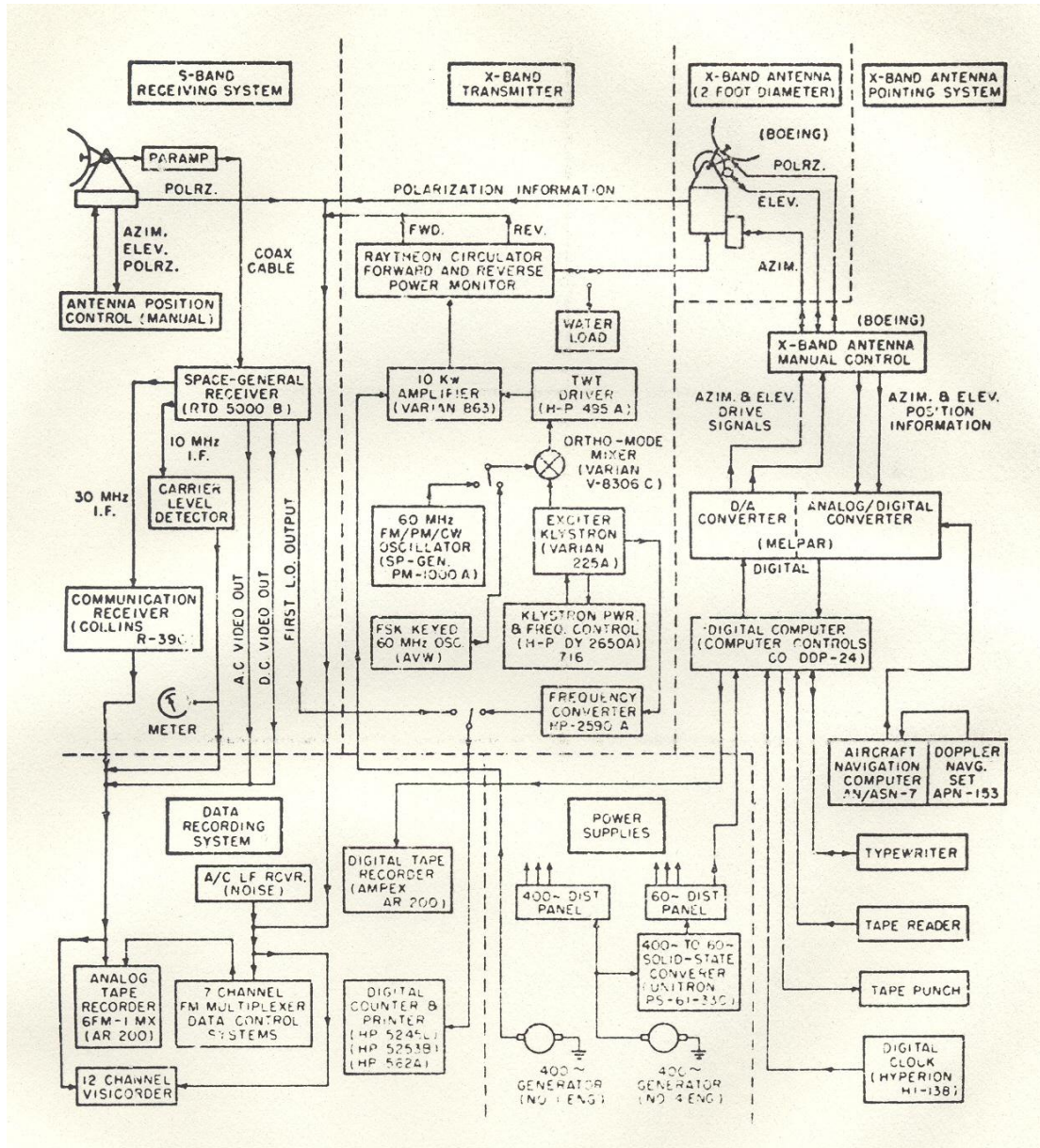
**Syncom III Satellite**

The microwave communication system aboard Syncom III is a frequency-translating, hard-limiting, microwave transponder which receives signals in the X-Band region (7.36 GHz) and retransmits them at S-Band (1.82 GHz). Two transponders are available for use, the first having a bandwidth of 5 MHz and the second having a selectable bandwidth of either 15 MHz or 50 KHz. The gain in the 50 KHz channel is 19.3 dB greater than the gain in the 15 MHz channel. The maximum power output of the transponder in the fully saturated condition is approximately two watts. In addition to the output on



the communication channels the transponder also had a beacon output at 1.82 GHz. When no up-link signal is being received the beacon output power is approximately two watts, but as the level of the up-link signal increases the beacon output is gradually suppressed to a minimum output of about 100 milliwatts.

**Leap Frog Airborne Terminal for Operation with Syncom III:** Under the Leap Frog Project, AFAL developed an airborne terminal to operate through the Syncom III Satellite.

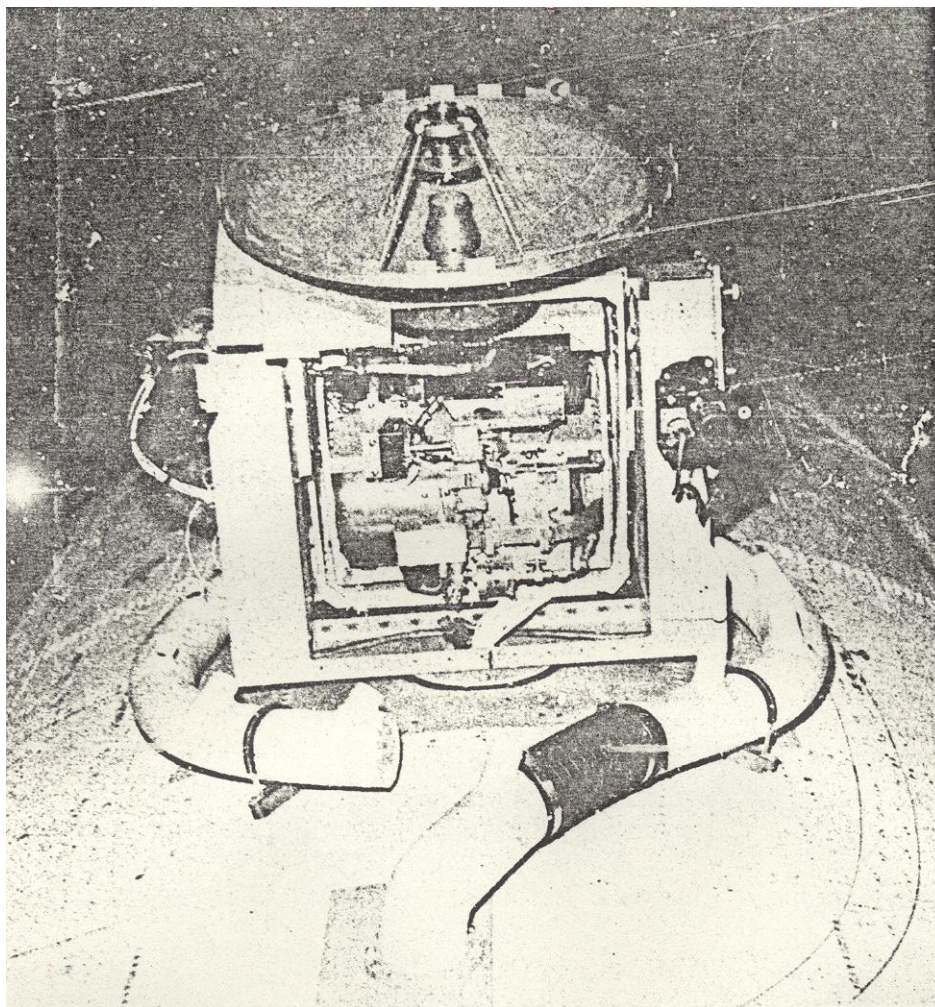


**Block Diagram of Leap Frog Microwave Communications System**

**X-Band Antenna:** The transmitting antenna was a 26-inch diameter parabolic reflector with a Cassegrainian feed and mounted inside a two-piece fiberglass tear-drop shaped radome on top of the aircraft's mid section. The antenna system was designed and built by the Boeing Company and was originally intended to work with the dipole belt launched in the Project West Ford Experiment.



Consequently it had to be modified to work with the Syncom III transmit frequency. The modified antenna had a gain of about 28 dB and a beamwidth of approximately 2.5 degrees. The X-band transmitter output was brought to the antenna through a nitrogen-pressurized, water-cooled waveguide, rotary joints in the waveguide permit mechanical scanning of the antenna beam in azimuth, elevation and polarization. Lear Servo-Actuators are used as the drives on the three adjustments; each drive consisting of a continuously running motor, a gearbox with counter-rotating outputs and two clutches to select either of the desired directions of rotation. Synchro resolvers provide information on the current azimuth, elevation and polarization positions. This information is displayed on three dials on the control panel and is also used as input formation to the antenna-pointing computer. Also included on the control panel are the polarization drive control and the manual over-ride controls for the azimuth and the elevation. Normally the operation of the azimuth and elevation drives was controlled by the antenna-pointing computer system.



**Two-foot X-band antenna on C-121 with Maser Amplifier and Liquid Helium Cooling**

**X-Band Antenna-Pointing System:** The main purpose of the Melpar-designed antenna-pointing computer system is the automatic tracking of a satellite by the X-band antenna. Other operations include the computer's use off-line to calculate satellite ephemeris data and the recording of the aircraft and antenna positional data while operating in the on-line or RUN mode. The heart of the system is a Computer Control Company (3C) DDP-24 general-purpose digital computer which was ruggedized for aircraft operation. In addition to the normal console, typewriter, tape reader and tape punch inputs and

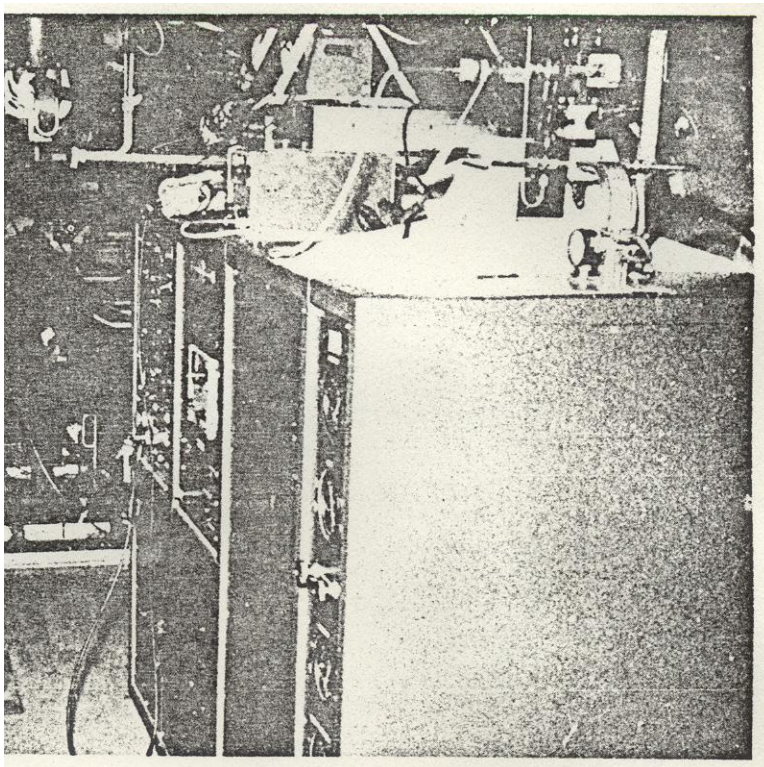
outputs, the system also includes analog-to-digital (AID) and digital-to-analog (DIA) converters, a digital output to a magnetic tape recorder and an input from a digital time-code generator. The AID converter was used to convert analog information from the aircraft navigational system (a PB-10A autopilot and an AN/ASN-7 navigational computer with inputs from an N-1 compass system, MC-1 rate sensors, and an AN/APN-153(V) Doppler navigational radar set) and from the X-band antenna-mount azimuth and elevation synchros into digital signals for input to the computer. The DIA converter is used to convert the digital output commands from the computer into analog drive signals for the X-band antenna azimuth and elevation drives. The digital clock input was obtained from a Hyperion model HI-138 time code generator and the digital output information from the computer is in the form of a non-standard parallel-serial output to a continuously running recorder (an Ampex AR200). Every 0.2 second the DDP-24 computer read in the navigational data, time and X-band antenna position from the analog signals present in the AID converter and, using the satellite ephemeris data originally stored in the computer, computes the satellite position, the relative azimuth and elevation of the satellite from the aircraft and the corrections needed in the X-band antenna pointing directions. A digital output containing the antenna pointing correction needed is converted into an analog signal and applied to the Lear actuators on the X-band antenna drive. During each computer cycle a burst of parallel-sequential digital output data is sent from the computer to the tape recorder. The format of this output data is changed from one computer cycle (0.2 second) to the next, with the pattern repeating every third computer cycle. Programs and subroutines are also available for off-line use of the computer in computing ephemeris data error checking and trouble-shooting.

**X-Band Transmitter:** The X-band transmitter was a nominal 10 kW klystron amplifier driven by a frequency-stabilized reflex klystron exciter, an ortho-mode mixer which mixes the klystron output with the output of a 60 MHz generator and a traveling-wave-tube driver amplifier. Modulation of the output signal (FM/PM/FSK) was obtained by modulating the 60 MHz mixer input signal. For CW, FM or PM operation, the 60 MHz signal was obtained from a Space-General model PM1000A generator, while for FSK it is obtained from a nominal 60 MHz frequency-shift keyed generator built by the Avionics laboratory. The exciter klystron was a Varian 225A which is operated from a Hewlett-Packard HP-716 power supply and a Hewlett-Packard model DY-2650A frequency synchronizer. The klystron operates at 60 MHz below the output frequency and its output was mixed in the Varian V-8306C hybrid ortho-mode mixer with the output from the 60 MHz generator. A sideband filter selects the upper sideband at 7361.165 or 7362.89 MHz; this is amplified by the Hewlett-Packard 495A TWT amplifier and used to drive the 10 KW klystron. The output power stage is built by Varian Associates, Inc., and incorporates a Varian VA-863 water-cooled klystron, a circulator to prevent reflected power from re-entering the 10 kW klystron, a water-cooled dummy load, and instrumentation for measuring the forward and reflected transmitter power.

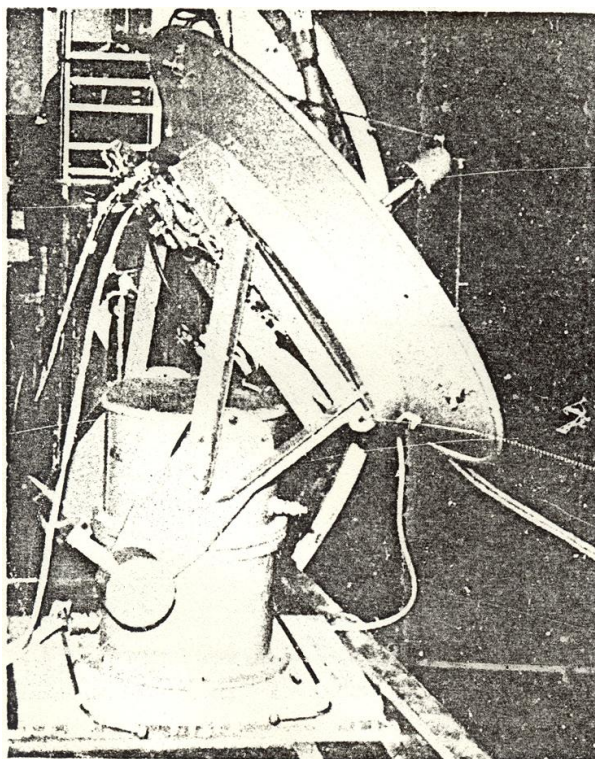
**S-Band Receiving System:** The S-Band system consists of a four-foot parabolic antenna which looks out through a radome mounted in the aft port cargo door. The antenna is adjustable in azimuth, elevation and polarization from a remote control panel. The antenna system and parametric amplifier front end was supplied by the Space-General Corporation. Because of the restrictions imposed by the radome-antenna configuration, azimuth adjustments are limited to about  $\pm 15$  degrees and elevation to about +40 and -5 degrees. The paramp output was connected through a long coaxial cable to a Space-General model RTD 5000B telemetry receiver with a special S-Band tuning head. The receiver is located in the control console at the aircrafts' mid-section. Additional data was obtained from the Space-General receiver by coupling a portion of its 30 MHz I.F. output to the input of a Collins R390 communications receiver. In addition, the 10 MHz I.F. output was fed into an amplitude detector built by The Ohio State University; this provides a DC output which is calibrated and used to determine the received power (signal + noise). The receiver AC and DC video outputs are available for recording the



variations in phase or frequency of the received signals or for recording the video output on audio tape recorders when signals were being received.



**Leap Frog 10 KW X-Band Transmitter Power Amplifier**



**S-Band Receiving Antenna and Paramp near Open Cargo Door**



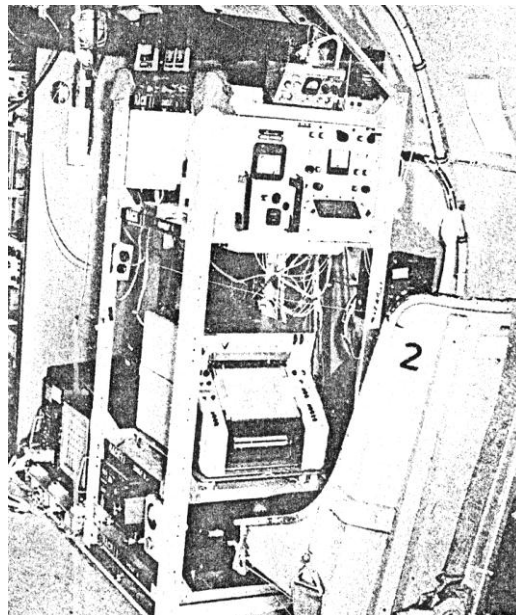
**Results From the Microwave Tests:** The January 1967, Phase III, HAVE LEAP FROG/Syncom III tests were successful in that carrier-only microwave signals were passed both ways between the airborne and ground terminals via the satellite's 5 MHz bandwidth transponder channel. The tests were performed during the winter solstice period, in which the Syncom III transponder characteristics were adversely affected by the sun and are not conducive to small terminal access.

Prior tests (April 1966, Phase II) resulted in a high quality voice and multiplexed teletype link from the aircraft to the ground when using Syncom III's narrowband, 50 KHz channel. Deteriorated performance was also experienced when using the 5 MHz channel during the Phase II tests, but performance was markedly better than during the winter solstice period.

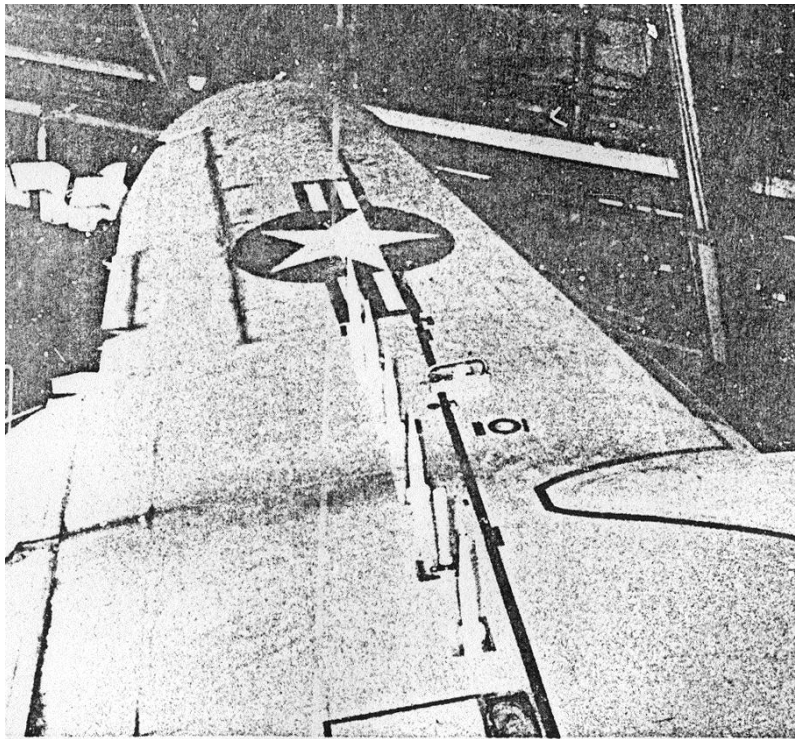
**VHF Airborne Terminal:** The Leap Frog VHF airborne terminal used a 250W power amplifier and a 27 dB gain low-noise pre-amplifier, which could be connected to one of the following four antennas:

<u>Antenna Location</u>	<u>Polarization</u>	<u>dB Gain</u>	<u>Degrees Elevation</u>	<u>Beamwidth</u>		<u>dB Cable Loss</u>
				<u>Az.</u>	<u>El.</u>	
Left fuselage	horizontal	9.5	36	35	24	0.9
Left wing	vertical	12.2	21	21	26	1.7
Right fuselage	horizontal	5.5	60	42	150	0.3
Fuselage top	vertical	3	25	360	60	0.3

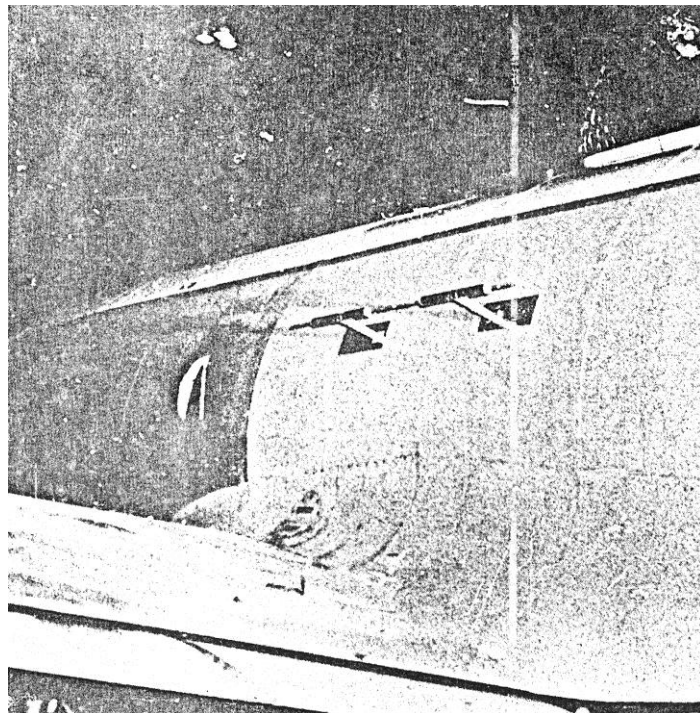
The Kaena Point "Hula" terminal used power amplifiers of either 750 W or 1,000W and a 23 dB gain pre-amplifier. A steerable antenna array having 22 dB gain on receive and 14 dB on transmit with vertical, horizontal and left- and right-circular polarizations was utilized. The ground station at Kaena Point had facilities for monitoring the TM from the satellite and for determining if the 9.745 KHz subcarrier transmitted to the satellite was at a level sufficient to suppress the TM output. An oscilloscope presented a display of the received signals in the 130 to 140 MHz range.



**Leap Frog's Airborne VHF Terminal**



**Leap Frog C-121 Left Wing VHF Antenna Installation**

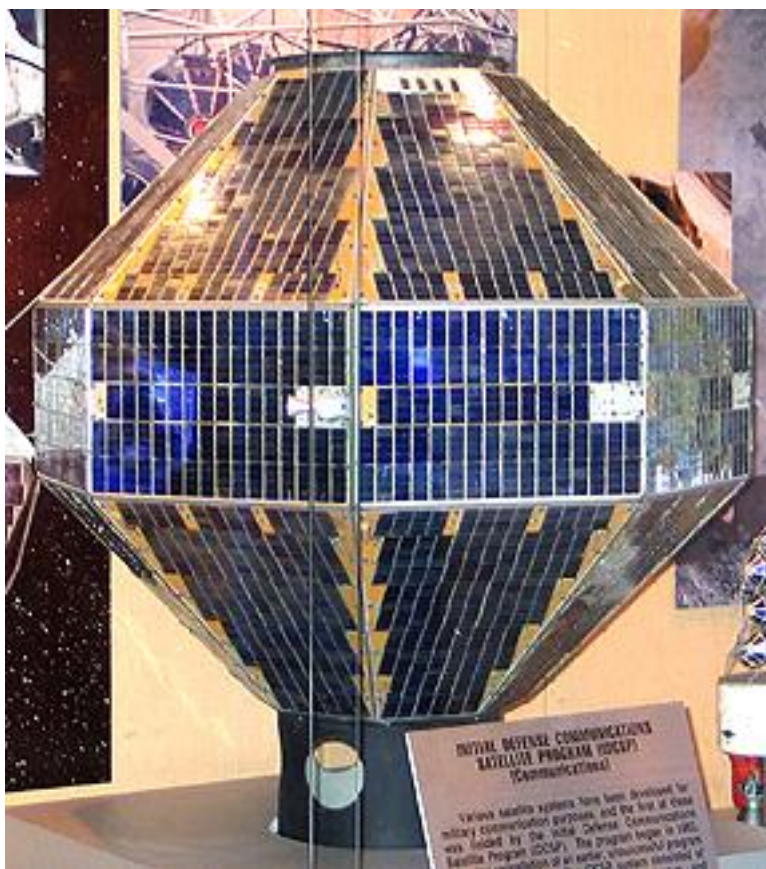


**Leap Frog C-121 Left Fuselage VHF Antenna Installation**

**Results of the VHF Tests:** Although some good copy was obtained at all speeds, it was not possible to demonstrate "conversational teletype" at any speed. The limiting factors were insufficient antenna

gain, unfavorable aircraft flight-path and interference from other equipment. The high-gain, vertically-polarized antenna on the aircraft was not available for transmission because it was located near fuel lines with a consequent risk of fire; this resulted in a loss of 9-12 dB from the original calculated "margin" in the aircraft-to-satellite link. To make best use of the left-vertical and left-horizontal antennas, the aircraft had to fly a north-westerly course, but the actual flight-path was based on requirements for the microwave tests, and avoidance of other traffic, so the useful time available for the VHF tests was limited. Unfortunately, the period of the tests coincided with the launching and stabilization in orbit of the Intelsat II satellite. Since this was a synchronous Pacific Ocean satellite, and was {during stabilization only) transmitting telemetry on exactly the same frequency as Syncom III (136.98 MHz), it interfered strongly with the data being received at Leap Frog. Interference was not noted at Hula, which had a highly directional antenna array. Some interference was caused at Leap Frog by the aircraft's own microwave equipment.

**IDCSP Experiment:** After completion of the air-to-ground communications tests with the Syncom III satellite by the USAF Avionics Laboratory, The Ohio State University Electro-Science Laboratory and others, an initial survey of the use of the Initial Defense Communications Satellite Program (IDCSP) satellites for communication between an aircraft and a ground station was made by the Electro-Science Laboratory. In particular, one satellite of this series, IDCSP-19, the Despun Antenna Test Satellite (or DATS), having an antenna gain for both receiving and transmitting about 8 dB greater than that of the conventional IDCSP satellites, was found to be suitable for air-to-ground communications at X-band using the OSU Satellite Communications facility as the ground terminal. Ground-to-air communications, however, would be marginal because of the limited receiving aperture at the aircraft terminal.



**The Initial Defence Communications Satellite Program Despun Antenna Test Satellite**

The IDCSP satellites were visible for the Ohio area, and used X-band frequencies for both the up-link and the down-link, hence The Ohio State University Electro-Science Laboratory's X-band Satellite Communications Facility was chosen as the cooperating ground terminal for tests with the Avionics Laboratory's C-121 airborne terminal.

In order to use the C-121 aircraft terminal with the DATS satellite it was necessary to change the frequency of the aircraft X-band transmitter slightly and also to replace the aircraft S-band receiver with an appropriate X-band receiver. The front end of the X-band receiver had already been provided for by the planned installation of a TRG parametric amplifier and mixer following the T-R switch on the X-band antenna. The installation of the paramp-mixer on the antenna polarization frame and the integration of it with the other antenna components was performed by TRG Inc. The remainder of the receiver design was suggested by The Electro-Science Laboratory. The design of the X-band local oscillator, as well as the components and receiving equipment necessary to convert the 70 MHz output of the TRG-supplied mixer into signals suitable for detection and recording were specified. Basically, the system made use of a commercial instrumentation-type phase-lock-loop receiver plus auxiliary equipment. However, it was found that the cost and delivery time required for the commercial receiver were prohibitive, and as a result the Electro-Science Laboratory assisted the Avionics Laboratory with the construction of a substitute system using a Collins R-390 receiver already available, plus other system components (IF preamplifier, distribution amplifier, phase-lock detector and local oscillator controller, etc.) supplied or built by the Electro-Science Laboratory.

A brief description of the major components of the test communication system is as follows:

- a. Transmit System -The transmit system consists of a 10 KW power amplifier operating at a frequency of 7.36 to 7.99 GHz. The power amplifier was driven by an exciter which requires a 60 MHz input at 50 to 100 milliwatts to affect a 10 KW output of the power amplifier.
- b. Receive System -The receive system utilizes a tunable, uncooled, 2-stage paramp having a noise temperature of less than 150°K and a gain of 25db. The received X-band signal is converted to 70 MHz, brought down from the antenna, converted to 30 MHz and fed to a Collins R-390 radio receiver. The R-390's 455 KHz IF signal is distributed to a phase-lock FM discriminator for audio recovery.
- c. Antenna System -The X-band antenna is a 26-inch, Cassegrain-feed, parabolic reflector mounted on a modified 8-29 turret gun mount. A general purpose digital computer is used for real time satellite orbital position and antenna look angle computations, and for antenna positioning commands. Inputs to the computer from the aircraft navigation and control equipment are combined with satellite ephemeris data to compute and command antenna pointing angles every 200 milliseconds.

**DATS Test Results:** Tests with the aircraft began in late 1967 with one test being conducted, in which an FM voice signal was successfully sent from the aircraft to the OSU terminal with fair-to-good results. Following this test the aircraft system was dismantled for modifications, and no further tests were conducted until March 1968. At this time during a flight test the aircraft sent a mark-hold teleprinter signal which was received at the OSU terminal for short periods of time. However, troubles with the teleprinter equipment and the aircraft transmitter prevented any further results. Other tests performed during late March and early April resulted in a teleprinter signal being received at OSU. During this period problems were also experienced with the aircraft transmitter and the satellite: The satellite was unusable for a period of about a week or more due to the despun antenna having



locked onto the sun during the equinox period. During this interval the teleprinter equipment was adjusted, and in late April successful teleprinter (TTY) copy and real-time voice communications were transmitted between the aircraft (on the ground at Wright Field) and the OSU terminal. At various times a problem with interfering signals on the satellite was experienced. This caused a decrease in the amount of satellite power which was available for the test signals, and resulted in a deterioration of the operational tests results. DCA was notified of this problem.

Tests over the OSU-to-aircraft direction of the link were first attempted in early April, with negative results. However, by early May successful operation over this direction of the link was obtained. Fairly good teleprinter and voice signals were obtained at the aircraft on 8 May 1968 although the voice reception was reported to be somewhat "muddy".

Two flight tests were successfully conducted in May, during which both voice and TTY messages were sent from the aircraft in flight to the OSU terminal. Operation over the OSU-to-aircraft direction of the link was attempted, but not obtained, primarily because of the problems associated with keeping the antenna pointing system locked onto the satellite and because of the variations experienced in the frequency of the receiver first local oscillator. The former problem is being studied in some detail. The other problem was alleviated by the construction of a phase-locked-loop control for the receiver's first local oscillator. During the second flight test the aircraft was put through several simple maneuvers to determine the tracking capability of the antenna pointing system. These tests indicated a serious lag in the pointing whenever the aircraft was turning or otherwise maneuvering.

The results of this testing indicate that air/ground microwave communications via the DATS satellite was feasible; however, with the airborne equipment used, it is certainly not a reliable link. The aircraft-to-ground link was reasonably reliable and once the link was established, good quality voice and teletype transmissions were possible; however, continuous HF single side band contact with the ground station was required so that the ground station receivers could be tuned to the correct frequency and so the ground station could relay to the aircraft instructions on antenna pointing. The ground-to-aircraft link was not established during flight. A marginal ground-to-aircraft link was established during one test while the aircraft was parked on the ramp and all equipment was tuned to optimum and the antenna peaked to maximum. This resulted in good teletype but very marginal voice transmission. The signal was unstable and had a maximum carrier-to-noise ratio of 5dB. Tests indicated that communications via a satellite of lesser power, or with a smaller ground terminal, would not be feasible.

One of the biggest problem areas was the antenna computer pointing system. Although the antenna pointed correctly and tracked reasonably well through aircraft turns on several flights; there was little confidence that the system would perform properly during the next mission or ground test. Numerous software changes were made to the computer program; but at the end of the project, software as well as hardware problems still existed.

#### **References:**

Gauder, Charles C., **Parametric Analysis of Air/Ground Communications Via Orbiting Dipoles;** Aeronautical Systems Division; Electronic Warfare and Communications Laboratory; ASD-TR-62-579; WPAFB OH; September 1962

Stoner, Richard L., **Leap Frog Syncom;** Flight Test Report ASTDV 66-19; ASD/ASTDV; WPAFB OH; 9 August 1966

Stoner, Richard L., **Leap Frog Syncom**; Flight Test Report ASTDV 67-16; ASD/ASTDV; WPAFB OH; 15 August 1967

Stoner, Richard L., **Leap Frog ATS-1**; Flight Test Report ASTDV 68-18; ASD/ASTDV; WPAFB OH; 6 August 1968

Stoner, Richard L., **Leap Frog DATS**; Flight Test Report ASTDV 69-1; ASD/ASTDV; WPAFB OH; 14 February 1969

Williams, R.A., **Airborne Communications Via the Syncom III Satellite Relay**; Ohio State University, ElectroScience Laboratory; AFAL-TR-68-151; Columbus OH; 18 September 1968

Williams, R.A. L.J. Fruit, W.G. Swarner, **Airborne Communications Via the DATS Satellite Relay**; Ohio State University, ElectroScience Laboratory; AFAL-TR-68-336; Columbus OH; 24 February 1969

## Project Steer – Polar UHF Satellite (1958-1960))

**Background:** In the 1950s, the United States had Strategic Air Command (SAC) B-52 bombers with nuclear weapons flying in the polar region with pre-planned targets in the Soviet Union. The “Positive Control” aspect of the US nuclear policy required that the bombers receive and acknowledge a secret, coded command before they were authorized to use their nuclear weapons. The only communications link available between SAC’s command post and the polar B-52s was High Frequency (HF) radio which bounces off the ionosphere to provide a beyond-line-of-sight link. The ionosphere in the polar region is highly irregular resulting in unreliable HF communications in that region. The bombers were often without communications for hours at a time.

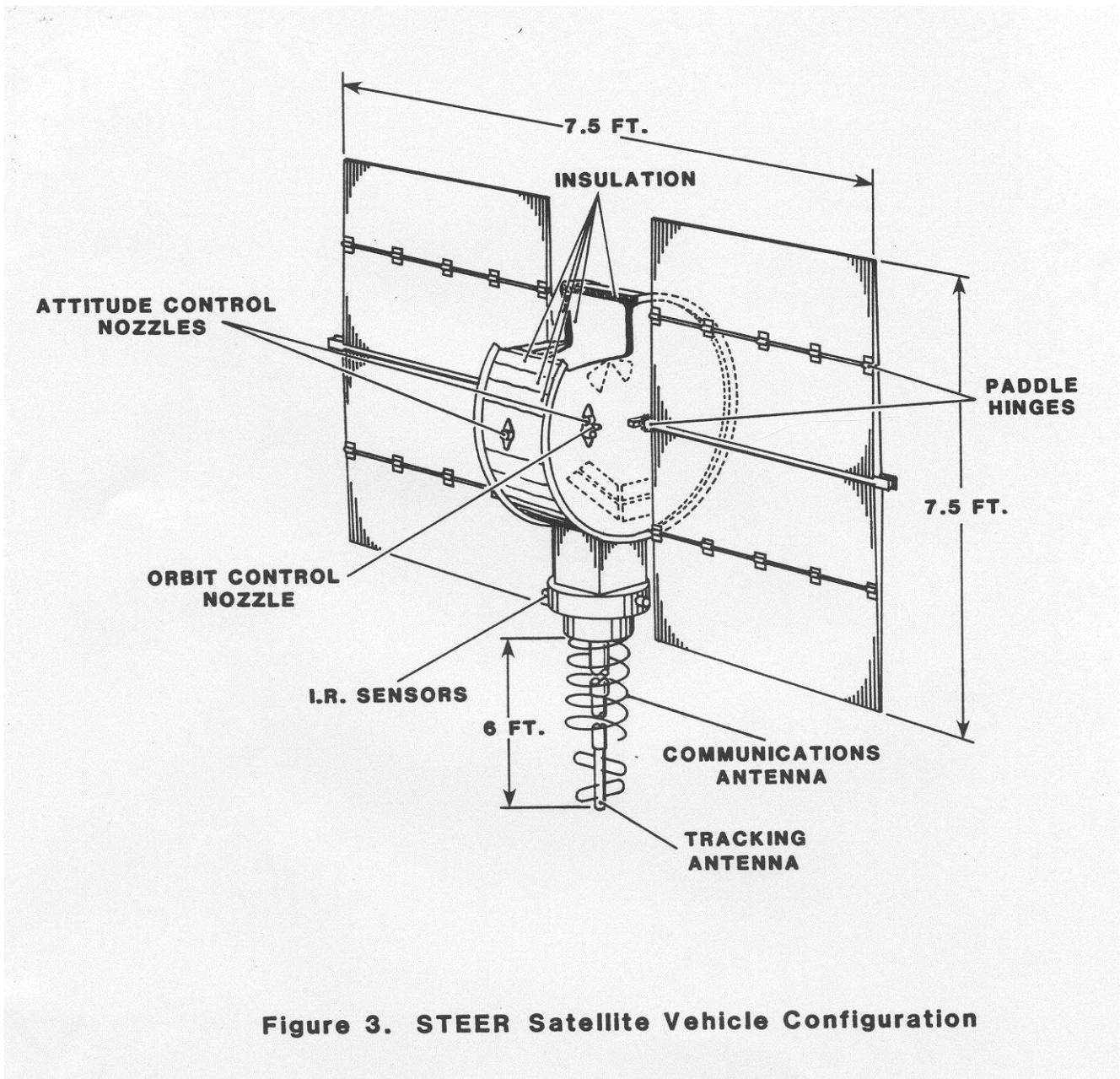
With the launch of the Russian Sputnik satellite in 1957, the Air Force began considering satellite communications to increase the reliability of reaching the bombers in the polar region. General Curtis E. LeMay, the Air Force vice chief of staff and future head of SAC, expressed general interest in the development of a 24-hour communications satellite, but maintained that the six-hour polar-orbit program, STEER, was vital to the effectiveness of Strategic Air Command bombers operating in the polar regions. This, said LeMay, was the major interest of the Air Force in the entire satellite communications program.

The Air Research and Development Command (ARDC) assigned the Wright Air Development Center (predecessor to the Air Force Avionics Laboratory) the development responsibility for both the airborne and ground communications systems and for the satellite communications package. General B.A. Schriever’s Air Force Ballistic Missile Division (AFBMD) assumed responsible for the satellite vehicle and launch capability. In August 1959, AFBMD awarded the Missile and Space Vehicle Division of the General Electric Company the polar portion of the satellite vehicle system.

WADC awarded an \$8.5 million contract with Bendix Radio Division in Ann Arbor MI for the satellite communications package. Since solid-state devices didn’t exist at the time, Bendix designed a 40 Watt UHF transmitter using a rugged vacuum tube developed for taxi-cab radios. They believed this was the only UHF tube that could survive the high vibrations of launch. WADC also let a contract with Magnavox to modify the AN/ARC-34 UHF command radio so it could transmit on one frequency and receive of a different frequency (full duplex). Normally the airborne radio transmits and receives on the same frequency (simplex).

**STEER Development:** The objectives of the Project STEER (Polar Communications Satellite) development were to provide a single channel voice ground-to-air and air-to-ground capability using not more than 40 watts of radiated power from the satellite and employing a frequency in the existing UHF aircraft communication band. The satellite was to have a nominal 5,600 nautical mile altitude circular polar orbit. It would maintain orientation of a nominal 10-db gain antenna toward the earth and approximate orientation of the required array of solar cells toward the sun. The booster would consist of an ATLAS-AGENA “B” combination. The AGENA “B” second stage has single restart and extended burn capabilities. Provision will be made for incorporation of approximately 30-db of anti-jam protection in the final communications system by using the AN/ARC 50 Wide Band radio. The program consists of four launches from the Pacific Missile Range.

**Trajectories and Orbits:** The launch trajectory was selected along a true azimuth of 181.8 degrees from Vandenberg AFB. The ATLAS first stage would fly a programmed gravity turn in pitch, and following ATLAS booster engine separation the General Electric ground-radio system will guide the ATLAS to fuel depletion. Forty seconds after separation from the ATLAS, the AGENA second stage will ignite and accelerate the vehicle into a Hohmann ellipse. An accelerometer in the AGENA will



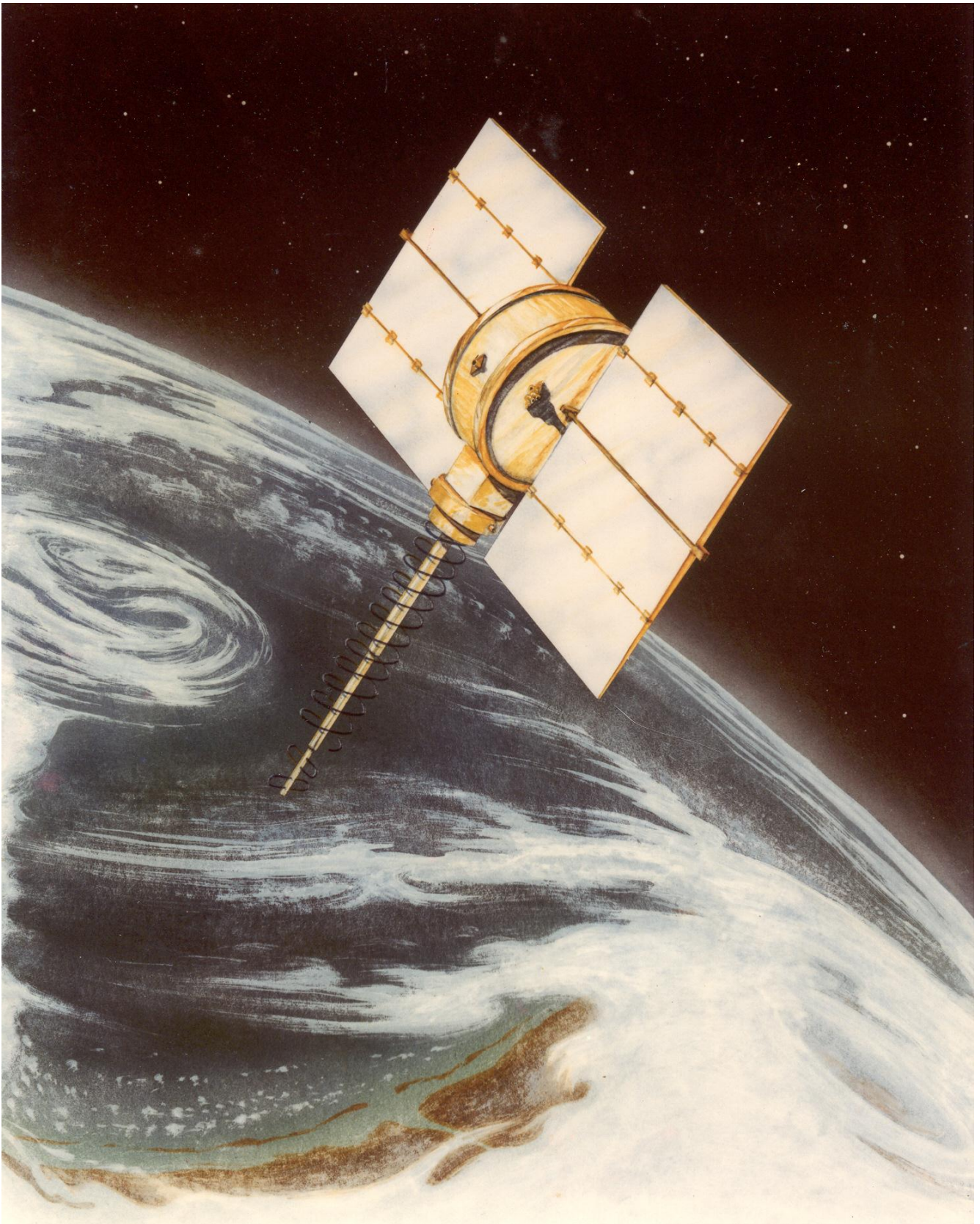
**Figure 3. STEER Satellite Vehicle Configuration**

shut the engine off and the vehicle will coast to the apogee of the Hohmann ellipse. At this point (over South East Africa) the AGENA engine will be reignited by a timer and will burn for a sufficient period to put the vehicle into a 5,600 mile circular polar orbit. Thrust termination will again be commanded by the second stage accelerometer.

Extensive ephemeris studies were performed for various possible polar orbits, including 6-hour elliptical orbits, 8-hour elliptical orbits as well as 6-hour circular orbits. The most promising of the various studies performed were the 6-hour circular and 6-hour elliptical orbits. Since the preparation of a System Specification was needed immediately, it was decided to use the 6-hour circular polar orbit as a standard.

Studies of the 6-hour circular polar orbit show that, with six satellites placed properly in specified orbits, communications with the North Polar Region can be maintained successfully by Offutt Air





**Artist Concept of the Steer Satellite**

Force Base and Westover Air Force Base at all times. Communications between March Air Force Base and the North Polar Region can be maintained throughout all but 89.46 minutes of a 24-hour day. A breakdown of these 89.46 minutes puts the longest concurrent blank period at 10.62 minutes. Guidance errors (within a 3-sigma dispersion) during ascent could cause these time periods to increase to 97.98 minutes and 12.66 minutes respectively, exclusive of any errors inherent in the satellite station-keeping system. Communications between Barksdale Air Force Base and the North Polar region can be maintained for all but 37.20 minutes out of a day with the longest blank period being 3.60 minutes.

Reliability: One of the major efforts in the Project STEER development is in creating an adequate program to insure that the overall reliability requirements will be met. These reliability requirements are as follows:

1. Successful first stage operation – 90%
2. Successful second stage operation – 90%
3. Initial success for final stage vehicle – 98%
4. Mean-useful-life of final stage vehicle – One year.

Communications Equipment: The communications equipment for Project STEER, consists of ground transmitting and receiving stations, satellite repeaters, and aircraft transmitting and receiving stations. This communications subsystem was developed by Bendix Aviation Corp. under the contract with Wright Air Development Division. Consistent with the original concepts of Project STEER, which calls for the Polar Communications Satellite feasibility demonstration, Bendix developed two communications subsystems designated as I-A and I-B equipment. The I-A equipment consists of a demodulator-remodulator system with a phase locked loop containing a phase sensitive detector and a voltage controlled oscillator. This system is designed to produce relatively high quality voice communications in the absence of enemy jamming action. Protection against jamming would be provided by the I-B transceiver equipment which uses the AN/ARC-50 technique to transmit spread-spectrum signals from the ground and from the aircraft to the satellite. This I-B spread-spectrum approach will provide 15 dB of jamming protection for a voice signal. However, in the interest of providing additional jamming protection, alternate communication system approaches have been investigated. One of these alternative approaches replaces the spread-spectrum demodulator in the satellite (the present I-B system) with a linear repeater of approximately 300 kHz band width. Voice transmission in the clear in the absence of jamming is unchanged from the present I-A or I-B approach. However, spread-spectrum equipment would be provided at both aircraft and ground terminals for both transmission and reception of signals in the presence of jamming.

In order to permit a decision between the existing I-B approach and the proposed linear repeater a program of studies and laboratory investigations was initiated by Bendix to demonstrate the performance of a 300 kHz linear repeater in the presence of jamming signals. The performance of the hard limiting feature in the presence of jamming is of particular interest in these investigations.

The following paragraphs describe briefly the proposed linear repeater communication subsystem and some preliminary information concerning use for ground-to-aircraft communication. Each satellite of the 300 kHz repeater system is a single-channel, wideband linear repeater which received one of seven frequencies, translates the received signal to a different frequency and re-radiates it after power amplification to a maximum of 40 watts.

Communications will be on frequencies within the UHF band from 224 to 280 MHz. The relay retransmits the phase modulation of the input signal essentially without distortion. Demodulation and subsequent remodulation of the carrier in the relay are avoided; consequently the ratio of desired signal power to interference power is not significantly degraded between the input and output of the relay. The relay bandwidth of 300 KHz allows use of wideband jam-resistant signals and has been selected as the maximum value consistent with a sufficient signal-to-noise ratio at the relay input. Two-way, push-to-talk voice communications are possible in the clear, and critical data can be transmitted despite some amount of enemy jamming. A hard limiter is inserted into the IF strip to provide a continuous drive for the power amplifier. Sensitivity is set just above the noise level by means of an adjustable threshold capable of being controlled by the command system.

A study of the visibility schedules discloses that up to three satellites may be simultaneously visible to a given ground station and a given aircraft. To prevent the possibility of performance degradation due to multipath propagation, a method of selecting the relays to be used is necessary. This is provided by having adjacent satellites operating at different input frequencies. The ground station is required to use the proper frequency for the satellite desired. To obviate the necessity for the aircraft to periodically change receiver frequencies, all satellites would transmit on the same frequency. Multiple transmission frequencies to the aircraft are not believed to cause an operational problem, since tables which specify the frequencies as a function of time of day can be prepared in advance, and since messages originating from ground stations can specify the correct frequency for reply.

When normal voice communications are used, the voice signal will be frequency modulated on the carrier with a moderate deviation ratio to produce a transmitted bandwidth of approximately 10 KHz. Because of Doppler effects, which can be as high as 3 or 4 KHz on a complete one-way path, the ground or aircraft receiver should have a bandwidth of about 18 KHz. With 40 watts radiated from the satellite, the carrier-to-noise ratio in the aircraft receiver ideally is 17 dB for an 18 KHz bandwidth. This is adequate even for a conventional FM receiver with a limiter and discriminator. However, to increase the margin for system degradation and fading, a phase-lock discriminator will be employed, thereby lowering the threshold by approximately 6 dB, with respect to a conventional discriminator.

For communications in the air-to-ground mode, the signal-to-noise ratio will be set at the relay input, under normal conditions because of the high gain of the ground antenna. In an 18 KHz band, the ratio at the relay input will be 31 dB, assuming a 1-KW transmitter on the aircraft. The input signal-to-noise ratio for the full 300 KHz bandwidth is 19 db, so that the relay transmitter output will have only a negligible noise component and can be reliably triggered by the presence of a signal. Although it would be desirable when the relay is subsequently used for jam-resistant communications, a wider bandwidth is not recommended.

Under conditions of enemy jamming, recourse to an anti-jamming mode of operation is necessary to maintain reliable communications. In the anti-jamming mode, the communications signal occupies the full 300 KHz bandwidth of the relay, and it conveys information at a rate commensurate with the protection achieved against jamming. It is assumed that the information to be transmitted is in digital form, so that either coded commands or digitalized speech (at a slowed-down rate) may be handled.

Results of a detailed study indicating an information rate, in bits per second, which can be reliably transmitted within a bandwidth of 300 KHz in the presence of jamming, is summarized below.

Jammer/Signal Ratio	Information Rate	Rate Type of Service
0 db	10,000 bits/sec	Speech
10 db	1,000	Speech
20 db	100	Teletype
30 db	10	Teletype
40 db	1	Commands
50 db	0.1	Commands

Results of the study indicate that an extremely low transmission rate must be used to combat intense jamming. The operating procedure to be used in the presence of jamming would be essentially as follows:

(a) The station or aircraft originating the communication would attempt voice contact and wait for verification on the return path.

(b) If successful communications do not result, coded digital transmission would be sent at a reduced rate. This procedure would be repeated, reducing the information rate by a factor of 10 at each successive step, obtaining an additional 10 db of protection against jamming, until the existence of communication is indicated in the receiver by presentation of a prearranged code to the operator.

The Bendix effort has consisted of establishing requirements and initiating design. Considerable effort is being expended on reliability studies. A mathematical reliability estimation of Phase I-A Satellite Communication Subsystem, using Space Technology Laboratory approved component failure rates, and the proposed circuitry, results in a minimum probability of 0.90 for successful operation of one year.

Subsystem progress as of January 1960 is described in the following paragraphs:

(1) Satellite Communication - Functions and preliminary circuit designs have been completed. Selection of power amplifier tubes for the final stage vehicle communication transmitter presents a critical reliability problem. Existing tubes do not offer particular promise of meeting life requirements. An investigation has been started to determine the best available tube or tubes. If necessary new tubes will be developed.

(2) Ground Communication - General Bronze will be the contractor for the steerable sixty foot antenna. The reflector structure will be based on the design used by General Bronze on antennas already operating at National Bureau of Standards, Boulder, Colorado. ITT is under contract to furnish the 10 KW power amplifiers. Work is on schedule.

(3) Airborne Communication - Development work on the Phase I-A airborne equipment has progressed through circuit development and testing of breadboard models. Scale-model pattern measurements for the airborne antenna were completed on a pair of crossed half-wave dipoles. Pattern measurements indicated that the antenna has good circularity however, the beam widths between the 3 dB points were 120 degrees where the gain was 0 dB above an isotropic radiator. Gain at 10 degrees above the horizon fell to minus 7 dB and the circularity of polarization deteriorated. Work is continuing. Design of the ARC-34 modification kit is nearly complete. An aircraft installation study has been started.



**STEER Cancelled:** In early 1960 a political decision was made to cancel the Military satellite programs and allow the commercial telephone companies and the National Aero Space Agency to develop and launch the first communications satellites. The Bendix satellite communications package was completed and delivered to WADC along with the modified ARC-34 UHF radio. Those systems were successfully tested in-house by WADC engineers before the project was halted. The Air Force got back into the satellite communications business in 1965 after the commercial satellites were firmly established.

## Project 1227 – Advanced Microwave Communications (1973-90)

**Background:** As the US developed new SATCOM systems, the Russians developed new jamming capabilities to counter the anti-jam features of each new system. Even before the AFSATCOM UHF SATCOM system was deployed, the Russians had the capability of jamming the uplink of that system. Shortly after the US launched the DSCS II SHF SATCOM system, the Russians developed high-power Klystrons and large antennas that could jam that system. In response to the Russians jamming threat, the Department of Defense (DOD) funded a program to develop a satellite communications system in the Extra High Frequency (EHF) band that, with the current technology limitations, could provide reasonable jam protection.

**Advanced Microwave Communications Developments:** In response to DOD's request for development of an EHF SATCOM capability, the MIT Lincoln Laboratory began development of the LES-8 and LES-9 satellites in the early 1970s, Figures 1 and 2. These satellites operated in the 38 GHz band providing earth coverage and spot-beam antennas along with a cross-link capability. They also provided a UHF capability cross-banded to the EHF.

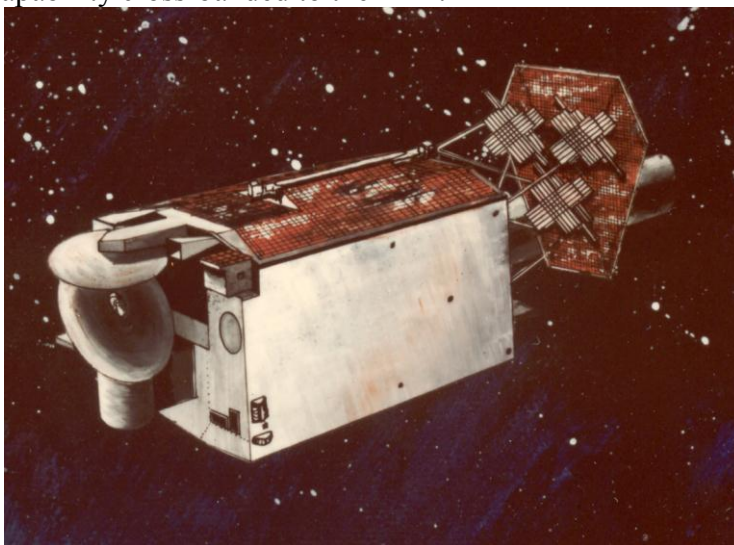


Figure 1 LES-8 Ka-Band Satellite

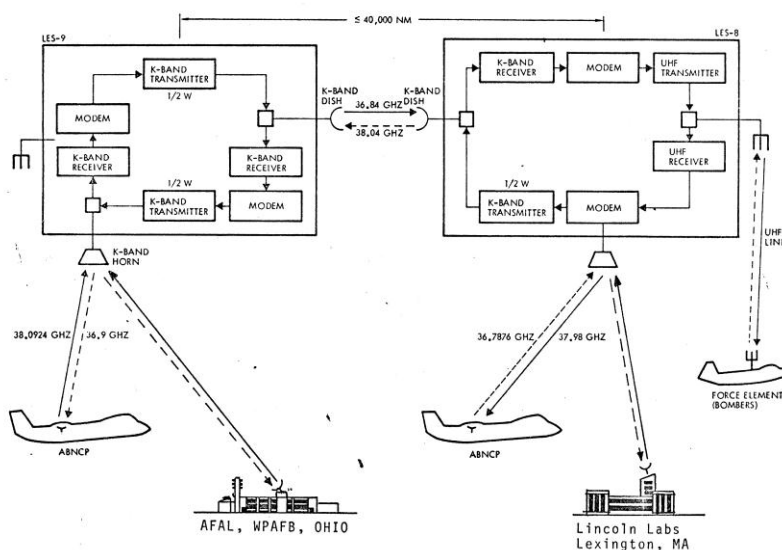


Figure 2 Les-8/9 Satellite System operation

**Ka-Band SATCOM Terminal – AN-ASC-22:** Early in 1973 the Air Force Avionics Laboratory (AFAL) awarded contract F33615-73-C-4036 to Raytheon Company of Wayland, Massachusetts. The purpose of the contract was to build an Advanced Development Model of a Ka-Band Satellite Communication Terminal to operate through the LES 8/9 Satellites.

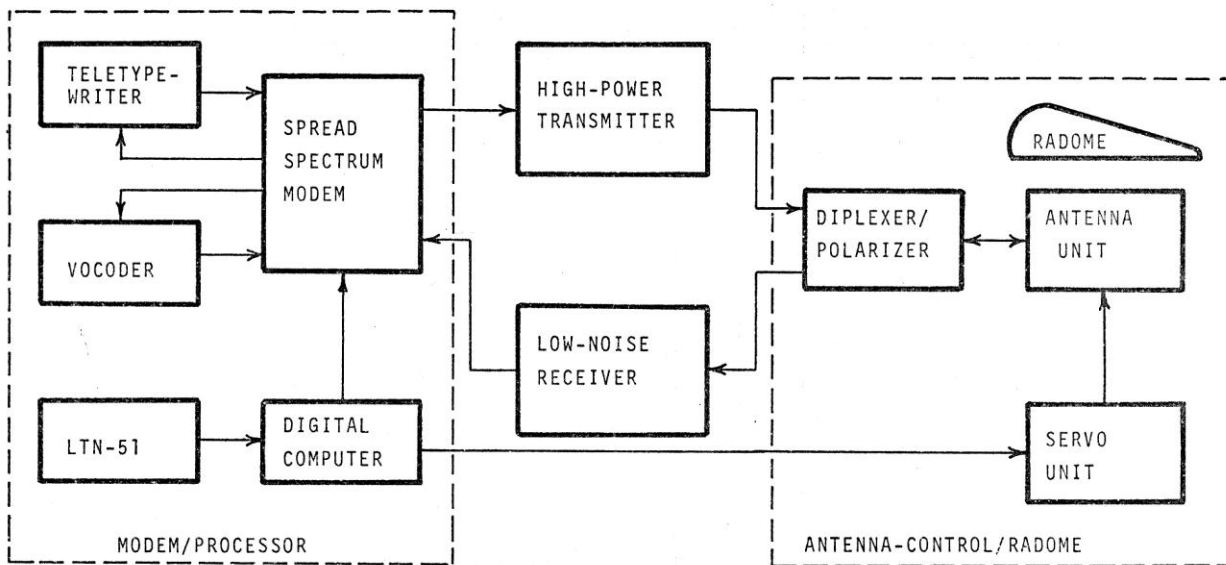
The transmit and receive functions of the airborne communications terminal are performed by four major subsystems, Figure 3, which are integrated into a complete system. These subsystems and responsible Industrial Members are:

Spread Spectrum Modem/Processor - TRW Inc. and Linkabit

High-Power Transmitter - Raytheon Company - Siemens

Low-Noise Receiver - Raytheon Company - AIL

Antenna-Control/Radome - Raytheon Company - Bell Aerospace Corporation

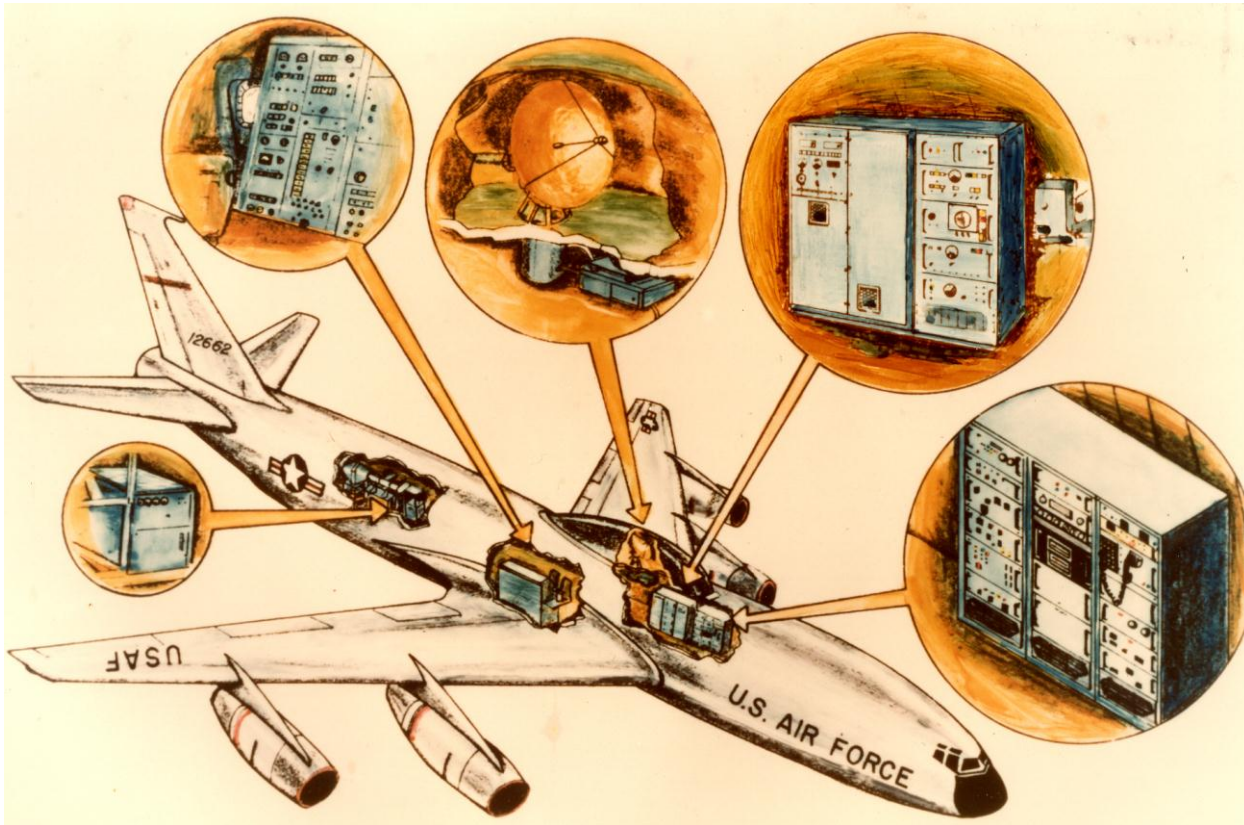


**Figure 3 AN-ASC-22 K-Band SATCOM System**

The communication functions of the transmit portion of the Ka Band Terminal will be described first. The modulator portion of the modem accepts digital data which is generated by either a teletypewriter (TTY) or Vocoder. The modulator reformats the digital data into a spread spectrum frequency-hopped signal which is superimposed onto a 700 MHz carrier. The 700 MHz output signal ( $0 \text{ dBm} \pm 1 \text{ dB}$ ) from the modem is coupled into a two-stage up-converter in the high-power transmitter where the signal is frequency translated to either 36.7876 GHz (LES-8) or 38.0924 GHz (LES-9). After frequency up-conversion, the communication signal is amplified in the two-stage High Power Amplifier (HPA) of the transmitter. The final power amplifier is a Periodic Permanent Magnet (PPM) Traveling Wave Tube (TWT) rated at 1 KW and is adjustable from 0 dBW to 30 dBW continuously. The output signal from the final power amplifier is coupled through a bandpass/bandstop filter and a diplexer/polarizer unit into the antenna waveguide circuitry.

The diplexer/polarizer converts the linearly polarized transmit signal into the proper circular polarization, right hand circular polarization (RHCP) for LES-8 and left hand circular polarization (LHCP) for LES-9. The signal propagates through both circular waveguide and rotary joints to the antenna feed. The Cassegrain antenna radiates the circularly polarized signal through the radome into space toward one of the two satellites.

Associated with the HPA, a ram-air cooling unit is provided to dissipate the heat load generated by the TWT by using a liquid-to-air heat exchanger. A motor-driven blower is used to supply the air flow for ground operation of the transmitter.



**Figure 4 AN-ASC-22 Ka-Band SATCOM System Location in Test Aircraft**

The Ka Band Terminal receives a circularly polarized DPSK Modulated Ka Band Signal radiated by either LES-9 (36.84 GHz or 36.90 GHz (both RHCP) or LES-8 (37.98 GHz or 38.04 GHz (both LHCP)). After being propagated through both space and radome, this signal is received by the antenna. From the antenna, the signal is coupled into the polarizer/diplexer unit where the signal is converted from circular to linear polarization. The signal is coupled through a bandpass/bandstop filter into the Low Noise Amplifier (LNA) of the low-noise receiver. The LNA is an uncooled parametric unit having a gain of 18 dB and a noise figure of 3.8 dB. The Ka Band DPSK signal is then coupled into a three-stage down-converter where the signal is frequency translated to a final IF (intermediate frequency) of 5 MHz. The second and third stages of down-conversion are integrated into a phase-lock/autotrack receiver. The 5 MHz DPSK signal is fed into a coherent phase demodulator where the signal is demodulated into digital data.

The digital data is coupled into the demodulator portion of the Spread Spectrum Modem/Processor where the digital data is processed and fed to the TTY or vocoder. The Ka Band Receiver is designed



to operate at data rates of 0.2, 10, 20, 100 and 200 KB/s. Additional IF Outputs of 700 MHz and 70 MHz are provided in the receiver.

Both the transmit and receive signals of the communications terminal are center frequency Doppler compensated over a range of  $\pm 100$  KHz within an accuracy of  $\pm 20$  Hz. Doppler compensation is accomplished by either an active or passive mode of operation. The active Doppler compensation is derived from the Doppler uncertainty superimposed on the received down-link carrier. The Doppler uncertainty is removed from the carrier by the phase-lock/autotrack receiver and applied to the local oscillators of the second and third down-converters to Doppler compensate the receive communication signal. The Doppler uncertainty is reversed in sign, multiplied by a constant equivalent to the frequency offset between transmit and receive signals and applied to the first up-converter in the transmitter to Doppler pre-compensate the transmit communication signal.

The passive Doppler compensations are derived by a digital computer in the modem/processor and applied to the transmitter and receiver in a similar manner to the active Doppler compensations. The inputs to the digital computer are described in the paragraph on antenna pointing.

One of the many critical design considerations of the airborne terminal was frequency stability. Based upon this consideration, most of the frequency sources within the terminal are stabilized by one of several reference frequencies provided by an improved Model HP5065A Rubidium Frequency Standard. The terminal has a long-term frequency stability of  $\pm 1 \times 10^{-10}$ /year and a short-term frequency stability of  $2.5 \times 10^{-10}$  RMS averaged during 5 MS.

The antenna-control subsystem consists of an antenna located on a two axis (elevation over azimuth) mount and a servo control unit. The antenna is a 36 inch parabolic main reflector with a Cassegrain feed and capable of handling 1.5KW of CW power. The sub-reflector is adjusted to a squint angle equivalent to a crossover loss of 0.5dB maximum. The antenna can transmit and receive both left and right hand circular polarizations and the polarization modes of operation are selectable based upon a given satellite.

The function of the servo control unit is to acquire and maintain the antenna pointed toward a given satellite of operation independent of the aircraft attitude. The antenna pointing data is derived by one of two means. For the active mode of pointing, the antenna sub-reflector is nutated at a 65 Hz rate. The nutation generates an amplitude modulated (AM) control signal which is superimposed on the DPSK communication signal. The phase-lock/autotrack receiver removes the AM control signal from the communication signal and sends this control signal to the servo control unit to be processed into the necessary elevation and azimuth control signals to maintain the antenna pointed at a given satellite. Initially, the antenna-control unit acquires the satellite by performing a signal acquisition with a conical scan technique. The command signals for the passive mode of antenna pointing are derived from the digital computer in the modem/processor based on stored satellite orbit ephemeris and aircraft navigational information provided by an LTN-51 Inertial Navigation System.

As part of the antenna subsystem, a dry-air pressurization unit is provided for the removal of any moisture in the waveguide components connecting the antenna, transmitter, and receiver. The dry air pressurization reduces the probability of arcing in the waveguide circuitry.

Associated with the airborne operation of the 36 inch antenna, an "A" sandwich radome was designed for the 36-40 GHz frequency band. The outer and inner skins of the radome are 0.082 inch and the

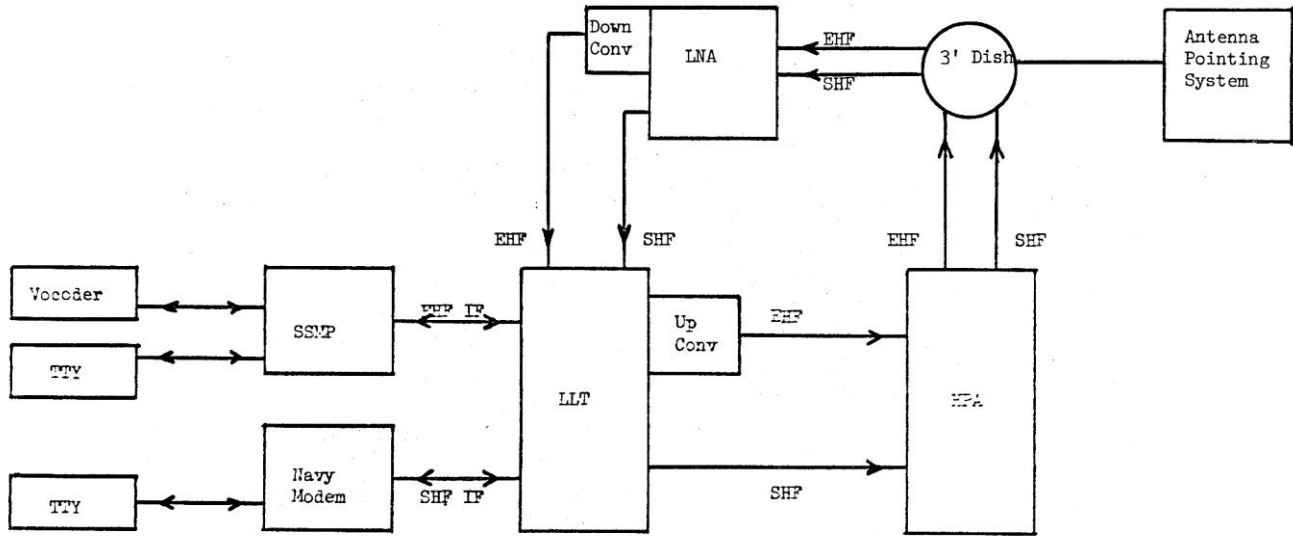
honeycomb core is 0.380 inch. The aerodynamic shape of this radome is based upon a successfully proven design for C-135 aircraft at X-Band.

**Dual Frequency SATCOM Terminal – AN/ASC-28:** The World Wide Military Command and Control System (WWMCCS) architecture plan recognizes satellite communications as one of the prime command and control communications systems between the National Command Authority and the Nuclear Capable Forces. Satellite communications offer the possibility of secure, jam-resistant communications for the dissemination of Emergency Action Messages and for force direction/reportback communications. To satisfy this requirement the Strategic Satellite System (SSS) was proposed. One of the first steps in the evolution of this system was the equipping of the Defense Satellite Communication System Phase III (DSCS III) with a processing communication package called the Single Channel Transponder (SCT). The Single Channel Transponder on DSCS III demodulates an SHF uplink signal from a command post and remodulates a UHF downlink to the force element terminals. More advanced stage of the SSS was proposed to be the STRATSAT with an EHF uplink and SHF/UHF downlinks.

The AFAL completed the advanced development of the ASC-18 SHF SATCOM terminal in 1972. That terminal was flight tested in the 1972/1975 period-on a C135 aircraft. Following the demonstration of the terminal feasibility, the SHF SATCOM terminal was transitioned into the E-4 National Advanced Operations Center by the Electronics System Division (ESD) and renamed as an ASC-24. The ASC-24 provides 10 kilowatts of SHF power to a 32 dB gain parabolic dish antenna. In 1976, AFAL completed the development of the ASC-22 Ka-Band terminal. Based on the requirement for the airborne command post to operate with both SHF and EHF satellites, in 1978 AFAL began development of a dual-frequency SATCOM terminal, the AN/ASC-28.

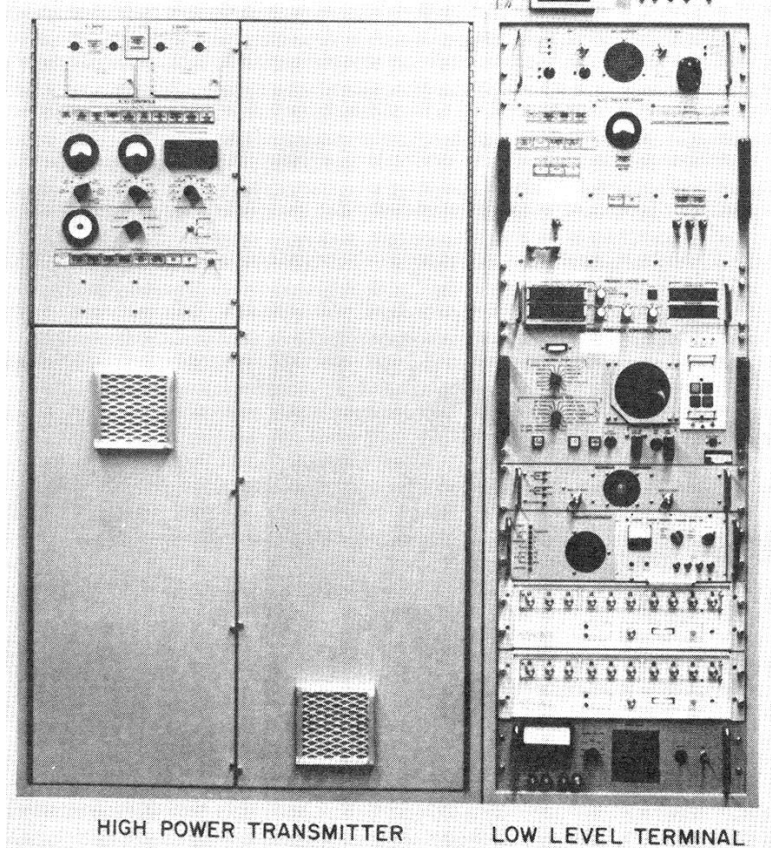
The Dual Frequency Satellite Communications System, AN/ASC-28, is an airborne system designed to operate at 7-8 GHz and 36-40 GHz. This system provides reliable, anti-jam communications using the LES 8/9 and DSCS II satellites. The system consists of the following major elements: (Figure 5)

- Dual Frequency SATCOM Terminal RF System
- Spread Spectrum Modem/Processor
- Navy SHF Modem
- Antenna System
- Remote Controls
- Cooling System



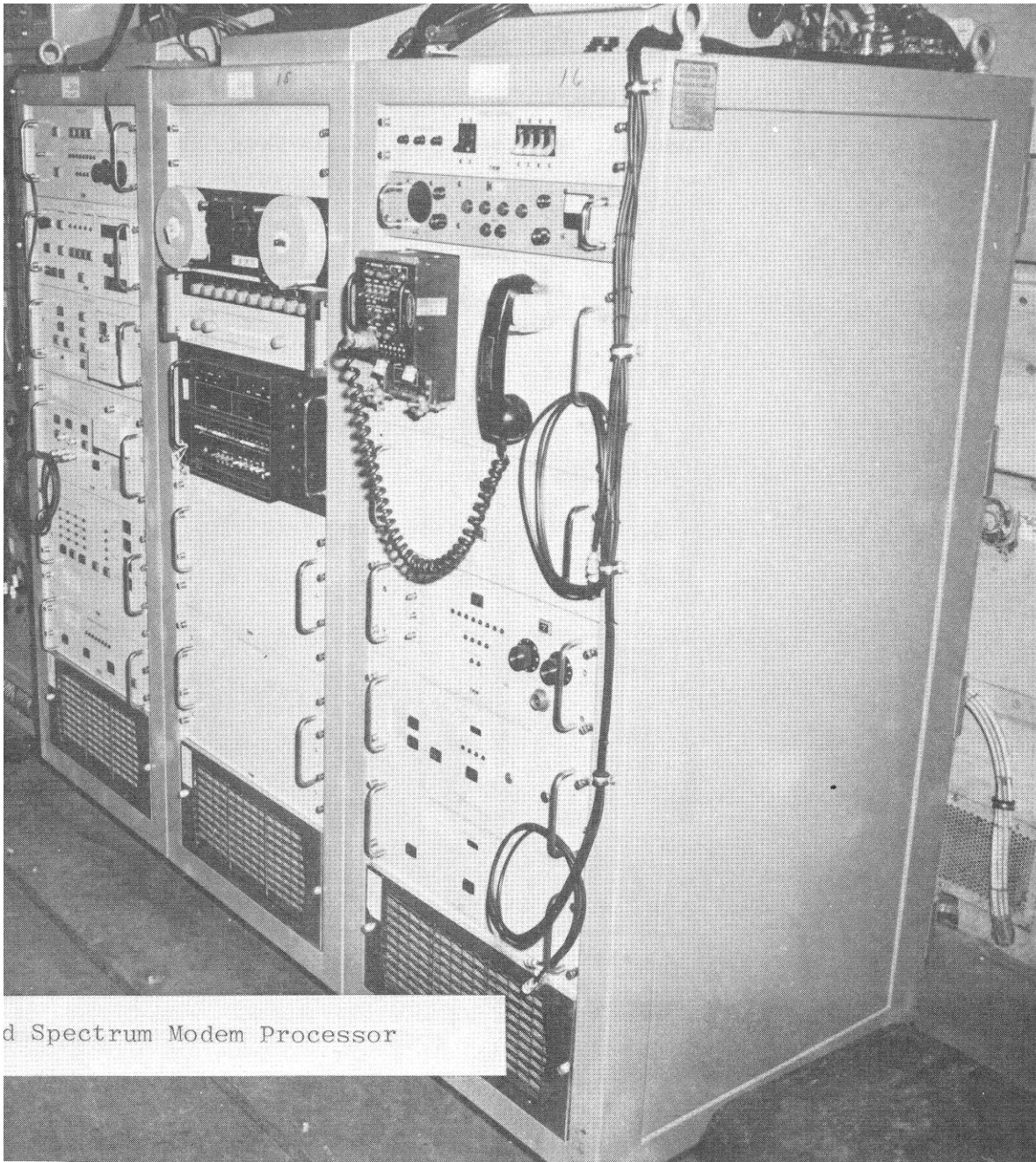
**Figure 5 AN/ASC-28 Dual Frequency SATCOM System**

The Dual Frequency SATCOM Terminal RF System (Figure 6) consists of a Low Level Terminal (LLT) and High Power Amplifier (HPA). The LLT accepts an intermediate frequency (70 or 700 MHz) signal from the modem, upconverts to the selected RF frequency, and provides low-level drive to the HPA. The HPA has two stages of traveling wave tube (TWT) amplification and provides up to 14 KW at SHF and 1 KW at Ka-Band of power to the antenna for transmission.



**Figure 6 AN/ASC-28 RF Terminal**

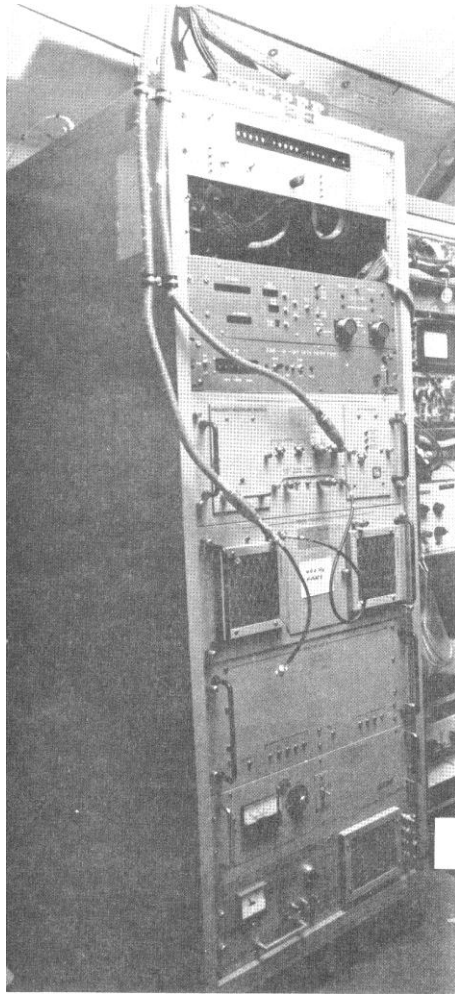
Because of the different modulation techniques used in the LES 8/9 and the DSCS III satellites, different modems were used for the two frequency bands. The Spread Spectrum Modem/Processor (SSMP) interfaces with the LLT for EHF operation. The SSMP (Figure 7) accepts data from the input/output (I/O) devices, provides proper modulation and delivers the IF signal to the LLT.



**Figure 7 Spread Spectrum Modem Processor**

At SHF frequencies, the Navy modem (WSC-7) shown in Figure 8 is used to interface the I/O devices and the LLT.



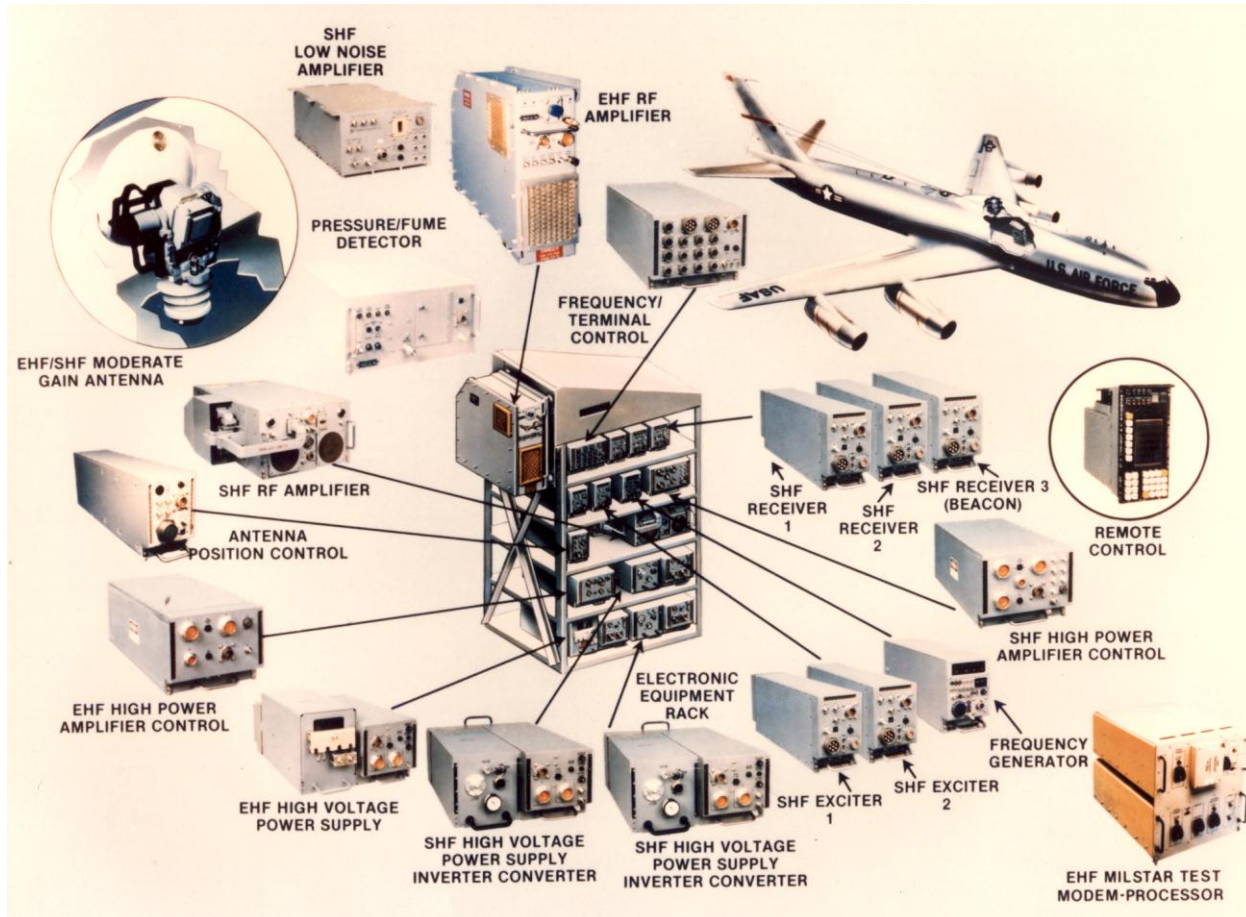


**Figure 8 Navy WSC-7 Modem**



**Figure 9 Dual Frequency Antenna**

The antenna system consists of a 36-inch steerable parabolic dish (Figure 9) capable of transmitting and receiving SHF and EHF, a 24 foot aerodynamic radome, and a Low Noise Amplifier (LNA) used to amplify and down-convert the received signal. From the LNA, the received signal is fed to the LLT for down-conversion to the IF, and then to the appropriate modem for demodulation. A view of the AN/ASC-28 hardware is shown in Figure 10.



**Figure 10 Dual Frequency Airborne SATCOM Terminal – AN/ASC-28**

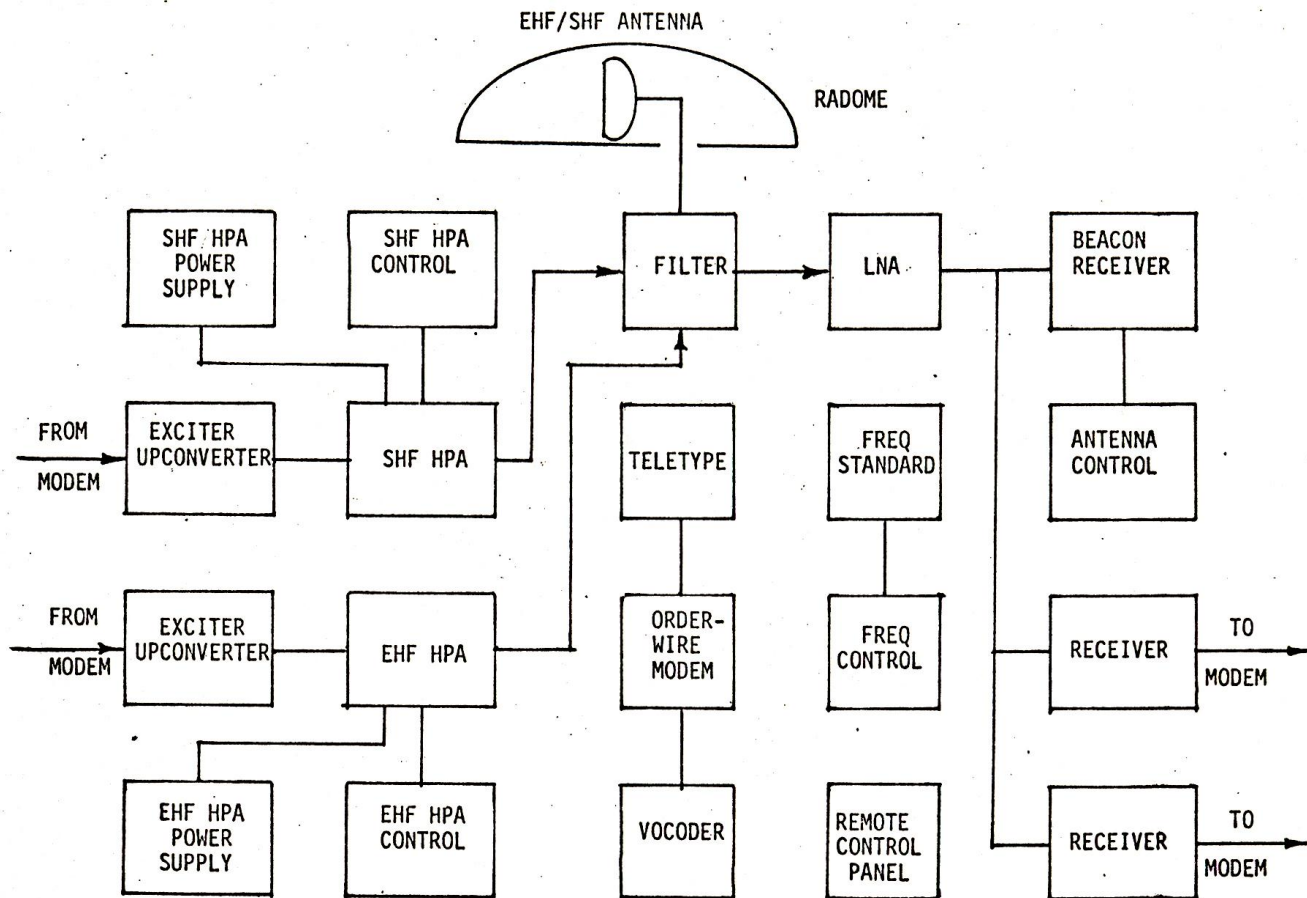
**AN/ASC-30 Small EHF/SHF Airborne SATCOM Terminal:** Because of the severe space and weight limitation on the smaller EC-135 (Boeing 707) and E-6 type airborne command post, the ASC-22, ASC-24 and ASC-28 size terminals were not candidates for installation. In addition, the EHF operating frequency for future satellites moved to the 43-45 GHz band instead of Ka-band. Therefore AFAL undertook development of the small EHF/SHF airborne SATCOM system, AN/ASC-30 with the Raytheon Company in Sudbury MA in 1978.

This terminal had the following characteristics:

- \*Air cooled transmitter
- \*Parabolic dish antenna
- \*Frequency of operation: SHF Rec 7.25- 7.75 GHz; SHF Transmit 7.9- 8.4 GHz; EHF Transmit 43- 45 GHz
- \*Intermediate frequency 70 and 700 MHz
- \*Uncoded parametric amplifier

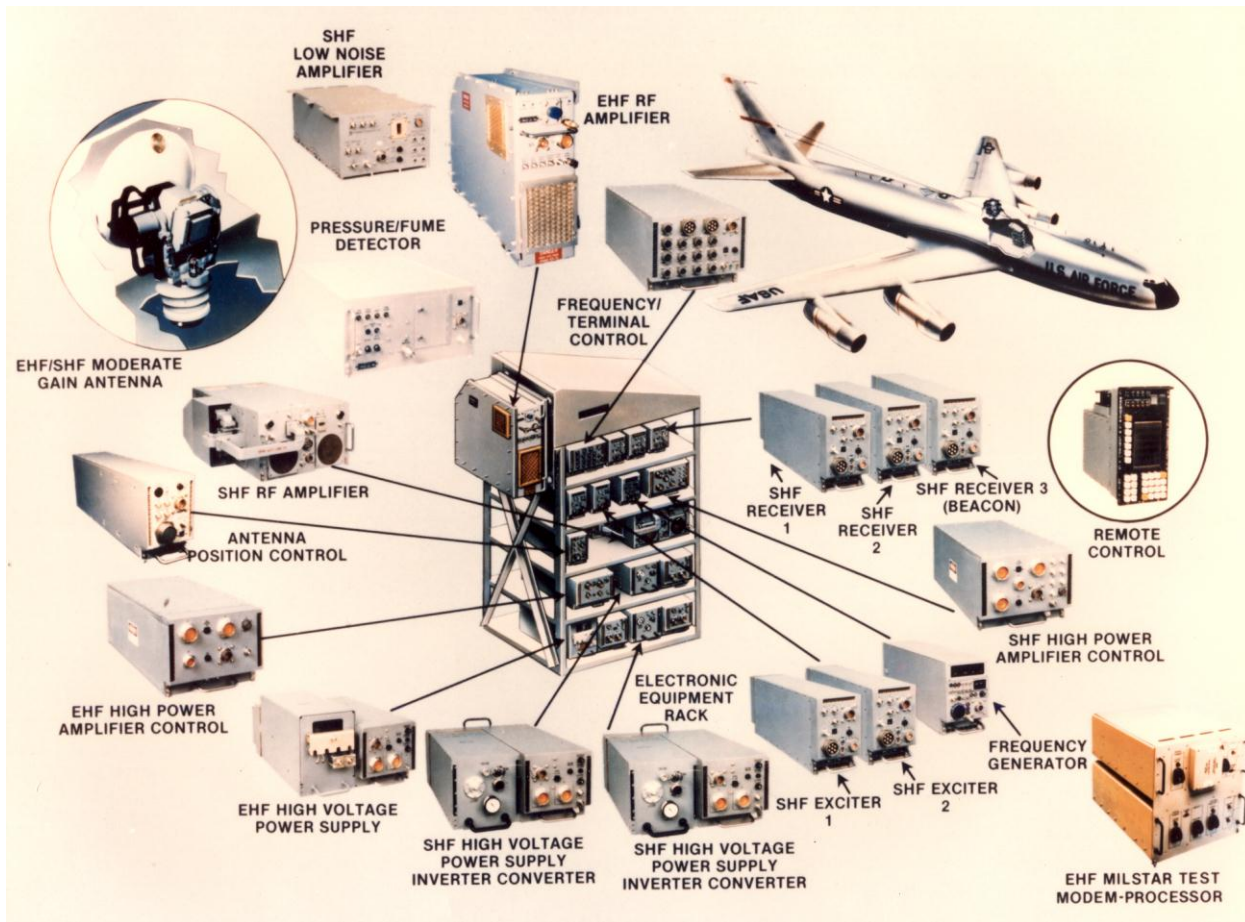
- \*Rubidium frequency standard
- \*Active or computer antenna tracking
- \*Primary modem - Command Post Modem/Processor (CPM/P)
- \*Two independent transmit and receive channels
- \*Digital control/display which interfaces with CPM/P
- \*Prime power 8 kilowatts at 400 Hz
- \*Reliability 500 hours MTBF
- \*Maintainability 30-minute MTTR for 90% of faults
- \*Weight 1200 pounds
- \*Volume 18 cubic feet
- \*Packaging in separate ATR line replaceable units

The Small EHF/SHF Airborne SATCOM Terminal is designed to interface with the Command Post Modem/Processor (CPM/P) being procured from the Linkabit Corp. of Sin Diego, CA. With the CPM/P the terminal will be capable of handling 75 bps teletype, 2400 bps vocoded voice or multiplex data streams. A block diagram of the system is shown in Figure 11 and a view of the hardware in Figure 12.



**Figure 11 AN-ASC-30 Block Diagram**





**Figure 12 AN/ASC-30 Hardware**

The upconverter will accept a 70 MHz IF signal from the modem and frequency translates it to the EHF band, 43 to 45 GHz, or the SHF band, 7.9 to 8.4 GHz. The upconverter can also accept a 700 MHz IF from other modems. It will provide an output level of approximately 0 dBm to the HPA. The upconverter can be frequency hopped over a wide bandwidth if provided a digital frequency command from a modem such as the Command Post Modem/Processor.

The high power-amplifier will accept the 0 dBm input level and amplify the signal. The EHF HPA utilizes a PPM focused travelling wave tube rated at approximately 125 watts air-cooled. The SHF HPA will utilize two 750 watt PPM focused travelling wave tubes connected through a combiner to provide the output power. The output power of both HPAs is controlled from 1 Watt to their maximum output.

The antenna acquisition of the satellite may be accomplished by manually pointing the antenna and initiating a spiral scan which allows the acquisition and track receiver to lock to the satellite downlink energy. An alternate method is to use a computer pointing system provided by the Command Post Modem/Processor which automatically points the antenna towards the satellite. After initial acquisition, tracking may be via the active tracking system utilizing the downlink energy from the satellite or the passive pointing system utilizing the Command Post Modem/Processor computer pointing. In the active tracking mode the beacon receiver locks to the downlink beacon from the satellite. The system is designed to acquire the beacon with a C/No of 34 dB or less within 60 seconds. Doppler errors of up to 100 KHz can be corrected using the beacon autotrack receiver.



The moderate gain antenna system developed consisted of a mechanically steered parabolic antenna with Cassegrain feed. A rate gyro system on the antenna provides the inertial stabilization necessary to maintain pointing during aircraft maneuvers. Tracking update occurs from the beacon autotrack system or the computer pointing system. The antenna was designed to have low side lobes and at least 20 dB isolation between transmit and receive ports for full duplex operation. The system can be operated in an SHF transmit/SHF receive mode or in EHF transmit/SHF receiver mode. The antenna will handle up to 3 kilowatts of CW power at SHF and up to 500 watts CW power at EHF. It is designed to operate from -15° elevation relative to the aircraft platform, up to the zenith. It is designed to continue to track during aircraft accelerations of up to 2 Gs. The antenna was mounted on top of the aircraft and covered by a fiberglass radome. The radome is approximately 31 inches high, 150 inches long and 30 inches wide. The radome is expected to increase the drag of the aircraft no more than 1% during normal operating configurations. The antenna pedestal protrudes inside the aircraft approximately 12 inches below the ceiling.

The uncooled SHF Low Noise Amplifier has a bandwidth of 500 MHz and gain of approximately 40 dB. The LNA will be located on the roof of the aircraft near the antenna pedestal to minimize the loss.

The SHF downconverter will frequency translate the SHF signal from the LNA down to a 70 or 700 MHz IF signal. The downconverter is designed to handle a signal in the 500 MHz band. The downconverter can be frequency hopped utilizing a digital control word from the modem. Various gains are available through the downconverter, depending upon the modem to be utilized.

The terminal contains a rubidium frequency standard with a long term stability of  $2 \times 10^{-11}$  per month. The frequency standard will output various frequency references including 5 MHz, 1 MHz, 100 KHz, 1 pulse per second and IRIG-B time-of-day code.

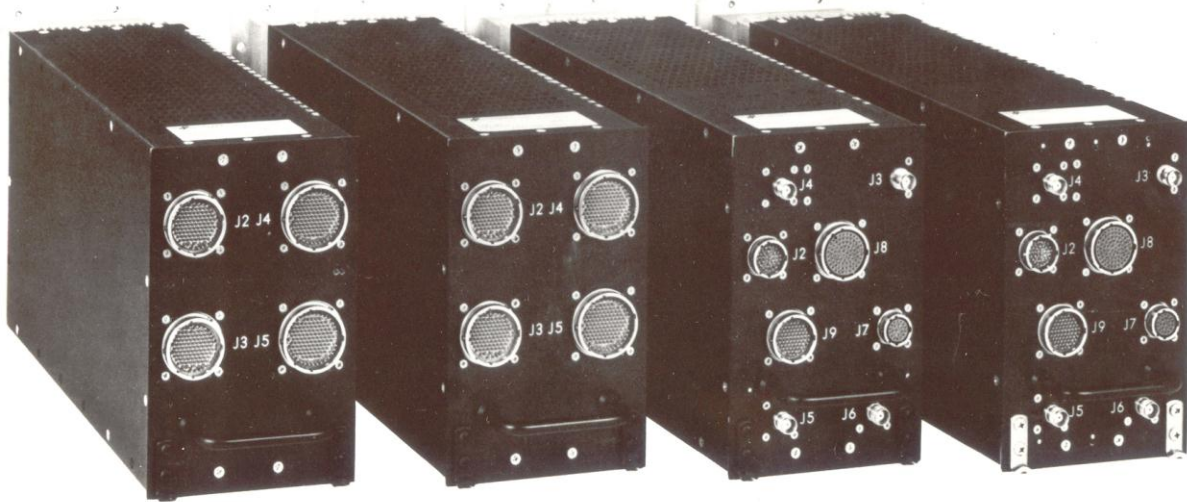
The frequency control unit consists of a microprocessor which controls the transmit frequency, receive frequency, frequency offset, Doppler correction and frequency hopping/dehopping information.

Through the remote control unit various Doppler modes, such as active Doppler, computer Doppler and atomic standard, may be selected. Likewise frequency hopping commands where the modem provides the bandsread or the terminal provides the bandsreading may be selected. Frequency correction for the satellite clock error can be inserted as an offset for system operation.

The remote control panel will provide the controls and indicator for controlling the small EHF/SHF airborne SATCOM terminal. It will also provide for the built-in-test/fault monitoring capability. The panel is being designed to minimize the number of switches and thumb wheel controls. A processor will be utilized in the remote control unit to ease operator procedures in such functions as terminal turn on, antenna pointing and systems start up. The control was designed as an exception type panel. Rather than displaying the status of all possible systems, the control panel will provide either a go status indication or an indication of what fault or actions may be required to get to the go status. All controls in the control panel utilize the digital interface so the entire operation of the remote control panel can be accomplished through the Command Post Modem/Processor. In that configuration the small EHF/SHF remote control panel is strictly a backup in case of failure to the Command Post Modem/Processor plasma display/control.

**Command Post Modem Processor:** AFAL developed the Command Post Modem/Processor (CPM/P) through Contract Number F33615-77-C-1269 awarded to the Linkabit Corporation of San Diego, California. Linkabit build one Laboratory Model and two Advanced Development Models

(ADMs) of the CPM/P, Figure 13. The Laboratory Model was used to establish the feasibility of the CPM/P design and for testing. Following the demonstration of feasibility through the development of the Laboratory Model, two CPM/P ADMs were built. The ADMs were put through a series of factory tests and delivered to AFAL for flight testing.



**Figure 13 Command Post Modem Processor ADM Hardware**

The modems and processors constitute the primary communications and control elements of the CPM/P. In this microprocessor based design, each of these line replaceable units (LRU's) contains two microprocessors which share message handling, command and control, ranging and pointing, and signal processing functions. The three LRU's have common subassemblies except for the I/O and the modem signal processing front end.

The two full duplex modems were identical; either could perform all of the communications processing for AFSAT I and AFSAT II SCT signalling formats. AFSAT I provides 75 bps communications using binary FSK modulation. Each modem could transmit one AFSAT I signal while receiving up to nine regenerative downlink signals simultaneously. Alternately, a modem could receive six regenerative downlinks and one non-regenerative downlink simultaneously. Each modem provides for Doppler correction in addition to full preamble and postamble processing. The AFSAT I modes include random signalling and the TDM-1 and TDM-2 timed modes.

The AFSAT II SCT signalling format provides a 75 bps MFSK communications link which is encoded, interleaved and frequency hopped. The modems operate full duplex in this mode as well.

The modem functions are digitally implemented using the LINKABIT microprocessor (LMP) to perform most of the functions within the modems including modulation, AGC, frequency calculation, bit timing and related functions. The various modulation schemes are controlled by accessing different areas of the program memory. Thus, expansion to include additional modulation schemes and signal structures can be accomplished by a change to the firmware.

The red and black processors provide terminal control, networking, satellite control, message handling, ranging and pointing and communications control functions. A variety of network control functions are

performed including TDM-I and TDM-2 protocols, satellite selection, status message handling, terminal configuration, and network membership selection. Satellite control functions include satellite mode control and frequency plan selection. Message control and processing functions include compose and edit, message priority ordering, and message logging. The red and black processors are also based on the LMP providing flexibility in system implementation.

**Transition and Production:** The EHF technology from over a dozen years of AFAL's development and flight testing was transitioned to the Electronic Systems Division at Hanscom AFB MA and used in the Engineering Development and production of the AN/ARC-208 Milstar Airborne SATCOM Terminal. Two production contracts was awarded to Raytheon Company and Rockwell International in 1993 for 44 Low Data Rate (LDR) terminals and upgraded to include the Medium Data Rate (MDR) capabilities in 1999. These terminals were installed in the Navy's E-6 Airborne Communications relay and strategic airborne command post aircraft to provide survivable, reliable, and endurable airborne command, control, and communications between the National Command Authority (NCA) and U.S. strategic and non-strategic forces. The E-6B was conceived as a replacement for the Air Force's Airborne Command Post due to the age of the EC-135 fleet.

#### **References:**

Dunham, P.; **Summary of Design Changes Ka Band Satellite Comm Set AN/ASC-22**; Raytheon Company; Sudbury MA; Report ER 77-4278; November 1977

Dunham, P., C.K.H. Tsao, R.N. Jackson; **Small EHF/SHF Airborne SATCOM Terminal (AN/ASC-30)**; Raytheon Company; Sudbury MA; AFWAL-TR-81-1258; January 1982.

Foshee, James J.; **Command Post Modem/Processor**; Air Force Avionics Laboratory; WPAFB OH; AFAL/AAD Memo for Record; 10 July 1978

Jacobs, Irwin; **Command Post Modem/Processor**; Linkabit Corp; San Diego CA; Product Brochure; April 1981.

Johnson, Allen L. and Thomas E. Joyner; **Small EHF/SHF Airborne SATCOM Terminal**; Air Force Avionics Laboratory; International Telemetry Conference; San Diego CA; 15 October 1980.

Joyner, Thomas E.; **Ka-Band Satellite Communications Terminal First Interim Report**; Air Force Avionics Laboratory; WPAFB OH; AFAL-TM-74-2; 21 January 1974.

Joyner, Thomas E.; **Airborne Ka-Band Satellite Communications Terminal Development**; Air Force Avionics Laboratory; National Aerospace Electronics Conference; Dayton OH; May 1974.

Joyner, Thomas E.; **AN/ASC-30 EHF/SHF Command Post SATCOM Terminal**; Air Force Avionics Laboratory; National Aerospace Electronics Conference; Dayton OH; May 1981.

Miller, Capt James G.; **SURVSATCOM (Ka-Band) Flight Test Report**; 4950<sup>th</sup> Test Wing; WPAFB OH; FTR-FFA-77-31; 20 January 1978.

Perdue, E.M., R. Pettai, E. Warder, V. Norden, B. Kurth, C.K.H. Tsao; **Dual Frequency SATCOM Low Level Terminal**; Raytheon Company; Sudbury MA; AFAL-TR-78-20; December 1978.

Wright, Lt Ralph N.; **Dual Frequency Satellite Communications System**; 4950<sup>th</sup> Test Wing;  
WPAFB OH; 4950-FTR-81-18; September 1981.



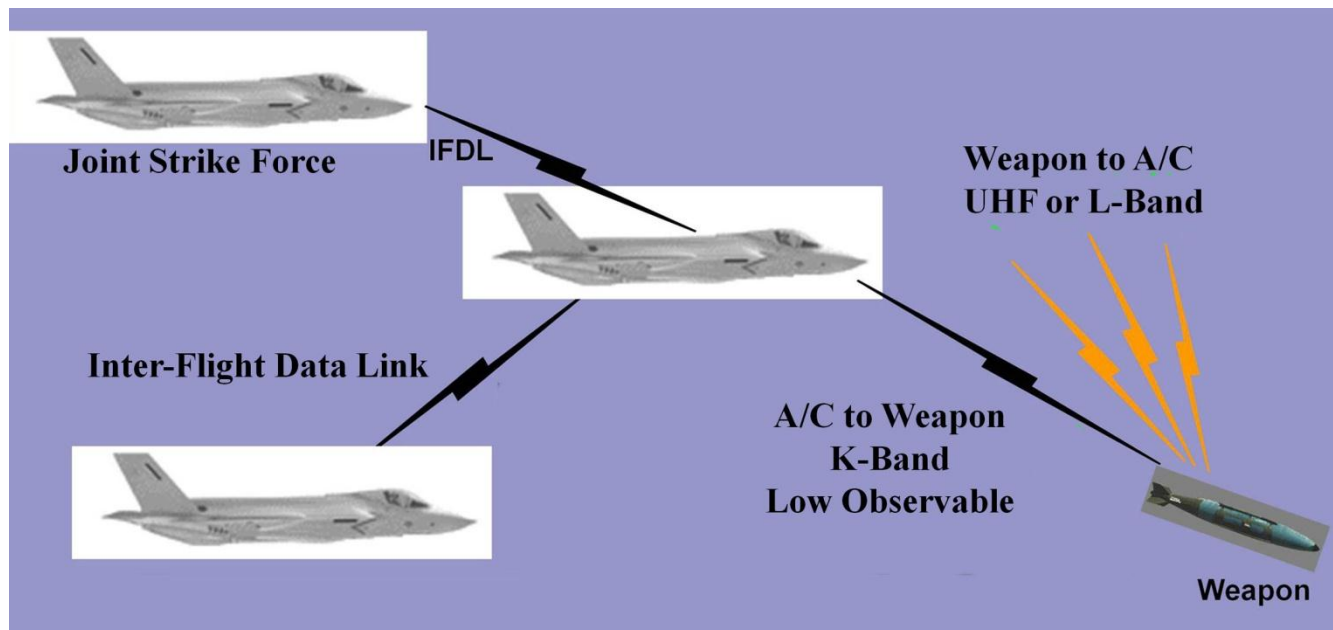
## Quint Network Technology (2005-2008)

**Background:** The Tactical Targeting Network Technology (TTNT) program began in 2001 to develop hardware for a distributed network data link. By 2005, Rockwell Collins had successfully completed the initial phase of TTNT and flight tested the hardware. The next challenge was to shrink the bread-box size hardware down to the size of a hockey puck so it would fit in a weapon.

**Quint Networking Technology (QNT) Development:** In 2005, the Defense Advanced Research Projects Agency (DARPA) in Arlington, VA., funded the Air Force Research Laboratory (AFRL) at WPAFB OH to initiate the QNT effort for a modular network data link to establish multiband communications among manned aircraft, unmanned combat air vehicles (UCAVs), weapons, tactical unmanned aerial vehicles (UAVs), and infantry ground forces. AFRL awarded parallel Phase I contracts to an industry team led Rockwell Collins of Cedar Rapids IA and another to the team led by Harris Corp of Melbourne FL. The goal of QNT was to develop the technology for a networking terminal that fit in a 10 cubic inch package.

Following the initial conceptual Phase I, AFAL down selected and awarded the Phase II contract to the Harris team in 2006.

The Harris team developed a breadboard QNT using the TTNT waveform data links to integrate tactical UAVs, infantrymen, and weapons into the future digital battlefield for network-centric warfare operations that use distributed sensor platforms to find, fix, track, and engage important stationary and moving targets in real time.



### Low Probability of Intercept Approach for QNT

QNT systems users are weapons, air control forces on the ground, and tactical UAVs. These three are the focal points of the QNT effort with the manned aircraft using TTNT hardware and waveforms from other established programs.

In Phase II, Harris developed a 20 cubic inch package for the Low Rate Data Link (LRDL) that was successfully flight tested in Phase III in 2007. They identified the technology developments required to meet the 10 cubic inch goal. These technologies included targeted microchip developments for the Red/Black crypto processing, Radio-Frequency Integrated Circuits for the RF core, Primary Energy Burst Storage Cells for the power supply and MMIC for the Power Amplifier filters.

Harris completed the QNT program in 2008 with a roadmap of technology developments necessary to meet the original program goals.

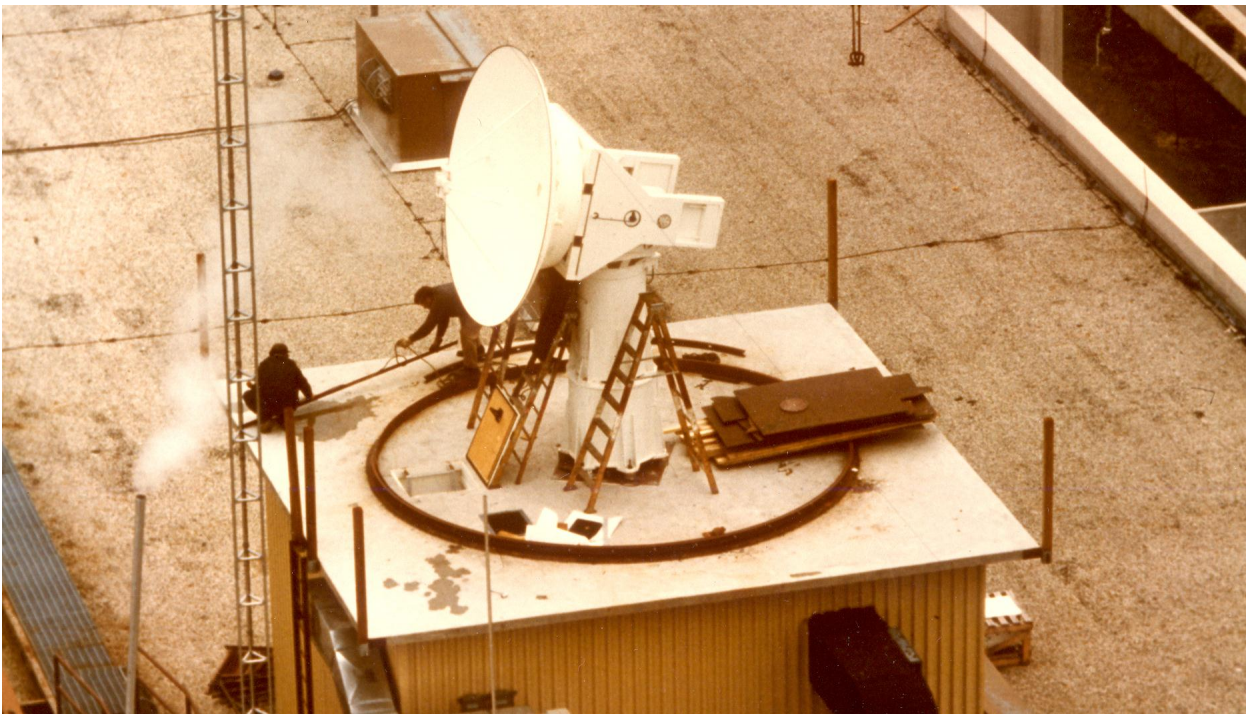
**Reference:**

Waller, LTC Stephen; **Quint Networking Technology Status Briefing**: Defense Advanced Projects Agency (DARPA/IXO); Arlington VA; January 2006

## **Rooftop Facility Building 620 (1972-2011)**

**Background:** Under Project 1227, Airborne SATCOM Terminals, the Air Force Avionics Laboratory (AFAL) developed and tested a number of UHF, SHF and EHF airborne SATCOM systems. The need for a local ground station was identified to allow checkout of the systems before they were installed in the test aircraft and to support the airborne testing. In the early 1970s, the Communications Branch contracted for the building of a communications support facility on the roof of Building 620 at WPAFB OH.

**Rooftop Communications Facility:** The Building 620 Rooftop Facility was designed and constructed to house equipment to conduct air-to-ground experiments over a wide range of dynamic variables to assist in the design definition of advanced airborne satellite relay communication equipment. The Rooftop Facility houses equipment needed to perform baseline performance measurements on line-of-sight communications with synchronous orbiting satellites. The initial equipment installed in the facility consisted of: the Sylvania Wideband Anti-jam Modem, the Collins AN/ASC-18 SHF (X-Band) Satellite Communications Terminal, the AN/ASC-22 Ka-Band Satellite Communications Terminal including the Digital Data Modem Group OM-53 (XA-1)/ASC-22, the Ka-Band Rooftop 10-foot Antenna Subsystem and peripheral equipment needed to support the primary equipment and test activities.



**Figure 1 10-foot Antenna on AFAL's Rooftop Facility - Building 620**

**Rooftop Antenna Subsystem:** The Ka-Band Rooftop Antenna Subsystem was designed to be used in conjunction with the AN/ASC-22 Ka-Band Satellite Communications Set which operates over the LES-8/9 Ka-Band Satellites. The Rooftop Antenna Subsystem consists of a ten-foot diameter antenna, a pedestal and drive mechanism, associated rotary joints and waveguide, antenna position and control/power unit, secant correction unit, joystick; remote control and indicator panel, and computer interface unit. The antenna and pedestal are located in a radome atop the Rooftop Facility, Figure 1 and 2. The position control/power unit, secant correction unit, joystick, and remote control and



indicator panel were rack-mounted inside the facility adjacent to the Ka-Band Terminal. The computer interface unit, the PDP-11/45 Computer control interface and the DR 11-C interface were located below the shelter in the CSEL area and interfaces with connecting cables.



**Figure 2 AFAL's Original Rooftop Facility on Building 620**

**Rooftop Facility Peripherals:** The Peripherals are those systems other than major systems which are essential to maintain the Rooftop Facility and to coordinate and collect data during test efforts. The peripherals consist of the ARC-164 Radio, phone patch system, warning light system, the Rooftop electrical, heat exchanger, and Air Handling Unit (AHU).

**The ARC/164 Radio:** The ARC/164 Radio located to the left of center on the operator's console provided UHF communications external to the Building 620 to other facilities and to the test aircraft while operating within a 130 NM (nominal) range.

**Phone Patch System:** The Phone Patch System located at the right end of the operator's console provides direct telephone communications through the operator's headset (press to talk), and UHF communications to be patched into the telephone through the ARC/164. The Phone Patch System also provided tape recorder outlets such that any conversation via the headset or telephone can be recorded.

**Warning Light System:** The Warning Light System consisted of a manually-operated "keyed" switch located to the right of the Rooftop Facility entrance, and four red rotating beacon lights. These lights are located, one in the covered walkway between the elevator and the Rooftop Facility, one at the rear exit of the Rooftop Facility, one at the roof area exit to the stairwell adjacent to the Rooftop Facility and one at the tower exit to the roof area. This system was used to warn personnel of a possible radiation hazard on the Building 620 roof. The warning system could be turned on whenever the possibility existed of radiating energy from any of the steerable antennas.





**Figure 3 Upgraded Rooftop Facility**

**Rooftop Electrical:** The Rooftop electrical (power supply) system was tapped off of the building uni-bus in Level 3. Through the system, 28 VDC, 120/208V AC 60 Hz, and 120/208V 400 Hz power was available from the side wall and under floor uni-bus within the Rooftop Facility.

**Rooftop Heat Exchanger:** The Rooftop Heat Exchanger located in the doghouse on the west side of the Rooftop structure was tapped into the building chilled water system and provided cooling for the Air Handling Unit (ABU) cooling coil and for removal of excess heat from water-cooled equipment.

**Air Handling Unit:** The Air Handling Unit (ABU) was an integral part of the Rooftop Facility. The AHU provided a complete environmental control system maintain the proper humidity, suspended particle, and air temperature for the electronics and Rooftop Terminal equipment.

**Rooftop Upgrades:** In the 1990s, the Rooftop was upgraded by adding an equipment room on the south side of the original facility and an office and maintenance room on the north side, Figure 3. New generations of Advance Development Systems, such as the AN/ASC-30 EHF SATCOM System and the Milstar EHF SATCOM System, were installed as those systems underwent flight test evaluation, Figure 4. In 2009, the 10-foot antenna was extensively overhauled and upgraded to operate in the 14-15 GHz frequency range with the TACSAT III satellite. A TACSAT III ground terminal was installed and secure lines extended down to the third floor vault to pass classified downlink information received from the TACSAT III satellite.



**Figure 4 Milstar EHF SATCOM System in Rooftop Facility**

**References:**

Grizinski, Ted; **Rooftop Radome Material Attenuation Measurements**; Air Force Avionics Laboratory; WPAFB OH; AFAL-TM-77-18-AAD; 31 March 1977.

Perdue, Edward M. and Thomas F. Joyner; **Ka-Band Rooftop Antenna Subsystem**; Raytheon Co; Wayland MA; AFRL-TR-76-27, January 1977.

Wasson, Major Robert; **Operating Procedures for AFAL's Rooftop Facility**; Air Force Avionics Laboratory; WPAFB OH; AFAL-TM-77-19-AAD; 25 April 1977.

## Same Frequency Repeater AN/ZRC-1 (1966-1974)

**Background:** At the request of the Air Force System Command (AFSC) Communications Program Director, the Systems Engineering Group (SEG/SEA) at WPAFB OH undertook a study of a Multi-frequency Airborne Relay in 1966. The original directions required the design to include relay of air-to-air communications on UHF, VHF-AM, and VHF-FM; relay ground-to-air communication and to relay ground-to-ground communication. The system should handle a minimum of 14 ground stations providing maximum utilization of the frequency spectrum. The relay package design shall not be restricted to a particular vehicle, but should be flyable in a drone, light aircraft or pod. The target weight was 200 pounds and size 9 cubic feet. The coverage was to be 100 mile diameter on the ground and 300 mile diameter air-to-air. The platform design altitude was 20,000 feet.

The air-to-air communication relay or air-to-ground relay should require no modification whatever to the users airborne communication equipment. Standard ground communication equipment should operate over the relay without modification. However, in order to obtain the capability of frequency translation, frequency selection and to assist the user aircrafts in these functions new ground communications sets or modifications to existing ground equipment may be required to make them compatible with the logic circuitry in the airborne relay.

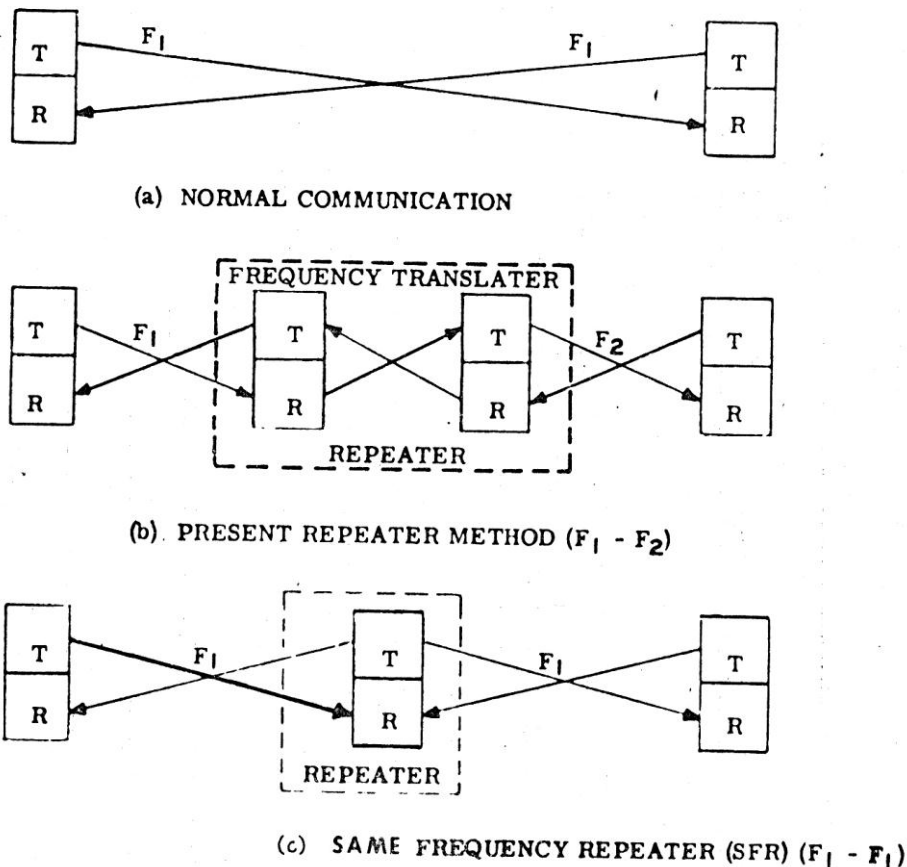
A study was undertaken by SEG and with the assistance of the Air Force Avionics Laboratory (AFAL). The study investigated communications limitations in the Vietnam Theater and determined that the most pressing need was for extension of the UHF communications line of sight range. Therefore, further work concentrated on that problem.

**Same Frequency Repeater Effort:** Limitation of range of transmission/reception at UHF frequencies to line-of-sight is well known. In recent years, associated problems in military applications have intensified the need for development of techniques to overcome this basic deficiency. As a result of this need, the AFAL initiated a program for the investigation and development of radio relay concepts and techniques which led to the design and fabrication of a series of Same Frequency Repeaters (SFR's).

The normal mode of operation in voice communications is push-to-talk, with both parties on the same frequency (Figure 1a). At UHF frequencies, a relay is necessary for beyond line-of-sight (LOS) range. One method of implementing the relay function is by using frequency translation, designated as F1/F2 (Figure 1b). It is noted that the relay requires two receivers, two transmitters, and two antennas, as well as two translation interfaces (not shown) per channel. Additionally, it requires paired users to be on two different frequencies. Thus, the F1/F2 relay, or frequency translating relay places the extra burden on users of co-operative frequency assignment. For mobile and aircraft applications in the military services, the comparative lack of flexibility in frequency assignment is an important consideration. With multiple antenna installations, typical antenna to antenna coupling factors and receiver selectivity dictate a minimum of 10 MHz spacing between receive and transmit frequencies.

An alternate F1/F2 approach, which could operate with one antenna, requires a multi-coupler to provide the necessary isolation between radios. Practical considerations limit this approach to 4-port multi-couplers and a resulting 2-channel relay system.

The Same Frequency Repeater (SFR) is designed to operate in the F1/F1 or non-frequency-translating mode (Figure 1c). Only one antenna, one receiver, one transmitter, and one frequency are required per



**Figure 1 Methods of Communications**

channel. User operation is unchanged from direct line-of-sight operation; no modification in the user's equipments is required.

**Design Considerations:** Two fundamental considerations must be addressed in the design of a Same Frequency Repeater (SFR): (1) local isolation of the receiver from the transmitter, to prevent self-jamming; (2) isolation of the receiver from backscatter. A practical SFR should have a receiver sensitivity on the order of -97 dBm, and a transmitter power output of 10 watts CW (+40 dBm). Thus, a minimum input-output isolation of at least 140 dB is required, allowing only a nominal 3 dB for modulation.

Techniques for achieving the required isolation(s) are intimately related to the choice of basic approach to developing an SFR, which can be either that of sampling (time-sharing between the receiver and transmitter) or non-sampling (continuous operation of both receiver and transmitter.)

The sampling approach and the non-sampling approach have both been investigated. Approximately 25 dB of isolation can be easily achieved over a wide bandwidth by the use of an appropriate RF duplexing device. In the non-sampling SFR, a refinement of this approach, an antenna hybrid, is used. Matching of the idler port impedance to the antenna results in transmitter/receiver isolation of over 70 dB. The sampling SFR achieves the major portion of the necessary isolation by commutative switching. The transmitter is OFF while the receiver is ON, and the signal is stored. The receiver is OFF during the interval the transmitter is ON to re-transmit the sample. Switching rate is high enough (14 kHz) that the sampling is not noticeable to the relay users. Both approaches include the use of



receiver/transmitter frequency offset (7 kHz to 16 kHz) and narrow-band filters to gain additional input-output isolation. The SFRs discussed are of the sampling type. Superficially, the sampling approach is easier to implement. However, other problems result from sampling; solutions to these problems will be discussed.

**Specifications:** The Research Repeater is a single channel unit with a power output of 2 watts. Tuning range is 225-300 MHz; 4 crystal controlled frequencies are available. Receiver sensitivity is 5 microvolts for incoming signals with 30% modulation.

The Evaluation Model, a single channel unit, has a power output of 10 watts. Operating frequency is synthesizer controlled; frequency selection is by means of thumb-wheel switches; 1750 channels at 100 KHz spacing are available.

For the Research Repeater program, emphasis was placed on implementing a design which would allow selection of various operating modes, and no attempt was made to optimize size and weight. This resulted in a two package configuration - a functional unit and a power supply unit, each in a single full ATR box, for a total weight of about 70 pounds. For the Evaluation Model, a minimum packaging effort resulted in a unit contained in a single full ATR box with a weight of 42 pounds.

The Multiple Channel Repeater System was designed as a laboratory test and demonstration unit. Three channels were fixed, crystal controlled; the fourth channel is synthesizer controlled, with 1750 channels available at 100 KHz steps. Again size and weight control were low on the order of priorities. The result was again a final configuration of two packages - a functional unit in a rack of standard width, 66 inches high, and a power supply unit, standard rack, 30" high, with a total weight of 400 pounds.

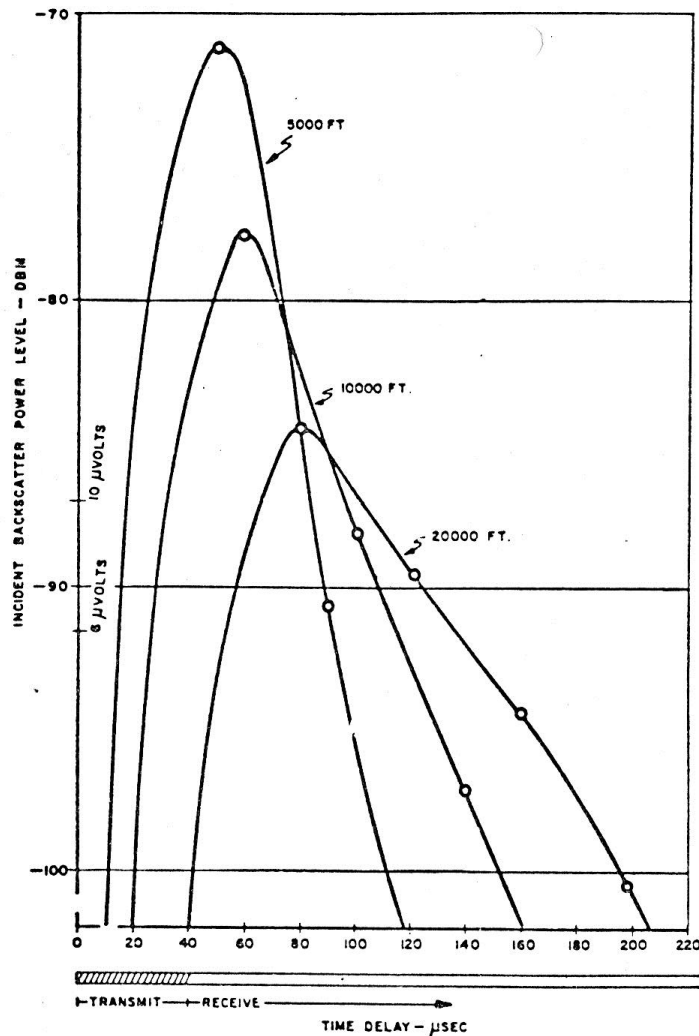
Principal MSFR specifications are given below:

Frequency Range	225.0 to 399.95 MHz
Number of Channels	Four
Frequency Control	One 1750 channel synthesizer and three crystal-controlled channel oscillators.
Transmitter Power	8 watts (nominal)
Receiver Sensitivity	-92 dBm for 10 dB $\frac{S + N}{N}$ @ 30% modulation

**Problem Areas:** The Research Repeater design allowed selection of various switching rates, use/non-use of guard time, and study of effects of switching pulse-shaping. Problem areas of fading and backscatter were investigated; squelch control circuitry and signal acquisition routines were studied.

**Backscatter and Switching:** The receiver of an SFR is exposed to backscatter from its own transmitter in the form of reflections, principally from the earth. Under conditions that can be expected to exist in airborne applications, the backscatter level at the SFR receiver input can become excessive; the result is either a closed loop self-oscillation, or a necessary reduction in SFR receiver sensitivity of 20 dB or more.

Critical factors in determining the backscatter power level at the SFR are altitude and the radiation pattern of the SFR antenna. A computer model of backscatter from the earth as illuminated by an airborne SFR was developed by Raytheon Company. Using this model, the expected backscatter level can be predicted for various altitudes, antenna patterns, switching rates, pulse widths, and duty factors, based upon a transmitter power output of 10 watts (+40 dBm). Figure 2 shows results for a single pulse.



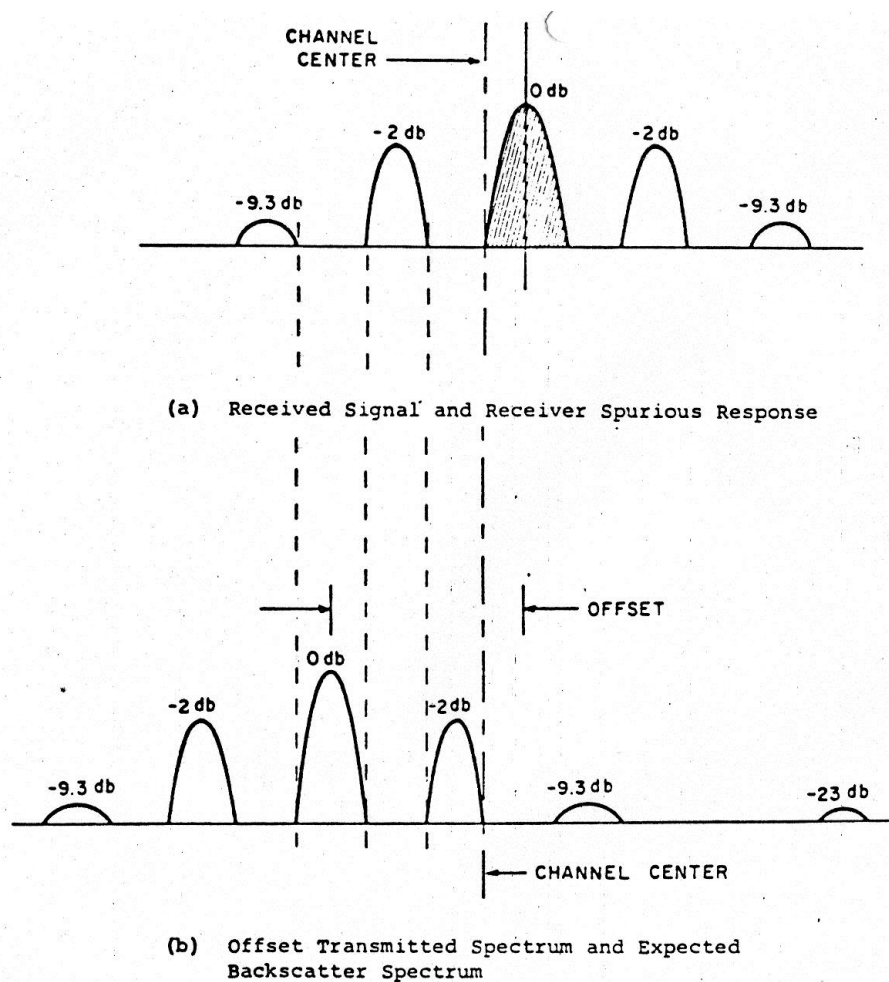
**Figure 2 Single Pulse Backscatter**

The computer results were verified in the Research Repeater flight test program. Two points are of interest:

- The high power level of the backscatter
- The time dispersion of the response

Switching creates effects seen in the frequency domain. In the receiver, the result is an effective widening of the bandpass response, seen as a series of response lobes, decreasing in amplitude with frequency. In the transmitter, an analogous effect is seen in the form of a similar series of output lobes.

The approach to backscatter control used in the sampling SFR's is that of in-channel frequency offset between received signal and the retransmitted signal, (Figure 3). By means of this offset, individual elements of the apparent receiver response are interleaved with the transmitter spectrum lobes and therefore the backscatter spectrum. Specifically, peaks of the transmitter spectrum coincide with the nulls in the receiver response.



**Figure 3 In-Channel Offset**

In implementing this technique, the approach chosen was that of offsetting the transmitter frequency relative to the received signal. The transmitter offset is always in the opposite direction to the offset found in the received signal relative to the channel center, thus minimizing the deviation of the transmitter from channel center. The magnitude of the offset is related to the switching rate. In the MSFR, switching is at a 14 KHz rate; the offset is 7 KHz. Backscatter rejection achieved by this scheme is better than 35 dB.

**Backscatter, Guard Time and Offset:** A plot of backscatter returns for a continuous train of pulses, on magnitude/time coordinates results in curves that are sinusoidal. The continuous nature of the returns is reflected in the ineffectiveness of guard time as a means of controlling backscatter. For a 50% duty cycle backscatter peaks occur during the RECEIVE cycle, these peaks ranging from -72 dBm for a 5000 foot elevation to -85 dBm for a 20,000 elevation. Incorporating Guard Time, during which neither the transmitter nor the receiver is ON, results in relatively little improvement. Using a guard time of 50%, coupled with 25% duty cycles for TRANSMIT and RECEIVE, peak backscatter is -84 dBm at a 12.5 KHz rate, and -90 dBm at a 6.25 KHz rate.

There are several drawbacks to the Guard Time Approach. (1) Both the RECEIVE and the TRANSMIT periods are shortened relative to the sampling rate, causing worse spurious performance by the SFR than if the full repetition period were used to receive and transmit. (2) Because of the

lower duty cycle, higher peak transmitter power is required to maintain the same average power output, and receiver sensitivity is degraded. (3) Only moderate amounts of isolation (10 to 20 dB) appear to be possible using this technique.

**Switching Pulse Shape:** To minimize the spurious elements resulting from switching, switching pulse shape is carefully controlled. The cosine-squared shape is used, the shape being close to the ideal Gaussian shape, but yet not too difficult to implement; roll-off of spurious approaches 18 dB per octave, compared to 6 dB per octave for the square wave and 12 dB per octave for the cosine wave.

Switching automatically means a duty factor of less than one. In the receiver, there is a loss of sensitivity, and an increase in noise figure of about 4 dB. In the transmitter, peak power requirement, including modulation and minor system losses, rises to 350 watts in the MSFR (4 channels, 8 watts average each).

**Fading, Squelch, and Signal Acquisition:** Early in the SFR program, it was discovered that fading was an especially difficult problem, and that this problem was exaggerated during air-to-air relaying. Two fading mechanisms appear during ground-air-air relaying which are not present during ground-air-ground relaying.

The first of these, multipath, arises because of destructive interference that occurs at the repeater between directly arriving signals and signals reflected from the earth's surface. This phenomena is more severe during aircraft banking maneuvers since ground reflected signals, normally weaker than direct path signals, are enhanced by the shift in the aircraft antenna's main lobe down towards the earth. Multipath fading of this type is typically very deep but also very brief since exact cancellation can only occur for a very specific set of geometries. The second type of fading is present in ground-air-ground relays but increases in severity for ground-air-air and air-air-air relays. This fading is the result of the multi-nodal azimuthal response of aircraft antennas. Aircraft antenna patterns, in azimuth, show typical gain variation of 3 to 10 dB. With several aircraft participating in an air-air-air relay very deep fading can occur. The Research Repeater was not designed to work with signals having this degree of fading, and under some circumstances communication was impossible.

Squelch action at the repeater is necessary for the acquisition of incoming signals. It is necessary to squelch the repeater when no channel traffic is present not only to stop useless re-transmission of a noise modulated carrier, but to prevent backscatter from obscuring incoming signals before acquisition by the repeater.

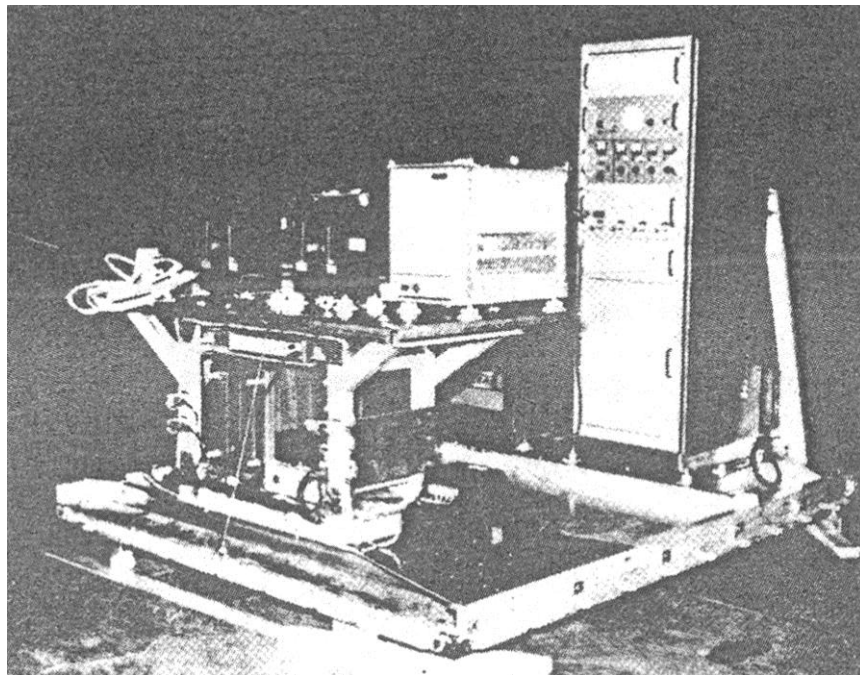
Squelch circuitry must be able to decide if the incoming signal is fading or has signed off. If the signal is fading, the repeater should not be forced to go through a re-acquisition procedure, especially for the short, deep fades which are common in multipath fading. Operationally, repeater acquisition and retransmission of incoming signals should occur in less than one second, preferably about 0.1 second.

The shortcomings of the Research Repeater were corrected in the Evaluation Model repeater. In the squelched condition, the receiver is continuously ON, and the transmitter is OFF. The squelch circuitry prevents the continuous transmission of noise by enabling channel transmission only under the following conditions: (1) the signal exceeds the selected threshold; (2) the signal has been properly acquired by the AFC. By having the receiver continuously ON during acquisition, the AFC is prevented from locking to a spurious spectrum line of the sampled received signal. Effectiveness of the re-designed squelch circuits was validated in the Evaluation Model SFR flight tests.



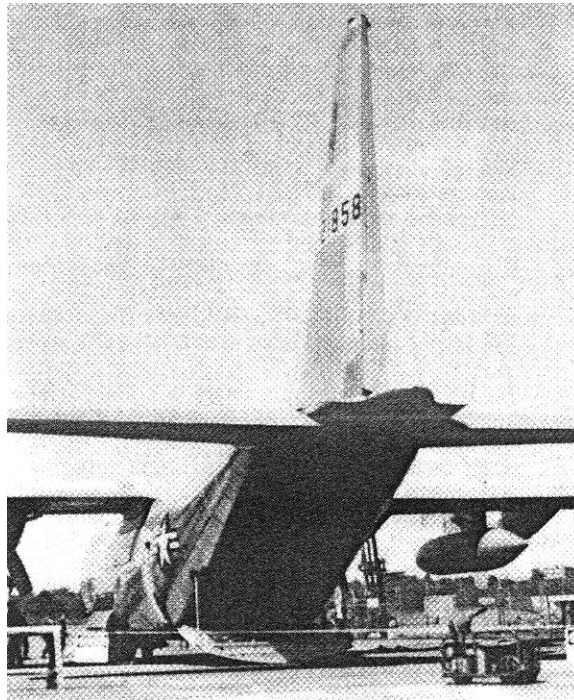
The same squelch design approach is used in the MSFR. The squelch circuitry contains both an absolute (front panel) adjustable squelch, as well as a relative squelch which responds to signal-to-noise conditions. If a signal fades below the selected threshold, repeater operation is not interrupted. A narrowband filter (IF demodulator, 300 Hz), positioned by the incoming carrier, "sees" the carrier during fades up to 30 dB. A one-second time delay inhibits squelch during such fades. If the fade exceeds one second in duration, squelching will take place. A second time delay is provided for deep fades, when the signal becomes undetectable in the 300 Hz filter, or when the signal is non-existent, as upon message termination. The second time delay is 0.1 second, permitting quick message exchanges between users. Thus, in moderate fades of less than one second, or in deep fades of less than 0.1 second, repeater action is not interrupted.

**MSFR Flight Test Installation:** In order to evaluate the MSFR, a 10-day flight test was performed in a C-130 cargo aircraft. The MSFR was shock-mounted on one side of a standard 7 x 9 foot aircraft cargo pallet (Figure 4). Pallet mounting considerably simplified the installation and removal of the equipment from the aircraft. The cargo area of the C-130 aircraft contains a bed of rollers, permitting easy fore/aft positioning of the pallet (Figure 5). Once in position, the pallet is locked into place, and



**Figure 4 Multichannel Single Frequency Repeater Mounted on Pallet**

the repeater is ready for operation. On the opposite side of the pallet, test and monitoring equipment was mounted. An oscilloscope was provided for possible diagnostic use. Two stereo tape recorders, connected to the four IF/demodulator test points, continuously recorded the receivers' outputs. Two dual channel chart recorders monitored received signal strengths via the IF/demodulator AGC test points. On the lower shelf, a signal generator/synchronizer provided a stable signal of known amplitude with which to calibrate the repeater's AGC characteristics. A 400-60 Hz power converter was used to power the laboratory test gear. The lower shelf also contained the single channel Evaluation Model SFR as a back-up in the event of a malfunction in the MSFR. The single channel SFR was tested during the first shakedown flight but was not required during the remainder of the test schedule.



**Figure 5 C-130 Test Aircraft**

**Test Operation:** Controls on the front panel allow a selected channel to be either monitored, or to form a local transceiver in place of the normal single frequency repeater. A channel selector switch selects the one desired channel; a channel mode switch determines whether that channel is to be monitored or formed into a transceiver. In the monitor position, each channel's audio can be heard in either the internal speaker or an externally connected headset. In the transceiver position, normal relaying in the selected channel is interrupted to allow the MSFR operator to enter the net. Instead, the exciter's transmission is controlled by the headset's push-to-talk switch. Headset and speaker audio are muted during this local transmission. Thus, the channel operates as a conventional single frequency transceiver, except that transmission and reception occur on a sampled basis.

The operation of the repeater was essentially automatic: once tuned to the desired channels, relay action occurs upon receipt of a preset signal level. The tune-up procedure consists of selection of desired channel and adjustment of a single control to achieve peak indication on a panel-mounted meter. Since the MSFR is configured with independent monitor and transceiver functions as well as the basic relay function, in orbit, at its vantage point within LOS of a great number of stations, it can serve to coordinate the operations of the stations which it links. When a radio operator is available at the relay platform, the following services can be provided:

1. Station Status. The repeater operator can keep a current listing of those stations he knows are active and monitoring their assigned frequencies. He can use this list to advise operators calling stations known to be not monitoring, or monitoring on another channel.
2. Radio Checks. The repeater operator can participate in radio checks with stations wishing to verify their up/down link to the repeater.

3. When the repeater is located in an airborne command post, the battle staff may access the nets served by the MSFR.

During the flight test program, varying degrees of assistance were provided by the relay operators. It became clear that this assistance was very useful, and communications generally benefited from the intercession of even untrained relay operators. In general, assistance was limited to operational difficulties, e.g., User A calling User B on Channel 4 when User B was authorized to operate on Channels land 3. However, during off peak hours, several equipment malfunction reports were given to stations exhibiting extremely low modulation levels and, in one case, to a station severely over-modulating.

**Test Performance:** The MSFR was flight tested as part of a combined services exercise known as EXOTIC DANCER VI, in cooperation with TAC, Langley Field, Virginia, during the period from 28 March through 10 April 1973. There were no equipment failures. Two flights per day for 10 days were flown, with the repeater airborne and operating for 20 hours per day, and on station 18 hours per day. A C-130 type aircraft, provided by 38th TAS, Langley Field, orbited at 21,000 feet. Stations using the relay were ground based, naval and airborne tactical forces. The forces would normally have been unable to communicate with each other because of line-of-sight limitations.

Since the purpose of the SFR is to extend UHF communications beyond LOS, the most important parameter is range. In flights of the MSFR predecessor, (the Evaluation Model Single Channel SFR), ranges achieved were 250 miles ground-to-air, and 350 miles air-to-air (Figure 6).

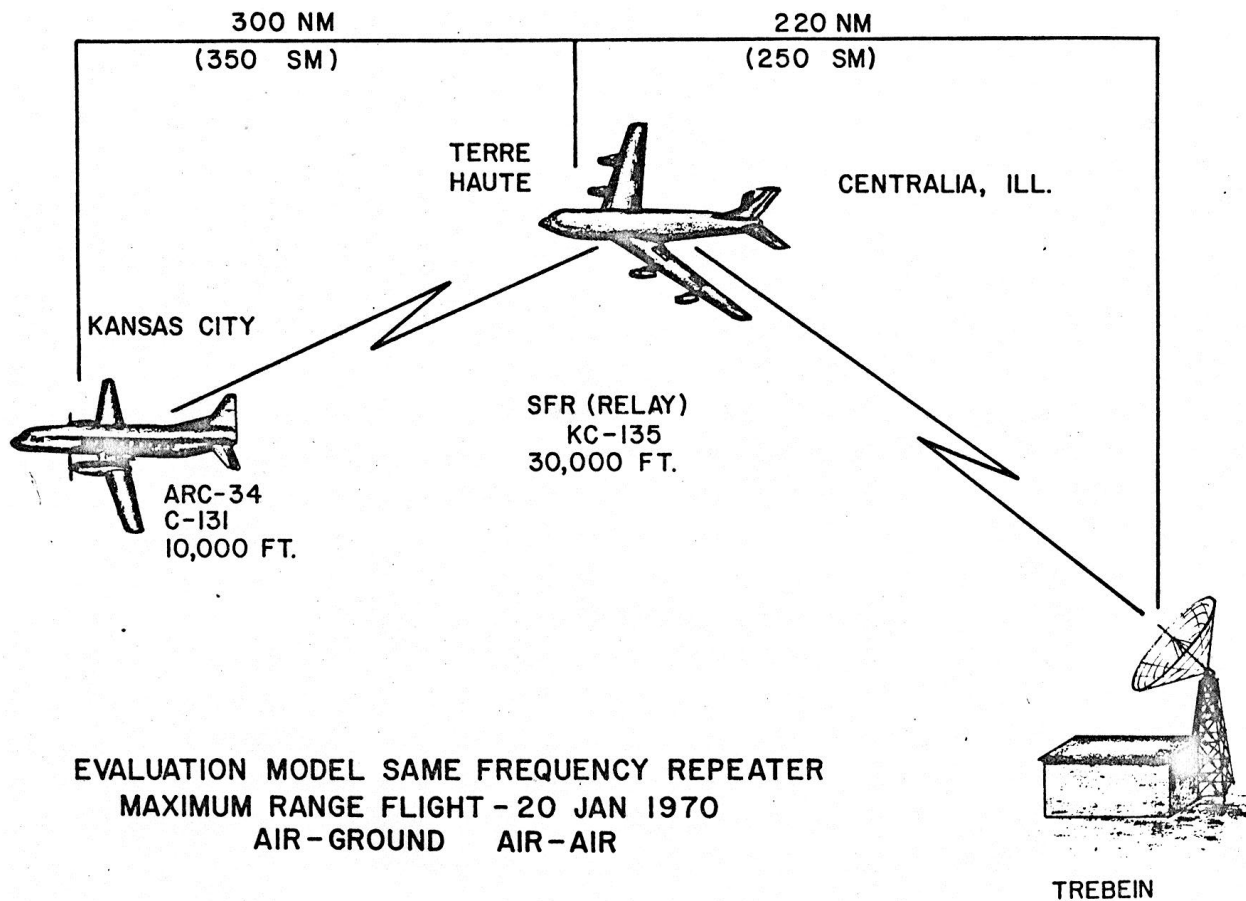


Figure 6 Test configuration

Two ranges must be considered in the deployment of a repeater. One, the range from a user to the repeater, is limited by the user's transmitter power and the repeater's sensitivity. The second, the range from a repeater to a user, is limited by the repeater's transmitter power and the user's receiver sensitivity. For any given repeater receiver sensitivity and transmitter power, nominal ranges can be specified for the repeater.

The normal LOS range for land-based stations is highly terrain dependent. For communication beyond LOS through an airborne relay, terrain constraints must be considered in addition to transmitter power. Theoretically, stations can "see" the relay aircraft when it is just above their horizon. Practically, ground stations require a certain minimum angle above the horizon to clear local terrain obstacles and be within the gain patterns of their antennas.

The range at which airborne terminals can "see" the repeater is a function of both the terminal's altitude and the repeater altitude. Range performance of the MSFR was in close agreement with the predicted range values derived from range/altitude curves using 2° grazing angle for fixed ground terminals, and 4° grazing angle for mobile terminals. With the MSFR at an altitude of 21,000 feet, ranges attained were up to 115 miles for airborne terminals, 100 miles for well-situated ground terminals, and about 75 miles for disadvantaged ground terminals. Three factors tended to limit the range, as compared to the ranges achieved in the Evaluation Model SFR flight tests: (1) maximum altitude of the relay aircraft in EXOTIC DANCER was 21,000 feet, as compared with 30,000 and 31,000 feet for the Evaluation Model tests; (2) one dB less of transmitter power in the MSFR; (3) location of the ground station in the Evaluation Model tests in very favorable terrain; in the EXOTIC DANCER exercise a number of ground stations were located in hilly, wooded areas.

#### **Flight Test Results:**

**Data - Signal Strength:** Data taken aboard the flight test aircraft on received signal strengths were in general agreement with up-link calculations (transmitter power, line losses, space loss, and antenna gains). Variations of +3 to -10 dB were observed during banking maneuvers.

**Operational Considerations:** The SFR was developed to provide an improved means of extending the communication range of standard UHF AM tactical radios. The guiding system design philosophy was compatibility with existing radio equipments and conventional communications procedures.

Throughout the sampling SFR program, one of the design considerations was the effect of the sampling-generated spectrum on channel allocation and utilization. The MSFR was designed for satisfactory operation with channel spacing as close as 0.5 MHz. In the EXOTIC DANCER exercise, a short test was conducted to verify the 0.5 MHz channel spacing capability. The test was conducted using Channel 2, transmitting noise at 252.0 MHz, and the receiver of Channel 1 tuning in 0.1 MHz increments with the available synthesizer. Backscatter was strong on the adjacent two channels ( $\pm 100$  KHz), weak two channels removed ( $\pm 200$  KHz) and not detectable three channels removed ( $\pm 0.3$  MHz). During this test, the aircraft was flying straight and level. Backscatter increases by 10-15 dB during banking turns which would have extended the backscatter out to  $\pm 0.4$  MHz. These results tend to confirm the original estimate of minimum channel spacing ( $\pm 0.5$  MHz) at which the repeater will operate with absolutely no degradation.

Size and weight, not optimized in this initial model MSFR, dictated the use of an aircraft with a cabin or cargo compartment with 6 foot high ceiling and work area of at least 100 to 120 square feet. Electrically, the MSFR is compatible with any aircraft which can provide 1,000 watts, 400 cycle prime



power, and a single UHF antenna. The C-130's used for the flight test had four UHF antennas: two top-mounted and two bottom mounted. One bottom antenna was used exclusively for the MSFR and one top antenna was connected to the single channel SFR.

It was observed during the flight test program that operation of the pilot's radio on the bottom antenna along with the MSFR increased the noise level in the pilot's radio. This situation was remedied by operating the pilot's radio using the top mounted antenna. This problem was attributed to the particular tuning configuration used in the MSFR and can easily be corrected to allow operation of both the MSFR and the pilot's radio with antennas in close proximity. No other compatibility problem existed with either of the two C-130's used during the flight test program.

**Transition:** Following the successful development and flight test of the Same Frequency Repeater it was transitioned to operational use and nomenclature as AN/ZRC-1.

**References:**

Gluszczak, Thomas, Ronald A. Salmay; **Evaluation Models UHF Sampling Same Frequency Repeater**; Raytheon Co. Sudbury MA; AFAL-TR-69-327; January 1970

Gluszczak, Thomas, Ronald A. Salmay; **Multiple Channel Same Frequency Repeater System**; Raytheon Co. Sudbury MA; AFAL-TR-72-346; December 1972.

Gluszczak, Thomas, William Kole, Ronald A. Salmay; **Wideband Digital UHF Same Frequency Repeater**; Raytheon Co. Sudbury MA; AFAL-TR-73-22; February 1973.

Johnson, Allen L., **Multi-Frequency Airborne Relay**; Technical Report, System Engineering Group; SEG/SEA; WPAFB, Ohio; 31 August 1966.

Nehez, James J., **Multiple Channel Same Frequency Repeater Flight Test**; National Aerospace Electronics Conference; Dayton, Ohio; July 1974

Parker, Morton S., Thomas Gluszczak, David B. Trask; **UHF Same Frequency Research Repeater**; Raytheon Co. Sudbury MA; AFAL-TR-68-229; July 1968.

Horne, W. Henry and Lionel D. Freeman; **Multiple-Channel Same Frequency Repeater Study**; Martin Marietta; Orlando FL; AFAL-TR-69-328; December 1969.

## Scattered-Light Test Airborne Receiver (STAR) (1984-1987)

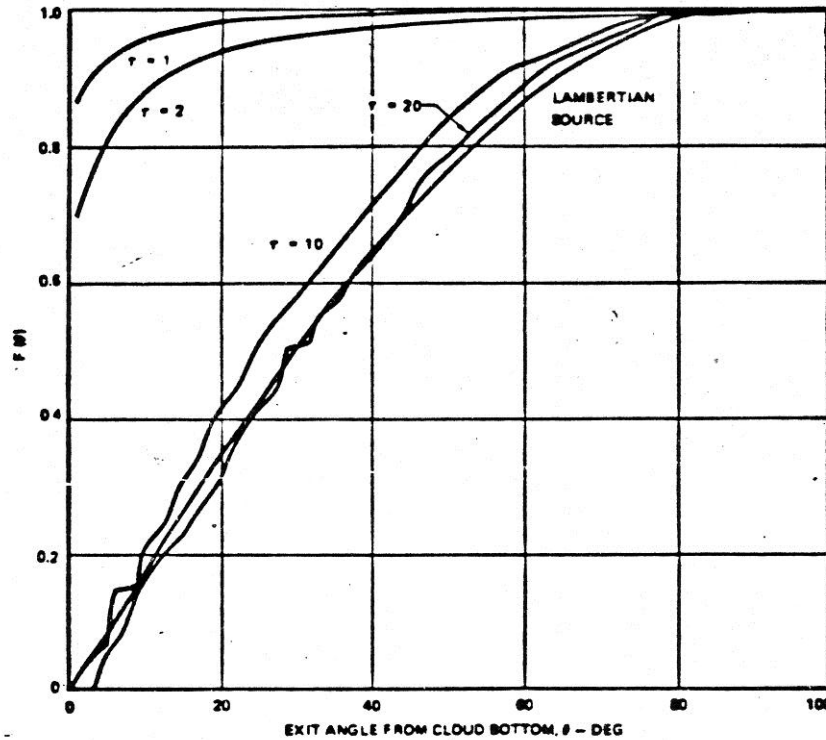
**Background:** Because of the potential near-term application of a scattered-light laser communications link, the New Initiatives office at headquarters Air Force Systems Command (AFSC/XRB) and The Defense Advanced Research Projects Agency (DARPA) provided direction and funding for the Scattered-light Test Airborne Receiver (STAR) effort to the Air Force Wright Laboratory's Communications Branch (AFWRL/AAA) under the Advanced Radio Techniques Project 7662 in 1984. This was a joint effort with the Navy Ocean Systems Center in San Diego CA.

**Introduction:** Communication to air, sea, and land vehicles by lasers propagated from space has recently received a great deal of study. The use of lasers permits both narrow beams for covert communications and a source of very high spectral power density. It is this second property of lasers which makes possible an all-weather broadcast communications system to low-flying aircraft. Laser communications from a satellite to low flying aircraft has, in the past, not been considered because of clouds in the propagation path. A communications system employing scattered-light technology could be used to downlink C<sup>3</sup>I information to low-altitude aircraft in an all-weather environment. Force direction messages) as well as threat warnings, could be communicated throughout an operating area to aircraft equipped with small laser receivers.

**Communications Channel:** The scattered-light transmission channel is significantly different from the typical RF, microwave, or cloud-free line-of-sight (CFLOS) optical channel. The primary difference is that the scattered-light system relies totally on scattered energy with virtually no unscattered energy arriving at the receiver. Although clouds have low absorption losses, the high degree of multipath scattering causes pulse stretching on the order of tens to hundreds of microseconds, thereby limiting the coherence bandwidth to 10-100 KHz. Due to the scattering the optical field incident upon the receiver will be incoherent in time, space, and frequency so direct detection is the best method for detection of signal energy. However, a scattered light system must have a large field of view to capture a significant portion of the scattered energy.

The amount of scattering that a signal incurs is directly related to the optical thickness of the clouds. The more predominant the scattering becomes, the less directionality there is associated with the signal. This effect is shown in Figure 1 for a signal which is propagating through clouds. The abscissa is the angle at which the signal is scattered from the cloud (0° is perpendicular to the cloud surface). Along the ordinate axis is the cumulative distribution function of the scattering angles. For  $T = 1$ , approximately 90% of the signal is scattered within 10° of the incident angle. As the optical thickness increases the distribution function approaches a curve in which the radiance emitted from the cloud is random in all directions. A source which emits a constant radiance in all directions is called a Lambertian source.

The scattering phenomena not only cause large transmission losses but also temporal pulse stretching and angular spreading, thereby increasing the pulse width and the beam divergence of the transmitted signal. This reduces the signal power density that exits the cloud. Accurate values of the pulse width, beam diameter, and cloud transmission parameters require using either measured data or rigorous computer simulations.



**Figure 1 Cloud Radiance versus Optical Thickness (Simulated)**

**System Example:** The above discussion can be used to analytically examine a scattered light communications system. This example chosen closely parallels one used by the Avionics Laboratory in a joint US Navy-Air Force experiment. The Navy experiment was called SLCAIR-85 phase 1B and the Air Force portion was titled Scattered-Light Test Airborne Receiver (STAR).

A quantitative value of SNR will be determined for a hypothetical communications link. The transmitter is a frequency doubled Nd:YAG laser capable of 1 J/pulse with 95% transmission through the source optics and a beam divergence such that the projected spot diameter is 10 km. The receiver filter has FOV of 0.785 sr (half angle = 30°) and optical bandwidth equal to 1 Å. Overall receiver system transmission is 15%. The detection device is a PMT with a quantum efficiency of 15% at blue-green wavelengths (0.532 nm) and detector area of 10 cm<sup>2</sup>. The effective receiver area is the same as the detector area. For PMTs the gain variance can generally be neglected; the cloud optical thickness is assumed to be 100, which using Van de Hulst equation gives 7.2% transmission through the cloud. The background source is the sun, with a radiance of 70 mW/cm<sup>2</sup>sr at 0.532 nm. The pulse width after propagation through the cloud is assumed to be 20 nsec. These values yield a SNR of 30.

Analysis shows desirable communications performance can be achieved by a small collection area receiver (10 cm<sup>2</sup>). Since only a small aperture is needed for satisfactory communication, airborne scattered-light receivers can potentially be made small and adapted to any airframe. Additionally normal laser communication system functions such as acquisition and tracking are eliminated in a scattered light receiver. The large receiver FOV's and spot areas only require that the receiver and transmitter be approximately aligned with each other which greatly simplifies receiver design.

**Airborne Applications of a Scattered Light System:** Potential scattered-light communication systems could range from worldwide broadcast coverage to limited coverage of high interest regions.

A worldwide broadcast system would employ laser transmitters based on geostationary satellites that would sequentially move a large spot of light over the satellites entire coverage area until it has been fully illuminated. Regional coverage would be accomplished in a similar fashion from either a satellite or high flying RPV, depending on the size of the area to be covered. After the coverage area has been illuminated, a message can be repeated or a new message sent.

A system of satellites in geostationary orbits could provide worldwide communications coverage. It is unlikely that a laser transmitter could be placed in orbit which is powerful enough to illuminate the entire footprint of the satellite with a single beam. However, lasers which could produce several joules of energy per pulse are possible and they would provide large area spots which could cover a subset area of the total footprint or be sequentially moved until the entire area of interest was covered. Communications to strategic forces for delivery of Emergency Action Messages is the most obvious application for a satellite based system. Tactical or rapid deployment forces could take advantage of the smaller subject area communication capability.

Tactical or rapid deployment forces which, once deployed, do not operate on a global scale could use limited theater coverage of a scattered light system. This limited coverage could be accomplished through use of a single spot satellite or a high flying RPV which scans a spot throughout the theater similar to the geostationary satellite. RPV coverage may provide large area coverage (500 X 500 Km) or fence coverage (20 X 500 Km). Possible communications could involve threat warnings or force direction to the deployed forces.

**Receiver Design:** An electro-optic receiver has been conceived to meet the requirements of this communications application. The physical design will meet a 1-cubic-foot volume goal, given LSI processor development and large-cathode, folded-dynode photomultiplier development. Performance limiters are the input optics 'transmission at large zenith angles and photodetector cathode quantum efficiency at the wavelengths of interest (850 and 890 nanometers). A block diagram of the receiver is shown in Figure 2.

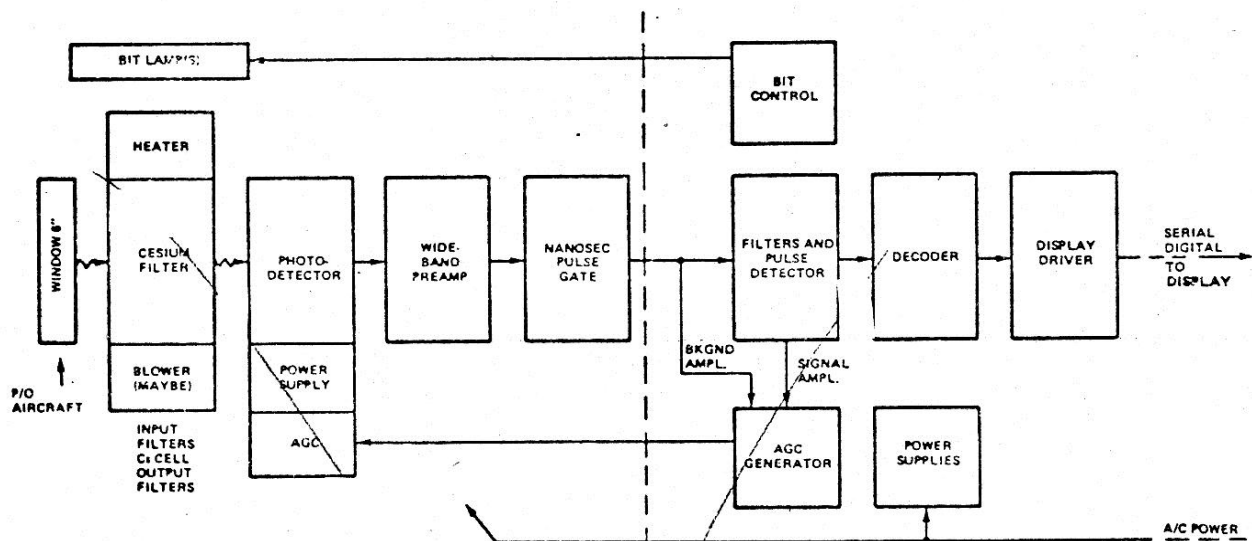
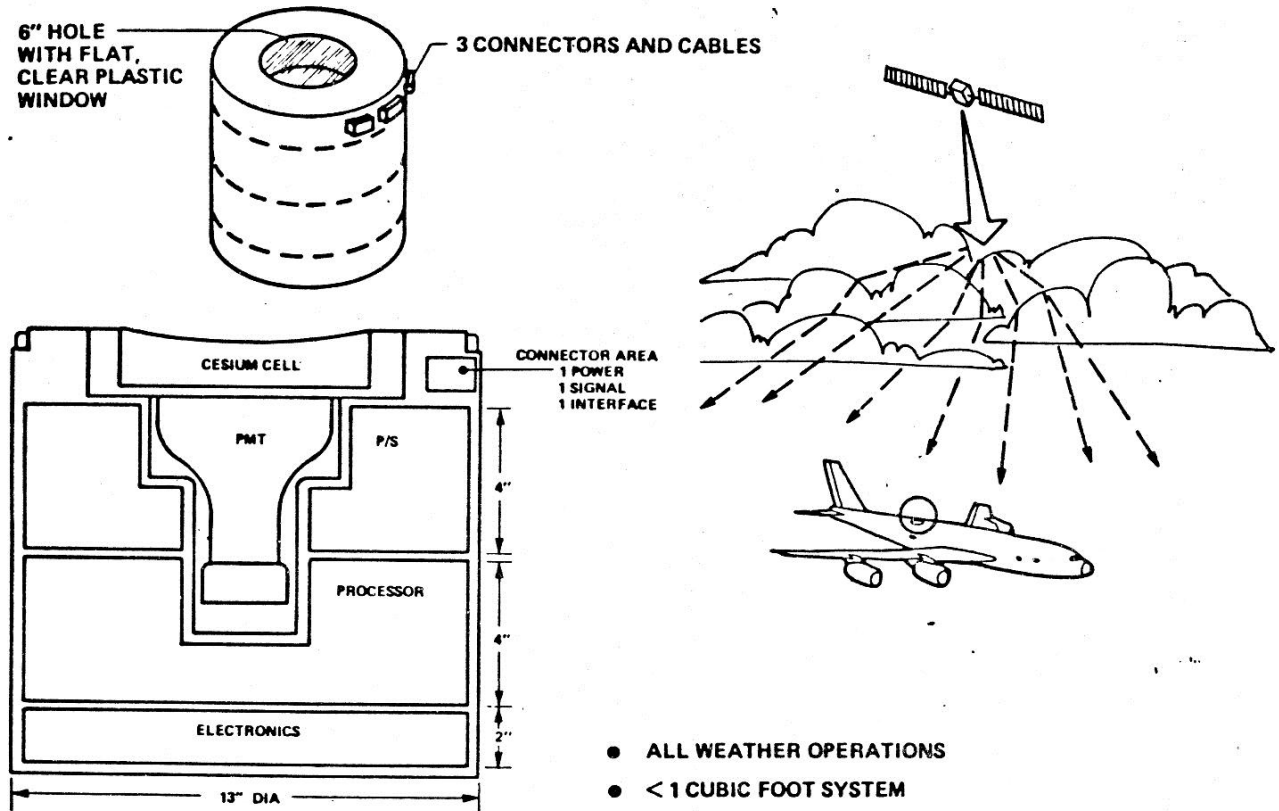


Figure 2 Optical Communications Receiver Block diagram



Several form factors were considered for the aircraft receiver package. The first, which is a cylinder 13 inches in diameter and 20 inches high, as shown in Figure 3 leaves much to be desired in the way of fabrication and assembly costs and in component accessibility. The input window, being part of the aircraft pressure hull, is detachable from the main receiver assembly.



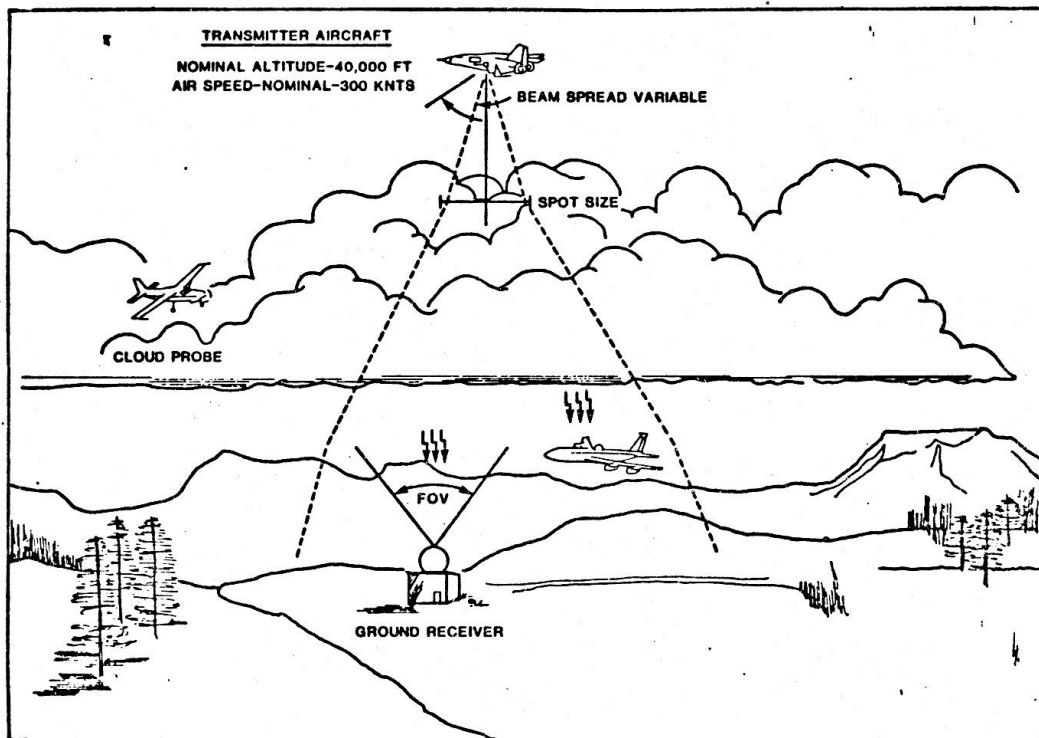
**Figure 3 Possible Operational Receiver Design**

**Scattered-Light Test Airborne Receiver (STAR):** The Naval Ocean Systems Center (NOSC) and the Air Force Wright Aeronautical Laboratories (AFWAL) conducted the test phase of an experiment to evaluate the viability of scattered light communications systems. The joint test program was designated the Cloud Experiment (Morgiewicz and Lintell, 1984-1) and was completed in December, 1984. The program used the test platforms shown in Figure 4: the transmitter aircraft (Figure 5), receiver aircraft (Figure 6), cloud probe aircraft, and a ground receiver station. AFWAL was responsible for testing a scattered-light receiver on-board a test aircraft and designated its participation in the experiment as Scattered-Light Test Airborne Receiver (STAR).

The test site for this experiment was located near Florence, Oregon. The site was chosen because the area could provide the required air control for the three aircraft and had high probability of the heavy cloud conditions needed to satisfy the test objectives. The cloud probe aircraft provided the means to characterize the cloud conditions.

The transmitter aircraft, equipped with a doubled Nd:YAG blue-green laser transmitter, flew over the Navy's ground receiver station and matched the ground track of the receiver aircraft. Both the ground

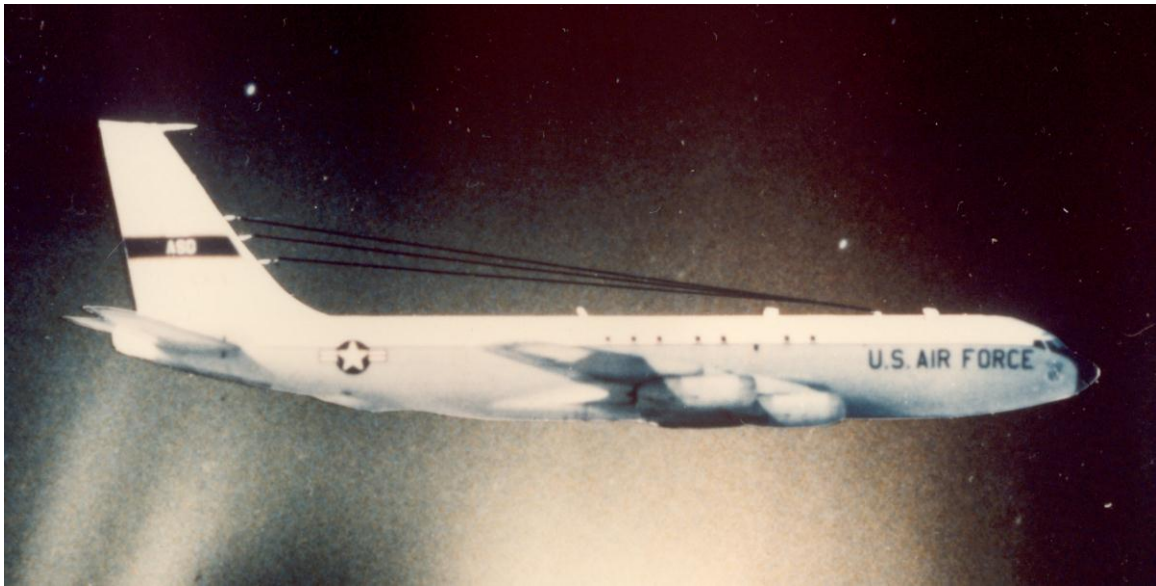
station and receiver aircraft were equipped with instrumentation systems to monitor and record the received optical signals. The transmitter and receiver aircraft flew two separate racetrack flight patterns, Figure 7 (Morgiewicz and Lintell, 1984-2). Because the receiver aircraft flew below and within the clouds, flight safety regulations restricted its flight pattern to be over the ocean and it could not simultaneously overfly the ground site. To accommodate both receivers, the transmitter aircraft flew over the ground receiver on the eastern leg of its track and then matched the receiver aircraft's track on the western leg.



**Figure 4 Cloud Experiment Configuration**



**Figure 5 Preflight Laser Test (Downlink Laser Cloud Experiment)**



**Figure 6a Receiver Aircraft C-135-3131**



**Figure 6b Receiver Aircraft (C-135-3131) with Top-mount Receiver**

**Test Objectives:** The primary objective of the Air Force portion of the Cloud Experiment was to measure the reliability of air-to-air communications using a scattered-light laser link. To meet this

objective, various parameters were measured to analyze the effect of the optical channel with clouds on the optical signal. Specific signal characteristics investigated included:

- \* The effect of clouds on pulse shape.
- \* The distribution of the energy emanating from the bottom of the clouds.
- \* The rate of change of Signal-to-Noise Ratio (SNR) as the receiver aircraft flew beneath non-homogenous clouds.
- \* The variations of the signal and noise characteristics when the receiver aircraft was in clouds as compared to beneath the clouds.

Additionally, equipment reliability and maintainability of the optical receiver was monitored during the experiment with no failures experienced during the test.

**Equipment Description:** The laser transmitter was built by GTE Sylvania for NOSC. The purpose of the laser is to simulate a satellite-based transmitter (which is the ultimate goal of the SLC program). To achieve this affect the transmitter output has a maximum beam divergence of  $\pm 20^\circ$ . This projects the signal over a large spot area, thereby, simulating the satellite's projection. The divergence is capable of being reduced to a minimum of  $\pm 2.5$  to maximize energy density in the spot contingent on extensive channel losses (i.e. excessively thick clouds).

The laser consists of four modules, each with two Nd:YAG rods. The modules lase at 1.06  $\mu\text{m}$ , which is then frequency doubled to provide an output at 532 nm, in the blue-green. Each module is timed to fire in succession to reduce damage to the optical components due to large energy densities. The combined optical output was designed to provide Joules in a nsec pulse. However, during flight testing, the output was limited to 50% of the designed output level and, at times, was less than 25%. This degraded output was due to both extensive losses through the aircraft window and laser component system degradations.

The needed high energy per pulse was achievable, but not without some limitations. The laser can only be fired at an average Pulse Repetition Frequency (PRF) of 10 Pulses Per second (pps). This allows the rods cooling time between firings. By improving the efficiency of the laser (i.e. output optical power vs. input power), the repetition frequency could be increased (or the output pulse energies increased for larger spot coverage). The current low PRF requires implementation of an optimum pulse position modulation (PPM) scheme to take full advantage of the channel capacity.

The all-weather communication requirement defines the maximum channel capacity for this system. For visible and near infrared (IR) laser systems, this implies penetration through clouds. Unfortunately, it does not take a very large cloud to prohibit direct transmission of the optical signal. However, the signal is not severely attenuated, but merely scattered by the cloud. This multiple scattering causes the signal to lose its spatial coherence and also incur temporal pulse stretching. The amount of scattering is a function of the optical thickness which is defined by the composition of the cloud and the physical line-of-sight (LOS) distance through the cloud. The optical thickness,  $T$ , can vary from 0 for a clear day to greater than 100 for dark thunderhead type clouds.

For  $T = 100$ , which is a worst case analysis, the pulse stretching could be as much as 100 nsec. The width of the stretched pulse limits the channel capacity. A 100 nsec pulse limits the channel capacity to 10 kHz or a maximum PRF of 10,000 pps.



FLIGHT ASSUMPTIONS

	ALTITUDE	GRD SPEED
TRANSMITTER A/C	25000 ft	365 kts
RECEIVER A/C	2000 ft	220 kts

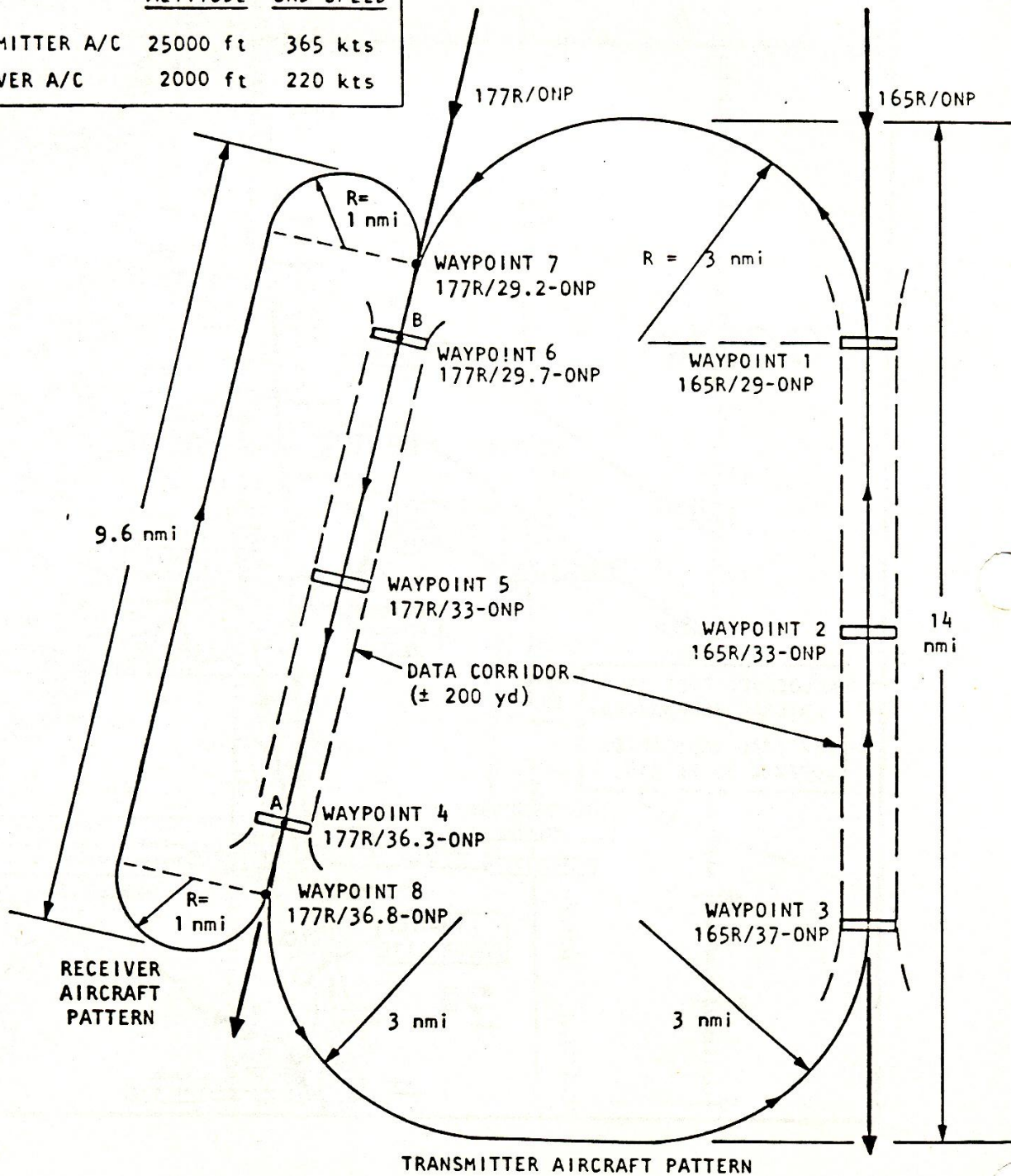


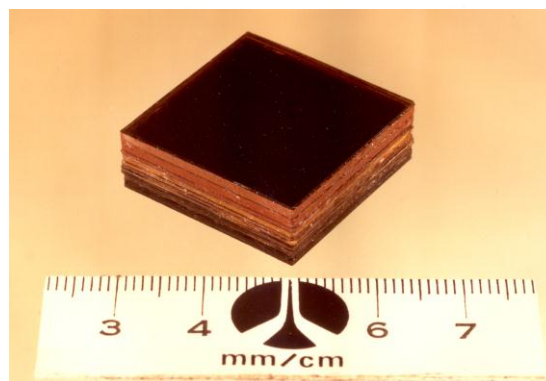
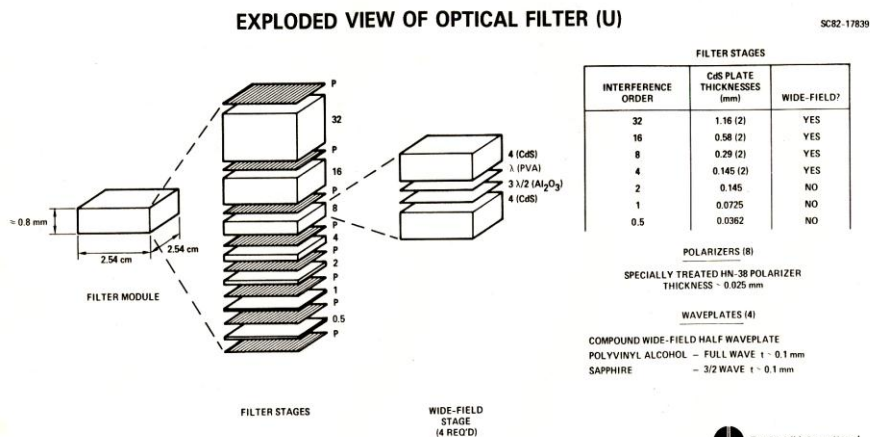
Figure 7 Cloud Experiment Racetrack Flight Pattern

As mentioned, to take full advantage of this channel and to overcome the low PRF of the laser suggests implementation of PPM. The optimum PPM format for this system under worst case conditions was to encode each pulse with 10 bits of information. By placing the pulse in one of 1024 slots ( $2^{10}$ ) 10 bits of

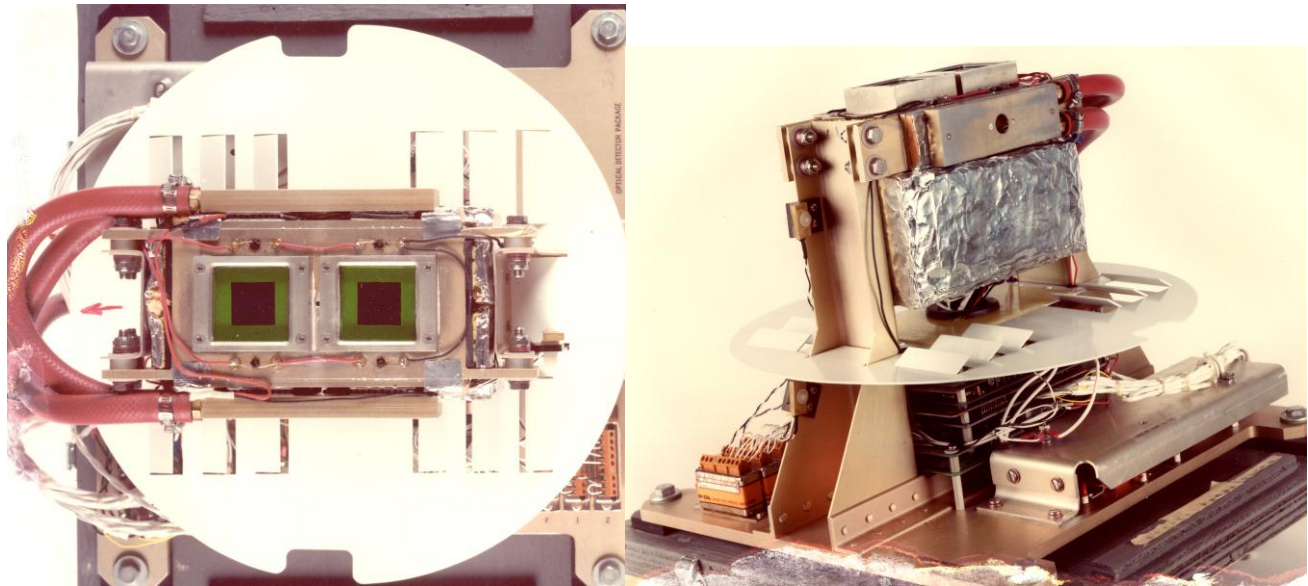
information can be transferred per pulse. At 10pps the allotted slotwidth will be slightly less than 100 nsec. Except for very heavy cloud conditions inter-symbol interference is minimized.

Along with temporal pulse stretching, a cloud will also cause the optical signal to lose its spatial coherence. As the signal photons enter a cloud, individual photons will be scattered in every direction and the signal energy will be dispersed throughout this region. To collect the scattered energy signal the receiver must be capable of accepting signal energy over a wide Field-of-View (FOV) while simultaneously rejecting background light.

Although narrow bandpass and wide FOV filters are not easily achieved, a suitable filter was developed by Rockwell International. The filter consists primarily of sandwiched layers of Cadmium Sulfide (CdS) and polarizing materials (Figure 8). CdS is a highly dispersive birefringent (DBF) material. By combining several stages of these materials of varying thicknesses, the bandpass of the filter can be made very narrow. Because CdS material has a high wavelength dispersion or dependence, fewer stages of the material are required to produce a narrow bandpass filter. This, in turn, allows a wider FOV since increasing the number of stages directly reduces the FOV. By using CdS material, Rockwell was able to produce filters with 0.18 nm bandpass and a near hemispherical FOV for the aircraft -receiver. To maintain a constant center frequency the CdS filters must be temperature stabilized. The optical head is insulated and a mineral oil coolant flows around the filters maintaining a constant temperature of 31°C. The temperature dependence (0.07 nm/C) of the filter allows tuning within a limited range of optical signals. This range is limited to frequency doubled Nd:YAG laser (0.53 nm) transmitters. The signal processor package and receiver are shown in Figure 9.



**Figure 8 Optical Filter module and Exploded View**



**Figure 9 Optical Detector Package**

**Conclusions:** The STAR project was a complicated test requiring the coordination and interaction of many personnel from the Navy, Air Force, and contractors. The Navy provided the overall test management and was supportive with advice and direction that enabled the Air Force to meet its objectives. The Air Force concentrated its efforts on obtaining data during heavy cloud conditions to perform worst case communications analysis. Despite the unpredictable and continually varying weather patterns encountered, the data collected was significant and has been valuable in assessing the performance of an airborne scattered-light receiver.

The STAR project has demonstrated that reliable all-weather communications to low flying aircraft can be implemented given the development of the more complex transmit system. It is not unreasonable to envision a joint Navy-Air Force program to establish a world-wide coverage capability for shared communication functions. Airborne receivers would be easily sized to fit all airframes and less expensive than comparable radio frequency receivers when mass produced. While worldwide coverage would require a constellation of satellites, a dual service program is an attractive cost effective approach, smaller area coverage could be achieved by individual services through use of RPVs. There is no reason the transmitter used during the STAR project XeCl laser could not be further developed to meet communications or payload requirements for RPV applications.

**References:**

Feldman, Robert, **All-Weather Laser Communications to Airborne Platform**; TTCP Panel S-6; Malvern, England, October 1985

Fisher, 1Lt Kirk L., **Scattered-light Test Airborne Receiver First Interim Report**; AFWAL-TM-84-25; WPAFB, Ohio; 30 December 1984.

Fisher, 1Lt Kirk L., **Scattered-light Test Airborne Receiver Second Interim Report**; AFWAL-TM-85-04; WPAFB, Ohio; 31 March 1985.

Fisher, Capt Kirk L., **Scattered-light Test Airborne Receiver Third Interim Report**; AFWAL-TM-86-04; WPAFB, Ohio; 12 March 1986.

Fisher, Capt Kirk L. and Robert Feldman, **Scattered-light Test Airborne Receiver Fourth Interim Report**; AFWAL-TM-86-27; WPAFB, Ohio; 2 December 1986.

King, A.R., **Cloud Modeling Requirements of Pulsed Laser Communications**; DTIC AD-A223-962; NOC, San Diego CA; July 1990

Kotzain, Capt Michael J. and 2Lt Christopher J. McCormack, **Scattered Light Test Airborne Receiver (STAR) Flight Test Summary**; 4950-FTR-85-8; WPAFB, Ohio; October 1985

Lentell, R., **Optical Transmission Through Clouds**; NOC-TD-1658; Titan Systems, San Diego CA; September 1989

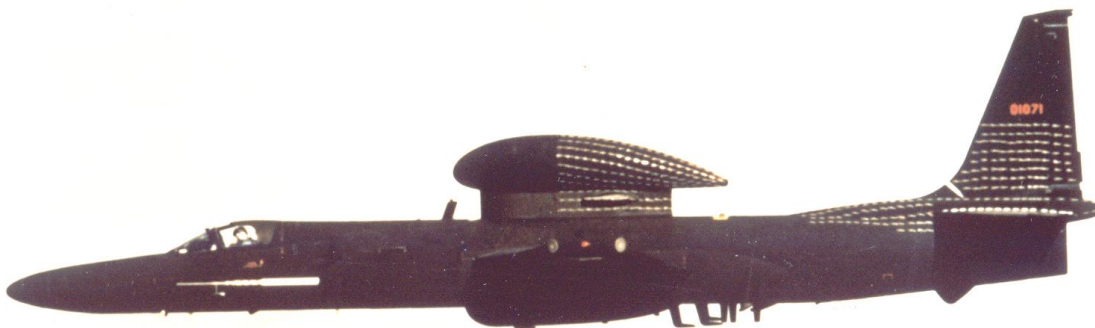
Morgiewicz, R.H., J.R. Lentell, G. Lee, C Waldman, J Puschell; **SLCAIR Final Report Vol 1 & 2**; Titan Systems Reports TLJ-87-2373 and TLJ-87-2374; San Diego CA; 1987



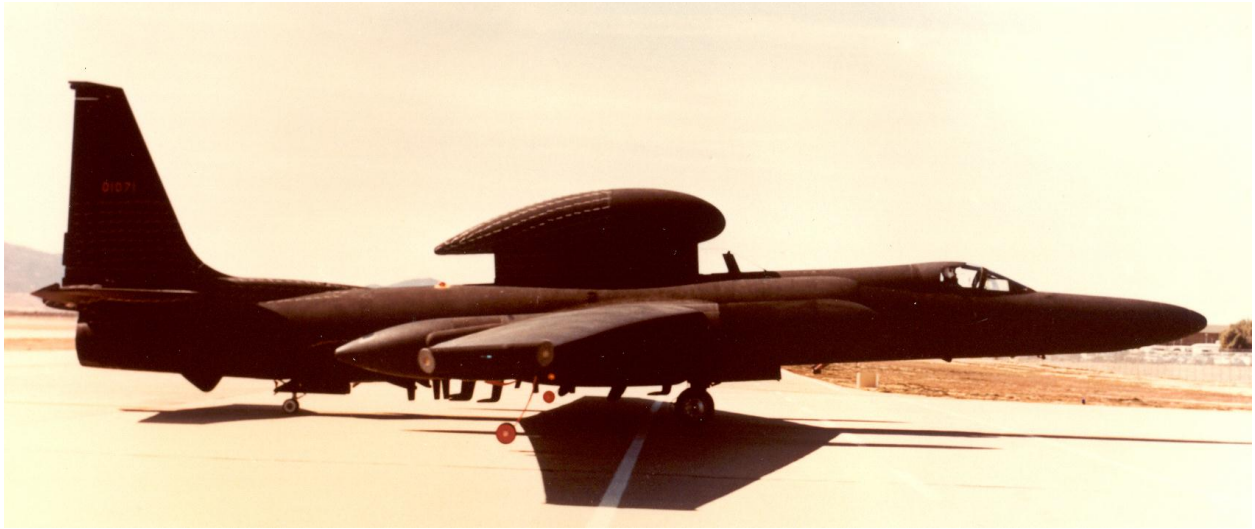
## **SHF Satellite Communications Transitioned to the Senior Year TR-1 Aircraft (1981-1982)**

**Background:** In the early 1970s, the Air Force Avionics Laboratory developed, tested and transitioned a Super High Frequency (SHF) satellite communications system to the National Emergency Airborne Command Post E4B aircraft program. In the early 1980s, when the Senior Year program office decided to add satellite communications to their TR-1 reconnaissance aircraft, they contacted AFAL and requested support in transitioning the SHF SATCOM technology to their program. An AFAL engineer was read in to the Senior Year program, and he helped the Senior Year engineers write the specifications for an SHF SATCOM terminal to be flown on the TR-1 aircraft.

**Result of the Transition:** The Senior Year program office contracted for the SHF SATCOM system using the AFAL-developed statement of work. The resulting terminal, built by Sperry, employed a 30 inch steerable parabolic dish, a 1 KW X-band transmitter and a low-noise receiver to communicate through the DSCS II/III satellites. The terminal was housed in 17-foot long tear-drop shaped radome mounted on a pylon above the aircraft's center fuselage. The radome was developed under the Senior Span program. The satellite communication system was known as the Span Data Link. It was employed to relay SIGINT data through the DSCS satellites to ground processing station from sensors such as the Airborne Reconnaissance Ground SIGINT System (ARGSS) at data rates of up to 12 Mbps.



**TR-1 flying with Senior Span Data Link**



**TR-1 with Senior Span Data Link**



**SHF SATCOM Terminal for Senior Span Data Link**

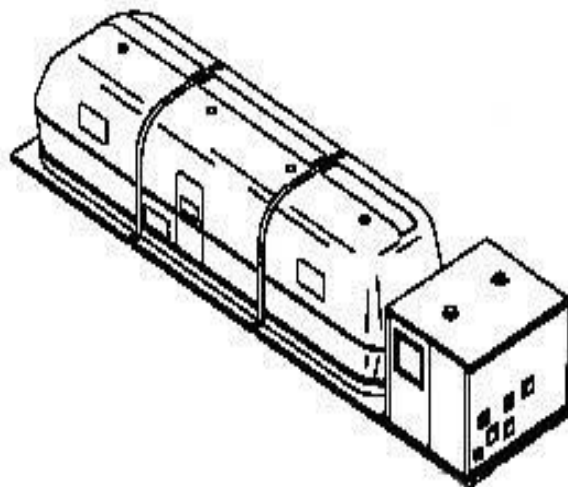
## Silver Bullet (1995-2005)

**Background:** The Distinguished Visitor (DV) or Senior Leader airborne communication mission started in the early 1990s when a requirement to transport the Secretary of Defense, the Joint Chief of Staff or other high ranking DVs into and out of a high-threat or austere environment was needed. Air Mobility Command, working with combatant commanders, developed a mobile command and control module that could be loaded onto a C-141 aircraft to provide long-range transportation with a robust global communications capability. The C2 module was a palletized Airstream trailer, with an embedded communications suite, and became known as the Silver Bullet. Two Silver Bullets were developed by the Air Force Research Laboratory's System Avionics Division, Information Transmission Branch. One was stationed at McGuire AFB NJ and the other at Yokota Air Base, Japan.

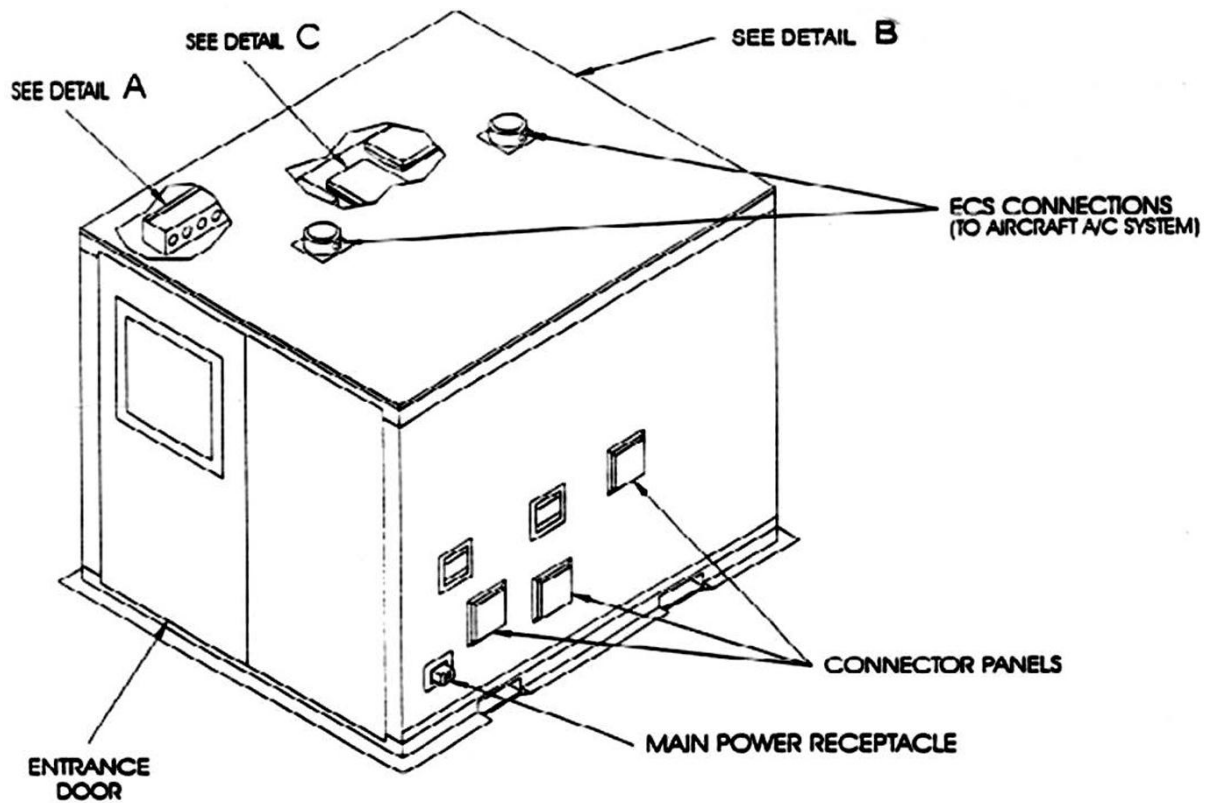
In the mid-90s, both Silver Bullets received a separate Command and Control Module (CCM) to provide UHF/VHF communications and commercial satellite voice and data services. In 1998, the capability to transport the Silver Bullet was expanded to include the KC-10, and then expanded to the C-17 in 2000. In late 2005, the Yokota Bullet became permanently assigned to McGuire AFB NJ.

The Silver Bullet is literally an office in the sky with a full suite of command and control capabilities spanning all entities of the U.S. government and military. People who use the Silver Bullet include the vice president, secretary of defense, secretary of state, chairman, joint chiefs of staff, members of Congress and many of the combatant commanders.

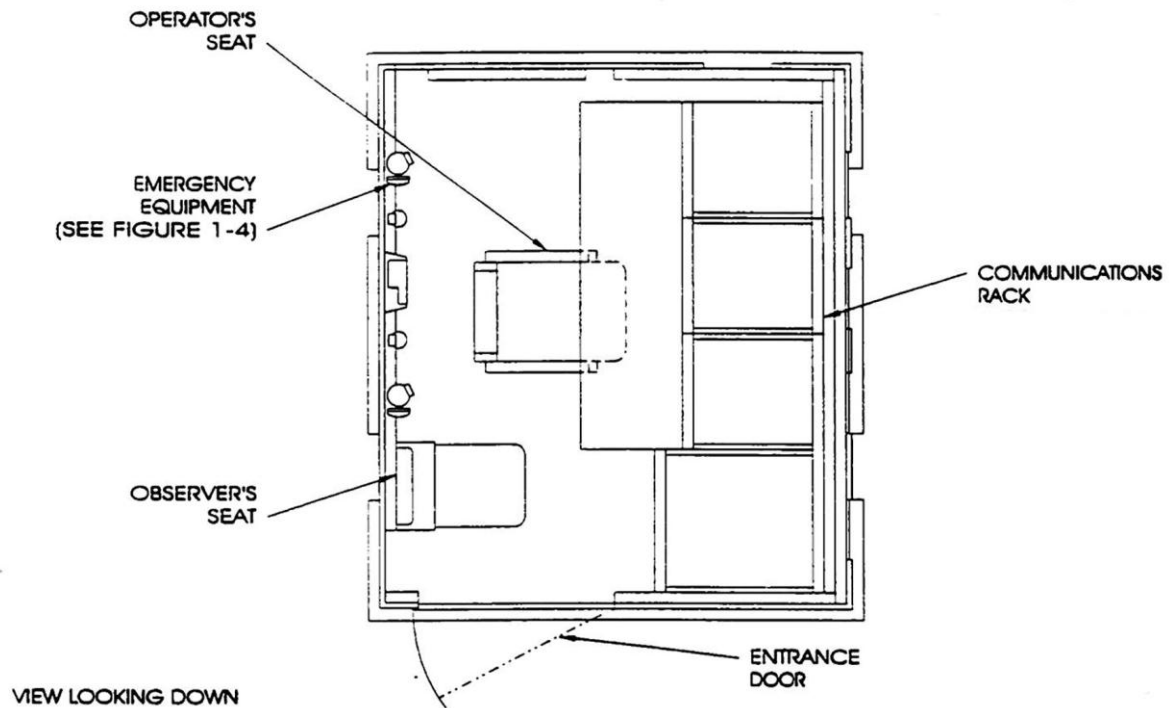
**Description:** The Command and Control Module (CCM) is comprised of three separate sections installed on standard airdrop pallets. Each section has the ability to communicate via STE secure telephone for INMARSAT/intercom or over UHF SATCOM/HF by utilizing separate beige handsets. The Communications Station Operator (CSO) controls each of these phones from the Communications Station (CS). The CS has provisions for one primary operator and a jump seat for one observer.



**Silver Bullet and Communications Module**



**Communications Module**



**Top View of Communications Module**



The CS contains equipment for conducting secure voice and data over UHF SATCOM, non-secure and secure voice and data over INMARSAT, and provides personal computer file transfer, facsimile/copier/printer/scanner capabilities, and access to the host aircraft's HF and intercom systems. Other amenities include a shredder for destroying up to and including top secret material, a safe and storage areas. The CS also contains circuit breaker panels, frequency converters, transformer/rectifiers and monitoring capability for power distribution.

The concept of operations provides the CSO with the ability to intercept all incoming requests for service. All incoming INMARSAT, HF, and UHF SATCOM traffic will be handles and distributed by the CSO. All UHF SATCOM outbound services are also managed by the CSO. The DV and staff have the ability to conduct their own outgoing PABX using certain dial commands. The DV can bypass the CSO to place his/her own calls.

**Hi-Speed Upgrade Accomplished In 2004:** In December 2004, the Silver Bullet Communications Module was upgraded to include the Honeywell MSC-7000 System to increase the Silver Bullet's communications capability from one high speed L-Band channel to two simultaneous L-Band channels over the Swift64 INMARSAT System. The upgrade included the addition of the HS-702 High-Speed Data System to the existing Honeywell SARS hardware, the Diva LAN ISDN Modem, the Scotty Adapter and a High-Speed Patch Panel. The Ricoh Secure Fax was removed and the Cryptek Secure Fax installed in its place.

## SKYNET-4 Satellite Antenna Null Investigation (1985-1989)

**Background:** Through The Technical Cooperation Program (TTCP), an international governmental program to share military research results between the US, United Kingdom (UK) Australia and Canada, the UK became aware of Wright Research and Development Center's (WRDC) unique airborne SHF SATCOM terminal and test capabilities. As the development of the UK's SKYNET-4 satellite proceeded, the Royal Signal and Radar Establishment (RSRE) at Defford, England began planning the on-orbit testing of the satellite. RSRE contacted the WRDC to determine if arrangements could be made through TTCP's Space Communications Panel (STP-6) for WRDC to assist in measuring the pattern of a special SHF antenna on SKYNET-4 during the post-launch satellite drift. WRDC agreed to use the 4950th Test wing aircraft C-135/372, equipped with an AN/ASC-30 SHF terminal to assist in evaluating the SKYNET-4 special antenna. This effort was accomplished under the Advanced Space Communications Program Element PE63431F, Project 1227, Work Unit 12270313, SATCOM Flight Test.

The SKYNET-4 satellite was a three-axis stabilized package with an initial on-orbit mass of slightly less than 800 kg. The spacecraft power was 1.2 kW and solar array span 16 m. The communications payloads include three X-band transponders and two UHF transponders.

The satellite's special SHF antenna was designed with an anti-jam feature that nulled out uplinks SHF signals coming from the Warsaw Pack area of Eastern Europe once the satellite was on its final orbital station. Since it would be difficult for WRDC to obtain permission to fly over that area during the Cold War, RSRE requested WRDC measure the antenna pattern as the satellite drifted from its Pacific injection location to its final orbit in the Atlantic. That made the timing of the measurement very critical, with only a few-day period from the time the satellite became visible to UK's Defford ground station and when the null would be over Eastern Europe.



SKYNET-4 Satellite

**Test Preparation:** Test planning for the SKYNET-4 special antenna pattern measurements (DAYTON VENTURE) started in 1985. The first launch of SKYNET-4 was planned for 1986 aboard the US Shuttle. Due to the Shuttle launch delay, the first launch turned out to be from French Guiana

on the Ariene-4 rocket. As the launch approached, dry-run tests of the UHF order wire and SHF link were undertaken by WRDC. The test procedures required WRDC's SHF transmitter to control the transmitter power so a known power flux density would arrive at the SKYNET-4 satellite. To accomplish this, WRDC used an automatic, computer-controlled test set-up (HP-9826) to calculate and adjust the uplink power. The raw transmit power had to be adjusted for the variable aircraft antenna radome attenuation and path length variation between the aircraft and the satellite. WRDC recommended a procedure for controlling the transmit power to mask the satellite's antenna gain. The procedure involved varying the uplink power in inverse relation to the expected antenna gain, so the downlink power would remain relatively constant. RSRE felt that procedure might make it difficult to interpret the computer-controlled receive signal at RSRE and to determine the gain of the special antenna in real time. RSRE requested WRDC transmit a randomly varying uplink power while returning to a fixed, high power level once every five minutes. That was the procedure used for the test. To aid the tester in coordinating the expected power level at the satellite over a noisy order wire link, word identifiers were assigned for the numerical power levels.



#### **4950<sup>th</sup> Test Wing Aircraft C-135/372 with SHF SATCOM Capability**

The WRDC test plan and Ops Directive were prepared prior to the first flight. Approval was obtained from the Foreign Disclosure Office (ASD/XRID Case OSXOF7011C) to distribute the raw test data to the UK. Frequency approval was obtained through ASD/SCNU to transmit over Canada, the Azores, and Greenland.

**Test Funding:** Because of the large expense associated with flying the test aircraft in support of the SKYNET-4 test, the UK agreed to provide test funding to WRDC. The final arrangement for the funds transfer involved a MOU between the UK, and Canada where Canada would be given operational time on the SKYNET-4 satellite and, in return, they would provide funds directly to WRDC. Arrangements were completed and a check sent from Canada to WRDC on 28 Nov 88. When the check was received, a Project Order was sent from WRDC to the 4950TW to cover the aircraft expenses.

**Flight Test Routes:** The SKYNET-4 was successfully launched on 10 Dec 88 aboard the French Ariene-4 rocket from French Guiana. On 24 Dec, the satellite's SHF beacon was switched on and received by RSRE at Defford and WRDC at WPAFB OH. Around 03:00Z on 28 Dec, the satellite's SHF transmitter was switched on and the test configuration confirmed by RSRE. At 0915Z on 28 December 1988, WRDC's test aircraft took off from Wright Patterson Air Force Base OH for the first leg of the test flight to Iceland where the aircraft landed. On 30 Dec, the test aircraft flew from Iceland to the Azores and on to Mildenhall, England. On 3 Jan 89, a test coordination meeting was conducted at Defford to exchange test data and discuss results. On 5 Jan, the test aircraft flew from Mildenhall back to WPAFB concluding the SKYNET-4 test.

**Conclusions and Recommendations:** The measurement results agreed closely with the anti-jam null simulation results obtained before the satellite launch. The successful accomplishment of the SKYNET-4 test by RSRE and WRDC was the result of several years of test preparation, an extensive over-the-air sequence of dry-run tests, and a Herculean effort of RSRE/WRDC personnel during the test measurement period. During the post test critique, the method of varying the uplink power was again discussed and it was agreed by both RSRE and WRDC that the test results could be better concealed by varying the uplink power in inverse proportion to the uplink antenna gain. That would result in the downlink power remaining relatively constant. If the test is repeated for another SKYNET-4 launch, the constant downlink power procedure will be implemented.

**Reference:** Johnson, Allen L., **SKYNET-4 Test Results**; Wright Research and Development Center; WRDC-TM-89-05; WPAFB OH; 27 March 1989.



## **Steel Eagle (2005-2011)**

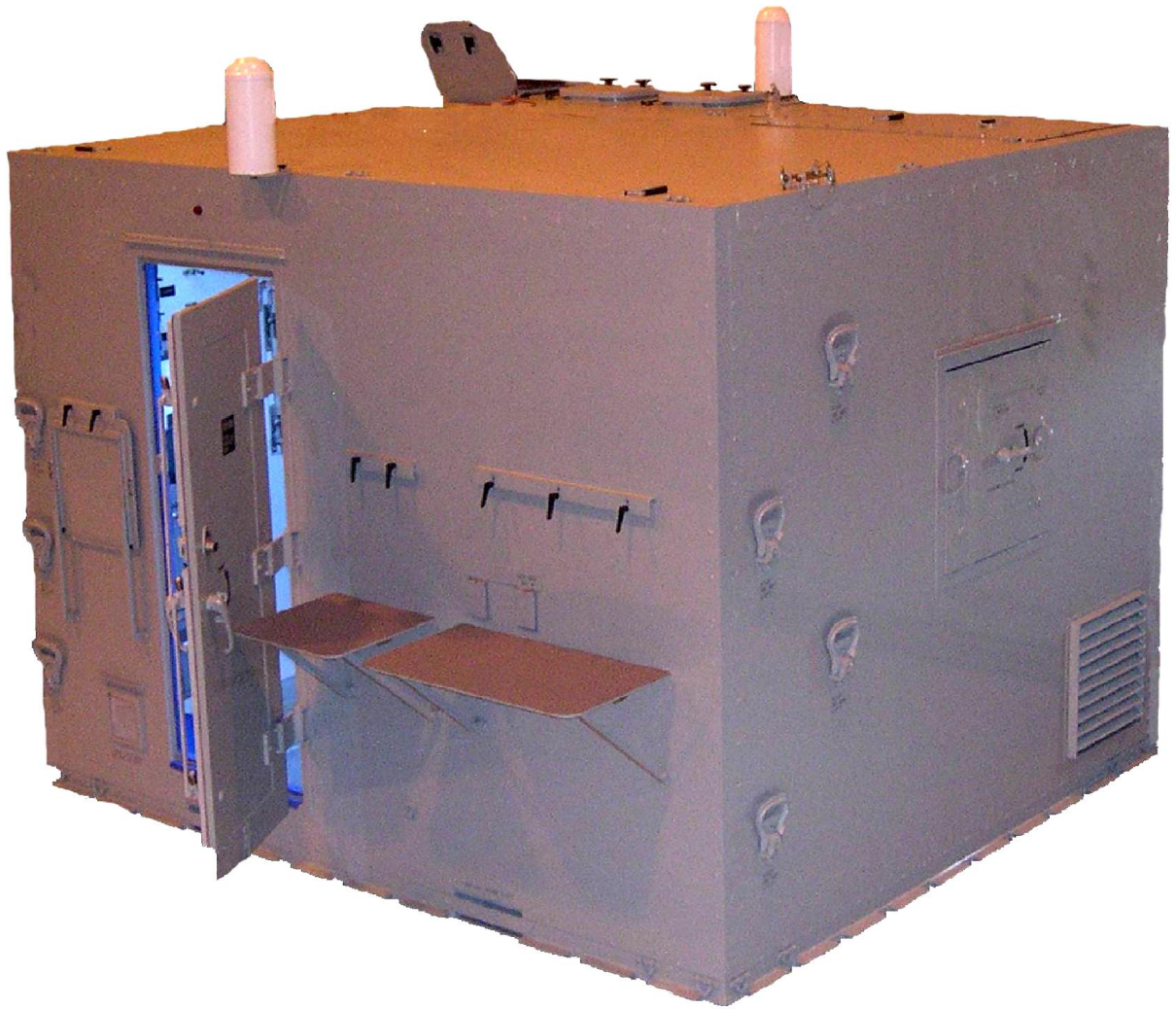
**Background:** The Office of the Secretary of Defense directed the Air Force Research Laboratory in 2005 to develop a transportable Command, Control and Communications Module (CCCM), called Steel Eagle, to replace the aging Silver Bullet CCCM and provide that vital function for the Secretary and Deputy Secretary of Defense, Chairman of the Joint Chiefs, and other Senior Leaders aboard modified military cargo aircraft (KC-10s and C-17s) when they travel overseas to or within the CENTCOM Areas of Operational Responsibility (AOR) or other high risk areas. This effort was under PE2742F, Advanced Communications Systems, Project 5227 – Steel Eagle.

**Steel Eagle Module:** The Steel Eagle Systems are designed to provide the next generation of modular Command and Control Communications capability for Senior Leaders traveling into hostile areas on modified C-17 and KC-10 cargo aircraft. The system is designed to provide a full suite of command and control capabilities spanning the major entities of the U.S. government and military by providing high-bandwidth, global, secure communications via the INMARSAT and military UHF Satellites.

The shell of the Shelter was constructed by AAR Mobility Systems (AAR Mobility), Cadillac MI. The basic shelter is 125-inches deep by 104-inches wide by 92 inches high. The frame is constructed of structural aluminum with three fixed walls and one removable wall. The rack wall is removable to allow the four equipment racks to be removed as one unit.

The Honeywell MCS-7200 INMARSAT terminal is an L-Band SATCOM system designed to provide up to 256Kbps connectivity for secure voice and secure Video TeleConference (VTC) into commercial Land Earth Stations (LES). The LES, in-turn, provides access to the World Wide Web, Public Telephone Networks, and ISDN circuits. The military UHF SATCOM use a pair of Raytheon ARC-231 radios through the UHF Follow-On (UFO) satellites into military ground entry stations to provide secure voice and data communications.

**Coverage:** The Steel Eagle Systems will provide world-wide operation through the INMARSAT satellites. The INMARSAT Land Earth Station (LES) locations will route the communications through the appropriate land line systems. The military UHF satellites and ground entry station will receive and relay the UHF communications.

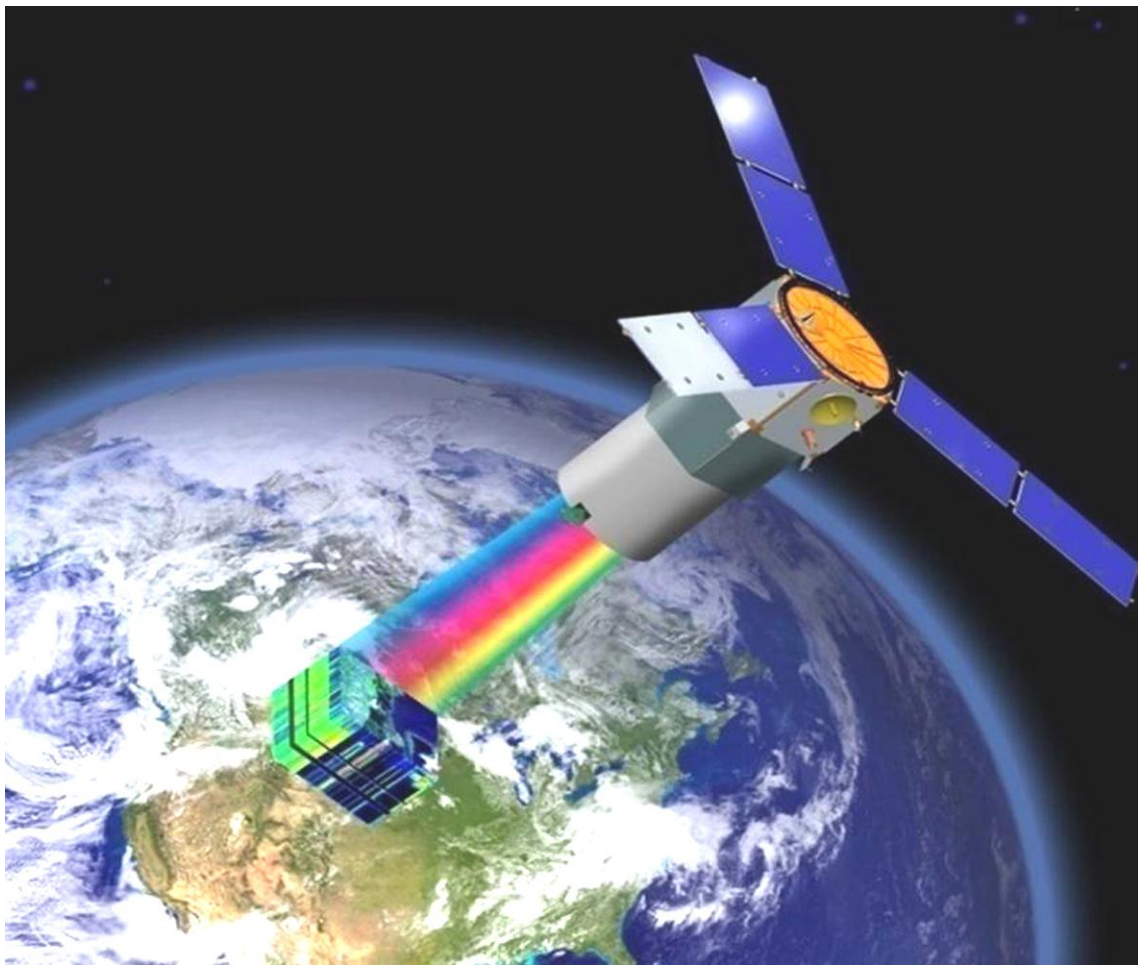


**Steel Eagle Command and Control Module**

## TacSat-3 Tracking and Downlink Reception (2006-2011)

**Background:** While satellites have been taking photos for intelligence purposes for 50 years, programming what to take photos of, commanding the satellite and retrieving the information usually takes weeks. A new breed of satellite is in development which would allow commanders in the field to request multi-spectral images in real time and get the results in minutes as they prepare an assault.

**TacSat-3 Multi-spectral Satellite Support.** The TacSat-3 satellite, Figure 1, was launched on 19 May 2009 from Wallops Island VA into a low earth orbit. The satellite carries a multi-spectral imaging device that can distinguish around 200 different “colors” or spectral lines with amazing clarity. The hyper-spectral capability allows the sensor to distinguish between the green of a tree, green paint on a truck, or a green building. It will allow analyst to distinguish between a field freshly planted with wheat, a mass grave or a freshly planted Improvised Explosive Devise (IED).

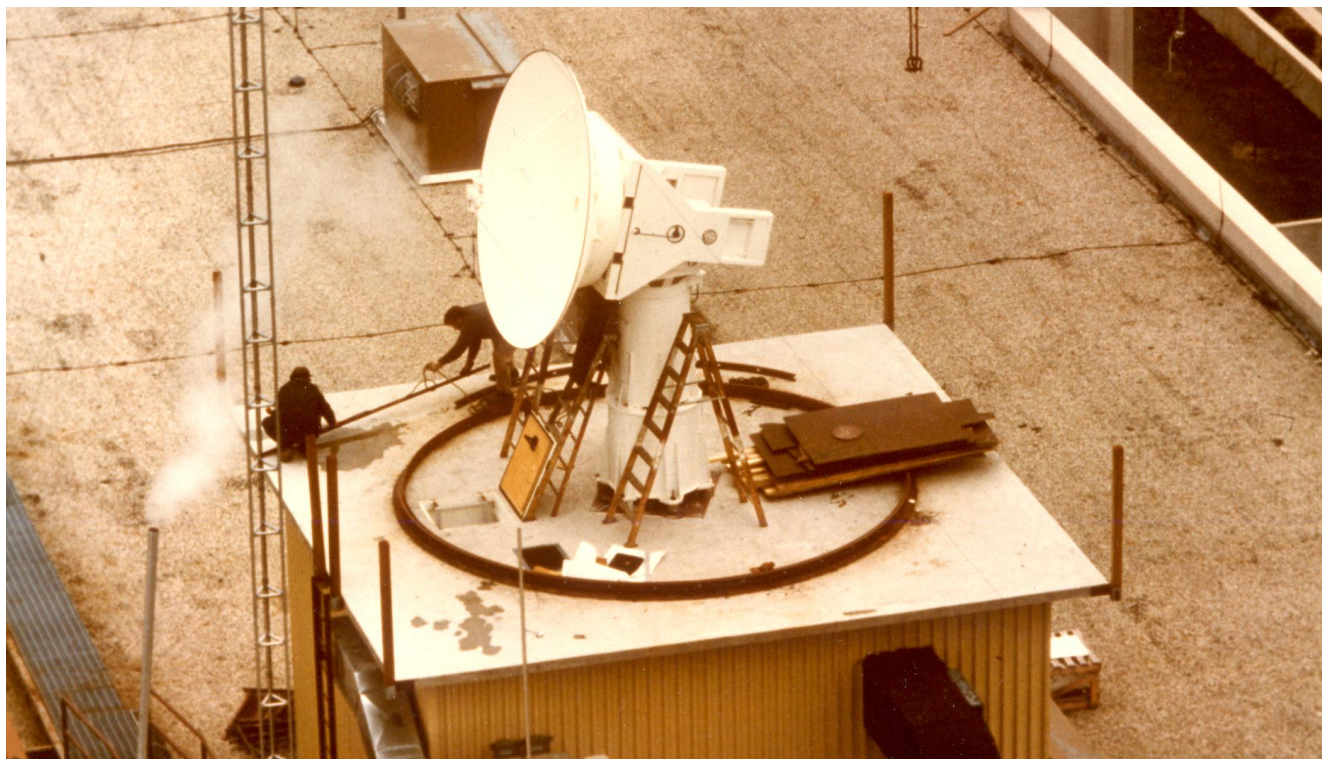


**Figure 1 TacSat-3 Hyper-Spectral Satellite**

The TacSat program office requested the Air Force Research Laboratory (AFRL) at WPAFB OH act as the major ground entry point to extract data from the TacSat-3 as it passed overhead. AFGL/RVAA preformed a manor upgrade of the 10-foot antenna, Figure 2, in AFRL’s Rooftop Facility to operate



with TacSat's 9 GHz downlink and 15 GHz uplink. A TacSat ground station was installed in the Rooftop and a secure data link run to another AFRL organization to process the received data.



**Figure 2 AFRL's 10-foot Rooftop Antenna was Upgraded for TacSat -3**

Following the satellite launch, AFRL personnel manned the ground station on 24-hour basis when satellite data dumps were scheduled. The TacSat program office reported AFRL captured valid data on a high percentage of the satellite passes. The success of this demonstration program should lead to a valuable operational system in the near future.



## Tactical Satellite Communications - Project 591 (1965-68)

**Background and History:** In order to provide improved military beyond-line-of-sight communications, in 1965 the Director of Defense Research and Development (DDR&E) requested the military departments investigate the use of a communication satellite repeater in the military UHF band to support a variety of tactical terminals including aircraft, ships, submarines, and ground vehicles.

The use of a satellite relay for communication to military aircraft was considered in 1960 (Project Steer). The effort was redirected, however, to microwave frequencies for ground terminals (Advent). NASA began experiments with satellite communication in commercial aircraft in the VHF band in 1964 using the command and telemetry channel of Syncom II, and continued the experiments with the ATS series of satellites.

Project 591 was originally authorized by the Department of Defense in 1965 as a low cost demonstration of the feasibility of using low data rate communication via satellite relay between aircraft of the USAF Strategic Air Command. As the program progressed, the Army, Navy, and other Air Force commands were invited to participate.

Although the principal program effort involved transmissions through the MIT Lincoln Laboratory LES-5 satellite relay, a significant amount of data relevant to the objectives was acquired by other means, including airborne recording of noise and interference, library research on global frequency allocations in the pertinent part of the RF spectrum, and airborne recording of UHF beacon transmissions from the LES-3 satellite.

**Feasibility Demonstration:** To support the feasibility demonstration, the Aeronautical Systems Division (ASD) and the Air Force Avionics Laboratory (AFAL) were directed in 1965 to develop and fly a UHF airborne terminal that could operate through the LES-5 satellite and determine the reliability of airborne satellite communications. ASD and AFAL contracted with the Electronics Communications Incorporated (ECI) in St. Petersburg FL for a flyable UHF satellite communications system. ASD/AFAL also developed a circularly polarized antenna, called a loop V, housed in a fiberglass radome and installed on top of the fuselage of a B-52 bomber and C-135 tanker. A standard UHF blade antenna was also installed for comparison measurements. Because of the satellites limited transmit power, the communications link would only support 60-word per minute teletype traffic. A Kleinschmidt FGC-80 keyboard, tape punch, tape reader and printer were also installed in the two test aircraft.

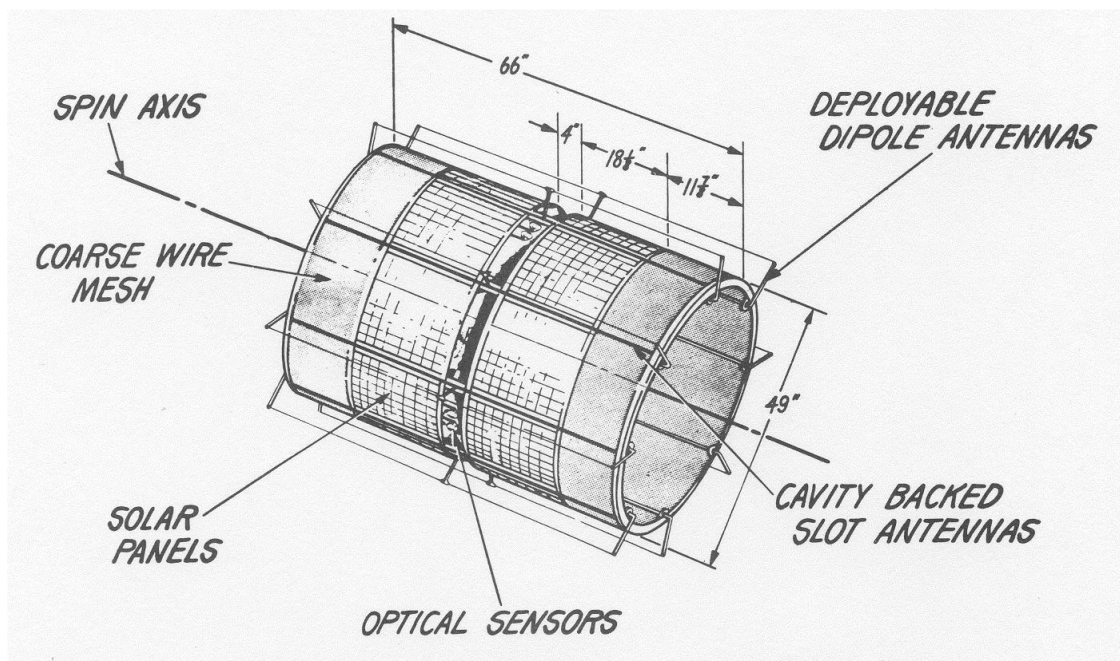
**Satellite Description:** The physical characteristics of the LES-5 are given in Table 1. A descriptive drawing of the satellite, indicating the antenna position as well as the various dimensions is given in Figure 1 and a photograph of the satellite in Figure 2. Power budgets for the uplink and downlink of a typical aircraft-to-satellite link based upon these characteristics are presented in Table 2.

The satellites antenna system receives and transmits signals with nominal Right Hand Circular Polarization (RHCP). The component of E parallel to the spacecraft is provided by eight center-fed dipoles, which are deployed from their stowed position. The orthogonal component of the E vector is provided by eight cavity-backed slot pairs. The members of each pair lie above and below the sensor view band.

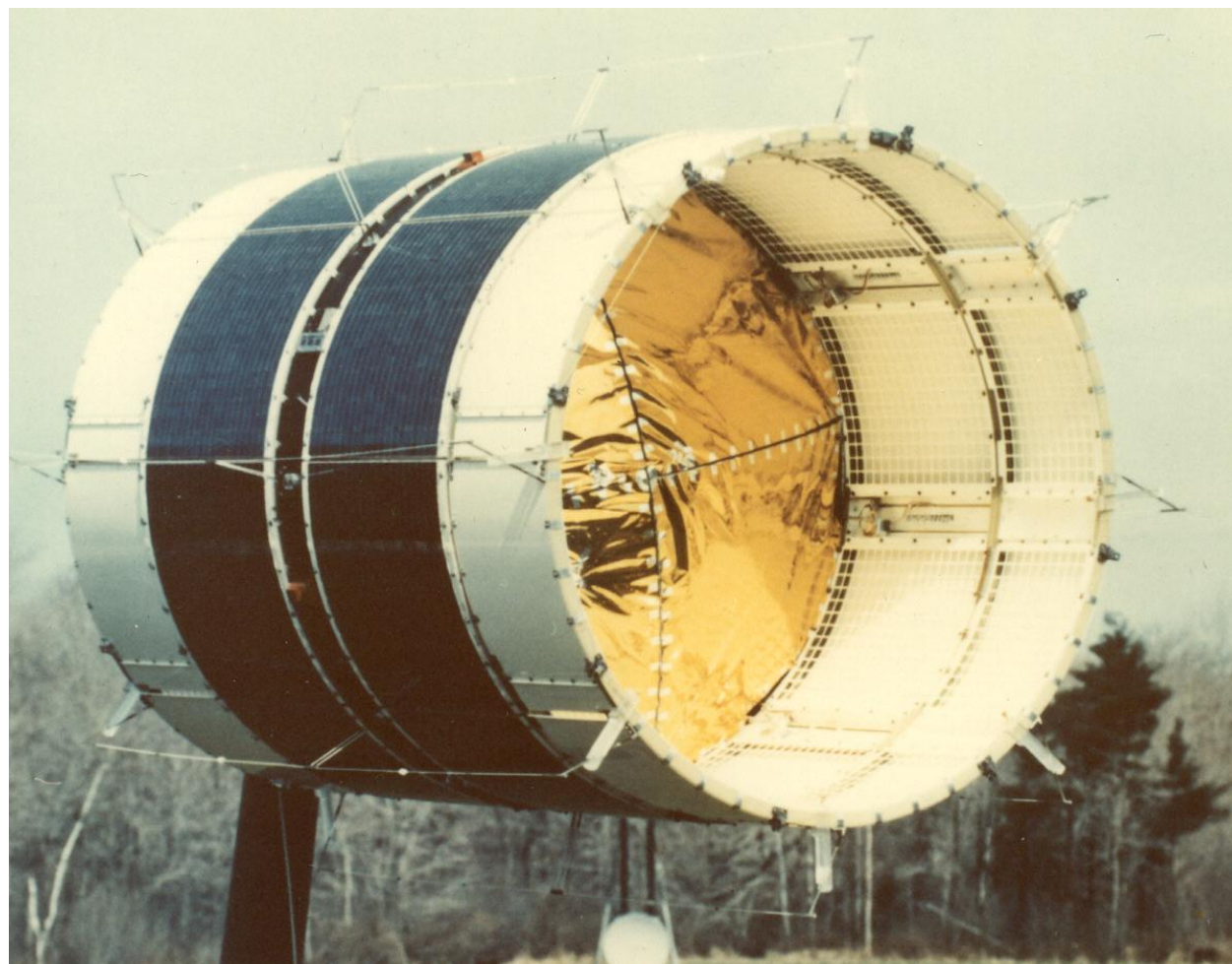
The uplink signals, band centered on 255 MHz, are received and separated by the triplexer from the downlink and telemetry signals. After amplification and filtering, they are mixed with the 222.5 MHz local oscillator to obtain an IF of 32.6 MHz, where two crystal bandpass filters with nominal

PHYSICAL CHARACTERISTICS		
Weight	225 lb	
Size	Cylindrical, 48 in. diam X 66 in. length	
COMMUNICATION CHARACTERISTICS		
Downlink	Transponder	Beacon
Center frequency	228.2 MHz	228.43 MHz
Frequency translation or offset	---	~-100 Hz
Before 24 Jan. 1968	~-150 Hz	
After 24 Jan. 1968	~+1700 Hz	
Nominal bandwidth	100 or 300 kHz (switchable)	800/sec biphase modulation of carrier
RF power	45 W	3.5 W
Antenna		
Polarization	RHCP	RHCP
Gain, satellite equator	2.5 dB	2.5 dB
Gain, 7 deg off beam	2.0 dB	2.0 dB
3 dB beamwidth	37 deg	37 deg
Axial ratio, worst case	3 dB	3 dB
Telemetry power	28.6 dBm (0.72 W)	
Antenna gain @237 MHz	-0.5 dB	
ERP	28.1 dBm (0.64 W)	
Uplink	Transponder	
Center frequency	255.1 MHz	
Receiver sensitivity		
Before 18 Mar. 1968	-115 dBm (300 kHz) -120 dBm (100 kHz)	
After 18 Mar. 1968	- 98 dBm (300 kHz) -103 dBm (100 kHz)	
Passband ripple (sensitivity variation from that for 225.12 MHz)		
Narrow band (100 kHz)	-1.5 dB (more sensitive) +1.0 dB (less sensitive)	
Wideband (300 kHz)	-2.0 dB (more sensitive) +5.0 dB (less sensitive)	
Antenna		
Polarization	RHCP	
Gain, satellite equator	2.2 dB	
Gain, 7 deg off beam	1.7 dB	
3 deg beamwidth	32 deg	
Axial ratio, worst case	3 dB	
ORBIT CHARACTERISTICS		
Orbit	~18,000 n mi near circular 7 deg inclination	
Drift rate	~32.93 deg per day, eastwardly	
Spin rate	Approximately 10 r/min	

Table 1 Physical Characteristics of LES-5 Satellite



**Figure 1 Drawing and Description of LES-5 Satellite**



**Figure 2 LES-5 Satellite on Test Range at Lincoln Laboratory**

PHYSICAL CHARACTERISTICS		
Weight	225 lb	
Size	Cylindrical, 48 in. diam × 66 in. length	
COMMUNICATION CHARACTERISTICS		
Downlink	Transponder	Beacon
Center frequency	228.2 MHz	228.43 MHz
Frequency translation or offset	---	~-100 Hz
Before 24 Jan. 1968	~-150 Hz	
After 24 Jan. 1968	~+1700 Hz	
Nominal bandwidth	100 or 300 kHz (switchable)	800/sec biphase modulation of carrier
RF power	45 W	3.5 W
Antenna		
Polarization	RHCP	RHCP
Gain, satellite equator	2.5 dB	2.5 dB
Gain, 7 deg off beam	2.0 dB	2.0 dB
3 dB beamwidth	37 deg	37 deg
Axial ratio, worst case	3 dB	3 dB
Telemetry power	28.6 dBm (0.72 W)	
Antenna gain @237 MHz	-0.5 dB	
ERP	28.1 dBm (0.64 W)	
Uplink	Transponder	
Center frequency	255.1 MHz	
Receiver sensitivity		
Before 18 Mar. 1968	-115 dBm (300 kHz) -120 dBm (100 kHz)	
After 18 Mar. 1968	- 98 dBm (300 kHz) -103 dBm (100 kHz)	
Passband ripple (sensitivity variation from that for 225.12 MHz)		
Narrow band (100 kHz)	-1.5 dB (more sensitive) +1.0 dB (less sensitive)	
Wideband (300 kHz)	-2.0 dB (more sensitive) +5.0 dB (less sensitive)	
Antenna		
Polarization	RHCP	
Gain, satellite equator	2.2 dB	
Gain, 7 deg off beam	1.7 dB	
3 deg beamwidth	32 deg	
Axial ratio, worst case	3 dB	
ORBIT CHARACTERISTICS		
Orbit	~18,000 n mi near circular 7 deg inclination	
Drift rate	~32.93 deg per day, eastwardly	
Spin rate	Approximately 10 r/min	

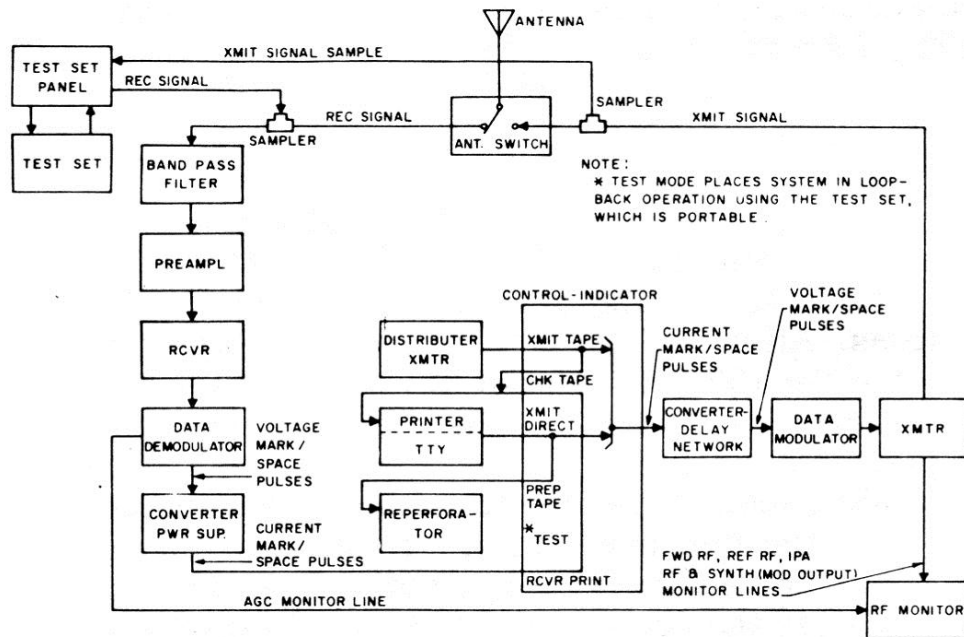
**Table 2 Link Budget for LES-5 Satellite**



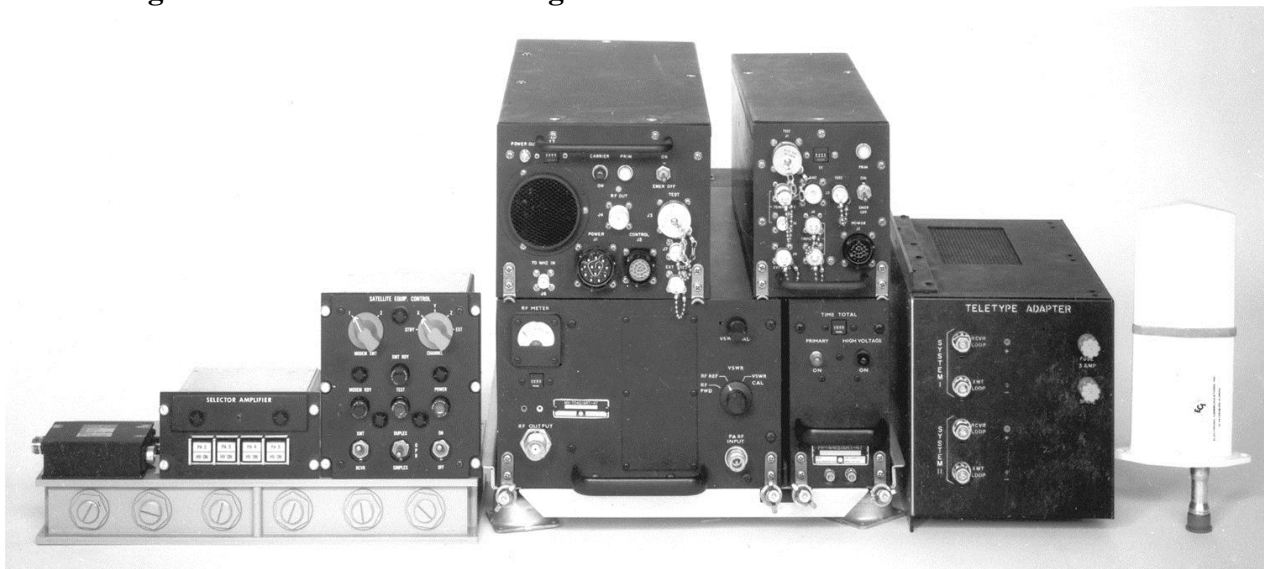
bandwidth of 100 kHz and 300 kHz are command selectable. After linear amplification and bandwidth selection at IF, the received signals enter an IF variable gain amplifier and hard limiter. The limited and filtered IF output is mixed up to RF at the downlink carrier (centered on 228.2 MHz). It is then linearly combined with the narrow band beacon, power amplified, and passed to the antenna by way of the triplexer.

**Terminal Description:** The airborne system consists of a teletypewriter (with tape capability), modulator, one kilowatt transmitter, low gain antenna, preselector filter, low-noise preamplifier (3.0 dB), receiver, demodulator, and control panel.

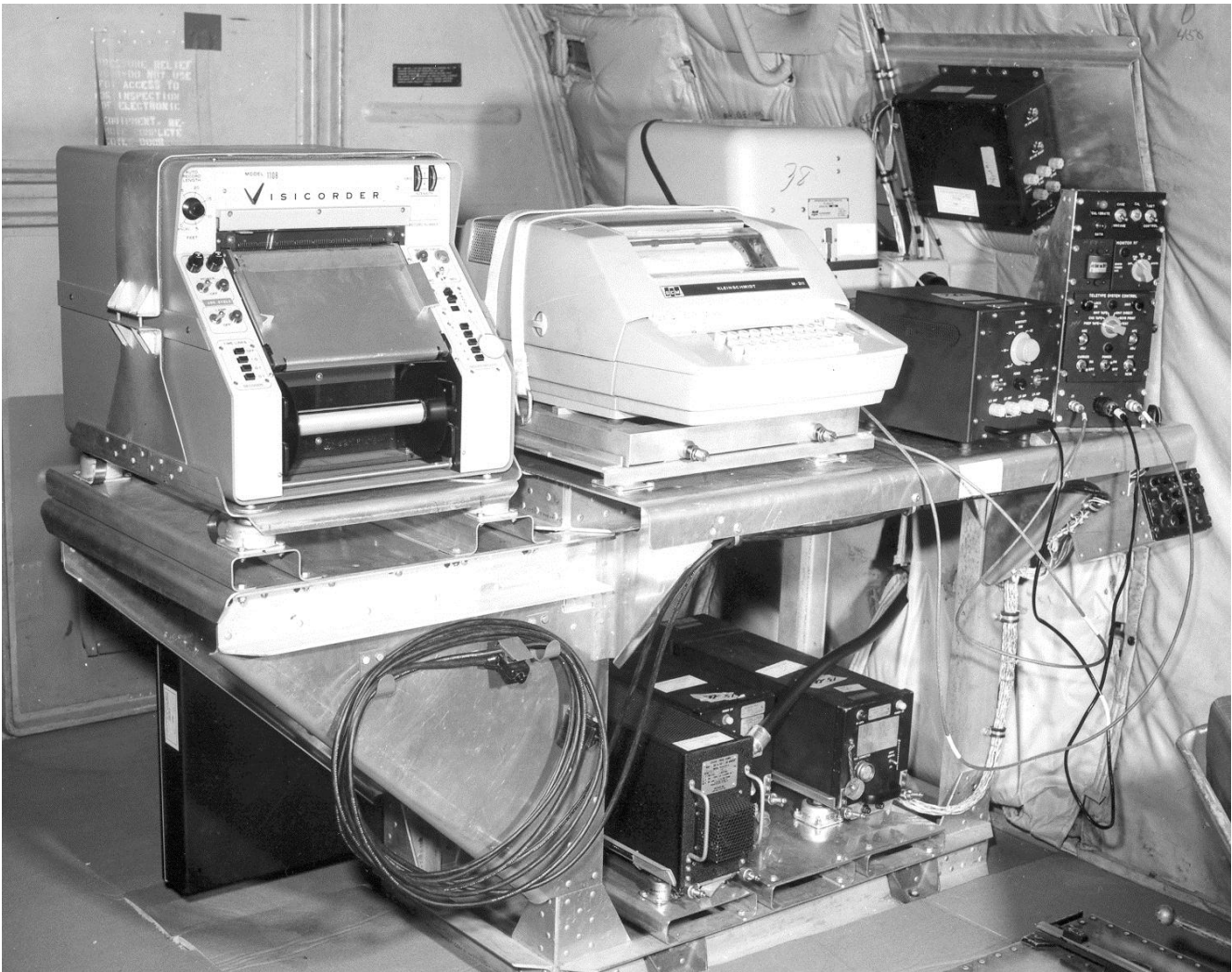
The functional block diagram of the system is shown in Figure 3. A photo of the major components is shown in Figure 4, and the teletype equipment in Figure 5. The HPA is shown on the bottom right. The IPA is on the left with the modulator in the middle. The receiver is shown on the upper left with the demodulator and power supply. The standard UHF blade is shown on the far right.



**Figure 3 Functional Block Diagram of Airborne UHF SATCOM Terminal**



**Figure 4 Major Components of UHF Airborne SATCOM Terminal AN/ARA-64**

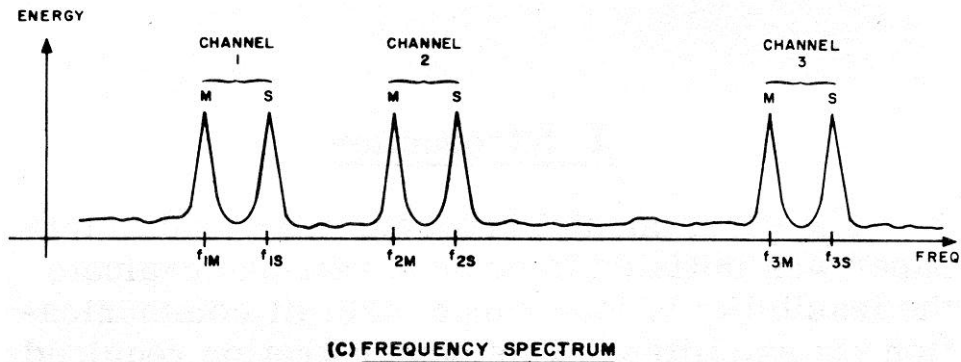


**Figure 5 Project 591 Teletype and Instrumentation Equipment Mounted in Test Aircraft**

The teletype equipment is a standard unit which is capable of both 60 and 100 words per minute and utilizes a 7.42 or 8 unit code. It also has the capability of punching tape and sending tape at the above mentioned rates. The control indicator also has a test function for demonstrating the complete system, except antenna, is performing properly. The terminal's transmit and receive frequencies are not the same; therefore, it is necessary to perform a frequency translation which simulates the satellite. This is accomplished by the test set, shown in the upper left hand corner of the Figure 3.

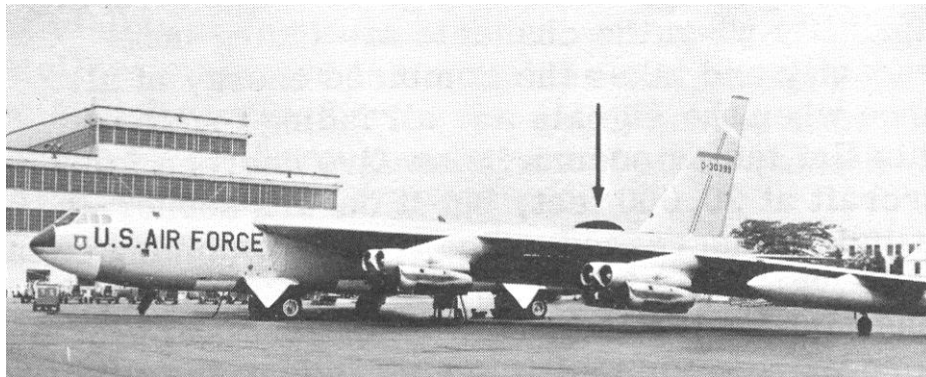
The incoming teletype message to the modulator is re-clocked and the 7.42 code is converted to an alternating 7 and 8 code. This results in a uniform bit stream which is split up into three chips, one chip for each channel. Each bit is transmitted on three different frequencies for a duration of one-third of the bit length. The six keying lines are used to key on their appropriate oscillators as shown by the frequency spectrum in Figure 6. The six oscillators have to be very stable to maintain their relationship to allow each frequency to be filtered individually by fixed filters.

The output of the Data Modulator is used to drive a standard UHF airborne transmitter which contains a times four multiplier in the IPA. The Power Amplifier (PA) has an output power of one kilowatt and is tunable over the 225 to 400 MHz frequency range.

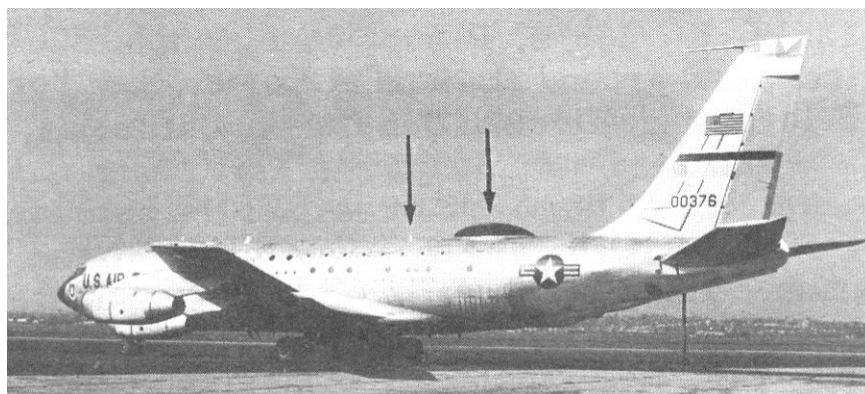


**Figure 6 Triple Diversity Modulation Scheme**

Several antennas were tested, including the standard UHF blade and a circularly polarized loop-vee. The circularly polarized receive antenna was essential in the early phases of the program when the availability of a circularly polarized transmission from the satellite was in doubt. When it was determined that it would be possible to put a circularly polarized antenna on LES-5, it made it possible to use a simple blade on the operational aircraft. The radome that is required for the loop-vee is 155 inches long; this was objectionable to some operational units. The loop-vee with radome is shown mounted on a B-52 aircraft in Figure 7. A standard UHF is shown just in front of the loop-vee on the C-135 aircraft in Figure 8. It can be seen from this example why antenna considerations are important for aircraft terminals.



**Figure 7 B-52 Test Aircraft with Loop Vee Antenna Radome**



**Figure 8 C-135 Test Aircraft with UHF Blade and Loop Vee Antenna Radome**

The expected interference and the broadband capability of the low noise preamplifier dictate the use of a good preselector filter. This filter has an insertion loss of approximately 1 dB and provides 75 dB rejection outside the band. The system noise figure was less than 4.5 dB and the preamp has an overload clipper to prevent burnout when a local transmitter tunes across the receive band.

The receiver was fixed tuned and highly stable to permit operation at the required low data rates. It had a triple conversion to obtain the proper filtering and provide an output for an external MODEM. The second IF is 10.7 MHz and has a 100 KHz crystal filter which defines the receiver bandwidth. The second local oscillator is a voltage-controlled crystal oscillator which is part of the AFC loop.

The system frequency uncertainty is greater than the demodulator bandwidth; therefore; it was necessary to perform a frequency scan of  $\pm 2$  KHz. To add to the flexibility of this equipment as a test device, an external frequency adjust pot is available on the control panel. This allows the sweep to be centered or manual acquisition without the sweep. The AGC is derived from three different sources, external control on the front panel, internal to the receiver, and from the DEMOD. The external AGC is for those applications where the receiver is used as a test instrument and the effects of AGC need to be removed. For noise leveling purposes, the internal AGC is normally applied to one stage of the receiver and can be used on all AGC stages when no DEMOD is available. The AGC normally comes from the DEMOD where the C/N is sufficient to give a decent error voltage. The third IF frequency was selected to give a good operating frequency for the crystal filters in the demodulator.

At the receiver IF output, the 100 KHz signal spectrum, plus noise, is centered at 342.5 KHz. This spectrum is applied to the DEMOD where there is a matched crystal filter for each of the mark frequencies and each of the space frequencies. These six filters are selected very carefully and are a matched set. Each one has a noise bandwidth of 200 Hz and is designed to give good time response even if the signal is appreciably off the center of the bandpass. This increases the acquisition and tracking range of the system. The outputs of the filters are used to accomplish four different functions. These functions are interrelated and most of them occur simultaneously. The frequency discriminators provide the error voltage for the AFC loop and the AGC detector provides the error voltage for the AGC loop.

Assuming acquisition has occurred and the timing is proper causes the data detectors to be sampled at the right times. Assuming no noise, the outputs of the envelope detectors will occur in a specific pattern, either three marks in a row, or three spaces in a row. The outputs of these detectors are sampled at the proper time and held until all three chips have been sampled. The three marks are linearly combined (as are the spaces) and differentially compared to determine if a mark or space was received. If the system is locked up the output is shaped and sent to the teletype printer.

The hopping pattern goes from  $M_1$  or  $S_1$  to  $M_2$  or  $S_2$ , to  $M_3$  or  $S_3$ , and back to  $M_1$  or  $S_1$  again. During the time  $M_1$  or  $S_1$  is on, the signal has to be  $f_{1M}$  or  $f_{1S}$  therefore, if these channels are combined, there will always be an output at that time. The same applies to time slots two and three. This results in a specific hopping pattern, minus information. The bit timing phase locked loop then becomes a simple cross-correlation detector which searches until the proper detectors are sampled at the right time. When the loop is locked up it provides timing to look at the right frequency, as well as the proper time during the chip. The loop also provides the properly phased clock pulse for the output teletype data.

The marks and spaces are also similarly combined for the AGC and threshold detection loop. This results in three 45 Hz waves which is characteristic of this system. The channel filters make the waves nearly sinusoidal, but of different phase. A 45 Hz filter is employed to reduce the effects of signals



which do not have this characteristic. The outputs of these filters are detected and the largest signal is used for the AGC loop and the threshold detector. This method has proven to be very effective against nuisance type interference that has bothered other transmissions.

The threshold detector stops the sweep generator and allows the AFC loop to track the incoming signals. The C/N level is improved by gating on the proper channels when the signal is expected to occur. The six crystal discriminators are matched to the six crystal filters.

The linear combining gives triple diversity capability when the channels are fading independently and takes the combined energy of all three when the signals are all fading together. This flat fading occurs below five degrees for an aircraft at 30,000 feet, but it occurs sooner as the altitude is decreased. The linear combining gains 4 dB over selection or switched diversity and is essential for the flat fading situations and provides more margin for multiple accesses to the satellite.

The sweep searches over a  $\pm 2$  KHz band in less than six seconds. The uncertainties have proven to be nearly an order of magnitude less than this so that the sweep range could be reduced considerably. The short term stability of the system is approximately  $\pm 10$  Hz and the long term stability is less than  $\pm 30$  Hz.

These systems were installed in B-52s, EC-135's, KC-135's, P-3's, vans, ships, submarines, and ground stations at Rome, New York; St. Petersburg, Florida; San Diego, California; Fishers Island, Connecticut; and Fort Monmouth, New Jersey. At least one of each of the above types of stations contributed significantly to the program. The C-135 stationed at Wright-Patterson (shown in Figure 8) was used to collect the major portion of the data for the airborne tests.

**Instrumentation of the ASD/AFAL Terminal:** Two ASD/AFAL test aircraft implemented with the Project 591 communications system were instrumented to determine the characteristics of the channel. A special connector on the front panel of the demodulator provided an output of all relevant features of the channel, plus other functions to aid in data analysis. Of primary interest are the outputs of the six envelope detectors which provide an excellent point to monitor the channels. The nature of the signal assures there will be a pulse of signal to obtain an indication of signal strength and an absence of signal for determining the relative noise level. This provides a good means to observe the effects of selective fading and the presence of interference.

The message was recorded to determine the error rate and the distribution of the errors. AGC voltage was also recorded to give a measure of the average signal strength and, when applicable, out-of-band noise was also measured.

The instrumentation system consisted of data amplifiers to condition the outputs of the data demodulator, a magnetic tape recorder for use in computer data reduction, and the Visicorder to allow continuous visual monitoring of the parameters and possible hand reduction of the data. The instrumentation system also contained a time code generator and a gyro package such that airplane attitude parameters and time could also be recorded.

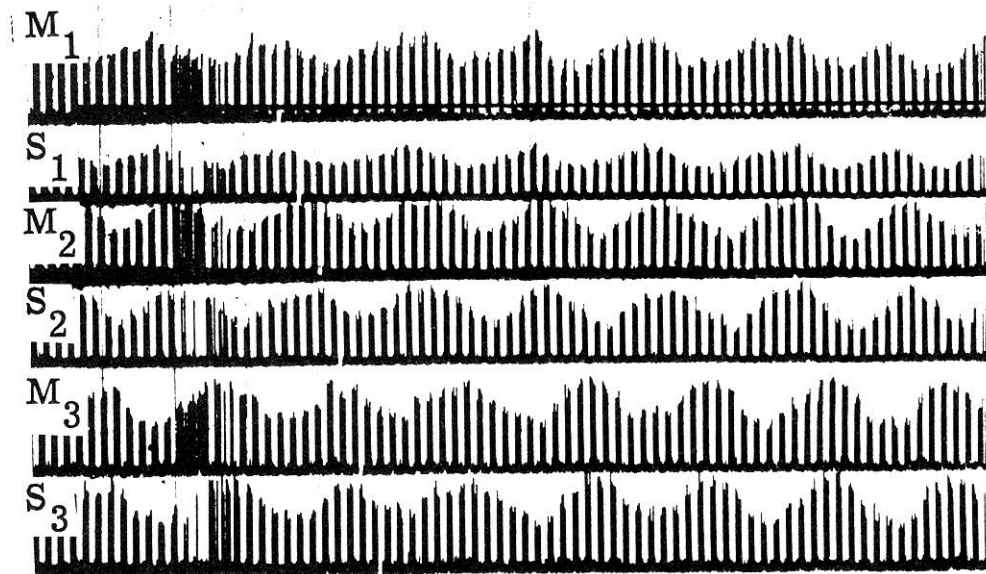
A satellite simulator was built into each system to check system sensitivity. This simulator was also used in some tests when the satellite was not visible and in some cases used in place of the satellite to remove the variables associated with the signal received from the satellite and allow for a much more thorough analysis of other system parameters.

The normal message used in the tests was obtained from a specially designed solid-state teletype simulator. This simulator was synchronized to the clock in the modulator and was used in the tests to obtain a continuous 8-unit teletype code. This simulator would generate four lines (64 characters to the line) and then repeat. The first line started with four Ks, called the preamble, and each line ended with an X, carriage return, letters, and line feed. The message would then be filled in with Alpha-Os, RYs, or spaces at the option of the operator. The use of Alpha-Os was most desirable because of their symmetrical character structure.

To aid in data reduction, data logs were kept by test personnel during test missions and a flight log containing aircraft positions at specific times was supplied by the aircraft navigator.

**Summary of Test Results;** The ASD/AFAL terminals have flown about 28 flights in the first six-months of testing for a total of 140 hours of data taking time. These tests have covered most types of terrain and a variety of locations around the world. Successful communications have been accomplished from terminals in the United States to our airborne terminal while it was flying over the North Pole, over South Vietnam, and in Europe. Extensive tests have been conducted over the Atlantic Ocean, Pacific Ocean, Arctic and Indian Oceans.

The data collected to date shows that multipath fading can be characterized in general by the simple two-ray multipath model. Multipath fading is almost always encountered on over-water flights when the look angle to the satellite is below 20 degrees. A typical strip chart recordings for flights over water is shown in Figure 9. Flights over polar ice produce results almost identical to over-water flights. Over-land flights produce very little multipath fading, while flights over mountains display no multipath. The fading encountered on over-water flights occurs from the horizon up to angles of 20 or 25 degrees. Above these look angles, the fading is not periodic, predictable, or significant. The level of fading encountered even at low look angles is in general 5 dB or less. Seldom are the fades as great as 10 dB. The deepest fading occurs between a look angle of 10 and 15 degrees. The lack of deep multipath fading is being investigated in greater detail.



**Figure 9 Aircraft's Received Signal Fading over Sea Water**

To investigate the validity of the simple multipath model it was necessary to run numerous flights over water at various look angles. The water surface gives the best approximation to the smooth earth model used to calculate the theoretical values. Engineers of Aerospace Corporation calculated expected fade rates and differential delay times for an airborne terminal at 30,000 feet flying toward the satellite. The fade rate is zero for a satellite overhead (90 degrees look angle) rises to around 0.6 Hz for most look angles and falls rapidly to zero again as the look angle becomes tangent to the earth (-3 degrees look angle).

To get continuous experimental data, the ASD/AFAL airborne terminal was flown from the horizon to a look angle of 55 degrees. The experimental airborne terminal fade rate data agreed very well with the theoretical fade curves.

The differential delay or phase difference of a fade on two different signal frequencies indicates how well a frequency diversity system will work.

Considering the 25 KHz spacing of the Mark 1 - Mark 2 Channel and the 85 KHz spacing of the Mark 1 - Mark 3 Channel, it is possible to determine the expected phase difference of fading on those two pairs. The agreement between predicted and experimental data was good. The Mark 1 and Mark 3 fade together (360 degrees difference), at about a 10 degree angle. The Mark 1 - Mark 2 pair do not reach 360 degrees until about 38 degree look angle. Since coherent fading is seldom encountered above 25 degrees, it is highly unlikely that all three channels would fade simultaneously due to multipath signals at any angle over a few degrees.

The teletype error rate encountered by an airborne terminal is a function of propagation effects, antenna pattern, aircraft maneuvers, and the look angle to the satellite. Therefore, the concept of a single number which defines the error rate for an airborne terminal is not considered meaningful. A dynamic error rate related to the mission profile should be a more useful concept. The following is an attempt to isolate the error rate dependents of each of the variables. Under the most optimum condition, which is normal flight with a look angle between 3 degrees and 40 degrees, the error rate is  $10^{-5}$ . Operating the terminal near the horizon or under conditions of fast fading, the error rate increases to  $10^{-3}$ . During the time when the satellite is in the poor portion of the antenna pattern, the error rate increases to  $10^{-2}$ . Conditions of radio frequency interference produce errors at the rate of  $10^{-1}$ . Under conditions of antenna blockage due to aircraft maneuvers the error rate can go as high as  $5 \times 10^{-1}$ .

Experience to date has shown no noticeable effect on error rate due to time of day, season, latitude, temperature, or altitude. The effect of terrain on error rate has also been minimal. There is a difference in multipath fading with terrain, but seldom does this fading cause errors.

The time-frequency diversity technique adopted for use on this program provides protection against multipath fading above a five degree look angle. Below that angle, the frequency separation is not sufficient to prevent correlated fading. While pretest estimates of the multipath indicated a severe problem for an airborne terminal operating over water, actual test results show only shallow fading to exist. Therefore, it is difficult for any diversity scheme to improve link performance which is already nearly error free. Definite improvement in the error rate is demonstrated under conditions of the unusual fading and radio frequency interference.

Calculations have been made of the mathematical correlation function existing between the six frequencies used in this test. The results show that over a variety of terrain a low correlation exists between the more widely spaced channels. Correlation usually is less than 0.4. However, conversion of

this correlation function into an improvement of communication time availability or communication reliability involves other variables. Therefore, the usefulness of this correlation function is questionable.

An evaluation was run on two airborne antennas, one a specially designed, circularized polar antenna (Loop Vee) and the other a standard UHF blade. Both antennas worked well between look angles of 5 degrees and 50 degrees. On the horizon or over 50 degrees, both antennas had less than the 0 dB gain desired. However, due to the system margin, the antennas do provide sufficient gain to allow acceptable communications on the horizon. Again, because of the system margin, the loop vee antenna allows acceptable communication from 50 degrees to 65 degrees. Above 65 degrees the gain is down to a point where communication is not possible. Because of the scalloping of the overhead pattern which the blade antenna displays, its performance above 50 degrees is unpredictable.

Tests were run to investigate the interference or spectrum congestion encountered by an airborne UHF terminal in South Vietnam during the active Vietnam Conflict. A total of seven hours of testing was accomplished on four different days. On two of the days, the satellite was not visible and had to be simulated with the loop tester. On the other two days, the satellite was used; once in a duplex mode communicating with ourselves and on the other day communicating with a ground terminal in California. The spectrum congestion on all four days appeared to be similar and agreed with what had been seen on a radiometer test early in 1967. However, the effect on the specific satellite down frequency differed each day. On the first day one hour of bad interference occurred, which caused complete loss of signal or high error rates. On the second day only one short burst of interference occurred, which caused less than one second of errors. On the third day no interference was experienced at all. On the fourth day there were several minutes of interference, but no errors were experienced due to this interference. These results have shown that the problem of interference in a tactical environment is indeed real. The exact effect of this interference is both time and location sensitive. A larger amount of data will need to be collected if a statistically meaningful evaluation is to be performed, but these results are encouraging.

Occasionally during these flight tests, a fast fading occurred which has a rate one-hundred times faster than the maximum predicted by the two-ray multipath model with reflections from a smooth earth. These fades will affect a single teletype chip while leaving the adjacent chip unaffected. Following is a list of their characteristics:

1. Fast fade can wipe out a single chip.
2. They are frequency selective.
3. They do not appear cyclic.
4. Signal enhancement, as well as degradation, occurs.
5. Switching antennas will often change the fading characteristic.
6. Fading has occurred with both the loop-vee antenna and the blade.
7. Fading is noticed only over water.
8. It has always been encountered at look angles of greater than 25 degrees.
9. It has occurred only within 30 degrees of the equator.
10. Have often flown high look angle flights over water and not seen fast fading.
11. It usually appears slowly, builds up to a maximum and then dies out.
12. It has never occurred for more than two hours.
13. Except for a few minutes when fast fading is at its maximum, the diversity techniques provides error-free copy.



14. Minor directional changes of 10 or 20 degrees do not seem to affect it, but major directional changes of 90 degrees do.

Many theories have been advanced as to the cause of the fast fading. However, to date it is not felt that sufficient information is available to draw conclusions as to the source of the problem. Future tests are planned to specifically investigate this area.

A number of the ground terminals have experienced severe fading due to ionospheric scintillation. Prior to the end of Project 591 in 1968, the airborne terminal had not experienced fading which could be identified as scintillation. Flights into the northern auroral region had been made and no noticeable effect to communications was encountered. However, flight times on those missions did not coincide with any enhanced auroral activity. Testing during the follow-on SATCOM program confirmed that ionospheric scintillation can cause severe fading of the airborne UHF SATCOM link when operating in the equatorial and polar regions.

The LES-5 satellite was put into orbit with a communication bandwidth of 100 KHz. After about four-months of testing, this bandwidth was switched to 300 KHz for wideband tests. Since the airborne terminal is not saturating the satellite receiver, the effect of the bandwidth change was to introduce 5 dB more noise power into the satellite receiver. Satellite transmitter redistributed its effective radiated power and the relayed information is therefore 5 dB weaker. If a ground station excites the satellite, they are still able to saturate it and keep the majority of the ERP concentrated in the retransmitted intelligence. The communication system margin is sufficient to make this 5 dB change unimportant at good look angles. However, on the horizon the previous 10 dB fade margin is now cut to 5 dB.

Occasional intermittent operation is now experienced on the horizon. With the satellite overhead, the airborne terminal was previously able to operate up to 75 degrees look angle with regularity. After the bandwidth increase, communications above 60 degrees were unreliable.

**Conclusions:** The feasibility of utilizing satellite relay to provide beyond-line-of-sight communication capability of operating commands has been conclusively demonstrated. Low data rate transmission is a potentially useful communications mode for aircraft, ship, submarine, and other vehicle application.

Further refinements in terminal equipments are needed. In particular, they include:

- (a) More convenient and smaller message entry and display devices with possible interfaces with on-board computers;
- (b) Reduction in size and weight to meet difficult installation problems;
- (c) Improved antenna coverage and efficiency.

The characteristics of the propagation medium and sources of natural interference were found to be essentially as predicted. Coverage is generally limited at the horizon by fading and at the high elevation angles by the terminal antenna pattern. The "fast" fading phenomenon observed on airborne terminals was a surprise. A further discussion is contained in Johnson's 1981 Reference. The effects of the fast fading appear to be easily compensated by anti-multipath diversity systems. The medium is compatible with a large variety of types of modulation and transmission.

The RFI investigation and test results are generally encouraging. Practically all sources of significant external interference encountered can be identified with terminals under control of the U.S. military

establishment. The use of a UHF satellite in a combat area such as Vietnam may require tighter control of frequency assignments than is presently exercised. With regard to the problem of potential interference to other services from a satellite with large ERP, it appears that the use of spread spectrum techniques is a realistic solution. The problems of locally generated RFI in specific terminal installations will continue to require individual attention; however, the experience from the terminals used on LES-5 tests indicates that the required receiver sensitivities can be realized.

The feasibility of frequency division multiple access was demonstrated successfully with terminals not in motion. A small amount of testing with moving terminals (ships) indicated difficulties in maintaining proper uplink power control. The results here are inconclusive.

Because of the greatly expanded interest in tactical satellite communications, it appears that the use of SHF should be considered for potential users who are capable of operating in this range, while the use of UHF should be generally restricted to terminals such as aircraft, submarines, and small ships, where SHF operation is not presently feasible.

#### **References:**

Bond, Fred E. and Hal F. Meyer; **Fading and Multipath Considerations in Aircraft/Satellite Communications Systems**; AIAA 1st Communications Satellite Systems Conference; Washington DC, June 1966.

Bond, Fred E.; **Precise Results for Differential Delay and Fading Rate for Aircraft/Satellite Link**; Unpublished Memo, Aerospace Corp, El Segundo CA; 3 October 1967.

Ellington, T.D. and Ken W. Kirk; **Air-to-Air Propagation Characteristics at Extreme Ranges**; National Aerospace Electronics Conference, Volume 22; Dayton, Ohio; 1966.

Foshee, James J., Gil L. LaVean, Allen L. Johnson, Richard M. Goode; **Multipath and Propagation Experiment Utilizing VHF/UHF Satellite Communications System**; AIAA 2<sup>nd</sup> Communications Satellite Systems Conference; San Francisco CA; April 1968.

Goode, Richard M. and Gil L. LaVean; **Tactical Satellite System Design Considerations**; IEEE International Conference on Communications; Minneapolis MN, June 1967.

Isgrig, Elvin D., Hal F. Meyer, Fred E. Bond; **Final Report of Tactical Satellite Communications Program 591 and LES-5 Test Report**; Space & Missile Systems Organization; Los Angeles CA; DTIC AD0857274; 21 July 1969.

Johnson, Allen L. and Richard M. Goode; **Six Month Report of Flight Test Results Program 591**; Air Force Avionics Laboratory; WPAFB OH; 31 January 1968.

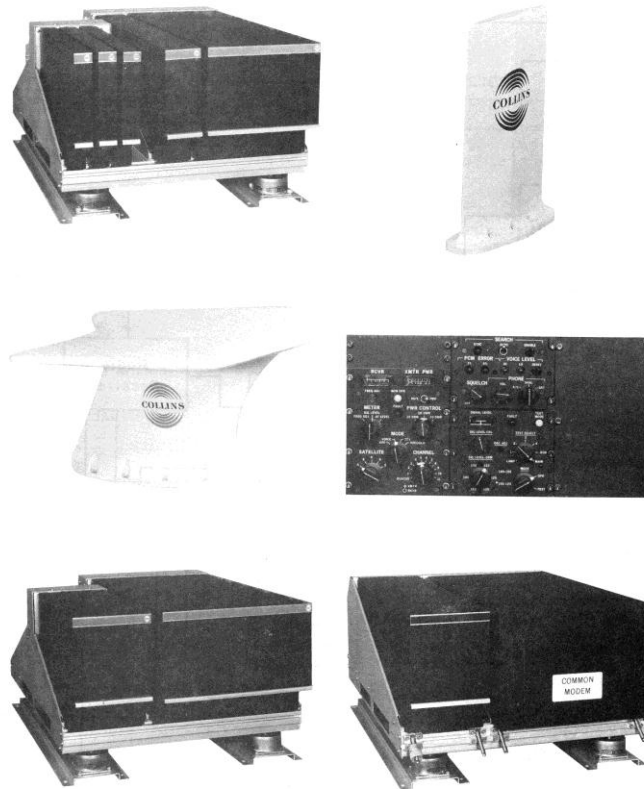
Johnson, Allen L.; **Coastal Multipath Fading**; IEEE Transaction on Antennas and Propagation; Volume AP-29, Number 4; Pages 665-668; July 1981.

## Tactical Satellite Communications Project 687-J (1960-1973)

**Background:** With the cancelation of the STEER UHF Satellite program in 1960, the Air Force Avionics Laboratory (AFAL) began planning for a replacement system under the Tactical Satellite Communications Program 687-J. Because of a congressional decision to delay military SATCOM until the civilian SATCOM was established, the program was deferred until 1966. At that time, funding was provided for several terminal programs, the LES-6 satellite and the TACSATCOM satellite.

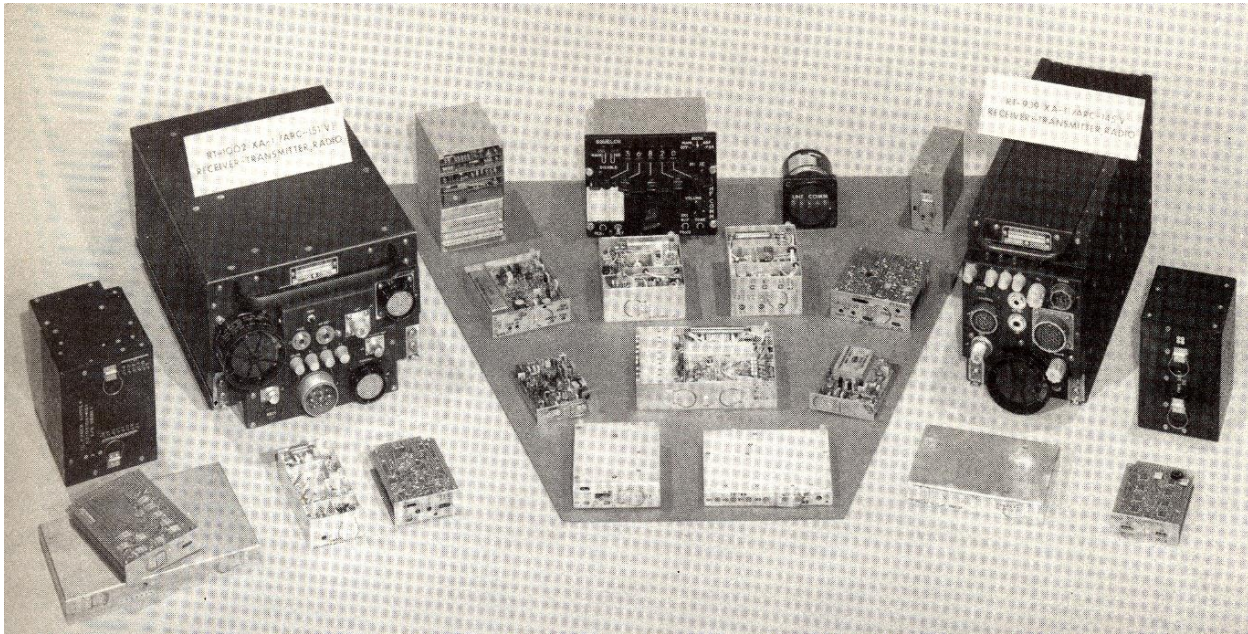
**Tactical Satellite Communications Developments:** In 1966 AFAL initiated a series of Advanced Development programs for tactical satellite communications terminals. A number of UHF and SHF SATCOM terminals were developed, flight tested and transitioned to production.

**AN/ARC-146 UHF SATCOM Terminal Development:** The AN/ARC-146, shown in Figure 1, is an airborne terminal, built by Collins Radio in Cedar Rapids IA, designed for UHF satellite communications. The radio provides a full duplex capability with 1 kW output power. The design is completely solid state up to the 100 watt level and utilizes a ceramic power tetrode final tube to obtain the 1 kW power level. The system has a built-in narrow band FM voice modulator and a 70 MHz interface for use with external modems. The system includes a built-in test translator which provides the frequency offset necessary to allow complete loop self-test. Electronic frequency synthesizers are used for rapid frequency switching. The radio is designed to work over the LES-6 and TACSATCOM satellite band with transmit frequencies from 300 to 315 MHz and receive frequencies from 240 to 260 MHz.



**Figure 1 AN/ARC-146 UHF SATCOM Terminal**

**AN/ARC-151 UHF SATCOM Terminal Development:** The AN/ARC-151 development was based on the design of the AN/ARC-145 radio with improvements to add a satellite communications capability, higher power output, 25 kHz channel spacing, and compatibility with an external modem. Incorporation of these increased capabilities was accomplished with a minimum of changes to the existing AN/ARC-145. The modules basically common to the AN/ARC-151(V) (XA-1) and the 25 kHz version of the AN/ARC-145 are shown in the trapezoidal shaded area at the center of Figure 2.



**Figure 2 AN/ARC-151 and AN/ARC-145 UHF Transceivers**

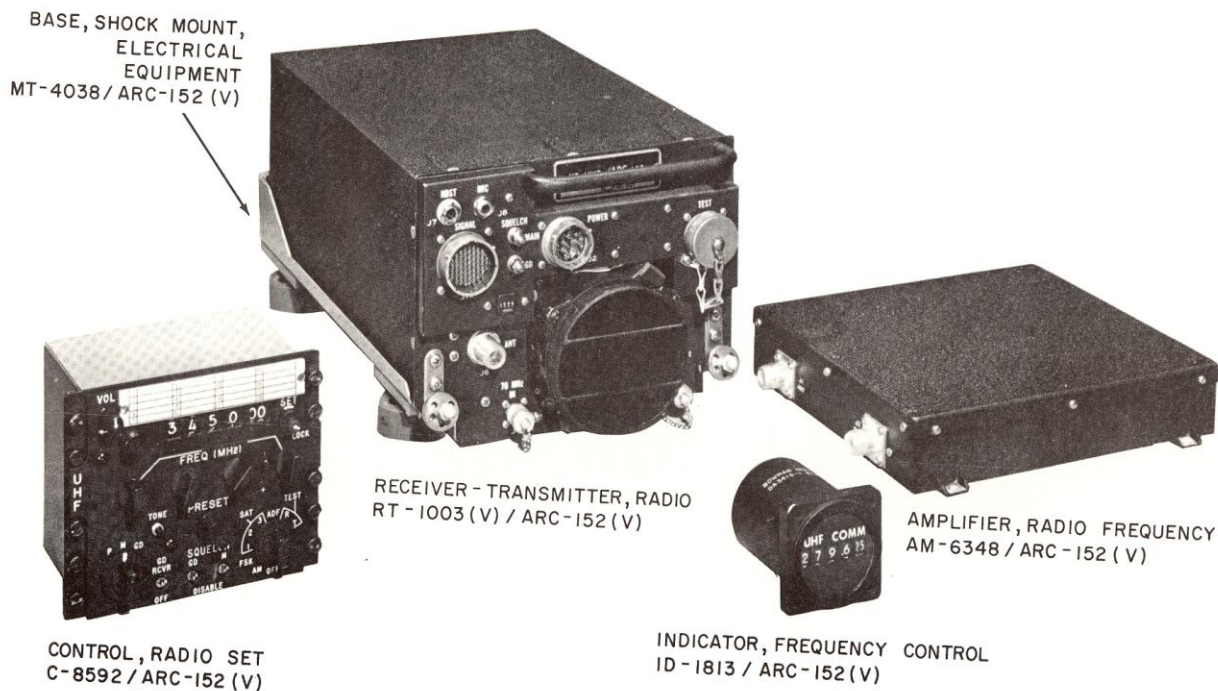
The space requirements for the basic R/T of the AN/ARC-151(V) (XA-1) are equal to or less than those of the AN/ARC-27, AN/ARC-34, AN/ARC-51 and AN/ARC-109. The maximum dimensions of the AN/ARC-151 Receiver-Transmitter and mount do not exceed those of the other units mentioned. Actual physical replacement of the other Radio Sets was not accomplished during this program. However, an AN/ARC-151(V) (XA-1) adapter tray was built for the AN/ARC-34 position and delivered as part of this contract.

Satisfactory tests of the AN/ARC-151 (V) (XA-1) in the FM Voice Mode were made through the LES-6 satellite. Communications were established through the ECI satellite laboratory using an ECI-built hand-held transceiver. Voice links were established using several types of antennae and Transmitter power levels. Communication was best when using the highest gain antenna and a 100 watt power level. However, usable communications were attained when using a blade antenna and a 70 watt Transmitter power output level.

Testing of the AN/ARC-151(V) (XA-1) Radio Set with various PSK and FSK 70 MHz modems has been conducted by the AFAL. These tests proved successful for both transmit and receive of the AN/ARC-151(V) (XA-1) with 75 bps FSK data and 2400 bps PSK data from external modems. The AN/ARC-151 Radio Set was also fully complied with the occupied bandwidth requirement of MIL-STD-188.



**AN/ARC-151 UHF SATCOM Terminal Development:** To achieve the goal of reasonable equipment reliability, affordable initial cost, ease of maintenance, comparable weight and volume, Contract F33615-69-1838 was issued to the RCA Corporation for design and development of a UHF Command/Satellite Transceiver, AN/ARC-152(V) Figure 3.

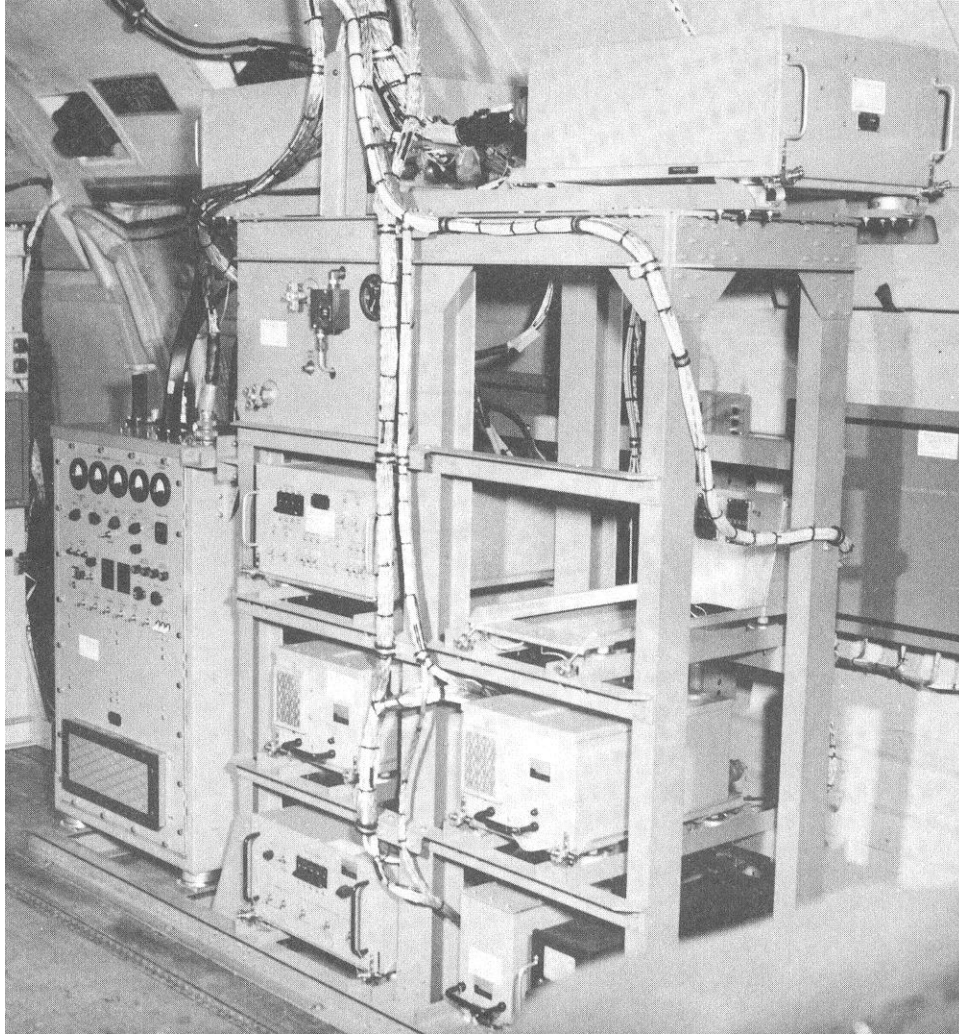


**Figure 3 AN/ARC-152 UHF Transceiver**

The objective of the program was to extend the capabilities of the existing Radio Set AN/ARC-144(V) (XA-1) to include communications via a satellite as well as direct line-of-sight, and to include increased power output (100 watts FM, 25 watts AM carrier), a narrowband voice FM capability, an external preamp (located at the antenna), and satellite modem capability. The Transceiver was designed for installation in new aircraft and was capable of retrofit to replace existing UHF AM Voice Radio Sets such as the AN/ARC-27, AN/ARC-34, AN/ARC-51 and AN/ARC-109.

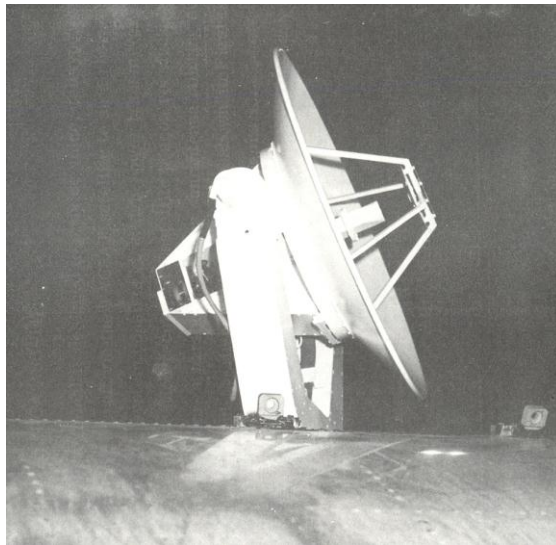
The conceptual design retained the AN/ARC-144(V) (XA-1) baseline design to the fullest extent practicable. The major areas of change were the Transmitter which required a completely new Power Amplifier to provide increased power output, the Power Supply which required separate AC and DC Power Supplies due to space constraints, and the Frequency Synthesizer and Control Box which required additional circuitry for satellite communications. During development, new types of integrated circuits became available which enabled hybrid construction to replace standard printed circuit board techniques. Consequently, the design was revised to reduce substantially the number of parts and boards and to reconfigure the functional assemblies and make better use of the available volume. This was necessary to fit into a volume no greater than that occupied by the AN/ARC-109. The design revisions also achieved improvements in reliability, maintainability, and producibility.

**SHF SATCOM Terminal AN/ASC-14:** The SHF airborne terminal, developed by RCA Corp of Moorestown NJ, was designed to provide voice, teletype, or data communication from an aircraft via the TACSATCOM satellite to an airborne or ground terminal. The SHF system consists of a high-power transmitter, an exciter, driver, a communication receiver, a satellite beacon receiver, a frequency-control subsystem, a parabolic antenna, an antenna pointing subsystem, a diplexer, and a liquid-to-air heat exchanger, as shown in Figures 4 and Figure 5.



**Figure 4 AN/ASC-14 SHF SATCOM Terminal Installed in Test Aircraft**

The transmitter produces 1 kW CW power over the frequency band of 7.9 to 8.4 GHz, by means of a traveling wave tube power amplifier. The communication receiver system consists of a low-noise preamplifier and a receiver/down converter with a 70 MHz output frequency. The beacon receiver is a phase-lock loop type which receives the satellite beacon signal and puts out a signal which is proportional to the Doppler frequency generated by the relative motion between the aircraft and the satellite. This output from the beacon receiver controls a master oscillator which corrects for the Doppler shift in both the transmitter and the receiver.



**Figure 5 SHF Antenna Mounted on Test Aircraft**

The antenna system consists of a 33-inch parabolic dish with Cassegrainian feed, which provides 32 dB gain. The antenna transmits right-hand circular polarization and receives left-hand circular polarization. The dual polarized feed, in conjunction with the diplexer, allows full duplex operations. For aerodynamic purposes the antenna is covered by a fiber glass radome 20 feet long and 40 inches high.

The antenna is designed to track the satellite's beacon signal by using an active tracking technique. The initial acquisition is accomplished manually by positioning the antenna within 10 degrees of the satellite position. It scans in an automatic search mode the  $20^{\circ} \times 20^{\circ}$  area, using a raster scan pattern. When it locates the satellite, the system automatically went into the active track mode. In the tracking mode, the antenna dithers in a 0.5 degree square figure-eight motion and maintains the satellite in the center of the scan. Aircraft attitude changes are eliminated by using "on axis" integrating rate gyros, which provide a "memory" for the antenna pointing system in the event the beacon signal path is lost for a short period of time.

The SHF system uses a 70 MHz interface to accommodate the external modulator-demodulators (modem). A built-in narrowband FM voice modem provides an "order wire" capability. The SHF system was designed to work with the Tactical Transmission System (TATS) modem or other 70 MHz interface modems.

**AFAL Flight Testing:** The AN/ARC-146, AN-ARC 151 and AN/ARC-152 terminals were successfully flight tested through the LES-6 and TACSATCOM satellites. The AN/ASC-14 was successfully flight tested in an air-to-air mode through the SHF portion of the TACSATCOM satellite between C-135/662 and C-135/129 with the aircraft separated by 5,000 miles.

**Transition and Production:** The technology of the AN/ARC-141, AN/ARC-151 and AN/ARC-152 was transitioned to the Electronic Systems Division (ESD) for the production of the AN/ARC-171 AFSATCOM UHF System. Over 1,000 of the AFSATCOM terminals were produced and deployed in SAC's EC-135 Airborne Command Post, B-51 bombers and KC-135 tankers operating over the AFSATCOM satellite system to provide secure, reliable world-wide communications.

The AN/ASC-14 SHF SATCOM System was upgraded and transitioned into the AN/ASC-18 SHF SATCOM System which was extensively flight tested by AFAL. The AN/ASC-18 was put into production by ESD re-nomenclatured as the AN/ASC-24 and installed on the E-4B National Airborne Operations Center (NAOC) which provided Presidential support.

**References:**

Corsetti, Capt Charles D.; **UHF Command/Satellite Transceiver, AN/ARC-151 Flight Test Report;** FTR-4950/ENE-73-7; 19 April 1973

Erdmann, Richard; **UHF Command/Satellite Transceiver AN/ARC-152(V);** RCA Corp; Camden NY: AFAL-TR-72-348; November 1972.

Johnson, Allen L. and Capt Michael Miller; **Three Years of Airborne Communications Testing via Satellite Relay;** Air Force Avionics Laboratory; WPAFB OH; AFAL-TR-70-156; November 1970.

Myers, Bruce J.; **UHF Command/Satellite Transceiver AN/ARC-151;** Electronics Communications IND; St. Petersburg FL: AFAL-TR-72-324; December 1972.

Weber, Harold E.; **Aircraft to Satellite SHF Communications;** Microwave Journal; pp 75-79, October 1969



## Tactical Targeting Network Technology (2001-2008)

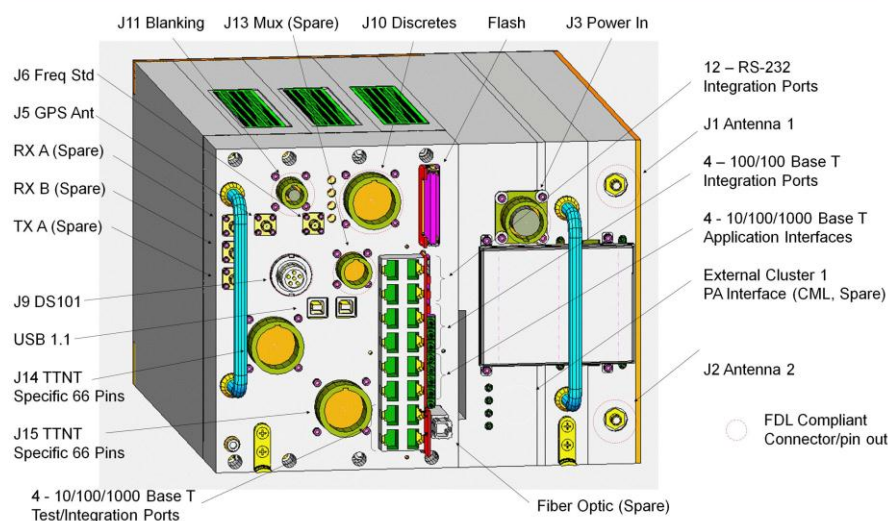
**Background:** Modern warfare tactics demand timely, high quality intelligence information. Strike aircraft are in special need of accurate, real-time targeting information due to their proximity to hostile targets. By the late 1990s, Department of Defense (DOD) planners realized that in the networked forward theaters of the near future, U.S. forces must exploit distributed sensor platforms to rapidly and precisely locate tactical targets and support real-time fire control processes.

**Tactical Targeting Network Technology (TTNT) Development:** In 2001 the Defense Advanced Research Project Agency (DARPA) funded the Air Force Research Laboratory (AFRL) to initiate Phase I of the TTNT program. AFRL awarded \$1 million contracts to each of four industry teams to develop breadboard data link terminals to improve distributed command and control operations through a low-latency, high bandwidth, and dynamically reconfigurable network infrastructure.

In 2002, following the Phase I demonstrations, AFRL down-selected the four TTNT efforts and awarded a Phase II contract to Rockwell Collins of Cedar Rapids IA in 2002 to develop a brassboard terminal for a flight test demonstration. That effort was followed by a Phase III development of a number of rack-mounted terminal, Figures 1 and 2, for flight test demonstration. In September 2005 a demonstration and flight test of TTNT took place at the Naval Air Weapons Station in China Lake CA. Fifteen prototype Phase III terminals were installed on several platforms for the test including F-15E, F/A-18, E2-C, Lear 25, T-39 a Command and Control Testbed aircraft (Boeing 707) a surrogate Combined Air Operations Center (CAOC) node and three mobile ground nodes.



### Phase 3 Terminal 40 Prototypes

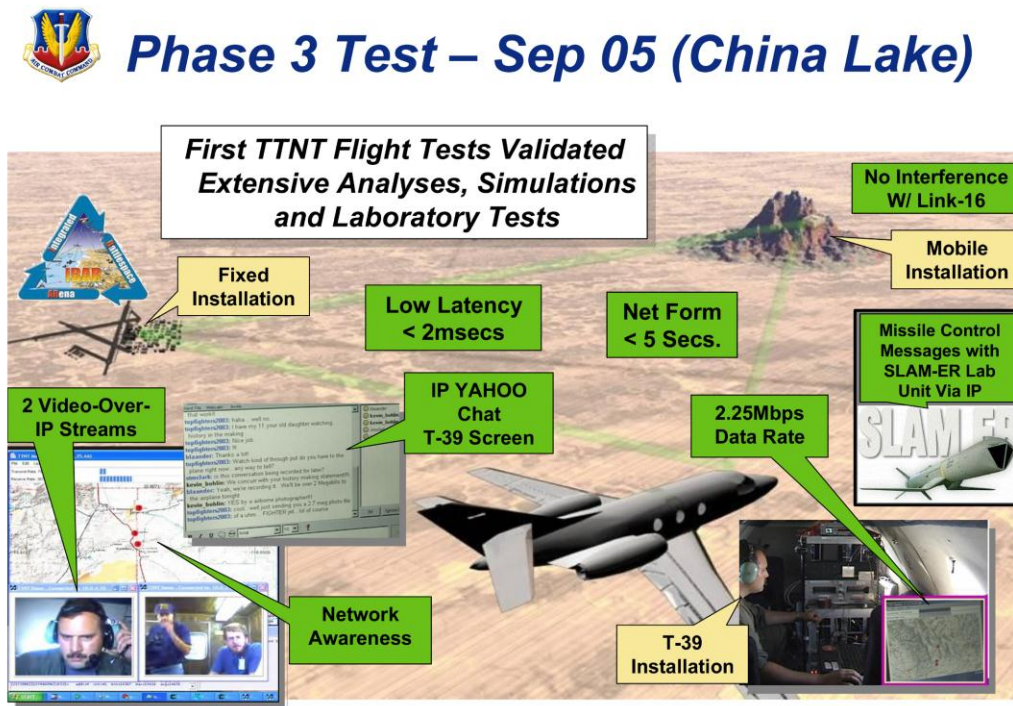


**Figure 1 TTNT Phase III Hardware Drawing**

**Figure 2 Phase III Flight Hardware**

The TTNT network successfully demonstrated the ability to: Transmit data at speeds of 2 megabits per second (mbps) over distances greater than 100 nautical miles (nm); Maintain a network with a 10 mbps; Transmit data further than 100 nm in less than 2 milliseconds in a low latency mode; Coexist with the military's existing Link 16 network; Register new platforms within 5 seconds of entry into the network; Transmit data in excess of 300 nm; and Route data across multiple nodes beyond line of

sight, including sending tactical internet protocol applications from aircraft to the surrogate CAO at China Lake, to Hanscom AFB MA and the Pentagon in Arlington VA.



**Figure 3 TTNT Phase III Flight Test**

During the test, Figure 3, TTNT demonstrated that it effectively supported a number of tactical internet protocols and low-latency applications including: Voice of Internet Protocol. Transmission of still images from aircraft to ground and from ground to air; Transmission of stream video from aircraft to ground nodes; Cursor on target; Joint Precision Approach Landing System; Automatic aerial refueling; 5,000 FAA aircraft tracks on one mission (simulating Blue Force Tracks); Common Operational Picture; Internet access for aircraft; Internet chat; and E-mail.

The TTNT Phase III flight test was a joint government/industry effort involving engineers and operators from DARPA, AFRL/IFG, Rockwell Collins, Naval Air Weapons Station China Lake, Naval Air Systems Command, SRS Technologies, Boeing, Northrop Grumman, Calspan and MIT Lincoln Laboratory.

March 31, 2006 the Office of the Under Secretary of Defense issued a memorandum declaring TTNT as the initial JAN-TE waveform. In December of that same year the Joint Tactical Radio Systems (JTRS) JPEO released a document that mandated the integration of TTNT into the MIDS-JTRS Radio.

TTNT has been demonstrated to be a viable, mature solution to satisfy the DOD's Airborne Networking requirements. With over 8 years of government investment, 1000's of hours of flight demonstration on virtually every airborne platform in the Air Force and Navy, TTNT is considered to be TRL 7, has Stage 4 frequency allocation typically reserved for production equipment, has NSA and JTRS involvement, has completed development of transceiver and power amplifier components, and a MIDS JTRS "hooks" assessment, Figure 4.



# TTNT – Mature Program in Transition

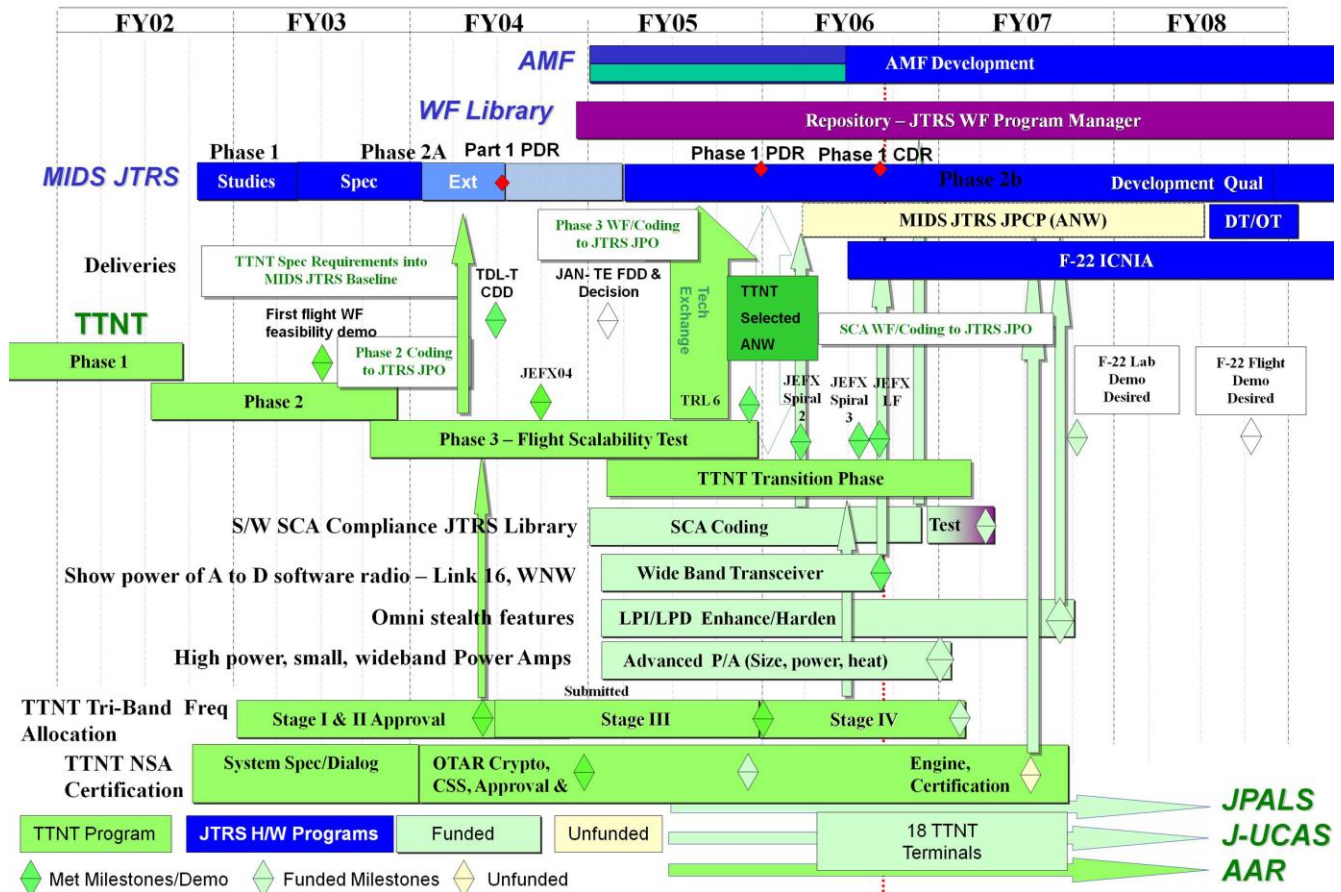


Figure 4 TTNT Schedule

TTNT was funded through DARPA and AFRL, beginning in 2001, passing through Phases 1, 2, 3 and Phase Transition. The current contract vehicle, TTNT System Modernization, will take the TTNT waveform from Critical Design Review through Final Qualification Testing. Following FQT the TTNT waveform will be submitted to the JTRS Information Repository for use in the JTRS waveform library. In 2009, Task Order 14 was awarded on the System Modernization contract vehicle, to complete TTNT waveform development. Additionally, a \$49.9M contract vehicle for continued TTNT development and test was awarded by the Air Force Research Laboratory in September of 2009. This contract vehicle will enable platforms and programs integrating TTNT into their systems a means to provide funding for flight demonstration and system test.

TTNT is a wireless IP networked waveform that compliments Time Division Multiple Access waveforms like Link 16 in scenarios where broad dissemination of data is important and/or when timeliness and accuracy of data delivery are most important.

Using Statistical Priority Multiple Access, TTNT is full duplex at the link layer, offering efficient, robust, scalable, simplistic operation for fast movers (up to Mach 8), as well as for nodes that benefit from the information that the Airborne Network collects such as ISR assets, C2 nodes, and gateway systems.

The chief benefits of TTNT include no network preplanning. TTNT uses Statistical Priority Multiple Access which allows for dynamic net join and exit, scalability, and automatic network capacity allocation. Multi-level traffic prioritization and class of service messaging ensures the delivery of key data, on time. This flexibility allows for simultaneous support of multiple widely varying traffic types, bursty traffic support, and line of sight long-range communications, tested at well over 300 nm.

In 2008, the TTNT program management was moved from AFRL Division at WPAFB OH to the AFRL Division at Rome NY as part of the Base Realignment and Closure (BRAC) process.

References;

**DARPA, Rockwell Collins Successfully Demonstrate TTNT**; Military Communications; 24 October 2005.

Datko, Joshua B.; **Supporting Secure, AD HOC Joins for Tactical Networks**; Naval Academy, Annapolis MD; 7 May 2002.

Highnam, Dr Peter; **Tactical Targeting Network Technology**; DARPA/IXO Briefing; Arlington VA; 2002.

**Tactical Targeting Network Technology White Paper**; Rockwell Collins; Cedar Rapids IA; 2009.

Waller, LTC Steve; **Airborne Networking**; DARPA/IXO TTNT Briefing, Arlington VA; 20 July 2006.

## UHF Airborne Antenna Diversity Combiner (1971-74)

**Background:** UHF airborne antennas designed to operate over a satellite link fail to provide uniform hemispheric coverage, causing the satellite communications link to drop lock as the aircraft maneuvers. A directive antenna would solve the coverage problem, but they tend to be big and require an expensive aircraft installation and antenna pointing system. Under the Project 687-J Tactical Satellite Communications program, AFAL began in the early 1970s to investigate combining the gain of multiple simple antennas to get the required hemispheric coverage.

**Antenna Diversity Combiner:** The recent interest in satellite communications from an aircraft has raised the problem of a suitable airborne antenna. The majority of the tactical satellite communication has and apparently will continue to utilize the military UHF band (225-400 MHz). Various antennas are available to provide horizon coverage or zenith coverage or combinations of the two. However, all the available antennas exhibit holes or nulls in their patterns due to interaction with the aircraft structure and in particular the wings and tail.

Combining of the signals from several antennas would be one way of overcoming the variability in the antenna gain of an individual antenna. Such a combination could also reduce multipath if the antennas are properly located. Combining may either be performed at baseband (after demodulation) or at radio frequency. AFAL contracted with Motorola to build a radio frequency (RF) antenna receiver/combiner for evaluation.

The basic problem in combining at RF is the random phase relationship of the received signals. The individual path lengths may vary and either add or subtract according to the exact length of each path. In order for an RF combiner to operate properly some means must be found to add up the several signals with the proper phase relationship.

The "predetection maximal ratio combiner" which was developed, coherently aligns the phase of each incoming signal and adds their amplitudes. The combiner works on a correlation mixing principle. The correlator provides a correlation peak whose amplitude is proportioned to the input signal to noise ratio. The double mixing process provides phase coherence along with a ratio squaring (maximal ratio) function, Figure 1. The time required to initially phase the system up is determined by the bandwidth of the double mixing loop. The combiner that was developed had a one KHz bandwidth which results in a phase-up time of about 1 millisecond.

While the antenna combiner is primarily a receiving device, transmitting capability is required for most applications. The combiner was designed to also handle a transmitted signal. The combiner routed the transmitter power to the antenna which displayed the largest received signal. This routing is accomplished by relays and no switching occurs during the transmission. Simplex transmit/receive operation is thus provided.

The antenna combiner has four UHF input ports (Figure 2). A filter and preamplifier on each port established the signal-to-noise ratio for the system. A mixer then down-converts each channel to an intermediate frequency. The correlator/mixing technique then strips off the phase and provides a new reference phase. The four signals are then summed and converted to a 70 MHz intermediate frequency. The nominal down-conversion gain is approximately 100 dB.



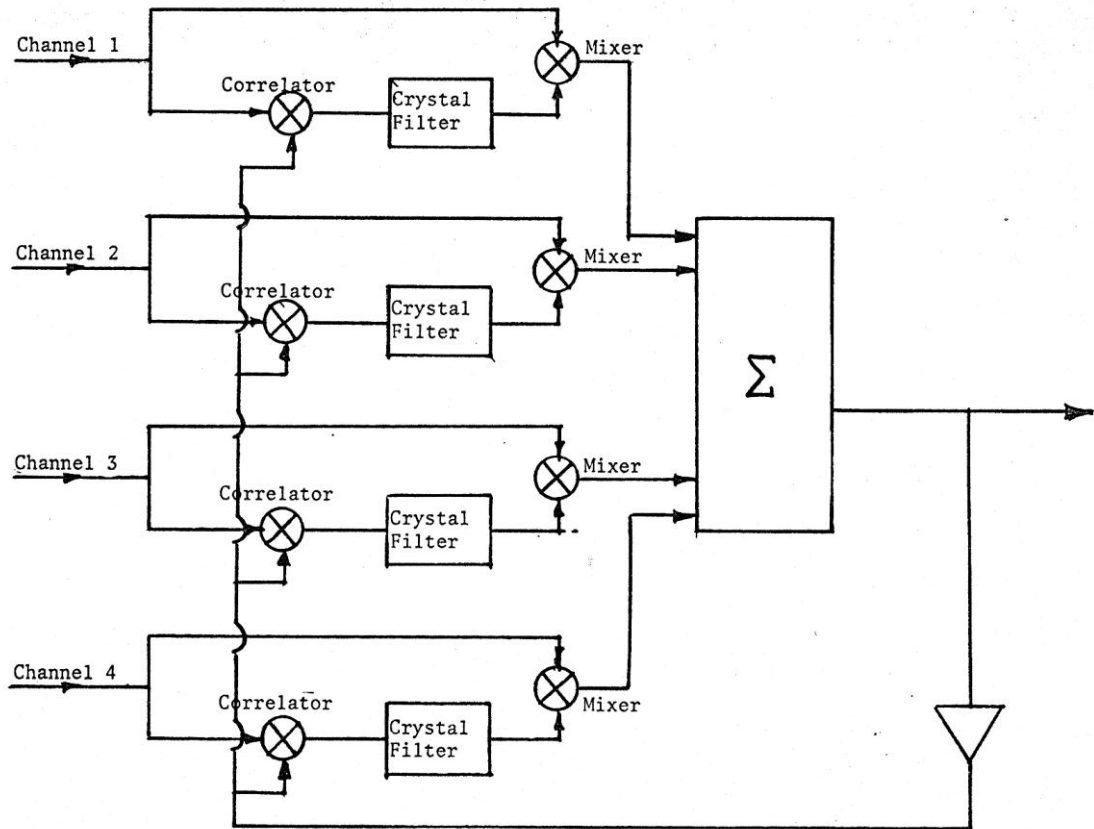


Figure 1 Signal Combiner Schematic

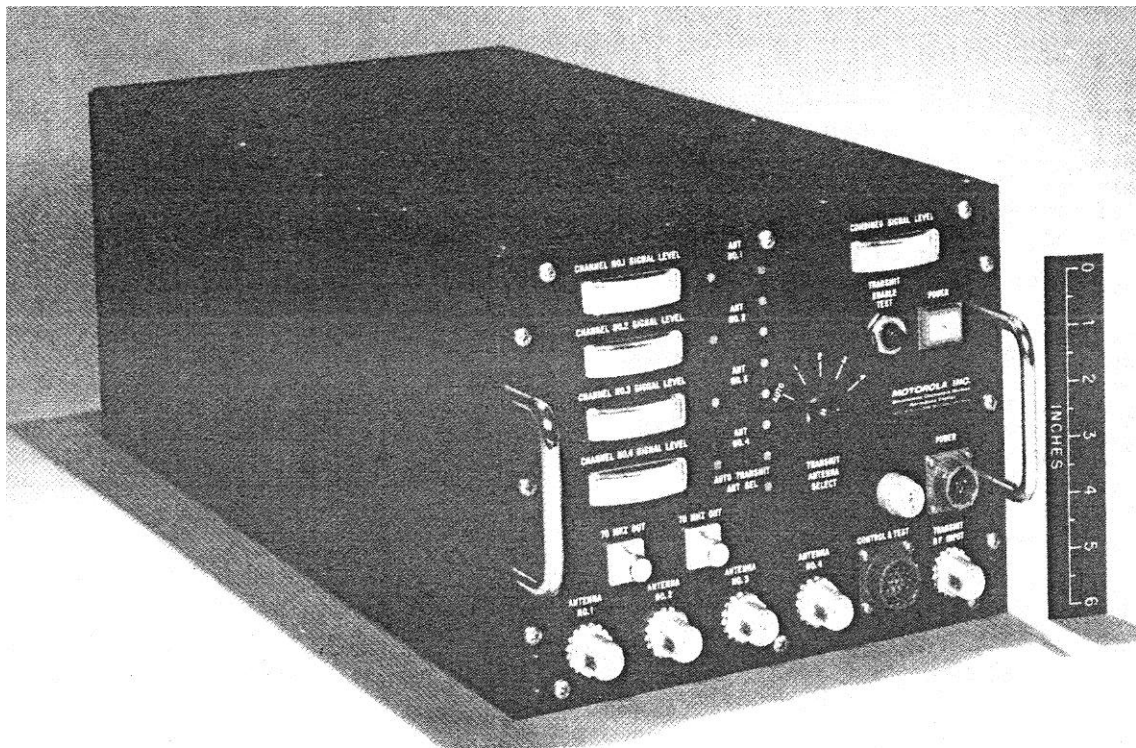
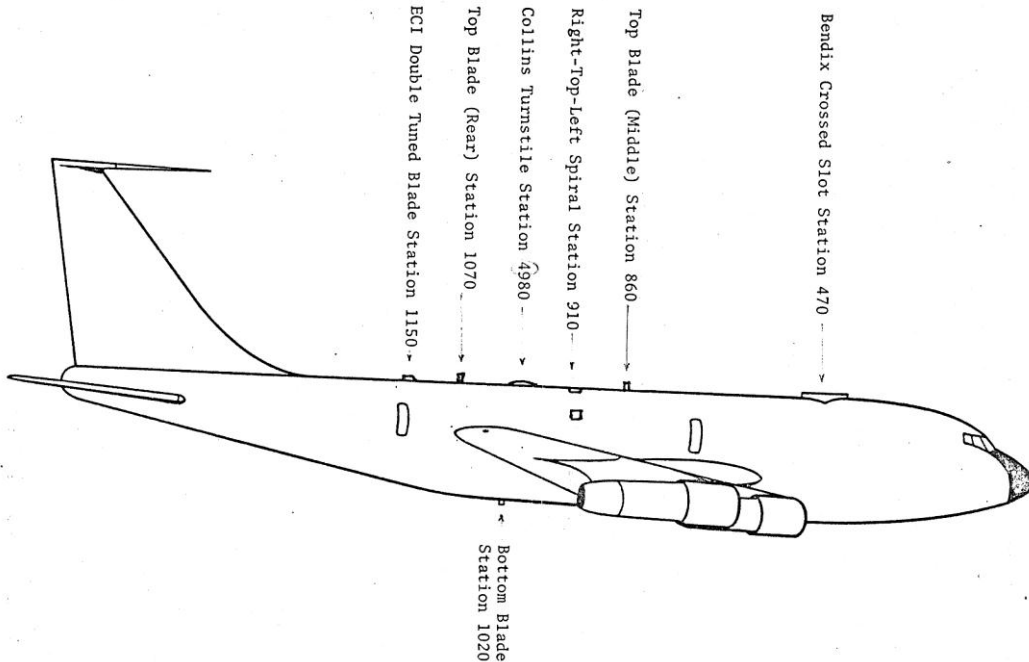


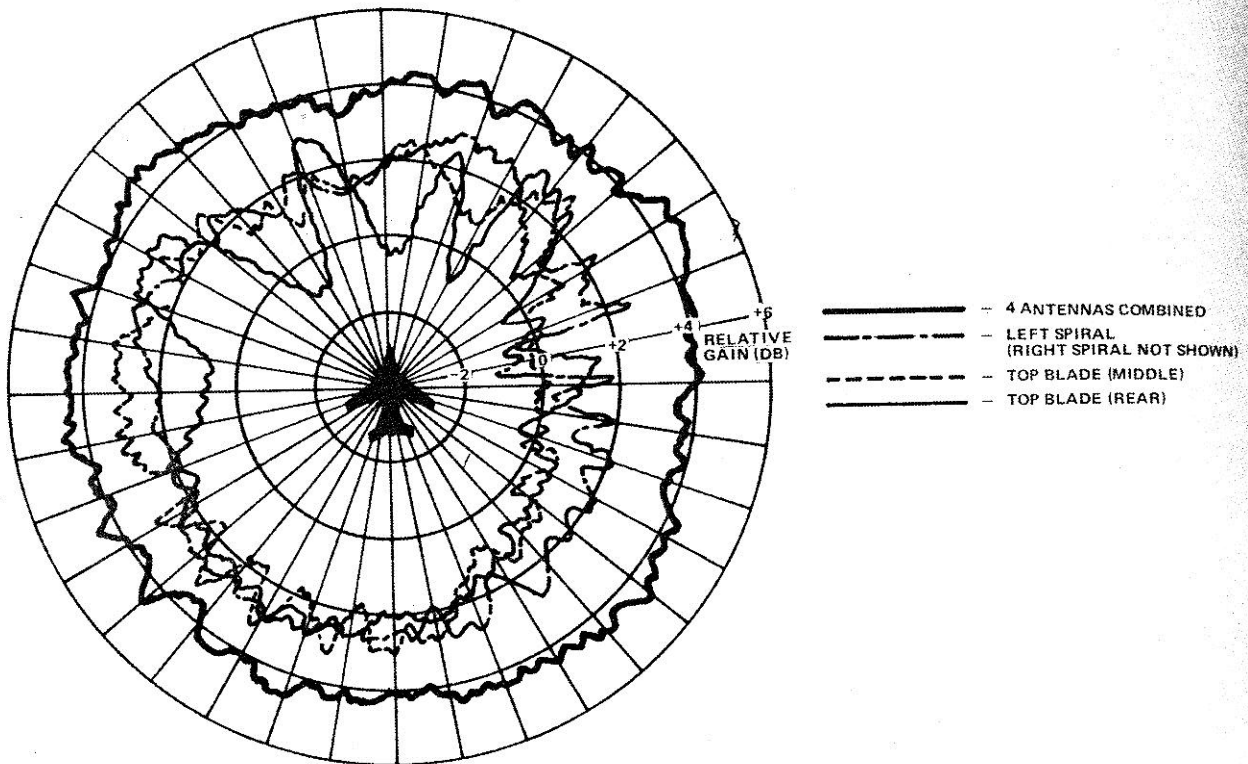
Figure 2 Motorola Antenna Combiner

**Test Configuration:** For the combiner test a ground station provided a CW uplink signal to the LES 6 UHF satellite. The UHF downlink signal from the satellite was received on an aircraft. Various individual antennas and combinations of the aircraft antennas were evaluated, Figure 3.



**Figure 3 UHF Antenna Locations on Test Aircraft**

The pattern of each antenna was taken individually by terminating the other three antenna inputs and flying a 360° turn while receiving the downlink UHF signal. The same maneuver was then flown with all antennas connected to the combiner, Figure 4.



**Figure 4 Antenna Pattern Enhancement Using the Combiner**

In the first test two high gain spiral antennas and two blade antennas were fed to the antenna combiner. The two spirals are mounted on opposite sides of the test aircraft. The patterns of the spirals are similar, with each having about 3 db peak gain when turned toward the satellite. The blade patterns have numerous peaks and nulls with an average gain of about +2 db at the elevation angle tested.

The measured pattern of the spiral antenna showed an average gain of about 3 db with nulls going to -1 dB when the antenna was pointed away from the satellite. The measured gain of each of the two blade antennas varied from +3 to -2 db with numerous holes or nulls in their patterns. When the four antennas were combined, there was a minimum of signal variation – approximately 1 dB. The four antenna combination provided a 4 to 5 db gain throughout the 360° turn.

**Conclusions:** The correlation techniques employed in the antenna combiner did remove the phase variations from separate antennas and provided a consistently better received signal level than available from any single antenna element. Such a technique should allow use of several simple antenna elements on an aircraft to provide consistently good antenna gain. The combiner makes the system look much like a phased array which automatically phase up on the incoming signal to provide the peak gain in that direction. By placing antennas at various locations around the aircraft the combiner can help to solve two other bothersome aircraft communication problems; multipath fading and aircraft antenna blockage. If the antennas are spaced far enough vertically or horizontally, the multipath fading they experience will be uncorrelated, and a diversity improvement can be obtained.

#### **References:**

Johnson, Allen L. and James J. Foshee; **Test Report on UHF Airborne Antenna Combiner**; Air Force Avionics Laboratory; AFAL-TM-72-4; 28 February 1972.

Johnson, Allen L.; **UHF Airborne Antenna Diversity Combiner Evaluation**; International Conference on Communications; April 1973.

Larson, I.D.; **A Simple Antenna System, Approach for Mobile SATCOM Terminals**; National Aerospace Electronics Conference, Dayton OH, May 1974.

Pohl, J.E.; **Space Diversity Reception for Fleet Communications**; Naval Electronics Laboratory Center; NELC-TR-1733; San Diego CA; 30 September 1970

## **UHF Dual Modem MD-1035B/A (1974-78)**

**Background:** In the early 1970s the Air Force Avionics Laboratory's (AFAL) Project 591 development and testing lead to the Electronic System Division's (ESD) production of the AN/ARC-171 UHF SATCOM system called AFSATCOM. The system was installed in the Strategic Air Command's (SAC) B-52 bomber and KC-135 tankers to provide a reliable, secure, survivable dissemination of the Emergency Action Message (EAM), force direction and force report back. The system used binary Frequency Shift Keyed (FSK) modulation to send the mark-space teletype message from the SAC's Airborne Command Post to the airborne forces via the LES-6 and TACSATCOM satellites.

The development of a more robust octal frequency shift keyed modulation incorporated in the LES-8 and LES-9 satellites meant an additional modem would have to be installed in the B-52s to operate with both type satellite modulations. AFAL had been working on the first software programmable fade-resistant modem design to overcome ionospheric scintillation fading for a number of years. While all previous modems used discrete components (inductors, capacitors, resistors) as analog frequency generator, filter, amplifiers and multipliers, the fade resistant modem used the digital equivalent in programmable software to accomplish the same results. The beauty of the digital approach was that a new modulation didn't require new discrete components, but a new software code with no new components.

At the request of ESD, AFAL began development of a UHF Dual Modem under the Project 1227 program which could provide the AFSATCOM binary FSK modulation and the LES-8 octal FSK modulation in a single package. Since a high cost and long time period would be required to retrofit the B-52s already equipped with the AN/ARC171 systems, ESD requested AFAL attempt to develop the UHF Dual Modem in a form factor that would allow the swapping of it with the existing ARC-171 modem package, both form fit and connectors. Retrofitting a production aircraft is extremely expensive and time consuming

**UHF Dual Modem Development:** Under the AFSATCOM Program's Project 1227, AFAL initiated the UHF Dual Modem development with the Linkabit Corporation in San Diego CA (contract F33615-74-C-1209) in 1974.

The AFSATCOM system was a world-wide UHF satellite communications system utilizing synchronous equatorial and non-synchronous satellites for both aircraft and ground Air Force users. The terminals associated with this system range from a simple half-duplex narrowband terminal to various combinations of multi-channel half-duplex narrowband and full-duplex wideband capabilities. All terminals operate at a 75 bits per second rate in the military UHF band (225-400 MHz).

Two types of satellite channels are used by AFSATCOM: 500 kHz non-regenerative wideband channels and 5 kHz narrowband channels which are both regenerative and non-regenerative, depending-on which satellite and channel are involved. The wideband channels employ a Code-Division Multiple Access (CDMA) spread spectrum modulation and can thus support a number of simultaneous users. These channels will be operated in random-access networks with message lengths restricted only by specific terminal capabilities. The 5 kHz narrowband channels employ binary FSK modulation and operate in both random-access and timed-access modes. The message format and

length for the random access mode is unrestricted, as in the wideband case. In the Time Division Multiple Access (TDMA) mode, each net member is assigned a specific fixed-length time slot during which he may transmit, thus, only fixed length messages can be used.

The LES-8/9 satellites provide anti-jam utilizing a processing satellite which provides decoding and demodulating of a wideband uplink signal and then reprocessing the signal for transmission on the downlink. Three types of anti-jam communications links are required. They are as follows:

- A forward/command link from an ABNCP (Ka Band uplink) to force elements (UHF downlink).

- A report back link from one or more force elements (UHF uplink) to ABNCP (Ka Band downlink).

- A conference link, to enable communications among ABNCPs (Ka Band).

The LES-8/9 satellites have been designed and developed by the Lincoln Laboratory to test the processing satellite concept. The LES-8/9 satellites are signal processing satellites which operate at UHF and Ka Band frequencies and provide crosslink capability.

**UHF Dual Modem:** The dual modem was built by Linkabit Corporation and performed both AFSATCOM 1 and LES-8/9 UHF functions. The UHF dual modem is designed to interface with the Collins AN/ARC-171 transceiver and the associated R/T control to provide a half duplex communication path between a force element and a command post via satellite relay. The modem interfaces with the radio at an Intermediate Frequency (IF) of 70 MHz. The radio supplies a 1 MHz frequency standard to the modem for timing and the modem provides frequency and mode commands to the radio.

**AFSATCOM Mode:** In the AFSATCOM mode, the dual model acts as a single channel FSK modem generating or receiving a binary non-coherent FSK signal at a data rate of 75 bits per second. The modem interfaces with a transceiver at an IF of 70 MHz and with data inputs and outputs devices by means of low-level dc data interfaces. It also performs the force synchronizer functions and provides frequency command information to the radio.

Each message generated or received is preceded by a preamble consisting of four 8-bit American Standard Code for Information Interchange (ASCII) characters to provide bit and character synchronization. The messages can be time division multiplexed for transmission in time slot or transmitted in the random mode. In the non-time mode, the modem adds as a suffix four even parity ETX characters. The modem is continually in search of a valid preamble which identifies either a normal or emergency message.

Doppler tracking is provided for offset frequencies up to  $\pm 1200$  Hz and frequency tracking is maintained for Doppler rates up to 20 Hz per second.

**LES-8/9 Mode:** In the transmit mode, the 70 MHz IF output signal is generated by a frequency synthesizer within the modem which covers a frequency range of  $\pm 12.5$  kHz. In transmit, the synthesizer output stability is effectively that of the 1 MHz frequency standard.

The message format consists of a two-second preamble during which only the multiple access sequence is transmitted, followed by twenty 200 millisecond frames, each containing fifteen 10 millisecond tones and 50 milliseconds of guard time.



In the receive mode, the UHF radio provides a wideband dehoppping local oscillator and the dual modem a narrowband dehoppping local oscillator, both under control of the modem. The net effect is to provide a combined local oscillator to heterodyne the received signal down to baseband.

**UHF Dual Modem Accomplishments:** The prime objective of the contract was to provide the Air Force Avionics Laboratory with one laboratory model and seven Advanced Development Models (ADM) of the dual modem and SATCOM control. The modem operates with AFSAT-type modulation, including all force synchronizer functions, and with LES 8/9 modulation in a standard AFSAT type IA terminal, with the ADM modems fitting into the same physical space as existing AFSAT equipment and with the same interconnecting cables being used. Performance was to be at least as good as that provided by the present AFSAT narrowband modem and force synchronizer. The overriding technical requirement was that the dual modem should be a mechanical, wiring harness, and connector compatible replacement for boxes in the AFSATCOM-type IA terminal, able to provide by panel switch selection a terminal functionally equivalent to either the LES-8/9 terminal or the UHF AFSAT I terminal.

The ADM dual modems meet all of the requirements placed on them in the contractual effort. In particular, they are mechanically, cable, and connector replaceable for existing AFSATCOM-type IA terminal equipment. Space and weight requirements are reduced and reliability is enhanced, since the dual modem is packaged in only two boxes:

The dual modem, which is the same size as the AFSATCOM narrowband FSK modem and which includes all synchronizer functions.

The SATCOM control, which occupies the same panel space but is less deep than the synchronizer control for the type IA terminal. The spaces in the type IA terminal used for the combined logic unit and for the synchronizer power supply are not used in the dual modem.

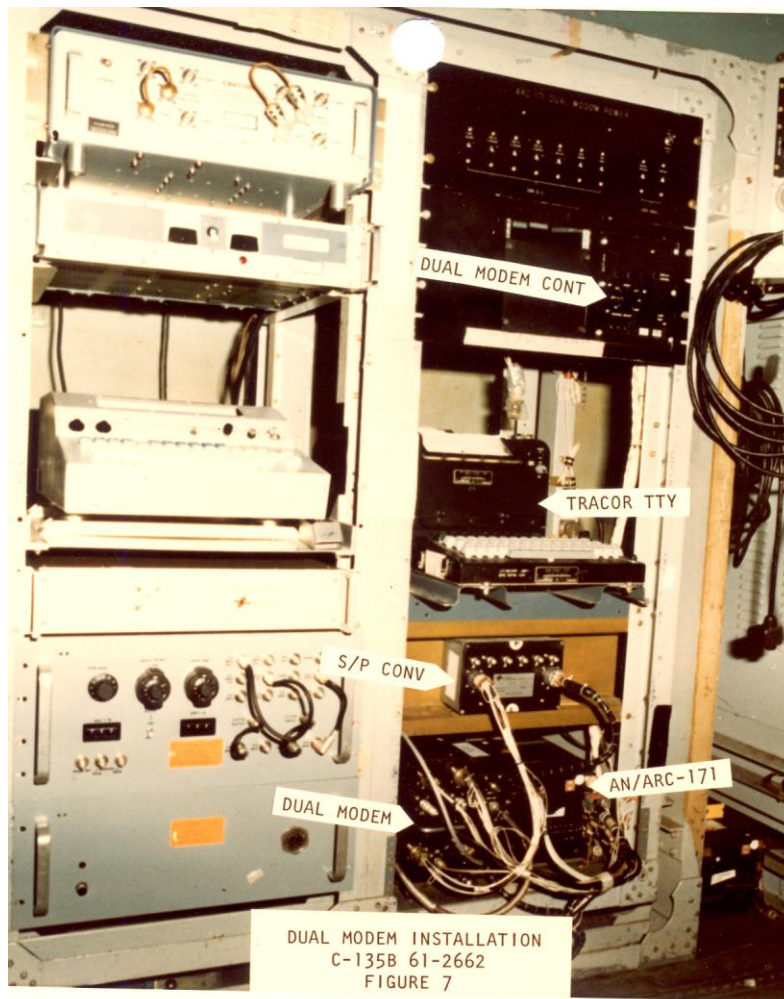
Connectors utilized by the dual modem are the same as those used in the type IA terminal, except that some certain connectors are not used at all. The only cabling change required is addition of a standby power supply lead if the standby power supply capability of the dual modem is to be utilized. If it is not utilized, the normal AFSATCOM three-second standby performance is still provided and is extended to the LES 8/9 modulation.

Functionally, the dual modem provides all of the performance of the AFSATCOM-type IA terminal plus performance in forward and report-back for LES 8/9 modulation. Actually, a number of the performance parameters of the AFSATCOM system are improved in the dual modem and none are degraded. In particular, error rate performance is typically achieved at signal-to-noise ratio 2 dB lower than required in the AFSATCOM narrowband modem. Acquisition is typically accomplished at a signal-to-noise ratio 4 to 5 dB lower than that required for the AFSATCOM narrowband modem. Furthermore, synchronization messages are more reliably received. Messages in which the termination is not correctly received are quickly terminated by the dual modem without operator intervention. The synchronizer in the dual modem is able to catch up immediately, so that transmission can always take place correctly in slot one in the TDM2 mode. This is not the case for the narrowband modem synchronizer.

The uplink Doppler correction is considerably improved in the dual modem over the narrowband FSK modem, in that errors due to channel spacing are removed from the downlink Doppler correction and the actual ratio of, transmit to receive frequency is used to calculate the correction, reducing the



**Dual UHF Modem and control**



**Flight Test installation of UHF Dual Modem**

absolute error significantly. Finally, additional growth capabilities are available in the ADM dual modem, which, in fact, are used to provide additional capabilities in the qualification model dual modem.

**UHF Dual Modem Production:** The UHF Dual Modem ADMs were flight tested by AFAL in a 4950<sup>th</sup> Test Wing aircraft and proved to be reliable and met or exceeded all contractual requirements. ESD went into production on the modem, designated MD-1035B/A, and the SAC aircraft were retrofitted with the production models. Over 1,100 UHF Dual Modems were produced, including a number that were sold to NATO countries. Their use significantly improved SAC's vital communications capability.

**References:**

Jacobs, Irwin M. and Klein Gilhousen; **UHF AFSAT/SURVSAT Dual Modem**; Air Force Avionic Laboratory; AFAL-TR-77-242; WPAFB OH; August 1977.

Miller, Capt James G.; **UHF AFSAT/LES-8/9 Dual Modem Flight Test Report**; 4950<sup>th</sup> Test Wing; ATR FFA 77-32; WPAFB OH 13 February 1978.

Nawman, Lowell, **Test Plan Dual UHF Modem**; Air Force Avionic Laboratory; AFAL-TM-76-4-AAD; WPAFB OH; 15 January 1977.

## UHF Paratune Filter (1980-84)

**Background:** Older tube-type airborne radios, such as the ARC-34, used narrow-band passive filters to clean up any spurious signals and keep the desired transmission in a relative narrow band so it didn't interfere with other radios or electronics on the airplane. Modern aircraft radios use solid-state components to achieve smaller, lighter, more reliable and less expensive designs as well as frequency agile or fast tuning. Unfortunately, a price is paid for these improvements. Since synthesis of the transmitted signal usually originates at levels of a few milliwatts, a large amount of broadband gain is needed to provide high transmitter output power which also amplifies broadband noise and spurious signals to high levels in the outputs.

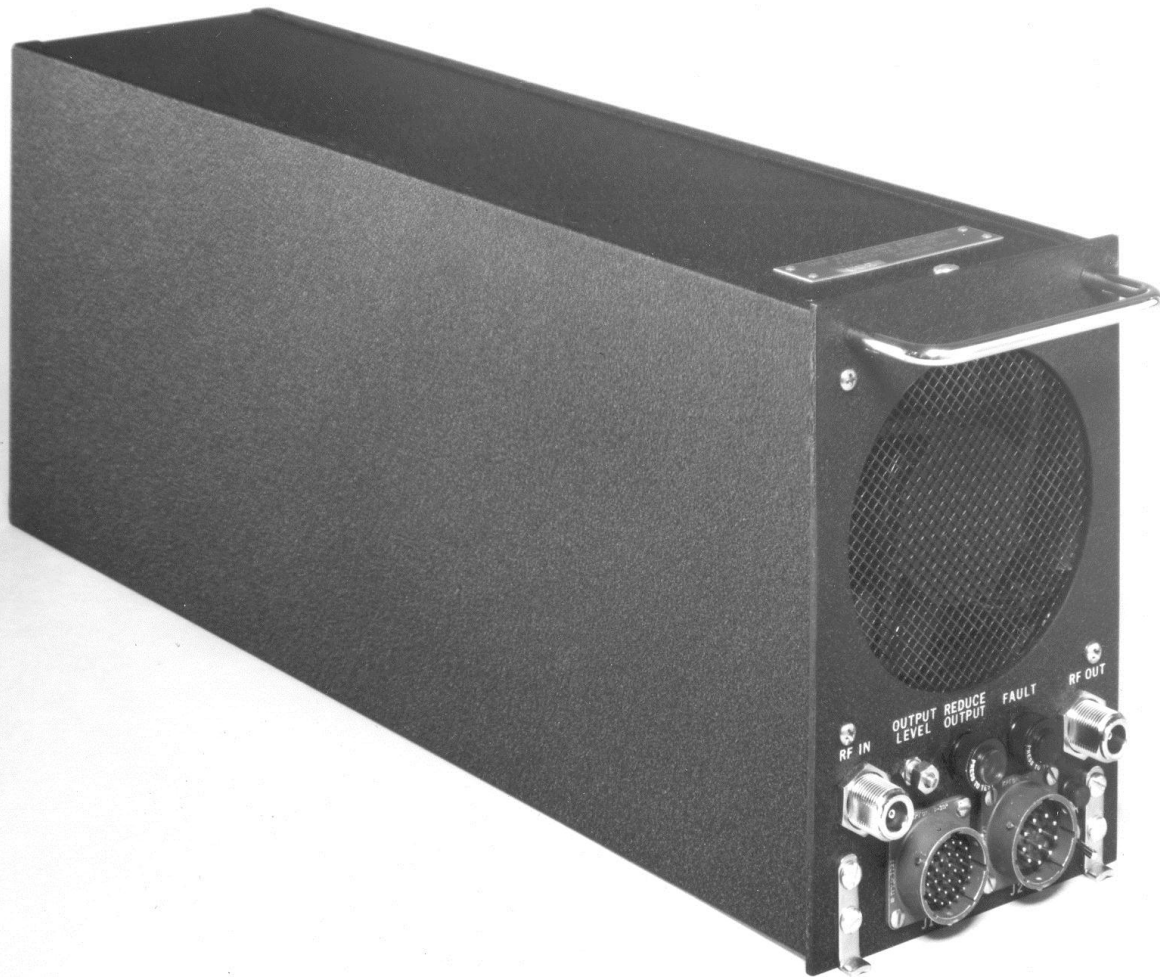
These noise and spurious outputs may be tolerable in ground environments in which only simplex operation of one receiver/transmitter is considered, but in an airborne application where multiple receiver/transmitter units are operated in close proximity, such as on Command and Control Aircraft, adequate isolation cannot be obtained by antenna separation. The problem is further aggravated by the need for even higher transmitter power output for satellite uplinks.

The advent of frequency-hopping modems for anti-jam protection on the uplink to the satellite further complicated the problem by generating more spurious and negating the possibility of using fixed-tuned, narrow band passive filters.

**Active Filter Design:** The Air Force Wright Avionics Laboratory (AFWAL) began investigating active filters in the early 1980s under the AFSATCOM programs Project 1227. They discovered a company, Xetron Corp. in Cincinnati, Ohio, that had patented the design approach for an active filter, called a Paratune filter, (US patent 4047110). The Paratune Filter was a break in tradition from established filter techniques. By using an active rather than passive design approach, the heretofore impossible combination of high power, super selectivity, fast tuning speed and all solid state design is accomplished. AFWAL awarded a contract to Xetron for a 100 watt Paratune filter designed to reduce the broadband noise and spurious outputs of UHF transmitters (225-400 MHz). The Paratune unit is not a conventional tuned circuit filter with loss, but is a regenerating amplifier which strips the modulation from the incoming signal and generates a clean 100 watt modulated output. As such, the filter appears lossless or may provide a power gain if the input signal is below 100 watts. The Paratune filter will reproduce AM, FM, FSK, PSK, CW or WBAM in modulation.

With suitable adjustment of a level control it can be driven by transmitters having nominal outputs in the range of 10 to 100 watts. The unit contains a variety of digital interfaces to provide compatibility with the AN/ARC-171AFSATCOM system used by SAC and associated AFSATCOM 1 and LES-8/9 modems.

In the auto-tune mode, no digital interfaces are necessary. The unit is installed in the antenna line and is supplied primary power. When the unit senses RF power from the transmitter, internal T/R switching inserts the filter, and the filter automatically tunes to the correct operating frequency. T/R switching bypasses the filter for receive operation or in the advent of equipment malfunction. Removing power from the unit also places the unit in the bypass configuration.



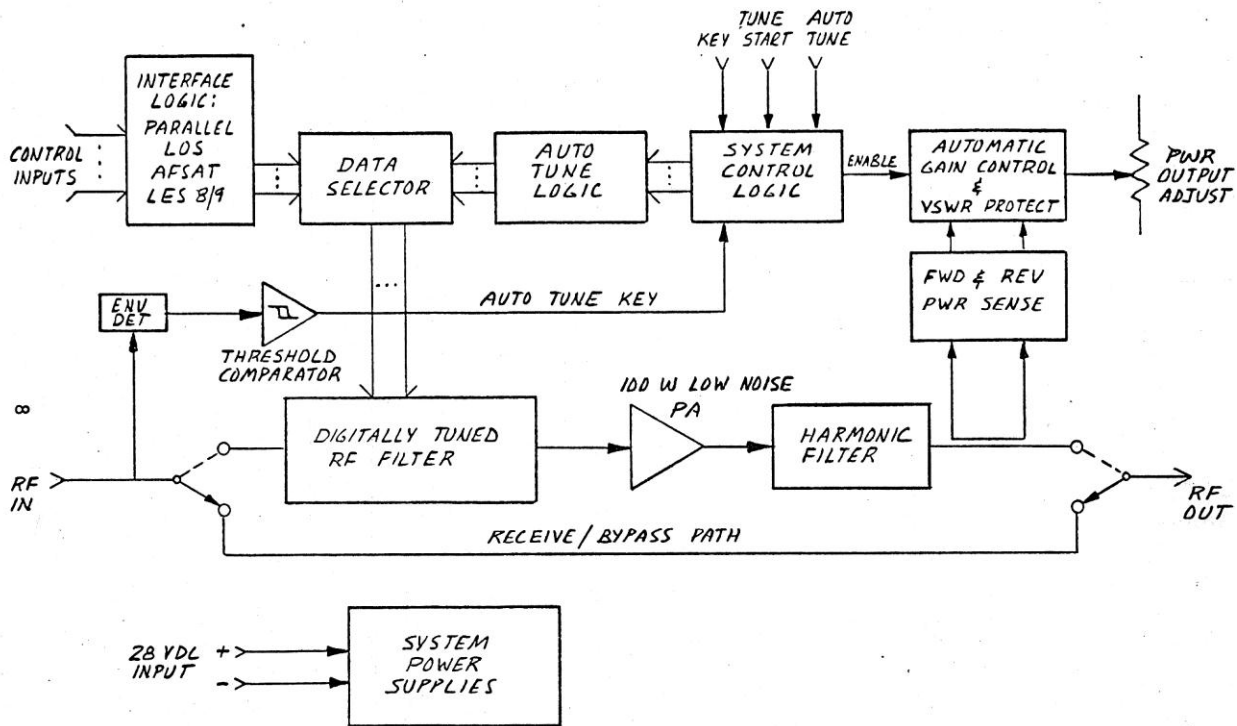
**Figure 1 UHF 100 Watt Paratune Filter**

The unit is physically housed in a one-half ATR (long) case, Figure 1. The filter requires +28 Volts DC @ 25 Amperes maximum via a standard MS type connector, mounted on the front panel. RF in and out of the unit is accomplished via two type N connectors on the front panel. A power switch and indicator are mounted on the front panel to control DC power to the unit. When the unit is turned off, T/R switching provides a low loss path through the unit. A fault indicator, on the front panel, illuminates in the event the filter fails to tune, at which time the unit automatically enters the bypass mode. A fault indication is automatically cleared when the RF input power is removed. The Paratune output will reproduce any variation in input power, assuming the Paratune output is not driven to levels greater than 100 watts. The gain of the filter is handled by adjusting the "output level" control on the front panel while it is being driven by a suitable transmitter and by monitoring the output power on an in-line wattmeter. Also mounted on the front panel is a "Reduce Output" indicator which will illuminate if the unit is overdriven. Reducing the "output level" control will extinguish this indicator.

**System Configuration:** The unit is a completely self-contained appliqué operating at an output level of 100 Watts. It is inserted in the RF line between transmitter and antenna and is powered from the +28 VDC aircraft supply.



The block diagram of the Paratune filter is shown in Figure 2. The heart of the system is a multipole, digitally tuned, highly selective RF filter. The filter provides high rejection to spectral components outside its pass band, yet its bandwidth ( $\approx 500$  kHz) is easily wide enough to provide compatibility with wide bandwidth digital or analog data and is compatible with all types of modulation (AM, FM, FSK, PSK, etc.). When the filter has received digital tuning information, it tunes to the commanded frequency in approximately 300  $\mu$  sec. This fast tuning capability allows it to be used in frequency hopping applications.



**Figure 2 Paratune Filter Block Diagram**

The digital information required to tune the filter is obtained either from the same control interface that controls the driving transceiver or from self-contained automatic tuning logic. External control of the filter (via the interface logic) is employed whenever fast tuning capability (300  $\mu$  sec) or frequency hopping is required. When rapid tuning is not required, the autotune logic will tune the filter to an applied RF signal in approximately 30 ms.

When autotune operation is in effect an envelope detector and threshold comparator sense the presence of applied RF drive. The control logic switches the unit's R/T relays to the transmit position. The autotune logic then performs a tuning algorithm that tunes the filter to the applied RF signal. When this process is complete, the automatic gain control loop is enabled and the power output is allowed to rise. This automatic tuning capability allows the incorporation of the appliqué into push-to-talk systems without any control interfaces, key lines, etc. Only insertion of the unit in the antenna feed line and +28 V aircraft power are required. The appliqué is thus easily cascaded with virtually any UHF AM or FM transceiver.

The appliqué was designed for easy interface to the ARC-171 and a wide variety of modems for use in frequency hopping applications. It therefore responds to the same control formats recognized by the ARC-171: Parallel BCD, LOS, AFSAT, and LES 8/9 interface logic used to decode these control

formats. LOS data and clock information is received serially on differential lines. AFSAT or LES 8/9 control is received in similar fashion on a second set of line receivers. The mode selection line cause the appropriate inputs to be routed to a shift register and configures error checking and frame detection logic to process the incoming data. When this logic determines that the data is of the correct format and is positioned properly within the shift register, it generates a "load" pulse and strobes the data into a storage latch. A set of data selectors then extracts the required frequency information from the stored word.

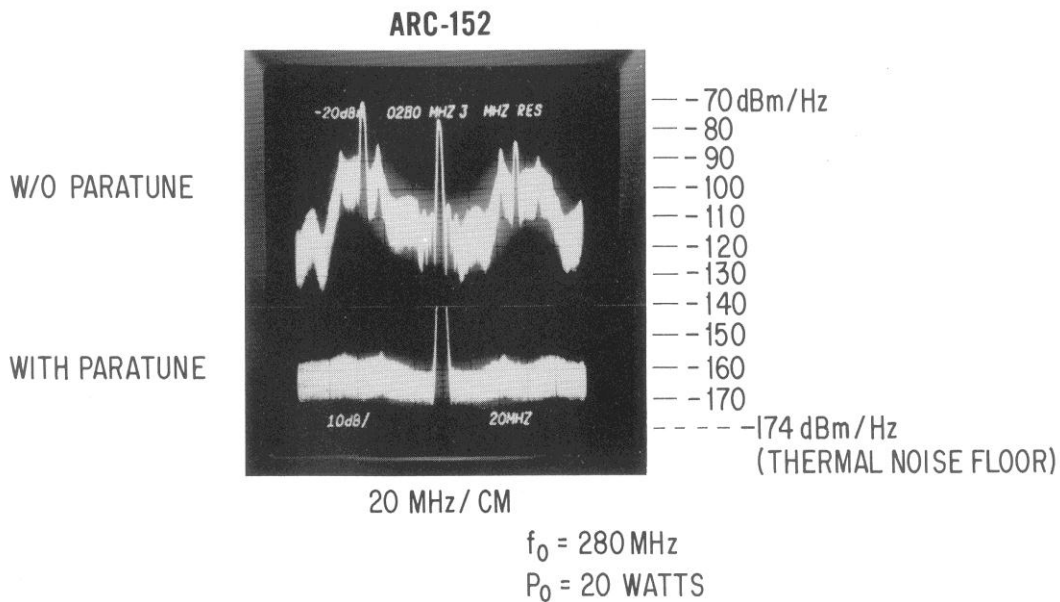
The signal emerging from the RF filter (having very low noise and spurious content) is applied to a low- noise power amplifier and amplified to 100 Watts PEP. The PA has sufficient gain to boost a 10 Watt driving transmitter to 100 Watt output. The PA's output is passed through a low pass filter to suppress harmonics generated within the PA. Output power is sensed via a directional coupler and adjusted by an automatic gain control loop. Gain of the filter is flat  $\pm 0.5$  dB across the entire band. Reflected power is also sensed to provide protection against high VSWR loads (e.g. opens, shorts, etc.). Power cutback does not begin until load VSWR reaches approximately 3.0 to 1 and maximum power rollback is approximately 6 dB (25 Watts forward power into infinite VSWR load).

The system control logic performs all "house keeping" chores. It controls all system timing, monitors internal functions for possible failures, and provides interface to external control lines such as Key, Tune Start, and Auto Tune. The function of the Key line is self explanatory. The Tune Start line is normally originated by a modem and prepares the appliqué for transmission by allowing it to throw its T/R relays to transmit prior to the actual start of the message. The Auto Tune line is normally grounded by the presence of an interface connector. If an interface connector is absent, the unit is automatically configured for Auto-Tune Operation, described earlier. The T/R relays within the unit bypass the filter for receive operation, unit failure, or absence of operating power.

**Test Results:** Various tests have been accomplished on the Paratune Filter Appliqué by the AFWAL/AAAD-1 organization. Other operational tests were performed by NAVEX and the ABCCC organizations. One of the basic tests performed by AFWAL/AAAD-1 demonstrated the unit's Paratune filtering capability.

An AN/ARC-152 UHF transceiver output was displayed on a spectrum analyzer both with and without the filter. This was accomplished by utilizing a narrow notch filter to drop the carrier level approximately 80 dB and a 30 dB amplifier with a 2 dB noise figure to display the spurious noise both before and after filtering. The AN/ARC-152 was tuned across its 225-400 MHz band in 10 MHz steps, and photos of the output were taken on the spectrum analyzer both with and without the filter of all these steps. Figure 3 is an example of its capability.

## PARATUNE FILTER NOISE & SPURIOUS CLEANUP



**XETRON**  
CORPORATION

**Figure 3 AN/ARC-152 Spectrum With and Without Paratune Filter**

**Application of Paratune Filter Technology:** The Paratune Filter went into production for applications in AFSATCOM systems aboard SAC's bombers, the Airborne Command Post, the Airborne Warning And Control System (AWACs) and in the One Kilowatt UHF Solid State Transmitter used in special applications.

### References:

Fischbach, Wayne O., UHF Paratune Filter Appliqué; American Institute of Aeronautics and Astronautics Symposium; Houston TX; March 1982

Janning, Eugene A.; Signal Spectral Purity – How Clean is Clean? Journal of Electronic Defense; pp 69-70; March/April 1981.

## **Ultra Reliable UHF Radio Set AN/ARC-144 and AN/ARC-145 (1967-74)**

**Background:** Historically airborne radios have exhibited poor reliability, often failing in just 10s of flight hours. Part of the problem was the high vibration level in flight and the fragile nature of electronic vacuum tubes. With the advent of solid state devices, in the late 1960s the Air Force Avionics Laboratory (AFAL) launched a program to make major improvements in the reliability of airborne radios.

**Ultra Reliable UHF Radios:** In 1967, AFAL awarded two parallel contracts under the 698-CK Program to investigate techniques for improving the reliability of UHF airborne radios. A contract for the AN/ARC-144 was awarded to the RCA Corp in Camden NJ and one for the AN/ARC-145 to Electronic Communications Inc (ECI) in St. Petersburg FL. The reliability goals for both contracts were a Mean Time Between Failure (MTBF) of 4,000 hours with a minimum acceptable MTBF of 2,000 hours.

The Ultra Reliable UHF Command Radio Set Program had a two-fold objective. The first and prime objective was to demonstrate that a high degree of reliability (2,000 hours MTBF) could be achieved in a UHF Radio Set using modern solid-state techniques and eliminating all electro-mechanical tuning techniques. The second objective was to produce a Radio Set which could be used to retrofit the existing Air Force Radio Command Sets AN/ARC-27 and AN/ARC-34 Air Force installations without any aircraft structural or wiring changes.

To meet the two objectives of this program, a modern UHF Radio Set was designed employing all solid-state techniques, as well as having such additional modes of operation as frequency shift keying (and receive only), self-test and relay. The design also included rapid preset channel memory loading (15 seconds maximum) and was composed of lighter and smaller physical components. Integrated circuits, transistors and other components were selected from devices already available having maximum reliability. The program consisted of a design and development phase, resulting in development models which were evaluated both for environmental and aircraft compatibility, and an equipment test model phase which again evaluated the models for performance under qualification tests, consisting of reliability, maintainability, and environmental performance.

The aircraft compatibility tests were conducted on 5 operational aircraft and demonstrated that existing UHF AN/ARC-27 and AN/ARC-34 Radio Set installations could be retrofitted by replacement with the AN/ARC-144 or AN/ARC-145 without changes to the aircraft wiring or structural members.

The reliability test was conducted on 13 radios for a total of 40,692 cumulative equipment hours per MIL-SITD-781B, test plan XVIII, test level F (-54°C to +71°C). The AN/ARC-144 Radio Set demonstrated an MTBF of 1182 hours to 90% confidence level in Phase VII of the Reliability Demonstration Test. The AN/ARC145 underwent 5,369 hours of reliability testing and had three failures, resulting in a 1790 hour MTBF for the test period. That calculates to a 90% confidence level of having better than 803 hour MTBF.

The Radio Set met environmental requirements except for some relatively minor performance discrepancies. The maintainability and aircraft compatibility demonstration tests were highly successful, and the Radio Set met essentially all the requirements of the applicable specifications.



INDICATOR  
FREQUENCY  
CHANNEL  
ID-1614(XA-1)  
ARC-144(V)  
ID-1670(XA-1)/  
ARC-144(V)

CONTROL, RADIO SET  
C-7828(XA-1)/ARC-144 (V)

RECEIVER-TRANSMITTER,  
RADIO  
RT-937(XA-1)/ARC-144 (V)

CONTROL, RADIO SET  
C-7829 (XA-1)/ARC-144 (V)

### AN/ARC-144 Ultra Reliable Radio System

An extensive flight test was conducted by the Air Force Avionics Laboratory using 4950<sup>th</sup> Test Wing aircraft and SAC and TAC operational aircraft. Results of in-flight evaluation of the radio sets from the standpoint of reliability indicates that field (in flight) reliability of the AN/ARC-144 and AN/ARC-145 was at best in the order of 77 hours at 90% confidence and approximately 105 hours at 60% confidence in one case and considerably less in another.

When comparing results of the flight evaluation to the results of the laboratory reliability demonstration test results in which a reliability of 1182 and 803 hours MTBF at 90% confidence was demonstrated on the ARC-144 and 145, respectively, a significant discrepancy in the two results is indicated.

This may be partially explained by the fact that flight evaluation was essentially conducted in a rather uncontrolled manner with the majority of the test personnel (both installation and operational) being unfamiliar with the equipment and many of its operational modes. Plus the fact that the ARC-144 and ARC-145 equipment had, prior to flight evaluation, been subjected to many thousands of hours of stress testing in reliability test chambers of the respective contractors (ARC-144 a total accumulated test time on 13 radio sets of 42,690 hours and the ARC-145 a total accumulated test time of 28,554 hours).

It is questionable that a 1 to 1 correlation between laboratory test conditions and field installation tests can be drawn based on the field evaluation phase of the program when all factors are considered.

It also appears worthwhile to note at this time that the approach to development of the ARC-144 and ARC-145 taken by the Air Force logically influenced the results of both reliability achieved in laboratory testing as well as flight testing. The entire development and fabrication of the equipment



was conducted as an advanced development program without the benefit of a feasibility and/or developmental model approach in the normal research and development concept. As a result, the approaches taken by both contractors were based to a large extent on unproven techniques and component parts. The effort was directed towards the achievement of reliability goals heretofore never realized in military airborne avionic equipment.

**Conclusions:** Specific objectives of the flight evaluation program on Radio Sets AN/ARC-144/145 as stated herein in USAF operational aircraft were successfully demonstrated. Among these was replacement of the ARC-27, ARC-34, ARC-133 and ARC-136 radios with no aircraft wiring or structural changes required.

Operational performance in USAF aircraft was superior to existing standard UHF radio command sets. A number of design features not available on current USAF standard UHF radios, such as the ARC-27 and ARC-34, were incorporated and successfully demonstrated in the ARC-144/145 such as electronic tuning, self-test, and overall compatibility with existing and systems.

Long-term (hundreds of hours) failure-free operation of the radios in an airborne operational environment was not achieved. The reliability achieved in a laboratory reliability test environment differed from that demonstrated in an aircraft.

The ARC-144/145 program was launched without any significant prior Government sponsored R&D effort in the development of UHF solid state circuitry, components, modular design or packaging techniques that generally precede an advanced development program. The number of relevant failures that occurred in both the laboratory demonstration tests and flight evaluation tests indicates the inadequacy of the radio sets and suggests considerable over-optimism by Government and industry.

#### **References:**

Erdmann, Richard C.; **Radio Set AN/ARC-144(V) (XA-1) Final Report**; RCA Corp; Camden NJ; AFAL-TR-72-192; August 1972.

Hanks, C.L., B.C. Spradlin, J.L. Easterday; **Equipment Reliability Test Analysis of Radio Set AN/ARC-144**; Battelle; Columbus OH, DTIC AD0902503; August 1972.

Perrago, William R.; **Flight Evaluation of Radio Sets AN/ARC-144 and AN/ARC-145**; Air Force Avionics Laboratory; WPAFB OH; AFAL-TM-74-26-AAI, September 1974.

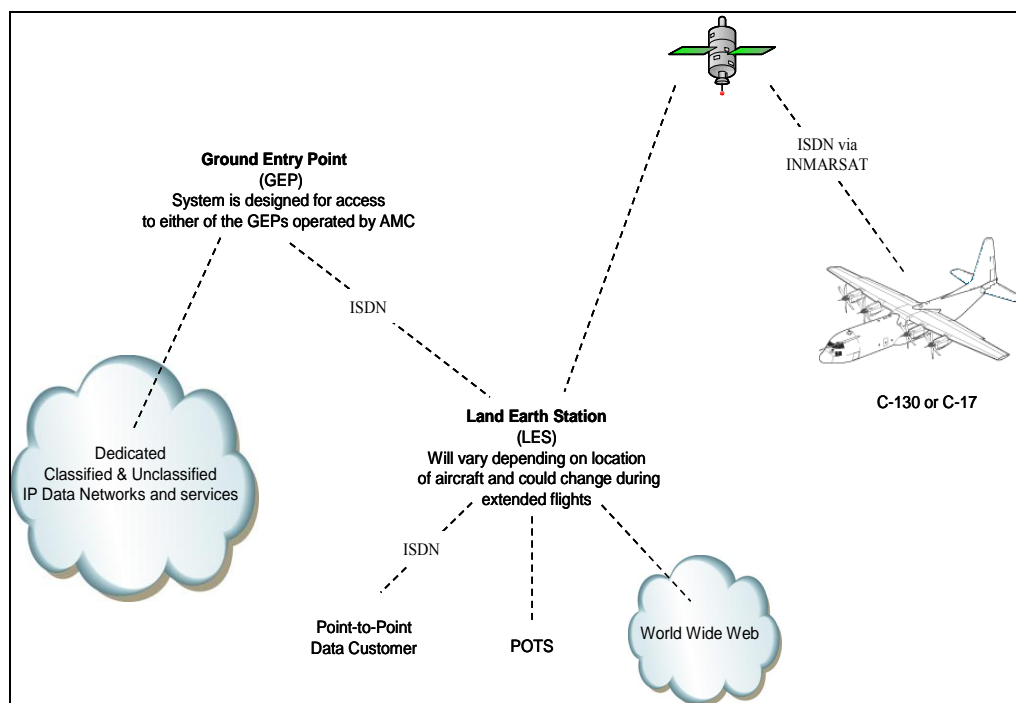
Seeley, George B.; **AN/ARC-145 Ultra Reliable UHF Radio Set Final Report**; Electronics Communications Inc; St. Petersburg FL; AFAL-TR-72-327; October 1972.

## Viper Roll-On-Roll-Off SATCOM (2004-2006)

**Background:** When high ranking Military commanders or Government personnel travel to the War Zone, they fly in non-descript military transport aircraft like a C-17 or C-130 so they won't be a prime target to terrorist. While in route, the VIPs need to have a secure communications link with their headquarters. The Viper Roll-On-Roll-Off SATCOM system was designed to satisfy that need.

**Viper Roll-On-Roll-Off SATCOM Development:** In 2004, The US Central Command Air Forces (CENTAF) (renamed US Air Force Central AFCENT in 2008) at Shaw AFB SC requested the Air Force Research Laboratory (AFRL) at WPAFB OH develop a portable SATCOM system that could be quickly installed in the cargo bay of military transport aircraft to provide secure communications via a satellite link between the aircraft and CENTAF headquarters. AFRL contracted with SelectTech Services Corp. for the development.

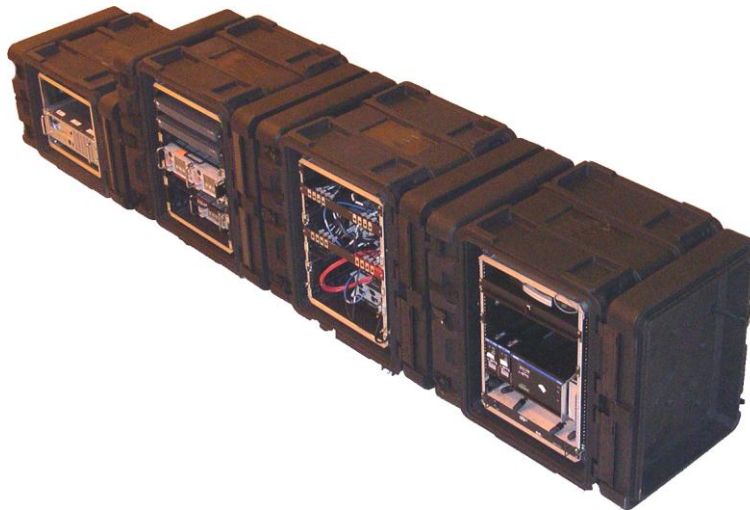
The Viper system assembled for CENTAF provided secure and non-secure voice and data from an airborne or ground site via the INMARSAT satellites into a commercial Land Earth Station (LES). From the LES, the traffic can be routed to Point-to-Point users via the Integrated Service Digital Network (ISDN) or to military operated Ground Entry Point (GEP) for connection to the Ground Network Operations Center (GNOC), World Wide Web and other data transfer points.



The CENTAF Mobile Viper System (CMVS) is self-contained and requires only power and navigation data from the aircraft, and either a topside hatch-mounted antenna (which is supplied as part of the system for C-130s) or connection to a pre-installed INMARSAT antenna (modified C-17s only). The CMVS is designed to be modular, allowing users to vary their configurations between maximum capability and minimum size/weight by varying which system cases are deployed with the aircraft. A minimum configuration allows secure SATCOM voice while a full complement of cases facilitates

simultaneous secure voice and secure data lines. Spare critical LRUs are pre-installed in the system cases to ensure service availability in the event of hardware failures

The Viper Case is the heart and brains of the system. It contains the L-Band HSD-128 transceiver, Secure Telephone (STE), Personal Computer, Antenna Control Unit, Beam Steering Unit (BSU) Protocol Converter and internal power supply. This case is designed primarily to receive filtered 115V 60 Hz power through the Power Conditioner case but can also be used in a stand-alone mode with either 115 V 60 Hz line power or 115V 400 Hz aircraft power using an appropriate supplied power cord. As a stand-alone case with associated antenna/navigation data inputs, it can provide secure voice via the ISDN STE through the Viper Swift 64 channel interface of INMARSAT.



**Four Viper Cases Make up the Primary Kit**

While the C-17 aircraft have a dedicated INMARSAT antenna mounted on top, the C-130 aircraft requires a hatch-mounted antenna that is part of the Viper kit. The C-130 Airborne antenna case contains the ATM-50 hatch-mounted antenna for use on the C-130H aircraft. It also contains the diplexer and LNA mounted to the base plate. This antenna provides a roll-on/roll-off high-gain antenna solution for non-permanent installation on the forward upper hatch of the C-130H aircraft. It is mounted through the hatch from inside the aircraft and allows airborne operation of the CMVS. The aircraft's location heading and attitude are fed through the BSU to control antenna pointing.



**C-130 Hatch-Mounted Antenna**

**Transition:** SelectTech develop, built and delivered a number of the Viper systems. These systems have been deployed to CENTAF at Shaw AFB SC and Al Udeid Air Base Qatar. Through an ongoing AFRL contract, SelectTech continues to upgrade and maintain the Viper systems for CENTSAF and provide training for the Air Force operators both at WPAFB and in Qatar.

## Wide Band UHF Radio - AN/ARC-50 (1958-70)

**Background:** As the Strategic Air Command (SAC) began planning for the operation of the A-12 (SR-71) spy plane in the early 1950s, they identified the need for a stealthy and secure means of communicating between the A-12 and the KC-135Q tankers that would refuel them. Communications research involving infrared (IR) and spread spectrum techniques were considered. In 1952, the Wright Air Development Center (WADC), the predecessor of the Air Force Avionics Laboratory (AFAL) let a contract with Sylvania Buffalo for a "Hush-Up Study." The study identified a Pseudo-Noise Spread Spectrum (PN-SS) technique that could hide the radio communications in the ambient noise. In 1956 a flyable Hush-Up breadboard was tested at Wright Patterson AFB OH and showed promise as a stealthy and potentially jam resistant means of communicating.

**Development of the AN/ARC-50:** In 1958, WADC Project Engineer, Lloyd Higginbotham, recognized that the high-speed, long-period generators being developed by industry could be used on the ARC-50 system which was emerging from the Hush-Up study at Sylvania Buffalo, to improve the Anti-Jam (AJ) performance.

The AJ push resulted in National Security Agency (NSA) being brought into the ARC-50 program for their coding expertise. However, because of their nature, NSA passed technical judgment rather than providing any concrete guidance. The NSA view was that the Spread Spectrum (SS) codes had to be cryptographically secure to guarantee AJ capability, and Lincoln Laboratory had established that the proposed ARC-50 PN-SS code was easily breakable.

In March 1958, WADC awarded the ARC-50 development contract to Magnavox because of their experience and knowledge of high-speed PN generators. Magnavox Research Laboratories at Torrance CA designed the code generators and modem, while RF equipment was built at Magnavox's Fort Wayne IN facility.

Although retaining the spirit of the Direct Sequence-Spread Spectrum (DS-SS) system developed at Sylvania, technologically the design evolved through several more phases at Magnavox. Nowhere was this more obvious than in the design of the SS code generators, the heart of the system. The earliest Magnavox code generators were built using a pair of lumped constant delay lines, run in syncopated fashion to achieve a rate of 5 Mchips/s. This technology was expensive with a code generator costing about \$5,000, and was not technically satisfactory. The first improvement in this design came when the delay lines were transistorized, and a viable solution was finally achieved when 100 of the first batch of high-beta, gold-doped, fast rise-time 2N753 transistors made by Texas Instruments were delivered and used to build a single-register code generator operating at 5 Mchips/s.

Originally to facilitate SS code synchronization, the system employed a synchronization preamble of 1023 chips followed by an m-sequence produced by a 31 stage shift register. Register length 31 was chosen because the period of the resultant m-sequence, namely 2,147,483,653, is a prime number, and it seemed unlikely that there would exist any periodic substructure useful to a jammer. Lacking knowledge of the proper connections for the shift register, a special machine was built which carried out a continuing search for long m-sequences. Problems were encountered involving false locks on correlation sidelobe peaks in the sync preamble (sometimes it seemed that a certain level of noise was necessary to make the system work properly), and concerning interference between different ARC-50 links as a result of poor cross-correlation properties between SS codes.

The ARC-50 was configured as a fully coherent system in which the SS code was first acquired, and the sinusoidal carrier was then synchronized using Phased Lock Loop (PLL) techniques. Because of



apprehension that jamming techniques might take advantage of coupling between the RF oscillator and the code chip clock, these two signals were generated independently in the transmitter. The receiver's PLL bandwidth was constrained by the fact that no frequency search was scheduled in the synchronization procedure; the assumption being that the pull-in range of the PLL was adequate to overcome both oscillator drifts and Doppler effects. Being a push-to-talk voice system which could operate either as a conventional AM radio or in an SS mode, a 5 second sync delay was encountered each time the SS modem was activated. Ranging up to 300 miles was possible with the measurement time taking about 40 seconds. To retain Low Probability of Intercept (LPI) capability in this AJ system, transmitter power was adjustable from minute fractions of a Watt, up to 100 Watts.

The preliminary test trials of the ARC-50 began in 1959 at WPAFB OH and later moved on to the Verona site at Rome Air Development Center (RADC) NY. One radio was installed in a C-131 aircraft and the other end of the link resided in a ground station along with a 10 kW, CW jammer (the FRT-49). Testing consisted of flying the aircraft in the beam of the jammer's 18 dB antenna while operating the ARC-50. Limited results in this partially controlled environment indicated that the receiver could synchronize at jammer-to-noise ratios near those predicted by theory.



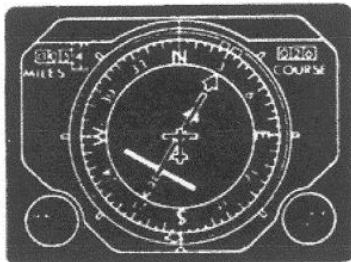
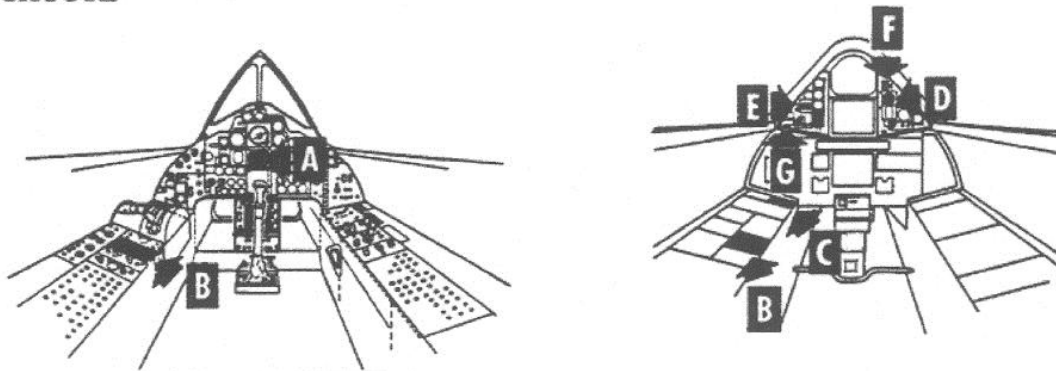
**Figure 1 AN/ARC-50 Wideband UHF Radio**

Shortly after these flight tests, an upgraded version of the ARC-50 was developed with significantly improved characteristics. To alleviate SS-code correlation problems, a new design was adopted, including an m-sequence combining procedure developed by Magnavox, which guaranteed low SS-code cross correlations for Code Division Multiple Access (CDMA) operation. The SS sync delay was reduced to one second and an improved ranging system yielded measurement in two seconds.

The ARC-50 project moved from WADC to AFAL in the early 1960s with John Flatz as Project Engineer. The production radios were installed on the SR-71s and AFAL managed various improvements and system upgrades into the 1970s.

**Operating Instructions:** These AN/ARC-50 operating instructions were obtained from the declassified SR-71 Operating Instruction Manual. The AN/ARC-50 UHF radio provides voice transmission and reception on any of 7000 channels in the P-Band frequency range. A direction-finding capability is also supplied. The radio is conventional except for a capability to operate in either an "Internal" mode (compatible with conventional UHF radio equipment), and an "External" mode (not compatible with other types of UHF radios). In the external mode, coded communication is only possible with other ARC-50 (or equivalent) radios. This mode has high resistance to jamming, allows message privacy, and has a range measuring capability.

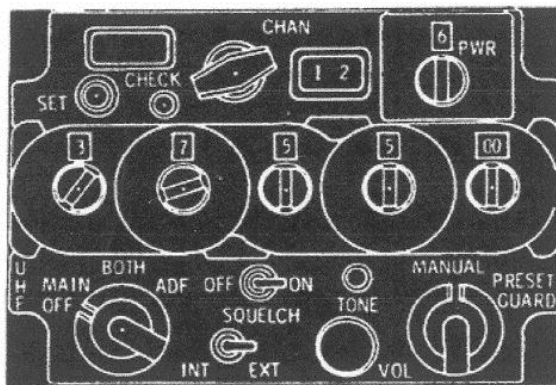
**COMNAV-50 UHF COMMAND RADIO CONTROL PANELS AND INDICATORS**



**DETAIL A**  
PILOT'S HSI



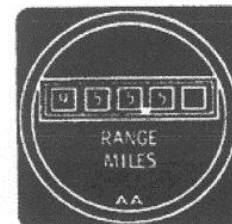
**DETAIL D**  
RSO'S BDHI



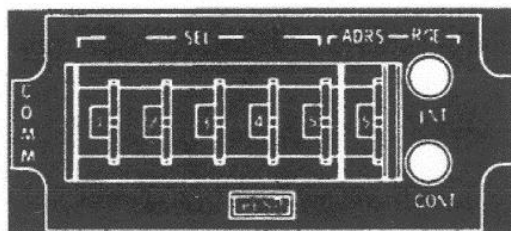
**DETAIL B**  
Pilot's UHF-1 and RSO's UHF-2  
Comnav-50 Radio Control Panel



**DETAIL E**  
RSO'S FREQUENCY INDICATOR



**DETAIL F**  
RSO'S DISTANCE INDICATOR



**DETAIL C**  
RSO's Modulator/Demodulator  
(Modem) Control Panel



**DETAIL G**  
RSO'S CONTROL TRANSFER SWITCH

**Figure 2 Locations of the AN/ARC-50 Controls in SR-71 Cockpit**

Two independent UHF radios are provided, designated UHF-1 (front cockpit) and UHF-2 (aft cockpit). They can be used independently, within limits, for internal mode communication. The modulator/demodulator (Modem) control (COMM) panel in the aft cockpit, controls coding of external mode signals and discrete selection of the ranging partner. The Modem controls can be switched by the RSO to become a part of either UHF system and give either UHF-1 or UHF-2 an external mode operating capability. Internal mode voice communication capability (without ADF function) is maintained by the opposite system; however, external mode transmissions can interfere with reception by the system operating in the internal mode if proper frequency separation is not maintained.



**Figure 3 SR-71 Connecting Up with KC-135Q Tanker Equipped with AN/ARC-50 Radios**

**Transmitter Power Output:** Transmitter power output in the internal mode is adjustable in five steps from 8.0 microwatts to 30 Watts in the frequency range from 225 to 399.975 MHz. Power positions 5 and 6 have the same transmitter power output in the internal mode. The transmitter power output in the external mode is adjustable in six steps from 8.0 microwatts to 100 watts in the frequency range from 230 to 394.975 MHz. Transmitter power should be kept as low as practical to reduce the probability of detection. The following tables list recommended transmitter power levels for air-to-air communication in the external mode.

**For Voice Comm & Ranging**

<b><u>Power setting</u></b>	<b><u>Estimated Distance Capability</u></b>
6	300 plus nm
5	100 to 300 nm
4	10 to 100 nm
3	1 to 10 nm
2	less than 1 nm
1	less than 0.1 nm

**For Direction Finding**

<b><u>Power Level</u></b>	<b><u>Distance</u></b>
6	100 to 200 nm
5	30 to 100 nm
4	3 to 30 nm
3	0.3 to 3 nm

**External Mode Signal Characteristics:** In the external mode, the transmitted signal is encoded to appear as noise to all receivers except those equipped with a compatible decoding device. The "mission code" feature prevents intelligible reception by stations which possess the necessary equipment but do not have the code. Ranging can occur only between two stations with the address code. Automatic direction finding (ADF) can also be accomplished with an addressed station in the external mode concurrently with ranging. Voice/ranging communication and ADF operations have distinct range differences for the same power level. Range measurements can be accomplished only in the external mode.

**UHF Radio Equipment Location and Power Supplies:** The UHF radio units, modulator/demodulator (Modem coding unit), and the ARA-48 automatic direction finding (ADF) equipment are located in the radio bay and cooled by the environmental control system. Power is furnished by the essential ac bus and the monitored dc bus.

**UHF Control Transfer Switch:** The push-on/push-off control transfer switch, labeled UHF TRANS, is located on the left side of the RSO's instrument panel. The switch determines which UHF radio has ADF and EXT mode capabilities. When the UHF TRANS switch is on (illuminated), UHF-2 is connected to the ADF antenna, the UHF Modem, and the forward UHF blade antenna; and UHF-1 is connected to the aft UHF blade antenna (INT mode voice communication capability only). Depressing the UHF TRANS switch when it is illuminated extinguishes the light and reverses UHF-1/UHF-2 capabilities. ADF and EXT mode communication/ranging can only be accomplished by the UHF radio connected to the ADF antenna, UHF Modem, and the forward antenna by the UHF TRANS switch. INT mode voice communication is always possible on either UHF radio.

**UHF Radio Control Panels:** A UHF radio control panel, labeled UHF, is located in each cockpit. Each crewmember can independently control operation of a UHF transmitter and its guard channel receiver. The ADF function of a radio is only operative when the RSO has selected control of the ARA-48 direction finding equipment (and the forward UHF antenna) for that radio, using the UHF TRANS switch.

**Function Selector Switch:** A four-position rotary function selector switch turns the radio ON and OFF and selects MAIN, BOTH or ADF. ADF is operable with UHF-1 if the UHF TRANS switch light is off, and with UHF-2 if the UHF TRANS switch light is on.

The UHF radio is not energized when the function selector switch is OFF. In MAIN, only the transmitter and main receiver operate. In BOTH, the transmitter, and main and guard receivers operate. The Modem unit (used for external operation) is in standby when the selector is not OFF. In ADF, the ARA-48 is energized, and the main receiver and transmitter operate. Directional signals from the ARA-48 can be displayed on the forward cockpit HSI bearing pointer and the aft cockpit BDHI No. 1 needle.

**Manual-Preset-Guard Selector:** The MANUAL-PRESET-GUARD switch controls frequency selection. In MANUAL, the manual frequency selector switches are functional. In PRESET, the preset channel selector switch is functional. In GUARD, guard channel frequency (243.0 MHz) is set on the main receiver and transmitter.

**INT-EXT Mode Switch:** The two-position transmitting mode selector switch is labeled INT-EXT. In INT, the UHF radio transmits and receives narrow-band AM signals. This position is used for conventional UHF transmitting and receiving. In EXT, the radio and modulator/demodulator (Modem)

are used together to receive and transmit the wide-band pseudo-noise encoded signal. Range information in EXT is displayed on the distance indicator in the aft cockpit. Direction-finding using the ARA-48 ADF can be done with the switch in INT or EXT. The UHF radio which is not controlling external mode operation has only internal mode communication capability and no ADF function.

**UHF Radio Operation:** The pilot controls UHF-1. The RSO controls UHF-2, the UHF TRANS switch and the Modem (COMM) panel. When the UHF TRANS switch is on (illuminated), only UHF-2 can use the direction finding and/or external communication modes. To use ADF and/or EXT mode functions on UHF-1, the RSO must select UHF TRANS off (not illuminated). The RSO controls the Modem for EXT operation with either radio.

**Operation in Internal Mode:** Normal Operation:

UHF radio panel:

1. Mode switch - INT.
2. Volume control - Nearly full clockwise. Use the interphone panel controls for volume adjustments. If necessary, decrease the UHF volume control level to maintain compatibility with the range of adjustments available in the interphone panel.
3. Power switch -Set. Position 6 is normally used.
4. Frequency - Set PRESET, MANUAL, or GUARD. Set the channel number with the CHAN knob if in PRESET. Use the five manual frequency selector switches if in MANUAL. Frequency is 243.0 if in GUARD.
5. Function selector switch - MAIN or BOTH. Set BOTH if guard channel monitoring is desired.
6. Interphone controls - Set. Select UHF-1 or UHF-2 with the interphone panel rotary selector knob and pull appropriate monitor button. Adjust volume by interphone volume control and the monitor button.

To transmit:

7. Radio transmit switch - Hold depressed.

**Operations in the External Mode:** Normal Operation:

1. Obtain UHF TRANS control. The RSO can operate the UHF-2 system independently when the UHF TRANS switch is on (illuminated). If UHF-1 is to be operated in the external mode; the UHF TRANS switch must be off and the RSO must operate the Modem panel. When operating one UHF in the external mode, the other UHF can only be operated in the internal mode. External mode transmissions by one radio can interfere with reception by the other radio.

UHF radio panel:

3. Volume control - Nearly full clockwise.
4. Power switch - Set. Position 6 is normal; however, Position 5 is normally the maximum within the U.S.



5. Frequency - Set PRESET or MANUAL. Set the channel number with the CHAN knob if in PRESET. Use the manual frequency selector switches if in MANUAL.
6. Function selector switch - MAIN or BOTH. Set BOTH if guard channel monitoring is desired.

Modem (COMM) panel:

7. Code selector switches - Set as briefed. Set 0 to 7 on each of the five code selector switches.
8. Range address switch - Set 0, or as briefed.
9. Interphone controls - Set.

To transmit:

10. Radio transmit switch - Hold depressed. A one second tone will be heard. Begin transmission after tone.

**References:**

Kucher, Paul R; **SR-71 Flight Manual (declassified)**; SR-71 Online Aircraft Museum; pp 150-158; 2011.

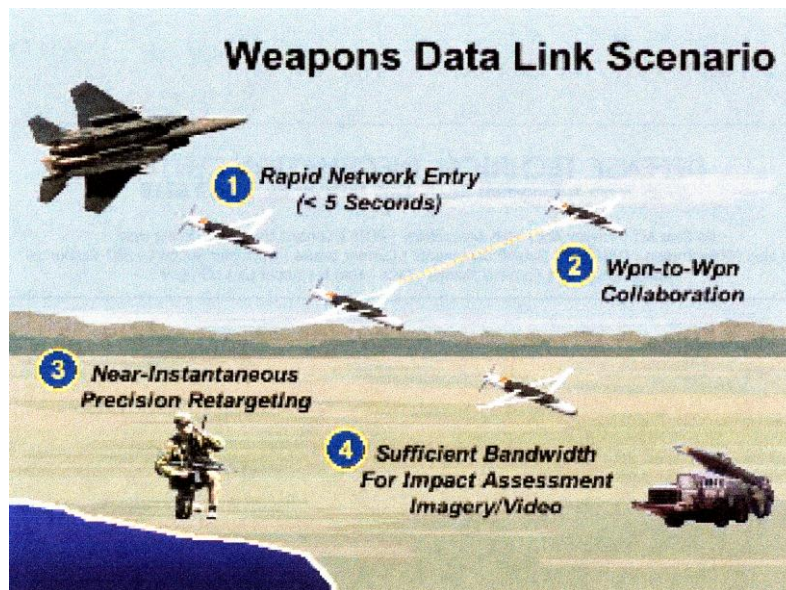
Simon, Marvin K., Jim K. Omura, Robert A. Scholtz, Berry K. Levitt; **Spread Spectrum Communications Handbook**; ISBN 0-07-057629-7; McGraw-Hill; New York NY; 1994

## Weapon Data Link (2002-2008)

**Background:** Historically, the weapons used by strike aircraft have not had the agile ability to follow a moving or relocating target. Once it is initialized and launched, it flies to the pre-designated location. The need existed for a video link to the weapon so the strike aircraft could redirect the weapon at a moving target in real time.

**Weapon Data Link (WDL) Development:** In 2003 the Air Force Research Lab (AFRL) at WPAFB OH awarded the Weapon Data Link Architecture (WDLA) program to Rockwell Collins of Cedar Rapids IA. The two-phase program consisted of the development and demonstration of a WDLA terminal suitable for use in networked weapon applications. It is based on Defense Advanced Research Projects Agency (DARPA) Banshee miniature data link program.

The goals of the program were to develop technology to (1) allow weapons to be integrated into a network-centric warfare system, (2) maximize interoperability, and (3) ensure long term viability and low life-cycle cost.



The first goal was to be achieved through alternative waveforms meeting the bandwidth and latency constraints within the operational environment. The proposed solution enables the capability of the second goal and offers technical justification to promote and advance the development of a new standard enhancing, if not replacing, the current Link 16 baseline. The program was divided into two phases or Spirals and defined below.

**Systems, Development, and Test:** The goal was to develop technology for a 50 cubic inch WDL radio and was complimented by additional delivery orders.

**Systems Engineering:** This effort focused on specialized studies facilitating the development of the Architectural Description Document. This phase (Spiral 1) spanned a planned 24 month period leading to the design, development, demonstration, and delivery of four (4) each 50 cubic inch low-power, Software Communications Architecture (SCA)-like systems.

Requirements pertaining to these studies were derived from a number of sources including the Concept of Operations issued by the Air Combat Command (ACC) and inputs from weapon prime contractors, (e.g., Boeing, Lockheed Martin, and Raytheon), and itemized below to facilitate an initial technical baseline for the design and demonstration portion of this effort. These in turn were used to develop the Weapons Data Link Architectural technical solution.

**Itemized requirements and design assumptions:**

- .Minimal impact to launch/control platforms
- .Low latency for Time Sensitive Targeting (TST)
- .Retargeting after launch
- .Transmit and/or receive capability as needed for Bomb Hit Indication (BHI), Bomb Damage Assessment (BDA), Acknowledge
- .Weapon Targeting Handover
- .Imagery/Video
- .Networked
- .Inherent Anti-jam (A/J)
- .Low Cost
- .Programmable Crypto
- .Software Communications Architecture (SCA) implementation

Fundamentally, the solution under study was to assess the viability of increasing data and communications bandwidth, while significantly reducing size/weight to facilitate data links for weapons within the Global Information Grid (GIG).

Concept of Operations (ConOps) information was obtained from the weapon User community (i.e. ACC), and from Weapon Prime manufacturers Boeing, Lockheed-Martin, and Raytheon. The diverse ConOps information was filtered down to a small number of Use Cases from which data flows and user characteristics were generated and documented in a Concept of Employment (CONEMP) study.

The outputs of the CONEMP study were fed to a Waveform study which evaluated numerous waveforms from the JTRS library and future waveforms for suitability of use in the WDL. Criteria for inclusion as a recommended WDLA waveform included: sufficient data throughput capability, heavy deployment of radio terminals with participants likely to communicate with data link equipped weapons, and parameters such as frequency range and latency.

The Network Study took the results from the CONEMP and Waveform studies and evaluated the recommended waveforms to determine the number the weapons that could be supported by the waveforms and associated networks. Recommended methods for network entry, bandwidth allocation, message implementation, and network exit were provided. In addition, a discussion of considerations related to minimum update rate was provided.

The JTRS/SCA Implementation Trade Study showed source-code reuse from both the JPO waveform library as well as the CLIP message-processing library. A single electrical circuit reference was designed. Each waveform and all required message processing software was compiled to the reference design using the operating system and object request broker selected for use by all weapon data links. Multiple mechanical instantiations were created that implement the reference design and were tested using the executables developed. While in storage, no updates need to be made to the weapon data

link. On the day the weapon is to be used, it is pulled from storage and all required executables are downloaded to the weapon data link.

The goal of the Weapon Integration Trade Study was to determine how to integrate a weapon data link terminal into a set of weapons consisting of Joint Air-to Surface Standoff Munition (JASSM), Joint Stand-off Weapon (JSOW), and Small Diameter Bomb (SDB II). To reduce the costs of integration and operation, one weapon data link terminal should be designed that would meet the mechanical and electrical requirements of as many weapons as possible. To this end, Rockwell Collins investigated the weapons' interfaces, data buses, and power systems. They compared the volume, form factor, and weight available for the weapon data link terminal across 5 weapons, and captured the signals and messages between the weapon mission computer and the weapon data link terminal. A more detailed ICD would be developed as part of a specific EMD program.

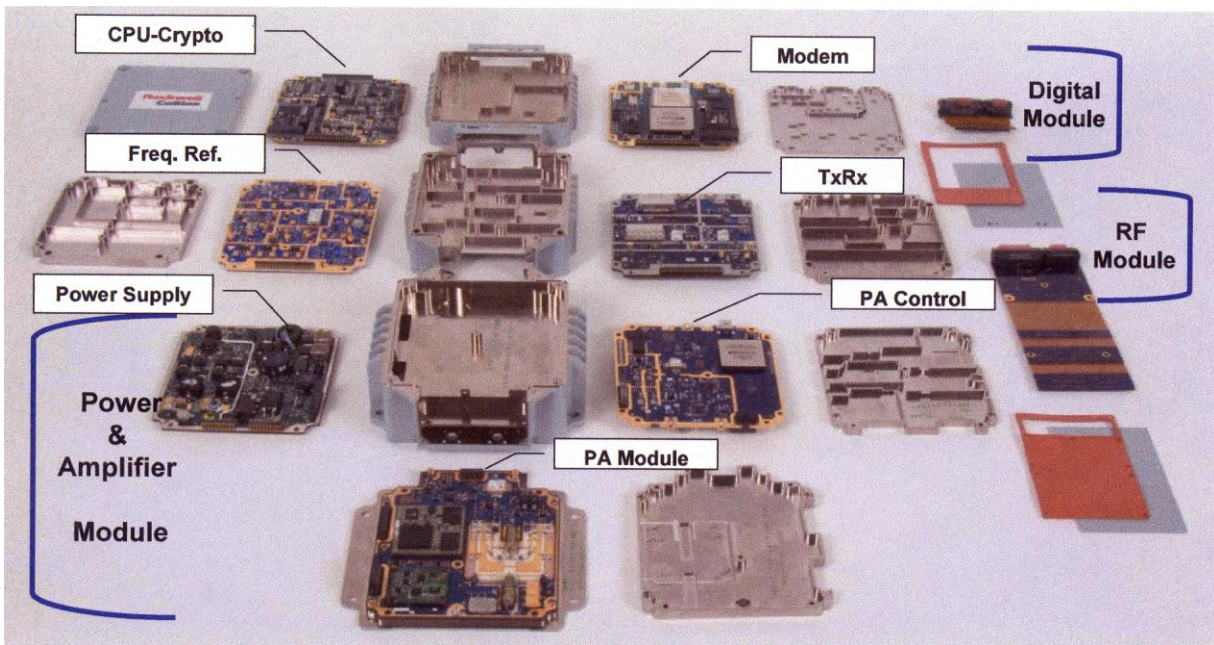
The Aircraft Integration Trade Study evaluated the integration requirements for the WDL interfaces and power availability to the aircraft launch platform. The study additionally gave an assessment of crypto loading requirements and possible design schemes.

The Networking Modeling and Simulation activity provided low fidelity modeling and simulation to validate the architecture supporting the final Architecture Description Document (ADD).

**Hardware Development and Testing:** After design work and integration was completed, the 79 cubic inch 2-channel, 3-waveform transceiver was demonstrated in the laboratory environment. The demonstration showed significant capabilities as it applies to weapons operations.



**Weapon Data Link Developmental Hardware**



**Exploded View of WDL Hardware**

Transmit testing was conducted with the units to verify that the terminal was capable of transmitting both 258- and 444-pulse messages as well as the various packing limits, for Link 16. Testing was also conducted with the units to verify packets were successfully transmitted to a UHF radio.

The terminal was tested in the Receive mode to verify synchronization. Testing was conducted with the units to verify that the terminal was capable of receiving both 258- and 444-pulse messages as well as the various packing limits, for Link 16. Testing was also conducted with the units to verify packets were successfully received from a UHF radio.

The terminal was tested for interoperability against various legacy systems for both Link 16 and UHF.

**Lessons Learned:** During the natural course of this analysis, several "Lessons Learned" were noted and documented below by heading topic:

**Common System of Systems Architecture**

- .Use COTS interfaces when available. Avoiding proprietary interfaces/ICDs allows for re-use among multiple programs/projects.
- .Work with the Customer early to develop and document key requirements, at a minimum, even on developmental programs/projects.
- .Common message sets ease software integration and test.

**Design Activities**

- .Design so test connectors are readily available.
- .Design for board-level test activities (Boundary Scan).



## **Integration Activities**

.Clearly define objectives and progression.

## **Small Parts Design**

.Smaller COTS components are readily available for digital processing.

.Specialized components, such as RF filters, still typically need to be designed increasing cost or limiting functionality.

## **Beyond Weapons**

.Small networking data links can be used by many non-weapon customers.

.If prototypes appear similar to production units, customers will assume it is or can be produced.

**Transition:** During 2008, the Weapon Data Link Program was transitioned to AFRL's Rome NY Laboratory as part of the Base Realignment and Closure (BRAC) 2005 action.

## **References:**

**Tactical Targeting Network Technology and Connectivity White Paper**; SLDINFO; Rockwell Collins; Cedar Rapids IA; 2009

**Weapon Data Link Phase I Study Report**; Rockwell Collins; Cedar Rapids IA; CAGEC 13499; 7 February 2008.