

# Naval Surface Warfare Center Carderock Division

West Bethesda, MD 20817-5700



**NSWCCD-CISD-2011/006** August 2011  
Ship Systems Integration & Design Department  
Technical Report

## Light UAV Support Ship (ASW) (LUSSA)

By:  
Cayle Bradley  
David Coar  
Daniel Nowakowski  
James Riley

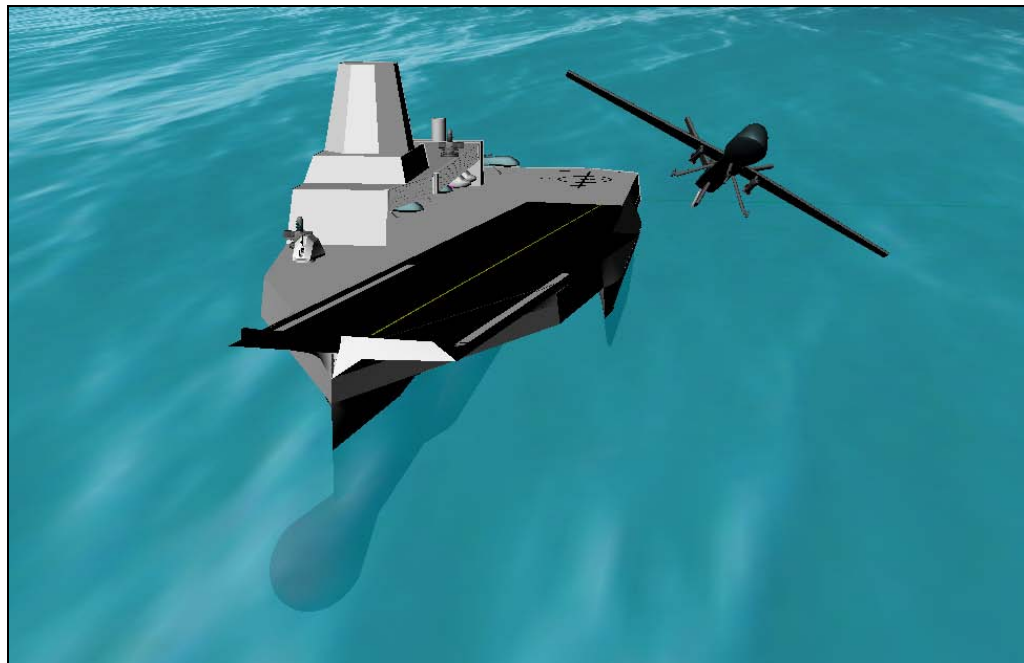

# REPORT DOCUMENTATION PAGE

*Form Approved*  
OMB No. 0704-0188

Public reporting burden for this collection of information is estimated to average 1 hour per response, including the time for reviewing instructions, searching existing data sources, gathering and maintaining the data needed, and completing and reviewing this collection of information. Send comments regarding this burden estimate or any other aspect of this collection of information, including suggestions for reducing this burden to Department of Defense, Washington Headquarters Services, Directorate for Information Operations and Reports (0704-0188), 1215 Jefferson Davis Highway, Suite 1204, Arlington, VA 22202-4302. Respondents should be aware that notwithstanding any other provision of law, no person shall be subject to any penalty for failing to comply with a collection of information if it does not display a currently valid OMB control number. **PLEASE DO NOT RETURN YOUR FORM TO THE ABOVE ADDRESS.**

|   |                                    |                                     |                                   |   |  |
|---|------------------------------------|-------------------------------------|-----------------------------------|---|--|
| <b>1. REPORT DATE (DD-MM-YYYY)</b><br>05-08-2011  |                                    | <b>2. REPORT TYPE</b><br>Final      |                                   | <b>3. DATES COVERED (From - To)</b><br>05-23-2011 - 08-05-2011              |  |
| <b>4. TITLE AND SUBTITLE</b><br>Light UAV Support Ship (LUSS)   |                                    |                                     |                                   | <b>5a. CONTRACT NUMBER</b>  |  |
|   |                                    |                                     |                                   | <b>5b. GRANT NUMBER</b>   |  |
|   |                                    |                                     |                                   | <b>5c. PROGRAM ELEMENT NUMBER</b>   |  |
| <b>6. AUTHOR(S)</b><br>Cayle Bradley, David Coar, Daniel Nowakowski, James Riley  |                                    |                                     |                                   | <b>5d. PROJECT NUMBER</b>   |  |
|   |                                    |                                     |                                   | <b>5e. TASK NUMBER</b>  |  |
|   |                                    |                                     |                                   | <b>5f. WORK UNIT NUMBER</b>   |  |
| <b>7. PERFORMING ORGANIZATION NAME(S) AND ADDRESS(ES) AND ADDRESS(ES)</b><br>Naval Surface Warfare Center<br>Carderock Division<br>9500 Macarthur Boulevard<br>West Bethesda, MD 20817-5700   |                                    |                                     |                                   | <b>8. PERFORMING ORGANIZATION REPORT NUMBER</b><br><br>NSWCCD-CISD-2011/006 |  |
| <b>9. SPONSORING / MONITORING AGENCY NAME(S) AND ADDRESS(ES)</b><br>Chief of Naval Research<br>One Liberty Center<br>875 North Randolph Street,<br>Suite 1425<br>Arlington, VA 22203-1995   |                                    |                                     |                                   | <b>10. SPONSOR/MONITOR'S ACRONYM(S)</b>                                     |  |
|   |                                    |                                     |                                   | <b>11. SPONSOR/MONITOR'S REPORT NUMBER(S)</b>                               |  |
| <b>12. DISTRIBUTION / AVAILABILITY STATEMENT</b><br>DISTRIBUTION STATEMENT A: Approved for public release; distribution is unlimited  |                                    |                                     |                                   |   |  |
| <b>13. SUPPLEMENTARY NOTES</b>  |                                    |                                     |                                   |   |  |
| <b>14. ABSTRACT</b><br><i>With the success of unmanned aerial vehicles (UAVs) in intelligence, surveillance, and reconnaissance (ISR) missions around the globe, the US Navy continues to re-evaluate its approach to other mission areas such as search and rescue and anti-submarine warfare (ASW). Recent tests onboard Navy aircraft carriers have proven the ability to successfully launch and recover large, fixed-wing aircraft autonomously from their flight decks. With these advancing technologies, a strong interest has emerged for a small support ship to launch and recover large, fixed-wing UAVs. This project was a ten week effort by Naval Research Enterprise Internship Program (NREIP) interns and NSWCCD naval architects to explore the feasibility of a light UAV support ship concept with an ASW focus. The final design integrates a new concept hull type known as the TriSWACH (Trimaran, Small Waterplane Area Center Hull). The favorable stability and seakeeping attributes of the TriSWACH allow the ship to effectively perform flight operations from a vessel smaller than the Navy's current destroyers. Additionally a concept of operations (CONOPS) was developed that allows the design to perform the entire ASW mission using only its manned and unmanned aircraft. This report describes the CONOPS and the design for a light UAV support ship with ASW capability (LUSSA).</i> |                                    |                                     |                                   |   |  |
| <b>15. SUBJECT TERMS</b><br>UAV, ASW, Trimaran, TriSWACH  |                                    |                                     |                                   |   |  |
| <b>16. SECURITY CLASSIFICATION OF:</b>  |                                    |                                     | <b>17. LIMITATION OF ABSTRACT</b> | <b>18. NUMBER OF PAGES</b>  | <b>19a. NAME OF RESPONSIBLE PERSON</b>                           |
| <b>a. REPORT</b><br>UNCLASSIFIED  | <b>b. ABSTRACT</b><br>UNCLASSIFIED | <b>c. THIS PAGE</b><br>UNCLASSIFIED |                                   |   | Colen Kennell  |
|   |                                    |                                     | SAR                               | 36  | <b>19b. TELEPHONE NUMBER (include area code)</b><br>301-227-5468 |

## Abstract

*With the success of unmanned aerial vehicles (UAVs) in intelligence, surveillance, and reconnaissance (ISR) missions around the globe, the US Navy continues to re-evaluate its approach to other mission areas such as search and rescue and anti-submarine warfare (ASW). Recent tests onboard Navy aircraft carriers have proven the ability to successfully launch and recover large, fixed-wing aircraft autonomously from their flight decks. With these advancing technologies, a strong interest has emerged for a small support ship to launch and recover large, fixed-wing UAVs. This project was a ten-week effort by Naval Research Enterprise Internship Program (NREIP) interns and NSWCCD naval architects to explore the feasibility of a light UAV support ship concept with an ASW focus. The final design integrates a new concept hull type known as the TriSWACH (Trimaran, Small Waterplane Area Center Hull). The favorable stability and seakeeping attributes of the TriSWACH allow the ship to effectively perform flight operations from a vessel smaller than the Navy's current destroyers. Additionally a concept of operations (CONOPS) was developed that allows the design to perform the entire ASW mission using only its manned and unmanned aircraft. This report describes the CONOPS and the design for a light UAV support ship with ASW capability (LUSSA).*

## Acknowledgements

The authors of this report would like to acknowledge and thank the following people for their patience and guidance.

Vice Adm. (Ret) Pete Nanos  
John Benedict at the Applied Physics Laboratory  
Alan Schwartz and John Vorwald from NSWCCD Code 53  
Colen Kennell, Dave Ruley, Robert Lamb, Mike Goodman, and Ryan Mortimer from CISD  
Pete Thomas and Jim Otis from NSWCCD Code 70

The student team consisted of:

David Coar



Daniel Nowakowski



## Table of Contents

|   |     |
|---|-----|
| Abstract .....                                    | i   |
| Acknowledgements .....                            | ii  |
| Table of Contents .....                           | iii |
| List of Tables .....                              | iv  |
| List of Figures .....                             | iv  |
| Acronyms .....                                    | v   |
| 1 Introduction .....                              | 1   |
| 1.1 Background .....                              | 1   |
| 1.2 Objective .....                               | 1   |
| 1.3 Concept of Operations .....                   | 1   |
| 1.4 Assumptions .....                             | 4   |
| 1.5 Requirements .....                            | 5   |
| 2 Concept Generation .....                        | 6   |
| 2.1 Hull form .....                               | 6   |
| 2.1.1 Monohull .....                              | 6   |
| 2.1.2 SWATH .....                                 | 7   |
| 2.1.3 TriSWACH .....                              | 8   |
| 2.2 General Arrangements .....                    | 8   |
| 2.2.1 Runway .....                                | 8   |
| 2.2.2 Flight Deck .....                           | 10  |
| 2.2.3 Main Deck .....                             | 11  |
| 3 Design Analysis .....                           | 14  |
| 3.1 Manning Estimations .....                     | 14  |
| 3.2 Volume Estimation .....                       | 15  |
| 3.3 Weight Estimation .....                       | 16  |
| 4 Propulsion and Machinery .....                  | 19  |
| 4.1 Propulsion Powering .....                     | 19  |
| 4.2 Ship's Service Electric Load Estimation ..... | 20  |
| 4.3 Machinery .....                               | 20  |
| 4.3.1 Engine Layout .....                         | 21  |
| 4.4 Propulsion .....                              | 21  |
| 4.5 Fuel and Range .....                          | 22  |
| 5 Stability Analyses .....                        | 24  |
| 6 Risks and Future Recommendations .....          | 28  |
| 7 Summary and Conclusion .....                    | 28  |
| 8 References .....                                | 29  |
| 9 Appendix .....                                  | 31  |
| 9.1 LUSSA Area and Volume Summary .....           | 31  |
| 9.2 LUSSA Weight Estimate .....                   | 32  |
| 9.3 LUSSA Electric Load Estimate .....            | 34  |
| 9.4 Speed-Power Data .....                        | 35  |
| 9.5 TriSWACH Model Test Data .....                | 35  |

## List of Tables

|   |    |
|---|----|
| Table 1: Aircraft General Characteristics .....               | 2  |
| Table 2: Requirements .....                                   | 5  |
| Table 3: Principal Characteristics .....                      | 6  |
| Table 4: Manning Estimation.....                              | 14 |
| Table 5: Avenger Detachment Manning.....                      | 15 |
| Table 6: Ship Weight Estimate and Basis Ships.....            | 17 |
| Table 7: Electrical Load Summary .....                        | 20 |
| Table 8: Engine Alternatives .....                            | 20 |
| Table 9: Fuel Consumption Tool .....                          | 23 |
| Table 10: Weight and Vertical Center of Gravity Summary ..... | 24 |

## List of Figures

|  |    |
|--|----|
| Figure 3: Sikorsky MH-60 (Sikorsky, 2011) .....              | 2  |
| Figure 1: MQ-9C Avenger(General Atomics, 2011).....          | 2  |
| Figure 2: Bat (Nothrop Grumman, 2011) .....                  | 2  |
| Figure 4: Concept of Operations.....                         | 3  |
| Figure 5: LUSSA Concept Graphic .....                        | 6  |
| Figure 6: DDG-51 .....                                       | 7  |
| Figure 7: SWATH Ship T-AGOS 23.....                          | 7  |
| Figure 8: TriSWACH Model .....                               | 8  |
| Figure 9: LUSSA Runway layout.....                           | 10 |
| Figure 10: LUSSA Flight Deck Layout.....                     | 10 |
| Figure 11: Flight Deck and Weapons Systems Layout.....       | 11 |
| Figure 12: Main Deck General Arrangements.....               | 12 |
| Figure 13: Front Profile View.....                           | 13 |
| Figure 14: Volume Summary Pie Chart.....                     | 15 |
| Figure 15: Weight Summary Pie Chart.....                     | 17 |
| Figure 16: Ship Structural Density .....                     | 18 |
| Figure 17: Power vs. Speed Curve for TriSWACH Hull Form..... | 19 |
| Figure 18: Single Engine Room Layout .....                   | 21 |
| Figure 19: Propulsion Machinery Layout.....                  | 22 |
| Figure 20: Ship Center of Gravity .....                      | 25 |
| Figure 21: 100 Knot Beam Wind.....                           | 26 |
| Figure 22: Crowding of Personnel to One Side.....            | 26 |
| Figure 23: Maximum Roll Angle for Flight Deck Awash.....     | 27 |

## Acronyms

|          |  |
|----------|--|
| AIM      | - Advanced Induction Motor                                     |
| AOR      | - Area of Responsibility                                       |
| AOU      | - Area of Uncertainty  |
| APL      | - Applied Physics Laboratory                                   |
| ASROC    | - Anti-Submarine Rocket  |
| ASW      | - Anti Submarine Warfare                                       |
| BM       | - Center of Buoyancy to Metacenter                             |
| C4I      | - Command, Control, Communications, Computers and Intelligence |
| CIC      | - Combat Information Center                                    |
| CISD     | - Center for Innovation in Ship Design                         |
| CONOPS   | - Concept of Operations  |
| CRP      | - Contra-Rotating Propeller                                    |
| EMALS    | - Electromagnetic Aircraft Launch System                       |
| GM       | - Center of Gravity to Metacenter                              |
| HFO      | - Heavy Fuel Oil   |
| IPS      | - Integrated Propulsion System                                 |
| IR       | - Infrared   |
| ISR      | - Intelligence, Surveillance, and Reconnaissance               |
| JHU      | - Johns Hopkins University                                     |
| KB4      | - Killer Bee 4, Swift Engineering UAV                          |
| KG       | - Keel to Center of Gravity                                    |
| KB       | - Keel to Center of Buoyancy                                   |
| LAMPS    | - Light Airborne Multi-Purpose System                          |
| LCG      | - Longitudinal Center of Gravity                               |
| LUSSA    | - Light UAV Support Ship (ASW)                                 |
| MFTA     | - Multi-Function Towed Array                                   |
| NREIP    | - Naval Research Enterprise Internship Program                 |
| RHIB     | - Rigid Hull Inflatable Boat                                   |
| SSCS     | - Ships Space Classification System                            |
| SWATH    | - Small Waterplane Area Twin Hull                              |
| SWBS     | - Ship Work Breakdown Structure                                |
| TCG      | - Transverse Center of Gravity                                 |
| TriSWACH | - Trimaran Small Waterplane Area Central Hull                  |
| UAV      | - Unmanned Aerial Vehicle                                      |
| UCLASS   | - Unmanned Carrier Launched Airborne Surveillance and Strike   |
| USS      | - United States Ship   |
| USW      | - Undersea Warfare   |
| VCG      | - Vertical Center of Gravity                                   |
| VLS      | - Vertical Launch System                                       |

# 1 Introduction

## 1.1 Background

Modern military operations are becoming increasingly reliant on unmanned aerial vehicles (UAVs) for persistent intelligence, surveillance, and reconnaissance (ISR). By removing the human operator from air assets, military forces have effectively increased the range and endurance of ISR missions and, more importantly, reduced human loss. Advances in UAVs and surveillance systems technologies have stimulated interest in exploiting these assets for extended range ASW. Large, fixed-wing, high-endurance UAVs searching with periscope detecting radars could meet the submarine threat out to a range of over 200 nm from their launching platform. Furthermore, studies from the Johns Hopkins University Applied Physics Laboratory (JHU/APL) and Naval Surface Warfare Center (NSWC) Carderock have identified tactical advantages to deploying a swarm of small UAVs to detect sub-surfaced threats out to 80 nm (Goodman & Mortimer, 2010). The Swarm concept applied to the ASW mission produces a favorable probability of detection dependent on the number of UAVs, their velocities, the search area, and the length of time they are on station. This concept ship design combines the large fixed-wing UAV delivery with the Swarm concept and additional manned aircraft to provide a complete ASW capability.

Large, fixed-wing UAV launch and recovery is currently restricted to land based runways and consequently, the reach of UAVs is limited by their fuel capacity. As more naval-oriented UAVs are developed, and carrier-based autonomous launch and recovery systems are tested, at-sea UAV operations will be adopted by the Fleet. Current aircraft carriers are costly to construct and operate, and are therefore limited in numbers. Interest has emerged for a light UAV support ship to meet this rising focus.

## 1.2 Objective

The objective of this project was to develop a concept ship design for a light UAV support ship with ASW capabilities (LUSSA). The focus was directed toward flight operations and arrangements that will allow the ship to complete the ASW mission with its air assets. The team identified benefits of the design solution as well as potential shortcomings and areas for further consideration.

## 1.3 Concept of Operations

Guidance provided by JHU/APL, the Signatures Division at Carderock, and NAVAIR was used to develop a concept of operations (CONOPS) that will allow the LUSSA design to complete the ASW mission with its manned and unmanned aerial vehicles. Possible shipboard ASW packages were evaluated for sizing purposes, although determination of the most effective ASW systems package proved to be outside the scope of this project. Assumed mission specifics, such as diesel submarine surface intervals and sensor ranges, played key roles in the CONOPS development.



The operational concept requires three types of aircraft to search, detect, classify and destroy the subsurface target. The mission requires a large, fixed-wing, high endurance UAV, with up to 47 small UAVs, and an ASW-capable helicopter. Although three specific aircraft were selected for completion of the CONOPS and the ship design, other equivalent aircraft could be implemented. General characteristics for those chosen are shown in Table 1.

Table 1: Aircraft General Characteristics

|                      | General Atomics<br>Sea Avenger | Northrop Grumman<br>Bat | Sikorsky<br>Seahawk |
|----------------------|--------------------------------|-------------------------|---------------------|
| <b>Wingspan</b>      | 20.1 m                         | 3.6 m                   | 16.4 m              |
| <b>Length</b>        | 13.4 m                         | 1.9 m                   | 19.8 m              |
| <b>Max TO Weight</b> | 7,100 kg                       | 99.8 kg                 | 10,600 kg           |
| <b>Payload</b>       | 2,948 kg                       | 34 kg                   | 4,535 kg            |
| <b>Range</b>         | 8,000 nm                       | 970 nm                  | 245 nm              |
| <b>Endurance</b>     | 18 hours                       | 14 hours                | 3 hours             |
| <b>Max Speed</b>     | 400 kts                        | 89 kts                  | 156 kts             |



Figure 1: MQ-9C Avenger(General Atomics, 2011)



Figure 2: Bat (Northrop Grumman, 2011)

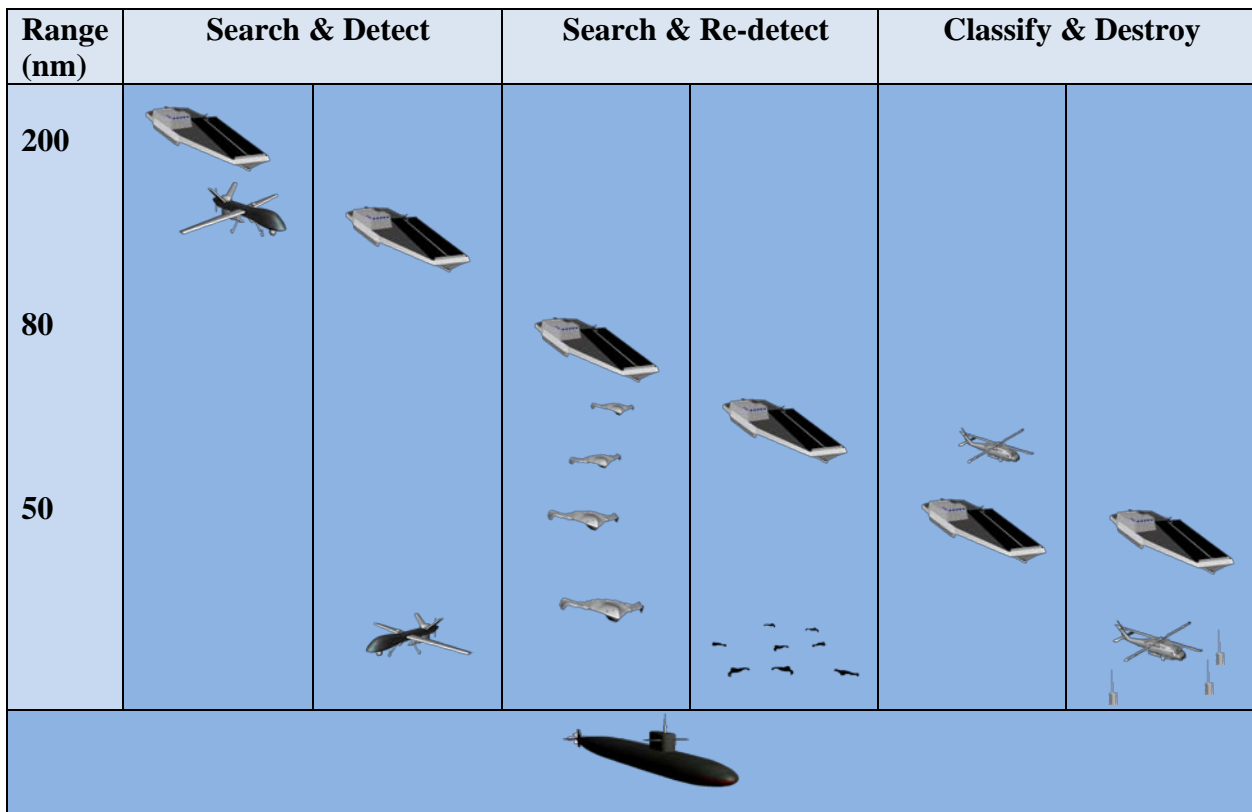

Figure 3: Sikorsky MH-60 (Sikorsky, 2011)

The CONOPS is illustrated in Figure 4. In a typical scenario, the CONOPS begins with intelligence reporting a submarine in the ship's area of responsibility (AOR). The ship begins closing on the submarine and launches one Avenger-type UAV. Once the UAV is within the submarine's area of uncertainty (AOU), it uses non-acoustic sensors such as synthetic aperture radar and infrared to detect the surfaced or snorkeling submarine. The UAV tracks the submarine until it is lost or the ship is within 80 nm.

At 80 nm from the submarine, or its AOU, the ship begins launching a Swarm of small, Bat-like UAVs. The Swarm begins searching the area, re-detects, and tracks the submarine using magnetic sensors.

The ship continues to close on the submarine or its AOU to a range of 50 nm. This range is maintained while the ship launches an MH-60 Seahawk configured for ASW. Once on the submarine's new datum, the helicopter launches a field of sonobuoys and continues to track and then classify the submarine. If ordered, the Seahawk then drops a weapon on the target.



**Figure 4: Concept of Operations**

## 1.4 Assumptions

The completion of this concept ship design, specifically the flight components, required several assumptions regarding the selected UAVs.

As previously mentioned, the Sea Avenger UAV was chosen as the large, fixed-wing, high endurance aircraft. This UAV is essentially a marinated version of the General Atomics MQ-9B Reaper currently in development. Consequently, many of this UAV's details have not been defined. The following assumptions were made regarding the launch and recovery requirements of the Sea Avenger:

- The aircraft will meet the Unmanned Carrier Launched Airborne Surveillance and Strike (UCLASS) requirements (Thompson, 2010). UCLASS requirements that are most relevant to the design assumptions are as follows:
  - The wings will fold to improve storing capabilities.
  - There will be a tail hook that will enable arresting cable recovery.
  - The aircraft will be able to endure forces associated with an arresting cable recovery.
- The arresting cables can be detachable to use the same platform for both launch and recovery.
- The runway length required for an Avenger can be reduced by 30% if it is launched from a Ski Jump (Furey, 1983).
- The automated landing sensors on the Avenger will be similar to or better than those tested on the US Navy's F-18's.

The Swarm aspect of the CONOPS isn't limited to any one type of UAV. However, previously conducted studies within the Center for Innovation in Ship Design (CISD) used the Northrop Grumman Bat UAV (formally known as the Swift Engineering Killer Bee KB4) to model launch, recovery, and operation of UAVs in the Swarm concept. Some features of the LUSSA design were based on these studies. Therefore, operational assumptions made in these previous studies were also made for this design.

- The Bat's launch catapults and recovery nets can be assembled and operated from the ship's flight deck.
- The newer versions of the Bat UAV can fold and stow similar to the earlier versions such as the KB4.

## 1.5 Requirements

The LUSSA design was challenged with meeting requirements provided by CISD. These requirements are shown in Table 2: Requirements.

**Table 2: Requirements**

| <b>LUSSA Specifications</b>                      |  |  |
|--|--|--|
|  | <b>Threshold</b>   | <b>Objective</b>                           |
| <b>Displacement</b>                              | 4,000 - 8,000 t  |  |
| <b>Range</b>                                     | 4,000 nm   | 5,000 nm                                   |
| <b>Sustained Speed</b>                           | 26 kts   | 31 kts                                     |
| <b>Fixed-wing UAV / Manned Aircraft Capacity</b> | 3 Reaper-sized UAVs  | 6 Reaper-sized UAVs OR<br>3 UAVs + 1 MH-60 |
| <b>Take-off Area</b>                             | 50 m EMALS   | 60 m EMALS                                 |
| <b>Landing Area</b>                              | 50 m EMAG  | 100 m EMAG                                 |
| <b>Boat Handling</b>                             | 1x7 m RHIB w/ L&R, Rescue Boat   |  |
| <b>Basic AAW</b>                                 | 2 x Phalanx CIWS   | 2 x SeaRAM                                 |
| <b>Basic SUW</b>                                 | 2 x 25 mm Mk 38  |  |
| <b>ASW Detection / Sensor ASW Prosecution</b>    | <i>Options: LF Hull Sonar / CAPTAS / MFTA / Sonobuoys<br/>Options: None / Torpedoes / VLS (e.g. ASROC)</i>   |  |
| <b>Decoys / CM</b>                               | Chaff Decoy Launcher (Mk 36), Buoy Decoy (AN/SLQ-49), Towed Decoy (NIXIE)                                    |  |
| <b>Combat System</b>                             | LCS-like (COMBATTS-21)   |  |
| <b>Radar / Comms.</b>                            | Surface Search / Nav. Radar (AN/SPS-67), TRS-3D Radar, Long Range Radar (AN/SPS-49), SATCOM, EWS (AN/SLQ-32) |  |
| <b>Modularity</b>                                | Variable UAV Payloads  | Hangar Mission Modules                     |
| <b>Fleet Interoperability</b>                    | Independent  | Battle Fleet C4I                           |
| <b>Sea State - Operability</b>                   | SS4  | SS5  |
| <b>Sea State - Survivability</b>                 | SS8  | SS8  |
| <b>Berthing</b>                                  | 200  | 300  |
| <b>Sustained Speed</b>                           | 15kts  | 20 kts                                     |

## 2 Concept Generation

The LUSSA design produced by this project is shown in Figure 5: LUSSA Concept Graphic. Principal characteristics for the LUSSA design are given in Table 3.

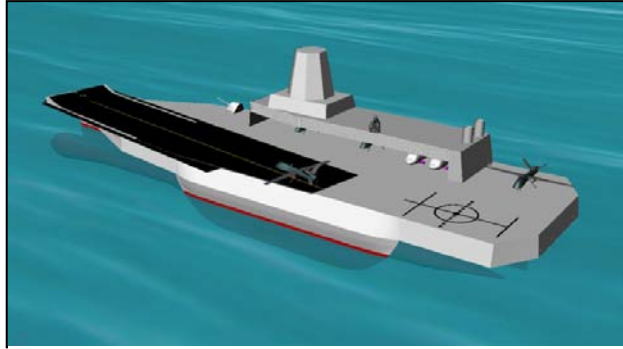

Figure 5: LUSSA Concept Graphic

Table 3: Principal Characteristics

|                          |   |
|--------------------------|---|
| <b>Displacement</b>      | 5,700T  |
| <b>Overall Length</b>    | 136.7m  |
| <b>Beam</b>              | 38.4m   |
| <b>Draft</b>             | 14.9m   |
| <b>Range</b>             | 7,900nm   |
| <b>Top Speed</b>         | 25kts   |
| <b>Cruising Speed</b>    | 19kts   |
| <b>Propulsion System</b> | Integrated Propulsion System (16.8MW)<br>Contra-Rotating Propeller (CRP) System<br>Shaft + Pod Hybrid |
| <b>Aircraft</b>          | 4x General Atomics MQ-9c Avenger UAVs<br>2x Sikorsky MH-60R Seahawk<br>47x Northrop Grumman Bat UAVs  |

The concept development began with the layout of the flight deck, one of the main design drivers. The flight deck's general arrangement then drove the decision for the selected hull form. Once the hull form was chosen, the design gained more detail with a basic arrangement to reflect volume, weight and manning requirements. Powering requirements were defined and machinery and propulsion systems were selected. Finally, center of gravity and stability analyses were completed.

### 2.1 Hull form

When selecting the hull form, the requirements greatly limited the design and drove the selection. The types of hulls considered were the monohull, the Small Waterplane Area Twin Hull (SWATH), and the Trimaran Small Waterplane Area Center Hull (TriSWACH). Ultimately, the TriSWACH was chosen for this concept.

#### 2.1.1 Monohull

The monohull hull type has proven itself within the Navy as an adequate platform for various mission types and will continue to meet the Fleet's needs for years to come. Although

monohulls have been the hull type of choice for aircraft carriers in the past, the stability and seakeeping associated with a 4,000-8,000 t monohull is inadequate. The rolling and pitching of a light support ship monohull in higher sea states is too great for flight operations. Additionally, the wing span of the type of aircraft to be implemented in this design proves too great for a vessel of this size. To meet the appropriate wingtip clearances, 25 m is required for the width of the runway. When compared to the DDG-51, shown in Figure 6: DDG-51, which has a displacement of roughly 9,000 t and a beam of less than 19 m, it is clear that a monohull of this size cannot support the required beam for the runway.



Figure 6: DDG-51

### 2.1.2 SWATH

The SWATH hull type attested to be a better suited candidate for this concept than the monohull for its excellent seakeeping and wide beam. However, although the hull type could have the necessary length and beam to support flight operations, the resulting volume and weight would have been in excess to what is required. Additional analysis into this hull type as a light UAV support ship, combined with the role of current T-AGOS vessels may show an ability to more closely meet mission demands of an independently steaming surveillance vessel. Figure 7: SWATH Ship T-AGOS 23 shows the acoustic surveillance SWATH vessel USS Impeccable.



Figure 7: SWATH Ship T-AGOS 23

### 2.1.3 TriSWACH

The TriSWACH hull type is essentially a combination of the trimaran and the SWATH hull types. As seen in Figure 8, the TriSWACH has a small waterplane area center hull with smaller outer hulls for stability. This hull form has shown promise in initial model tests with stability and seakeeping characteristics that are comparable to the SWATH. As previously mentioned, good seakeeping and stability are necessary to perform at-sea flight operations. The versatility of flight deck arrangement makes this hull form more suitable than the SWATH. The hull form presents the ability to angle the runway which optimizes deck space by allowing a larger area for aircraft on the aft end of the ship. Having the runway angled over the center hull will also reduce structural weight. The flight deck was one of the major design drivers in this concept and will be discussed in greater detail in Section 2.2.

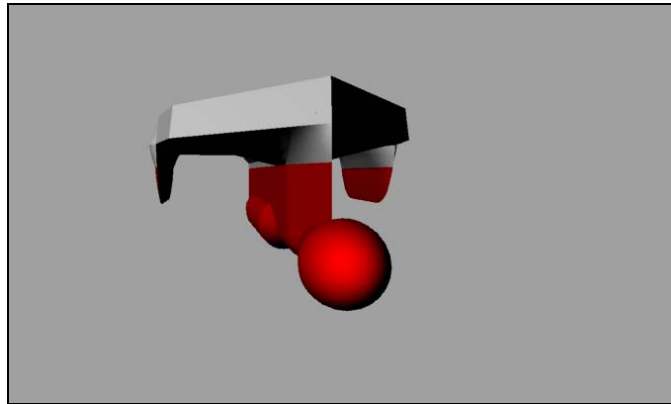

Figure 8: TriSWACH Model

## 2.2 General Arrangements

LUSSA's general arrangements were primarily driven by two issues unique to the hull form and requirements of the design. The key issue was to optimize the space on the flight deck while maintaining the ability to launch and recover the aircraft. The next challenge was the placement of engines and larger auxiliary units. After these issues were addressed, the remainder of the volume was arranged to maximize stability.

### 2.2.1 Runway

The concept's aircraft runway proved to be the most difficult design challenge mainly due to the infancy of the Avenger, and therefore the lack of relevant information. Two concepts were strongly considered for runway type - a short catapulted runway, which is largely dependent of the aircraft landing requirements, and a longer unassisted take-off runway, which is largely driven by take-off requirements. An uncatapulted style runway was ultimately chosen. The selection process for runway style is described throughout the remainder of this section.

As stated in the assumptions, by meeting the UCLASS requirements the Avenger should withstand the forces applied during arresting cable recovery. The amount of force the landing gear can endure as well as data regarding the additional weight to support the landing gear was unavailable; however, it is commonly believed that the marinization of the MQ-9 Reaper

included additional components and structure for flight deck launching and recovery. The runway was modeled by scaling the Gerald R Ford Class carrier flight deck. The size, weight, and approach angle of the F-18 Hornet fighter jet were considered and then the runway was conservatively scaled using the size, weight and approach angle of the Avenger. The landing area on the Gerald R Ford Class carrier is nearly 135 m long which is broken down into three zones. The first is the buffer zone, which is used as a safety margin, followed by the touchdown area and then the arresting zone. Arguably the most important zone is the touchdown zone, because this is where the aircraft hooks the arresting wire and eventually slows to a stop.

Current conventional carriers recover aircraft using three arresting wires that are separated by 15 m (Rudowsky, 2002). This spacing is based on a convention that was originally derived from the accuracy and confidence of the pilots. Today, autonomous landing is beginning to become a reliable alternative. Based on a study conducted in the nineties where numerous autonomous landing tests were performed with an F-18, the mean error in autonomous landing was less than two meters in the longitudinal direction with a standard deviation of seven meters. The F-18 is about three times heavier than the fully loaded Avenger and four times heavier when both are empty. The Avenger has a mean chord of about 1.2 m and weight of 7,100 kg. This gives a wing loading of approximately  $290 \text{ kg/m}^2$  and an aspect ratio of about 17. The F-18 has a wing loading of about  $550 \text{ kg/m}^2$  and an aspect ratio of about 3.5. In comparison, the much lower wing loading and much higher aspect ratio of the Sea Avenger results in the approach speed being much lower and the glide slope much higher. For this concept design it was assumed that if the standard deviation for an F-18 is seven meters, the error for Avenger landing would be somewhat less, and therefore a five meter spacing between arresting cables and a 15 meter buffer zone was determined to be adequate. This spacing also assumes that the automatic landing system would be the same or better than those on the F-18 tests. Additionally, if the Avenger's hooking system can endure the same arresting forces as an F-18, the Avenger can be brought to a stop in nearly ten meters. Therefore, the Avenger requires a minimum length of 60 m for landing. Dimensions of each zone on the LUSSA runway are shown in Figure 9.

The capability to support unassisted take-off adds greatly to the functionality of this support ship concept. Catapult systems have typically been steam systems that require a lot of volume, and recently, Electromagnetic Aircraft Launch Systems (EMALS) have become viable options but are large, expensive, heavy, and are still somewhat unproven. Many of today's aircraft carriers utilize runway ski-jumps which have proven to reduce the take-off distance by 30% (Furey, 1983). Again, many of the specifications for the Avenger UAV have not been released but from simple calculations it was determined that a fully loaded Avenger would need to achieve about 150 kts velocity to take off. This velocity was used, along with the Avenger's turbofan engine thrust to determine that a runway length of 90 meters was needed to launch the UAV from a Ski Jump into 25 knot relative winds (Kasitz, 2009).



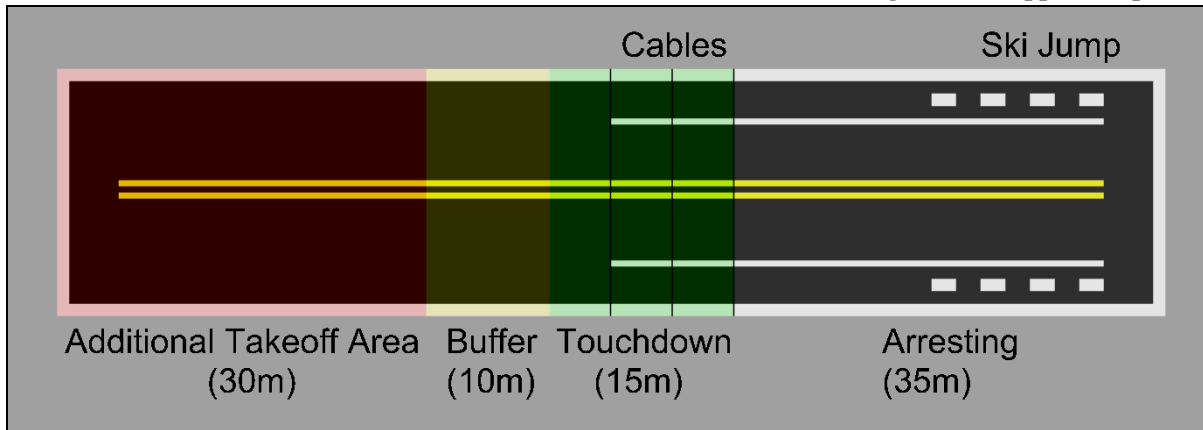

Figure 9: LUSSA Runway layout

### 2.2.2 Flight Deck

The flight deck was one of the biggest design drivers in the LUSSA concept. The difference between the runway in the previous section and the final runway is that the take-off zone was cut off at the edge of the ship while the landing area remains full width as illustrated in Figure 110. The additional material is unnecessary and increases the weight and structure required. There is full wingtip coverage under where the aircraft touches down plus the ten meters of buffer zone. The aircraft does not have to change the way it would approach the runway even though there is potential added lift due to ground effect. This force is only relevant with smaller craft when their wings are only a distance of one chord above the surface, just over a meter for the Avenger.

The large structure on the flight deck is an aluminum aircraft hangar and Pilot House. Aluminum was chosen to reduce the ships weight. The hangar has the ability store one Swarm of 47 Bat UAVs, two Avengers and two MH-60s with space for machinery exhausts at the aft end. To augment hangar stowing of aircraft, tie-down space has been designated on the flight deck for two more Avengers. If necessary, another two additional Avengers could be tied down to the helicopter landing area at the aft port end of the flight deck.

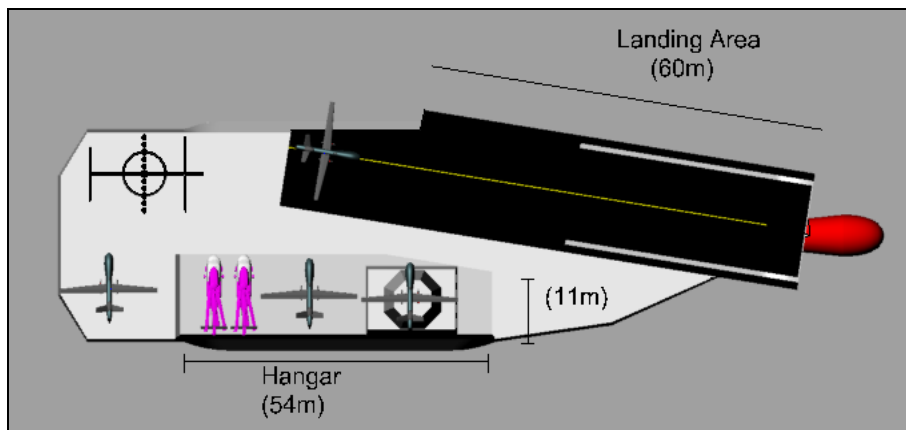

Figure 10: LUSSA Flight Deck Layout

For anti-missile defense, two SeaRAM missile launcher systems have been added - one on top of the hangar and the other forward of the deckhouse. The hangar mounted SeaRAM can be seen in Figure 11. Additional offensive weapons capability may be desirable for use when the aircraft are not in operation, but the selection of these systems require further research. Several alternatives were considered however. The MK-110, 57 mm gun, shown forward of the deckhouse in the figure, is an attractive alternative because of its reliability and versatility. A Harpoon missile launcher system is feasible but not favored because of its lack of interchangeability in payload. The MK-143 armored box launcher would provide Tomahawk missile capability for the ship; however by the time the ship is designed to enter service the technology would be outdated. A Vertical Launch System (VLS) is a very effective system which can support many weapons. However, the system is nine meters high which makes it difficult to integrate with the LUSSA. The side-hulls are not wide enough to house the structure and locating the system along the centerhull would interfere with flight operations.

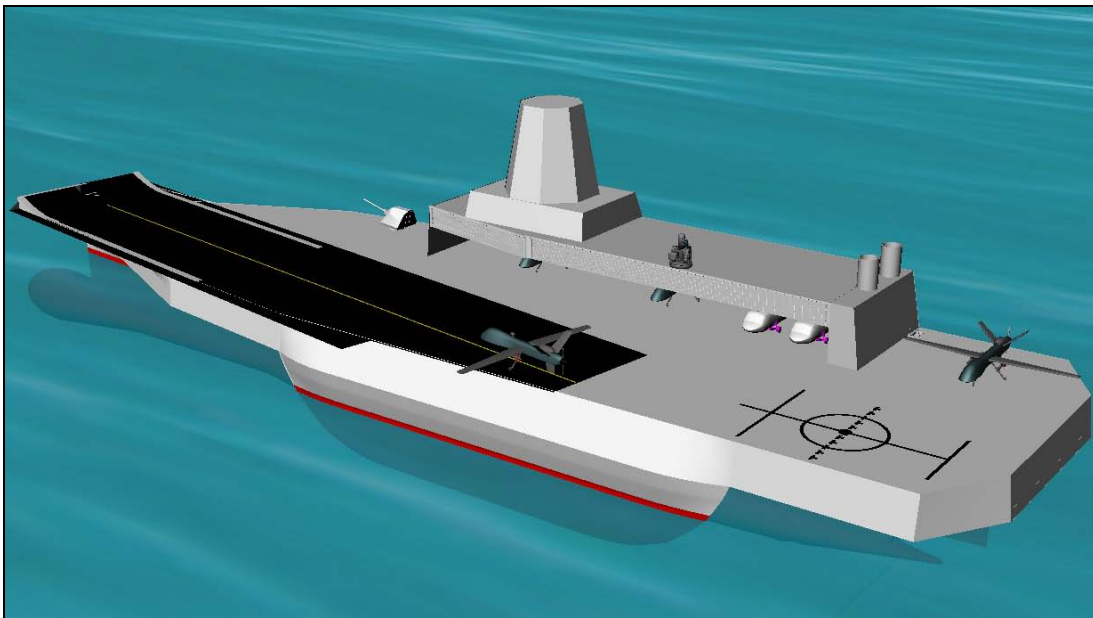
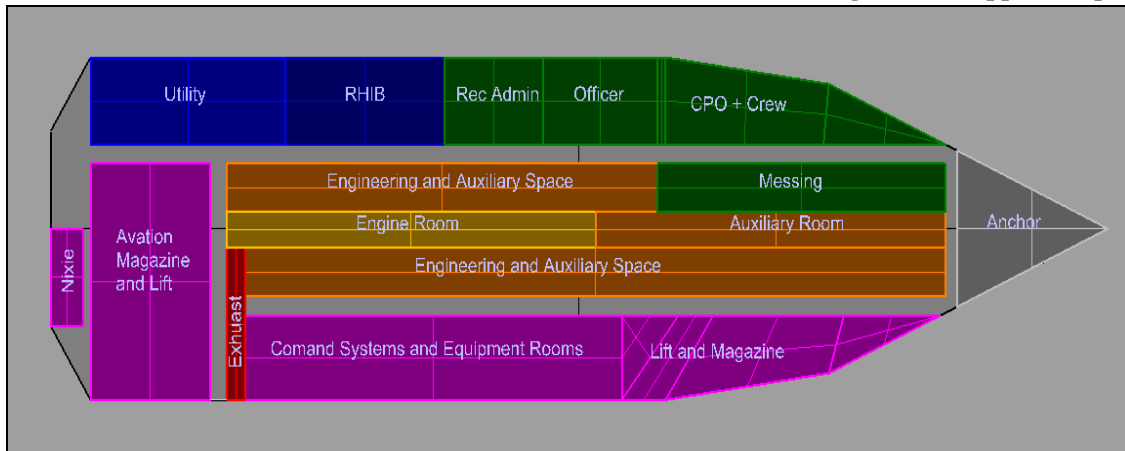

Figure 11: Flight Deck and Weapons Systems Layout

### 2.2.3 Main Deck

The Main Deck is located just below the flight deck and contains most of the ship's configurable area. As shown in Figure 12, this deck includes the entire berthing section along with auxiliary compartments, and houses the Anchor Compartment and all the combat system spaces.



**Figure 12: Main Deck General Arrangements**

The forward-most space on the Main Deck is the Anchor Room which houses the anchor's windlass, chain, and other equipment. The forward port section of the ship is mainly dedicated to crew living spaces as shown in Figure 12. Outboard on the port side are berthing spaces, and just aft of the officers' berthing is an area for recreation, administration, and the main medical compartment. The ship's mess is inboard of the berthing spaces. Utility spaces and the Rigid Hull Inflatable Boat (RHIB) stowage are located aft on the port side. The utility space is not a part of the required volume, but has been assigned as such to house any storage or auxiliary equipment not accounted for in the volume estimate.

Shown in purple on the figure is area designated for combat systems spaces. In the aft-most compartment of the ship is the Torpedo Countermeasure (NIXIE) Room, so located to allow deployment of torpedo countermeasures. The aviation magazine was given a large footprint to house ammunition for up to six Avengers and two MH-60s for long deployments. There is also a lift in this section to bring the weapons to the flight deck. The command systems and equipment section will be used as the Combat Information Center (CIC). This area was given a large margin because combat systems are not well defined. There is an additional lift and magazine in the forward starboard section of the ship to service the SeaRAM and other weapons systems forward.

The auxiliary rooms and main engine room are located along the centerline to accommodate taller equipment, such as the engines. These spaces are six meters high realized by dropping between the port and starboard side double bottoms and into the centerhull and as shown in Figure 13.

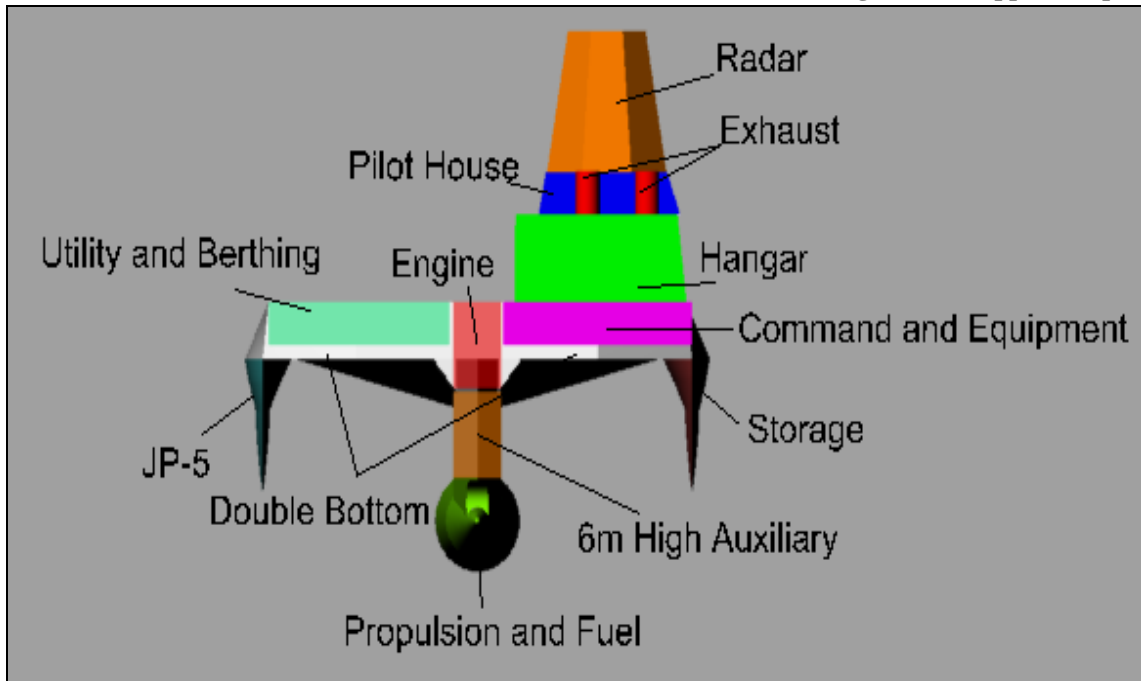

Figure 13: Front Profile View

The engine room would not have been able to fit anywhere on the ship except along the centerhull because of its height. With the addition of the double bottom, it was possible to keep the engines above the waterline which, along with acoustic enclosures, reduces the ship's acoustic signature. Some space within the double bottom, about one meter high, is available for piping and electrical system runs. This will reduce clutter and more effectively use volume.

### 3 Design Analysis

#### 3.1 Manning Estimations

Manning was difficult to estimate primarily because there is very limited data on the air wing associated with the UAVs. Furthermore, in reality, Avenger maintenance crews might also maintain Bat UAVs? Little information was available regarding the degree of expertise needed to support either of these aircraft. To maintain a conservative design, it was assumed that a separate air wing would support each vehicle. With this in mind, the LUSSA’s total crew is estimated to be 130 personnel as broken down in Table 4.

The manning estimate began with a core crew of 40 personnel, the same as the LCS-2. The LCS-2 was chosen because it is a similar sized trimaran by volume. It was assumed that it would require a comparable amount of personnel to operate the ship. This was thought to be a conservative estimate because of the more complex systems on the LCS.

Air wings were added for the different aircraft onboard. The Avenger detachment estimate was determined by augmenting the personnel needed to launch, recover, monitor and maintain one aircraft with an estimate of the added support needed for each additional aircraft as shown in Table 5. The air wing detachment for the MH-60s was determined using the same process as the Avengers, but modified to fit their operational needs. Lastly, the Swarm detachment was directly based on a report from CISD on the Swarm Concept (Goodman & Mortimer, 2010).

With the additional air wing detachments, fifteen more personnel were added for the additional supply, maintenance, service, and administration roles. Finally a 10% margin was added in accordance with the United States Navy standards (Policy for Weight and Cg Margins; NAVSEA Instruction 9096.6B).

**Table 4: Manning Estimation**

| LUSSA Manning           |            |
|-------------------------|------------|
| LCS-2 Core              | 40         |
| Avenger Detachment      | 22         |
| MH-60 Detachment        | 24         |
| Swarm Detachment        | 17         |
| Service/Admin Personnel | 15         |
| Sub-Total               | 118        |
| Margin (10%)            | 12         |
| <b>Total</b>            | <b>130</b> |

**Table 5: Avenger Detachment Manning**

| Avenger Detachment |                    |    |       |      |               |     |     |       |                 |
|--------------------|--------------------|----|-------|------|---------------|-----|-----|-------|-----------------|
| # of UAV's         | Quantity Dependent |    |       |      | Non-Dependent |     |     |       | Total Personnel |
|                    | Tech.              | IT | Radar | Ord. | OIC           | CPO | LPO | ADMIN |                 |
| <b>1</b>           | 5                  | 1  | 3     | 2    | 1             | 1   | 1   | 1     | <b>15</b>       |
| <b>2</b>           | 3                  |    |       |      |               |     |     |       | <b>18</b>       |
| <b>3</b>           | 1                  |    |       |      |               |     |     |       | <b>19</b>       |
| <b>4</b>           | 1                  | 1  |       | 1    |               |     |     |       | <b>22</b>       |

### 3.2 Volume Estimation

In the beginning stages of the concept development, the ship was considered to be volume driven because of the challenge of storing these large aircraft either in the hangar or on the deck. After volume and weight analyses were performed considerable unassigned volume existed in the design.

The required volume was initially derived from the LCS-2 area/volume summary because it is a similarly sized trimaran warship. Many of the auxiliary systems were assumed to be similar in size. Further analyses indicated that certain LCS systems were not needed. The large spaces needed to support gas turbines and their related systems were replaced with spaces appropriate for diesels and the water-jet spaces were replaced by the appropriate propulsion devices. The engine room was then tailored to fit LUSSA’s engines based on its power needs.

Berthing was scaled on the number of crewmen in the LUSSA concept. The LCS mission bay was replaced with the hangar requirements for the stowed aircraft. Space for the MK-110 gun was included in the ship’s volume estimate. With these adjustments, required volume was estimated to be 19,000 cubic meters. LUSSA has a total volume of 22,000 cubic meters which leaves 3,000 cubic meters of unassigned space. Figure 14 shows how volume is distributed between each Ship’s Space Classification System (SSCS) group.

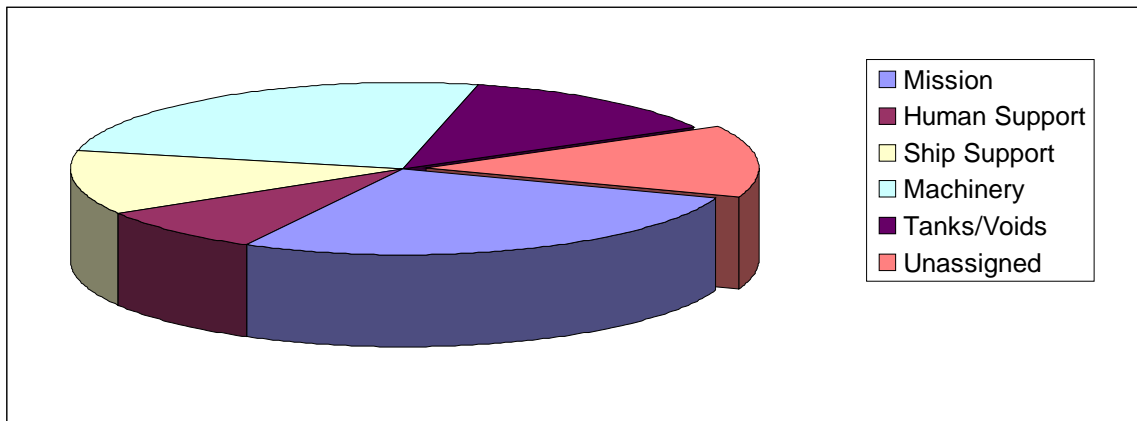

**Figure 14: Volume Summary Pie Chart**

### 3.3 Weight Estimation

Weight was a significant design driver for this project. Weight was parametrically estimated in the Ship Work Breakdown Structure (SWBS) system using the CISD weight estimating spreadsheet. Table 6 summarizes the weight estimate and the ships that were used for scaling.

Weight data for the ships listed in was used selectively for estimating LUSSA's weight. Because of the similarities discussed in the volume and manning sections of this report LCS-2 was used for scaling some SWBS groups as indicated by the "X" in the table. *Triton* was used to estimate structural weight because it is currently the only operational large steel trimaran. Both of the T-AGOS ships were used because they are SWATH hulls and provide a more accurate structural estimate than a monohull, and they have integrated electric propulsion systems like LUSSA. FFG-7 was used because it is a similarly sized light combatant and has an aluminum deckhouse. LHD-1 was used because it was the only ship with data in the CISD spreadsheet that had a full flight deck. It is also the only ship in the spreadsheet that stores and supports more than two helicopters. Lastly, LPD-17 was used because it is a newer ship designed to modern warship standards. Figure 15 shows the weight distribution of the 1-digit SWBS categories.

Estimating the structural weight of this concept proved to be difficult because a full scale TriSWACH has never been constructed, nor has a multi-hulled aircraft carrier. So, a variety of methods were used in determining structural weight. In the earliest design stage, a ratio of structural weight-to-total weight was taken from both the T-AGOS and the *Triton* and applied to the concept ship. This weight was used as a baseline for later weight estimations. The final weight estimate was determined by performing a structural density calculation that was compared with the Warship Structural Density plot shown in Figure 16. LUSSA has a structural density of just less than seven pounds per cubic foot.

A 15% design margin and a 7.5% service life allowance was included in the weight estimate in accordance with Navy standards for aircraft carriers (Commander, NAVSEA, 2001). A large margin is necessary this early in the design because of the limited information available for the TriSWACH hull form and lack of data for small warships capable of supporting fixed-wing aircraft.

**Table 6: Ship Weight Estimate and Basis Ships**

| Light UAV Support Ship (ASW) SWBS              |                      |              | Scaling Ship  |          |          |       |       |        |  |
|--|----------------------|--------------|---------------|----------|----------|-------|-------|--------|--|
| SWBS Group                                     | Weight (T)           | LCS-2        | <i>Triton</i> | TAGOS 19 | TAGOS 23 | FFG-7 | LHD 1 | LPD 17 |  |
| 100  | Hull Structure       | 2,414        |               | X        | X        | X     | X     | X      |  |
| 200  | Propulsion Plant     | 414          |               |          | X        | X     |       |        |  |
| 300  | Electric Plant       | 224          |               |          | X        | X     |       |        |  |
| 400  | Command & Control    | 112          | X             |          |          |       | X     | X      |  |
| 500  | Auxiliary Systems    | 364          | X             |          | X        | X     |       | X      |  |
| 600  | Outfit & Furnishings | 248          | X             |          | X        | X     | X     | X      |  |
| 700  | Armament             | 59           | X             |          |          |       | X     | X      |  |
| <b>Lightship</b>                               |                      | 3,836        |               |          |          |       |       |        |  |
| <b>Lightship + 15% Design Margin</b>           |                      | 4,411        |               |          |          |       |       |        |  |
| 800  | Loads                | 915          |               |          |          |       |       |        |  |
| Aviation Fuel                                  |                      | 66           |               |          |          |       |       |        |  |
| Ship's Fuel                                    |                      | 150          |               |          |          |       |       |        |  |
| <b>Full Load + Service Life Margin (7.5 %)</b> |                      | <b>5,725</b> |               |          |          |       |       |        |  |

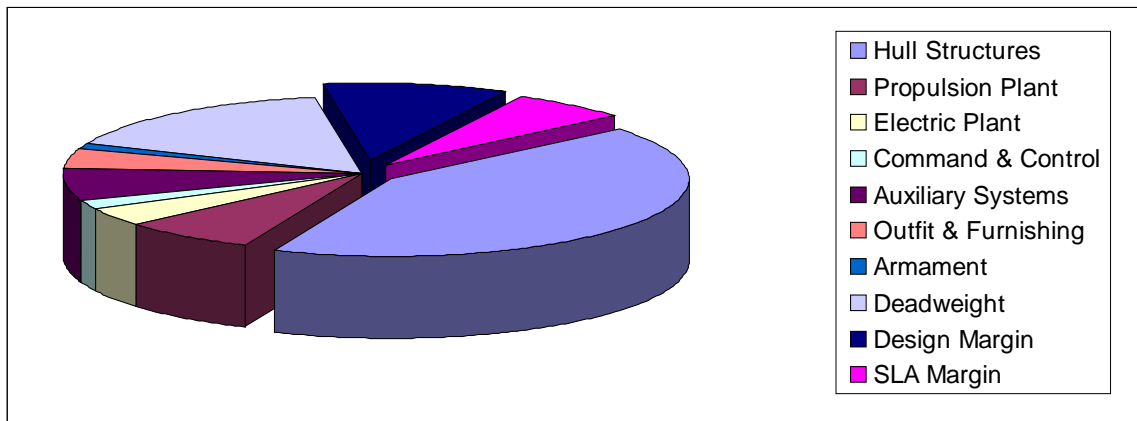

**Figure 15: Weight Summary Pie Chart**



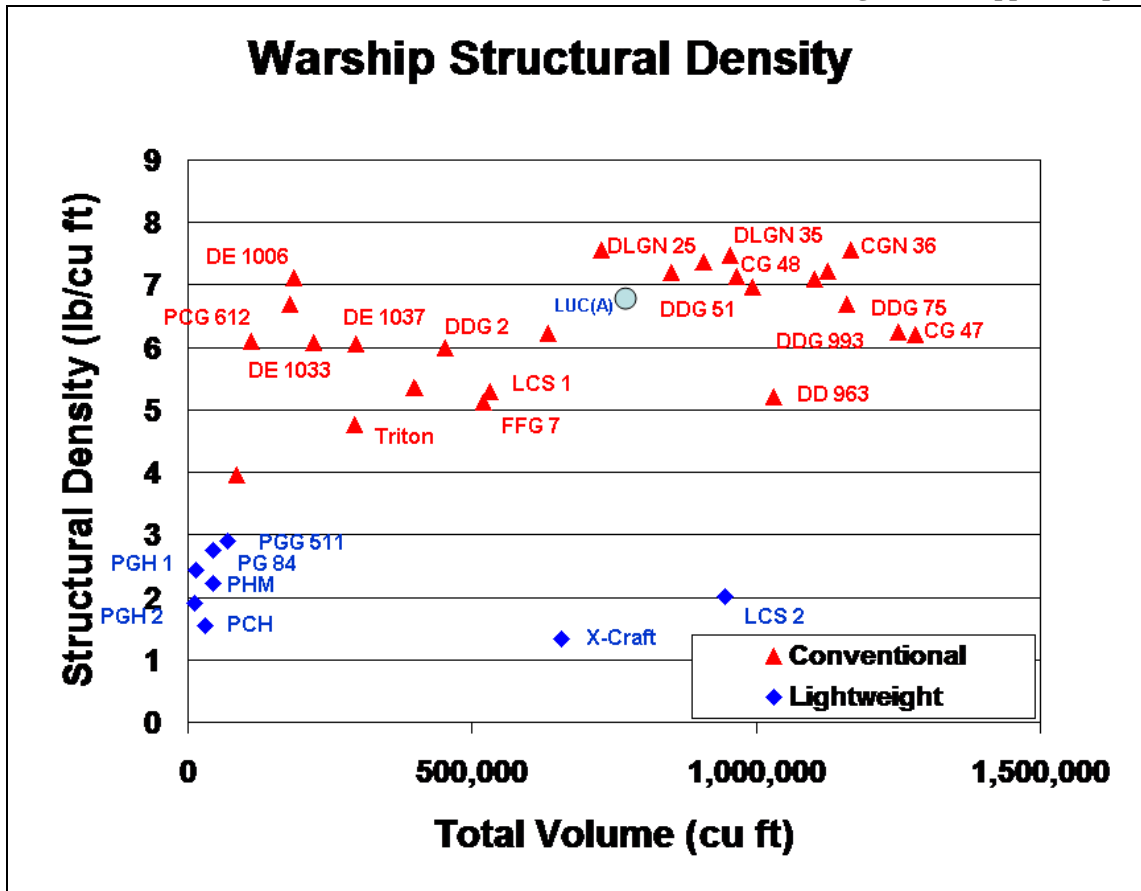

Figure 16: Ship Structural Density

## 4 Propulsion and Machinery

### 4.1 Propulsion Powering

The propulsion power requirements were determined using model test data for the centerhull, combined with TriSWACH model test data conducted at the Stevens Institute of Technology (Jenkins 1986). Model test results are shown in Appendix Section 9.5 TriSWACH Model Test Data. The hull resistance was calculated and analyzed using the Reynolds and Froude number scaling to estimate the power requirements for the design. The speed-power curve for LUSSA is shown in Figure 17. Important operating speeds from the assumed operating profile are:

- Sprint Speed (25 knots) - required for take-off and landing operations for the aircraft.
- Transit Speed (19 knots) - defined by calculating the power requirement at 79% (peak fuel efficiency) of two of the three engines' capacity.
- Patrol speed (5 knots) - an approximation derived from the CONOPS.

A propulsion power requirement of 14.27 MW at the 25 knot sprint speed was determined using the TriSWACH model test data. This requirement stemmed the propulsion system design.

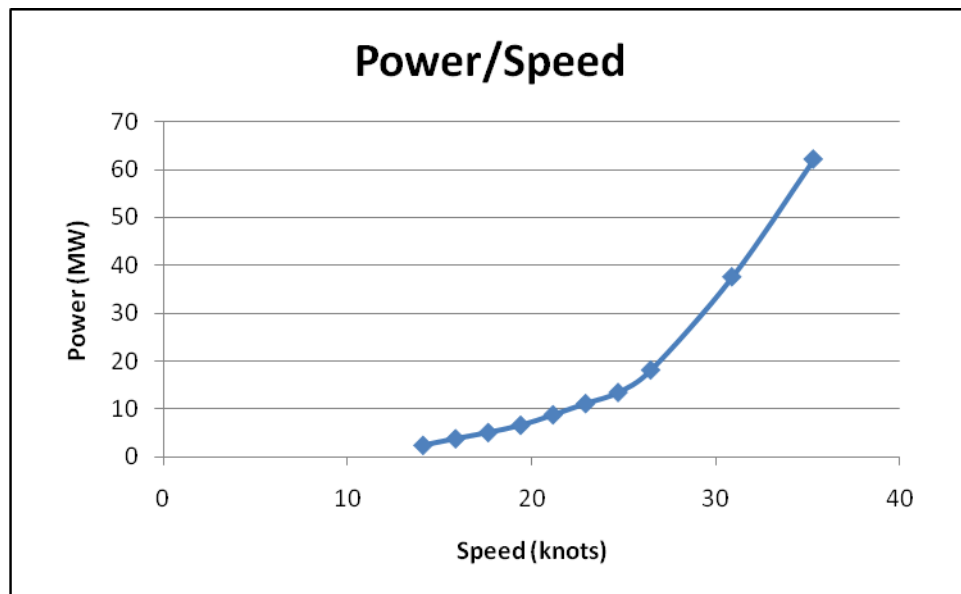

Figure 17: Power vs. Speed Curve for TriSWACH Hull Form

## 4.2 Ship’s Service Electric Load Estimation

The ship’s service electric load was scaled from LCS-2 because of its comparable size in volume. The load was estimated to be 3 MW; however, the total ship service load is not required throughout the entire operating profile, or sprint, transit and patrol speeds. The percentage of this peak ship service load used for each operating condition was estimated from the LCS-2 Electric Load and Power Analysis spreadsheet. The results are shown in Table 7 and Appendix Section 9.3 LUSSE Electric Load Estimate. At sprint speed the ship is estimated to be using 50% of its ship service load, while at transit and patrol speeds, the ship is expected to be using a maximum of 80%.

**Table 7: Electrical Load Summary**

| 1-Digit SWBS                   | Sprint (kW)   | Transit (kW) | Patrol (kW)  |
|--------------------------------|---------------|--------------|--------------|
| 200 (Propulsion Plant)         | 14,277        | 6,419        | 370          |
| 300 (Electric Plant)           | 85            | 85           | 85           |
| 400 (Command and Surveillance) | 280           | 280          | 280          |
| 500 (Auxiliary Systems)        | 2,193         | 2,193        | 2,193        |
| 600 (Outfit and Furnishings)   | 294           | 294          | 294          |
| 700 (Armament)                 | 389           | 389          | 389          |
| <b>Total</b>                   | <b>15,898</b> | <b>9,011</b> | <b>2,962</b> |

## 4.3 Machinery

The machinery selection process was driven by several constraints, predominantly by the narrow width of the machinery space (3.5 m) in the centerhull of the TriSWACH design. The ship’s machinery and propulsion selection was also influenced by the need to maintain a quiet ship for ASW operations and the desire for an engine count of 3-4 units for survivability and fuel efficiency in different operating conditions. The design explored all of these constraints as well as the consideration of the power-to-weight and power-to-volume ratios of the generator sets (gensets). Engine alternatives were evaluated using an engine power spreadsheet. The spreadsheet holds a list of engines and their characteristics and is shown in Table 8.

**Table 8: Engine Alternatives**

| No Req. | Engine                    | Power Each (kW) | Combined Power (kW) | Width (m) | Comb. Weight (t) | RPM | Power/Weight (kW/t) | Power/Volume (kW/m <sup>3</sup> ) |
|---------|---------------------------|-----------------|---------------------|-----------|------------------|-----|---------------------|-----------------------------------|
| 3       | Wartsila 8L38 Genset      | 5,600           | 16,800              | 2.9       | 330              | 600 | 50.9                | 35.96                             |
| 3       | Wartsila 9L38 Genset      | 6,525           | 19,575              | 3.1       | 390              | 600 | 50.2                | 37.40                             |
| 4       | CAT cC280-16 Genset       | 4,840           | 19,360              | 1.99      | 206              | 900 | 94.1                | 62.67                             |
| 3       | CAT VM 32C 16V Genset     | 7,373           | 22,119              | 3.00      | 315              | 750 | 70.2                | 36.00                             |
| 3       | FM-MAN 9L 40/54           | 5,962           | 17,885              | 2.82      | 407              | 720 | 43.9                | 48.35                             |
| 3       | Colt-Pielstick PA6B 20V   | 6,440           | 19,320              | 2.40      | 327              | 900 | 59.1                | 105.06                            |
| 4       | Colt-Pielstick PA6B 16V   | 5,152           | 20,608              | 2.40      | 412              | 900 | 50.1                | 96.95                             |
| 2       | Colt-Pielstick PC2.6B 12V | 8,280           | 16,560              | 3.67      | 342              | 600 | 48.5                | 69.94                             |

Because this concept ship design has limited volume in its engine room the Wartsila 8L38 Genset was chosen for its favorable power-to-volume characteristic. Each engine produces 5.6MW, including electrical losses, with a combined power of 16.8MW (three engines) and runs at a speed of 600 RPM (Wartsila, 2008). The low RPM rating for the engine allows for the design to be quieter which is beneficial to the ASW mission.

#### 4.3.1 Engine Layout

The ship is equipped with an integrated propulsion system (IPS) and therefore the power of the ship's propulsion comes from the same generators that power the service loads. This sort of diesel-electric IPS opens up opportunities for the engine room and propulsion system arrangements. The engines are arranged in a straight line along the centerline and partially within the centerhull to help maintain favorable stability. Implementing an IPS also allows for the machinery to be separate from the propulsion units. This allows the engines to be placed higher in the ship to reduce self-noise. While the engines are placed along the same line, they are split up into three separate rooms by bulkheads. This will increase the survivability of the ship in case of an engine room casualty. A single engine room layout is shown in Figure 18.

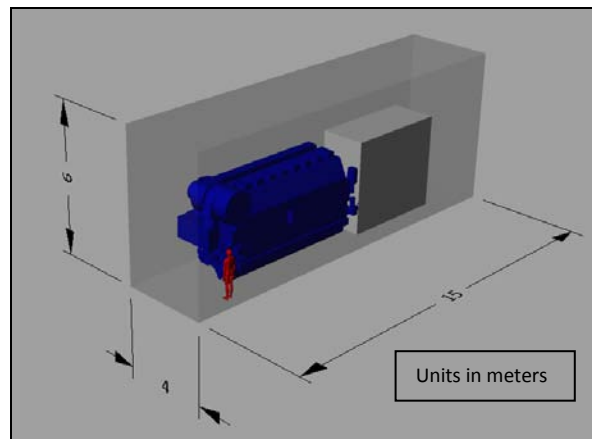

Figure 18: Single Engine Room Layout

#### 4.4 Propulsion

The propulsion system shares similar dimensional constraints as the machinery rooms being in the centerhull. Several arrangements were considered for the concept's propulsion system. A single screw system has advantages with its simplicity, but for survivability, an auxiliary propulsion unit would have been required. Installing a twin screw system adds the survivability, but two propeller shafts will not fit into the centerhull and single shaft systems could not fit into each of the side-hulls.

Alternative propulsor concepts were evaluated for the design including pump-jets, and contra-rotating propellers. The pump-jet was not chosen because previous studies concluded that it induces high cavitation levels on surface ships. The ship's final design implemented a contra-rotating propeller (CRP) system. CRP propulsion provides high propulsive efficiency, added survivability with redundancy, and if applied as a shaft driven and azimuthing pod combination, does not have as large of a footprint as the other systems.

The results from CRP system model tests on the SWATH-10 hull type, which is very similar to the TriSWACH hull type, revealed that the application of a CRP system decreases the required propulsion power by 5-15% at speeds of 20 knots and above (Jenkins, 1986). However, the data from this study was not directly relevant to the TriSWACH hull form. Therefore, the propulsion powering estimate used in this study is based on the two separate propulsion systems, one single shaft and the other an azimuthing pod.

The design's CRP system is comprised of a Wartsila 2510 L-drive Modular Thruster with a maximum power output of 3.5 MW, and a Wartsila 4E1190 controllable pitch propeller (CPP), which has a maximum capacity of roughly 10.2 MW. This configuration is shown in Figure 19. The propeller is powered by a single Converteam Advanced Induction Motor (AIM), generating sufficient power to propel the ship at 25+ knots. Because of the application of a transverse thruster, the need for a rudder is eliminated.

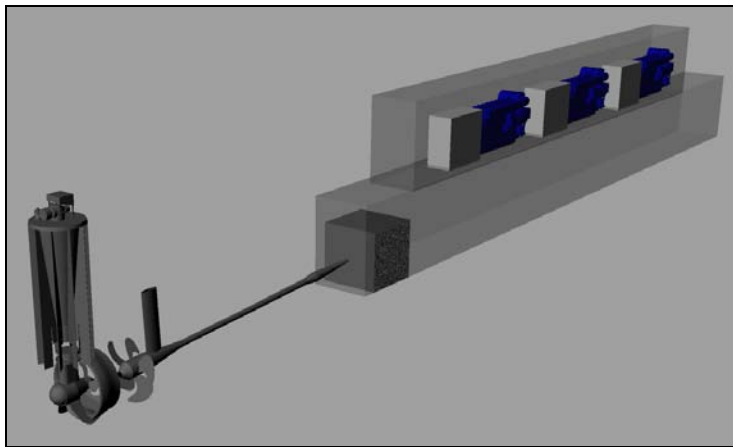

Figure 19: Propulsion Machinery Layout

## 4.5 Fuel and Range

The ship's fuel consumption was calculated using the design's CONOPS and the selected engine's specific fuel consumption (Wartsila, 2008). Fuel consumption by operation is shown in Table 9. The operational timeline for the ship is fourteen total days in transit and ten days on patrol. During patrol, the ship will spend roughly twenty-two hours per day at patrol speeds and two hours at sprint speeds for take-off and landing aircraft. In an ideal situation, the ship will require 753 m<sup>3</sup> of fuel (710 t) adding up to an overall range of 7,900 nm. The fuel calculation includes a 5% allowance for unpumpable fuel. The calculated range surpasses the required 5,000 nm and provides a fuel margin of 37%. In case of an emergency where the ship is forced to stay at-sea for a longer period of time, it has surplus fuel for further operations.

Naval Surface Warfare Center Carderock Division  
 Naval Research Enterprise Intern Program  
 Light UAV Support Ship (ASW)

**Table 9: Fuel Consumption Tool**

| Fuel Consumption   | HFO                                  | Units                   |                                    |                          |              |
|--|--------------------------------------|-------------------------|------------------------------------|--------------------------|--------------|
| <i>At 100% Load</i>  | 183                                  | <i>g/kWh</i>            |                                    |                          |              |
| <i>At 85% Load</i>   | 180                                  | <i>g/kWh</i>            |                                    |                          |              |
| <i>At 75% Load</i>   | 180                                  | <i>g/kWh</i>            |                                    |                          |              |
| <i>At 50% Load</i>   | 186                                  | <i>g/kWh</i>            |                                    |                          |              |
| <i>Fuel Density</i>  | 991                                  | <i>kg/m<sup>3</sup></i> | <i># of Engines online</i>         | <i>% Load per Engine</i> |              |
| <i>Total Power at Sprint Speed (25kts)</i>                                 | 15,796                               | kW                      | 3                                  | 94%                      |              |
| <i>Total Power at 80% Load (22kts)</i>                                     | 13,440                               | kW                      | 3                                  | 80%                      |              |
| <i>Power At Transit Speed (19kts)</i>                                      | 8,848                                | kW                      | 2                                  | 79%                      |              |
| <i>Power At Patrol Speed (5kts)</i>  | 2,429                                | kW                      | 1                                  | 43%                      |              |
| Operation  | Fuel Usage/Day (m <sup>3</sup> /day) | Days                    | Total Fuel Usage (m <sup>3</sup> ) | Total Weight (t)         | Range (nm)   |
| <b>Transit Fuel Requirements</b> (14 days @ transit speed)                 | <b>40</b>                            | <b>14</b>               | <b>558</b>                         | <b>553</b>               | <b>6,344</b> |
| <b>Patrol Fuel Requirements</b> (10 days total, 22 hrs/day @ patrol speed) | 10                                   | 10                      | 100                                | 99                       | 1,100        |
| Sprint Fuel Requirement(10 days total, 2 hrs/day @ sprint speed)           | ~6                                   | 10                      | 58                                 | 58                       | 500          |
| <b>Total Mission Fuel Consumption</b>                                      | <b>56</b>                            | <b>24</b>               | <b>752</b>                         | <b>710</b>               | <b>7,944</b> |

## 5 Stability Analyses

Intact stability analyses were performed using the hydrodynamic modeling tool Paramarine. The vertical center of gravity (VCG) of the support ship concept was estimated at the two digit SWBS level, and then overall VCG was calculated. **Error! Reference source not found.** summarizes single digit SWBS group weights and VCGs, and a two digit summary can be found in the Appendix Section 9.2. An effort was afforded to maintain the transverse and longitudinal CGs above the concept's center of buoyancy, but further analysis is required in these areas. SWBS groups that were not associated with specific locations, such as lighting systems, were estimated by scaling to the LCS-2 VCGs. Figure 21 shows the locations of the VCG and metacenter on the concept at design displacement.

**Table 10: Weight and Vertical Center of Gravity Summary**

| SWBS Group                              |                                    | Weight(kg)   | VCG(m)      |
|---|------------------------------------|--------------|-------------|
| <b>100</b>                              | <b>HULL STRUCTURES</b>             | <b>2,366</b> | <b>11.0</b> |
| <b>200</b>                              | <b>PROPULSION PLANT</b>            | <b>386</b>   | <b>4.7</b>  |
| <b>300</b>                              | <b>ELECTRIC PLANT, GENERAL</b>     | <b>223</b>   | <b>14.5</b> |
| <b>400</b>                              | <b>COMMAND &amp; CONTROL</b>       | <b>109</b>   | <b>19.0</b> |
| <b>500</b>                              | <b>AUXILIARY SYSTEMS, GENERAL</b>  | <b>364</b>   | <b>9.6</b>  |
| <b>600</b>                              | <b>OUTFIT+FURNISHING,GENERAL</b>   | <b>247</b>   | <b>13.6</b> |
| <b>700</b>                              | <b>ARMAMENT</b>                    | <b>29</b>    | <b>17.4</b> |
| <b>800</b>                              | <b>LOADS</b>                       | <b>915</b>   | <b>4.3</b>  |
| <b>F10</b>                              | SHIPS FORCE                        | 30           | 17.5        |
| <b>F20</b>                              | MISSION RELATED<br>EXPENDABLES+SYS | 85           | 14.4        |
| <b>F23</b>                              | AIRCRAFT                           | 55           | 19.0        |
| <b>F30</b>                              | STORES                             | 16           | 12.4        |
| <b>F40</b>                              | LIQUIDS, PETROLEUM BASED           | 727          | 2.7         |
| <b>F50</b>                              | LIQUIDS, NON-PETRO BASED           | 57           | 1.3         |
| <b>FULL LOAD (Margins not included)</b> |                                    | <b>4,638</b> | <b>9.5</b>  |

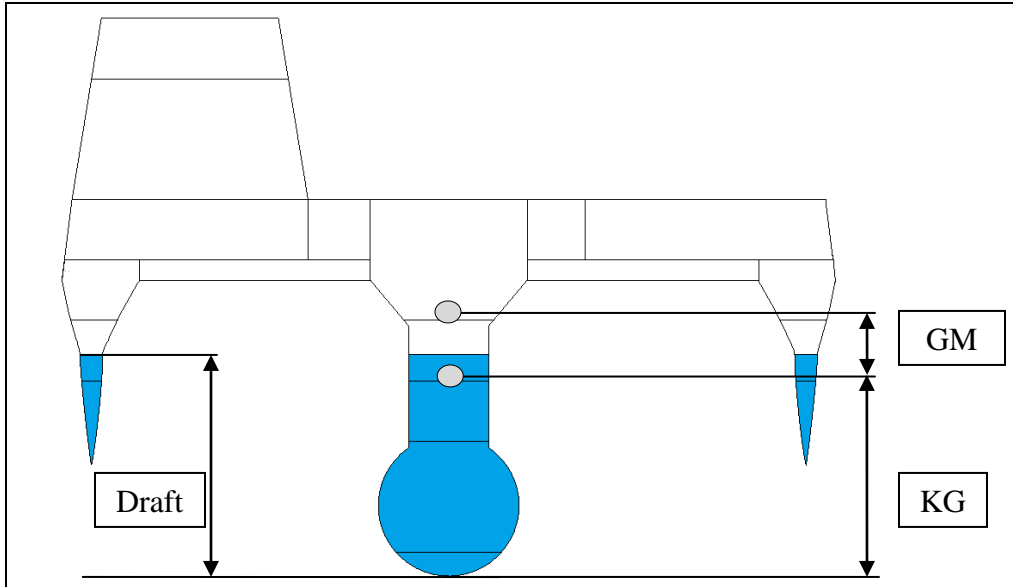

Figure 20: Ship Center of Gravity

|                                      |        |
|--------------------------------------|--------|
| Draft                                | 10.8 m |
| Keel to Center of Gravity, KG        | 9.5 m  |
| Keel to Center of Buoyancy, KB       | 5.5 m  |
| Center of Buoyancy to Metacenter, BM | 5.7 m  |
| Center of Gravity to Metacenter, GM  | 1.7 m  |

The concept's CAD model was imported into Paramarine along with VCG to find Righting Arm (GZ) curves for conditions of "100 Knot Beam Winds" and "Crowding of Personnel to One Side". These curves are shown in Figure 21 and Figure 22 respectively. The design meets the Navy's criteria for intact stability in these conditions (Naval Ship Engineering Center, 1975). Because the design has a relatively low profile, wind forces are minimal to the design's wind heeling. Stability advantages of the TriSWACH hull are easily seen in both GZ curves. Low righting moment at lower angles and higher righting moment at greater angles is a result of increased displacement as the TwiSWACH's outer hulls are submerged. When compared with the GZ curves of conventional mono hulls, the point of vanishing stability is at much greater angles with the TriSWACH which is favorable for aircraft launch and recovery.



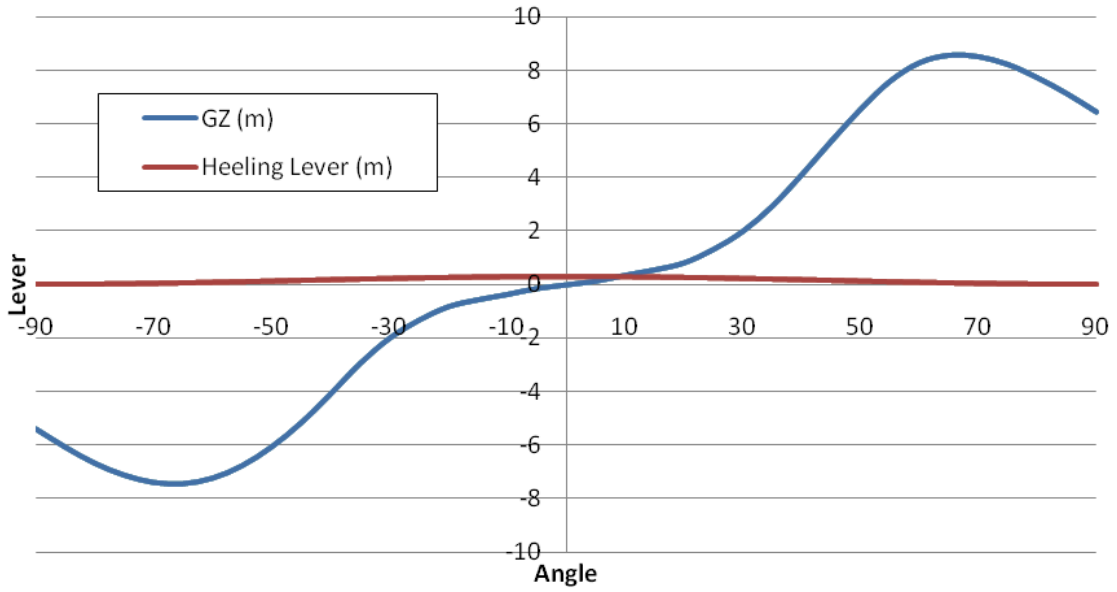

Figure 21: 100 Knot Beam Wind

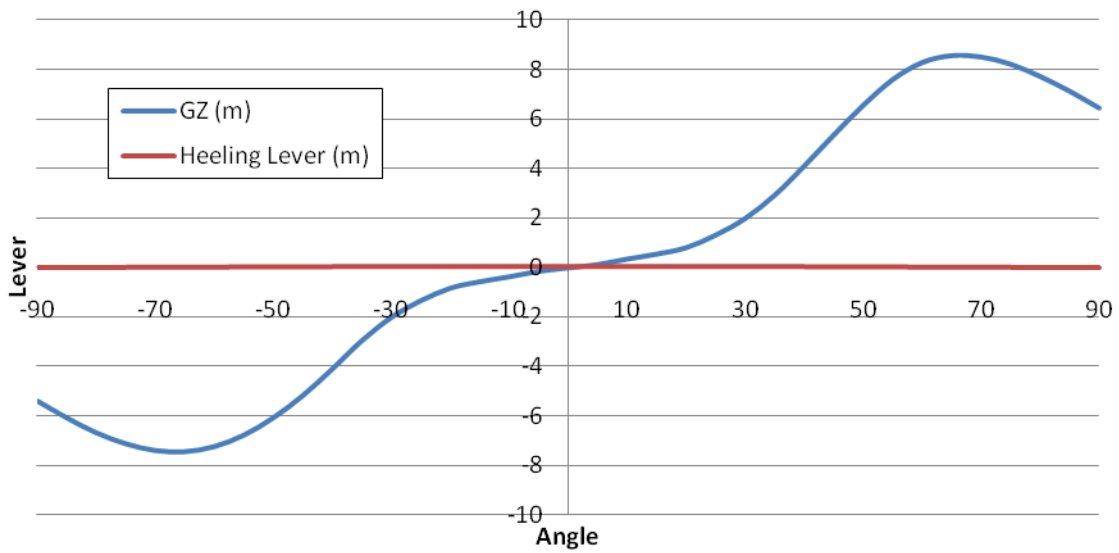

Figure 22: Crowding of Personnel to One Side

For completeness, Paramarine was also used to determine the maximum roll angle allowed before the design begins to take green water onto its flight deck, which could be a flooding concern. These angles are shown on Figure 23 by the lines at 43 and -43 degrees. These angles could be improved by increasing the ships freeboard which would require increasing the design's internal volume. Although some consideration was given to the topside arrangement in regard to maximum roll angle and watertight integrity, the placement of ventilation penetrations and lifts should be further evaluated. Furthermore, additional analyses are required to assess dynamic stability and damage stability.

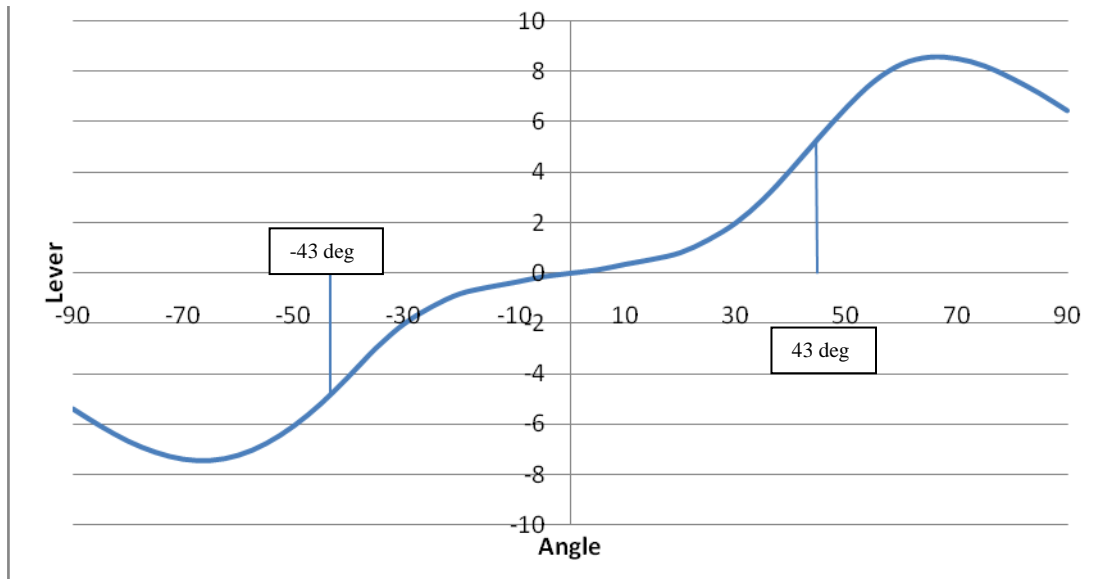

Figure 23: Maximum Roll Angle for Flight Deck Awash

## **6 Risks and Future Recommendations**

The LUSSA concept ship design uses a developmental hull and is considered to be a high risk design in regards to design margins. Several specific analyses of the TriSWACH hull-form would be valuable to improve the LUSSA concept design such as in-depth seakeeping testing. Additionally, the design may benefit from increasing the size of the side-hulls to provide more usable volume. Resistance analysis on various sizes of side-hulls would be useful to guide side-hull selection and find an optimal displacement.

The effectiveness of the CRP hybrid system on a TriSWACH hull form should be further assessed to determine if the necessary components and equipment could even fit on the hull. Also, preliminary testing currently being performed at the NSWC's tow basin has identified power efficiency problems with the hybrid concept.

This design's aircraft hanger and topside arrangement require that some UAVs are stowed on the weather deck exposed to weather. A larger hangar should be considered for future design iterations to allow all aircraft to be stowed internally.

## **7 Summary and Conclusion**

This ship design concept shows a viable solution for a light UAV support ship with the ability to complete the ASW mission with its manned and unmanned aircraft. The design achieves the light ship status with a displacement of 5,700 t, and also maintains adequate stability and seakeeping for aircraft operations by integrating the developmental TriSWACH hull form. The design displays ability to stow large, fixed-wing, high endurance UAVs and small, fixed-wing UAVs with a topside aircraft hangar. Avenger type UAVs are launched from the concept's runway using a Ski Jump, and without a catapult system. Design requirements that were not met were challenged, and include the crew size and use of an EMALS system to launch aircraft. Explanations for the challenges are given in their respective sections within this report. Potential shortcomings and recommendations are described and additional design work is required; however, the concept has proven to be a promising solution for the emerging need of a light UAV support ship with ASW capability.

## 8 References

- ABB Marine and Turbocharging. (2004). *Project Guide for Azipod Propulsion Systems*.
- ABS. *Margins, Ship Design, ABS Guide for Building and Classifying Naval Vessels*.
- Collins, M. (2006). *Integrated Power Systems (IPS) for DDG 1000 and Future Navy Ships*. American Society of Naval Engineers.
- Commander, Naval Sea Systems Command. (2001). *Policy for Weight and Vertical Center of Gravity Above Bottom of Keel (KG) Margins for Surface Ships*. Washington, DC: NAVSEA.
- DOD. (2008). *ABS Guide for Building and Classing Naval Vessels*.
- Estabrook, A. (1998). *Unmanned Air Vehicle Impact on CVX Design*.
- Furey, R. J. (1983). *Short Take-off Performance Using a Gravity Assist Ski Jump*. Bethesda: David W. Taylor Naval Ship Research and Development Center.
- General Atomics. (2011). *Predator C Avenger*. Retrieved from General Atomics Aeronautical: [http://www.ga-asi.com/products/aircraft/predator\\_c.php](http://www.ga-asi.com/products/aircraft/predator_c.php)
- Goodman, M., & Mortimer, R. (2010). *UAV Swarm Integration Aboard U.S. Navy Ships*. Bethesda: NAVSEA: Center for Innovation in Ship Design.
- Jenkins, D. S. (1986). *Wake and Powering Predictions for SWATH 10, A 10,660 LT SWATH Ship, Represented by Hull Models 5410-1 and Contra Rotating Propellers 4872 & 4873 and 4878 & 4879*. Bethesda: David Taylor Model Basin Research and Development Center.
- Kasitz, K. (2009, April 9). *GA-ASI Successfully Executes First Flight of Predator C Avenger*. Retrieved June 9, 2011, from General Atomics News and Events: [http://www.ga-asi.com/news\\_events/index.php?read=1&id=186](http://www.ga-asi.com/news_events/index.php?read=1&id=186)
- Mason, D. (2004). *LCS Flight 0 Final System Design N00024-03-C-2310 L00300EA00-1113-02171/Engineering Analysis, Electrical Plant Load*. General Dynamics.
- (2003). *NAVAIR Air Capable Ship Aviation Facilities Bulletin No. 1J*. Navair Lakehurst-4.8.10.4.
- Naval Ship Engineering Center. (1975). *Design Data Sheet 079-1 - Stability and Buoyancy of U.S. Naval Surface Ships*. Department of the Navy.
- Northrop Grumman. (2011). *BAT Unmanned Aircraft System (UAS)*. Retrieved from Northrop Grumman: <http://www.as.northropgrumman.com/products/batuas>
- Policy for Weight and Cg Margins; NAVSEA Instruction 9096.6B*. NAVSEA.

- Rudowsky, T. (2002). *Review of the Carrier Approach Criteria for Carrier-Based Aircraft-Phase I; Final Report*. Naval Air Warfare Center Aircraft Division.
- Sikorsky. (2011). *MH-60R Helicopter*. Retrieved from Sikorsky:  
<http://www.sikorsky.com/Products>
- Sousa, P. (2003). *Test Result for an F/A-18 Automatic Carrier Landing Using Shipboard Relative Global Positioning System*. NAVAIR Patuxent River Division.
- Thomas, P. C. (2010). *Search Considerations for Submarine Detection by MAD UAVs from P-8 Aircraft*. NAVSEA Carderock.
- Thomas, P. C. (2011). *Submarine Detection by MAD UAVs*. NAVSEA Carderock.
- Thomas, P. C. (2010). *UAVs and Maritime Domain Awareness: The Potential of mini-UAVs with Short Range Detection Systems*. NAVSEA Carderock.
- Thompson, R. (2010). *A-RFI Request for Information for Unmanned Carrier Launched Airborne Surveillance and Strike (UCLASS) System Key Capabilities*. Patuxent River: NAVAIR.
- Wartsila. (2008). *Wartsila 38 Project Guide*. Wartsila Engines.

## 9 Appendix

### 9.1 LUSSA Area and Volume Summary

| SSCS     |  |              |               |
|----------|--|--------------|---------------|
| SSCS     | Group Name                             | Area (m2)    | Volume (m3)   |
| <b>1</b> | <b>MISSION</b>                         | <b>1,474</b> | <b>6,045</b>  |
| 1.1      | command, communications & surveillance | 566          | 1,362         |
| 1.2      | weapons                                | 123          | 572           |
| 1.3      | aviation                               | 710          | 3,878         |
| 1.4      | amphibious                             | 0            | 0             |
| 1.5      | cargo                                  | 0            | 0             |
| 1.6      | intermediate maintenance               | 0            | 0             |
| 1.7      | embarked commander facilities          | 0            | 0             |
| 1.8      | special mission                        | 0            | 0             |
| 1.9      | small arms                             | 75           | 234           |
| <b>2</b> | <b>HUMAN SUPPORT</b>                   | <b>712</b>   | <b>1,914</b>  |
| 2.1      | living                                 | 361          | 1,056         |
| 2.2      | food service                           | 200          | 471           |
| 2.3      | medical                                | 24           | 56            |
| 2.4      | general services                       | 23           | 46            |
| 2.5      | personnel stores                       | 23           | 58            |
| 2.6      | cbr protection                         | 76           | 211           |
| 2.7      | lifesaving                             | 6            | 17            |
| <b>3</b> | <b>SHIP SUPPORT</b>                    | <b>1,554</b> | <b>5,617</b>  |
| 3.1      | ship control                           | 10           | 269           |
| 3.2      | damage control                         | 122          | 334           |
| 3.3      | administration                         | 18           | 52            |
| 3.5      | deck systems                           | 219          | 550           |
| 3.6      | maintenance                            | 6            | 16            |
| 3.7      | stowage                                | 77           | 367           |
| 3.8      | access                                 | 1,060        | 1,056         |
| 3.9      | tanks / voids                          | 42           | 2,972         |
| <b>4</b> | <b>MACHINERY</b>                       | <b>976</b>   | <b>5,597</b>  |
| 4.1      | propulsion systems                     | 191          | 1,860         |
| 4.2      | propulsor & transmission systems       | 0            | 0             |
| 4.3      | auxiliary systems                      | 784          | 3,737         |
| <b>5</b> | <b>UNASSIGNED</b>                      | <b>6</b>     | <b>19</b>     |
| 5.1      | unassigned                             | 6            | 19            |
| 5.2      | reserved                               | 0            | 0             |
|          | <b>TOTAL</b>                           | <b>4,722</b> | <b>19,192</b> |

## 9.2 LUSSA Weight Estimate

| SWBS Group  |                                   | Weight (kg)  | VCG (m)     |
|-------------|-----------------------------------|--------------|-------------|
| <b>W100</b> | <b>HULL STRUCTURES</b>            | <b>2,414</b> | <b>11.0</b> |
| W110        | SHELL + SUPPORTS                  | 1,127        | 7.3         |
| W120        | HULL STRUCTURAL BULKHDS           | 535          | 12.1        |
| W130        | HULL DECKS                        | 317          | 15.4        |
| W140        | HULL PLATFORMS/FLATS              | 67           | 19.0        |
| W150        | DECK HOUSE STRUCTURE              | 140          | 21.9        |
| W160        | SPECIAL STRUCTURES                | 114          | 15.8        |
| W170        | MASTS+KINGPOSTS+SERV PLATFORM     | 8            | 25.3        |
| W180        | FOUNDATIONS                       | 106          | 6.5         |
| W190        | SPECIAL PURPOSE SYSTEMS           | 1            | 9.8         |
| <b>W200</b> | <b>PROPULSION PLANT</b>           | <b>414</b>   | <b>4.7</b>  |
| W210        | ENERGY GEN SYS (NUCLEAR)          | 0            |             |
| W220        | ENERGY GENERATING SYSTEM (NONNUC) | 0            |             |
| W230        | PROPULSION UNITS                  | 154          | 3.7         |
| W240        | TRANSMISSION+PROPULSOR SYSTEMS    | 173          | 3.7         |
| W250        | SUPPORT SYSTEMS                   | 22           | 12.3        |
| W260        | PROPUL SUP SYS- FUEL, LUBE OIL    | 18           | 5.8         |
| W290        | SPECIAL PURPOSE SYSTEMS           | 47           | 5.1         |
| <b>W300</b> | <b>ELECTRIC PLANT, GENERAL</b>    | <b>224</b>   | <b>14.5</b> |
| W310        | ELECTRIC POWER GENERATION         | 59           | 14.4        |
| W320        | POWER DISTRIBUTION SYS            | 82           | 17.6        |
| W330        | LIGHTING SYSTEM                   | 36           | 14.3        |
| W340        | POWER GENERATION SUPPORT SYS      | 34           | 10.0        |
| W350        | GROUNDING AND BONDING             | 0            |             |
| W390        | SPECIAL PURPOSE SYS               | 13           | 8.8         |
| <b>W400</b> | <b>COMMAND &amp; CONTROL</b>      | <b>112</b>   | <b>19.0</b> |
| W410        | COMMAND+CONTROL SYS               | 10           | 17.5        |
| W420        | NAVIGATION SYS                    | 6            | 16.0        |
| W430        | INTERIOR COMMUNICATIONS           | 15           | 16.0        |
| W440        | EXTERIOR COMMUNICATIONS           | 6            | 21.2        |
| W450        | SURF SURV SYS (RADAR)             | 18           | 26.0        |
| W460        | UNDERWATER SURVEILLANCE SYSTEMS   | 0            |             |
| W470        | COUNTERMEASURES                   | 13           | 27.3        |
| W480        | FIRE CONTROL SYS                  | 1            | 17.5        |
| W490        | SPECIAL PURPOSE SYS               | 43           | 15.2        |

Naval Surface Warfare Center Carderock Division  
 Naval Research Enterprise Intern Program  
 Light UAV Support Ship (ASW)

|              |                                   |              |             |
|--------------|-----------------------------------|--------------|-------------|
| <b>W500</b>  | <b>AUXILIARY SYSTEMS, GENERAL</b> | <b>364</b>   | <b>9.6</b>  |
| W510         | CLIMATE CONTROL                   | 55           | 12.8        |
| W520         | SEA WATER SYSTEMS                 | 45           | 8.5         |
| W530         | FRESH WATER SYSTEMS               | 9.5          | 8.5         |
| W540         | FUELS/LUBRICANTS,HANDLING+STORAGE | 86           | 6.5         |
| W550         | AIR,GAS+MISC FLUID SYSTEM         | 31           | 11.7        |
| W560         | SHIP CNTL SYS                     | 23           | 3.5         |
| W570         | UNDERWAY REPLENISHMENT SYSTEMS    | 23           | 11.7        |
| W580         | MECHANICAL HANDLING SYSTEMS       | 84           | 12.0        |
| W590         | SPECIAL PURPOSE SYSTEMS           | 8.0          | 7.6         |
| <b>W600</b>  | <b>OUTFIT+FURNISHING,GENERAL</b>  | <b>247</b>   | <b>13.6</b> |
| W610         | SHIP FITTINGS                     | 16           | 16.8        |
| W620         | HULL COMPARTMENTATION             | 67           | 11.5        |
| W630         | PRESERVATIVES+COVERINGS           | 87           | 13.2        |
| W640         | LIVING SPACES                     | 14           | 17.5        |
| W650         | SERVICE SPACES                    | 8            | 17.5        |
| W660         | WORKING SPACES                    | 23           | 17.5        |
| W670         | STOWAGE SPACES                    | 30           | 12.2        |
| W690         | SPECIAL PURPOSE SYSTEMS           | 3            | 9.5         |
| <b>W700</b>  | <b>ARMAMENT</b>                   | <b>59</b>    | <b>17.4</b> |
| W710         | GUNS+AMMUNITION                   | 7            | 20.5        |
| W720         | MISSILES+ROCKETS                  | 46           | 17.5        |
| W730         | MINES                             | 0            | 0.0         |
| W740         | DEPTH CHARGES                     | 0            | 0.0         |
| W750         | TORPEDOES                         | 1            | 17.5        |
| W760         | SMALL ARMS+PYROTECHNICS           | 1            | 13.1        |
| W770         | CARGO MUNITIONS                   | 0            |             |
| W780         | AIRCRAFT RELATED WEAPONS          | 1            | 17.5        |
| W790         | SPECIAL PURPOSE SYSTEMS           | 3            | 9.5         |
| <b>800</b>   | <b>Loads</b>                      | <b>915</b>   | <b>4.3</b>  |
| F10          | SHIPS FORCE                       | 30           | 17.5        |
| F20          | MISSION RELATED EXPENDABLES+SYS   | 85           | 14.4        |
| F23          | AIRCRAFT                          | 55           | 19.0        |
| F30          | STORES                            | 16           | 12.4        |
| F40          | LIQUIDS, PETROLEUM BASED          | 727          | 2.7         |
| F50          | LIQUIDS, NON-PETRO BASED          | 57           | 1.3         |
| F60          | CARGO                             | 0            |             |
| <b>TOTAL</b> |                                   | <b>4,751</b> | <b>9.5</b>  |



### 9.3 LUSSA Electric Load Estimate

| 3 Digit SWBS Group                              |   | Power (kW)      |
|---|---|-----------------|
| <b>GROUP 3 TOTAL (ELECTRIC PLANT)</b>           |   | <b>85.00</b>    |
| 314   | POWER CONVERSION EQUIPMENT              | 14.95           |
| 320   | POWER DISTRIBUTION SYSTEMS              | 30.05           |
| 331   | LIGHTING DISTRIBUTION                   | 40.00           |
| <b>GROUP 4 TOTAL (COMMAND AND SURVEILLANCE)</b> |   | <b>279.59</b>   |
| 400   |   | 55.28           |
| 409   |   | 0.13            |
| 410   | COMMAND AND CONTROL SYSTEMS             | 7.03            |
| 411   | DATA DISPLAY GROUP                      | 17.07           |
| 412   | DATA PROCESSING GROUP                   | 0.12            |
| 436   | ALARM, SAFETY AND WARNING SYSTEMS       | 5.25            |
| 440   | EXTERIOR COMMUNICATIONS                 | 112.86          |
| 450   | SURVEILLANCE SYSTEMS (EXTERIOR)         | 81.85           |
| <b>GROUP 5 TOTAL (AUXILIARY SYSTEMS)</b>        |   | <b>2,192.66</b> |
| 500   |   | 43.50           |
| 512   | VENTILATION SYSTEM                      | 658.85          |
| 514   | AIR CONDITIONING SYSTEM                 | 508.00          |
| 516   | REFRIGERATION SYSTEMS                   | 8.50            |
| 520   | SEA WATER SYSTEMS                       | 348.40          |
| 529   | DRAINAGE AND BALLASTING SYSTEMS         | 56.20           |
| 530   | FRESH WATER SYSTEMS                     | 7.50            |
| 537   |   | 165.78          |
| 556   | HYDRAULIC FLUIDS SYSTEMS                | 274.95          |
| 582   | MOORING AND TOWING SYSTEMS              | 44.00           |
| 588   | AIRCRAFT HANDLING, SERVICE AND STOWAGE  | 5.00            |
| 590   | SPECIAL PURPOSE SYSTEMS                 | 10.67           |
| 593   | ENVIRONMENTAL POLLUTION CONTROL SYSTEMS | 14.30           |
| <b>GROUP 6 TOTAL (OUTFIT AND FURNISHING)</b>    |   | <b>293.83</b>   |
| 600   |   | 114.93          |
| 633   | CATHODIC PROTECTION                     | 0.25            |
| 655   | LAUNDRY SPACES                          | 178.65          |
| <b>GROUP 7 TOTAL (ARMAMENT)</b>                 |   | <b>389.00</b>   |
| 700   | ARMAMENT                                | 389.00          |
| <b>GRAND TOTAL</b>                              |   | <b>3,073</b>    |
| <b>55%</b>                                      |   | <b>1,690</b>    |
| <b>80%</b>                                      |   | <b>2,459</b>    |

## 9.4 Speed-Power Data

| Final Power Table |      |                   |
|-------------------|------|-------------------|
| Vs                | PE   | Req'd PE<br>(70%) |
| [kt]              | [MW] | [MW]              |
| 14.121            | 1.7  | 2.5               |
| 15.888            | 2.7  | 3.9               |
| 17.655            | 3.6  | 5.1               |
| 19.422            | 4.7  | 6.7               |
| 21.181            | 6.2  | 8.9               |
| 22.948            | 7.8  | 11.2              |
| 24.716            | 9.5  | 13.5              |
| 26.483            | 12.7 | 18.2              |
| 30.892            | 26.4 | 37.7              |
| 35.310            | 43.5 | 62.2              |

## 9.5 TriSWACH Model Test Data

| Trimaran Interference |                |                   |                      |                  |
|-----------------------|----------------|-------------------|----------------------|------------------|
| Model Speed           | F <sub>n</sub> | R <sub>TMCH</sub> | R <sub>TMCHTRI</sub> | C <sub>ICH</sub> |
| m/s                   |                |                   |                      |                  |
| 1.646                 | 0.215          | 15.05             | 15.26                | 0.014            |
| 1.852                 | 0.241          | 18.95             | 19.32                | 0.020            |
| 2.058                 | 0.268          | 23.31             | 23.8                 | 0.021            |
| 2.264                 | 0.295          | 28.43             | 29.67                | 0.044            |
| 2.469                 | 0.322          | 33.40             | 34.92                | 0.046            |
| 2.675                 | 0.349          | 39.49             | 40.97                | 0.037            |
| 2.881                 | 0.376          | 48.36             | 50.74                | 0.049            |
| 3.087                 | 0.402          | 60.75             | 65.34                | 0.076            |
| 3.601                 | 0.469          | 89.92             | 101.91               | 0.133            |
| 4.116                 | 0.537          | 116.99            | 131.43               | 0.123            |

**Naval Surface Warfare Center Carderock Division**  
**Naval Research Enterprise Intern Program**  
**Light UAV Support Ship (ASW)**

| <b>Sidehull Scaled Test Data</b> |                      |                   |                      |                       |                       |
|----------------------------------|----------------------|-------------------|----------------------|-----------------------|-----------------------|
| <b>Model Speed</b>               | <b>F<sub>n</sub></b> | <b>Ship Speed</b> | <b>V<sub>s</sub></b> | <b>C<sub>OR</sub></b> | <b>C<sub>OF</sub></b> |
| [m/s]                            |                      | [m/s]             | [kt]                 |                       |                       |
| 1.646                            | 0.068                | 7.264             | 14.121               | 6.70E-06              | 1.80E-03              |
| 1.852                            | 0.076                | 8.173             | 15.888               | 6.54E-06              | 1.77E-03              |
| 2.058                            | 0.085                | 9.083             | 17.655               | 6.48E-06              | 1.74E-03              |
| 2.264                            | 0.093                | 9.992             | 19.422               | 6.49E-06              | 1.72E-03              |
| 2.469                            | 0.102                | 10.896            | 21.181               | 6.28E-06              | 1.70E-03              |
| 2.675                            | 0.110                | 11.806            | 22.948               | 6.17E-06              | 1.68E-03              |
| 2.881                            | 0.119                | 12.715            | 24.716               | 6.31E-06              | 1.67E-03              |
| 3.087                            | 0.127                | 13.624            | 26.483               | 6.69E-06              | 1.65E-03              |
| 3.601                            | 0.148                | 15.892            | 30.892               | 7.86E-06              | 1.62E-03              |
| 4.116                            | 0.170                | 18.165            | 35.310               | 8.46E-06              | 1.59E-03              |