

D766.82  
.A6  
pt. 2  
Sec. 3

~~UNCLASSIFIED~~

# HISTORY OF AFHQ

PART  
TWO

DECEMBER 1942 — DECEMBER 1943

SECTION 3



~~UNCLASSIFIED~~

LIBRARY  
ARMED FORCES STAFF COLLEGE

# Report Documentation Page

*Form Approved*  
*OMB No. 0704-0188*

Public reporting burden for the collection of information is estimated to average 1 hour per response, including the time for reviewing instructions, searching existing data sources, gathering and maintaining the data needed, and completing and reviewing the collection of information. Send comments regarding this burden estimate or any other aspect of this collection of information, including suggestions for reducing this burden, to Washington Headquarters Services, Directorate for Information Operations and Reports, 1215 Jefferson Davis Highway, Suite 1204, Arlington VA 22202-4302. Respondents should be aware that notwithstanding any other provision of law, no person shall be subject to a penalty for failing to comply with a collection of information if it does not display a currently valid OMB control number.

1. REPORT DATE <b>1943</b>	2. REPORT TYPE <b>N/A</b>	3. DATES COVERED <b>-</b>		
4. TITLE AND SUBTITLE <b>History of Allied Force Headquarters - Part Two Dec 1942 - Dec 1943</b>		5a. CONTRACT NUMBER		
		5b. GRANT NUMBER		
		5c. PROGRAM ELEMENT NUMBER		
6. AUTHOR(S)		5d. PROJECT NUMBER		
		5e. TASK NUMBER		
		5f. WORK UNIT NUMBER		
7. PERFORMING ORGANIZATION NAME(S) AND ADDRESS(ES) <b>Allied Force Headquarters</b>		8. PERFORMING ORGANIZATION REPORT NUMBER		
9. SPONSORING/MONITORING AGENCY NAME(S) AND ADDRESS(ES)		10. SPONSOR/MONITOR'S ACRONYM(S)		
		11. SPONSOR/MONITOR'S REPORT NUMBER(S)		
12. DISTRIBUTION/AVAILABILITY STATEMENT <b>Approved for public release, distribution unlimited</b>				
13. SUPPLEMENTARY NOTES <b>JFSC - WW II Declassified Records.</b>				
14. ABSTRACT				
15. SUBJECT TERMS				
16. SECURITY CLASSIFICATION OF:			17. LIMITATION OF ABSTRACT	
a. REPORT <b>unclassified</b>	b. ABSTRACT <b>unclassified</b>	c. THIS PAGE <b>unclassified</b>	<b>UU</b>	18. NUMBER OF PAGES <b>141</b>
				19a. NAME OF RESPONSIBLE PERSON

*"Allied forces."*

HISTORY OF  
ALLIED FORCE HEADQUARTERS  
AND  
HEADQUARTERS NATOUSA

LIBRARY  
ARMED FORCES STAFF COLLEGE

PART II

PERIOD

of the

TUNISIAN, SICILIAN, AND SOUTH ITALIAN CAMPAIGNS

(December 1942 to December 1943)

SECTION 3

LIBRARY  
ARMED FORCES STAFF COLLEGE

TABLE OF CONTENTS

	Page
Part II. The Tunisian, Sicilian, and South Italian Campaigns (Dec 1942 to Dec 1943)	
Section 3.	
Table of Contents	iii
Chapter XI. Supply Staff Organizations	357
1. Chief Administrative Officer.....	357
2. G-4 Section (A) AFHQ-NATOUSA.....	364
3. G-4 Section (B).....	370
4. Q (Maintenance) Branch (B).....	375
5. Q (Army Equipment) Branch (B).....	379
6. Logistical Plans Section (B).....	383
7. Quartermaster Section AFHQ-NATOUSA.....	388
8. Supply and Transport Service (B).....	393
9. Petroleum Section AFHQ-NATOUSA.....	398
10. Salvage Service (B).....	402
11. Printing and Stationery Services (B).....	404
12. North African Economic Board.....	409
13. General Purchasing Board, North Africa.....	412
14. Local Products Allocation Committee.....	417
15. Allied Force Local Resources Sect AFHQ-NATOUSA.....	420
16. AFHQ-ME Administrative Information Section.....	423
Chapter XII. Transportation Staff Organizations	427
1. G-4 (Movements and Transportation) Section.....	427
2. Transportation Section NATOUSA.....	432
3. Transportation (B).....	435
4. Military Railway Service AFHQ-NATOUSA.....	440
5. North African Shipping Board.....	444
6. Air Priorities Board.....	447
Chapter XIII. Finance Staff Organizations	450
1. Finance Section (A) AFHQ-NATOUSA.....	450
2. Pay Services (B).....	454
3. Joint Military Financial Committee.....	457
4. Banking and Currency Advisor (B).....	458
5. Financial Advisor (B).....	461
Chapter XIV. Staff Organizations for Civil Affairs	463
1. Civil Affairs Section AFHQ-NATOUSA.....	464
2. Military Government Section AFHQ-NATOUSA.....	469
3. Passive Air Def & Civil Def Sect AFHQ-NATOUSA.....	473
4. Political and Economic Council.....	477
5. Joint Commission, Political Prisoners & Refugees.....	478

	Page
Chapter XV. Liaison Staff Organizations	480
1. Liaison Section AFHQ-NATCUSA.....	480
2. Joint Rearmament Committee AFHQ-NATCUSA.....	486

## Chapter XI

### SUPPLY STAFF ORGANIZATIONS

The AFHQ staff organizations dealing with supply were more numerous than those of any other specialized function, sixteen in all. And these sixteen were only those organizations primarily concerned with supply. There were many others having some supply functions, such as Engineer, Ordnance, and Medical sections, which have been included, however, in other chapters because of their technical nature.

The Office of Chief Administrative Officer is presented first because he acted as a Deputy Chief of Staff for the general supervision and co-ordination of G-1 and G-4 matters. Since the greater part of his duties involved supply, the account of his office is presented in this chapter rather than in that on personnel. The rest of the supply organizations are arranged and treated in groups dealing with general staff sections and branches, special staff sections and services, and finally committees and boards, in that order.

#### 1. Chief Administrative Officer (CAO) AFHQ

a. Chief Administrative Officer. Major General H. M. Gale (B) continued to hold the position of Chief Administrative Officer throughout 1943. Upon being knighted (5 August) and promoted (9 August) he carried the rank and title of Lieutenant General Sir Humphrey M.

1  
Gale.

b. Functions. The duties of the CAO remained in principle the same as in 1942, but the responsibilities of the post were greatly increased by the following facts:<sup>2</sup>

(1) The Headquarters Line of Communications (B) with its various areas and sub-areas was brought under the command of the CAO at AFHQ on 1 January 1943 and, with the battle area moving into ITALY, had become by November 1943 North Africa District (NORTH AFRICA and TUNISIA), No 1 District (SICILY), No 2 District (southern ITALY). Although AFHQ Advanced Administrative Echelon (FLAMBO) had been constituted on 15 October 1943 to co-ordinate all matters of general administration and supply on the mainland of ITALY, the CAO remained responsible for the co-ordination of all American and British maintenance in the Theater.<sup>3</sup>

(2) The British staff branches and services, or parts thereof, which had been at-

---

1. Promoted by order of the King to Knight Commander of the British Empire, Gen Gale had been previously a Commander of the British Empire. Appendix A to GRO 402, 20 Aug 43; London Gazette, 10 Aug 43.

2. History of AFHQ, II, 175-183. Statement of Maj Gen Lewis, 3 Nov 44. AFHQ Admin Memo No 24, 31 Dec 42; Ltr, Whiteley to Kennedy, 16 Mar 43 (SGS AFHQ file: 312-15); Min of CofS Conference No 50, 20 Apr 43; Memo to CAO from G-4 (B), 12 July 43 (G-4 (B) AFHQ file: 98).

3. For details of FLAMBO see History of AFHQ, II, 202-212.



tached as an increment to the 1st Army (B) during the preparations for, and conduct of, the actual invasion, took their proper position in AFHQ on 1 January 1943. This brought Q (Maint) and all the services connected with G-1 (B) and Q (Maint) directly under the command of the CAO.

(3) The differences in the American and British systems of administration proved too great to allow either to adopt the other's system. It was therefore decided that the administrative side of AFHQ should contain whatever separate American and British organizations were necessary to operate their respective systems. Co-ordination was effected, under the direction of the CAO, by consultations between the CAO and Deputy Theater Commander, NATOUSA.

(4) Within the Headquarters the CAO constituted a court of final appeal to which points of dispute could be carried by British and American subordinate administrative and supply organizations.

(5) The responsibility for the issue of American equipment to British units and vice versa rested with the CAO.

Although he was never officially designated as such, the CAO was indicated as a Deputy Chief of Staff in a cable to the War Department describing the organization and functions of AFHQ:

The CofS is assisted by two deputies. One DCofS is charged with the general co-ordination of tactical matters (i.e., with G-2 and G-3 functions). The other DCofS (CAO) is charged with the co-ordination of supply matters... . As the supply DCofS is also the British CAO, he is charged with the administration of British personnel and in this capacity deals directly with the WO.<sup>4</sup>

The position of the CAO in relation to the British Forces is clearly defined in the following cable sent by AFHQ to C-in-C INDIA:

CAO is title of senior British Army Officer at AFHQ. He commands all troops not under command GOC-in-C 15th Army Group and holds full warrants from His Majesty with powers of delegation to commanders of lower formations. He performs all legal acts and other functions of C-in-C for British troops. He is not staff officer except to US C-in-C.<sup>5</sup>

In this connection the CAO had the following powers:<sup>6</sup>

- (1) To convene courts-martial and confirm the findings thereof.
- (2) To promote officers up to the rank of major.
- (3) To authorize war establishments affecting formations and units in the British North African Force (BNAF) within certain limitations. G-3 (Org) (B) was responsible for the detailed examination of proposed new British war establishments. Where such an establishment was outside the war establish-

---

4. Cable No W6285, AFHQ to WD, 1 Aug 43.

5. Cable No 2612, G-1 (B) AFHQ to C-in-C INDIA, 26 Oct 43, (AG AFHQ file: 321 (CAO)).

6. Draft Memo to G-3 (Org) AFHQ, 27 Jan 43, (G-3 Org AFHQ file: 4/12 (No 1)); GRC No 90, 12 March 43.

ment powers granted to the CAO by the War Office, G-3 (Org) (B) was responsible for obtaining the approval of the War Office to the new proposed establishment. In this instance G-3 (Org) (B) was responsible to the CAO and not to the ACofS G-3.

c. Organization. The mass of work which had to be transacted in the Office of the CAO was such that in May 1943 it was necessary to establish a secretariat to screen correspondence, prepare briefs of important papers, and act as a buffer for individuals seeking advice from the CAO. Likewise in October 1943 the DQMG (G-4 (B)) was upgraded to major general, and an ADQMG was introduced to co-ordinate the activities of Q (Maint) and Q (AE).<sup>7</sup> The effect of these changes was:

(1) Time could be better devoted to matters of policy.

(2) Certain matters previously dealt with by the CAO could be handled by the DQMG.

(3) Directors of Services (B) wishing to appeal above the ADQMG would approach the DQMG in the first instance. Directors right of access to the CAO under Field Service Regulations remained unchanged but would be exercised through the DQMG.

(4) International supply policy matters and matters of administrative organization,

---

7. Memo from Log Plans to CAO, 26 May 43 (CAO AFHQ file: CAO 1001); AFHQ Staff Memo No 79, 20 Oct 43.

economic policy, and so forth, which required handling on a higher level, were dealt with by G-4, with reference to the CAO when necessary.

The CAO conferences on administrative matters started in December 1942, continued to be held during 1943, with representatives from the Navy, Air Forces, Civil Affairs, and other interested general and special staff sections and services.

A chart of those parts of the AFHQ organization for which the CAO was responsible in November 1943 is shown on the following page.

d. Personnel. The authorized personnel in the CAO's office on 1 December 1943 are shown in the following table:

<u>OFFICERS</u>			<u>WARRANT OFFICERS</u>			<u>OTHER RANKS</u>		
Rank	Oct* 42	Dec# 43	Rank	Oct* 42	Dec# 43	Rank	Oct* 42	Dec# 43
Maj Gen	1	1	WO I		1	Tec 3		1 <sup>x</sup>
Lt Col		1	WO II	1		Sgt		1
Maj		1				Cpl		1
Capt	1	1						
Totals:	2	4		1	1			3

	<u>1942</u>	<u>1943</u>
Total British :	3	7
Total Americans:		1
COMBINED TOTALS:	3	8

8. Crane Report, Chart No 6, 28 Sep 43. AFHQ Staff Memo No 79, 20 Oct 43, sect III.

\* AFHQ WE VIII/374/1, 12 Oct 42, which includes the increment to 1st Army (WE VIII/1A/2).

# AFHQ WE XII/1/4, wef 1 Dec 43 (AG AFHQ file: 321-1 AFHQ).

x Ltr, AG AFHQ to CAO AFHQ, 29 Oct 43 (AG NATOUSA file: 200.3-130).

CHART OF ORGANIZATIONS UNDER CHIEF ADMINISTRATIVE OFFICER AFHQ  
November 1943

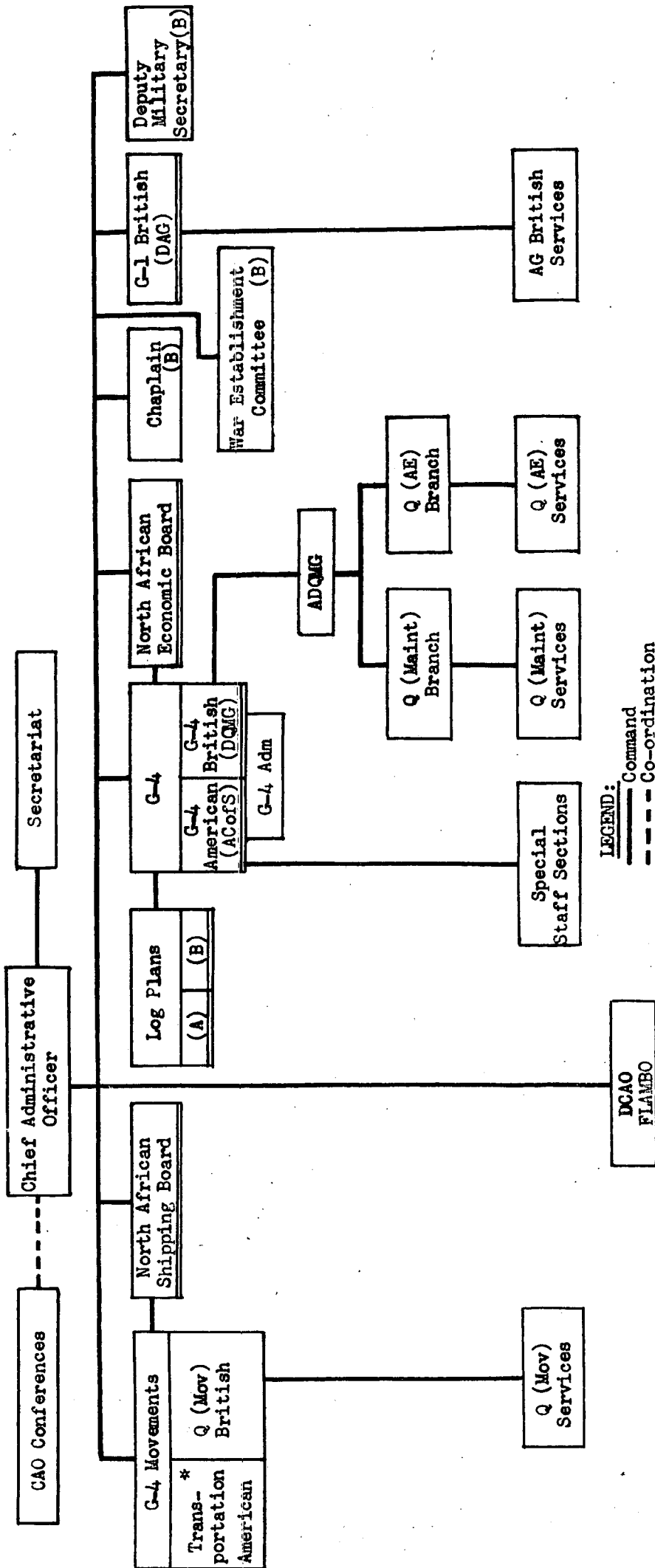

LEGEND:

- Command
- - - Co-ordination
- Branch or section which was under CAO in 1942
- \* American special staff section of Hq NATOUSA also serving AFHQ.

LIBRARY  
ARMED FORCES STAFF COLLEGE

2. G-4 Section (American) AFHQ--NATOUSA

a. Activation of G-4 NATOUSA. On 4 February 1943 Hq NATOUSA was established, and the American G-4 of AFHQ became likewise the G-4 Section of NATOUSA. This arrangement was confirmed by a later order on 8 May 1943.

b. Changes in ACofS G-4. Brigadier General Archelaus L. Hamblen (A) continued in his duties as the ACofS G-4 AFHQ until 20 March 1943. He was succeeded by Colonel Clarence L. Adcock (A) who remained in that appointment throughout the rest of 1943. Colonel Adcock was promoted to the rank of brigadier general on 25 March 1943.

In addition to their duties at AFHQ both Generals Hamblen and Adcock served successively as ACofS G-4 NATOUSA as well until 8 May 1943. For the rest of 1943 the Executive Officer of G-4 AFHQ, Colonel Lawrence E. Heyduck (A), also served as ACofS G-4 NATOUSA.

c. Changes in Functions. The differences between the American and British staff systems resulted by 1 January 1943 in the introduction of the British "Q" staff branches and services into the AFHQ organization.

---

9. NATOUSA GO No 1, 4 Feb 43. Statement of Col J. J. Donahue (A) in Sep 44.

10. NATOUSA GO No 28, 8 May 43.

11. NATOUSA SO No 43, 20 Mar 43.

12. AFHQ GO No 26, 20 Mar 43.

13. NATOUSA 1st Ind to TAG WD, 18 Apr 43.

14. NATOUSA GO No 1, 4 Feb 43; NATOUSA SO No 43, 20 Mar 43.

15. Memo, Adcock to IAG NATOUSA, 18 July 43.

16. AFHQ Adm Memo No 24, 31 Dec 42.

Since a large number of these British units handled supply matters under the British staff system, two parallel organizations--one British and one American--constituted G-4 AFHQ after the first of the year. Although the title of ACoFS G-4 AFHQ remained with the senior American officer, the ranking British officer, known as Major General G-4 (British) or the DQMG, became head of G-4 (British) and co-ordinated on matters of international concern with the ACoFS G-4. An arrangement between the Major General G-4 (British) and the ACoFS G-4 provided that directives of major import appearing over the signature of either officer had<sup>17</sup> been previously co-ordinated between them.

The activation of SOS NATOUSA on 15 February 1943 relieved G-4 (American) AFHQ of the bulk of the supply and maintenance operations within the Theater for American troops.<sup>18</sup> The manner in which this transfer of functions took place was described by Major General Thomas B. Larkin (A), Commanding General of SOS NATOUSA,<sup>19</sup> on 9 August 1944:

.....SOS NATOUSA had been in existence only about one month when General Adcock reported to AFHQ, but he set about progressively to delegate to SOS NATOUSA all the United States supply functions short of the formulation of Theater policy. By so doing he left the highest Theater headquarters free to confine itself in supply matters to those of a major or international character. At the same time he eliminated duplication and fostered effective co-operation by enabling SOS NATOUSA to pursue its mission with a minimum of unnecessary interference.

---

17. AFHQ Staff Memo No 79, 20 Oct 43. See also the discussion under G-4 (British) within this chapter.

18. NATOUSA GO No 6, 14 Feb 43.

19. Ltr, Gen Larkin to CG NATOUSA, 9 Aug 44 (AG AFHQ Personnel, 201 file: Adcock, Clarence L.).

This delegation of functions conformed with earlier decisions reached in the AFHQ Chief of Staff Conference of 29 January 1943 which empowered the ACoS G-4 to "direct the C-in-C policy" to SOS.<sup>20</sup>

Additional functions assigned to G-4 (American) in 1943 in its relations to other Headquarters agencies are summarized as follows:

(1) To co-ordinate generally the policies and activities of the following special staff sections:<sup>21</sup>

Quartermaster	Signal
Ordnance	Chemical Warfare Service
Engineer	Transportation
Medical	Finance

(2) To supervise or to recommend changes in tables of basic allowances (T/BA) or tables of equipment (T/E).<sup>22</sup>

(3) To exercise general staff supervision over the disposition of captured materiel and battlefield clearance as well as over the evacuation of prisoners of war and casualties.

(4) To handle the procedure in Lend-Lease matters.

(5) To supervise the procurement of American training arms and ammunition.

---

20. Min of CofS Conference, 29 Jan 43 (SGS AFHQ file: CofS Conf).

21. AFHQ Adm Memo No 24, 31 Dec 42.

22. Crane Report, Chart No 15, 29 Sep 43. Other functions listed from (3) to (12) inclusive also come from the Crane Report.



(6) To determine policies for American air travel and traffic control.

(7) To be responsible for station lists of American units.

(8) To recommend activation of American service units in addition to determining their status, recommending their movements, and screening bids for their employment.

(9) With the G-4 (British) to direct the activities of the Logistical Plans Section and to carry out logistical planning for future military operations, including the following responsibilities: evaluation of administrative and supply plans of the task forces, co-ordination of requirements for the task forces with the special staff sections of AFHQ and SOS NATOUSA; allocation of tonnages from the UNITED STATES between ground, naval, and air forces; and assignment of priorities of shipments.

(10) To issue administrative instructions concerning the performance of its assigned functions.

(11) To determine policies for the maintenance of current operations.

(12) To determine policies concerning the construction and maintenance of roads, railways, hospitals, pipelines, and storage facilities.

(13) To co-ordinate closely with the following AFHQ agencies in civilian supply activities:<sup>23</sup> Civil Affairs and Military Government sections, NAEB, Q (Maint), and the Petroleum Section.

c. Changes in Organization. The following modifications within G-4 (American) in 1943 occurred during<sup>24</sup> the months indicated:

The Requirements and Distribution Branch ceased to exist in February.

The Plans Branch was added in March.

The Supply Branch was added in June.

The Construction Branch was added in July.

The Civil Branch was added in August.

An organizational chart of G-4 (American) AFHQ for November 1943 is shown on the next page.<sup>25</sup>

d. Changes in Personnel. Although its authorized personnel almost trebled from 1942 to 1943, this Section's allotment still remained small. The authorized personnel figures of G-4 (American) for November 1942

---

23. NATOUSA GO No 28, 8 May 43; Organizational and Functional Chart of G-4 (A) AFHQ, c. Sep 43, furnished by Col J. J. Donahue on 2 Feb 45.

24. Statements of Col J. J. Donahue (A), G-4 (A) AFHQ, in Sep 44.

25. Ibid.

**ORGANIZATIONAL CHART OF G-4 (AMERICAN) AFHQ-NAIDUSA**  
November 1943

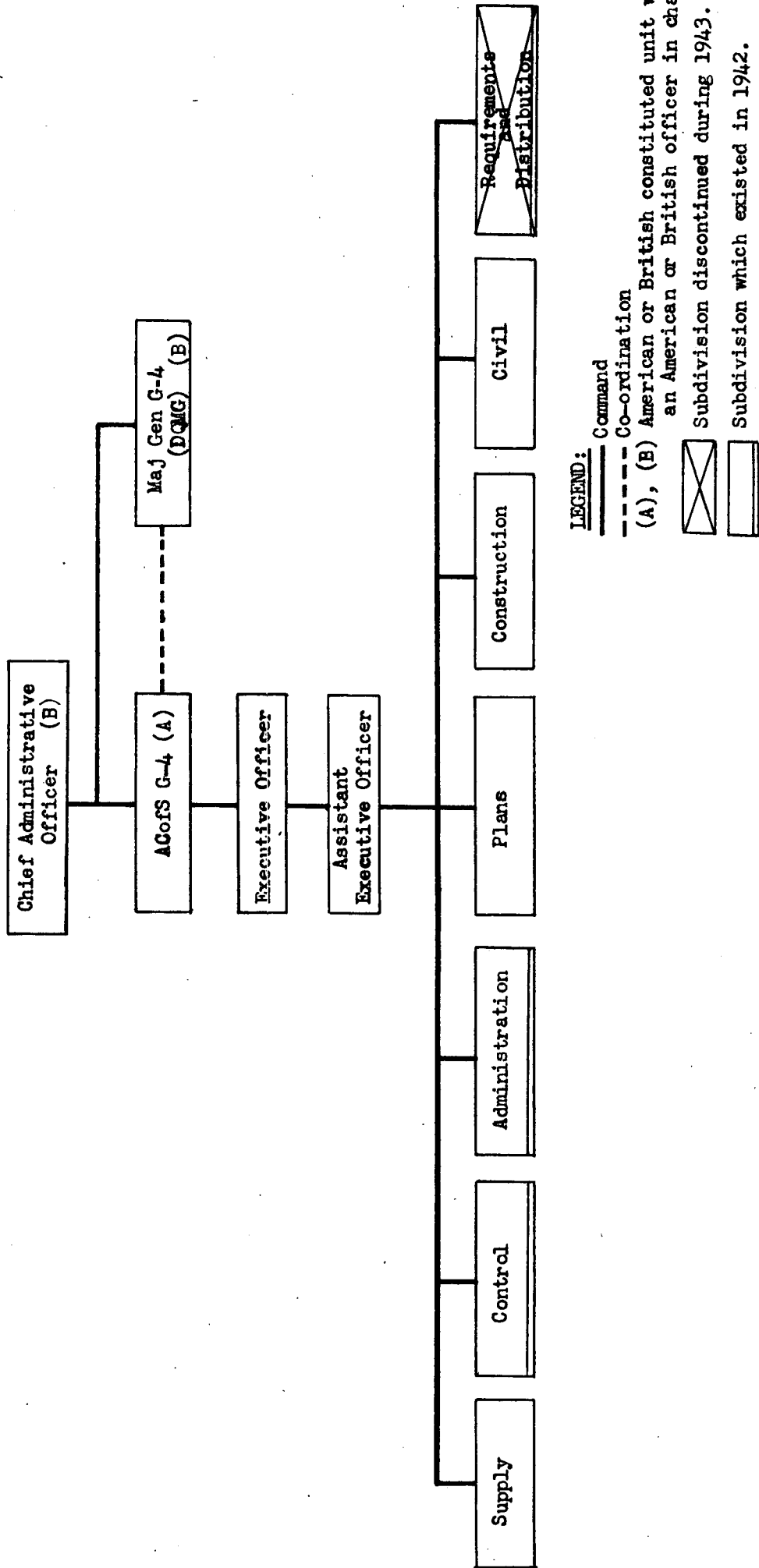



**LEGEND:**

— Command

- - - Co-ordination

(A), (B) American or British constituted unit with an American or British officer in charge.

 Subdivision discontinued during 1943.

 Subdivision which existed in 1942.

and 1943 are shown below:

<u>OFFICERS</u>			<u>WARRANT OFFICERS</u>			<u>ENLISTED MEN</u>		
Rank	Nov* 42	Nov# 43	Rank	Nov* 42	Nov# 43	Rank	Nov* 42	Nov# 43
Gen & Col	2	3	CWO		1	M/Sgt		1
Lt Col	1	3	WOJG	1		T/Sgt		1
Maj	2	5				S/Sgt	1	
Capt		4				Tec 3	2	2
						Sgt	1	
						Tec 4		6
						Tec 5		2
Totals:	5	15		1	1		4	12

	<u>1942</u>	<u>1943</u>
Total Americans:	10	28

### 3. G-4 Section (British) AFHQ

a. Deputy Quartermaster General. Brigadier R. G. Lewis (B) continued to be the officer responsible for the maintenance and supply of the British forces in the Theater throughout 1943. He was promoted to the rank of major general on 6 October 1943.<sup>26</sup> Although his title in the British war establishment for AFHQ was Deputy Quartermaster General (DQMG), General Lewis continued to be known as G-4 (British) in conformity with the organization of this headquarters.<sup>27</sup>

b. Changes in Functions. There were a number of changes in the G-4 organization during 1943 which are

\* Personnel table, 19 Nov 42 (G-1 NATOUSA file: T/O AFHQ Old, in envelope at end of file).

# AG NATOUSA Ltr to ACoFS G-4 NATOUSA, 18 Sep 43 (AG NATOUSA file: 200.3-157).

26. Cable No 77686SD3a, WO to AFHQ, 10 Oct 43.

27. AFHQ Staff Memo No 79, 20 Oct 43.

explained below:

(1) The difference between the American and British systems was so great that it was decided, in December 1942, that the administrative side of the Headquarters should contain separate American and British organizations requisite for the operation of their respective systems. G-4 Section therefore became G-4 (American) with General Hamblen as ACoS and G-4 (British) with General Lewis as DQMG. Co-ordination on matters of policy between the American and British systems was effected by close contact and liaison between General Hamblen and General Lewis each of whom received technical advice from their own special staff sections or services.

28

(2) The British staff branch, Q (Maintenance), and its attendant services joined AFHQ on 1 January 1943, when for the first time the DQMG had the full organization under his direct command.

29

(3) Q (Army Equipment), Q (AE), came in to the Headquarters as a new staff branch on 15 July 1943 and absorbed from Q (Maint) all general staff functions concerning the Ordnance, REME, and Salvage services. It also took over from G-3 (Org) (B) the duties of control of special stores and the equipping

---

28. AFHQ Adm Memo No 24, 31 Dec 42.

29. Statement by Maj Gen Lewis (B), 3 Nov 44.

of British units and formations.

(4) The MEDITERRANEAN was considered as a single entity for the purpose of British supply and maintenance, and on 1 October 1943 the AFHQ--Middle East Administrative Information Section (AM AIS) was constituted to provide co-ordination between AFHQ and GHQ MEF. The head of the Section reported<sup>31</sup> to G-4 (British).

(5) The DQMG acted for the CAO when<sup>32</sup> the latter was absent on tours and visits.

(6) The reorganization of the British side of AFHQ under the CAO resulted in the upgrading of the appointment of DQMG to major general, the provision of an ADQMG (a brigadier) to co-ordinate the day-to-day activities of Q (Maint) and Q (AE), and the placing of Logistical Plans Section under the combined heads, American and British, of G-4<sup>33</sup> with the following effects:

(a) Certain matters which of necessity had been handled by the CAO were now handled by the DQMG.

(b) Directors of British services, wishing to appeal above the level of the ADQMG, would approach the DQMG in

30. AFHQ Staff Memo No 67, 19 July 43.

31. Memo, CAO to All Concerned, 5 Oct 43, (CAO AFHQ file: CAO/1009/3).

32. Statement by Maj Gen Lewis (B), 3 Nov 44.

33. AFHQ Staff Memo No 79, 20 Oct 43.

the first instance.

(c) The division of duties between the CAO, the DQMG, and the ADQMG was not defined in detail. but, in principle, matters of routine British supply were handled finally by the ADQMG and matters of British policy in the first instance by the DQMG.

(d) International supply policy matters and matters of administrative organization, economic policy, and so forth, which required handling on a higher level, were handled by both the American and British G-4 sections, with reference to the CAO when necessary.

(e) G-4 decisions of a purely British implication were issued over the signature of the Major General G-4 (British). Those of international significance appearing over the signature either of the ACofS G-4 (American) or the Major General G-4 (British) were accepted as having been fully co-ordinated.

c. Organization. A chart of the organization which was under the DQMG in November 1943 is shown on the following page.

---

34  
34. Crane Report, Chart No 6, 28 Sep 43. Amended to November 1943.

ORGANIZATION CHART OF G-4 (BRITISH) SECTION AFHQ  
November 1943

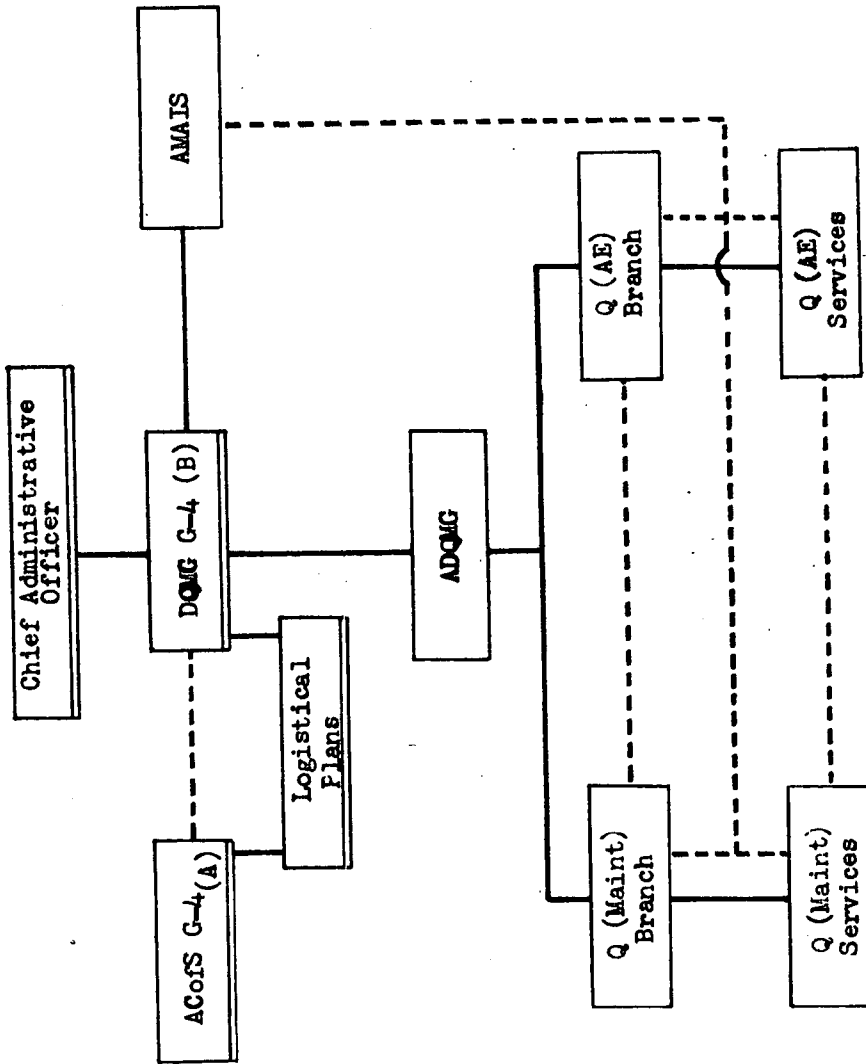

LEGEND:

Command

Co-ordination

Existed in 1942





d. Personnel. The following table of the authorized personnel of G-4 (British) Section on 1 December 1943 has been taken from the AFHQ War Establishments XII/1/4. No comparative figures for 1942 are available, as G-4 (British) was included with Q (Maint) in the WE for that period.

<u>OFFICERS</u>		<u>WARRANT OFFICERS</u>		<u>OTHER RANKS</u>	
<u>Rank</u>	<u>Dec 43</u>	<u>Rank</u>	<u>Dec 43</u>	<u>Rank</u>	<u>Dec 43</u>
Maj Gen	1	WO II	1	Cpl	1
Brig	1			L/Cpl	1
Capt	1			Pte	1
Totals:	3		1		3

Total British: 7

#### 4. Q (Maintenance) Branch (British) AFHQ

a. Activation. The British Q (Maintenance) Branch had been, to a great extent, with the GHQ increment to the 1st Army and did not take up its proper position as part of AFHQ until 1 January 1943.<sup>35</sup> The offices of the Branch were not, however, moved from MAISON CARREE to Ecole Ste. Genevieve, in ALGIERS, until 9 January 1943.<sup>36</sup>

b. Assistant Deputy Quartermaster General Q (Maint). Colonel R. J. Cooke (B), who had been appointed DQMG GHQ Increment on 3 September 1942, became ADQMG Q (Maint) on 1 January 1943. Colonel Cooke was succeed-

35. Statement by Maj Gen Lewis (B), 3 Nov 44.

36. Office Instruction No 3, 7 Jan 43, (Q (Maint) AFHQ file: 501/Q (Maint)).

ed, in turn, by Colonel F. A. S. Clarke (B) (30 March 1943) and by Colonel S. R. Garratt (B) (7 July 1943). As a result of the reorganization of the British administration under the CAO at AFHQ the position of ADQMG Q (Maint) was upgraded and Brigadier W. H. D. Ritchie (B) was appointed to that post on 23 October 1943. He was succeeded by Brigadier R. M. J. Goldie (B) on 3<sup>37</sup> December 1943.

c. Functions. Q (Maint) was the British staff branch which, under G-4 (British), was responsible for the supervision, direction, and co-ordination of the services dealing with the maintenance of the British forces in the Theater, and for notifying the War Office of priority in order of provision and distribution in accordance with the relative urgency of the various demands from the services under it. The principal British<sup>38</sup> matters with which this branch was concerned were:

(1) Storage and distribution of supplies, of engineer and RASC stores, and of veterinary stores and animals.

(2) Issue of equipment, weapons, armored and load-carrying vehicles, clothing, and signal stores.

(3) Electrical and mechanical workshops, and repair and maintenance of equipment and vehicles.

---

37. D/MS AFHQ, Record of Officers, WO Auth, MS1/1/484, 15 Sep 42; G1/B/5430/5MS, 26 Mar 43; 7767/MS, 5 July 43; 105/MS, 21 Oct 43; 7722/MS, 30 Nov 43.

38. Statement by Capt Colville, Q (Maint) AFHQ, 6 Nov 44; AFHQ, BQI's. FSR, vol I, 13 Dec 39, sect 29.

- (4) Accommodation and construction of permanent camps and hospitals.
- (5) Construction of depots, installations, and airfields.
- (6) Purchase, requisition, and hire of billets, buildings, and land.
- (7) Employment and distribution of non-combatant and civilian labor.
- (8) Canteens and institutes.
- (9) Collection and disposal of salvage.
- (10) Ration scales and changes therein.
- (11) Postal service for the official and private correspondence of the British forces.
- (12) Ammunition and explosives.
- (13) Protection against fire.
- (14) Office equipment, army forms, books, and stationery.
- (15) Army stores destined for the RAF.
- (16) Issue of British 'Q' Instructions.

Co-ordination on international matters was effected by close contact and liaison with G-4 (American) and by consultation between the American special staff sections and the British services on technical points. Co-ordination of specific matters, which were not purely national, was made the responsibility of definite subsections of the American and British staff machinery, and the table showing the heads responsible for such co-ordination was issued in March 1943.

---

39. AFHQ Adm Memo No 42, 31 Dec 43; ibid., No 26, 12 Mar 43.

d. Organization. Q (Maint) was composed originally of four subsections Qx, Q1, Q2, and Q3.<sup>40</sup> Qx dealt with the maintenance aspects of future operations and was responsible for the co-ordination of the other subsections, each of which supervised and co-ordinated specific services. When Q (AE) was established, it relieved Q (Maint) of the staff duties in regard to the Ordnance, REME, and Salvage services, and the remaining organization of Q (Maint) contained only Qx, Q1, and Q3.<sup>41</sup> Q2, however, was re-established with different duties in August 1943 when Q (Maint) successfully applied for an increased war establishment for the following reasons:<sup>42</sup>

(1) Increased volume of work due to the size of AFHQ order of battle.

(2) Decision that 15th Army Group would not function fully on the administrative side, causing additional work to be done or co-ordinated by AFHQ.

(3) Extensive and rapid development of the Theater.

(4) Accommodation problems due to (3) and to the approach of winter.

(5) The Branch was working with a minimum staff and with consequent long hours and rushed work.

---

40. AFHQ Adm Memo No 26, 12 Mar 43.

41. AFHQ Staff Memo No 67, 19 July 43; AFHQ Q (Maint) Office Instn No 17, 18 July 43.

42. Memo submitted by Q (Maint) to AFHQ WE Committee, 19 Aug 43.

A chart giving the duties of the subsections of Q (Maint) and the services co-ordinated by them is shown on the following page.

e. Personnel. The following table shows the personnel of Q (Maint) Branch according to the AFHQ war establishments for 12 October 1942 and 1 December 1943. The figures for 1942 included personnel in G-4 (British) and the GHQ Increment to 1st Army.

<u>OFFICERS</u>			<u>WARRANT OFFICERS</u>			<u>OTHER RANKS</u>		
Rank	Oct* 42	Dec# 43	Rank	Oct* 42	Dec# 43	Rank	Oct* 42	Dec# 43
Brig	1	1	WO I	1	1	S/Sgt	2	2
Col	1		WO II	2	2	Sgt	1	2
Lt Col	3	3				Cpl	3	4
Maj	3	6				L/Cpl	2	2
Capt	3	5				Pte	14	15
Totals:	11	15		3	3		22	25

1942    1943  
 Total British:    36    43

5. Q (Army Equipment) Branch (British) AFHQ

a. Activation. Q (Army Equipment), Q (AE), was activated at the Ecole Ste Geneviève, ALGIERS, with the appointment of the ADQMG (AE) on 15 July 1943. The establishment of the Branch, as part of the G-4 (British) organization, was officially announced in a staff memo-

---

43. Crane Report, Chart No 43, 28 Sep 43; ltr, CAO to All Concerned, 12 Oct 43 (Q (Maint) AFHQ file: 500/Q (Maint)).

\* WE VIII/374/1, 12 Oct 42.

# WE XII/1/4, 1 Dec 43.

ORGANIZATION CHART OF Q (MAINTENANCE BRANCH AFHQ)  
November 1943

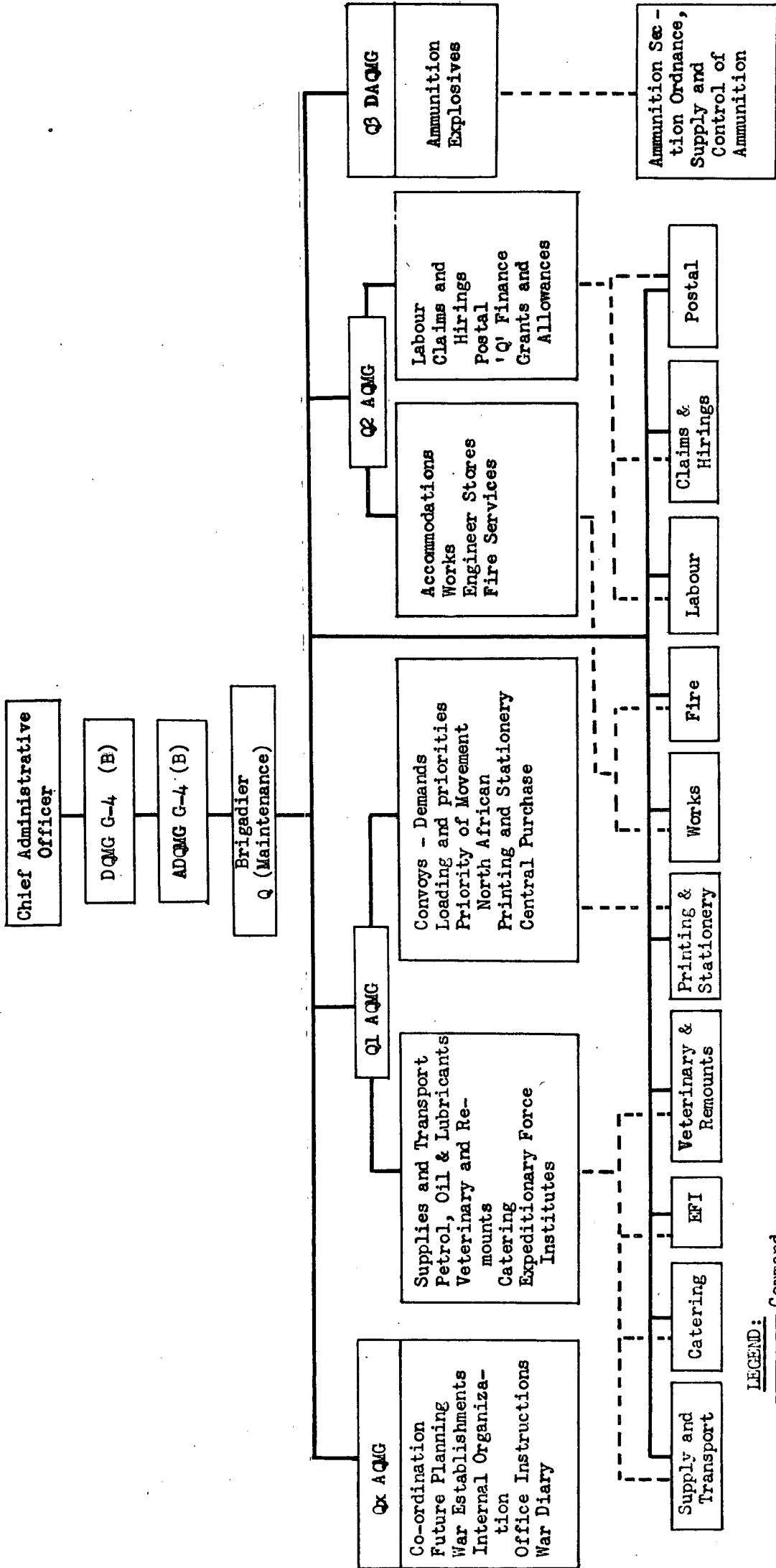

LEGEND:        Command

44

randum on 19 July 1943.

b. The ADQMG (AE). Brigadier A. H. Fernyhough (B), who had been Deputy Director of Ordnance Service (B) at AFHQ, was appointed ADQMG (AE) and head of the Branch on 15 July 1943. He continued to serve in that position throughout the rest of 1943.<sup>45</sup>

c. Functions. The new branch of Q (AE) was formed because Q (Maint) (B) had not had the necessary staff to exercise executive control and to issue the necessary orders in accordance with the staff policies for the provision and distribution of equipment. To assist Q (Maint) under the old system, G-3 Org (B) had found it necessary to undertake detailed executive work at the expense of its duties concerning future policy and planning. Q (AE), therefore, took over from Q (Maint) and G-3 Org (B) the duties in connection with:<sup>46</sup>

- (1) Staff functions for the Ordnance, REME, and Salvage services.
- (2) Provision of information regarding the state of equipment of British units.
- (3) Issue of releases for all vehicles and controlled stores.

These over-all duties of Q (AE) involved the following detailed responsibilities:<sup>47</sup>

---

44. AFHQ Staff Memo No 67, 19 July 43. WO Auth, 5430/18/MS, 1 Aug 43.

45. See footnote 44 above.

46. Ltr, DQMG G-4 (B) to AFHQ WE Com, July 43 (Q (AE) AFHQ file: 6000/1/Q (AE)).

47. Ibid. AFHQ Staff Memo No 67, 19 July 43. Memo, Q (AE) to G-3 Org (B), 28 Aug 43 (Q (AE) AFHQ file: 6000/1/Q (AE)).

- (1) Decisions on policy matters in connection with army equipment.
- (2) Authority to release vehicles, controlled stores, and signal equipment and the priority attached to such releases.
- (3) Priority for shipping of controlled and other stores.
- (4) Supervision of Ordnance installations, their locations, and the stocks held therein.
- (5) Supervision of REME workshops, their locations, and priority in the maintenance and repair of equipment and vehicles.
- (6) Provision of information relating to the state of equipment of all British formations and units under the administrative control of AFHQ and the necessary statistical records in connection therewith.
- (7) Census returns for vehicles and warlike stores.
- (8) Communications with the War Office concerning the Ordnance and REME services.
- (9) Liaison with other commands regarding the equipment of British formations.
- (10) Planning and re-equipment programs for present and future operations.
- (11) Supervision of the collection, storage, and disposal of salvaged materials and equipment.
- (12) Supervision of the British inspectorate of army equipment.



d. Organization. A chart of the organization of the Q (AE) Branch in November 1943 is shown on the next <sup>48</sup> page.

e. Personnel. The original personnel for Q (AE) were obtained from G-3 Org (B), Q (Maint), and Ordnance (B) in July, but the work involved necessitated the Branch applying for additional staff in September 1943. The following table shows the personnel of Q (AE) as authorized in the British war establishment for AFHQ on <sup>49</sup> 1 December 1943.

<u>OFFICERS</u>		<u>WARRANT OFFICERS</u>		<u>OTHER RANKS</u>	
Rank	Dec 43	Rank	Dec 43	Rank	Dec 43
Brig	1	WO I	1	S/Sgt	2
Lt Col	2	WO II	1	Sgt	4
Maj	4			Cpl	7
Capt	8			L/Cpl	6
				Pte	28
<b>Totals:</b>	<b>15</b>		<b>2</b>		<b>47</b>

Total British: 64

#### 6. Logistical Plans Section (British) AFHQ

a. Activation. A small staff had worked directly under the Chief Administrative Officer on logistical planning at Norfolk House, but it was not until 19 December 1942 that this staff was designated officially <sup>50</sup> as the Logistical Plans Section.

---

48. Crane Report, Chart No 44, 28 Sep 43. DO ltr, Fernyhough to Goldie, 18 Oct 43, (Q (AE) AFHQ file: 6000/1/Q (AE)).

49. WE XII/1/4, wef 1 Dec 43.

50. Memo D/320, issued by CAO, 19 Dec 42 (CAO AFHQ file: 20).

ORGANIZATION CHART OF Q (ARMY EQUIPMENT) BRANCH AFHQ  
November 1943

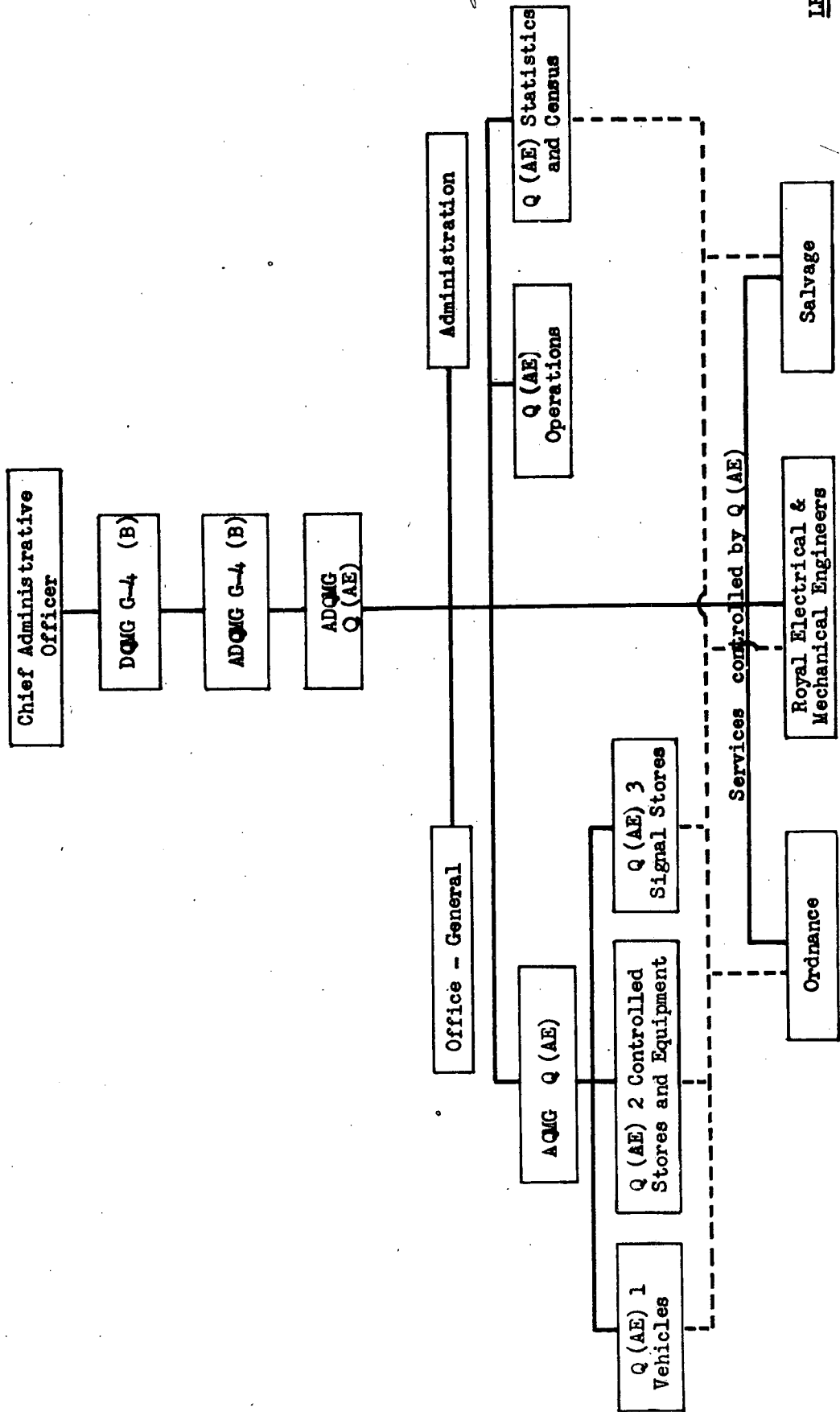

LEGEND:

- Command
- Co-ordination

b. Chiefs of Section. Lieutenant Colonel J. C. D'A. Dalton (B) was the senior officer of the personnel who became the Logistical Plans Section<sup>51</sup> and continued as Chief of the Section until 11 August 1943 when Colonel C. P. R. Johnston (B) succeeded him.<sup>52</sup> Colonel Johnston, in turn, was succeeded on 19 October by Colonel R. G. Thurburn (B) who remained the Chief of the Section for the rest of 1943.<sup>53</sup>

c. Functions. The Logistical Plans Section had two main functions: first, to represent the CAO on all future planning so as to ensure that the administrative aspect was considered right from the start; second, to act as an information center for all the administrative sections of the staff, particularly with regard to future operations.<sup>54</sup> The more detailed duties of the Section were:<sup>55</sup>

(1) To acquire and collate logistical data concerning forces under command of the Allied C-in-C, the territory now occupied by these forces, and such other territories as might from time to time be involved in future planning.

(2) To hold such data available for

---

51. Statement by Lt Col Stapleton (B), Log Plans, 1 Mar 45.

52. Ibid. WO Auth, 5430/5/MS, 2 Oct 43.

53. WO Auth, 105/MS, 23 Oct 43.

54. Memo, Lt Col Dalton to Col Johnston, 11 Aug 43 (Log Plans AFHQ file: 158).

55. Memo D/320, issued by CAO, 19 Dec 42 (CAO AFHQ file: 20). Memo, Gen Lewis to G-3, 19 June 43 (CAO AFHQ file: 20).

reference by any other section of AFHQ.

(3) Unless otherwise arranged, to represent the logistical viewpoint at planning group meetings.

(4) To undertake logistical planning as directed by the CAO.

(5) To refer to the appropriate principal staff officer questions on logistical policy which are raised at planning meetings.

(6) To represent the CAO and G-4 Section (British) on the Executive Planning Section.

The Section was responsible for many plans of a joint American and British nature and was associated very closely with the Planning Subsection of G-4 Section (American).<sup>56</sup>

d. Organization. The Logistical Plans Section originally reported directly to the CAO, but after 20 October 1943 it came under the combined heads of the American and British G-4 sections.<sup>57</sup> A chart of the organization of the Section in November 1943 is shown on the next page.<sup>58</sup>

e. Personnel. The personnel authorized for the Logistical Plans Section on 1 December 1943 are shown

---

56. Statement by Lt Col Stepleton (B), Log Plans, 1 Mar 45.

57. AFHQ Staff Memo No 79, 20 Oct 43.

58. See footnote 56 above.

**ORGANIZATIONAL CHART OF LOGISTICAL PLANS SECTION AFHQ**  
 November 1943

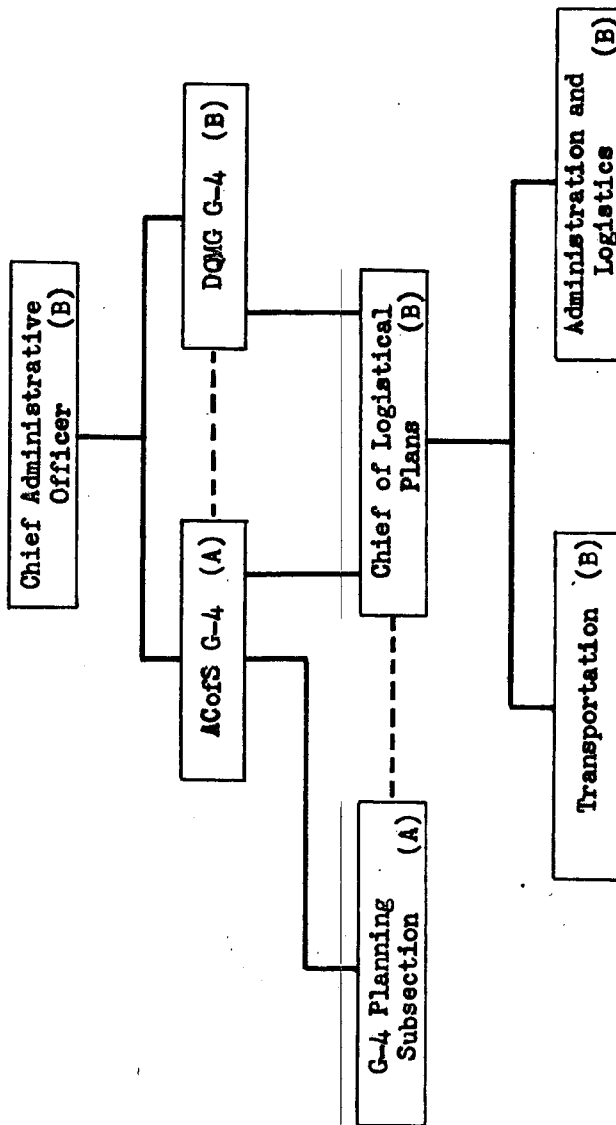

**Legend:**

----- Command

----- Co-ordination

(A), (B) indicate that the position or subsection was entirely staffed with American or British personnel.

<u>OFFICERS</u>		<u>OTHER RANKS</u>	
<u>Rank</u>	<u>Dec*</u> <u>43</u>	<u>Rank</u>	<u>Dec*</u> <u>43</u>
Col	1	Sgt	1
Maj	2	Cpl	2
Totals:	3		3

Total British: 6

7. Quartermaster (QM) Section AFHQ--NATOUSA

a. Activation. Although the Quartermaster Section AFHQ had been activated as a combined section on 15 September 1942, its American component on 8 May 1943 was likewise constituted as the Quartermaster Section NA-<sup>59</sup>TOUSA. The two sections worked, however, as one organization, since their separation was not envisaged unless QM NATOUSA remained behind after a possible move forward by QM AFHQ. But this move did not occur in 1943.

b. Chief of Section. Colonel Thomas H. Ramsey (A) continued to serve as Chief of the Quartermaster Section AFHQ during 1943. Colonel Ramsey also became Chief of the QM Section NATOUSA on 4 February 1943, which assign-<sup>60</sup>ment he retained for the remainder of the year. He was promoted to the rank of brigadier general with ef-

---

\* AFHQ WE XII/1/4, wef 1 Dec 43 (AG AFHQ file: 321-1).

59. NATOUSA GO No 28, 8 May 43, sect III.

60. NATOUSA GO No 1, 4 Feb 43, sect V.

61  
fect from 17 September 1943.

c. Changes in Functions. The functions of the Quartermaster Section AFHQ--NATOUSA remained generally the same in 1943 as in 1942<sup>62</sup> with the following four principal exceptions:

(1) With the establishment of the British staff branches and services of Q (Maint), Q (AE), Supply and Transport, Ordnance, and Salvage, the responsibility of the QM Section AFHQ was limited to purely American items and units, with the exception of fuels and captured materiel for which it served both Americans and British.<sup>63</sup>

(2) With the establishment of the Petroleum Section AFHQ on 1 February 1943, the QM Section's responsibility for fuels was limited to coal and coal products.<sup>64</sup>

(3) With the reorganization of its Battlefield Clearance Subsection into the Captured Enemy Materiel Executive Committee (CEMEC) on 3 September 1943, the functions of the CEMEC of the QM Section were elaborated and defined as follows:<sup>65</sup>

---

61. WD SO No 280, 7 Oct 43, par 1.

62. See FM 101-5, 19 Aug 40, par 39; an outline of the functions of the Quartermaster at AFHQ, 22 Oct 42, approved by the Chief Quartermaster; and History of AFHQ, I, 75.

63. Statement of Lt G. T. B. Page (A), QM Sect, 4 Mar 45.

64. AFHQ GO No 14, 2 Feb 43.

65. AFHQ Cir No 63, 3 Sep 43.

(a) To be the channel of communication between AFHQ and the liaison sections (CEMEC) in subordinate headquarters.

(b) To formulate policies for the operation and control of liaison sections (CEMEC) at subordinate headquarters.

(c) To call for, receive, and collate all reports from liaison sections (CEMEC) at subordinate headquarters.

(d) To list separately serviceable and repairable materiel and obtain allocation instructions from G-3 (Org).

(e) To receive all demands for allocation of captured materiel and supplies and to process such demands to G-3 (Org) for all allocation instructions.

(f) To issue disposition instructions based on G-3 allocations.

(4) In regard to the responsibility for coal the QM AFHQ had the following duties:

(a) To submit all requisitions for the importation of coal, except that required by the Royal Navy and the Ministry of War Transport. Requisitions for British coal will be submitted to the representative at NAEB of the Ministry of Fuel and Power who will forward these requisitions to the Ministry of Fuel and Power, LONDON, with copy to Movements.



(b) To allocate all coal, except that requisitioned by the Royal Navy (RN) and the Ministry of War Transport (MWT), through M. Betier, Chef des Mines, in co-ordination with NAEB.

d. Organization. The organization of the QM Section AFHQ--NATOUSA in September 1943 is shown by the chart on the next page.

e. Personnel. The authorized personnel of the QM Section AFHQ--NATOUSA in December 1943 are shown in the table below:

<u>OFFICERS</u>					<u>ENLISTED MEN</u>				
<u>Rank</u>	<u>Am</u>		<u>Br</u>		<u>Rank</u>	<u>Am</u>		<u>Br</u>	
	<u>Nov*</u>	<u>Nov#</u>	<u>Oct<sup>x</sup></u>	<u>Dec<sup>@</sup></u>		<u>Nov*</u>	<u>Nov#</u>	<u>Oct<sup>x</sup></u>	<u>Dec<sup>@</sup></u>
	42	43	42	43		42	43	42	43
Gen &					M/Sgt		1		
Col	2	2			T/Sgt		1		
Lt Col	1	2		1	S/Sgt		1		2
Maj		2		1	Tec 3	1	1		
Capt				2	Tec 4	3	1		
Totals:	3	6		12	Cpl				1
<u>WARRANT OFFICERS</u>					Tec 5		1		
WOJG				1	Pfc		2		
Totals:				1	Pvt		4		14
						4	12		17
					<u>1942</u>	<u>1943</u>			
					Total Americans:	7	18		
					Total British :		30		
					COMBINED TOTALS:	7	48		

67. Crane Report, Chart No 42, 28 Sep 43. AFHQ Cir No 63, 3 Sep 43.

\* Table of American personnel at AFHQ, 19 Nov 42, in envelope at back of G-1 MTOUSA file: T/O AFHQ Old.

# Memo, AG NATOUSA to QM Sect AFHQ, 21 July 43 (AG NATOUSA file: 200.3/151).

x There was no British WE for the QM Sect in 1942; the British personnel present in the QM Sect in 1942 were on DS from some other unit, such as Supply and Transport Service.

@ For CEMEC: AFHQ WE NA/90/2, wef 26 Aug 43. For Coal Sect of QM Sect: AFHQ WE NA/226/1, wef 9 Dec 43.

**ORGANIZATION CHART OF THE QUARTERMASTER SECTION AFHQ-NATOUISA**  
September 1943

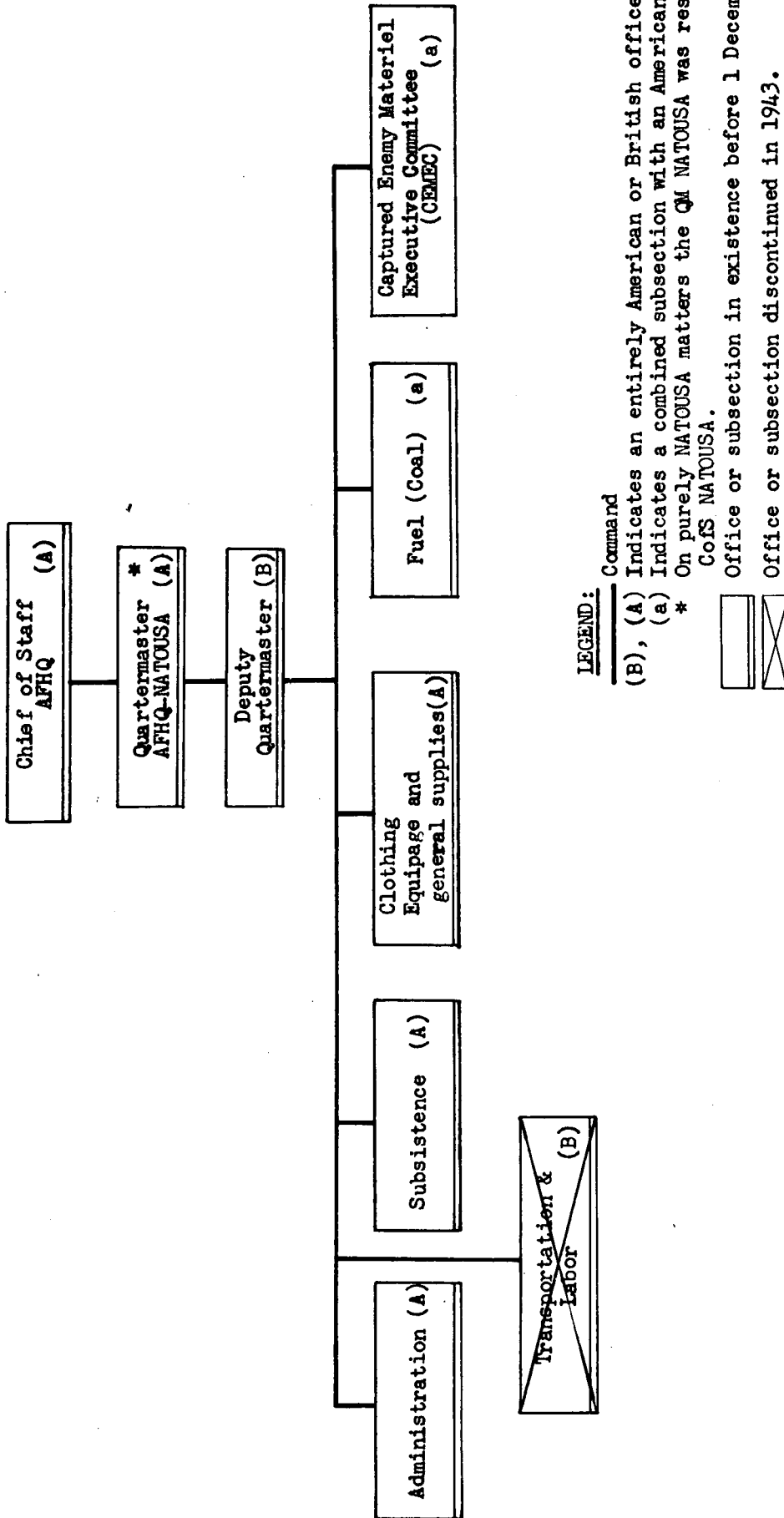

8. Supply and Transport Service (British) AFHQ

a. Activation. The Supply and Transport Service (S and T) was activated with the appointment of the Director of Supply and Transport (DST), Allied Force, on 14 August 1942.<sup>68</sup> Prior to and during the invasion of NORTH AFRICA the DST, with a small staff, was chiefly engaged in the over-all planning of the development and operation of the Service as part of the combined American and British QM Section AFHQ. The detailed work connected with the supplies for the Eastern Task Force was done by the S and T staff attached to Hq 1st Army. The S and T Service took its proper place as part of AFHQ when the S and T personnel of AFHQ and Hq 1st Army combined on 1 January 1943.<sup>69</sup>

b. Director of Supply and Transport (DST). Brigadier E. S. White (B) was appointed the Director of Supply and Transport on 14 August 1942.<sup>70</sup> He was succeeded on 5 March 1943 by Brigadier H. M. Hinde (B) who continued in this assignment throughout the remainder of 1943.<sup>71</sup>

c. Functions. The DST was responsible for the distribution of Royal Army Service Corps (RASC) personnel in the Theater and for the supply of food, forage, petrol, fuel, lubricants for mechanical vehicles, light, disinfectants, medical comforts, and for the supply and

---

68. WO Auth MS 1/1/347, 27 Aug 42.

69. Statement by Maj Nockolds, S and T AFHQ, 10 Mar 45.

70. WO Auth MS 1/1/347, 27 Aug 42.

71. D/MS Records of Officers (H. M. Hinde), Auth AFHQ 3686, 1 Mar 43.

maintenance of all vehicles driven by RASC personnel.

An elaboration of these responsibilities was:

(1) Advice to the staff branches or sections on the employment and distribution of RASC transport units, including pack transport and motor boat companies.

(2) Statistics concerning RASC transport in the Theater.

(3) Inspection, maintenance, and repair of RASC vehicles.

(4) Policies for the hiring of, and contracts for the use of, civilian transport.

(5) Maintenance of records for RASC officers and their postings and transfers in conjunction with the Deputy Military Secretary AFHQ.

(6) Liaison with staff branches and sections on matters concerning RASC units, personnel, strengths, and reinforcements.

(7) Advice to staff branches and sections on food and other supplies and estimates of the quantities required for future operations.

(8) Allocation of supplies to areas and sub-areas.

(9) Compilation of ration scales.

(10) Supervision of depots and the accounting for supplies therein.

---

72. Crane Report, Chart No 48, 28 Sep 43. FSR, vol I, 13 Dec 39, sect 76.

(11) Local procurement and purchase of items normally supplied by the Service.

(12) Allocation of British petrol units in the Theater.

(13) Supervision of bulk storage installations and petrol tin factories.

(14) Supply and maintenance of technical equipment for petrol and oil units.

(15) Technical inspections of petrol, oil, and lubricants.

(16) Supply of RAF requirements of petrol, oil, and lubricants to within 25 miles of airfields.

(17) Allocation of civilian requirements in conjunction with the American base sections.

(18) Contracts for the supply of petrol, oil, and lubricants.

(19) Movement of petrol, oil, and lubricants within the Theater to ensure distribution of reserves and the balancing of stocks.

The S and T Service was relieved of certain responsibilities for the provision of petrol and coal when the separate Petroleum Section and the Coal Subsection of QM Section AFHQ were established on 2 February and 3 June 1943 respectively.<sup>73</sup>

---

73. AFHQ GO No 14, 2 Feb 43. AFHQ Adm Memo No 40 (revised), 3 June 43 (AG AFHQ file: 463.3-1).

The Chief Catering Advisor was transferred from Hq 1st Army to AFHQ on 1 January 1943 and reported directly to Q (Maint). He and his representatives throughout the Theater were brought under the command of the DST on 12 March 1943.<sup>74</sup> These advisors were technical experts on catering, cooking, and dietary problems and were responsible for advice and reports on all matters connected therewith.<sup>75</sup>

A British Ration Scale Committee was established on 8 July 1943 as a central authority for the purpose of keeping ration scales under review and introducing new scales or altering existing scales as required.<sup>76</sup> The Committee met with a frequency and at a time and place decided by the DST in consultation with the Director of Medical Services (B). In addition the DST supplies an officer as the secretary and any other assistance required for the maintenance of records and files for the Committee.<sup>77</sup>

d. Organization. A chart of the organization of the S and T Service at AFHQ as it was in November 1943<sup>78</sup> is shown on the next page.

e. Personnel. A comparison of the personnel authorized for the S and T Service at AFHQ on 12 October

---

74. AFHQ GRO No 95, 12 Mar 43.

75. Ibid.

76. AFHQ BQI's Annex 16, 8 July 43.

77. Ibid.

78. See footnote 69 above.

ORGANIZATIONAL CHART OF SUPPLY AND TRANSPORT SERVICE (BRITISH) AFHQ  
November 1943

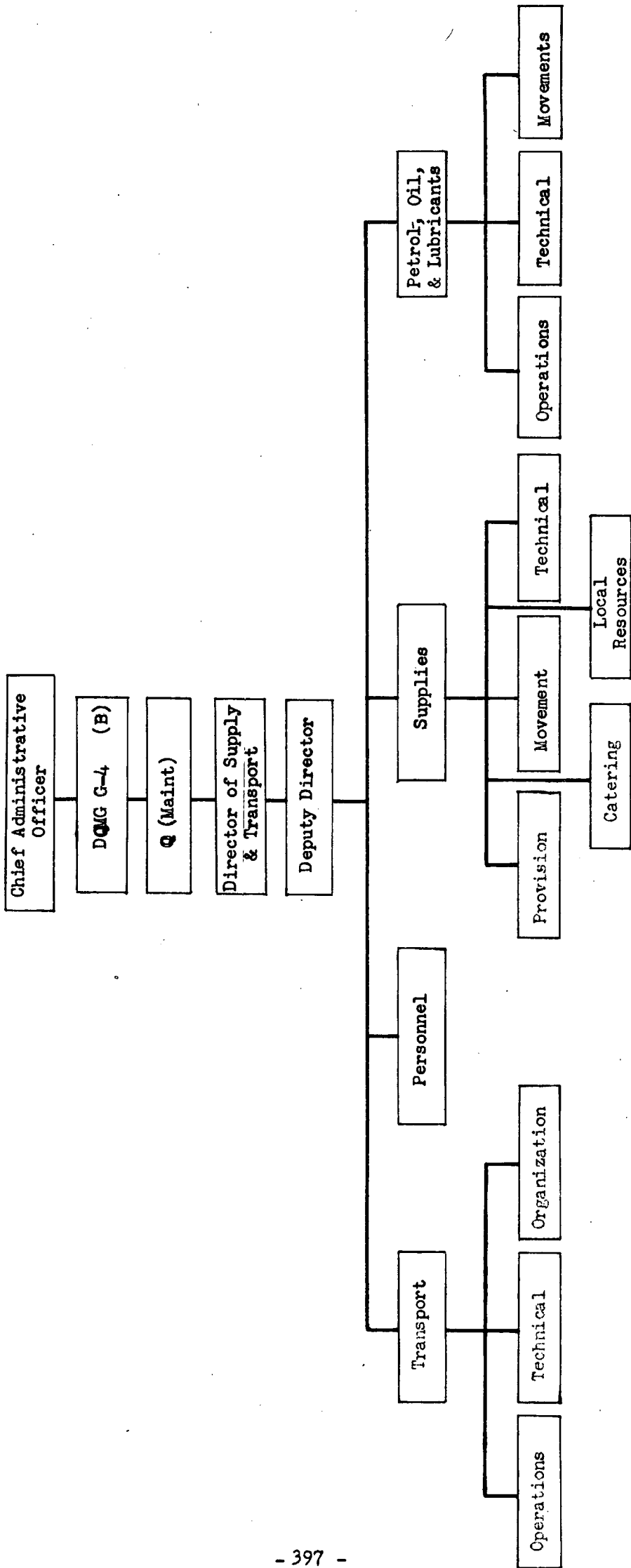

1942 and 1 December 1943 is shown in the table below:

<u>OFFICERS</u>			<u>WARRANT OFFICERS</u>			<u>OTHER RANKS</u>		
Rank	Oct* 42	Dec# 43	Rank	Oct* 42	Dec# 43	Rank	Oct* 42	Dec# 43
Brig	1	1	WO I	1	1	S/Sgt	1	3
Col	1	4	WO II	3	3	Sgt	6	8
Lt Col	3	4				Cpl	8	14
Maj	9	13				L/Cpl	4	14
Capt	10	17				Pte	28	43
Lt		6						
Totals:	24	45		4	4		47	82

Total British in 1942: 75  
Total British in 1943: 131

#### 9. The Petroleum Section AFHQ--NATOUA

a. Activation. Among the early sections to be established as part of AFHQ during 1943 was the Petroleum Section which was activated on 2 February.<sup>79</sup>

b. Chief of Petroleum Section. Colonel Gustave H. Vogel (A) acted as the Chief of the Section at its inception and throughout the remainder of 1943.<sup>80</sup>

c. Functions. The general functions of the Petroleum Section were outlined in the activation order of the Section on 2 February 1943. These were "to control and co-ordinate all problems of petroleum products brought to, stored in, and distributed to Military,

\* WO WE VIII/374/1, wef 12 Oct 42.

# AFHQ WE XII/1/4, wef 1 Dec 43 (AG AFHQ file: 321-1 AFHQ).

79. AFHQ GO No 14, 2 Feb 43.

80. Statement of Col Vogel on 7 Feb 45. No order was published concerning Col Vogel's appointment as Chief of Section.



81  
Naval, Air Force, and Civil Agencies."

However, by November of the same year, it was de-  
82  
termined specifically that the Petroleum Section would:

(1) Advise the Chief Administrative Officer on all petroleum matters.

(2) Be the sole agency for the co-ordination of communications ex-Theater concerning slated petroleum products, except for movement of tankers.

(3) Supply petroleum products to ocean terminals as required by users based thereon and control through local representatives of the Commanding General NATOUSA and of the Director of Supply and Transport, this headquarters, all stocks in ocean terminals, except naval fuel oil, in excess of local requirements.

(4) Direct the movement of petroleum products and containers.

(5) Allocate bulk storage facilities to product or user.

(6) Recommend petroleum engineering projects in co-ordination with the Chief Engineer, this headquarters (AFHQ).

(7) Recommend the allocation of rail tank cars.

(8) Maintain a technical service to act as consultant on all technical petroleum matters.

(9) Co-ordinate the activities of base and mobile laboratories.

(10) Request the movement of tankers (under control of C-in-C Med).

(11) Maintain local control groups where necessary to decentralize functions of Petroleum Section.

(12) Direct the importation of petroleum products and containers therefor.

---

81. See footnote 79 above.

82. AFHQ Adm Memo No 20, 12 Feb 43 (Revised to 4 Nov 43).

(13) Direct the preparation of such reports as are required in the performance of its functions.

(14) Plan distribution of petroleum products for future operations in conjunction with AFHQ planning staffs.

d. Organization. The organization of the Petroleum Section for November 1943 is shown in a chart on <sup>83</sup> the next page.

e. Personnel. In the table below are comparative figures of both American and British personnel authorized for the Petroleum Section and in effect on 1 December 1943.

<u>OFFICERS</u>			<u>WARRANT OFFICERS</u>			<u>ENLISTED MEN</u>		
<u>Rank</u>	<u>Am*</u>	<u>Br#</u>	<u>Rank</u>	<u>Am*</u>	<u>Br#</u>	<u>Rank</u>	<u>Am*</u>	<u>Br#</u>
Col	2		CWO	1		M/Sgt	1	
Lt Col	3	1	WOJG		1	T/Sgt	3	
Maj	5	3				S/Sgt	3	
Capt	3	1				Tec 3	1	
1st Lt	2					Sgt		2
						Tec 4	4	
						Cpl		1
						Tec 5	5	
						Pfc	3	1
						Pvt	2	3
<b>Totals: 15</b>			<b>5</b>			<b>22</b>		
			<b>1</b>			<b>7</b>		

Total Americans: 38  
Total British : 13

COMBINED TOTAL : 51

83. Statements of Col Vogel on 7 Feb 45; AFHQ Adm Memo No 20, 12 Feb 43 (Revised to 4 Nov 43); Crane Report, Chart No 41, 28 Sep 43. It is to be noted that for communication purposes on petroleum matters direct contact was made by the Petroleum Section AFHQ with C-in-C Med, MAC, civilian agencies in NORTH AFRICA, as well as with governmental and military petroleum agencies in ENGLAND and the UNITED STATES.

\* AG NATOUSA Ltr to Chief, Petroleum Sect, 25 Oct 43 (AG NATOUSA file: 200.3/160A-0).

# AFHQ WE XII/1/4, wef 1 Dec 43 (AG AFHQ file: 321.1).

ORGANIZATION CHART OF THE PETROLEUM SECTION AFHQ  
November 1943

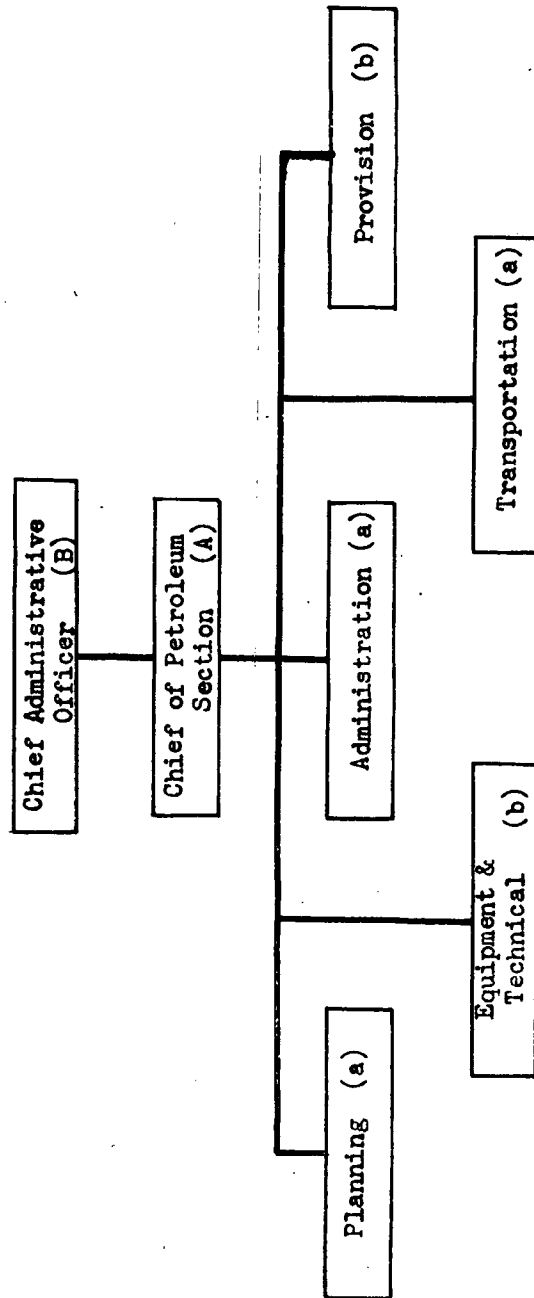

LEGEND:

(A), (B) Indicate a wholly American or British unit.

(a), (b) Indicate an integrated unit with an American or British officer at the head.

10. Salvage Service (British) AFHQ

a. Activation. The Salvage Service was activated at AFHQ with the appointment of an Assistant Director of Salvage on 26 October 1942.<sup>84</sup> It was not, however, until early in January 1943 that a conference was held to determine the layout of the organization and the disposition of the available salvage personnel in the Theater.<sup>85</sup>

b. Deputy Director of Salvage (DD Salvage). Lieutenant Colonel H. F. Montague (B) was appointed the Assistant Director of Salvage on 26 October 1942.<sup>86</sup> He continued to serve as the head of the Service throughout 1943 and was promoted to the rank of colonel on 13 July 1943 when the position was upgraded to Deputy Director.<sup>87</sup>

c. Functions. The Salvage Service was responsible for all salvaged materials evacuated from the areas occupied by British troops and had the following duties:<sup>88</sup>

- (1) Advising and assisting formations on salvage matters.
- (2) Organizing and co-ordinating all British salvage operations.
- (3) Establishing salvage transit centers and depots.
- (4) Sorting, grading, and packing

---

84. WO Auth MS 1/1/730, 30 Oct 42.  
85. Notes on Salvage, L of C Area--NORTH AFRICA 1943, Dec 43.  
86. WO Auth MS 1/1/730, 30 Oct 42.  
87. WO Auth 5430/16/MS, 30 July 43.  
88. AFHQ BQI's, Annex 35, 12 Feb 43.

materials in salvage depots.

(5) Ensuring that salvage was evacuated to base salvage depots and salvage shipping depots.

(6) Shipping salvage, not required in the Theater, to the UNITED KINGDOM.

(7) Selling locally any salvaged materials which were not considered suitable for shipment to the UNITED KINGDOM.

(8) Reissuing salvaged materials to the services in accordance with the instructions which were issued from time to time.

(9) Maintaining close liaison with the RAF on all salvage matters and accepting scrap material from them.

(10) Issuing to field units items which were not required by any of the services.

(11) Maintaining liaison with the American salvage organizations and transferring to them any salvaged American materials.

No arrangements had been made, in the early part of 1943, for the disposal of American military scrap, and the Assistant Director of Salvage was asked to establish a program for the disposition of both American and British military scrap. Arrangements whereby all American salvage and scrap were processed through American salvage organizations were completed in April

---

89. Memo, DTC to AD Salvage, 16 Mar 43 (Salvage (B) AFHQ file: 5/SAL).

90  
1943.

d. Organization. Staff and policy matters in connection with British salvage were originally handled by Q.(Maint). These duties were transferred to Q (AE) when it was formed on 15 July 1943.<sup>91</sup> A chart of the organization of the Salvage Service at AFHQ in November 1943<sup>92</sup> is shown on the next page.

e. Personnel. A comparison of the personnel authorized for the Salvage Service at AFHQ in October 1942 and December 1943 is shown in the table below:

<u>OFFICERS</u>			<u>OTHER RANKS</u>		
<u>Rank</u>	<u>Oct*</u> <u>42</u>	<u>Dec#</u> <u>43</u>	<u>Rank</u>	<u>Oct*</u> <u>42</u>	<u>Dec#</u> <u>43</u>
Col		1	Sgt		1
Lt Col	1		Cpl	1	
Maj		1	Pte	2	2
Capt	1	1			
Lt		1			
Totals:	2	4		3	3

Total British in 1942: 5  
Total British in 1943: 7

11. Printing and Stationery Services (British) AFHQ

a. Activation. The Printing and Stationery Services (PSS) were constituted at AFHQ on 4 February 1943

---

90. Memo, AD Salvage to Q (Maint) AFHQ, 24 Apr 43 (Salvage (B) AFHQ file: 15/SAL).

91. AFHQ Staff Memo No 67, 19 July 43.

92. Statement by Maj Elliot, Salvage (B) AFHQ, 13 Mar 45.

\* WE VIII/374/1, wef 12 Oct 42.  
# WE XII/1/4, wef 1 Dec 43 (AG AFHQ file: 321-1 (AFHQ)).

ORGANIZATIONAL CHART OF SALVAGE SERVICE (BRITISH) AFHQ  
November 1943

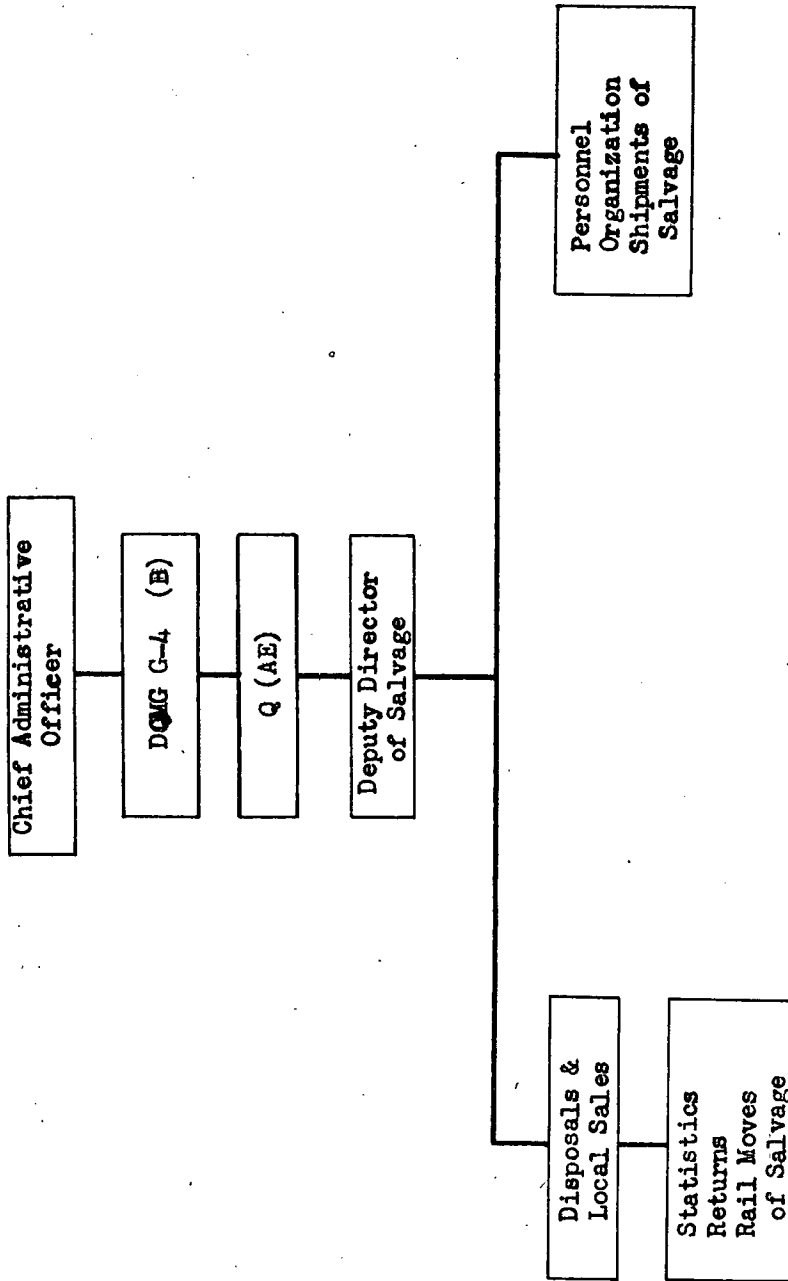

when the war establishment for a Printing and Stationery Directorate was approved by the AFHQ War Establishment Committee.<sup>93</sup>

b. Deputy Assistant Director of Printing and Stationery Services (DADPSS). Major C. A. Tacey (B) was appointed Deputy Assistant Director and head of the Services on 22 February 1943.<sup>94</sup> He continued in this position until the appointment as head of these Services was upgraded and Lieutenant Colonel H. J. Blewett (B) was designated as Assistant Director (ADPSS) on 28 November 1943.<sup>95</sup>

c. Functions. The DADPSS was responsible for planning and controlling all British printing and stationery units in the Theater. The more specific duties of the DADPSS and his staff at AFHQ in relation to the British forces were:<sup>96</sup>

- (1) Advisor to the CAO on all technical matters relating to printing and stationery.
- (2) Provision and supply of army forms, books, stationery, and rubber stamps.
- (3) Provision and supply of printing materials and machinery.
- (4) Supervision of all printed matter.
- (5) Supervision and distribution of installations for the supply of publications and stationery.

---

93. Min of AFHQ WE Com, Mtg No 3, 4 Feb 43.

94. AFHQ Auth G1/E/1002/7/A1, 3 Mar 43.

95. WO Auth 2740/MS, 18 Nov 43.

96. AFHQ BQI's, Annex 22, 28 Feb 43. FSR, vol I, 13 Dec 39, sect 74.



(6) Provision, supply, and maintenance of typewriters and duplicating machines.

(7) Local purchase and requisition of printing materials, stationery, and office machinery.

(8) Production and dispatch of general and army routine orders in accordance with instructions from DAG, G-1 (B).

(9) Revision of army forms in use and introduction of new forms as required in consultation with the sections and services concerned.

d. Organization. A chart of the organization of PSS at AFHQ as it was in November 1943 is shown on the next page.  
97

e. Personnel. The personnel authorized for the PSS at AFHQ on 1 December 1943 are shown in the table below:

<u>OFFICERS</u>		<u>OTHER RANKS</u>	
<u>Rank</u>	<u>Dec* 43</u>	<u>Rank</u>	<u>Dec* 43</u>
Lt Col	1	S/Sgt	1
Maj	1	Sgt	1
Capt	1	Cpl	1
Lt	2	Pte	6
Totals:	5		9

Total British in 1943: 14

---

97. Chart of Organization, no date (PSS AFHQ file: Org). Statement by Lt Harris PSS, 15 Dec 44.

\* AFHQ WE XII/1/4, wef 1 Dec 43 (AG AFHQ file: 321-1 AFHQ).

ORGANIZATION CHART OF THE PRINTING AND STATIONERY SERVICE (BRITISH) AFHQ  
November 1943

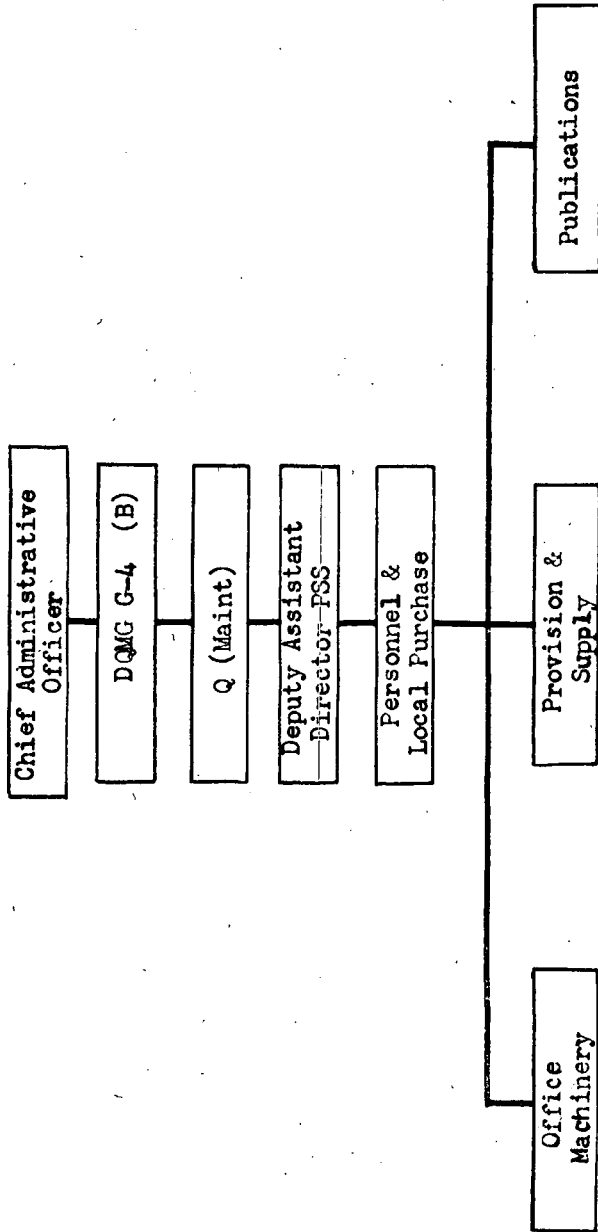

12. North African Economic Board (NAEB) AFHQ

a. The Joint Chairmen. Mr. Robert D. Murphy (A), Chief Civil Administrator AFHQ, served as Civil Chairman of NAEB until 19 May 1943. On that date he was replaced by Mr. Alexander B. Royce (A), Director of Economic Operations. Major General Sir H. M. Gale (B), CAO AFHQ, remained Military Chairman throughout 1943.<sup>98</sup>

b. Changes in Functions. The functions outlined in 1942 continued with no major changes in 1943. However, there was an elaboration in the Board's general duty of "initiating, formulating, and establishing policies, plans and programs" with respect to the following civilian economic matters in NORTH AFRICA:<sup>99</sup>

- (1) The purchase of commodities and their exportation or distribution.
- (2) The development of local resources.
- (3) The controls employed in regard to enemy trade, monetary, fiscal, and exchange matters.
- (4) The importation and distribution of goods for civilian use.
- (5) The controls over undesirable commercial and financial transactions.
- (6) Public health and relief matters, including the importation and distribution of goods for medicinal and relief purposes.

---

98. AFHQ Adm Memo No 37, 19 May 43. Wef 9 Aug 43, General Gale held the rank of lieutenant general.

99. AFHQ Ltr to All Concerned, 20 Jan 43 (AG AFHQ file: 336.1/051 A-M).

(7) The importation and distribution of coal, including the development of local coal production and briquette manufacture.

The coal supply question for the Theater was also, in part, the responsibility of the QM AFHQ during 1943. To clarify this relationship, the following arrangements<sup>100</sup> were made by the middle of the year:

(1) NAEB was to co-ordinate with the QM AFHQ and the French Chef des Mines all coal allocations, except for the coal utilized by the Royal Navy (RN) and the Ministry of War Transport (MWT) which had their own arrangements.

(2) NAEB was to receive requisitions for British coal and forward these to the British Ministry of Fuel and Power, LONDON, with a copy to G-4 (Mov and Tn). Other requisitions for coal were forwarded by the QM AFHQ.

All cables and correspondence relating to financial and economic matters associated with civil affairs were handled directly by NAEB during 1943, while the matters of purely political import continued to be functions of the Civil Affairs Section.<sup>101</sup>

c. Organization and Personnel. The organization of NAEB became more fully elaborated during 1943. The following five subsections, or "divisions", were added

---

100. AFHQ Adm Memo No 40 (revised), 3 June 43.  
101. Ibid.

to the Civil Department after 20 January 1943:

The Procurement and Development Division

The Import Division

The Financial and Control Division

The Public Welfare and Relief Division

The Coal Division

Also to direct the activities of this expanded Department, an Executive Committee, an Executive Officer, and an Associate Executive Officer were added to the staff at this same time. Regional offices of the Civil Department were established at ORAN, CASABLANCA, and DAKAR on 9 February,<sup>103</sup> while a fourth was opened at TUNIS<sup>104</sup> about 1 June 1943.

The former office of the "Executive Vice-Chairman" was expanded during January to include one military and one civilian representative who served together until 2 April as the "Joint Executive Vice-Chairmen."<sup>105</sup> However, on this latter date the office reverted to its original designation, "Executive Vice-Chairman", since<sup>106</sup> only the civilian appointee remained.

Among other organizational changes during 1943 were those pertaining to the Military Department of NAEB. The General Purchasing Board, established on 30 January, immediately assumed the responsibility for supervising Allied purchasing agencies in NORTH AFRICA which there-

102. See footnote 99 above.

103. AFHQ Ltr to All Concerned, 9 Feb 43 (AG AFHQ file: 336.1/051 A-M).

104. Statement of Mr. T. S. Estes, US POLAD, 9 Mar 45.

105. AFHQ Adm Memo No 2, 6 Jan 43.

106. AFHQ Adm Memo No 31, 2 Apr 43.

tofore, in a very general manner, had been associated  
with NAEB.<sup>107</sup> Within another two weeks, on 12 February,  
the Military Oil Subcommittee (MOSC) was "constituted"  
under G-4 and thereafter became administratively disas-  
sociated from the Military Department of NAEB.<sup>108</sup>

An organization chart for NAEB for the latter part  
of September 1943 appears on the next page.<sup>109</sup> It has  
been prepared in such a manner as to reveal the promi-  
nent position of the civilians who considerably outnum-  
bered the military personnel in actual strength.<sup>110</sup>

The military representatives were carried for ac-  
counting purposes on personnel allotments of other agen-  
cies than NAEB, which had no authorized allowance of its  
own. During November 1943, British personnel were car-  
ried on the war establishment of the General Purchasing  
Board,<sup>111</sup> while the American military component was fur-  
nished by the Civil Affairs Section.<sup>112</sup>

13. General Purchasing Board, North Africa, AFHQ

a. Activation. To guide the several separate agen-  
cies dealing with the local procurement of supplies and  
facilities for both American and British forces, General  
Purchasing Board, North Africa, was established on 30

---

107. AFHQ Adm Memo No 16, 30 Jan 43.

108. AFHQ Adm Memo No 20, 12 Feb 43.

109. The Crane Report, Chart No 37, 28 Sep 43.

110. The Crane Report, Chart No 37, 28 Sep 43.

Here the total actual civilian strength is 214 as com-  
pared to the military of 66 for both nationalities.

111. Statement of Lt Col J. H. Ford (B) of AFLRS  
AFHQ on 7 Mar 45.

112. AG NATOUSA Ltr to Chief Civil Affairs Sect  
and CO Hq Comd AF, 26 July 43 (AG NATOUSA file: 200.3/  
142).

ORGANIZATIONAL CHART OF THE NORTH AFRICAN ECONOMIC BOARD AFHQ  
September 1943

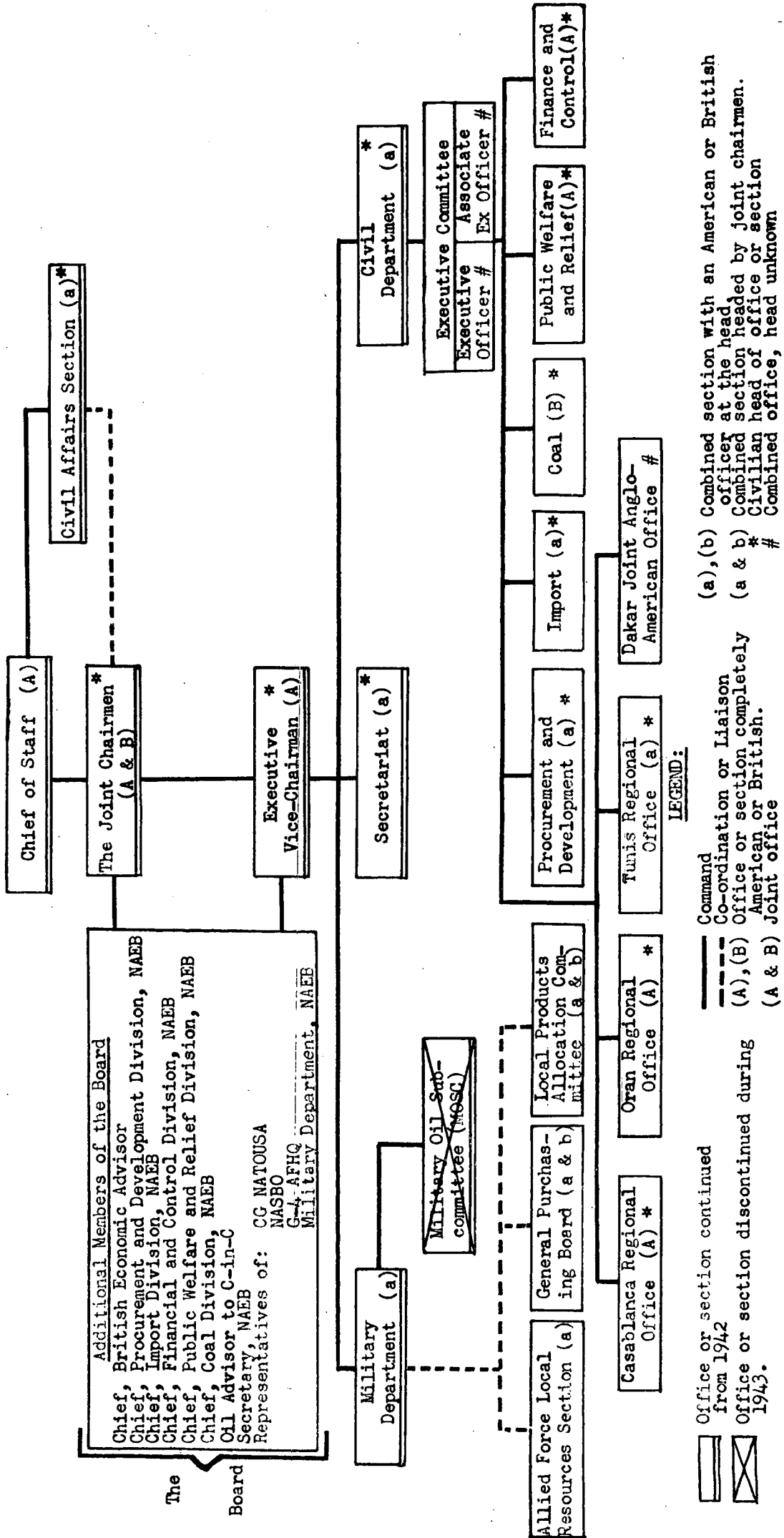

[Symbol: Box with horizontal lines] Office or section continued from 1942  
 [Symbol: Box with diagonal lines] Office or section discontinued during 1943.  
 [Symbol: Solid box] Command  
 [Symbol: Dashed line] Co-ordination or Liaison  
 [Symbol: Box with (A), (B)] Office or section completely American or British.  
 [Symbol: Box with (A & B)] Joint office  
 [Symbol: Box with #] Combined office, head unknown  
 [Symbol: Box with (a), (b)] Combined section with an American or British officer at the head.  
 [Symbol: Box with (a & b)] Combined section headed by joint chairmen.  
 [Symbol: Box with #] Civilian head of office or section

LEGEND:

113  
January 1943.

b. The Joint Chairmen. Colonel John Morrow, Jr. (A) and Colonel B. M. Clarke (B) were appointed as Joint Chairmen of the Board on 30 January 1943<sup>114</sup> and continued to direct its activities throughout the year. After 27 April 1943 Colonel Morrow was also Chief Purchasing Agent NATOUSA in addition to his other duties.<sup>115</sup>

c. Functions. The Board was generally responsible for the co-ordination of, and "supervision over, purchases and procurement made by or for United States and British Forces." It was also to operate in close co-operation with the Commanding General of SOS NATOUSA, American base section commanders, and appropriate British agencies concerning:<sup>116</sup>

(1) Development of supply sources and facilities.

(2) Estimation of potential production of indigenous commodities.

(3) Assistance to North African manufacturers in increasing production of products vital to the armed forces and the local manufacture of which will result in saving of military shipping space.

(4) Maintaining records of all sources investigated, purchases made, and replacement transactions concluded.

(5) Maintaining records of production and export of articles useful to the armed forces.

(6) Assisting and advising in definition and application of general purchasing

---

113. AFHQ Adm Memo No 16, 30 Jan 43.

114. Ibid. See also AFHQ Adm Memo No 30, 30 Mar 43.

115. NATCUSA SO No 81, 27 Apr 43.

116. AFHQ Adm Memo No 30, 30 Mar 43.



policies and directives issued by this headquarters (AFHQ).

(7) Taking full advantage of available resources and facilities without depriving the local inhabitants of reasonable supplies of food and utilities.

(8) Purchasing and procuring of controlled and rationed items through the appropriate French control.

(9) Planning ahead for local purchasing in accordance with requirements of Commanding General SOS and ADQMG (Maint).

(10) Insuring that replacements agreed upon are actually made.

The Board was also empowered to call upon the Commanding General SOS NATOUSA or the ADQMG (Maint) for any reports necessary to carrying out the functions listed

117  
above.

d. Organization. The Board was responsible to the CAO AFHQ and, in addition to its delegates, consisted of two subsections: one concerned with research and development, the second with administrative matters. The organization for the latter part of September 1943 is  
118  
shown by the chart on the next page.

e. Personnel. Until 9 December 1943 the personnel of the Board were both American and British. However, having assigned the British component to AFLRS, only American representatives remained with the Board after  
119  
that date. The authorized allowances for the person-

---

117. Ibid.

118. Crane Report, Chart No 24, 28 Sep 43.

119. Statement of Lt Col J. H. Ford (B) of AFLRS AFHQ on 25 Feb 45.

ORGANIZATION CHART OF THE GENERAL PURCHASING BOARD AFHQ  
September 1943

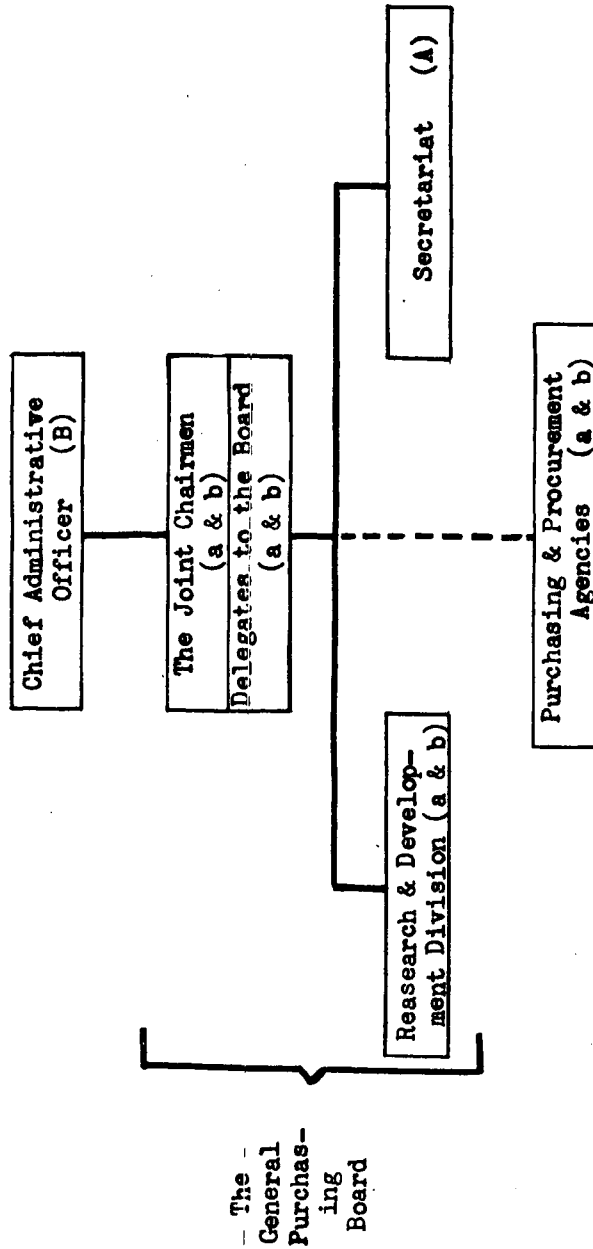

**LEGEND:**  
 \_\_\_\_\_ Command  
 - - - - Policy and supervision  
 (A), (B) Members are all American or British  
 (a & b) Combined membership and direction

nel of this Board during November 1943 were:

<u>OFFICERS</u>			<u>ENLISTED MEN</u>		
<u>Rank</u>	<u>Am*</u>	<u>Br#</u>	<u>Rank</u>	<u>Am*</u>	<u>Br#</u>
Col	1	1	M/Sgt	1	
Maj	1	1	T/Sgt	1	
Capt	1		Sgt		1
			Cpl	1	5
			Pfc	1	3
			Pvt	1	4
<hr/>			<hr/>		
Totals:	3	2		5	13

Total Americans: 8

Total British : 15

COMBINED TOTAL : 23

#### 14. Local Products Allocation Committee AFHQ

a. Activation. In order to allocate properly certain critical products of local manufacture in NORTH AFRICA, a combined agency, known as the Local Products Allocation Committee, was established on 3 July 1943.<sup>120</sup>

b. Chairmen of the Committee. The Joint Chairmen of the General Purchasing Board, Colonel John Morrow, Jr. (A) and Colonel B. M. Clarke (B), acted alternately as the Chairman of the Committee at each of its meetings.<sup>121</sup>

c. Functions. The combined Committee had the general function of allocating to the American and British forces specific items of short supply manufactured in

---

\* AF NATOUSA Ltr to Joint Chairmen of Gen Purch Bd and CO Hq Comd AF, c. 25 July 43 (NATOUSA AG file: 200.3-157).

# WE NA/33/2 for General Purchasing Board, North Africa, wef 30 May 43.

120. AFHQ Adm Memo No 47, 3 July 43.

121. Ibid. See also AFHQ Adm Memo No 30, 30 Mar 43.

NORTH AFRICA. The first list of controlled products was then modified when necessary by G-4 AFHQ.<sup>122</sup> After 3 July 1943 the allocation of the following products was controlled by the Committee: cement, lime, brick, lumber, paint, oxygen, acetylene, and hydrogen.<sup>123</sup> By the end of October 1943 this initial list was extended to include "those subsistence items locally produced which are in excess of stocks required by the French Army and civilian population in NORTH AFRICA and which are desired by the Allied forces."<sup>124</sup>

Relative to the products discussed above, the following functions were performed by the Committee until its responsibilities were transferred to the Allied Forces Local Resources Section (AFLRS) in early December 1943. These were:<sup>125</sup>

(1) Determine military requirements and quantity of products available from local sources.

(2) Take action that may be necessary to secure materials and parts essential to local industry to assure proper production of these products.

(3) Supervise the acquisition, by purchase or otherwise, of such products.

(4) Allocate such products in accordance with priority of operational needs. (This allocation was final if the vote of the Committee was unanimous, otherwise the case in question would be referred to G-4 for decision.)

(5) ...co-ordinate Allied requirements with French requirements through appropriate channels.

---

122. See footnote 120 above.

123. Ibid.

124. AFHQ Adm Memo No 73, 29 Oct 43.

125. Ibid.

d. Organization and Composition. From July, when it was formed, until December 1943 the Committee was responsible to G-4 AFHQ. However, after AFLRS had been established by the latter date, the Committee lost its individual identity, and AFLRS assumed its responsibilities.<sup>126</sup> During the period between July and October 1943, the Committee was composed of members from the following organizations:<sup>127</sup>

G-4 AFHQ

Chief Engineer IAFHQ

Chief Engineer NATOUSA

Director of Works (B) AFHQ

Chief Engineer ISOS NATOUSA

General Purchasing Board

General Purchasing Agent SOS NATOUSA

Added to this list, from October to December, were representatives from each of the following:<sup>128</sup>

Quartermaster AFHQ

Director of Supply and Transport AFHQ

Quartermaster SOS NATOUSA

Besides the official Allied representatives listed above, it was also stated in July 1943 that both the military and civilian "representatives" from the French "Commandant en Chef" would be requested to "sit as members" of the Committee. This was primarily to aid in clarifying procedure and in obtaining releases of materials involved.<sup>129</sup>

---

126. Statement of Lt Col J. H. Ford of AFLRS on 27 Feb 45.

127. Ibid. See also footnotes 120 and 124 above.

128. See footnote 124 above.

129. See footnote 120 above.

15. Allied Force Local Resources Section (AFLRS)

AFHQ--NATOUSA

a. Activation. The Allied Force Local Resources Section (AFLRS) was established as a combined staff section of AFHQ on 11 November 1943<sup>130</sup> and was represented, at first, by the members of the General Purchasing Board and the Military Department of the North African Economic Board (NAEB).<sup>131</sup> However, within a month, AFLRS had received authorized personnel allotments of its own and was able to operate as a distinct unit.<sup>132</sup>

b. Chairman of AFLRS. Although there was no order specifying a chairman of AFLRS upon the activation of that Section, the Joint Chairmen of the General Purchasing Board, Colonel B. M. Clarke (B) and Colonel John Morrow, Jr. (A), who also held assignments in the Military Department of the North African Economic Board, co-operated in directing AFLRS activities until Colonel Morrow was appointed Chairman of AFLRS on 13 January 1944.<sup>133</sup>

c. Functions. The purpose and functions of AFLRS were outlined in the same memorandum establishing the Section at AFHQ. It was determined that AFLRS would:<sup>134</sup>

(1) Be responsible for the organization, within various designated territories in this Theater of Operations, of local boards to co-

---

130. AFHQ Adm Memo No 77, 11 Nov 43.

131. AFHQ Bull No 55, 19 Nov 43. Statement of Lt Col J. H. Ford (B) on 19 Feb 45.

132. AG NATOUSA ltr to: CO Hq Comd AF, ACoFS G-4 AFHQ, and Chief of AFLRS AFHQ, 6 Dec 43 (AG AFHQ file: 321-AFLRS); WE NA/239/1 for AFLRS AFHQ, wef 9 Dec 43.

133. AFHQ Staff Memo No 6, 13 Jan 44.

134. See footnote 130 above.

ordinate the procurement and allocation of all forms of local resources and services, except such as are allocated to other agencies available to the armed forces.

(2) Assist the respective boards in the development of information concerning local supplies and facilities and aid the boards in the procurement of local supplies and facilities required for the armed forces.

(3) Obtain through the Allied Force Headquarters Middle East Administrative Information Section (AMAIS) information concerning the Middle East Supply Center resources which may be made available to this headquarters (AFHQ).

This memorandum went on to clarify other responsibilities and procedures connected with AFLRS:

The local boards will ascertain what is available to the armed forces and co-ordinate prices to be paid, in liaison with the Allied Control Commission, Allied Military Government, or other government authority responsible for controlling the economy of the territory in which the board is operating.

The Section (AFLRS) will recommend to G-4, this headquarters, the basic policies under which the local boards will operate. It will be responsible for the execution of these policies by the local boards. Any matters for decision by higher authority will be forwarded by the Chairman to this headquarters

The chairmen of local boards will be appointed by this headquarters (AFHQ).

d. Organization. The organization of AFLRS is shown in the chart on the next page. The dates for the establishment of the local boards are indicated in the appropriate boxes.

e. Personnel. The authorized personnel figures

---

135. Statements of Lt Col J. H. Ford (B) of AFLRS AFHQ on 19 Feb 45. See also Adm Memos Nos 78, 86, and 87 of 12 Nov, 7 and 8 Dec 43 respectively for the establishment of the local boards indicated.

ORGANIZATIONAL CHART OF THE ALLIED FORCES LOCAL RESOURCES SECTION AFHQ  
December 1943

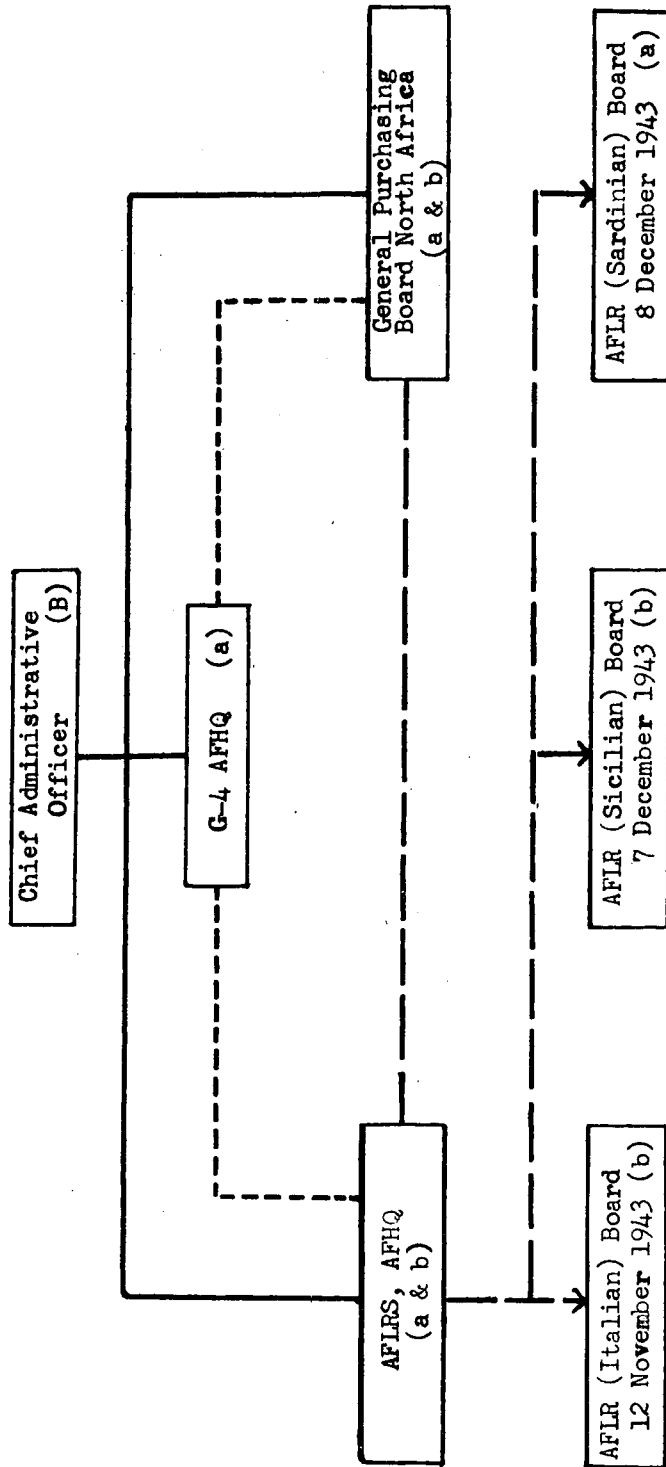

LEGEND:

- Command
- - - Supervision
- - - Co-ordination and/or policy execution
- (B) Indicates British unit
- (a), (b) Indicate integrated unit with an American or British at its head.



for December 1943 are shown in the table below.

<u>OFFICERS</u>			<u>WARRANT OFFICERS</u>			<u>ENLISTED MEN</u>		
<u>Rank</u>	<u>Am*</u>	<u>Br#</u>	<u>Rank</u>	<u>Am*</u>	<u>Br#</u>	<u>Rank</u>	<u>Am*</u>	<u>Br#</u>
Col	2	1	CWO		1	M/Sgt	1	
Lt Col	4	5				T/Sgt	1	
Maj	4	6				Sgt		2
Capt	5	7				Tec 4	3	
1st Lt	4					Cpl		6
						Tec 5	6	
						Pfc	5	3
						Pvt	5	34
<b>Totals: 19</b>			<b>1</b>			<b>21 45</b>		

Total Americans: 40

Total British : 65

COMBINED TOTAL : 105

16. AFHQ--Middle East Administrative Information Section

(British)

a. Activation. The AFHQ--Middle East Administrative Information Section (AM AIS) was activated with the appointment of the Chief of Section on 1 October 1943 and the war establishment for the Section was approved with effect from the same date.

b. Chief of Section. Brigadier C. F. Forestier-Walker (B) was designated the Chief of AM AIS on 1 October 1943 and continued in that position for the remainder of the year.

\* AG NATOUSA ltr to CO Hq Comd AF, ACofS G-4 AFHQ, and Chief of AFLRS AFHQ, 6 Dec 43 (AG AFHQ file: 321-AFLRS).

# WE NA/239/1 for AFLRS AFHQ, wef 9 Dec 43.

136. WO Auth 876/MS, 31 Oct 43.

137. Min of AFHQ WE Com Meeting No 44, 14 Oct 43.

138. WO Auth 876/MS, 31 Oct 43.

c. Functions. The British forces which operated in SICILY and ITALY during 1943 were composed of troops from NORTH AFRICA and the MIDDLE EAST which were maintained originally by AFHQ and GHQ MEF respectively. AMAIS was established to provide co-ordination between the two headquarters and to ensure that the best use of all sources of supply was made on the basis of the MEDITERRANEAN being a single entity for the purpose of  
139  
British supply and maintenance. The personnel of the Section were supplied by GHQ MEF and were allotted to staff branches and services at AFHQ to maintain detailed liaison between their own staff branches and services and the corresponding ones at AFHQ. The Chief of Section reported to G-4 (B), AFHQ and had the following duties:  
140

(1) To provide for heads of branches and services such information as cannot be provided by the personnel of the AMAIS attached to them.

(2) To co-ordinate the requirements of any service in respect of Middle East matters where these requirements have an effect upon another service.

d. Organization. The officers of AMAIS were attached to staff branches and services at AFHQ, and a chart showing their distribution in October 1943 is  
141  
shown on the next page.

---

139. Memo, Gen Gale to Gen Lewis, 14 Sep 43 (CAO AFHQ file: 1009/3). Memo, CAO to All Concerned, 5 Oct 43 (CAO AFHQ file: 1009/3).

140. Memo, CAO to All Concerned, 5 Oct 43 (CAO AFHQ file: 1009/3).

141. Ibid.

ORGANIZATIONAL CHART OF AFHQ-MIDDLE EAST ADMINISTRATIVE INFORMATION SECTION (BRITISH) AFHQ  
 October 1943

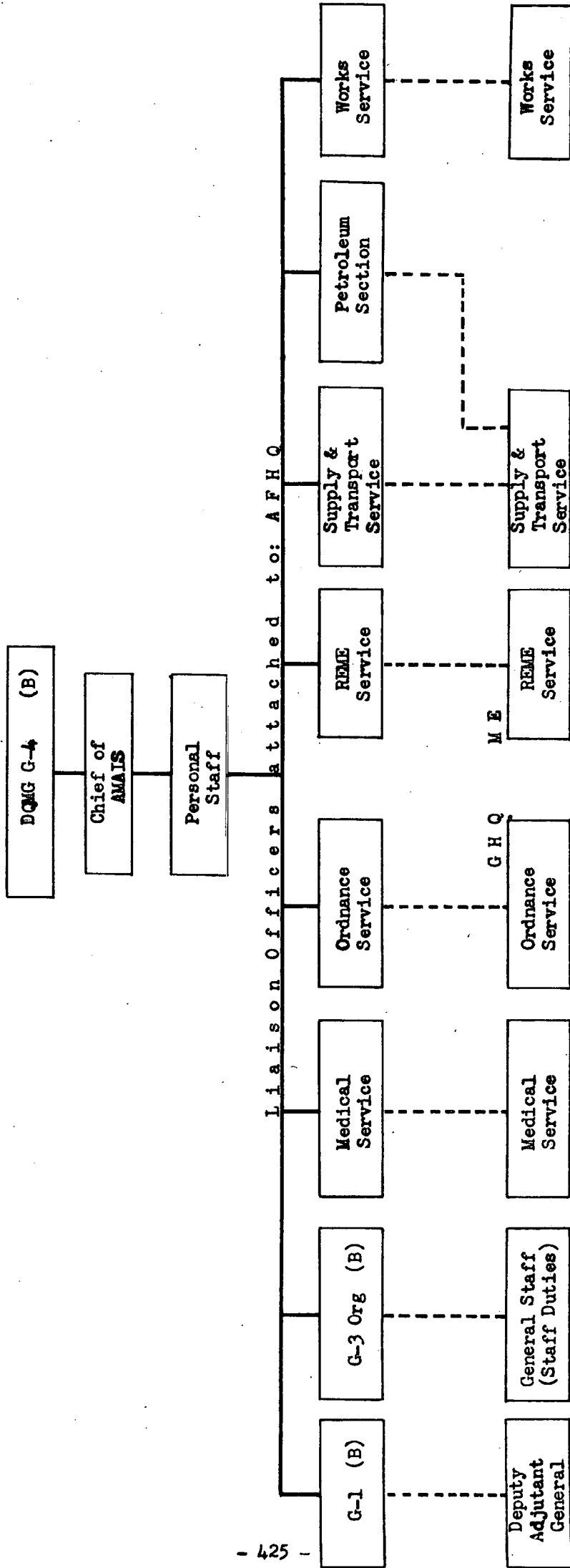

LEGEND:  
 \_\_\_\_\_ Command  
 - - - - - Liaison

e. Personnel. The personnel authorized for AMAIS on 1 December 1943 are shown in the table below:

<u>OFFICERS</u>		<u>OTHER RANKS</u>	
<u>Rank</u>	<u>Dec*</u> <u>43</u>	<u>Rank</u>	<u>Dec*</u> <u>43</u>
Brig	1	Sgt	1
Lt Col	8	Cpl	1
Maj	1	Pte	2
<u>Totals:</u>	<u>10</u>		<u>4</u>

Total British: 14

---

\* WE XII/1/4, wef 1 Dec 43 (AG AFHQ file: 321-1 AFHQ).

## Chapter XII

### TRANSPORTATION STAFF ORGANIZATIONS

One of the principal differences between American and British transportation staff organizations is that the British Q (Movements) Branch is considered a general staff section, while the American Transportation Section is considered a special staff section. The compromise arrangement provided for a second G-4 section, called G-4 (Mov and Tn), which consisted of two separate and parallel staff sections of British Q (Movements) and US Transportation Section. In this chapter the account of G-4 (Mov and Tn) includes that of Q (Movements). The US Transportation Section, which was transferred to Hq NATOUSA, is given a separate treatment. Likewise the Military Railways Service, which was given a distinct staff and operational organization, also is treated separately. Two boards, North African Shipping Board and Air Priorities Board, complete the AFHQ transportation picture.

Over them all for co-ordination was the Chief Administrative Officer whose office has already been discussed in Chapter XI above.

#### 1. G-4 (Movements and Transportation) Section AFHQ

a. Chief of Section. Brigadier A. T. de Rhe Philipe (B), the British Deputy Quartermaster General (Movements), DQMG (M), continued to be the Chief of G-4 (Mov and Tn) Section throughout 1943. The Chief of

Transportation (US) was the senior officer in the American component of the Section, which later became Transportation Section NATOUSA.<sup>1</sup>

b. Changes in Functions. G-4 (Mov and Tn) Section continued to have the functions dealing with the planning, policy formulation, and supervision of transport facilities described in Part I above.<sup>2</sup> A new function was added on 29 April 1943 when the Section was made responsible for screening the demands from the ground forces for air transportation.<sup>3</sup> The duties in connection with this were:<sup>4</sup>

(1) Receiving all ground force demands for air transportation of personnel and cargo.

(2) Obtaining the necessary information from the appropriate staff sections in support of demands and of their relative degrees of urgency.

(3) Passing approved demands to the Air Priorities Board and obtaining completed action thereon.

The appointment of Brigadier General Carl R. Gray, Jr. (A) as Director General of Military Railways on 14 February 1943 relieved the Chief of Transportation (US) of the responsibilities for the technical development and operation of all railways and the discipline and

---

1. NATOUSA GO No 28, 8 May 1943. For Chief of Transportation US-NATOUSA see AFHQ History, II, 432-435.

2. AFHQ History, I, 55.

3. Ltr, Eisenhower to All Concerned, 29 Apr 43 (SGS AFHQ file: 500-3).

4. Ibid.

training of American military railway personnel.

G-4 (Mov and Tn) Section was faced with the problem that demands for transportation always exceeded the capacity of the facilities available in the Theater. The system of weekly Priorities of Movement Meetings (POM) was therefore used to establish priorities and allocations of personnel and supplies to be moved by special staff sections and services.<sup>6</sup> Separate POMs, at which the chair was taken by a senior officer of G-4 (Mov and Tn), were held for rail and sea traffic. Additional factors which added to the work of the Section during 1943 were as follows:

(1) The strain placed on transportation facilities by the rapid advance through TUNISIA and SICILY.

(2) The transport required for the disposal of the large number of prisoners of war after the Tunisian campaign.

(3) The preparations required for the invasions of SICILY and ITALY.

(4) The port and railways installations in TUNISIA, SICILY, and southern ITALY which had been put out of action by Allied bombings or enemy demolitions before they were occupied by the Allies.

c. Organization. The organization of G-4 (Mov and Tn) was peculiar in that Q (Movements) was a British

---

5. AFHQ GO No 19, 14 Feb 43.

6. Statement by Maj Bennett (B), G-4 (Mov and Tn), 27 Feb 45.

general staff branch, whereas Transportation (US) was a special staff section. The Chief of Transportation (US) therefore acted in the dual capacity of a general staff officer and a head of an operational service. This was clearly expressed by Brigadier de Rhe Philipe to General Lewis (B), DQMG G-4 (B), in a memorandum from which the following is an extract:

The British system makes Movements a general staff branch, the American makes Transportation a special staff branch. In a combined headquarters, I consider that Movements questions must be dealt with as a general staff matter on British lines and the compromise reached in AFHQ of inventing a G-4 (Mov and Tn) as a sort of younger brother to G-4 has been successful in a hq organized on the US system. Chief of Transportation in his 'Movements' capacity forms part of the general staff branch G-4 (Mov and Tn), in his US Transportation capacity he is head of a special service branch.

The British side of the Section was reorganized on 6 August 1943 into two main branches to deal with Mediterranean movements and North African movements. Transportation (US) was officially transferred from AFHQ to NATOUSA on 8 May 1943. A chart of the organization of G-4 (Mov and Tn) AFHQ in November 1943 is shown on the following page.

d. Personnel. The following table shows the British personnel authorized for Q (Movements) of G-4 (Mov

---

7. Memo, Brig de Rhe Philipe to Gen Lewis, G-4 (B), 22 Feb 43, quoted from Historical Record, Transportation (US), 31 Oct 43, at tab C.

8. AFHQ Adm Memo No 52, 5 Aug 43.

9. NATOUSA GO No 28, 8 May 43. Full details of the organization on the American side will be found in AFHQ History, II, 432-435.

10. Crane Report, Charts No 36 and 61, 28 Sep 43; Historical Record, Transportation (US), 31 Oct 43, at tab K.



ORGANIZATIONAL CHART G-4 (MOVEMENTS & TRANSPORTATION) AFHQ  
November 1943

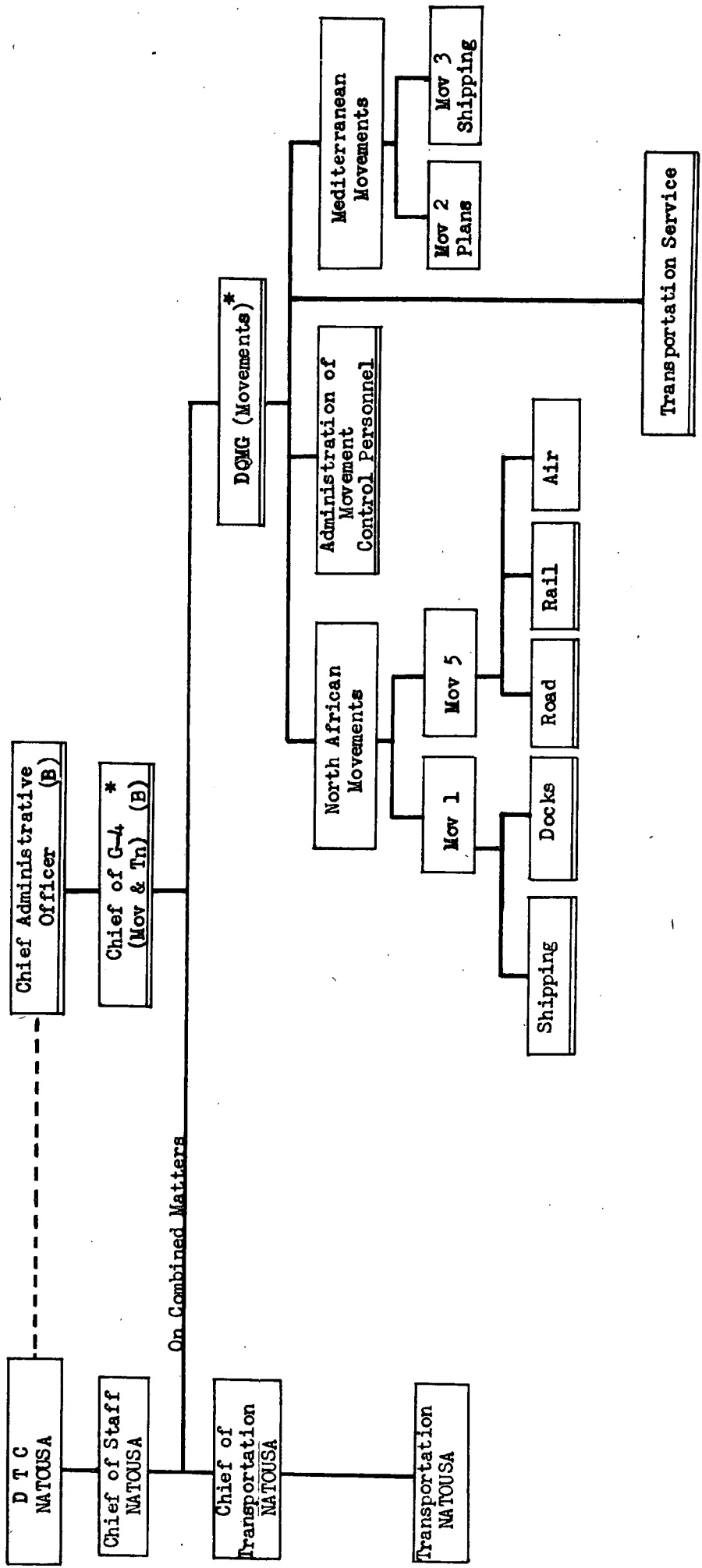

AMERICAN

BRITISH

- LEGEND:
- Command
  - - - - Co-ordination
  - Section existed in 1942.
  - \* Both of these positions were held by the same officer.

end Tn) on 1 December 1943. The American personnel are  
 shown under Transportation NATOUSA.<sup>11</sup>

<u>OFFICERS</u>			<u>WARRANT OFFICERS</u>			<u>OTHER RANKS</u>		
Rank	Oct* 42	Dec# 43	Rank	Oct* 42	Dec# 43	Rank	Oct* 42	Dec# 43
Brig	1	1	WO I	1	1	S/Sgt		1
Col	1	2	WO II	1	3	Sgt	4	6
Lt Col	4	4				Cpl	7	10
Maj	7	6				L/Cpl	6	9
Capt	6	10				Pte	21	42
1st Lt		1						
Totals:	19	24		2	4		38	68

Total British 1942: 59  
 Total British 1943: 96

## 2. Transportation Section NATOUSA

a. Activation. The staff organization of the Transportation Section NATOUSA had existed in 1942 and early 1943 as the American component of the combined G-4 (Movements and Transportation) Section of AFHQ. From 4 February to 8 May 1943 this American component served also as the United States Transportation Section of NATOUSA.<sup>12</sup> On 8 May 1943 it was separated from AFHQ and transferred to Headquarters NATOUSA, but thereafter it still continued to serve AFHQ in caring for American responsibilities in combined transportation matters.<sup>13</sup>

11. History of AFHQ, II, 433.

\* AFHQ WE VIII/374/1, wef 12 Oct 42.

# AFHQ WE XII/1/4, wef 1 Dec 43 (AG AFHQ file: 321-1).

12. NATOUSA GO No 1, 4 Feb 43, sect V.

13. NATOUSA GO No 28, 8 May 43, sects I and II.

The Historical Record, Office of the Chief of Transportation, US Army AFHQ--NATOUSA (31 Oct 43), sect II, par 9, says: "However above changes were merely 'paper transactions' and the policies and duties remained the same as under AFHQ."

b. Chiefs of the US Transportation Section. Colonel Frank S. Ross (A) was Chief of Transportation for both SOS ETOUSA and AFHQ from his arrival in ALGIERS on 20 November 1942 until his departure from the Theater on 26 January 1943.<sup>14</sup> From 26 January to 13 February Lieutenant Colonel Thomas Fuller (A) was the Chief of US Transportation AFHQ, and from 4 to 13 February 1943 he was also Chief of Transportation NATOUSA.<sup>15</sup> Lieutenant Colonel Fuller was succeeded on the latter date by Colonel George C. Stewart (A), who remained the Chief of Transportation NATOUSA and Chief of US Transportation AFHQ for the rest of 1943.<sup>16</sup> Colonel Stewart was promoted to the rank of brigadier general on 21 September 1943.<sup>17</sup>

c. Changes in Functions. The Transportation Section NATOUSA performed for the American side all the transportation functions as described above in this history in part I, page 55, and as modified in the account of 1943 in part II, pages 428 and 429.

d. Organization. The organization of the Transportation Section NATOUSA in September 1943 is shown by the chart on the next page.<sup>18</sup>

e. Personnel. The authorized personnel of Trans-

---

14. Historical Record, Chief of Transportation (31 Oct 43), sect I, par 7; and sect II, par 3.

15. Ibid., sect II, par 3. NATOUSA GO No 1, sect V.

16. Historical Record, Chief of Transportation (31 Oct 43), sect II, par 9.

17. WD SO No 280, 7 Oct 43.

18. Crane Report, Chart No 61, 28 Sep 43.

ORGANIZATION CHART OF TRANSPORTATION SECTION NATOUSA  
September 1943

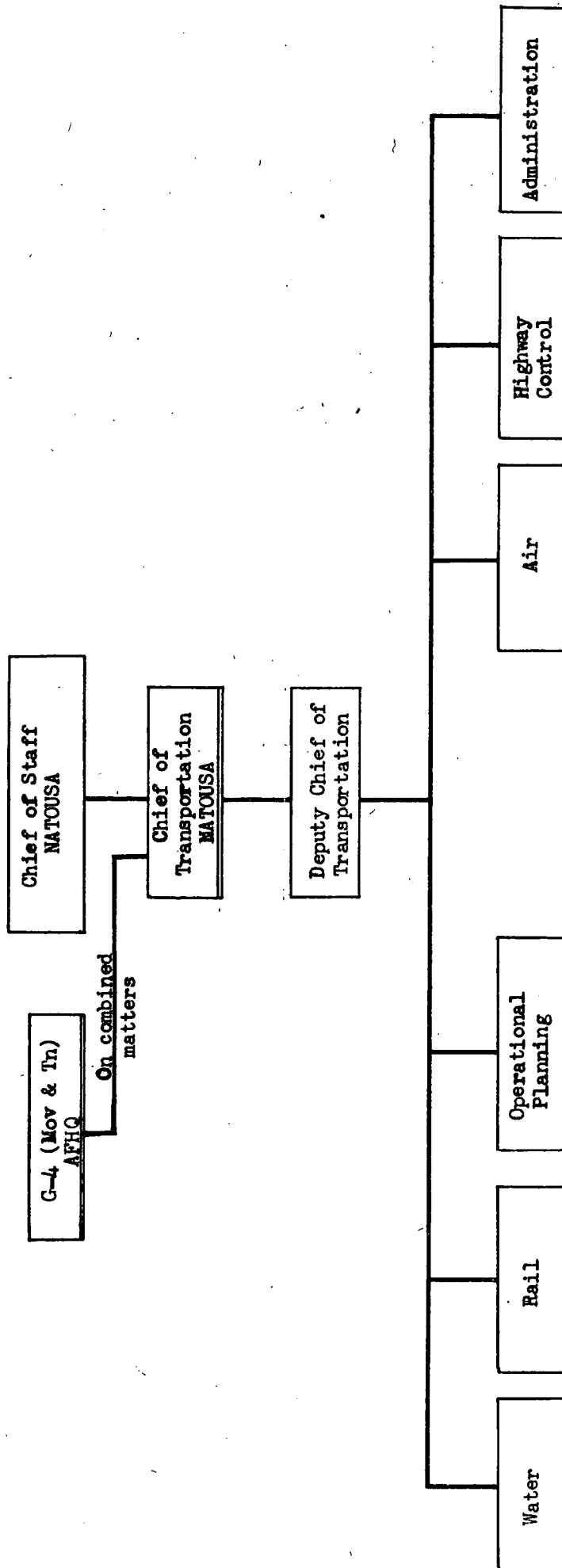

LEGEND:

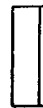

Indicates a subdivision in existence before 1 December 1942.

portation Section NATOUSA in effect in November 1943 are shown in the following table:

<u>OFFICERS</u>			<u>WARRANT OFFICERS</u>			<u>ENLISTED MEN</u>		
<u>Rank</u>	<u>Nov*</u> <u>42</u>	<u>Nov#</u> <u>43</u>	<u>Rank</u>	<u>Nov*</u> <u>42</u>	<u>Nov#</u> <u>43</u>	<u>Rank</u>	<u>Nov*</u> <u>42</u>	<u>Nov#</u> <u>43</u>
Gen &			CWO		1	M/Sgt		3
Col	2	3				T/Sgt	1	4
Lt Col	1	4				S/Sgt		2
Maj		5				Tec 3	1	5
Capt		3				Tec 4		8
						Cpl		2
						Tec 5		5
						Pfc		2
						Pvt		4
<b>Totals:</b>	<b>3</b>	<b>15</b>			<b>1</b>		<b>2</b>	<b>35</b>

	<u>1942</u>	<u>1943</u>
Total Americans:	5	51

### 3. Transportation (British) AFHQ

a. Activation. Transportation (British) was included in the GHQ Increment to 1st Army prior to and during the North African invasion. It became part of AFHQ under the title of Transportation (British) AFHQ<sup>19</sup> on 1 January 1943.

b. Director of Transportation (D Tn). Brigadier R. F. O'D. Gage (B) was designated as D Tn 1st Army (GHQ Increment)<sup>20</sup> on 30 August 1942. He remained as D Tn when the Service was established at AFHQ and in addition

\* Table of AFHQ authorized personnel, 19 Nov 42, in envelope at back of G-1 MTOUSA file: T/O AFHQ Old.

# AG NATOUSA ltr to Chief of Transportation, 14 July 43 (AG NATOUSA file: 200.3-147).

19. Tn (B) AFHQ Progress Report No 2, Dec 42.

20. WO Auth MS1/1/295, 21 Aug 42.

was appointed deputy to the Director General of Military  
Railways in February 1943.<sup>21</sup> Brigadier Gage continued  
in these assignments throughout 1943.

c. Functions. The American and British transportation organizations were not integrated at AFHQ owing to the differences in their methods and functions. Close liaison, however, was maintained between them to ensure the co-ordination of transportation facilities in the Theater. The British Service was responsible for the construction, maintenance, operation, and repair of docks, railways, and inland water transport services.<sup>22</sup> The duties of the D Tn and his staff at AFHQ and throughout the Theater in relation to British matters were as follows:<sup>23</sup>

(1) Policy formulation, planning, and co-ordination of transportation facilities in the Theater.

(2) Provision, supply, and maintenance of stores and equipment for railway and dock operating units.

(3) Administration and control of transportation stores' units and depots.

(4) Supervision of contracts for supply of transportation stores by local purchase.

(5) Negotiation of financial arrangements for transportation services furnished

---

21. Tn (B) AFHQ Progress Report No 5, Mar 43.

22. FSR, vol I, 13 Dec 39, sect 78.

23. Ibid; Crane Report Chart No 35, 28 Sep 43; Tn (B) AFHQ Progress Reports 1-6, Nov 42--Apr 43.

by civilian railway authorities for the British forces and checking accounts rendered for such services.

(6) Operation of railways for military purposes, including maintenance of engines, rolling stock, and plants.

(7) Survey, construction, and repair of railways.

(8) Administration and control of British railway operating, constructing, surveying, and bridging units.

(9) Operation of docks and maintenance of handling gear and other port equipment.

(10) Construction of new ports and development and repair of existing ports.

(11) Liaison with naval port authorities for clearance and repair of harbors.

(12) Administration and control of dock operating, port maintenance, construction, and repair units.

(13) Financial arrangements with civil port authorities and checking accounts rendered by them.

(14) Liaison with civil port authorities to ensure efficient use of civilian port facilities and personnel for military purposes.

(15) Liaison with the British Labour Service for supply of military and civil labor for unloading ships and clearing docks.

(16) Administration and control of in-

land water transport units and supervision of the work thereof.

(17) Compilation of all statistics required by the Service.

All American and British railway units were brought under one command with the appointment of the Director General of Military Railways (DGMR) on 14 February 1943.<sup>24</sup> This relieved Transportation (British) of the responsibility for formulating and implementing railway policies.<sup>25</sup> The D Tn (B), however, was appointed deputy to the DGMR and therefore served in a dual capacity at AFHQ from February 1943 onwards.<sup>26</sup> As D Tn (B) he was responsible for the operations of all British docks and inland water transport units and under the DGMR he was responsible for the technical development and operation for military purposes of all British-operated railways in the Theater.

d. Organization. The subsections of the railway component of Transportation (British) AFHQ have been treated as part of the combined American and British Military Railway Service which is discussed in the next section of this History. They have therefore been excluded from the chart of the organization of Transportation (British) AFHQ in September 1943 which is shown on the next page.<sup>27</sup>

e. Personnel. A comparison of the personnel au-

---

24. AFHQ GO No 19, 14 Feb 43.

25. Ibid.

26. See footnote 21 above.

27. Crane Report Chart No 35, 28 Sep 43.



ORGANIZATIONAL CHART OF TRANSPORTATION (BRITISH) AFHQ  
28 September 1943

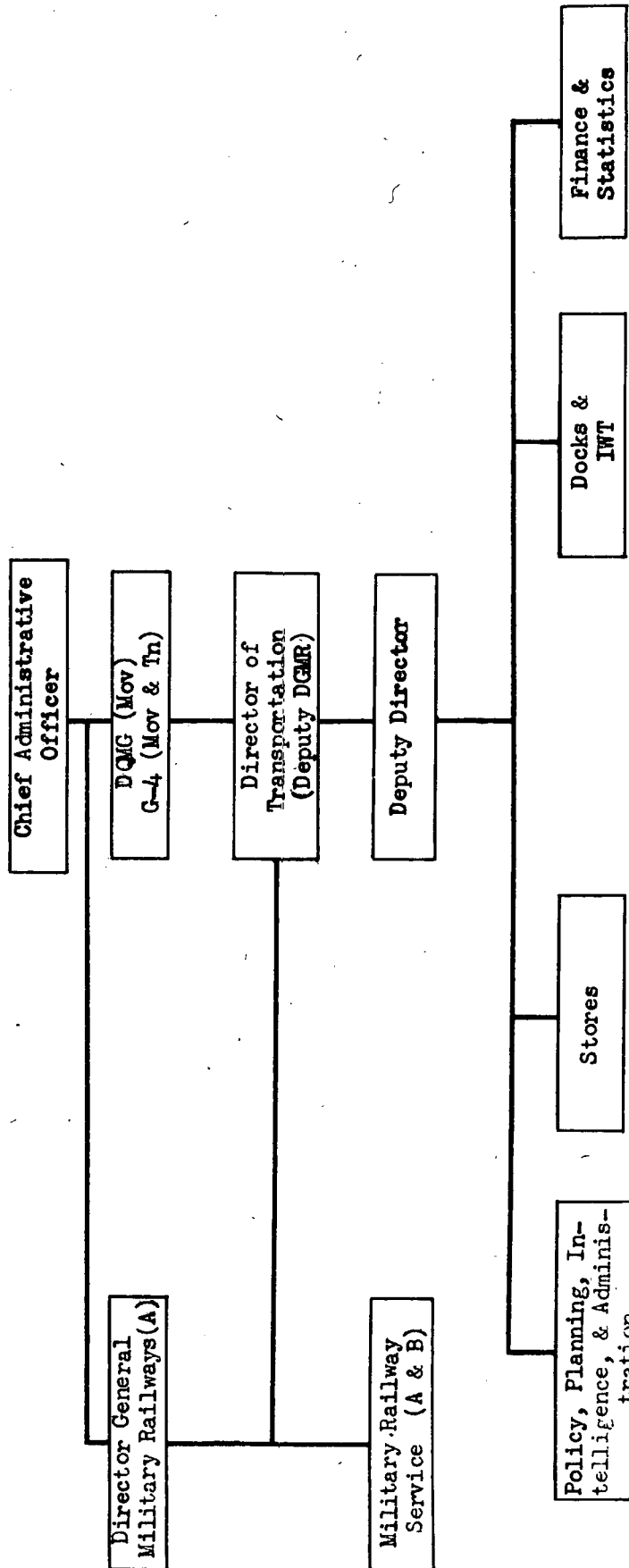

LEGEND:

- (A) Indicates that an American officer held the position.
- (A & B) Indicate that the service was integrated.

thorized for Transportation (British) AFHQ in October 1942 and December 1943 is shown in the table below. The figures for 1943 include the British personnel working in the headquarters of the Military Railway Service.

<u>OFFICERS</u>			<u>WARRANT OFFICERS</u>			<u>OTHER RANKS</u>		
Rank	Oct* 42	Dec# 43	Rank	Oct* 42	Dec# 43	Rank	Oct* 42	Dec# 43
Brig	1	1	WO I	2	2	S/Sgt	2	3
Col	1	1	WO II	2	2	Sgt	5	6
Lt Col	5	6				Cpl	8	10
Maj	6	6				L/Cpl	7	6
Capt	9	11				Pte	15	25
Lt		2						
<b>Totals:</b>	<b>22</b>	<b>27</b>		<b>4</b>	<b>4</b>		<b>37</b>	<b>50</b>

Total British 1942: 63  
Total British 1943: 81

#### 4. Military Railway Service AFHQ--NATOUA

a. Activation. The Military Railway Service was established on 14 February 1943 as a section separate from US Transportation Section or Transportation (British) to deal specifically with "the technical development and operation for military purposes of all railways in the North African Theater."<sup>28</sup>

b. Director General of Military Railways. Brigadier General Carl R. Gray, Jr. (A) was designated as Director General of Military Railways on 14 February 1943 and continued to serve in that capacity throughout

---

\* WE VIII/374/1, wef 12 Oct 42.  
# WE XII/1/4, wef 1 Dec 43 (AG AFHQ file: 321-1 AFHQ).  
28. AFHQ GO No 19, 14 Feb 43.

all of 1943.<sup>29</sup>

c. Functions of the Military Railway Service.

The Director General of Military Railways at AFHQ was responsible for the following functions:<sup>30</sup>

(1) Technical development and operation for military purposes of all railways in the Theater.

(a) In United States Communications Zone and base section areas: responsible to the DTC.

(b) In areas of British railway installations: responsible to the CAO.

(2) Recommendations to the CAO at AFHQ on the matter of the extent of operations to be carried out by American, British, and French personnel.

(3) Posting of railway guards where necessary.

(4) Consultation with G-4 on movement of railway units.

(5) Training of American military railway troops.<sup>31</sup>

(6) After the invasion of ITALY, the technical development and operation of Italian State and privately owned railways.<sup>32</sup>

The MRS also sent American and British representatives to meet regularly with the French authorities in the Allied Railway Commission, established early in 1943

---

29. Ibid.  
30. AFHQ GO No 19, 14 Feb 43.  
31. AFHQ GO No 38, 7 June 43.  
32. AFHQ GO No 60, 22 Oct 43.

to discuss and settle railway problems in NORTH AFRICA.

d. Organization. The headquarters organization of the Military Railway Service was a combined and integrated British--American section as shown by the chart <sup>33</sup> on the next page.

e. Personnel. The authorized British personnel for Headquarters MRS is included in the totals of the war establishment of the Transportation Service (B) and therefore can not be distinguished here from the authorized figures of other British Transportation personnel at AFHQ. The American authorized Headquarters MRS personnel, as carried on the War Department T/O 55-302 in effect in November 1943, are shown in the following table: <sup>34</sup>

<u>OFFICERS</u>		<u>WARRANT OFFICERS</u>		<u>ENLISTED MEN</u>	
<u>Rank</u>	<u>Nov 43</u>	<u>Rank</u>	<u>Nov 43</u>	<u>Rank</u>	<u>Nov 43</u>
Gen & Col	6	WOJG	2	M/Sgt	6
Lt Col	5			T/Sgt	8
Maj	7			S/Sgt	6
Capt	8			Tec 3	6
1st Lt	5			Sgt	1
2d Lt	1			Tec 4	40
				Cpl	1
				Tec 5	39
				Pfc	29
				Pvt	29
<b>Totals:</b>	<b>32</b>		<b>2</b>		<b>165</b>

Total Americans: 199  
 Total British : (Included in Transportation Service (B)).

32a. Historical Record, CofT (31 Oct 43), sect III.

33. Crane Report, Chart No 35, 28 Sep 43.

34. WD T/O and E 55-302 for Transportation Corps: Hq and Hq Co MRS, 10 Apr 43.

ORGANIZATION CHART OF THE MILITARY RAILWAY SERVICE AT AFHQ  
September 1943

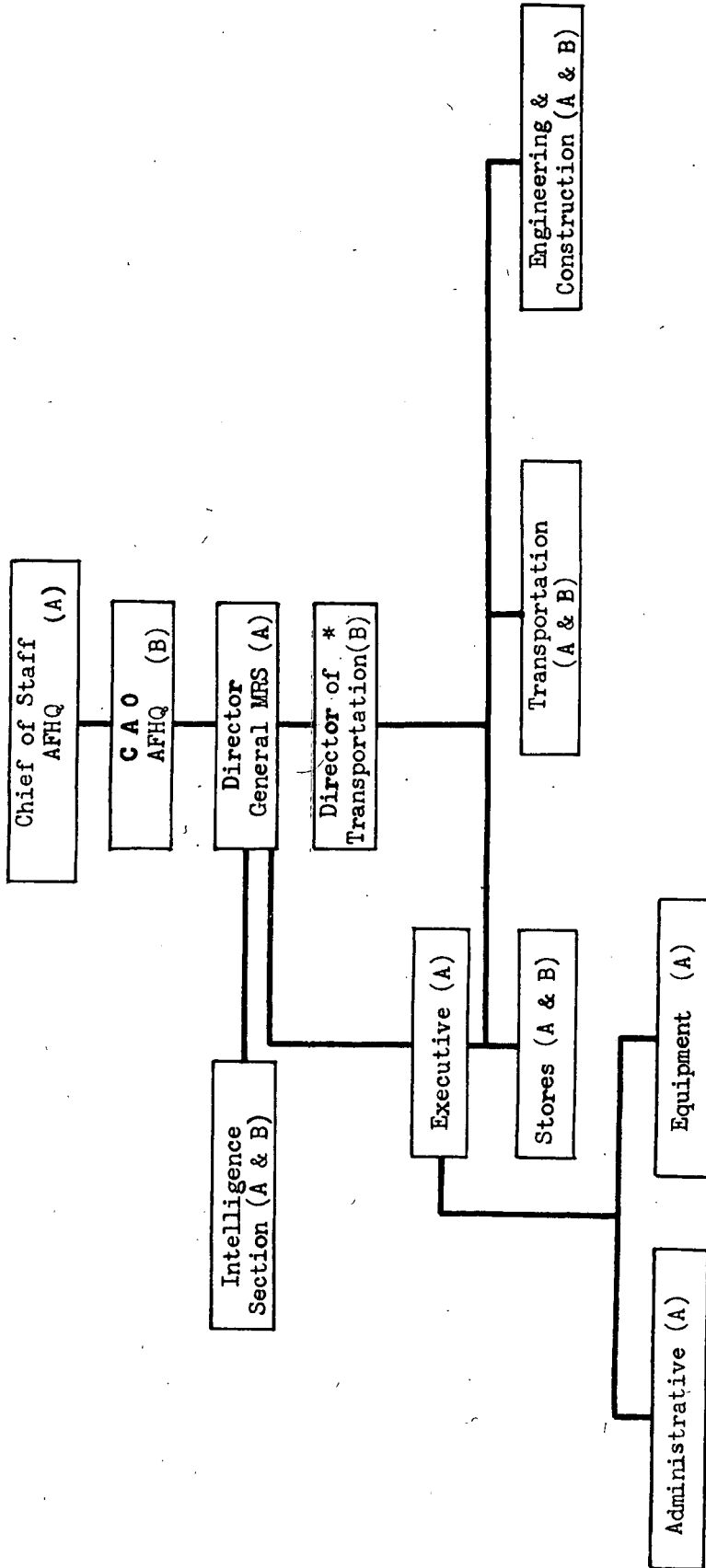

LEGEND:

- \* The British components of the combined subsections were personnel from the British Transportation Service under the British Director of that Service.
- (A), (B) Indicate that the personnel or officer was either American or British.
- (A & B) Indicates that the personnel was composed of both Americans and British.

5. North African Shipping Board (NASBO) AFHQ

a. Chairman. The Mediterranean Representative, of the Ministry of War Transport (MWT), Mr. J. Gibson Graham (B), continued to serve as Chairman of the Board throughout 1943.<sup>35</sup>

b. Changes in Functions. An increase in NASBO's functions occurred with the formation of its Shipping and Intelligence Divisions Room. The purpose of this Room was:

(1) To serve as a co-ordination and record center for all merchant shipping matters in the area.<sup>36</sup>

(2) To collect day-to-day merchant shipping intelligence.<sup>37</sup>

(3) To keep a tally on the positions of all ships<sup>38</sup> and to publish the Daily State.<sup>39</sup>

(4) To issue instructions for movements of merchant ships as required by the directing authority,<sup>40</sup> and for port acceptances.<sup>41</sup>

(5) To keep NASBO posted on matters affecting the disposal of diversions of mer-

---

35. Min of NASBO Meetings for 1943 (MWT files at AFHQ). The last meeting of NASBO was held on 16 Nov 43. Thereafter the organization was known as Mediterranean Shipping Board (MEDSO).

36. Statements of Mr. Fereday (B), Secy of MEDSO, 16 Oct 44. Min of NASBO Meetings for July 1943.

37. Ibid.

38. Statement of Mr. J. Gibson Graham, 13 Mar 45.

39. See footnote 36 above.

40. See footnote 38 above.

41. See footnote 36 above.

chent shipping.

c. Changes in Organization and Representation.

There were two organizational changes within NASBO during 1943. The Technical Subcommittee held its last meeting on 5 February, after which time its duties were absorbed by the Repair Committee.<sup>43</sup> The other change took place during early July when the NASBO Shipping Intelligence and Diversions<sup>44</sup> Room was established.

From the total of nine organizations represented on the Board in December 1942, an addition of new representatives and the redesignation of former organizations having representatives increased the members to a total of ten by November 1943. The designation of these members appears on the organization chart of NASBO shown on the following page.<sup>45</sup>

The only full-time individual whose duties dealt exclusively with NASBO during 1943 continued to be the Secretary of the organization, a British civilian.<sup>46</sup>

To facilitate arrangements concerning the repair of French vessels, the French authorities in NORTH AFRICA during 1943 sent delegates to the Repair Committee meetings, although there was never any representation of the French on the Board itself.<sup>47</sup>

---

42. Ibid.

43. Ibid.

44. Min Nos 1820, 1881, 1958, and 1980 of NASBO Meetings, c. July 43 (MWT files at AFHQ).

45. Information in this matter was furnished by the Secy for MEDBO on 13 Mar 45.

46. Ibid.

47. Ibid.

**ORGANIZATION CHART OF THE NORTH AFRICAN SHIPPING BOARD (NASBO) AFHQ**  
 15 November 1943

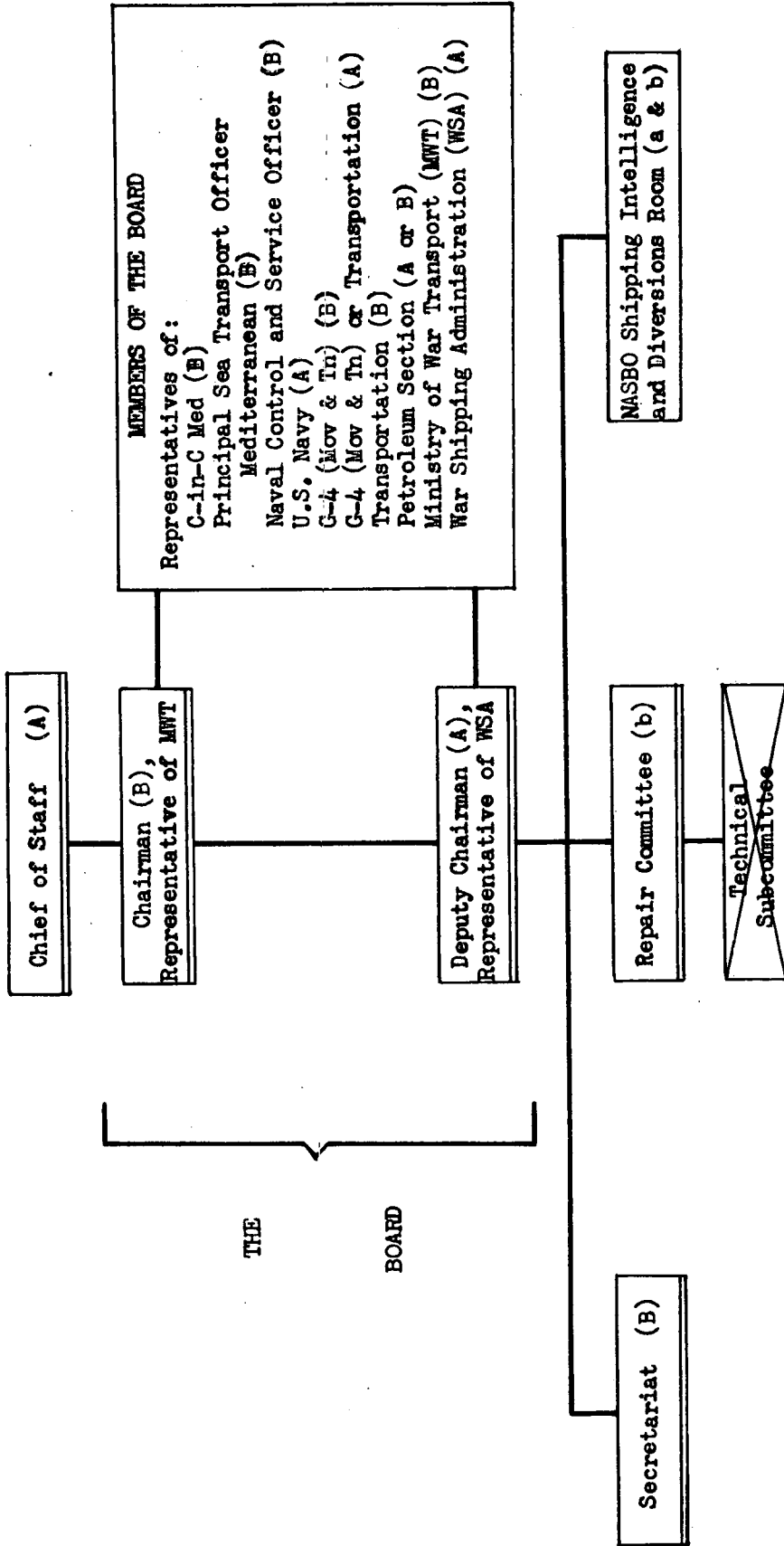

**LEGEND:**

Section or office organized in 1942 and continued during 1943.

Section discontinued during 1943.

(A), (B) Section, office, or representation completely American or British.  
 (a), (b) Combined section headed by either American or British.  
 (a & b) Combined section.



6. Air Priorities Board AFHQ

a. Establishment. An informal arrangement for meetings of an "Air Transportation Priorities Board" consisting of the

ACofS G-3 AFHQ

ACofS Air AFHQ

Chief of Civil Affairs Section AFHQ

Chief of Staff of the Naval Commander  
of X Force

was provided as early as 15 November 1942 to allot priorities on any waiting list or new bids for air transportation.<sup>48</sup> The members of this informal board were too

busy, however, to handle the growing volume of requests for air transportation priorities, and a proposal was made at the CAO Conference of 29 March 1943 that a new central office should be created to deal with the problem.<sup>49</sup> Action was taken to establish a new Air Priorities Board by AFHQ Staff Memorandum No 33 of 2 April

1943,<sup>50</sup> but three days later this memorandum was ordered withdrawn by the Chief of Staff.<sup>51</sup> The new board, however,

was officially established by an AFHQ letter on 29 April 1943.<sup>52</sup>

b. Chairmen of the Air Priorities Board. As Com-

---

48. Memo, DCofS AFHQ to All Staff Sections, 15 Nov 42 (SGS AFHQ file: 500-3).

49. Notes of CAO Conference No 80, 29 Mar 43, par 902.

50. AFHQ Staff Memo No 33, 2 Apr 43.

51. Min of CofS Conference No 44, 5 Apr 43, par 8. It was officially rescinded on 1 May 43 by AFHQ Staff Memo No 37, sect I.

52. AFHQ ltr to All Concerned, subject: "Air Priorities Board," 29 Apr 43 (SGS AFHQ file: 500-3).

manding General, Mediterranean Air Transport Service,  
Brigadier General Robert Kauch (A) was Chairman of the  
Air Priorities Board from 29 April to the end of 1943. <sup>53</sup>

c. Functions. The functions of the Air Priorities  
Board, as they were more fully defined by August 1943,  
<sup>54</sup>  
were:

(1) To establish priorities for air transportation of all personnel and freight to be moved by air transport within the Theater.

(2) To assign the priorities required by this headquarters for personnel and cargo moving into or out of the Theater by air transport and to notify the appropriate authority at the point of origin.

(3) To issue all necessary instructions with respect to the methods of securing, and the proper use of, air priorities.

d. Composition and Organization. The membership of the Air Priorities Board and the channels for processing priority applications are shown by the chart on the  
<sup>55</sup>  
next page.

---

53. Ibid., AG ltr to All Concerned, No AG 509-1 GCT-AGM, 26 Aug 43 (G-3 AFHQ file: 52/6); statement from MATS Executive Office, 19 Feb 45.

54. AG ltr to All Concerned, No AG 509-1 GCT-AGM, 26 Aug 43 (G-3 AFHQ file: 52/6).

55. Taken from chart prepared by Air Priorities Board, 4 Aug 43 (AG AFHQ file: 321 Air Priorities Board) with modifications made by the writer, based on reference in footnote 54 above.

**ORGANIZATION OF AIR PRIORITIES BOARD AFHQ**  
August 1943

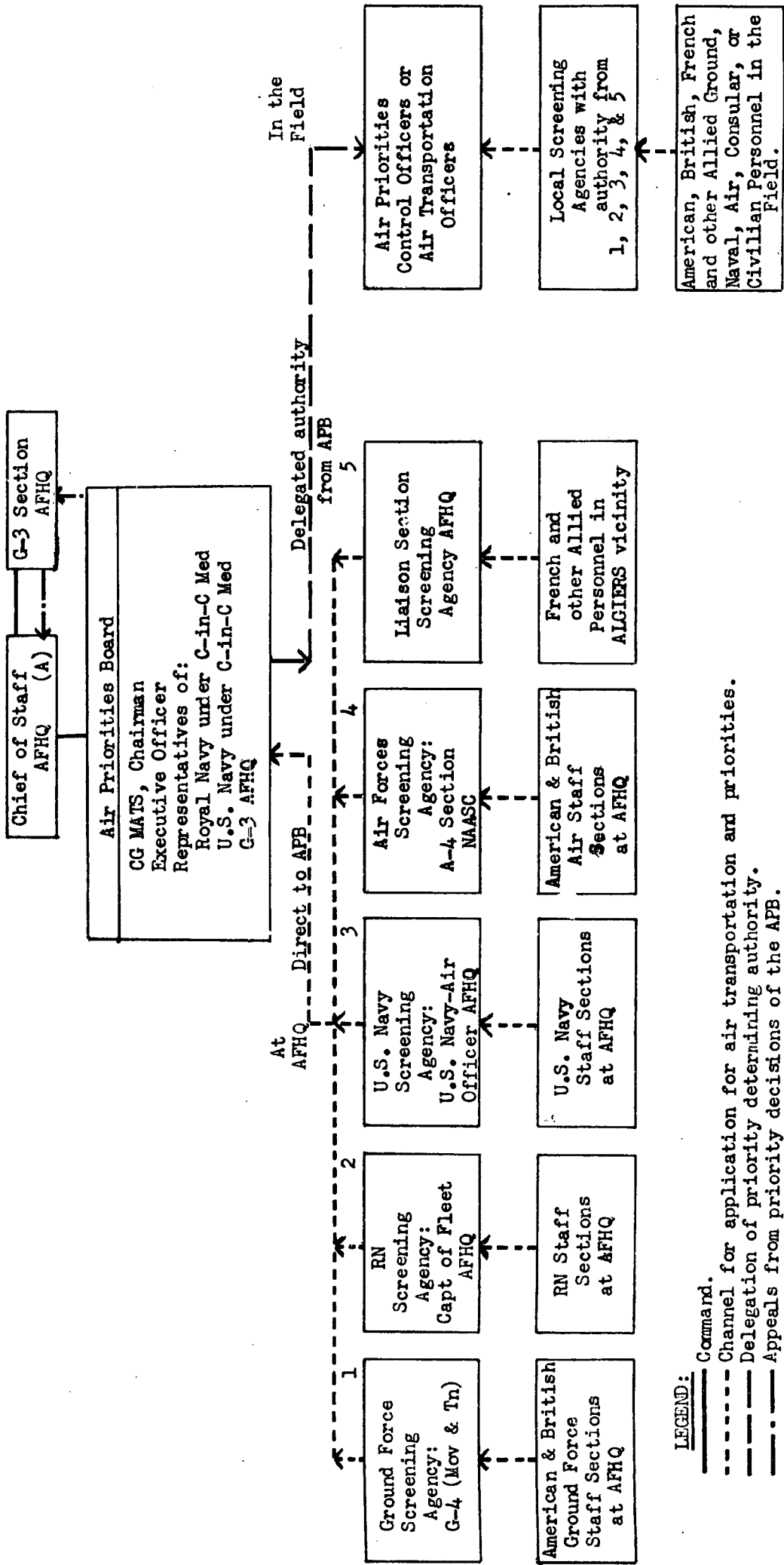

- LEGEND:**
- Command.
  - - - - - Channel for application for air transportation and priorities.
  - - - - - Delegation of priority determining authority.
  - . - . - Appeals from priority decisions of the APB.

The staff organizations at AFHQ dealing with financial matters were of three types: special staff sections, a joint committee, and advisory specialists. The Finance Section (American) and the Office of the Deputy Paymaster-in-Chief (British) were the normal special staff sections of the two national services, while the Joint Military Financial Committee was created to coordinate the financial policies of the two services. In addition there were two British advisors, the Financial Advisor and the Banking and Currency Advisor. The duties of these officers, however, were not limited to advising the staff at AFHQ. The Financial Advisor was primarily the local representative of the Under-Secretary of State for War with direct responsibility to him for the supervision of the accounts and expenditure of the British forces in the Theater. The Banking and Currency Advisor was a specialist in his own particular fields and as such acted also as a Treasury representative to the Minister Resident.

1. Finance Section (American) AFHQ--NATOUA

a. Activation. The Finance Section (American) AFHQ had been activated in September 1942,<sup>1</sup> but on 4 February 1943 it began to serve also as a corresponding

---

1. AG AFHQ Ltr to All Concerned, 12 Sep 42 (AG AFHQ file: 330.31-5). See also History of AFHQ, I, 64.

Finance Section this dual role of serving both AFHQ and NATOUSA was in reality a fiction because, as a purely American AFHQ section, it performed the identical duties of a NATOUSA section. This anomalous situation was finally terminated on 8 May 1943 when the Finance Section AFHQ was transferred to Headquarters NATOUSA.<sup>3</sup>

b. Chief of Finance Section AFHQ--NATOUSA. Colonel Leonard H. Sims continued to serve as Chief of the Finance Section (American) AFHQ until 8 May 1943 when the Section was discontinued at AFHQ. From 4 February until 8 May 1943 he served both as Chief of the Finance Section AFHQ and NATOUSA and thereafter continued to serve solely as Chief of the Finance Section NATOUSA for the rest of 1943.<sup>4</sup> Colonel Sims was promoted to the rank of brigadier general with effect from 3 November 1943.<sup>5</sup>

c. Changes in Functions. In general the functions of the Finance Section NATOUSA remained the same in 1943 as in 1942.<sup>6</sup> The following elaboration and extension of its basic functions in 1943 included:<sup>7</sup>

(1) Supervision of the assignment of American finance personnel in the Theater.

(2) Maintenance of Lend-Lease and re-

---

2. NATOUSA GO No 1, 4 Feb 43, sect V.

3. NATOUSA GO No 28, 8 May 43, sect II.

4. See footnotes 2 and 3 above.

5. WD SO No 333, 29 Nov 43.

6. FM 101-5, 19 Aug 40, par 35. See also History of AFHQ, I, 65.

7. Crane Report, Chart No 55, 28 Sep 43.

(3) Allotment of funds to contracting agencies.

(4) Forwarding of final pay accounts of deceased personnel.

(5) Liaison with the British Pay Services.

(6) Representation on the Joint Military Financial Committee and co-ordination of the Section's activities with the Committee's recommendations.<sup>8</sup>

d. Organization. The organization of the Finance Section NATOUSA, as it existed in September 1943, is shown by the chart on the following page.<sup>9</sup>

e. Personnel. The authorized personnel of the Finance Section NATOUSA in November 1943 are shown in the following table:

<u>OFFICERS</u>			<u>WARRANT OFFICERS</u>			<u>ENLISTED MEN</u>		
Rank	Nov* 42	Nov# 43	Rank	Nov* 42	Nov# 43	Rank	Nov* 42	Nov# 43
Col	1	2	CWO		1	M/Sgt	1	2
Maj		1	WOJG	1		T/Sgt	1	4
Capt	1	2				Tec 3	1	5
						Tec 4		5
Totals:	2	5		1	1		3	16

Total Americans (1942): 6  
Total Americans (1943): 22

8. AFHQ GO No 6, 15 Jan 43, sect II.  
9. Crane Report, Chart No 55, 28 Sep 43.  
\* On AFHQ table of personnel, 19 Nov 42, in envelope at back of G-1 MTOUSA file: T/O AFHQ Old.  
# Memo, AG NATOUSA to Fin Sect, 6 Oct 43 (AG NATOUSA file: 200.3-164).

ORGANIZATION CHART OF THE FINANCE SECTION (AMERICAN) NATOUSA  
 September 1943

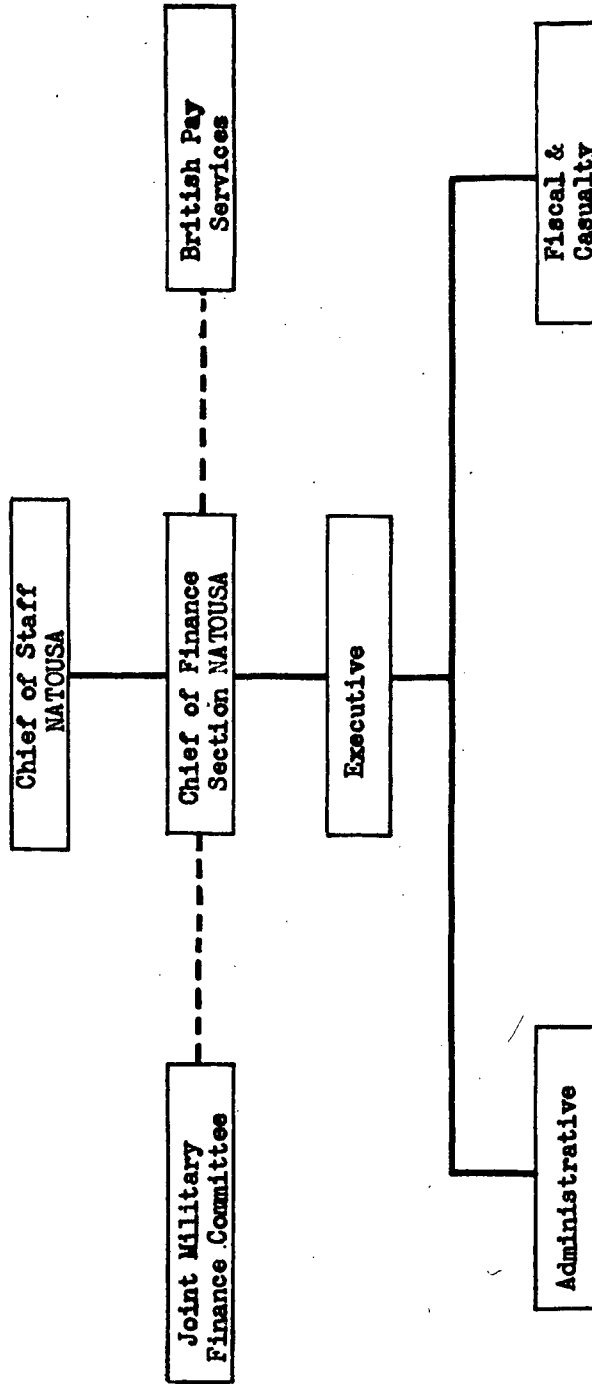

LEGEND:  
 ——— Command  
 - - - - Liaison and co-ordination

## 2. Pay Services (British) AFHQ

a. Activation. The No 1 Hq Pay Service arrived in NORTH AFRICA on 13 November 1942 as part of the Hq 1st Army, but it was not until 1 January 1943 that it was transferred to AFHQ as Pay Services (British).<sup>10</sup>

b. Deputy Paymaster-in-Chief (DPIC). Brigadier R. G. Stanham (B), who had been appointed DPIC with the 1st Army on 1 September 1942,<sup>11</sup> became the DPIC at AFHQ on 1 January 1943. He was succeeded on 9 June 1943 by Brigadier I. P. Brickman (B) who continued to serve throughout the remainder of the year.<sup>12</sup>

c. Functions. The DPIC's office was a non-integrated section at AFHQ, but the closest co-operation was maintained with the American Chief of the Finance Section (NATOUSA). The DPIC was the advisor to British commanders on all questions of pay, allowances, and cash services for British troops and controlled the British personnel who performed pay and cash duties throughout the Theater.<sup>13</sup>

Additional duties of the DPIC and his staff were as follows:<sup>14</sup>

(1) Provision of funds for the British Army and financing the Royal Navy, Royal Air Force, dominion and Indian troops, and military liaison headquarters.

- 
10. Statement by Brig Brickman, DPIC AFHQ, 6 Jan 45.  
11. D/MS Records, AFHQ, 1st Army Security List, SID/42.  
12. D/MS Records, AFHQ, WO Auth 1058/MS, 14 June 43.  
13. Same as footnote 10 above.  
14. Ibid. Also FSR, vol I, 13 Dec 39, sect 69.



- (2) Issue of pay and allowances.
- (3) Accounts in respect of cash expended and received.

(4) Payment of services performed for the British forces.

(5) Claims against individuals, or others, for repayments and collection of monies due.

(6) Administration of a central office for payment of requisitioning claims.

The numerous currencies handled included those for all the southern European and Mediterranean countries, in addition to sterling, US dollars, British Military Authority notes, and Allied military lire.<sup>15</sup>

d. Organization. A chart of the organization of the Pay Services at AFHQ in September 1943 is shown on the next page.<sup>16</sup>

e. Personnel. The war establishment for AFHQ did not include the personnel in the DPIC's Office. The War Office establishment provided the following personnel for the Office in November 1943.<sup>17</sup>

<u>OFFICERS</u>		<u>WARRANT OFFICERS</u>		<u>OTHER RANKS</u>	
<u>Rank</u>		<u>Rank</u>		<u>Rank</u>	
Brig	1	WO I	1	Sgt	2
Lt Col	1			Cpl )	
Capt and Lt	3			L/Cpl )	5
				Pte )	
Totals:	5		1		7
Total British: 13					

15. See footnote 10 above.

16. Crane Report, Chart No 40, 28 Sep 43.

17. Statement by Capt Lane, DPIC's office AFHQ, 27 Aug 45. WE III/3J/1, wef 1931.

ORGANIZATION CHART OF THE PAY SERVICES (BRITISH) AFHQ  
September 1943

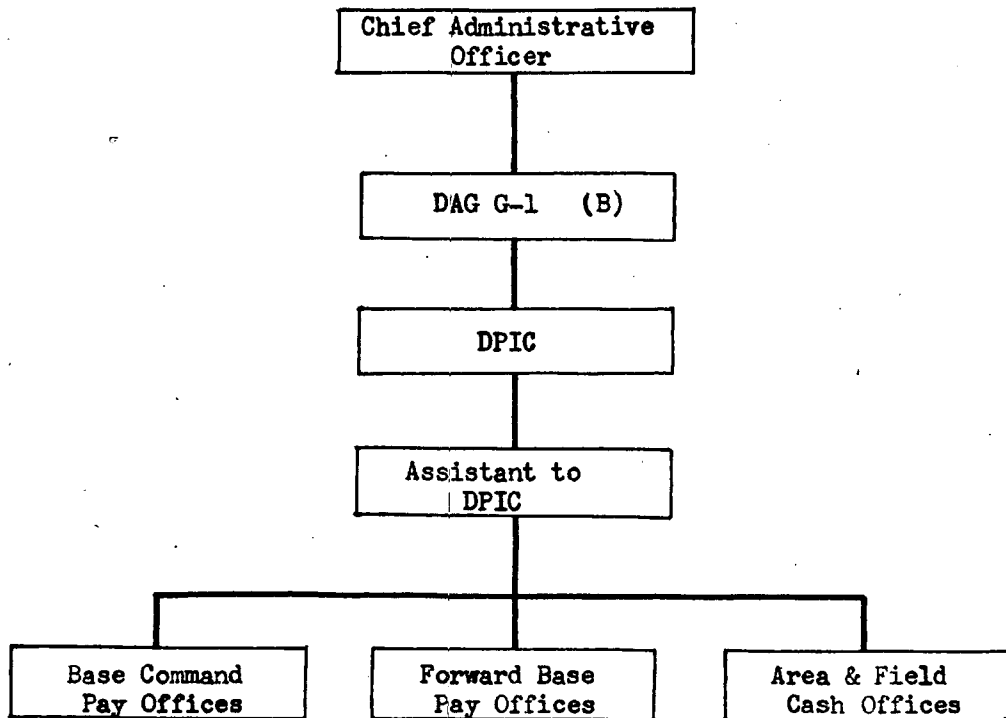

### 3. Joint Military Financial Committee AFHQ

a. Establishment. The Joint Military Financial Committee was established on 15 January 1943.<sup>18</sup>

b. Chairmen. The Chairman of the Joint Military Financial Committee was the Chief Administrative Officer of AFHQ. For the year 1943 the Chairman was, therefore, Major General H. M. Gale (B) (after 9 August Lieutenant General Sir Humfrey M. Gale).<sup>19</sup>

c. Functions. The functions of the Joint Military Financial Committee were:<sup>20</sup>

(1) To ensure the close regular co-ordination of Allied military financial policy in the North African Theater.

(2) To issue such instructions as are necessary to spending special staffs and services as will ensure this co-ordination with particular reference to financial relations with public bodies, contractors, owners of hired premises, and like agencies.

(3) In the discharge of these duties, to work in close co-operation with the Civil Department and the Military Department of NAEB<sup>21</sup> and to assure that its military policy is in agreement with the broader policies set by NAEB. To assist to this end, the members from the Military and Civil Departments of NAEB are charged with the additional duty of liaison between the two bodies.

(4) ...to co-ordinate (all instructions) with G-1 and G-4, as applicable, before submitting them to the Adjutant General for publication.

(5) ...to elect such additional members as may from time to time be desirable.

---

18. AFHQ GO No 6, 15 Jan 43, sect II.

19. Ibid. See also app A to GRO 402, 20 Aug 43; and London Gazette, 10 Aug 43.

20. AFHQ GO No 6, 15 Jan 43, sect II.

21. North African Economic Board.

(6) ...to require persons to attend upon it to give evidence necessary to the discharge of its duties.

d. Composition. The Joint Military Financial Committee<sup>22</sup> was composed of:

the Chief Administrative Officer AFHQ as Chairman.

a Vice-Chairman to be nominated by the Chairman.

the Financial Advisor to NAEB.

the Finance Officer AFHQ (NATOUSA).

the Financial Advisor to the CAO AFHQ.

the Currency Advisor to the CAO AFHQ.

a representative of the Purchasing Agency of the Military Department of NAEB.

The CAO was provided a secretariat for this Committee by his Financial Advisor (B).

4. Banking and Currency Advisor (British) AFHQ

a. Activation. The Banking and Currency Advisor,<sup>23</sup> appointed with effect from 2 October 1942, formed part of Headquarters 1st Army. He was not transferred to AFHQ, however, until 20 May 1943.<sup>24</sup>

b. Banking and Currency Advisor. Brigadier F. Rabino (B) was appointed the Banking and Currency Advisor<sup>25</sup> on 2 October 1942 and continued in this position until 18 December 1943 when he was succeeded by Major W.

---

22. AFHQ GO No 6, 15 Jan 43, sect II.  
23. WO Directive to Brig Rabino, 22 Oct 42 (AG AFHQ 381-2).  
24. Min of AFHQ WE! Com Mtg No 22, 20 May 43.  
25. See footnote 23 above.

c. Functions. The Banking and Currency Advisor was responsible for advising and assisting the British military authorities in the Theater in matters relating to banking and currency and had the following duties:<sup>27</sup>

(1) Informing the British military authorities of the substance of all problems concerning matters for which he was responsible which might affect directly or indirectly the monetary or financial dealings of the British forces, the emoluments of British soldiers in the area, or the provision of supplies or services to or by the British military authorities in order that the British commander might have the requisite opportunity of putting his views before the commanding general.

(2) Advising the British Paymaster-in-Chief regarding the control, issue, circulation, and eventual withdrawal of the special sterling notes issued in the area by the British military authorities.

(3) Maintaining liaison with the British Financial Advisor on currency and other matters affecting the British forces.

(4) In conjunction with the British

---

26. Memo, CAO to G-3 Org (B), 28 Feb 44. Ltr Mr Reilly to G-3 Org (B), 17 Apr 44 (G-3 Org AFHQ file: 287).

27. See footnote 23 above.

Paymaster-in-Chief making all general banking arrangements for the British forces.

(5) Acting as a Treasury representative<sup>28</sup> for the British Resident Minister.

(6) Working in close liaison with the<sup>29</sup> American Civil Affairs Administration.

The functions of the Advisor necessitated close personal contact with officials of various American, British, and French civilian finance organizations.

d. Organization. The Banking and Currency Advisor was a member of the North African Economic Board and the Joint Military Financial Committee and, although originally he was directed to report through the GOC 1st<sup>30</sup> Army, the Advisor on his transfer to AFHQ came under the direction of the CAO.

e. Personnel. The personnel authorized for the office of the Banking and Currency Advisor at AFHQ on 1 December 1943 are shown in the table below:

<u>OFFICERS</u>		<u>OTHER RANKS</u>	
<u>Rank</u>	<u>Dec*</u> <u>43</u>	<u>Rank</u>	<u>Dec*</u> <u>43</u>
Brig	1	Pte	1
Maj	1		
Totals:	2		1

Total British: 3

---

28. Min from PUS (F) Sir E. Speed, 27 Feb 44 (G-3 Org AFHQ file: 287).

29. See footnote 23 above.

30. Ibid.

\* WE XII/1/4, 1 Dec 43 (AG AFHQ file: 321-1 AFHQ).

5. Financial Advisor (British) AFHQ

a. Financial Advisor. Brigadier E. S. O. Dunlop (B) was designated as the British Financial Advisor at AFHQ and continued in that assignment throughout the year 1943.

b. Functions. The Financial Advisor was the local representative of the Under-Secretary of State for War and communicated directly with accounting officers of the War Office on all matters pertaining to the Financial Advisor's office. The duties of the Financial Advisor and his staff in relation to British forces in the Theater were as follows:

(1) Advising the CAO and principal staff officers on all questions of financial policy.

(2) Advising the heads of services in regard to the control of expenditure of funds and stores.

(3) Exercising general control by means of a current audit, as far as was practicable, over all cash, store, and supply accounts.

(4) Raising, on his own initiative, with the CAO any matters which his knowledge and experience suggest as practicable economies.

(5) Acting as consultant in regard to financial relations with allied, dominion, and colonial governments and the necessary

---

31. KR's, app V, amend Apr 43; FSR, vol I, 13 Dec 39, sect 199.

accounting arrangements for services of an abnormal character.

(6) Approving write-offs which were in excess of the powers granted to the CAO and the heads of services.

(7) Supervision of all contracts and local purchases made by the heads of services in excess of the financial powers granted to them.

(8) Advising the staff branches on financial matters which required to be published in General Routine Orders.

The advice of the Financial Advisor was not binding on the CAO or heads of services, and it did not relieve such officers of the responsibility for any administrative action taken as a result of it. All decisions of financial importance or otherwise bearing on the duties of the Financial Advisor, however, with which he had not stated his concurrence were required to be communicated to him without delay, and in the event of his being unable to concur he reported the matter directly to the Under-Secretary of State for War, attaching the correspondence to his report.

c. Personnel. The personnel in the office of the Financial Advisor were not included in the war establishment for AFHQ. Officers were posted directly by the War Office according to the requirements of the Theater. No table of personnel is included therefore in this section.



## Chapter XIV

### STAFF ORGANIZATIONS CONCERNED WITH CIVIL RELATIONS

Besides its strictly military functions AFHQ was also responsible for civil affairs in NORTH AFRICA and ITALY. Adopting the principle that the activities of the civil population are of paramount military concern, the British and American governments, through the CCS, charged the Allied C-in-C with the complex task of administering civil affairs in the Theater as long as the military situation should require. Consequently during the period 1942--43 the Allied C-in-C created several staff sections, boards, and commissions at AFHQ to advise him on various civil affairs matters and to discharge his civil responsibilities.

The two main staff sections dealing with civil relations were the Civil Affairs Section, responsible for civil affairs in NORTH AFRICA, and the Military Government Section, created prior to the Sicilian invasion to handle all Theater civil affairs matters outside NORTH AFRICA. A special Joint Committee on Political Prisoners and Refugees was also established to deal with the North African refugee problem.

To advise General Eisenhower on the many complex high-level political problems arising in the Theater, the two Allied governments appointed political advisors at AFHQ. At the end of 1942 His Majesty's Government appointed Mr. Harold MacMillan, a member of the British

Cabinet, as Minister Resident at AFHQ.<sup>1</sup> On the American side President Roosevelt appointed Mr. Robert D. Murphy to serve as his personal representative in NORTH AFRICA, with the rank of Minister, in addition to his duties as Chief Civil Administrator on General Eisenhower's staff.<sup>2</sup> Although present at AFHQ, these two advisors were not subordinate to the Allied C-in-C in their political capacity, but were rather the representatives at his headquarters of the British Cabinet and American State Department respectively. They served as the channel for the expression of the political, in contrast to the military, views of the two governments to the Allied C-in-C. General Eisenhower also formed a small Political and Economic Council, of which the two advisors were principal members, to advise him on political matters.

1. Civil Affairs Section AFHQ

a. Chief of the Civil Affairs Section. Mr. Robert D. Murphy (A) remained Chief Civil Administrator at the head of the Civil Affairs Section throughout 1943. In addition, on 15 December 1942 he was appointed personal representative of President Roosevelt in NORTH AFRICA with the rank of Minister.<sup>3</sup>

b. Changes in Functions. The original functions of the Civil Affairs Section were substantially modified

---

1. NAF Cable No 74, Eisenhower to CCS, 31 Dec 42. Statement by the Administrative Officer, Office of the British Resident Minister at AFHQ, 28 May 45.

2. Cable No 272, WD to AFHQ, 18 Dec 42.

3. Ibid.; AFHQ GO No 36, 25 Dec 42, sect I.

during 1943 as new staff sections and boards were created to assume responsibilities formerly allotted to it. Responsibility for the supervision of psychological warfare activities, originally under the Civil Affairs Section, was transferred to the newly established INC Section AFHQ on 5 January 1943.<sup>4</sup> When AFHQ planned to extend operations to SICILY and later to ITALY, a new staff section, the Military Government Section, was established on 18 June 1943 to be responsible for all civil affairs matters outside NORTH AFRICA. Thus the Civil Affairs Section remained the C-in-C's advisor solely on civil affairs in NORTH AFRICA.<sup>5</sup>

The Section's detailed functions can best be considered under its three functional subdivisions: political, economic, and military. With the appointment of Mr. Murphy as personal representative of President Roosevelt in NORTH AFRICA, the Political Subsection acquired a dual function. It acted both as part of a staff section of AFHQ and as an American diplomatic mission to the French authorities in ALGIERS responsible, through the State Department, to the President. The detailed functions of the Political Subsection were:<sup>6</sup>

- (1) Contacts with French, British, and American authorities.
- (2) Study of political problems and

---

4. AFHQ Staff Memo No 1, 5 Jan 43.

5. Min of CofS Conferences No 66, 25 June 43 (SGS AFHQ file: CofS Confs). See sect 2. of this chapter for the functions of MGS.

6. Memo, Murphy to Senators Mead and Brewster, 23 Aug 43. In its civil capacity the Civ Aff Sect was known as the Office of Civil Affairs.

trends.

- (3) Political reports.
- (4) Political refugees.
- (5) Reports on prisoner of war camps.
- (6) Supervisory jurisdiction over American consular offices in the Theater.

With the transfer of NAEB to NORTH AFRICA it was decided that after 8 January 1943 all economic, financial, and kindred aspects of civil affairs in NORTH AFRICA would be handled by NAEB.<sup>7</sup> Although NAEB had to be made independent because it was a combined board, it served in all American economic matters as a subsection of the Civil Affairs Section. The Section also retained direct contact with NAEB through the fact that Mr. Murphy served as Civil Chairman of NAEB in his capacity as Chief Civil Administrator.

The Military subsection was divided into four geographical units: Civil Affairs Representative Eastern Algeria, Civil Affairs Section MBS, Civil Affairs Section ABS, and Tunisian Detachment. Their functions were:

- (1) Co-ordination of the use of local labor with that provided by the military forces.
- (2) Supervision of the handling and accounting for Lend-Lease imports.
- (3) Supervision of the supply of goods

---

7. AFHQ Adm Memo No 2, 6 Jan 43. For the functions of NAEB see History of AFHQ, II, 409-412.

for civilian relief markets.

c. Changes in Organization. The Civil Affairs Section was organized originally to supervise the French civil administration after the invasion of NORTH AFRICA. When the French authorities proved friendly and were left in complete charge of civil administration, this form of organization was no longer necessary. Consequently it was modified along functional lines, as shown in the chart on the following page.<sup>9</sup>

d. Personnel. Since the Civil Affairs Section was at the same time an AFHQ staff section and a diplomatic mission, it contained both military and civilian personnel. In accordance with the Allied policy of transferring administration of civil affairs to civilian agencies, as soon as the military situation would permit, civilian personnel gradually replaced the military during 1943. As of 28 September 1943 the Section included 232 American and 44 British civilians. Most of the Americans and all of the British were under NAEB. Twelve French civilians also were employed.<sup>10</sup> Authorized military personnel in November 1943, including NAEB, are

---

8. Memo, Murphy to Senators Mead and Brewster, 23 Aug 43.

9. Crane Report, Chart No 21, 28 Sep 43. Chart of CA Section Org atchd to Memo, CA Sect to G-1 NATOUSA, 24 Apr 43 (G-1 MTOUSA file: T/O Civ Aff).

10. See footnote 9 above.

ORGANIZATIONAL CHART OF CIVIL AFFAIRS SECTION AFHQ  
September 1943

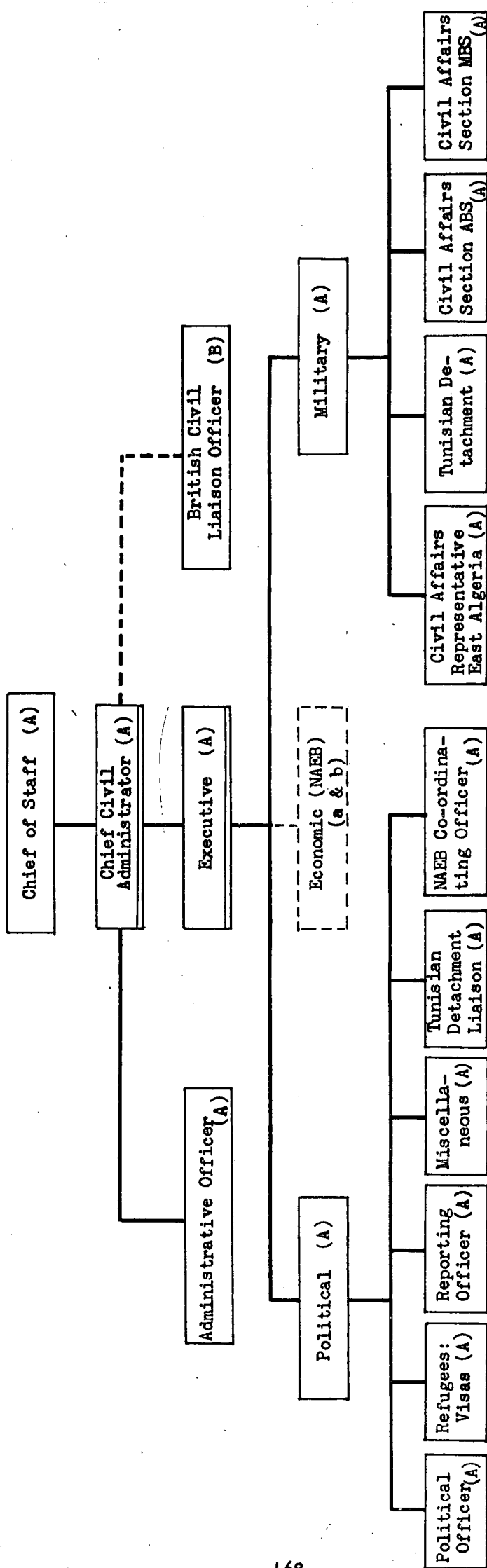

LEGEND:

— Command

- - - Co-ordination

┌┐ Represents an independent board which handled the economic aspects of civil affairs in NORTH AFRICA.

┌┐ Offices or organizations in existence in 1942.

┌┐ (A), (B) Indicates the office or subsection is entirely American or British.

(a & b) Combined section with a joint American and British head.

shown in the following table:

<u>OFFICERS</u>			<u>ENLISTED MEN</u>		
<u>Rank</u>	<u>Am*</u>	<u>Br#</u>	<u>Rank</u>	<u>Am*</u>	<u>Br#</u>
Col	1	1	M/Sgt	1	
Lt Col	4		T/Sgt	2	
Maj	3		S/Sgt	2	
Capt	4		Tec 3	4	
1st Lt	12		Tec 4	10	
			Tec 5	10	
			Pfc	5	
			Pvt	10	
<hr/>			<hr/>		
Totals:	24	1		44	10

Total Americans: 68

Total British : 11

COMBINED TOTALS: 79

## 2. Military Government Section AFHQ

a. Activation. The Military Government Section (MGS) AFHQ was activated on 18 June 1943 to advise the Allied C-in-C on military government in the forthcoming invasion of SICILY.<sup>11</sup> The older Civil Affairs Section AFHQ remained solely responsible for civil affairs matters<sup>12</sup> pertaining to NORTH AFRICA.

b. Chief of the Military Government Section. The Chief of MGS from 18 June 1943 through December 1943 was

---

\* AG AFHQ ltr 200.3/142, 26 July 43.

# Crane Report, Chart No 21, 28 Sep 43 gives British totals. The British officer served as British Civil Liaison Officer while the other ranks gave clerical help. No breakdown of British other ranks is available.

11. AFHQ Staff Memo No 50, 18 June 43; Memo, CofS to British Resident Minister, 17 June 43 (G-5 AFHQ file: 322-13).

12. Min of CofS Conferences No 66, 25 June 43 and No 76, 26 July 43 (SGS AFHQ file: CofS Confs).

Colonel Julius C. Holmes (A), former Chief of the Liaison Section AFHQ.<sup>13</sup> He was promoted to brigadier general on 4 July 1943.<sup>14</sup>

c. Functions. MGS was made "the executive section for the Commander-in-Chief in all questions pertaining to the military government of occupied territory, including political questions arising out of military occupation."<sup>15</sup> As the C-in-C's executive, MGS had the following functions:<sup>16</sup>

(1) To advise the Allied C-in-C on civil affairs matters (exclusive of NORTH AFRICA).

(2) To take appropriate executive action in respect to civil affairs matters (exclusive of NORTH AFRICA).

(3) To co-ordinate civil affairs policies between AFHQ and other headquarters having civil affairs responsibilities.

(4) To direct and co-ordinate civil affairs planning for future operations.

(5) As part of civil affairs planning, to estimate minimum essential civilian supply needs in occupied areas.

(6) To supervise the procurement and training of civil affairs personnel.

---

13. AFHQ Staff Memo No 50, 18 June 43.

14. WD SO No 185, 4 July 43, par 1.

15. AFHQ Staff Memo No 50, 18 June 43.

16. AFHQ Staff Memo No 48, 14 May 44; Memo, Holmes to CofS on Responsibilities of MGS, 27 June 43 (G-5 AFHQ file: 020); AG AFHQ ltr 400-1 (AMGOT), 31 Aug 43, superseded by AG AFHQ ltr 400-1 (AMGOT), 16 Dec 43.



(7) To review and edit civil supply requisitions submitted by civil affairs organizations in the field.

d. Organization. The Military Government Section was a completely integrated combined staff section with British and American personnel working together at all levels. Its organization, as it had developed by November 1943, is shown by the chart on the following page.<sup>17</sup>

e. Personnel. The following table shows the authorized allotment of personnel to the Military Government Section at the end of November 1943:

<u>OFFICERS</u>			<u>ENLISTED MEN</u>		
<u>Rank</u>	<u>Am*</u>	<u>Br#</u>	<u>Rank</u>	<u>Am*</u>	<u>Br#</u>
Gen & Col	1	1	M/Sgt	1	
Lt Col	3	4	T/Sgt	1	
Maj	2	2	S/Sgt	2	1
Capt	6	4	Tec 3	2	
			Tec 4	2	
			Cpl		2
			Tec 5	2	
			Pfc		1
			Pvt		4
<b>Totals:</b>	<b>12</b>	<b>11</b>		<b>10</b>	<b>8</b>

Total Americans: 22

Total British : 19

COMBINED TOTAL : 41

---

17. MGS Office Memo No 13, 16 Nov 43 (G-5 AFHQ file: 310.1); AG NATOUSA ltr 200.3-134, 20 Nov 43.  
 \* AG NATOUSA ltr 200.3-164, 24 July 43.  
 # WE XII/1/4, wef 1 Dec 43 (AG AFHQ file: 321-1 AFHQ).

**ORGANIZATION OF MILITARY GOVERNMENT SECTION AFHQ**  
 November-December 1943

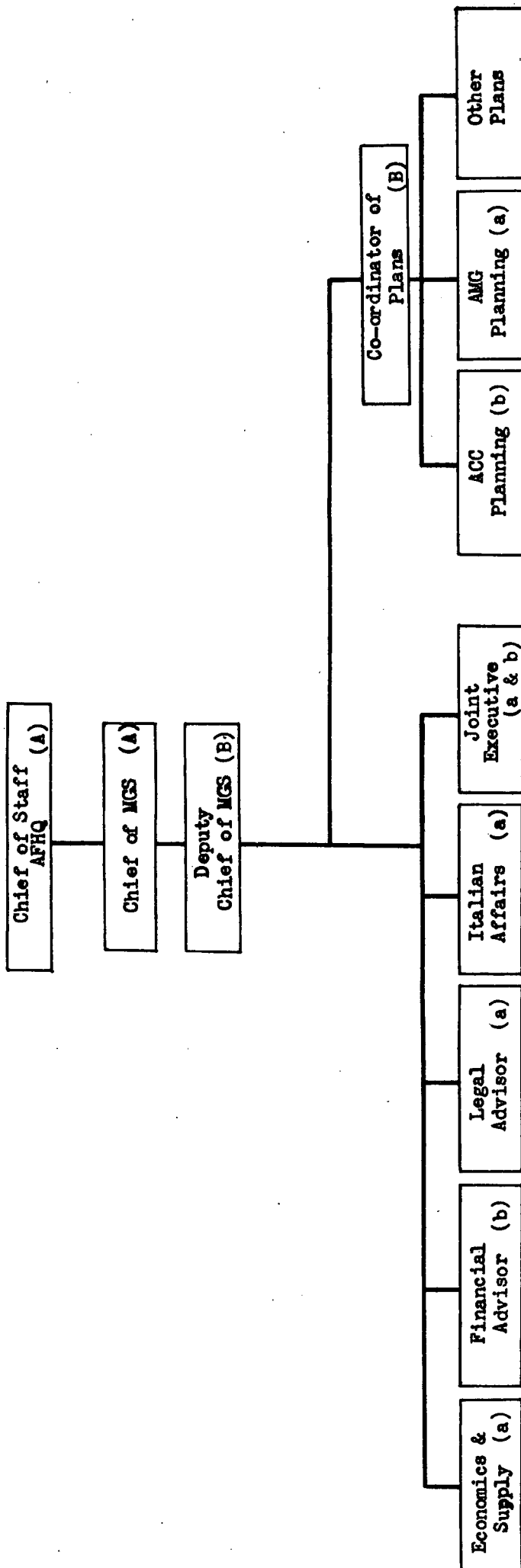

**NOTE:**  
 (A), (B) indicate that the whole office or subsection is either American or British.  
 (a), (b) indicate that the office or subsection is mixed but headed by an American or British officer.

### 3. Passive Air Defense and Civil Defense

#### Section AFHQ--NATOUSA

a. Activations. The Passive Air Defense and Civil Defense (PAD and CS) Advisor AFHQ was appointed on 13 December 1942,<sup>18</sup> but the Advisor's staff organization was not designated as a "section" until 21 September 1943.<sup>19</sup> On 20 June 1943, a separate Civil Defense Advisor's (CDA) Section NATOUSA was constituted, consisting of two American officers. These officers and their section, however, were reintegrated with the PAD and CD Section AFHQ on 19 November 1943.<sup>20</sup>

b. PAD and CD Advisors AFHQ--NATOUSA. Captain Iven B. Franks, Royal Navy, was appointed as the Passive Air Defense and Civil Defense Advisor to the Allied C-in-C on 13 December 1942 and continued in that appointment throughout the year 1943.<sup>21</sup> Colonel Harry L. White (A), who was liaison officer for the American forces, also served as Chief of the Civil Defense Advisor's (CDA) Section NATOUSA from 20 June 1943 until the integration of the NATOUSA Section with PAD and CD on 19 November 1943 when he became Deputy Chief of Section in charge of American PAD and CD activities.<sup>22</sup>

c. Functions. The functions of the combined organizations of PAD and CD Section AFHQ and the CDA's Sec-

---

18. AFHQ GO No 26, 13 Dec 42.

19. AFHQ GO No 56, 21 Sep 43.

20. NATOUSA GO No 42, 20 June 43; NATOUSA SO No 287, 19 Nov 43.

21. AFHQ GO No 26, 13 Dec 42.

22. See footnote 20 above. Statement by Lt Col S. E. H. Daw (B), PAD and CD Sect, 1 Mar 45.

tion NATOUSA during the year 1943 were:

- (1) To advise the Allied C-in-C (CG NATOUSA) on all matters pertaining to passive air defense and civil defense in the Theater.
- (2) To co-ordinate all PAD and CD activities (American, British, French, and Italian) in the Theater.
- (3) To operate under the direct supervision of the ACofS G-3 AFHQ, who had general staff responsibility for all military PAD matters in the Theater, and with Civil Affairs and Military Government Section on civil defense matters.
- (4) To reorganize the civil defense in NORTH AFRICA.
- (5) To advise on the procurement of equipment for PAD and civil fire fighting in NORTH AFRICA and Allied occupied ports in ITALY.
- (6) To develop plans and policies for PAD and CD operations in the Theater.
- (7) To prepare draft directives concerning PAD for the American forces.
- (8) To supervise the training of American and British PAD staff officers for task forces and bases.
- (9) To revise PAD plans and policies in the light of lessons learned in the Tunisian, Sicilian, and south Italian campaigns.

---

23. History of PAD and CD Section AFHQ (Dec 42--Feb 44), sect I, par 1. Statement of Lt Col S. E. H. Daw (B), PAD and CD Sect, 1 Mar 45.

(10) To prepare operational and training directives, and specifically the projected PAD and CD manual for the American forces in the Theater.

(11) To introduce PAD into the American Air Forces in the Theater.

(12) To introduce and develop PAD (Defense Passive Militaire) in the French Army.

(13) To assist the Supreme Headquarters Allied Expeditionary Force (SHAEP) in its PAD planning, organization, and policy formulation.

d. Organization. The organization of the PAD and CD Section AFHQ after the reintegration of the CDA Section NATOUSA on 19 November 1943 is shown by the chart <sup>24</sup> on the next page.

e. Personnel. The authorized personnel of the PAD and CD Section as of 1 December 1943 are shown in the following table:

<u>OFFICERS</u>			<u>ENLISTED MEN</u>		
<u>Rank</u>	<u>Am*</u>	<u>Br#</u>	<u>Rank</u>	<u>Am*</u>	<u>Br#</u>
Gen & Col	1	x 1	T/Sgt	1	
Lt Col	1	2	S/Sgt	1	
Maj	1	3	Tec 3	1	
Capt	1		Tec 4	1	
			Tec 5	1	
<b>Totals:</b>	<b>4</b>	<b>6</b>		<b>5</b>	
		<b>Total Americans:</b>	<b>9</b>		
		<b>Total British :</b>	<b>6</b>		
		<b>COMBINED TOTAL :</b>	<b>15</b>		

24. Crane Report, Chart No 22, 28 Sep 43. Statement of Lt Col S. E. H. Daw (B), PAD and CD Sect, 1 Mar 45.

\* Ltr, AG NATOUSA to PAD and CD Sect, 23 Nov 43 (AG NATOUSA file: 320.3/115 A-0).

# AFHQ WE XII/1/4, wef 1 Dec 43.

x Captain, Royal Navy.

ORGANIZATION CHART OF THE PAD AND CD SECTION AFHQ  
November 1943

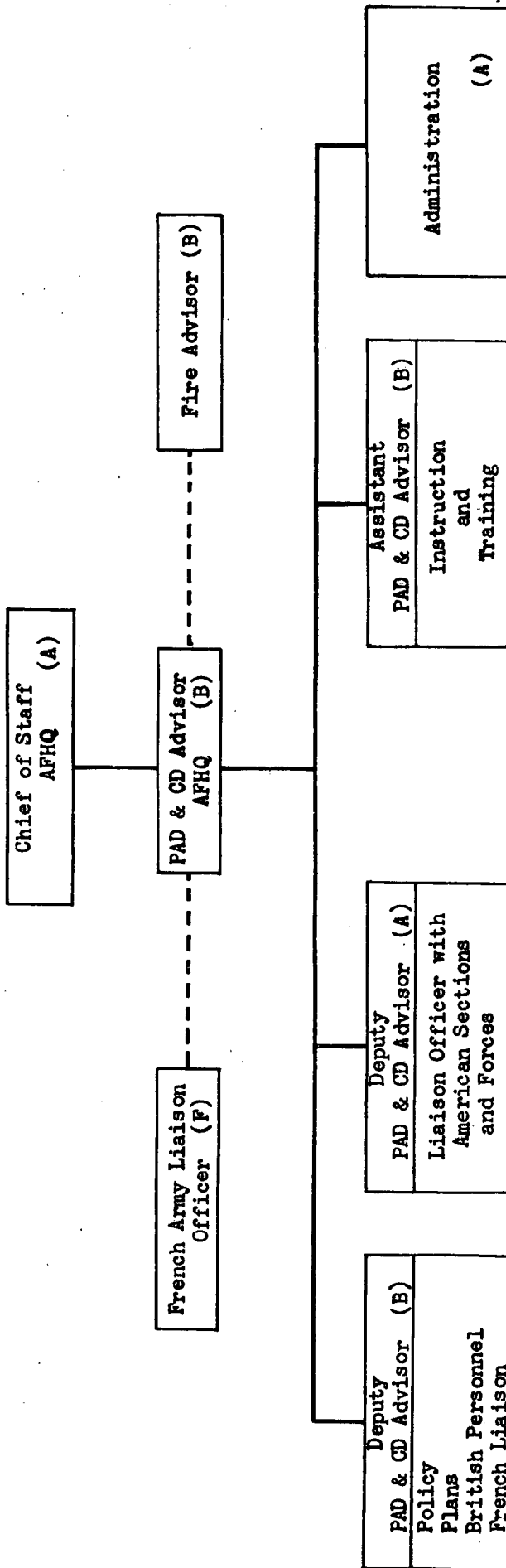

**LEGEND:**  
 \_\_\_\_\_ Command  
 - - - - - Co-ordination  
 (A), (B), (F) indicate that the entire office or subsection is either American, British, or French.

#### 4. Political and Economic Council AFHQ

a. Establishment and Discontinuance. The Political and Economic Council, established on 7 January 1943, held fourteen meetings at irregular intervals between January and July 1943 to deal with political and economic problems.<sup>25</sup> After the formation of the French Committee of National Liberation, however, French affairs became more stabilized, and the need for such an advisory body was no longer felt. Consequently the Council became inactive.

b. Functions. The functions of the Political and Economic Council were to advise the Allied C-in-C on political and economic problems arising primarily in NORTH AFRICA and to guide and co-ordinate the work of American and British experts in this field.<sup>26</sup> After the Committee became inactive, the British Resident Minister and the American Political Advisor dealt with such matters.

c. Composition. Major General W. B. Smith (A), Chief of Staff AFHQ, was Chairman of the Political and Economic Council during its existence. Admiral Sir Andrew B. Cunningham, Naval C-in-C, or his representative; Mr. Robert D. Murphy, personal representative of the President of the UNITED STATES; and Mr. Harold MacMillan, British Resident Minister, also were full members. Other members from interested AFHQ staff sections, particularly representatives from NAEB, NASBO, INC, and PAD

---

25. AFHQ GO No 4, 7 Jan 43. Min of Mtgs of Pol and Ec Council (SGS AFHQ file: 334.8-2).

26. AFHQ GO No 4, 7 Jan 43.

and CD, were invited to attend as required. An officer from the Office of Civil Affairs and one from the office of the British Resident Minister acted as a joint secretariat for the Council.<sup>27</sup>

5. Joint Commission (AFHQ) on Political Prisoners and Refugees in French NORTH and WEST AFRICA

a. Establishment. At the beginning of 1943 British and American public opinion was demanding the release of political prisoners, notably former members of the Spanish Republican Brigade, from French concentration camps in MOROCCO and ALGERIA. To investigate this situation and recommend release and disposal of the prisoners, the Allied C-in-C established on 15 January 1943 a Joint Anglo--French--American Commission on Political Prisoners and Refugees in French NORTH and WEST AFRICA.<sup>28</sup> A field party from the Commission visited French internment camps to gather necessary information. In late August the Commission made a report of its investigations and, having accomplished its mission, was dissolved.<sup>29</sup>

b. Functions. The function of the Commission was to visit places in French NORTH and WEST AFRICA containing political internees and:

---

27. Ibid. AFHQ Staff Memos No 17, 23 Feb 43, and No 19, 24 Feb 43.

28. Min of 1st Mtg of the Political and Economic Council, item 3, 12 Jan 43 (SGS AFHQ file: 334.8-2); AFHQ GO No 6, 15 Jan 43.

29. Ltr, Joint Chairmen to Eisenhower, 31 Aug 43 enclosing Report of Joint Commission for Political Prisoners and Refugees in French NORTH AFRICA, dated 25 Aug 43 (SGS AFHQ file: 334.8-2); Statement by Col S. S. Hill-Dillon, G-2 AFHQ, 8 Mar 45.



(1) To report the number and name of such persons of each nationality in each place, the reasons for detention, the evidence on which detention was ordered, and, if detained under sentence, a record of witnesses who testified and the substance of their testimony.

(2) To make appropriate recommendations in each individual case for release and disposal after release.

(3) To endeavor to obtain for such prisoners, prior to release, as tolerable living and sanitary conditions as possible.<sup>30</sup>

c. Composition. The Joint Chairmen of the Commission were Mr. S. H. Wiley, American Consul General at ALGIERS, and Mr. J. E. M. Carvell, British Consul General at ALGIERS. Other members represented the Judge Advocate General AFHQ--NATOUSA, the G-2 Section AFHQ, and the Civil Affairs Section AFHQ. Representatives of the Relief Administrator, PWB, Medical Section, Engineer Section, ISS, American Red Cross, and International Red Cross served in a consultative capacity.<sup>31</sup>

---

30. AFHQ GO No 6, 15 Jan 43.

31. Ibid.

## Chapter XV

### LIAISON STAFF ORGANIZATIONS

One special staff section and one committee had functions which were primarily liaison in nature. The Liaison Section AFHQ served all services of the Theater and all staff sections of the Headquarters as an intermediary in their dealings with the French and Italian military and naval authorities. Likewise, the Joint Re-armament Committee, while being particularly concerned with supplies and equipment, was another link between the Allies and the French. Indeed, for a time the JRC formed a part of the Liaison Section. Therefore these two organizations are discussed here in a separate chapter.

#### 1. Liaison Section AFHQ--NATOUSA

a. Activation. The Liaison Section of AFHQ was among the first of several sections to be organized and activated after the successful landings in NORTH AFRICA late in 1942. Announcement of the establishment of the Liaison Section was made on 4 December 1942.<sup>1</sup>

b. Chiefs of Section. Colonel Julius C. Holmes (A) was designated as the first Chief of the Liaison Section on 4 December 1942<sup>2</sup> and served until 19 June 1943 when he was succeeded by Colonel Joseph R. Burrill

---

1. AFHQ Staff Memo No 46, 4 Dec 42.  
2. Ibid. Col Holmes was promoted to brig gen wef. 30 June 43 by WD SO No 185, 4 July 43.

(A).<sup>3</sup> However, two more changes were made during 1943: the first occurring on 19 July when Brigadier General Sidney P. Spalding (A) became both the Chief of the Liaison Section and the Chairman of the Joint Rearmament Committee;<sup>4</sup> and the second change on 7 August when Colonel Lawrence Higgins (A) became the next Chief of the Liaison Section.<sup>5</sup>

c. Functions. When the Liaison Section was established, its relations with other agencies were limited to matters concerning the French military or civil authorities. However, as the campaigns in the Mediterranean area progressed, relations with several other nationalities were also handled through the Liaison Section.<sup>6</sup> The functions of the Section during 1943 were:

(1) To establish liaison and general relations with French military and civil authorities concerning military matters.

(2) To maintain a liaison mission at both the French High Command and the French Naval Headquarters, as well as at other required places; and to assure that the C-in-C's policies were known and carried out by the Allied liaison officers.

(3) To present to the French, and to follow through to a conclusion, all matters which were to be discussed between AFHQ sec-

---

3. AFHQ Staff Memo No 51, 19 June 43.

4. AFHQ GO No 42, 19 July 43.

5. AFHQ GO No 45, 7 Aug 43.

6. AFHQ Staff Memo No 47, 5 Dec 42, provides the basis for functions described in (1) through (5) inclusive.

tions and the French authorities.

(4) To receive initially French liaison officers accredited to AFHQ and to co-ordinate the work of the French Military Mission.

(5) To be responsible for the co-ordination with the Chief Civil Administrator of civil matters affecting the French authorities and having a military or politico-military character.

(6) To be responsible for the supervision of the functions of the Joint Rearmament Commission between 5 June and 7 August 1943.<sup>7</sup>

(7) To approve applications for the travel of foreigners<sup>8</sup> by American air transport in the Theater.<sup>9</sup>

(8) To establish relations with all foreign military missions or officers stationed in or visiting the Theater, and to manage their visits, quartering, and entertainment.<sup>9</sup>

(9) To supervise directly the activities of the Allied Liaison Service (a group, distinct from the Liaison Section, whose duties were largely with lower echelons in the Theater).<sup>10</sup>

---

7. AFHQ Staff Memo No 45, 5 June 43; NATOUSA GO No 74, 7 Aug 43; ltr AFHQ to All Concerned, 8 May 43 (SGS AFHQ file: 500-3).

8. "Foreigners" in this instance applied to all persons except Americans and subjects of Great Britain and of dominions which were at war against the Axis.

9. The Crane Report, Chart No 30, 28 Sep 43; memo ACoS to Liaison Sect, 8 Oct 43 (G-3 AFHQ file: 46/5.1).

10. AFHQ GO No 63, 18 Nov 43.

(10) To serve as the Liaison Section  
 for NATOUSA after 4 February 1943.<sup>11</sup>

d. Organization. The organization of the Liaison  
 Section AFHQ is shown by the chart on the next page.<sup>12</sup>

e. Personnel. The personnel authorized for the  
 Liaison Section at the date nearest November 1943 are  
 shown in the table below. On 8 November the American  
 authorization shown below was modified with the forma-  
 tion of the Allied Liaison Service (a pool of liaison  
 personnel for service with lower echelons) some of whose  
 personnel, in addition to other commitments, were to  
 "provide...for an increase in the staff of the Liaison  
 Section...as required."<sup>13</sup>

Rank	<u>OFFICERS</u>		<u>ENLISTED MEN</u>	
	Am* Oct 43	Br# Dec 43	Rank	Am* Oct 43
Col	2		S/Sgt	1
Lt Col	2	2	Sgt	1
Maj	1	3	Tec 4	2
Capt	1	1	Tec 5	2
			Pfc	1
			Pvt	1
Totals:	6	6		8

Total Americans: 14  
 Total British : 6

COMBINED TOTAL : 20

11. NATOUSA GO No 1, 4 Feb 43; NATOUSA GO No 28, 8 May 43; statement of Lt Col J. L. Tappin, Liaison Sect, 29 Jan 45. This dual role pertained only to the American personnel.

12. Crane Report, Chart No 30, 28 Sep 43; AFHQ GO No 63, 8 Nov 43.

13. See footnote 10 above.

\* AG NATOUSA ltr to CO Liaison Sect AFHQ, 29 Oct 43 (AG AFHQ file: 321/132).

# WE XII/1/4, 1 Dec 43 (AG AFHQ file: 321-1).  
 There were no British other ranks authorized.

ORGANIZATIONAL CHART OF THE LIAISON SECTION AFHQ-WAFOUSA,  
November 1943

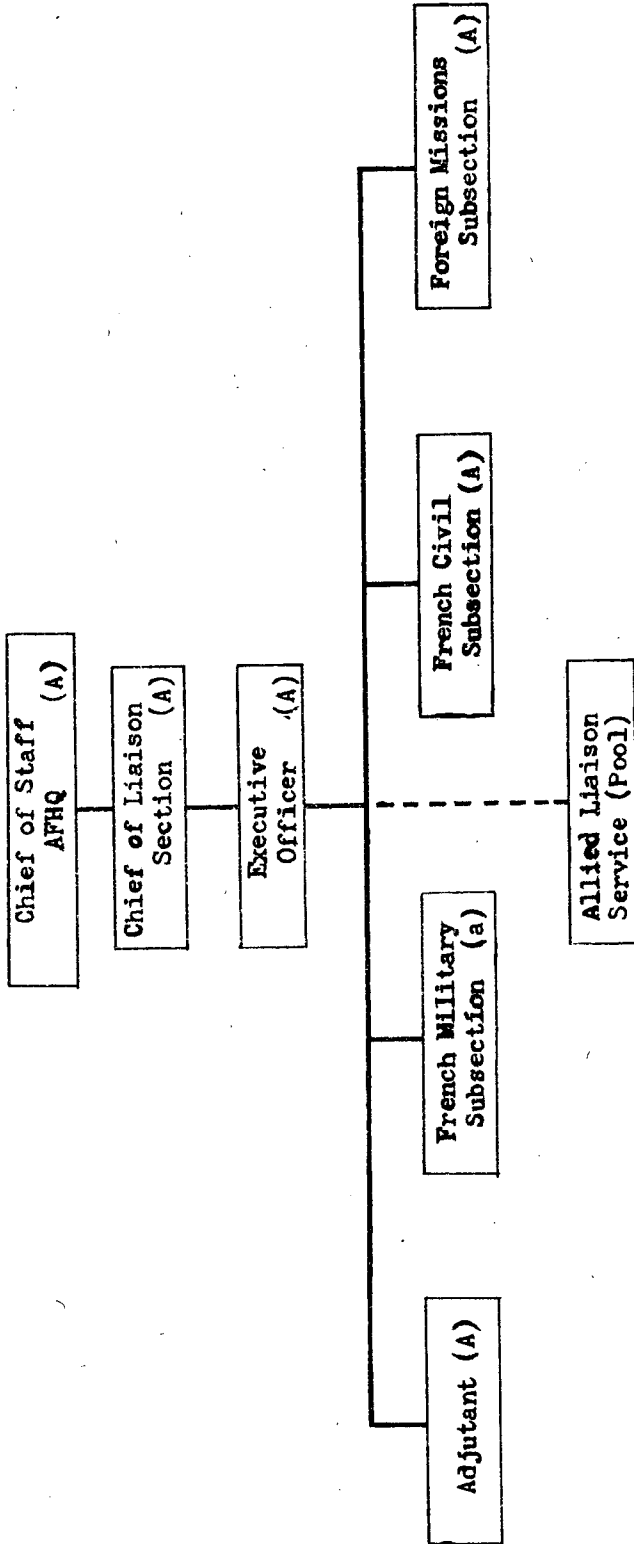

LEGEND:  
 ———— Command  
 - - - - Operational control  
 (A) Entirely American subsection  
 (a) Integrated subsection with an American officer in charge.

f. Allied Liaison Service. This organization was established on 8 November 1943 "to provide liaison between Allied commanders and foreign ground forces serving under them." It was a combined agency, mainly for liaison duties with lower echelons, and was placed under the direct supervision of the Liaison Section AFHQ.<sup>14</sup>

<sup>15</sup>  
The Service consisted of the following:

(1) Headquarters training and replacement center.

(2) Liaison detachments for assignment to headquarters of foreign corps and divisions in training and for attachment to foreign corps and divisions operating under them.

The manner in which this Allied organization of nearly 250 authorized personnel was to be distributed is of particular interest:<sup>16</sup>

The personnel for liaison with the French forces shall ultimately be 80% US and 20% British; for Polish forces 80% British and 20% US. To facilitate rapid procurement, initial variations from this proportion are authorized.

The authorized personnel statistics for the Allied Liaison Service in effect during November 1943 are shown in the table below. Since most of the liaison work at this time was being performed in conjunction with French forces, the American personnel figures are proportionately greater than the British.

---

14. AFHQ GO No 63, 18 Nov 43.

15. Ibid.

16. Ibid.

<u>OFFICERS</u>			<u>WARRANT OFFICERS</u>			<u>ENLISTED MEN</u>		
Rank	Am* Nov 43	Br# Nov 43	Rank	Am* Nov 43	Br# Nov 43	Rank	Am* Nov 43	Br# Nov 43
Col.	4	1	CWO		1	M/Sgt	3	
Lt Col	17	3	WOJG	1		S/Sgt	11	3
Maj	20	5				Tec 3	2	
Capt	15	4				Sgt		4
						Tec 4	14	
						Cpl		6
						Tec 5	24	
						Pfc	54	2
						Pvt		12
Totals:	56	13		1	1		108	27

Total Americans: 165

Total British : 41

COMBINED TOTAL : 206

## 2. Joint Rearmament Committee AFHQ--NATOUSA

a. Activation. The Joint Rearmament Committee was organized on 16 December 1942 as an AFHQ agency to deal with French rearmament problems.<sup>17</sup> Six months after its formation on 5 June 1943 the Joint Rearmament Committee was transferred to the Liaison Section AFHQ.<sup>18</sup> Then, on 7 August 1943, the Committee was again transferred from the Liaison Section AFHQ to Headquarters NATOUSA<sup>19</sup> where it remained throughout the rest of 1943.

b. Chairmen of the Committee. As the senior officer representing AFHQ on the Committee, Colonel William T. Gardiner (A) was the first Chairman.<sup>20</sup> However, when

\* Ltr AG NATOUSA to CO Hq Cmd AF Subj: "Organization of 2672d Hq Co Allied Liaison Service (Prov)" (AG NATOUSA file: 321/132 A+0).

# WE NA/177/1, 28 Oct 43.

17. AFHQ Staff Memo No 52, 16 Dec 42.

18. AFHQ Staff Memo No 45, 5 June 43.

19. NATOUSA GO No 74, 7 Aug 43.

20. See footnote 17 above.



the Committee was transferred to the Liaison Section AFHQ on 5 June 1943, Colonel Gardiner was succeeded by Lieutenant Colonel George L. Artamonoff (A).<sup>21</sup> He in turn served until Brigadier General Sidney P. Spaulding (A) relieved him on 7 August 1943 when the Committee was transferred to Hq NATOUSA.<sup>22</sup> General Spaulding was likewise succeeded on 7 October by Brigadier General Harold E. Loomis (A) who continued to serve as Chairman throughout the rest of 1943.<sup>23</sup>

c. Functions. The responsibilities and functions of the Committee were outlined on 16 December 1942<sup>24</sup> and remained generally unchanged throughout 1943 except for a few additions. The original memorandum stated that the Joint Rearmament Committee was:

(1) To be responsible to the Chief of Staff AFHQ.

(2) To maintain proper liaison with all general and special staff sections of AFHQ which were concerned with the work of the Committee.

(3) To receive all requests for military equipment from French sources.

(4) To develop a program for the rehabilitation of the French armed forces, taking into consideration the "degree of readiness" of French units for which equipment is in-

---

21. See footnote 18 above.

22. See footnote 19 above.

23. NATOUSA GO No 106, 7 Oct 43.

24. See footnote 17 above.

tended.

(5) To insure that the executive action necessary to implement the approved program is placed with the proper staff section.

(6) To co-ordinate with all agencies and organizations in matters pertaining to the Lend-Lease administration, the French authorities, or other matters concerned with rearming the French.

Following the Anfa Conference in January 1943, the program for the re-equipment of the French forces was greatly accelerated. It was made clear by 31 January that the Allied C-in-C was the final approving authority for French requisitions and could "modify such requisitions to conform to the availability of equipment and shipping and to the terms of the general policy."<sup>25</sup> At the same time that this executive power was announced by the C-in-C, the Joint Rearmament Committee was directed<sup>26</sup> to maintain an up-to-date schedule showing:

(1) How equipment issued by this headquarters (AFHQ; later by Hq NATOUSA) has been assigned by the French authorities.

(2) How the French authorities intend to assign future issues of equipment.

There were two exceptions to the apparent monopoly of the Joint Rearmament Committee in handling requests or making recommendations concerned with French rearma-

---

25. Min of the CofS Conf No 19, 29 Jan 43 (SGS AFHQ file: CofS Confs); and also AFHQ memo to All Concerned, 31 Jan 43 (AG AFHQ file: 400/322 A-M).

26. AFHQ memo to All Concerned, 31 Jan 43 (AG AFHQ file: 400/322 A-M).

ment. These were as follows:

(1) Allied commanders of those forces, which included French units under their command or adjacent to their areas actively operating against a common enemy, might furnish these French forces supplies from Allied reserves at their disposal.<sup>27</sup>

(2) The Petroleum Section of AFHQ handled all requests from the French forces concerning petroleum products.<sup>28</sup>

Other changes pertaining to command relationships during 1943 were as follows:

(1) Between 5 June and 7 August the responsibility for supervising the functions of the Joint Rearmament Committee became that of the Liaison Section AFHQ.<sup>29</sup>

(2) After 7 August the Committee, in the execution of its functions, was directly supervised by the Deputy Theater Commander NATOUSA.<sup>30</sup>

(3) By September the Joint Rearmament Committee had assumed the function of supervising the training of French ground forces in the use and maintenance of US equipment.<sup>31</sup>

d. Organization and Composition. In December 1942,

---

27. AFHQ Cir No 19, 9 Feb 43.

28. AFHQ Cir No 24, 19 Feb 43.

29. See footnote 18 above.

30. See footnote 19 above. See also Crane Report, Chart No 57, 28 Sep 43.

31. Crane Report, Chart No 57, 28 Sep 43.

G-3 and G-4 of AFHQ, the Allied Air and Naval Staffs, and "the C-in-C of French Land and Air Forces" were represented at the meetings of the Committee.<sup>32</sup> At this time, and for several months thereafter, the Committee was supervised by the Chief of Staff AFHQ. However, by 7 August 1943 the responsibility for rearming the French had become an American one, and the Joint Rearmament Committee, transferred from AFHQ, was placed directly under the supervision of the Deputy Theater Commander<sup>33</sup> NATOUSA.

By September 1943 the Joint Rearmament Committee was organized into two main divisions (as shown by the chart on the next page): a policy-formulating body, consisting of varying numbers of representatives from the air, ground, and naval services, and an "executive staff" with subsections which carried out the measures determined by the policy-formulating body.<sup>34</sup> Some mem-<sup>35</sup>bers of the "executive staff" attended policy meetings. The French, also represented at meetings of the policy-formulating body, had an equal voice in its discussions throughout the year. Although they remained in their own chain of command, the French developed an administrative system parallel to that of the Joint Rearmament Committee NATOUSA which facilitated co-ordination at all

---

32. See footnote 17 above.

33. See footnote 30 above.

34. See footnote 31 above.

35. G-3 AFHQ memo to All Concerned (Min of Fr Rearmament Conf 10 Dec 43), 13 Dec 43 (G-3 AFHQ file: 37/18).

**ORGANIZATIONAL CHART OF JOINT REARMAMENT COMMITTEE (NATOUSA)  
September 1943**

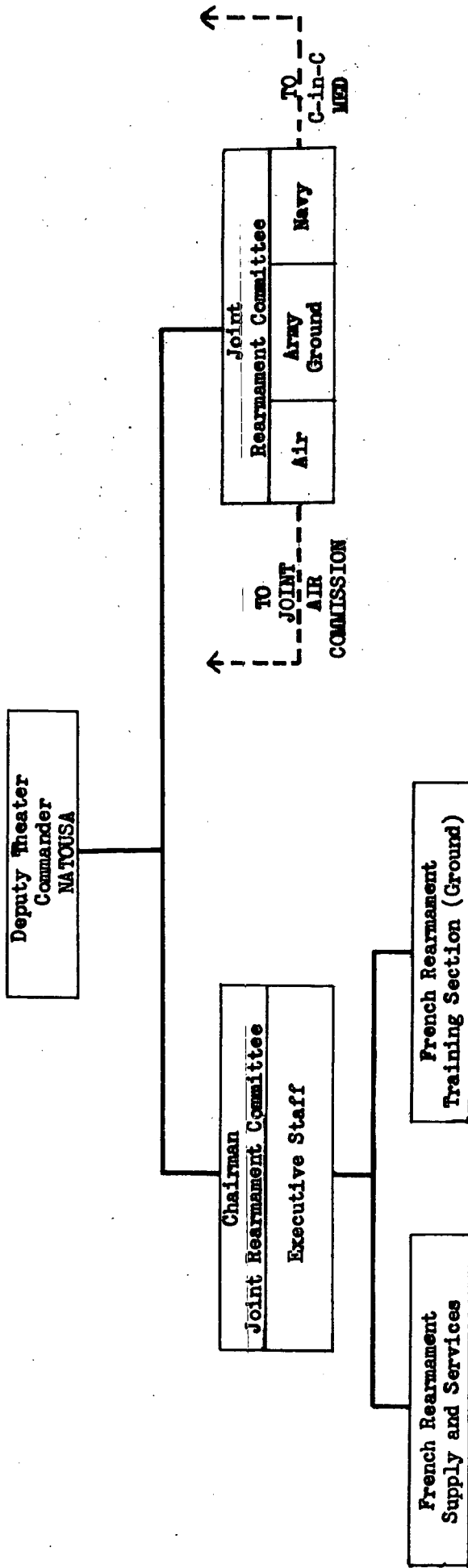

levels of command.

The table below shows the authorized American personnel strength for the Committee in effect during November 1943.<sup>37</sup> This personnel included the Chairman, his executive staff, and personnel of the administrative subdivisions. Personnel attending meetings of the policy-formulating body, on the other hand, were assigned<sup>38</sup> for the most part to other staff organizations.

<u>OFFICERS</u>		<u>WARRANT OFFICERS</u>		<u>ENLISTED MEN</u>	
Rank	Nov 43	Rank	Nov 43	Rank	Nov 43
Gen & Col	3	WOJG	1	M/Sgt	1
Lt Col	4			T/Sgt	1
Maj	3			S/Sgt	1
Capt	3			Tec 3	2
1st Lt	3			Tec 4	4
				Tec 5	2
				Pfc	2
Totals:	16		1		13
		Total Americans:		30	

36. "Note au sujet du Comite Mixte de Rearmement" furnished by the Chief of the French Military Mission to AFHQ, to the MTOUSA Hist Sect G-3 AFHQ, 13 Apr 45. This document points out that: (1) "Les Français et les Américains avaient voix égale dans les discussions, mais il n'y a pas eu, semble-t-il, de 'vote' décisif de l'adoption ou du rejet d'une demande." (2) "Les officiers français n'étaient pas sous les ordres de ces officiers généraux (chairmen of JRC)... car ils ont toujours été considérés comme les représentants de l'Etat-Major Général Français auprès de l'Officier Général Président du Comité." (3) "L'organisation française était suffisamment parallèle à l'organisation américaine et surtout travaillait en commun avec elle..."

37. AG NATOUSA ltr to Chm JRC and CO Hq Comd AF, 20 Oct 43 (AG NATOUSA file: 200.3/159 A-0).

38. See footnote 35 above.