

U.S. Army Research Institute of Environmental Medicine

Natick, Massachusetts

TECHNICAL REPORT NO. T11-03

DATE August 2011

ADA

PREDICTED THERMAL RESPONSES OF MILITARY WORKING DOG (MWD) TO CHEMICAL, BIOLOGICAL, RADIOLOGICAL, NUCLEAR (CBRN) PROTECTIVE KENNEL ENCLOSURE

Approved for Public Release; Distribution Is Unlimited

**United States Army
Medical Research & Materiel Command**

DISCLAIMERS

The opinions or assertions contained herein are the private views of the author(s) and are not to be construed as official or as reflecting the views of the Army or Department of Defense.

Citations of commercial organizations and trade names in this report do not constitute an official Department of the Army endorsement or approval of the products or services of these organizations.

Approved for public release; distribution unlimited.

USARIEM TECHNICAL REPORT T11-03

**PREDICTED THERMAL RESPONSES OF MILITARY WORKING DOG (MWD) TO
CHEMICAL, BIOLOGICAL, RADIOLOGICAL, NUCLEAR (CBRN)
PROTECTIVE KENNEL ENCLOSURE**

Larry G. Berglund, Ph.D.

Miyo Yokota, Ph.D.

William R. Santee, Ph.D.

Thomas L. Endrusick, B.S.

Adam W. Potter, B.A.

MAJ Scott J. Goldman, V.M.D., Ph.D.

Reed W. Hoyt, Ph.D.

Biophysics and Biomedical Modeling Division

August 2011

U.S. Army Research Institute of Environmental Medicine
Natick, MA 01760-5007

REPORT DOCUMENTATION PAGE

*Form Approved
OMB No. 0704-0188*

The public reporting burden for this collection of information is estimated to average 1 hour per response, including the time for reviewing instructions, searching existing data sources, gathering and maintaining the data needed, and completing and reviewing the collection of information. Send comments regarding this burden estimate or any other aspect of this collection of information, including suggestions for reducing the burden, to Department of Defense, Washington Headquarters Services, Directorate for Information Operations and Reports (0704-0188), 1215 Jefferson Davis Highway, Suite 1204, Arlington, VA 22202-4302. Respondents should be aware that notwithstanding any other provision of law, no person shall be subject to any penalty for failing to comply with a collection of information if it does not display a currently valid OMB control number.

PLEASE DO NOT RETURN YOUR FORM TO THE ABOVE ADDRESS.

1. REPORT DATE (DD-MM-YYYY)		2. REPORT TYPE		3. DATES COVERED (From - To)	
4. TITLE AND SUBTITLE				5a. CONTRACT NUMBER	
				5b. GRANT NUMBER	
				5c. PROGRAM ELEMENT NUMBER	
6. AUTHOR(S)				5d. PROJECT NUMBER	
				5e. TASK NUMBER	
				5f. WORK UNIT NUMBER	
7. PERFORMING ORGANIZATION NAME(S) AND ADDRESS(ES)				8. PERFORMING ORGANIZATION REPORT NUMBER	
9. SPONSORING/MONITORING AGENCY NAME(S) AND ADDRESS(ES)				10. SPONSOR/MONITOR'S ACRONYM(S)	
				11. SPONSOR/MONITOR'S REPORT NUMBER(S)	
12. DISTRIBUTION/AVAILABILITY STATEMENT					
13. SUPPLEMENTARY NOTES					
14. ABSTRACT					
15. SUBJECT TERMS					
16. SECURITY CLASSIFICATION OF:			17. LIMITATION OF ABSTRACT	18. NUMBER OF PAGES	19a. NAME OF RESPONSIBLE PERSON
a. REPORT	b. ABSTRACT	c. THIS PAGE			19b. TELEPHONE NUMBER (Include area code)

TABLE OF CONTENTS

<u>Section</u>	<u>Page</u>
List of Figures.....	iv-vi
List of Tables.....	vii
List of Equations.....	vii
Acronyms and Terms	viii-ix
Acknowledgments	x
Executive Summary	1
Introduction	2
Methods	2
Chemical Protective Kennel Cover	2
Dry and Evaporative Heat Transfer Characteristics of Protective Cover	3
Military Working Dog (MWD) Model	4
Physiological control mechanism.....	6
Results	10
Steady state conditions and responses	10
Responses to transient conditions.....	28
Quasi steady responses to constant conditions.....	29
Safe Stay Times	31
Discussion.....	34
Conclusions.....	35
Recommendations	36
References.....	37

LIST OF FIGURES

<u>Figure</u>		<u>Page</u>
1	Schematic of protective cover.	3
2	Chemical protective cover over kennel in test chamber with cover door closed and open.	3
3	Belgian Malinois MWD.	5
4	Schematic of MWD model.	6
5a	Kennel air temperatures for resting MWD with outside environment of 20°C(68°F), 50%RH with 0.4m/s(0.9mph) air movement in full shade.	11
5b	Water vapor pressures from resting MWD with 20°C, 50%RH outside conditions.	12
5c	Metabolism of resting MWD in and outside of kennel with 20°C, 50%RH full shade and 0.4m/s wind outside conditions.	12
5d	Panting responses in and outside of kennel with 20°C, 50%RH full shade and 0.4m/s wind outside conditions.	13
5e	Core temperature in and outside of kennel with 20°C, 50%RH full shade and 0.4m/s wind outside conditions.	13
5f	Skin temperature in and outside of kennel with 20°C, 50%RH full shade and 0.4m/s wind outside conditions.	14
5g	Cumulative water loss over 4 hours for MWDs inside and outside of kennel with 20°C, 50%RH full shade and 0.4m/s wind outside conditions.	14
6a	Air temperatures outside and inside kennel for standing and moving about activities with 20°C, 50%RH full shade and 0.4m/s wind outside conditions.	15
6b	Water vapor pressure for standing and moving about activities with 20°C, 50%RH full shade and 0.4m/s wind outside conditions.	15
6c	Metabolism for standing and moving about activities with 20°C, 50%RH full shade and 0.4m/s wind outside conditions.	16
6d	Panting ventilation for standing and moving about activities with 20°C, 50%RH full shade and 0.4m/s wind outside conditions.	16
6e	Core temperatures for standing and moving about activities with 20°C, 50%RH full shade and 0.4m/s wind conditions outside.	17
6f	Skin temperature for standing and moving about activities (~2 MET) with 20°C, 50%RH full shade and 0.4m/s wind conditions outside.	17
6g	Cumulative water loss for standing and moving about activities with 20°C, 50%RH full shade and 0.4m/s wind outside conditions.	18

<u>Figure</u>		<u>Page</u>
7a	Air temperature for resting Belgian Malinois with 5 & 10 mm thick fur when environment outside kennel is 30°C, 50%RH and 0.4m/s wind.	18
7b	Water vapor for resting Belgian Malinois with 5 & 10 mm thick fur when environment outside kennel is 30°C, 50%RH and 0.4m/s wind.	19
7c	Panting ventilation of resting Belgian Malinois with 5 & 10 mm thick fur when environment outside kennel is 30°C, 50%RH and 0.4m/s wind.	19
7d	Core temperature of resting Belgian Malinois with 5 & 10 mm thick fur when environment outside kennel is 30°C, 50%RH and 0.4m/s wind.	20
7e	Skin temperature of resting Belgian Malinois with 5 & 10 mm thick fur when environment outside kennel is 30°C, 50%RH and 0.4m/s wind.	20
7f	Cumulative water loss of resting Belgian Malinois with 5 & 10 mm thick fur when environment outside kennel is 30°C, 50%RH and 0.4m/s wind.	21
8a	Kennel air temperatures for Belgian Malinois MWDs with 5 and 10mm thick fur standing and moving about (2 MET) when environment outside kennel is 30°C, 50%RH and 0.4m/s.	21
8b	Water vapor pressure for Belgian Malinois MWDs with 5 and 10mm thick fur standing and moving about (2 MET) when environment outside kennel is 30°C, 50%RH and 0.4m/s.	22
8c	Metabolism of Belgian Malinois MWDs with 5 and 10mm thick fur standing and moving about (2 MET) when environment outside kennel is 30°C, 50%RH and 0.4m/s.	22
8d	Panting response of Belgian Malinois MWDs with 5 and 10mm thick fur standing and moving about (2 MET) when environment outside kennel is 30°C, 50%RH and 0.4m/s.	22
8e	Core Temperature of Belgian Malinois MWDs with 5 and 10mm thick fur standing and moving about (2 MET) when environment outside kennel is 30°C, 50%RH and 0.4m/s.	23
8f	Skin Temperature of Belgian Malinois MWDs with 5 and 10mm thick fur standing and moving about (2 MET) when environment outside kennel is 30°C, 50%RH and 0.4m/s.	23
8g	Cumulative water loss of Belgian Malinois MWDs with 5 and 10mm thick fur standing and moving about (2 MET) when environment outside kennel is 30°C, 50%RH and 0.4m/s.	24
9a	Core temperatures for resting activities with an outside environment of 35°C, 50%RH, full shade and 0.4m/s wind.	25
9b	Core temperatures for resting activities with an outside environment of 35°C, 20%RH, full shade and 0.4m/s wind.	25

<u>Figure</u>		<u>Page</u>
10a	Core temperatures for 2 MET activities with an outside environment of 35°C, 50%RH, full shade and 0.4m/s wind.	25
10b	Core temperatures for 2 MET activities with an outside environment of 35°C, 20%RH, full shade and 0.4m/s wind.	26
11a	Core temperatures for resting activities with an outside environment of 40°C, 50%RH, full shade and 0.4m/s wind.	26
11b	Core temperatures for resting activities with an outside environment of 40°C, 15.5%RH, full shade and 0.4m/s wind.	27
12a	Core temperatures for 2 MET activities with an outside environment of 40°C, 50%RH, full shade and 0.4m/s wind.	27
12b	Core temperatures for 2 MET activities with an outside environment of 40°C, 15.5%RH, full shade and 0.4m/s wind.	28
13	Core temperatures, panting and metabolic responses during intermitent activities and kennel occupancies with an outside environment of 25°C, 50%RH, full shade and 0.4m/s wind.	28
14	Core temperature, panting and metabolic responses during intermitent activities and kennel occupancies with an outside environment of 40°C, 50%RH, full shade and 0.4m/s wind.	29
15	Core temperatures, panting and metabolic responses during intermitent activities and kennel occupancies with a 40°C, 15%RH, full shade and 0.4m/s wind outside environment.	29
16	Steady state core temperatures for resting MWDs related to outside air temperature.	30
17a	Steady state core temperatures relative to outside conditions with 50%RH for MWDs standing and walking about.	30
17b	Steady state core temperatures relative to outside conditions with 9°C dew point for MWDs standing and walking about.	31
18a	Safe stay times for standing and moving about and resting activities with humid (constant 50%RH) outside environment and 10mm thick fur.	32
18b	Safe stay times for standing and moving about and resting activities with humid (constant 50%RH) outside environment and 5mm thick fur.	33
19a	Safe stay times for standing and moving about and resting activities with a low humidity (constant 9°C dew point) outside environment and 10mm thick fur.	33
19b	Safe stay times for standing and moving about and resting activities with a low humidity (constant 9°C dew point) outside environment and 5mm thick fur.	34

LIST OF TABLES

Table		Page
1	Measured dry and evaporative heat transfer properties for the protective cover.	10
2a	Safe Stay Times (SST) for $T_c \leq 40.5^\circ\text{C}$ and 10mm fur thickness.	31
2b	Safe Stay Times (SST) for $T_c \leq 40.5^\circ\text{C}$ and 5mm thick fur.	32

LIST OF EQUATIONS

Table		Units	Page
1	$Q_{k_dry} = (T_k - T_a) / R_{dk} - a$	W	3
2	$Q_{k_evap} = (P_k - P_a) / R_{pk} - a$	W	3
3	$i_{m\ k-a} = R_{dk-a} / (LR \cdot R_{pk} - a)$	dimensionless	3
4a	$P_{antVent1} = (0.0137 \cdot W_t + 0.4457) \cdot W_t$	L/min	7
4b	$P_{antVent2} = 1.5 \cdot P_{antVent1}$	L/min	7
5a	$E_{ffrT} = (T_{ex} - T_i) / (T_c - T_i)$		7
5b	$E_{ffrP} = (P_{ex} - P_i) / (P_s(T_{ex}) - P_i)$		7
6a	$T_{ex} = T_i + E_{ffrT} \cdot (T_c - T_i)$		8
6b	$P_{ex} = P_i + E_{ffrP} \cdot (P_s(T_{ex}) - P_i)$		8
7	MET = actual metabolism/resting metabolism		8
8	$BasalM = 3.5 \cdot W_t^{0.75}$	W	8
9	$R_f = 3.19 \cdot (\text{thick}/25.4)$; $clo = 0.155 \cdot 3.19 \cdot (\text{thick}/25.4)$	$\text{m}^2\text{C/W}$	8
10	$R_{pf} = R_f / (LR \cdot ipcl)$	$\text{m}^2\text{Torr/W}$	8
11	$M/BSA = q_{res} + q_{kc} + q_{skbf} + W_c/BSA \cdot C_c \cdot dT_c/dt$		8
12	$M = met \cdot BasalM + shiver \cdot BSA$		8
13	$BSA = 0.0002268 \cdot L_{ngth} \cdot W_t^{0.667}$	m^2	9
14	$dT_c/dt = (met \cdot BasalM/BSA + shiver) - q_{res} - q_{kc} - q_{skbf} \cdot BSA / (W_c \cdot C_c)$		9
15	$T_{c2} = T_{c1} + [dT_c/dt]_1 \cdot \Delta t$		9
16	$dT_{sk}/dt = (q_{kc} + q_{skbl} - q_{dry} - q_{diff}) \cdot BSA / (W_{sk} \cdot C_c)$		9
17	$T_{sk2} = T_{sk1} + [dT_{sk}/dt]_1 \cdot \Delta t$		9

ACRONYMS AND TERMS

BasalM	basal metabolic heat production
BSA	body surface area
CBRN	Chemical, Biological, Radiological, Nuclear
Cc	specific heat of core compartment
clo	unit of thermal resistance of clothing (1 clo = 0.155 °C m ² /watt)
dt	small time step
dTset	change in set point temperature
Δt	size of model's integration time step
EffrP	effectiveness of respiratory moisture exchange as measured by water vapor pressure.
EffrT	effectiveness of respiratory dry heat exchange as measured by respiratory air temperatures
im k-a	dimensionless vapor permeability of kennel cover
ipcl	dimensionless vapor permeability of clothing fabrics
LR	Lewis Relationship for comparing convection & vapor diffusion (2.2°C/Torr)
Lntgh	length of dog from nose to beginning of tail
M	total metabolic heat production
MET	ratio of metabolism to resting metabolism
MWD	military working dog
Qdry	dry heat flow
Qdiff	heat flow by water diffusion
Qk_dry	dry heat flow from inside kennel to outside environment
Qevap	evaporative heat flow
Qk_evap	evaporative heat flow from inside kennel to outside environment
qkc	heat flow by conduction from core to skin per unit surface area
qskbf	heat flow from core to skin per unit skin area via skin blood flow
Qres	total respiratory heat loss rate
qres	total rate of respiratory heat loss per unit area of skin
PantVent1	pulmonary air flow from panting with smallest tidal volume
PantVent2	pulmonary air flow from panting with larger tidal volume

Pa	water vapor pressure of ambient environment outside of kennel
Pi	water vapor pressure in inhaled air
Pk	water vapor pressure in kennel
Ps(T)	saturated vapor pressure of water at temperature T
Rf	thermal resistance of fur
RH	relative humidity of air
RHk	relative humidity of air in kennel
Rpf	evaporative heat flow resistance of fur
shiver	heat production by shivering per unit skin area
SST	safe stay time
Ta	air temperature
Tc	core temperature
Tcset	set point temperature of core compartment
Tex	temperature of exhaled air
Ti	temperature in inhaled air
Tk	air temperature in kennel
thick	fur thickness on back in mm
Torr	pressure in mm Hg
Tsk	skin temperature
Tskset	set point temperature of skin compartment.
Tr	mean radiant temperature
TTCR	human core set point temperature
TTSK	human skin set point temperature
Wc	weight of core compartment
Wsk	weight of skin compartment
Wt	total weight of dog
V	air speed
Vk	air speed in kennel

ACKNOWLEDGMENTS

The authors would like thank Robin Szczuka and Natick Soldier Research, Development and Engineering Center, Fabric Structures Team for providing the chemical protective dog tent.

EXECUTIVE SUMMARY

The thermal physiological responses of military working dogs (MWD) enclosed in a kennel with a chemical protective cover were evaluated under various conditions using a thermo-physiological simulation computer model. The intent was to quantify the thermal properties of the protective kennel enclosures and to estimate the varied effects on the MWD's physiological responses, including an estimated timeline the animal can safely remain in the enclosure for given ambient meteorological conditions.

More specifically, climate chamber studies of the chemical protective kennel cover were conducted over a range of environmental conditions using a human head thermal manikin with sweating capabilities to simulate the MWD. The simulations assumed that a MWD with a core temperature (T_c) of 40.5°C or greater experience heat-related illnesses. The simulated MWD responses indicated that a resting Belgian Malinois could remain in a covered kennel without experiencing heat-related illnesses for up to 12 h under external environmental conditions of: 30°C , 35°C and 40°C and 50%RH. However, if the animal is restless and moving about in the kennel, a 30°C outside condition could cause the dog's core temperature to approach or exceed an unsafe 40.5°C after about 5 hours.

The study results provide guidance for safe stay times in an actively-ventilated or passively-ventilated kennel enclosed by a chemical protective cover, and illustrated the thermo-regulatory value of reducing fur length. Please note that this new MWD thermo-physiological simulation model needs to be validated and verified through laboratory and field tests with actual MWDs.

INTRODUCTION

The military working dog (MWD) handler may need protection from toxic environments during transportation, temporary housing and field work. In field surveillance, they are often the first to enter and assess situations of suspected explosive and/or toxic chemical environments. In addition, it may not always be possible to quickly leave the contaminated area. If so, the handler can don a field protective mask and protective clothing and then setup a chemical protective tent kennel to house the MWD until the danger clears or they are able to exit the area. A significant additional danger in such situations is overheating of the dog and handler due to the additional insulation and water vapor impermeability of the chemical protective clothing for the handler and the protective tent for the MWD. While the thermal physiological effects of chem-bio protective gear on Soldiers have been carefully examined, little is known about the effect of the protective tent kennel on the MWD. The purpose of this study was to quantify the biophysical properties of the chemical protective kennel enclosure and to estimate the effects on the MWD's thermal physiological responses to predict how long the dog could safely remain in the enclosure for various ambient environmental conditions.

Climate chamber studies of the kennel cover were conducted using a human head thermal manikin with sweating capabilities to simulate the MWD. A thermo-physiological simulation computer model was developed to predict the possible thermal effects on the MWD and aid in the design and use of the protective kennel cover.

METHODS

Chemical Protective Kennel Cover

The chemical protective kennel cover supplied by US Army Natick Soldier Research Development and Engineering Center (NSRDEC) was tested in a climate-controlled chamber to quantify its insulation and vapor permeability properties. A schematic of the chemical protective kennel cover with dimensions is shown in Figure 1.

Figure 1. Schematic of protective cover.

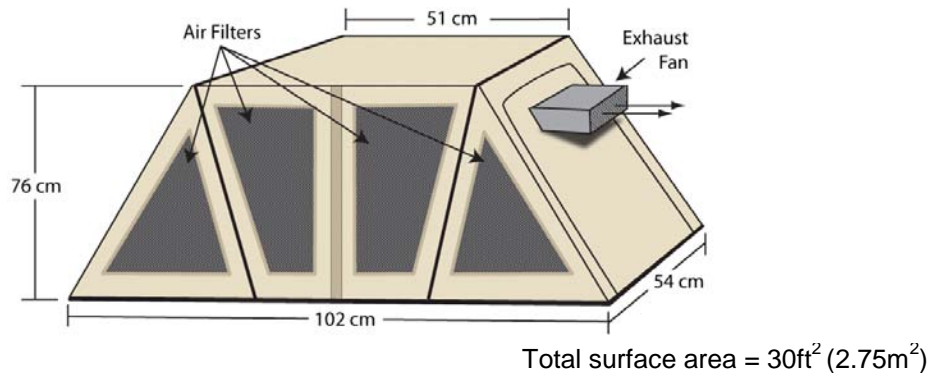

The tent shelter was placed on a table in the chamber during the test. For the test a dog cage (Deluxe Vari Kennel, Petmate, Arlington, Texas) supported the cover. In the field a dog cage would likely not be practical except for dog transport or similar situations, and the cover could be a free standing tent supported by cords and or a collapsible tube frame. A sweating human thermal manikin head was used as a heat and moisture source to simulate a dog for the tests. The views in Figure 2 are of the kennel entrance with the cover door closed (left view) and open (right view) revealing the manikin head. The climatic chamber controlled temperature (± 1 degree C), relative humidity ($\pm 3\%$), and the air flow (0.4 m/s) was horizontal from the right side of Figure 2. The temperature and humidity in both the kennel and chamber were measured and recorded every minute during each test.

Figure 2. Chemical protective cover over kennel in test chamber with cover door closed and open.



Protective cover with door closed.

Protective cover with door open.

Dry and Evaporative Heat Transfer Characteristics of Protective Cover

The flow of dry heat (Q_{k_dry}) from within the kennel (k) to the surrounding ambient (a) environment can be expressed as:

$Q_{k_dry} = (T_k - T_a) / R_{dk-a}$	W	Eq. 1
---------------------------------------	---	-------

Where T_k and T_a are the air temperatures in the kennel and outside ambient environment, and R_{dk-a} is the thermal resistance ($^{\circ}C/W$) to dry heat flow from the kennel air to the ambient environment.

Similarly, the heat (Q_{k_evap}) transferred by water vapor from inside evaporation sources to the outside can be expressed as:

$Q_{k_evap} = (P_k - P_a) / R_{pk-a}$	W	Eq. 2
--	---	-------

Where P_k and P_a are the water vapor pressures in the kennel and outside in the ambient environment, and R_{pk-a} is the resistance (Torr/W) to vapor heat flow from the kennel air to the ambient environment.

The dry and vapor heat are transported largely by air diffusion and mixing mechanisms in flowing from inside to outside and are related by the Lewis Relationship (ASHRAE, 2005a). The vapor permeability of the cover (im_{k-a}) is the ratio of the resistance to dry heat flow divided by resistance to vapor heat flow:

$im_{k-a} = R_{dk-a} / (LR \cdot R_{pk-a})$	dimensionless	Eq. 3
---	---------------	-------

where $LR = 2.2 \text{ } ^{\circ}C/Torr$ is the Lewis Relationship. Values of im range from 0 for impermeable materials to about 1.

Heat transfer measurements were made with chamber environments of 20, 25 and 30 $^{\circ}C$ and 50%RH, air speed (V) of 0.4 m/s, with the kennel cover's ventilation exhaust fan on and off and with the manikin head dry and sweating with a skin temperature of 33 $^{\circ}C$.

Military Working Dog (MWD) model

The preferred MWD breed for most field situations is the Belgian Malinois (also known as the Malinois variety of the Belgian Shepherd Dog) shown working in Figure 3. An adult is about 75-80 lbs (35kg) and about 4ft (1.2m) long not including tail. The Belgian Malinois we modeled was 35 kg in weight, 1.2 m length nose-to-rump, with 1.04 m² estimated surface area.

These MWDs are highly trained for specific odor recognition and warning tasks and have a useful working life to about 10 yrs of age. Anthropometric model input parameters are weight, length and fur length. For modeling purposes, the Belgian Malinois is somewhat like a small human with fur. However their thermoregulatory system, although similar to that of the human, does not include eccrine sweating mechanisms of the skin but instead relies on panting for evaporative cooling from tongue, nose, throat and respiratory surfaces.

Figure 3. Belgian Malinois MWD.



The USARIEM MWD model evolved from and is a combination of the Gagge (1971, 1986), Kraning (1997) and Yokota (2006) human thermo-physiological models with added or modified physiological mechanisms for the dog. A schematic of the MWD model is illustrated in Figure 4. The model represents the animal as two concentric lumped parameter physiological compartments (core, and skin) surrounded by the fur. The fur is modeled like clothing of the human and the kennel cover is modeled as an optional passive compartment surrounding the dog.

The core is about 95% of the total weight (depending on skin blood flow), which generates all the metabolic energy (M), and has a uniform temperature T_c . At this point in the development program, the model assumes the MWD does no external work (i.e., metabolic energy production = metabolic heat production). The core compartment loses heat to the skin by passive conduction through the tissues, and by actively controlling the flow of warm core blood to the skin for cooling. The core also loses heat directly to the immediate surroundings by respiration (Q_{res}) which includes panting.

Figure 4. Schematic of MWD model.

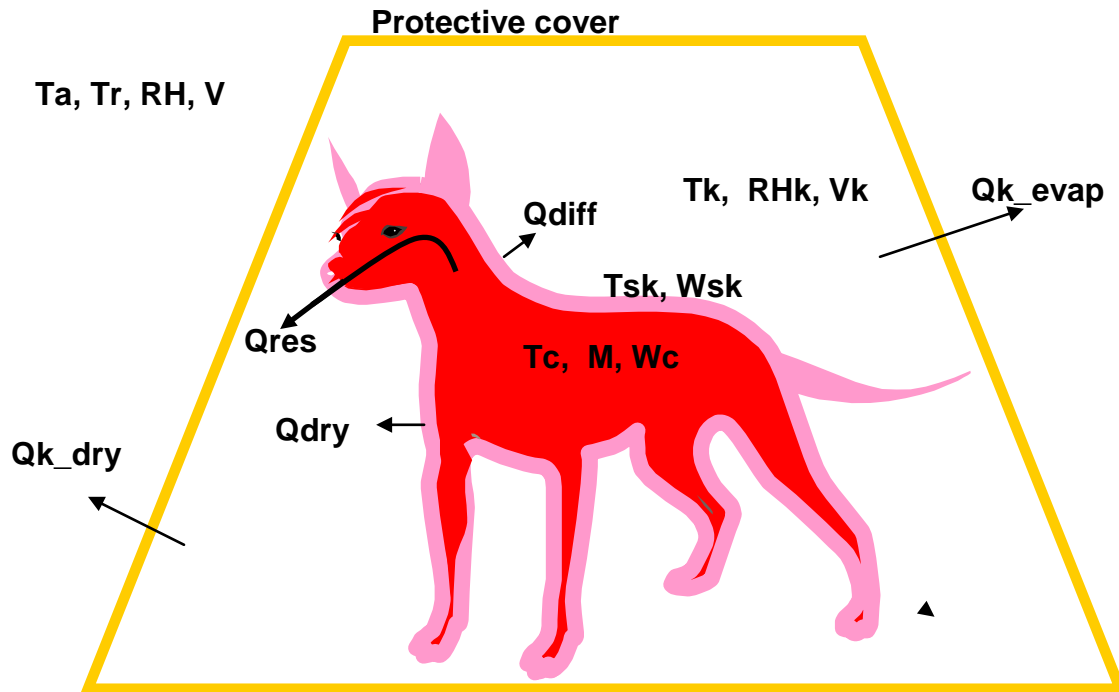

Terms defined in surrounding text or acronym list (see p. viii).

With this model the skin is also assumed to have a uniform temperature T_{sk} but no metabolic heat production. It receives heat from the core, and loses dry heat (Q_{dry}) by convection through the fur, and loses moist heat (Q_{diff}) by diffusing water vapor through the skin and fur. Though simple, this is a reasonable model for warm conditions that has been successfully used in modeling human thermal responses to warm and hot environments.

Physiological control mechanism

The model regulates core temperature (T_c) by actively adjusting skin blood flow, panting, and shivering (Hellstrom, 1967). The skin blood flow and shivering controls are proportional to deviations in core and skin temperatures from their respective set point temperatures (T_{cset} , T_{skset}). However the normal core and skin body temperatures of dogs in neutral thermal conditions are about 1.5°C higher than the human's 36.8°C core temperature (T_{TCR}) and 33°C skin temperature (T_{TSK}) set points (Kanno, 1982; Refinetti, 2003). Currently the computer model allows the user to adjust the set points by adding an increment (dT_{set}) to the human set points ($T_{cset}=T_{TCR}+dT_{set}$; $T_{skset}=T_{TSK}+dT_{set}$). At present, dT_{set} is the same for both core and skin.

Panting, which the dog uses in place of sweating, is different from any heat loss mechanism used by the human. Panting is a higher frequency, smaller tidal volume respiratory motion superimposed on the lower frequency, larger tidal volume respiratory movements used to for gas exchange. Panting does not affect gas exchange, but rather promotes evaporative cooling from the upper respiratory tract.

The literature indicates that panting is regulated approximately by a three position on-off respiratory control mechanism with two levels of flow depending on body temperatures (Goldberg et al., 1981). To minimize the metabolic energy needed to move air in and out across the evaporation surfaces when panting, the breathing rate is increased to approximately the elastic natural frequency of the chest and lungs (thoracic cavity and respiratory system) and two sizes of panting tidal volume are used (Hemingway, 1961; Crawford, 1962; Schmidt-Nielsen, 1970; Meyer, 1989). The panting frequency depends on individual MWD anthropometrics. Analysis of data in the literature generated the following expressions for MWD panting pulmonary ventilation (PantVent1 and PantVent2):

$$\text{PantVent1} = (0.0137 \cdot W_t + 0.4457) \cdot W_t \quad \text{L/min} \quad \text{Eq. 4a}$$

$$\text{PantVent2} = 1.5 \cdot \text{PantVent1} \quad \text{L/min} \quad \text{Eq. 4b}$$

where W_t is the dog's weight (kg). The MWD model uses panting control inputs similar to those of the human model's sweat control, adjusted for the dog's set point temperatures, to start, stop, and adjust levels of panting. Currently, PantVent1 starts when compartment temperatures exceed the set-points by 0.1°C , and goes to the higher panting level (PantVent2) when temperatures rise by 0.2°C . The heat loss by respiration with or without panting depends on the difference in energy content between exhaled and inhaled air. Data in the literature indicates that thermal and moisture ventilation effectiveness (EffrT and EffrP) values are about 0.82 and 0.84 respectively. Ventilation effectiveness is defined as:

$$\text{EffrT} = (\text{Tex} - \text{Ti}) / (\text{Tc} - \text{Ti}) \quad \text{Eq. 5a}$$

$$\text{EffrP} = (\text{Pex} - \text{Pi}) / (\text{Ps}(\text{Tex}) - \text{Pi}) \quad \text{Eq. 5b}$$

where the subscripts ex and i indicate exhaled and inhaled temperature and vapor pressure conditions and $\text{Ps}(\text{Tex})$ is saturated vapor pressure of water at temperature Tex . If the dog's exhaled air was at core temperature and saturated, the ventilation effectiveness for temperature and moisture would both be 1.

Rearranging eq. 5a and 5b enables the exhaled air temperature (Tex) and water vapor pressure (Pex) to be estimated:

$$\text{Tex} = \text{Ti} + \text{EffrT} \cdot (\text{Tc} - \text{Ti}) \quad \text{Eq. 6a}$$

$$\text{Pex} = \text{Pi} + \text{EffrP} \cdot (\text{Ps}(\text{Tex}) - \text{Pi}) \quad \text{Eq. 6b}$$

Further, the dog's higher T_c , by approximately dT_{set} ($+1.5^\circ\text{C}$) offset over the human's, enhances its respiratory heat loss potential.

The model quantifies metabolism (M) with the dimensionless MET unit as:

$$\text{MET} = \text{actual metabolism}/\text{resting metabolism} \quad \text{Eq. 7}$$

Where resting or basal metabolism (BasalM) (ASHRAE, 2005b) is:

$$\text{BasalM} = 3.5 \cdot W_t^{0.75} \quad \text{W} \quad \text{Eq. 8}$$

Walking can be in the 2 to 3 MET range depending on speed. When in the kennel, the MWD's metabolism is estimated to be in the 1 to 2 MET range.

The thermal insulation of the MWD's fur depends on its thickness (Folk, 1974; Hammel, 1955; Schmidt-Nielsen, 1979). Clothing thermal resistance is commonly quantified with the clo unit. A winter business suit has a resistance of about 1 clo, while summer trousers and a short sleeved shirt is about 0.5 clo. Further, 1 clo = $0.155 \text{ m}^2\text{C/W}$. The model estimates the thermal resistance of fur (R_f) as:

$$R_f = 3.19 \cdot (\text{thick}/25.4); \text{ clo} = 0.155 \cdot 3.19 \cdot (\text{thick}/25.4) \quad \text{m}^2\text{C/W} \quad \text{Eq. 9}$$

where "thick" is the fur thickness in mm on the back. The fur thickness on the back of a Belgian Malinois is about 10mm giving its coat an insulation level of approximately 1.26 clo. If in hot conditions, when the fur is sheared to about a 5mm thickness, the insulation decreases to approximately 0.63 clo.

The energy resistance to vapor flow through the fur (R_{pf}) is estimated by the Lewis Relationship using vapor permeability common for woven fabrics ($ipcl=0.45$):

$$R_{pf} = R_f / (LR \cdot ipcl) \quad \text{m}^2\text{Torr/W} \quad \text{Eq. 10}$$

Energy balances of each compartment enable the rate of energy and temperature gain of the compartment to be determined. The energy balance for the core compartment is:

$$M/BSA = q_{res} + q_{kc} + q_{skbf} + Wc/BSA \cdot Cc \cdot dT_c/dt \quad \text{Eq. 11}$$

Where M is total metabolic heat production:

$$M = \text{met} \cdot \text{BasalM} + \text{shiver} \cdot \text{BSA}, \quad \text{Eq. 12}$$

BSA is body surface area, q_{res} is the heat loss from normal respiration with or without panting, q_{kc} is heat loss by conduction through body tissue to the skin, q_{skbf} is

heat loss from core by blood flow to a given area of the skin. The right term in equation 11 is the rate of energy storage in the core where C_c is specific heat of the tissue (0.97W h/(kg °C)). BSA is estimated with the Cowgill (1927) equation:

$$BSA = 0.0002268 \cdot Lngth \cdot Wt^{0.667} \quad m^2 \quad \text{Eq. 13}$$

Where Wt (kg) is the dog's weight and $Lngth$ (m) is the dog's length from nose to beginning of tail. The MWD model at present uses conductance values between skin and core measured on humans and skin blood flow control equations also from human models. At present, the conductance is un-adjustable for body fat. By rearranging eq 11, 7 and 8, the rate of core temperature change (dT_c/dt) is:

$$dT_c/dt = (met \cdot BasalM/BSA + shiver) - q_{res} - q_{kc} - q_{skbf} \cdot BSA / (W_c \cdot C_c) \quad \text{Eq. 14}$$

This can be step-wise integrated over small time steps (Δt) to find the next core temperature (T_{c2}) after the time step relative to its present temperature (T_{c1}):

$$T_{c2} = T_{c1} + [dT_c/dt]_1 \cdot \Delta t \quad \text{Eq. 15}$$

Similarly an energy balance for the skin compartment rearranged for dT_{sk}/dt yields:

$$dT_{sk}/dt = (q_{kc} + q_{skbl} - q_{dry} - q_{diff}) \cdot BSA / (W_{sk} \cdot C_c) \quad \text{Eq. 16}$$

where q_{dry} is the dry convection and radiation heat loss rate from the skin to the surrounding environment and q_{diff} is the vapor heat loss for moisture diffusion from the skin.

$$T_{sk2} = T_{sk1} + [dT_{sk}/dt]_1 \cdot \Delta t \quad \text{Eq. 17}$$

In this step-by-step process the time responses of T_c and T_{sk} and related physiological items can be rationally determined.

Energy and moisture balances between the dog and the ambient environment results in similar step wise integrations of the kennel's inside temperature (T_k) and humidity ratio (w_k). At present, the model only considers dry thermal and water storage in the kennel's air and neglects heat storage in fabric, filters and support structures. As a result, the predicted temperature and humidity in the kennel can change rapidly. Adding thermal and moisture capacitance for kennel and cover materials would likely slow the modeled temperature and humidity changes of the kennel air.

RESULTS

The MWD model together with the kennel cover's measured thermal and moisture properties were used to simulate a Belgian Malinois's responses to various environments, metabolic activity levels and fur thicknesses with the MWD outside the kennel, inside with fan on and inside with fan off. Steady and transient response results and estimated safe stay times are presented in the following sections.

The steady-state dry and evaporative heat transfer properties for the protective kennel cover are shown in Table 1. The resistances to both dry heat and vapor heat flow decreased by 17% when fan is on.

Table 1. Measured dry and evaporative heat transfer properties for the protective kennel cover.

Fan on/off	Resistance to dry heat flow R _{dk-a} (°C/W)	Resistance to vapor heat flow R _{pk-a} (Torr/W)	vapor permeability im _{k-a}
on	0.1083	0.226	0.2174
off	0.1299	0.272	0.2171

The ventilation exhaust air flow (V_{ex}) from the kennel cover when the fan on was measured by traversing the exhaust outlet with a hot wire anemometer. The exhaust air flow measured with the tent door sealed and open (Figure 2) were:

$$\begin{aligned} V_{ex} &= 6.33 \text{ L/s} && \text{tent door closed} \\ V_{ex} &= 7.06 \text{ L/s} && \text{tent door open.} \end{aligned}$$

Opening the door with the fan running increased ventilation air flow by about 10%. The dry and vapor heat flow resistances and air flow values imply that the large high performance particle and chemical filters in the vertical side walls of the cover have a relatively low flow resistance which suggests that when fan is off or disabled some ventilation air flow will occur.

Steady State Conditions and Responses

MWD responses to constant exposure conditions were simulated for outside humidity of 50%RH and a drier humidity with a 9°C dew point temperature, fully shaded sun and 0.4 m/s wind with air temperatures of 20°C, 25°C, 30°C, 35°C and 40°C. Further the MWD was modeled for normal and thinner fur, and resting and standing activities (1 & 2 MET) levels. The simulated responses to 20°C and 30°C outside conditions are presented in following graphs. Figures 5 & 6 present the 20°C 50%RH results for 1 and 2 MET activities. At 20°C and 50% RH the dew point is 9°C.

The air temperature in the kennel (Figure 5a) is about 5°C higher than outside due to the cover's thermal insulation together with the resting MWD's heat production. Water vapor pressures from resting MWD with 20°C, 50%RH outside conditions are shown in Figure 5b. Heat production in Figure 5c is elevated for this resting state because of shivering. The MWD with 5mm thick fur shivers more than with 10mm thick fur and causes the kennel's temperature and humidity to be slightly warmer and more humid (Figure 5b). The metabolism is most elevated when the MWD is resting outside with the thinner 5mm fur. In the kennel, it is warmer (Figure 5a) and shivering metabolism is reduced. All of the metabolic responses with 20°C outside conditions exhibit some shivering to regulate T_c making panting unnecessary (Figure 5d). Metabolic rate patterns (Figure 5c) are associated with similar patterns in heat storage and core temperature.

Figure 5a. Kennel air temperatures for resting MWD with outside environment of 20°C(68°F), 50%RH with 0.4m/s(0.9mph) air movement in full shade.

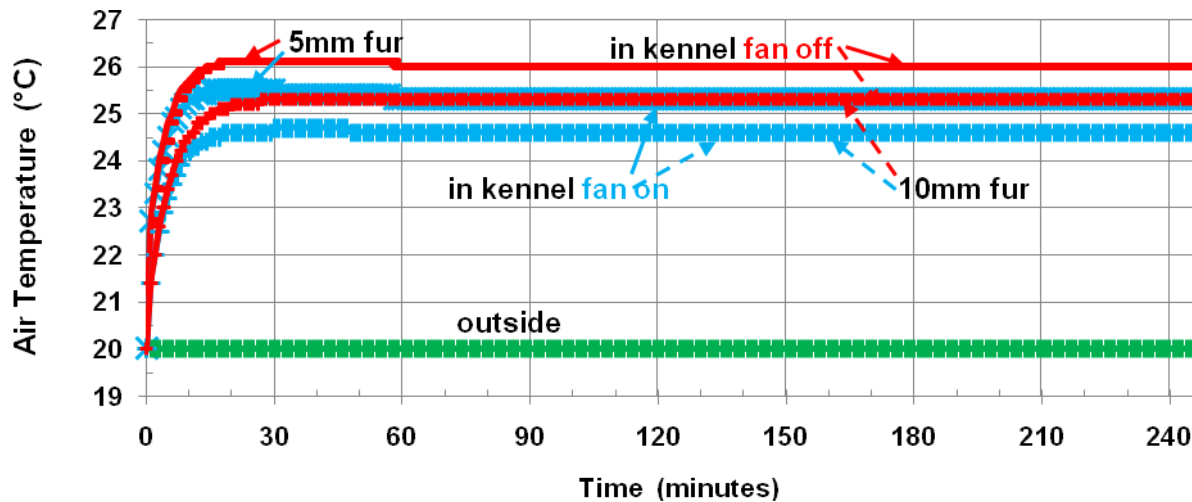

Figure 5b. Water vapor pressures from resting MWD with 20°C, 50%RH outside conditions.

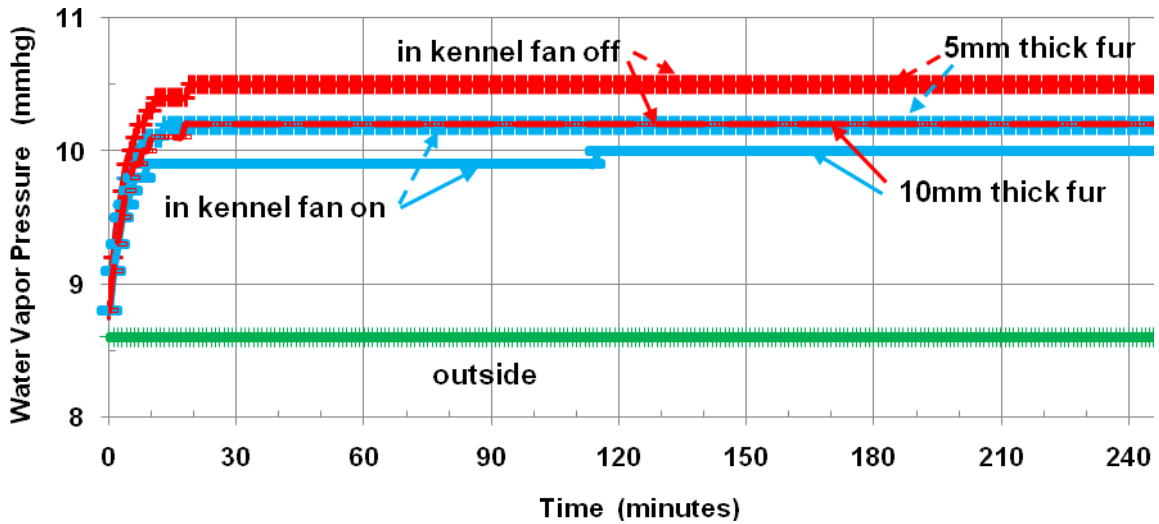

Figure 5c. Metabolism of resting MWD in and outside of kennel with 20°C, 50%RH full shade and 0.4m/s wind outside conditions.

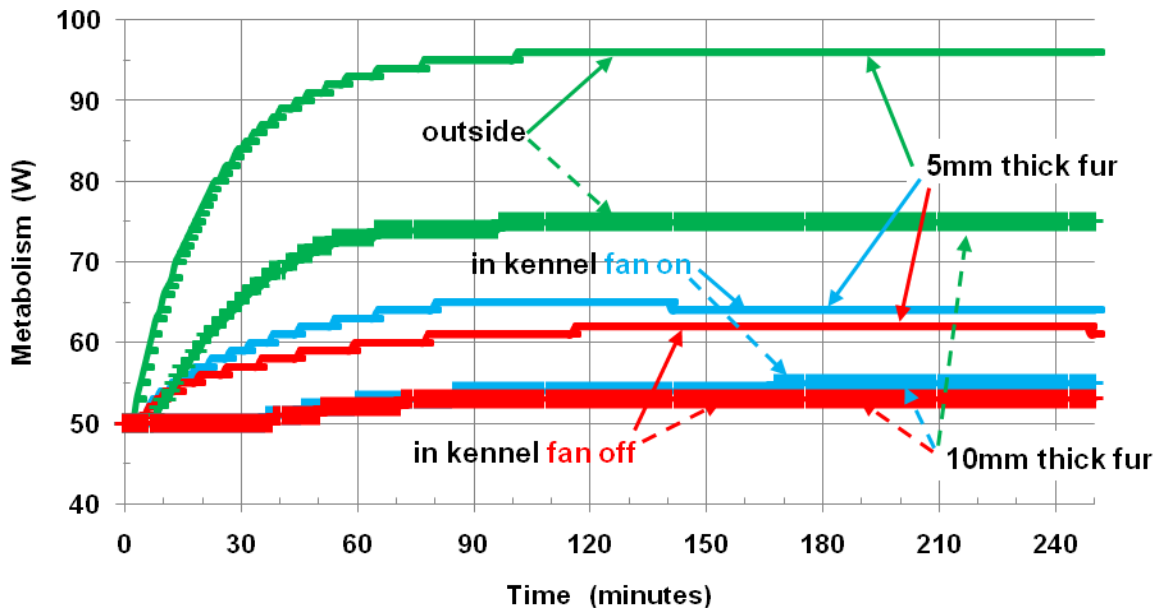

Figure 5d. Panting responses in and outside of kennel with 20°C, 50%RH full shade and 0.4m/s wind outside conditions.

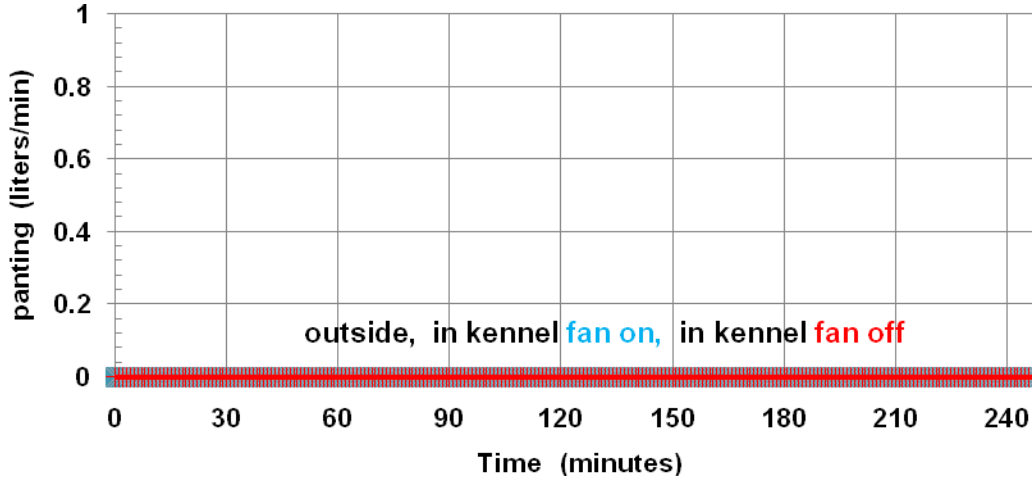

Figure 5e. Core temperatures in and outside of kennel with 20°C, 50%RH full shade and 0.4m/s wind outside conditions.

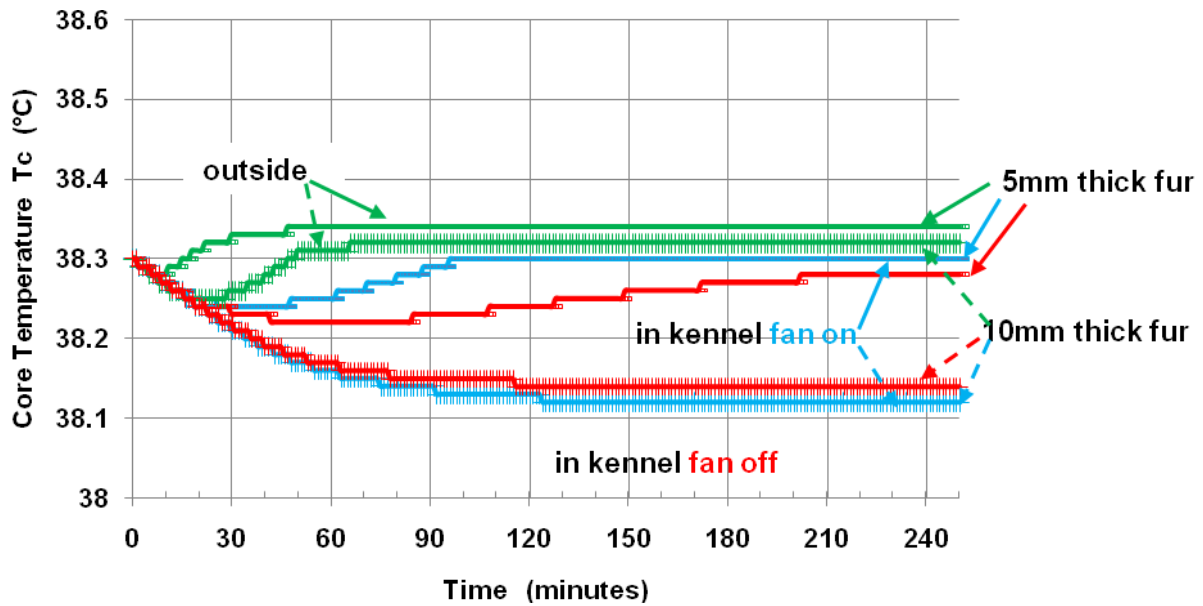

Figure 5f. Skin temperature in and outside of kennel with 20°C, 50%RH full shade and 0.4m/s wind outside conditions.

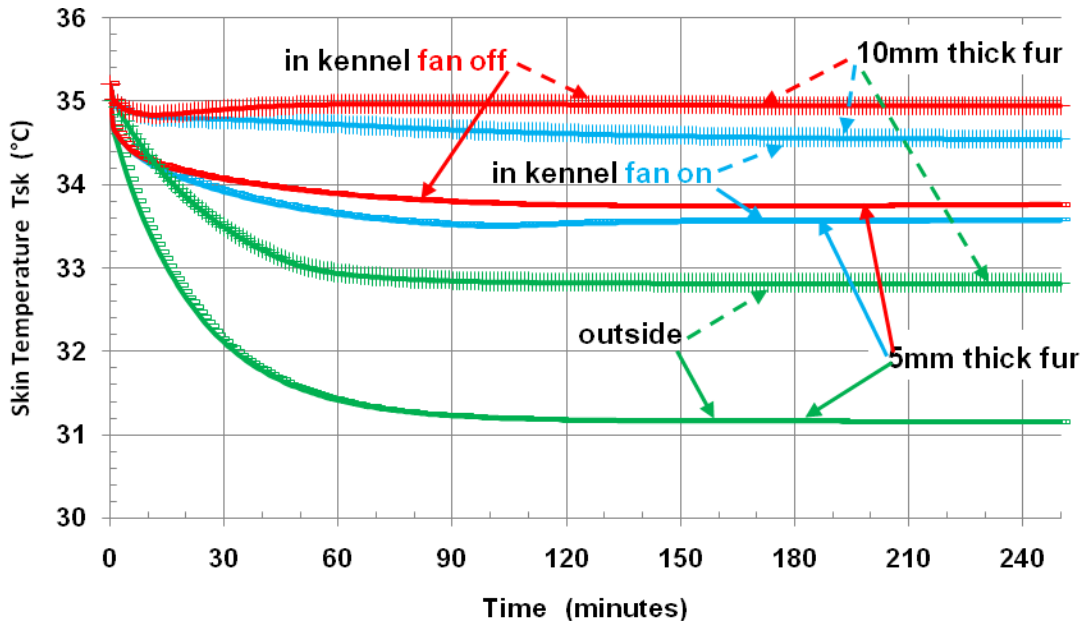
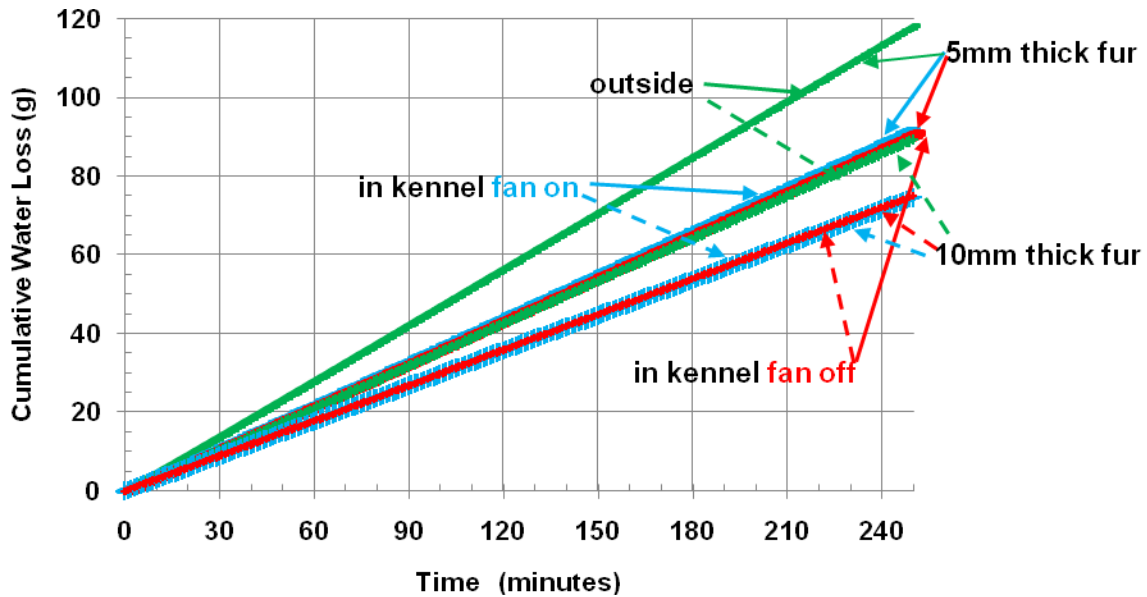

Figure 5g. Cumulative water loss over 4 hours for MWDs inside and outside of kennel with 20°C, 50%RH full shade and 0.4m/s wind outside conditions.



The simulated responses for standing and moving about (2 MET) activities of the MWD with 20°C, 50%RH outside and full shade conditions are displayed in Figures 6a-g. The standing and moving about activities have metabolisms (Figure 6c) of about 100 watts which raises temperatures and humidities (Figure 6a, b) inside the kennel accordingly. Shivering is not predicted to be necessary to maintain core temperatures

(Figure 6e) except for when the MWD is outside the kennel with shortened 5mm fur. However in contrast, the non-shivering MWDs at these conditions require some intermittent panting (Figure 6d). For the MWD with normal 10mm fur thickness in the kennel with the fan off, panting is most steady with a 32 Liter/min panting ventilation rate with short bursts to 49 Liter/min. With the fan on, the 32 L/min panting is less steady and the bursts to 49L/min are less frequent. The panting and resulting increased evaporation from respiratory surfaces increases the MWD's water loss (Figure 6g).

Figure 6a. Air temperatures outside and inside kennel for standing and moving about activities with 20°C, 50%RH full shade and 0.4m/s wind outside conditions.

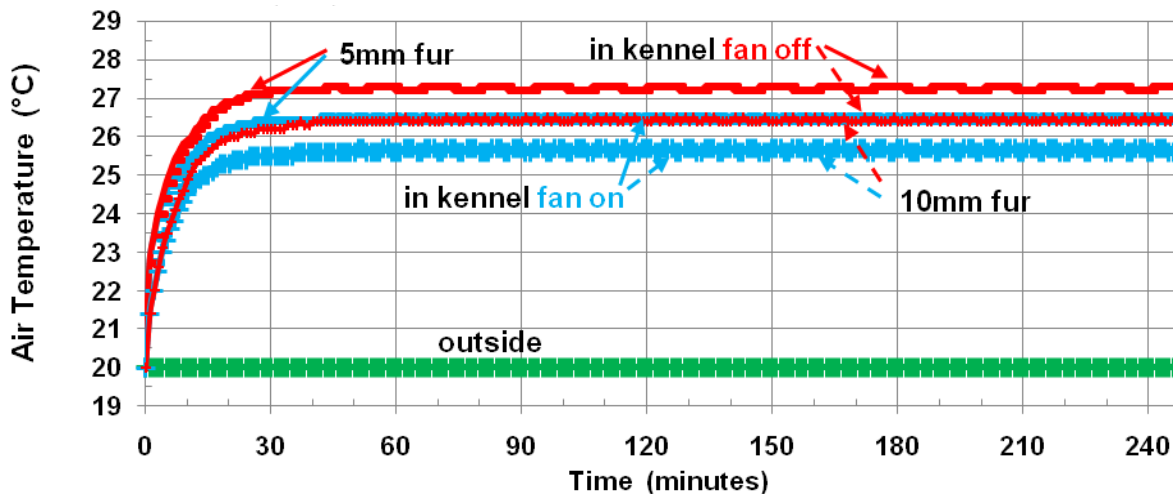

Figure 6b. Water vapor pressure for standing and moving about activities with 20°C, 50%RH full shade and 0.4m/s wind outside conditions.

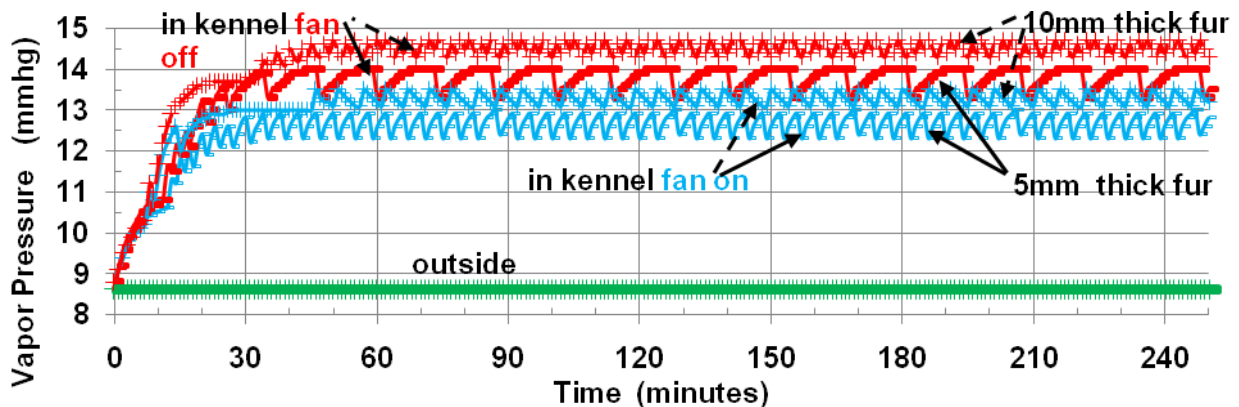

Figure 6c. Metabolism for standing and moving about activities with 20°C, 50%RH full shade and 0.4m/s wind outside conditions.

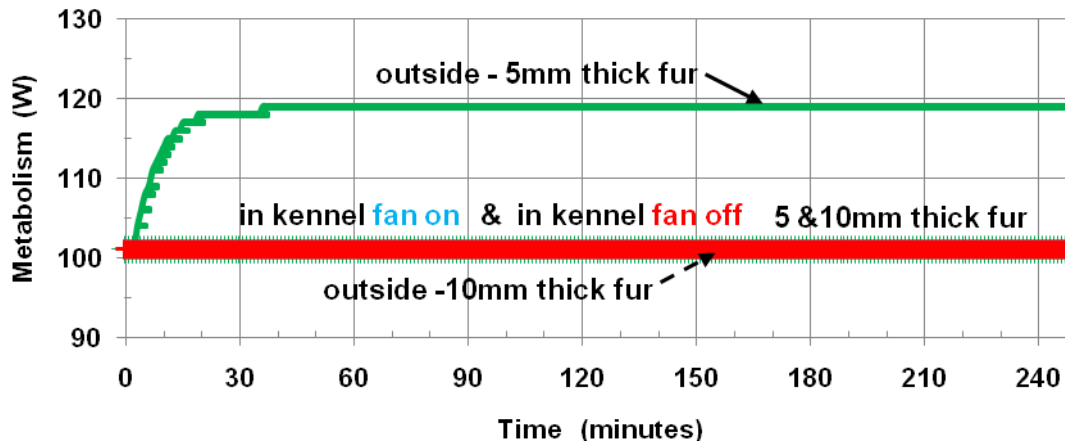

Figure 6d. Panting ventilation for standing and moving about activities with 20°C, 50%RH full shade and 0.4m/s wind outside conditions.

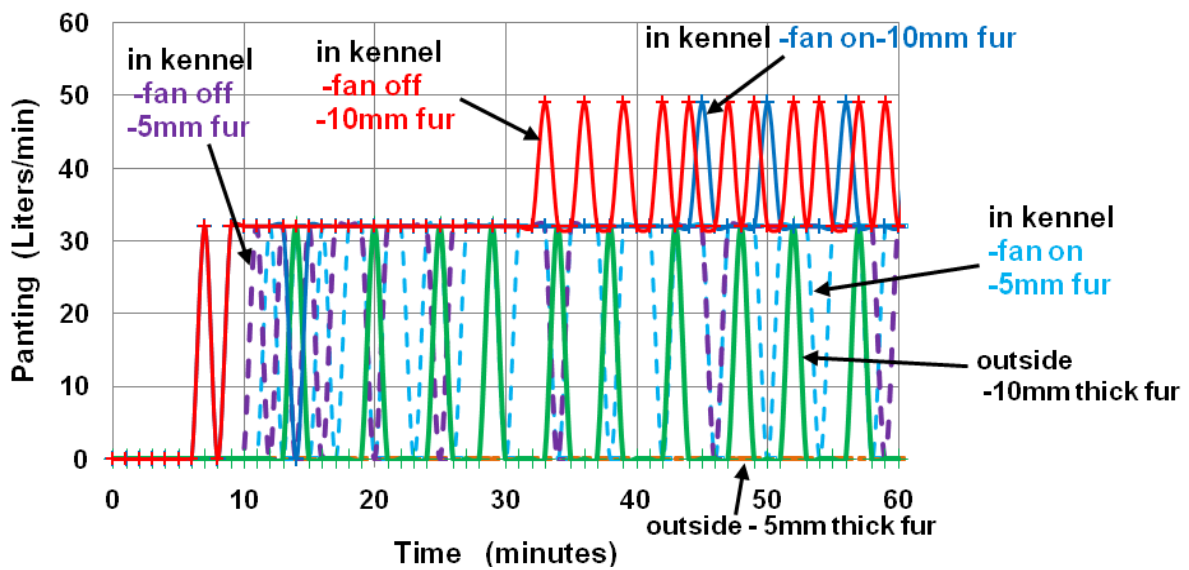

Figure 6e. Core temperatures for standing and moving about activities with 20°C, 50%RH full shade and 0.4m/s wind conditions outside.

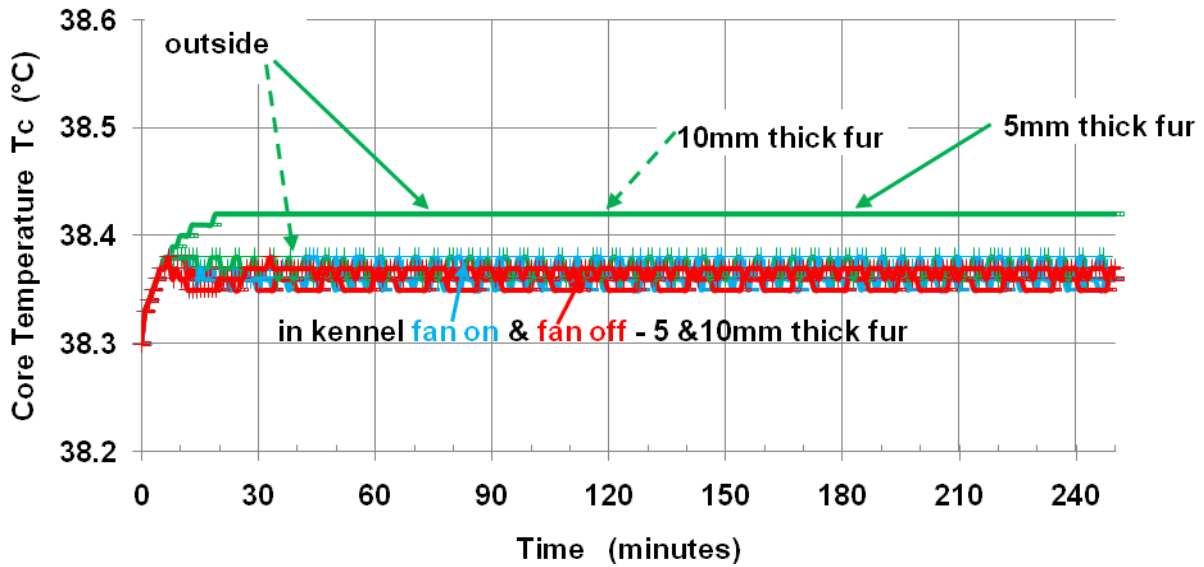

Figure 6f. Skin temperature for standing and moving about activities (~2 MET) with 20°C, 50%RH full shade and 0.4m/s wind conditions outside.

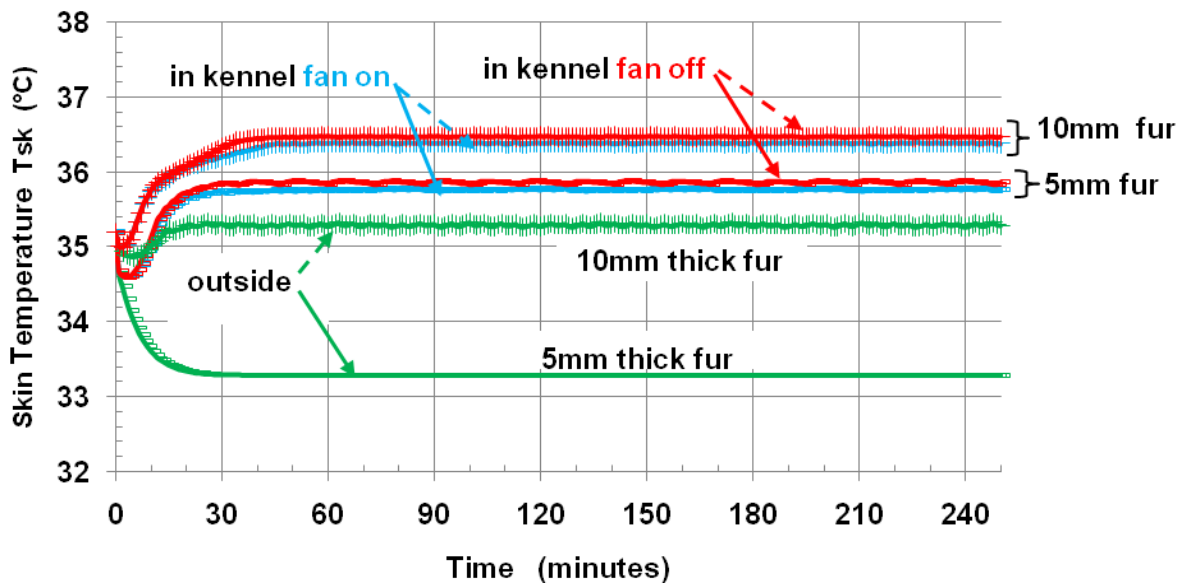
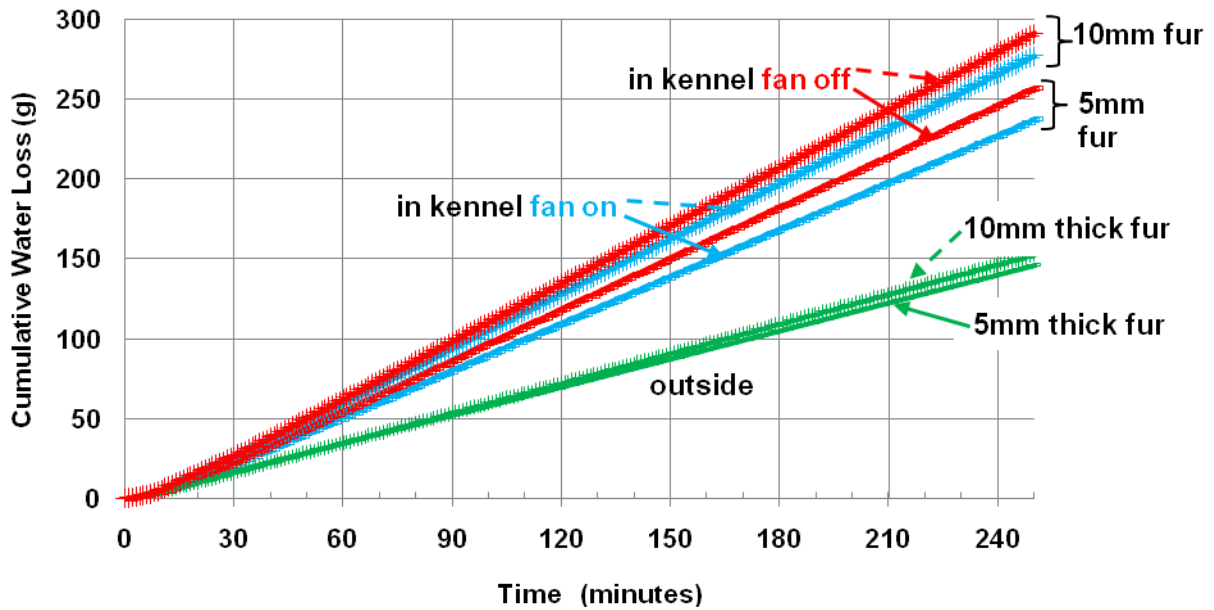

Figure 6g. Cumulative water loss for standing and moving about activities with 20°C, 50%RH full shade and 0.4m/s wind outside conditions.



The following Figures 7 and 8 present MWD responses at the warmer temperature of 30°C and 50%RH for the same resting and standing activities as in Figures 5 & 6.

Figure 7a. Air temperature for resting Belgian Malinois with 5 & 10 mm thick fur when environment outside kennel is 30°C, 50%RH and 0.4m/s wind.

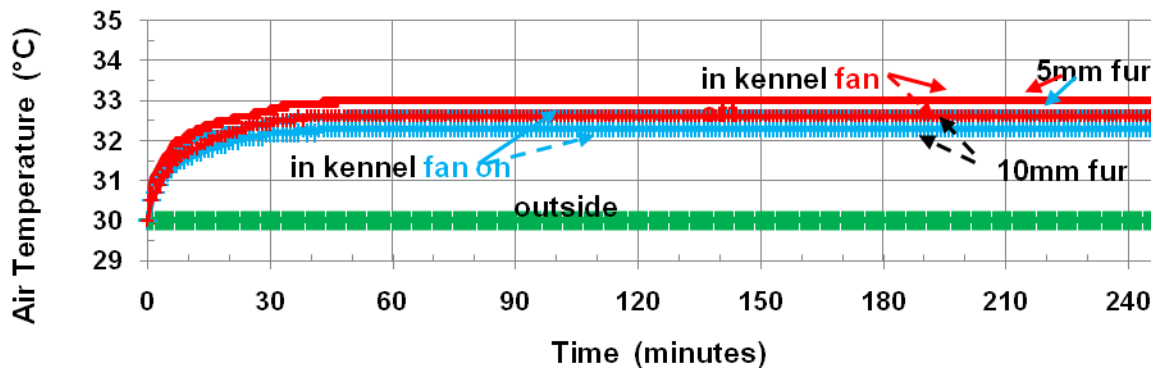

Figure 7b. Water vapor for resting Belgian Malinois with 5 & 10 mm thick fur when environment outside kennel is 30°C, 50%RH and 0.4m/s wind.

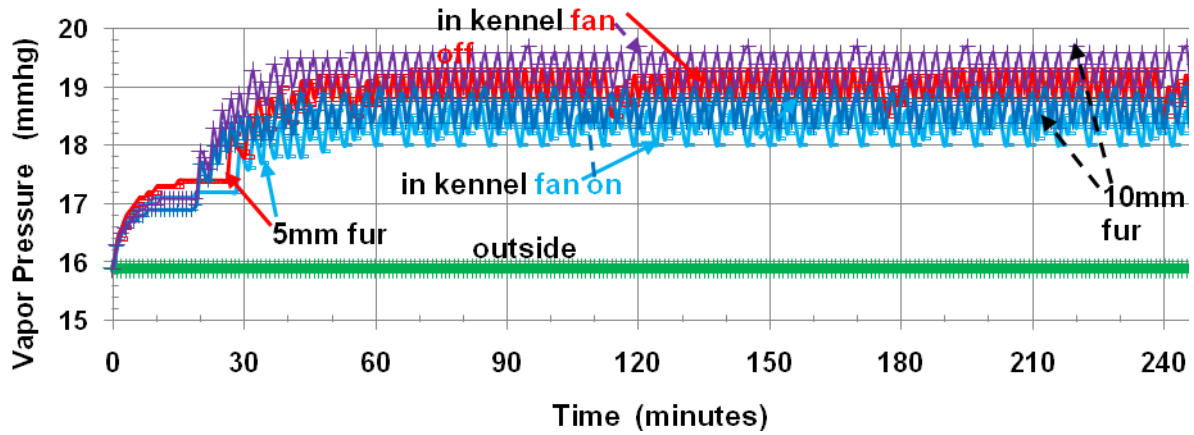

Figure 7c. Panting ventilation of resting Belgian Malinois with 5 & 10 mm thick fur when environment outside kennel is 30°C, 50%RH and 0.4m/s wind.

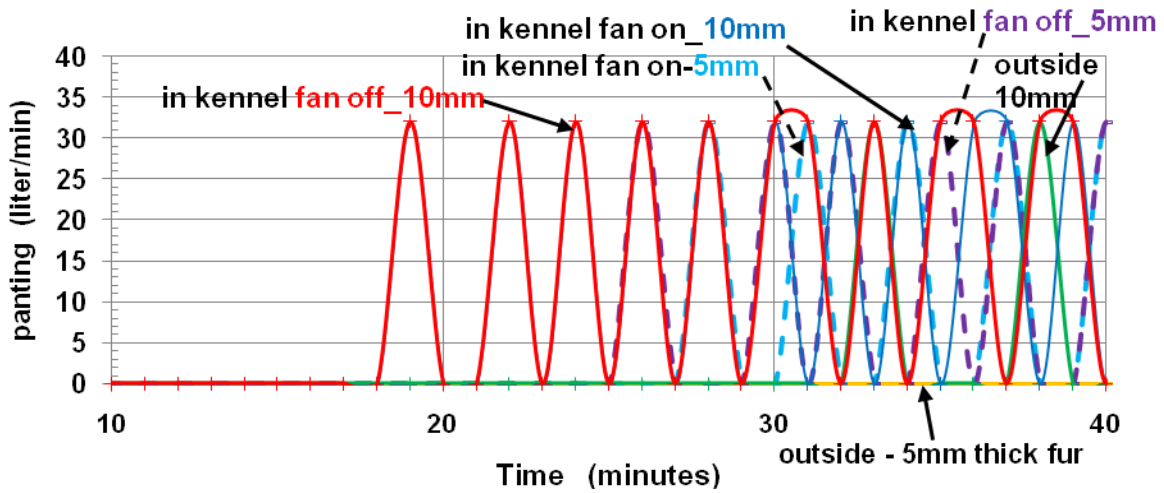

Figure 7d. Core temperature of resting Belgian Malinois with 5 & 10 mm thick fur when environment outside kennel is 30°C, 50%RH and 0.4m/s wind.

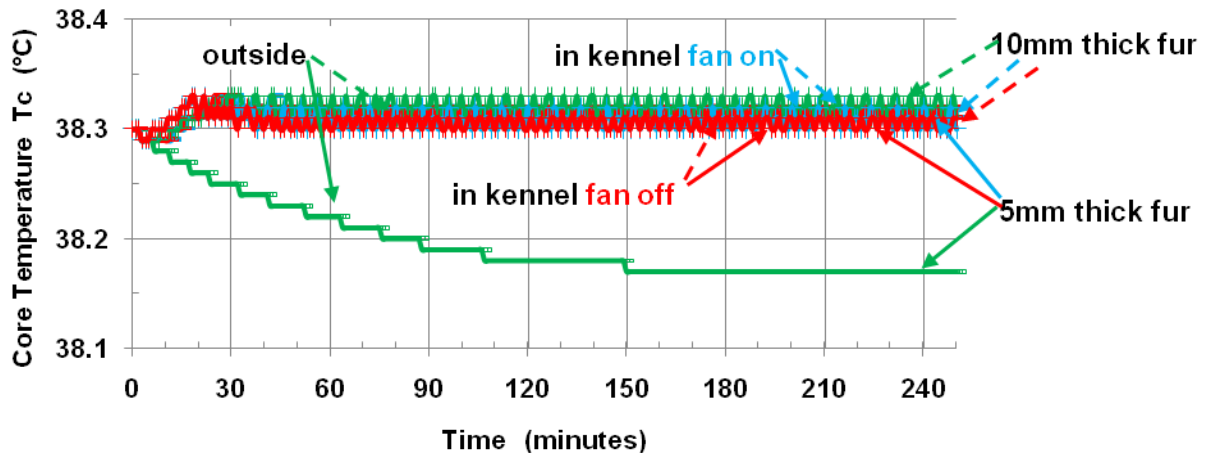

Figure 7e. Skin temperature of resting Belgian Malinois with 5 & 10 mm thick fur when environment outside kennel is 30°C, 50%RH and 0.4m/s wind.

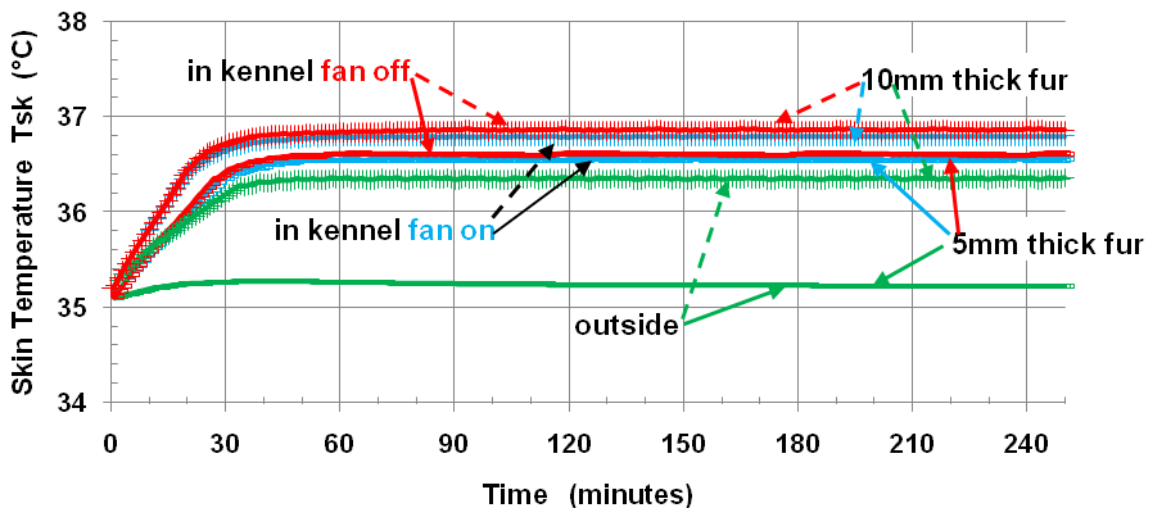
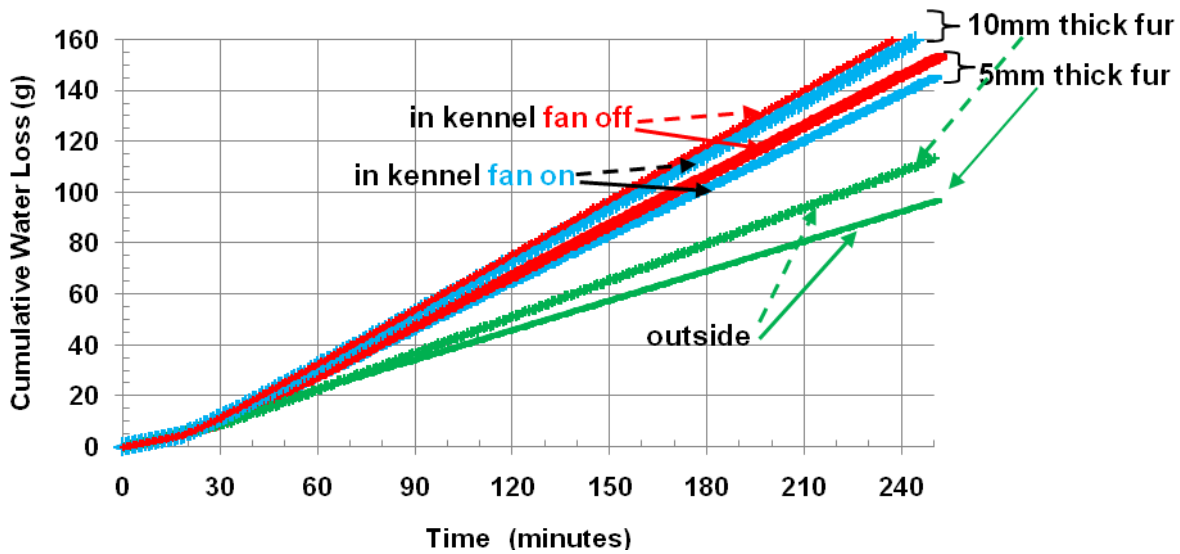

Figure 7f. Cumulative water loss of resting Belgian Malinois with 5 & 10 mm thick fur when environment outside kennel is 30°C, 50%RH and 0.4m/s wind.



The more active MWD who is standing and moving about in the covered kennel causes a nearly steady rise in kennel air temperature over the 12 hour simulation period (Figure 8a). The partial pressure of water vapor pressure within the kennel also steadily increases (Figure 8b).

Figure 8a. Kennel air temperatures for Belgian Malinois MWDs with 5 and 10mm thick fur standing and moving about (2 MET) when environment outside kennel is 30°C, 50%RH and 0.4m/s.

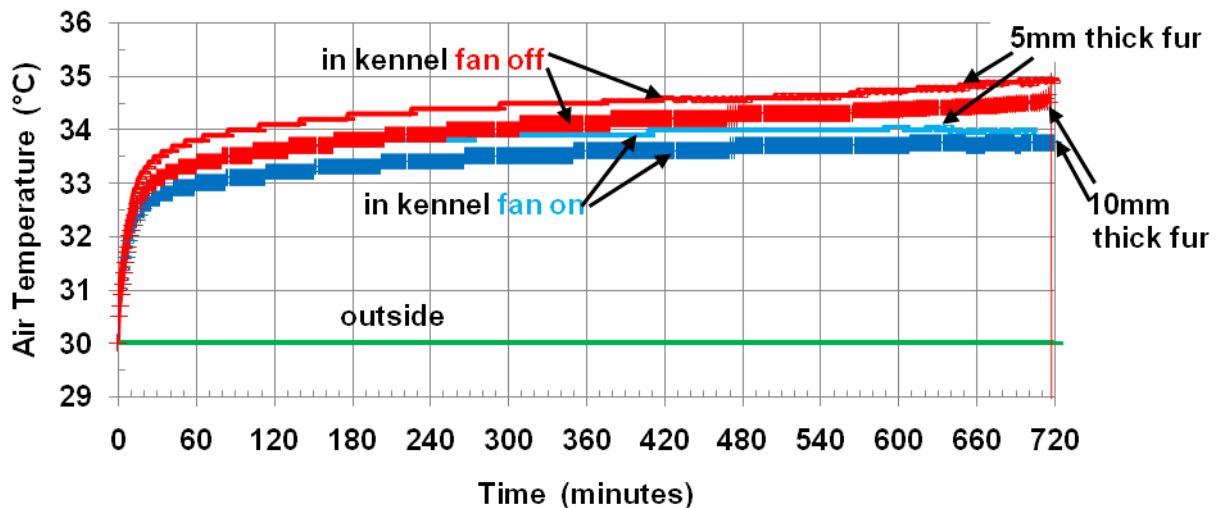

Figure 8b. Water vapor pressure for Belgian Malinois MWDs with 5 and 10mm thick fur standing and moving about (2 MET) when environment outside kennel is 30°C, 50%RH and 0.4m/s.

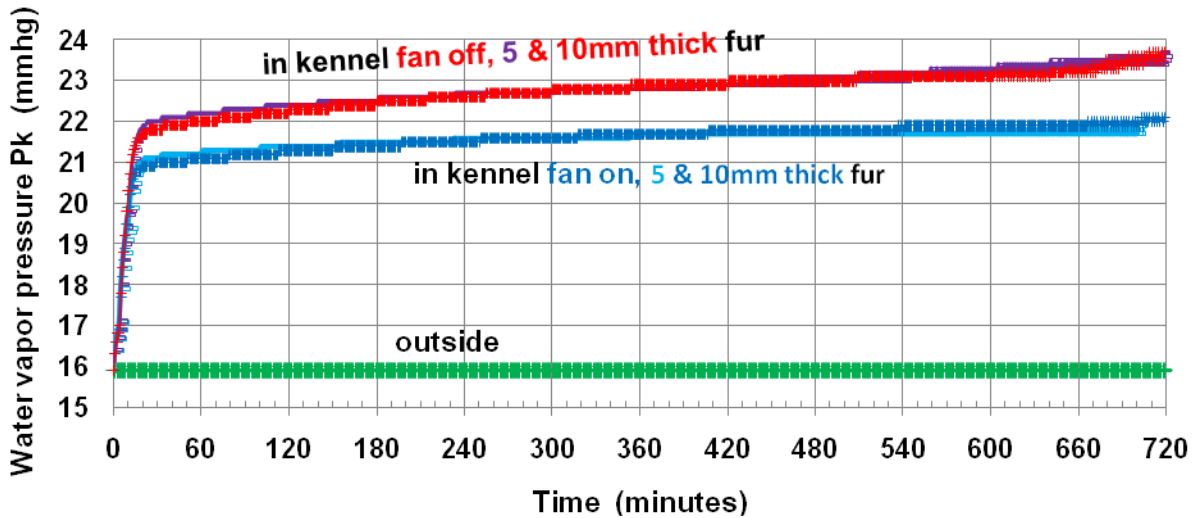

Figure 8c. Metabolism of Belgian Malinois MWDs with 5 and 10mm thick fur standing and moving about (2 MET) when environment outside kennel is 30°C, 50%RH and 0.4m/s.

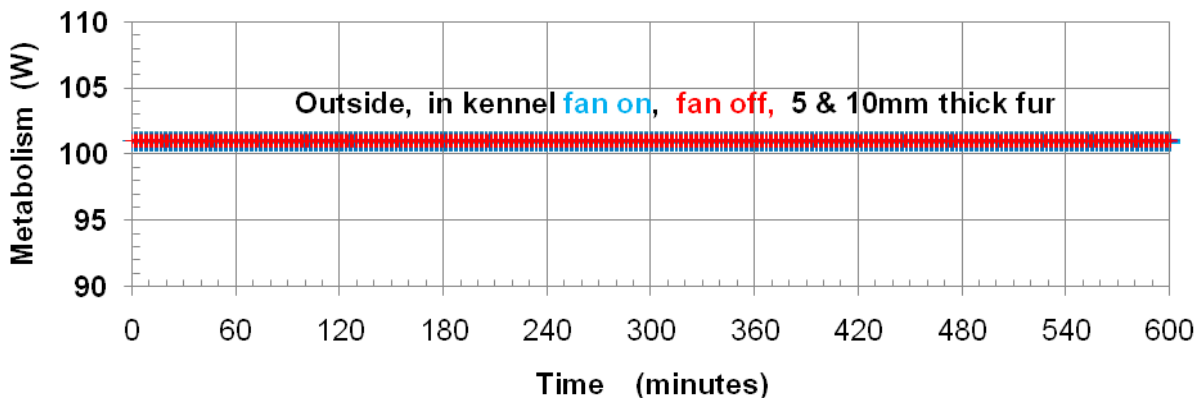
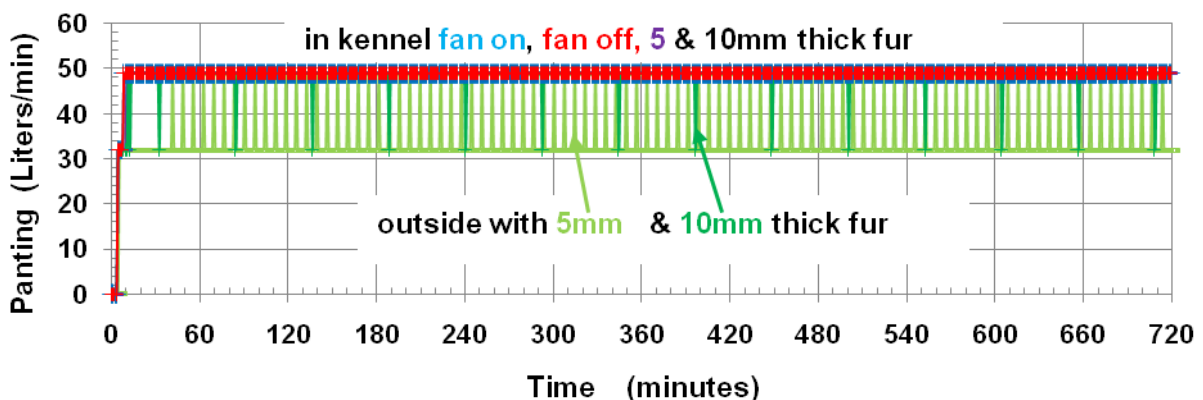

Figure 8d. Panting response of Belgian Malinois MWDs with 5 and 10mm thick fur standing and moving about (2 MET) when environment outside kennel is 30°C, 50%RH and 0.4m/s.



Panting is now required for all conditions when the MWD is standing and walking about. Inside the protective kennel cover, panting is maximal at 49 Liters/min for both fan on and off and for both thick and thin fur (Figure 8d). However, the panting and other heat losses are insufficient to halt the slow rise in core temperature when the MWD is in the covered kennel (Figure 8e). With normal 10 mm thick fur the active (2 MET) MWD's T_c rises to an unsafe core temperature level of 40.5°C in about 450 minutes with the fan on, but with the fan off it reaches that level 2 hours sooner in about 320 minutes. Both safe stay times are relatively long and likely the standing and walking about activity is not sustained for such durations. It is seen that for these conditions the shaved 5mm thick fur greatly slows the rise in core temperatures of this simulated MWD in the protective kennel.

Figure 8e. Core Temperature of Belgian Malinois MWDs with 5 and 10mm thick fur standing and moving about (2 MET) when environment outside kennel is 30°C, 50%RH and 0.4m/s.

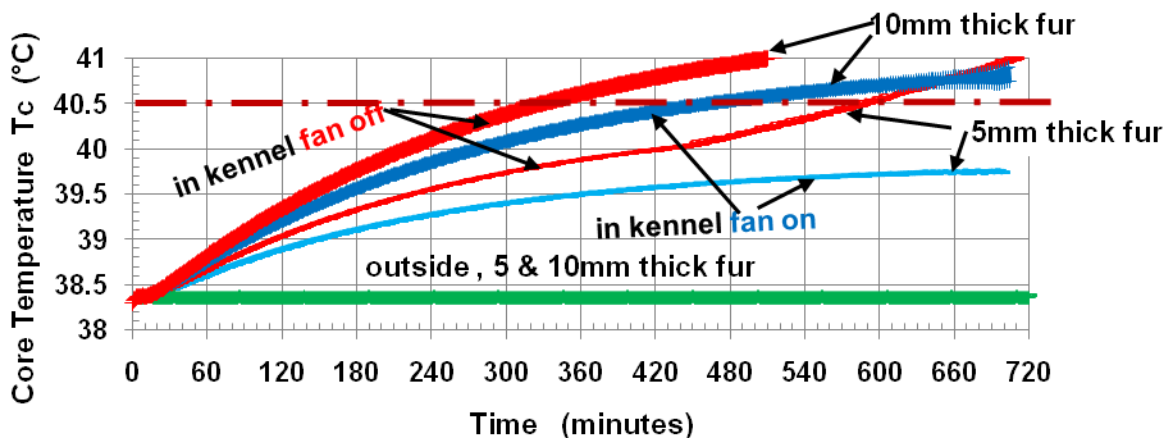

Figure 8f. Skin Temperature of Belgian Malinois MWDs with 5 and 10mm thick fur standing and moving about (2 MET) when environment outside kennel is 30°C, 50%RH and 0.4m/s.

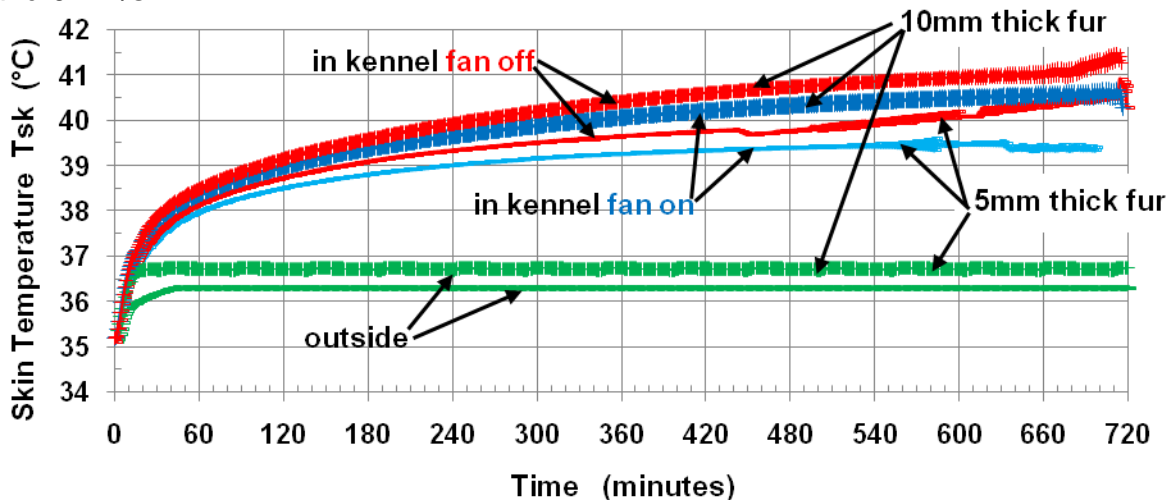
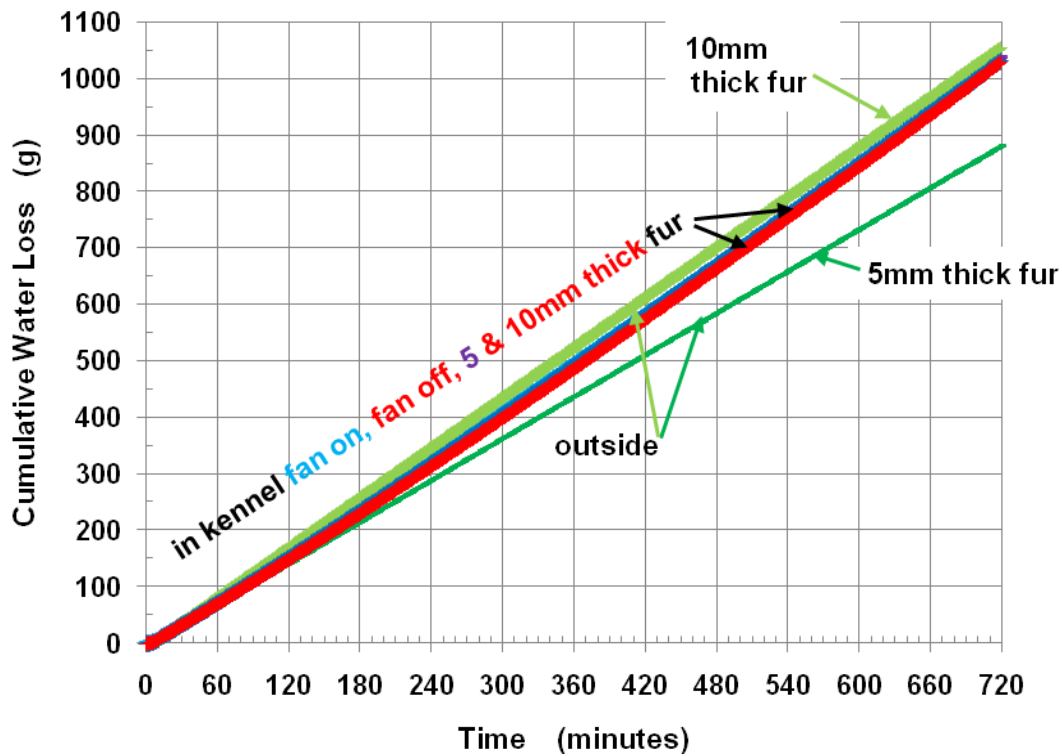

Figure 8g. Cumulative water loss of Belgian Malinois MWDs with 5 and 10mm thick fur standing and moving about (2 MET) when environment outside kennel is 30°C, 50%RH and 0.4m/s.



Figures 5 through 8 illustrate how a MWD responds to the outside and kennel environments and how activity, fur thickness and kennel cover fan operation affect the MWD at the two common levels of air temperature of 20°C and 30°C. The responses to other temperatures of interest (25°C, 35°C, and 40°C) have a similar form as those of 20°C and 30°C shown in Figures 5 - 8. Therefore, only the core temperature response results are presented here (Figures 9-10 and 11-12) for the outside environments of 35°C and 40°C at the activity levels of 1 and 2 MET. Further, Figures 9a, 10a, 11a and 12a are for the 50%RH conditions of each temperature which at 35°C and 40°C is very humid with dew points of 23°C and 27.5°C respectively. Figures 9b, 10b, 11b and 12b are with the humidity reduced to a drier constant 9°C dew point.

Figure 9a. Core temperatures for resting activities with an outside environment of 35°C, 50%RH, full shade and 0.4m/s wind.

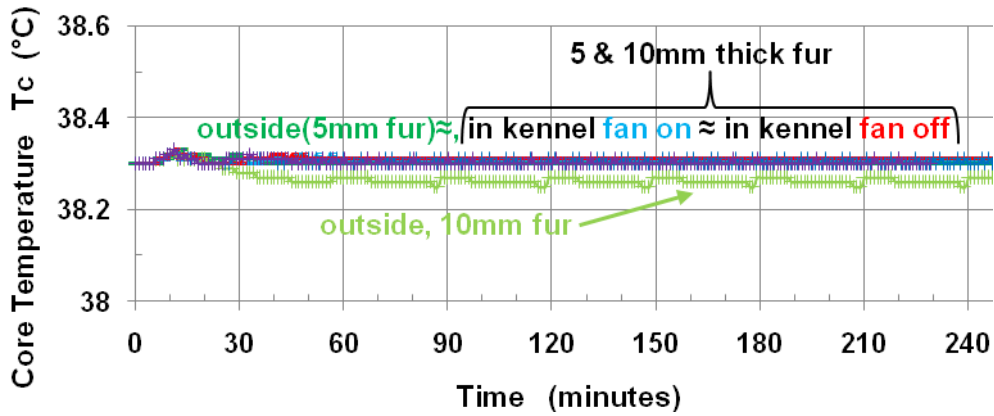

Figure 9b. Core temperatures for resting activities with an outside environment of 35°C, 20%RH, full shade and 0.4m/s wind.

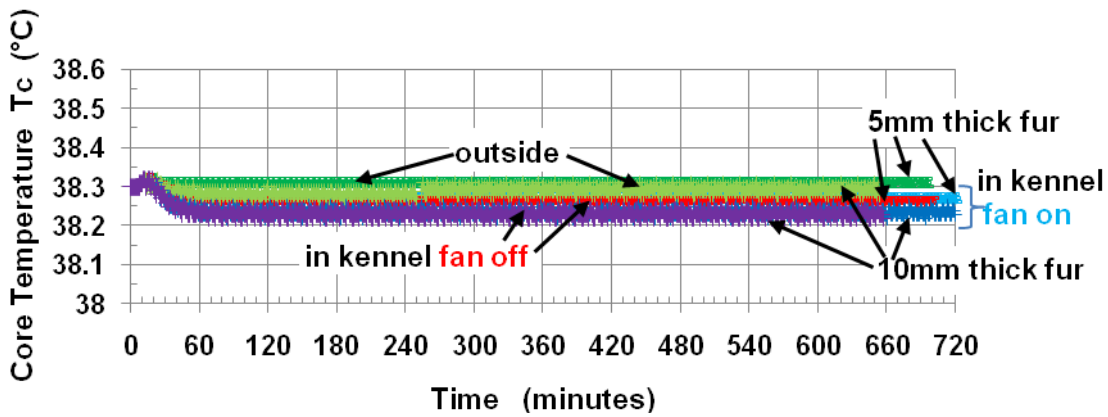

Figure 10a. Core temperatures for 2 MET activities with an outside environment of 35°C, 50%RH, full shade and 0.4m/s wind.

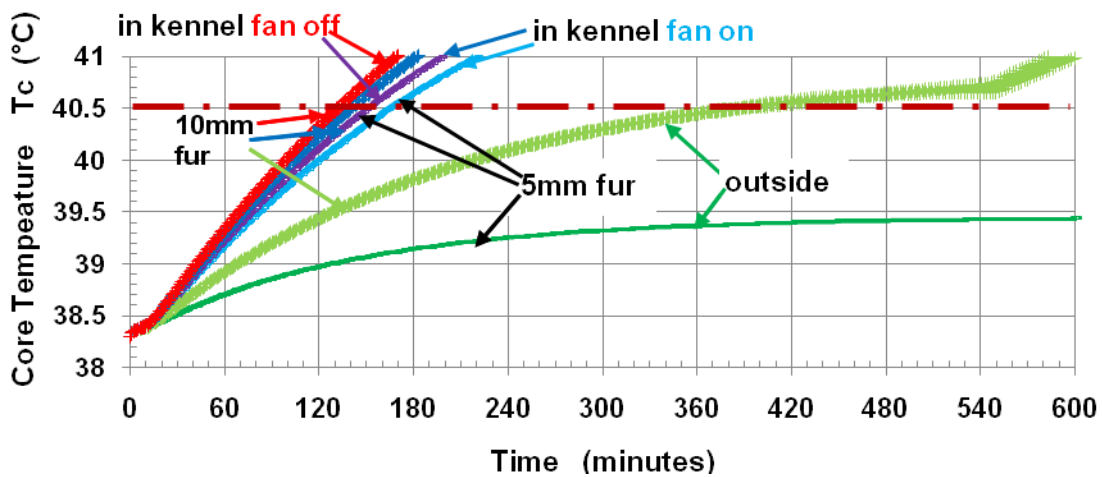
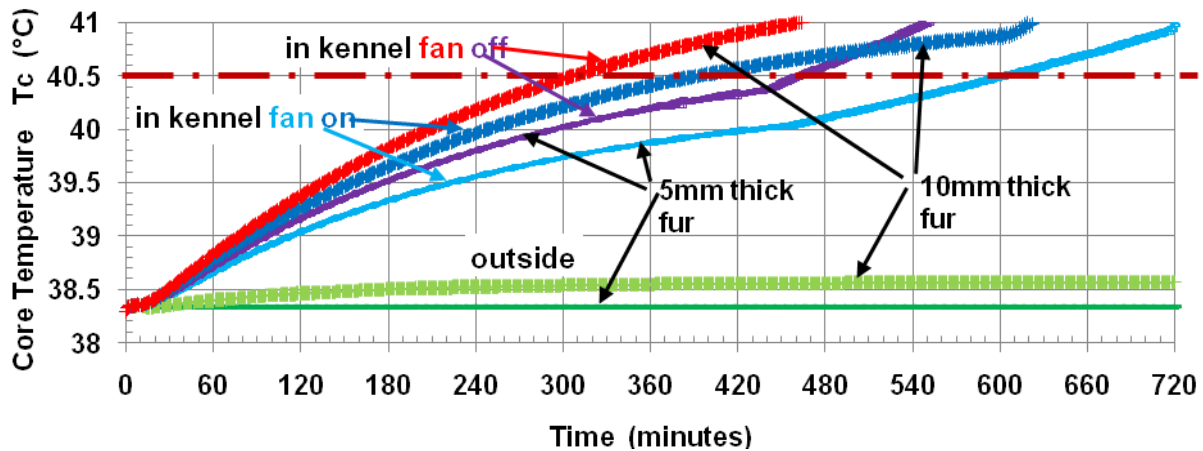

Figure 10b. Core temperatures for 2 MET activities with an outside environment of 35°C, 20%RH, full shade and 0.4m/s wind.



The MWD model simulations indicates that the resting dog's metabolic heat dissipation by panting is adequate to maintain a healthy core temperature (Figure 9) in 35°C and 50%RH or 20%RH outside environments. However, if the MWD is standing and moving about in the kennel under 35°C and 50%RH ambient environmental conditions, T_c will reach unsafe levels after approximately 130 to 170 minutes (Figure 10a). Even outside in this environment, the MWD with 10 mm thick fur will reach the 40.5°C T_c level in about 6.5 hours. At the drier 20% RH condition; the safe exposure times are about double those in the 50%RH outside environment. Outside the kennel in the 35°C 20%RH environment, the modeled MWD can control T_c to safe levels (Figure 10b).

Figure 11a. Core temperatures for resting activities with an outside environment of 40°C, 50%RH, full shade and 0.4m/s wind.

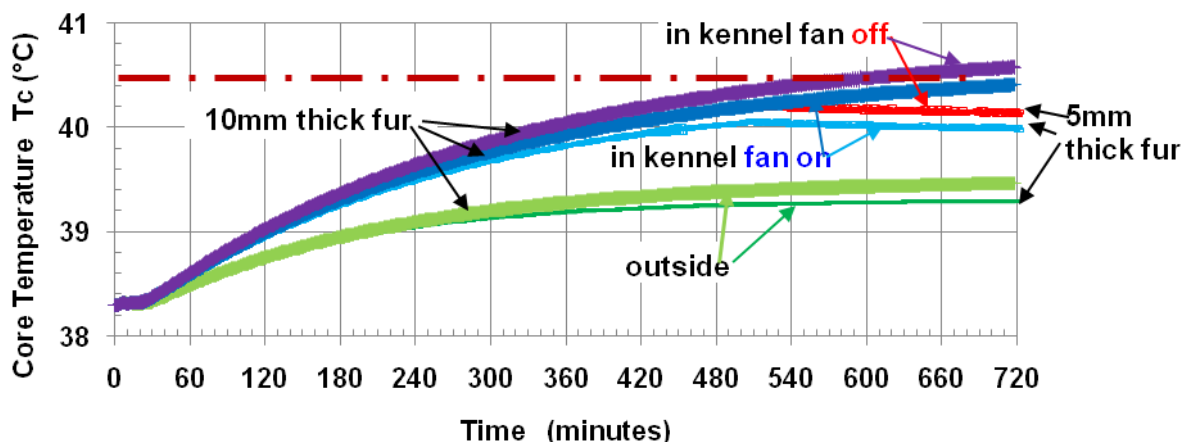
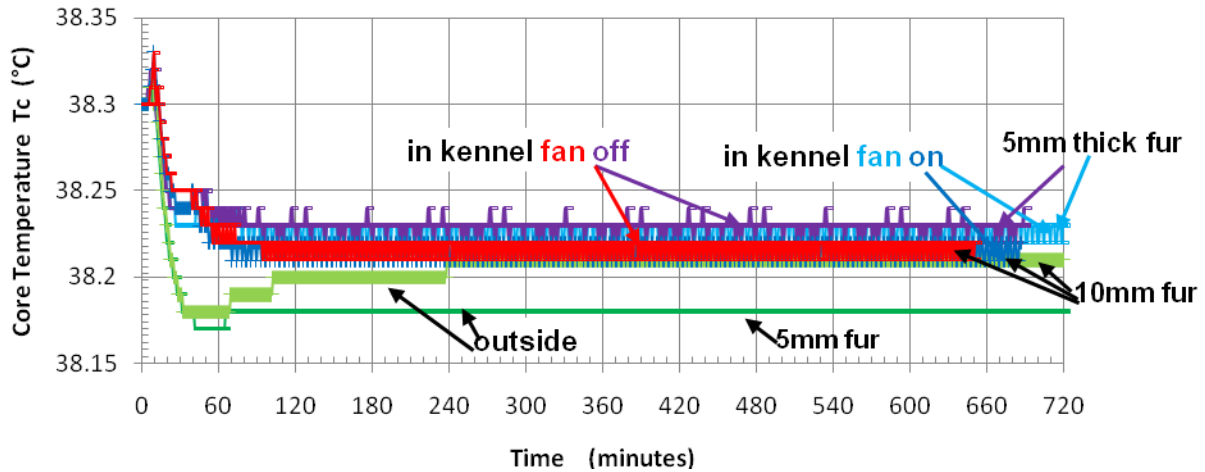

Figure 11b. Core temperatures for resting activities with an outside environment of 40°C, 15.5%RH, full shade and 0.4m/s wind.



At 40°C and 50%RH, panting is insufficient for resting kennel occupancy and T_c rises steadily to above 40.5°C for 10mm thick fur MWD and above 40°C with 5 mm fur thickness (Figure 11a). For the drier 40°C/15%RH outside condition, panting heat loss increased enabling T_c to be controlled (Figure 11b). However, if the MWD is standing and walking about under the kennel cover (Figure 12a), T_c becomes unsafe after about 80 to 100 minutes with the 50%RH outside humidity and in about twice that time for the 15%RH outside condition (Figure 12b). Further, at this outside temperature, 15%RH, and 2 MET activity level, only the MWD with shorter 5mm fur approached but did not reach the 40.5°C T_c level during a 12 hour exposure (Figure 12b).

Figure 12a. Core temperatures for 2 MET activities with an outside environment of 40°C, 50%RH, full shade and 0.4m/s wind.

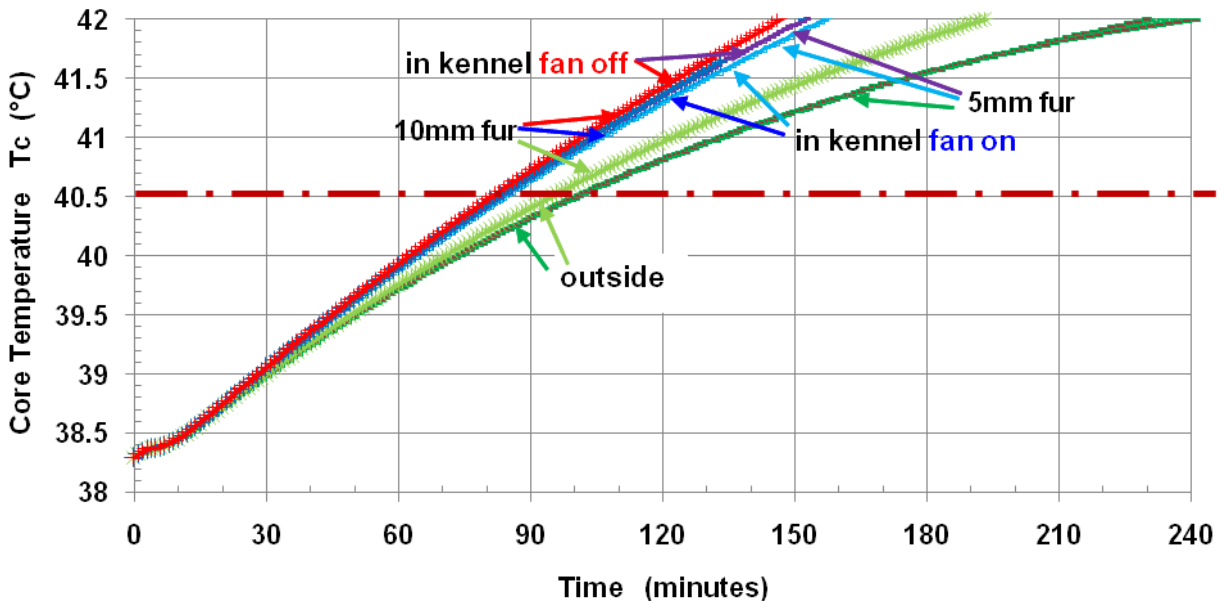
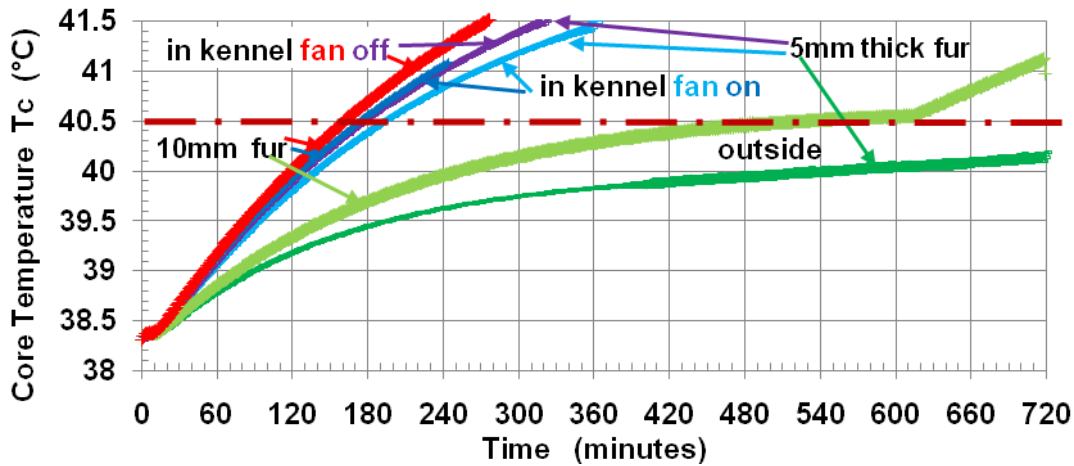

Figure 12b. Core temperatures for 2 MET activities with an outside environment of 40°C, 15.5%RH, full shade and 0.4m/s wind.



Responses To Transient Conditions

Simulated responses of the MWD going through a sequence of activities that the MWD may experience in the field with the chem-bio protective cover are displayed in Figures 13, 14 and 15 for 25°C/50%RH, 40°C/50%RH and 40°C/15%RH outside environments. The plots shown in Figures 13-15 are all for a normal 10mm fur thickness. Though the earlier simulations for extended exposures to constant environments indicated that outside conditions of 30°C and above were thermally threatening for activities above resting, Figures 13, 14 and 15 indicate that standing and walking activities can be safe even at 40°C if intermittent and not too long in duration.

Figure 13. Core temperatures, panting and metabolic responses during intermittent activities and kennel occupancies with an outside environment of 25°C, 50%RH, full shade and 0.4m/s wind.

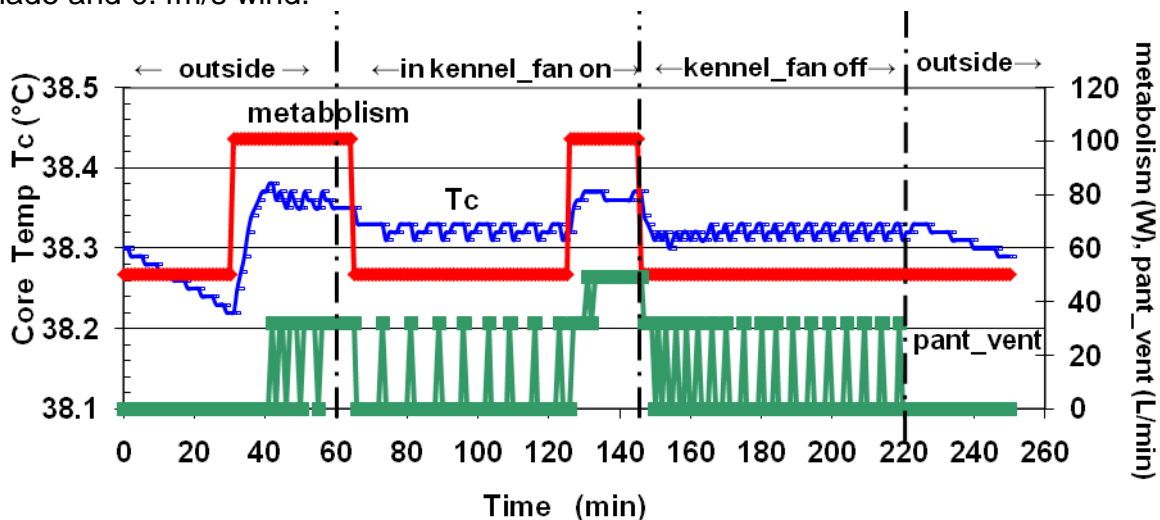

Figure 14. Core temperature, panting and metabolic responses during intermittent activities and kennel occupancies with an outside environment of 40°C, 50%RH, full shade and 0.4m/s wind.

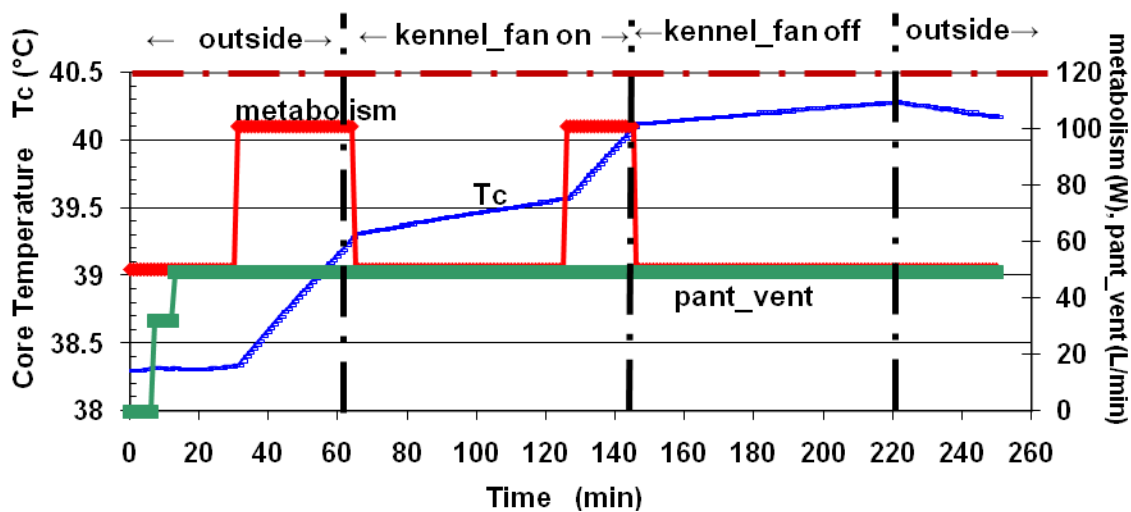
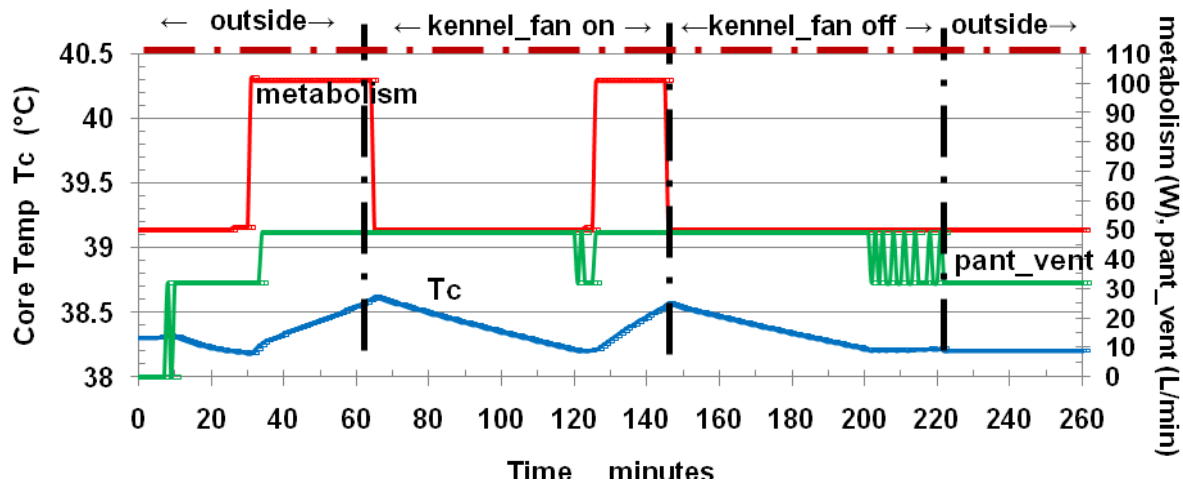

Figure 15. Core temperatures, panting and metabolic responses during intermittent activities and kennel occupancies with a 40°C, 15%RH, full shade and 0.4m/s wind outside environment.



Quasi Steady Responses To Constant Conditions

Equilibrium or quasi steady core temperature simulation results are plotted in Figure 16 for the resting MWD with outside temperatures between 20°C and 40°C. It is seen that the modeled resting MWD can regulate core temperature very well through panting for outside temperatures of 35°C and below. However, for the increased activity of standing and walking about (Figure 17a and b), it is much more challenging to maintain safe body temperatures, particularly in humid conditions of 50%RH or dew points above about 14°C. At this elevated metabolic rate (~2 METS), it becomes difficult for the MWD to prevent core temperature from rising beyond 40.5°C when in the kennel with outside temperatures above 25°C at 50%RH. In Figures 17a and 17b show

the conditions (outside air temperature, fan on/off, long or short fur, inside/outside covered kennel) at which core temperature first reaches $T_c = 40.5^\circ\text{C}$.

Figure 16. Steady state core temperatures for resting MWDs related to outside air temperature.

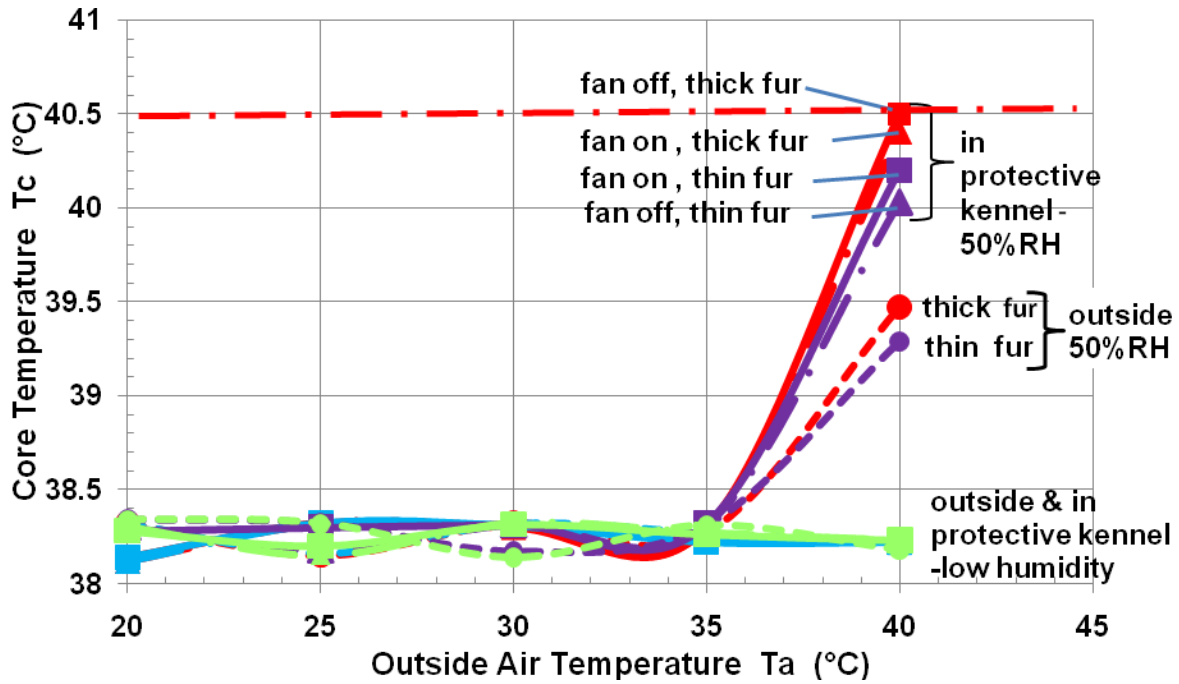

Figure 17a. Steady state core temperatures relative to outside conditions with 50%RH, for MWDs standing and walking about.

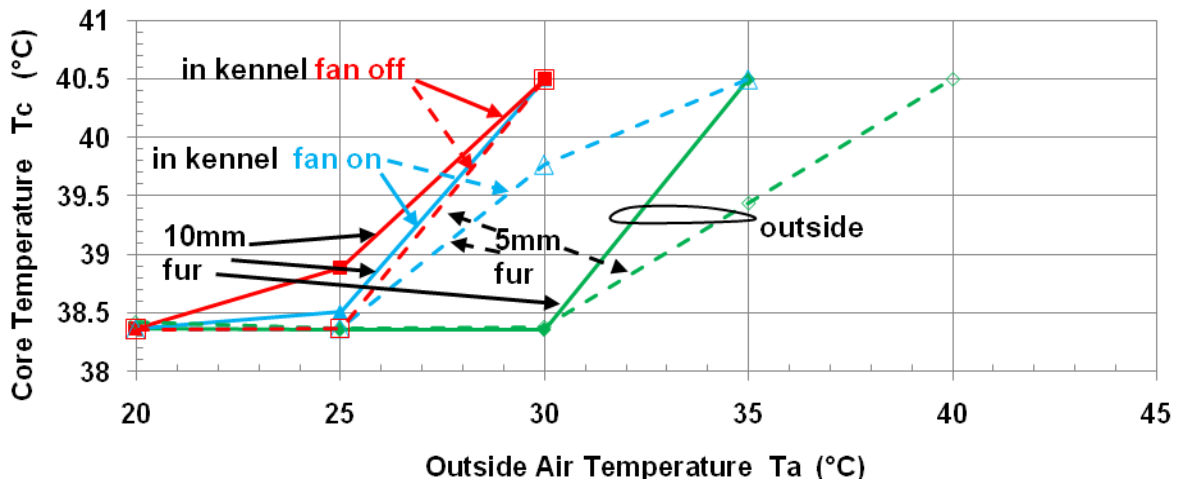
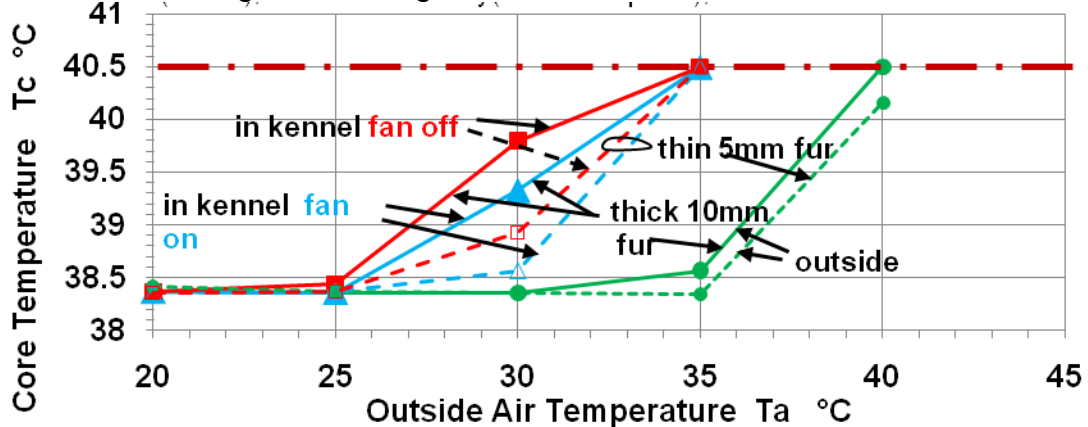

Figure 17b. Steady state core temperatures relative to outside conditions with 9°C dew point for MWDs standing and walking about.



The quasi steady T_c responses to constant conditions indicates the significant effect of humidity for resting MWDs at T_a above 35°C, and for standing and walking about activities at outside temperatures above 25°C. Reducing the MWD's fur to a shorter length also helps lower T_c in warm conditions.

Safe Stay Times

The safe stay or exposure times for all the conditions considered in this study are summarized in Table 2a for 10mm fur and Table 2b for 5mm fur. The simulated exposures were limited to 720 minutes or 12 hours.

Table 2a. Safe Stay Times (SST) for $T_c \leq 40.5^\circ\text{C}$, various humidities, and 10 mm fur thickness for quiet (1 MET) and physically active (2 MET) dogs.

Outside environment			SST (min): Resting – 1 met			SST(min): Standing & moving – 2 met		
Ta	RH	Tdp	outside	fan on	fan off	outside	fan on	fan off
20	49	9	>720	>720	>720	>720	>720	>720
25	50	13	>720	>720	>720	>720	>720	>720
30	50	18.5	>720	>720	>720	>720	459	327
35	50	23	>720	>720	>720	384	141	81
40	50	27.5	>720	>720	>720	95	87	>720
20	49	9	>720	>720	>720	>720	>720	>720
25	36	9	>720	>720	>720	>720	>720	>720
30	27	9	>720	>720	>720	>720	>720	>720
35	20	9	>720	>720	>720	>720	393	304
40	16	9	>720	>720	>720	533	175	163

Table 2b. Safe Stay Times (SST) for $T_c \leq 40.5^\circ\text{C}$, various humidities, and 5mm thick fur for quiet (1 MET) and physically active (2 MET) dogs.

Outside environment			SST (min): Resting – 1 met			SST(min): Standing & moving – 2 met		
Ta	RH	Tdp	outside	fan on	fan off	outside	fan on	fan off
20	49	9	>720	>720	>720	>720	>720	>720
25	50	13	>720	>720	>720	>720	>720	>720
30	50	18.5	>720	>720	>720	>720	>720	583
35	50	23	>720	>720	>720	>720	164	150
40	50	27.5	>720	>720	>720	100	84	83
20	49	9	>720	>720	>720	>720	>720	>720
25	36	9	>720	>720	>720	>720	>720	>720
30	27	9	>720	>720	>720	>720	>720	>720
35	20	9	>720	>720	>720	>720	391	304
40	16	9	>720	>720	>720	533	192	176

The safe stay times of Tables 2a and 2 b are graphed in Figures 18a and b for 10 and 5 mm fur thicknesses with 50%RH outside humidity.

Figure 18a. Safe stay times for (a) standing and moving about and (b) resting activities with humid (constant 50%RH) outside environment and 10mm thick fur.

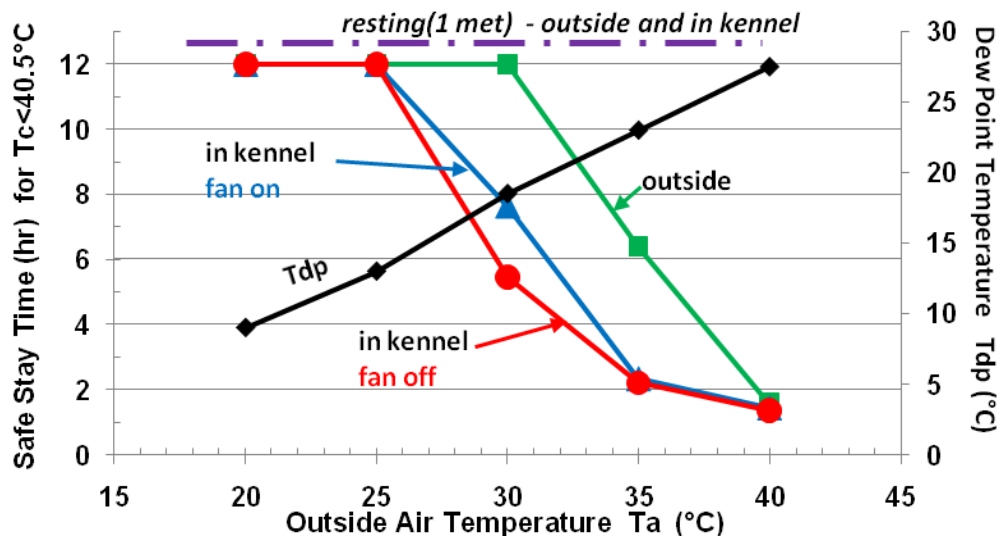

Figure 18b. Safe stay times for (a) standing and moving about and (b) resting activities with humid (constant 50%RH) outside environment and 5mm thick fur.

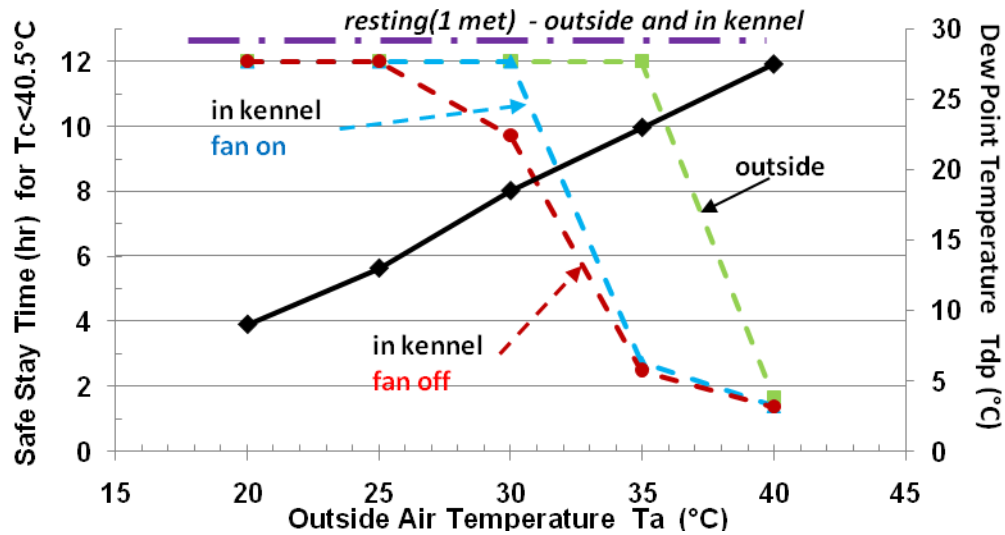

Figure 19a and b displays the safe stay time results for the drier 9°C dew point outside conditions.

Figure 19a. Safe stay times for standing and moving about and resting activities with a low humidity (constant 9°C dew point) outside environment and 10mm thick fur.

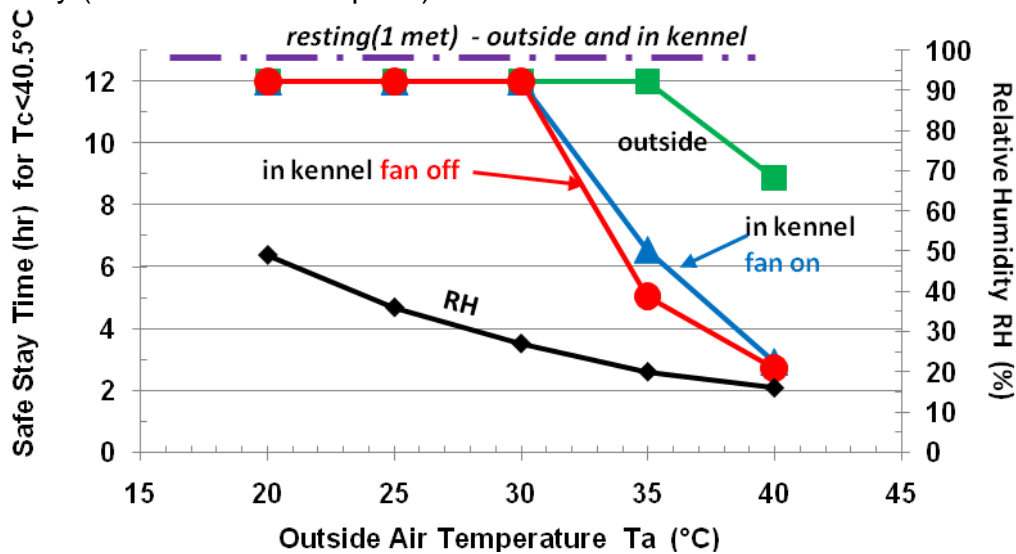

Figure 19b. Safe stay times for standing and moving about and resting activities with a low humidity (constant 9°C dew point) outside environment and 5mm thick fur.

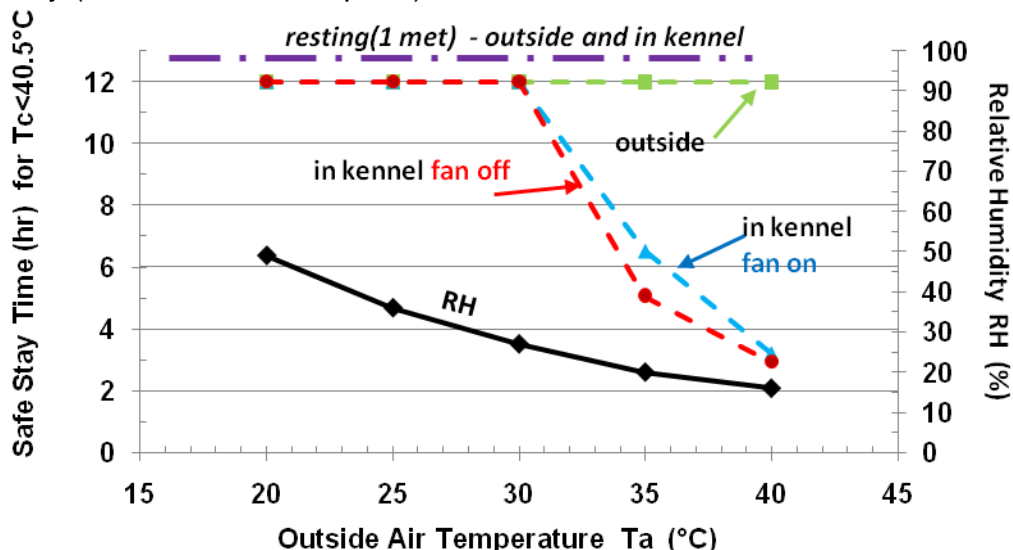

Table 2 and Figures 18 and 19 indicate that in warm outside conditions (25°C to 35°C), fur thickness has a marginal effect on safe stay times, and outside humidity has a persistent greater effect. The fan’s operation as simulated affects stay times only at temperatures about 30°C for 50%RH outside conditions and about 35°C at drier 9°C dew point outside levels.

DISCUSSION

The thermo-physiological responses of a simulated MWD in a chemical protective kennel enclosure were modeled. The results were used to estimate the lengths of time MWDs can safely remain in the enclosure under various ambient meteorological conditions. These simulations provided useful insights into CBRN protective kennel cover design and its safe use. However, the model is simple in comparison to the real animal and until the model is better validated, the results and conclusions should only be used as guides.

The US military employs the largest canine force in the world, with almost 2,800 MWDs. Each MWD is estimated to cost in excess of \$40,000 USD per year, to train, feed, and maintain. With increased military forces and constant expansion of policing and war fighting activities abroad, the demands for MWDs continues to increase. Given this high cost, high demand, and increasing expansion of MWD forces, strategies to minimize health risks and expand the performance capabilities of these canines will benefit the military.

According to FM 3-19.17, the current list of equipment and sustainment supplies required for MWDs during deployed operations is fairly robust (i.e. each MWD’s average water requirements is estimated at 10 gallons per day). Addition of this equipment

poses an increased burden on the already high logistical challenge. This logistical burden should be taken into consideration when concepts for designing new equipment arise.

CONCLUSIONS

Climate chamber studies of the chemical protective kennel cover were performed over a range of conditions using a human head thermal manikin with sweating capabilities to simulate a MWD. The measured thermal and moisture properties of the cover with the exhaust fan on and off were used together with a thermo-physiological computer model of the MWD to estimate the animal's responses to being caged under the cover in a variety of conditions. The MWD model was specifically developed for this project, and relies on USARIEM human models modified for the dog's physiology and anthropometrics to conform to published canine experimental data.

The simulated MWD responses indicate that with 30°C, 35°C and 40°C and 50%RH outside conditions, a resting Belgian Malinois would not experience heat related illnesses in the covered kennel during 720 minute or 12 hour stays. However, if the animal is restless and moving about in the kennel, a 30°C outside condition could cause dog's core temperature (T_c) to approach or exceed 40.5°C after about 5 hours. The literature indicates that $T_c > 40.5^\circ\text{C}$ are to be avoided as this a level where heat related illness will likely begin to occur with heat stroke at $T_c \geq 43.4^\circ\text{C}$ (Bynum, 1977).

The battery powered ventilation fan extends the safe stay times marginally. For example, at 35°C/50%RH outside conditions, the caged standing and walking about Belgian Malinois would reach the heat illness level in approximately 130 minutes with the exhaust fan off and 140 minutes with the fan on.

A Shepherd's normal fur thickness on the back was estimated to be about 10mm for these simulations. If the fur thickness is reduced to 5mm, as many owners do in the hot summer months, the safe covered kennel stay times increase to 150 and 165 minutes respectively with a 35°C 50%RH outside environment and the dog's metabolic rate at 2 MET. Thus the measurements and simulations indicate that the ventilation exhaust fan increases the safe stay time by about 10 to 15 minutes, and therefore the effect of its disablement, should that occur, would not be large. At higher temperatures the time differences are shorter.

Lower outside humidities also increase the safe stay times. At a 35°C outside air temperature, the safe stay times for standing and moving about more than doubles from 130 and 140 minutes at 50%RH with fan off and on to 300 and 390 minutes respectively for a lower humidity of 20%RH.

The transient response simulations of the MWD going in and out of the covered kennel with fan on and off and the 2 MET activity limited to 30 minutes or less, indicates that heat illness symptoms may be avoidable at 40°C 50%RH outside conditions and more certainly with lower outside humidity.

RECOMMENDATIONS

The results simulated from this effort should be used as guidance material for safe stay times and procedures when implementing and sustaining MWDs in protective kennels. Based on these results, the battery powered ventilation fan should be used when possible in order to extend the safe stay times. Fur thickness of MWDs should be groomed to a length of 5mm on the back during warmer climate months to provide another increase in duration of safe stay time. Particular attention should be paid to outside temperatures and humidities as they may also weigh heavily on the duration of safe stay times.

REFERENCES

1. ASHRAE, 2005a. *ASHRAE Handbook of Fundamentals*, chapter 8. American Society of Heating Refrigerating and Air-Conditioning Engineers. Atlanta.
2. ASHRAE, 2005b. *ASHRAE Handbook of Fundamentals*, chapter 10, Table 8.1. American Society of Heating Refrigerating and Air-Conditioning Engineers. Atlanta.
3. Bynum, G., Patton, J., Bowers, W., Leav, I., Wolfe, D., Hamlet, M., Marsili. M. 1977. An anesthetized dog heat stroke model. *J. Appl. Physiol.: Respirat. Environ. Exercise Physiol.* 43(2):292-296.
4. Cowgill, G.R., Drabkin, D.L. 1927. Determination of a formula for the surface area of the dog together with a consideration of Formulae available for other species. *Am. J. Physiol.* 81: 36-61.
5. Crawford, E.C.1962. Mechanical aspects of panting dogs. *J. Appl. Physiol.*17:249-251.
6. Folk, G.E. 1974. *Textbook of Environmental Physiology.*146-147. Lea & Febiger
7. Gagge, A.P., Stolwijk, J., Nishi, Y. 1971. An effective temperature scale based on a simple model of human physiological regulatory response. *ASHRAE Transactions*, Vol. 77(1):247-62. 1986.
8. Gagge, A. P, A. Fobelets, Berglund, L.1986. A Standard Predictive Index of Human Response. *ASHRAE Transactions*, Vol. 92(2B).
9. Goldberg, M.B., Langman, V.A., Taylor, C.R. 1981. Panting in dogs: paths of air flow in response to heat and exercise. *Respiration Physiology* 43: 327-338.
10. Hammel, H.T. 1955. Thermal properties of fur. *Am. J. Physiol.* 369-376.
11. Hellstron, B., Hammel, H.T. 1967. Some characteristics of temperature regulation in the unanesthetized dog. *J. Appl. Physiol.* 213(2):547-556.
12. Hemingway, A. 1961. The panting response of normal un-anesthetized dogs to measured doses of diathermy heat. *Am. J. Physiol.* 121:747-754.
13. Kanno, Y. 1982. Experimental studies on body temperature rhythm in dogs III. Thermometric frequency and hours essential for analyzing the circadian body temperature rhythm. *Jpn. J. Vet. Sci.* 44(4):645-652.
14. Kraning K, Gonzalez R. 1997. A mechanistic computer simulation of human work in heat that accounts for physical and physiological effects of clothing, aerobic fitness, and progressive dehydration. *Journal of Thermal Biology* 22,331-342.
15. Meyer, M., Hahn, G., Buess, C., Mesch, U., Piiper, J. 1989. Pulmonary gas exchange in panting dogs. *J. Appl. Physiol.*66(3):1258-1263.
16. Refinetti, R., Piccione, G. 2003. Daily rhythmicity of body temperature in the dog. *J. Vet. Med. Sci.* 65(8):935-937.
17. Schmidt-Nielsen, K., Bretz, W.L., Taylor, C.R. 1970. Panting in dogs: unidirectional air flow over evaporative surfaces. *Science*, 169:1102-1104.

18. Schmidt-Nielsen, K. 1979. Temperature Regulation. *Animal Physiology: Adaptation and environment*. Chapter 8, Cambridge University Press.
19. United States, 2005. Military Working Dogs: Field manual 3-19.17, Washington, DC: Headquarters, Dept. of the Army.
20. Vari Kennel. Extra large deluxe Vari Kennel. www.petmate.com (accessed on 25 July 2011).
21. Yokota, M., Berglund L.G., 2006. Validation of an Initial Capability Decision Aid (ICDA) Thermal Prediction Model. U. S. Army Research Institute of Environmental Medicine, Natick, MA 01760 USA, January 2006 (Technical Report T06-03) (AD A446078).