

EXECUTIVE SUMMARY

Title: A MARINE AIR CONTROL AND SUPPORT GROUP FOR THE 21ST CENTURY

Author: Major Jeffrey L. Merchant, U.S. Marine Corps

Thesis: Marine aviation requires more effective command and control and wing support organizations to meet the demands of 21st century warfare.

Discussion: Currently organized into functional units of squadrons and battalions, the Marine Air Control Group (MACG) provides the personnel and equipment for an integrated Marine Air Command and Control System (MACCS). The MACCS provides the Aviation Combat Element (ACE) with the capability to control aviation warfare operations. The MACG organization reflects the legacy suites of MACCS sensors, weapons systems, communications equipment, and computers. A modernization effort will replace currently fielded stovepipe equipment with a Common Aviation Command and Control System (CAC2S) that uses common hardware and common software. CAC2S will provide the flexibility to combine C2 functionality into task-organized and cross-functional elements. The MACG that supports this new MACCS must be more dynamic, effective, and efficient while reducing non-essential support structure.

The Marine Corps evolution toward *Operational Maneuver From the Sea* (OMFTS) resulted in a series of recommendations from the Force Structure Planning Group (FSPG)'99. Key recommendations include moving the Unmanned Aerial Vehicle squadrons to the MACG, merging the Marine Wing Headquarters Squadron with the Marine Tactical Air Command Squadron (MTACS), and reducing the combat service support capability of the Marine Wing Support Squadron (MWSS). These changes set the groundwork for future efforts in transforming the MACG and Marine Wing Support Group (MWSG) into a single organization capable of responding to the challenges of 21st century warfare.

Recommendations: The MACG and MWSG should merge into a MACSG organization responsible for all aviation C2 and EAF support. The Air Traffic Control detachments should merge with the MWSS to enable one organization to support all facets of expeditionary airfield operations. The merger of the Marine Air Support Squadron and Marine Air Control Squadron into an Expeditionary Air Control Squadron will result in a multi-functional organization capable of conducting air control, airspace management, and air defense management. Reinvestment of MWCS structure into MTACS and EACS will improve the squadrons' responsiveness and efficiencies by providing voice-data communications expertise. The legacy MACCS operator and maintainer occupational fields will consolidate into fewer, more generalized specialties. Specific recommendations include establishing a restricted ATC officer specialty and merging the air control officer specialties to create a more well rounded air C2 specialty.

Report Documentation Page

Form Approved
OMB No. 0704-0188

Public reporting burden for the collection of information is estimated to average 1 hour per response, including the time for reviewing instructions, searching existing data sources, gathering and maintaining the data needed, and completing and reviewing the collection of information. Send comments regarding this burden estimate or any other aspect of this collection of information, including suggestions for reducing this burden, to Washington Headquarters Services, Directorate for Information Operations and Reports, 1215 Jefferson Davis Highway, Suite 1204, Arlington VA 22202-4302. Respondents should be aware that notwithstanding any other provision of law, no person shall be subject to a penalty for failing to comply with a collection of information if it does not display a currently valid OMB control number.

1. REPORT DATE 2000		2. REPORT TYPE		3. DATES COVERED 00-00-2000 to 00-00-2000	
4. TITLE AND SUBTITLE A Marine Air Control And Support Group For The 21st Century				5a. CONTRACT NUMBER	
				5b. GRANT NUMBER	
				5c. PROGRAM ELEMENT NUMBER	
6. AUTHOR(S)				5d. PROJECT NUMBER	
				5e. TASK NUMBER	
				5f. WORK UNIT NUMBER	
7. PERFORMING ORGANIZATION NAME(S) AND ADDRESS(ES) United States Marine Corps, Command Staff College, Marine Corps University, 2076 South Street, Marine Corps Combat Development Command, Quantico, VA, 22134-5068				8. PERFORMING ORGANIZATION REPORT NUMBER	
9. SPONSORING/MONITORING AGENCY NAME(S) AND ADDRESS(ES)				10. SPONSOR/MONITOR'S ACRONYM(S)	
				11. SPONSOR/MONITOR'S REPORT NUMBER(S)	
12. DISTRIBUTION/AVAILABILITY STATEMENT Approved for public release; distribution unlimited					
13. SUPPLEMENTARY NOTES					
14. ABSTRACT					
15. SUBJECT TERMS					
16. SECURITY CLASSIFICATION OF:			17. LIMITATION OF ABSTRACT Same as Report (SAR)	18. NUMBER OF PAGES 48	19a. NAME OF RESPONSIBLE PERSON
a. REPORT unclassified	b. ABSTRACT unclassified	c. THIS PAGE unclassified			

CONTENTS

DISCLAIMER.....	ii
EXECUTIVE SUMMARY.....	iii
CONTENTS.....	iv
LIST OF FIGURES.....	v
Chapter	
1. MARINE AIR CONTROL AND SUPPORT FOR THE 21 ST CENTURY.....	1
2. THE MACG AND MWSG CONTRIBUTION TO MARINE AVIATION.....	5
MAGG Units Provide MACCS Agencies, 6	
MWSG Provides Airfield Capabilities, 10	
3. TECHNOLOGY AND DOCTRINE: DRIVERS FOR CHANGE.....	13
The Common Hardware – Common Software Solution, 14	
Force Structure Planning Group '99 Directs Changes, 14	
4. PROPOSAL FOR THE MACSG OF THE 21 ST CENTURY.....	20
Migrate ATC to the Marine Wing Support Squadron, 20	
Merge the Non-Flying Groups, 25	
Evolution of the MAGTF Information Warrior, 26	
Cross-Functional Air Control Squadrons, 38	
5. SUMMARY.....	41
BIBLIOGRAPHY	44

LIST OF FIGURES

Figure	Page
1. Notional MAW Organization	6
2. Notional MACG Organization	7
3. Notional MACS Organization	8
4. Notional MWSG Organization	11
5. Post-FSRG'99 MACG Organization	16
6. Notional Airfield Operations Sections	21
7. Air Traffic Control Communications Connectivity	22
8. Current MOS 7202 Occupational Field	30
9. Training Elements for Proposed MOS 7218	33
10. Proposed 72XX Officer Occupational Field	36
11. Proposed Marine Air Control and Support Group.....	40

CHAPTER 1

MARINE AIR CONTROL AND SUPPORT FOR THE 21ST CENTURY

We must preserve those elements of our organization, which have continuing relevance and quickly jettison those, which do not. What serves us well today might not be what is needed tomorrow.

General Charles C. Krulak
Commandant of the Marine Corps

Joint Vision 2010 is the Defense Department's conceptual document for the future. It serves as an operational template for the evolution of the armed forces in a challenging and uncertain future. Each service has a companion or supporting concept that supports *Joint Vision 2010*. The Marine Corps concept for the future projection of naval power ashore is *Operational Maneuver From the Sea* (OMFTS). OMFTS builds upon the foundation established with the joint Marine Corps-Navy ...*From the Sea* and *Forward...From the Sea* documents. In the spring of 1999, General Krulak, the 26th Commandant of the Marine Corps, directed a top-level Force Structure Planning Group (FSPG) to address moving the Corps toward an OMFTS force.¹ The group's deliberations focused primarily on the "littoral battle-space characterized by unpredictability, asymmetry, and the requirement for military operations spanning the

¹ Commandant of the Marine Corps (CMC) letter, 1000 CMC, subject: "Force Structure Planning Group," 8 February 1999.

spectrum of conflict.”² The FSPG made a range of structure and policy recommendations aimed at maximizing Marine Corps relevance and effectiveness in a complex and unpredictable future. The following pages outline some of the recommendations pertaining to air control and wing support groups while contributing a proposed course of action for consideration by future force structure review groups. The proposal centers on reducing support structure and improving the projection of Marine aviation ashore.

Marine Air Control For the 21st Century. Command and control (C2) equipment and organizations designed in the 1960’s and 1970’s will not meet the fast paced and highly technical demands of 21st century warfare. “We must leap forward in our thinking, leap ahead organizationally, and leap over generations of accumulated hardware.”³ Marine aviation specifically requires a more dynamic, efficient and effective Marine Air Command and Control System (MACCS) to meet the demands of an OMFTS force.

The MACCS must be capable of deployment and employment wherever and whenever required to support Marine Air Ground Task Force (MAGTF) operations. It must be capable of performing the requisite C2 functions without hindering MAGTF maneuver and mission accomplishment. The 21st century MACCS must provide the Aviation Combat Element (ACE) with the means to exercise control of all air and antiair

² Director, Force Structure Planning Group (FSPG) 1999 letter, 1000 FSPG, subject: “FSPG 1999 Report,” 27 April 1999.

³ General Charles C. Krulak, USMC, “Operational Maneuver From The Sea,” *Proceedings*, January 1997, 27.

warfare operations in the area of responsibility. It must provide the means to direct, manage, coordinate, and integrate all air activity, including other service and coalition air activity, in the MAGTF airspace. It must accomplish tasks such as airspace management, including air traffic control, and terminal control of aircraft, missiles, and unmanned aerial vehicles. The MACCS must provide the means to integrate and interoperate with higher, lower, and adjacent echelons of command engaged in the control of air and antiair warfare operations. The fundamental concept of employment will remain “centralized command and coordination, and decentralized control and execution.”⁴ The Marine Air Control Group (MACG) must facilitate rapid and effective deployment and employment of this future MACCS and reduce support structure.

Marine Air Wing Support for the 21st Century. The Marine Wing Support Group (MWSG) provides ground combat service support to the ACE. The subordinate Marine Wing Support Squadron (MWSS) has a limited capability to build and maintain airfields and a robust capability to operate airfields. The MWSS is a central element in the expeditionary nature of Marine aviation because

the ACE can never relinquish the capability to operate in close proximity to the GCE [Ground Combat Element.] To achieve desired sortie generation rates and rapid aircraft turnaround, precise amounts of fuel, ammunition, logistics, and ACE-specific services must be available at shore locations. Thus, the ACE must possess an organic capability to establish and operate flexible expeditionary sites ashore, ensuring responsiveness and endurance. The ACE will not “phase

⁴ Fleet Marine Force Reference Publication (FMFRP) 14-5, *Marine Air Command and Control System Operational Concept (MACCS 2000)* (Quantico, Virginia: Marine Corps Combat Development Command (MCCDC), 31 May 1989) iii.

ashore” in the traditional sense, but operate within a continuum comprised of both seabased and shore positions.”⁵

The MWSS performs many functions that duplicate the capabilities resident within the Force Service Support Group (FSSG) organization. This duplication is an inefficient use of the Marine Corps’ limited resources. A plan to modernize the ACE must eliminate unnecessary duplications of other MAGTF capabilities and focus on reducing support structure in the expeditionary enabling MWSS organizations. The following pages outline a plan to accomplish these goals.

⁵ Krulak, “MAGTF Aviation and Operational Maneuver From The Sea [OMFTS],” *Marine Corps Gazette*, February 1999, A-6.

CHAPTER 2

THE MACG AND MWSG CONTRIBUTION TO MARINE AVIATION

Marine aviation participates as the air component of the MAGTF in the seizure and defense of advance naval bases and the conduct of land operations as may be essential for the prosecution of a naval campaign. A collateral mission is to participate as an integral component of naval aviation in such other Navy functions as the fleet commanders so direct. Marine aviation tasks include the following six functional areas: offensive air support, anti-air warfare, assault support, air reconnaissance, electronic warfare, and the control of aircraft and missiles.⁶

The MACCS provides the ACE with the capability to control aircraft and missiles. This function specifically involves the coordination and employment of facilities, equipment, communications, procedures, and personnel that allows the ACE commander to plan, direct, and control the efforts of the ACE to accomplish the MAGTF mission. The MACCS executes this function while integrating the activities of the other five functions into a coordinated effort.⁷

Marine aviation includes three active and one reserve air wing. The Marine Aircraft Wing (MAW) provides the personnel and equipment for the MAGTF ACE.

⁶ Marine Corps Reference Publication (MCRP) 5-12D, *Organization of Marine Corps Forces* (Washington, DC: Headquarters Marine Corps (HQMC), 13 October 1998), 3-1.

⁷ MCRP 5-12D, 3-3.

Each MAW has a unique organizational structure comprised of aircraft, air control, and wing support groups. Each group includes the squadrons and battalions necessary to accomplish that group's role in Marine aviation while providing the wing with the capability to perform all six functions of Marine aviation. A notional MAW (depicted in figure 1) includes two fixed-wing Marine Aircraft Groups (MAGs), two rotary-wing MAGs, one MACG, one MWSG, and one Marine Wing Headquarters Squadron (MWHS).

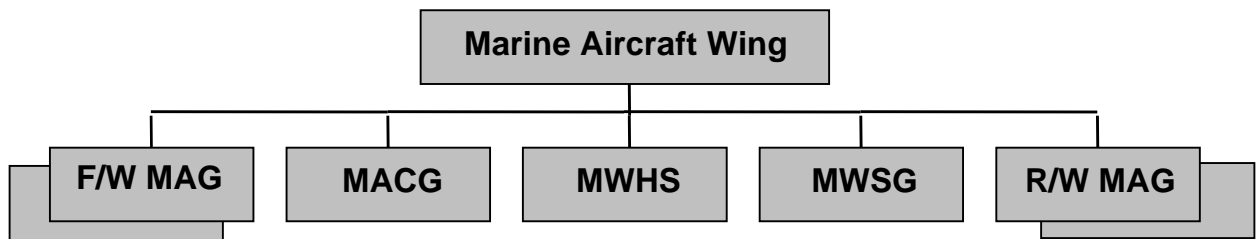

Figure 1. Notional MAW Organization

MAGG Units Provide MACCS Agencies

The mission of the MACG is to provide the personnel and equipment for the MACCS. The MACG contains subordinate units (squadrons and battalions) that provide agencies for the MACCS. It typically consists of a Marine Tactical Air Command Squadron (MTACS), a Marine Air Support Squadron (MASS), a Marine Air Control Squadron (MACS), a Low Altitude Air Defense Battalion (LAAD Bn), and a Marine Wing Communications Squadron (MWCS). Figure 2 depicts a notional MACG.

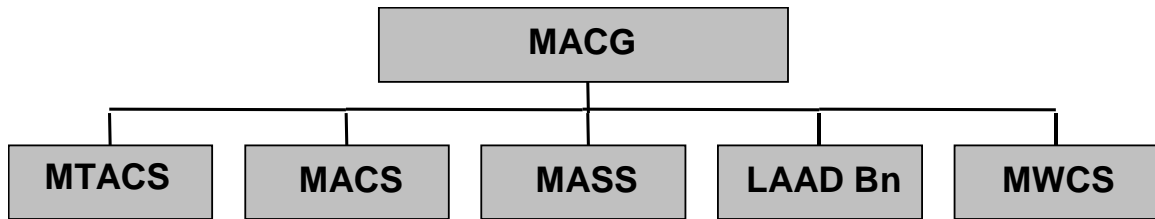

Figure 2. Notional MACG Organization⁸

Tactical Air Command Center – The Wing Command Post. The MTACS provides equipment, maintenance, and operations for the Tactical Air Command Center (TACC). The TACC serves as the senior air command and control agency and serves as the operational command post for the ACE. The TACC provides the facility from which the ACE Commander and his battle-staff plan, supervise, coordinate, and execute all current and future MAGTF air operations. The TACC integrates these functions with the MAGTF command element through linkage with the MAGTF Force Fires Coordination Center (FFCC) and Combat Operations Center (COC). The TACC is capable of integrating, coordinating, and directing joint and combined air operations. The MTACS equips, mans, operates, and maintains the current operations section of the TACC. The squadron also provides and maintains a facility for the TACC future operations planning section manned by the ACE Staff. Current operations refer to those air activities currently directed against an enemy and planned through the next 24-hours. Future operations refer to follow-on air activities against an enemy force. The building of an Air Tasking Order (ATO) is a critical element in planning future air operations. The TACC

⁸ MACG-18, 1st MAW located in Okinawa possesses a LAAD Btry vice a LAAD Bn.

is equipped with the latest joint hardware and software for ATO generation and distribution.

Tactical Air Operations Center – The Hub of Marine Air Defense. The MACS provides the personnel and equipment for the Tactical Air Operations Center (TAOC). The mission of the TAOC is to detect, identify, and control the intercept of hostile aircraft and missiles, and to provide navigational assistance to friendly aircraft in the accomplishment of various support missions. A long-range radar provides the TAOC with the capability of supporting airspace management and air defense weapons control operations. The MACS also provides equipment and personnel for the establishment of the Sector Anti-Air Warfare Coordinator (SAAWC) who functions as an air defense battle manager for the TACC. Each MACS organization is comprised of a TAOC detachment, an Early Warning Control (EWC) detachment, and four Air Traffic Control (ATC) detachments. Figure 3 shows the MACS organization.

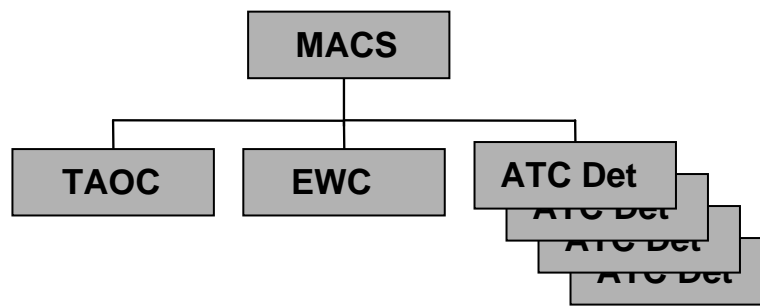

Figure 3. Notional MACS Organization⁹

⁹ 2d and 3d MAW each have four ATC detachments as depicted. 1st and 4th MAW have two detachments each. FSPG'99 recommended migrating to a mix of heavy and light ATC detachments.

Air Traffic Control at the Expeditionary Airfield. Each MACS (depicted in Figure 3) provides equipment and personnel for the Air Traffic Control (ATC) detachments. The ATC detachments are responsible for providing traditional air traffic control services for friendly aircraft operating at expeditionary airfields (EAF). The Marine ATC capability includes continuous, all weather, radar and non-radar, approach, departure, en-route, and tower air traffic control services to friendly aircraft operating out of main air bases, air facilities, and expeditionary air sites.

Shore Based Air Defense Weapons. The LAAD Bn is comprised of a battalion headquarters, a headquarters and service battery, and two firing batteries. The LAAD Bn mission is to provide close-in, low altitude surface-to-air weapon fires in defense of forward combat areas, vital areas, and installations. It also provides surface-to-air weapon support of units engaged in special operations and various independent operations. The LAAD Bn provides capabilities that are consistent with the size of the MAGTF and the scope of the air defense plan.

Direct Air Support Center – The Hub for Direct Air Support. The MASS provides Direct Air Support Center (DASC) capabilities for the control and coordination of fixed and rotary wing aircraft operating in direct support of MAGTF forces. The DASC processes requests for immediate air support, coordinates aircraft employment with other supporting arms, and manages terminal control assets supporting ground combat and combat service support forces. Other missions include the control of assigned aircraft and itinerant aircraft transiting through its area of responsibility. The DASC is the principal air control agency task organized to provide direction of air

operations directly supporting ground forces. The DASC is normally the first major air control agency to deploy ashore during amphibious operations. The DASC co-locates with the senior FSCC of the GCE. It must maintain communications connectivity with MACCS agencies (particularly the TACC), units requesting air support, aircraft under DASC control, and terminal controllers.

Expeditionary Communications. The MWCS does not provide a separate MACCS agency but serves in a critical C2 support capacity. The MWCS is responsible for expeditionary communications for the ACE headquarters and TACC. The squadron consists of a headquarters element and one or two detachments. Each MWCS may be independently deployed to provide external communications for up to two airfields and four forward bases. The MWCS coordinates communications functions internally and externally to the ACE, provides digital communications support, and provides electronic message distribution. The MWCS is also responsible for telephone services, and deployed local area network (LAN) and wide area network (WAN) server support.

MWSG Provides Airfield Capabilities

The MWSG provides the ACE with the requisite ground support and combat service support (CSS) for fixed wing or rotary wing components deployed to a forward operating base.¹⁰ A typical MWSG includes a Headquarters and Headquarters Squadron (H&HS),

¹⁰ MCRP 5-12D, 3-32.

two fixed wing oriented MWSS, and two rotary wing oriented MWSS. Figure 4 shows a notional MWSG organization. The group provides motor transport, engineering services,

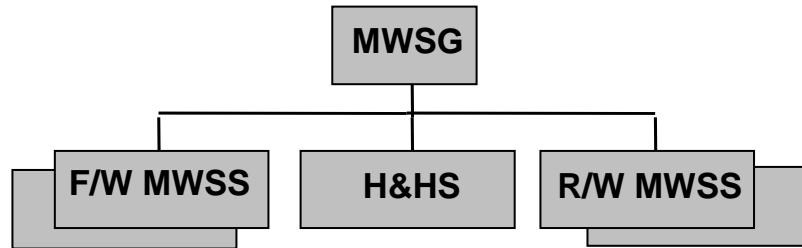

Figure 4. Notional MWSG Organization

and organizational maintenance (motor transport and engineering) for MAW units. The H&HS provides admin support to the group and squadron headquarters.

The MWSS conducts airfield operations, except for air traffic control (ATC), for supported ACE units. This airfield operations support includes the following areas:

1. Internal airfield communications.
2. Weather services.
3. Expeditionary airfield (EAF) services.
4. Aircraft Rescue and Fire Fighting (ARFF) and structural fire fighting services.
5. Aircraft and ground vehicle refueling.
6. Essential engineer services.
7. Motor transport for operations internal to the airbase.
8. Messing facilities.
9. Routine and emergency sick call, and aviation medical functions.
10. Individual and unit training of organic personnel and selected personnel of supported units.
11. Organic nuclear, biological, and chemical defense.

12. Security and law enforcement services.

13. Airbase Commander functions.

CHAPTER 3

TECHNOLOGY AND DOCTRINE: DRIVERS FOR CHANGE

Many military professionals and defense analysts believe a revolution in military affairs and the nature of warfare is in progress and driven by the emerging power of information technology. This information revolution offers the potential to form a powerful partnership between information and combat power. Just as gunpowder and mechanization rendered existing forms of warfare obsolete, today's technological improvements are pressuring military institutions to reevaluate basic concepts, organization, and practices for employing military forces. Faster data rates, greater bandwidth, improved reliability, and more interoperability do not necessarily improve command and control. The improvements can provide the illusion of enhancing C2 while introducing hidden and undesirable side effects.¹¹

Evolving requirements for an OMFTS force drive the need for equipment and organizational changes to the MACG and MACCS. The capability needed for an air C2 system in an OMFTS environment is not resident within today's MACCS. The need to conduct air operations in the world's chaotic littorals, the three block war in urban terrain, and the reach-back requirements of a sea-based force require new MACG and MACCS

¹¹ Major Brian J. Kelly, Air Force Senior Fellow, *From Stone to Silicone: A Revolution in Information Technology and Implications for Military Command and Control*, (Armed Forces Communications and Electronics Association (AFCEA) Educational Foundation, 31 December 1993) 1.

organizations. The evolving requirements for ship-to-objective-maneuver (STOM) and sustained-operations-ashore (SOA) also demand a MACCS capable of functioning across the warfare spectrum. The MACCS and OMFTS document examines the aviation C2 modernization initiatives while serving as a roadmap for the 21st century. The current MACCS equipment modernization efforts focus on the Common Aviation Command and Control System (CAC2S).

The Common Hardware – Common Software Solution

Today's MACCS is comprised of multiple stovepipe, legacy systems with large logistical footprints. These legacy systems support individual MACCS agencies and require specific MACG organizations with specialized operators and technicians. The Common Aviation Command and Control System (CAC2S) program will replace the antiquated MACCS equipment with a single, common hardware system that uses open architecture software. CAC2S will possess a true expeditionary capability compatible with OMFTS requirements. The impact of CAC2S will extend to both the MACCS agencies and supporting MACG organizations.

Force Structure Planning Group '99 Directs Changes

The mission of the Force Structure Planning Group (FSPG) '99, was to reshape the Corps into an *OMFTS* Force. The FSPG made numerous restructuring recommendations to the Commandant. The Corps-wide changes profoundly affect all

elements of the MAGTF and the Marine Corps' supporting establishment. Marine Commandant General Krulak approved some of the FSPG recommendations and the incoming Commandant General Jones approved others. General Jones has directed a review of the remaining recommendations by the Corps' senior leadership during calendar year 2000.

The FSPG recommendations include moving the Unmanned Aerial Vehicle (UAV) squadrons (VMU) to the MACG organization, merging the Marine Wing Headquarters Squadron (MWHS) with the MTACS, and reducing some of the MWSS Combat Service Support (CSS) capability. Figure 5 depicts the post-FSPG'99 MACG structure. The following paragraphs outline the FSPG changes to establish the groundwork for reengineering the MACG and MWSG organizations.

A New Home for the Unmanned Aerial Vehicle Squadrons. The UAV platforms gather intelligence in support of MAGTF operations. Currently, some fixed wing MAGs serve as the higher headquarters for the UAV squadrons with VMU-1 attached to MAG-13 and VMU-2 attached to MAG-14. Each VMU has five PIONEER aircraft. The MAG-VMU relationship is an inefficient organizational relationship because the parent MAG does not possess an information dissemination capability. In other words, the MAG does not possess the capability to disseminate the information obtained by the VMU PIONEER aircraft. FSPG'99 was concerned with improving integration between the VMUs and the ACE, specifically the integration between the

ACE C4I¹² providers, namely the MACCS. The FSPG recommended moving VMU to the MACG organizations. The MACGs have an inherent means of disseminating information through the MACCS C4I equipment. The issue of UAV (PIONEER) connectivity is being resolved through the CAC2S acquisition. Structure savings associated with the VMU migration to MACG result from reduced overhead in squadron administration, logistics, motor transportation, and aviation logistics support. The new squadrons retain the capability to support multiple detachments. Intermediate and organizational maintenance concepts for the UAV remain unchanged. Figure 5 shows the new MACG organization including the addition of the VMU.

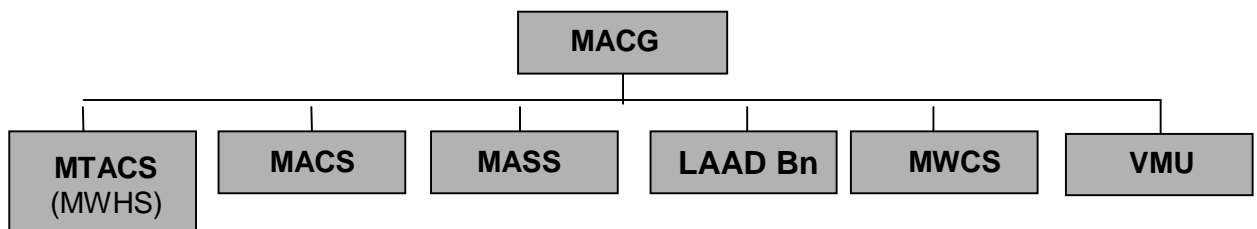

Figure 5. Post-FSPG'99 MACG Organization¹³

The Wing Headquarters Squadron Merger. The MWHS provides command, administrative, and supply support for the MAW headquarters and certain elements of the MACG. Its tasks include providing camp facilities and services, including food service, to the wing headquarters, MTACS, and MWCS. The organization normally functions as

¹² Command, Control, Communications, Computers, Intelligence (C4I)

¹³ Organization chart reflects the post-FSPG'99 MACG with MTACS merged with MWHS and addition of VMU squadrons.

an integral unit of the MAW to support the above mentioned units. FSPG'99 recommended merging the MWHS with the MTACS; see figure 5.

Merging the platoon sized MWHS organization into MTACS is logical since MTACS already performs the administrative functions for the MACG headquarters and both organizations (MTACS and MWHS) provide support to the MAW. The MTACS provides personnel and equipment for the wing commanders' TACC while the MWHS provides administrative and supply support to the wing headquarters. The merger of these two organizations increases organizational and functional efficiencies and reduces structure. Personnel support detachments will likely provide direct administrative support on-site at the MAW headquarters building or deployed location.

Reduced Capability of the Wing Support Squadrons. As depicted in Figure 1, each Marine wing possesses one MWSG. Each MWSG has four MWSSs; two squadrons support a rotary wing EAF and two squadrons support a fixed wing EAF. MWSSs are organized and structured in a similar fashion with the exception of arresting gear equipment and personnel resident within the fixed wing MWSS. The MWSS is capable of constructing and maintaining small landing fields and operating airfields of nearly any size. More specifically, the MWSS is capable of organic construction of helicopter airfields and STOVL¹⁴ facilities. Traditionally, these squadrons provide the capability to operate an EAF and provide limited CSS to the wings. The CSS functions duplicate

¹⁴ The MWSS is capable of construction (except for subsurface and surface preparation), improvement, and maintenance of Short Take Off and Vertical Landing (STOVL) facilities not to exceed 900 feet. Source: MCRP 5-12D, 3-33.

those capabilities resident in the Force Service Support Group (FSSG) and the Naval Mobile Construction Battalions (NMCB).¹⁵ The FSSG can provide engineering, motor transport, food services, and military police support just as effectively as the MWSS.

Historically and doctrinally, the NMCB and FSSG construct Marine Corps expeditionary airfields. From the island hopping campaigns of *World War II* to the steamy jungles of Vietnam, the NMCB built the Corps' airfields. During the *Gulf War*, the FSSG constructed the huge forward operating base *Lonesome Dove*. Today's doctrine and operational plans require the same construction support for Marine airfields. Recent doctrine reinforces the Corps' reliance on the FSSG and NMCB.

EAF(s) provide the MAGTF commander with the ability to augment host nation airfields or exploit captured airfields within the AOR [area of responsibility]. The MWSSs EAF and Engineering Sections can alter an airfield's configuration and make it all-weather capable, while retaining the capability to construct an airfield with the assistance from the [FSSG] and/or Naval Construction Force (NCF) units...¹⁶

The demands of an OMFTS force require an integrated approach to CSS. The FSPG'99 developed a *Total Force CSS Plan* that divested non-aviation unique CSS from the MWSS while maintaining the aviation unique combat support. The rationale was the ACE must focus on what it does best (i.e., operate from airfields) and allow other elements of the MAGTF to support the ACE with their unique and tailored capabilities.

OMFTS represents a cultural paradigm shift calling for ever-greater interdependence and closer integration between MAGTF elements. Ground and aviation Marines must immerse themselves in each other's tactics, capabilities, and limitations to foster our shared vision and develop trust "tactics."¹⁷

¹⁵ The NMCB units are commonly referred to as Sea Bees.

¹⁶ Marine Corps Bulletin 3125, *The Marine Aviation Implementation Plan for FY98*, 54.

¹⁷ Krulak, "MAGTF Aviation and OMFTS," A-10.

The FSPG CSS plan reinforces this concept of close integration of MAGTF elements. Under the FSPG plan, the MWSS Military Police, food service, motor transport operations, and engineer operations personnel and equipment migrate to the FSSG. The FSSG will then assume responsibility for providing all non-aviation unique CSS to the ACE. Fueling trucks, ambulances, eight 5-ton trucks, and twenty HMMWVs¹⁸ remain in each MWSS for day-to-day combat support. The MWSS will retain the capability to operate pre-existing airfields, forward operating bases, or EAFs. The FSSG will provide task-organized detachments to perform MAGTF common engineer and other CSS to the ACE. The CSS detachments (CSSD) would be capable of functioning in a mobile CSSD configuration in support of maneuver warfare. This concept allows the ACE to focus on operating from EAFs not building and maintaining them. The FSPG proposal is an efficient use of *Total Force CSS* assets and should be approved as recommended. Under this concept, all the airfield operations support for expeditionary airfields is resident within the MWSS. The only exception is ATC support that currently remains in the MACS organization.

¹⁸ High Mobility Multi-Wheeled Vehicle (HMMWV).

CHAPTER 4

PROPOSAL FOR THE MACG OF THE 21ST CENTURY

Migrate ATC to the Marine Wing Support Squadron

With the reduction of CSS capability and mission requirements, the MWSSG with its four MWSSs is a smaller organization. It remains responsible for operating four independent EAFs with an increased reliance on the Combat Service Support Element (CSSE). Each MWSS is capable of providing aircraft launch and recovery, Aircraft Rescue and Fire Fighting (ARFF), refueling, weather (meteorological), and airfield operations support. Essentially, the MWSS provides all services required at an EAF with the exception of ATC support. It makes little sense to have the critical ATC EAF function remain outside the EAF centric MWSS organization. The operational organization of a typical airfield (see figure 6) contains all the current MWSS capabilities plus ATC. Indeed, the airfield operations sections of all Marine Corps and Navy air stations include both ATC and other airfield support sections.

The MWSS is fully capable of providing the adequate infrastructure for employing and deploying ATC detachments. The MWSS is involved in many operational and support areas alongside the ATC detachments. The detachments' parent unit, the MACS, is not involved in these same areas. For example, Navy "*blue dollars*"¹⁹

¹⁹ Navy *Blue Dollar* equipment programs are managed by Naval Air Systems Command (NAVAIRSYSCOM), Naval Air Station Patuxent River, Maryland.

provides funding for both ATC equipment and MWSS equipment programs such as arresting gear. Marine Corps “*green dollars*”²⁰ provides funding for the MACS equipment. Both the MWSS sections and ATC operate in accordance with Naval Aviation Training and Operating Standards (NATOPS)²¹ procedures and rules. The rest of the MACCS is not involved in the NATOPS program. MWSS sections and the ATC community are also heavily involved in the Fleet Assistance Program (FAP).²² The MWSS and ATC detachments provide personnel, through the FAP, to the airfield operations sections of the air stations. The FAP serves as a source of manpower for the air stations and improves the skill levels for the involved Marines. The FAP is another support area that involves both MWSS and ATC detachment organizations.

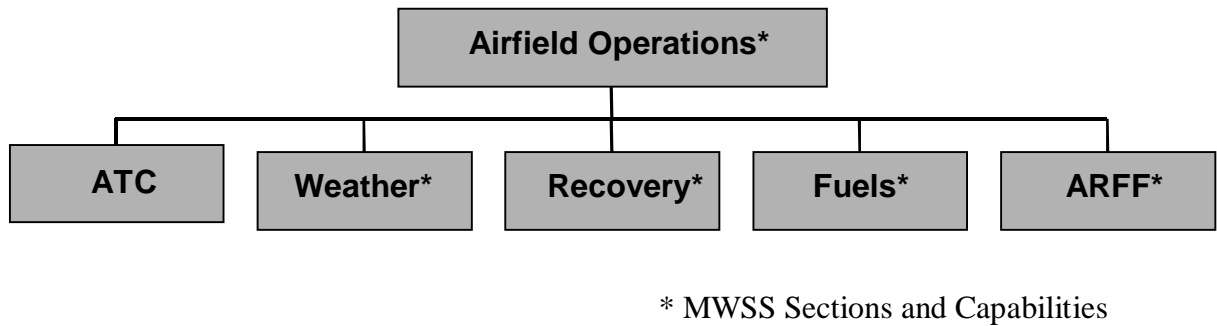

Figure 6. Notional Airfield Operations Sections

²⁰ Marine Corps *Green Dollar* equipment programs are managed by the Marine Corps Systems Command (MARCORSYSCOM), Marine Corps Base Quantico, Virginia under the cognizance of the Marine Corps Material Command.

²¹ NAVAIR 00-80T-114 ATC NATOPS is applicable to both Navy and Marine Corps air operations.

²² Despite the current Marine Corps initiative to reduce the FAP burden on the operating forces, the FAP provides a critical means of MOS qualification and skill development for ATC personnel.

In a tactical environment, ATC coordinates more extensively with the MWSS than the MACG provided MACCS agencies. To illustrate this point, consider the tactical ATC communications requirements within the MACCS and at the MWSS supported airfield. As depicted in figure 7, ATC serves as the control hub for movement around the MWSS supported airfield. In contrast, the connectivity between ATC and the MACCS agencies is essentially one of coordination. Even with the smallest deployment of an

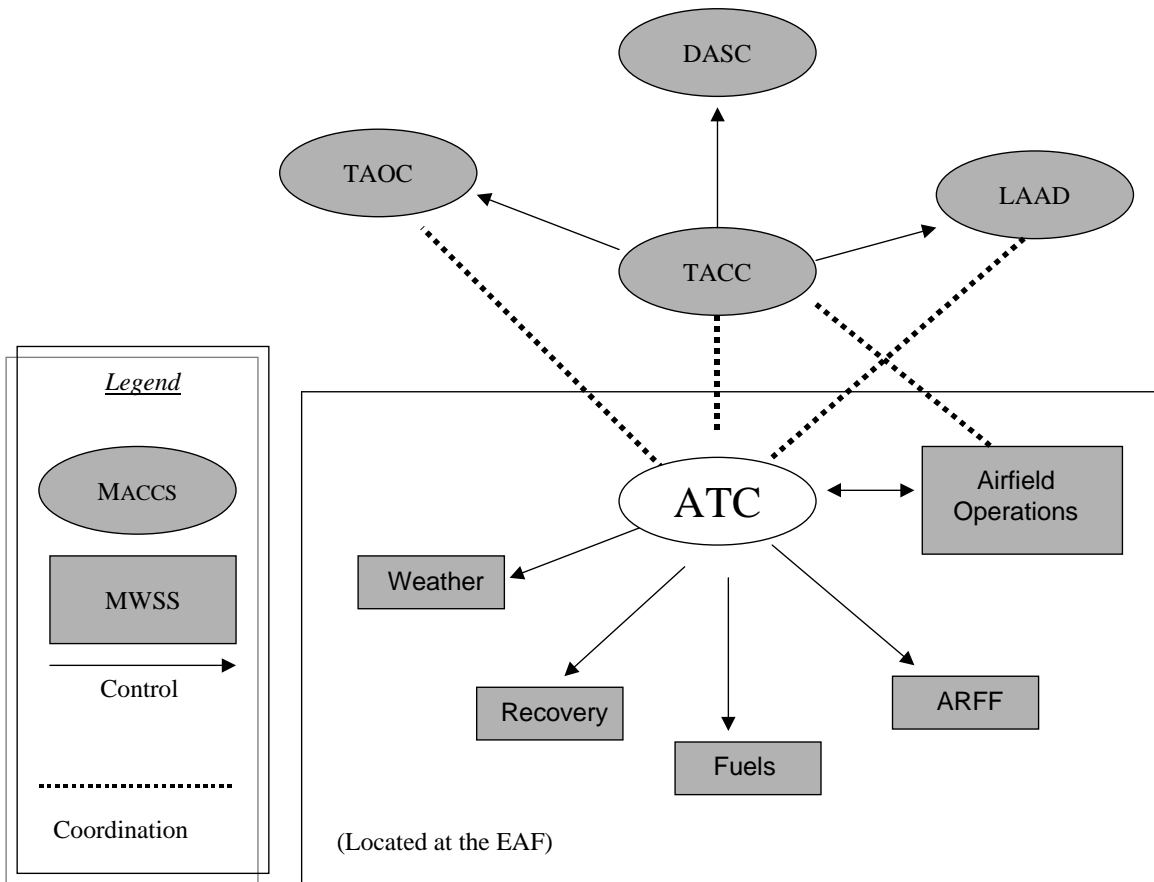

Figure 7. Air Traffic Control Communications Connectivity

ATC element, the mobile team, to a forward landing site, such as a forward arming and refueling point, the ATC mobile team must coordinate and work as a team with the MWSS sections. As the operational scenario expands to a larger airfield with more

aircraft, ATC becomes increasingly important to the MWSS airfield mission. The ATC importance in operating an airfield is a function of the number of aircraft operating out of the supported airfield. The requisite ATC capability increases exponentially with the number of aircraft the airfield is required to support. The ATC function is not dependent on the enemy air threat nor the presence of any other MACCS agency. ATC is vitally important to the MWSS from an elementary mobile team level to a full ground controlled approach airport service.²³ Throughout its history, ATC has been a vital element in MWSS mission accomplishment.

The Next Step in the Evolution of Marine ATC. Throughout the 1960's, the wing ATC capability was resident within the Marine Air Base Squadron (MABS) Marine ATC Units (MATCU). The MATCU functioned with limited connectivity (procedural or communication) with the MACCS. A hand-over net provided a means of infrequent radar coordination with the TAOC. The MATCU was very responsive to the attached MAG at the EAF. A concern for uniting the MATCU elements under one command and increasing responsiveness to aviation requirements resulted in the 1976 formation of ATC squadrons (MATCS) that were comprised of ATC detachments. The 1975 study that recommended establishment of the MATCS also de-coupled deployable ATC elements from the air station ATC organizations.²⁴ The Vietnam-era MABS organization

²³ Capt. Gregory P. Hold, USMC, "Marine Air Traffic Control: Misplaced in the MACCS," *Marine Corps Gazette*, May 1997, 57.

²⁴ CMC letter, RD/AAM-5-mrc 55-73-01, subject: "Organization and Assignment of Marine Air Traffic Control Units (MATCUs) in the Period 1973-1982 (Short Title: MATCU Study)," 5 May 1975.

was a merger of both air station and tactical ATC that proved problematic to both mission areas.

With a goal of enabling the MACCS to provide air control service from taxiway, through mission sorties, and back to the runway, MATCS became a part of the MACG. During the MATCS era, the focus of ATC broadened and expanded with the fielding of new equipment and digital information link capabilities. MATCS proved an effective organization during combat operations in the *Persian Gulf War*. A task-organized reinforced MATCS provided ATC services at four remote area landing sites, three control tower sites with limited radar support, and full approach control services at five EAFs. Following the liberation of Kuwait during *Operation Desert Storm*, the deployed MATCS also restored ATC services to Kuwait International Airport.²⁵ MATCS further proved its worth in follow-on combat operations in Mogadishu, Somalia during *Operation Restore Hope*. An ATC detachment was the only MACCS element to deploy to Mogadishu and it deployed with an MWSS detachment.

Despite many successes, in 1994 the Marine Corps divested MATCS and merged the ATC detachments into the MACS organization. Although this change resulted in a loss of ATC expertise within the squadron headquarters, Marine ATC has continued to meet the demands of Marine Aviation. Often, the ATC detachments deploy to exercises and real world operations as the sole MACCS element. During the recent *Operation Allied Force* in Kosovo, the only MACCS element to deploy was an ATC team. Deployed to Allied Air Base Tazsar, Hungary, an ATC team co-located with an MWSS

²⁵ LtCol Robert J. Bozelli, USMC, "Managing Change in Today's Marine Corps: The MATCS Case," *Marine Corps Gazette*, May 1994, 63.

detachment in support of MAG-31(minus) aircraft operations. The ATC Marines performed in a superb manner while providing a critical function to MAG-31 and Allied air operations at the Hungarian base.²⁶ Combat and peacetime exercises have proven the effectiveness of the ATC detachments to deploy as a stand-alone MACCS element. The ATC detachments often deploy with an MWSS detachment. Logistically, programmatically, and operationally, "...ATC detachments make more sense outside the MACS. Just as tactical air control parties are part of the ground combat element, even though they are an aviation command and control node..."²⁷ ATC detachments are capable of residing effectively outside the MACS. The EAF centric ATC detachments should merge with the EAF centric MWSS.

Merge the Non-Flying Groups

The reduced CSS capability of the MWSS offers the opportunity to merge the two non-flying MAW groups, the MACG and MWSG. The evolving MWSG-MWSS is smaller in both mission requirements and organization. As explained above, FSPG'99 reduced MWSS capabilities to primarily supporting EAF operations and increased reliance on the CSSE. With the proposed addition of ATC detachments, the MWSS is capable of providing all the requisite multi-functional support required at an EAF.

²⁶ LCpl Derek A. Shoemake, USMC, "ATC Marines Keep Birds Flying in Tazsar," (<http://www.usmc.mil/news/news99.nsf/2385e8ac1be1aa3c852567850047bdab/7118fe022bd0acc58525679900472721?OpenDocument>), 23 June 1999.

²⁷ Capt Jeffrey S. Kojac, USMC, "Restructure the Marine Air Command and Control System," *Marine Corps Gazette*, December 1996, 23.

Likewise, the ACE would receive more effective and efficient tactical support by having one dynamic, concentrated, hybrid air control and support organization that provides both C2 and EAF support. The elimination of one group headquarters (MWSG) would provide manpower savings for reinvestment into other areas. The merger of the MWSG and MACG would result in a new non-flying air control and support group (MACSG).

Evolution of the MAGTF Information Warrior

The Marines within the MACCS are experts in air defense, air support of ground forces, air traffic control, and air command center operations. This core of officers and enlisted Marines understand how to provide commanders with the requisite information for effective planning, decision-making, and execution. These air C2 subject matter experts will be increasingly important during the transition to a 21st century force. The MACCS officers will become invaluable, not only to Marine aviation, but to the entire MAGTF as C4I capabilities continue to evolve.

The future relevance of MAGTF aviation's air command and control capability depends upon joint interoperability, innovative concepts and tools, and MAGTF Information Warriors, all organized and "packaged" to provide full support for MAGTF operations in the Joint/combined environment.²⁸

The following paragraphs outline very specific manpower recommendations that evolve the MACCS occupational specialties toward a MAGTF Information Warrior.

²⁸ Headquarters U.S. Marine Corps (HQMC), *DRAFT: The Marine Air Command and Control System and Operational Maneuver From The Sea, Part One: The Roadmap* (Washington, DC: HQMC, 15 Dec 1999), 3.

Bring Back the Restricted Air Traffic Control Officer. For several years, restricted and unrestricted officers (warrant and limited duty officers) formed the air command and control officer corps. Initially, the restricted ATC officers filled the requirement for approach controllers. Later, these officers experienced mission creep and assignments to a variety of billets traditionally filled by unrestricted line officers. Restricted and unrestricted ATC officers became interchangeable. In the early 1990's, Pentagon rules concerning restricted officers changed. Specifically, restricted and unrestricted officers could no longer be assigned to the same occupational specialty. Marine Corps manpower officials subsequently eliminated all restricted officers, including ATC officers, from the air C2 occupational field (72XX). The impact on the MACCS community was a loss of depth in officer experience that used to reside within the restricted officer ranks. The result was a loss of mentors for junior officers and enlisted personnel that lengthened the time to train and qualify MACCS personnel. With the extensive Federal Aviation Administration (FAA), NATOPS, and lengthy time to train and qualify, the ATC community's loss of expertise has been acute.

One of the issues often discussed at Marine ATC conferences is the loss of restricted officers as mentors for enlisted and staff non-commissioned officers. The highly qualified restricted officers were invaluable in organizing and conducting training programs for air station ATC facilities. The station ATC facilities function as the training environment for skill development and MOS qualifications for school trained controllers. The facilities are a critical element for maintaining a Corps-wide pool of qualified controllers for both air station and ATC detachment missions.

The joint Navy-Marine Corps Air Traffic Control School, located at the Naval Air Technical Training Center (NATTC), Naval Air Station Pensacola, Florida, is responsible for training Navy and Marine ATC personnel. The unrestricted Marine officers receive the very same ATC “A” school training as junior enlisted sailors and Marines. Upon arrival at an air station ATC facility, these junior officers and enlisted Marines achieve basic MOS qualifications on elementary control positions. Current MOS requirements for the junior ATC officer include qualification on both tower ground control and radar final control positions.²⁹ After achieving these basic qualifications, the young officer can expect assignment to various leadership billets throughout the facility. Few of these unrestricted officers have sufficient time to complete the lengthy on-the-job-training to master more senior, complex control positions. This is not a desirable goal anyway. Training an unrestricted officer on advanced control positions takes valuable training time and air traffic away from enlisted controllers who must achieve advanced qualifications for MOS, NATOPS, and Training and Readiness (T&R)³⁰ requirements. Training unrestricted officers for senior control positions offers very little return on the facility’s training investment. Furthermore, qualified enlisted controllers, not the officers, must man ATC crew positions on a daily basis. One analogy is the Aircraft Maintenance Officer (AMO), while well versed on all the systems of the aircraft, the AMO is not fully trained and qualified to make specific repairs on all the systems. The Aircraft Mechanics (enlisted personnel) are trained to make those repairs. The

²⁹ Marine Corps Order (MCO) P5400.18D, *Military Occupational Specialty (MOS) Manual* (Washington, DC: HQMC, 1999).

³⁰ MCO P3500.12D, *Training and Readiness (T&R) Manual* (Washington, DC: HQMC, 1999).

unrestricted ATC officer must complete other training requirements to ensure competitiveness for promotion. These requirements include professional military education (PME) and assignments to deploying MACS ATC detachments or MACG MEU detachments.

A restricted officer does not share the same demands for career broadening assignments. The restricted officer primarily serves within the framework of his occupational specialty. Restricted officers add a depth of expertise that benefits Marine aviation in many high technology fields. Staffing ATC facilities and detachments with highly specialized restricted ATC officers possessing supervisory experience would enhance training while improving the level of service provided to the aviation community. Other highly technical aviation fields, including the traditional MWSS occupational fields such as Aircraft Rescue and Fire Fighting (ARFF), benefit from the technical expertise provided by restricted officers. Creating a restricted ATC officer MOS (7230) will provide Marine aviation with the same caliber of subject matter expert. Structure for this new MOS will come from the savings yielded from merging the MACG and MWSG organizations. This conversion proposal also supports the concept of moving the ATC detachments to the MWSS and merging the MWSG and MACG.

Evolving the Air Control Officer Generalists. An on-going MACCS concern revolves around the question of how to “build” field grade air command and control officers (Military Occupational Specialty (MOS) 7202.) The Marine Corps does not have a unique 7202 MOS producing course. Although initially conceptualized with the

inception of the MOS approximately six years ago, a separate course was never established. Today, four company grade MOSs serve as feeders into the 7202 MOS³¹; see figure 8. In response to ongoing concerns, the Marine Aviation Weapons and Tactics

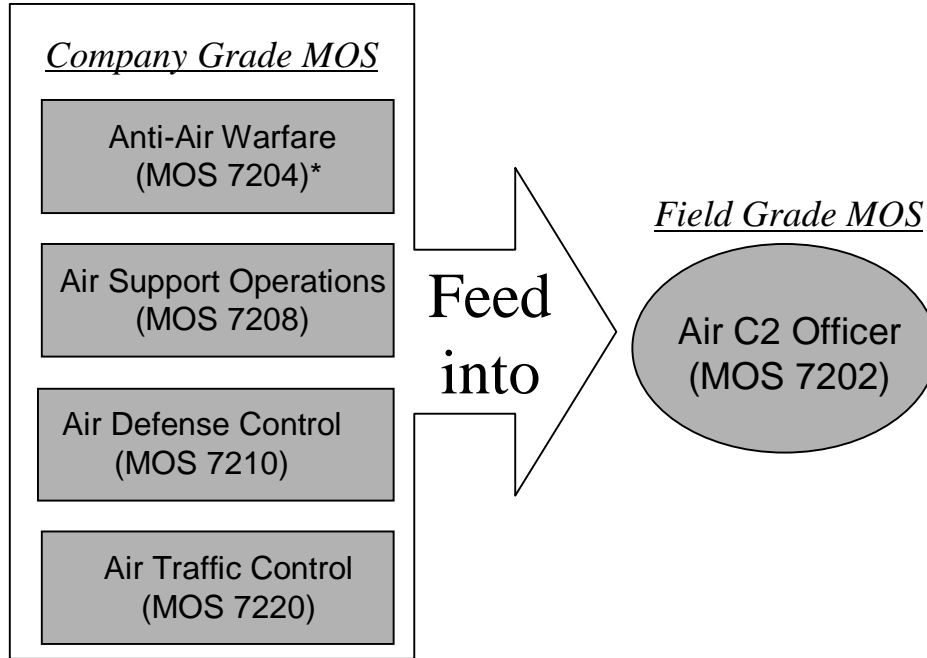

Figure 8. Current MOS 7202 Occupational Field

*Assumes return of MOS 7204 in FY01. See footnote #32

Squadron (MAWTS)-1 stood up a field grade air C2 course in the fall of 1999.

The course was developed to address the training requirement for 7202 Majors returning to the [Marine Corps operating forces] after a tour away to better prepare them for service as a MACCS squadron or battalion Operations Officer. Additionally, the training sought to address the fact that many of these officers, as 7202s, may be serving in units within the MACCS in which they had not “grown up.”³²

³¹ This discussion and accompanying diagram (figure 8) include the planned return of MOS 7204 during FY01.

³² Marine Aviation Weapons and Tactics Squadron (MAWTS)-1 C3 Department’s Semi-Annual Newsletter, *Air Command and Control Officer Course*, Vol. 5 Number 1 of *Eagle Vision*, Winter 1999, 2.

For instance, a 7202 Major with a 7208 background (company grade MOS) “grew up” in MASS units. As a Major, that same officer, could now be assigned to a MACS or any other MACG squadron or battalion. The curriculum for the inaugural field grade air C2 course “...covered the various agencies and capabilities of the MACCS and how they tie in to MAGTF and joint operations. The culmination of the training was a Marine Aviation Planning Problem.”³³ While certainly no panacea for the perceived problems in training a generic well-rounded field grade MACCS officer, the course has made a bold step in providing air C2 refresher training. The initial response from the MACCS leadership has been positive.

Create a Single Air Control Officer Specialty. Currently, the MACCS officer community is comprised of three air control specialties. The DASC (MOS 7208) and TAOC (MOS 7210) air controllers receive their basic MOS training at the Marine Corps Communications and Electronics School (MCCES), Marine Corps Base 29 Palms, California. These courses provide basic MACCS training as well as specific DASC and TAOC training. The training throughput at MCCES is 36 MOS 7208 officers³⁴ and 16 officers with MOS 7210. As stated earlier, ATC officers (MOS 7220) receive their MOS

³³ MAWTS-1, *Air Command and Control Course*, 2.

³⁴ The throughput for MOS 7208 officers reflects the current merged 7204-7208 MOS. The throughput for 7208 officers will decrease when the 7204 MOS is broken out in the future.

training at NATTC in Pensacola, Florida. The NATTC throughput includes 11 ATC officers (MOS 7220.)³⁵

Over the last several years, Training and Readiness (T&R)³⁶ requirements for both DASC and TAOC personnel have migrated away from the highly specialized officer controller. The requirements for today's officers involve a more generalist air controller or asset manager. Conversely, the requirements for the enlisted controller have evolved into a more specialized controller. For example, the current T&R for TAOC officers (7210) does not require specific Ground Controlled Intercept (GCI) training and qualifications. The senior enlisted TAOC controller (MOS 7236) is now required to obtain GCI qualifications. Regardless, focused GCI training still comprises the majority of the 7210 course work at MCCES.

Considering the relatively small training throughput of the officer courses, MCCES could easily merge the course work into a single course of instruction that covers multi-functional air control training. This training would cover not only the tactical air C2 requirements for DASC, TAOC, and TACC functions, but also include the increasingly important civil air traffic issues. The current ATC officer syllabus provides the requisite training in civil air traffic procedures and airspace management that is needed to integrate tactical air operations with local civil airspace managers or host nation aviation agencies. Merging training elements from MOS 7208, 7210, and 7220 into a single air C2 course will provide the Fleet with a more effective, multi-disciplinary

³⁵ FY00 training goal numbers provided by MSgt Michael R. Baker, USMC, HQMC (APC), email, 21 January 2000.

³⁶ MCO P3500.12D, *Training and Readiness (T&R) Manual*.

air control officer. This officer will be better prepared to meet the complex air C2 environment of the 21st century from a tactical air control function to a host nation civil air traffic agency. Figure 9 shows the training elements required for training a multi-functional company grade air control officer. With an increase of one instructor, MCCES could easily absorb the increased throughput required for proposed MOS 7218. As stated above, the current MCCES throughput is 42 officers, comprised of 36 officers with MOS 7208 and 16 officers with MOS 7210. The new MOS 7218 would require an increased throughput of 11 officers. Transferring one instructor from the ATC School to MCCES will provide the necessary manpower overhead for transition to the new pipeline.

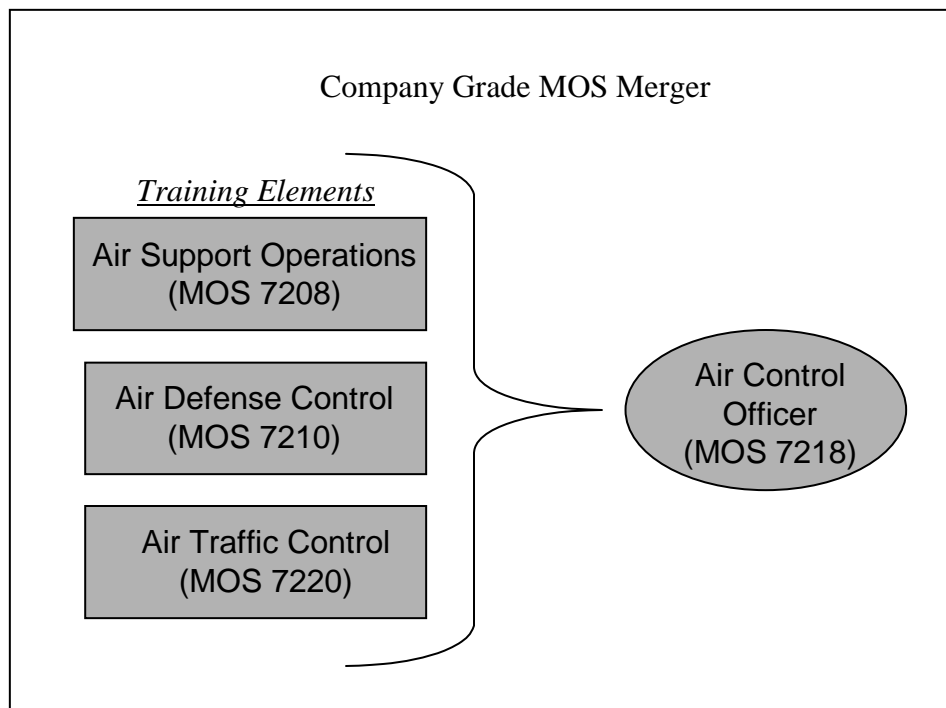

Figure 9. Training Elements for Proposed MOS 7218

Lessons Learned From Merger of MOS 7204 and 7208. With the divestiture of HAWK³⁷ in 1997, the MOS 7204 (Antiair Warfare Officer) was deemed too small to effectively exist as a stand-alone MOS. The only MOS 7204 billets resided within the LAAD Bn and MOS 7204 School at Fort Bliss, Texas. Many Headquarters Marine Corps Action Officers believed a merger of like occupational specialties to be the most effective course of action for this MOS. Specifically, a merger of the antiair warfare (MOS 7204) with the air defense control officer (MOS 7210) appeared to be the strongest marriage. Regardless, the decision was made to merge the 7204 MOS with MOS 7208 (DASC air support operators). The rationale for this decision centered on the argument that both LAAD Bn and MASS (DASC) deploy in direct support of the MAGTF Ground Combat Element. The decision makers discounted possible problem areas including having one officer MOS providing the manpower for two widely divergent organizations and mission areas. Specifically, air support operations and antiair warfare operations. This decision did not merge like-functions and the result has not been effective.

The merger also created a problem with assigning women Marines to the new MOS 7208. Marine Corps orders do not allow women Marines in LAAD Bn and restrict the deployment of women in the MASS units to the division level and higher organizations. In the past, women Marine officers with MOS 7204 were assigned to the LAAM Bn organizations in support of the HAWK missile system. Women Marines with MOS 7204 were not assigned to LAAD Bn. The 7204 merger with MOS 7208 created

³⁷ Light Antiaircraft Missile Battalion (LAAM Bn) deployed the HAWK missile system as the Marine Corps' medium range surface to air missile defense capability. The divestiture of HAWK resulted in the deactivation of the LAAM Bn organizations.

confusion in dealing with women Marine assignments.³⁸ The confusion centered on being able to assign women Marine officers (MOS 7208) to the MASS and LAAD Bn organizations. In the author's opinion, the current policies are unfair to women Marines by limiting their deployment and career opportunities. The policies are also unfair to male Marines by forcing them to deploy even more than should be expected to make up for the absence of the women Marines. The policies further place commanders in the position of "bending" or "skirting" the rules due to low manning levels in MOS 7208.

Working through the MACG Operational Advisory Group (OAG), the Marine Corps operating forces have requested a return back to the separate 7204 MOS and 7208 MOS.³⁹ Headquarters Marine Corps will likely approve the OAG request. The merger of the 7204 and 7208 MOSs, the expected reversal of the decision, and lessons learned is noteworthy when considering further MOS mergers. One of the primary problems with the new 7208 MOS was that it continued to support two remarkably different organizations; the LAAD (antiair warfare) and MASS-DASC (direct air support) environment. The one MOS (7208) was now providing company grade officers for both LAAD and MASS communities and proved problematic.

In contrast to the ill fated 7204-7208 merger, the changes proposed herein are more extensive and merge like functions. The new MOS 7218 (combined elements from

³⁸ From a joint perspective, women soldiers are assigned to all Army SHORAD (Short Range Air Defense) units.

³⁹ Initially established as the TACC OAG, the MACG OAG is chartered as a forum for direct fleet interface with requirements officers, program managers, and headquarters advocates. It serves as a vehicle of identifying and prioritizing issues which directly impact C2 capabilities, standardization, training, readiness, and safety. The Commanding General, 3d MAW serves as the chair.

the 7208, 7210 and 7220 MOSs) will support an entirely new air control organization that is tasked with both air operations (TAOC), airspace management (ATC), and air support (DASC) missions. This organization will have a larger pool of officers to support recurrent exercises such as the Combined Arms Exercises (CAX) and Weapons and Tactics Instructor (WTI) evolutions, and the MEU(SOC) rotations. Currently, MOS 7210 officers do not deploy with MACG MEU detachments. The result will be a more effective and well-rounded air control officer who is more competitive for promotion.⁴⁰ The new MOS 7218 and MOS 7204 will serve as feeders into the field grade MOS 7202 and obviate the current problems experienced with four MOSs feeding into MOS 7202. Figure 10 outlines the proposed structure.

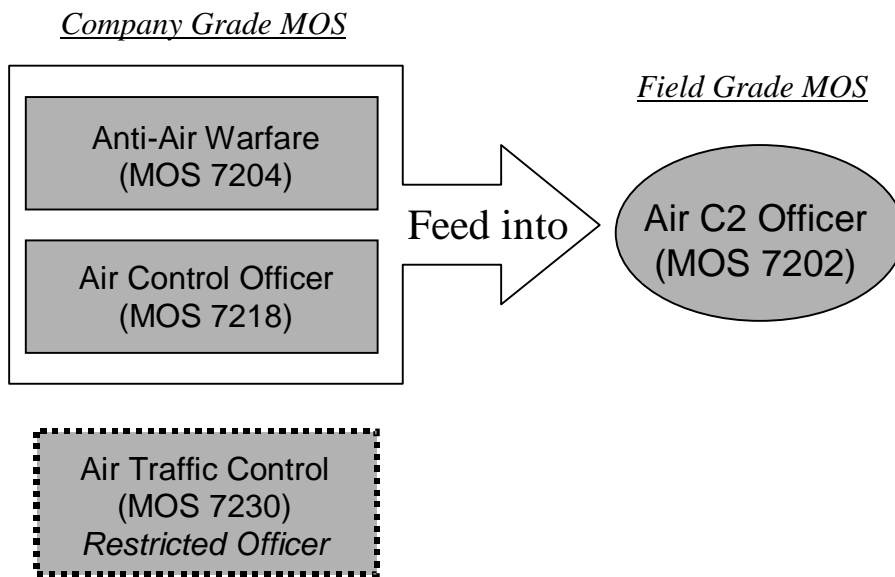

Figure 10. Proposed 72XX Officer Occupational Field

⁴⁰ MOS 7210 had the lowest percentage of officers selected for promotion by the FY99 active duty Captain Promotion board.

Although the antiair warfare officers (MOS 7204) will not have the same entry level MACCS training as the air control officers (MOS 7218), the skill development requirements for this community remain robust. The antiair warfare officer should continue to receive basic air defense training at the Army Air Defense Artillery School at Fort Bliss, Texas. There is no value added in having MCCES replicate the superb training offered at this facility. Furthermore, this training provides a sound framework to prepare these officers for positions of leadership within the LAAD Bn. The officer billets and command opportunities are comparable to the billets available in the ground combat occupational fields. Therefore, a successful antiair warfare officer should remain competitive for promotion among his peer group Corps-wide. Likewise, the small number of officers in the MOS should not dilute the benefits of adopting the air control officer (MOS 7218) structure. On the contrary, these antiair warfare officers would add the dynamics of the SHORAD experience and expertise to the larger context of the field grade air C2 officer (MOS 7202) community. A future MACCS structure review group may want to weigh the benefits of continuing with a separate antiair warfare MOS. With the fielding of future equipment and organizational changes as proposed, a merger with MOS 7218 may be appropriate.

Cross-Functional Air Control Squadrons

Today's Marine Air Command and Control System will provide the foundation from which ACE command and coordination will emerge.⁴¹ The specialized MACCS agencies and MACG units of the 1990's will evolve into cross-functional commands.⁴² The merger of the MWSG and MACG into one air control and EAF support group (MACSG) should increase efficiencies and effectiveness. Merging the ATC detachments into the EAF centric MWSS would provide an effective, concerted, cross-functional EAF command. Even the MTACS-MWHS merger is an example of cross-functionality. The MTACS will now provide administrative as well as tactical command post (TACC) tasks.

Yet, the real benefits in saved structure, reduced overhead, and increased efficiencies come from merging the air control squadrons and air support squadrons into cross-functional commands. The resultant organization would be a dynamic, air control squadron with the mission of airspace management, air control, and direct air support. The proposal to merge the 7208, 7210, and 7220 MOSs into one air control MOS 7218 supports the new air control organization's mission areas. The new Expeditionary Air Control Squadron (EACS) would enable the "streamlining [of] air control functions"⁴³ and provide the capability to task organize for a myriad of air control and air support missions. These mission areas include the traditional TAOC and DASC roles. The promises of new technology solutions and the acquisition of CAC2S provide further opportunities for change to a new EACS for the 21st century.

⁴¹ Krulak, "MAGTF Aviation and OMFTS," A-4.

⁴² HQMC, *DRAFT: The Marine Air Command and Control System and Operational Maneuver From The Sea, Part One: The Roadmap*, 15.

⁴³ Krulak, "MAGTF Aviation and OMFTS," A-5.

The draft *MACCS and Operational maneuver From the Sea* document outlines the migration to a modern, highly mobile and scalable C2 system. CAC2S should provide an integrated multi-role and multi-mission capability for real-time combat direction of aviation assets. The system should facilitate the fusion of data from a variety of sources using streamlined information dissemination and management techniques and procedures. The voice and data communications experts within the MWCS will remain critical to a future ACE C2 organization. The fielding of the new CAC2S equipment supports the migration to cross-functional EACS command. The CAC2S equipped EACS requires operators, maintainers, and the voice-data communications experts who understand the challenge of managing a modern automated C2 environment. CAC2S drives further integration of the skill sets resident within the air C2 (72XX specialties) and data and voice communications (06XX specialties) occupational fields. The MWCS structure should be functionally organized into detachments for both the MTACS and EACS organizations. Each squadron should possess the personnel, structure, and equipment to meet their unique voice-data communications requirements. A resident communications support capability enhances the cross-functional nature of the EACS and the responsiveness of the MTACS. Spread-loading MWCS detachments among these two squadrons further enhances each units' ability to task-organize in support of various mission requirements. Figure 11 shows the proposed Marine Air Control and Support Group for the 21st century.

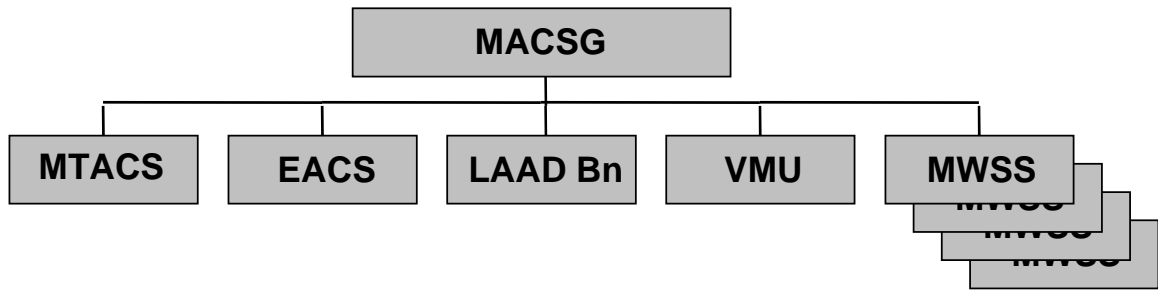

Figure 11. Proposed Marine Air Control and Support Group

CHAPTER 5

SUMMARY

Marine aviation requires a more effective C2 and support organization to meet the demands of 21st century warfare. Emerging technology and doctrine drive the need for change in a challenging and uncertain future. The Marine Corps has embraced *Operational Maneuver From The Sea* as its overarching concept for the future projection of naval power ashore. The current air C2 and support organizations, designed during the *Cold War* of the 1970's, will not meet the fast paced, highly technical, streamlined needs of an OMFTS force. The fielding of new CAC2S equipment provides the vehicle for meeting the technical demands while new organizations facilitate the rapid and effective deployment and employment of multi-functional MACCS and EAF elements.

Leveraging off the groundwork of FSPG'99, the proposed changes result in a more effective organization capable of meeting the new and emerging demands. The FSPG recommendations for the ACE include moving the VMU squadrons into the MACG, merging the wing headquarters squadrons with the MTACS, and reducing the CSS capability of the wing support squadrons. The proposed changes further evolve the air control and support group organizations. The overriding concept centers on the creation of a Marine Air Control and Support Group (MACSG) from a merger of the two non-flying groups, MACG and MWSG. With the reduction of CSS capability and mission requirements, the MWSG is a much smaller organization. The four MWSSs

remain responsible for providing all services required at an EAF except for ATC support. The critical ATC capability should merge with the EAF centric MWSS to create a multi-functional EAF command. The new MACSG reduces support structure and saves manpower by divesting one group headquarters. The ACE will receive more effective and efficient tactical support by having one dynamic, concentrated, hybrid air control and support organization that provides both C2 and EAF support.

Evolving MAGTF information warriors from the current air C2 officer structure is a critical thread in this air C2 and support modernization plan. The proposed concept includes creation of a restricted ATC officer specialty (MOS 7230) from structure savings yielded in the merger of the MACG and MWSG organizations. The proposal also includes merging the current air support (MOS 7208), air defense (MOS 7210), and ATC (MOS 7220) officer structure into a single air control MOS (7218). The merger supports the current HQMC action toward bringing back the antiair warfare specialty (MOS 7204.) It also resolves the MACG community's concerns regarding the lack of formal training for field grade air C2 officers. The air control officer (7218) would be a school and fleet trained expert in air support, air defense, and air traffic control operations. The new MOS 7218 and re-emerging MOS 7204 would serve as feeders into the field grade 7202 MOS. The proposed officer structure supports the evolution toward cross-functional commands.

The merger of MACS and MASS into an Expeditionary Air Control Squadron (EACS) squadron epitomizes the ideal cross-functional organization. Each EACS would be capable of conducting air space management, air support, and air control missions. The fielding of the new CAC2S equipment provides the opportunity to reinvest MWCS

structure into providing both the MTACS and EACS with a resident voice-data communications support capability. A resident communications support capability enhances the cross-functional nature of the EACS and the responsiveness of the MTACS.

The proposed changes to officer structure and air C2 and support organization are not the *End State* but rather the framework of an evolutionary process. FSPG'99 offered bold initiatives toward an OFTS force. The proposals outlined in this paper leverage off the FSPG recommendations, emerging CAC2S technology, and evolving doctrinal requirements to provide recommendations for consideration by follow-on force structure reviews.

BIBLIOGRAPHY

- Baker, MSgt Michael R., USMC. Headquarters U.S. Marine Corps (HQMC) (APC). Email. 21 January 2000.
- Bozelli, LtCol Robert J., USMC. "Managing Change in Today's Marine Corps: The MATCS Case." *Marine Corps Gazette*, May 1994, 63.
- Commandant of the Marine Corps (CMC). Letter. 1000 CMC. Subject: "Force Structure Planning Group." 8 February 1999.
- CMC. Letter. RD/AAM-5-mrc 55-73-01. Subject: "Organization and Assignment of Marine Air Traffic Control Units (MATCUs) in the Period 1973-1982 (Short Title: MATCU Study)." 5 May 1975.
- Department of Defense. *Conduct of Persian Gulf War*. Final Report to Congress. April 1992.
- Director, Force Structure Planning Group (FSPG) 1999. Letter. 1000 FSPG. Subject: "FSPG 1999 Report." 27 April 1999.
- Fleet Marine Force Reference Publication (FMFRP) 14-5. *Marine Air Command and Control System Operational Concept (MACCS 2000)*. Quantico, Virginia: Marine Corps Combat Development Command (MCCDC). 31 May 1989.
- Headquarters U.S. Marine Corps (HQMC). DRAFT Document. *The Marine Air Command and Control System and Operational Maneuver From The Sea, Part One: The Roadmap*. Washington, DC: HQMC. 15 December 1999.
- Hold, Capt. Gregory P., USMC. "Marine Air Traffic Control: Misplaced in the MACCS." *Marine Corps Gazette*, May 1997, 57.
- Kelly, Major Brian J., Air Force Senior Fellow. "From Stone to Silicone: A Revolution in Information Technology and Implications for Military Command and Control." Armed Forces Communications and Electronics Association (AFCEA) Educational Foundation, 31 December 1993.
- Kojac, Capt Jeffrey S., USMC. "Restructure the Marine Air Command and Control System." *Marine Corps Gazette*, December 1996, 23.
- Krulak, General Charles C., USMC. "Operational Maneuver From The Sea." *U.S. Naval Proceedings*, January 1997, 26.
- Krulak. "MAGTF Aviation and OMFTS." *Marine Corps Gazette*, February 1999, insert.

- Marine Aviation Weapons and Tactics Squadron (MAWTS)-1 C3 Department's Semi-Annual Newsletter Vol. 5 Number 1. *Eagle Vision*. Yuma, Arizona: MAWTS-1, Winter 1999.
- Marine Corps Bulletin 3125. *The Marine Aviation Implementation Plan for FY98*. Washington, DC: HQMC. 1997.
- Marine Corps Doctrinal Publication (MCDP) 6. *Command and Control*. Washington, DC: Department of the Navy. 4 Oct 1996.
- Marine Corps Order (MCO) P5400.18D. *Military Occupational Specialty (MOS) Manual*. Washington, DC: HQMC. 1999.
- MCO P3500.12D. *Training and Readiness (T&R) Manual*. Washington, DC: HQMC. 1999.
- Marine Corps Reference Publication (MCRP) 5-12D. *Organization of Marine Corps Forces*. Washington, DC: HQMC. 13 October 1998.
- Melson, Major Charles D., Englander, Evelyn A., and Dawson, Capt David A. *U.S. Marines in the Persian Gulf, 1990-1991, Anthology and Annotated Bibliography*. 1992. U.S. Marine Corps History and Museums Division. Washington, DC: 1992.
- Murray, Williamson. *Air War in the Persian Gulf*. Baltimore: Nautical and Aviation Publishing Company of America, 1991.
- Quilter, Colonel Charles J., II. *U.S. Marines in the Persian Gulf, 1990-1991, With the I Marine Expeditionary Force in Desert Shield and Desert Storm*. Monograph. U.S. Marine Corps History and Museums Division. Washington, DC: 1993.
- Quinn, Major John T., III. *U.S. Marines in the Persian Gulf, 1990-1991, Marine Communications in Desert Shield and Desert Storm*. Monograph. U.S. Marine Corps History and Museums Division. Washington, DC: 1996.
- Shoemaker, LCpl Derek A., USMC, "ATC Marines Keep Birds Flying in Tazsar." <http://www.usmc.mil/news/news99.nsf/2385e8ac1be1aa3c852567850047bdab/7118fe022bd0acc58525679900472721?OpenDocument>, 23 June 1999.
- Winnefeld, James A., and Johnson, Dana J. *Joint Air Operations: Pursuit of Unity in Command and Control, 1942-1991*. Annapolis, Maryland: Naval Institute Press, 1993.