

# TerraSAR-X

## Ground Segment

### Basic Product Specification Document

CAF – Cluster Applied Remote Sensing

editors:  25.02.08  
T. Fritz, M. Eineder Date  
SAR Product Verification Responsible  
& TMSP Team

reviewed:  25.02.08  
J. Mittermayer Date  
IOCS Project Manager

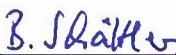
reviewed:  25.02.08  
B. Schättler Date  
PGS System Engineer SAR

approved:  25.2.08  
W. Balzer Date  
PGS Project Manager

approved:  25.2.08  
S. Buckreiß Date  
TS-X Mission Manager

released:  4.3.08  
R. Werninghaus Date  
TS-X Project Manager

## Report Documentation Page

*Form Approved  
OMB No. 0704-0188*

Public reporting burden for the collection of information is estimated to average 1 hour per response, including the time for reviewing instructions, searching existing data sources, gathering and maintaining the data needed, and completing and reviewing the collection of information. Send comments regarding this burden estimate or any other aspect of this collection of information, including suggestions for reducing this burden, to Washington Headquarters Services, Directorate for Information Operations and Reports, 1215 Jefferson Davis Highway, Suite 1204, Arlington VA 22202-4302. Respondents should be aware that notwithstanding any other provision of law, no person shall be subject to a penalty for failing to comply with a collection of information if it does not display a currently valid OMB control number.

1. REPORT DATE <b>2008</b>	2. REPORT TYPE <b>N/A</b>	3. DATES COVERED <b>-</b>		
4. TITLE AND SUBTITLE <b>TerraSAR-X Ground Segment Basic Product Specification Document</b>		5a. CONTRACT NUMBER		
		5b. GRANT NUMBER		
		5c. PROGRAM ELEMENT NUMBER		
6. AUTHOR(S)		5d. PROJECT NUMBER		
		5e. TASK NUMBER		
		5f. WORK UNIT NUMBER		
7. PERFORMING ORGANIZATION NAME(S) AND ADDRESS(ES) <b>CAF - Cluster Applied Remote Sensing</b>		8. PERFORMING ORGANIZATION REPORT NUMBER		
9. SPONSORING/MONITORING AGENCY NAME(S) AND ADDRESS(ES)		10. SPONSOR/MONITOR'S ACRONYM(S)		
		11. SPONSOR/MONITOR'S REPORT NUMBER(S)		
12. DISTRIBUTION/AVAILABILITY STATEMENT <b>Approved for public release, distribution unlimited</b>				
13. SUPPLEMENTARY NOTES <b>The original document contains color images.</b>				
14. ABSTRACT				
15. SUBJECT TERMS				
16. SECURITY CLASSIFICATION OF:			17. LIMITATION OF ABSTRACT <b>UU</b>	
a. REPORT <b>unclassified</b>	b. ABSTRACT <b>unclassified</b>	c. THIS PAGE <b>unclassified</b>		18. NUMBER OF PAGES <b>103</b>
				19a. NAME OF RESPONSIBLE PERSON



- This page intentionally left blank -



## **Document Preparation**

The document was prepared with contributions from

M. Eineder	IMF
T. Fritz	IMF
J. Mittermayer	IHR
A. Roth	DFD
E. Börner	IMF
H. Breit	IMF

## **Document Distribution**

This document is publicly available.



## Document Change Log

Issue	Date	Page	Change Description	Note (i.e. reason of change)
0.5	12.12.2002		Initial Version	
1.0 Draft			Included changes due to RIDs raised at the G/S Preliminary Design Review - Added definitions and estimates for DTAR, ISLR, PSLR in product tables. - Added left looking, full access incidence angle range and 300 MHz - Performed editorial changes - Changed Document ID according to new standards	
1.0	16.3.2004		<ul style="list-style-type: none"> <li>- editorial changes</li> <li>- changed Doc. number acc. to GS document tree</li> <li>- applicable documents revised</li> <li>- p. 24, 26, 28, 29: increased sampling from 1 to 2 meters</li> <li>- included 10% margin in all geometric resolution values</li> <li>- added incidence angle mask in product size</li> <li>- pp. 24–31: reorganized and compacted product tables</li> <li>- p. 26: increased sampling from 1 to 2 meters</li> <li>- pp. 30-31: increased resolution of ScanSAR products to 15/20 m, reduced radiometric accuracy to 1.5 dB</li> <li>- pp. 30-31: removed undefined dualpol ScanSAR products</li> <li>- reduced criterium for RE products to 1.5 dB (~6 looks) increasing their resolution</li> <li>- allowed arbitrary pixel spacing to reduce product size significantly</li> <li>- Changed product mnemonic to proposed PGS standard, removed polarization to reduce length if identifier</li> <li>- reduced dual pol resolution to 2.4 meters acc. to ASTRIUM Spec.</li> <li>- harmonized, i.e. reduced dual polarization combinations acc. to TX-AED-RS-0001</li> <li>- introduced values for radiometric stability etc.</li> <li>- inserted incidence angle mask and DEM mask</li> <li>- inserted detailed list of pa-</li> </ul>	Major revision.

1.1	6.7.2004		<p>rameters</p> <ul style="list-style-type: none"> <li>- changed revision of referenced documents and made old RD-1 applicable (WER-R-13/DCR-0079)</li> <li>- pg. 24: Change central meridians from 6° to 9° (UT32) and 9° to 15° (UT33) (SCH-R-2g/DCR-0057) (SCH-R-2d/DCR-0056)</li> <li>- Table 4.1: DTAR of -17 dB was a requirement and pessimistic. Changed to &lt;-20 dB to reflect most cases.</li> <li>- Table 4.2: DTAR value of -16 dB was a requirement. Changed to &lt;-17 dB to reflect all cases.</li> <li>- Explained DTAR (SCH-R-2k/DCR-0058)</li> <li>- Table 4.3: changed DTAR from -17 to &lt;-17 dB.</li> <li>- Table 4.4: changed DTAR from -17 to &lt;-17 dB. (SCH-N-6/DCR-0050)</li> <li>- Table 4.5: changed DTAR from -17 to &lt;-19 dB.</li> <li>- Table 4.6: changed DTAR from -16 to &lt;-17 dB.</li> <li>- Table 4.7: replaced DTAR "unspecified " to &lt;-20 dB reflecting the majority of cases.</li> <li>- ScanSAR access range changed to 15°-60° (SCH-N-7/DCR-0051)</li> <li>- Updated annotation tables in chapter 5.1 (URB-F-2/PGS-DCR-0069).</li> <li>- Clarified avail. of incidence angle mask (SCH-N-2/DCR-0048)</li> <li>- Explained calculation of product size. (SCH-N-15/DCR-0047)</li> <li>- Changed size of GIM from 1 to 2 bytes, increasing detected product size.</li> <li>- Changed radiometric performance values in 3.3 and tables 4.x acc. to inputs from ICS (MIT-J-8/DCR-0028)</li> <li>- Added size of images (MIT-J-2/DCR-0027)</li> <li>- Editorial changes (MIT-J-1/DCR-0023)</li> <li>- Increased resolution of all detected single pol. products with Hamming=0.75 to 1.1 meter</li> <li>- Increased resolution of complex single pol. products with Hamming=1.0 to 1.0 meter</li> <li>- Included Hamming coefficient In tables 4.x</li> </ul>	
-----	----------	--	---	--

1.2	9.5.2005		<ul style="list-style-type: none"> <li>- Product format and annotation parameter description transferred to separate document.</li> <li>- Revised Basic Product Data Structure description (chapter 5)</li> <li>- Added NESZ comment (value outdated)</li> </ul>	
1.3	05.10.2005		<ul style="list-style-type: none"> <li>- Editorial changes</li> <li>- Included references to the Level 1b Product Format Specification</li> <li>- Mentioned occurrence of varying PRF</li> <li>- NEBZ will be annotated instead of NESZ</li> <li>- DEM coverage map description added</li> <li>- Increased SC rad. enhanced. Resolution @45° to theoretical limit of 17.6 meter</li> </ul>	
1.4	06.10.2006		<ul style="list-style-type: none"> <li>- Due to new performance analysis results the dual polarization combination VV/HV is changed to VV/VH</li> <li>- Sentence on TxRx polarization scheme definition added</li> <li>- Paragraph on 150 MHz / 100 MHz range bandwidth switches included</li> <li>- Assumption of constant 150 MHz bandwidth removed from NESZ section</li> <li>- Pixel localization accuracy of detected products in the product tables replaced by reference to relevant section.</li> <li>- Pixel localization accuracy of complex products changed to 2 m, assuming the rapid orbit accuracy</li> <li>- Annex B inserted indicating the configured MGD, GEC, EEC product variants</li> <li>- Editorial changes</li> </ul>	
1.5	24.02.2008		<ul style="list-style-type: none"> <li>- All product performance values throughout the document and the product tables are (replaced by) the verified ones of the operational products which were adjusted in the commissioning phase to the SAR performance analysis results. Some major changes are:             <ul style="list-style-type: none"> <li>o absolute pixel localization accuracy is improved from 2m to 1m including all signal propagation effects</li> <li>o absolute radiometric accuracy (SM mode) is im-</li> </ul> </li> </ul>	<p>Post commissioning phase version.</p> <p>Major revision including in-orbit calibration and product verification results and settings for operational phase</p>

			<p>proved from 1.1dB (1.4dB worst case) to 0.6 dB including long term stability</p> <ul style="list-style-type: none"> <li>o relative radiometric accuracy (SM mode) is improved from 0.68dB (0.78dB worst case) to 0.3 dB</li> <li>o ScanSAR radiometric accuracy improved to 0.7dB (0.4 dB relative)</li> <li>o Spotlight azimuth resolution is improved from 2.2m to 1.7m (from 4.4m to 3.4m in dual pol)</li> <li>o point target response sidelobe suppression is improved by at least 4dB due to new weighting with a Hamming factor of 0.6</li> <li>o the PTR improvement results in a slight deterioration in slant range resolution of 150 MHz bandwidth products from 1.1m to 1.2m.</li> <li>o as a compensation, the experimental 300 MHz bandwidth mode option for the high resolution spotlight acquisitions is introduced – yielding 0.6m slant range resolution at the cost of a reduced scene range extent beyond 30° incidence angle.</li> <li>o all specified dual pol resolutions (especially of detected products) strongly improved by selection of nominal range bandwidths (150MHz - instead of originally planned 75MHz).</li> <li>o The ScanSAR azimuth resolution is slightly worsened from 17.7 to 18.5m to allow a better burst overlap and a more homogeneous radiometry.</li> </ul> <p>- Annex B is completely revised and all plots are replaced by those derived from the operational filter settings of the TMSP processor. Some product type plots are added.</p>	
--	--	--	--	--

			<ul style="list-style-type: none"> <li>- Annex C is new, containing comprehensive SAR performance plots for operational modes and details on SAR instrument performance and commanding limitations. It also lists the operational elevation beams for the entire data collection range.</li> <li>- A section on product coverage and location is added (including the 300MHz swath extent characterization results)</li> <li>- A section on the new recommended performance range chosen to avoid ambiguities in high contrast scenes is included.</li> <li>- The section on pixel localization accuracy has been revised and a subsection on delivery/latency is added.</li> <li>- The section on geometric resolution has been revised. The resolution class sketch has been replaced by overview plots of the relative resolution of all available product variants.</li> <li>- The radiometric performance section is more specific with respect to the annotated parameters in the products and the noise parameters.</li> <li>- The product examples are now derived from TerraSAR-X acquisitions.</li> <li>- Some wording and details in the chapter on the product structure are changed</li> <li>- Details and editorials changed in Annex A</li> <li>- Restriction of document distribution adapted</li> <li>- Editorial changes</li> </ul>	
--	--	--	---	--

Verify that this is the correct revision before use. Check the document server for the latest version. Distributed hardcopies of documents are not automatically updated. In case of uncertainty contact the person who released the document or the documentation manager.

## Table of Contents

<b>1</b>	<b>Introduction .....</b>	<b>11</b>
1.1	Scope .....	11
1.2	Applicable Documents.....	11
1.3	Reference Documents .....	11
1.4	Document Structure .....	12
1.5	Definition of Basic Products .....	12
<b>2</b>	<b>The TerraSAR-X Instrument .....</b>	<b>13</b>
2.1	Imaging Modes .....	14
2.2	Full Performance and Data Access Range.....	19
2.3	Recommended Performance Range.....	19
2.4	Product Coverage and Repeatability .....	20
2.5	Experimental Modes.....	22
<b>3</b>	<b>Basic Products .....</b>	<b>23</b>
3.1	Geometric Resolution .....	23
3.2	Radiometric Performance .....	27
3.3	Radiometric Accuracy .....	27
3.4	Pixel Localization Accuracy .....	28
3.5	Geometric Projections and Data Representation .....	30
3.6	Map Projections and Grid Formats.....	34
3.7	Product Identification Scheme .....	37
<b>4</b>	<b>Basic Product Tables .....</b>	<b>38</b>
4.1	Single Polarization Stripmap Products (SM).....	39
4.2	Dual Polarization Stripmap Products (SM) .....	40
4.3	High Resolution Single Polarization Spotlight Products (HS) .....	41
4.4	High Resolution Dual Polarization Spotlight Products (HS).....	42
4.5	Single Polarization Spotlight Products (SL) .....	43
4.6	Dual Polarization Spotlight Products (SL).....	44
4.7	ScanSAR Products (SC) .....	45
<b>5</b>	<b>Basic Product Data Structure .....</b>	<b>46</b>
5.1	Annotation.....	47
5.2	SAR Image Channels .....	47
5.3	Auxiliary Raster Files .....	47
5.4	Quicklooks .....	47
5.5	Administrative Parameter Files .....	47
	<b>ANNEX A) Definition of Performance Parameters .....</b>	<b>48</b>
	<b>ANNEX B) Configuration of Detected Product Variants .....</b>	<b>50</b>
	<b>ANNEX C) SAR Performance Details and Parameters .....</b>	<b>63</b>
	Polarization Channel Combinations.....	63
	Improvement of Radiometric Accuracy .....	63
	TX-RX Bandwidth in Stripmap and ScanSAR Modes .....	63
	Comment to Radiometric Resolution .....	65
	NESZ Calculation and BAQ .....	66
	Stripmap and Spotlight Elevation Beam Definition.....	67
	Product coverage and swath width degradation (terrain, Height Error Map).....	72
	High-Resolution and Spotlight Scene Extension.....	72
	<b>Performance Plots .....</b>	<b>73</b>



Stripmap single .....	73
Stripmap dual HHV .....	76
Stripmap dual HHHV (equivalent VVH) .....	79
Spotlight single .....	83
Spotlight dual HH/V .....	85
High-Resolution Spotlight single (HS 150MHz) .....	89
High-Resolution Spotlight 300MHz single (HS 300MHz) .....	91
High-Resolution Spotlight dual .....	93
ScanSAR .....	97
ScanSAR (Completion of Data Collection Angle Range) .....	100
<b>ANNEX D) Acronyms and Abbreviations .....</b>	<b>103</b>

## 1 Introduction

TerraSAR-X is a joint project between the German Aerospace Center (DLR) and the German industry (ASTRIUM). DLR owns and operates the satellite and the payload ground segment (PGS) and holds the rights for the scientific exploitation of the data. ASTRIUM holds the exclusive rights for the commercial exploitation of the data products.

### 1.1 Scope

This document specifies the operational TerraSAR-X basic products generated at PGS for scientific and commercial use. In the context of the project the products are called basic products because they are the basis for higher level information products. The document summarizes the operation modes of TerraSAR-X and the characteristic parameters. It describes the product design criteria, lists the different product types and introduces their structure.

The document in hand is supplemented by the Level 1b Product Format Specification document [RD 8] specifying the binary data formatting and the detailed annotation parameters of the product.

### 1.2 Applicable Documents

This document is based on the requirements specified in the following documents.

[AD 1]	TX-PGS-RSD-1005	PGS Requirements Specification Document Issue 2.0
[AD 2]	RD-RE-TerraSAR-DLR/02	TerraSAR-X Ground Segment Requirements Issue 2.0

### 1.3 Reference Documents

Reference	Document Number	Document Title
[RD 1]	TX-AED-TN-0010	TerraSAR-X System Performance Modeling and Analysis Document, 15.3.2002
[RD 2]		DLR Internal Technical Note: DLR/HR-Comments on TerraSAR-X Performance Specification, J. Mittermayer, 13.3.2002
[RD 3]	ERS-D-TN-22910-A/9/88	Map Projections for SAR Geocoding, Remote Sensing Laboratories, University of Zurich
[RD 4]	TX-AED-RS-0001	TerraSAR-X Mission & System Requirements Specification Issue 5, 14.7.2003
[RD 5]	RD-RE-TerraSAR-DLR/01	TerraSAR-X Space Segment Requirements, Issue 1.0
[RD 6]		A Plea for Radar Brightness, R.K. Raney, T. Freeman, R.W. Hawkins, R. Bamler, IGARSS 1994.
[RD 7]	TX-IOCS-DD-4402	IOCS Instrument Operations Section Design Document, Volume 06, TerraSAR-X Instrument Table Generator Design Document
[RD 8]	TX-GS-DD-3307	Level 1b Product Format Specification, Version 1.3
[RD 9]	TX-SEC-TN-JM-10	Definition of Recommended Target Area
[RD 10]	TX-SEC-TN-JM-11	Inputs to Appendix for TS-X Basic Product Spec from SAR Performance



## **1.4 Document Structure**

This document is structured as follows:

Chapter 1 introduces the structure and scope of the document.

Chapter 2 gives a description of the TerraSAR-X instrument. The available imaging and polarization modes are characterized and discussed.

Chapter 3 defines those processing parameters influencing the nature and specification of the basic products. This includes product identification, product definition, etc.

Chapter 4 contains tables for summarizing the product characteristics and specifications.

Chapter 5 gives an overview of the data structure and the content of a basic product.

## **1.5 Definition of Basic Products**

TerraSAR-X basic products are the operational products offered by the TerraSAR-X PGS to commercial and scientific customers. These products can be ordered through and will be delivered by the PGS user services at DLR. They are generated by the TerraSAR Multi Mode SAR Processor (TMSP).

## 2 The TerraSAR-X Instrument

TerraSAR-X is a side-looking X-band synthetic aperture radar (SAR) based on active phased array antenna technology. The active antenna allows not only the conventional stripmap imaging mode but additionally spotlight and ScanSAR mode. Fig. 2-1 shows an artists view of the satellite and Table 2-1 summarizes the characteristic values of the platform and the SAR instrument.

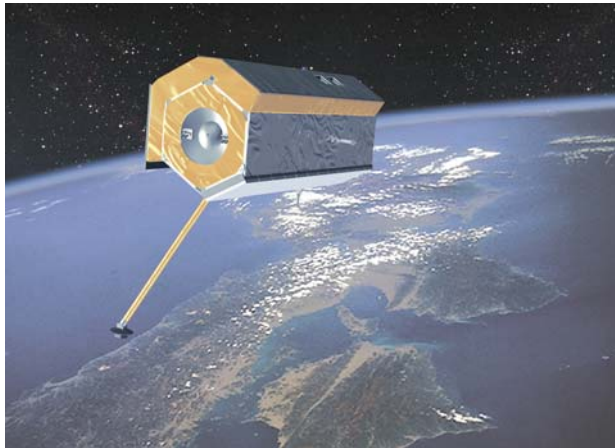

Fig. 2-1: Artists view of TerraSAR-X

Orbit and Attitude Parameters	
Nominal orbit height at the equator	514 km
Orbits / day	15 <sup>2</sup> / <sub>11</sub>
Revisit time (orbit repeat cycle)	11 days
Inclination	97.44°
Ascending node equatorial crossing time	18:00 ± 0.25 h (local time)
Attitude steering	"Total Zero Doppler Steering"

System Parameters	
Radar carrier frequency	9.65 GHz
Radiated RF Peak Power	2 kW
Incidence angle range for stripmap / ScanSAR	20° – 45° full performance (15°-60° accessible)
Polarizations	HH, VH, HV, VV
Antenna length	4.8 m
Nominal look direction	right
Antenna width	0.7 m
Number of stripmap / ScanSAR elevation beams	12 (full performance range) 27 (access range)
Number of spotlight elevation beams	91 (full performance range) 122 (access range)
Number spotlight azimuth beams	229
Incidence angle range for spotlight modes	20° – 55° full performance (15°-60° accessible)
Pulse Repetition Frequency (PRF)	2.0 kHz – 6.5 kHz
Range Bandwidth	max. 150 MHz (300 MHz experimental)

Table 2-1: Orbit and system parameters of TerraSAR-X

## 2.1 Imaging Modes

The instrument timing and pointing of the electronic antenna can be programmed allowing a numerous combinations. From the many technical possibilities four imaging modes have been designed to support a variety of applications ranging from medium resolution polarimetric imaging to high resolution mapping. Due to the short antenna the system is optimized for high azimuth resolution. Consequently, the pulse repetition frequency (PRF) must be high which limits the maximum width of the swath.

The following imaging modes are defined for the generation of basic products:

- Stripmap mode **SM** in single or dual polarization
- High Resolution Spotlight mode **HS** in single or dual polarization
- Spotlight mode **SL** in single or dual polarization
- ScanSAR mode **SC** in single polarization

In the following chapters the imaging modes are characterized. Detailed parameters of the derived products can be found in the tables in chapter 4. Note that the resolution values given here are typical for nominal complex basic products and include processing bandwidths, weightings and accuracy margins. Residual deviations e.g. from orbit height variations may be found. The values do not necessarily reflect the instrument performance or geometric imaging configurations alone.

### 2.1.1 Stripmap Mode (SM)

This is the basic SAR imaging mode as known e.g. from ERS-1 and other satellites. The ground swath is illuminated with a continuous sequence of pulses while the antenna beam is pointed to a fixed angle in elevation and azimuth. This results in an image strip with constant image quality in azimuth. In Fig. 2-2 the stripmap mode geometry is illustrated. The characteristic parameters of this mode are listed in Table 2-2. The maximum length of an acquisition is limited by battery power, memory and thermal conditions in the sensor. The latter depend mainly on the PRF and on previous acquisitions.

Note: Because of tight timing margins the pulse repetition frequency (PRF) may vary in a data take in order to maintain the nominal swath width even at varying terrain height. This will be accounted for in the SAR processor and complex Basic Products will be sampled with the highest occurring PRF in the corresponding raw data.

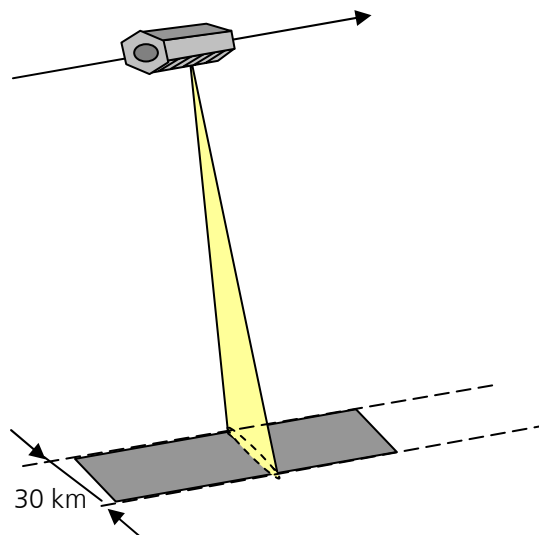

Fig. 2-2: Imaging geometry in stripmap mode

Parameter	Value
Swath width (ground range)	30 km single pol. 15 km dual pol.
Nom. L1b product length	50 km
Full performance incidence angle range	20° - 45°
Data access incidence angle range	15° - 60°
Number of elevation beams	27 (12 full perf.)
Azimuth resolution	3.3 m (6.6 m dual pol.)
Ground range resolution	1.70 m - 3.49 m (@ 45°.. 20° incidence angle)
Polarizations	HH or VV (single) HH/VV, HH/HV, VV/VH (dual)

Table 2-2: Characteristic parameters of SM mode

As listed in Table 2-2, stripmap can be operated in single or in dual polarization mode resulting in one or two image layers, respectively. Each polarization channel is identified by two letters where the first letter denotes the transmit polarization and the second one refers to the receive polarization.

The dual polarization mode is implemented by toggling the transmit and/or receive polarization between consecutive pulses. The effective PRF in each polarimetric channel is thus half of the total PRF. In order to sample the antenna azimuth spectrum properly in each channel, the total PRF has to be increased compared to single polarization mode. Due to the increased PRF the maximum ground swath width is only half of the single polarization mode. For the dual polarization beam with 15km wide swathes have been defined, i.e. stripNear and stripFar. The beams match the corresponding halves of the equally numbered single polarization beams.

Because of an upper total PRF limit of 6.5 kHz, the azimuth ambiguities in the dual polarization channels are higher than in single polarization mode and can only be reduced by limitation of the azimuth bandwidth in the SAR processor. Therefore the azimuth resolution is reduced by a factor of 2 in the product tables.

For distributed targets the same part of the Doppler spectrum is recorded by both polarimetric channels. Therefore the polarimetric phase between the channels can be exploited, e.g. for polarimetric interferometry.

### 2.1.2 Spotlight Modes

As depicted in Fig. 2-3 spotlight mode uses phased array beam steering in azimuth direction to increase the illumination time, i.e. the size of the synthetic aperture. The larger aperture results in a higher azimuth resolution at the cost of azimuth scene size. In the extreme case of starring spotlight the antenna footprint would rest on the scene and the scene length corresponds to the length of the antenna footprint.

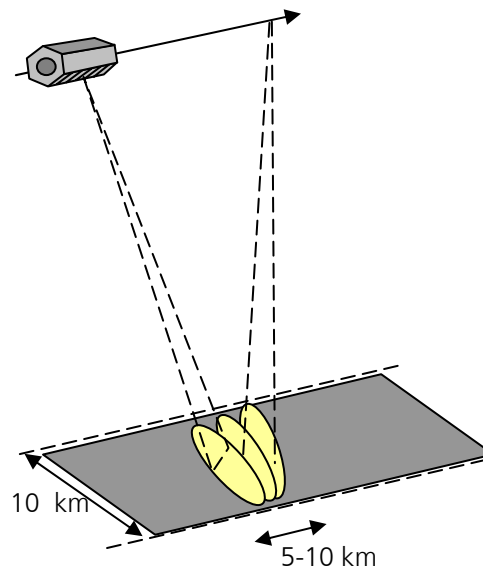

Fig. 2-3: Imaging geometry in spotlight mode

Because of the small size of the X-Band antenna footprint a starring spotlight mode is not foreseen for TerraSAR-X. Instead, two variants of sliding spotlight mode are designed with different values for azimuth resolution and scene size. For the product identification they are named "Spotlight" (SL) and "High Resolution Spotlight" (HS).

Since a spotlight imaging takes only a few seconds and requires simultaneously a precise antenna steering as the sensor passes the scene, hitting the desired area of interest requires precise pointing and timing. TerraSAR-X offers high flexibility in order to image the user's area of interest. In elevation, 122 spotlight elevation patterns are defined in order to adjust the scene center in small increments so that the required area can be placed in the

middle of a scene. In azimuth up to 125 beams from a set of 229 beams are used in one data take to extend the synthetic aperture. The imaging process is started GPS-controlled, i.e. when the satellite reaches a position along the orbit that is calculated from the user's required scene center coordinates. This way the effect of along track orbit prediction errors on the final product location is almost compensated.

### 2.1.2.1 High Resolution Spotlight Mode (HS)

This mode is designed for an azimuth resolution of 1.1 meter resulting in an azimuth scene size of 5 km. The characteristic values are:

Parameter	Value
Scene extension	5 km (azimuth) x 10 km (ground range)
Full performance incidence angle range	20° - 55°
Data access incidence angle range	15° - 60°
Number of elevation beams	91 (full performance) 122 (data access)
Number of azimuth beams	up to 125 out of 229
Azimuth steering angle	up to $\pm 0.75^\circ$
Azimuth resolution	1.1 m (single polarization) 2.2 m (dual polarization)
Ground range resolution	1.48 m - 3.49 m (@ 55°..20° incidence angle) 0.74 m – 1.77 m (with 300 MHz bandwidth option and reduced swath extent in range)
Polarizations	HH or VV (single) HH/VV (dual)

Table 2-3: Parameters of high resolution spotlight mode

TerraSAR-X may be operated in an experimental mode with 300 MHz range bandwidth instead of the nominal 150 MHz. The sensor performance for this mode is not specified and the derived products may not fulfill all specifications established for 150MHz products. However, the characterization activities in the commissioning phase revealed excellent performance parameters for the **HS 300 MHz single polarization** mode in terms of focusing quality, phase stability and radiometry. The only drawback is that instrument constraints limit the range extent in this mode and it falls below the specified 10km for far range beams. Therefore products from this mode are not specified and only characterized by this document. Nevertheless, they can be ordered as an option for the HS mode by the user. All other *nominal* products mentioned in this document are based on a maximum 150 MHz bandwidth.

### 2.1.2.2 Spotlight Mode (SL)

In this mode the beam steering velocity is lower than in high resolution spotlight mode resulting in reduced azimuth resolution and increased azimuth scene extension. The characteristic values are:

Parameter	Value
Scene extension	10 km (azimuth) x 10 km (ground range)
Full performance Incidence angle range	20° - 55°
Data access incidence angle range	15° - 60°
Number of elevation beams	91 (full performance) 122 (data access)
Number of azimuth beams	up to 125 out of 229
Azimuth steering angle	up to $\pm 0.75^\circ$
Azimuth resolution	1.7 m (single polarization) 3.4 m (dual polarization)
Ground range resolution	1.48 m - 3.49 m (@ 55°..20° incidence angle)
Polarizations	HH or VV (single) HH/VV (dual)

Table 2-4: Parameters of spotlight mode

Note that reduced margins and newly established commanding sequences which extent the used azimuth beam steering angle range yield an improvement in azimuth resolution from the originally specified 2.2m (4.4m) to 1.7m (3.4m) in SL single (dual) polarization mode. These resolutions are achieved despite the broadening by the improved sidelobe suppression weighting functions while keeping the azimuth scene extent specifications.

### 2.1.2.3 ScanSAR Mode (SC)

In ScanSAR mode electronic antenna elevation steering is used to switch after bursts of pulses between swaths with different incidence angles. In the designed TerraSAR-X ScanSAR mode 4 stripmap beams are combined to achieve a 100 km wide swath. Due to the switching between the beams only bursts of SAR echoes are received, resulting in a reduced azimuth bandwidth and hence, reduced azimuth resolution. Fig. 2-4 illustrates the ScanSAR imaging geometry. The ScanSAR swaths are composed exclusively from stripmap beams, i.e. they use the calibrated stripmap antenna patterns.

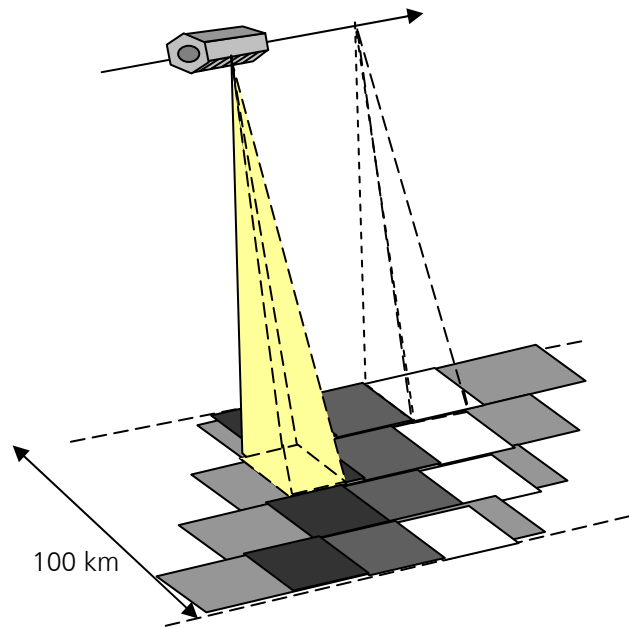

Fig. 2-4: Four beam ScanSAR imaging geometry

Characteristic values are:

Parameter	Value
Number of sub-swaths	4
Swath width (ground range)	100 km
Nominal L1b product length	150 km
Full performance incidence angle range	20° - 45°
Data access incidence angle range	15° - 60°
Number of elevation beams	27 (9 x 4-beam combinations in full perf. range)
Azimuth resolution	18.5 m
Ground range resolution	1.70 m - 3.49 m (@ 45°..20° incidence angle)

Table 2-5: Parameters of ScanSAR Mode

Similar to spotlight imaging, the start of a ScanSAR data take can be triggered by GPS when a predefined orbit location is reached. This feature allows repeated ScanSAR acquisitions with synchronized burst patterns which is a prerequisite for ScanSAR interferometry.

## 2.2 Full Performance and Data Access Range

The TerraSAR-X instrument performance is specified by the manufacturer for incidence angles within the so-called *full performance range* in right-looking mode. The spacecraft may also be operated in left-looking mode or with a wider range of incidence angles defining the *data access range*. These operations improve the access time to a scene. However, due to reduced performance these products are not open for general access.

Imaging Mode	Polarization Mode	Full Performance Beam Configurations	Incidence Angle (Look Angle) Range
Stripmap	single	strip_003- strip_014	<b>19.7° - 45.5°</b> (18.2° - 41.3°)
Stripmap	dual	stripNear_003 - stripFar_014	<b>19.9° - 45.4°</b> (18.3° - 41.3°)
<b>Spotlight &amp; High-Resolution Spotlight</b>	single & dual	spot_010 – spot_100	<b>19.7° - 55.2°</b> (18.2° - 49.5°)
ScanSAR	single	scan_003 – scan_011	<b>19.7° - 45.5°</b> (18.2° - 41.3°)

Table 2-6: Full performance beams and incidence angle ranges

All elevation beams covering the data access range in single polarization stripmap and ScanSAR mode are listed in the Annex C. They are called strip\_01 to strip\_27 and the 122 spotlight beams are called spot\_001 to spot\_122, respectively. The ScanSAR beam configurations scan\_xy are composed of 4 consecutive stripmap beams beginning with the corresponding near range one. The performance specifications in this document refer only to the full performance range, i.e. Strip\_3 to Strip\_14 in stripmap/ScanSAR modes and Spot\_010 to Spot\_100 in spotlight modes. Basic products based on the left-looking mode or with incidence angles outside the full performance range can not be ordered nominally, since they may have a degraded performance. Since the left-looking mode has additionally impact on mission operations (the solar array is turned away from the sun, the SAR antenna is turned into the sun), the access for users is restricted. The smaller dual polarization swathes in stripmap are adjusted to the single polarization beams with the same numbering.

## 2.3 Recommended Performance Range

Generally, for TerraSAR-X the ambiguity control and evaluation is a challenge due to the short antenna. Consequence of the antenna dimension is a quite high PRF with minimum values of about 3000 Hz. The initially specified ambiguity ratios are generally meet but in some imaging geometries and instrument settings the ambiguities may dominate the visual impression of images of high contrast scenes (e.g. harbors). In the commissioning phase, the image analysis w.r.t. range and azimuth ambiguities concluded that there should be an indication for the user on the ambiguity quality dependent on the scene context. This resulted in the introduction of an additional performance range, the **Recommended Performance Range** which indicates the range of incidence angles considered preferable for scenes with **very high contrast**, e.g. land see transitions.

It was also found that a total ambiguity ratio is not significant. Therefore, the ambiguity requirement is applied separately to azimuth and range ambiguities. Based on the results of the performance estimation, the recommended performance range indicates incidence angles, where the azimuth ambiguities are around -20 dB or better and the range ambiguities are around -25 dB or better. See Annex C for details on the ambiguity performance for each mode and beam.



Mode	Pol Mode	High Contrast Recommended Performance Beams (Criteria Rg -25 dB Az -20 dB)	Incidence Angle (Look Angle) Ranges
Stripmap	Single	strip_003 - strip_014	19.7° - 45.5° (18.2° - 41.3°)
Stripmap	Dual	stripNear_003 - <b>stripFar_011</b>	19.9° - <b>40.3°</b> (18.3° - 36.8°)
SL & HS	Single	spot_010 - <b>spot_079</b>	19.7° - <b>49.7°</b> (18.2° - 44.9°)
SL & HS	Dual	spot_010 - <b>spot_059</b>	19.7° - <b>43.3°</b> (18.2° - 39.4°)
ScanSAR	Single	scan_003 - scan_011	19.7° - 45.5° (18.2° - 41.3°)

Table 2-7: Recommended performance beams and incidence angle ranges for high contrast scenes

## 2.4 Product Coverage and Repeatability

The location of a product strongly depends on the orbit position, an accurate data take azimuth start time, the correct echo window setting in range (the error of DEM used for commanding) and - especially for spotlight modes - the Doppler centroid used for processing to zero Doppler coordinates.

The orbit tube around the reference track of +/- 250m is taken into account by margins in range of more than 1km for the SM swathes in the full performance range. Also the echo window is commanded to follow terrain variations. See the Annex C for details and limitations causing possible swath width degradations due to extreme geometric imaging configurations or reference DEM errors.

When ordering a scene from nominal spotlight modes, the user is guaranteed that the delivered product covers at least 10 km x 10 km in SL and 10 km x 5 km in HS mode around the ordered scene centre coordinates. As for all SAR data acquisitions, the Doppler centroid and its variations strongly influence the product azimuth start and stop times. Whereas the duration of data taking in stripmap or ScanSAR configuration can be quite easily extended by considerable margins, the situation is more complex for the spotlight modes due to the azimuth beam steering. Margins are lower in azimuth direction to ensure the high resolution. Nevertheless, the scenes are generally fulfilling the specified 300m margin for product location accuracy. The processor focuses and delivers the entire valid area of an acquired scene. In case that the product exceeds the specified extent, the center coordinate of the product is not necessarily identical to the ordered one but the product covers the specified extent of it. See Fig. 2-5 for examples from the SL and HS coverage location and extent verification.

Important TerraSAR-X system features set the base for this high location accuracy achieved in spotlight data taking: The antenna look direction is accurately measured with star trackers and thus reduces the pointing knowledge on ground to less than 20 m error. The attitude is actively controlled by the Total Zero Doppler Steering law which reduces the Doppler offset to less than 120 Hz. Based on GPS measurements, a data take start time correction value is determined and applied on-board with respect to the assumed predicted value which effectively shifts the acquired scene towards the ordered location. The latter feature is also important for the ScanSAR repeat pass burst overlap required for interferometric use. The commissioning phase analysis verified an along track deviation of repeated acquisitions of below 50m on ground in most cases. This corresponds to less than 10% of ScanSAR burst lengths.

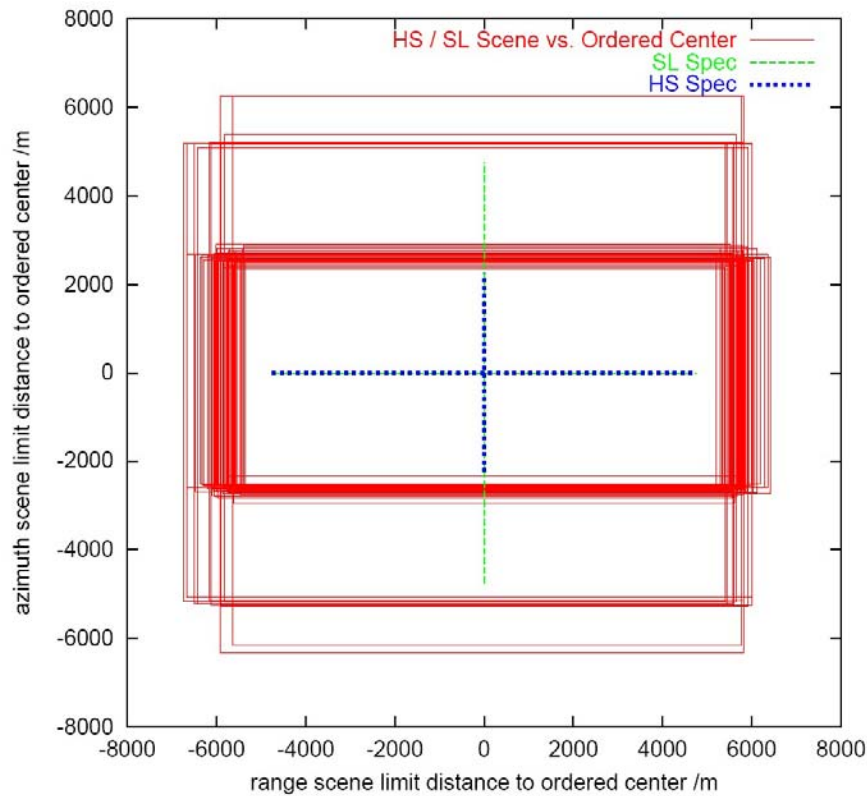

Fig. 2-5: Measured coverages and positioning of HS / SL products (red boxes) w.r.t. user ordered center position and specified scene extents (dotted crosses) taken from the commissioning phase product characterization report.

In some cases also a slightly reduced azimuth extent for spotlight modes is encountered due to the timing and Doppler centroid accuracy constraints. The HS products with the experimental 300MHz range bandwidth option show a reduced range extent (still centered around the ordered scene coordinates) due to the on-board echo buffer limitations. See the Fig. 2-6 for measured scene extents of HS 300MHz products (the two different colors for each dimension represent different processing levels). Note further that for HS products with 300 MHz range bandwidth *in dual polarization* mode, the range extent is further reduced while it may exceed the azimuth extent of 5km (which is specified for HS 150MHz products) due to a lower processing bandwidth. *The latter mode combination is not recommended and not specified.*

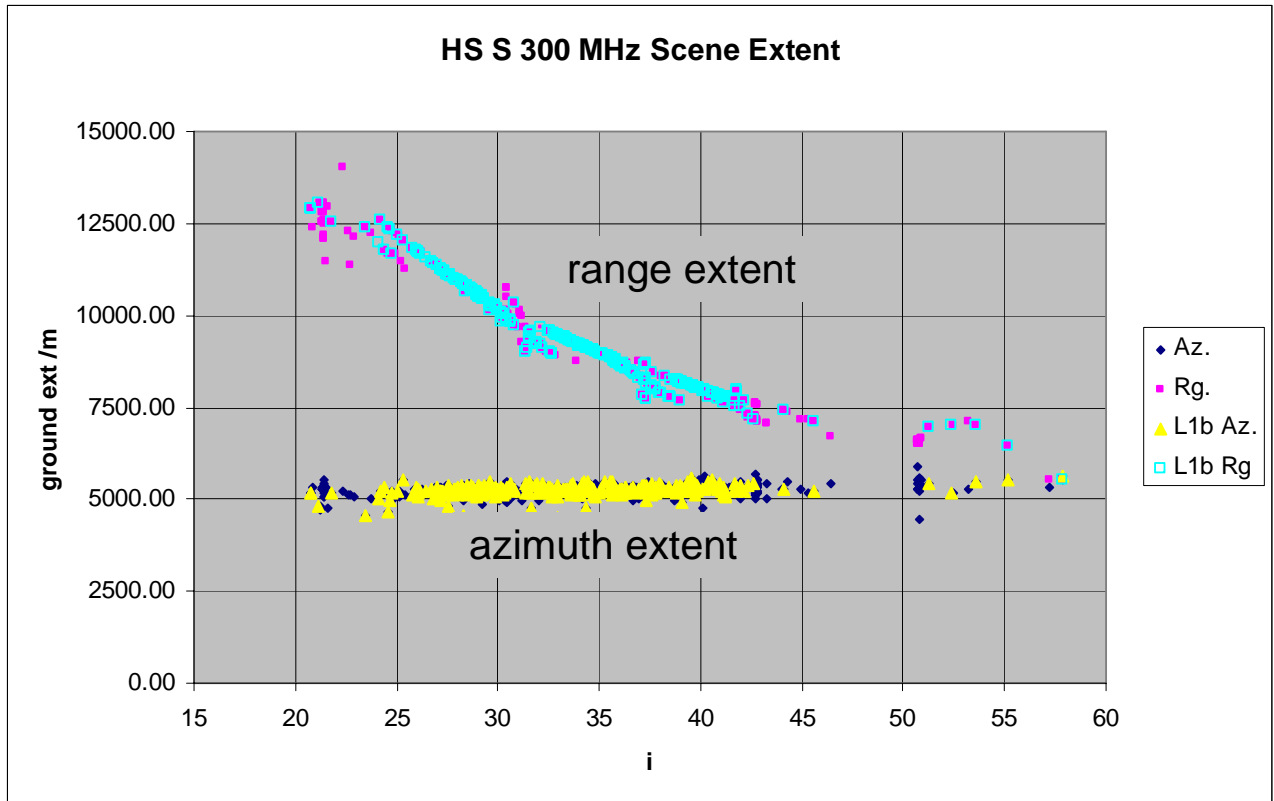

Fig. 2-6: Measured scene extent of High-Resolution Spotlight products in single pol 300 MHz mode for different scene center incidence angles ( $i$ ) taken from the commissioning phase product characterization report.

## 2.5 Experimental Modes

The experimental Dual Receive Antenna (DRA) configuration splits the antenna in to two halves and can be used for fully polarimetric quad polarization imaging or along track interferometric (ATI) imaging. Another experimental acquisition mode for ATI is to switch alternately between the two antenna halves for reception (Aperture Switching). For these modes instrument performance specifications are not available and the potential products are not included in this document. The DRA modes will be investigated and full polarimetric products may be added to this document as soon as this mode is operationally qualified and the product characteristics have been assessed. As of today, the instrument has not been switched to DRA mode in orbit.

### 3 Basic Products

In the context of the TerraSAR-X ground segment the SAR raw data are processed to basic products by the TerraSAR-X Multi Mode SAR Processor (TMSP). Given the capabilities of the SAR instrument and the platform, a set of products has been designed by selecting appropriate processing algorithms and parameters, e.g.

- geometric and radiometric resolution
- geometric projection
- auxiliary information and annotation

The following chapter describes the design logic while more details are given in chapter 4. All specified values refer to nominal product generation with the operational processor. They reflect the optimization process that was performed during the commissioning phase which results in different improvements – i.e. wider azimuth steering ranges and improved sidelobe suppression. For fast access to the data (e.g. for crisis management), a near real time (NRT) processing option has been established. Products generated this way are based on input data of reduced accuracy and the specified values generally do not apply to such NRT products.

#### 3.1 Geometric Resolution

The theoretical maximum slant range resolution of TerraSAR-X in single polarization is 0.89 meter based on the range bandwidth of 150 MHz if no spectral weighting is applied. For all products the maximum resolution is deliberately reduced by weighting the range and the azimuth spectrum with a Hamming window ( $\alpha$  coefficient 0.6) in order to suppress the sidelobes of the point target response (PTR) function to -25 dB or better. This better side-lobe suppression is specifically important in imaging urban and industrial areas where the high spatial resolution of the system exposes high numbers of extremely strong scatters leading to high image contrasts. As well, the level of azimuth ambiguities is decreased. By enlarging the azimuth processing bandwidth in stripmap mode and the azimuth steering angles in SpotLight mode, the resulting impulse response broadening could be compensated. However, due to the fixed range bandwidth, the range resolution values are slightly worsened, resulting in a slant range resolution of 1.2 meters instead of the formerly specified 1.1m at 150 MHz. The spectral weighting also widens the azimuth resolution w.r.t. to former specified values but this effect is compensated by increased bandwidths, reduced processing and instrument degradation margins and wider azimuth steering angles.

Complex products have the same Hamming window applied as detected ones to ensure a consistent product performance for all types. From the comprehensive product annotation it is principally possible to undo the weighting (which is a complex task especially in spotlight modes). Note that weighting and processing bandwidth are balanced against each other to optimize resolution, sidelobe suppression and ambiguity performance. They can not be maximized separately.

Depending on the incidence angle the 1.2 meters slant range resolution scales to ground by  $1/\sin(\text{incidence angle})$ , i.e. to 1.70 meters at  $45^\circ$  incidence angle or to 3.49 m at  $20^\circ$ , respectively. Due to instrument timing limitations, the range bandwidth of 150 MHz can not be achieved for all incidence angles. Depending on the actual timing parameters, far range beams in Stripmap and ScanSAR mode are operated with a reduced range bandwidth setting of 100 MHz. The specified ground range resolution for detected products is kept this way but the number of radiometric looks is lowered. This limitation may also lead to different range bandwidth settings in the 4 ScanSAR beams. See the Annex C for details. On the other hand the 300 MHz range bandwidth option can be ordered for the HS mode which fixes the bandwidth to this value but then the instrument buffer limits lead to a reduced scene range extent for higher incidence angles.

In azimuth the theoretical resolution in stripmap mode is half the antenna length ( $4.8 \text{ m} / 2 = 2.4 \text{ m}$ ). Due to finite sampling of the  $\sin(x)/x$  shaped Doppler spectrum aliasing always occurs. In the processor, bandwidth reduction and spectral shaping is performed in order to reduce the ambiguities caused by aliasing (improving the signal azimuth ambiguity ratio "SAAR") and to improve the shape of the PTR. A constant resolution of 3.3 meters is a design goal for all stripmap single polarization products. In ScanSAR mode, an additional margin in commanding is required to ensure complete burst overlaps for all geometries slightly broadens the azimuth PTR from the initially planned 17.6m to 18.5m.

In stripmap dual polarization mode the effective PRF per channel is decreased and the effective resolution of the products will be adjusted to 6.6 meters, i.e. half of the single polarization resolution. The processed Doppler

bandwidths in single polarization and dual polarization stripmap mode are hence 2765 Hz and 1380 Hz, respectively. An analogous strategy is applied on dual polarization spotlight data.

Note, that for the complex SSC products the resolution is given in azimuth and slant range (assuming the nominal 150 MHz range bandwidth). For all detected products the geometric resolution is given in ground range.

In the detected product variants the resolution is reduced (the number of looks is increased accordingly) in order to reduce speckle and thermal noise, i.e. to improve the radiometric resolution. In contrast to ERS-1 and ENVISAT/ASAR the range resolution is close to or even better than the azimuth resolution and looks can not be derived by degrading only the azimuth resolution. Therefore two different strategies have been followed in order to design two variants of detected products. One is optimized for resolution (spatially enhanced) and one is optimized for radiometry (radiometrically enhanced). In both variants a square sized ground resolution cell is implemented.

The filter settings are adjusted and annotated for near range (the worst case). Additionally, the filtering is implemented not to deteriorate the better resolution as long as the azimuth and range resolutions differ in the cm range only. Thus the resolution is in general significantly better than specified for the entire swath and slightly asymmetric PTRs (not pixels) may occur (e.g. 1.1x1.2m). In ScanSAR, the azimuth resolution always dominates the PTR, allowing for more looks in range than required for RE variants and a slight relaxation of the range resolution to better values. The pixel spacing of spatially enhanced products is dynamically adjusted to satisfy the Nyquist sampling criterion (half the resolution for detected products) and to multiples of 25 cm if adequate.

In the complex SSC product the pixel spacing is given by the natural sampling of the radar, i.e. the pulse repetition frequency (PRF) and the range sampling frequency (RSF). The exact settings depend on the acquired scene. For the product tables in section 4 these time intervals have been converted into *approximate* metric pixel spacing in azimuth and in slant range. Note that for Spotlight the sampling frequency in azimuth is higher in the processed image than in the raw data. If PRF changes occurred in the raw data, the SAR processor will deliver the product with the highest constant PRF that occurred in the raw data belonging to that product.

### 3.1.1 Spatially Enhanced Products (SE)

The spatially enhanced product is designed for the highest possible square ground resolution. Depending on imaging mode, polarization and incidence angle the larger resolution value of azimuth or ground range determines the square pixel size. The smaller resolution value is adjusted to this size and the corresponding reduction of the bandwidth is used for speckle reduction.



Fig. 3-1: Example for a spatially enhanced stripmap product with 1.2 looks and approx. 3.2 meter resolution of the Oberpfaffenhofen calibration site. The extent is 2.9km x 1.4km (pixel spacing: 1.25m)

### 3.1.2 Radiometrically Enhanced Products (RE)

The radiometrically enhanced product is optimized with respect to radiometry. The range and azimuth resolution are intentionally decreased to significantly reduce speckle by averaging approximately 6 (5 to 7) looks to obtain a radiometric resolution of about 1.5 dB. The SNR that generally decreases with larger incidence angles is also considered assuming a backscatter of  $-6$  dB at  $20^\circ$  and  $-12$  dB at  $50^\circ$ . Because of the lower resolution, the required pixel spacing can be reduced and the product data size decreases significantly.



Fig. 3-2: Example for a radiometrically enhanced stripmap product with 5.5 looks and 6.8 meter resolution.

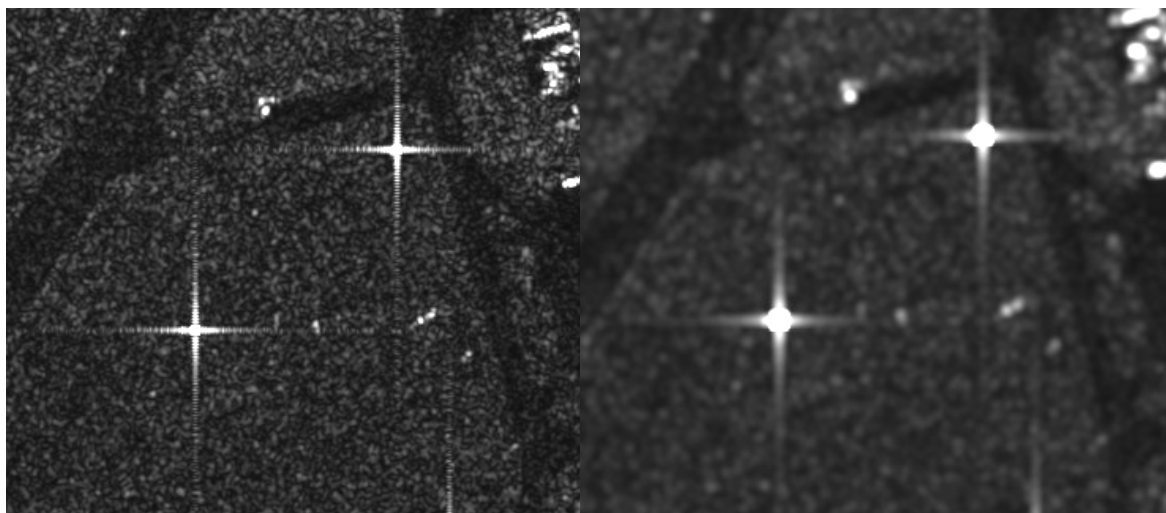

Fig. 3-3: Blow up of the to product variants. The pixel spacing is set to the one of the SE variant for demonstration purposes.

The Fig. 3-4 and Fig. 3-5 below give an overview of the relative resolution cell sizes of the various product variants.

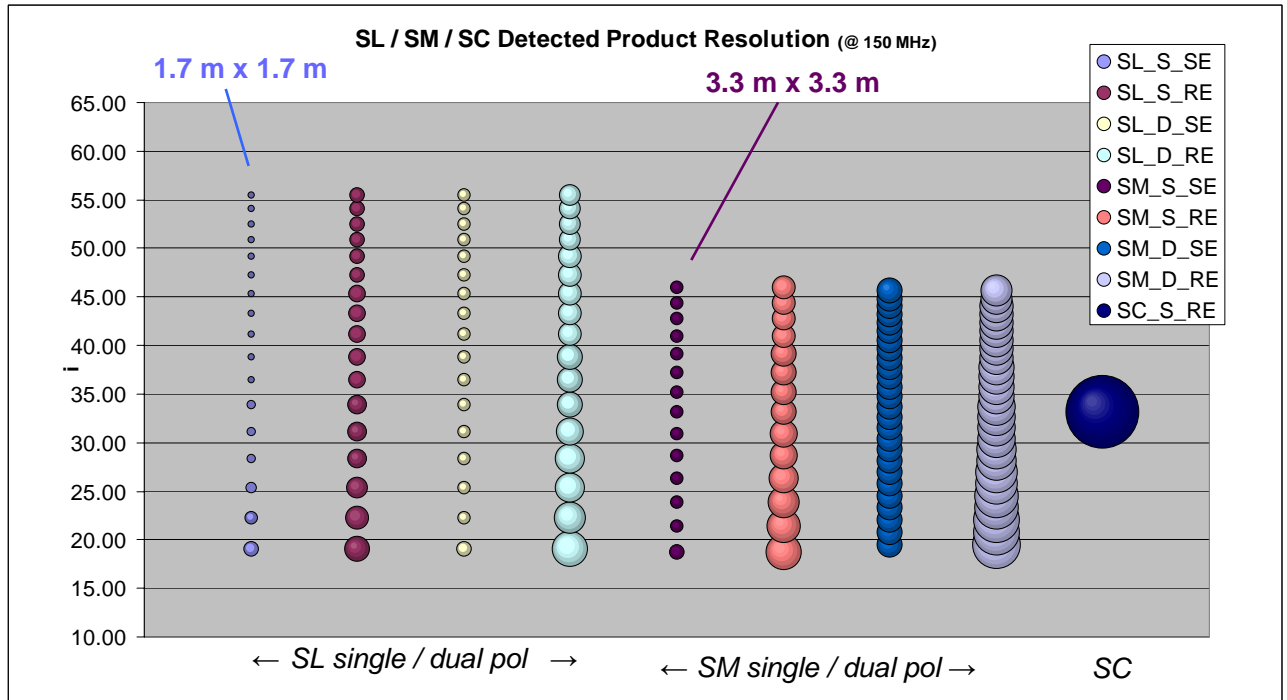

Fig. 3-4: The relative resolutions of detected product variants for all operational SM, SL and SC modes as they depend on the incidence angle.

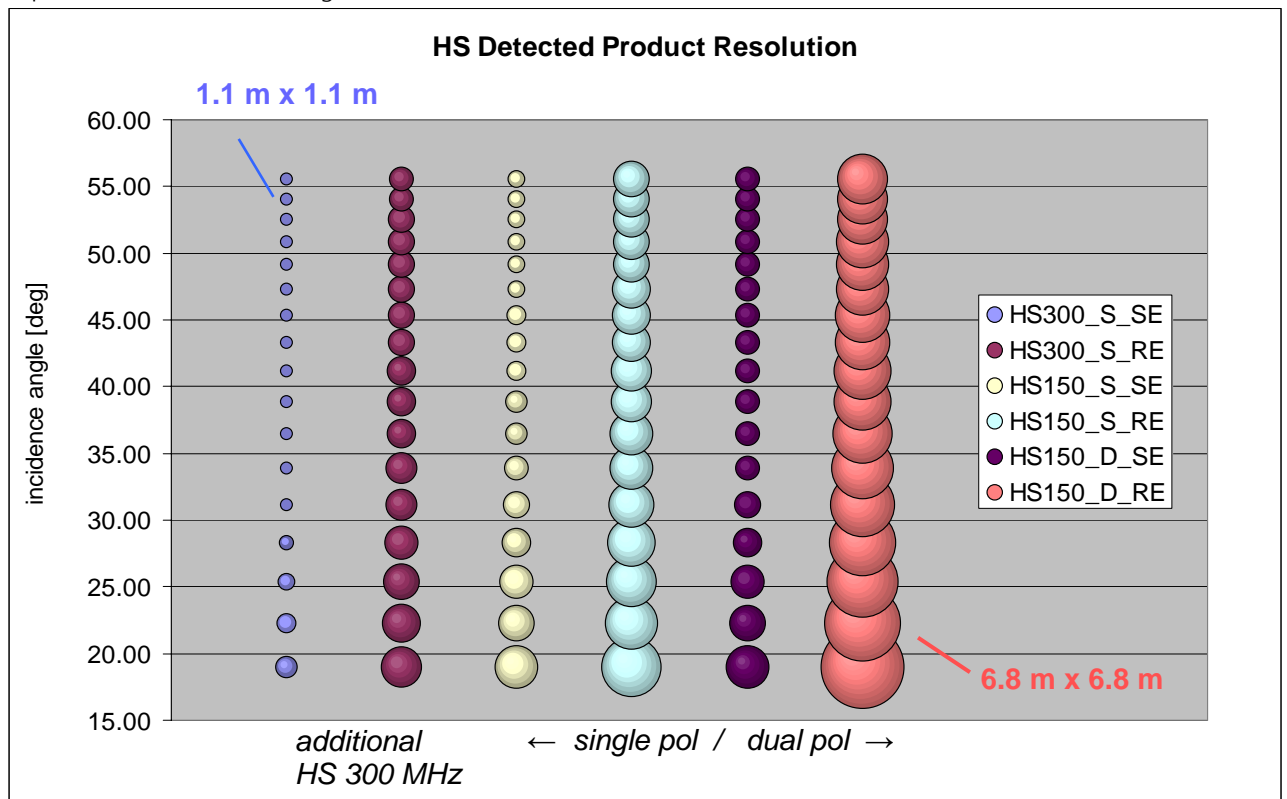

Fig. 3-5: The relative resolutions of detected product variants for the HS modes as they depend on the incidence angle.

## 3.2 Radiometric Performance

### 3.2.1 Derivation of Backscatter Coefficient for Distributed Targets

All TerraSAR-X products are processed and delivered in radar brightness  $\beta_0$ , compatible to the detected ground range products from ERS, ENVISAT/ASAR and RADARSAT and following the recommendations in [RD 6]. In contrast to ENVISAT and ERS, also the complex slant range products are delivered in radar brightness. The normalized backscatter  $\sigma_0$  is derived from the binary pixel values  $DN$  (digital numbers - representing the amplitude) as follows (see [RD 8] for details):

$$\sigma_0 = \left( k_s \langle |DN|^2 \rangle - NEBN \right) \sin(\theta_i),$$

where  $\theta_i$  is the local incidence angle (contained in the incidence angle mask of EEC products) at the pixel,  $k_s$  is the calibration *and processor scaling* factor for SAR signals annotated in each product and  $NEBN$ , the noise equivalent beta naught which is derived from the noise profiles annotated in the product using the same factor (see 3.2.2). In the SAR processor the following effects are compensated:

- elevation antenna pattern
- azimuth antenna pattern in ScanSAR and spotlight modes (best effort)
- effects of different azimuth and range bandwidth
- sensor settings like receiver gain, transmit power etc.

Beta naught is selected for the description of noise because like the radar brightness it is a system parameter that does not depend on the terrain and requires no knowledge of the scatterer. The relationship between the system noise expressed in beta naught and sigma zero is simply

$$NESZ = NEBN \cdot \sin(\theta_i)$$

Note that only the stripmap antenna patterns that are also used for ScanSAR are calibrated and verified. The large number of spotlight range and azimuth patterns and the ScanSAR azimuth pattern are calibrated using approximations and a "best effort" approach.

### 3.2.2 Noise Equivalent Sigma Zero

The values given for noise equivalent sigma zero in the product tables are estimates based on performance estimations verified by measurements. They are specified between -19 dB and -26 dB. The NESZ depends on a number of factors, e.g. the antenna pattern (i.e. the position in the scene), the power of the transmitted pulse, the quantization, the receiver noise and the bandwidth. The average value specified for the instrument is -23 dB. See Annex C for details on the NESZ performance for each mode and beam range.

The expected NEBN (not the NESZ) is annotated in the products in form of polynomials over range with azimuth time tags that describe the noise power (scaled with the identical  $k_s$  as the imaging DNs) as a function of range considering the major contributing factors, i.e. elevation antenna pattern, transmitted power and receiver noise.

## 3.3 Radiometric Accuracy

The radiometric accuracy is defined twofold:

### *Absolute Radiometric Accuracy*

This parameter is the root mean square (RMS) error between the measured and the true radar cross section at different locations within one scene and also over time. The absolute radiometric accuracy for the products (including all errors from calibration devices and processing) derived during the commissioning phase is **0.6 dB**. *This value includes the long term stability*. It is thus much lower than the originally specified 1.1 dB. See the Annex C for details.

### *Relative Radiometric Accuracy*

This parameter is the standard deviation of the radiometric error of known targets within one data take, i.e. over range and within 220 seconds. Contributions come from the antenna pattern, the pointing knowledge of the



antenna pattern and drifts of the instrument during operation. The relative radiometric accuracy is **0.3 dB** including long term stability.

### 3.4 Pixel Localization Accuracy

The pixel localization accuracy defines how accurate a pixel in a TerraSAR-X basic product can be transformed to a ground position.

For complex slant range products no slant to ground projection is performed in the processor and only the system errors are relevant. A major error contribution comes from the GPS orbit determination. Three types of orbits will be used for the processing of basic products:

Orbit type	Required Accuracy	Purpose
predicted (PRED)	700 m along track	Processing of near real time products (NRT) only.
rapid (RAPD)	2 m (3D, 1 sigma)	Standard processing of basic products.
science (SCIE)	20 cm (3D, 1 sigma), aiming at 10 cm	Processing for high accuracy purposes, e.g. for interferometry.

Table 3-1: Orbit types used for basic product processing

Note that currently the achieved orbit accuracies are much better and that even the operational *rapid* orbit error is found to be below 20cm, provided that TOR-IGOR GPS measurements are available. This is nominally the case. However, during solar maximum the accuracy of all orbit types will possibly decrease but is kept well within the specified values.

The former version of the specification stated that with the timing and orbit information provided in the basic products a user is able to locate his 3D coordinates in the complex slant range SAR image with an accuracy of 2 meters and better. The pixel localization accuracy refers to SSCs in slant range coordinates.

The value of 2m was specified for *perfect knowledge* of the signal path. The radar signal is however subject to a path delay due to the different refractive indices of vacuum, ionosphere and troposphere. This results in a slant range error of the order of 2-4 m that depends on the actual conditions in the passed media and on the length of the signal path - hence the incidence angle. The tropospheric path delay is relatively easy to model and nearly constant in time, while the ionospheric effects are more erratic but of small magnitude in the X band. Average delays for the entire scene are corrected for in the processor. They are approximated by standard models, used for all geo-location & geocoding and annotated in the product. The residual incidence angle dependent differential effects are below 0.5 m. Note that all coordinates used and annotated are hence corrected ones. However, the time tags for the corresponding coordinates annotated in the products are the instrument measurements including electronic delay corrections but excluding these signal path corrections.

A major result of the commissioning phase activities is that the achieved absolute geometric accuracy is much better than formerly specified due to the reliable orbit accuracy, the precisely calibrated instrument delays and the accurate delay and timing corrections performed in the processor. Thus the specified accuracy is tightened to **1 m absolute** geometric accuracy and is now valid for all nominal imaging conditions (using science orbits) *including all uncertainties on the signal path and along-track (azimuth) errors*. Same geometry, repeat pass acquisition L1b products are found to be "intrinsically" co-registered down to the sub-pixel level.

#### 3.4.1 Geocoded Product Location Accuracy

Geocoded EEC products are projected to the digital elevation model (DEM) surface and an error in the DEM additionally affects the pixel localization accuracy. This error is given in horizontal northing and easting coordinates. The achievable accuracy depends on the orbit precision, the timing accuracy and specifically the elevation accuracy of the reference DEM. For low incidence angles the DEM accuracy is more significant than for higher ones.

The main contribution to the pixel localization accuracy in geocoded products is the height accuracy of the reference DEM used during processing as illustrated in Fig. 3-6.

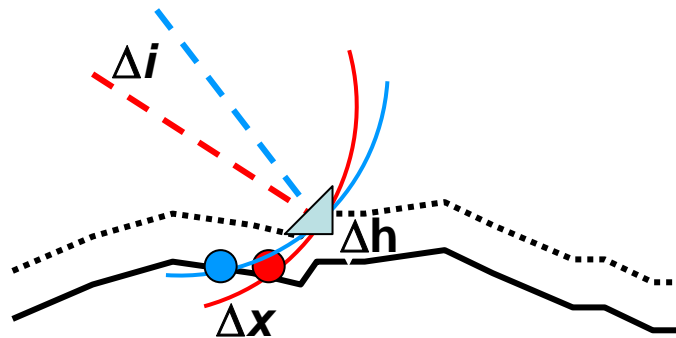

Fig. 3-6: Sketch of DEM height to location error relation for different incidence angles

With perfect knowledge of the terrain, a localization accuracy that corresponds to the pixel spacing is theoretically also achievable for geocoded products. The specified value thus refers to flat terrain and high incidence angles *not* considering the DEM error contributions. It reflects the accuracy of the SAR-processing and geocoding procedures. As the elevation accuracy of the DEM might locally vary, the effect on the pixel location accuracy can be estimated from the following table:

	20°	23°	26°	29°	32°	35°	38°	41°	44°	47°	48°	50°	incidence angle
DEM elevation error	2,75	2,36	2,05	1,80	1,60	1,43	1,28	1,15	1,03	0,93	0,90	0,83	displacement factor
2 m	5,5	4,7	4,1	3,6	3,2	2,9	2,6	2,3	2,1	1,9	1,8	1,7	resulting location error in meters
6 m	16,5	14,2	12,3	10,8	9,6	8,6	7,7	6,9	6,2	5,6	5,4	4,9	
8 m	22	19	16	14	13	12	11	9	9	8	7	7	
16 m	44	38	33	29	25	23	21	18	17	15	14	13	
30 m	82	71	61	54	48	43	38	34	31	28	27	25	
100 m	275	236	205	180	160	143	128	115	103	93	90	83	

Table 3-2: Pixel localization error resulting from DEM errors at different incidence angles

The table listed above demonstrates the pixel displacement in range that is caused by DEM elevation errors. An elevation range from 2 m to 100 m is listed vs. the incidence angle range of TerraSAR-X. The cotangent of the incidence angle is the factor that converts a height error into a location error.

The DEM-sources used for the operational TerraSAR-X production are listed below:

DEM product	vertical accuracy		grid size	limitations
	relative	absolute		
SRTM / X-SAR	6 m	16 m	1 "	+/-60° with gaps
SRTM / C-band	8 m	16 m	3 "	+/- 60°
ERS-tandem	20 m	30 m	1 "	limited availability
DTED-1	20 m	30 m	3 "	limited availability
GLOBE	varying 10 m – 100s of meters		30 "	no restrictions, poor quality

Table 3-3: Characteristics of DEM sources available for TerraSAR

A DEM map is provided with EEC products in order to indicate the actual DEM used in different areas of an image.

Multi-Look Ground-range Detected (MGD) Products and Geocoded Ellipsoid Corrected (GEC) product types are both generated using *one* average height for projection of the entire scene on ground and are thus very limited in their (range) location accuracy. MGDs additionally are provided in linear azimuth / ground range orientation and are thus not precisely georeferenced. However, using the annotation information and the auxiliary product components (Mapping Grid & Geo Grid), they can be re-projected in to the time domain with an accuracy that is only limited by the interpolation accuracy of the grids. In that sense, they are also accurately localized.

### **3.4.2 Impact of Orbit Selection on Product Generation and Delivery Latency**

The generation latency of an L1b product strongly depends on the availability of the auxiliary data with the desired accuracy. The delivery latencies of the orbit products are specified to within 15 hours after GPS data dump for the rapid orbit and 3 weeks for the science orbit.

Note however that currently the majority of rapid orbit products are available much faster (within 10 hours after image acquisition) and that – depending on the availability of input data – a 5-day latency can be achieved for the science orbit products in many cases. Thus most catalogue orders will use science orbit accuracy (even if rapid accuracy is selected) while future products are generated as soon as the specified orbit is available. Each L1b product is generated upon availability of an orbit product with at least the user ordered accuracy. Nominally, the product could be delivered immediately after processing. But keep in mind that currently (due to the new satellite data security regulations enforced by the German government) “very high resolution data” (which is to be specified further by the new regulations) and complex products have to undergo a “quarantine” period of ten days from *acquisition time* to delivery. Hence selecting science orbit accuracy can be advised for *future scene orders* of such product types since it will usually not *further* delay the delivery of very high resolution or complex products.

## **3.5 Geometric Projections and Data Representation**

### **3.5.1 Single Look Slant Range Complex (SSC)**

Geometric Projection: Azimuth – Slant Range (time domain)

This product is the basic single look product of the focused radar signal. The pixels are spaced equidistant in azimuth (according to the pulse repetition interval  $PRI=1/PRF$ ) and in slant range (according to the range sampling frequency) and the data are represented as complex numbers. Each image pixel is processed to zero Doppler coordinates, i.e. perpendicular to the flight track. This convention is compatible with the standard slant range products available from ERS-1/2, ENVISAT/ASAR, RADARSAT and from X-SAR/SIRC.

Spotlight products will be processed to zero Doppler coordinates like stripmap products with an artificial PRF selected large enough to hold the total processed Doppler spectrum. The products are therefore widely compatible with complex stripmap products. However, it must be considered that the Doppler centroid varies strongly with azimuth.

The SSC product is intended for scientific applications that require the full bandwidth and the phase information, e.g. SAR interferometry and interferometric polarimetry.

### 3.5.2 Multi Look Ground Range Detected (MGD)

Geometric Projection: Azimuth – Ground Range (without terrain correction).

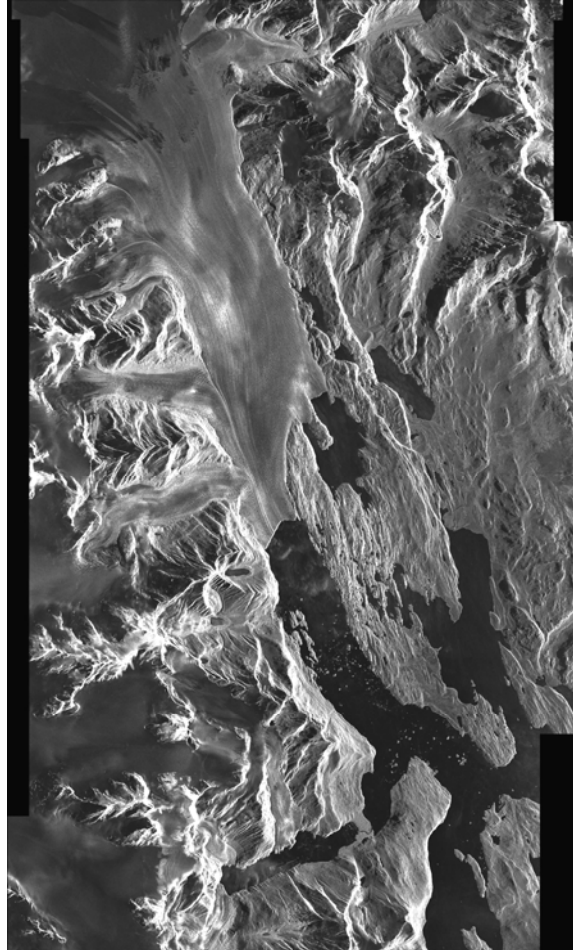

*Fig. 3-7: Example for a MGD projection over mountainous terrain where the echo window coarsely follows the DEM variations (TerraSAR-X stripmap product 30x55 km, Upsala glacier in Patagonia).*

This product is a detected multi look product with reduced speckle and approximately square resolution cells on ground. The image coordinates are oriented along flight direction and along ground range. The pixel spacing is equidistant in azimuth and in ground range. A simple polynomial slant to ground projection is performed in range using a WGS84 ellipsoid and an average, constant terrain height parameter.

The advantage of this product is that no image rotation to a map coordinate system is performed and interpolation artifacts are thus avoided. Consequently, the pixel localization accuracy is lower than in geocoded products. As for all TS-X L1b products, a coarse grid of coordinates is annotated in the product. The grid coordinates are calculated using a coarse DEM, while the projection of the image data is performed using an ellipsoid with one elevation determined for the scene.

### 3.5.3 Geocoded Ellipsoid Corrected (GEC)

Geometric Projection: Map geometry with ellipsoidal corrections only (no terrain correction performed).

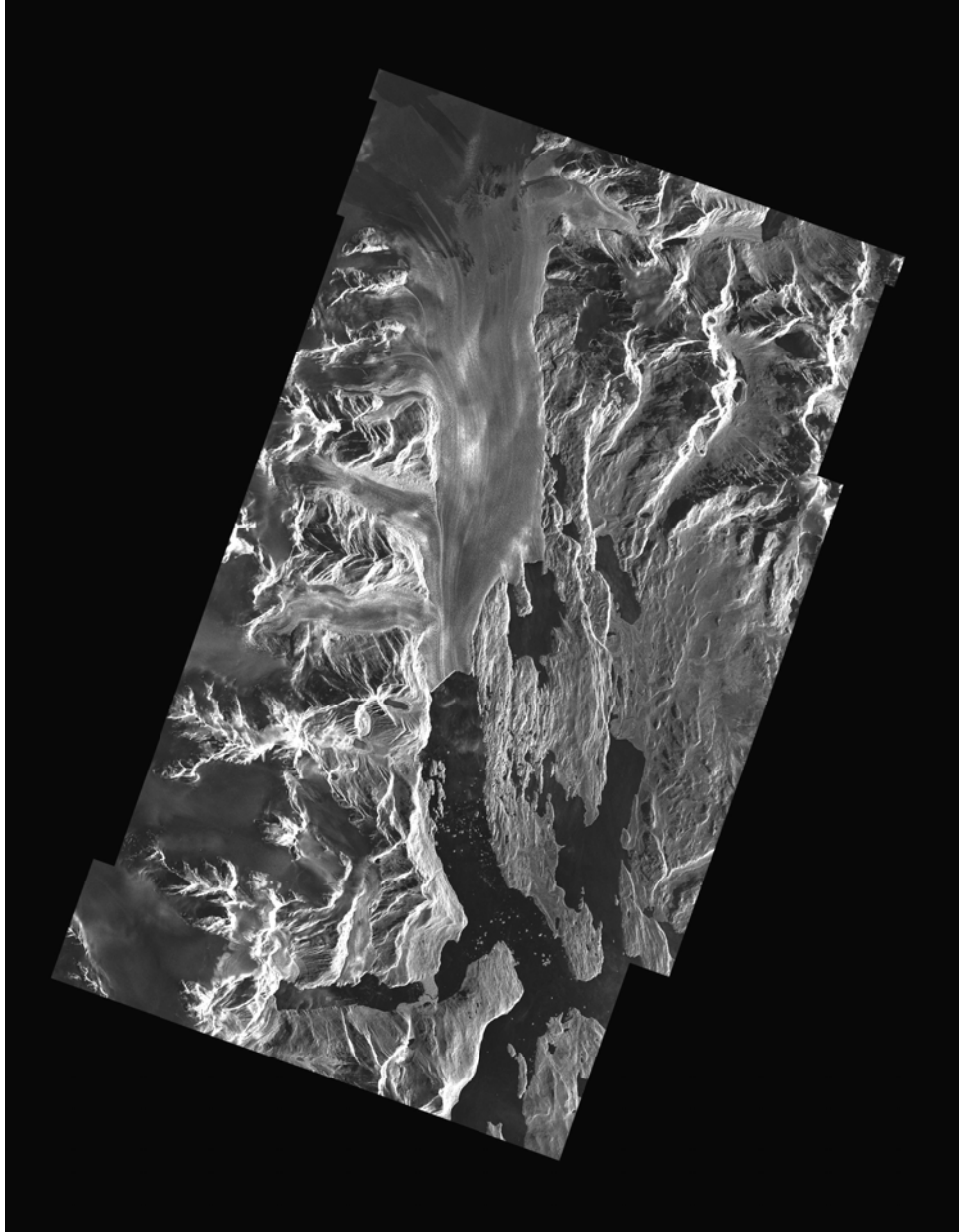
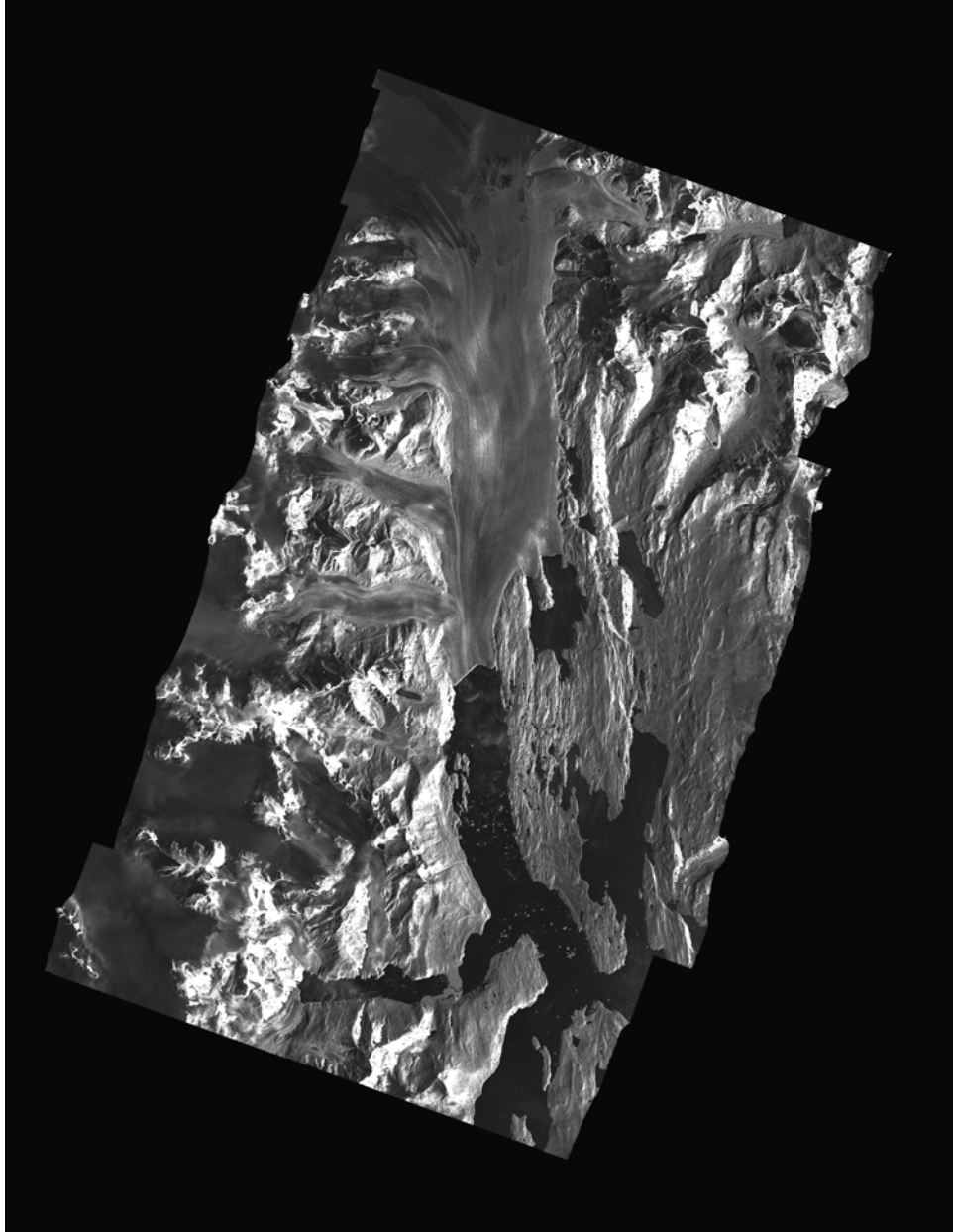

*Fig. 3-8: Example for a GEC projection. The image is rotated but not terrain corrected.*

The GEC product is a multi look detected product. It is projected and re-sampled to the WGS84 reference ellipsoid assuming one average terrain height. Available grid formats are UTM and UPS (see section 3.6). As the ellipsoid correction does not consider a DEM, the pixel location accuracy varies due to the terrain. The accuracy measures provided in chapter 4 are valid for flat surfaces. For other types of relief, the terrain induced SAR specific distortions will not be corrected and significant differences can appear in particular for strong relief and steep incidence angles.

### 3.5.4 Enhanced Ellipsoid Corrected (EEC)

Geometric Projection: Map geometry with terrain correction, using a digital elevation model (DEM).



*Fig. 3-9: Example for an EEC projection. The image is rotated and terrain corrected.*

Like the GEC, the EEC is a multi look detected product. It is projected and re-sampled to the WGS84 reference ellipsoid. The image distortions caused by varying terrain height are corrected using an external DEM. Available grid formats will be either UTM or UPS [see section 3.6].

Terrain induced distortions are corrected using a DEM. Therefore the pixel localization in these products is highly accurate. The accuracy still depends on the type of terrain as well as the quality and resolution of the DEM and on the incidence angle.

The EEC is generated using the best available digital elevation model (DEM) at PGS. These DEMs are compiled from different sources like SRTM/X-SAR, SRTM/C-band, ERS-tandem data, DTED-1 and DTED-2. Remaining gaps are filled with GLOBE-data. SRTM is the best globally available source of elevation data and provides an excellent basis for the rectification of the SM and SC modes. However in case of undulated terrain it is still relatively coarse with respect to the horizontal resolution of the HS and SL modes.

**DEM coverage map:** The DEM used for rectification is annotated in a matrix delivered with the image. The resolution of the DEM coverage map depends on the best available DEM for the geocoding (e.g. 1 arcsec for SRTM X-band DEM). Each cell of the matrix contains an index that identifies the name(s) of the DEM(s). A lookup table, which describes the index, is part of the delivered product.

The DEM itself is not a TerraSAR-X product and is not delivered with the basic product.

EEC products will optionally be complemented with a geocoded incidence angle mask (GIM). The GIM provides information about the local incidence angle for each pixel of the geocoded SAR scene and about presence of layover and shadow areas.

**Local incidence angle:** The local incidence angle is the angle between the radar beam and a line perpendicular to the slope at the point of incidence. For its determination it is necessary to know the slant range vector and the local surface normal vector.

**Shadow areas:** Areas of SAR shadow are determined via the off-nadir angle, which in general increases for a scan line from near to far **range**. Shadow occurs as soon as the off-nadir angle reaches a turning point and decreases when tracking a scan-line from near to far range. The shadow area ends where the off-nadir angle reaches that value again, which it had at the turning point.

The GIM product shows the same cartographic properties like the geocoded output image with regard to output projection and cartographic framing. The content of the GIM product is basically the local terrain incidence angle and additional flags indicate whether a pixel is affected by shadow and/or layover or not.

The following coding of the incidence angles into the GIM product is specified:

- incidence angles are given as 16bit integer values in tenths of degrees, e.g. 10,1° corresponds to an integer value of 1010.
- The last digit of this integer number is used to indicate shadow and/or layover areas as follows:

1.....	indicates layover	(ex. 1011)
2.....	indicates shadow	(ex. 1012)
3.....	indicates layover and shadow	(ex. 1013)

## 3.6 Map Projections and Grid Formats

### 3.6.1 Geodetic Datum and Map Projection

In order to be able to produce maps of the earth's surface it is necessary to precisely know its size and shape. Two mathematical descriptions were established – the geoid and the ellipsoid.

The geoid represents the mean sea-level surface which is thought to be continuing underneath the continents. It is the equipotential surface corresponding to an overall absolute elevation of 0 m. The geoid is often used as reference for elevation models.

Usually the earth surface is described by an ellipsoid or a sphere. The ellipsoid can be defined by its semi-major and semi-minor axis. The polar axis is shorter than the equatorial axis and the earth is flattened. However ellipsoid and geoid don't fit very well everywhere. Therefore individual countries use different ellipsoids to minimize deviations between these two surfaces in their area of interest. Additionally the ellipsoids' origins are not necessarily identical with the center of the earth and their shape and size may vary considerably. Ellipsoids that have been defined with size, shape and location in space are referred to as *geodetic datums*.

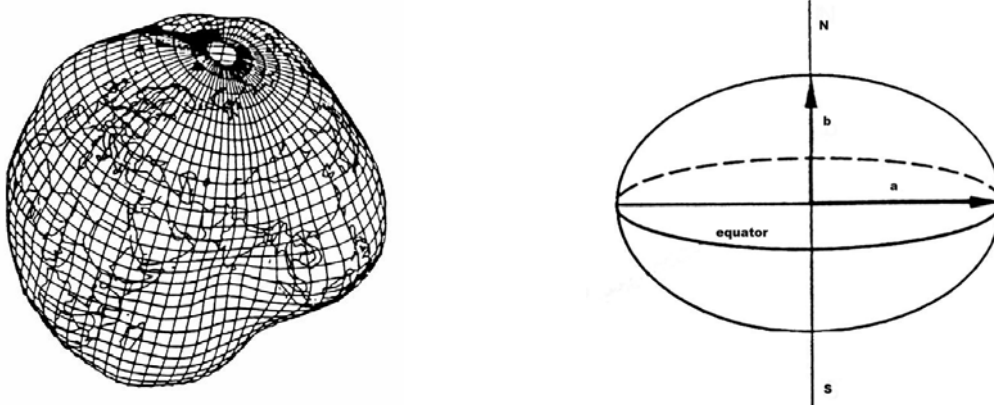

Fig. 3-10: Geoid (left), Ellipsoid (right). Figures taken from [RD 3].

Finally, a map projection needs to be selected in order to represent the curved surface of the ellipsoid on a plane surface. However each of the projections has some kind of distortions. They either preserve angular relationships (conformal projection), distances or area relationships. Usually over land conformal projections are preferred (like Transverse Mercator). Angles on a conformal map are the same as those that would be measured on the earth's surface.

For TerraSAR-X WGS84 is used as geodetic datum. Universal Transverse Mercator (UTM) is the standard projection. For polar regions Universal Polar Stereographic (UPS) will be applied. These projections are supported by all of the common image processing systems and are well established also for other spaceborne missions like ERS and ENVISAT-ASAR.

The projection and zone are derived from the scene center coordinates. Whenever the scene center latitude crosses  $84^\circ$  north or  $80^\circ$  south UPS is selected. The UTM-zones are  $6^\circ$  wide with e.g.  $3^\circ$  (UT31),  $9^\circ$  (UT32),  $15^\circ$  (UT33), ... as central meridians. The scene center longitude determines the zone of the entire scene.

### 3.6.2 Universal Transverse Mercator (UTM) Grid

The UTM is a conformal cylindrical projection where the surface of the WGS84 ellipsoid is projected onto a cylinder (as shown in Fig. 3-11) that cuts the earth along two lines parallel to the central meridian. The scale is 1 at the cuts and the scale error is mainly a function of the distance from the central meridian. In order to avoid significant distortions UTM is limited in its east-west extent. UTM is a global system consisting of 60 zones each being  $6^\circ$  wide in longitude and providing a rectangular and metric grid.

### 3.6.3 Universal Polar Stereographic (UPS) Grid

As UTM would produce big distortions in polar regions, the Universal Polar Stereographic Projection is applied for areas between  $84^\circ$  to  $90^\circ$  northern and  $80^\circ$  to  $90^\circ$  southern latitudes thus providing two different "zones".

Universal Polar Stereographic is a conformal azimuthal projection. It is a perspective projection on a plane tangent to either the North or the South Pole as shown in Fig. 3-13. It is conformal free from angular distortions.



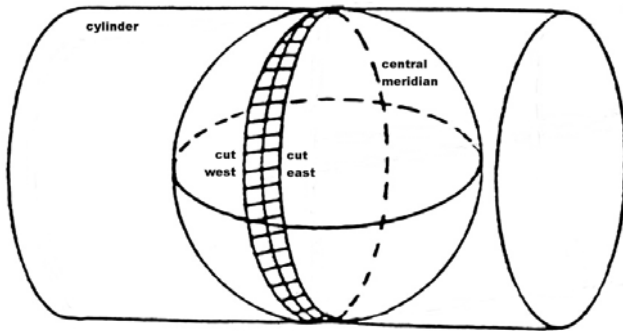

Fig. 3-12: Transverse Mercator Figure taken from [RD 3].

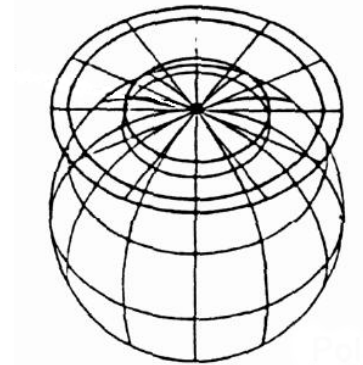

Fig. 3-13: Polar Stereographic Projection. Figure taken from [RD 3].

For compatibility with existing and future standards used in geographic information systems (GIS) and for navigation, all TerraSAR-X products are horizontally referenced to the WGS84 ellipsoid. Depending on the geographical latitude, UTM or UPS grids are used.

### 3.7 Product Identification Scheme

The different basic products for TerraSAR-X are identified and classified by a mnemonic scheme described in the following. The purpose of this scheme is to enable the identification of products that are compatible with respect to imaging mode or polarization mode. Since the compatibility requirements depend on the intended application, a minimal set of radar and product parameters are used to compose a product identifier:

- the radar imaging mode influencing the resolution and the scene size
- the polarization mode influencing the number of available polarization channels
- the resolution class, a processing parameter
- the geometric projection, a processing parameter

The product identifier follows the standards proposed for the TS-X PGS. It is split into 4 sub-identifiers and the global product name is composed as:

**<projection>\_<resolution class>\_<imaging mode>\_<polarization mode>**

e.g. **MGD\_SE\_SM\_S** for a spatially enhanced single polarization stripmap product in multi look ground range projection. If a sub-identifier is not applicable, like the resolution class for complex products, it is omitted.

#### Definition of Product Identifier

##### 3.7.1 Radar Imaging Mode Identifier

Four different imaging modes are currently defined:

Imaging Mode	Identifier
High Resolution spotlight	HS
spotlight	SL
stripmap	SM
ScanSAR	SC

##### 3.7.2 Polarization Mode Identifier

Single Polarization and Dual Polarization are the two standard modes which are possible for each image mode, except ScanSAR, which is restricted to single polarization.

Furthermore two more polarization modes, Quad Polarization and Twin Polarization are technically possible. They are currently not available as Basic Products.

Polarization Mode	Identifier
Single	S
Dual	D
Quad	Q
Twin	T

##### 3.7.3 Projection Identifier

The following options for geometrical projection and for data representation will be selectable:

Identifier	Projection, data representation
SSC	<b>S</b> ingle Look <b>S</b> lant Range, <b>C</b> omplex representation
MGD	<b>M</b> ulti Look <b>G</b> round Range, <b>D</b> etected representation
GEC	<b>G</b> eocoded <b>E</b> llipsoid <b>C</b> orrected, detected representation
EEC	<b>E</b> nhanced <b>E</b> llipsoid <b>C</b> orrected, detected representation

## 4 Basic Product Tables

The following tables list the TerraSAR-X basic products for each radar image mode together with the characteristic parameters. The products have a fixed size in azimuth and range. No framing is applied and the product location along a longer stripmap or ScanSAR data take can be freely selected.

Single and dual polarization variants are sorted in consecutive tables. The given product size should give a minimum estimate for product storage and transport purposes. It is roughly calculated as

$$size = \left( n_{pol} \cdot bps + 2 \cdot n_{inc} \right) \frac{R \cdot A}{\Delta r \cdot \Delta a \cdot 10000000} \text{ [MB]},$$

where

- $n_{pol}$  is the number of polarimetric layers,
- $bps$  is the number of bytes per sample, i.e. 2 for detected and 4 for complex products,
- $n_{inc}$  is the number of incidence angle masks, i.e. 1 for EEC, 0 for all other products,
- $R$  is the scene size in range,
- $A$  is the scene size in azimuth,
- $\Delta r$  is the pixel spacing in range,
- $\Delta a$  is the pixel spacing in azimuth.

The values given for detected products contain the incidence angle mask which is only provided with geocoded EEC products. The incidence angle mask makes 50% of a single polarization product and 33 % of a dual polarization product. The relative increase in product size due to a slightly tilted flight track is significant only for small products and thus neglected.

The DEM index file additionally increases the product size of EEC products but it is expected that this map can be compressed efficiently.

#### 4.1 Single Polarization Stripmap Products (SM)

Mnemonic	{MGD, GEC, EEC}_SE_SM_S	{MGD, GEC, EEC}_RE_SM_S	SSC_SM_S	
Imaging Mode	SM			
Product Type	Detected			Complex
Geometric Projection	{MGD, GEC, EEC}			SSC
Polarization Mode	S			
Resolution Mode	SE	RE		
Number of Polarimetric Channels	1			
Polarization Mode	{HH, VV}			
Data collection range	15°-60°			
Full Performance range	20°-45°			
Recomm. Performance range	20°-45°			
Range Scene Size [km]	30			
Azimuth scene size [km]	50			
Abs. Radiometric Accuracy [dB]	0.6			
Relative Radiom. Accuracy [dB]	0.30			
NESZ [dB]	-19			
Ambiguity Ratio [dB]	< -17			
PSLR [dB]	-25			
ISLR [dB]	-18			
Num. of Inc. Angle Masks	1			0
Bit per Pixel	16			32
Hamming coefficient	0.6			0.60
Incidence angle (20°-45°)	20	45	20	45
Slant range resolution [m]				1.2
Ground Range Resolution [m]	3.5	3.3	8.0	7.0
Azimuth Resolution [m]	3.5	3.3	8.0	7.0
Approx. Range Pixel Spacing [m]	1.5	1.25	4	3.25
Appr. Azimuth Pixel Spacing [m]	1.5	1.25	4	3.25
Effective number of looks	1.0	1.3	6.1	6.4
Pixel localization accuracy [m]				1.0
Radiometric resolution [dB]	3.1	2.9	1.5	1.5
Product Size (MB)	2667	3840	375	568
				3300

Table 4-1: Single polarization stripmap products for 20° and 45° beams

Notes:

- SM = stripmap
  - SE = Spatially enhanced (high resolution), RE = Radiometrically enhanced (high radiometry)
  - S = Single polarization
- all values for detected products at 20° and SSCs are based on 150 MHz range bandwidth, for 45° 100 MHz is used

## 4.2 Dual Polarization Stripmap Products (SM)

Mnemonic	{MGD, GEC, EEC}_SE_SM_D	{MGD, GEC, EEC}_RE_SM_D	SSC_SM_D	
Imaging Mode	SM			
Product Type	Detected			Complex
Geometric Projection	{MGD, GEC, EEC}			SSC
Polarization Mode	D			
Resolution Mode	SE	RE		
Number of Polarimetric Channels	2			
Polarization Mode	{HH/VV, HH/HV, VV/VH}			
Data collection range	15°-60°			
Full Performance range	20°-45°			
Recomm. Performance range	20°-40°			
Range Scene Size [km]	15			
Azimuth scene size [km]	50			
Abs. Radiometric Accuracy [dB]	0.6			
Rel. Radiometric Accuracy [dB]	0.30			
NESZ [dB]	-19			
Ambiguity Ratios [dB]	< -16			
PSLR [dB]	-25			
ISLR [dB]	-18			
Inc. Angle Masks	1			0
Bit per Pixel	16			32
Hamming coefficient	0.6			0.60
Incidence angle (20°-45°)	20	45	20	45
Slant range resolution [m]				1.2
Ground Range Resolution [m]	6.6	6.6	11.8	9.9
Azimuth Resolution [m]	6.6	6.6	11.8	9.9
Range Pixel Spacing [m]	3	3	5.5	4.5
Azimuth Pixel Spacing [m]	3	3	5.5	4.5
Effective number of looks	1.8	2.8	6.5	6.6
Pixel localization accuracy [m]				1.0
Radiometric resolution [dB]	2.5	2.1	1.5	1.5
Product Size (MB)	500	500	149	222
				2667

Table 4-2: Dual polarization stripmap products for 20° and 45° beams

Notes:

- SM = stripmap
- SE = Spatially enhanced (high resolution), RE = Radiometrically enhanced (high radiometry)
- D = Dual polarization

### 4.3 High Resolution Single Polarization Spotlight Products (HS)

Mnemonic	{MGD, GEC, EEC}_SE_HS_S		{MGD, GEC, EEC}_RE_HS_S		SSC_HS_S
Imaging Mode	HS				
Product Type	Detected				Complex
Geometric Projection	{MGD, GEC, EEC}				SSC
Polarization Mode	S				
Resolution Mode	SE	RE			
Number of Polarimetric Channels	1				
Polarization Mode	{HH, VV}				
Data collection range	15°-60°				
Full Performance range	20°-55°				
Recomm. Performance range	20°-50°				
Range Scene Size [km]	10				
Azimuth scene size [km]	5				
Abs. Radiometric Accuracy [dB]	unspecified				
Rel. Radiometric Accuracy [dB]	unspecified				
NESZ [dB]	-19				
Ambiguity Ratios [dB]	< -17				
PSLR [dB]	-25				
ISLR [dB]	-18				
Inc. Angle Masks	1				0
Bit per Pixel	16				32
Hamming coefficient	0.6				0.60
Incidence angle (20°-55°)	20	55	20	55	
Slant range resolution [m]					1.2
Ground Range Resolution [m]	3.5	1.4	4.7	3.1	
Azimuth Resolution [m]	3.5	1.4	4.7	3.1	1.1
Range Pixel Spacing [m]	1.5	0.5	2	1.5	0.9
Azimuth Pixel Spacing [m]	1.5	0.5	2	1.5	0.8
Effective number of looks	3.0	1.3	6.3	5.9	
Pixel localization accuracy [m]					1.0
Radiometric resolution [dB]	2.1	3.0	1.5	1.7	
Product Size (MB)	89	800	50	89	275
	<b>HS 300 MHz (Characterisation only)</b>				
Range Scene Size [km]	10 ... 5				
Slant range resolution [m]					0.6
Ground Range Resolution [m]	1.8	1.1	3.4	2.2	
Azimuth Resolution [m]	1.8	1.1	3.4	2.2	1.1
Range Pixel Spacing [m]	0.75	0.5	1.5	1	0.5
Azimuth Pixel Spacing [m]	0.75	0.5	1.5	1	0.8
Effective number of looks	1.5	1.2	5.0	4.7	
Radiometric resolution [dB]	2.7	3.1	1.7	1.8	
Product Size (MB)	356	800	89	200	500

Table 4-3: Tables of single polarization high resolution spotlight products for 20° and 55° beams

Notes: HS = High Resolution Spotlight, SE = Spatially enhanced (high resolution), RE = Radiometrically enhanced (high radiometry), S = Single polarization

#### 4.4 High Resolution Dual Polarization Spotlight Products (HS)

Mnemonic	{MGD, GEC, EEC}_SE_HS_D		{MGD, GEC, EEC}_RE_HS_D		SSC_HS_D
Imaging Mode	HS				
Product Type	Detected				Complex
Geometric Projection	{MGD, GEC, EEC}				SSC
Polarization Mode	D				
Resolution Mode	SE		RE		
Number of Polarimetric Channels	2				
Polarization Mode	HH/VV				
Data collection range	15°-60°				
Full Performance range	20°-55°				
Recomm. Performance range	20°-43°				
Range Scene Size [km]	10				
Azimuth scene size [km]	5				
Abs. Radiometric Accuracy [dB]	unspecified				
Rel. Radiometric Accuracy [dB]	unspecified				
NESZ [dB]	-19				
Ambiguity Ratios [dB]	< -16 (-9 above 45°)				
PSLR [dB]	-25				
ISLR [dB]	-18				
Inc. Angle Masks	1				0
Bit per Pixel	16				32
Hamming coefficient	0.6				0.6
Incidence angle (20°-55°)	20	55	20	55	
Slant range resolution [m]					1.2
Ground Range Resolution [m]	3.3	2.2	7.2	4.4	
Azimuth Resolution [m]	3.3	2.2	7.2	4.4	2.2
Range Pixel Spacing [m]	1.5	1	3	2	0.8
Azimuth Pixel Spacing [m]	1.5	1	3	2	1.5
Effective number of looks	1.5	1.5	6.5	6.0	
Pixel localization accuracy [m]					1.0
Radiometric resolution [dB]	2.7	2.8	1.5	1.6	
Product Size (MB)	133	300	33	75	333

Table 4-4: Table of high resolution dual polarization spotlight products for 20° and 55° beams

Notes:

- HS = High Resolution Spotlight
- SE = Spatially enhanced (high resolution), RE = Radiometrically enhanced (high radiometry)
- D = Dual polarization

#### 4.5 Single Polarization Spotlight Products (SL)

Mnemonic	{MGD, GEC, EEC}_SE_SL_S		{MGD, GEC, EEC}_RE_SL_S		SSC_SL_S
Imaging Mode	SL				
Product Type	Detected				Complex
Geometric Projection	{MGD, GEC, EEC}				SSC
Polarization Mode	S				
Resolution Mode	SE	RE			
Number of Polarimetric Channels	1				
Polarization Mode	{HH, VV}				
Data collection range	15°-60°				
Full Performance range	20°-55°				
Recomm. Performance range	20°-50°				
Range Scene Size [km]	10				
Azimuth scene size [km]	10				
Abs. Radiometric Accuracy [dB]	unspecified				
Rel. Radiometric Accuracy [dB]	unspecified				
NESZ [dB]	-19				
Ambiguity Ratios [dB]	< -17				
PSLR [dB]	-25				
ISLR [dB]	-18				
Inc. Angle Masks	1				0
Bit per Pixel	16				32
Hamming coefficient	0.6				0.60
Incidence angle (20°-55°)	20	55	20	55	
Slant range resolution [m]					1.2
Ground Range Resolution [m]	3.5	1.7	6.1	3.8	
Azimuth Resolution [m]	3.5	1.7	6.1	3.8	1.7
Range Pixel Spacing [m]	1.5	0.75	3	1.75	0.9
Azimuth Pixel Spacing [m]	1.5	0.75	3	1.75	1.3
Effective number of looks	2.0	1.2	6.0	6.1	
Pixel localization accuracy [m]					1.0
Radiometric resolution [dB]	2.4	3.1	1.5	1.6	
Product Size (MB)	178	400	44	131	338

Table 4-5: Table of single polarization spotlight products for 20° and 55° beams

Notes:

- SL = spotlight
- SE = Spatially enhanced (high resolution), RE = Radiometrically enhanced (high radiometry)
- S = Single polarization



#### 4.6 Dual Polarization Spotlight Products (SL)

Mnemonic	{MGD, GEC, EEC}_SE_SL_D		{MGD, GEC, EEC}_RE_SL_D		SSC_SL_D
Imaging Mode	SL				
Product Type	Detected				Complex
Geometric Projection	{MGD, GEC, EEC}				SSC
Polarization Mode	D				
Resolution Mode	SE		RE		
Number of Polarimetric Channels	2				
Polarization Mode	HH/VV				
Data collection range	15°-60°				
Full Performance range	20°-55°				
Recomm. Performance range	20°-43°				
Range Scene Size [km]	10				
Azimuth scene size [km]	10				
Abs. Radiometric Accuracy [dB]	unspecified				
Rel. Radiometric Accuracy [dB]	unspecified				
NESZ [dB]	-19				
Ambiguity Ratios [dB]	< -16 (-9 above 45°)				
PSLR [dB]	-25				
ISLR [dB]	-18				
Inc. Angle Masks	1				0
Bit per Pixel	16				32
Hamming coefficient	0.6				0.60
Incidence angle (20°-55°)	20	55	20	55	
Slant range resolution [m]					1.2
Ground Range Resolution [m]	3.5	3.4	8.5	5.5	
Azimuth Resolution [m]	3.5	3.4	8.5	5.5	3.4
Range Pixel Spacing [m]	1.5	1	4	2.5	0.9
Azimuth Pixel Spacing [m]	1.5	1	4	2.5	2.6
Effective number of looks	1.0	2.4	5.8	6.4	
Pixel localization accuracy [m]					1.0
Radiometric resolution [dB]	3.1	2.4	1.6	1.6	
Product Size (MB)	267	600	38	96	342

Table 4-6: Table of dual polarization spotlight products for 20° and 55° beams

Notes:

- SL = spotlight
- SE = Spatially enhanced (high resolution), RE = Radiometrically enhanced (high radiometry)
- D = Dual polarization

#### 4.7 ScanSAR Products (SC)

Mnemonic	<b>{MGD, GEC, EEC}_RE_SC_S</b>	
Imaging Mode	SC	
Product Type	Detected	
Polarization Mode	S	
Geometric Projection	{MGD, GEC, EEC}	
Resolution Mode	RE	
Number of Polarimetric Channels	1	
Polarization Mode	{HH, VV}	
Data collection range	15°-60°	
Full Performance range	20°-45°	
Recomm. Performance range	20°-45°	
Range Scene Size [km]	100	
Azimuth Scene Size [km]	150	
Abs. Radiometric Accuracy [dB]	0.7	
Rel. Radiometric Accuracy [dB]	0.4	
NESZ [dB]	-19	
Ambiguity Ratios [dB]	< -15	
PSLR [dB]	unspecified	
ISLR [dB]	unspecified	
Inc. Angle Masks	1	
Bit per Pixel	16	
Hamming coefficient	0.6	
Incidence angle (20°-45°)	<b>20</b>	<b>45</b>
Ground Range Resolution [m]	19.2	17.0
Azimuth Resolution [m]	19.2	18.5
Range Pixel Spacing [m]	8.25	8.25
Azimuth Pixel Spacing [m]	8.25	8.25
Effective number of looks	5.6	11.1
Radiometric resolution [dB]	1.6	1.2
Product Size (MB)	882	882

Table 4-7: Table of ScanSAR products, samples for 20° and 45°

Notes:

- SC = ScanSAR
- RE = Radiometrically Enhanced (High Radiometry)
- S = Single Polarization

## 5 Basic Product Data Structure

For each ordered Basic Product a standard set of components will be delivered to the user. In the following the structure of a Basic Product is described while the detailed parameters and the detailed format and contents are defined in the separate annex document [RD 8]. For the purpose of storage on a media and for shipping to the customer, more than one product may be bundled.

Basic Product	
Annotation Parameter Files	
Annotation File Header	General information on the main annotation file.
Product Components Directory	Pointers to all product components.
Product Information Parameters	General generation, mission, scene and imaging mode related parameters. Image data description. <i>Basic information on the product.</i>
Product Specific Parameters	Specific information for SSCs, detected and geocoded products
Processing Setup Parameters	Screening and processing chain setup and control parameters.
SAR Processing Parameters	Processor and product configuration parameters and parameters of the data determined and used during screening and processing.
Instrument Parameters	Sensor specific parameters at the time of the image acquisition.
Calibration Parameters	The base for the application of radiometric and other data corrections. Nominal performance of the product.
Noise annotation.	Polynomials characterizing the expected noise in the image layers.
Platform Parameters	Orbit and attitude data of the platform used for the processing.
Product Quality Parameters	Assessment of the signal data and summary of the image and processing quality flags.
Georeference Grid (add. file)	Parameters related to geolocation of (SSC) image layers.
Image Raster Files	
HH-Layer	Containing one or more polarimetric channels in separate binary data matrices. For DRA mode geometric layers are contained. Data format is 16 bit integer for geocoded products and 16 / 16 bit integer complex for SSCs.
VV-Layer	
HV-Layer	
...	
Auxiliary Raster Files (optional, only for MGD, GEC, EEC)	
Incidence Angle Mask	Incidence angle for each image pixel derived from DEM (EEC only).
DEM Map	Map indicating which DEM is used for geocoding.
Mapping Grid	Coarse grid which correlates pixel of projected images with range/azimuth times.
Image Preview Files	
Quicklook & Browse Images	Rescaled images readable with common tools for cataloguing and quality control purposes.
Map Plot	Geographical map showing the image footprint.
Administrative Parameter File (in delivery package, not part of the L1b user product))	
Delivery Package and Processing Facility Related Information	Uniquely identifies the delivered product and describes the product package structure. Characterizes the processing facility and mode.

Table 5-1: Data structure of a Basic Product

## 5.1 Annotation

The product annotation is provided in XML format, see document [RD 8] for details. Since every delivered level 1b product is at least based on an intermediate complex product in slant range geometry (SSC) and all calibration is performed on that one, the characteristics of that SSC are annotated even for detected or geocoded products. This approach of a modular annotation structure which includes the history of parameters allows to trace (and to reverse if wished) the corrections applied during processing. Such a flexible and extendable annotation also facilitates the use of one product model for the large variety of product variants. The basic annotation is thus supplemented by product variant specific information (e.g. SSC processing parameters or map projection parameters for geocoded products). Even the inclusion of additional components from further processing steps is thus a straight-forward process.

Different product types may extend the annotation. However, for all product variants there is a common annotation segment containing the product parameters that describe the basic characteristics of the product.

## 5.2 SAR Image Channels

Contains one or more polarimetric channels in separate binary data matrices. As detailed in [RD 8], detected images will be delivered in GeoTIFF format while complex data are provided in the COSAR file format.

## 5.3 Auxiliary Raster Files

The incidence angle mask and the DEM mask contain for EEC products the slope dependent local incidence angle for each image pixel (including a flag for shadow or layover conditions) and the reference to the DEM used for this pixel. The mapping grid gives range and azimuth times for coarsely sampled image points of projected and geocoded products.

## 5.4 Quicklooks

### 5.4.1 Quicklook Image

Image quicklooks rescaled to a resolution class of approximately 5-10 times the original one (pixel spacing is for SC: 50m, SM: 25m, SL: 10m, HS: 5m), in TIFF format readable with common display tools. Additionally, a RGB color composite quicklook of the polarization layers and a smaller browse image with half the resolution are contained.

### 5.4.2 Map Plot

A coarse geographical map showing the footprint of the image.

## 5.5 Administrative Parameter Files

The product and processing facility identifiers as well as the data set descriptors are generated by the product library data base for the delivered product package.

## ANNEX A) Definition of Performance Parameters

### Measures for the Point Target Response Function

The point target response (PTR), or impulse response function (IRF) of a SAR system (sensor and processor) is the 2-D image of a point target in either slant range or ground range representation. As the SAR principle exhibits an approximate separability in range and azimuth, often only the 1-D slices in range and azimuth are used to characterize the 2-D IRF.

Quantitative analysis of a PTR of real world SAR data necessitates interpolation (oversampling) of the image by a factor of at least 16. Care has to be taken that the interpolation kernel does not alter the shape of the IRF.

- *Peak Sidelobe Ratio (PSLR)*

The peak sidelobe ratio is the worst case measure of the SAR ability to identify a weak target from a nearby strong target. The PSLR is defined as the ratio of the peak intensity in the mainlobe of the IRF to the peak intensity of the most intense sidelobe. It is calculated as

$$\text{PSLR} = 10 \log_{10} [I_{\text{peak}} / I_{\text{side}}]$$

For general image quality and for detection purposes a spatially compact IRF is desirable. However, there is a trade-off between resolution, i.e. compactness of the IRF and sidelobes, ambiguous responses that are spatially separated from the main response.

Assuming an ideal SAR sensor with rectangular range spectra and a sinc shaped azimuth pattern, the shape of the PTR is essentially a function of processing parameters, i.e. bandwidth and spectral shaping. Generally reduction of sidelobes results in degradation of resolution and a trade-off between sharpness and low sidelobes has to be performed. Further deterioration of the sidelobes may be caused by errors of the real SAR sensor. From the commissioning phase analysis, a compromise between resolution and sidelobe suppression has been found by using a Hamming coefficient of 0.6.

- *Integrated Sidelobe Ratio (ISLR)*

The integrated side lobe ratio characterizes the ability to detect weak targets in the neighbourhood of bright targets. The ISLR is defined as the ratio of energy of the mainlobe to that in the sidelobes and is calculated as:

$$\text{ISLR} = 10 \log_{10} [E_{\text{main}} / E_{\text{side}}]$$

The ISLR can be measured both in a one-dimensional and a two-dimensional way. In the one-dimensional case, the mainlobe is defined to be of width  $2X$  in azimuth and  $2Y$  in the range directions, centered on the IRF peak. The spatial resolutions in range and azimuth are referred to as the range resolution  $Y$  and azimuth resolution  $X$ , respectively. The sidelobe region is defined to extend to a total length of  $20X$  in the azimuth and  $20Y$  in the range directions, centered at the peak of the IRF, but excluding the mainlobe region just defined.

In the two-dimensional case, the mainlobe is defined as the area enclosed within a contour obtained enlarging the  $-3$  dB contour by a factor of 2 in each direction, centered on the peak of the IRF, while the sidelobe region is the area obtained by enlarging the  $-3$  dB contour by a factor 20 in each direction and excluding the mainlobe area.

The values given for PSLR and ISLR in the product tables are estimates based on verified performance estimations and include a very small deterioration by the SAR processor.

### **Signal to Azimuth Ambiguity Ratio (SAAR)**

The SAAR is defined as the ratio between the mean image intensity of a distributed target within a given resolution cell and the sum of the mean image intensities observed in the same resolution cell but originating from distributed targets within the azimuth ambiguous zones, that is:

$$SAAR = 10 \cdot \log_{10} \frac{\int_{-PBW/2}^{PBW/2} |S_a(f - \Delta fDC)|^2 df}{\sum_{m=-\infty, m \neq 0}^{\infty} \int_{-PBW/2}^{PBW/2} |S_a(f - \Delta fDC - m \cdot PRF)|^2 df}$$

where  $\Delta fDC$  is the Doppler centroid estimation error, PBW the processing bandwidth,  $S_a$  the azimuth amplitude spectrum and  $m$  an integer. The SAAR is directly related to the shape of the azimuth antenna pattern, so it is often estimated substituting  $S_a$  with the antenna pattern. While the SAAR is given by the antenna pattern and PRF, it can be improved in the processor at the cost of azimuth resolution.

### Geometric Resolution

The spatial resolution of an imaging system is a measure for its ability to distinguish between adjacent targets and is defined as the IRF width measured at 3 dB (half of the intensity) below the peak value. The spatial resolutions in range and azimuth are referred to as the range resolution  $Y$  and azimuth resolution  $X$ , respectively. The values given in the product tables and plots are estimates based on verified performance predictions and measurements. The maximum geometric azimuth resolution is fixed for a given radar imaging mode and can be reduced in the processor to enhance the radiometric resolution.

### Radiometric Resolution

The radiometric resolution describes the expected residual radiometric variation per pixel depending on the number of looks  $N_L$  and the signal to noise ratio SNR [RD 2].

$$\gamma = 10 \cdot \log_{10} \left( 1 + \frac{1 + \text{SNR}^{-1}}{\sqrt{N_L}} \right)$$

The SNR depends mainly on the thermal noise power and the reflected signal power. Therefore, the SNR depends on the incidence angle and on the physical properties of the target. For the product tables in chapter 4 different backscatter estimates of -6 dB, -9 dB and -12 dB for incidence angles of 20°, 45° and 55° have been assumed.

### Distributed Target Ambiguity Ratio (DTAR)

The DTAR is the average ratio between signal power and the aliased power caused by azimuth and range ambiguities for one pixel. Note that the values in the tables now give typical upper limits for the individual azimuth and range contributions that can be derived in detail from the performance plots in Annex C.

### Noise Equivalent Sigma Zero (NESZ)

NESZ is the normalized backscatter which is equivalent to the background noise observed in a SAR image. It is caused by thermal noise, analog digital converter quantization noise and, to a negligible extent, processing noise. Typically, the spatial distribution and the spectral properties of noise differ from the SAR signal. Hence, the noise power depends on the spectral and spatial weighting in the processor. Especially compensation of the range spreading loss  $1/R^3$  and of the antenna pattern in the processor cause a spatial variation of the noise level in the product.

### Noise Equivalent Beta Zero (NEBZ)

NEBZ is a system parameter that is better suited to describe the background noise of the SAR system than NESZ, because it does not depend on the local incidence angle. Because it depends on system parameters like range spreading loss and antenna pattern, it can be described in the form of polynomials. The NEBZ is related to the NESZ via the local incidence angle  $\theta_i$  by

$$NESZ = NEBN \cdot \sin(\theta_i)$$

## ANNEX B) Configuration of Detected Product Variants

The following figures exemplary represent the configured quadratic resolution cell sizes and radiometric looks of **detected** products over the incidence angle range. These are adjustable in the processing system due to the flexible time domain incoherent averaging and are optimized for the two spatially enhanced (**SE** – best quadratic resolution) and radiometrically enhanced (**RE** – constant number of looks) product variants. The exact values depend on the actual instrument commanding (e.g. the selected range bandwidth) and processing parameters (e.g. azimuth processing bandwidth).

The range looks, azimuth looks and the resulting equivalent number of looks (ENL) shown here are derived from simulations using the real filter settings in the processor. The latter are iteratively optimized during processing and the depicted values are thus only approximations of what to expect for typical products.

Note that the figures for Stripmap and ScanSAR mode refer to either the nominal 150 MHz or 100 MHz range bandwidth which is not always selected uniformly for all beams due to instrument buffer limitations (see Annex on performance for details). Incidence angle ranges where the depicted setting is unlikely to be selected by commanding are shaded. The spotlight 100 MHz variants are included here for completeness but nominally not used in commanding since the highest possible nominal bandwidth is selected (i.e. 150 MHz). In the HS mode, the 300 MHz range bandwidth option may be ordered by the user to increase range resolution while trading off some scene range extent due to the buffer limitations.

In the ScanSAR mode, there is only one resolution variant since the azimuth resolution always limits the best achievable quadratic resolution cell still allowing for several range looks. The ENL even surpasses the targeted 6-7 looks for far range beams by allowing more range looks at this fixed resolution. For ScanSAR products with combinations of 100 & 150 MHz beams, the worst of the 4 beams resolution is used for the entire swath – thus increasing the number of looks accordingly.

### Stripmap Products

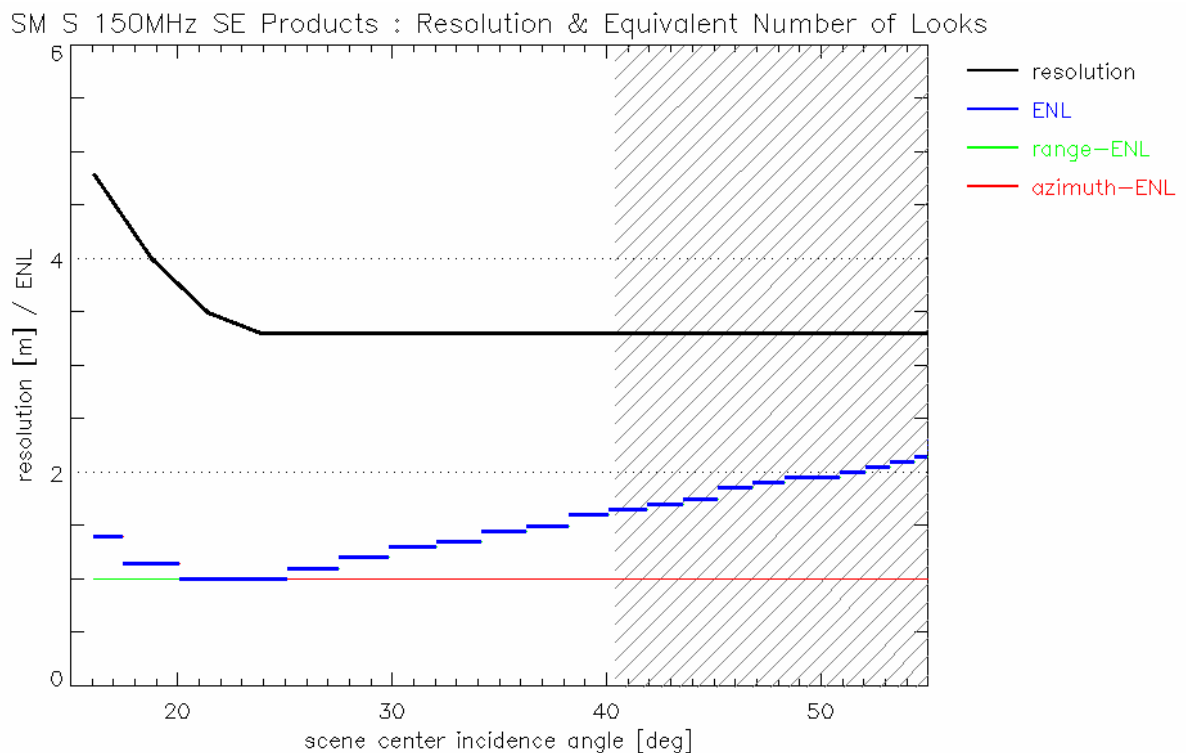

Fig. 1: Stripmap single polarization SE product variant for 150 MHz range bandwidth.

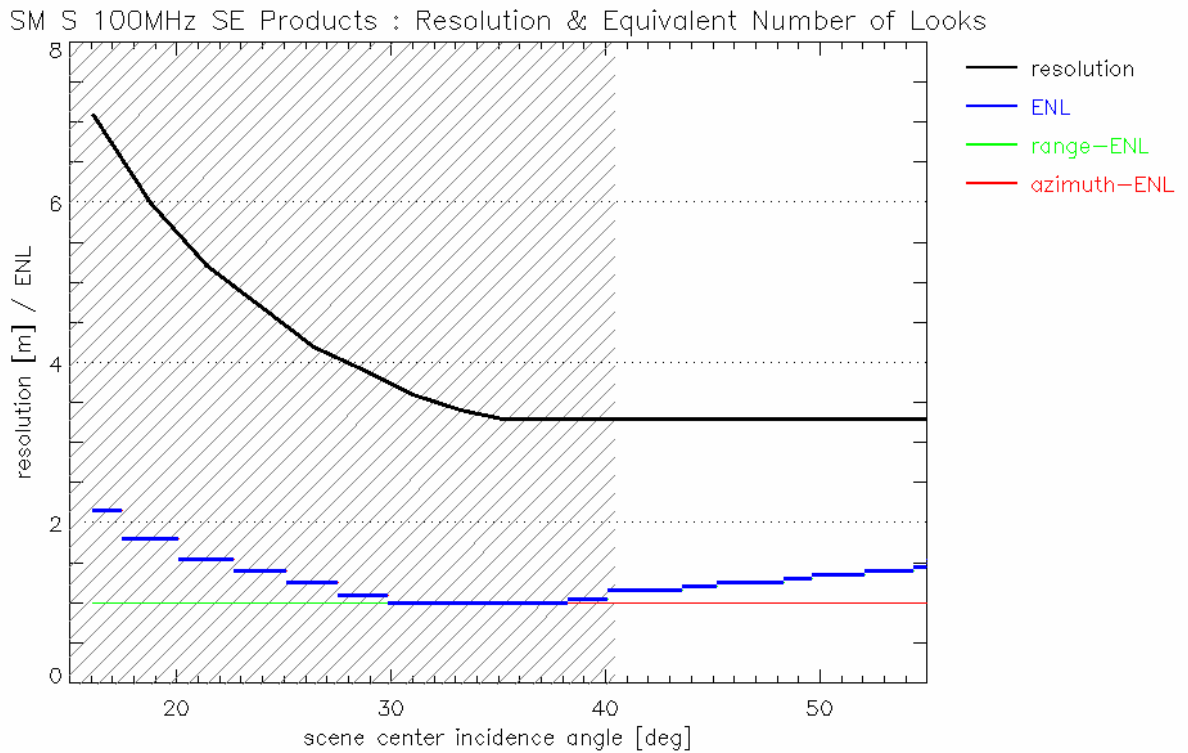

Fig. 2: Stripmap single polarization SE product variant for 100 MHz range bandwidth.

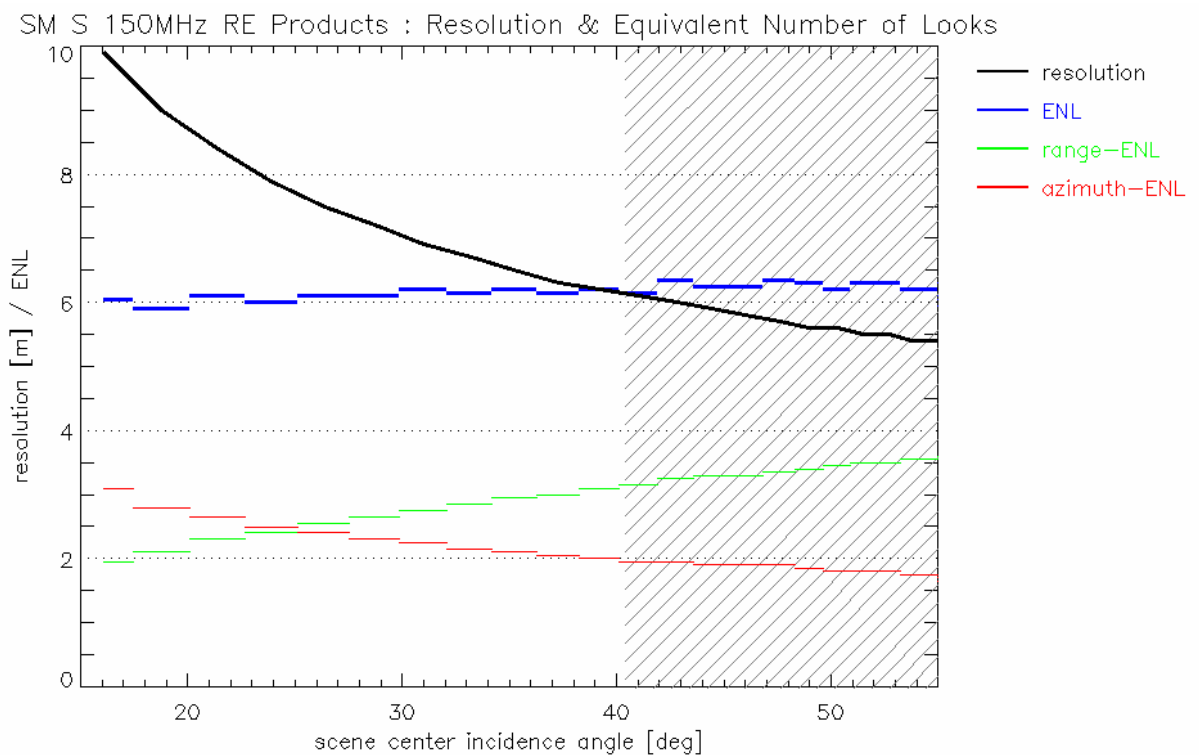

Fig. 3: Stripmap single polarization RE product variant for 150 MHz range bandwidth.



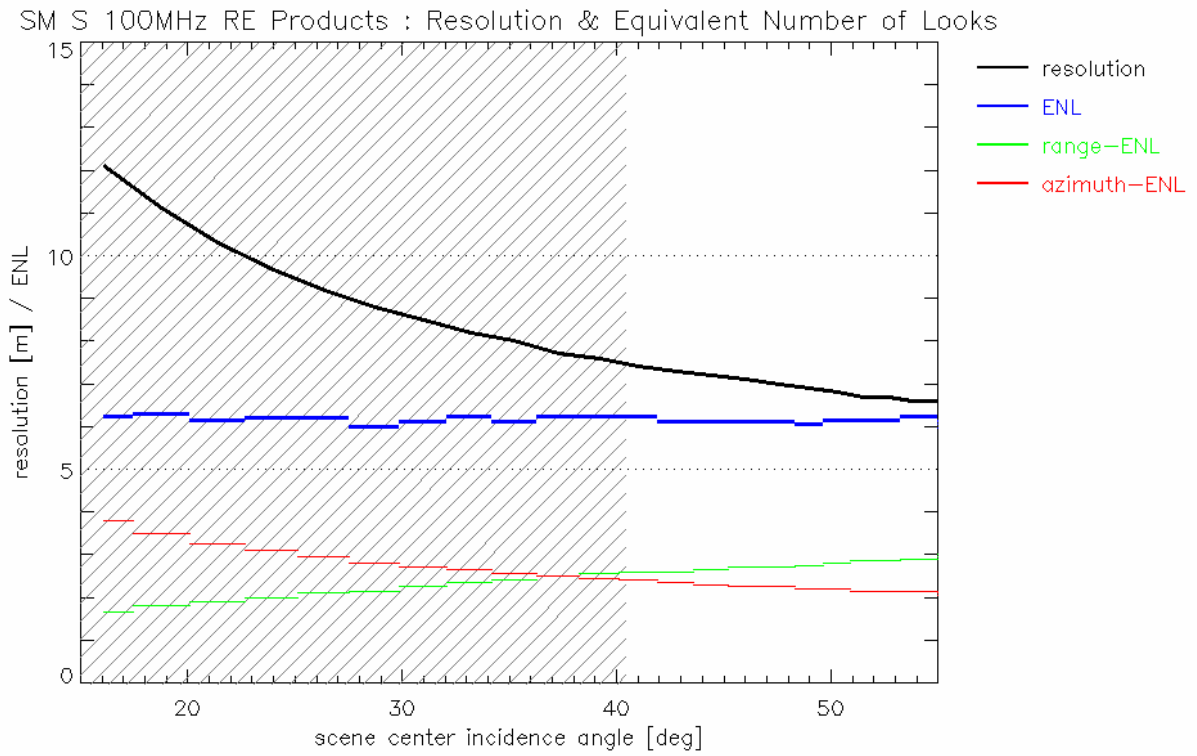

Fig. 4: Stripmap single polarization RE product variant for 100 MHz range bandwidth.

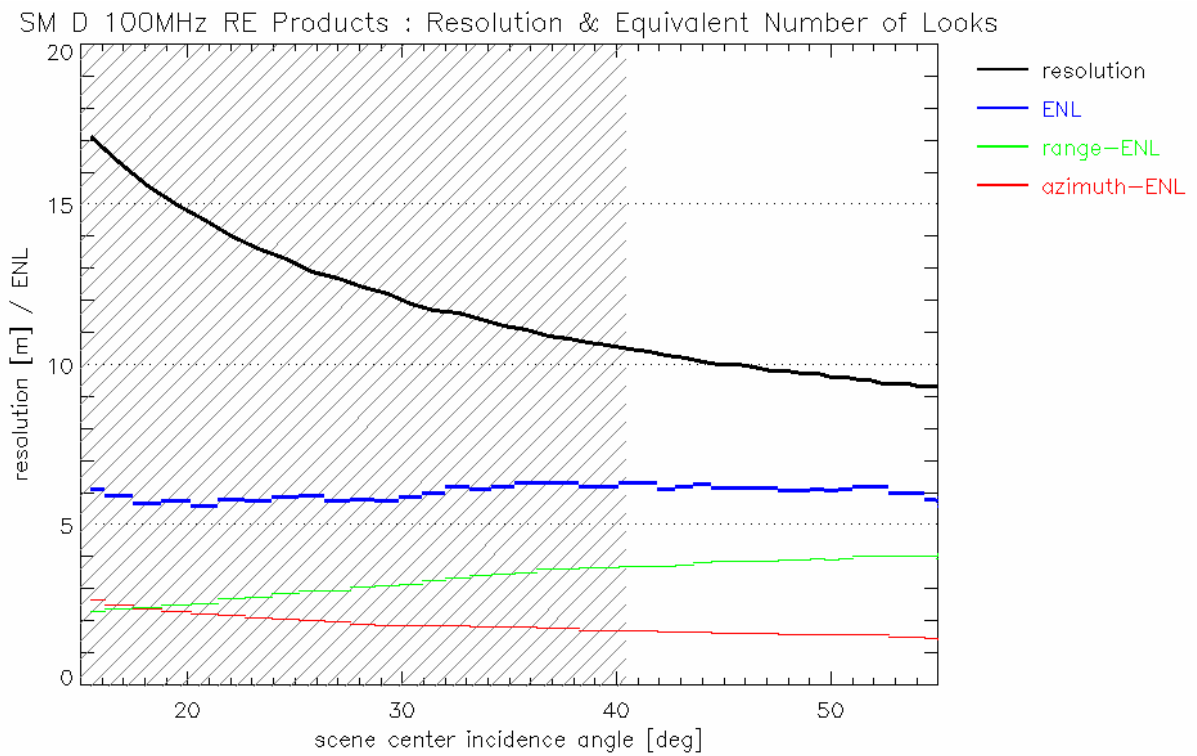

Fig. 5: Stripmap dual polarization RE product variant for 100 MHz range bandwidth.

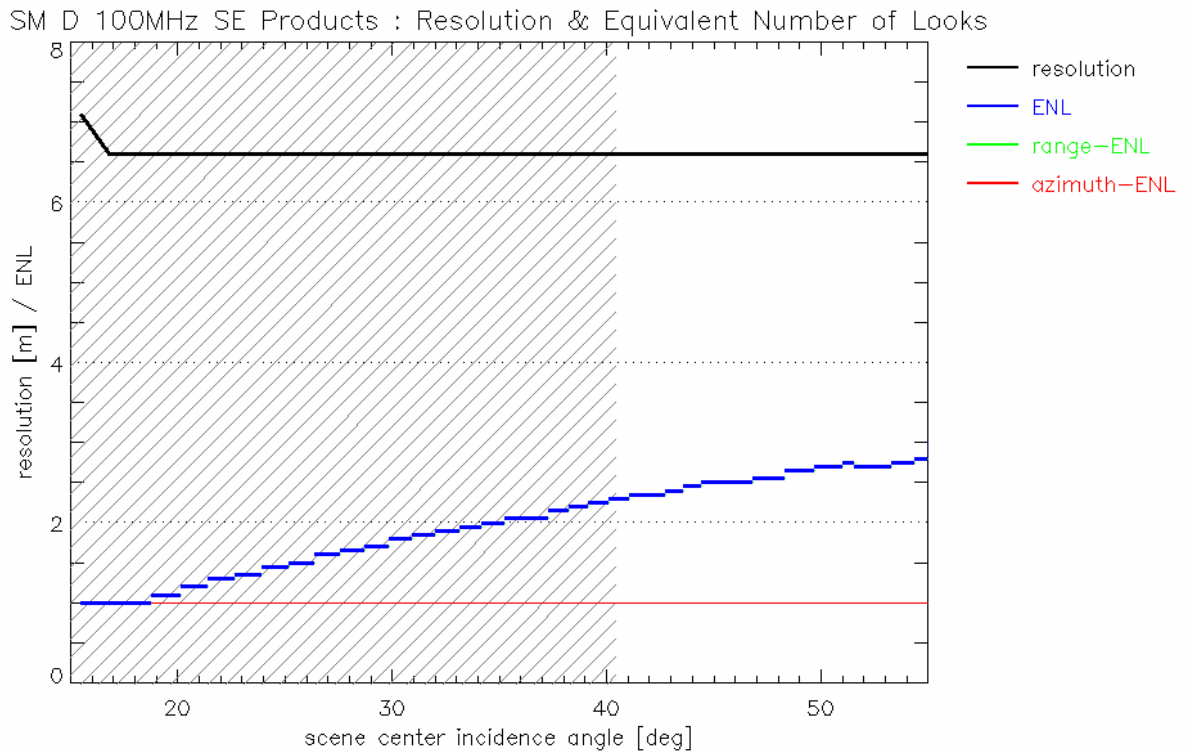

Fig. 6: Stripmap dual polarization SE product variant for 100 MHz range bandwidth.

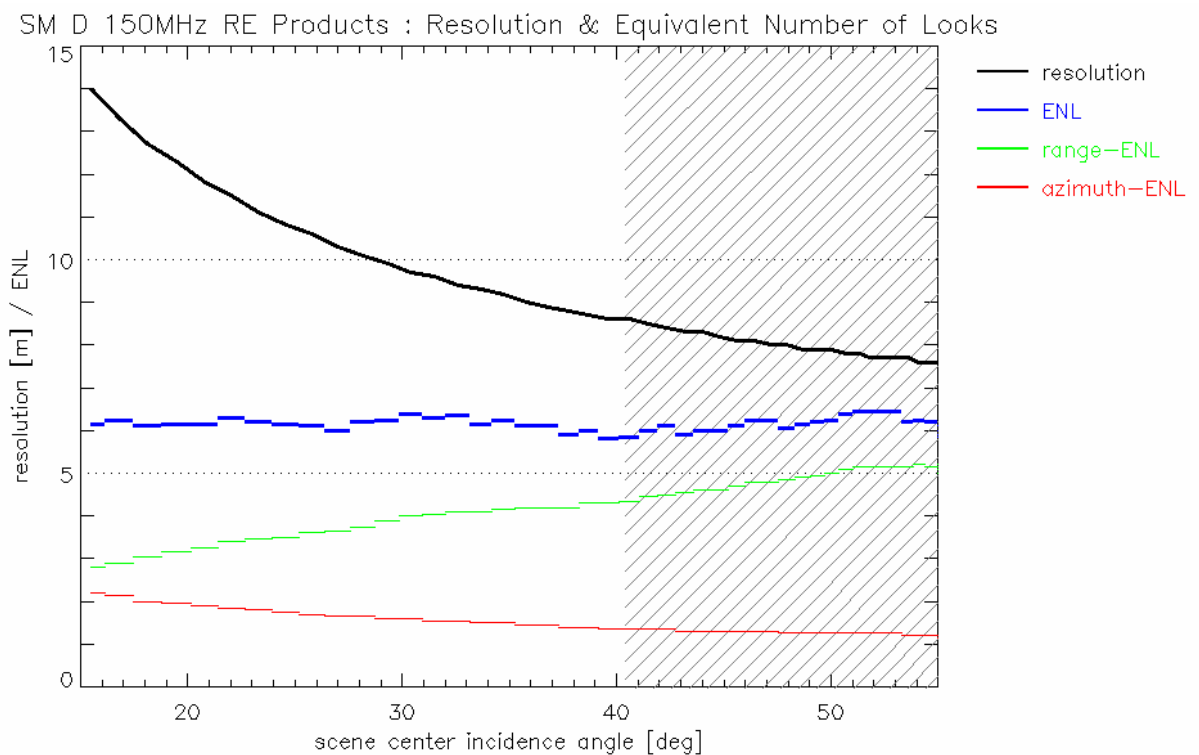

Fig. 7: Stripmap dual polarization RE product variant for 150 MHz range bandwidth.

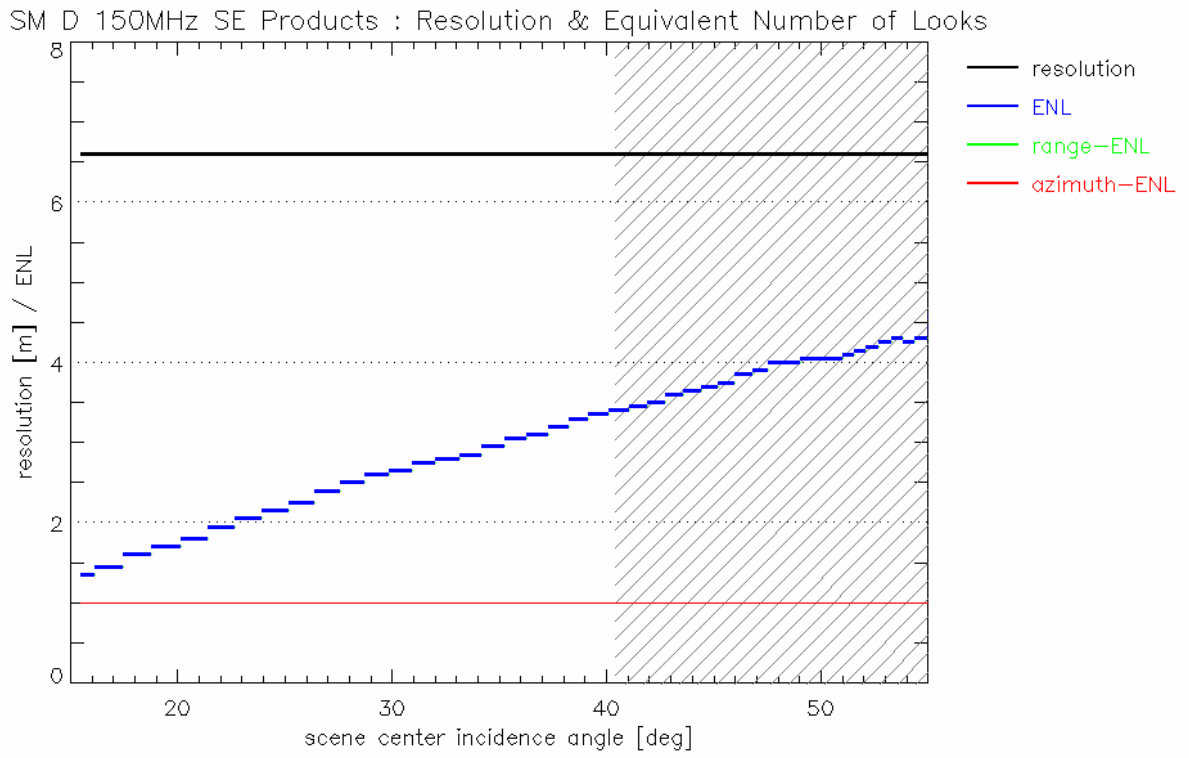

Fig. 8: Stripmap dual polarization SE product variant for 150 MHz range bandwidth.

## ScanSAR Products

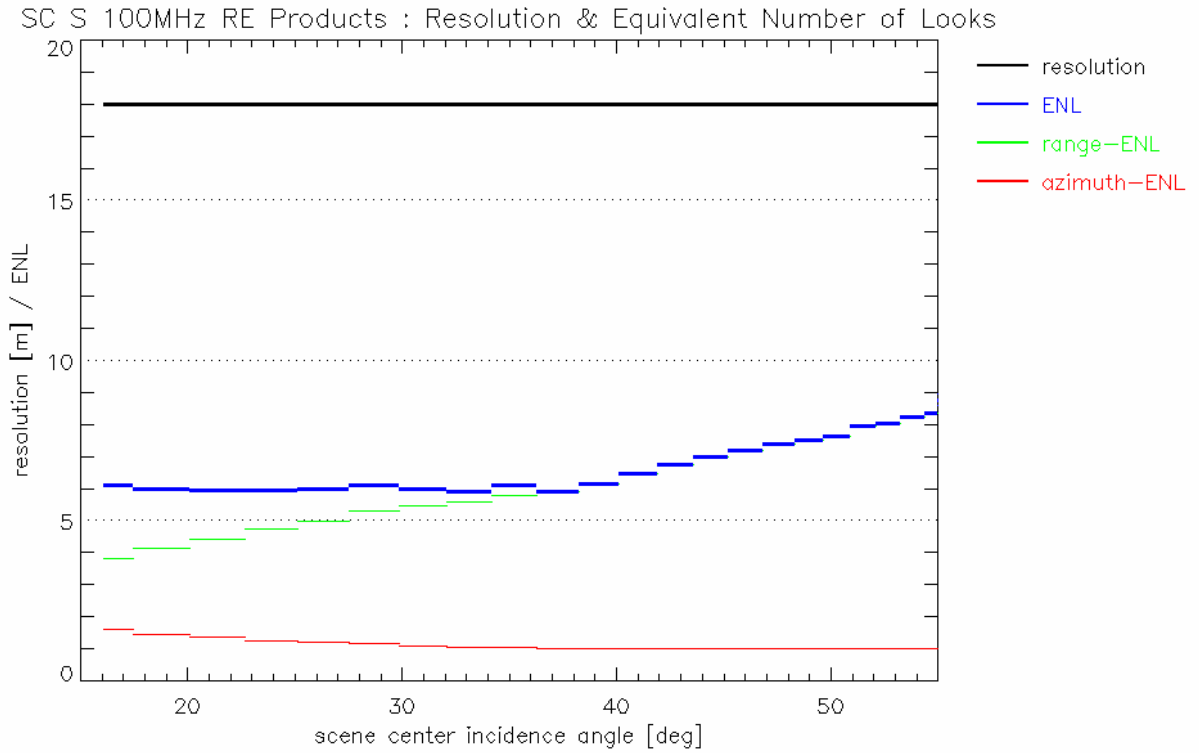

Fig. 9: ScanSAR single polarization RE product variant for 100 MHz range bandwidth.

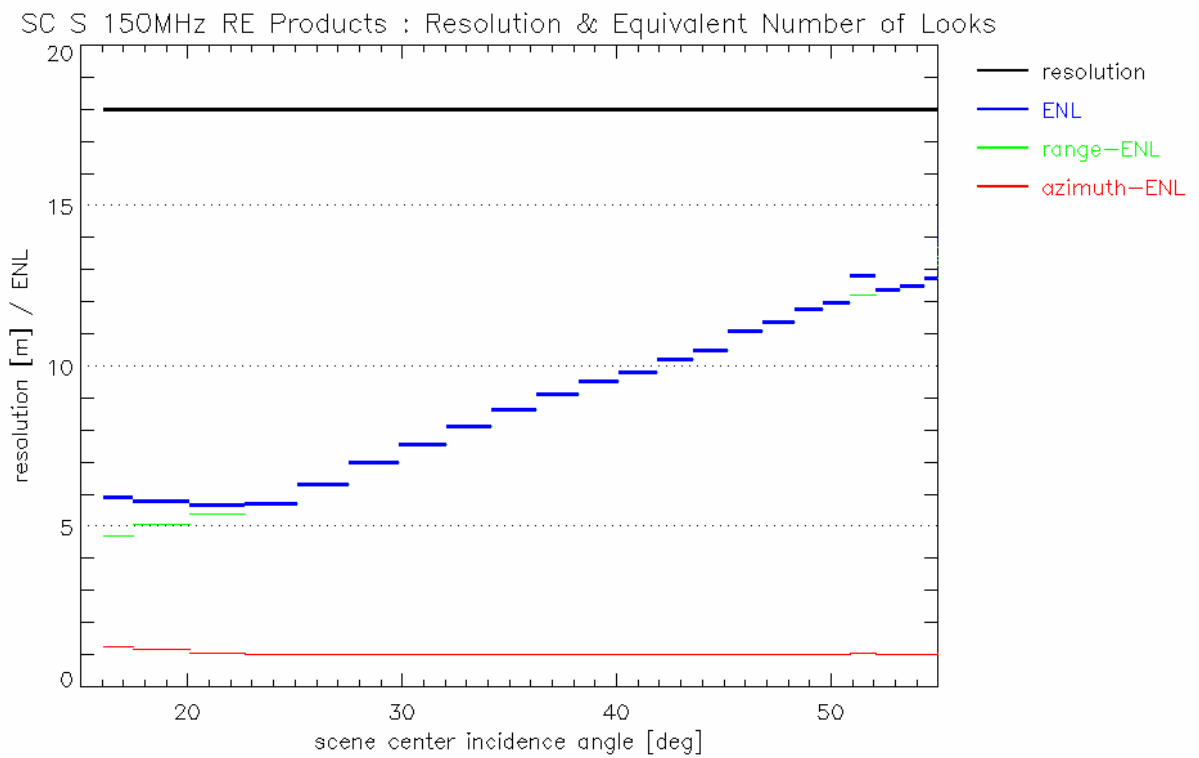

Fig. 10: ScanSAR single polarization RE product variant for 150 MHz range bandwidth.

## Spotlight Products

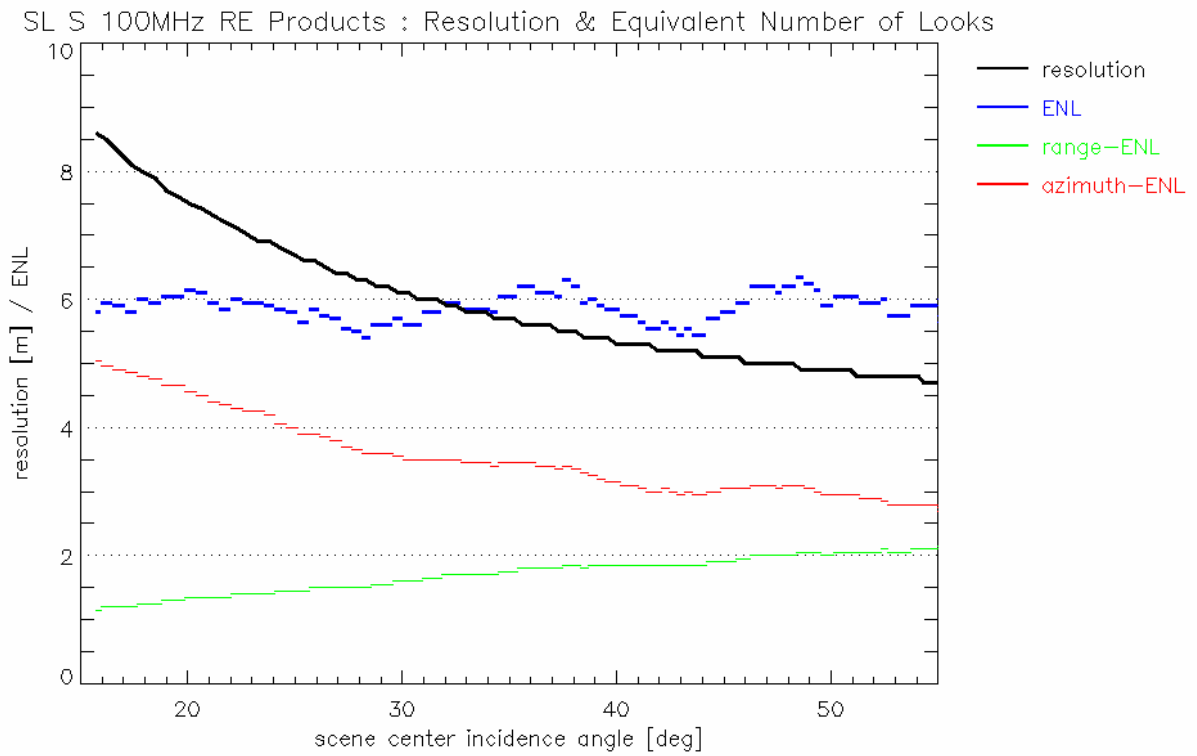

Fig. 11: Spotlight single polarization RE product variant for 100 MHz range bandwidth.

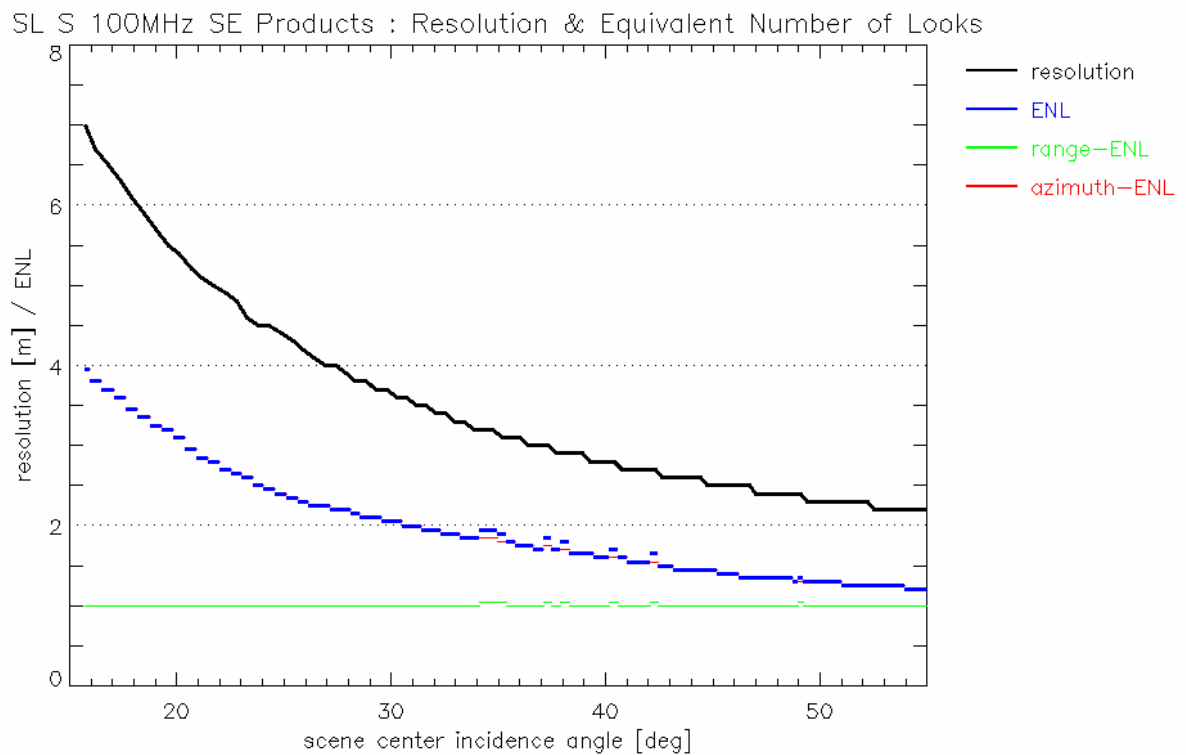

Fig. 12: Spotlight single polarization SE product variant for 100 MHz range bandwidth.

SL S 150MHz RE Products : Resolution & Equivalent Number of Looks

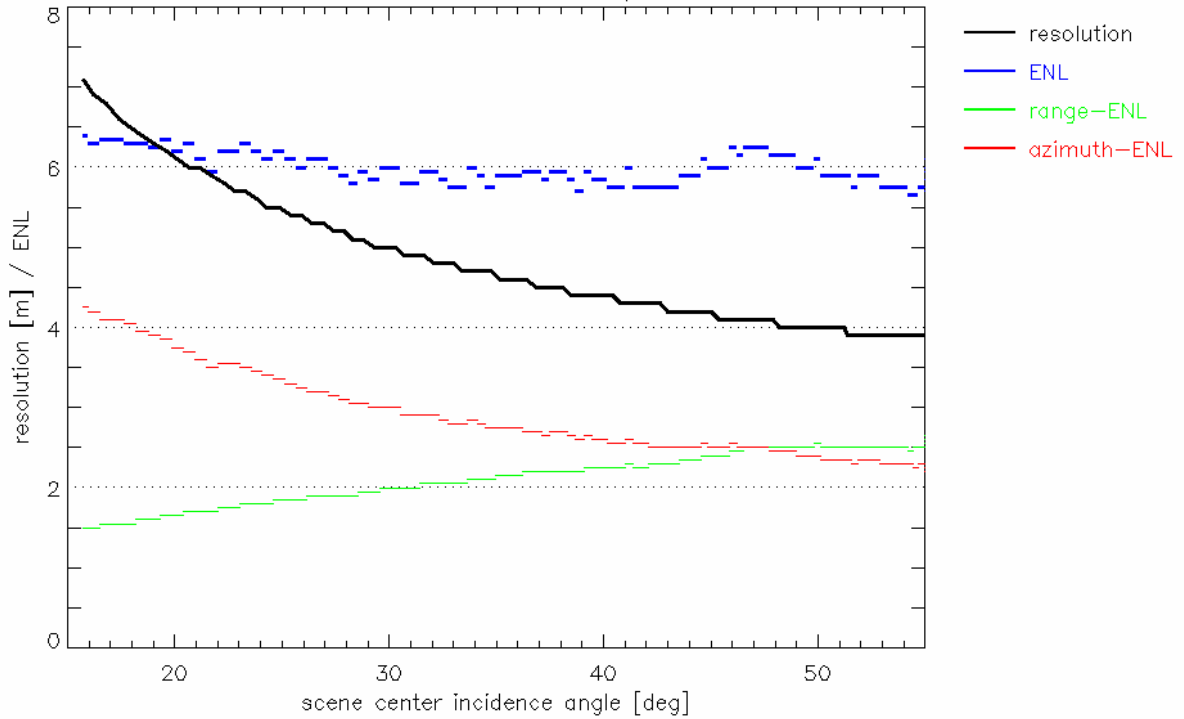

Fig. 13: Spotlight single polarization RE product variant for 150 MHz range bandwidth.

SL S 150MHz SE Products : Resolution & Equivalent Number of Looks

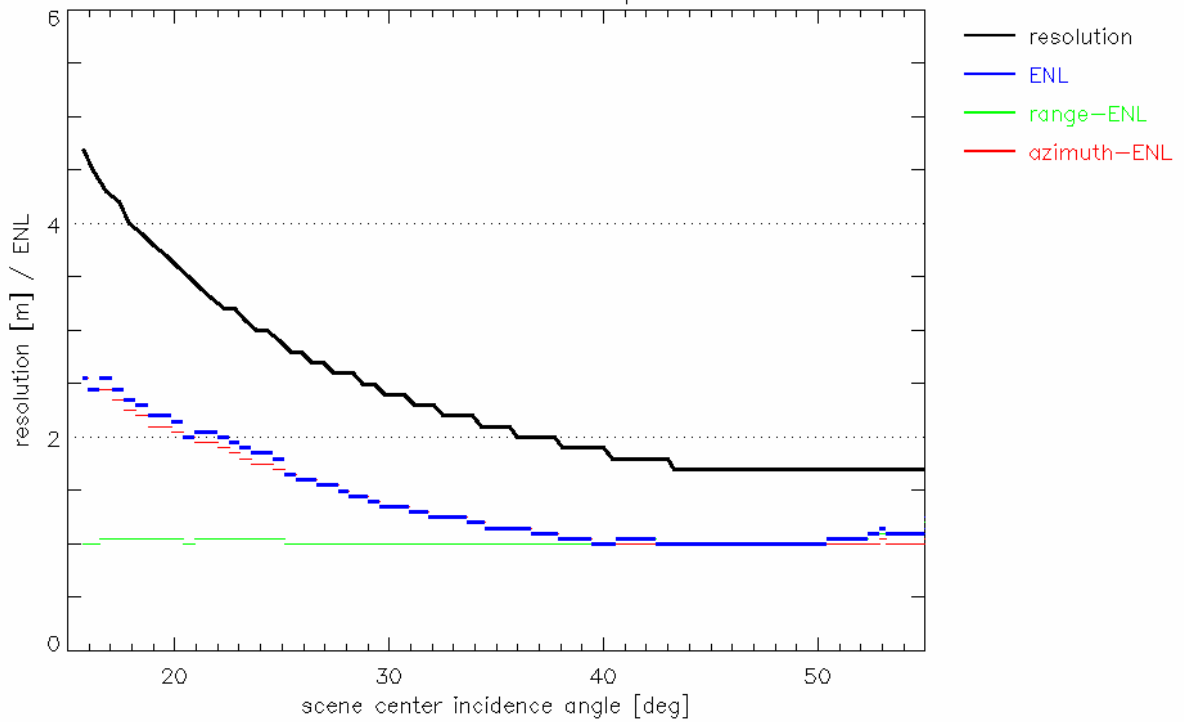

Fig. 14: Spotlight single polarization SE product variant for 150 MHz range bandwidth.

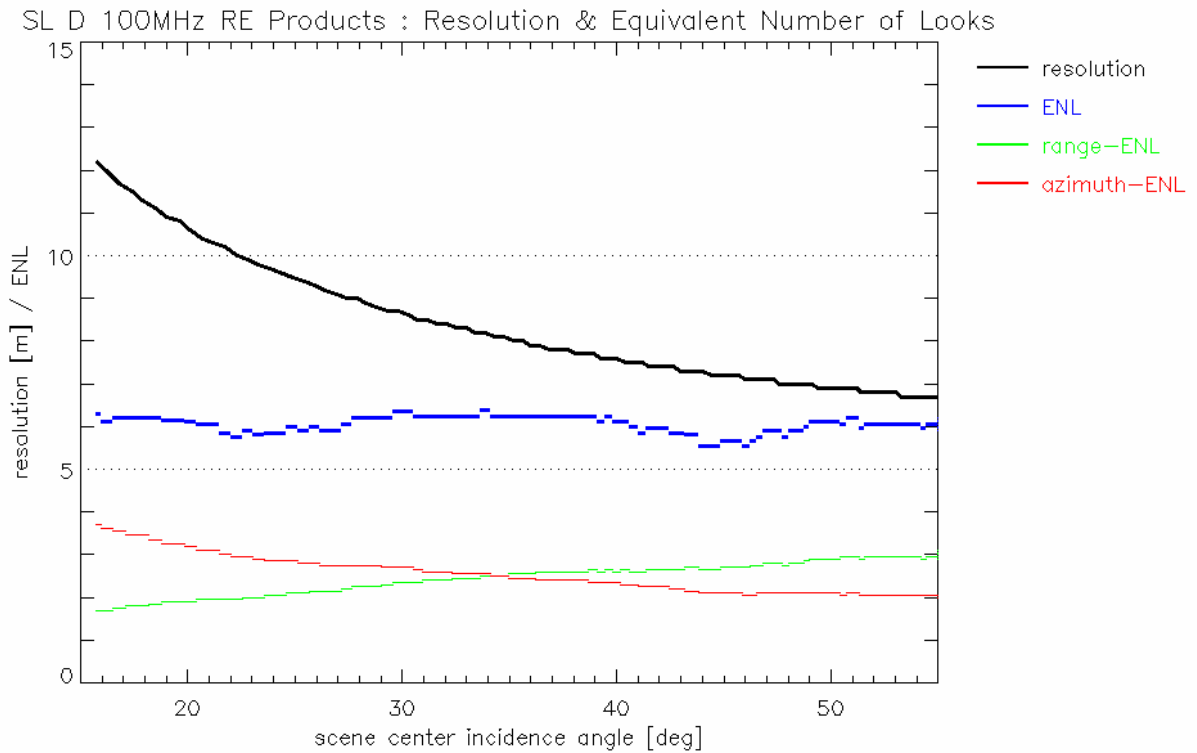

Fig. 15: Spotlight dual polarization RE product variant for 100 MHz range bandwidth.

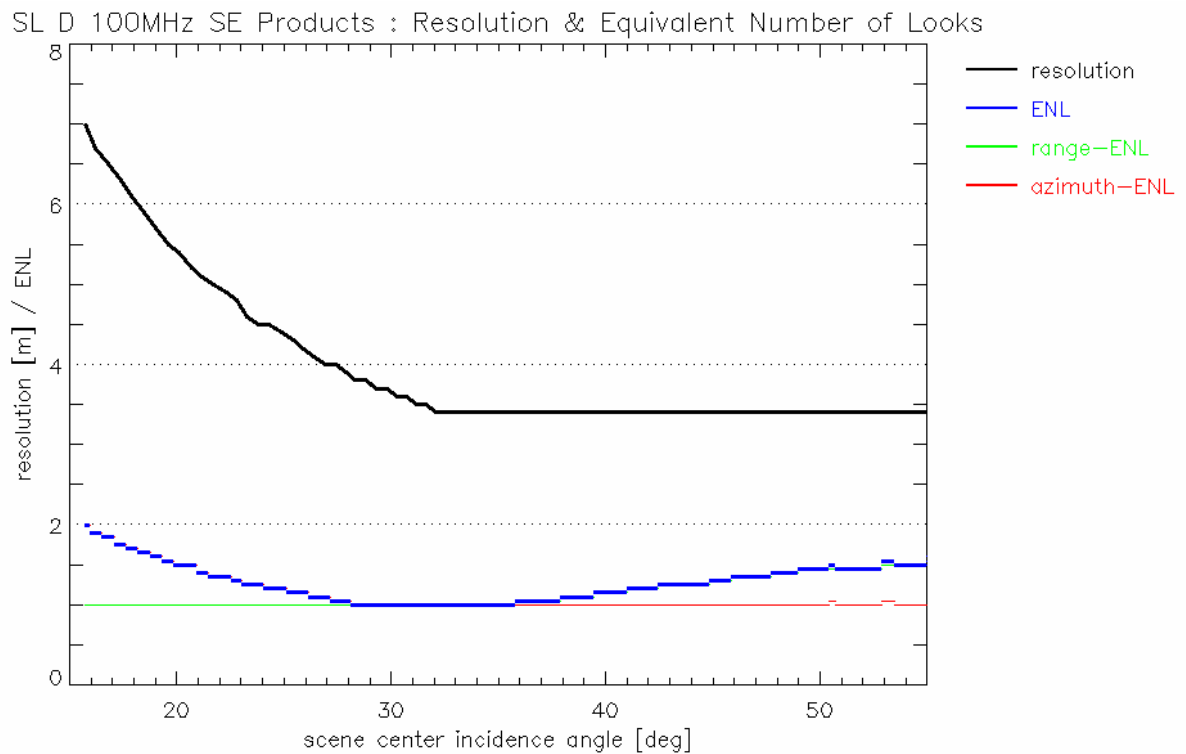

Fig. 16: Spotlight dual polarization SE product variant for 100 MHz range bandwidth.

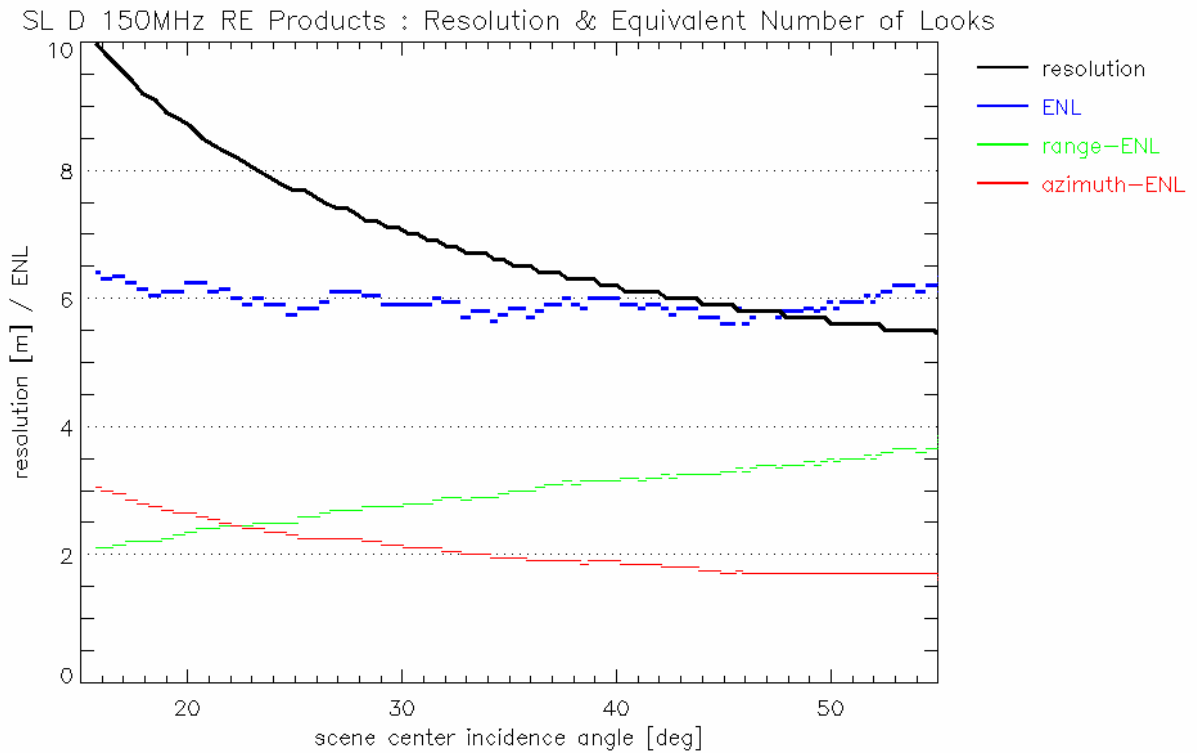

Fig. 17: Spotlight dual polarization RE product variant for 150 MHz range bandwidth.

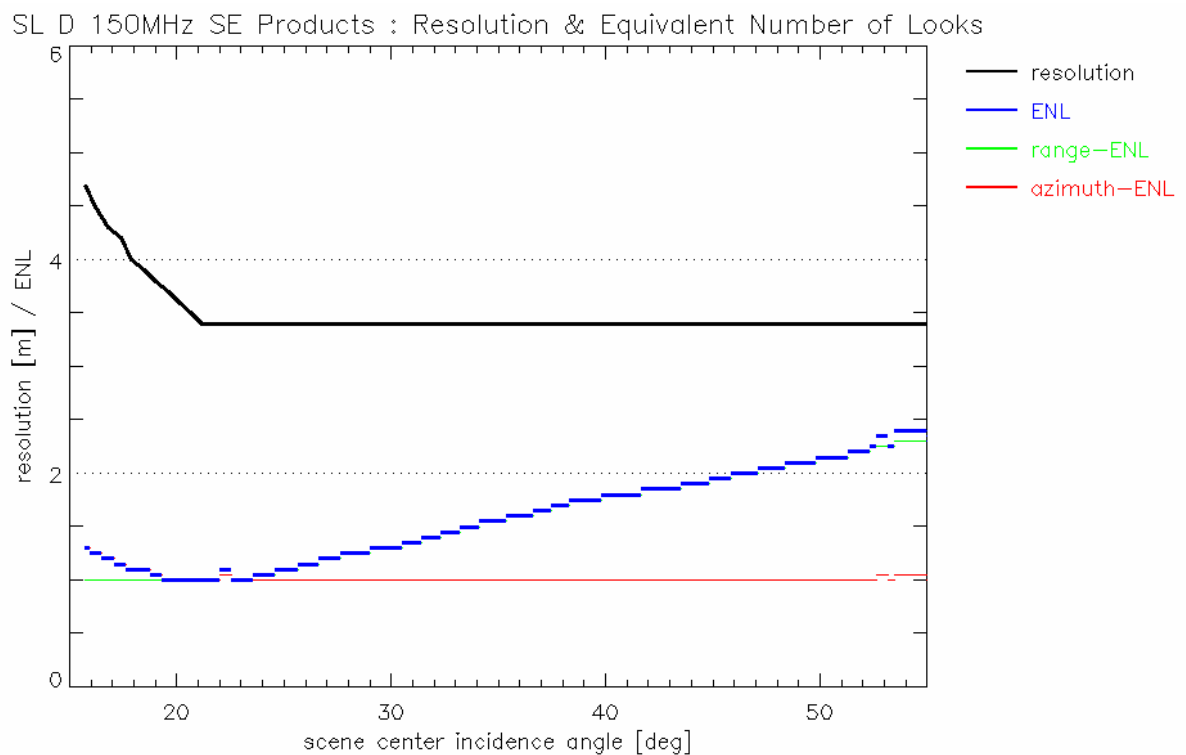

Fig. 18: Spotlight dual polarization SE product variant for 150 MHz range bandwidth.



## High-resolution Spotlight Products

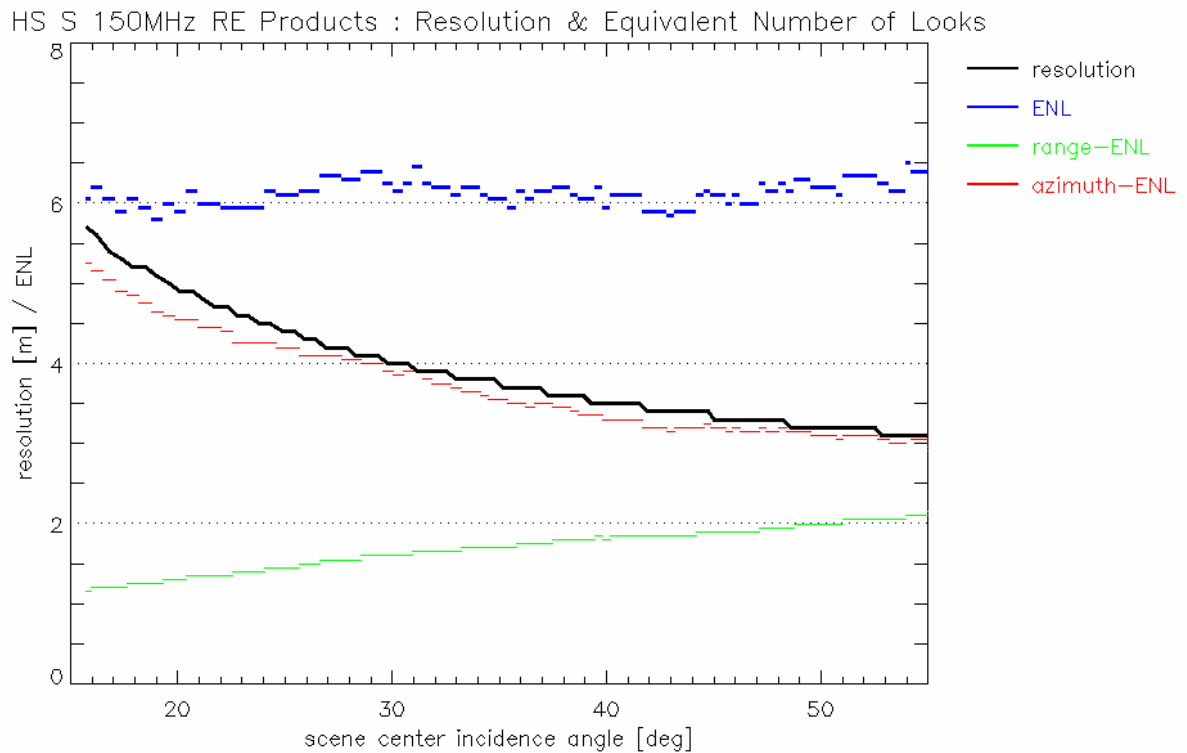

Fig. 19: High-resolution Spotlight single polarization RE product variant for 150 MHz range bandwidth.

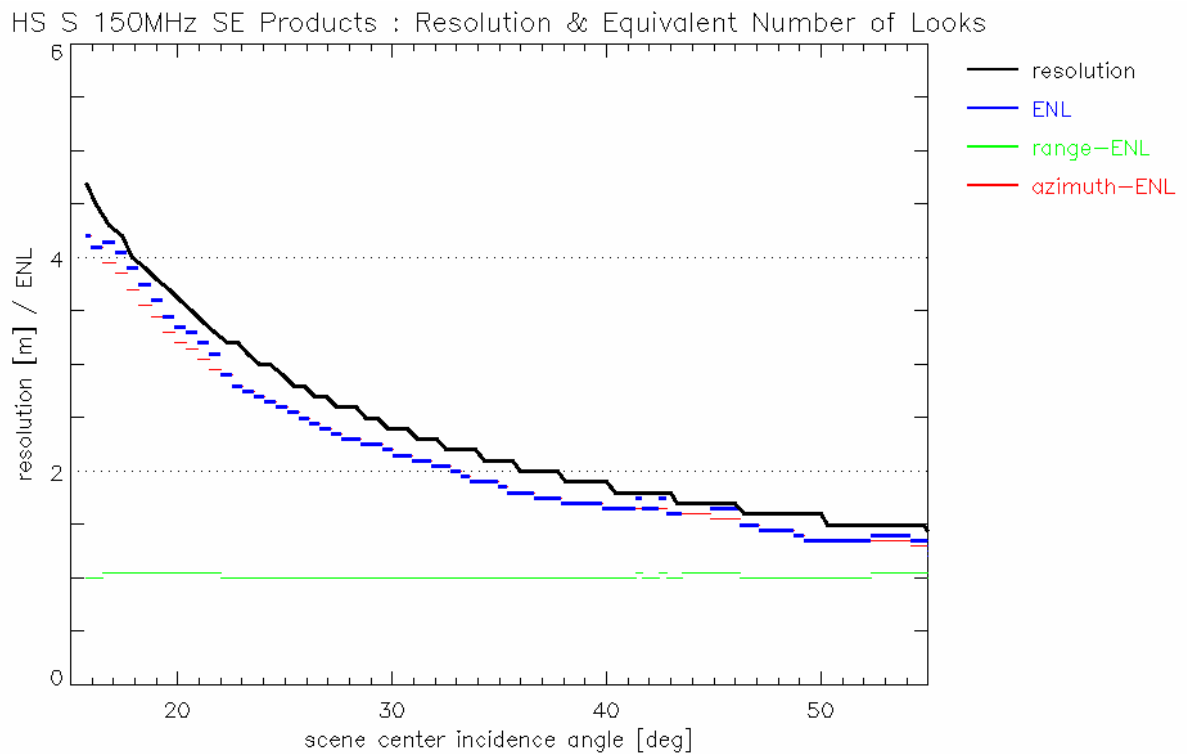

Fig. 20: High-resolution Spotlight single polarization SE product variant for 150 MHz range bandwidth.

HS D 150MHz RE Products : Resolution & Equivalent Number of Looks

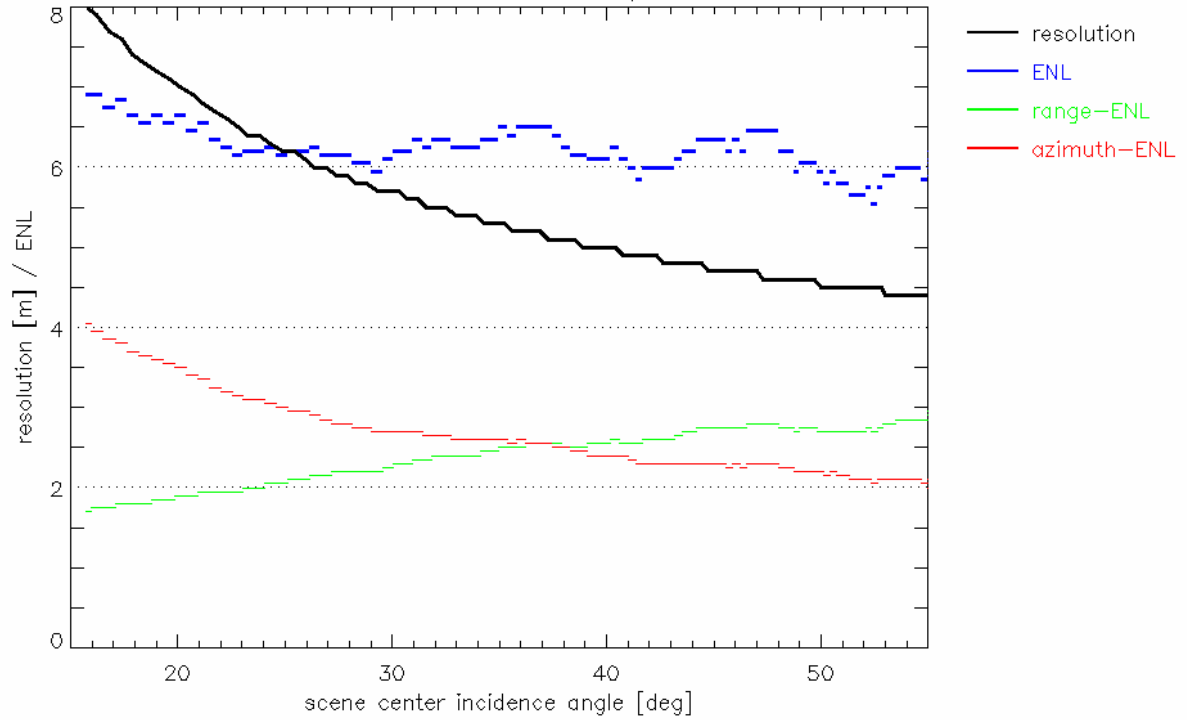

Fig. 21: High-resolution Spotlight dual polarization RE product variant for 150 MHz range bandwidth.

HS D 150MHz SE Products : Resolution & Equivalent Number of Looks

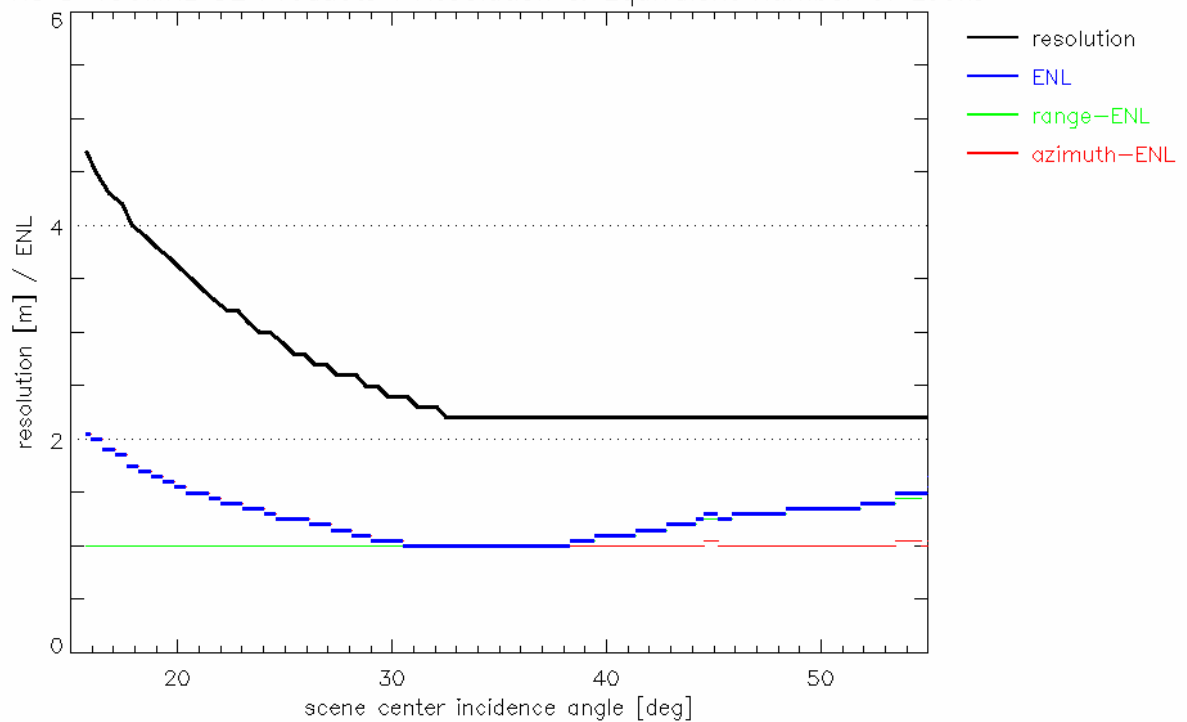

Fig. 22: High-resolution Spotlight dual polarization SE product variant for 150 MHz range bandwidth.

HS S 300MHz RE Products : Resolution & Equivalent Number of Looks

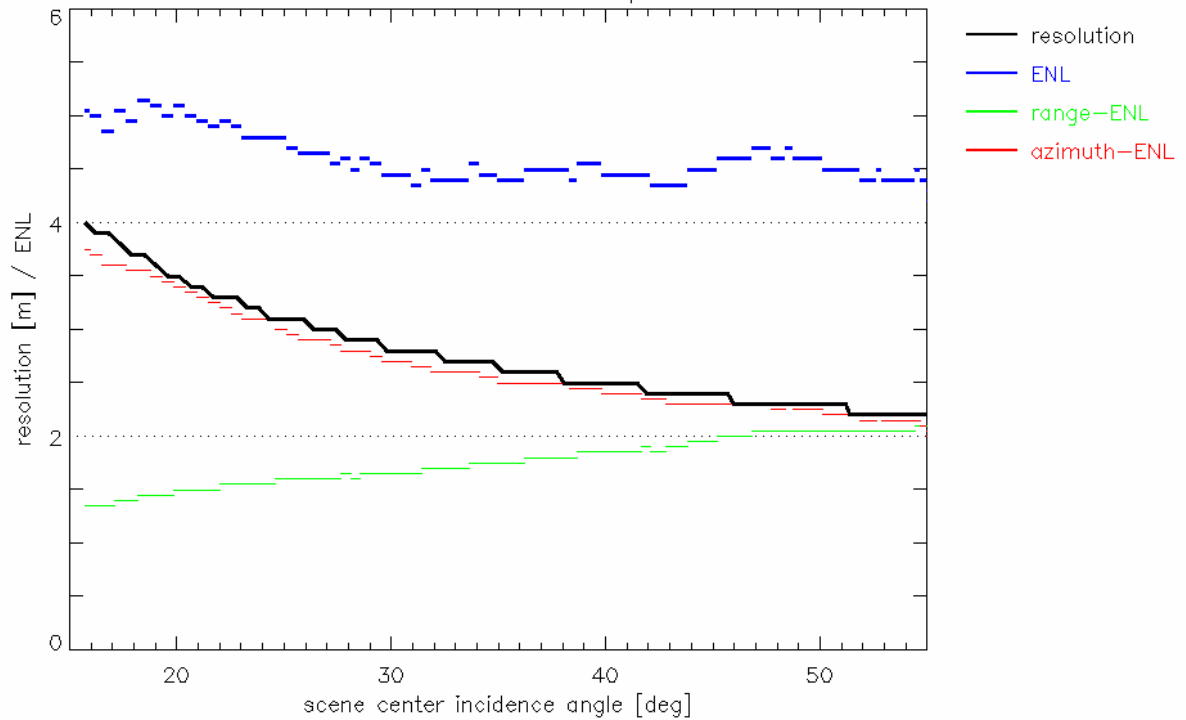

Fig. 23: High-resolution Spotlight single polarization RE product variant for 300 MHz range bandwidth (note that this mode reduces the range extent of the scenes).

HS S 300MHz SE Products : Resolution & Equivalent Number of Looks

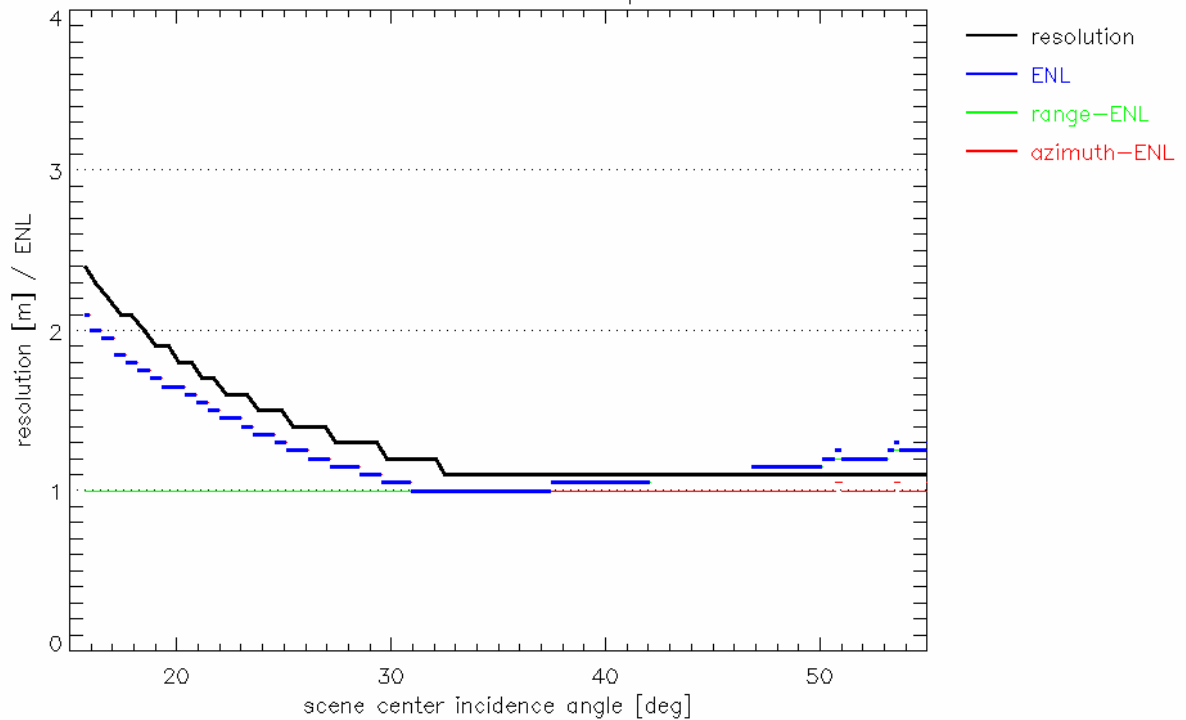

Fig. 24: High-resolution Spotlight single polarization SE product variant for 300 MHz range bandwidth (note that this mode reduces the range extent of the scenes).

## ANNEX C) SAR Performance Details and Parameters

In this Annex some explanations and details of the major SAR system performance parameters are provided based on [RD 9] and [RD 10]. These are the basis for most of the product performance parameters. **Note however that the values given here do not directly translate into the specified product characteristics since the latter take also into account the accuracy of auxiliary data (e.g. orbit products) and processing approximations.** Also some background information on the selection of specific instrument modes is given.

### Polarization Channel Combinations

There are 12 principal combinations for dual polarization combinations. 6 combinations do not provide new polarization information, e.g. HH-VV and VV-HH. From the remaining 6 combinations 3 provide only small additional information, e.g. HH-HV and HH-VH.

There are 4 basic products with dual polarization, 3 for Stripmap and 1 for Spotlight/HighRes. As the performance for dual polarization far beams is considerably dominated by range ambiguities, the selection of the 3 stripmap dual polarization combination was driven by the range ambiguity performance. The following combinations are basic products:

- HH-VV
- VV-VH
- HH-HV

For Spotlight/HighRes only the co-pol combination HH-VV is a basic product.

### Improvement of Radiometric Accuracy

The product specification has been updated with improved values for absolute and relative radiometric accuracy of Stripmap products.

ScanSAR radiometry is more complex due to the combination of beams and bursts in this mode but turned out to be of similar accuracy.

The absolute/relative radiometric accuracy is valid for rain rates below 5mm/h and Medium Drop Size.

### TX-RX Bandwidth in Stripmap and ScanSAR Modes

Due to the hardware design of the TS-X instrument, 150 MHz Rx-bandwidth is not possible for all Stripmap beams. Depending on the PRF and the incidence angle, the bandwidth is set to 100 MHz for far range beams. The commanding is optimized to always use 150 MHz when possible for optimum radiometric resolution. Since there is no pre-defined fixed beam, the following plot shows the SSC ground range resolution for both frequencies. The overlapping beams are strip\_010 to strip\_014, i.e. 36° and 45° incidence angle as shown in the figure below. The red line is for 150 MHz and the white line for 100 MHz.

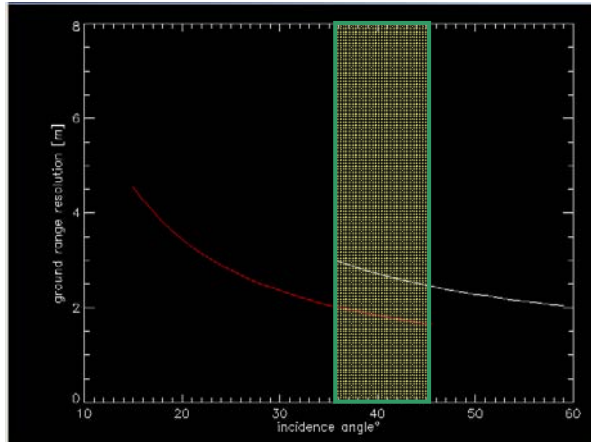

The probability of 100 MHz data taking in full performance beams was estimated based on 2024 basic stripmap DTs acquired until December 2007. The result is shown in the table below.

	#1 00 MHz	# total	% with 100 MHz
strip003	0	296	0.0
strip004	0	81	0.0
strip005	0	65	0.0
strip006	0	287	0.0
strip007	3	132	2.3
strip008	2	59	3.4
strip009	8	136	5.9
strip010	21	304	6.9
strip011	163	163	100.0
strip012	65	65	100.0
strip013	130	147	88.4
strip014	289	289	100.0

2024

total # 100 MHz (strip003-009)	13	1.2%
total # (strip 003-009)	1056	

DTs with 100 MHz acquired in the beams strip003 to strip009 can not fulfill the geometric resolution requirement of SSC 3.3m. From the above it can be derived, that the probability of 100 MHz DTs in beams strip003 to strip009 due to difficult terrain and timing reasons is 1.2%.

Also for the SL/HS modes there is a non-vanishing probability that in extreme conditions the fallback of 100 MHz might be selected to guarantee the swath coverage and adequate timing settings.

For Stripmap dual pol the SSC requirement is 6.6m and thus there is no special reporting on 100 MHz DTs for stripNear of stripFar beams lower than 10. However, analysis of 769 Dual-Pol stripmap DTs carried out that only 1 DT in strip\_009 was commanded with 100 MHz.

The change in NESZ to be applied for conversion from 100 MHz to 150 MHz data acquisition is as follows:

$$nesz_{100MHz} = nesz_{150MHz} - 1.76091[dB]$$

The corresponding change in radiometric resolution depends on the SNR and the number of looks and is shown in the next figure:

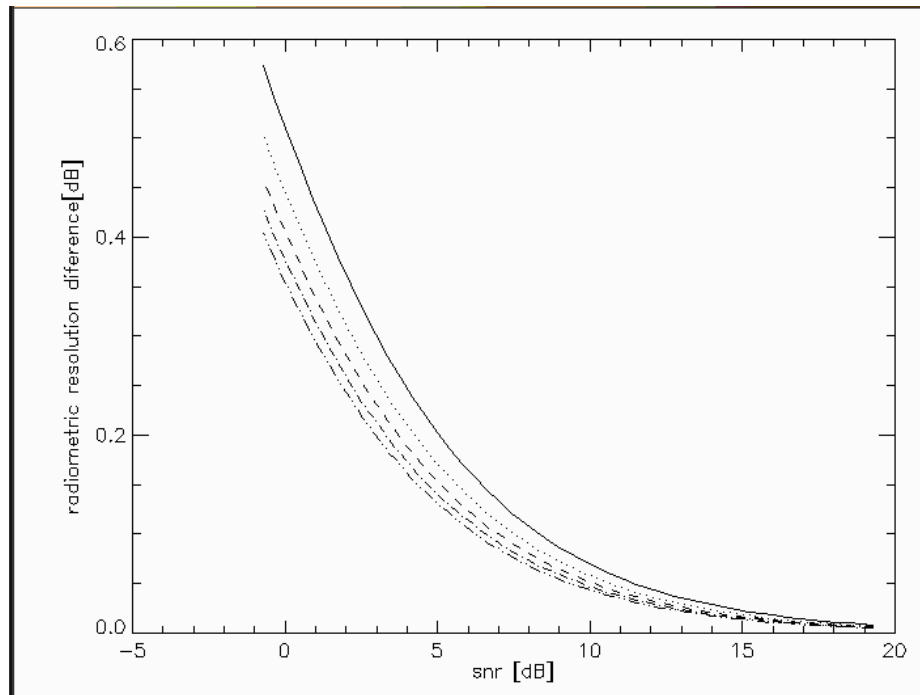

The different lines show the difference in radiometric resolution for SSC for different number of looks, i.e. the continuous line is for 1 look and the lines in direction to the x-axis are for 2,3,4 and 5 looks.

### Comment to Radiometric Resolution

There are differences between the theoretical radiometric resolution and the radiometric resolution measured for dedicated scenes. The theoretical value in the product spec is calculated for a certain reference SNR, i.e. reference sigma0 model.

The radiometric resolution depends on the SNR and number of looks  $N_L$  according to the following expression:

$$\gamma = 10 \cdot \log \left( 1 + \frac{1 + SNR^{-1}}{\sqrt{N_L}} \right)$$

Therefore, the measured values of the radiometric resolution strongly depend on the SNR of the selected area. Curves showing the dependency of the radiometric resolution on the SNR and number of looks are reported in the following figure:

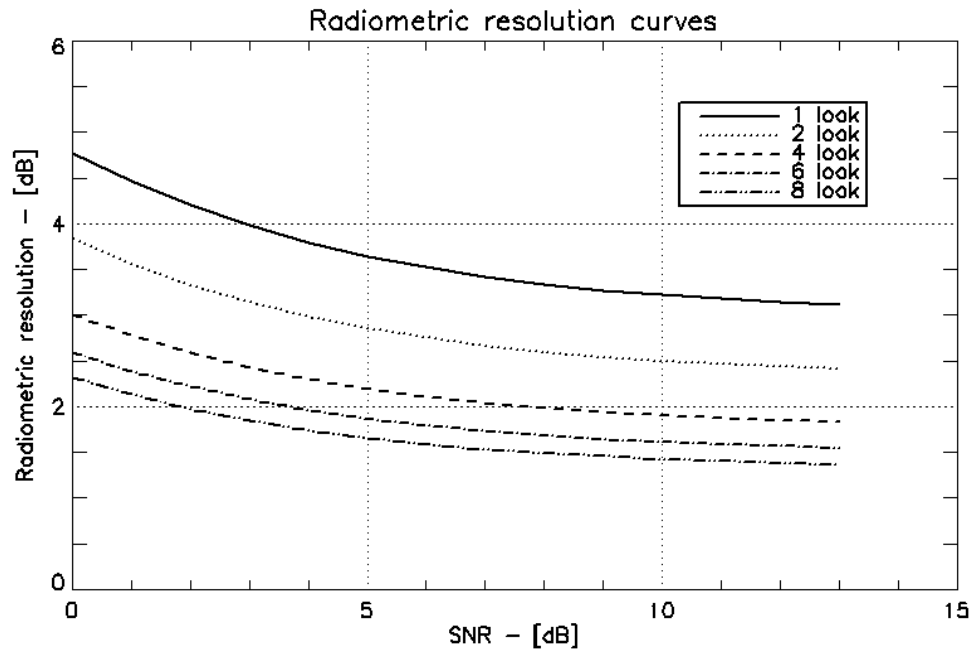

### NESZ Calculation and BAQ

The NESZ performance plots in this document are calculated with a raw data compression with a BAQ of 8:8 to allow a fully sigma0 free representation of the NESZ. In any estimation of NESZ degradation due to BAQ there has to be made an assumption in the SNR, i.e. the sigma0 of a scene.

The influence of different BAQ settings on the radiometric resolution is shown in the next figure as a function of SNR. It is less than 0.4 dB for the SSC case which is similar to the specially enhanced products. In radiometrically enhanced products, where the number of looks is high, the variation in radiometric resolution can be neglected.

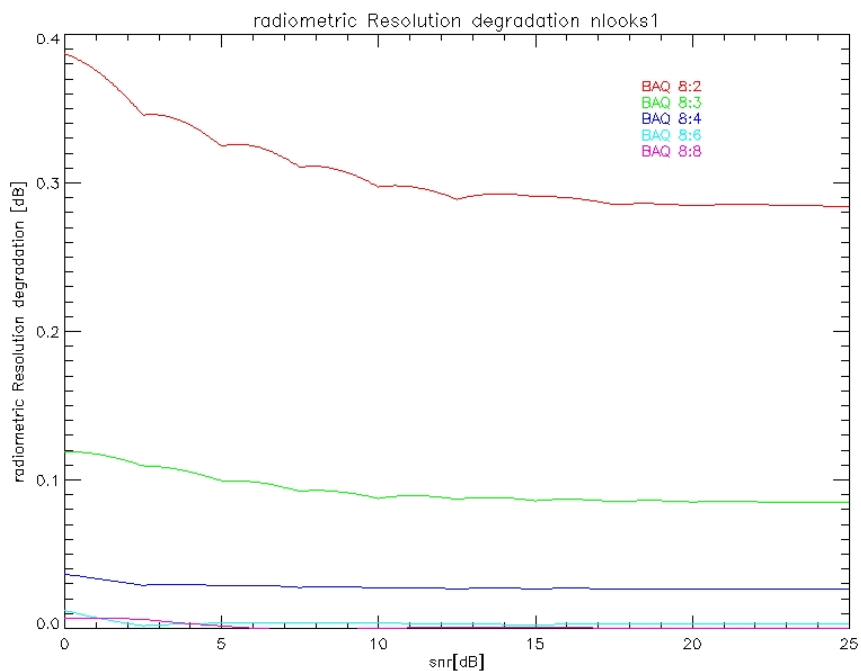



## **Stripmap and Spotlight Elevation Beam Definition**

The following tables show the Stripmap and spotlight elevation beam definition. The Stripmap table also includes the stripmap\_near and stripmap\_far beams. This pre-launch definition has not been changed during the commissioning phase.





Public

Elevation Beam Identification	Angle Range	Minimum Incidence Angle [°]	Maximum Incidence Angle [°]	Minimum Look Angle [°]	Maximum Look Angle [°]	Ground Swath Width [km]	Ground Swath Overlapp to following swath [km]
strip_001	data collection	14.338	17.906	13.254	16.538	31.589	7.597
stripNear_001	data collection	14.510	16.396	13.413	15.149	16.594	4.598
stripFar_001	data collection	15.876	17.739	14.671	16.385	16.594	4.598
strip_002	data collection	17.058	20.535	15.759	18.952	31.589	7.597
stripNear_002	data collection	17.226	19.065	15.913	17.603	16.594	4.598
stripFar_002	data collection	18.559	20.373	17.139	18.803	16.594	4.598
strip_003	full performance	19.710	23.086	18.196	21.288	31.589	7.597
stripNear_003	full performance	19.874	21.661	18.345	19.984	16.594	4.598
stripFar_003	full performance	21.169	22.929	19.534	21.145	16.594	4.598
strip_004	full performance	22.287	25.556	20.557	23.543	31.589	7.597
stripNear_004	full performance	22.445	24.177	20.702	22.285	16.594	4.598
stripFar_004	full performance	23.701	25.404	21.850	23.404	16.594	4.598
strip_005	full performance	24.783	27.941	22.838	25.711	31.589	7.597
stripNear_005	full performance	24.937	26.610	22.978	24.502	16.594	4.598
stripFar_005	full performance	26.151	27.794	24.084	25.578	16.594	4.598
strip_006	full performance	27.195	30.237	25.034	27.792	31.589	7.597
stripNear_006	full performance	27.343	28.956	25.168	26.633	16.594	4.598
stripFar_006	full performance	28.513	30.096	26.231	27.665	16.594	4.598
strip_007	full performance	29.520	32.445	27.143	29.785	31.588	7.597
stripNear_007	full performance	29.662	31.214	27.272	28.675	16.594	4.598
stripFar_007	full performance	30.788	32.310	28.290	29.663	16.594	4.598
strip_008	full performance	31.756	34.564	29.164	31.688	31.588	7.597
stripNear_008	full performance	31.892	33.383	29.287	30.628	16.594	4.598
stripFar_008	full performance	32.974	34.434	30.261	31.572	16.594	4.598
strip_009	full performance	33.903	36.595	31.095	33.504	31.588	7.597
stripNear_009	full performance	34.034	35.463	31.213	32.493	16.594	4.598
stripFar_009	full performance	35.072	36.471	32.143	33.393	16.594	4.598
strip_010	full performance	35.961	38.540	32.938	35.233	31.588	7.597
stripNear_010	full performance	36.087	37.457	33.051	34.271	16.594	4.598
stripFar_010	full performance	37.081	38.421	33.937	35.128	16.594	4.598
strip_011	full performance	37.933	40.401	34.695	36.878	31.588	7.597
stripNear_011	full performance	38.054	39.364	34.802	35.963	16.594	4.598
stripFar_011	full performance	39.005	40.287	35.645	36.778	16.594	4.598
strip_012	full performance	39.821	42.180	36.366	38.442	31.588	7.597
stripNear_012	full performance	39.936	41.189	36.468	37.572	16.594	4.598
stripFar_012	full performance	40.846	42.071	37.270	38.347	16.594	4.598
strip_013	full performance	41.625	43.881	37.956	39.927	31.588	7.597
stripNear_013	full performance	41.735	42.933	38.052	39.101	16.594	4.598
stripFar_013	full performance	42.605	43.777	38.814	39.836	16.594	4.598
strip_014	full performance	43.350	45.506	39.465	41.337	31.588	6.797
stripNear_014	full performance	43.456	44.601	39.557	40.553	16.594	4.598
stripFar_014	full performance	44.287	45.406	40.280	41.251	16.594	3.799
strip_015	data collection	45.053	47.008	40.945	42.630	29.989	5.998
stripNear_015	data collection	45.153	46.142	41.032	41.886	14.994	2.999
stripFar_015	data collection	45.946	46.913	41.717	42.549	14.994	2.999
strip_016	data collection	46.626	48.494	42.302	43.901	29.989	5.998
stripNear_016	data collection	46.722	47.666	42.385	43.195	14.994	2.999
stripFar_016	data collection	47.480	48.403	43.035	43.824	14.994	2.999
strip_017	data collection	48.129	49.915	43.590	45.106	29.989	5.998
stripNear_017	data collection	48.221	49.123	43.668	44.436	14.994	2.999
stripFar_017	data collection	48.945	49.828	44.285	45.033	14.994	3.149
strip_018	data collection	49.565	51.106	44.811	46.109	26.990	5.398
stripNear_018	data collection	49.644	50.423	44.878	45.535	13.495	2.699
stripFar_018	data collection	50.268	51.031	45.405	46.046	13.495	2.699
strip_019	data collection	50.804	52.285	45.856	47.094	26.990	5.398
stripNear_019	data collection	50.880	51.628	45.919	46.546	13.495	2.699
stripFar_019	data collection	51.480	52.212	46.422	47.033	13.495	2.699
strip_020	data collection	51.994	53.417	46.852	48.032	26.990	5.398
stripNear_020	data collection	52.067	52.786	46.913	47.510	13.495	2.699
stripFar_020	data collection	52.643	53.348	47.392	47.975	13.495	2.699
strip_021	data collection	53.138	54.506	47.802	48.927	26.990	5.398
stripNear_021	data collection	53.208	53.899	47.859	48.429	13.495	2.699
stripFar_021	data collection	53.762	54.439	48.316	48.872	13.495	2.699
strip_022	data collection	54.238	55.553	48.707	49.780	26.990	5.398
stripNear_022	data collection	54.305	54.969	48.762	49.305	13.495	2.699
stripFar_022	data collection	54.837	55.489	49.198	49.728	13.495	2.699



Public

strip_023	data collection	55.295	55.360	55.999	56.561	49.623	49.570	50.141	50.594	13.495	26.990	2.699	5.398
stripNear_023	data collection	55.360	55.999	56.561	49.623	49.570	50.141	50.594	13.495	26.990	2.699	5.398	
stripFar_023	data collection	55.872	56.499	50.038	50.544	13.495	2.699						
strip_024	data collection	56.312	56.375	56.990	57.531	50.394	50.444	50.938	51.370	13.495	26.990	2.699	5.398
stripNear_024	data collection	56.375	56.990	57.531	50.394	50.444	50.938	51.370	13.495	26.990	2.699	5.398	
stripFar_024	data collection	56.868	57.472	50.840	51.323	13.495	2.699						
strip_025	data collection	57.292	57.352	57.944	58.466	51.179	51.227	51.698	52.111	13.495	26.990	2.699	5.398
stripNear_025	data collection	57.352	57.944	58.466	51.179	51.227	51.698	52.111	13.495	26.990	2.699	5.398	
stripFar_025	data collection	57.827	58.408	51.605	52.065	13.495	2.699						
strip_026	data collection	58.235	58.293	58.864	59.367	51.929	51.974	52.424	52.818	13.495	26.990	2.699	5.398
stripNear_026	data collection	58.293	58.864	59.367	51.929	51.974	52.424	52.818	13.495	26.990	2.699	5.398	
stripFar_026	data collection	58.751	59.311	52.335	52.774	13.495	2.699						
strip_027	data collection	59.145	59.200	59.751	60.236	52.644	52.688	53.117	53.493	13.495	26.990	2.699	0.000
stripNear_027	data collection	59.200	59.751	60.236	52.644	52.688	53.117	53.493	13.495	26.990	2.699	0.000	
stripFar_027	data collection	59.642	60.182	53.032	53.451	13.495	0.000						
<b>number of full performance swaths</b>		<b>12 stripNear Beam</b>		<b>12 stripFar Beam</b>									
<b>total number of swaths</b>		<b>27 stripNear Beam</b>		<b>27 stripFar Beam</b>									
minimum required ground range		15 km + 1.6 km Margin		15 km without margin for $\theta_{inc} > 45^\circ$ ,		13.5 km without margin for $\theta_{inc} > 50^\circ$							
swath width		=16.5 km											
minimum required ground swath overlap		3km +1.6 km Margin		3km without margin for $\theta_{inc} > 45^\circ$		2.7 km for $\theta_{inc} > 50^\circ$							
stripNear_001 Beam coverag region start to 15° of incidence angle in ground range:		4.287 km		(required 0.800 km)									
stripNear_003 Beam coverag region start to 20° of incidence angle in ground range:		1.163 km		(required 0.800 km)									
stripFar_014 Beam coverag region end to 45° of incidence angle in ground range:		6.083 km		(required 0.800 km)									
stripFar_027 Beam coverag region end to 60° of incidence angle in ground range:		4.583 km		(required 0.800 km)									

Table 1: Stripmap (and ScanSAR) beam specification.



Public

Elevation Beam Identification	Angle Range	Minimum Incidence Angle [°]	Maximum Incidence Angle [°]	Minimum Look Angle [°]	Maximum Look Angle [°]	Ground Swath Width [km]	Ground Swath Overlapp to next swath [km]
spot_001	data collection	14.677	16.684	13.567	15.414	17.694	12.695
spot_002	data collection	15.247	17.244	14.092	15.930	17.694	12.695
spot_003	data collection	15.815	17.801	14.615	16.442	17.694	12.695
spot_004	data collection	16.380	18.356	15.135	16.952	17.694	12.695
spot_005	data collection	16.942	18.907	15.652	17.458	17.694	12.695
spot_006	data collection	17.501	19.455	16.166	17.961	17.694	12.695
spot_007	data collection	18.057	20.000	16.677	18.461	17.694	12.695
spot_008	data collection	18.610	20.541	17.185	18.958	17.694	12.695
spot_009	data collection	19.159	21.079	17.690	19.451	17.694	12.695
spot_010	full performance	19.706	21.614	18.192	19.941	17.694	12.695
spot_011	full performance	20.249	22.145	18.690	20.427	17.694	12.695
spot_012	full performance	20.789	22.673	19.185	20.910	17.694	12.695
spot_013	full performance	21.326	23.197	19.677	21.390	17.694	12.695
spot_014	full performance	21.859	23.718	20.165	21.865	17.694	12.695
spot_015	full performance	22.389	24.235	20.650	22.338	17.694	12.695
spot_016	full performance	22.915	24.749	21.131	22.806	17.694	12.695
spot_017	full performance	23.437	25.258	21.609	23.271	17.694	12.695
spot_018	full performance	23.956	25.764	22.083	23.732	17.694	12.695
spot_019	full performance	24.472	26.267	22.554	24.190	17.694	12.695
spot_020	full performance	24.984	26.765	23.020	24.643	17.694	12.695
spot_021	full performance	25.492	27.260	23.484	25.093	17.694	12.695
spot_022	full performance	25.996	27.751	23.943	25.539	17.694	12.695
spot_023	full performance	26.497	28.238	24.399	25.982	17.694	12.695
spot_024	full performance	26.993	28.722	24.851	26.420	17.694	12.695
spot_025	full performance	27.487	29.201	25.299	26.855	17.694	12.695
spot_026	full performance	27.976	29.677	25.743	27.286	17.694	12.695
spot_027	full performance	28.461	30.149	26.184	27.713	17.694	12.695
spot_028	full performance	28.943	30.617	26.621	28.136	17.694	12.695
spot_029	full performance	29.421	31.081	27.054	28.555	17.694	12.695
spot_030	full performance	29.895	31.541	27.483	28.970	17.694	12.695
spot_031	full performance	30.365	31.998	27.908	29.382	17.694	12.695
spot_032	full performance	30.831	32.450	28.329	29.790	17.694	12.695
spot_033	full performance	31.293	32.899	28.747	30.193	17.694	12.695
spot_034	full performance	31.752	33.344	29.160	30.593	17.694	12.695
spot_035	full performance	32.207	33.785	29.570	30.990	17.694	12.695
spot_036	full performance	32.657	34.222	29.976	31.382	17.694	12.695
spot_037	full performance	33.104	34.656	30.378	31.770	17.694	12.695
spot_038	full performance	33.547	35.085	30.776	32.155	17.694	12.695
spot_039	full performance	33.987	35.511	31.170	32.536	17.694	12.695
spot_040	full performance	34.422	35.933	31.561	32.913	17.694	12.695
spot_041	full performance	34.854	36.351	31.948	33.286	17.694	12.695
spot_042	full performance	35.282	36.766	32.331	33.656	17.694	12.695
spot_043	full performance	35.706	37.176	32.710	34.021	17.693	12.695
spot_044	full performance	36.126	37.583	33.085	34.384	17.693	12.695
spot_045	full performance	36.542	37.986	33.457	34.742	17.693	12.695
spot_046	full performance	36.955	38.386	33.824	35.097	17.693	12.695
spot_047	full performance	37.364	38.782	34.188	35.448	17.693	12.695
spot_048	full performance	37.769	39.174	34.549	35.795	17.693	12.695
spot_049	full performance	38.171	39.563	34.906	36.139	17.693	12.695
spot_050	full performance	38.569	39.948	35.259	36.479	17.693	12.695
spot_051	full performance	38.963	40.329	35.608	36.815	17.693	12.695
spot_052	full performance	39.353	40.707	35.954	37.149	17.693	12.695
spot_053	full performance	39.740	41.082	36.296	37.478	17.693	12.695
spot_054	full performance	40.124	41.453	36.634	37.804	17.693	12.695
spot_055	full performance	40.504	41.820	36.969	38.127	17.693	12.695
spot_056	full performance	40.880	42.184	37.301	38.446	17.693	12.695
spot_057	full performance	41.253	42.545	37.628	38.762	17.693	12.695
spot_058	full performance	41.622	42.902	37.953	39.074	17.693	12.695
spot_059	full performance	41.988	43.256	38.274	39.383	17.693	12.695
spot_060	full performance	42.351	43.607	38.591	39.689	17.693	12.695
spot_061	full performance	42.710	43.954	38.906	39.991	17.693	12.695
spot_062	full performance	43.065	44.298	39.216	40.290	17.693	12.695
spot_063	full performance	43.418	44.639	39.524	40.586	17.693	12.695
spot_064	full performance	43.767	44.976	39.828	40.878	17.693	12.695
spot_065	full performance	44.113	45.310	40.129	41.168	17.693	12.695
spot_066	full performance	44.455	45.642	40.426	41.454	17.693	12.695



Public

spot_066	full performance	44.455	45.642	40.426	41.454	17.693	12.695
spot_067	full performance	44.794	45.970	40.721	41.737	17.693	12.695
spot_068	full performance	45.130	46.295	41.012	42.017	17.693	12.695
spot_069	full performance	45.463	46.617	41.300	42.294	17.693	12.695
spot_070	full performance	45.793	46.936	41.585	42.568	17.693	12.695
spot_071	full performance	46.120	47.251	41.867	42.839	17.693	12.695
spot_072	full performance	46.443	47.564	42.145	43.107	17.693	12.695
spot_073	full performance	46.764	47.874	42.421	43.372	17.693	12.695
spot_074	full performance	47.081	48.181	42.693	43.635	17.693	12.695
spot_075	full performance	47.396	48.486	42.963	43.894	17.693	12.695
spot_076	full performance	47.707	48.787	43.230	44.150	17.693	12.695
spot_077	full performance	48.016	49.085	43.493	44.404	17.693	12.695
spot_078	full performance	48.322	49.381	43.754	44.655	17.693	12.695
spot_079	full performance	48.625	49.674	44.012	44.903	17.693	12.695
spot_080	full performance	48.925	49.964	44.267	45.148	17.693	12.695
spot_081	full performance	49.222	50.252	44.520	45.391	17.693	12.695
spot_082	full performance	49.516	50.537	44.769	45.631	17.693	12.695
spot_083	full performance	49.808	50.819	45.016	45.868	17.693	12.695
spot_084	full performance	50.097	51.099	45.260	46.103	17.693	12.695
spot_085	full performance	50.383	51.376	45.501	46.335	17.693	12.695
spot_086	full performance	50.667	51.650	45.740	46.564	17.693	12.695
spot_087	full performance	50.948	51.922	45.976	46.791	17.693	12.695
spot_088	full performance	51.226	52.191	46.210	47.016	17.693	12.695
spot_089	full performance	51.502	52.458	46.441	47.238	17.693	12.695
spot_090	full performance	51.776	52.723	46.669	47.458	17.693	12.695
spot_091	full performance	52.046	52.985	46.895	47.675	17.693	12.695
spot_092	full performance	52.315	53.245	47.118	47.890	17.693	12.695
spot_093	full performance	52.580	53.502	47.339	48.102	17.693	12.695
spot_094	full performance	52.844	53.757	47.558	48.312	17.693	12.695
spot_095	full performance	53.105	54.010	47.774	48.520	17.693	12.695
spot_096	full performance	53.364	54.261	47.988	48.726	17.693	12.695
spot_097	full performance	53.620	54.509	48.199	48.929	17.693	12.695
spot_098	full performance	53.874	54.755	48.408	49.130	17.693	12.695
spot_099	full performance	54.126	54.999	48.615	49.329	17.693	12.695
spot_100	full performance	54.375	55.240	48.820	49.526	17.693	12.695
spot_101	data collection	54.622	55.480	49.022	49.720	17.693	12.695
spot_102	data collection	54.867	55.717	49.222	49.913	17.693	12.695
spot_103	data collection	55.110	55.952	49.420	50.103	17.693	12.695
spot_104	data collection	55.351	56.186	49.616	50.292	17.693	12.695
spot_105	data collection	55.589	56.417	49.809	50.478	17.693	12.695
spot_106	data collection	55.826	56.646	50.001	50.662	17.693	12.695
spot_107	data collection	56.060	56.873	50.190	50.844	17.693	12.695
spot_108	data collection	56.292	57.098	50.377	51.024	17.693	12.695
spot_109	data collection	56.522	57.321	50.563	51.203	17.693	12.695
spot_110	data collection	56.751	57.543	50.746	51.379	17.693	12.695
spot_111	data collection	56.977	57.762	50.927	51.554	17.693	12.695
spot_112	data collection	57.201	57.979	51.107	51.726	17.693	12.695
spot_113	data collection	57.423	58.195	51.284	51.897	17.693	12.695
spot_114	data collection	57.644	58.409	51.460	52.066	17.693	12.695
spot_115	data collection	57.862	58.621	51.633	52.233	17.693	12.695
spot_116	data collection	58.079	58.831	51.805	52.398	17.693	12.695
spot_117	data collection	58.294	59.039	51.975	52.562	17.693	12.695
spot_118	data collection	58.507	59.246	52.143	52.723	17.693	12.695
spot_119	data collection	58.718	59.451	52.309	52.883	17.693	12.695
spot_120	data collection	58.927	59.654	52.474	53.042	17.693	12.695
spot_121	data collection	59.135	59.856	52.636	53.198	17.693	12.695
spot_122	data collection	59.341	60.056	52.797	53.353	17.693	0,000

<b>number of full performance swaths</b>	<b>91</b>
<b>total number of swaths</b>	<b>122</b>
Minimum required ground range swath width	17.7 km
Minimum required ground swath overlap	12.7 km
spot_001 coverage region start to 15° of incidence angle in ground range: 2.827 km (required 1.350 km)	
spot_010 coverage region start to 20° of incidence angle in ground range: 2.702 km (required 1.350 km)	
spot_100 coverage region end to 55° of incidence angle in ground range: 4.968 km (required 1.350 km)	
spot_123 coverage region end to 60° of incidence angle in ground range: 1.394 km (required 1.350 km)	

Table 2: High-Resolution and Spotlight beam specification.

## Product coverage and swath width degradation (terrain, Height Error Map)

For areas where in the command generation the DEM height error is above 200m, there is the possibility of deviations in the acquired product location from the swath preview as shown in the EOWEB user interface.

From the height error  $h_{err}$  for the cases above 200m the displacement of the acquired swath can be calculated for the worst case, i.e. that all other margin like reference orbit deviation or pointing error has been exploited, as follows:

$$\text{displacement} = (h_{err} - 200\text{m}) * \tan(90^\circ - \text{incidence\_angle})$$

Note, the displacement does not reduce the delivered swath width but the overlap of the delivered product with the ordered swath based on the user ordered swath. This causes also implicitly a product location mismatch.

The *nominal* height error in the DEM available for command generation is sketched in the following height error map. However, the DEM height error indicates only the uncertainty in each height value but not necessarily a real deviation of entire regions.



80% of the land earth surface have maximum DEM errors smaller than 200m. Larger errors may occur mainly at latitudes  $\geq \pm 60^\circ$ .

## High-Resolution and Spotlight Scene Extension

Due to the maximization of azimuth resolution only a small margin is applied in the azimuth scene extension, i.e. this can cause small deviations from the specified azimuth scene extent of up to 300m, as observed in the commissioning phase in extreme and rare cases caused by complex terrain and nominal Doppler centroid variations in-between  $\pm 120$  Hz.

## Performance Plots

The plots are taken from [RD 10]. Note that (except for those of the geometric resolution), they refer to look angles instead of incidence angles.

Note, that the stripmap performance shown in the plots is w.r.t. commanding 150 MHz for the beams strip\_001 to strip\_0010 and that for higher beams 100 MHz tx bandwidth is commanded.

All dual pol performance is shown for commanded 150 MHz range bandwidth.

A preliminary characterization only of the HS 300 MHz mode for single polarization is given in the performance plots.

In ScanSAR, all beams higher than strip\_007 are commanded with 100 MHz, apart from beam strip\_009 which is commanded with 150 MHz. Beams strip\_006 and lower are commanded with 150 MHz.

## Stripmap single

### Geometric Resolution

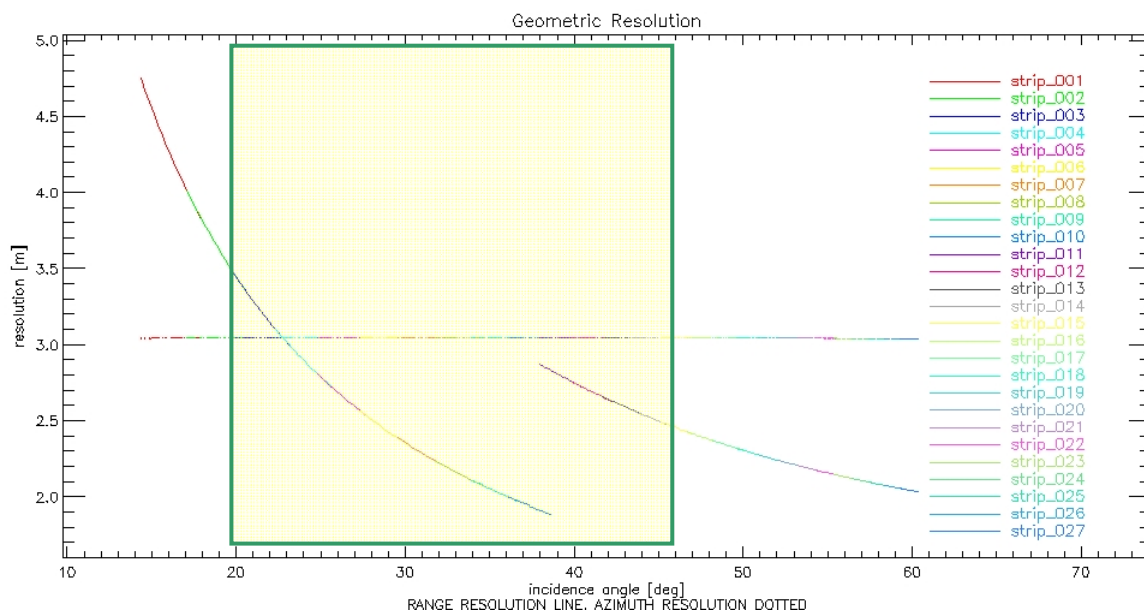

### Radiometric Parameters

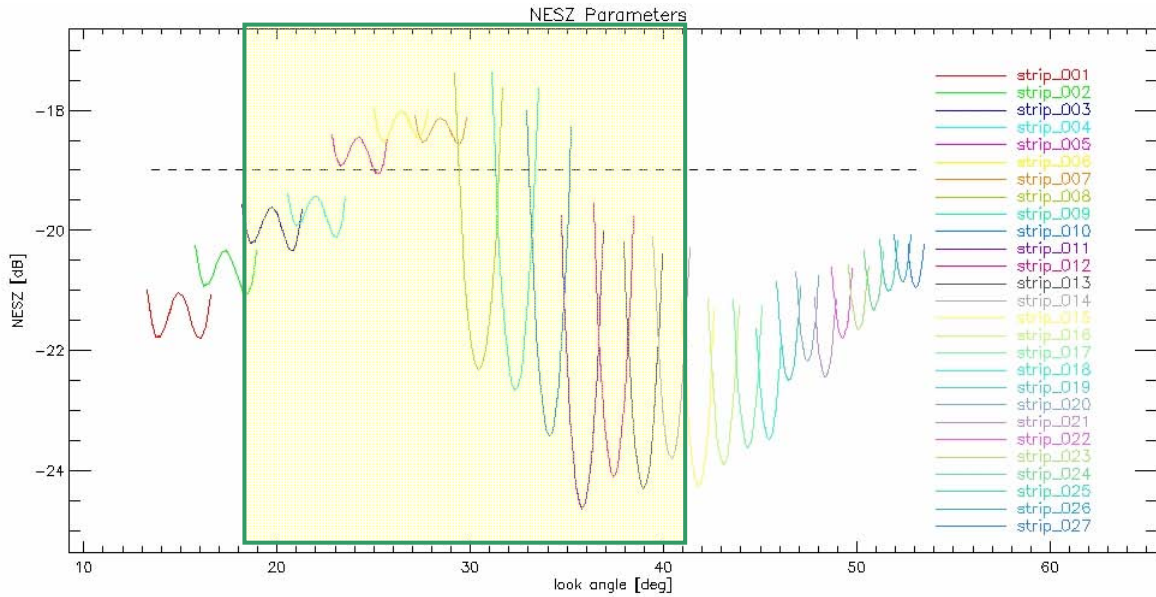

### Ambiguity Ratio Parameters

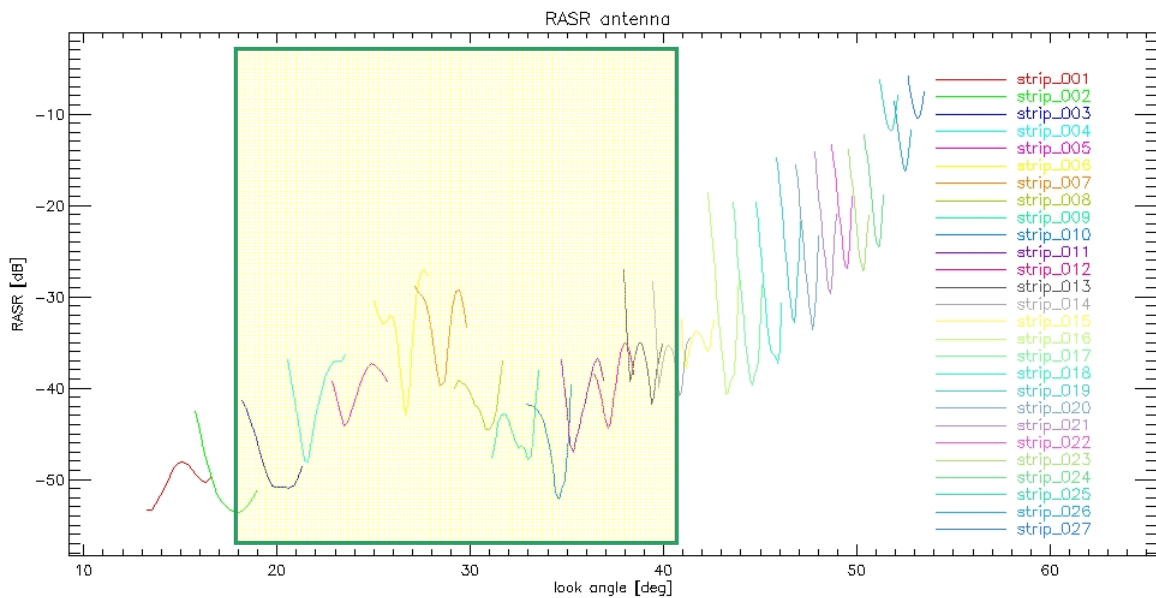



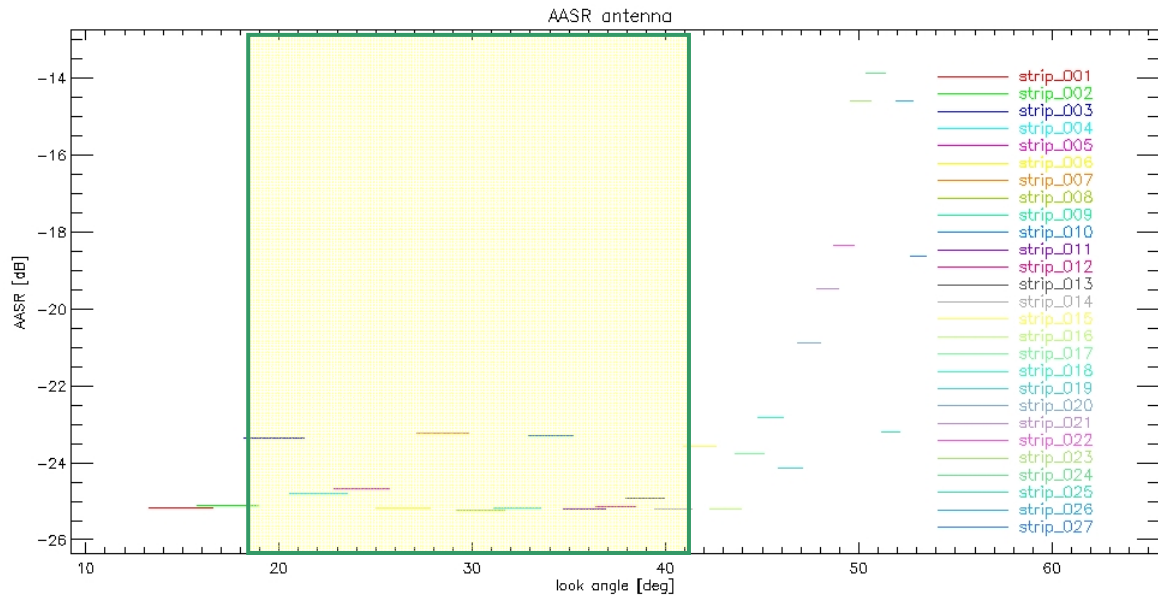



## Stripmap dual HHVV

### Geometric Resolution

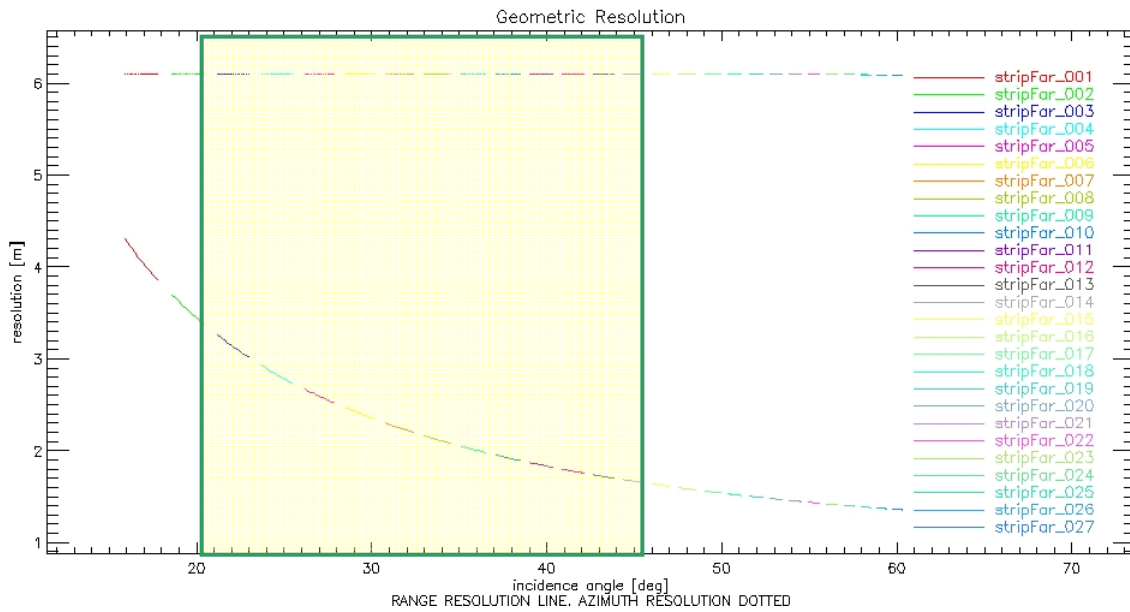

### Radiometric Parameters

#### HH

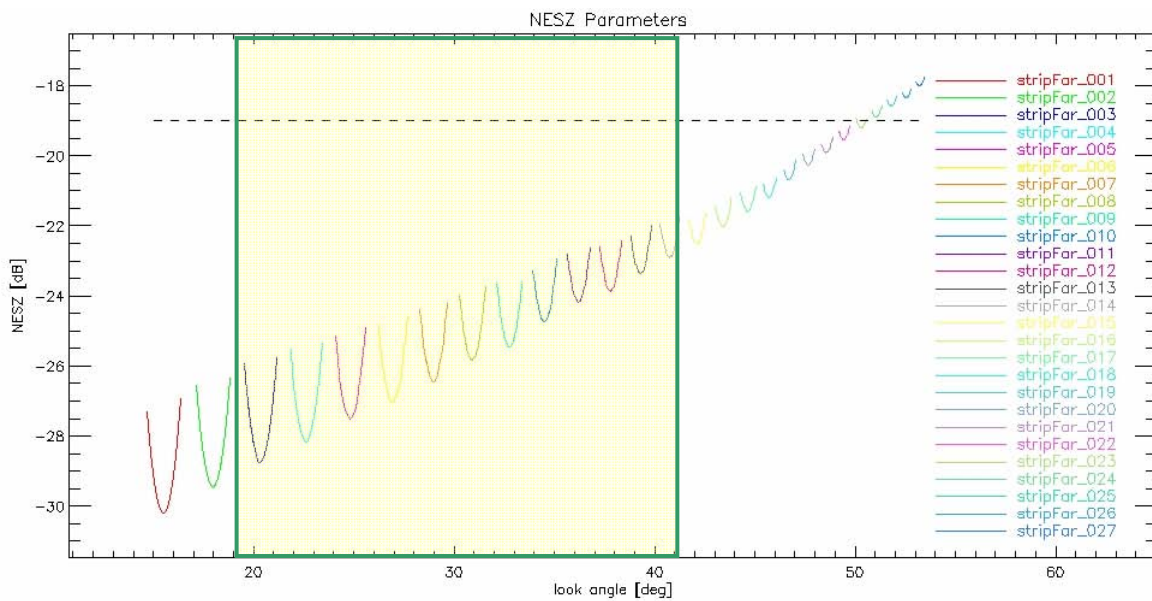

#### VV

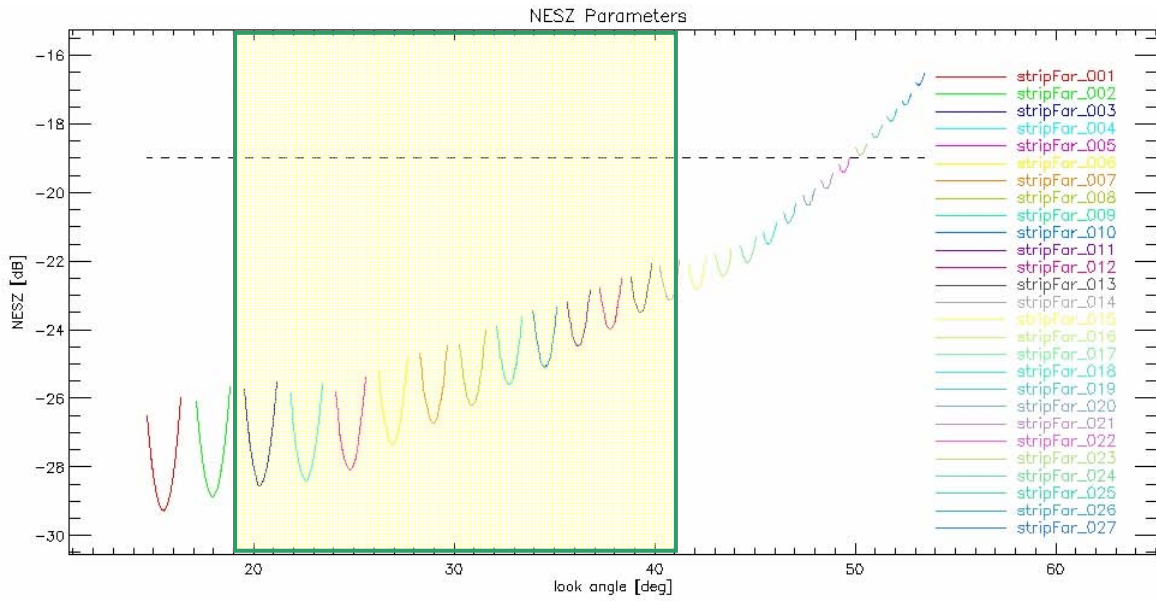

**Ambiguity Ratio Parameters**

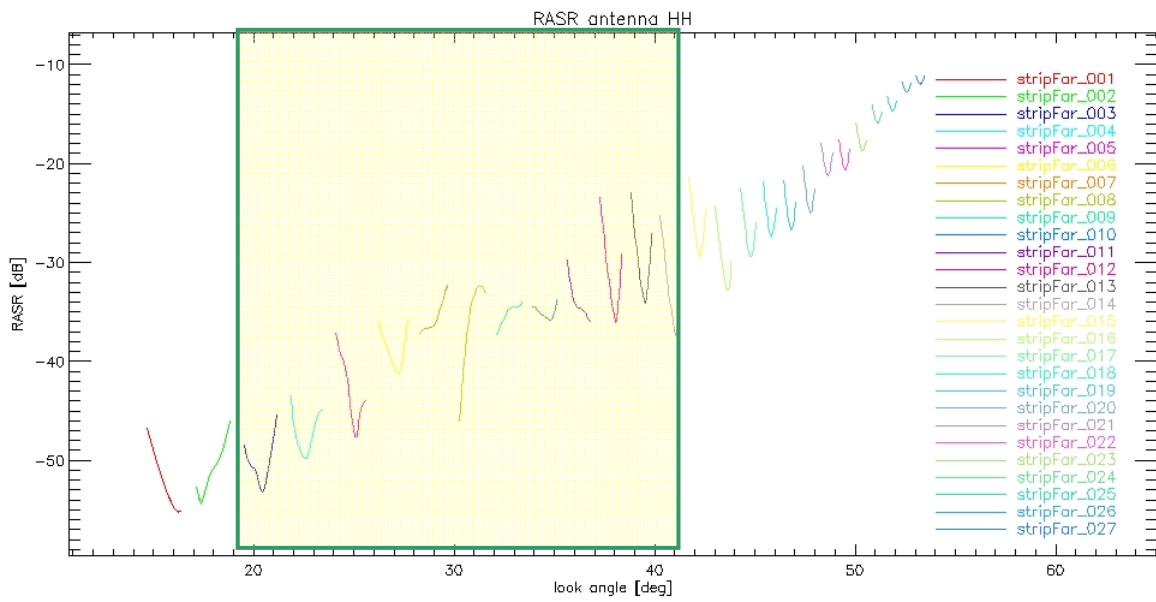

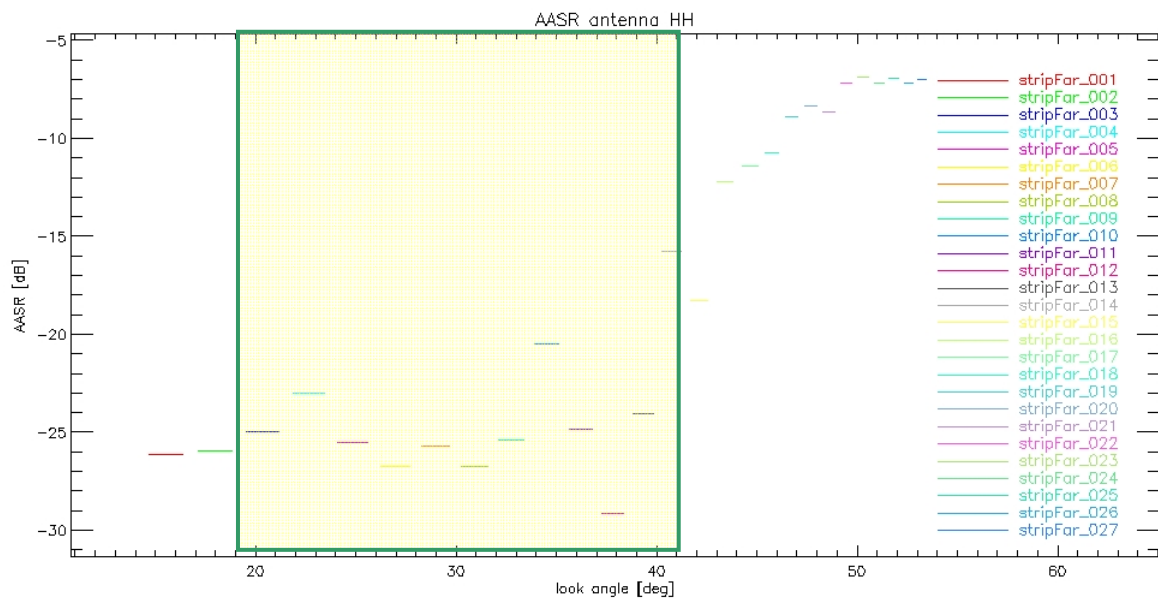
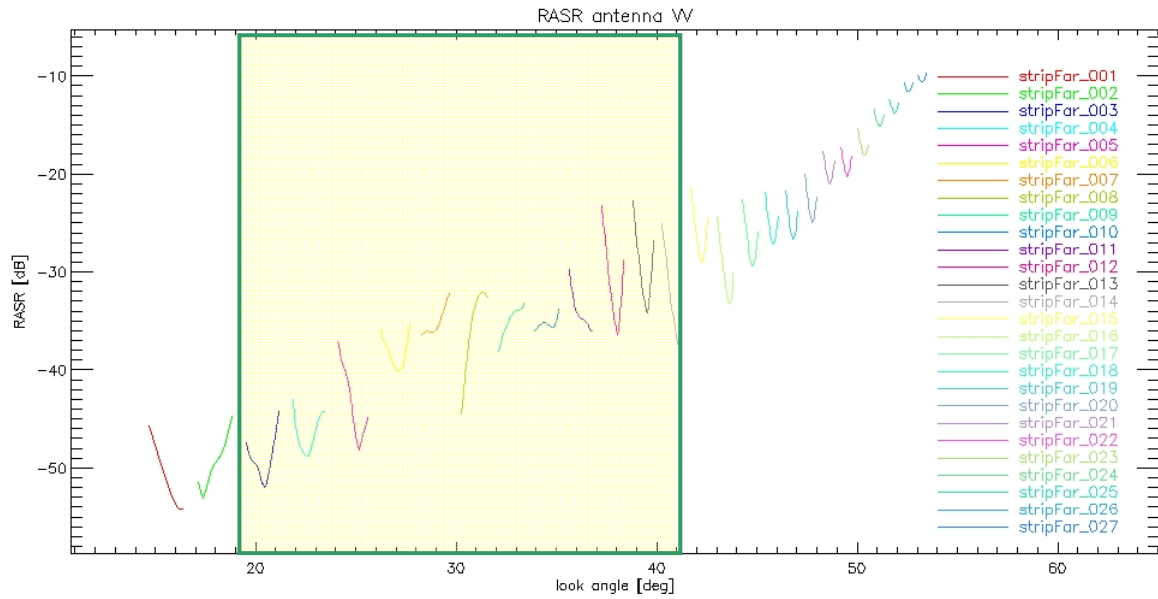

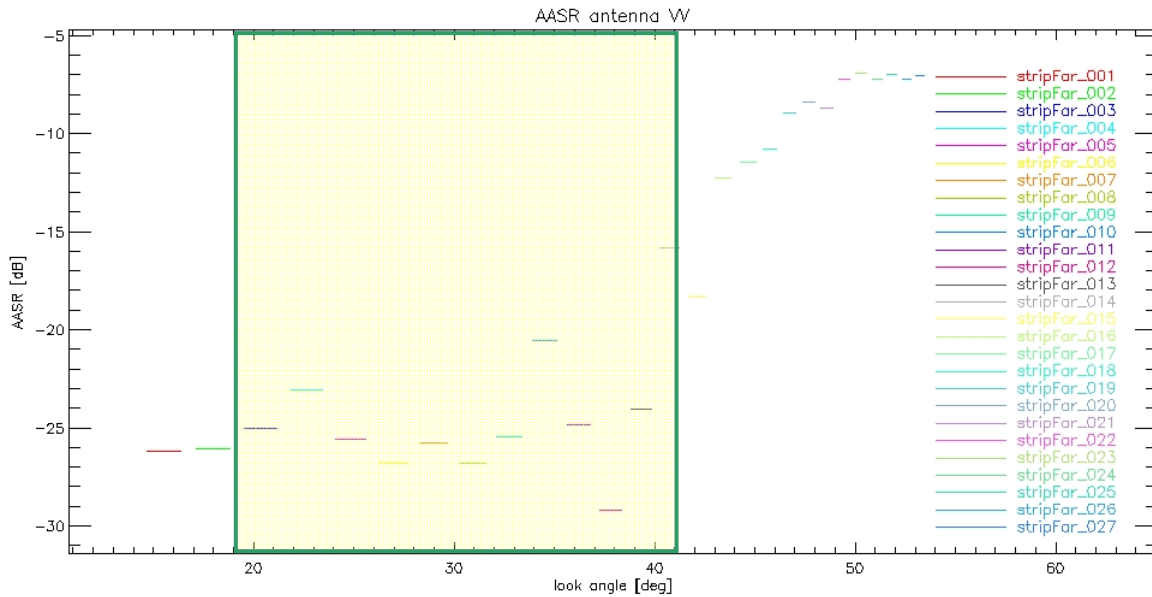

## Stripmap dual HHHV (equivalent VVVH)

### Geometric Resolution

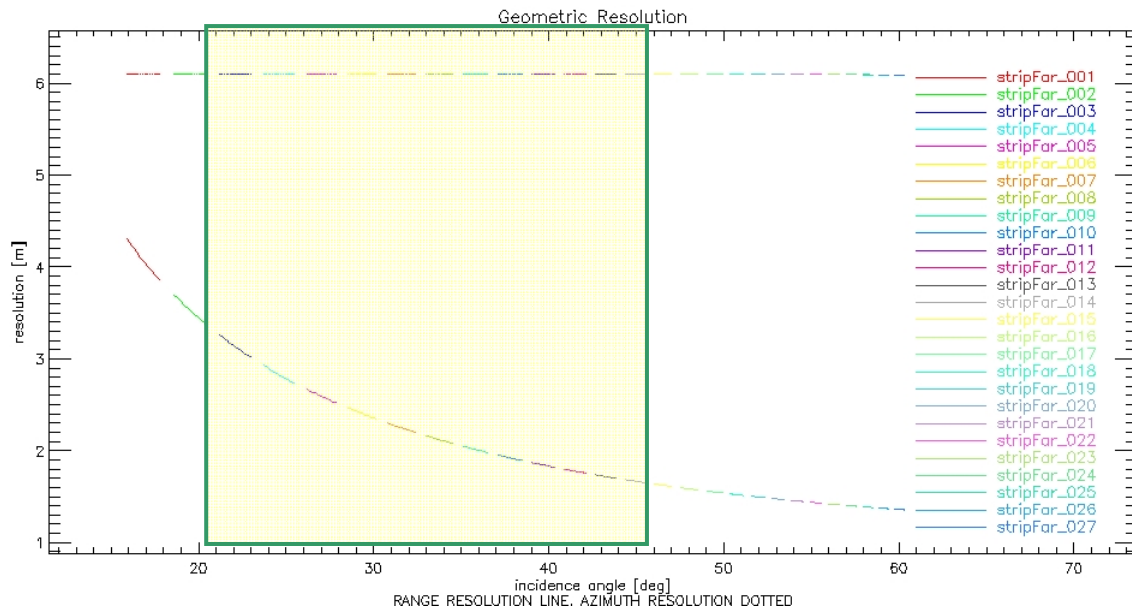

### Radiometric Parameters

HH

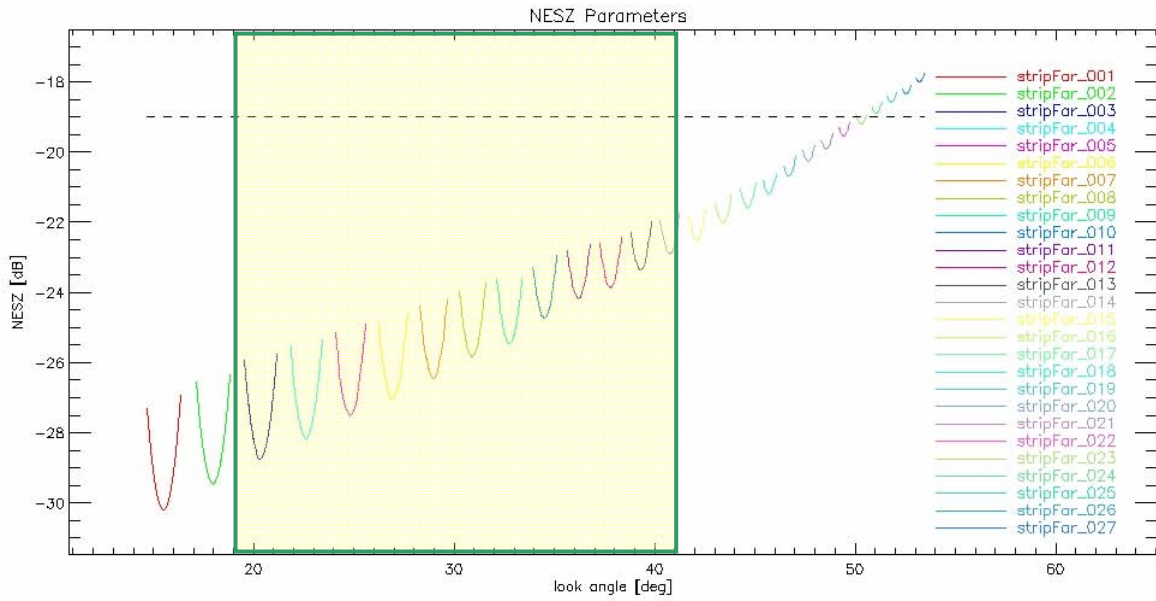

HV

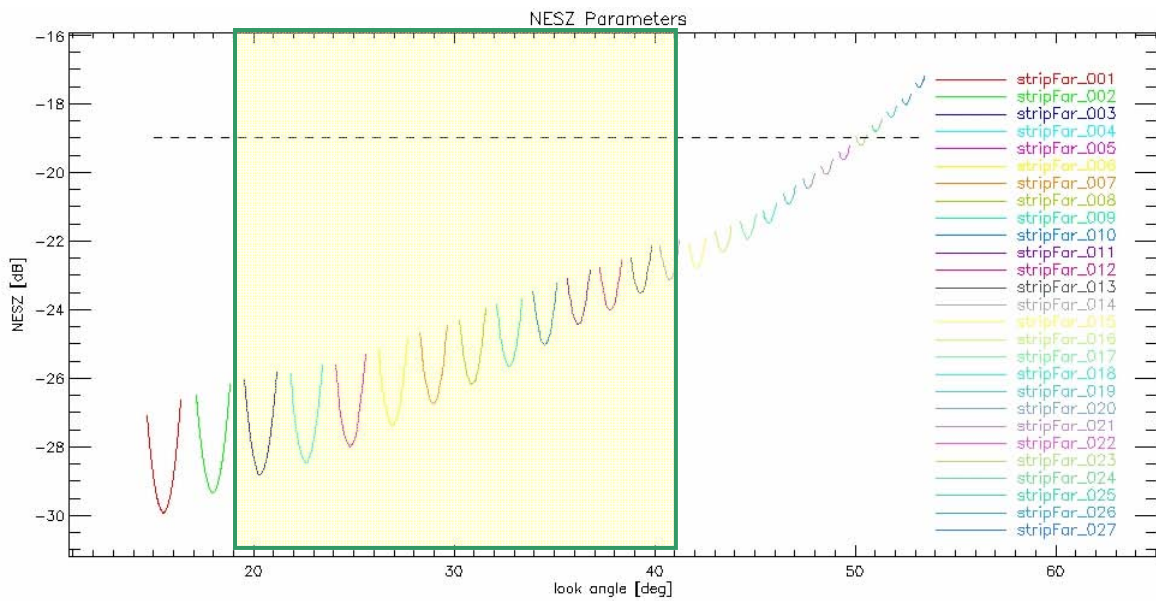

### Ambiguity Ratio Parameters

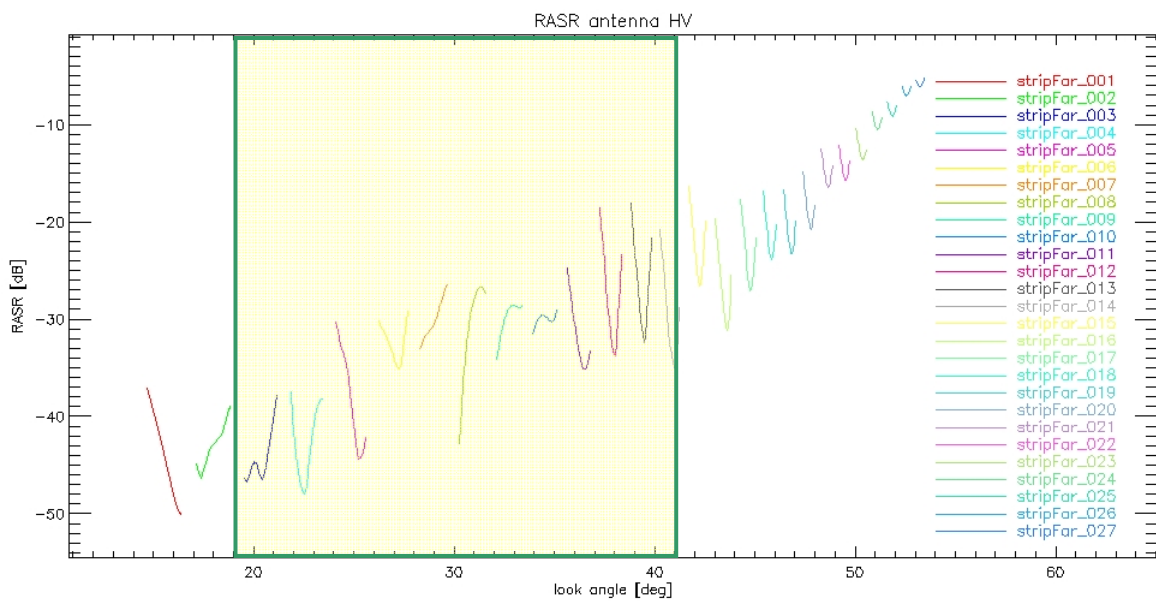
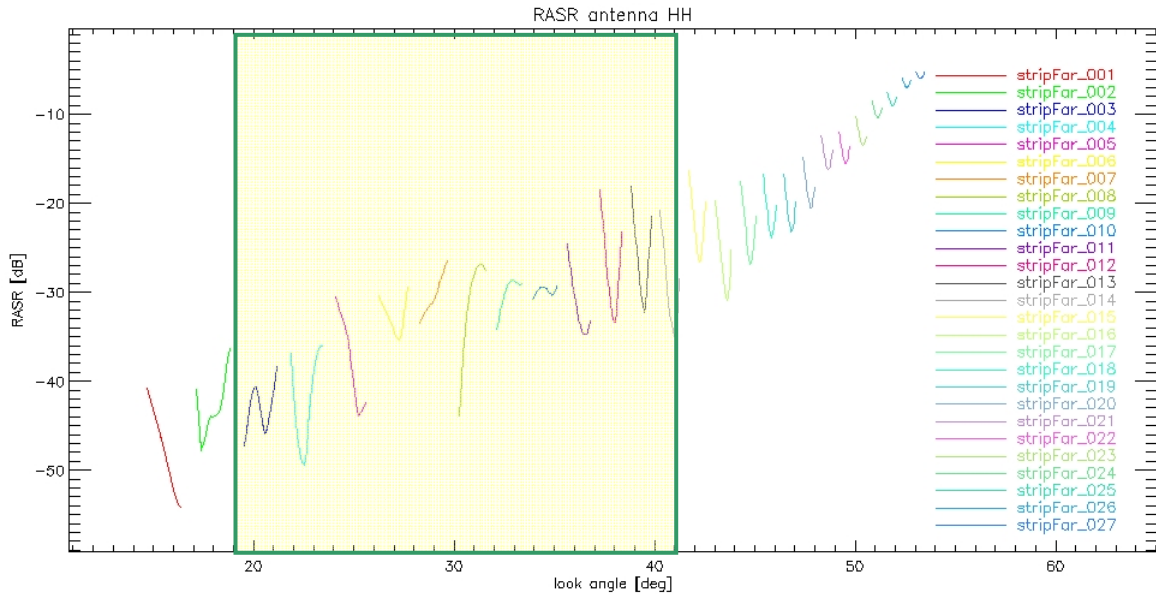

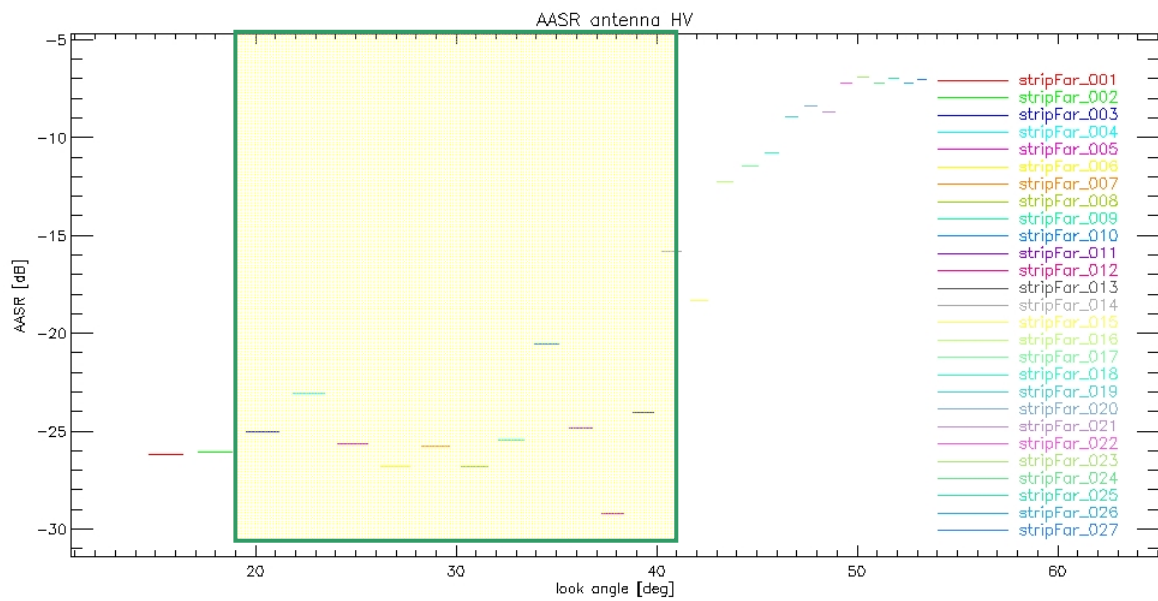
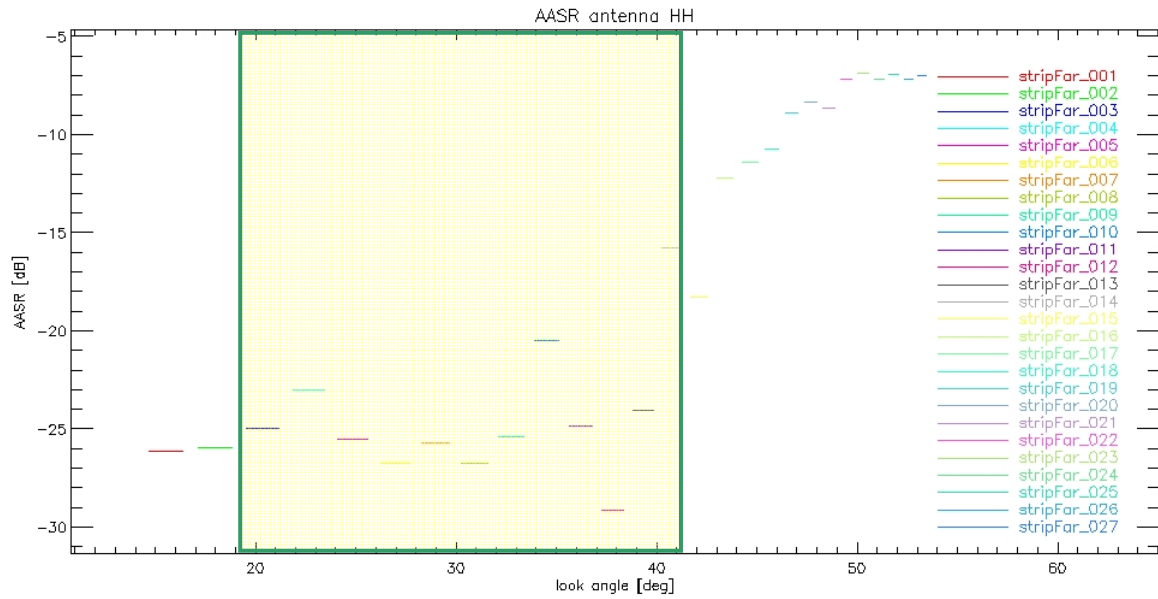

## Spotlight single

### Geometric Resolution

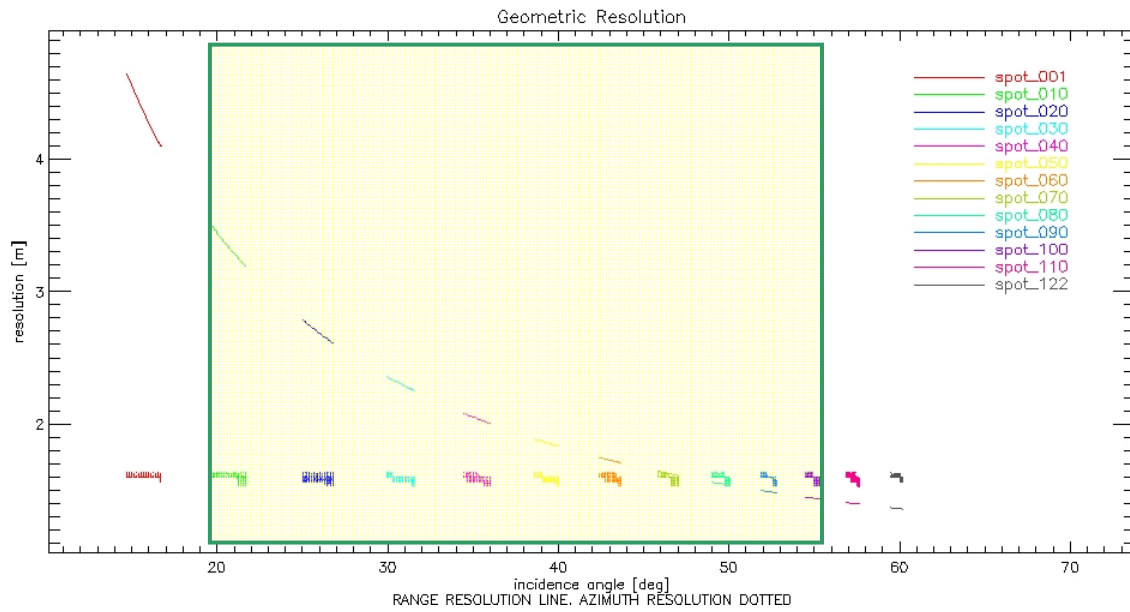

### Radiometric Parameters

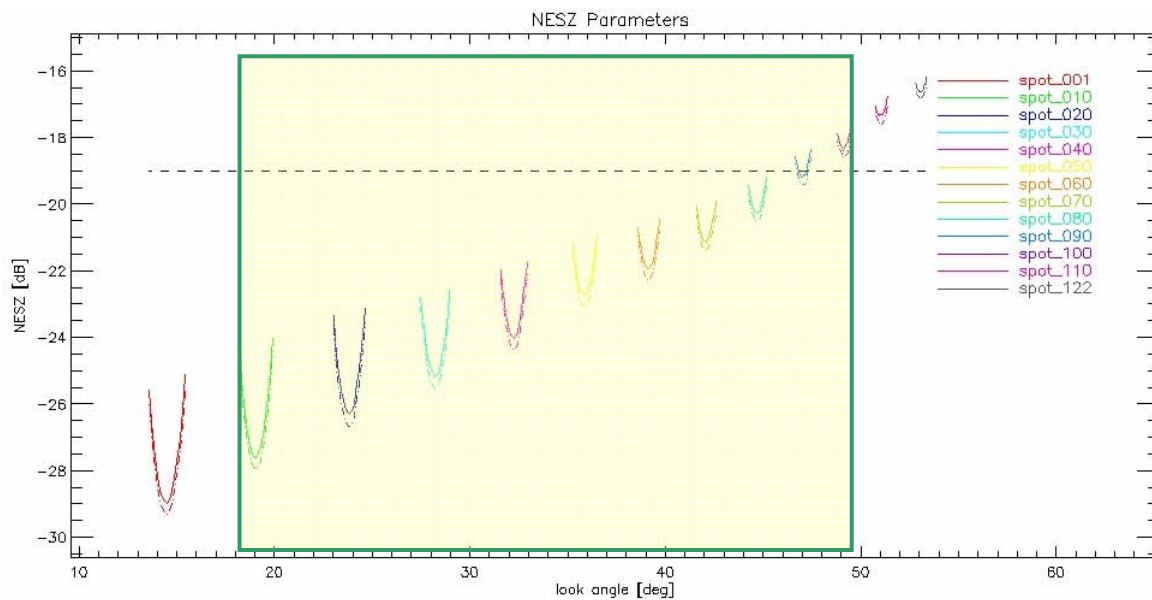



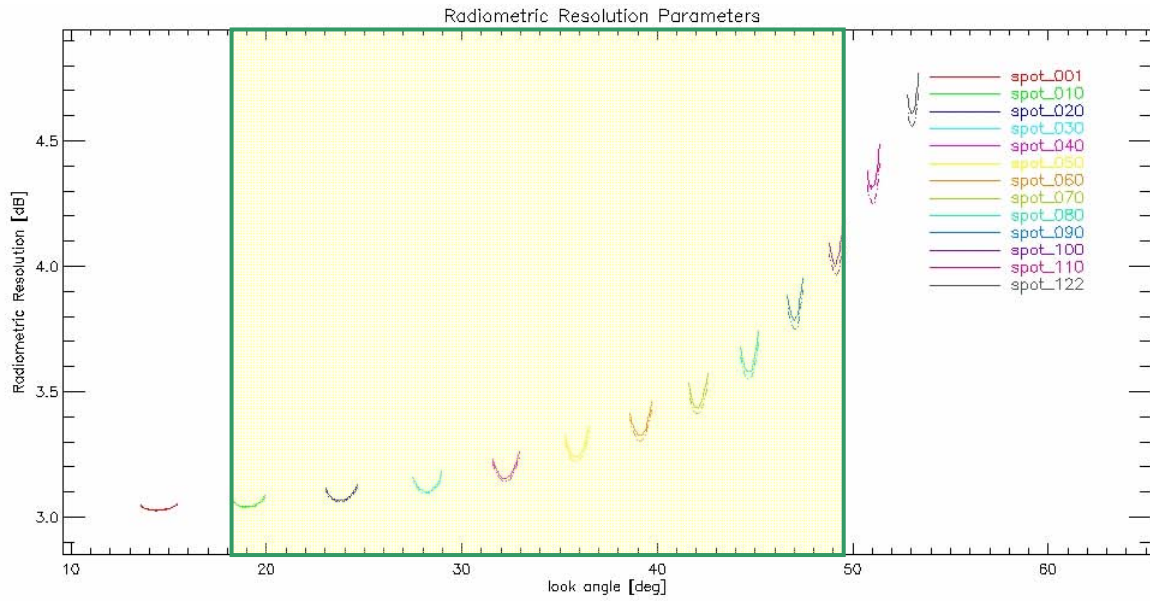

### Ambiguity Ratio Parameters

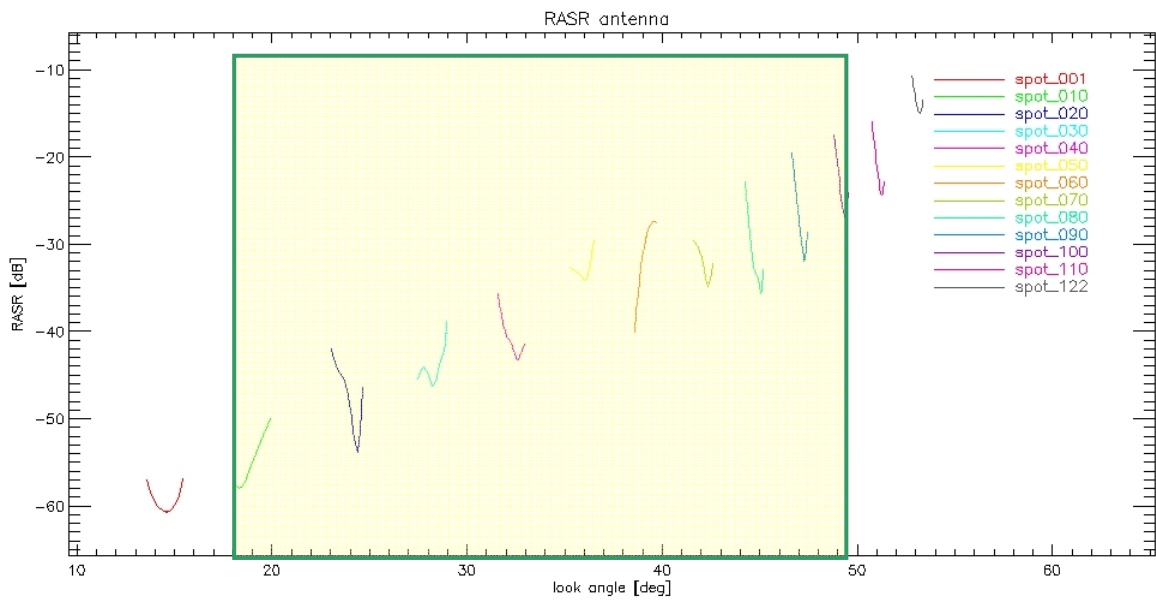

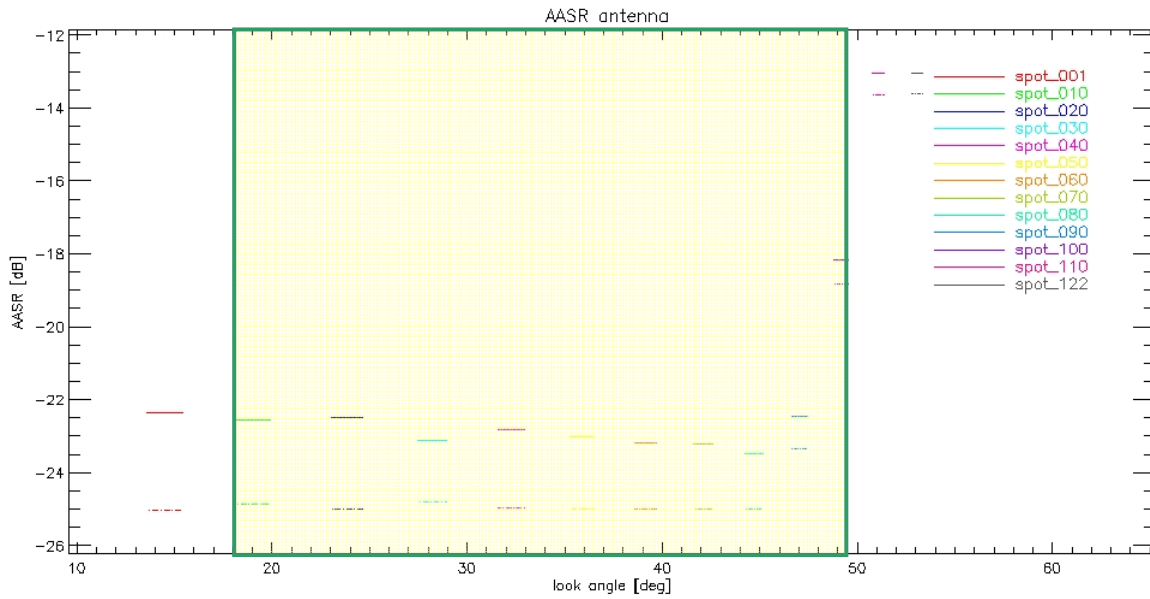

## Spotlight dual HH/VV

### Geometric Resolution

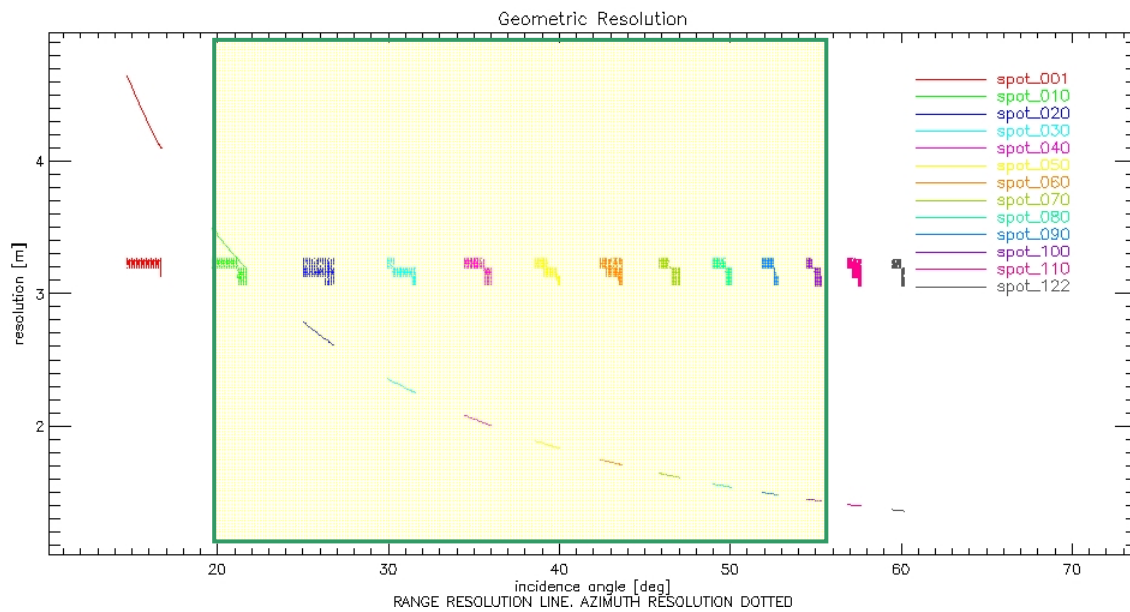

### Radiometric Parameters

HH

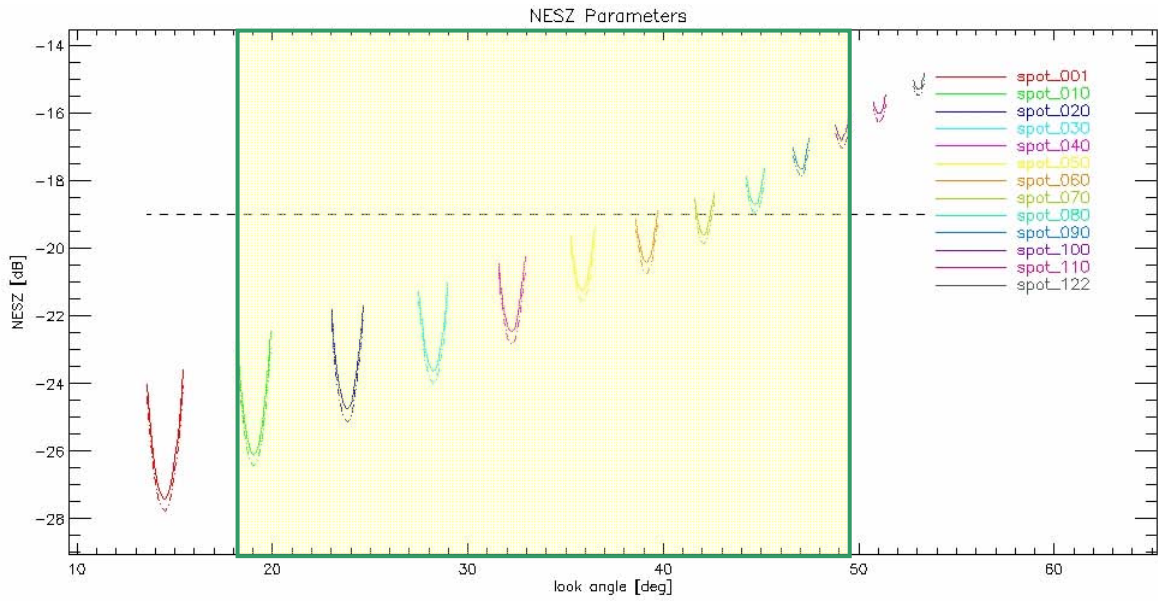

VV

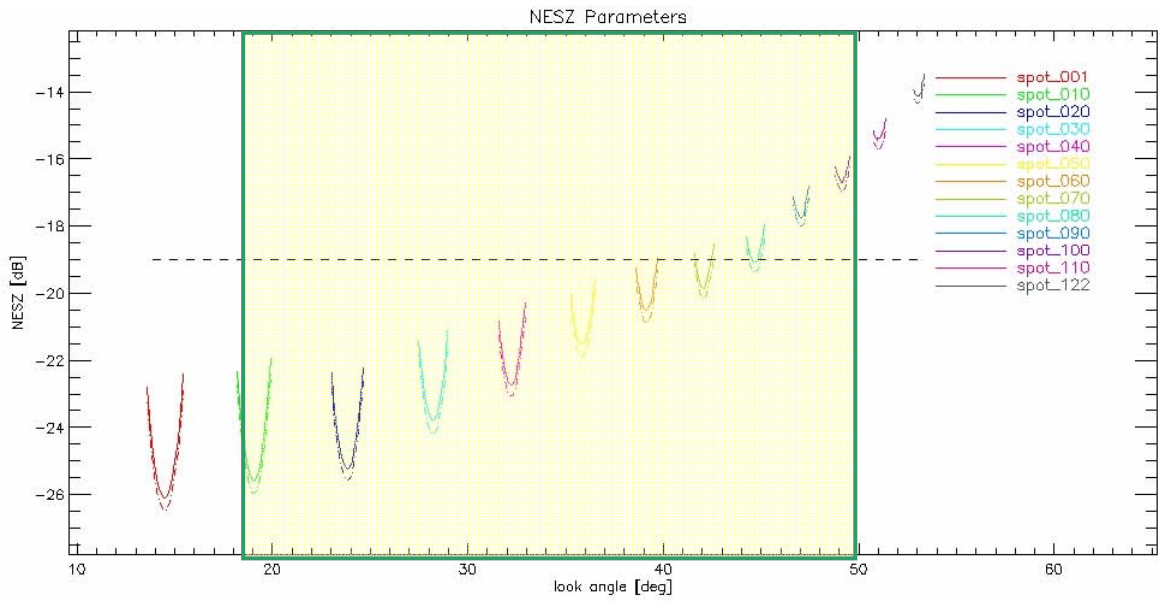

### Ambiguity Ratio Parameters

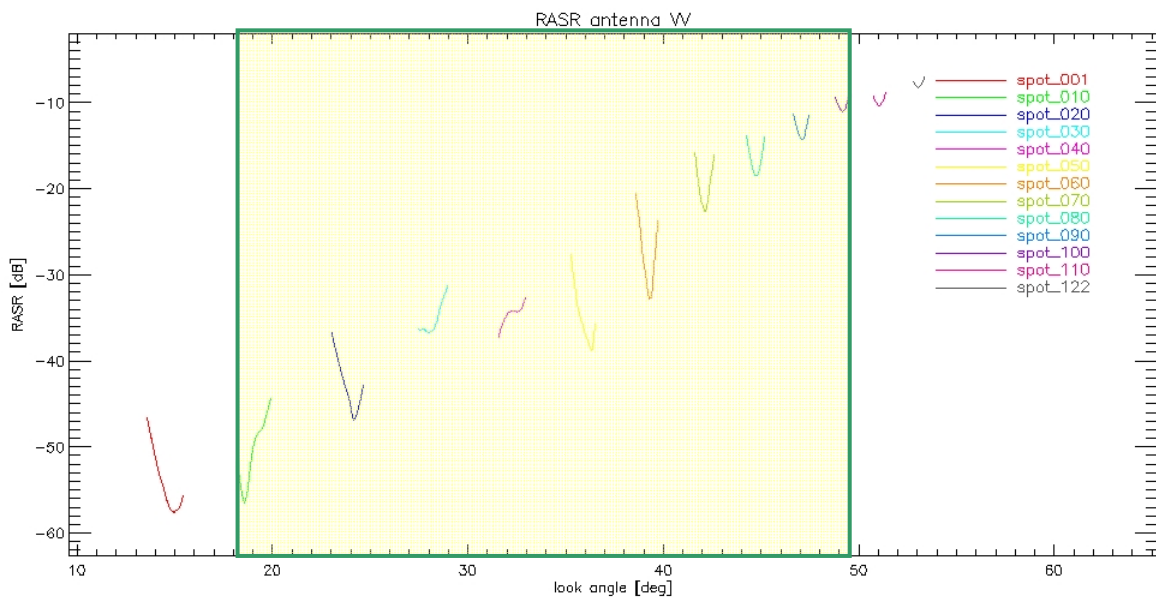
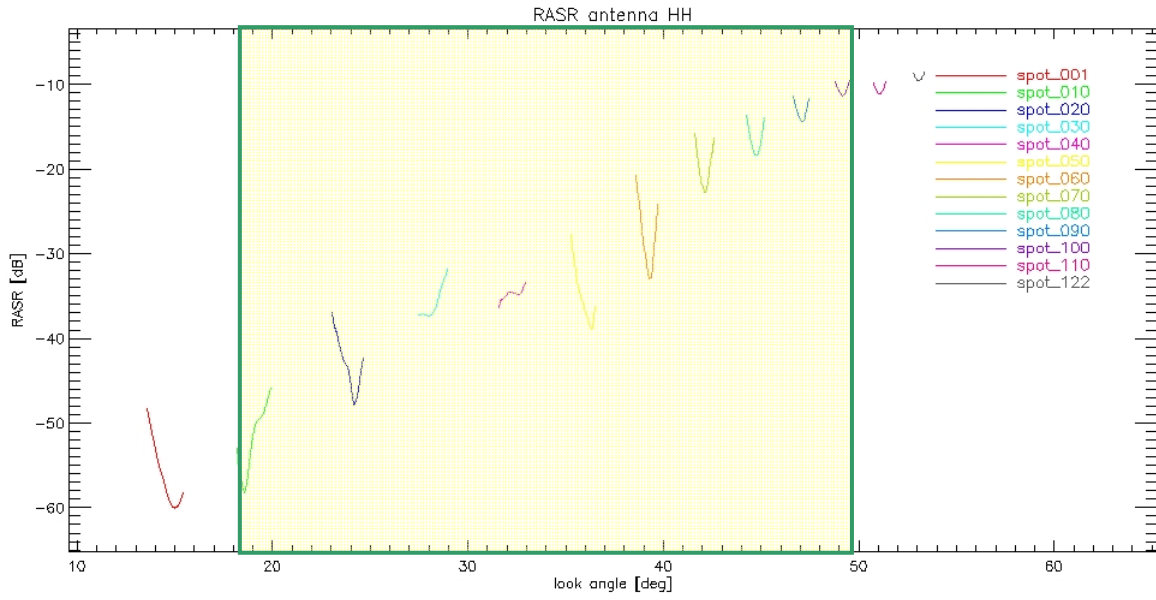

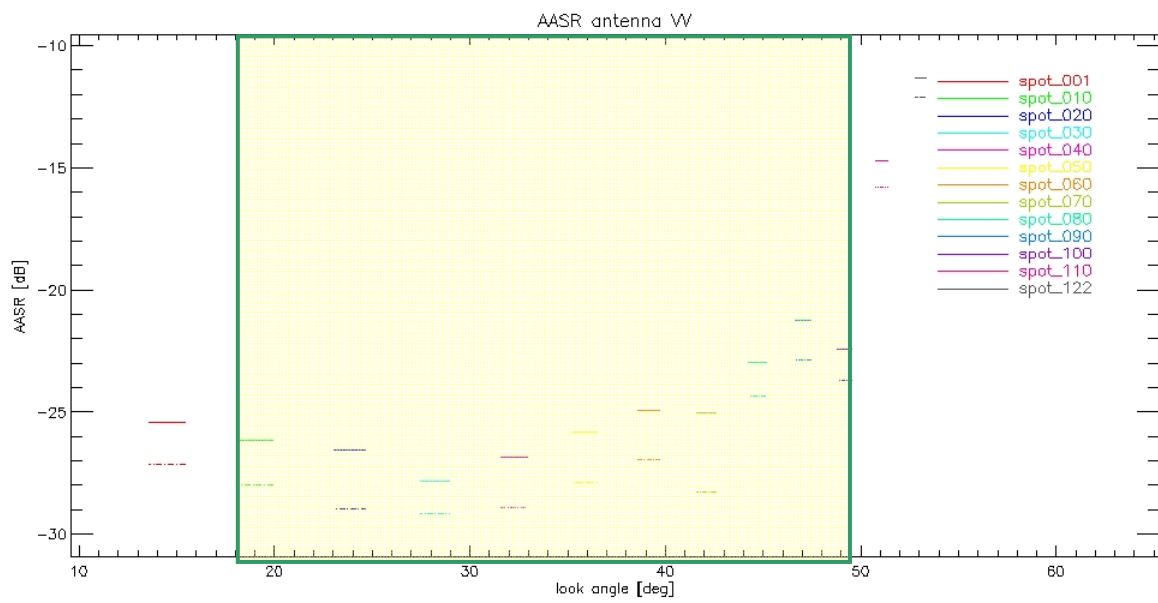
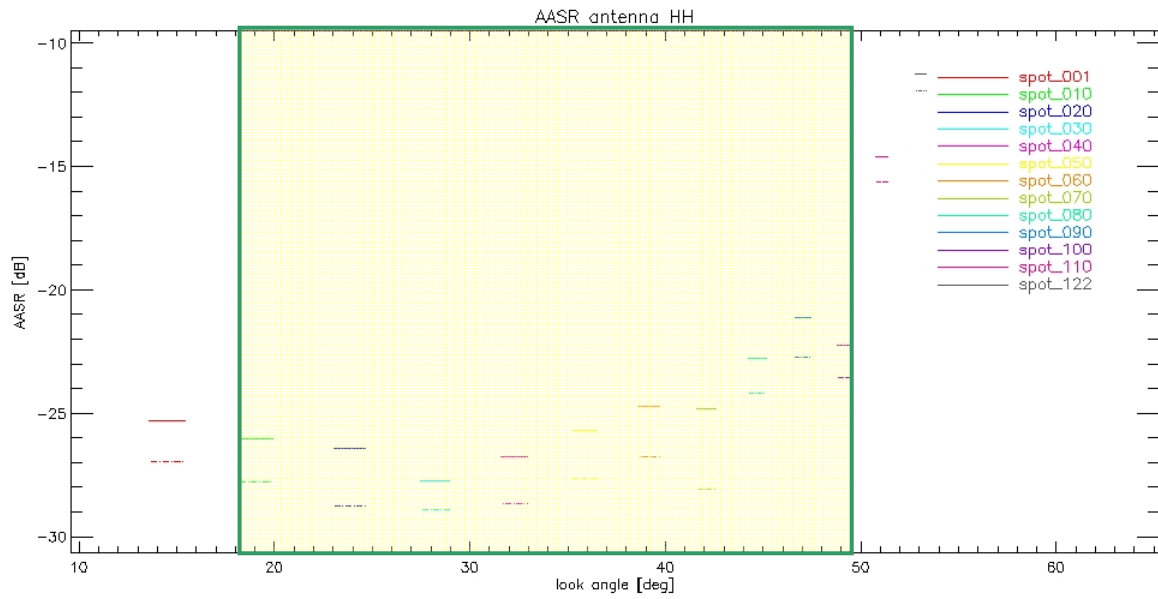

## High-Resolution Spotlight single (HS 150MHz)

### Geometric Resolution

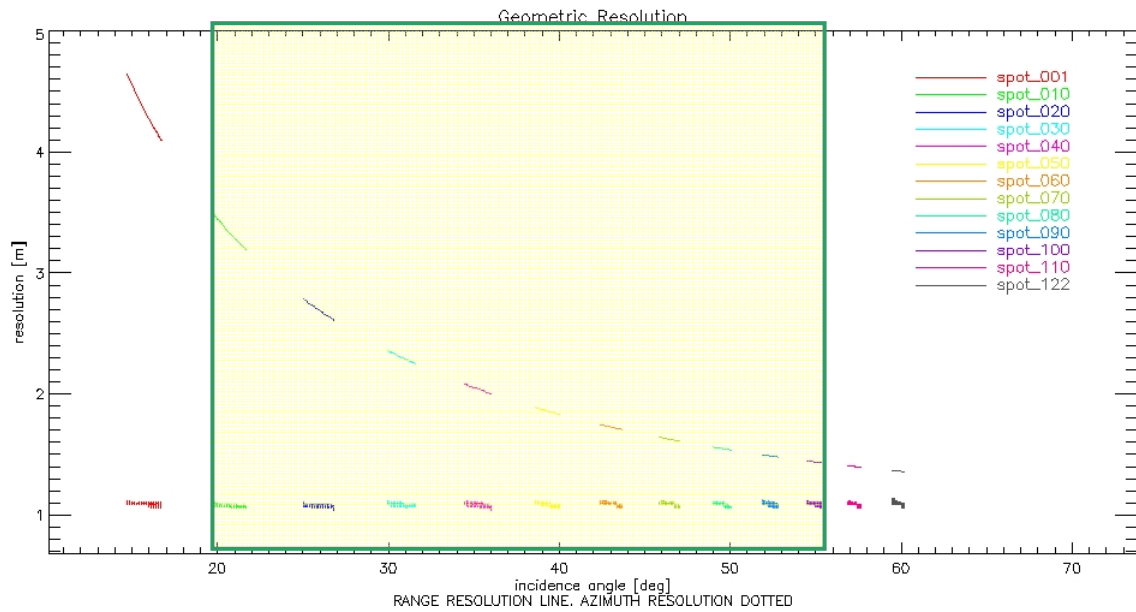

### Radiometric Parameters

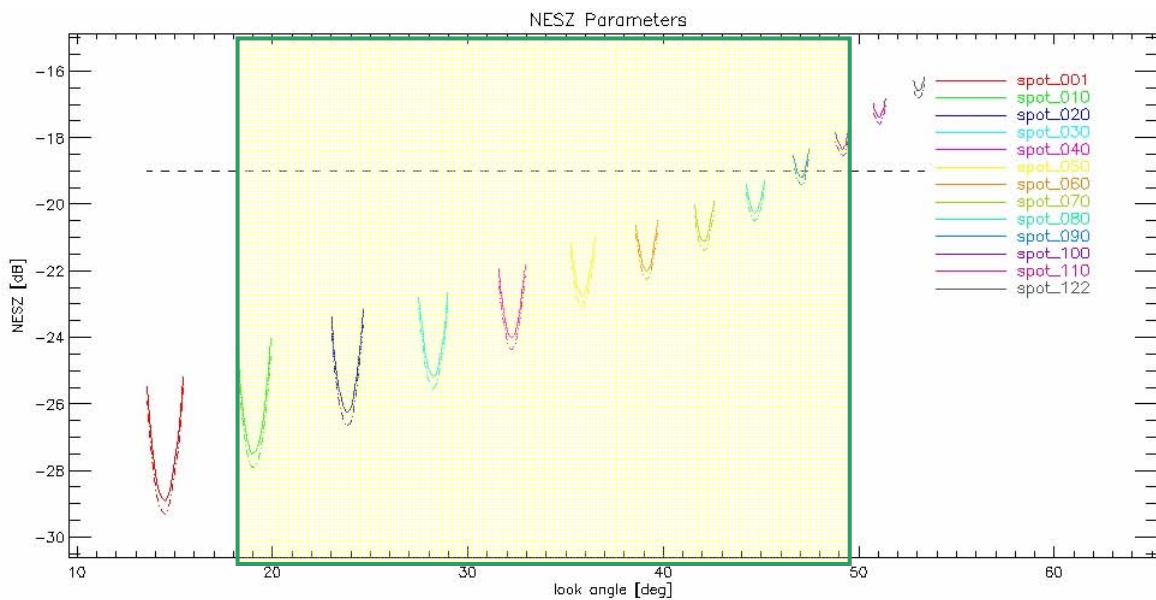

### Ambiguity Ratio Parameters

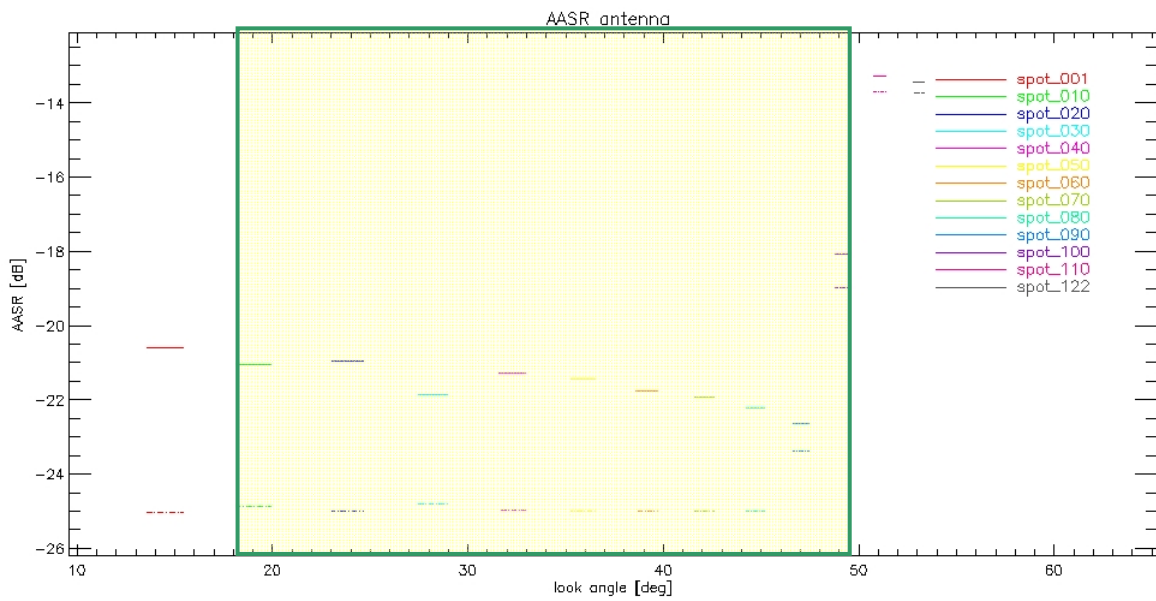
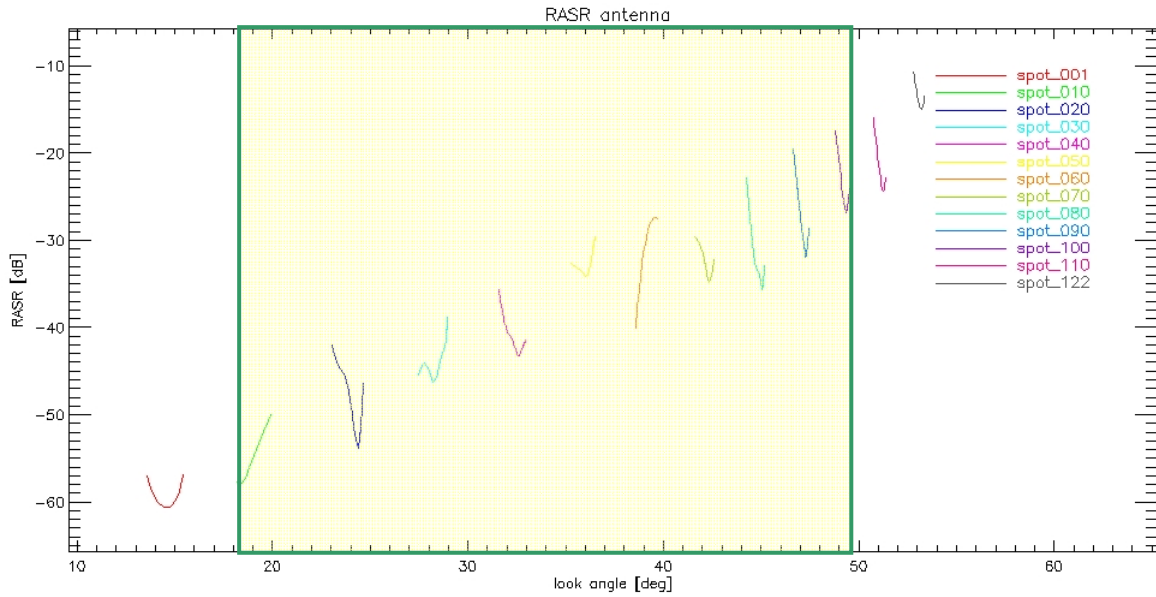

## High-Resolution Spotlight 300MHz single (HS 300MHz)

### Geometric Resolution

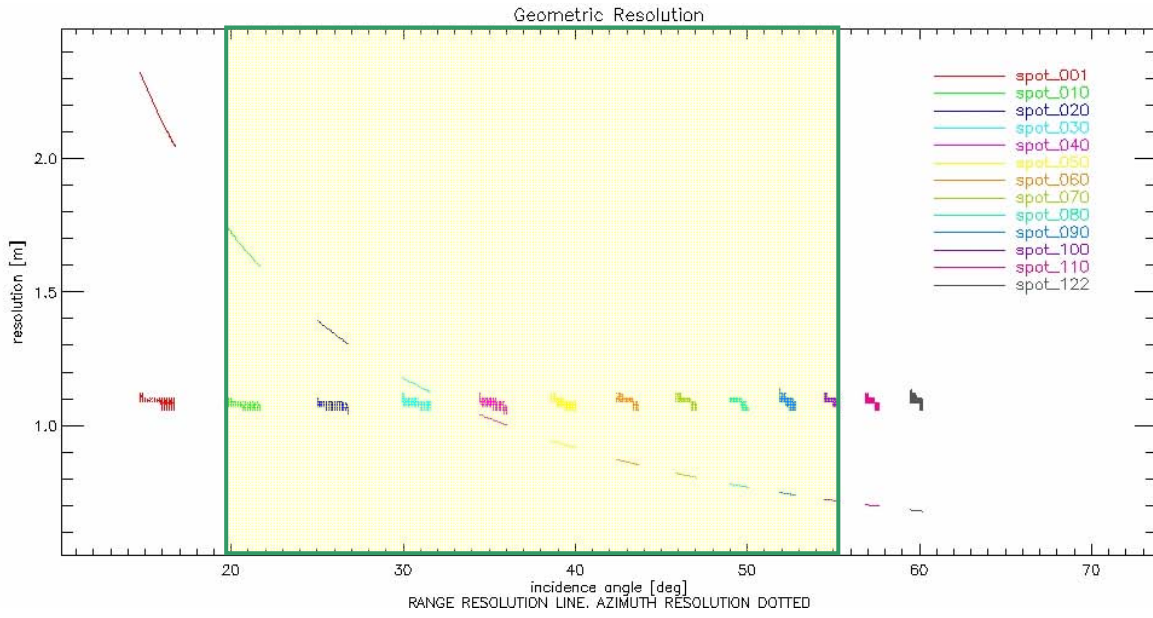

### RADIOMETRIC PARAMETERS

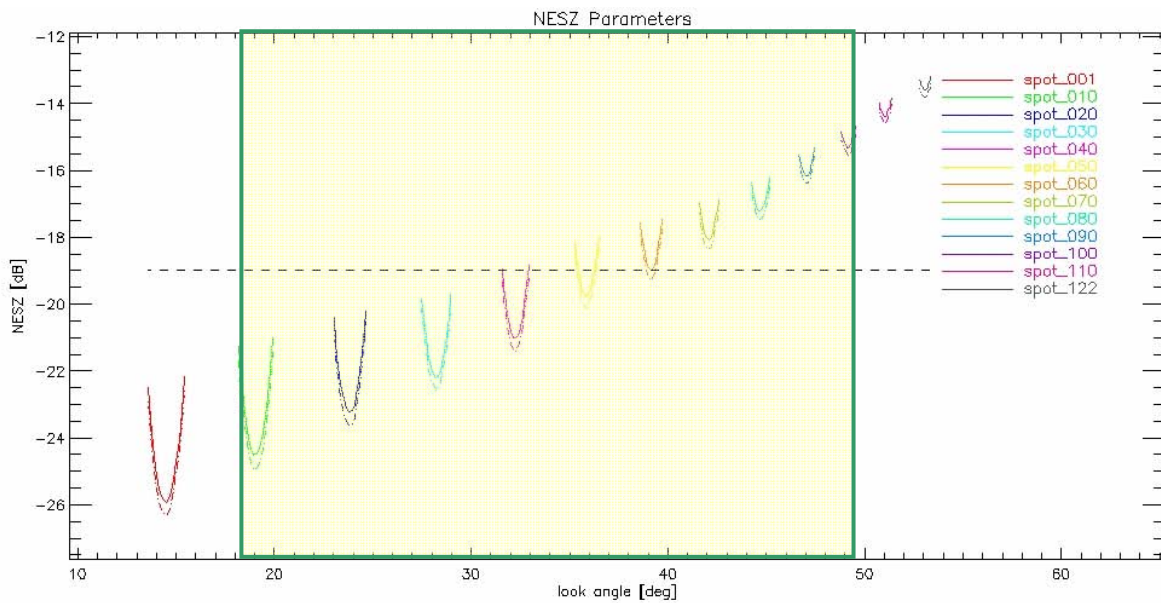



### Ambiguities

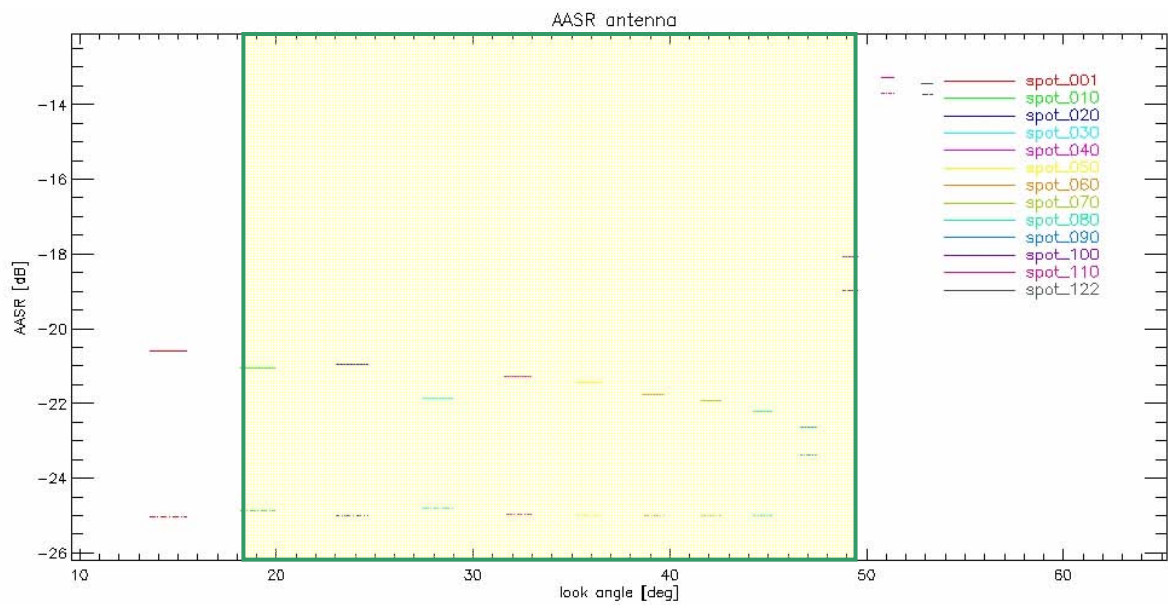
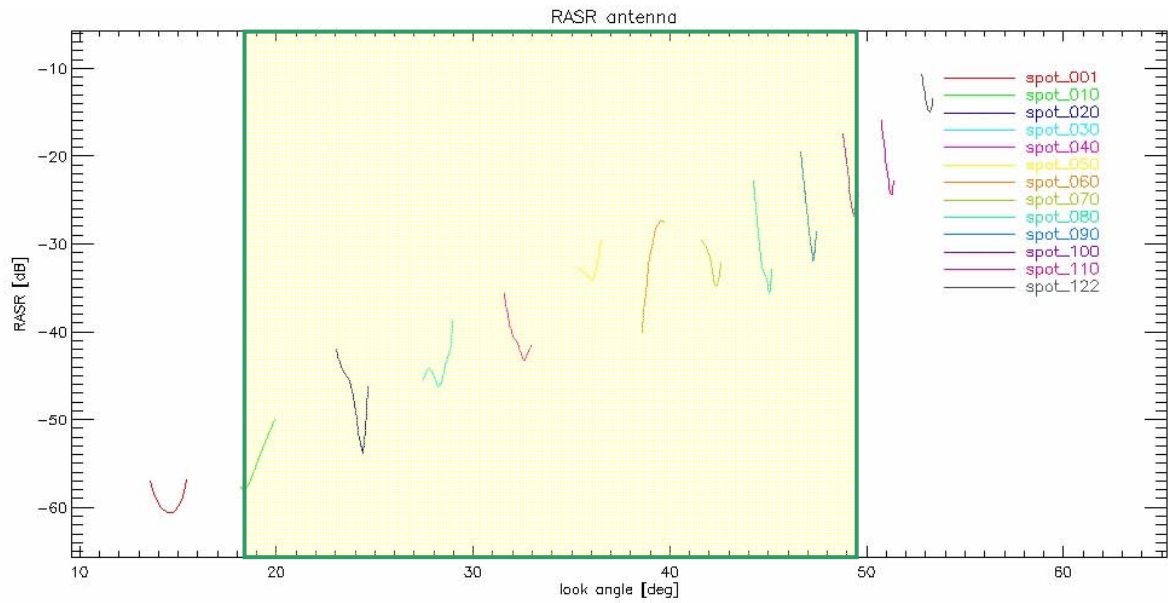

## High-Resolution Spotlight dual

### Geometric Resolution

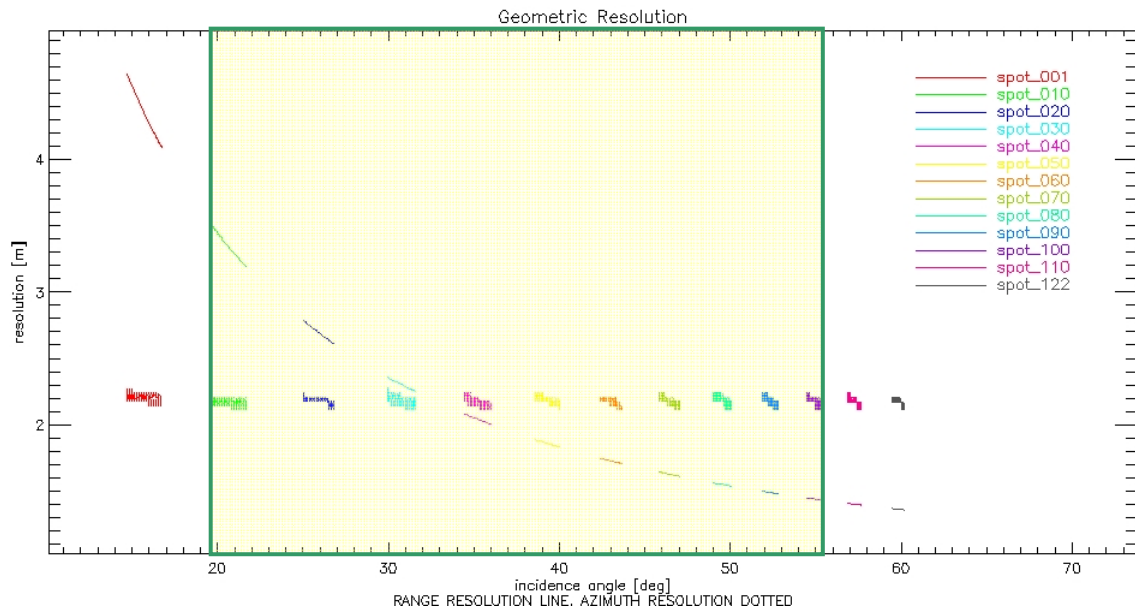

### Radiometric Parameters

#### HH

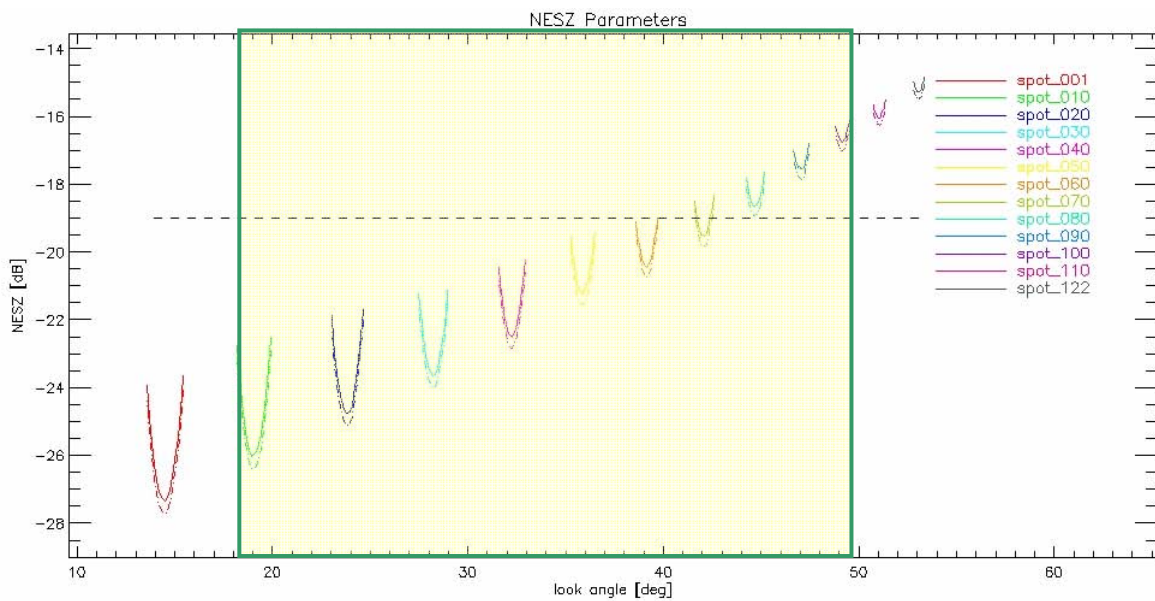

#### VV

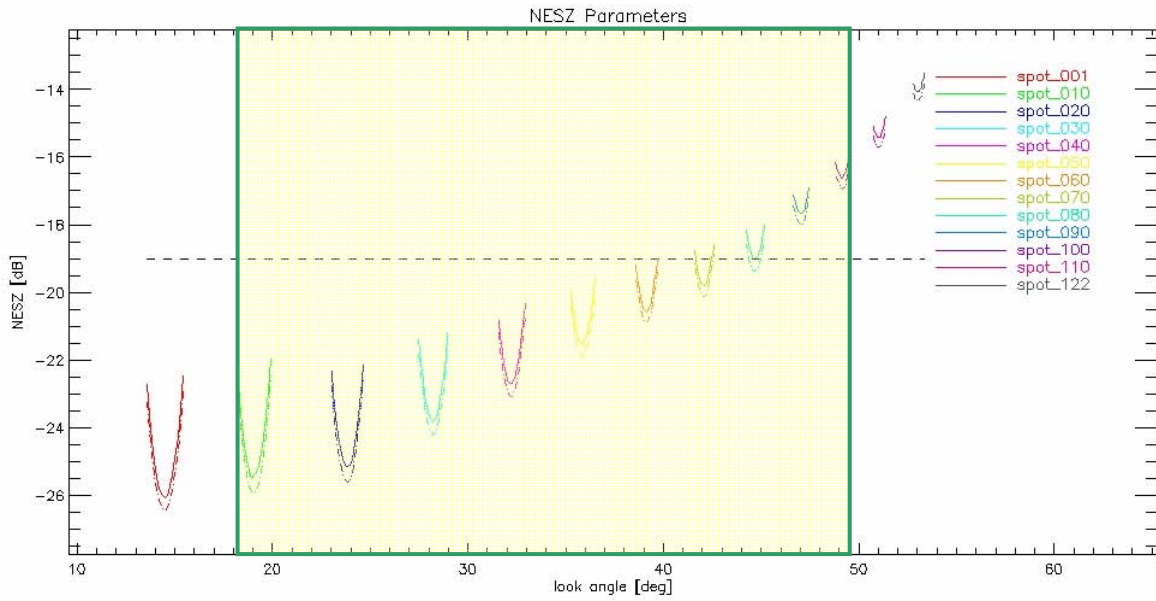

### Ambiguity Ratio Parameters

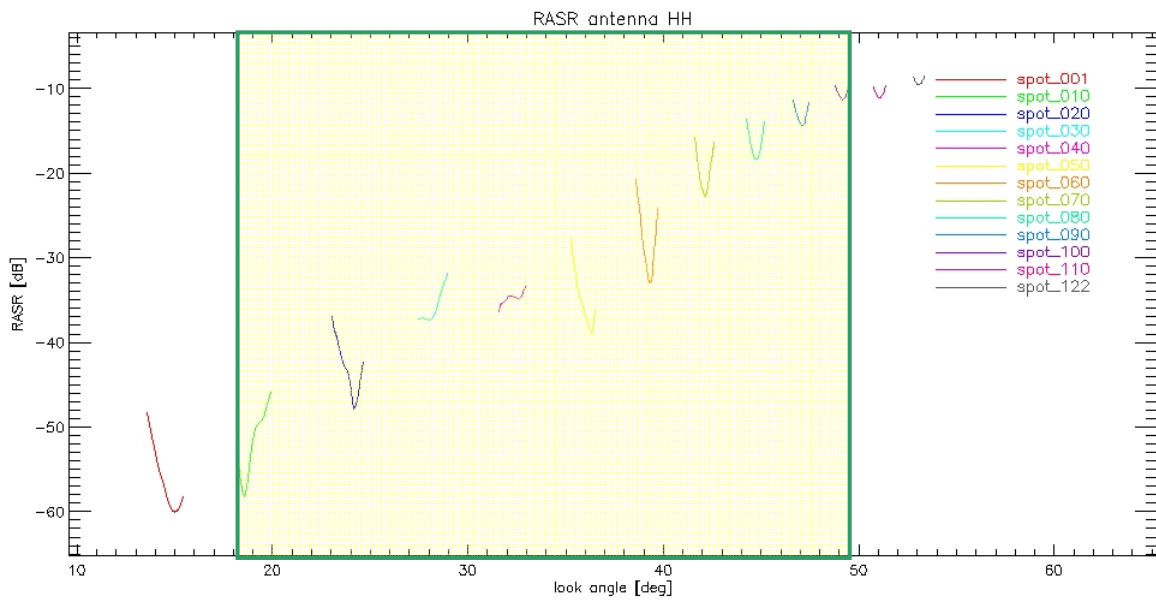

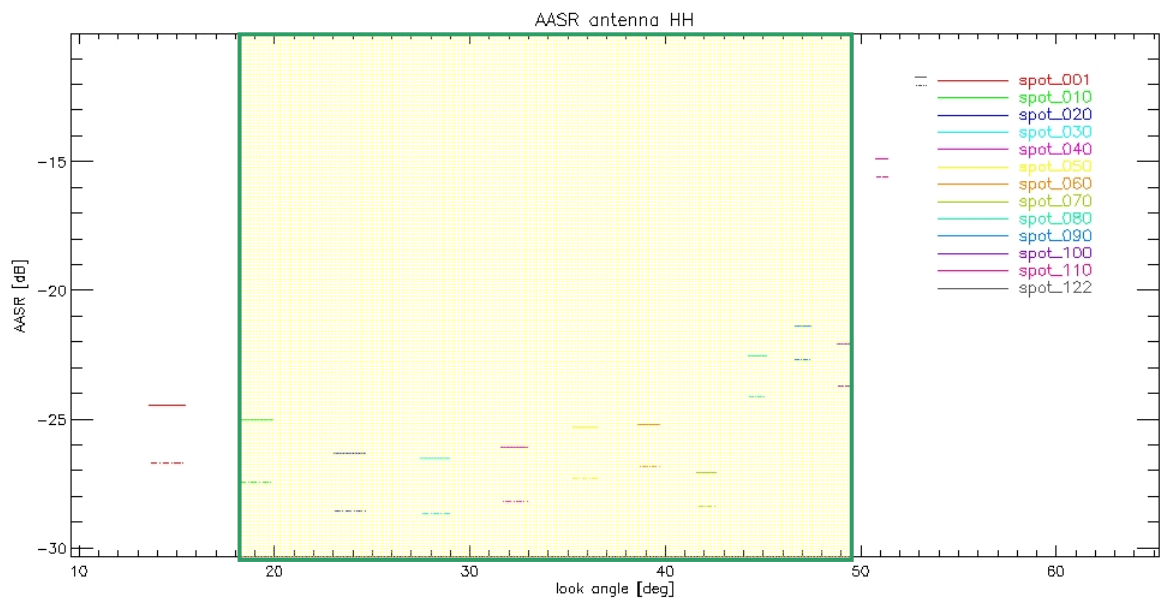
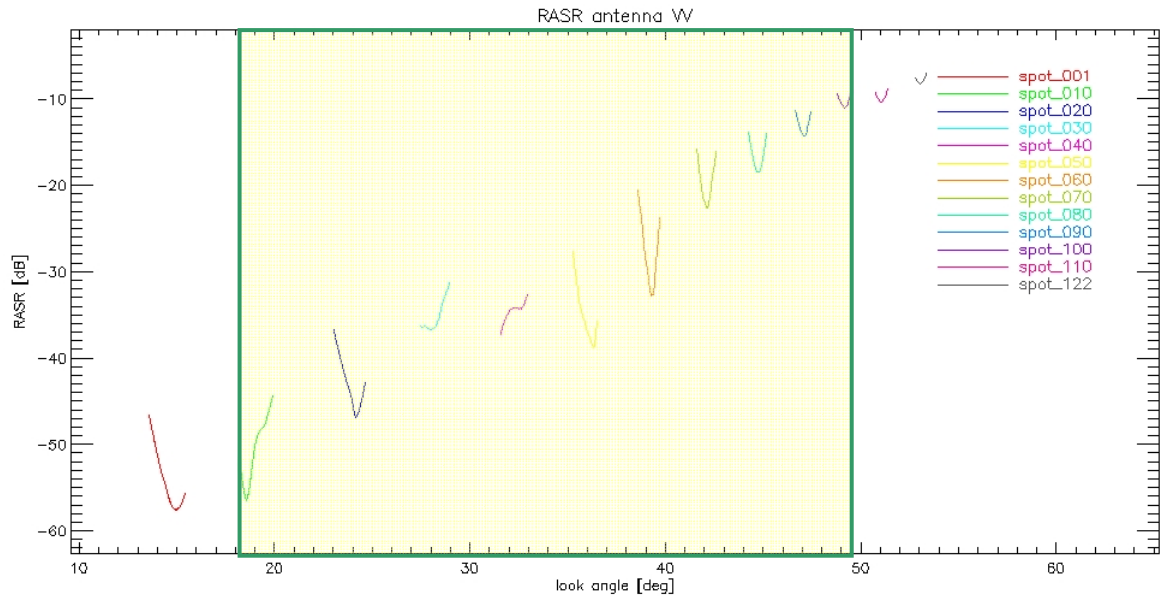

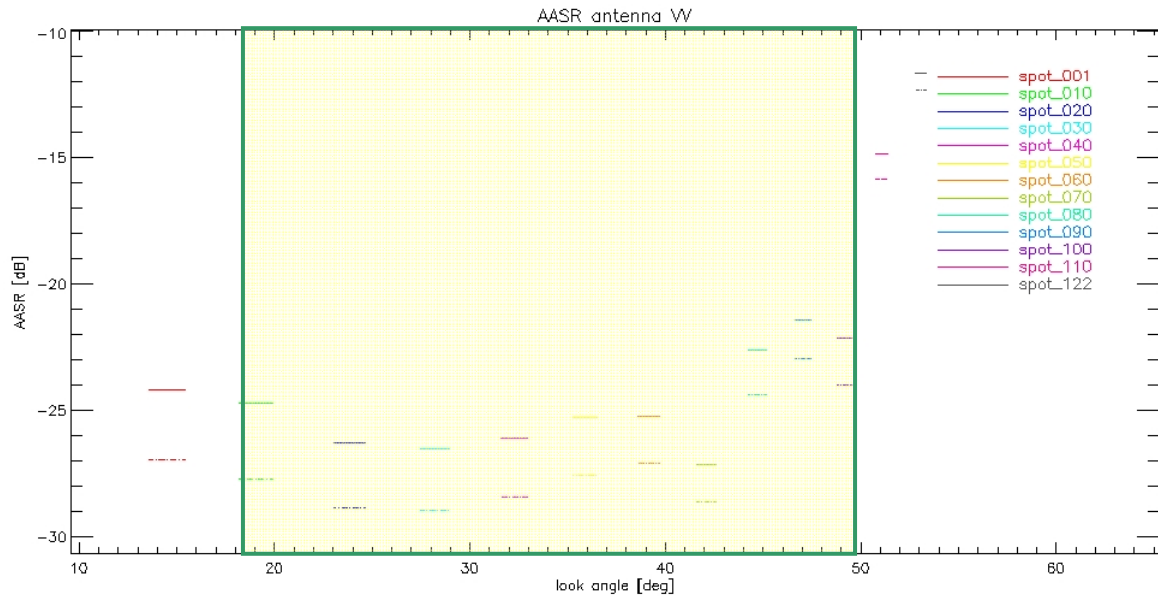

## ScanSAR

Note, the completion of the full data collection angle range for ScanSAR can be found in the next section.

### Geometric Resolution

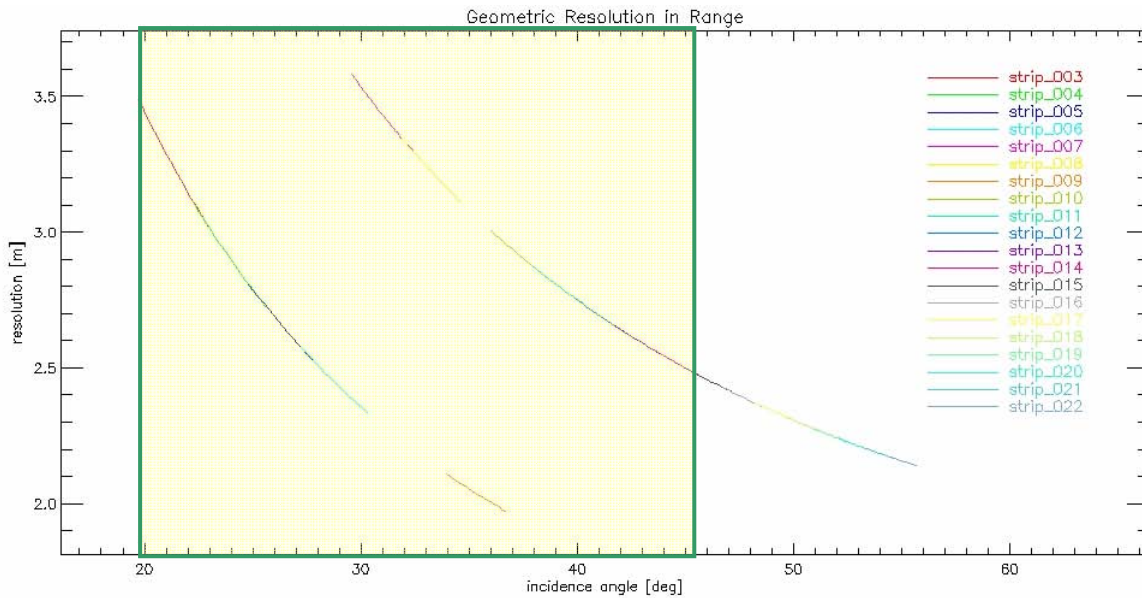

ScanSAR	Beam	Azimuth Resolution [m]
Scan_003-006	strip_003	17.83
	strip_004	17.80
	strip_005	17.81
	strip_006	17.75
Scan_007-010	strip_007	17.93
	strip_008	17.91
	strip_009	17.94
	strip_010	17.91
Scan_011-014	strip_011	18.01
	strip_012	17.98
	strip_013	17.93
	strip_014	17.94
Scan_015-018	strip_015	17.92
	strip_016	17.94
	strip_017	17.91
	strip_018	17.95
Scan_019-022	strip_019	17.81
	strip_020	17.78
	strip_021	17.82
	strip_022	17.79

## Radiometric Parameters

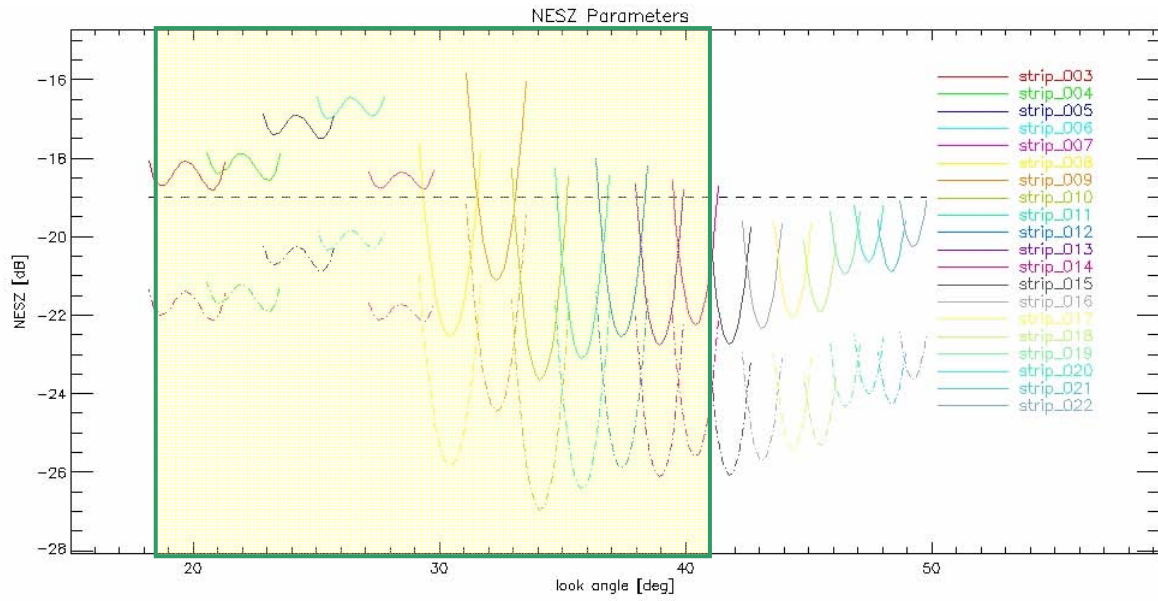

### Ambiguity Ratio Parameters

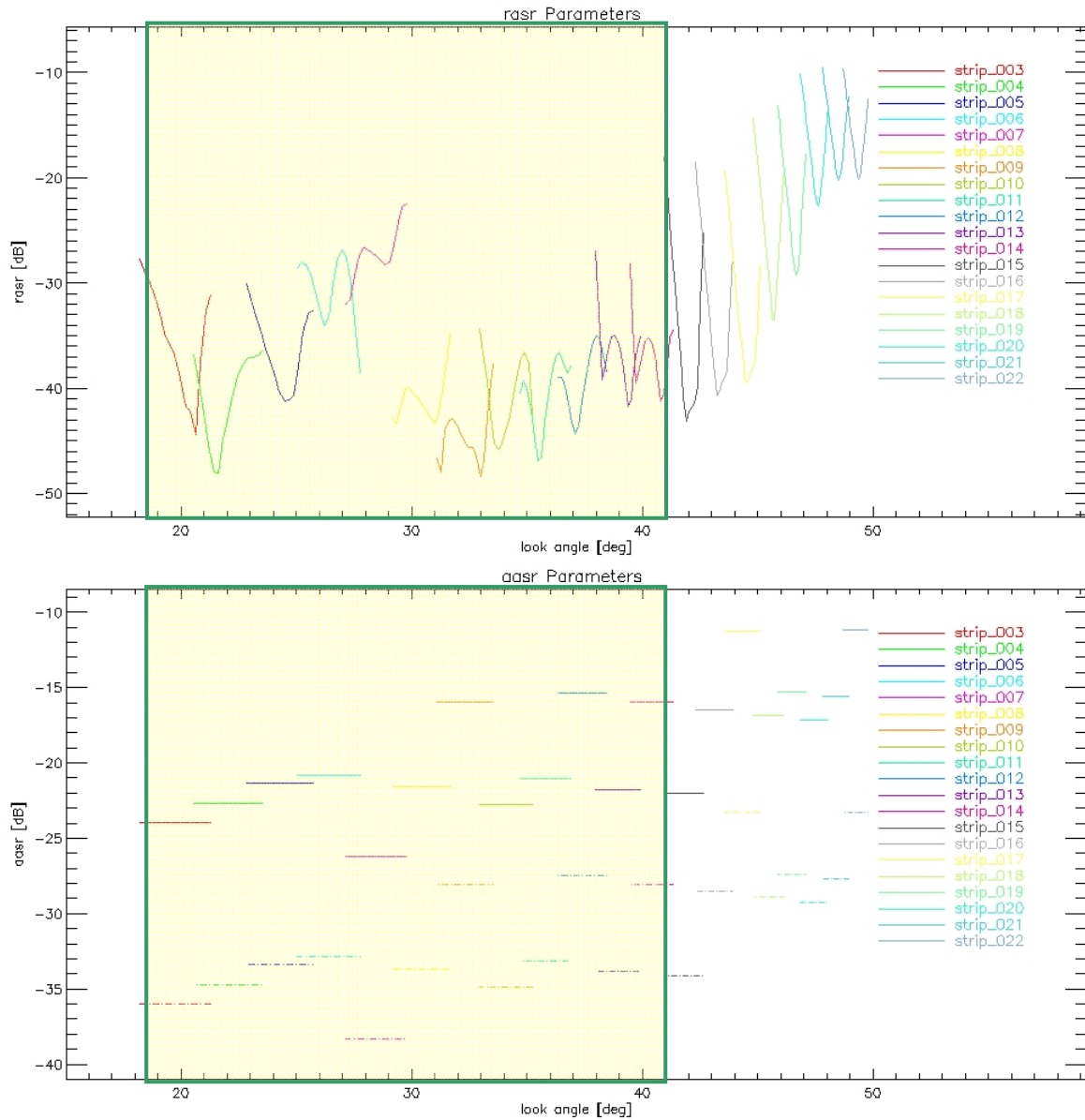



## ScanSAR (Completion of Data Collection Angle Range)

### Geometric Resolution

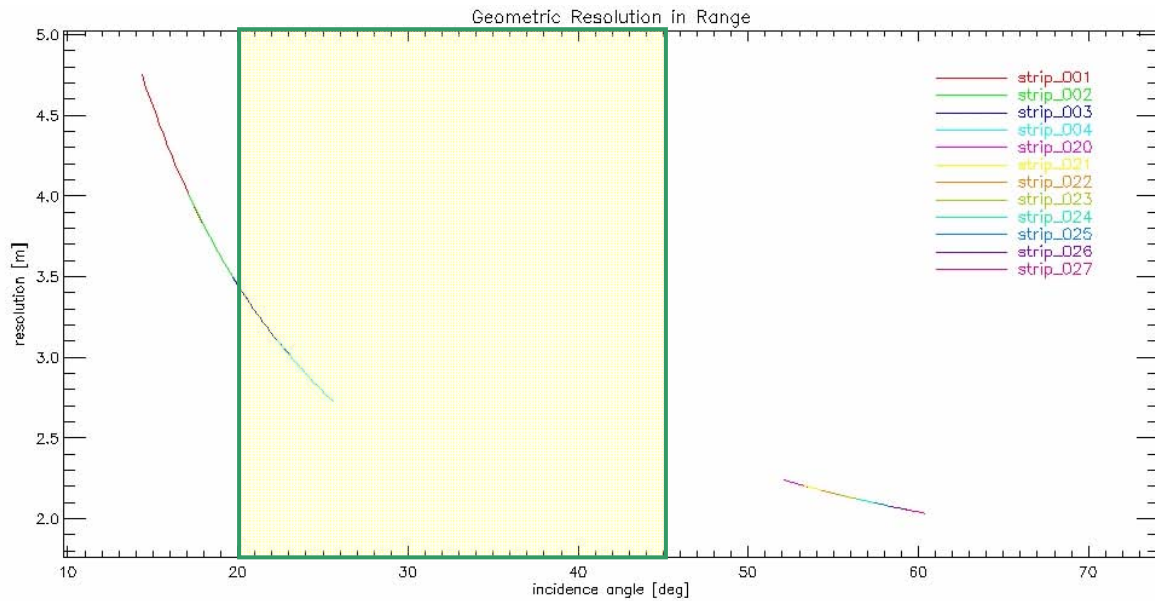

ScanSAR	Beam	Azimuth Resolution [m]
Scan_001-004	strip_001	17.74
	strip_002	17.67
	strip_003	17.70
	strip_004	17.69
Scan_020-023	strip_020	17.78
	strip_021	17.78
	strip_022	17.79
	strip_023	17.79
Scan_024-027	strip_024	17.74
	strip_025	17.73
	strip_026	17.74
	strip_027	17.70

### Radiometric Parameters

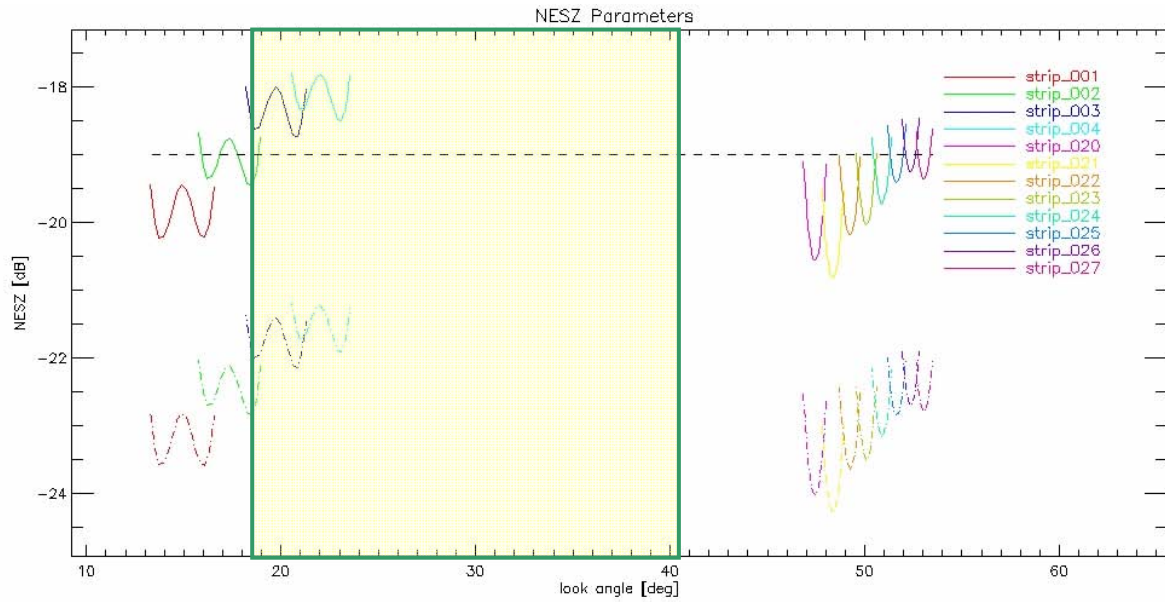

### Ambiguity Ratio Parameters

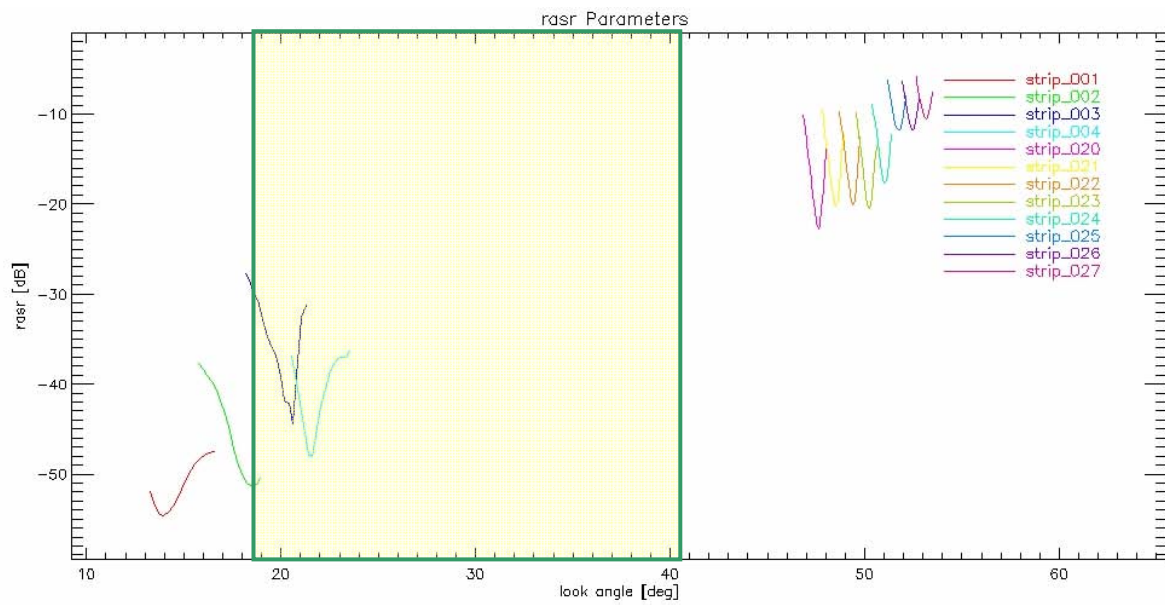

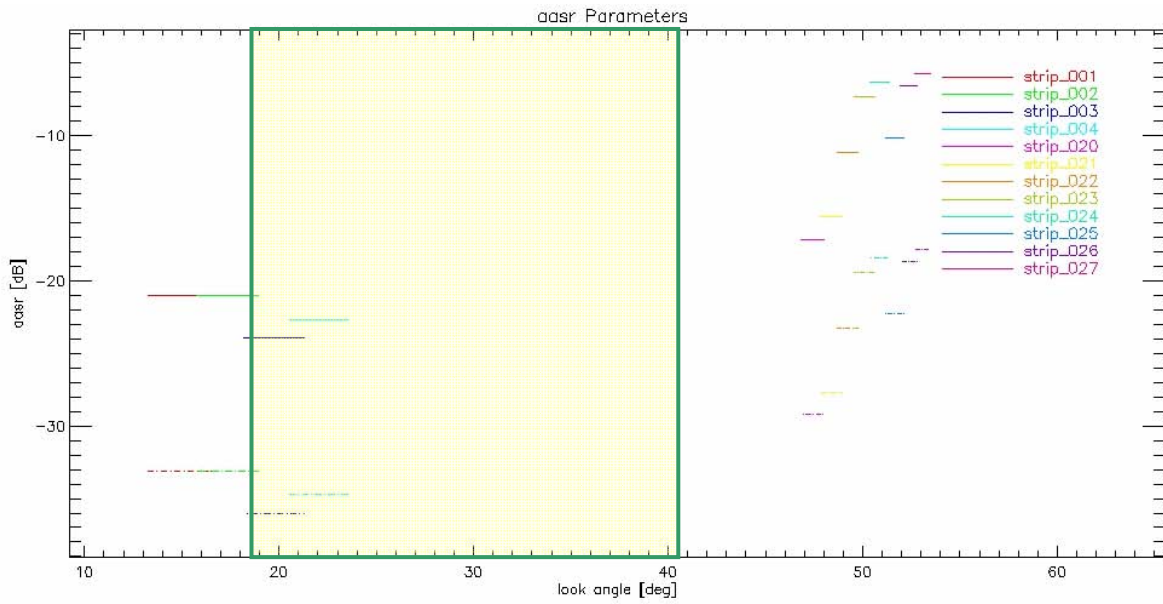

## **ANNEX D) Acronyms and Abbreviations**

ADC	Analog to Digital Converter
D	Dual Polarization
DAC	Direct Access Customer
DEM	Digital Elevation Model
DTAR	Distributed Target Ambiguity Ratio
EEC	Enhanced Ellipsoid Corrected
GEC	Geocoded Ellipsoid Corrected
GTC	Geocoded Terrain Corrected
H	Horizontal Polarization
HS	High Resolution spotlight Mode
ISLR	Integrated Sidelobe Ratio
IRF	Impulse Response Function
MGD	Multi Look Ground Range Detected
NEBZ	Noise Equivalent Beta Zero
NESZ	Noise Equivalent Sigma Zero
PRF	Pulse Repetition Frequency
PSLR	Peak Sidelobe Ratio
PTR	Point Target Response
Q	Quad Polarization
RAW	Raw Data
S	Single Polarization
SAAR	Signal Azimuth Ambiguity Ratio
SC	ScanSAR Mode
SL	spotlight Mode
SM	stripmap Mode
SRTM	Shuttle Radar Topography Mission
SSC	Single Look Slant Range Complex
T	Twin Polarization
TBC	to be confirmed
TBD	to be defined
TMSP	TerraSAR Multi Mode SAR Processor
UPS	Universal Polar Stereographic
UTM	Universal Transverse Mercator
V	Vertical Polarization