

Universal Software Defined Radio Development Platform

Dr. Bertalan Eged*, Benjamin Babják**

*Sagax Communication Ltd., Haller u. 11-13. Budapest 1096 Hungary

**Budapest University of Technology and Economics,

Department of Broadband Infocommunications and Electromagnetic Theory

Goldmann Gy. tér 3.

Budapest 1111

Hungary

bertalan.eged@sagax.hu

ABSTRACT

Software defined radio components will play important role in future of wireless communication networks. The paper deals with the introduction of a prototype platform for software defined radio solutions, which supports the development of the waveforms and applications for reconfigurable radio components with adaptive and reactive modulation formats. High-speed, high-bandwidth converter family is shown with some example applications to demonstrate the capability of the components.

1.0 INTRODUCTION

As an introduction for the topic let us summarize some basic characteristic of existing and evolving radio communication. As you may know the armed forces are equipped with a lot of communication devices including radio equipments and systems. E.g. in the US Army up to 25-30 radio-families are in use, which applied in a complex mission have to co-operate with Navy and Air force systems too. Assuming an operation carried out by international troops the number of systems and equipments becomes even larger, and the problem of interoperability becomes sorely serious.

More complex missions require more complex communication systems. Each newly added system specification is accompanied by the demand of new radio devices, requiring application specific hardware and software components. Manifolding new radio equipment adds significant costs to service and maintenance of these systems.

2.0 SOFTWARE DEFINED RADIO TECHNOLOGY

Let us examine how Software Defined Radio Technology could help us solve the previously mentioned and other problems. The main principle of SDR is that considerable part of the radio is realized as software running on programmable and reconfigurable hardware devices. The hardware itself is referred to as the „radio platform”, while the different layers of software are called „application framework”. This scheme provides universal and reusable components, which save costs and can be easily upgraded. It is important to emphasize that although it is an enabling technology, SDR itself is not an actual product. SDR is rather a kind of principle to build radio devices on. SDR covers different kind of hardware and software components, which can be stand-alone products used to build SDR based solutions. The providers and users of this technology joined in an industrial alliance called SDR Forum [1].

Eged, B.; Babják, B. (2006) Universal Software Defined Radio Development Platform. In *Dynamic Communications Management* (pp. 11-1 – 11-12). Meeting Proceedings RTO-MP-IST-062, Paper 11. Neuilly-sur-Seine, France: RTO. Available from: <http://www.rto.nato.int/abstracts.asp>.

Report Documentation Page

Form Approved
OMB No. 0704-0188

Public reporting burden for the collection of information is estimated to average 1 hour per response, including the time for reviewing instructions, searching existing data sources, gathering and maintaining the data needed, and completing and reviewing the collection of information. Send comments regarding this burden estimate or any other aspect of this collection of information, including suggestions for reducing this burden, to Washington Headquarters Services, Directorate for Information Operations and Reports, 1215 Jefferson Davis Highway, Suite 1204, Arlington VA 22202-4302. Respondents should be aware that notwithstanding any other provision of law, no person shall be subject to a penalty for failing to comply with a collection of information if it does not display a currently valid OMB control number.

1. REPORT DATE 01 OCT 2006	2. REPORT TYPE N/A	3. DATES COVERED -	
4. TITLE AND SUBTITLE Universal Software Defined Radio Development Platform		5a. CONTRACT NUMBER	
		5b. GRANT NUMBER	
		5c. PROGRAM ELEMENT NUMBER	
6. AUTHOR(S)		5d. PROJECT NUMBER	
		5e. TASK NUMBER	
		5f. WORK UNIT NUMBER	
7. PERFORMING ORGANIZATION NAME(S) AND ADDRESS(ES) Sagax Communication Ltd., Haller u. 11-13. Budapest 1096 Hungary		8. PERFORMING ORGANIZATION REPORT NUMBER	
9. SPONSORING/MONITORING AGENCY NAME(S) AND ADDRESS(ES)		10. SPONSOR/MONITOR'S ACRONYM(S)	
		11. SPONSOR/MONITOR'S REPORT NUMBER(S)	
12. DISTRIBUTION/AVAILABILITY STATEMENT Approved for public release, distribution unlimited			
13. SUPPLEMENTARY NOTES See also ADM202422., The original document contains color images.			
14. ABSTRACT			
15. SUBJECT TERMS			
16. SECURITY CLASSIFICATION OF:			17. LIMITATION OF ABSTRACT
a. REPORT unclassified	b. ABSTRACT unclassified	c. THIS PAGE unclassified	UU
			18. NUMBER OF PAGES 36
			19a. NAME OF RESPONSIBLE PERSON

Universal Software Defined Radio Development Platform

The SDR architecture (figure 1.) consists of functional hardware elements connected through open interfaces, and firmware procedures for adding software specific tasks to each of the functional areas. These parts of the model are jointly referred to as the „hardware platform”.

The software necessary to operate is called the „operating software” (OS) running on the hardware based on its firmware. This operating environment provides a common interface for the upper layer. With the common interface we have a radio infrastructure, which is ready to run application specific software modules completing the whole solution.

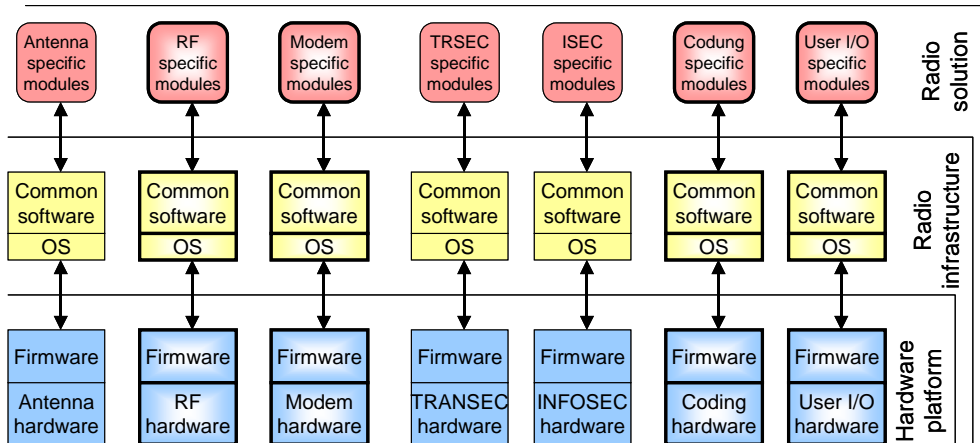

Figure 1: SDR architecture model

The common interface also known as software API layer is very important, since it allows solutions and platforms provided by different vendors to work together. The common software API layer shown in figure 2. is standardized with common functions having open and published interfaces.

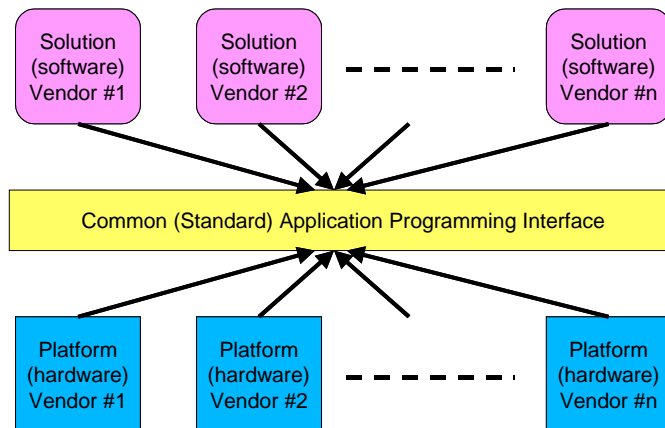

Figure 2: SDR open architecture

Currently the accepted common interface for military applications is the Software Communication Architecture developed by the Joint Tactical Radio System (JTRS) project.

„The Joint Tactical Radio System is a DoD initiative. JTRS is designed to provide a flexible new approach to meet diverse warfighter communication needs through software programmable radio technology.”

Quoted from JTRS homepage [2].

The key result of the JTRS Program shown in figure 3. is the specification of the Software Communications Architecture (SCA), which serves as standard for (nearly) all military SDRs [3]. It is a framework of an open, distributed, object oriented architecture, and it separates the application (waveform functionality) from the Operating Environment. SCA defines common interfaces for the behaviour and the installation of software components. Furthermore it defines common services and Application Programming Interface to support the portability of devices and applications.

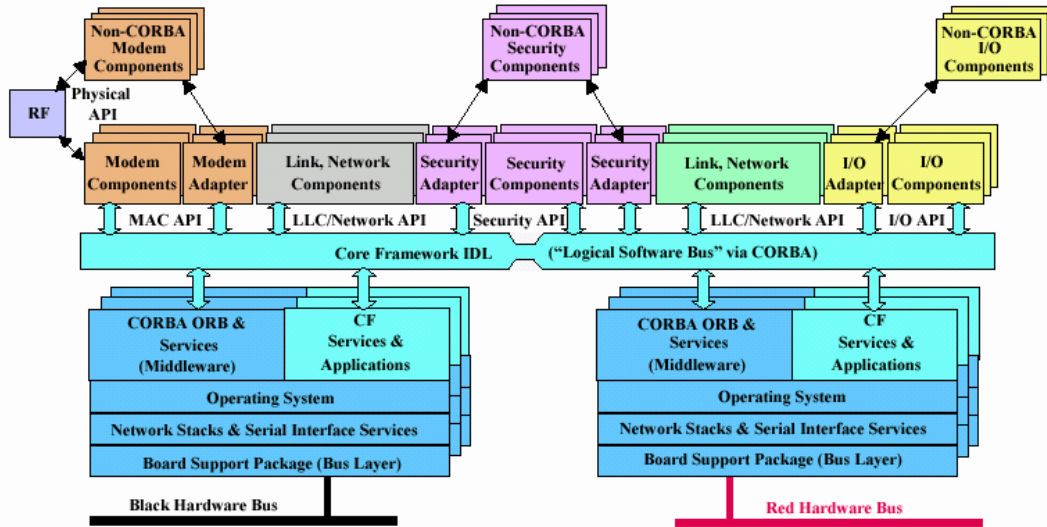

Figure 3: Software Communication Architecture

3.0 RADIO DEVICE MODELLING

Traditionally a radio has been considered to be the „box” connecting to the antenna and everything behind that. However many system designs are segmented into separate subsystems: RF to IF down-conversion, baseband conversion and demodulation, man-machine interface elements. The high-level functional model of the SDR radio platform (figure 4.) consists of only three main elements: the analogue front-end, the domain conversion and the digital back-end.

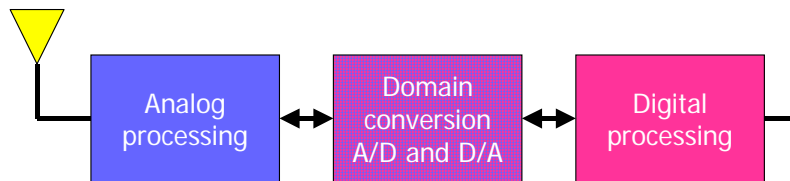

Figure 4: SDR based radio implementation

The analogue front-end is responsible for frequency conversion between the transmitted signal frequency and the digitally processable frequency and bandwidth. The front-end is based on analogue amplifiers, mixers, filters and frequency sources. The domain converter responsible for the conversion between the analogue and digital domain are based on high-speed, wideband A/D and D/A converters. Properties of the domain converters highly influence the functionality of soft radio platforms. The digital back-end contains FPGA based configurable and/or DSP based programmable computing resources to run the software components.

Universal Software Defined Radio Development Platform

Software defined radio technology is based on the principle, that conversion between analogue and digital domains should take place as close to the antenna as possible, providing the potential of maintaining signals in digital domain.

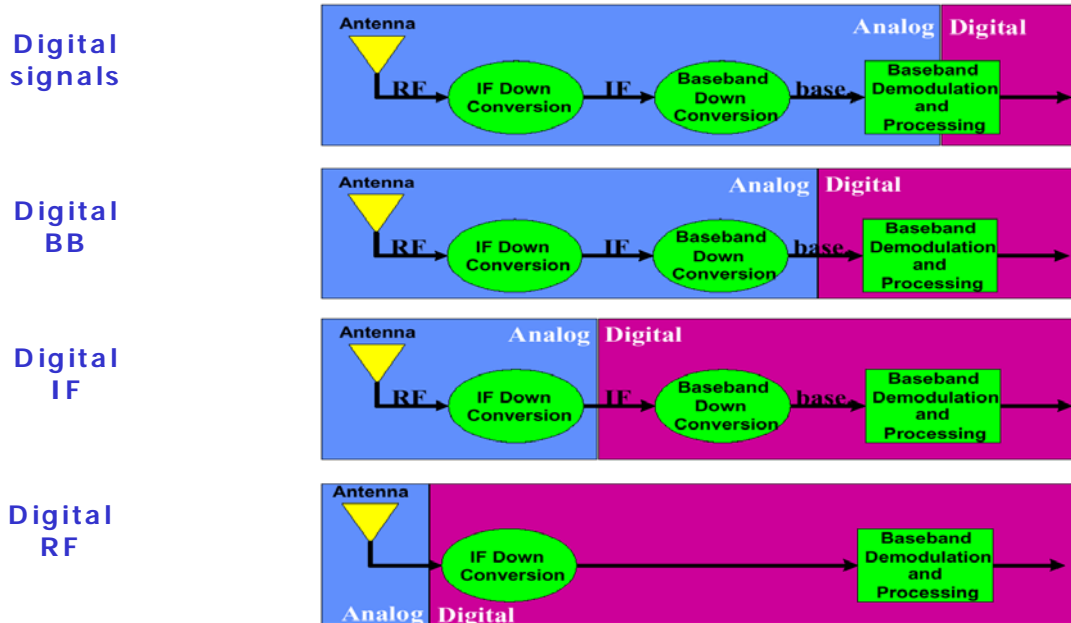

Figure 5: Implementation levels

Based on the domain conversions place (shown in figure 5.) the implementation level of SDR technology can be classified from digital signal handling through digital baseband, digital IF or even digital RF implementation. This is the reason, why the converters bandwidth is so important. It can determine the whole solutions implementation level.

4.0 DEVELOPMENT PLATFORM COMPONENTS

In figure 6. components of an experimental SDR platform are shown.

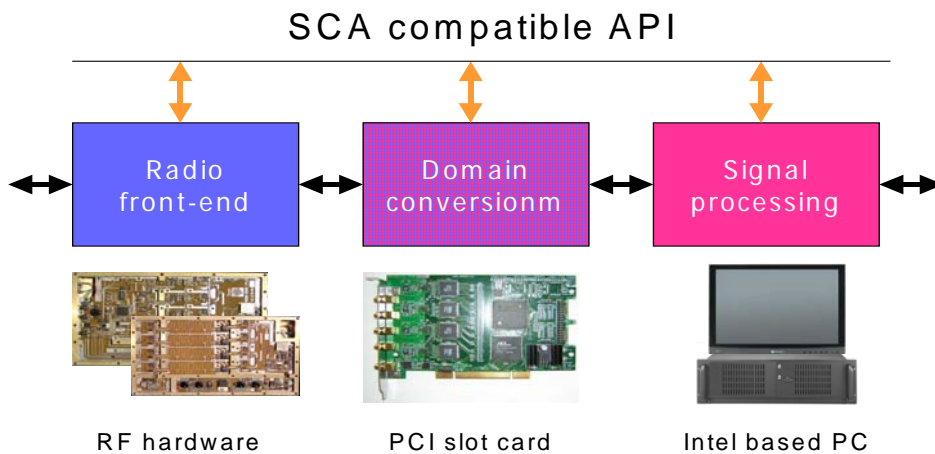

Figure 6: Experimental SDR platform

We have developed ready to use solutions for the analogue radio front-end (in the form of traditional radio frequency hardware) and for the wide-band and narrow-band domain conversion (in the form of PC slot cards with PCI interface). Signal processing is done with an off-the-shelf Intel based PC, which also serves as control platform. Let us examine the components one by one.

4.1 Front-end

The radio front-ends are based on a universal structure build around 6 basic blocks shown in Figure 7.

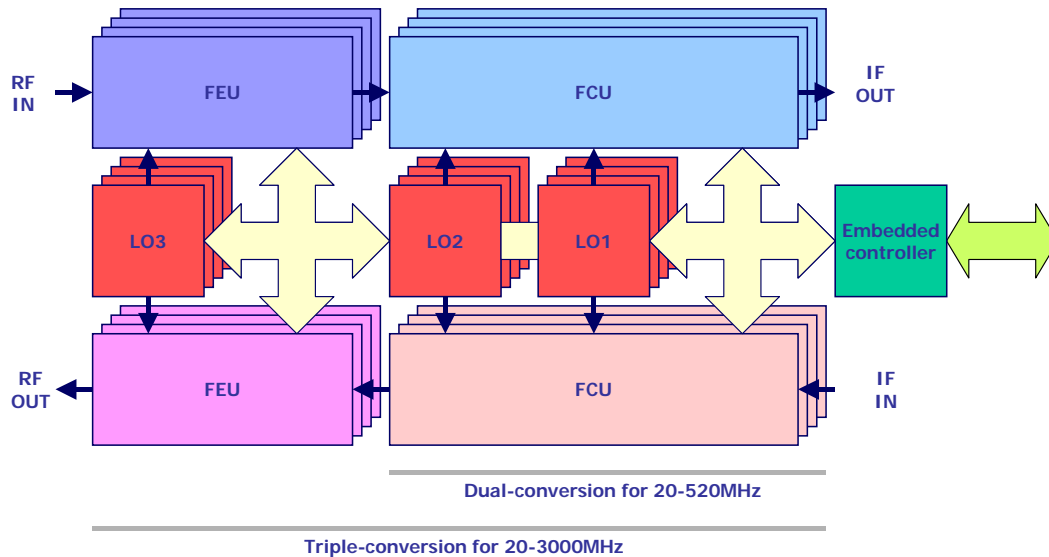

Figure 7: Universal front-end structure

The frequency conversion between VHF/UHF frequency band and any standard intermediate frequency (IF) is realized by a dual-conversion structure, which requires two frequency synthesizers as local sources, and conversion hardware containing frequency mixers, filters, amplifiers.

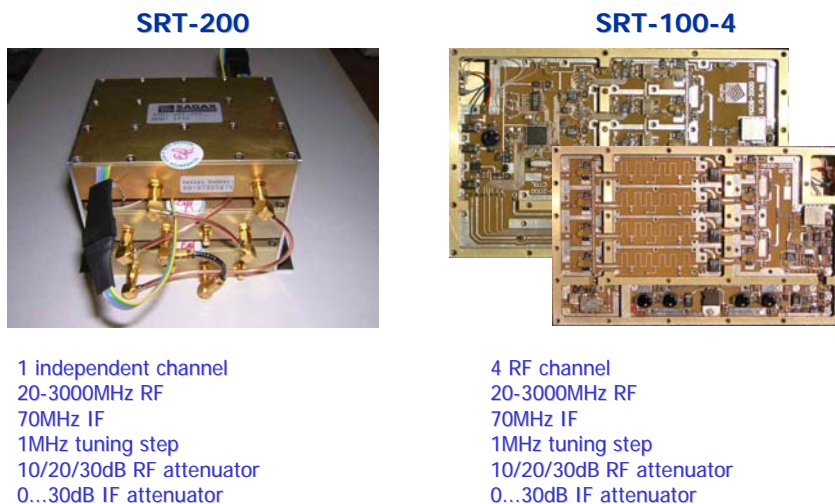

Figure 8: RF front-ends

Universal Software Defined Radio Development Platform

The number of basic building blocks depends on the application, which could be a receiver, transmitter or transceiver, single- or multi-channel and in case of multi-channel independent or phase array. The frequency and gain control elements could be controlled by the internal embedded controller, or could be controlled directly by the application or digital processor if the high-speed processing speed is required. In the case of VHF/UHF application where frequency coverage up to 3 GHz is required one additional frequency extension unit and one more local oscillator is used. The number of units is determined by the application requirements.

In figure 8. two RF front-end implementations are shown. The first front-end has 1 independent channel, while the second is capable of processing 4 RF channels simultaneously. Other parameters are fairly similar.

4.2 Conversion technology

The parts of the converter product family are based on the same base structure (shown in figure 9.). The cards contain a 5V tolerant, master mode, DMA capable PCI host-interface chip, which is connected to the FPGA reserved for on-board data pre-processing and glue-logic implementation. The required logic functionality is implemented in the FPGA to control the front-end functionality and manage the data flow. The FPGA can be configured directly through its JTAG port or it can boot from the programmed configuration EEPROM. Users also have the possibility to download firmware through the PCI bus providing on the field pre-processor reprogrammability.

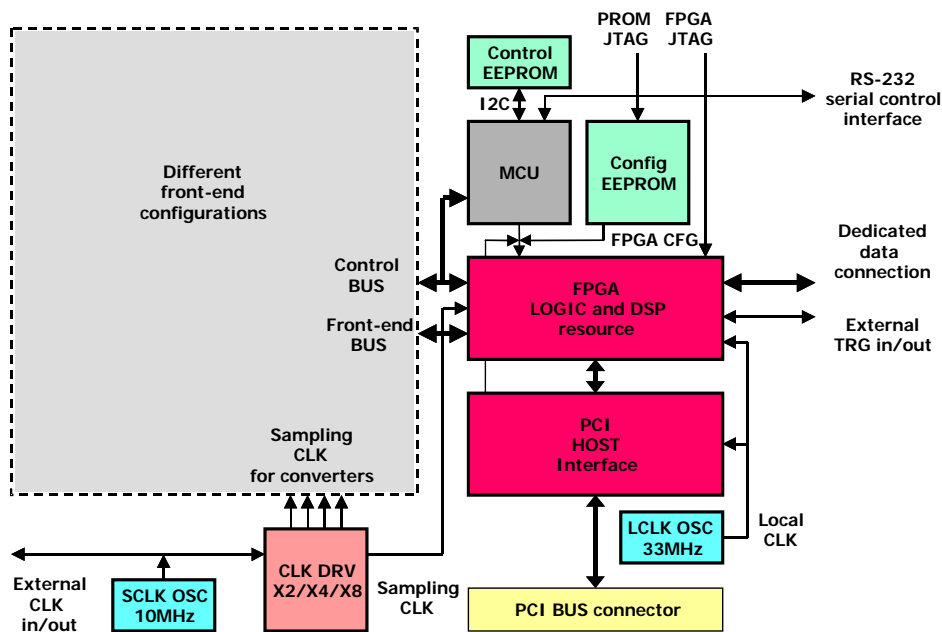

Figure 9: General digital back-end for converters

The cards also contain a micro controller unit. This MCU has an I2C connected external EEPROM and an external serial port connection. The MCU is routed to the control bus and to the FPGAs configuration connection. Through its connections the MCU is able to configure the FPGA provided a configuration EEPROM is present, and is able to control the front-end if PCI control is not applicable.

The data flow from/to the front-end can be implemented through the PCI bus or it is also possible to route the data flow to the dedicated ports of the FPGA. This option can be used to implement direct high-speed

data connection directly to a DSP processor. In this case the PCI interface is used for control only, in addition the front-end may also be controlled by the MCU.

The cards contain a clock generation block with internal and external clocking options. The clock buffer is able to multiply the clock by 2 to 8 depending on the configuration. The sampling clock is routed to the dedicated global clock input of the FPGA. The communication between the FPGA and the PCI chip is clocked from a separate local clock source. Sampling may also be triggered externally.

Currently we offer two basic types of converter cards for domain conversion (shown in figure 10).

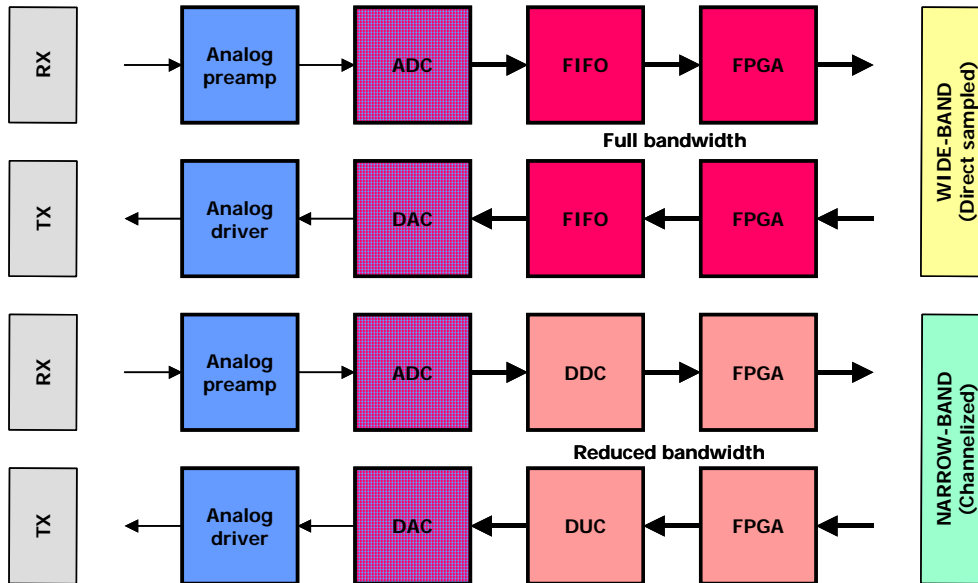

Figure 10: Wide-band and narrow-band converters

One of them is wide-band, meaning that digitised samples are stored in a high-speed FIFO memory. Samples can be accessed by the digital pre-processor implemented in the FPGA for the purpose of reading or writing in case of transmit or receive operation. This way the converter hardware itself does not limit the data bandwidth. Generally it is limited by the throughput of the digital interface between converter and digital processor, e.g. the PCI bus. Provided we have enough resources it is possible to implement bandwidth reduction processing optionally in the configurable on-board pre-processor FPGA.

Second type of the converter family is a narrow-band or channelised converter. In this case we have built in dedicated channel selector hardware components between the converters and the pre-processor. The bandwidth reduction is realised by the digital down-converter (DDC) and the digital up-converter (DUC) for the receiver and transmitter operations respectively. The digital tuners are implemented in ASIC chips in order to optimise the workload of the processing elements.

In figure 11. two wide-band converters are shown. The first converter is from the DCU-2xx product family, it has 4 channels and a 32bit PCI interface. Converter products in the DCU-3xx family can also process 4 channels, and are connected to the host system via a 64bit PCI interface.

In figure 12. two narrow-band converters are shown. The first converter is from the DRU-2xx product family, it has 4 channels and a 32bit PCI interface. Converter products in the DRU-3xx family may process up to 16 channels, and are connected to the host system via a 64bit PCI interface.

Universal Software Defined Radio Development Platform

DCU-2xx



Max. 4 analog I/O channels
 1 clock I/O channel
 80Msps/14bit sampling
 500MHz bandwidth
 40 bit front-end bus
 Xilinx Spartan II FPGA
 32bit/33MHz PCI interface
 133Mbyte/sec signalling rate

DCU-3xx

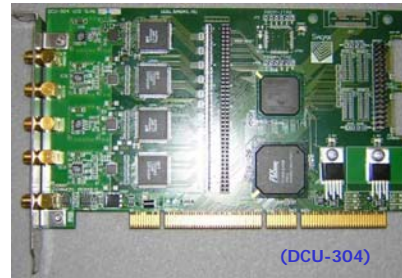

Max. 4 analog I/O channels
 1 clock I/O channel
 80Msps/14bit sampling
 500MHz bandwidth
80 bit front-end bus
Xilinx Virtex II FPGA
64bit/66MHz PCI interface
528Mbyte/sec signalling rate

Figure 11: Wide-band converters

DRU-2xx

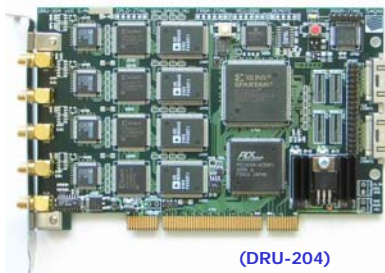

Max. 4 independent analog I/O channels
 1 clock I/O channel
 80Msps/14bit sampling
 500MHz bandwidth
 Xilinx Spartan II FPGA
 Max. 4 independent digital tuner

DRU-3xx



Max. 16 independent analog I/O channels
 1 clock I/O channel
 80Msps/14bit sampling
 500MHz bandwidth
Xilinx Virtex II FPGA
Max. 16 independent digital tuner

Figure 12: Narrow-band converters

4.3 Digital Signal Processing

Digital processing may be done with dedicated digital signal processors (DSP) or general purpose processors. The DSP elements generally provide more and dedicated bandwidth for data transfer. They provide more processing power mainly by their dedicated hardware multipliers and other processing oriented architectural elements.

However, general processors recently show extremely fast growing thanks to the high volume production and market demands. It seems that data bandwidth between the peripheral components, memory and processor has significantly increased as they are routed together by one chip with dedicated data connections. The architecture and clock speed of general processors provide enough processing power for implementing signal processing algorithms without dedicated processing elements like multipliers.

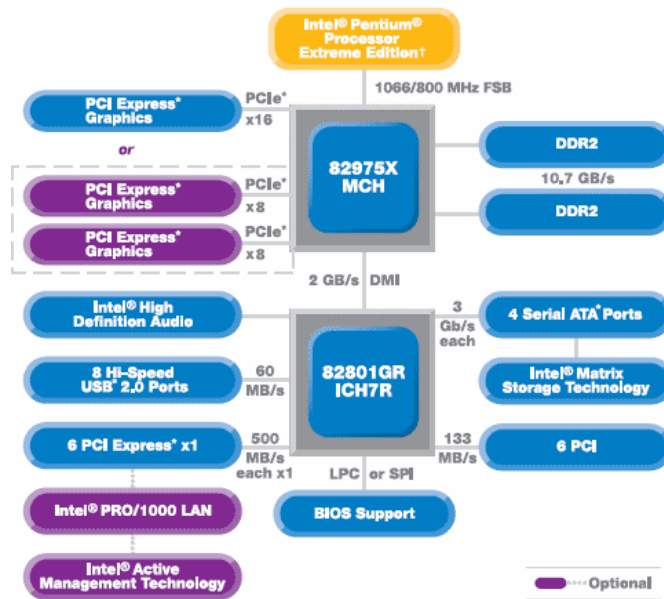

Figure 13: State of the art PC architecture [4]

On the other hand ready to use operating systems (OS) or even real-time operating systems (RTOS) are available for these processors with well-documented and well-supported software development tools. So we have decided to use latest Intel based architecture and processors (shown in figure 13.) as signal-processing element instead of dedicated DSPs.

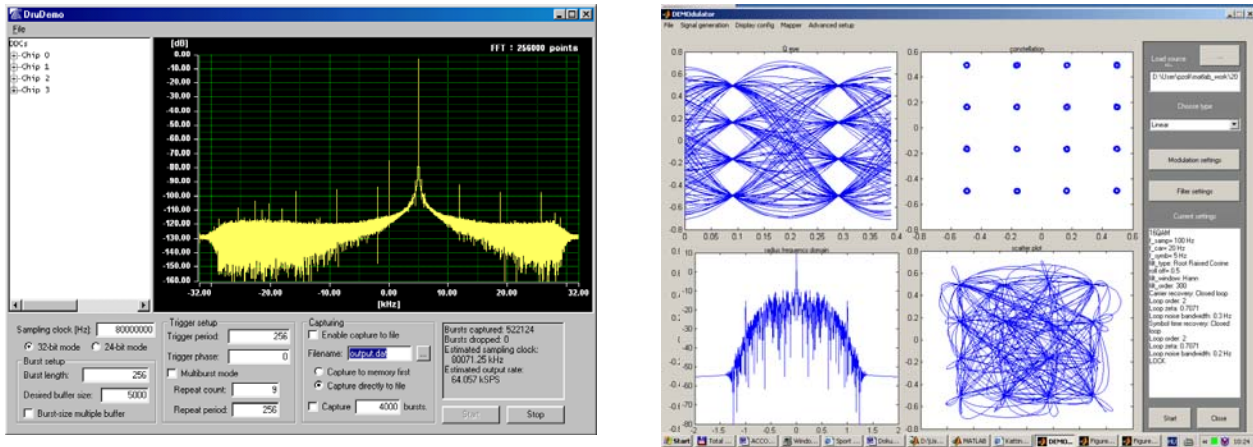

Figure 14: Digital analysis

After choosing the PC as our working platform, we have developed for processing purposes some basic software including waveform generation and signal analysis as represented by the pictures in figure 14. As described at the principle of SDR technology, the success of the SDR is based on the published and open interface of the components. Our software is based on an application-programming interface (API) defined by us. Software modules and application developed by our team could be used as starting point to develop any other solution based on our hardware elements.

Universal Software Defined Radio Development Platform

5.0 EXAMPLES

In the following part of this document we will show some practical example implementations based on our SDR technology.

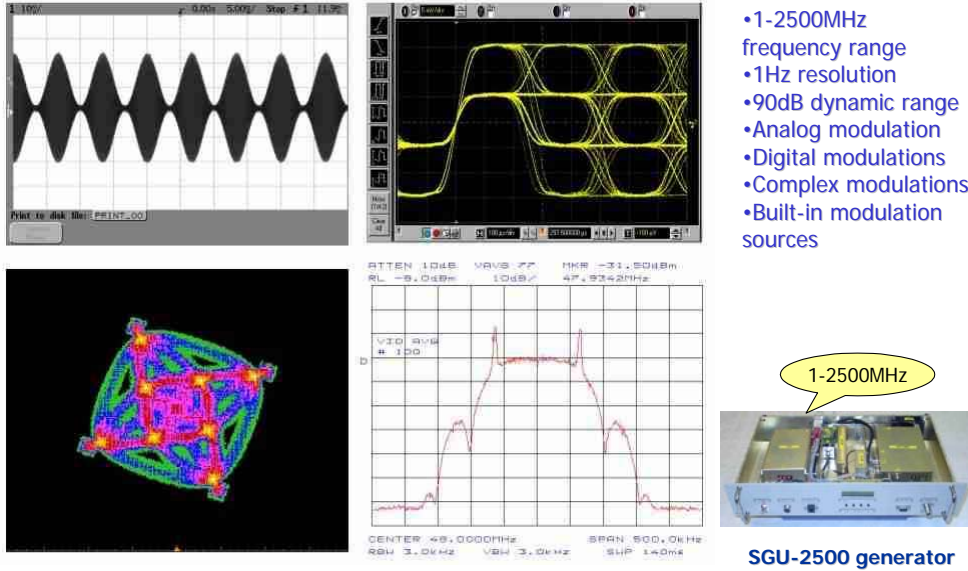

Figure 15: Modulation generator

The first case seen in figure 15. is a good example for complex waveform generation. This device can be used to generate modulated carriers from 1MHz up to 2500MHz with 1Hz resolution. The unique feature of this equipment is that it contains lot of modulation formats and sources called waveforms in the language of SDR technology. Simple analogue modulations like AM, FM, SSB, digital modulations like ASK, PSK, FSK and its variants, complex modulations up to 256 QAM and some other techniques like DSSS, FHSS, FDM, TDM could be used.

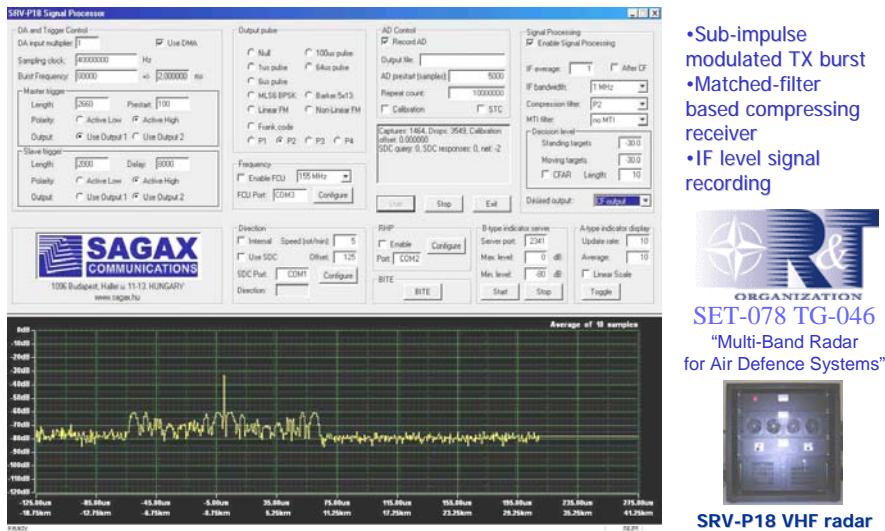
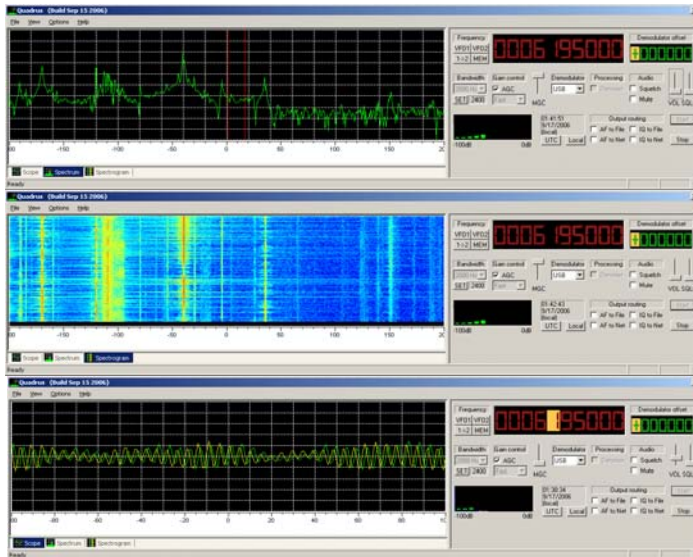

Figure 16: Burst of the radar application

The next example is also a kind of waveform generation, but in this case we use the SDR technology and platform components to generate radar signals with sub-impulse modulation. As you may see from the screen shot of the signal processor (shown in figure 16.) the application is used for generating different kind of sub-pulse modulated BPSK bursts with some code content, linear and non-linear FM modulation. The signal processor of the receiver contains the matched filter based pulse compressor for these signals. This experimental radar system was used in the trial of SET-078 TG-46 too.

The two last examples show other type of usage of our SDR technology.



- Integrated front-end tuner
- 20-3000MHz VUHF
- 1.5-32MHz HF
- 300KHz IF bandwidth
- AM/FM/SSB/ISB demodulation
- Hard disk recording facility



SRM-3000H receiver

Figure 17: Monitoring receiver

One of them is a monitoring receiver (shown in figure 17.) where the narrow-band converter is used for digitising the incoming 40MHz bandwidth limited from 1.5MHz to 32MHz HF band and forms a direct digital receiver (DDR) for that band. The monitoring receiver provides up to 300KHz instantaneous bandwidth for digitally implemented demodulators.

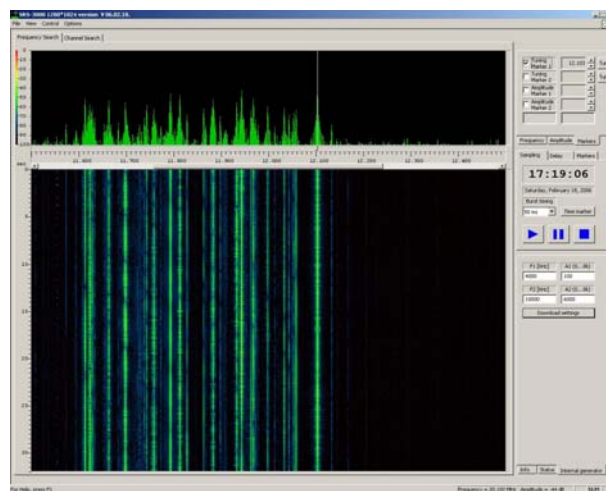

- 40MHz instantaneous bandwidth
- 1ms time resolution
- 1KHz frequency resolution
- 1200/3200 pixel display
- Full or partial bandwidth processing



SRS-3000H receiver

Figure 18: Scanning receiver

Universal Software Defined Radio Development Platform

The last example (shown in figure 18.) illustrates the usage of the wide-band converter to build a fast scanning panorama receiver. In that case the spectrum estimation is done by digital processing, and by using the Windows-based graphical interface it is possible to search a wide frequency range for signals. This kind of receiver can be integrated into a bigger spectrum management system.

6.0 CONCLUSION

In this document we have introduced the basic principles of the SDR, the technology that is the framework of future radio devices and system development. We have defined a basic model of radio devices based on SDR. Following that we have introduced a universal development hardware platform and its components. Finally we presented some example applications based on the previously mentioned hardware platform.

- [1] <http://www.sdrforum.org>
- [2] <http://jtrs.army.mil>
- [3] <http://jtrs.spawar.navy.mil/sca>
- [4] <http://www.intel.com/products/chipsets/975x>

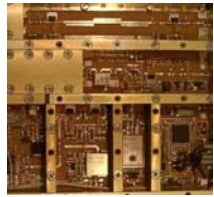

Analog-



and digital hw

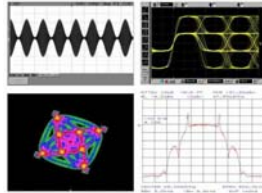

Signal processing-



and operating sw



Equipment



System

Universal Software Defined Radio Development Platform

Dr. Bertalan Eged*, Benjamin Babják**

*Sagax Communication Ltd., 1096 Budapest Haller u. 11-13. Hungary

**Budapesti University of Technology and Economics,

Department of Broadband Infocommunications, 1111 Budapest Goldmann Gy. tér 3. Hungary

CONTENT

- Introduction (1)
 - Introduction to Software Defined Radio technology (4)
 - Basic principle
 - SDR open structure
 - Architectural model
 - SCA
 - SDR based radio devices (2)
 - Functional elements
 - Implementation levels
 - Platform components (9)
 - Radio front-ends
 - Signal processing
 - Converters
 - Implementation examples (5)
 - Signal generator
 - Monitoring receiver
 - Radar application
 - Scanning receiver
 - Summary (1)
- (22)

Introduction

- The interoperability of existing various radio systems is highly limited
 - Eg. in US Army 25-30 radio families are used
 - In complex mission it is required to co-operate with Navy or Air Force
 - In the case of operation implemented by international troops the interoperability becomes more serious
- Each newly added system specification is accompanied by the demand of new radio devices, requiring application specific hardware and software components
- Manifolding new radio equipment adds significant costs to service and maintenance of these systems

Introduction to Software Defined Radio

- To solve the previously mentioned and some other problems the concept of SDR has been introduced
- The main principle: considerable part of the radio is realized as software on programmable and reconfigurable hardware
 - The hardware: radio platform
 - The software: application framework

This scheme provides universal and reusable components which save costs and can be easily upgraded.

- Software Defined Radio: enabling technology, a kind of principle to build radio devices

The providers and users
joined in an
industrial alliance



www.sdrforum.org

SDR architecture model

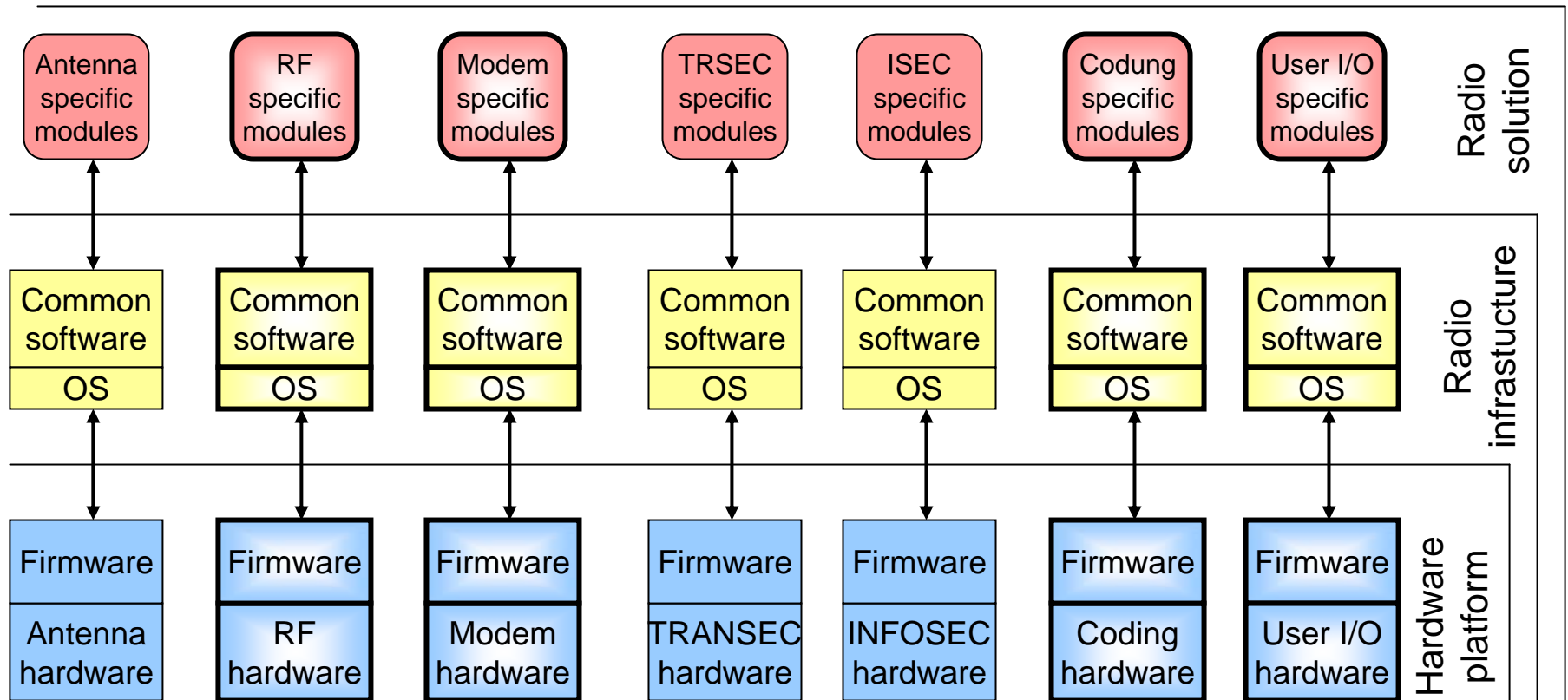

SDR open architecture

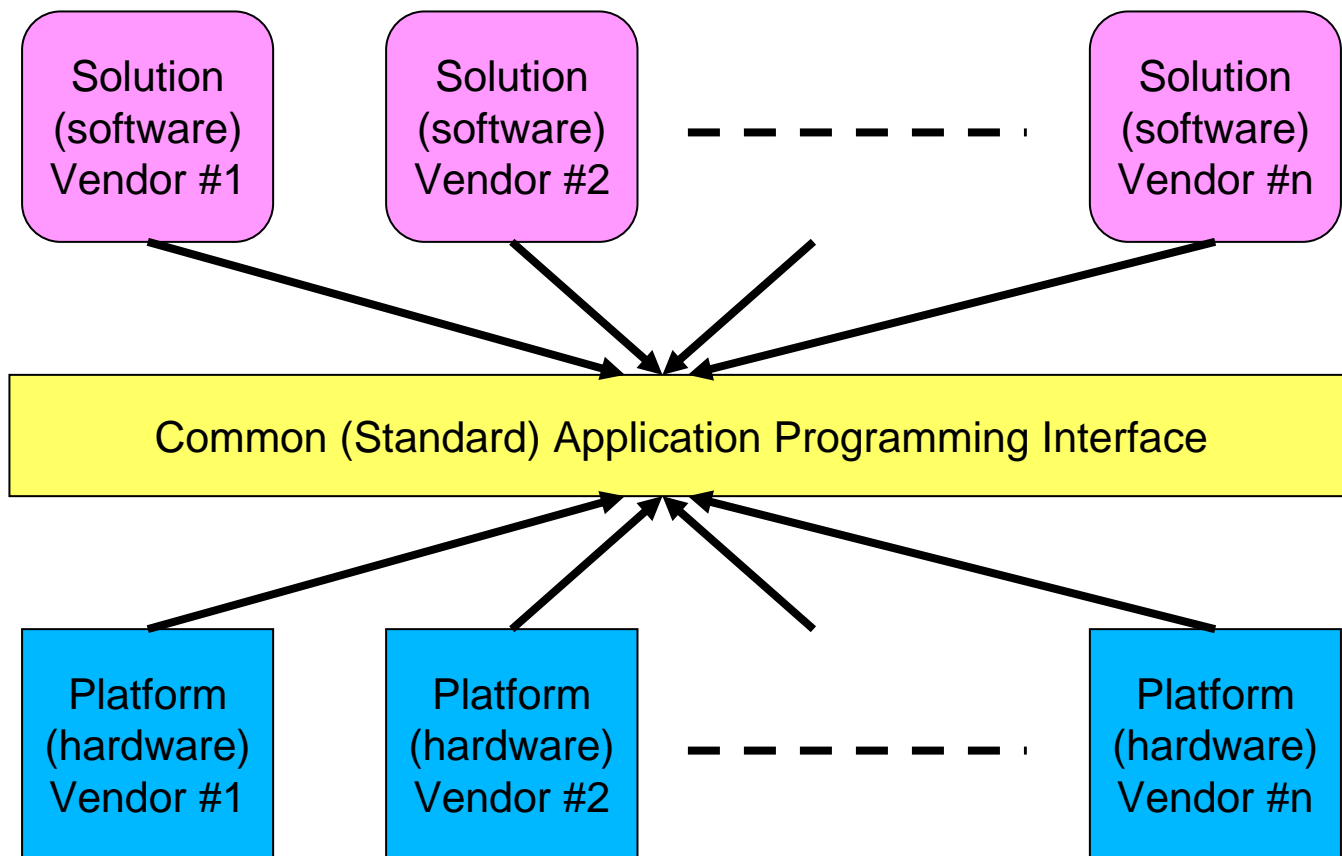

Software Communication Architecture

- The most important initiative to accomplish all the benefits of SDR for military applications is the US Joint Tactical Radio System project
- One of the most important outcome of the JTRS program is SCA

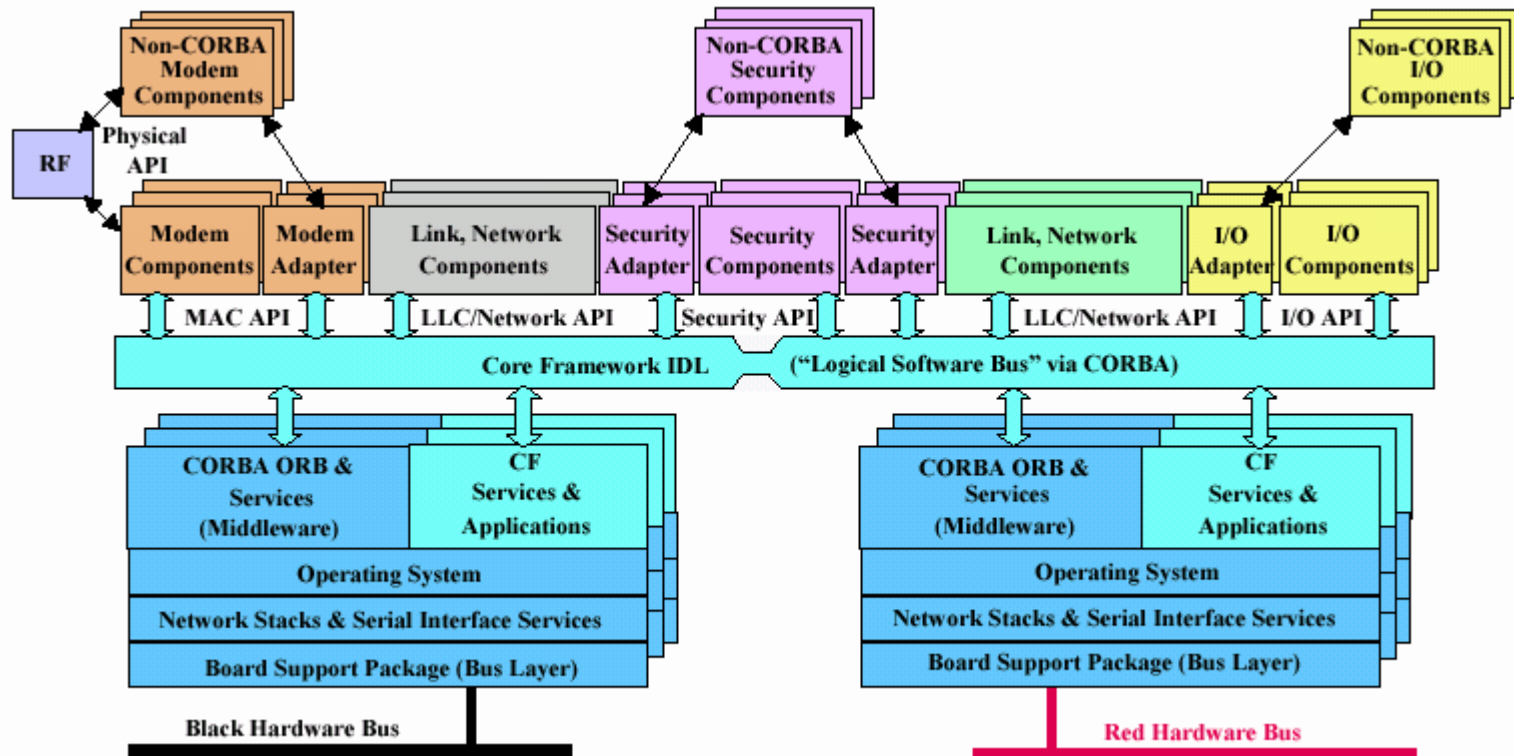

Radio device modelling

Traditional implementation

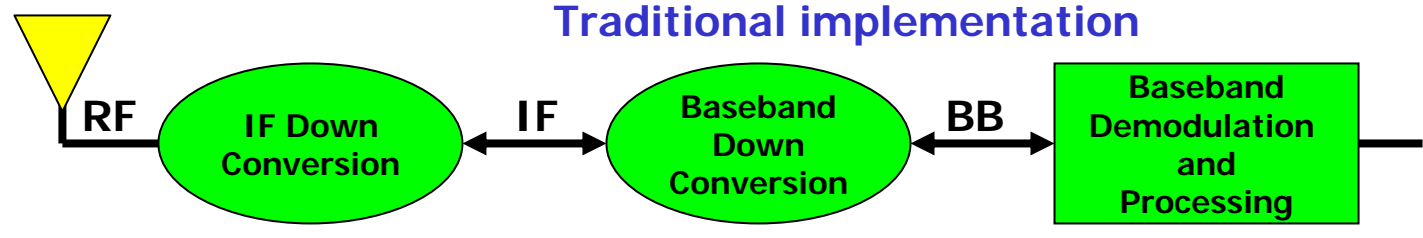

Software Defined Radio based implementation

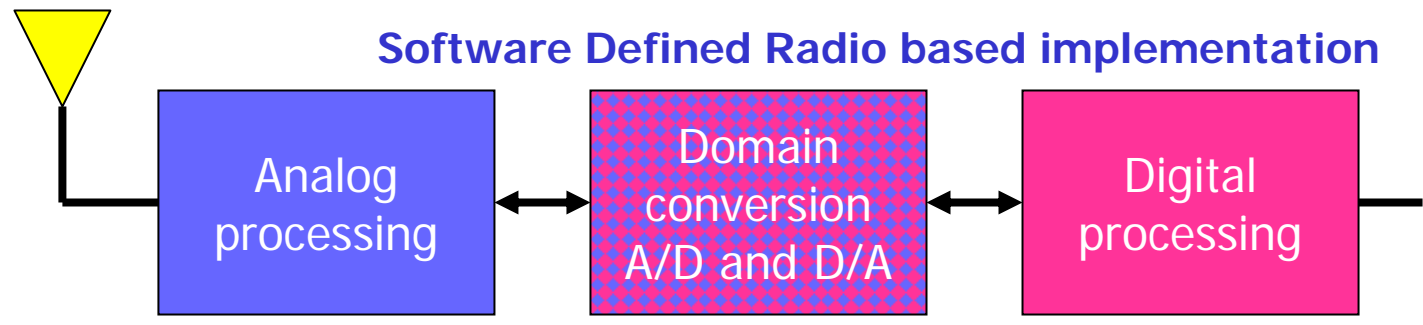

RF technology

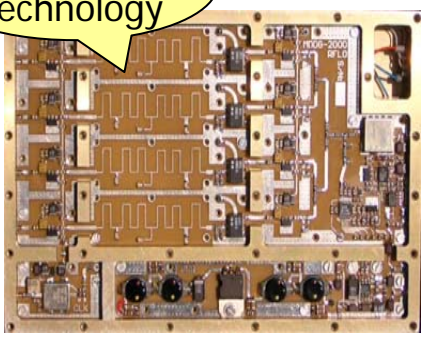

Conversion technology

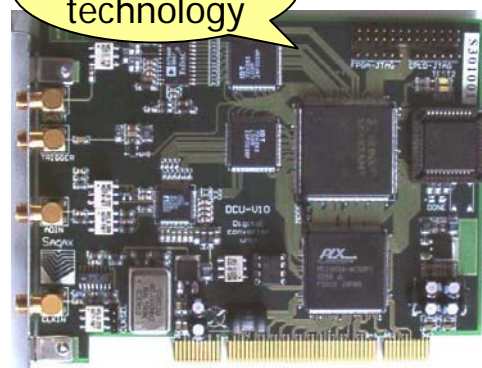

DSP technology

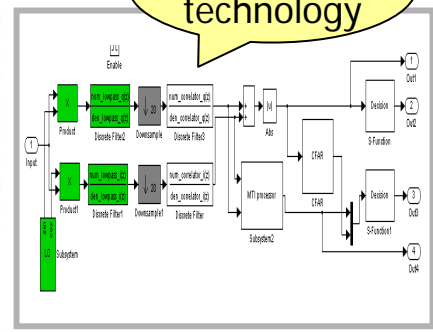

GUI technology



Implementation levels

Digital signals

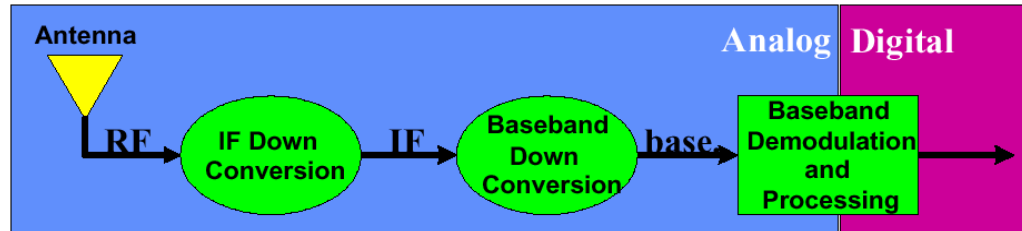

Digital BB

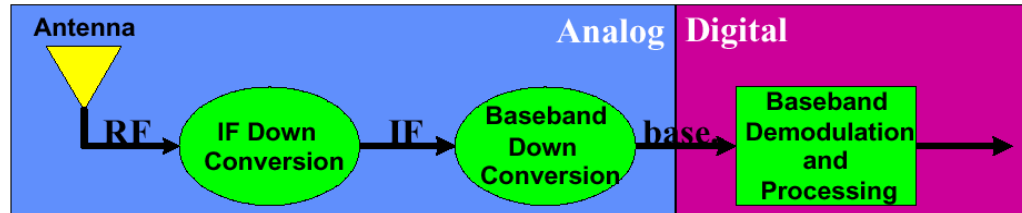

Digital IF

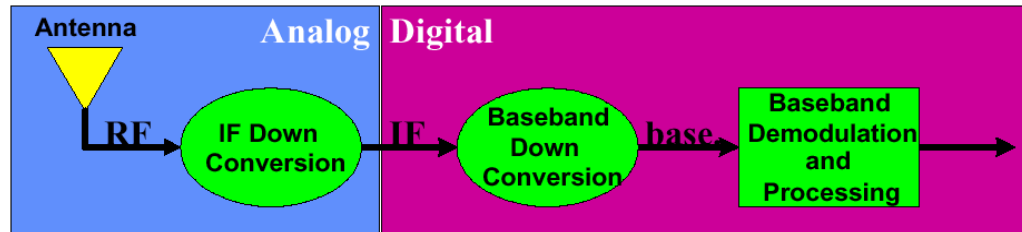

Digital RF



Experimental SDR platform

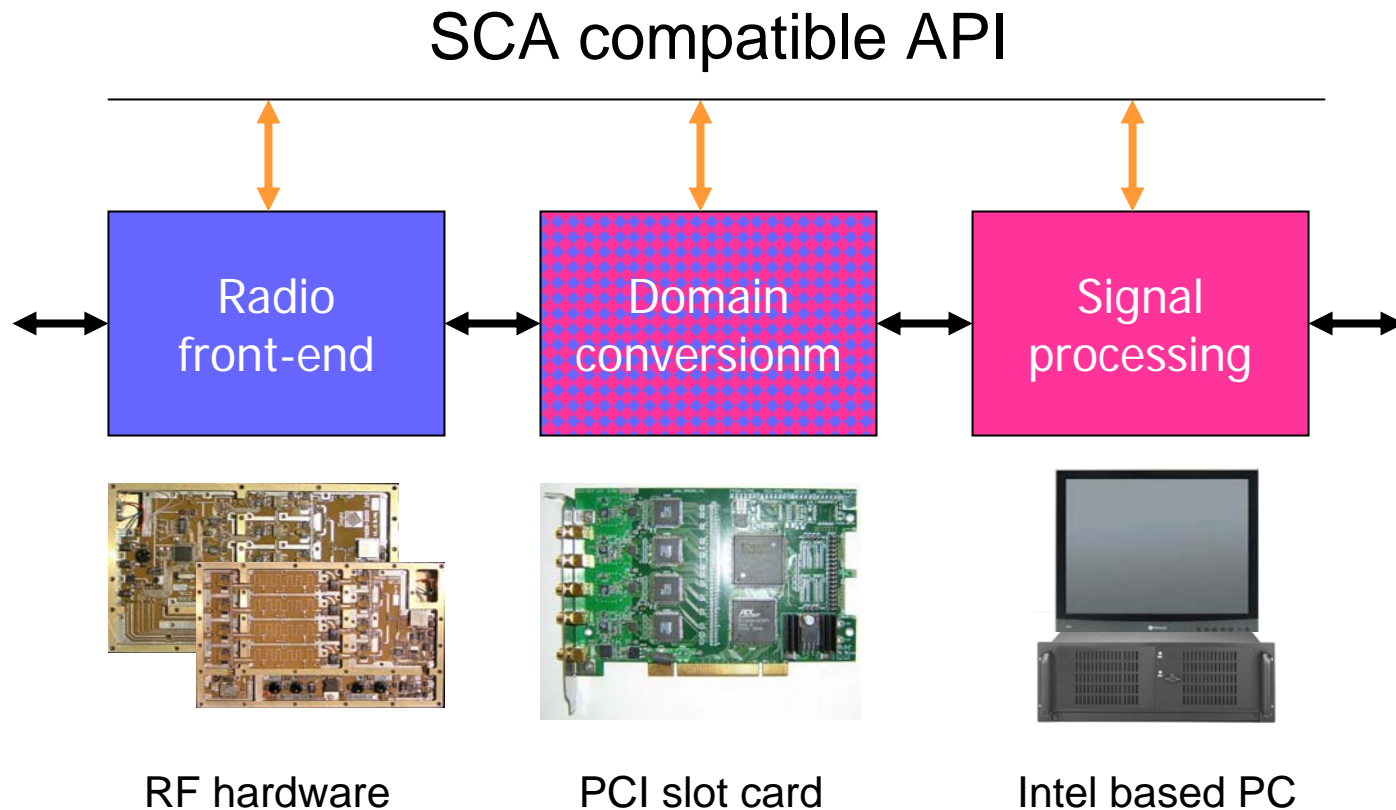

Universal front-end structure

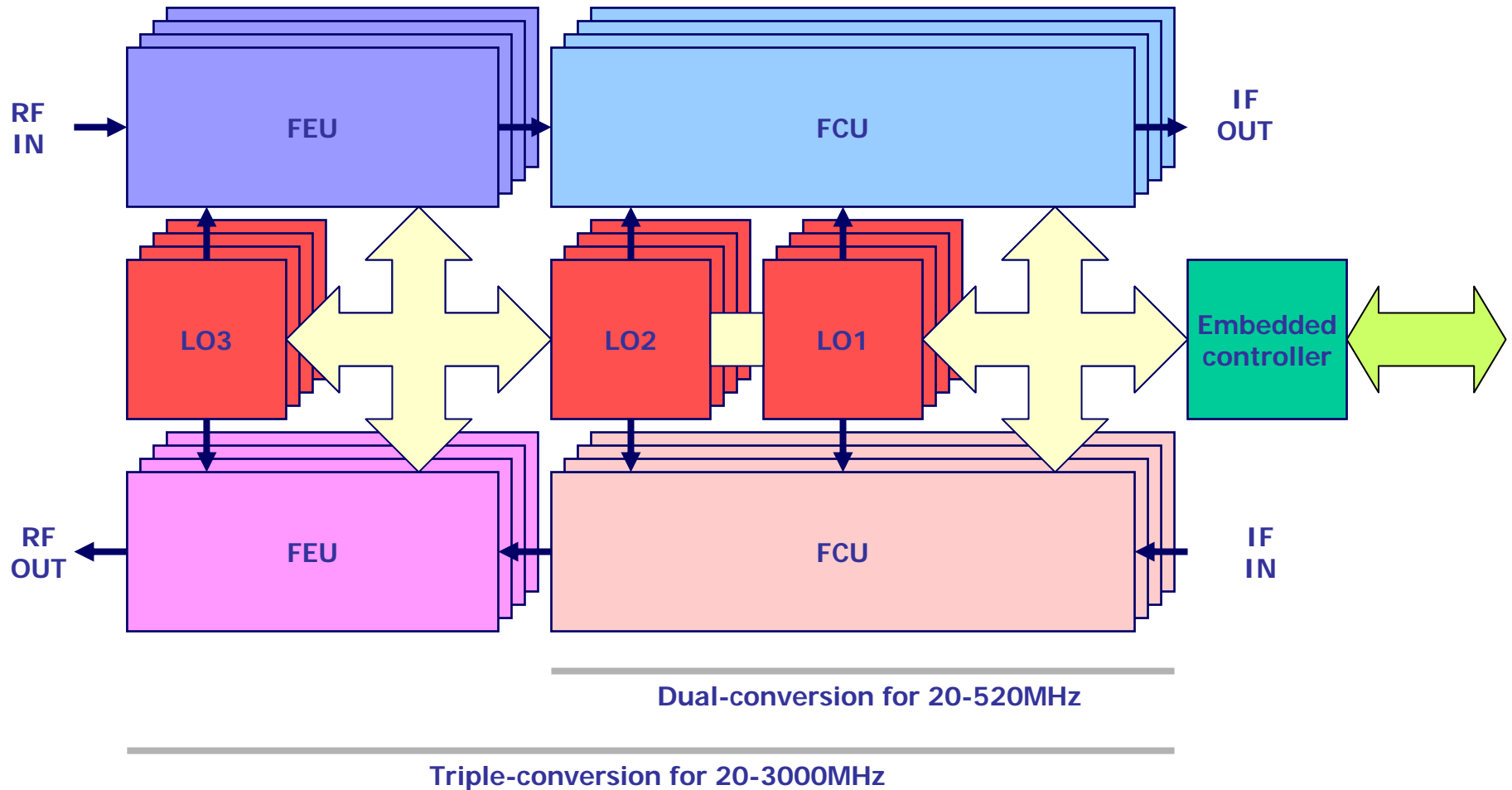

Platform components: RF front-ends

SRT-200



1 independent channel
20-3000MHz RF
70MHz IF
1MHz tuning step
10/20/30dB RF attenuator
0...30dB IF attenuator

SRT-100-4

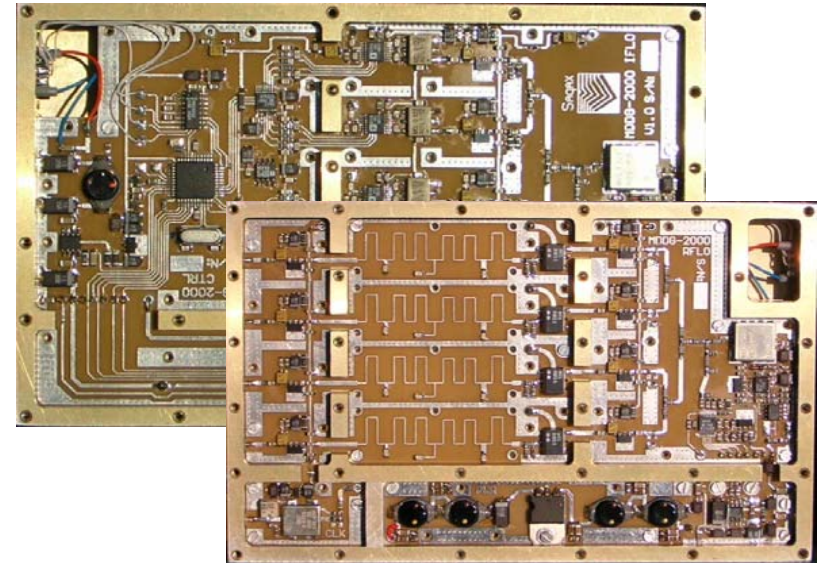

4 RF channel
20-3000MHz RF
70MHz IF
1MHz tuning step
10/20/30dB RF attenuator
0...30dB IF attenuator

General digital back-end for converters

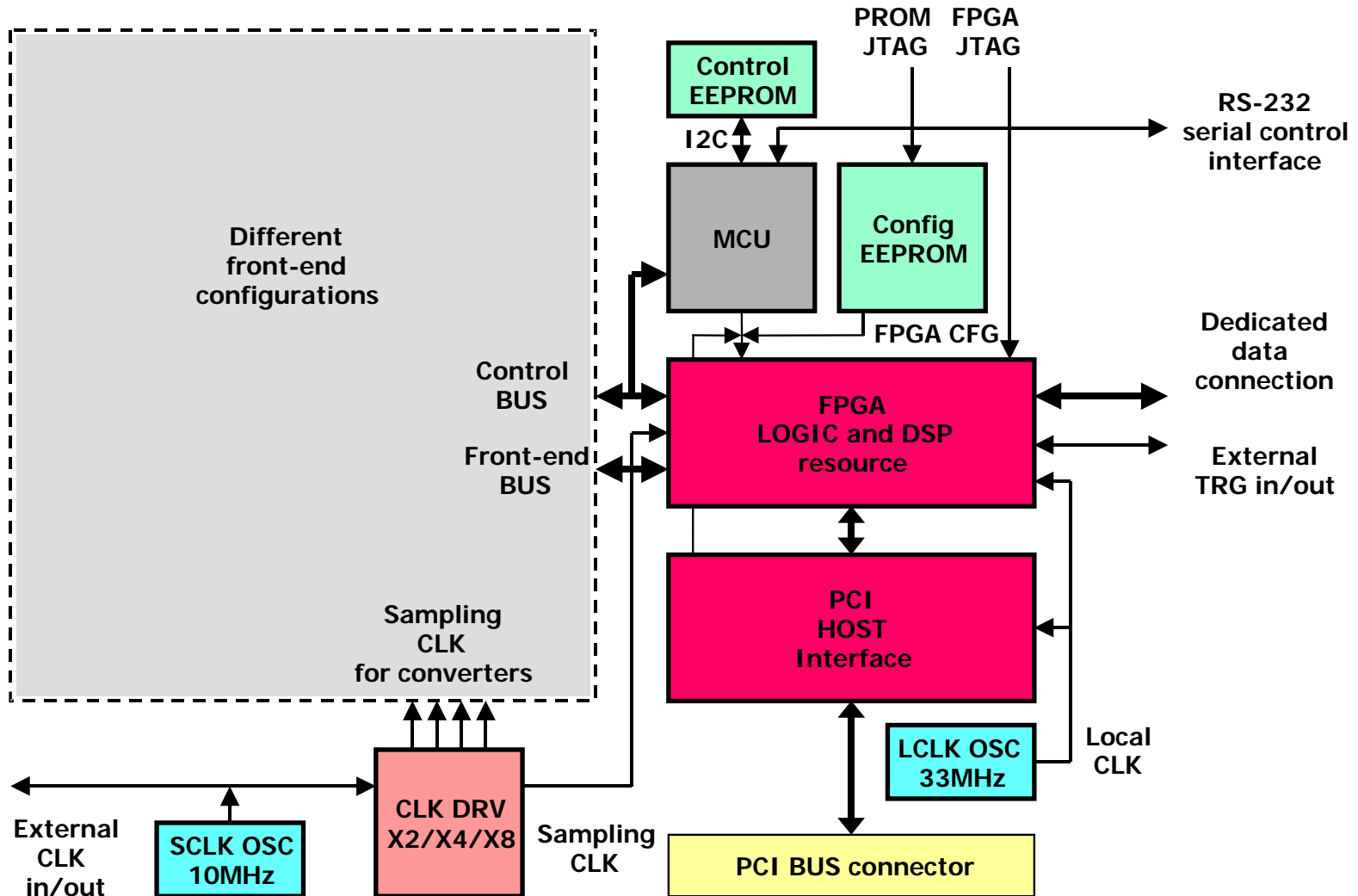

Wide-band and narrow-band converters

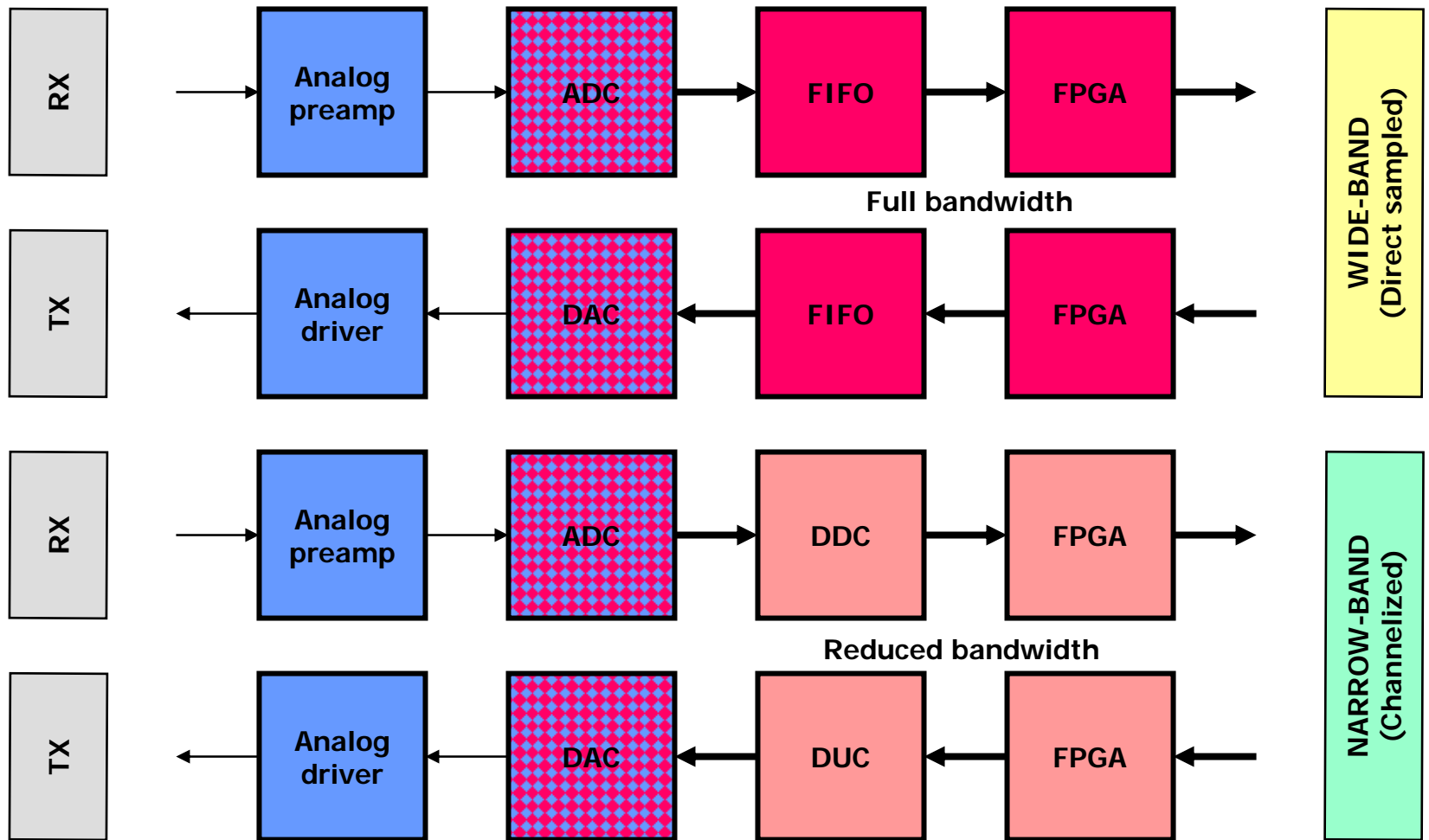

Wide-band converters

DCU-2xx

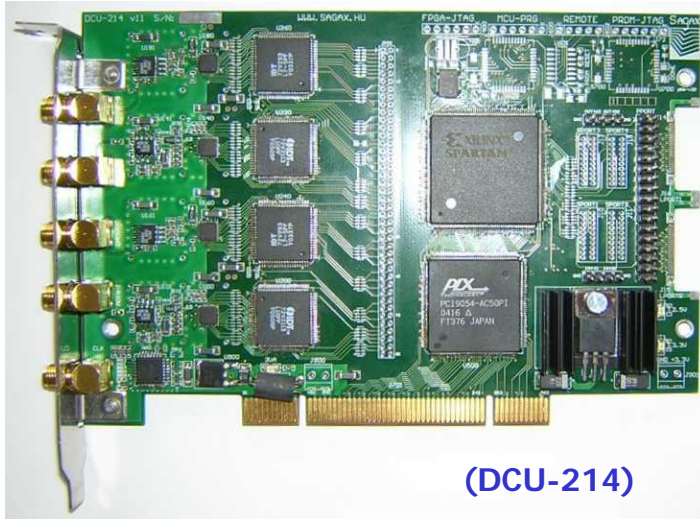

(DCU-214)

- Max. 4 analog I/O channels
- 1 clock I/O channel
- 80Msps/14bit sampling
- 500MHz bandwidth
- 40 bit front-end bus
- Xilinx Spartan II FPGA
- 32bit/33MHz PCI interface
- 133Mbyte/sec signalling rate

DCU-3xx

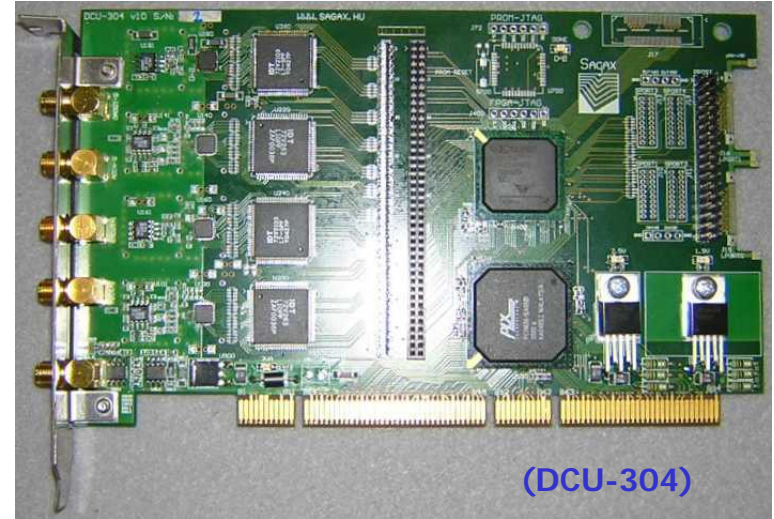

(DCU-304)

- Max. 4 analog I/O channels
- 1 clock I/O channel
- 80Msps/14bit sampling
- 500MHz bandwidth
- 80 bit front-end bus**
- Xilinx Virtex II FPGA**
- 64bit/66MHz PCI interface**
- 528Mbyte/sec signalling rate**

Narrow-band converters

DRU-2xx

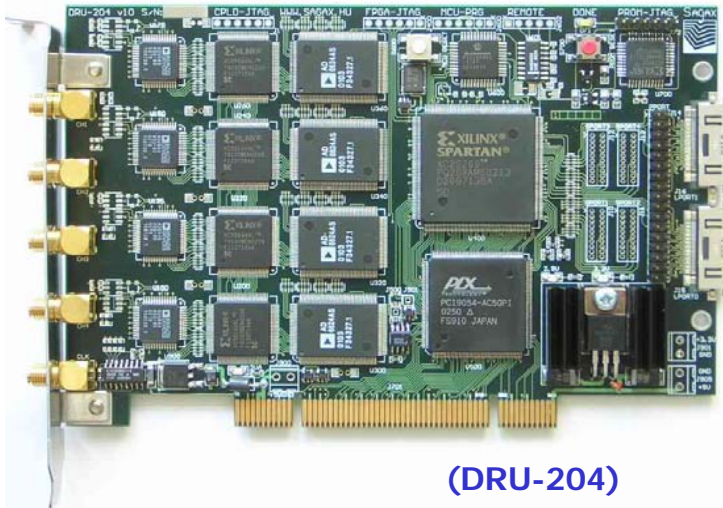

(DRU-204)

- Max. 4 independent analog I/O channels
- 1 clock I/O channel
- 80Msps/14bit sampling
- 500MHz bandwidth
- Xilinx Spartan II FPGA
- Max. 4 independent digital tuner

DRU-3xx

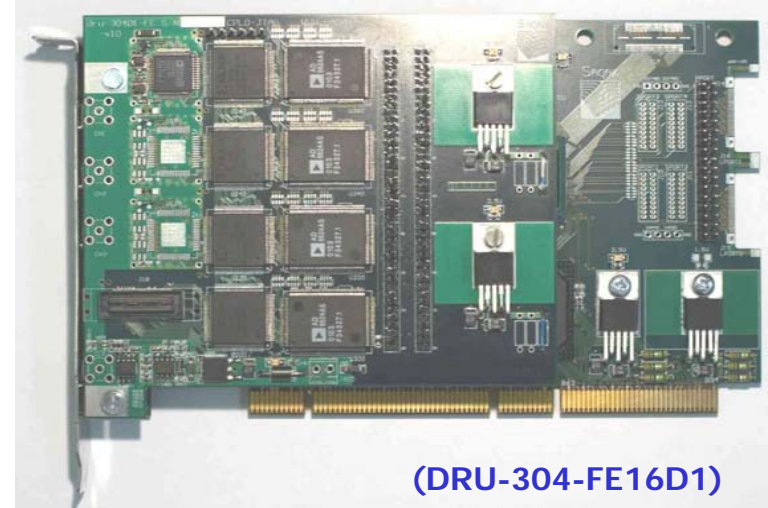

(DRU-304-FE16D1)

- Max. 16 independent analog I/O channels
- 1 clock I/O channel
- 80Msps/14bit sampling
- 500MHz bandwidth
- Xilinx Virtex II FPGA**
- Max. 16 independent digital tuner**

Platform components: processing

DSP:

- dedicated bw for data flow
- dedicated hw multilyers and processing oriented architecture

GP:

- fast growing clock speed
- increasing data bw between processor memory and peripherals
- OS/RTOS

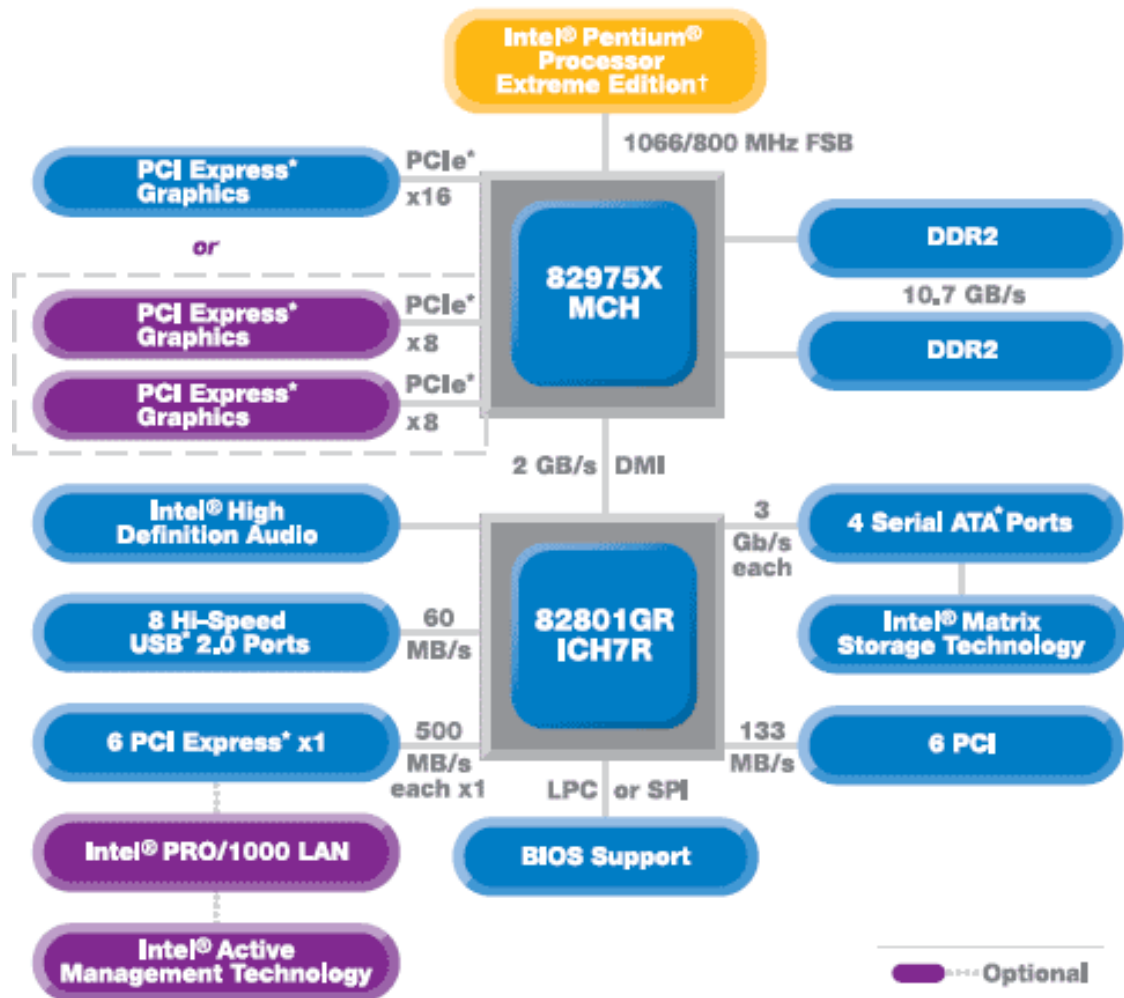

Platform components: processing

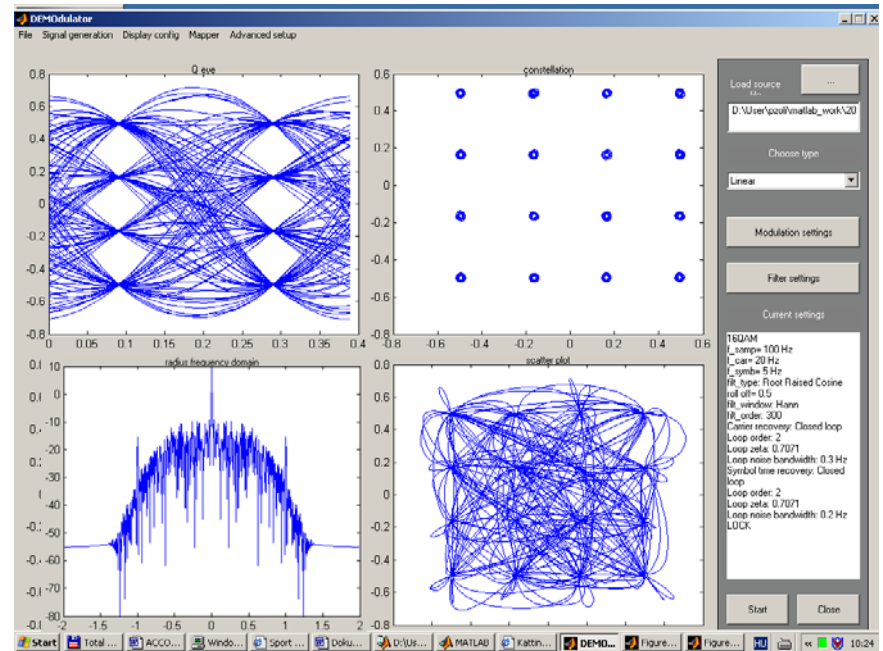
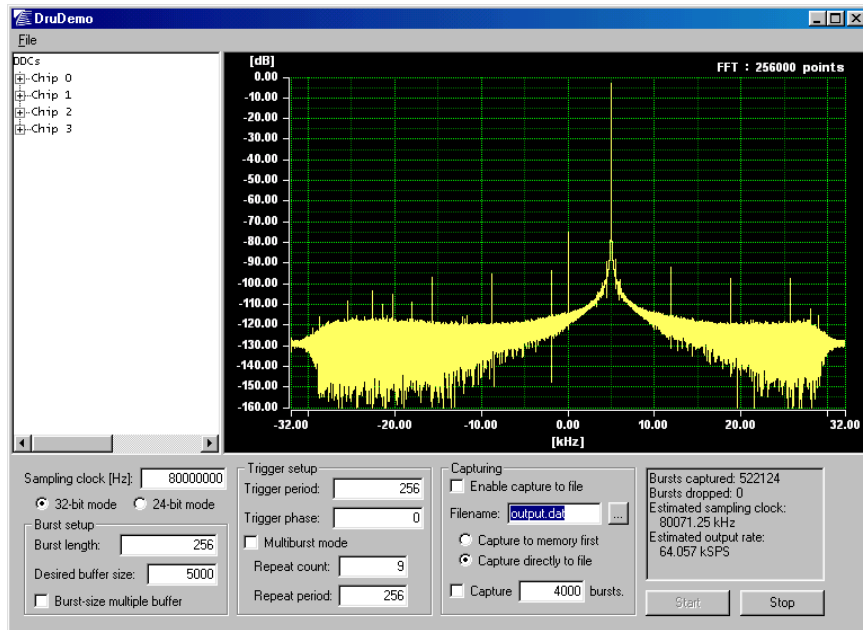

- Basic software modules: waveform generation and signal analysis tools
- As described earlier the principle of SDR technology is based on a published and open interface of the components.
- Our software based on an application programming interface (API) available and they could be used as a starting points to develop any other solution

Example: modulation generator

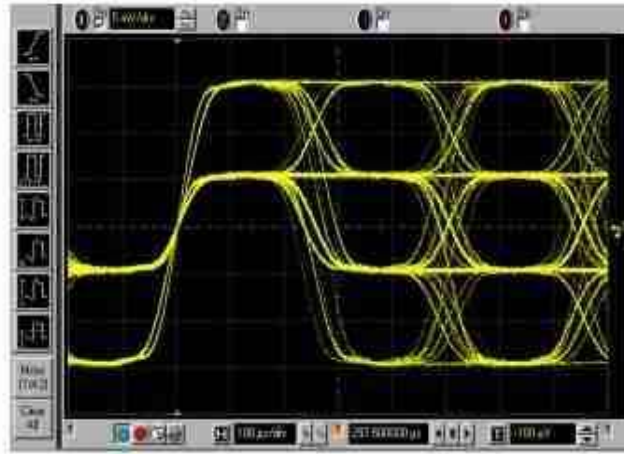
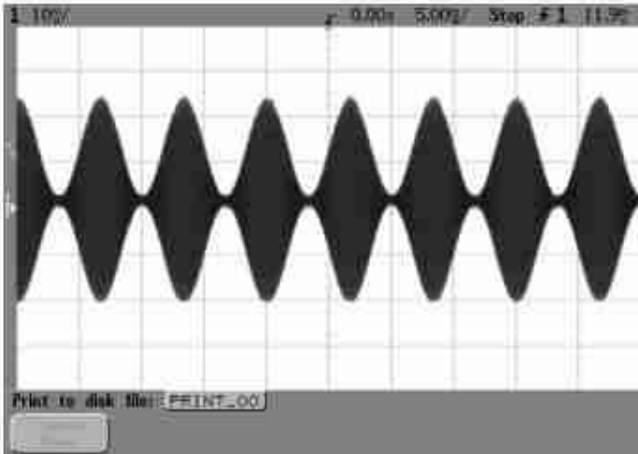

- 1-2500MHz frequency range
- 1Hz resolution
- 90dB dynamic range
- Analog modulation
- Digital modulations
- Complex modulations
- Built-in modulation sources

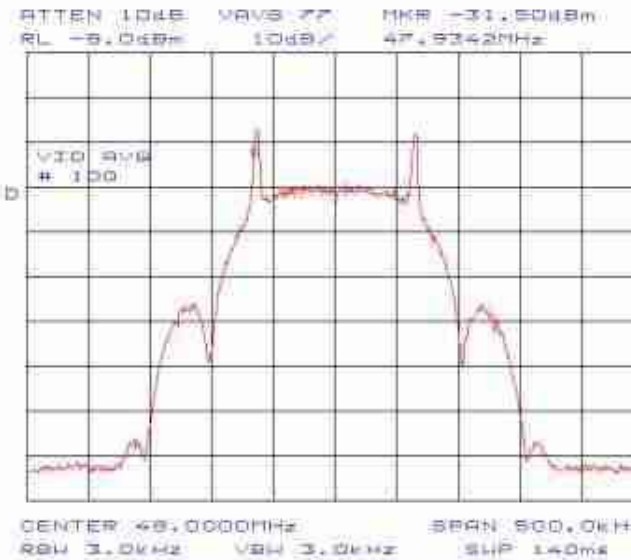
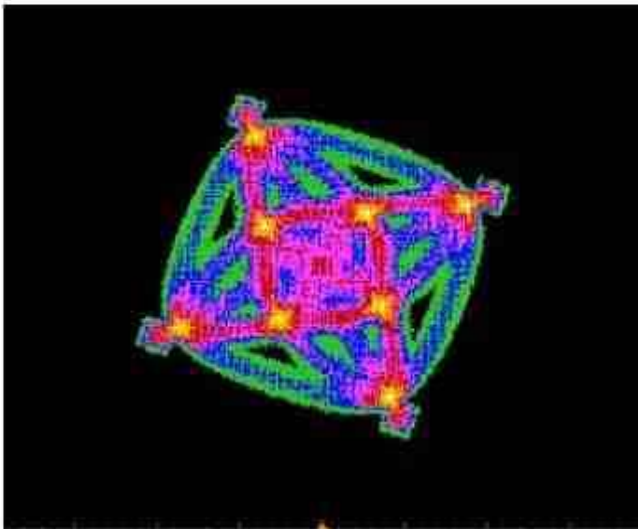

1-2500MHz



SGU-2500 generator

Example: radar application

- Sub-impulse modulated TX burst
- Matched-filter based compressing receiver
- IF level signal recording



SET-078 TG-046
 “Multi-Band Radar for Air Defence Systems”



SRV-P18 VHF radar

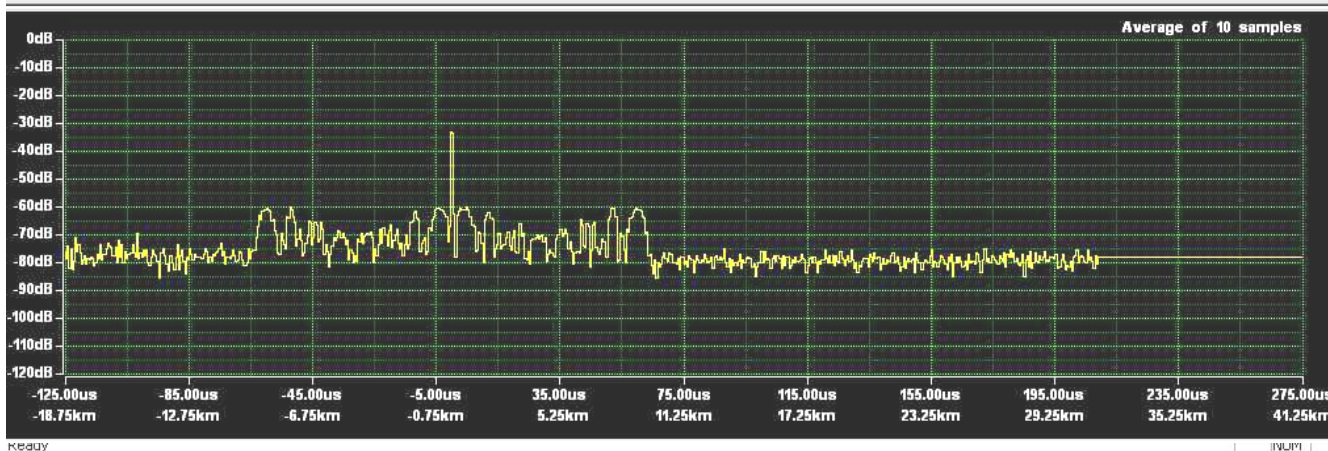

Example: radar application

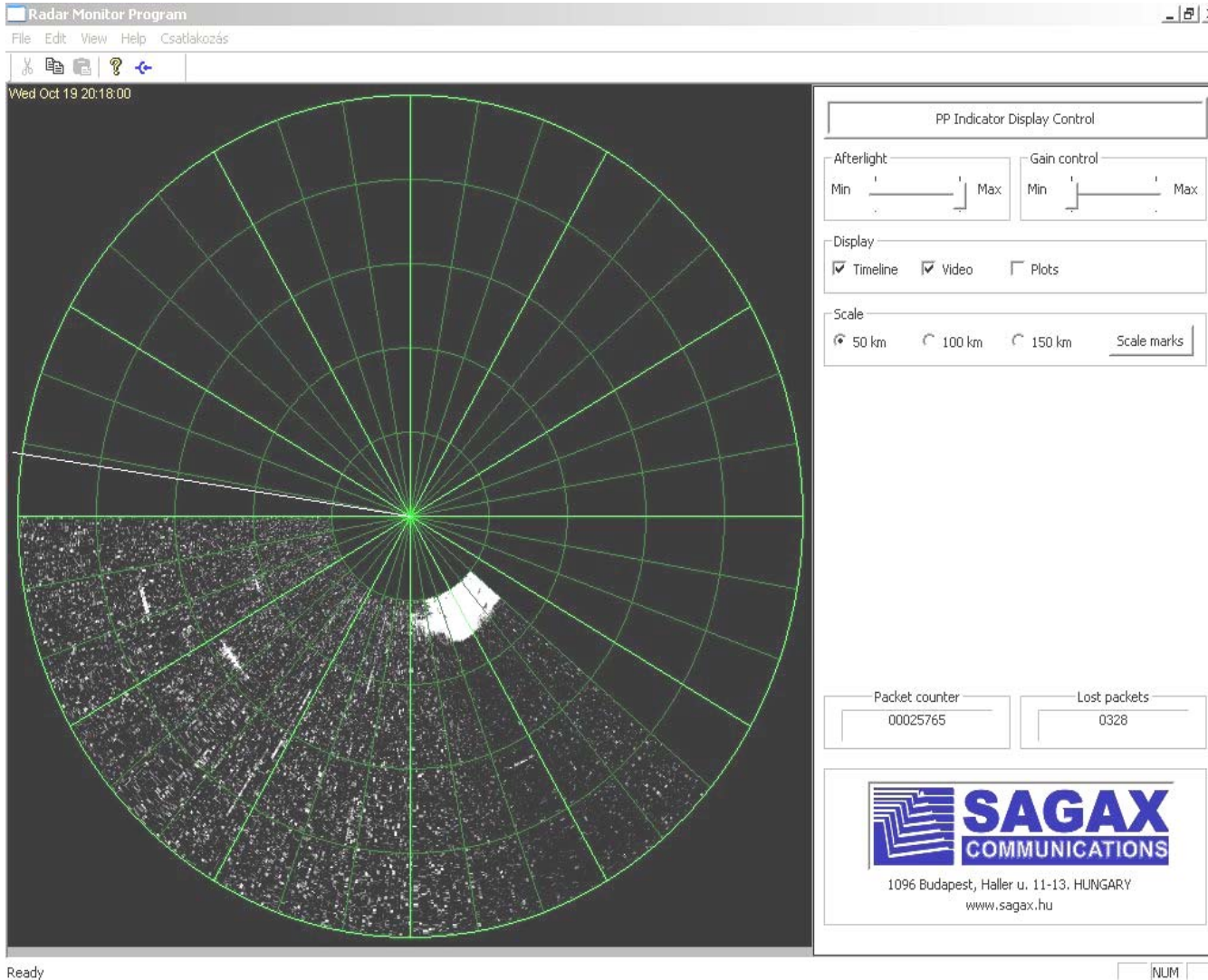

- Sub-impulse modulated TX burst
- Matched-filter based compressing receiver
- IF level signal recording



SET-078 TG-046

“Multi-Band Radar for Air Defence Systems”



SRV-P18 VHF radar

Example: monitoring receiver

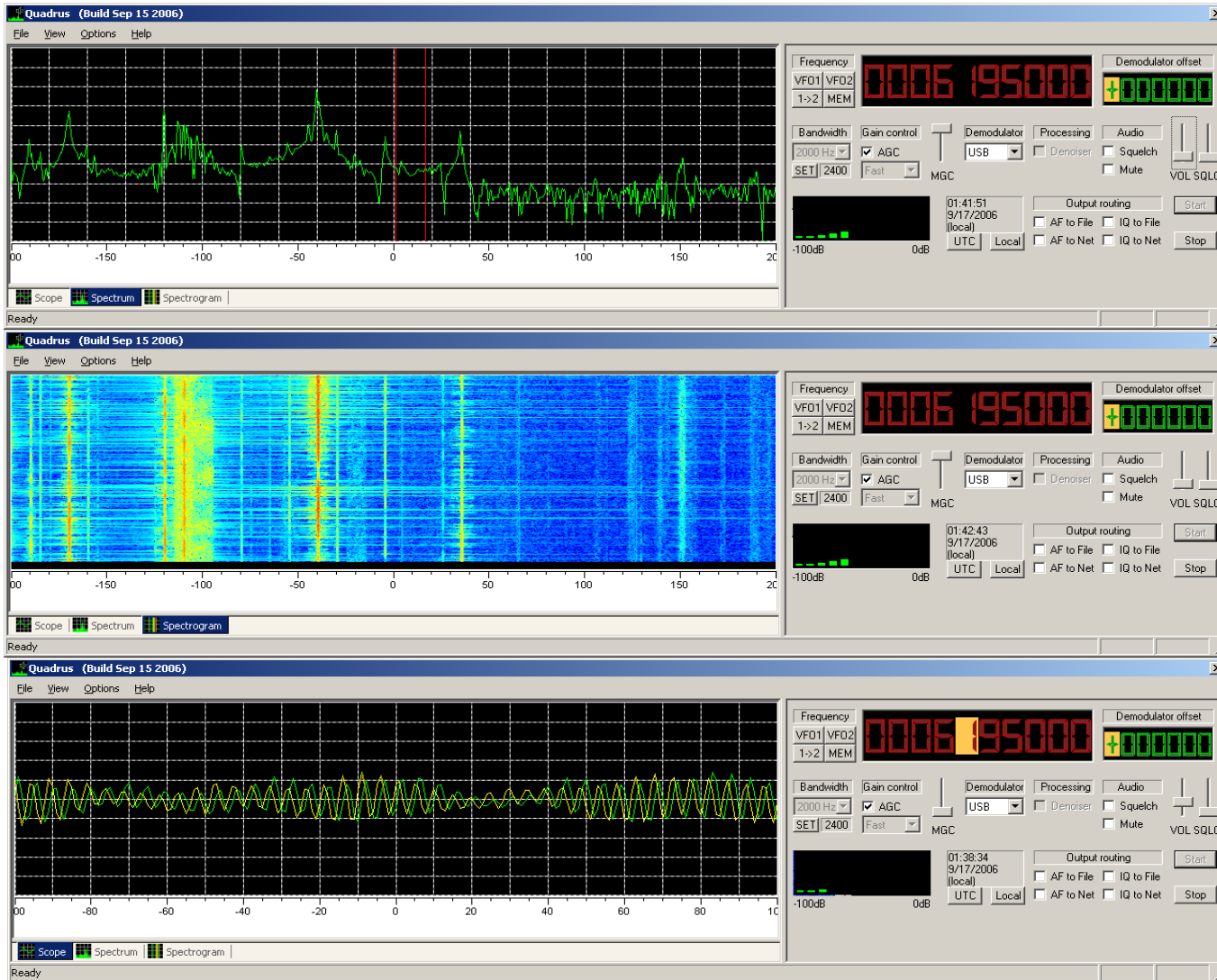

- Integrated front-end tuner
- 20-3000MHz VUHF
- 1.5-32MHz HF
- 300KHz IF bandwidth
- AM/FM/SSB/ISB demodulation
- Hard disk recording facility

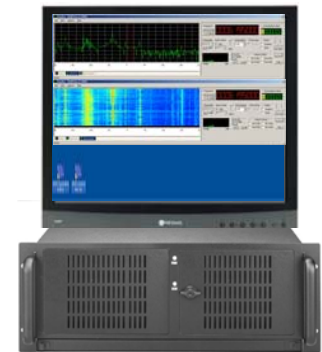

SRM-3000H receiver

Example: scanning receiver

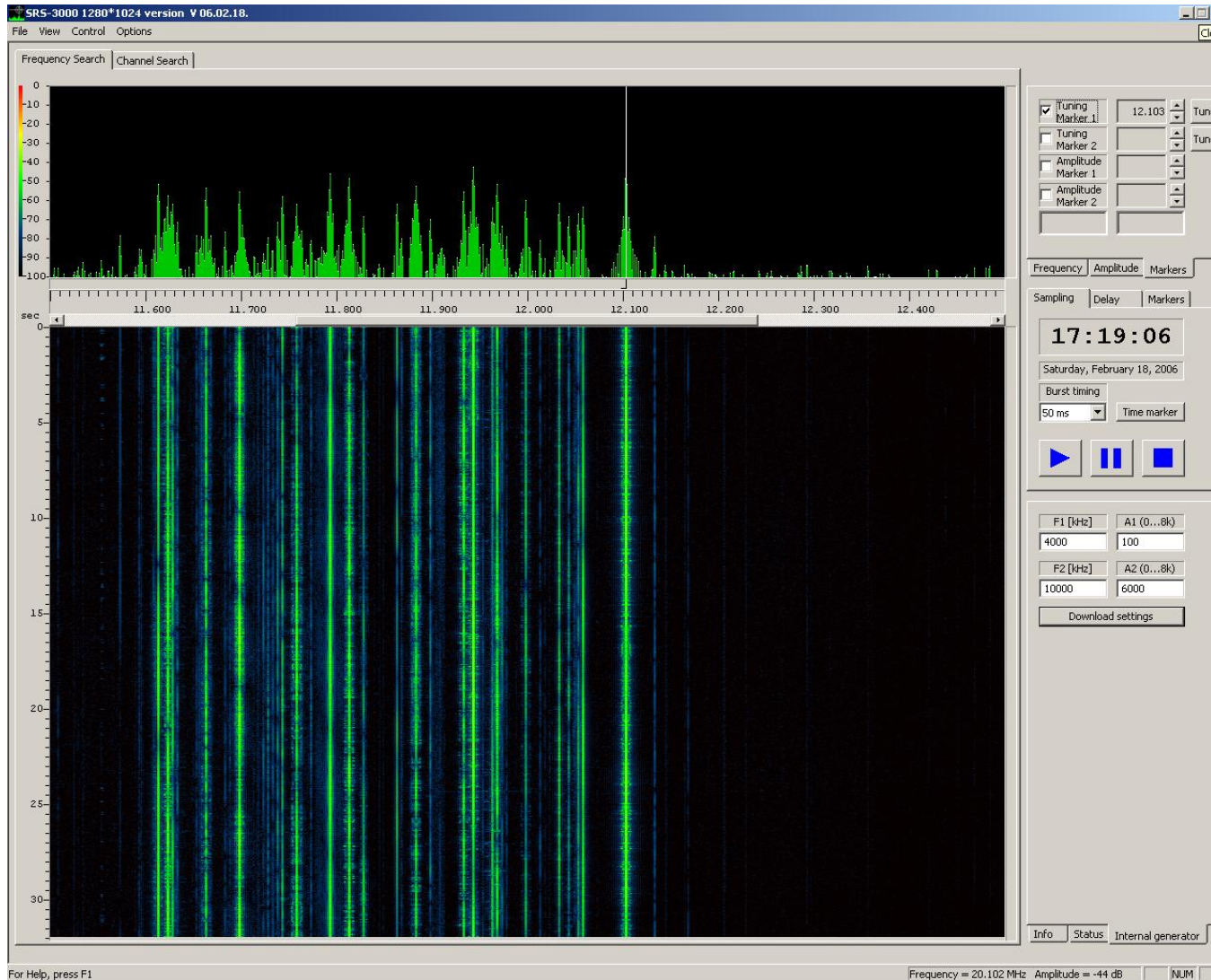

- 40MHz instantaneous bandwidth
- 1ms time resolution
- 1KHz frequency resolution
- 1200/3200 pixel display
- Full or partial bandwidth processing

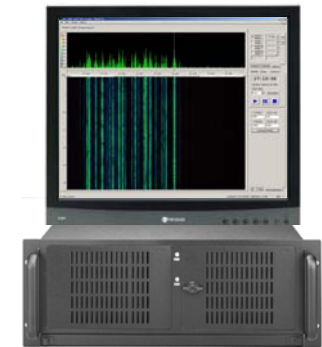

SRS-3000H receiver

Summary

- In my presentation I introduced the basic principle of SDR technology as the framework of future radio equipment and system developments
- I defined a basic model for SDR radio devices consisting of three main elements: analogue front-end, converter and digital processor
- I introduced the available components of an universal development platform for radio solution developments
- Finally I presented some example application for the platform components