

ARMY RESEARCH LABORATORY



**Bone Conduction: Anatomy, Physiology,
and Communication**

by Paula Henry and Tomasz R. Letowski

ARL-TR-4138

May 2007

NOTICES

Disclaimers

The findings in this report are not to be construed as an official Department of the Army position unless so designated by other authorized documents.

Citation of manufacturer's or trade names does not constitute an official endorsement or approval of the use thereof.

DESTRUCTION NOTICE—Destroy this report when it is no longer needed. Do not return it to the originator.

Army Research Laboratory

Aberdeen Proving Ground, MD 21005-5425

ARL-TR-4138

May 2007

Bone Conduction: Anatomy, Physiology, and Communication

**Paula Henry and Tomasz R. Letowski
Human Research and Engineering Directorate, ARL**

REPORT DOCUMENTATION PAGE

Form Approved
OMB No. 0704-0188

Public reporting burden for this collection of information is estimated to average 1 hour per response, including the time for reviewing instructions, searching existing data sources, gathering and maintaining the data needed, and completing and reviewing the collection information. Send comments regarding this burden estimate or any other aspect of this collection of information, including suggestions for reducing the burden, to Department of Defense, Washington Headquarters Services, Directorate for Information Operations and Reports (0704-0188), 1215 Jefferson Davis Highway, Suite 1204, Arlington, VA 22202-4302. Respondents should be aware that notwithstanding any other provision of law, no person shall be subject to any penalty for failing to comply with a collection of information if it does not display a currently valid OMB control number.

PLEASE DO NOT RETURN YOUR FORM TO THE ABOVE ADDRESS.

1. REPORT DATE (DD-MM-YYYY) May 2007		2. REPORT TYPE		3. DATES COVERED (From - To)	
4. TITLE AND SUBTITLE Bone Conduction: Anatomy, Physiology and Communication				5a. CONTRACT NUMBER	
				5b. GRANT NUMBER	
				5c. PROGRAM ELEMENT NUMBER	
6. AUTHOR(S) Paula Henry and Tomasz R. Letowski (both of ARL)				5d. PROJECT NUMBER 62716AH70	
				5e. TASK NUMBER	
				5f. WORK UNIT NUMBER	
7. PERFORMING ORGANIZATION NAME(S) AND ADDRESS(ES) U.S. Army Research Laboratory Human Research and Engineering Directorate Aberdeen Proving Ground, MD 21005-5425				8. PERFORMING ORGANIZATION REPORT NUMBER ARL-TR-4138	
9. SPONSORING/MONITORING AGENCY NAME(S) AND ADDRESS(ES)				10. SPONSOR/MONITOR'S ACRONYM(S)	
				11. SPONSOR/MONITOR'S REPORT NUMBER(S)	
12. DISTRIBUTION/AVAILABILITY STATEMENT Approved for public release; distribution is unlimited.					
13. SUPPLEMENTARY NOTES					
14. ABSTRACT Humans hear through air and bone conduction pathways. Both pathways can be used to transmit sound to a listener and from a talker although traditionally, the air conduction pathway has been used. Communication through bone conduction is a feasible alternative to air conduction reception and transmission and provides benefits to the user that an air conduction system cannot provide. This report combines results of an extensive literature review of the anatomy and physiology of human hearing, theories behind the mechanisms of bone conduction transmission, devices for use in bone conduction transmission, and the use of the bone conduction pathway for communication. Bone conduction for the transmission of communication is effective and feasible for Soldiers because it provides a means of providing radio communication in combination with hearing protection devices.					
15. SUBJECT TERMS bone conduction; communication; hearing					
16. SECURITY CLASSIFICATION OF:			17. LIMITATION OF ABSTRACT SAR	18. NUMBER OF PAGES 204	19a. NAME OF RESPONSIBLE PERSON Paula Henry
a. REPORT Unclassified	b. ABSTRACT Unclassified	c. THIS PAGE Unclassified			19b. TELEPHONE NUMBER (Include area code) 410-278-5848

Contents

List of Figures	vii
List of Tables	xi
Acknowledgments	xii
1. Introduction	1
1.1 Purpose	1
1.2 Air and Bone Conduction.....	1
1.3 Historical Account of Bone Conduction	3
2. Air Conduction Hearing	6
2.1 Anatomy and Physiology of the Auditory System.....	6
2.2 Outer Ear	7
2.3 Middle Ear.....	14
2.4 Inner Ear.....	20
2.5 Central Auditory Nervous System	26
2.6 Summary and Conclusions.....	30
3. Bone Conduction Hearing	30
3.1 Skull Anatomy.....	32
3.2 Vibration Modes of the Skull.....	35
3.3 Resonances of the Head	39
3.4 Mechanical Impedance of the Head	41
3.5 Trans-cranial Attenuation of Sound	45
3.6 Transcranial Delay of Sound.....	47
3.7 Nonlinear Behavior of Bone Conduction.....	48
3.8 Tactual Perception of Vibrations.....	49
3.9 Summary and Conclusions.....	52
4. Speech Perception by Talker	52
4.1 Self-Perceived Speech.....	52

4.2	Summary and Conclusions.....	57
5.	Hearing Sensitivity	57
5.1	Air Conduction Versus Bone Conduction Thresholds.....	58
5.2	Static Force and Contact Area.....	60
5.3	Location of Transducer.....	62
5.4	Audible Frequency Range for Bone-Conducted Sounds.....	68
5.5	Summary and Conclusions.....	69
6.	Ear Occlusion	69
6.1	The Occlusion Effect.....	70
6.2	Timbral Effects of Ear Occlusion.....	75
6.3	Speech Production and the Occlusion Effect.....	76
6.4	Ear Occlusion and Noise.....	77
6.5	Summary and Conclusions.....	77
7.	Bone Conduction Spatial Perception	78
7.1	Spatial Hearing.....	78
7.2	Human Localization Capabilities.....	84
7.3	Bone Conduction Spatial Cues.....	87
7.4	Summary and Conclusions.....	91
8.	Bone Conduction Devices	92
8.1	Bone Vibrators.....	92
8.2	Bone Conduction Microphones.....	97
8.3	Measurements and Calibration.....	98
8.3.1	Bone Vibrator Measurements and Calibration.....	99
8.3.2	Contact Microphone Measurements.....	105
8.4	Summary and Conclusions.....	107
9.	Clinical Applications of Bone Conduction	108
9.1	Clinical Audiology.....	108
9.2	Tuning Fork Tests.....	109
9.2.1	Weber Test.....	110
9.2.2	Rinne Test.....	111
9.2.3	Schwabach Test.....	112

9.2.4	Bing Test	112
9.2.5	Gellé Test	113
9.2.6	Levis (Federici) Test	113
9.2.7	Summary of Tuning Fork Tests.....	113
9.3	Diagnostic Bone Conduction Pure Tone Audiometry.....	114
9.4	Diagnostic Bone Conduction Speech Audiometry.....	116
9.5	Auditory Brain Stem Response	117
9.6	Oto-acoustic Emissions	119
9.7	Summary and Conclusions.....	119
10.	Bone Conduction Hearing Aids	119
10.1	Introduction to Bone Conduction Hearing Aids.....	120
10.2	Conventional Hearing Aids	122
10.3	Direct or Implantable Bone Conduction Hearing Aids	123
10.4	Middle Ear Implants	128
10.5	HiSonic Hearing Aid.....	130
10.6	Vibro-Tactile Communication Aids.....	131
10.7	Summary and Conclusions.....	132
11.	Commercial Applications of Bone Conduction	132
11.1	General Characteristics of the Commercial Market.....	133
11.2	Bone Conduction Communication Systems.....	133
11.3	Advantages and Limitations of Bone Conduction Communication Systems	139
11.3.1	Quiet Environments.....	139
11.3.2	Noisy Environments	140
11.4	Special Purpose Commercial Systems	142
11.4.1	Telephone Devices	142
11.4.2	Toys/Entertainment	145
11.4.3	Devices for Swimmers	145
11.4.4	Assistive Devices	147
11.4.5	Devices for Listening to Music	148
11.5	Summary and Conclusions.....	149
12.	Perception of Ultrasonic Sounds	149
13.	Effects of Extraneous Vibrations	153

13.1 Pilot Study	154
13.2 Full Study of Bone Conduction Communication in Vehicles	155
13.3 Summary and Conclusions	158
14. Summary and Conclusions	158
15. References	161
Acronyms	186
Distribution List	189

List of Figures

Figure 1. Paledino’s fonifero, 1876 (left) and Rhodes’ audiphone, 1879 (right)	4
Figure 2. Sonotone’s B-533 bone conduction body hearing aid (left) and M-300 system developed for the U.S. Signal Corps (right)	5
Figure 3. Cross section of the ear.....	7
Figure 4. Functional diagram of the auditory system (one ear).....	7
Figure 5. Diagram of the left human pinna.....	8
Figure 6. Directional characteristics of the outer (right) ear at 200 Hz, 1000 Hz, and 8000 Hz. 10	
Figure 7. Sound pressure amplification by the ear canal and surrounding structures (Shaw, 1974).	12
Figure 8. Sound pressure amplification by the ear canal as a function of frequency for different source azimuths (Pickles, 1988).	12
Figure 9. The middle ear space and ossicular chain	15
Figure 10. The ossicular chain with portions of the bones labeled Janfaza et al. (2001).	16
Figure 11. The concept of the pressure transducer	17
Figure 12. The mechanism of middle ear lever action (modified from Pickles [1988]).	18
Figure 13. Frequency characteristics of middle ear resistance and reactance (from Zwislocki, 1975).	20
Figure 14. The structures of the inner ear	21
Figure 15. The structure of the cochlea (Andringa, Niessen, & Nillesen, 2004).....	21
Figure 16. Microscopic photograph of the cross section of the cochlea.....	22
Figure 17. Unrolled view of the basilar membrane	23
Figure 18. The mechanism of the traveling wave (Feilding, 2005).....	24
Figure 19. The organ of Corti (the cross section of the basilar membrane in the human)	25
Figure 20. Central and peripheral nervous system.....	26
Figure 21. Human brain	28
Figure 22. Auditory brain stem.....	28
Figure 23. Sagittal view of the cerebral cortex and the Brodmann’s areas.....	29
Figure 24. Auditory cortex in the Sylvian fissure of the temporal lobe	30
Figure 25. General organization of the bones of the skull (Howell, Williams, & Dix, 1988).....	33
Figure 26. Block diagram of the air conduction (upper panel) and bone conduction (lower panel) pathways of sound to the inner ear.....	35
Figure 27. Skull displacements in the horizontal plane for different frequencies when a vibrator was applied to the forehead (Bekesy, 1932).....	40
Figure 28. Magnitude and phase characteristics of the impedance of the skull (Håkansson, Carlsson, & Tjellström, 1986).	43
Figure 29. A cross-sectional view of the skull through the petrous bone (left) and a lumped	

parameter analog circuit diagram of the mechanical impedance of the human skull (right) (Stenfelt & Goode, 2005).....	43
Figure 30. Magnitude and phase characteristics of the skin impedance covering the human skull (Håkansson et al., 1986).....	44
Figure 31. The lumped parameter model of skin impedance.....	44
Figure 32. The decline of the amplitude of vibrations from the vocal folds as they travel over the surface of the body.....	57
Figure 33. The effect of static force (in grams) on the signal transmission gain (dB) through bone conduction when the amplitude of vibration is kept constant (Bekesy, 1939; modified).....	61
Figure 34. The general effect of static force (in grams) on transmission loss (dB) of vibrations transmitted through the skin when the actual alternating pressure applied to the skin is kept constant (Bekesy, 1939).....	62
Figure 35. Test locations on the head for optimal bone conduction vibrator placement (from McBride, Letowski, & Tran, 2005).	66
Figure 36. Hearing sensitivity as a function of frequency for bone conduction stimulation on the mastoid bone as found in several research studies.....	68
Figure 37. The positions of the cranial bones and the mandible in relation to the opening of the EAC (Howell, Williams, & Dix, 1988).	71
Figure 38. Occlusion effect (dB) as a function of the depth of earplug insertion (probe microphone data).	74
Figure 39. Occlusion effect (dB) as a function of the depth of earplug insertion (probe microphone data).	74
Figure 40. Occlusion effects caused by various types of earphones.....	75
Figure 41. Relative contributions of the external (occluded) ear canal and the inner and middle ears to the loudness of bone conduction signals (adapted from Tonndorf et al., 1976).	75
Figure 42. Changes in spectra based on the location of a sound source in the vertical plane. ...	82
Figure 43. MAA between successive pulses of a pure tone as a function of the frequency and the direction of the source measured for angles (bottom to top at left hand side) 0, 30, 60, and 75 degrees (from Mills, 1972, p. 310).....	85
Figure 44. MAA in the horizontal plane for white noise pulses of 100 ms duration (Blauert, 2001).	86
Figure 45. MAA in the median plane for continuous speech produced by a familiar person (Blauert, 2001, after Damaske & Wagener, 1969).	86
Figure 46. MAMA values reported by Strybel, Manligas, and Perrott (1992).....	87
Figure 47. Instantaneous acoustic pressure waveforms recorded at four locations of the human head model	89
Figure 48. The principle of energy conversion through the use of a transducer.	92
Figure 49. Schematic (upper) and external view (lower) of the Radioear B-71 vibrator.	94

Figure 50. Frequency response of three common Radioear electro- magnetic bone conduction vibrators measured with the Bruel & Kjaer 4930 artificial mastoid.....	95
Figure 51. Dynamic range of a typical clinical bone conduction vibrator (Radioear B-71).	96
Figure 52. Piezoelectric transducer used as a basis for the DolphinEar hydrophone (Goodson & Lepper, 1995).....	97
Figure 53. Bruel & Kjaer 4930 artificial mastoid and bone vibrator.....	101
Figure 54. Larson-Davis AMC493 mechanical coupler for bone vibrator calibration: sensor (1), mechanical guide (2), and weight (3).....	102
Figure 55. Schematic of the equipment setup for the measurement of the frequency response of a bone conduction vibrator.	104
Figure 56. An example screen from the MLSSA system showing the frequency response of a bone conduction vibrator.....	105
Figure 57. Schematic of the equipment setup for the measurement of the frequency response from a bone conduction microphone.	107
Figure 58. An example of the screen from the MMF VC110 showing the frequency response of a bone conduction microphone.....	107
Figure 59. Set of tuning forks used in by musicians for tuning musical instruments.....	109
Figure 60. Percutaneous (left) and transcutaneous (right) implanted bone conduction hearing aids	121
Figure 61. Bone conduction hearing aid showing the headband, hearing aid and oscillator (vibrator)	122
Figure 62. Bone conduction eyeglasses.....	123
Figure 63. Diagram of the Vibrant Soundbridge middle ear implant from Symphonix.....	129
Figure 64. Photo of the HiSonic Hearing device	130
Figure 65. Three of the Temco bone conduction systems: the HG-17 (left panel), the FM-200 face mask (center panel) and the SK-1 (right panel)	135
Figure 66. Two hybrid systems from Temco.....	135
Figure 67. Two hybrid bone conduction devices from Radioear/New Eagle/Sensory Devices	136
Figure 68. The HB-1 hybrid system incorporating the PerCom 17MIT bone conduction microphone	136
Figure 69. Bone conduction transducers available from PerCom: 17MIT (left panel), 31MIT (center panel), inertial teardrop transducer (right panel)	137
Figure 70. Two bone conduction devices from Duwomi Vonia: the EZ-3000S (left panel) and the BH-70MB (right panel).....	137
Figure 71. A hybrid bone conduction communication device from Tactical Communication Industries.....	138
Figure 72. Two hybrid bone conduction communication devices from Savox Communications	138
Figure 73. Mirafone telephone with bone conduction vibrator in receiver	143
Figure 74. Sanyo TS41 bone conduction cellular phone	144

Figure 75. Photograph of the FingerWhisper and accompanying schematic	144
Figure 76. A photograph of the AquaSphere Aqua FM system (left panel) and a photograph of a person using the Aqua FM.....	146
Figure 77. A photograph of the SwiMP3 from Finis.....	147
Figure 78. Three versions of the Duwomi Vonia devices designed for listening to music: EZ- 80P/S20 (left panel), EZ-3200-S20 (center panel), and EZ-500P/S20 (right panel)	148
Figure 79. Spatial relationship between the structures of the vestibular system, the cochlea, and the cerebrospinal fluid (CSF) spaces (Salt, 1996).....	151
Figure 80. Summary of data from the vehicle study where the talker was outside the vehicle.	155
Figure 81. Summary of data from the vehicle study where the talker was inside the vehicle...	155
Figure 82. The two helmets used in the current study: PASGT (left) and CVC (middle) as well as the bone conduction headgear (right) worn by the talker whose transducers were integrated into the helmets.....	156
Figure 83. Speech recognition performance across the headgear and environment conditions	157

List of Tables

Table 1. Material components of the human head with densities and corresponding speeds of sound transmission (O'Brien & Liu, 2005).....	32
Table 2. Cranial and facial bones of the human skull.....	33
Table 3. Basic average (50th percentile) dimensions of the human head and ear (NASA, 1978; Burkhard, 2004; Department of Defense (DoD), 2000).	34
Table 4. Trans-cranial attenuation (in decibels) as a function of signal frequency (Snyder, 1978).	47
Table 5. Normal monaural hearing thresholds for air-conducted sounds at different frequencies for TDH-39 supra-aural headphones and sound field reception (loudspeaker located at 0 degrees' azimuth) conditions (ANSI, 1996).	59
Table 6. Normative bone conduction hearing threshold values (in dB re 1 μ N) listed in various publications for a vibrator on the mastoid bone.....	60
Table 7. Common locations for bone conduction transducers on the human head.	63
Table 8. Normal monaural force hearing thresholds for bone-conducted sounds at different frequencies for a B-71 vibrator placed on the mastoid and at the forehead (ANSI, 1996)...	65
Table 9. Threshold values for forehead versus the average across four tooth location placements.....	67
Table 10. Comparison of occlusion effects (in dB) caused by supra-aural earphones at various audiometric frequencies (a – mastoid stimulation; b – forehead stimulation).	72
Table 11. Main auditory cues used for spatial orientation by humans.	79
Table 12. Geometric dimensions of the Radioear bone conduction vibrators.....	94
Table 13. Estimated difference (Δ BC) between direct and conventional bone conduction hearing thresholds (Carlsson et al., 1995).....	126
Table 14. Listing of commercially available bone conduction communication and hybrid systems.....	134
Table 15. Special purpose commercially available devices incorporating bone conduction. ...	142

Acknowledgments

This report was developed as a part of the Situational Understanding Army Technology Objective (ATO) by the U.S. Army Research Laboratory's (ARL) Human Research and Engineering Directorate, Visual and Auditory Processes Branch, at Aberdeen Proving Ground, Maryland. The authors would like to acknowledge the contributions of Timothy Mermagen, Francis Breitenbach, and Justin MacDonald, all of ARL, who collaborated in the research studies described in this report. We would also like to acknowledge the contributions of Phuong Tran for the section about measurements and calibration of bone conduction transducers. Melissa Dixon (ARL), Diana Emanuel (Towson University), and Justin MacDonald (ARL) provided helpful comments and insight on initial version of this report. Finally, the authors would like to thank the listeners who participated in the research studies. Without their voluntary participation, the data reported in this report would not exist.

1. Introduction

1.1 Purpose

Interest in bone conduction communication has recently gained in popularity. Modern radio communication and computer interfaces need to operate effectively in quiet and noisy environments. This is especially critical in military applications. Soldiers need to quietly hear the surrounding environment and to have their ears protected in the presence of noise. A communication system must allow Soldiers to clearly communicate with the members of their squad (through direct speech) as well as with other groups (through radio communication), but the enemy must not be allowed to gain knowledge of the squad's location. The ideal military radio communication system would allow for hands-free operation so that the Soldier could simultaneously operate a weapon or other equipment as needed. These diverse requirements make bone conduction transmission a natural sound transmission pathway option. Speech signals can be transmitted to and from the Soldier through transducers on the head, which leave the ear canals open or covered (protected) as needed without affecting the communication interface. The goal of this project was to create a comprehensive source of current information about all aspects of bone conduction communication in order to provide a solid foundation for further research and development activities.

1.2 Air and Bone Conduction

Hearing is the process of receiving acoustic stimuli via the auditory system and converting them into auditory sensations. The auditory system consists of two ears and an associated neural network. Acoustic stimuli arriving at the ears are converted into mechanical vibrations that stimulate the cochlea where they are converted into neural impulses. Neural impulses originating in the inner ear travel along the auditory nerve to the brain where they are translated into auditory sensations and perceptions in the auditory cortex. There are two transmission pathways by which physical sound waves can be transformed into mechanical vibrations that stimulate the inner ear: air conduction and bone conduction.

- Air conduction is the process by which an acoustic signal travels through the structures of the outer and middle ear and arrives at the cochlea.
- Bone conduction is the process by which an acoustic signal vibrates the bones of the skull to stimulate the cochlea. Skull bone vibration can be a result of acoustic or mechanical stimulation of the skull.

Air conduction and bone conduction support the same conversion mechanism in the cochlea where mechanical vibrations are converted into neural impulses (Bekesy, 1932; Lowy, 1942).

This means that the cochlear processes in the inner ear are the same, regardless of the pathway by which the cochlea is stimulated (Gelfand, 1991). Bekesy (1932) demonstrated this fact by delivering the same tone simultaneously by air and bone conduction and perceptually canceling them by amplitude and phase adjustments of the air-conducted signal. If the processing mechanisms in the cochlea for both types of signals were different, such cancellation would not be possible.

The air conduction pathway is the primary transmission pathway for reception of information about the acoustic environment by a person with normal hearing and open (uncovered) ears. The external and middle ear mechanisms are designed to channel and enhance acoustic information, optimize its conversion into mechanical vibrations of the three small bones of the ossicular chain of the middle ear, and deliver it to the mechano-neural converter of the cochlea. The bone conduction pathway bypasses the external and the middle ear mechanisms, resulting in suboptimal sound transmission to the cochlea. Direct transmission of the acoustic signal to the cochlea through the skull vibration is 40 dB (in the mid and high frequencies) to 70 dB (in the low frequencies) less effective than the air conduction pathway (Blauert, Els, & Schroeter, 1980). Therefore, in the case of a person listening to air-conducted sound with open ears, bone conduction has minimal (if any) contribution to auditory perception. This situation may be different in some animals, such as elephants, rhinoceri, and mole rats whose ears differ anatomically from humans and who communicate by infrasound (Heffner & Heffner, 1980; Rado et al., 1989; Reuter, Nummela, & Hemila, 1998). However, bone conduction transmission determines the limits to which human hearing can be protected from external noise by hearing protection devices. Covering or occluding the ears reduces the amount of sound energy entering the auditory system through the ear canal but has no effect on the amount of sound energy transmitted through bone conduction. In other words, if a sound is of a sufficiently high intensity, the ears will be stimulated through bone conduction even if the air conduction pathway is maximally occluded (protected). In addition, every human hears through air and bone conduction when talking since the vibrations of the vocal folds vibrate the bones of the skull.

During normal listening conditions, the sound arriving at the human head from the surrounding environment is transmitted by the air conduction and the bone conduction pathways. As stated before, the bone conduction pathway is 40 to 70 dB less effective than the air conduction pathway and can be neglected during most operational conditions. Bone conduction transmission is a much more effective contributor to auditory perception when the audio signal is transmitted directly to the human head through a vibrator placed on the skull or touching the teeth instead of from an airborne sound wave striking the head. Such direct stimulation of the head is used in audiology for testing the integrity of the cochlea and in hearing aids for people with missing or deformed ear canals. The phenomenon of bone conduction sound transmission has also been used by the entertainment industry in such toys as Sound Bites¹ and radio systems such as the Aqua FM²

¹Sound Bites is a trademark of Hasbro, Inc.

²not an acronym

snorkel and SwiMP3³. Despite these applications, historically, bone conduction has not been considered a very useful transmission method.

1.3 Historical Account of Bone Conduction

The sensitivity of the human body to vibrations is a phenomenon known from ancient times. Touching an object with a finger or a hand provides information about vibrations of the object even if these vibrations cannot be heard or seen. Although this sensation could be attributable to tactile perception and not to hearing, touching the same object with the forehead or another part of the skull makes this sensation stronger and audible because of stimulation of the cochlea through bone vibration. Our ancestors put their heads to the ground to hear distant movement that could not be heard through the air, and this was an intuitive use of bone conduction.

Despite physical evidence that people could feel and hear vibrations, hearing was believed for many centuries to be a result of the direct transmission of sound through air to the brain. The ear was thus considered to be an aerial organ. This concept was proposed by Aristotle (circa 350 BC) in a form of “air internus” whereby the ear was separated from external air by the tympanic membrane and the sound waves were sent directly to the brain (Stenfelt, 1999). Despite these early misconceptions, some elements of conductive hearing have been known and used since the 16th century. For example, in the 16th century, Girolamo Cardano determined that sound can be transmitted through the teeth and the skin (Ore, 1953). In the same time period, Girolamo Capivaccio used an iron rod held against the teeth to assess ear pathology. If no sound could be heard after the rod was struck, cochlear deafness was determined (Stenfelt, 1999). Also during that period, Giovanni Filippo Ingrassia recommended sound transmission through the teeth as a way to enhance auditory perception (Weinkove, 1998), and in the 18th century, Ludwig van Beethoven apparently used this technique after he became deaf. He listened to his piano by holding a wooden rod connecting the piano keys to his teeth (Niemoeller, 1940). However, the sound transmission from the teeth to the cochlea was still misunderstood in the 16th and 17th centuries and was wrongly attributed to air conduction through the Eustachian tube.

The actual concept of listening through bone conduction was developed at the beginning of the 18th century when it became generally accepted that the cochlea was filled with fluids and that fluids and solids could transmit sound waves. At that time, people realized that bone conduction transmission had a practical value to help deaf people hear. The first commercial bone conduction hearing aid, called the *fonifero*, was reportedly developed by Giovanni Paladino in 1876. The aid had a metal rod providing direct connection between the vibrations of the talker's neck and the listener's forehead or teeth (Pollack, 1975, p. 5). A similar concept was used in the *audiphone* designed and patented by Richard Rhodes in 1879 (anonymous, 1880). The audiphone was a fan pressed against the teeth of the listener, which converted the talker's speech into mechanical vibrations transmitted to the teeth. The concepts of *fonifero* and *audiphone* are shown in figure 1.

³SwiMP3 is a trademark of Finis, Inc.

Both devices are examples of a broader class of devices designed to transmit sound through the teeth of the listener, referred to as *dentiphones* (U.S. Patent Classifications; Class 181 - Acoustics, Major Subclass 127 - Dentiphones). Dentiphones experienced considerable popularity until the invention of the carbon-electric hearing aid in the early 20th century (Berger, 1976). Modern bone conduction hearing aids are electro-acoustic transducers typically placed on the temporal bone or, in the case of the bone-anchored hearing aid, attached to a metal plate that has been surgically inserted into the temporal bone of the person with impaired hearing.

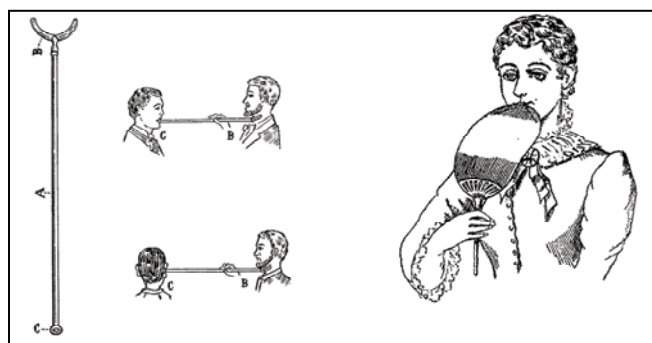

Figure 1. Paledino's fonifero, 1876 (left) and Rhodes' audiphone, 1879 (right). (See <http://website.lineone.net/~rweinkove/hearing/#bone>.)

The first clinical applications of the transmission of sound through the bone conduction pathway have included the *Weber*, *Rinne*, and *Schwabach* tuning fork tests. These tests use a tuning fork to compare the hearing abilities of a person through the air and bone conduction pathways. These tests, first developed in the early 19th century, are still in use today by health care providers as screening methods for hearing loss.

Until very recently, the interest in bone conduction communication beyond audiology testing and the hearing aid industry was minimal. Transmission of sound through bone conduction was not considered an option for anything other than clinical testing and hearing aids. In 1932, Hugo Lieber, the founder of the company Sonotone, developed a small and effective bone conduction receiver advertised in *National Geographic* as the "Lieber oscillator". It was one of Sonotone's hearing aid flagships at that time. In 1944, the U.S. Signal Corps asked Sonotone to develop a radio headset that could fit under the Army's new battle helmet and provide clear sound during various levels of background noise. Although Sonotone had the opportunity to incorporate bone conduction technology into their device, they decided to trust classical air conduction technology instead and equipped the helmets with M-300 insert earphones (see figure 2) (Russell, 2003). Bone conduction technology for use by the military seemed to have missed its great opportunity.

The situation did not change until 50 years later when, in the 1990s, the military, firefighters, and special forces again searched for radio communication interfaces that would be effective in noise, secure against eavesdropping, and hands free in operation. Bone conduction communication naturally became one of the very few options considered. Unfortunately, bone conduction

technology had not progressed much through the previous 50 years and was not ready for this challenge. Until this point, the lack of effective bone conduction transducers and good understanding of bone conduction mechanics hampered the progress of technology. This time, however, the sudden growth of interest in bone conduction communication caused scientific and technological progress in this area, which could soon result in bone conduction transmission being the primary method for radio communication.



Figure 2. Sonotone's B-533 bone conduction body hearing aid (left) and M-300 system developed for the U.S. Signal Corps (right). (Pictures courtesy of Sonotone, Inc.)

As discussed before, bone conduction had been regarded for a long time as a mechanism with no general application. Its usefulness had been believed to be limited to audiologic diagnostics and conductive hearing aids (Hood, 1962; Dirks, 1985). There were very few attempts in the literature to address bone conduction beyond this scope, and the information about bone conduction that can be useful in human factors engineering is scattered or nonexistent. Currently, however, bone conduction transmission is being considered as another communication channel to be used by emergency personnel, divers, military forces, police teams (particularly SWAT [special weapons and tactics] teams), and fire fighters. The common factors for all these groups are a desire to have a hands-free system of receiving communication, the ability to hear sounds in the environment with ears uncovered, and to be protected against environmental noise through the use of hearing protection. The use of bone conduction in these communication conditions is critical to safe and effective operations. However, potential applications of bone conduction communication extend beyond those mentioned since bone conduction is a flexible and effective mode of communication that can be easily implemented in many military and civilian activities. Therefore, the purpose of this report is to assemble scattered basic information about bone conduction and provide for a basic understanding of its mechanics, capabilities, and limitations.

The current report combines results of a critical literature review in the areas of bone conduction perception and transmission along with selected results of in-house research studies conducted by the U.S. Army Research Laboratory's (ARL's) Human Research and Engineering Directorate, Visual and Auditory Processes Branch, at Aberdeen Proving Ground, Maryland. A special focus of the studies was on the effects of vehicle vibrations on bone conduction communication (section

13). The literature review and the reports from in-house studies are supplemented by information regarding calibration of bone conduction transducers and measurement of frequency response and dynamic range (section 8). An integral component of this report is also personal observations of the authors regarding various prototypes of bone conduction systems used and evaluated at ARL.

2. Air Conduction Hearing

Section 2 is dedicated to the anatomy and physiology of the air conduction human hearing process. The understanding of the process of hearing through air conduction is essential as a basis for understanding how humans hear through bone conduction.

2.1 Anatomy and Physiology of the Auditory System

The act of hearing is called *audition*. Audition is the primary means by which language is learned and events around the observer are perceived. The sensory and perceptual system that facilitates hearing is called the hearing mechanism or the *auditory system*. This system consists of the right and left ears connected through a network of ascending and descending neural fibers connected to the brain. The ear is the organ for hearing and balance. The ear structure consists of three major parts: the *outer ear* (external ear), the *middle ear*, and the *inner ear*, shown in figure 3. The outer ear and the middle ear collect and transmit sounds. The outer ear is a passageway through which sound waves travel to the middle ear where the sound is converted into mechanical vibrations. These vibrations created in the middle ear are received by vibration receptors in the inner ear and converted into neural impulses that are sent to the brain in the process of sound perception. The neural fibers leading from the cochlea to the higher structures in the brain are collectively known as the auditory nerve (the cranial nerve VIII). The brain is the source of all auditory perceptions, but it is at the location of the ears where the acoustic stimuli are received, processed, and converted into neural impulses.

The auditory system is complex and can be examined from anatomical and physiological perspectives. These two perspectives complement each other and together provide the basis for our understanding of the normal and pathological perception of sound. The actual act of perception is the domain of psychology, which is the science of the mind. A branch of psychology called psychoacoustics is concerned with the relationship between acoustic stimuli and the effects they produce in the mind.

A functional block diagram of the air conduction pathway of the auditory system is shown in figure 4. The structure and function of the individual blocks of this diagram are described in detail in subsequent parts of this section. As shown in the diagram, the air conduction pathway involves stimulation of the inner ear by sounds traveling through the outer and middle ears. However, the vibration receptors in the inner ear can also respond to direct vibration of the skull produced by

sound waves striking the skull or through mechanical forces applied to the human body. This pathway is known as bone conduction and is discussed in depth in section 3. It is important to realize that auditory sensation is a result of a complex stimulation of the organ of hearing through air conduction and bone conduction pathways.

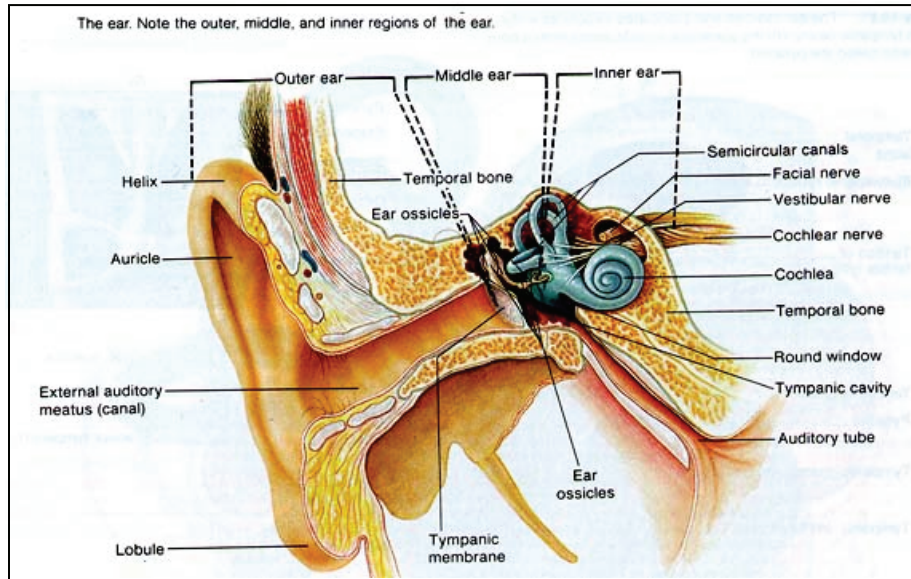

Figure 3. Cross section of the ear. (Downloaded from <http://www.sfu.ca/~saunders/133098/Ear.f/Earintro.html>, June 25, 2005.)

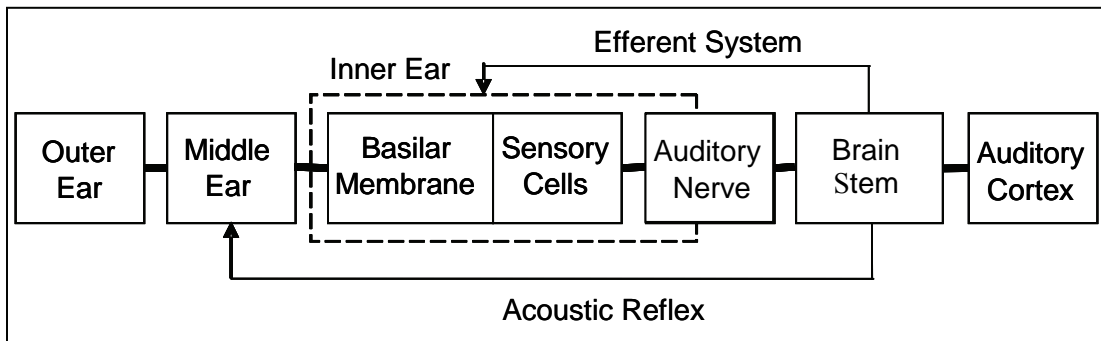

Figure 4. Functional diagram of the auditory system (one ear).

2.2 Outer Ear

The outer ear is an anatomical structure directing the sound waves to the middle ear and acting as a sound collector and acoustic amplifier. It includes the *pinna* (auricle), which is the visible earflap, and the *external auditory canal* (ear canal or external auditory meatus) terminated by the *tympanic membrane* (TM) (eardrum). The TM separates the outer ear from the middle ear. The acoustic function of the outer ear is to collect and selectively amplify incoming acoustic stimuli and to direct them toward the TM and associated structures of the middle ear. Additionally, both

the pinna and the external auditory canal (EAC) protect the TM against injury, foreign bodies, and outside changes in temperature and humidity.

The pinnae are situated on the left and right sides of the human head but their precise locations are not fully symmetrical about the head. Furthermore, there are large individual differences in the specific location, shape, and geometry of the outer ears. The pinna is an earflap projecting from the side of the head at a horizontal angle of about 30 degrees toward the front of the head and covering the entry to the ear canal from the back. The average length of the adult male pinna is 67 mm with an average width (or breadth) of 34.5 mm (Wever & Lawrence, 1954). The pinna is tilted along the vertical axis by approximately 15 degrees (Wever & Lawrence, 1954; Yost & Nielsen, 1977). The pinna is composed of elastic cartilage and fibrous tissue covered by skin. The frontal surface of the pinna is convoluted and includes various grooves, pits, and ridges (see figure 5). The *lobule* (ear lobe) is comprised of skin and fat, but there is no underlying cartilage. The deepest cartilaginous groove, a bowl-shaped depression in the lower center of the pinna, is called the *concha* (or concha bowl) and is approximately 10 to 20 mm in diameter and leads directly to the opening of the EAC. The concha has a resonance frequency around 5 kHz (Yost & Nielsen, 1977). The rim-like flange of the pinna is called the *helix* and descends into the concha frontally (anteriorly). A small cartilaginous flap in front of the EAC is called the *tragus* and it protects the entrance to the EAC from the front. The notch point at the upper rim of the tragus is called the *tragion* and is frequently used as a point of reference in anatomical measurements. The notch point below the lower rim of the tragus is called the *intertragal notch* and is frequently used as a reference point for inserting a probe microphone into the ear canal in real-ear measurements. The distance between the intertragel notch and the entrance to the EAC is about 10 mm (Hawkins, Alvarez, & Houlihan, 1991; Pumford & Sinclair, 2001). The tragus is often used by individuals to manually close the EAC and attenuate noise in the environment. When the tragus is pushed over the opening of the EAC, the air conduction transmission of sound is minimized.

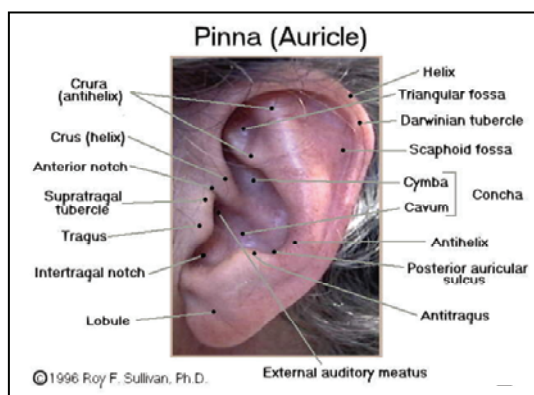

Figure 5. Diagram of the left human pinna. (Downloaded from <http://www.sfu.ca/~saunders/133098/Ear.f/extear.html>, June 25, 2005.)

The main functions of the pinna are to direct incoming sound toward the EAC and to aid in sound localization. Some animals (e.g., dogs) can move their pinnae to aid in sound localization,

but humans do not typically have this ability. People who may possess the ability to move their pinnae do not normally do so in order to better localize sounds as do other animals. The pinnae have shock-absorbing properties and protect the EAC and inner ear structures from potential damage caused by a lateral blow to the head. Batteau (1967) demonstrated that sounds reflected from various ridges and valleys of the pinnae are time delayed by as much as 300 μ s in relation to the direct sound arriving to the EAC and that the delays are highly correlated to the direction of the incoming sound. For example, the farther the sound source is toward the back of the head, the longer the delays are between the direct and indirect sounds. Such delays also depend on the elevation of the sound source. The effects of the pinnae seem to be particularly important for localization of sound sources in the median (vertical) plane that divides the listener into left and right halves, for determination of the elevation of a sound source (Gardner & Gardner, 1973) and for high frequency sounds above 4000 Hz. Typical directional characteristics of the outer (right) ear in the horizontal plane as a function of the frequency of the incoming sound are shown in figure 6. As shown in the figure, the ear is most directionally sensitive to sounds of higher frequencies. The 8000-Hz tone presented to the right side of the head arrives at the right ear with much higher intensity than a sound presented from the left side. This difference in intensity for high frequency tones as opposed to low frequency tones is known as the “head shadow effect” in which the head blocks sounds coming from one side from reaching the other side. Through this anatomical feature, we are able to localize high frequency sound sources in the environment. The topic of auditory localization is discussed in further detail in section 7.

The EAC is an s-shaped tube terminated medially (centrally) by the TM. The walls of the EAC are lined with skin and the most external part of the canal is covered with small dust-filtering hairs and mucous glands producing *cerumen* (ear wax) that trap small objects entering the EAC. The hairs and cerumen protect the ear from foreign bodies such as dirt and bugs. The lateral (outer) one-third of the canal is surrounded by cartilage and the medial (inner) two-thirds of the canal pass through the temporal bone. The cartilaginous one-third of the EAC is covered with skin that is approximately 0.5 to 1 mm thick and contains a well-developed dermis and subcutaneous layer. The bony two-thirds of the EAC are lined with very thin skin that is continuous with the external layer of the TM. The average length of the adult EAC is 25 mm (1 inch) (Wever & Lawrence, 1954; Yost & Nielsen, 1977). Because of the oblique orientation of the TM, the postero-superior canal wall is approximately 6 mm shorter than the opposite (antero-inferior) wall. The effective acoustic length of the canal is about 25% longer than its physical length because of the “end effect”⁴ of the concha and the manner in which the concha is coupled to the ear (Teranishi & Shaw 1968). The average fundamental resonance frequency of the EAC is 2600 Hz (Yost & Nielsen, 1954), which corresponds to the effective length of the ear canal (32 mm). The volume of the ear canal is about 1 cm³ (Wever & Lawrence, 1954). The average

⁴The end effect is caused by the gradual rather than abrupt change in air behavior inside and outside the ear canal, caused by air stiffness and gradual transition of the ear canal into concha. This effect causes the effective length of the canal to be somewhat longer than its physical length.

diameter of the ear canal is 7 mm, its average circumference is 22 mm, and the average cross-sectional area corresponds to 0.40 cm^2 (Wever & Lawrence, 1954). The cross-sectional area is the largest at the entrance to the EAC (0.45 cm^2) and has an elliptical shape with average horizontal and vertical diameters of 6.5 mm and 9 mm, respectively (Wever & Lawrence, 1954). The inner 8 to 10 mm of the EAC are tapered to form a gradually narrowing cross-sectional area and are terminated by the TM inclined at an angle of about 40 degrees relative to the midline of the EAC. The narrowest part of the EAC is called the *isthmus* and is situated about 4 mm in front of the TM.

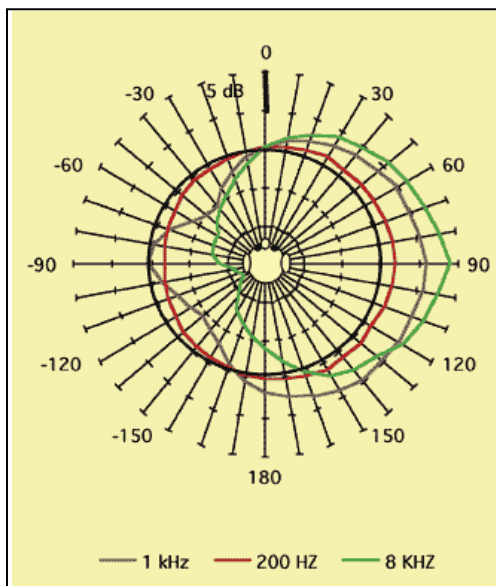

Figure 6. Directional characteristics of the outer (right) ear at 200 Hz, 1000 Hz, and 8000 Hz. (The listener is represented as the head in the center of the plot with the nose toward the top of the graph. Markers on the vertical lines indicate 5-dB steps. Downloaded from <http://www.audio-media.com/archive/features/us-0101/us-0101-ears/us-0101-ears.htm>, June 26, 2005.)

Innervations of the EAC and TM are provided by three cranial nerves: the vestibulo-cochlear nerve (cranial nerve VIII), the facial nerve (cranial nerve VII), and the vagus nerve (cranial nerve X). The vestibulo-cochlear (or combined vestibular and auditory) nerve is responsible for our sense of hearing. The facial nerve is responsible for the sensation from and movement of our facial muscles as well as the sense of taste (together with vagus nerve). The vagus nerve (from Latin *vagus* meaning “wandering”) is the longest of the cranial nerves and provides a variety of sensory (afferent) and motor (efferent) functions innervating, among others, the throat, heart, stomach, and abdomen. The facial and vagus nerves also innervate some parts of the middle ear.

A description of the sound field in the EAC is a complex task, especially at higher frequencies at which sound wavelengths approach the dimensions of the EAC. Fortunately, the cross-sectional area (lumen) of the EAC is small enough that transversal propagation can be neglected for most of the audible frequencies. According to Middlebrooks, Makous, and Green (1989), the primary mode of wave propagation in the EAC is a planar progressive wave that travels medially along the EAC. If one considers the EAC to behave like a horn (Webster, 1919), the assumption holds well for frequencies below a certain cutoff frequency, f_o , that can be calculated as

$$f_o = \frac{c}{\pi d},$$

in which c is the speed of sound in air and d is the diameter of the EAC. Below this frequency, the average diameter of the horn is small in comparison to the wavelength of the propagating wave, and wave propagation in the direction perpendicular to the main axis of the horn can be neglected. If one assumed that the EAC were a straight horn, the one-dimensional propagation of the sound waves along the EAC could be the only type of propagation until about 15 kHz. As frequency increases, wavelength decreases; therefore, above 15 kHz, additional resonances would appear because of reflections within the EAC. However, the EAC is not a straight horn. Because of the significant curvature, the actual cut-off frequency is much lower and does not exceed 8 kHz. Stinson and Daigle (2005) reported spatial variations of sound pressure within the cross section of the EAC reaching 1.5 dB at 8 kHz and 4.5 dB at 15 kHz. Below 4 kHz, spatial variations were negligible.

The actual geometry of the EAC and the mechanical properties of the EAC walls result in a relatively broad resonance in the 2000- to 3000-Hz range. Some additional amplification of the sound pressure at higher and lower frequencies is the result of resonance properties of the concha and reflections from various parts of the human body. Figure 7 shows the sound pressure gain in the EAC caused by various body parts when the sound arrives at the ear at a 45-degree angle. The curve labeled “T” is the overall transfer function of the EAC combining the effects of the EAC itself, the pinna, and body reflections. The resonance properties of the concha increase the sound pressure in the EAC around 5000 Hz (curve “3”), and the reflections from the helix and antihelix increase the pressure across a broad range of frequencies around 4000 Hz (curve “4”). The combined reflective and resonance effects result in amplification of the incoming sound at the TM by 5 to 20 dB between 1500 to 7000 Hz.

The increase in sound pressure caused by the pinna, head, and shoulders depends on the direction of the incoming sound. This effect is shown in figure 8. Sound approaching from a 45-degree angle results in the greatest overall gain in the mid- to high-frequency region and the concha resonance contributes the most for sounds arriving at 90- and 135-degree angles (Shaw, 1974).

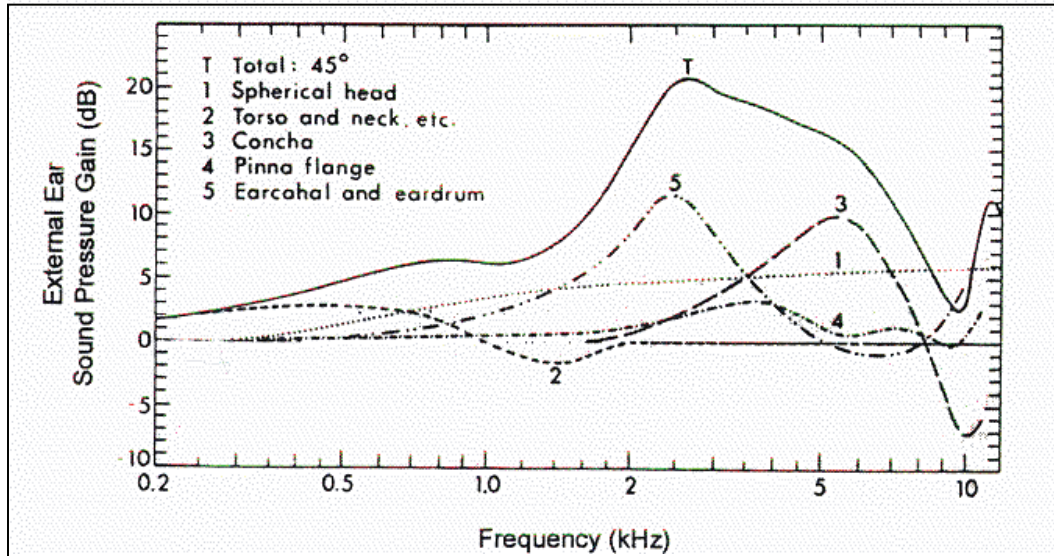

Figure 7. Sound pressure amplification by the ear canal and surrounding structures (Shaw, 1974).

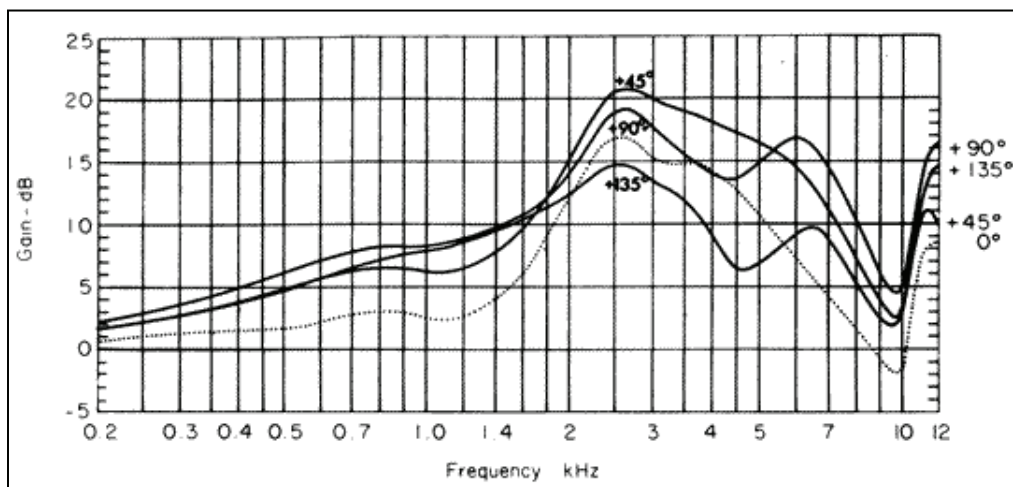

Figure 8. Sound pressure amplification by the ear canal as a function of frequency for different source azimuths (Pickles, 1988).

The TM serves as the border between the outer ear and middle ear structures. It is a thin and translucent film with an average thickness of 0.074 mm (Donaldson & Miller, 1980); it weighs approximately 14 mg. It has an elliptical shape with a vertical diameter of 9 to 10 mm and a horizontal diameter of 8 to 9 mm (Gelfand, 1991). Its modulus of elasticity (Young module) characterizing stiffness is about 0.02 GPa (Bekey, 1949). The cross-sectional area of the TM varies from 55 to 90 mm² (average = 64 mm²). The TM has a concave shape, forming a cone about 2 mm high, with its tip (umbo) facing the middle ear. It is attached to the manubrium of the malleus (one of the three middle ear bones) (Pickles, 1988). Because of its conical shape and the fact that it has two parts of different stiffness, the effective area of the TM is about 55 mm². The stretched part of the membrane, called *pars tensa*, forms about 65% of the membrane, whereas the rest of the membrane, called *pars flaccida*, is relatively loose. The role of *pars*

flaccida is to allow the *pars tensa* to move like a piston, that is, it facilitates mobility of the *pars tensa* at its edges (Bekesy, 1949). The *pars flaccida* also compensates to some degree for the atmospheric pressure differences across the tympanic membrane (Zemlin, 1988).

The TM serves as the front end of an acousto-mechanical transducer occupying the middle ear. It responds to acoustic pressure and converts it into mechanical vibrations transferred to the associated middle ear structures. The actual sound pressure of signals that arrive at the TM varies with source azimuth (Shaw, 1974). Shaw and Vaillancourt (1985) published detailed tables showing the dependence of the sound pressure at the TM as a function of the angle of incidence. The difference in sound pressure levels from sounds arriving at the ear from different angles contributes to our auditory localization abilities, discussed in section 7.

The amplitudes of vibrations of the TM at the threshold of hearing are very small and do not exceed the size of an atom of helium (10^{-9} cm). These displacements are very small in comparison to the “mean free path” of air particles moving randomly during normal atmospheric conditions ($\sim 10^{-5}$ cm). However, these random movements are not heard when the temperature and static pressure on both sides of the TM are the same. In such cases, air particles move with the same energy and cancel each other’s effects. The need to maintain the same temperature on both sides of the TM explains the need for a relatively long and s-shaped EAC. This shape also protects the TM against direct hits by dust particles or foreign bodies entering the EAC.

The effective transfer of sound energy through the auditory system depends on impedance matching between subsequent parts of the system. The impedance of a medium describes its opposition to movement. Impedance is a complex entity consisting of two parts: resistance (friction) and reactance. The reactive component of acoustic impedance results from sound energy being transmitted back and forth between its mass (inertia) and stiffness (elasticity).

The characteristic acoustic impedance Z_0 of an unbound medium is defined as the product of the medium’s density, ρ , and the speed of sound, c , in the medium

$$Z_0 = \rho c \text{ [g/cm}^2 \cdot \text{s]} = \rho c \times 10 \text{ [Nsm}^{-3}\text{]},$$

in which g is the mass in grams, cm is the distance in centimeters, and s is the time in seconds.

For a sound wave propagating through the medium, the impedance of the medium is equal to the complex ratio of the sound pressure, p , at a point in space to the particle velocity, v , at that same point

$$Z_0 = \frac{p}{v}.$$

The unit of characteristic impedance is called the *rayl*. The characteristic impedance of boundless air at 20° to 22 °C, Z_0 , is approximately 41 rayls (cgs) or 410 Nsm^{-3} . For comparison, the characteristic impedance of sea water (the medium considered to have similar acoustic

properties to the inner ear fluids) at the same temperature is about 160,000 rayls, resulting in almost a 4000:1 ratio between these two impedances.

Whereas Z_1 and Z_2 are the characteristic impedances of the two media, the proportion T of incident power transmitted from Z_1 to Z_2 may be calculated as (Pickles, 1988, p. 5)

$$T = \frac{4Z_1Z_2}{(Z_1 + Z_2)^2}.$$

This means that when a sound wave transmitted through the air arrives at the sea surface, less than 0.1% (36 dB) of the total sound energy is transferred into the water. Likewise, because the inner ear is filled with water, acoustic energy alone, as it exists in the air, is too small to move the fluids of the inner ear. To mitigate this impedance mismatch, the outer ear is connected to the inner ear through the middle ear, which serves as a transformer that matches the impedance of the inner ear to that of the air in the EAC.

2.3 Middle Ear

The middle ear is an osseous (bony) cavity, measuring 2.0 cm³ (Dallos, 1973; Yost & Nielsen, 1977), lined with a mucous membrane and situated in the mastoid process of the temporal bone (see figure 9). The middle ear cavity is separated from the EAC by the TM. The middle ear cavity is filled with air and houses a chain of three bones (*ossicles*) as well as their supporting muscles and ligaments. The lining of the middle ear cavity covers the air cells of the mastoid bone. The air pressure within the middle ear cavity is controlled by the Eustachian tube connecting the middle ear space to the nasopharyngeal cavity of the upper throat. The Eustachian tube serves as a vent equalizing static pressure in the middle ear to that of outside atmospheric pressure. The Eustachian tube extends from the anterior wall of the middle ear into the posterior wall of the nasopharynx.

The Eustachian tube is a bony canal in the upper one-third of its length as it exits the middle ear and is cartilaginous in the lower two-thirds of its length as it approaches the nasopharynx. The middle ear opening of the Eustachian tube in adults is about 20 to 25 mm higher than the pharyngeal opening. This allows the tube to serve as a drainage system for disposing of excess middle ear secretions (cerum) into the nasopharynx (throat) (DiBartolomeo & Henry, 1992). The typical length of the Eustachian tube in adults is 36 mm. The cartilaginous part of the tube is normally closed to protect the middle ear space, but it opens during swallowing or yawning. It also opens when the difference between the air pressure in the middle ear cavity and in the nasopharynx exceeds about 20 mm mercury. The Eustachian tube can be forced open through the Valsalva maneuver where the nose is plugged and positive pressure accumulates in the middle ear space. The positive pressure within the middle ear cavity causes the Eustachian tube to open, allowing for an equalization of pressure on both sides of the TM. This maneuver is regularly conducted by scuba divers in order to pressurize their ears when they descend into deeper waters. If the Eustachian tube fails to open and regulate air pressure in the middle ear, negative pressure builds

in the middle ear, causing a sensation of stiffness or even pain. This pressure accumulation occurs frequently when people travel through different elevations, such as while driving in the mountains, flying, or scuba diving. People experiencing this effect typically yawn or swallow in an attempt to open the cartilaginous portion of the Eustachian tube and thereby relieve the pressure.

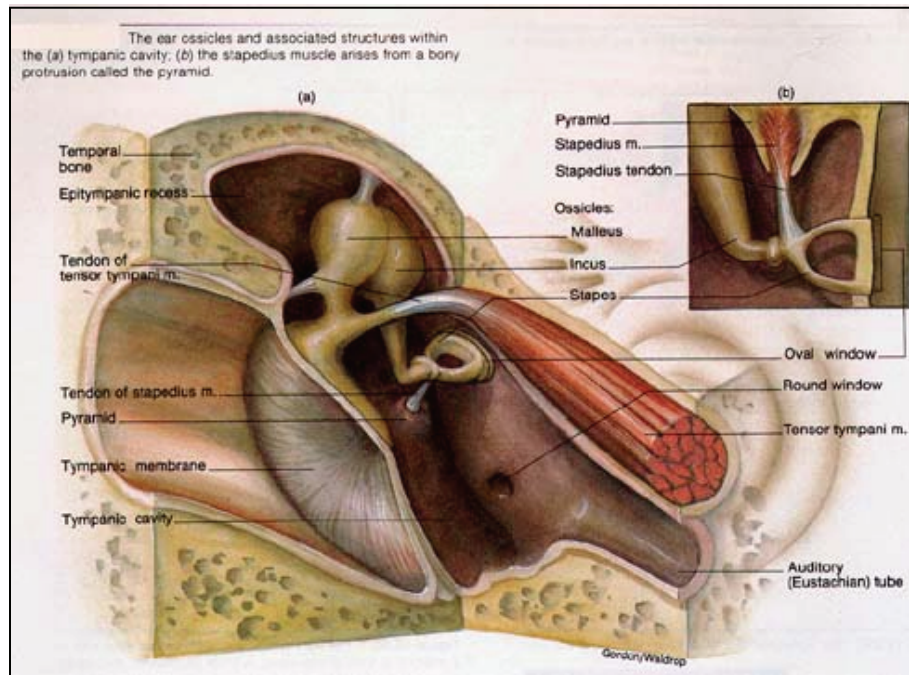

Figure 9. The middle ear space and ossicular chain. (Downloaded from <http://www.sfu.ca/~saunders/133098/Ear.f/midear.html>, June 25, 2005.)

Prolonged blockage of the Eustachian tube can result in the accumulation of middle ear secretions that cannot drain. These secretions can then become infected through bacteria traveling through the Eustachian tube and can result in otitis media (a middle ear infection). Children experience ear infections more often than adults because their Eustachian tubes are oriented more horizontally than an adult's. The horizontal orientation does not have the benefit of gravity to allow for easy opening of the Eustachian tube. During childhood, along with the growth of the human head, the Eustachian tube becomes more vertical, allowing secretions to drain more easily and for the Eustachian tube to open and close more freely with the help of gravity. In children with frequent ear infections, a tube is sometimes surgically inserted into the anterior inferior quadrant of the TM to artificially ventilate and drain the middle ear space. These tubes are often called pressure equalization tubes since they serve as a functional replacement for the Eustachian tube.

The medial boundaries of the middle ear cavity are the oval and round windows of the cochlea. Most of the space in the middle ear is occupied by the *ossicular chain* connecting the TM to the oval window of the cochlea. The three ossicles of the ossicular chain are called the malleus (hammer), the incus (anvil), and the stapes (stirrup). They weigh approximately 25, 28, and 3 mg, respectively (Yost & Nielsen, 1977). The malleus is attached to the TM, whereas the footplate of

the stapes is suspended over the membrane covering the oval window. The malleus, incus, and stapes are not aligned so that they connect the TM with the oval window; rather, the ossicular chain (see figure 10) is oriented backward (posterior) as it travels medially.

The ossicles are connected to the bony structure of the middle ear cavity by two small muscles: the stapedius and the tensor tympani. The stapedius muscle attaches to the head of the stapes and the tensor tympani muscle attaches to the manubrium of the malleus. These muscles provide mechanical support for the ossicles but also contract when the ear is exposed to an intense sound. The stapedius muscle's contraction pulls the stapes and tilts its base in the oval window, thereby reducing the range of movements of the stapes. The tensor tympani muscle's contraction pulls the handle of the malleus medially, tensing the TM, and reducing the amplitude of its oscillations.

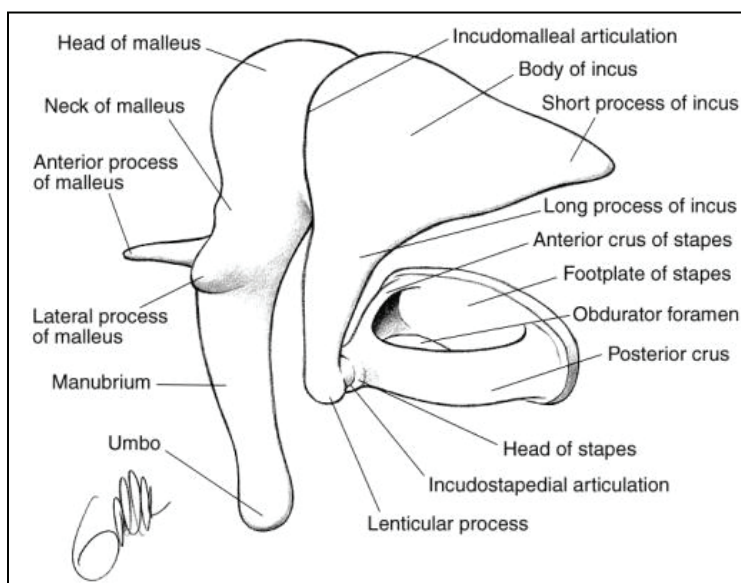

Figure 10. The ossicular chain with portions of the bones labeled Janfaza et al. (2000).

The contraction of the muscles in response to a loud sound is known as the *acoustic reflex* (or middle ear reflex) and is the main protective mechanism against exposure to loud sounds. When a loud sound occurs or is expected to occur, the two muscles contract, making the ossicular chain rigid and less able to transfer sound between the TM and the oval window. The acoustic reflex is most effective at reducing the transmission of low frequency sounds (Pickles, 1988).

The system of bones and muscles of the middle ear has some stiffness and elasticity and as such, it has some resonance properties. Bekesy (1941) found the ossicular chain to be a highly damped vibratory system with a natural frequency around 1400 Hz. Similarly, Moller (1961) observed the major resonance peak of the middle ear structure to be around 1200 Hz and a smaller one at 800 Hz, whereas Carhart (1950) reported the resonance frequency of the ossicular chain to be closer to 2000 Hz.

When sound energy arrives at the TM, the movements are transferred through the ossicular chain to the oval window of the cochlea. The role of the ossicular chain is to match the high impedance of the fluid-filled cochlea to the low impedance of the air in the EAC and thus facilitate an effective transfer of energy. The measurements conducted by Goode (1986) in fresh cadaver temporal bones revealed that the impedance of the inner ear fluid (Z_1) approximates 1,000,000 rayls (acoustic ohms) between 500 and 2000 Hz (Z_1). A much lower impedance value of 160,000 rayls was obtained by Lynch, Nedzelnitsky, and Peake (1982). For comparison, the impedance of water is about 144,000 rayls and the impedance of sea water is about 160,000 rayls. All these values are very high in comparison to the impedance of air (Z_2), which equals about 40 rayls, depending on temperature and atmospheric pressure. The ratio of these two impedances is quite large, equaling

$$\frac{Z_1}{Z_2} = \frac{160,000 \text{ to } 1,000,000}{40} = 4,000 \text{ to } 25,000.$$

In order to compensate for this impedance mismatch between air and water, the middle ear needs to increase the pressure acting at the oval window by 60 to 160 times (i.e., by 35 to 45 dB) in comparison to the sound pressure acting at the TM. The middle ear acts as a matching transformer between the EAC and the inner ear and provides about 35 dB of amplification of the pressure transmitted through the system. Without the middle ear system, 99.9% of the acoustic energy arriving at the EAC would be reflected back by the TM.

The matching transformer of the middle ear consists of three mechanisms: (a) a pressure transducer between the large area of the TM and the small area of the oval window, (b) a lever converting small force acting at the malleus into larger force acting at the stapes, and (c) a lever converting the large displacement of the TM to the small displacement of the malleus.

The most effective of these three mechanisms is the pressure transducer. The principle of the pressure transducers is shown figure 11. The ratio between the active area of the TM ($S_1 = 55 \text{ mm}^2$) and the area of the oval window ($S_2 = 3.2 \text{ mm}^2$) is 17:1 and acts as pressure amplifier. Assuming that the ossicular chain is a stiff system transmitting constant force from the manubrium of the malleus to the footplate of the stapes, this mechanism provides about 25 dB of amplification.

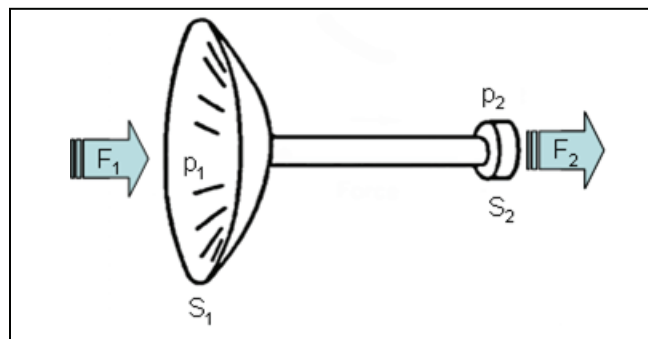

Figure 11. The concept of the pressure transducer. (Modified from Pickles [1988]. Subscripts 1 and 2 correspond to the TM and oval window, respectively.)

The second mechanism is the lever action of the ossicular chain. This lever action results from the fact that the ossicular chain is supported by the middle ear ligaments at the malleus-incus juncture with the mass of the ossicles distributed approximately equally on both sides of this point (Buser & Imbert, 1992, p. 137). The vibratory movement of the TM creates a rotational motion of the ossicular chain around the anterior-posterior (front to back) axis at this junction, and the lever-like action of the ossicular chain transfers energy from the relatively larger bone (malleus) to the smaller bones (incus and stapes). This lever action is shown in figure 12.

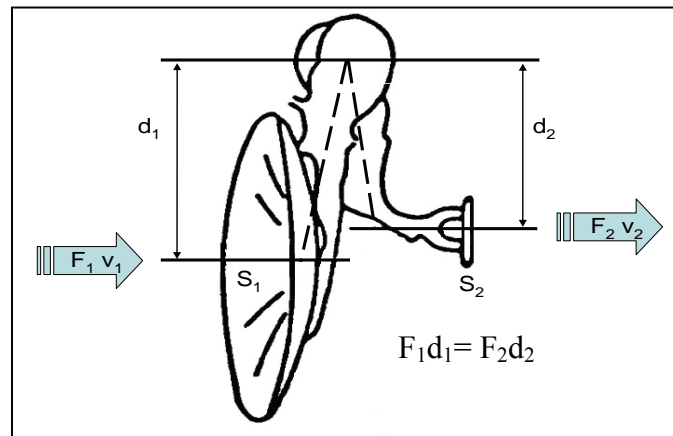

Figure 12. The mechanism of middle ear lever action (modified from Pickles [1988]).

The difference between the length of the malleus (d_1) and the length of the stapes (d_2) results in a lever action that increases the force at the footplate of the stapes by a factor of 1.15. Assuming that the middle ear is a perfect transformer and there is no energy loss in the transmission, this lever action results in an increase of the force ratio by 1.15 or 1.2 dB (Pickles, 1988). In reality, this ratio is a function of frequency as well as anatomical differences among people and varies from 1.0 to as much as 2.5 (Brenkman, Grote, and Rutten, 1987).

The third mechanism is the buckling effect of the TM that acts as a second lever mechanism of the ear. Because of the shape of the TM and the radial position of the handle of the malleus, the malleus is displaced less at the umbo than at the edge and increases the force acting on the ossicular chain. Since the ossicular chain operates as a single unit at low sound intensities, the force increase at the malleus acts upon the stapes, increasing pressure at the oval window. The net effect of the buckling mechanism of the TM is an increase in the pressure at the oval window by about 2 times (6 dB).

The combined effects of the lever action of the ossicles and the buckling effect of the TM result in a $2 \times 1.15 = 2.3$ increase of force acting on the footplate of the stapes as compared to the force acting at the umbo of the TM. This increase causes only a 2.0 to 2.5 decrease in peak-to-peak displacement as reported by several authors (Brenkman, Grote, & Rutten, 1987; Gyo, Aritomo & Goode, 1987). These two mechanisms, coupled with an increase in the sound pressure level (SPL) by 17 times because of the pressure transducer, create a total increase in the SPL at the

footplate of the stapes of 39 times (or 32 dB) of the original energy. This increase matches a potential 30+ dB loss of energy caused by the initial impedance mismatch between the air and cochlear fluid.

The compensation provided by the middle ear for the impedance mismatch holds for low and middle frequencies as high as ~2000 Hz. Above this frequency, several effects cause the middle ear function to become increasingly inefficient. A complex pattern of vibration of the TM at frequencies above 2400 Hz results in the lack of the entire area of the TM contributing to sound transmission (Tonndorf & Khanna, 1970). The peak-to-peak displacements of the TM at the umbo are relatively constant at low frequencies until about 500 Hz and then decrease at a rate of 6 dB/octave (Shaw, 1974; Brinkman, Grote, & Rutten, 1987). The reduced displacements result in a decrease in sound pressure transmitted across the ossicular chain. In addition, a 3000-Hz notch in middle ear transmission caused by a mastoid cavity and *aditus ad antrum* resonance further decreases the effective sound pressure transmission (McElveen et al., 1982; Gyo, Goode, & Miller, 1986). The slippage in the ossicular transmission and the changes in axes of movement within the ossicular chain decrease the displacement of the stapes above 1000 Hz, resulting in the displacement ratio dropping from about 2.5:1 at 1000 Hz to approximately 5:1 at 2000 Hz (Gunderson, 1971; Gyo, Aritomo & Goode, 1987). However, limited functionality of the middle ear transformer above 2000 Hz is compensated to some degree by external ear resonances providing good acoustic transmission to about 6000 Hz.

We can assess the linearity of sound transmission through the middle ear with changes in intensity by measuring the displacement of the stapes in response to a given acoustic pressure at the TM. This means that for every increase in intensity, there is a corresponding increase in displacement of the stapes. The range of middle ear linearity depends on the specifics of the acoustic signals but typically extends to 70 to 80 dB SPL. Above this intensity level, the transmission becomes nonlinear because of the presence of the acoustic reflex. If the acoustic reflex can be prevented, middle ear linearity can be observed as high as 120 dB SPL (Guinan & Peake, 1967).

The average middle ear resistance and reactance values measured by Zwislocki (1975) are shown in figure 13. At low frequencies, the ear impedance⁵ results mainly from negative reactance associated with the compliance (elasticity) of the TM and reaches -1000 to -2000 acoustic ohms. The negative reactance decreases with increases in frequency and becomes negligible at about 700 Hz. At higher frequencies, the ear impedance results mainly from the positive reactance associated with the mass (inertia) of the middle ear structures. The stiffness and mass-controlled parts of the reactance have opposite signs and cancel each other at the mid-frequency range. Ear reactance is practically negligible in the 800- to 6000-Hz range, causing the energy transmission from the TM to the cochlear fluids to be at its maximum (Gelfand, 1991). The resistance of the TM is 250 to 300 rayls to approximately 3000 Hz (Moller, 1963, 1974; Zwislocki, 1975). The modulus $|Z|$ of the middle ear impedance decreases to 1000 Hz with the slope of about -12 dB

⁵The term impedance is described in section 3.4.

per octave, stays relatively constant between 1000 and 3000 Hz and shows an increase with irregularities above 3000 Hz (Buser & Imbert, 1992).

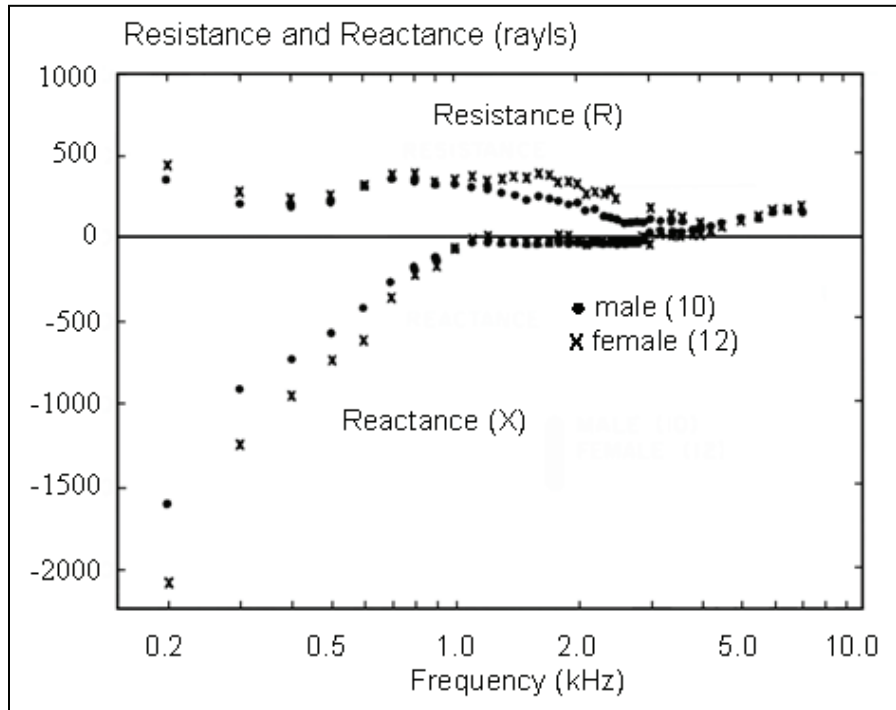

Figure 13. Frequency characteristics of middle ear resistance and reactance (from Zwislocki, 1975).

In summary, the middle ear mechanisms and the resonance properties of the external ear compensate for most of the sound energy loss caused by the impedance mismatch between the cochlear fluids of the inner ear and the air in the EAC. Ear reactance is practically negligible in the mid-frequency range, thus facilitating effective energy transfer of speech energy.

2.4 Inner Ear

The inner ear is the most medial part of the ear structure (see figure 14). It contains the organs for hearing and balance and is situated in the bony labyrinth of the petrous portion of the temporal bone. The structure of the inner ear is shown in figure 15.

The bony labyrinth of the inner ear has an overall volume of about 200 mm³ (Buckingham & Valvassordi, 2001) and is divided into three sections called the *vestibule*, the *semicircular canals*, and the *cochlea*. All three sections are occupied by a small membranous labyrinth surrounded by an incompressible fluid called *perilymph* that is high in sodium and low in potassium like the fluid between body cells. The main parts of the membranous labyrinth are the membranous semicircular canals, the utricle, the saccule, and the cochlea. The membranous labyrinth is filled with a fluid called *endolymph* that is high in potassium and low in sodium like the fluid within cells. The relationships between the bony labyrinth, the membranous labyrinth, and associated fluids are shown in figure 15. The utricle and the saccule (in the vestibule area) and the membranous

semicircular canals are parts of the vestibular system. This system is the organ of balance containing receptors sensitive to gravity, linear movements, and angular acceleration of the head. The cochlea contains the cochlear aqueduct that houses the neural receptors sensitive to vibrations and serves as the end organ for hearing.

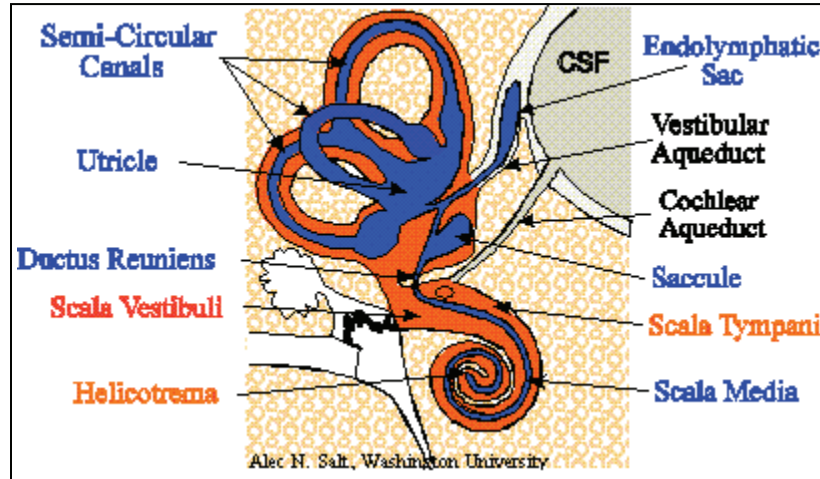

Figure 14. The structures of the inner ear. (The darker [endolymph] and lighter [perilymph] spaces are filled with the inner ear fluids. The dashed line in the picture separates graphically the vestibular system [above] from the cochlea [below]. Downloaded from <http://oto.wustl.edu/cochlea/intro1.htm>, June 26, 2005.)

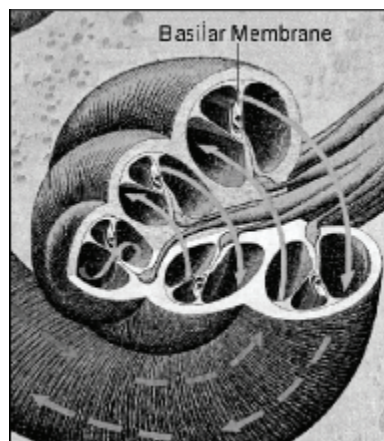

Figure 15. The structure of the cochlea (Andringa, Niessen, & Nillesen, 2004).

The cochlea is a snail-shaped shell twisted about $2\frac{1}{2}$ to $2\frac{3}{4}$ times (Yost & Nielsen, 1977) around a bony pillar called the *modiolus*. The shell of the cochlea wrapped around the modiolus is shown in figure 16. The auditory nerve and blood vessels that supply the structures of the cochlea enter the cochlea through the modiolus. The wide end of the cochlea is called the base while the narrow end of the cochlea where the turns become tighter is called the apex. The basal end is terminated by

the oval and round windows. The cochlea is approximately 9.0 mm in diameter at its base and 5.0 mm at its apex. Its total (uncoiled) length extends to about 32 mm. The organization of the cochlea is such that stimulation of the basal end of the cochlea results in the perception of high frequencies, and stimulation of the apical end of the cochlea results in the perception of low frequencies.

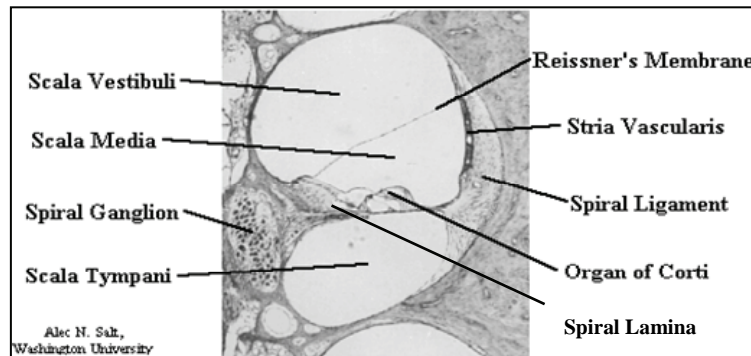

Figure 16. Microscopic photograph of the cross section of the cochlea. (Downloaded from <http://oto.wustl.edu/cochlea/intro2.htm>, June 26, 2005.)

A microscopic picture of the cross section of the cochlea is shown in figure 16. The left side of the picture shows the modiolus containing the spiral ganglion of the auditory nerve. Projecting outward to the right from the modiolus is a thin bony plate called the spiral lamina that divides the cochlea into two canals called *scala vestibuli* (located superiorly) and *scala tympani* (located inferiorly). *Scala vestibuli* originates at the oval window and is an extension of the vestibule (see figure 17). The oval window is a small opening in the cochlea covered with a membrane. The footplate of the stapes is suspended over the oval window. The oval window serves as the junction for the transmission pathway between the middle and inner ears. *Scala tympani* originates at another membranous opening to the middle ear cavity called the round window (figure 17). There is no junction between the round window and the ossicular chain. The lack of a juncture allows for the round window to compensate for pressure applied to the oval window by the footplate of the stapes. *Scala vestibuli* and *scala tympani* are filled with perilymph. The two canals are separate except at the very narrow opening at the apex of the cochlea called the helicotrema. Between *scala vestibuli* and *scala tympani* there is another triangular channel called the *cochlear duct (scala media)*. *Scala media* is filled with endolymph and terminates at the helicotrema. The upper boundary of *scala media*, separating it from *scala vestibuli*, is called the *vestibular membrane* (Reissner's membrane) while the lower boundary, separating it from *scala tympani*, is called the *basilar membrane*.

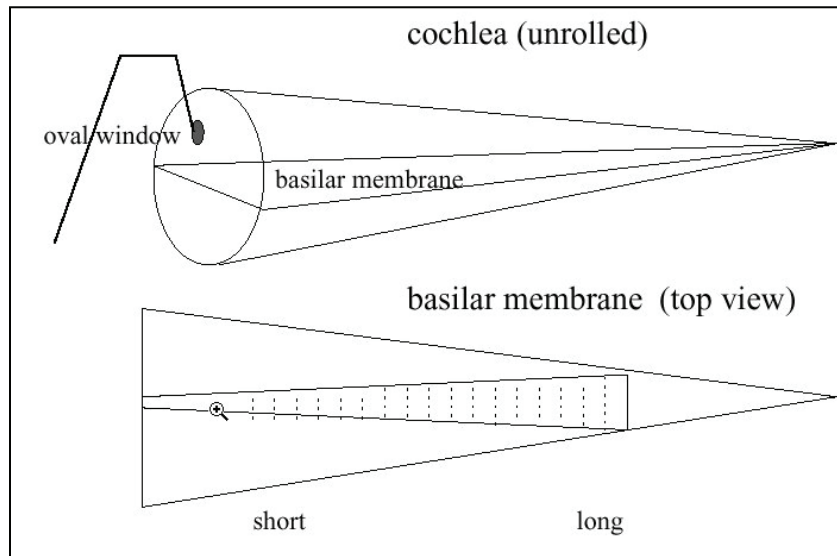

Figure 17. Unrolled view of the basilar membrane. (Downloaded from <http://www.cim.mcgill.ca/~langer/646/2004/hearingintro.pdf>, June 26, 2005.)

The basilar membrane separates scala vestibuli from scala tympani and is the anatomical base of the organ of Corti⁶. The basilar membrane and the organ of Corti serve as the final transformer of sound energy from mechanical to chemical. The organ of Corti is a mechano-biological transducer where mechanical vibrations of the cochlear fluids are converted into neural impulses that are sent to the brain. The organ of Corti is situated within scala media and is spread along the entire length of the basilar membrane.

The basilar membrane is attached to the outer wall of the cochlea by the spiral ligament and to the modiolus by the spiral lamina, which extends out of the modiolus like threads of a screw. The membrane is approximately 32 mm long and 0.1 mm thick and consists of about 24,000 fibers running in a perpendicular direction to the axis of the cochlear duct. Auditory nerve cells and blood vessels extend from the modiolus into the basilar membrane and support the biochemical processes performed in the organ of Corti. Although the width of the cochlea decreases from the base to the apex, the width of the basilar membrane tapers in the opposite direction. It changes from a width of 0.06 mm at the base to 0.5 mm at the apex (Yost & Nielsen, 1977). Accordingly, its stiffness and mass also change along its length. The basilar membrane is about 100 times stiffer at the base than at the apex. A schematic view of the unrolled basilar membrane is shown in figure 17.

The vibration of the stapes in the oval window sets into motion the cochlear fluid (perilymph) in scala vestibuli. When the stapes is pushed medially, some of the incompressible fluid in the inner ear is pushed through the helicotrema to scala tympani, which causes an outward bulging of the round window. When the stapes is pulled away from the cochlea, the round window membrane of scala tympani is displaced inward toward the cochlea. The presence of the round

⁶The organ was named after Alfonso Corti who originally described it in 1851.

window eliminates potential reflections so that there are no interference effects inside the cochlear fluid during oval window motion. However, because of different sizes and mobilities of the oval and round windows, the displacements of the round window are about 10 dB smaller than the displacements of the oval window (Maspétiol, 1963).

The motions of the oval and round window membranes are delayed against each other because of the time needed to move fluid through the helicotrema. These delayed back-and-forth movements of the fluid in scala vestibuli and scala tympani create pressure differentials between both channels, which set into motion the basilar membrane. The motion of the basilar membrane is needed to accommodate the instantaneous excess of fluid moving along its length. The motion of the basilar membrane takes the form of a traveling (transverse) wave that changes its magnitude along the cochlea. The velocity of the traveling wave is greatest at the base (about 2 m/s) of the cochlea and decreases with the wave progression toward the apex. The wavelength of the traveling wave becomes longer with increased distance from the base. The place of greatest displacement of the basilar membrane is defined by the frequency of the stapes movement and the changes in the stiffness and mass characteristics of the basilar membrane along its length. The peak displacements of the basilar membrane are about 30 times larger than those of the footplate of the stapes, although they are still very small: on the order of $0.01\ \mu\text{m}$ at 100 dB SPL (less than the diameter of a hydrogen atom). The mechanism of the traveling wave is shown in figure 18.

The movements of the basilar membrane set into motion the organ of Corti that results in creating a biochemical reaction in the nerve cells of the organ. The organ of Corti is a structure containing the vibration receptors of the inner ear that convert mechanical energy into electrical energy. This energy results in neural impulses that are transmitted to the brain. The structure of the organ of Corti is shown in figure 19.

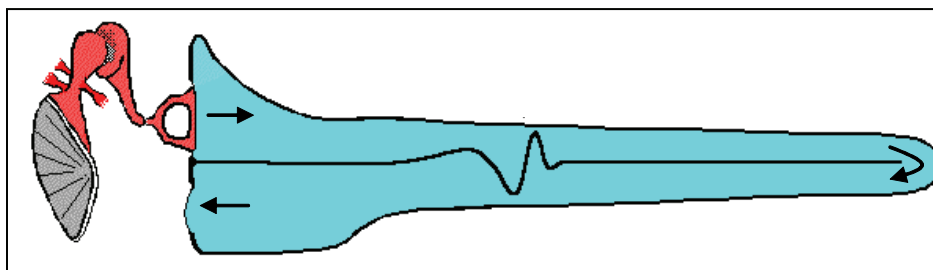

Figure 18. The mechanism of the traveling wave (Feilding, 2005).

The organ of Corti contains approximately 15,500 small sensory cells called hair cells (Yost & Nielsen, 1977) that are organized in four rows that run longitudinally along the basilar membrane. They are rigidly attached to the fibrous layer of the basilar membrane by supporting cells (Deiter's cells) and the inner and outer pillar cells (rods of Corti). The rods of Corti form the triangular channel of Corti. The name of the cells derives from the numerous hair-like structures (cilia) that project from the top of the cells. The stereocilia of each hair cell are arranged in several characteristically shaped rows of gradually changing height, and their tips are connected to the hair cells by special fibers, called *tip links*.

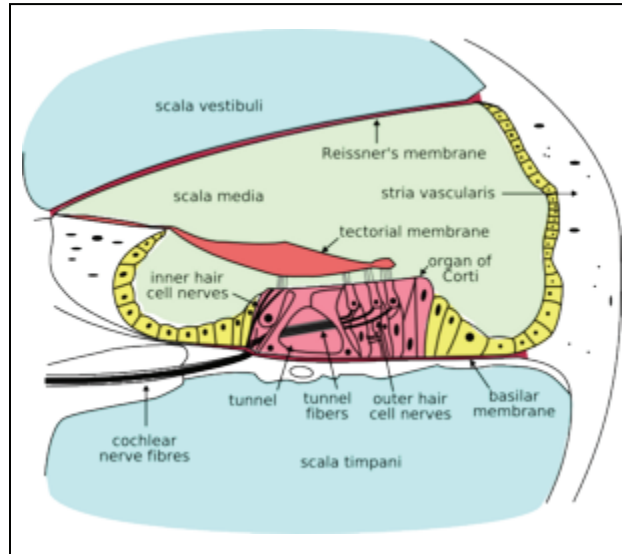

Figure 19. The organ of Corti (the cross section of the basilar membrane in the human). (Downloaded from http://en.wikipedia.org/wiki/Organ_of_Corti, June 26, 2005.)

There are two types of hair cells in the organ of Corti: the inner hair cells (IHCs) and the outer hair cells (OHCs). The IHCs form a single row of 3,500 cells and are located on the modiolar side of the inner pillar cells. The OHCs form three rows that are located on the outer side of the pillar cells. The typical number of OHCs in humans is about 12,000 (Yost & Nielsen, 1977).

Individual hair cells and their associated nerve cells are tuned to respond best to one specific frequency, called the *characteristic frequency* (CF). The CF of the specific hair cell corresponds to the location of this cell along the length of the basilar membrane. When sound waves generate a traveling wave in the cochlea, the point of maximum displacement of the basilar membrane coincides with the location of the hair cells tuned to the frequency of the stimulus. Therefore, each signal frequency is tonotopically mapped onto a specific location where the neural response is generated. This, together with periodicity of the rate of fire by the groups of neurons, is the mechanism of coding signal frequency into neural response. Signal intensity is coded into the number of hair cells excited by the stimulus and the frequency of the subsequent neural firing.

The mechanical properties of the basilar membrane vary too slowly for us to completely explain the acute sensitivity and frequency selectivity of the cochlea. Studies by von Békésy in 1930s were conducted in cadavers rather than in live humans. The mechanical properties can account for the slope of the maximum displacement of the cochlea to about 25 dB/octave, which is much less than that observed in *in vivo* (live human) measurements (Wilson, 1974), but they cannot account for the precise tuning of the cochlea. OHCs within the organ of Corti change their shape during excitation and influence the mechanics of the basilar membrane by means of mechanical feedback. The potential for movement on the part of the OHCs was first discovered by Brownell and colleagues (1985). The movement of the OHCs results presumably from the fact that some

molecules in the cells react to voltage changes affected by the efferent nerve fibers innervating the OHCs. The efferent fibers are the pathways that carry neural impulses from the central nervous system to an effector, in this case, the cochlea. The efferent innervation of the OHCs (known as the active mechanism of the cochlea) allows for them to move in response to sound. It has been assumed that this mechanism is the additional (second) tuning mechanism of the cochlea and is responsible for the high sensitivity and frequency selectivity of cochlear transduction in live animals. One piece of objective evidence for an active mechanism within the cochlea is the existence of oto-acoustic emissions. Simply put, oto-acoustic emissions are the reflection of sound energy from the hair cells in the cochlea. The presence of oto-acoustic emissions (OAEs) was first discovered in the late 1970s (Kemp, 1978). Since then, the underlying anatomical structures that contribute to the presence of OAEs has been examined and a test of the function of the hair cells through measurement of OAEs has been developed.

The IHCs serve as mechanical to neural transducers. Sound waves arriving at the TM are translated into transverse vibrations of the basilar membrane along with the attached organ of Corti. The vibration of the basilar membrane and organ of Corti is converted into a neural signal by the IHCs and results in the firing of the auditory nerve cells which travels through the afferent nerve fibers to the brain stem and up the nervous system to be perceived in the brain.

2.5 Central Auditory Nervous System

The overall nervous system is divided into two subsystems: the peripheral nervous system (PNS) and the central nervous system (CNS). The PNS is further divided into two parts: the sensory-somatic nervous system and the autonomic nervous system. The relation between these three systems is shown in figure 20.

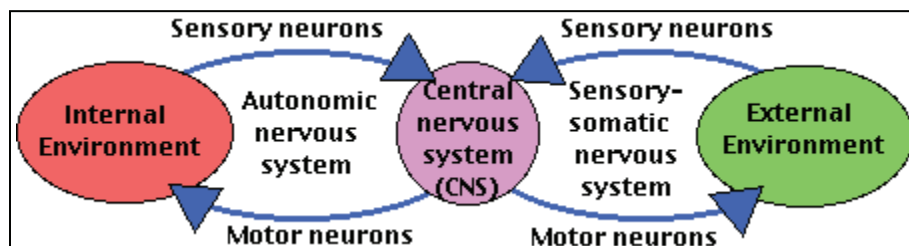

Figure 20. Central and peripheral nervous system. (Downloaded from <http://www.users.rcn.com/jkimball.ma.ultranet/BiologyPages/P/PNS.html>, June 28, 2005.)

The CNS consists of two main structures: the spinal cord and the brain. The spinal cord is a complex bundle of nerve fibers enclosed in the bony vertebral column. The spinal cord transmits sensory information from the PNS to the brain. The brain is the massive network of neurons located within the cranium (skull). The main part of the brain is the cerebrum that consists of two (left and right) lobes: the cerebral hemispheres. The outer layer of the cerebrum is called the cerebral cortex. The cortex is responsible for all high level functions of the brain.

The brain functions as the primary receiver, organizer and distributor of information for the body. Both the spinal cord and the brain consist of bundles of myelinated axons responsible for information transmission (white matter) and masses of cell bodies and dendrites covered with synapses responsible for information processing (gray matter). The human brain is estimated to contain 100 billion (10^{11}) neurons with an average of 10,000 synapses on each of the neurons. This results in about 10^{15} connection points within the brain structure (Kimball, 2005).

The part of the brain that serves as an entry point and is continuous with the spinal cord is called the brain stem. The brain stem consists of the medulla oblongata, pons, and the midbrain. In addition to the spinal cord, there are a number of nerves, called the *cranial nerves* that enter and join the brain stem directly through the skull openings. The cranial nerves consist of left-right pairs of nerves (12 pairs in humans) that connect sensory centers and muscles of the head to the brain. Ten pairs of cranial nerves connect to the brain stem. One of the cranial nerves is the vestibulo-cochlear nerve (cranial nerve VIII) that consists of two groups of fibers originating in the inner ear. The vestibulo-cochlear nerve (combined vestibular and auditory nerves) enters the brain stem through the internal auditory canal and connects the cochlea, utricular and saccular maculae, and the semicircular canals to the brain stem. The *auditory nerve* is the portion of the vestibulo-cochlear nerve that relays auditory information from the cochlea to the brain, whereas the vestibular portion of the vestibulo-cochlear nerve relays balance information to the brain. Basic anatomy of the brain is shown in figure 21. Specific auditory pathways in the brain stem are shown in figure 22. They extend from the auditory nerve to the thalamus and to the transverse temporal gyri. They transmit signals along both ipsilateral (same side) and contralateral (opposite side) pathways. Contralateral connections (communications between the two ears) take place at the cochlear nuclei, superior olivary complex (SOC), and inferior colliculus levels.

The auditory nerve includes approximately 30,000 afferent and efferent nerve fibers connecting the vestibular and cochlear systems and the brain through the brain stem. The afferent fibers traveling from the cochlea arrive at the cochlear nuclei in the upper medulla and synapse almost exclusively on the ipsilateral cochlear nucleus. This can be seen in figure 22. The cochlear nuclei are the first stage in processing time- and frequency-related auditory information as well as the first level where left and right ear information is cross referenced. The cochlear nuclei also serve as the distribution points delivering auditory information along ipsilateral (same side) and contralateral (opposite side) parallel paths to the lateral lemniscus, SOC, and inferior colliculus for further processing (Reyes, 1998). Some of the afferent fibers originating at the cochlear nuclei travel through the lateral lemniscus directly to the inferior colliculus whereas some others travel via the trapezoid body to the superior olivary nuclei of the SOC. The SOC processes information about interaural time delays and signal intensity differences and acts as a cross-over site for spatially oriented auditory information. Most nerve fibers pass from the olivary nuclei to the inferior colliculus as a complex tract of fibers known as the lateral lemniscus. Some of the nuclei, however, connect directly into the reticular activating system that is responsible for involuntary responses to acoustic stimuli.

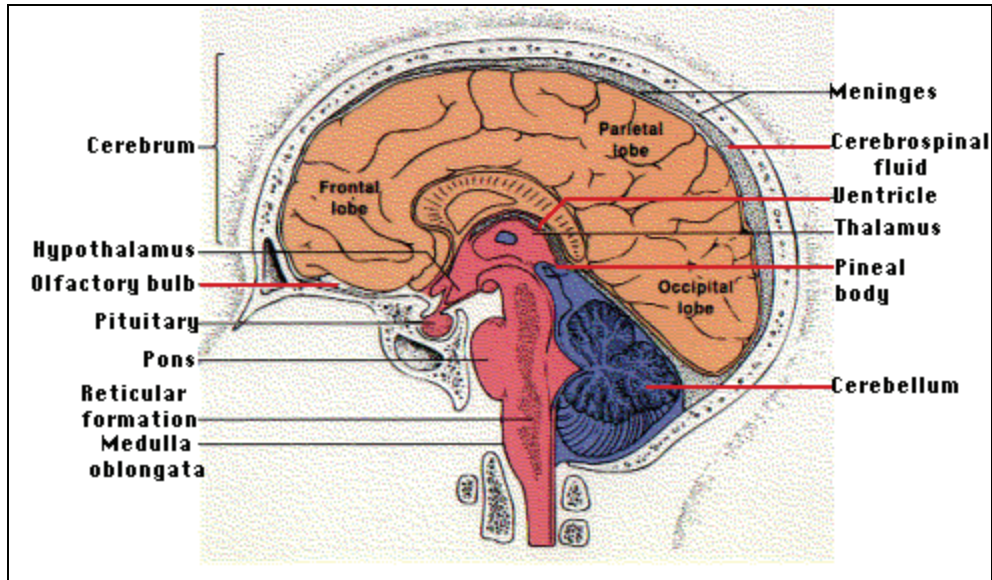

Figure 21. Human brain. (Downloaded from <http://www.rcn.com/jkimball.ma.ultranet/BiologyPages/C/CNS.html>, June 28, 2005.)

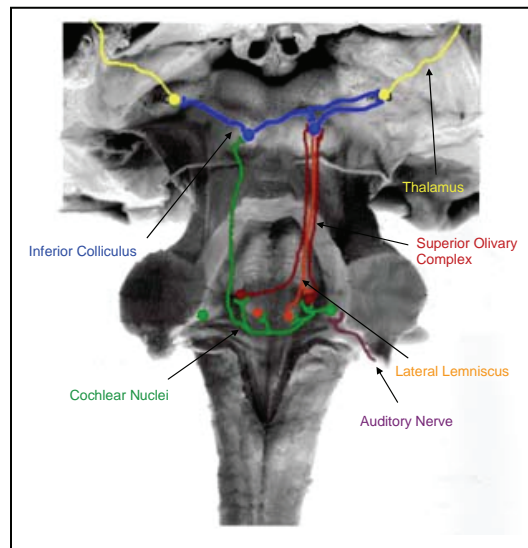

Figure 22. Auditory brain stem. (Different parts of the auditory pathway are color coded. Modified drawing from <http://serous.med.buffalo.edu/hearing>, downloaded June 28, 2005.)

The inferior colliculus is situated in the midbrain and is the principal subcortical nucleus of the auditory pathway. The inferior colliculus processes input from the peripheral brain stem nuclei and the auditory cortex. This is the last processing stage of the brain stem pathway leading to the brain. Afferent nerve fibers from the inferior colliculus enter the brain (cerebrum) at the thalamus and synapse in the medial geniculate body (MGB). All sensory information, with the exception of olfaction (smell), enters the brain through the thalamus (Seikel, King, & Drumright, 2000) and is transmitted to specific sensory centers in the cerebral cortex. The cerebral cortex is the outer layer

of gray matter of the cerebral hemispheres that is thought to be responsible for higher brain functions including sensation, thought, and memory. The cortex appears to be organized by various activity areas called the Brodmann's areas (figure 23).

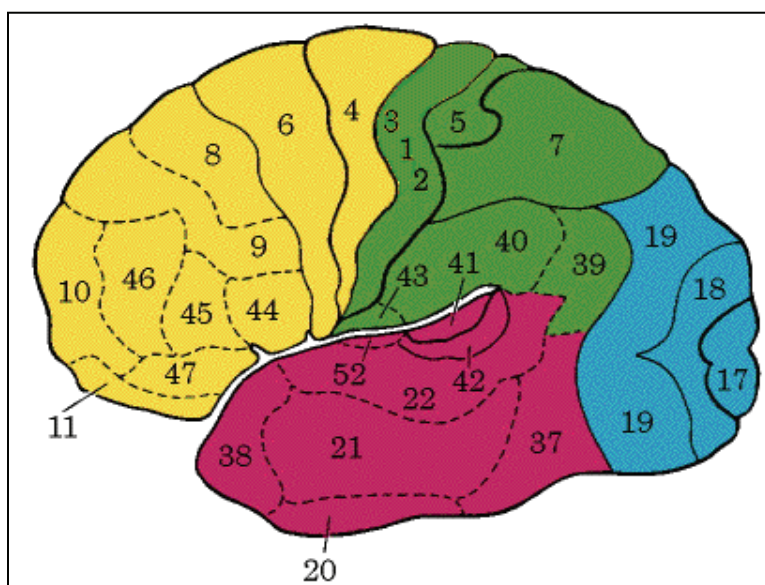

Figure 23. Sagittal view of the cerebral cortex and the Brodmann's areas.
(Downloaded from <http://www.umich.edu/~cogneuro/jpg/Brodmann.html>, June 28, 2005.)

The auditory center in the brain is situated in Brodmann's areas 41 and 42 (primary auditory cortex) and in Brodmann's area 22 (secondary auditory cortex) (see figure 23). These areas lie in the posterior half of the superior temporal gyrus and also descend into the lateral sulcus (Sylvian Fissure) as the transverse temporal gyri (also called *Heschl's gyri*). A view of the Sylvian Fissure, which assisted in the identification of Brodmann's areas 41 and 42, is shown in figure 24. As mentioned earlier, the cochlea is organized tonotopically, meaning that certain locations are established for responding to sounds of certain frequencies. The primary auditory cortex is also tonotopically organized. Brodmann's area 22 is the auditory association cortex which is involved in identifying and segregating auditory events and in identifying the location of a sound source in space. Brodmann's area 22, located in the left hemisphere, is involved in the generation and understanding of speech and rhythm processing, whereas Brodmann's area 22, located in the right hemisphere, is responsible for pitch, melody, loudness, and timbre processing (Robinson & Solomon, 1974; Seikel, King & Drumright, 2000).

The auditory cortex seems to consist of a set of six mutually connected processing layers. Auditory information arriving from the cochlea is transmitted from the thalamus to layer IV of the primary auditory cortex. Layers V and VI have efferent connections to the medial geniculate nucleus and the inferior colliculus, respectively. Additional layers have connections to other parts of the brain. Through these connections, all processing centers in the brain create synergetic perceptual images of the world, evoke motoric actions and cognitive activities, and trigger creativity and emotions.

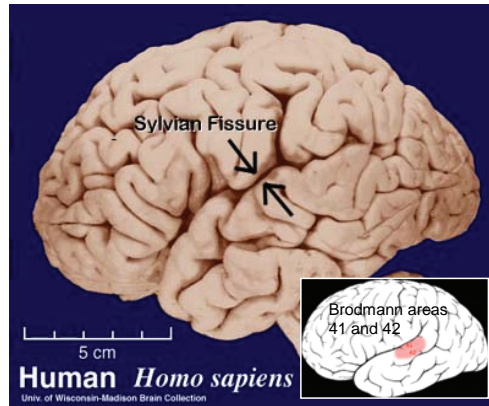

Figure 24. Auditory cortex in the Sylvian fissure of the temporal lobe. (Downloaded from http://serous.med.buffalo.edu/hearing/auditory_cortex.html with insert from en.wikipedia.org/wiki/Primary_auditory_cortex, June 26, 2005.)

2.6 Summary and Conclusions

The air conduction pathway of hearing involves acoustic waves traveling through the air, down the external auditory canal to the tympanic membrane, vibrating the ossicles of the middle ear and stimulating the cochlea. Neural responses generated by the cochlea are sent to the brain to be processed as the perception of hearing. The process of hearing is generally less well understood than the senses of touch or vision. Only in the last 20 years have there been improvements in the understanding of how the hair cells of the cochlea function. The current information about the sense of hearing is not easily obtainable outside the very specialized literature. A thorough understanding of the process of hearing through air conduction is essential to understanding the theories behind the process of hearing through bone conduction. Section 3 contains detailed information regarding the normal hearing process through bone conduction.

3. Bone Conduction Hearing

In contrast to the air conduction pathway of sound transmission discussed in section 2, hearing through bone conduction is the process of transmitting sound energy through vibrations of the skull or neighboring parts of the body, which results in an auditory sensation. It is a secondary auditory pathway supplementing the air conduction process. The sound waves impinging on the human skull from the surrounding environment and direct mechanical stimulation of the skull by a vibratory source can result in auditory sensation. However, the impedance mismatch between the skull and air makes the contribution of bone conduction to the sense of hearing negligible compared to the contribution of air conduction in situations of indirect stimulation.

Theoretically, any place on the human body may serve as a point of entry for sound energy through vibration. However, the reception of vibrations as sound from places other than the head makes auditory sensation very unlikely because of the loss of sound energy during transmission. There are many situations when body vibrations can be felt but they do not necessarily produce auditory sensations. Thus, bone conduction stimulation needs to be differentiated from tactile vibratory stimulation where mechanical (cutaneous) receptors of the skin respond to physical touch and mechanical pressure. Tactile devices are used to provide tactile sensations on the surface of the skin without the production of an auditory sensation. One such device, Tactaid⁷, designed to translate auditory stimuli into tactile sensations, is discussed in more detail in section 10. Alternatively, some mechanical vibrations and electrical signals can excite the brain cells and nerve endings in the human brain directly (electrical activity within a cell) or indirectly (through bone vibrations), causing auditory sensations. The nature of these phenomena is not well understood, and these phenomena are currently classified as special cases of sound transmission. The summary of scientific, anecdotal, and inferential information about the auditory effects caused by direct mechanical and electrical stimulation of the brain is provided in sections 12 and 13.

The main difference between hearing through air conduction and bone conduction is the manner in which the cochlea receives its stimulation. In the air conduction process, sound energy travels in a unidirectional manner down the EAC, vibrates the TM, travels across the ossicular chain and creates movement of the stapes against the oval window of the cochlea⁸. In bone conduction, the bones of the skull vibrate and, depending on the direction of stimulation, the stapes remains steady or vibrates with some time lag because of its inertia. The vibrations of the skull coming from various directions vibrate the fluids in the cochlea. Neural impulses produced within the cochlea are sent to the brain to be interpreted as sound. The fact that recordings of our own voices made through an air microphone sound very different than the voice we hear while we are talking is because the microphone recordings do not account for what we hear through bone conduction. The phenomenon of hearing one's own voice through bone conduction is discussed in detail in section 4.

To understand the known and hypothesized transmission pathways through bone conduction, it is first necessary to understand the components of the head. This section begins with anatomy of the head and continues through what is known about bone conduction transmission as it relates to the sensation of hearing.

⁷Tactaid is a trademark of the Audiological Engineering Corporation.

⁸Other potential and less understood auditory pathways are discussed in the later sections.

3.1 Skull Anatomy

The structure of the human head includes the bony skull, cartilage, and various types of tissue and cerebral fluids. All these elements take part in the transmission of an external auditory stimulus to the cochlea through bone conduction. The densities of the components of the head structure and the respective speeds of sound through them are listed in table 1 (O'Brien & Liu, 2005). The properties of air and water have been added to the table for comparison. The speed of sound in air is the slowest and the corresponding wavelength is the shortest among all materials listed in table 1. The speed of sound in tissue, blood, and brain matter is about four times greater than the speed in air, and the speed of sound in the bones of the skull is about seven times greater than that in air. According to Sauren and Classens (1993), the whole system of skull bones can be characterized mechanically by average values of ρ (density) of 1412 kg/m^3 , Young (elastic) modulus of $6.5 \times 10^9 \text{ N/m}^2$ or 50 GPa, and Poisson ratio of 0.22 (Evans & Lebow, 1951; Sauren & Classens, 1993). The Young modulus (E) refers to the stiffness of an elastic body and characterizes the longitudinal elasticity of the bones. It is a ratio of applied stress (pressure) to the relative change of the shape of an elastic body in the direction of an acting force. The Young modulus for rubber is 0.1 GPa, for wood is 10 GPa, for glass is 70 GPa, and for steel is 200 GPa, so the Young modulus value for the skull is closer to glass than to rubber or steel. The Poisson ratio (ν) is another measure of elasticity. It is the ratio of transverse contraction to longitudinal extension of material in the direction of stretching force. The Poisson ratio for rubber is 0.5 and for steel is 0.28, so the Poisson ratio for the skull is closer to steel than to rubber.

Table 1. Material components of the human head with densities and corresponding speeds of sound transmission (O'Brien & Liu, 2005).

Material	Speed of Sound (m/s)	Density (kg/m^3)
Air	340	1.2
Water	1500	1000
Soft tissues	1520 to 1580	980 to 1010
Lipid-based tissues	1400 to 1490	920 to 940
Collagen-based tissues	1600 to 1700	1020 to 1100
Aqueous humor	1002 to 1006	1500
Vitreous humor	1090	1530
Blood	1580	1040 to 1090
Brain – gray	1532 to 1550	1039
Brain – white		1043
Skull – compact inner and outer tables	2600 to 3100	1900
Skull – spongy diploe*	2200 to 2500	1000

*Spongy diploe is porous bony tissue between the hard outer and inner bone layers of the cranium.

The skull is the uppermost structure of the skeleton of the human body. It consists of two major parts: the *cranium*, forming the bony case around the brain, and the *facial bones*, supporting the face and the mouth. The cranium is formed by eight bones connected by fibrous seams called *sutures*. Four cranial bones are singular and two come in pairs (left and right). All these bones

take the form of curved plates with thicknesses of about 0.5 cm (Tonndorf & Jahn, 1981). In addition, some small irregular and isolated bones, called sutural or Wormian bones, may occur in the cranial structure filling gaps. They are named after Ole Worm, who is credited with the first detailed description of these bones. The sutural bones have a tendency to appear symmetrically on the two sides of the skull, and they vary in size. Their number is generally limited to two or three but a much greater number can exist in the skull of a hydrocephalic person, one who suffers from a genetic disease caused by the accumulation of a watery fluid within the brain.

There are 14 facial bones on the human skull. As in the case of the cranial bones, some of these bones exist in pairs (left and right) whereas others, which cross the mid-sagittal plane, are singular. All the skull bones, with the exception of the middle ear bones and sutural bones, are listed in table 2 and the basic structure of the human skull is shown in figure 25. As shown in figure 25, there are five large cranial bones that dominate bone conduction: one occipital, two frontal, and two parietal bones. These bones are fused together along the metopic, coronal, sagittal and lambdoid sutures.

Table 2. Cranial and facial bones of the human skull.

Cranial Bones		Facial Bones	
Single	Paired	Single	Paired
frontal bone	parietal bone	mandible	maxilla
occipital bone	temporal bone	vomer bone	palatine bone
sphenoid bone			zygomatic bone
ethmoid bone			nasal bone
			lacrimal bone
			nasal concha

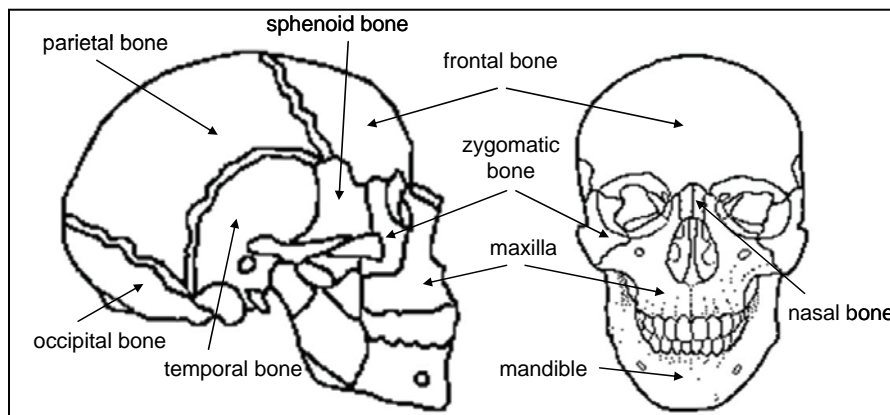
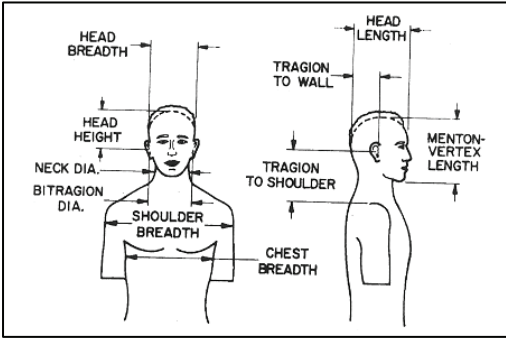

Figure 25. General organization of the bones of the skull (Howell, Williams, & Dix, 1988).

Some bones that are listed in table 2 are not visible in figure 25. The ethmoidic and vomer bones form the nasal septum, the palatine bones form the hard palate as well as a portion of the nasal cavity, the lacrimal bones form the anterior portion of the medial wall of each eye orbit, and the nasal conchae assist in forming the lateral wall of the nasal cavity.

The average mass of the human head *in vivo* is about 3.5 kg. The shortest average straight line distance between mastoid processes is usually reported as 14 to 16 cm and the corresponding circumference measured just above the nuchal line is about 22 to 25 cm. The nuchal line is the line passing through a bump at the back of the skull called the external occipital protuberance. The distance from mastoid process to the proximal cochlea is approximately 3 cm (Tonndorf & Jahn, 1981). The basic dimensions of the male and female heads are listed in table 3. The measurements of the human ear from the same studies are provided for reference.

Table 3. Basic average (50th percentile) dimensions of the human head and ear (NASA, 1978; Burkhard, 2004; Department of Defense (DoD), 2000).

Dimension	Male Head	Female Head	Source
Head breadth	155 mm 152 mm	147 mm* 144 mm	Burkhard DoD
Head length	196 mm* 197 mm	180 mm* 187 mm	Burkhard DoD
Head height	130 mm*	130 mm*	Burkhard
Tragion-to-tragion distance	142 mm* 145 mm	135 mm* 133 mm	Burkhard DoD
Tragion-to-shoulder distance	188 mm*	163 mm*	Burkhard
Menton vertex height	232 mm* 232 mm	211 mm* 218 mm	Burkhard DoD
Head circumference	570 mm	550 mm	NASA
Neck diameter	121 mm*	103 mm*	Burkhard
Shoulder breadth	455 mm* 491 mm	399 mm* 431 mm	Burkhard DoD
Chest breadth	305mm *	277 mm*	Burkhard
			
* median values (Burkhard, 2004)			
Ear length	68.5 mm	62.4 mm	Burkhard
Ear length above tragion	33.0 mm	30.7 mm	Burkhard
Ear breadth	37.7 mm	33.6 mm	Burkhard
Ear protrusion, distance	22.8 mm	20.3 mm	Burkhard
Ear protrusion, angle	156.7°	155.1°	Burkhard
Vertical tilt, front	3.0°	2.7°	Burkhard
Vertical tilt, side	7.6°	4.7°	Burkhard
Concha volume	4.65 cm ³	3.94 cm ³	Burkhard
Concha length	27.3 mm	25.3 mm	Burkhard
Concha length; tragion-to-lower notch	14.4 mm	14.4 mm	Burkhard
Concha breadth	18.8 mm	17.2 mm	Burkhard
Concha breadth, tragion-to-helix	18.2 mm	16.5 mm	Burkhard
Concha depth	12.9 mm	12.9 mm	Burkhard

The first modern theory of hearing through bone conduction is credited to Herzog and Krainz (1926) who proposed that hearing through bone conduction is a combined effect of two phenomena: (a) the relative motion of the middle ear ossicles caused by head vibrations, and (b) the compressional waves in the cochlea resulting from the transmission of vibrations through the skull. Soon thereafter, Bekesy (1932) showed clearly that air conduction and bone conduction were two different transmission pathways resulting in the same mode of excitation of the cochlea. Most of the current theories of bone conduction are based on these two landmark publications and the comprehensive study made by Tonndorf (1966) who extended the Herzog and Krainz (1926) work and identified seven specific mechanisms that contribute to the auditory perception of bone-conducted sound. Most of these mechanisms are associated with the inner ear, but some of them are related to the sound transmission from the skull to the middle and outer ears. A block diagram showing the bone conduction pathways to the ear during acoustic and mechanical stimulation of the hearing organ is shown in figure 26.

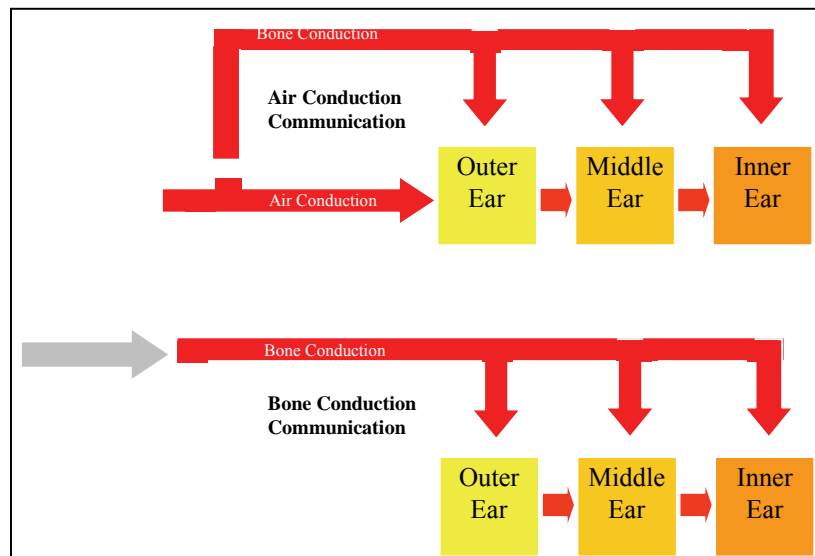

Figure 26. Block diagram of the air conduction (upper panel) and bone conduction (lower panel) pathways of sound to the inner ear.

3.2 Vibration Modes of the Skull

The seven bone conduction mechanisms identified by Tonndorf (1966) result from two basic modes of vibration of the human skull that operate at the low and high frequencies. These two modes of vibration are the

1. *inertial mode*, in which the whole skull vibrates as a unit, making oscillatory movements in the direction of an acting force, and
2. *compressional mode*, in which the skull is divided into a number of parts that vibrate in opposite directions, creating pulsating movements of the bony structure.

Inertial bone conduction is the effect of differences in ranges of motion and time delays (parallel shifts) in the movements of individual elements in the inner ear. Acceleration of the temporal bone surrounding the inner ear causes inertial displacements of incompressible cochlear fluids and subsequently vibrations of the basilar membrane within the cochlea. Tonndorf (1966) differentiated between cochlear fluid inertia, oval window inertia, and round window inertia, but these three mechanisms are very similar and have been treated by others as one. In addition to the inner ear structures, the inertial mode of skull vibration can affect the middle ear structures, resulting in two actual mechanisms of inertial bone conduction:

1. inertial inner ear mechanism, by which vibrations of the skull are transmitted directly to the inner ear through the vibrations of the temporal bone surrounding the ear (osseous pathways), and
2. inertial middle ear mechanism, by which vibrations from the skull are causing relative movements of the ossicular chain in the middle ear because of the differences in inertia of the individual bones (osseotympanic pathways).

The inertial inner ear mechanism depends on the inertia of the cochlear fluids in response to the vibration of the surrounding bony walls. According to Bekesy (1932) and Tonndorf (1966; 1972), the low frequency translational vibrations of the whole skull are transferred to the bony cochlea, where the cochlear walls move in respect to the cochlear fluids because of the fluid inertia. The bony cochlea also moves in respect to the position of the stapes, which has its own inertia, whereas the round window membrane moves together with the cochlea. All these relative movements result in the phase shift between the movements of the oval and round windows and the movement of the cochlear fluids that displaces and excites the basilar membrane.

Low frequency translational (inertial) vibrations of the human head caused by forehead stimulation seem to be the strongest along the medial (vertical) plane with very little displacement in the lateral (horizontal) direction. Similarly, the inertial mechanism of the ear is the strongest in the lateral direction when the axis of vibration coincides with the axis of the position of the cochlea. This response is even stronger than the median plane response observed in forehead stimulation. Therefore, a lateral placement of a bone vibrator on the mastoid process is a very effective stimulation site for a healthy cochlea. Guild (1936) hypothesized that the osseous pathway connecting the medial part of the posterior wall of the EAC to the lateral aspect of the horizontal semicircular canal is the most important temporal bone inertial pathway to the inner ear fluids. This pathway leads through the porous bone surrounding the medial part of the EAC and the posterior (mastoid) wall of the middle ear cavity that consists of a latticework of bony plates called trabeculae filled with bone marrow and mastoid air cells. Guild (1936) and Ciocco (1936) studied the acuity of bone conduction hearing at 512 Hz in patients having equally good air conduction hearing and observed that the bone conduction threshold was affected by the amount of fractures of the trabeculae in the vestibular wall of the middle ear cavity.

The vibrations of the temporal bone surrounding the middle ear cavity are not only transmitted to the bony walls of the cochlea but also cause inertial displacements of the ossicular bones in a manner similar to those caused by displacements of the TM by air-conducted sounds. When the bones of the skull vibrate as a whole, the vibration of the ossicles in the middle ear is delayed because of the inertia caused by their suspension by elastic ligaments. The contribution of the middle ear to bone-conducted sound is the greatest when the force (vibrator) is operating in the horizontal plane along the lateral axis of the head, that is, along the low-frequency in-and-out motion axis of the stapes (Bárány, 1938; Stenfelt & Goode, 2005). Since the inertial mode of skull vibration operates most efficiently for frequencies below 800 Hz, inertial movement of the ossicles should make the greatest contribution to the bone conduction transmission of low frequency sounds (Hirsh, 1952; Fournier, 1954; Carhart, 1962). However, as discussed in section 2, the mechanical system of the ear is a resonant system with a resonance frequency between 800 and 1200 Hz (Kelly & Prendergast, 2001; Moller, 1961). For example, Willi, Ferrazzini, and Huber (2002) measured the umbo displacement caused by a flat multi-sine airborne stimulus at 90 dB SPL applied to nine cadaver ears and observed the main peak displacement between 600 and 1100 Hz and the secondary (smaller) peak between 2000 and 4000 Hz. They also reported a separate ossicular chain resonance at about 1700 Hz, which agrees with previous findings. Thus, the middle ear status may contribute to the audibility of bone-conducted sounds in this frequency range. In addition, immobility (fixation) of the stapes because of otosclerosis⁹ may affect audibility of bone-conducted sounds at even higher frequencies because of decreased mobility of the cochlear fluids and decreased efficiency of the compressional mode of bone conduction. Overall, the reduction in bone conduction sensitivity because of otosclerosis is about 5 dB at 500 Hz, 10 dB at 1000 Hz, 15 dB at 2000 Hz, and 5 dB at 4,000 Hz (Carhart, 1971). The decrease in the bone conduction threshold around 2000 Hz is called the *Carhart notch* and is an important clinical sign of stapes fixation (Carhart, 1950; Carhart & MacConnell, 1952). Linstrom, Silverman, Rosen, and Meiteles (2001) compared postoperative and preoperative bone conduction thresholds in ossicular chain reconstruction and reported at least 10 dB postoperative improvement in bone conduction thresholds at 250, 1000, and 2000 Hz in 71% of the cases. These data provide a quantitative estimate of the role of the inner ear mechanism in bone conduction hearing.

The compressional mode of skull vibration results primarily from action by the bone conduction mechanisms of the inner and outer ears. These mechanisms are the

1. compressional inner ear mechanism, by which compressional vibrations of the temporal bones move cochlear fluids within their chambers (osseous pathways), and
2. compressional outer ear mechanism (also know as the osseotympanic mechanism), by which vibrations from the osseous portion of the EAC are radiated back to the inner ear along the air conduction pathway (osseotympanic pathways).

⁹A disease resulting in bone growth around the footplate of the stapes over the oval window so that the stapes does not move normally.

The compressional inner ear mechanism is the result of the alternate compression and expansion of the cochlear shell in synchrony with positive and negative polarities of the impinging sound waves. Tonndorf (1966) considered this mechanism to be a sum of two mechanisms rather than one. Both mechanisms result from the fact that the cochlear fluid is incompressible and must yield under the influence of the opposite movements of the cochlear shell.

The first mechanism is a result of the difference in compliance between the oval and round windows of the cochlea. Since the cochlear fluid is incompressible, alternating compressions and expansions of the cochlear shell must produce 180-degree out-of-phase movements of the oval and round window membranes in order to accommodate the fluid pressure changes. The round window is displaced to a greater degree than the oval window because the mobility of the oval window is limited by the presence of the stapes footplate (Kirikae, 1959). The asymmetric ratio in compliance between the oval and round windows is about 1:5 with the round window being more compliant than the oval window (Kirikae, 1959). This asymmetry causes movement of fluid within the cochlea and creates momentary pressure differences across scala media. As was discussed in section 2, the momentary pressure differences result in displacement of the basilar membrane with subsequent excitation of the inner and outer hair cells (Tonndorf, 1962).

The second compressional mechanism is a result of the difference in the volumes of fluid occupying scala tympani and scala vestibuli, and it operates in phase with the first mechanism (Stenfelt, 1999, p. 19). Scala vestibuli and scala tympani have relative volumes of about 22 and 29 mm³ (Salt, 1996). However, scala vestibuli are connected to the perilymphatic chamber of the vestibular system and the resulting mass of fluid moving attributable to alternate compression and expansion of the cochlear shell is larger than in scala tympani. The ratio of these two volumes of fluid is approximately 5:3, which increases the difference of pressure on both sides of the basilar membrane and increases its displacements.

The compressional behavior of the cochlea is not mitigated by the protective mechanism of the stapedial reflex. The contraction of the stapedius muscle attached to the stapes may increase the stiffness of the ossicular chain and protect the cochlea from excessive inertial middle ear stimulation but it does not protect the cochlea from overstimulation attributable to the compressional bone conduction mechanism of the inner ear.

The compressional outer ear mechanism was initially described by Bekesy (1960). This mechanism is based on the difference between the movements of the mandible (jaw) and those of the skull. The flexible attachment of the mandible to the skull, the temporal-mandibular joint (TMJ), lies just below the cartilaginous portion of the EAC. The lag in the movement of the mandible creates vibration of the walls of the EAC. Contractions of the walls of the EAC result in changes in the sound pressure in the EAC that imparts its energy on the TM and subsequently on the ossicular chain. An unoccluded EAC does not contribute much to bone conduction hearing because most of the sound energy is radiated outward. However, when the EAC is occluded,

sound energy produced by the contractions of the bony walls cannot escape and can therefore set more strongly into motion the TM and ossicular chain (Freeman, Sichel, & Sohmer, 2000).

The closure of the EAC and resultant increased perception of loudness is known as the occlusion effect and is discussed in detail in section 6. Briefly, the larger the volume of trapped air under a cover or through the use of an earplug, the stronger the occlusion effect is, mostly because of the compressional outer ear mechanism. On the other hand, the deep and firm closure of the EAC may not be effective in increasing the perceived loudness of bone-conducted sound. This is because the increased impedance of the TM (increased static pressure), the reduced volume of air and the decreased mobility of the TM and ossicles. In such cases, a small controlled leakage can loosen the TM and increase the perceived loudness of the sound.

3.3 Resonances of the Head

An auditory signal transmitted through the head vibrates the skull as a whole (inertial mode) or as a system of parts (compressional modes), depending on the frequency of stimulation. At low frequencies, the skull vibrates as a single rigid body in the direction of the applied force (inertial mode). At high frequencies, mechanical excitation of the skull travels from one location to another in the form of a complex progressive mechanical wave involving transverse and longitudinal particle movements. The complex progressive mechanical wave moves in a continuous manner through the head until it encounters another wave or a boundary with another part of the head. When two sound waves or the wave and its reflection from a medium boundary have certain frequency and phase relationships, the two waves can cancel or boost each other at different locations in space in such a way that the resulting wave looks like a sine wave that is not moving but standing in place. Such a wave is called a standing wave and is characterized by equally distributed nodes (no vibration at all) and antinodes (maximum vibrations). Standing waves have amplitudes much larger than those of contributing waves because of synergetic actions. The specific frequencies of standing waves are determined by the dimensions of the vibrating object. These frequencies are called the natural frequencies or the resonance frequencies of the object. The resonance is an oscillation (vibration) of a large amplitude of any system (object) excited by a periodic force whose frequency is equal or very close to the natural frequency of the system. The phenomenon opposite to resonance is called antiresonance (or parallel resonance). Antiresonance appears when the impedance of a system approaches infinity and any change in stimulation frequency results in an increased response of the system. The frequency characterizing the antiresonance of the system is called the antiresonance (notch) frequency.

The first theory of human skull vibrations was proposed by Bekesy (1932) who considered the skull to be a thin sphere that is able to vibrate in several different modes (patterns) because of the distributed elasticity and density of its structures. Low frequencies have longer wavelengths than high frequencies. Therefore, frontal excitation of the skull at low frequencies whose wavelengths are larger than the dimensions of the head makes the elements of the skull move together as a single vibrating body (inertial vibrations). This does not occur for high frequencies. At high

frequencies, the back of the head gradually begins to lag behind the vibration of the forehead because of different inertia of various parts of the head. This lag facilitates development of standing waves in the skull bones, which divide the skull into several vibrating elements (Bekesy & Rosenblith, 1953). The vibration mode of the skull changes at approximately 600 Hz. Thus, above 600 Hz, the skull can no longer be considered as a single vibrating object (lumped system) but as a system of small masses connected together by elastic links (distributed system). Different parts of the skull have different resonance frequencies and vibrate with different amplitudes and phases, depending on the signal frequency. Bekesy (1932) identified the first natural (compressional) resonance of the head to be around 800 Hz. In this mode of vibration, the head vibrates as a front-back oriented dipole (two-directional system). Above 800 Hz, the unidirectional front-back compressional mode of head vibration gradually changes into the second compressional mode where the head begins to vibrate as two out-of-phase pairs of elements moving along the medial and lateral axes in such a way that the skull interchangeably elongates and widens. The second natural resonance corresponding to this mode of vibration was reported by Bekesy (1932) to be around 1600 Hz. Three examples of skull vibration are illustrated in figure 27.

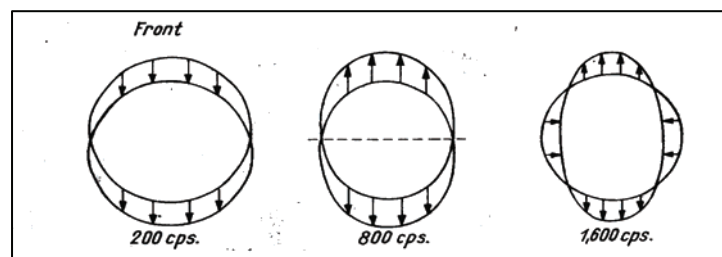

Figure 27. Skull displacements in the horizontal plane for different frequencies when a vibrator was applied to the forehead (Bekesy, 1932).

The low frequency inertial behavior of the skull observed by Bekesy was confirmed by several other studies conducted on *in vitro* (dry and wet non-living) and *in vivo* (living) human skulls (e.g., Khalil, Viano, & Smith, 1979; Håkansson, Brandt, & Carlsson, 1994). However, the resonance frequencies of the skull reported by the authors vary widely. For example, Franke (1956) and Stenfelt et al. (2000) reported the resonance frequency of the dry skull to be about 600 Hz for the mastoid placement of the vibrator. Franke (1956) and Flottorp and Solberg (1976) measured the skin impedance on living humans but were not able to extract the resonance frequencies of the human skull from the data. Zwislocki (1953) reported head antiresonances at 400 and 2000 Hz, and Tonndorf and Jahn (1981) reported the same two antiresonances as well as an additional resonance at 800 Hz. Similarly, Håkansson, Brandt, and Carlsson, (1994) reported skull resonances *in vivo* at 800 and 2000 Hz and Pörschmann (2000) observed a harmonic series of resonances at 900 Hz, 1800 Hz, and 3600 Hz.

In several studies, the human skull was directly stimulated after removal of the skin. In these studies, the first natural resonance of the head was observed at about 1000 Hz in clinical patients (Håkansson, Carlsson, & Tjellström, 1986) and in cadaver heads (Stenfelt & Goode, 2005). In

both studies, the vibrator was situated on a metal screw implanted into the mastoid bone. The slightly higher resonance frequency observed in these studies as opposed to those mentioned may be explained by the absence of skin and soft tissue at the point of stimulation, which normally loads the skull bones and shifts the resonance frequencies of the head downward. Håkansson et al. (1986) also reported a second resonance of the head at 1500 Hz. They reported large variability in the resonance frequencies across the heads they tested with standard deviations of 200 and 270 Hz, for the first and second natural resonances, respectively.

Reported differences in the natural resonance frequencies of the human skull are mainly because resonance frequencies depend on the anatomical characteristics of one's skull and the place of vibrational excitation. More importantly, physical properties of living human skulls differ significantly from those of dry and wet skulls and *in vitro* heads. The former may also depend on the age of the person participating in the study since the density and flexibility of bones change with age (Tonndorf & Jahn, 1981). Finally, it is important to realize that many of the studies were limited to a single human skull and a single point of excitation and, as such, may differ considerably in reported results. Nevertheless, existing data provide important information in the formation of the general theory of bone conduction.

Based on the studies just reported, it can be stated that the human skull can vibrate in several vibration modes with two dominant vibration modes at 800 to 1000 Hz (compressional) and 1500 to 1600 Hz (inertial). In addition to the natural resonances of the head structure, a strong low frequency inertial antiresonance has been observed in the 150- to 400-Hz range (Håkansson et al., 1986; Stenfelt & Goode, 2005). This antiresonance is attributable to the coupling between the vibrator and the head. The frequency of the antiresonance is defined by the maximum of the mechanical impedance of the head structure (section 3.4).

Finally, the antiresonance of the head observed by some investigators at 2000 Hz is most likely attributable to the resonant properties of the ossicular chain. As mentioned earlier, the fixation of the stapes can result in a sharp decrease in the bone-conducted hearing threshold at about 2000 Hz, which is known as the Carhart notch (section 3.2.)

3.4 Mechanical Impedance of the Head

The mechanical (point) impedance of the human head (Z) is the ratio of the magnitude of the force (F) applied to a single point on the head divided by the resulting velocity (v) of the head structure at the stimulation point and is calculated as

$$Z = \frac{F}{v}$$

The mechanical impedance of an object represents its total opposition to external forces acting upon it. The higher the impedance, the more difficult it is to move or deform the system. In mechanical systems, the total impedance of the system depends on the friction, mass (inertia), and stiffness of its elements and their surroundings. In order to transfer energy efficiently from

one system to another, the impedances of both systems must be matched. If they do not, the source of the energy is expending a lot of energy and transferring very little (high to low impedance transfer) or cannot generate much energy itself although almost all of the generated energy is efficiently transferred (low to high impedance transfer).

The two basic components of mechanical impedance are resistance (related to friction) and reactance (related to mass and stiffness). Energy transferred to a system is partially stored in the system because of its reactance and partially converted to heat and lost or changed to another form of energy because of its resistance. It is also important to note that a complex system may have different impedances for energy arriving at the system than for energy leaving the system. In such a case, the impedances are distinguished as the input impedance and the output impedance. Examples of such systems are levers, horns, and electrical transformers.

When a sound wave or mechanical vibrator exerts its energy on the human head, it needs to overcome the head's opposition to energy transfer caused by its impedance. Several investigators have attempted to measure the impedance of the skull with and without the skin present (Corliss & Koidan, 1955; Franke, 1956; Flottorp & Solberg, 1976; Håkansson et al., 1986; Stenfelt & Håkansson, 1998). These two impedance measures are frequently referred to as the *skin impedance* (Z_S) and the *skull impedance* (Z_T).

Let us consider the skull impedance first. An example of the magnitude and phase characteristics of the skull impedance is shown in figure 28. At low frequencies, the magnitude of the skull point impedance increases with frequency, indicating a mass-controlled system. This is also indicated by the positive value of the phase angle of the impedance (Stenfelt & Goode, 2005). The point impedance reaches its maximum at the inertial antiresonance of the head (150 to 400 Hz). Above the resonance frequency, the magnitude of the point impedance decreases with frequency and the phase angle becomes negative, indicating a stiffness controlled system.

Stenfelt et al. (2000) measured the point impedance of the dry human skull and reported a sharp low frequency (between 500 and 600 Hz) resonance reaching 80 to 85 dB (re: 1 Nsm^{-1}) for the mastoid placement of the vibrator. Later, Stenfelt and Goode (2005) measured the point impedance of a cadaver head and reported its maximum between 10^3 and 10^4 Nsm^{-1} at the inertial resonance of the head (150 to 400 Hz). Overall, the impedance level away from the inertial resonance frequency varies between 30 dB and 50 dB (re: 1 Nsm^{-1}) for most frequencies in the 100- to 8000-Hz band (Flottorp & Solberg, 1976; Håkansson et al., 1986; Stenfelt & Håkansson, 1998). If the skull is covered with skin and soft tissue, the reported impedance is the input impedance of the skull as seen by the skin. However, the coupling between the skin and the skull is not yet well understood (Håkansson, Carlsson, & Tjellström, 1986).

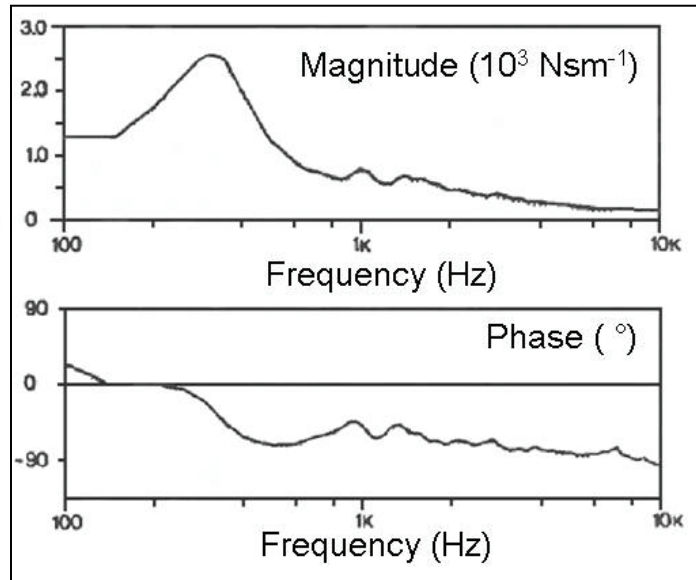

Figure 28. Magnitude and phase characteristics of the impedance of the skull (Håkansson, Carlsson, & Tjellström, 1986).

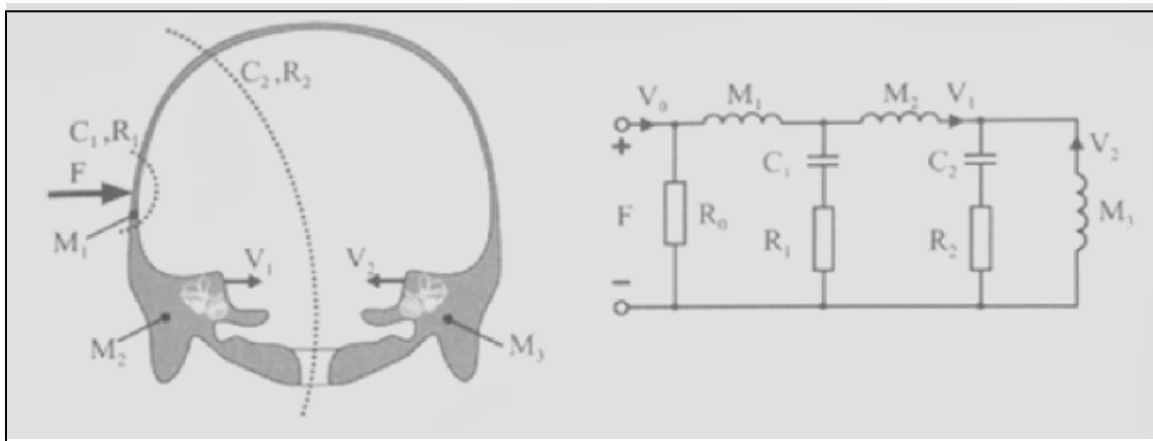

Figure 29. A cross-sectional view of the skull through the petrous bone (left) and a lumped parameter analog circuit diagram of the mechanical impedance of the human skull (right) (Stenfelt & Goode, 2005). (F is the force acting on the skull and V_1 and V_2 are the velocities of vibration at the left and right cochleae.)

Figure 30 presents the one-dimensional mass-spring model of the mechanical impedance of the human skull (not the head) proposed by Stenfelt and Goode (2005). The model estimates the low-frequency velocity at the cochleae in the lateral direction and is appropriate for frequencies below the first compressional resonance of the skull ($f = 1.0$ kHz). The specific values used in the model are $M_1 = 0.05$ kg, $M_2 = 0.1$ kg, $M_3 = 0.7$ kg, $C_1 = 0.14$ N⁻¹m, $C_2 = 0.17$ N⁻¹m, $R_0 = 30$ kNsm⁻¹, $R_1 = 200$ Nsm⁻¹, and $R_2 = 600$ Nsm⁻¹. However, this is not a functional model of bone vibration but simply a set of lumped parameters to approximate the data obtained for one specific condition in Stenfelt and Goode's (2005) study. Another model of the skull impedance, shown in figure 31, was proposed by Håkansson et al. (1986).

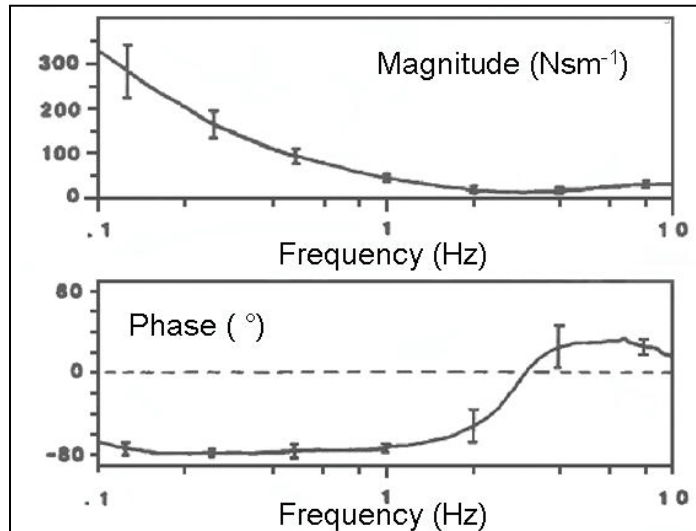

Figure 30. Magnitude and phase characteristics of the skin impedance covering the human skull (Håkansson et al., 1986).

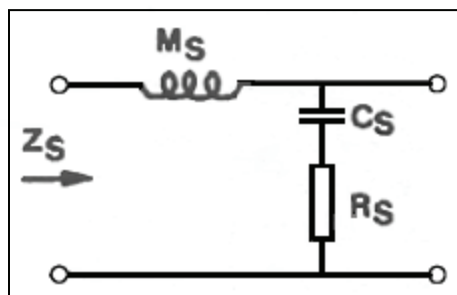

Figure 31. The lumped parameter model of skin impedance.

The frequency characteristic of the skin impedance is very different from that of the skull. An example of the magnitude and phase characteristics of skin impedance is shown in figure 31. The magnitude of the skin impedance decreases continuously with increasing frequency until it reaches its maximum at the resonance frequency of approximately 3 kHz (Corliss & Koidan, 1955; Håkansson et al., 1986). The phase angle shown in the bottom panel of the figure is negative until about 3 kHz, which agrees with the stiffness controlled character of skin impedance in this frequency range. Above the resonance frequency of the skin impedance, the magnitude of the impedance increases slightly and the phase angle changes to positive values indicating the mass-controlled character of the impedance. Similarly to the frequency of the skull inertial resonance, the resonance frequency of the skin varies greatly among people. Håkansson et al. (1986) measured resonance frequency of the skin in seven participants and reported a standard deviation of 590 Hz.

Resistance and reactance of the skin on the head have been measured by several investigators (e.g., Bárány, 1938; Bekesy 1939; Corliss & Koidan, 1955; Franke, 1956; Flottorp & Solberg, 1976;

Håkansson et al., 1986). The average resistance (r) was reported to be around 10^1 Nsm^{-1} , and the average stiffness (K) was reported to be around 10^6 Nm^{-1} . For example, Franke (1956) reported that the average head skin resistance was 100 Nsm^{-1} , and the average head skin reactance at 1 kHz was $5 \times 10^3 \text{ Nsm}^{-1}$. More recently, Håkansson et al. (1986) directly compared skin and skull impedance and reported that the magnitude of skin impedance was approximately 10 to 30 dB lower than skull impedance. The greatest differences were seen in the 150- to 400-Hz and 2000- to 3000-Hz regions. These values are relatively high in comparison to the magnitude of the acoustical impedance of air which is about 400 Nsm^{-3} (please note the difference in the units of measurement). The difference in impedance is the reason why hearing thresholds for air conduction are so different than those measured by bone conduction for sounds arriving from the free field. The difference is on the order of several magnitudes (see section 5).

A simple model of skin impedance is shown in figure 31. Identical or very similar models are shown in several publications dealing with skin impedance (e.g., Corliss & Koidan, 1955; Flottorp & Solberg, 1976; Håkansson et al., 1986). The model is a serial circuit of three elements affecting transmission of vibration to the skin: skin compliance ($C_S = 1/K$), skin resistance (R_S), and mass (M_S) of the part of the skin that is effectively moved by the vibrator. According to Flottorp and Solberg (1976), $M_S = 0.6 \times 10^{-3} \text{ Ns}^2\text{m}^{-1}$, $C_S = 4.7 \times 10^{-6} \text{ N}^{-1}\text{m}$, and $R_S = 20 \text{ Nsm}^{-1}$. The two models presented in figures 30 and 31 can be cascaded to estimate the bone conduction hearing threshold for specific conditions of stimulation (Håkansson, Tjellström & Rosenhall, 1985; Håkansson et al., 1986).

3.5 Trans-cranial Attenuation of Sound

When acoustic signals are delivered to the ears, the head provides some degree of isolation between them. This isolation is referred to as the *interaural attenuation* (IA). The greatest IA is obtained when sounds are presented to the ears through insert earphones (ER-3A) and may reach 100 dB at low (250 to 500 Hz) and 80 dB at high (2000 to 4000 Hz) audiometric test frequencies for deeply inserted earphones (Zwislocki, 1953). The typical audiometric supra-aural (over the ear) earphones (TDH-49) provide IA on the order of 50 dB at low frequencies to 60 dB at high frequencies (Bekesy & Rosenblith, 1951; Chaiklin, 1967; Sklare & Denenberg, 1987). This means that if a signal greater than 60 dB hearing level (HL) is presented to one ear through a supra-aural earphone, it may cross the skull bones and stimulate the opposite ear. As discussed in later sections, this ability for sounds to cross through the bones of the skull becomes important when one is trying to establish the hearing threshold levels for ears that differ significantly in sensitivity to auditory signals.

The amount of IA for air-conducted sounds delivered through well-fitted earphones is considerably large in comparison to the IA observed in the sound field when the sound is delivered through a loudspeaker. During free-field conditions, the IA is the largest when the sound source is situated along a lateral axis on one side of the head and varies from 0 dB for low frequencies (<200 Hz) to about 20 dB for high frequencies (>10 kHz).

In the case of bone-conducted sounds, the term *interaural attenuation* (IA) is replaced by the term *transcranial attenuation* (TA), reflecting cranial rather than aural stimulation. If the vibratory

signal is delivered through a vibrator placed in the median plane of the skull, e.g., on the forehead, the TA is practically zero because of symmetrical attenuation effects on the sound reaching both cochleae. If the vibratory signal is delivered through a location on the side of the head or off midline, the TA is something other than zero because of differential attenuation of the sound by the structures of the head as it reaches each of the cochleae. The differential effects depend on the frequency of the acoustic signal. Kirikae (1959), Silman and Silverman (1991), Stenfelt et al. (2000), and Stenfelt and Goode (2005) reported that the TA for a vibrator on the side of the head is less than 5 dB in the 250- to 500-Hz range but increases with frequency to about 15 to 20 dB in the 2000- to 4000-Hz range and above. These values are quite similar to the IA values observed in an open sound field. According to Stenfelt and Goode (2005), the average TA for frequencies above 1000 Hz is between 0.5 and 1.5 dB/cm. This means that for every centimeter off midline that the vibrator is placed, a difference of 0.5 to 1.5 dB in transmission intensity between the two cochleae can exist. The TA is an important concept in the discussion of the feasibility of the spatial perception of auditory signals through bone conduction discussed in section 7.

The TA data just reported are based on skull vibrations measured in one specific direction. Most frequently, the axis of measurement coincided or was close to the lateral axis of the head. However, any skull stimulation can produce three-dimensional excitation of the head structure, especially at high frequencies, and other directions of wave propagation may excite the cochleae in addition to the lateral direction. Khalil et al. (1979) observed that the vibrations of the skull were largest in the direction perpendicular to the transducer surface. Vibration levels in any other direction were less than 10% of the perpendicular levels. Stenfelt et al. (2000) and Stenfelt and Goode (2005) used a triaxial accelerometer and reported that for frequencies as great as 500 Hz, the direction of greatest head excitation coincided with the direction of stimulation. Furthermore, the degree of excitation dominated other directions by 5 to 10 dB. At high frequencies, the directional effect of stimulation gradually disappeared except for the region close to the cochlea where the direction of stimulation still dominated the direction of maximum excitation. The authors hypothesized that the global response of the cochlea resulting from the specific placement of the vibrator on the skull may be proportional to the spatially averaged quadratic summation of excitations in all three Cartesian directions. Overall response can also be affected by the directional sensitivity of the cochlea, which is still unknown (Stenfelt & Goode, 2005).

This discussion indicates that the perceived effect of bone conduction may be different from the predicted effect from objective single direction measurements (Nolan & Lyon, 1981; Stenfelt & Goode, 2005). Nolan and Lyon (1981) conducted a psycho-acoustic assessment of TA. They reported an average value of TA of 10 dB in the 250- to 4000-Hz range, with rather large variability (-10 dB to 40 dB). Hurley and Berger (1970) investigated bone conduction in monaurally deaf individuals and reported average TA values of 5 dB between 500 and 2000 Hz. Frequency specific TA data reported by Snyder (1973) are listed in table 4. All the data from the studies mentioned agree fairly well and indicate that effective TA at low frequencies may be slightly higher than that predicted by the unidirectional physical measurements.

Table 4. Trans-cranial attenuation (in decibels) as a function of signal frequency (Snyder, 1973).

Frequency (Hz)					
	250	500	1000	2000	4000
Mean	8	8	7	11	13
SD	6.0	7.1	6.6	8.1	8.1

In the case of hearing testing through bone conduction in clinical audiology, the relatively low TA requires that when a difference in hearing thresholds between the ears is discovered, the ear not being tested (non-test ear) must be masked in some way in order to eliminate its contribution to auditory perception. However, occluding the non-test ear with an earphone amplifies the bone-conducted signal and creates an additional problem for bone conduction testing. Masking noise provided to the non-test ear through an earphone allows for the exclusion of the non-test ear and the assurance that the bone vibrations are perceived by the test ear exclusively. The least intrusive technique for excluding the non-test ear from the auditory test seems to be occluding the non-test ear with a firmly inserted insert earphone and providing narrow-band masking noise through it.

3.6 Transcranial Delay of Sound

Sound waves arriving at the head from the sound source along the median plane arrive at the two ears at the same time. When the sound source is moved off the median plane (off axis), there is a certain interaural time delay between the sound wave arriving at the proximal (nearer) and distal (farther) ear. This time delay, called the *interaural time difference* (ITD), is the largest when the sound source is situated on the lateral axis of the head (± 90 degrees) and may be as large as 600 to 800 μs , depending on the size of the listener's head. Differences in time of arrival at the two ears for sounds presented in the free field cannot be controlled. However, during earphone listening conditions, there is no natural ITD and the difference in the time of arrival of the sound to one ear versus another can be controlled and is therefore theoretically unlimited. The ITD is important in the spatial location of sounds, called localization, which is discussed further in section 7.

In the case of bone conduction, *transcranial delay* (TD) depends on the mechanical properties of the head and the point of stimulation. If the head is stimulated by a sound wave propagating through space and both ears are excluded from the sound reception through air conduction by ideal ear occlusion (see section 6), the TD is determined by the speed of sound through the structures of the head. According to the data presented in table 1, the speed of sound through dry bones is about 2000 to 3000 ms^{-1} —almost an order of magnitude greater than the speed of sound in air. The speed of sound through brain matter is about 1000 to 1400 ms^{-1} . Wigand (1964) measured the phase velocity of sound in a dry skull and reported the speed of sound through bones to be about 2600 ms^{-1} .

The first attempt to measure the actual speed of sound through the head of a live person was made by Bekesy (1948). He clicked his teeth and measured the speed of sound through the head by comparing the times of signal arrival at two vibration pickups placed on his forehead and back of the head. He also calculated the speed of sound from his finding of the skull resonance at 1800 Hz. Both these methods yielded similar values of 570 and 540 ms^{-1} , respectively, for the speed of sound through the head. Zwislocki (1953) and Tonndorf and Jahn (1981) used the phase cancellation technique to determine phase velocity of bone-conducted sound and reported 260 ms^{-1} ($f > 500$ Hz) and 330 ms^{-1} ($f > 2000$ Hz), respectively. Franke (1956) also reported similar phase velocity of 300 ms^{-1} ($f > 1000$ Hz). Assuming that the distance from the mastoid process to the distal cochlea is about 22 cm (Tonndorf & Jahn, 1981), the transcranial time delay for bone conduction transmission is about 600 to 800 μs . This delay is almost identical to that for air-conducted pathways in an open field (see section 7). Most recently, Stenfelt and Goode (2005) reported phase velocities of 250 m/s and 400 m/s at the cranial vault and the skull base of the cadaver head, respectively. They also noted a frequency-dependent group velocity. It is important to note that in all studies involving low and high frequencies, the speed of sound at frequencies below 400 Hz was much lower (50 to 100 ms^{-1}) than that at higher frequencies.

In the case when the ear is stimulated by airborne sound and the head is simultaneously stimulated by the same signal applied by a vibrator, the airborne sound arrives at the cochlea earlier than the bone-conducted sound. Boezeman, Bronkhorst, Kapteyn, Houffelaar, and Snel (1984) simultaneously transmitted the same impulse signal to the ear and the head of a listener and observed a frequency-dependent time lag. When the vibrator was placed on the frontal bone, the authors observed a time lag of 2.0 ms at 500 Hz, and 0.8 ms at 2000 Hz and 4000 Hz. When the vibrator was placed on the mastoid process, the time lag decreased to 1.5 ms at 500 Hz and zero at 2000 Hz. These frequency- and location-dependent time delays of bone-conducted sounds are evidence of frequency-dependent velocity of sounds transmitted through the skull.

The relatively low speed of sound measured in the head *in vivo* in comparison to the speed of sound measured in a dry skull can be partially attributed to the low stiffness of the live (wet) skull in comparison to that of dry bones. Additionally, wave propagation through live bones is damped by the high viscosity of brain tissue and elasticity of skin outside the skull, which may decelerate wave propagation. As documented previously, the velocity of sound in the head is frequency dependent. These observations indicate that the type of wave transmission through the head is quite complex. Tonndorf and Jahn (1981) and Stenfelt and Goode (2005) suggested that the waves propagating in the skull are the plate waves that include longitudinal and latitudinal components. In such waves, the phase and group velocities change with frequency. This dependence may result in audible nonlinear distortions of high intensity bone-conducted sounds because of the change in the overall waveform pattern.

3.7 Nonlinear Behavior of Bone Conduction

Several studies have reported a nonlinear character of sound transmission through the skull. For example, Arlinger, Kylene, and Hellqvist (1978) and Khanna, Tonndorf, and Queller (1976, p. 245)

observed considerable second (symmetrical) and third (asymmetrical) harmonic distortions at low frequencies. Various mechanisms were proposed to explain this nonlinearity, ranging from nonlinear behavior of skin and soft tissue through nonlinearity of cochlear response.

Håkansson, Carlsson, Brandt, and Stenfelt (1996) investigated the linearity of sound propagation through the human skull *in vivo* using titanium fixtures for attachment of bone-anchored hearing aids (BAHAs). This method permitted direct stimulation of the skull and reception of the BC signal without an interfering layer of skin and soft tissue. They reported no indication of any significant nonlinear behavior in the frequency range from 100 to 10,000 Hz and signal levels as great as 77 dB HL at discrete audiometric frequencies. Stenfelt and Goode (2005) hypothesized that this range of linearity can be extended to 100 dB HL. In addition, Håkansson (1984) measured the skin impedance over the mastoid process and found no sign of skin nonlinearity. The authors argued that the results of the previous reports were confounded by nonlinearity of the transducers and the measuring techniques (see section 8.1).

Results presented by Håkansson (1984) as well as Stenfelt and Goode (2005) indicate that sound perception through bone conduction hearing aids (see section 10) can be treated as a linear process. However, caution is advised in interpreting the reported results when complex low frequency signals and high levels of stimulation are used. A frequency-dependent phase velocity of sound through the skull in the low frequency range indicates that low frequency signals are prone to temporal (transient) distortions. Such distortions occur when different components of the signal arrive at the receiver at different times and may be a result of inertial vibration of the head at low frequencies. Assuming that the distance between the point of stimulation and the distal cochlea is 22 cm and phase velocities of two sine signals are 100 ms^{-1} and 330 ms^{-1} (Tonndorf & Jahn, 1981), the time difference in arrival of these two signals at the cochlea will be as large as 1.5 ms. Similarly, the levels of low frequency skull vibrations exceeding 77 dB HL are not exceptional and they can evoke nonlinear behavior of the skull. During bone conduction speech communication in noise, these levels may even exceed 100 dB HL. To avoid these potential distortions, bone conduction transmission of high intensity signals should be limited to mid and high frequencies only.

3.8 Tactual Perception of Vibrations

Pressure on the skin or a tap on the shoulder can result in the localized tactual¹⁰ (cutaneous) sensation. A bone vibrator placed on the body of a listener may, in some conditions, create a tactual sensation at the location of the vibrator in addition to or independently of an auditory sensation. The presence of a tactual sensation depends on the frequency of stimulation and is limited to signals below 1000 Hz and impulse stimuli. A listener can perceive auditory and tactual stimulation when bone-conducted sound is not masked by air-conducted sound. The strength of the tactual sensation relative to that of the auditory sensation is not the same for all

¹⁰The terms *tactual* and *tactile* are synonymous terms referring to the perception by touch.

vibrator positions on the head, and it changes with the surface area and static pressure of the contact (Bekesy, 1960).

The cutaneous receptors of the skin respond to pressure, touch, heat, cold, and light. One class of the cutaneous receptors is the mechanoreceptors (tactual receptors), such as the Ruffini, Meissner, and Pacini corpuscles that respond to pressure, texture, touch, and skin (tissue) deformation. The main tactual receptors are the Pacinian corpuscles that reside in the lower layers of the skin, the muscles, and the tendons. They respond to changes in pressure and vibrations up to 1000 Hz. The Pacinian receptors are very large, can reach as far as 4 mm in diameter and are quite unevenly distributed over the skin. The greater the density of the Pacinian corpuscles in the skin, the more sensitive the skin is to tactual stimulation. Wilska (1954) studied sensitivity to vibrations of various locations on the human body and reported the greatest sensitivity at the finger tips and the head locations (e.g., lips) with gradually decreasing sensitivity at stimulation sites closer to the abdomen.

Tactual stimulation is widely used in the medical field in a form of wearable tactual aids that are used as alternate means of communication with individuals with profound deafness and multiple handicaps. Some tactual aids may translate sound into patterns of vibration on the skin, whereas others may alert the user to the presence of a door bell sound, phone call, or smoke detector buzz. All tactual aids can be classified in terms of how they produce the sensation of touch. Tactual aids are classified as being electro-tactile or vibro-tactile. Electro-tactile devices use the arrays of surface electrodes placed on the head (e.g., tongue) or at the fingertip to produce localized touch sensation. Vibro-tactile aids use a single mechanical transducer or an array of mechanical transducers placed on a person's arm, chest, or abdomen to deliver the tactual signal.

Vibro-tactile aids are used all over the world. Examples of single channel vibro-tactile devices are the Tam (RNID¹¹/Summit, United Kingdom), MiniVib (Special Instruments Development, Sweden), and mini-Suvag (S.E.D.I.¹², France). These devices provide a pulsing action to inform the user about a specific event (e.g., alarm clock buzz, telephone ring), or they convert a speech signal into skin vibration to aid in speech recognition. Examples of multichannel arrays are the Tactphone (Japan), the Optacon (Telesensory Systems, Inc., U.S.), and the Tactaid. The incoming sound to these systems is filtered into a number of narrow-band stimuli, and each stimulus is delivered to a different vibrator creating a spectrum-dependent pattern of vibration on the skin. The user must learn to associate individual patterns with specific sounds.

The transducers used in the vibrotactile aids are vibrators and tactors. Vibrators are used in single channel devices that supplement auditory speech perception for people with hearing loss. Tactors are electromechanic actuators used in vibrotactile arrays or in the vibrotactile cueing and warning devices. Tactors are small electric motors or electric relays that provide low frequency pulses of a

¹¹not an acronym

¹²service européen de diffusion des inventions

specific rate and duty cycle. They differ from vibrators in their principle of operation. Tactors do not convert audio (electro-acoustic) signals into vibratory signals but provide one specific signal (pulse or vibration) when activated.

Although tactual aids are most commonly used to aid in speech communication or to provide warnings about specific acoustic or non-acoustic effects, there have been some attempts to develop tactual aids to help the user identify sounds within the surrounding environment (e.g., Reed & Delhorne, 2003). Tactors are also used as haptic feedback devices in virtual reality environments. Very powerful (50 to 1000 W) low frequency vibrators (shakers), operating in the 1- to 500-Hz range are also used to drive large surfaces, such as seats and floors, in various music and theme park applications. They are advertised to enhance the listening experience by providing tactile information for explosions, gun shots, and other high noise events (e.g., Tactile Effects System [TES 100] from Crowson Technology LLC (Limited Liability Company), ButtKicker Low Frequency Effects System (BK-LFE) from ButtKicker, Inc.). They are also used as sources of rhythmic information in dance floors for individuals with hearing impairment and as ground vibration simulators in military training environments.

In military applications, vibrotactile belts or patches on the upper body are occasionally used to provide directional tactual information to the user. One example of such a device is the Tactor Evaluation System (TES) developed by Engineering Acoustics, Inc., as a navigation aid for divers. The TES is an array of as many as six C-2 tactors on four sides of the body and the hands. The tactors are connected to the fluxgate compass and the depth sensor on the diver's navigational board (TAC). The signals from the tactors provide directional guidance and depth control information using mechanical pulses at a specific rate and duty cycle. The diver enters into the control system such parameters as heading, run time, and destination depth and the TES provides differential stimulation indicating the required course of action.

Another example of a military tactual aid is the Tactile Situation Awareness System (TSAS) developed at the Naval Aerospace Medical Research Laboratory (NAMRL) in Pensacola, Florida. The TSAS is a tactor array worn over the torso of a flight jacket. The device is designed to provide pilots with auxiliary orientation, targeting, and situation awareness information (Raj, McGrath, Rochlis, Newman, and Rupert, 1998).

The fact that a vibratory signal can create tactual and auditory sensations simultaneously or in succession may have practical application in military communication. An array of small vibrators (e.g., micro-electro-mechanical systems [MEMS]), distributed around the head may provide auditory communication and directional information regarding the direction of an incoming message or the position of another object in space. For example, such a system of transducers may be used for providing spatially enhanced multichannel communication, GPS instructions, and information about the location of an enemy sniper.

3.9 Summary and Conclusions

The process of hearing through bone conduction is still not thoroughly understood. Recent studies of the transmission pathways through the human skull, in living humans and in cadavers, have added to our understanding of the anatomy and physiology of the human head. Long-standing assumptions regarding hearing through bone conduction need further research in order to support or refute new theories of bone and tissue conduction. Basic research conducted within ARL has contributed to the understanding of hearing through bone conduction and has enabled further investigation into the feasibility of using bone conduction transmission as a means for providing communication to the individual Soldier. These applications are discussed in subsequent sections. The average human's experience with bone conduction is through the differences in the quality of his or her own voice heard when talking versus heard when played back from a recording. The perception of a talker's speech is discussed in section 4.

4. Speech Perception by Talker

The influence of bone conduction on a listener's hearing experience is very important. Talkers hear their own voices differently while talking than when played back from a recording device. The difference in the sound quality is attributable to the ability to hear oneself through bone conduction while talking and not while listening through a recording device. Bone conduction transmission for communication purposes must consider the perceptual effects resulting from its application, namely, the need to provide feedback to the talker through bone conduction in high levels of background noise. In this section, we discuss the importance of bone conduction transmission to the perception of speech by a talker.

4.1 Self-Perceived Speech

One of the easiest demonstrations of the contribution of bone conduction to hearing is its effect on self-perceived speech of the talker. Speech is a nonstationary acoustic signal produced in the vocal tract in the process of verbal communication. During speech production, the stream of air pressure generated by the lungs is restricted and modulated by vibrations of the vocal folds (the larynx). Vocal fold vibrations produce changes in air pressure in the vocal tract that, together with noise generated by air passing through tract constrictions, are the source of speech. The frequency of vocal fold vibration (fundamental frequency or f_0) depends largely on a person's physical size and varies from 80 to 160 Hz in male talkers and from 150 to 250 Hz in female talkers (Baken, 1987). The fundamental frequency is a low frequency periodic acoustic signal generated in the larynx and is subsequently modified in the processes of articulation (movement of the articulator organs such as the tongue and lips) and vocal filtering (passage through the cavities of the vocal tract). The resulting sound emitted from the talker is called speech. Talkers

have some ability to control the fundamental frequency of their voice, but these changes primarily affect pitch and quality of the voice and have minimal effects on speech production. Specific actions of the larynx and vocal tract produce specific sounds of speech that, when combined, serve as the communication signal carrying messages defined by the rules of a specific language.

Air pressure generated by the lungs followed by actions of the vocal tract produce high sound pressure levels at the back of the mouth that can reach 115 dB SPL (sound “ah”) or 140 dB SPL (sound “ee”) (Killion, Wilber, & Gudmundsen, 1988). This sound energy is modulated by the vocal articulators in the process of speech production and is then radiated by the mouth and nose openings to the external environment. In addition to the creation of sounds that are emitted into the external environment, the high SPLs in the back of the mouth are intense enough to vibrate the structures of the head of the talker. These signals are also transmitted as bone-conducted sound to the ears of the talker. Therefore, speech heard by a talker has different properties than speech arriving at other people’s ears or recorded through a microphone. The speech produced by the talkers reaches their ears through three distinct pathways:

1. bone conduction pathway from the oral cavity through the cheek bones and mandible to the temporal bones and the cochleae (direct bone conduction pathway),
2. air conduction pathway from the mouth and nose openings through the air around the head to the EAC (direct air conduction pathway, also called a *side tone*), and
3. air conduction pathway from the mouth and nose openings to the EAC through reflections from surrounding objects (indirect air conduction pathway).

People listening to another person’s speech hear only the air conduction component. This speech is additionally modified by the distance between the talker and the listener and their positions relative to other acoustic objects in space. This speech has a different timbre (quality) than the speech that is perceived by the talker, primarily because of the missing bone conduction component.

There is a simple way to experience the individual contributions of air and bone conduction transmission to hearing one’s own speech. First, say something in a normal voice. In this situation, you are hearing yourself through a combination of both air and bone conduction. Your voice is leaving your mouth and traveling to your EACs through the air. The vibration of your vocal folds is also causing the bones of your skull to vibrate. Thus, you are hearing yourself through air conduction and bone conduction pathways simultaneously. Next, plug your ears and say something in a normal voice. In this case, the plugging of your ears prevents the majority of the sound from your mouth from entering your EACs through the air, and you are hearing your voice primarily through bone conduction. Now, listen to a recording of your voice. When you are listening to the recording of your voice, you are hearing your voice through air conduction only. The sound energy from the loudspeaker or the earphones is not sufficient to vibrate the bones of the skull to the same degree as when you were speaking. This is why people have difficulty in

recognizing their own voice when listening to it for the first time on a recording. It is also why a recording of our own voice sounds unnatural to our ears. However, the recording is true to how others hear us.

SPLs created by the talker's own speech in their open EACs are about 40 to 50 dB lower than the levels measured inside their oral cavity. Bekesy (1949a) observed that closing both EACs with tubes (diameter 7 cm) filled with absorbing material reduced the level of the talker's voice by about 6 dB. From this observation, he concluded that the contributions of the talker's voice transmitted by air and bone conduction are about equal. Pörschmann (2000) measured differences (ΔI) in masked hearing thresholds for air-conducted and bone-conducted speech in the 400- to 6500-Hz range and observed that the bone conduction component was slightly dominant ($0 < \Delta I < 5$ dB) in the 700- to 1200-Hz range, whereas the air-conducted component was dominant ($0 < \Delta I < 15$ dB) outside this range. Švec and colleagues (Švec, Titze, & Popolo, 2005) compared SPLs generated by speech at a location of 5 cm in front of their mouth as well as through skin acceleration measured just below the larynx. They reported that the mean intensity level of voiced speech at the lips could be estimated from the accelerometer reading at the larynx with a precision of ± 2.8 dB in 95% of the cases for a range of vocal effort. This result indicates a direct relationship between sound energy transmitted through the human body and the level of produced speech. Even if the SPLs of air- and bone-conducted speech heard by the talker are similar, the absolute levels may differ quite a bit among talkers.

Maurer and Landis (1990) made two-channel recordings (one simulating air conduction and one simulating bone conduction) of a talker's speech using an air microphone and an accelerometer mounted on the mastoid bone. Twenty talkers listened to both channels of the recorded speech and were asked to mix the levels in such a proportion as to approximate the quality of the voice they heard in their head naturally when they spoke. The authors reported that the talkers were fairly repeatable in selecting the mixtures of levels but differed greatly in the absolute levels they chose. This result seems to indicate that various talkers experience different contributions of bone-conducted sound in self-perceived speech.

This situation will only be slightly altered when a person talks in a steady state noise or in a multitalker environment such as in a cafeteria. The auditory effects of the airborne side tone and bone-conducted vibrations of one's own voice will be similarly masked by external noise. There is, however, a certain minimum signal-to-noise ratio (SNR) that is required for efficient voice monitoring. This ratio is especially important for singers performing in a choir. According to Ternström (1989), the minimum required self-to-others-ratio (SOR) for the self-perception of voice in choral singing is +5 dB.

In the case of the air conduction pathway, the average intensity level difference between the back of the talker's throat and the lips is 10 to 20 dB, depending on the vocalized sound (Bekesy, 1949). The contribution of the air conduction pathway is greatest for sounds produced with a wide open mouth (*father*) and the smallest for sounds produced with small lip openings (*pool*). The intensity

levels emanating from the mouth decrease rapidly with increasing distance from the source and are reduced by 20 to 25 dB at the entrance to the EAC. The sum of the difference in intensities between the back of the throat and the lips and the mouth and the EACs shows similar attenuation of speech along the air conduction side tone pathway to that of bone-conducted speech resulting from the internal head absorption (40 to 50 dB).

Part of the relatively large attenuation applied to the talker's speech by the bone conduction mechanism is the specific configuration of the middle ear. Bárány (1938) demonstrated that the ossicular chain is constructed in such a manner that its point of rotation coincides with the center of gravity. Thus, inertial movement of the ossicles during phonation is minimized. Bekesy (1949) analyzed the structure of the middle ear system and found several anatomical elements that maximized air conduction transmission and minimized bone conduction involvement. For example, orientation of the ossicles in the middle ear cavity is such that head vibrations during phonation are minimal in the direction of the ossicles' axis of action.

It is important to stress that the relatively large attenuation offered by the skull structures to bone-conducted sound is a necessary part of human physiology. It minimizes self-perception of body noises, such as blood flow and cracking of the joints, food chewing, and overstimulation by bone-conducted speech (Dirks, 1985). Recalling that the SPLs in the laryngeal cavity can be as large as 140 dB (for the sound "ee"), self-perception of speech through a potentially low attenuating head structure could create hearing damage.

Usually, people prefer the sound of their voice heard in the process of speaking to the sound of their voice played from a recorder (Maurer & Landis, 1990). The bone conduction pathway provides a natural enhancement of low frequency energy that makes the voice while talking sound lower, warmer, and more powerful. However, listening to a recording of one's own voice allows the person to "hear" the voice from someone else's point of view.

It is important to note that self-perceived speech may sound different from normal when the talker is wearing hearing aids (see section 10) or has the ears occluded with hearing protectors (see section 6). In the former case, the amount of perceived side tone can be considerably amplified by the hearing aid reducing self-perception of bone-conducted speech. In the latter case, the opposite takes place.

In some pathological states of the ear, such as Patulous Eustachian Tube disorder caused by the Eustachian tube always being open, one's audibility of his or her own voice can be negatively affected. If the tube remains open, it conveys sound energy from the upper pharynx to the middle ear cavity, which works as an additional resonator and the talker may hear his or her own voice or breathing as too loud (a phenomenon known as autophony).

The ability to hear our own speech contributes to our ability to monitor what we are saying. In high noise environments, the air conduction pathway is often diminished or obliterated, leaving only the bone conduction pathway. Talkers tend to raise their voices in the presence of high levels

of background noise in an attempt to self monitor. The phenomenon of talking louder in the presence of noise is known as the Lombard Effect. The raising of one's voice in the presence of noise changes the frequency of the signal but the talker also tends to speak more clearly (slower and with better pronunciation), allowing for better recognition of his or her speech on the part of the listener. For people who are wearing a communication device, their own voices may not be heard well, which can be problematic for the talker. To assist the talker in self monitoring, the talker's own voice can be transmitted back (referred to as a side tone) through air conduction or bone conduction. Regardless of the transmission path, the provision of a side tone is essential for enabling a talker to monitor his or her own voice. Besides talking in high levels of noise, a second example of the need for self monitoring is seen in the case of professional singers (e.g., someone singing the national anthem in a sports arena). These people routinely wear monitors in their ears to hear how their voices are being projected. Without monitors, a singer can have a difficult time performing songs.

Bekey (1949a) compared skull vibrations produced in the vertical, medial, and lateral directions during phonation. He observed very intense skull motion in the vertical direction extending over the whole body (see figure 32) with smaller vibrations at the forehead (front-back vibrations) and minimal vibrations at the temporal bone (lateral vibrations). Bekey attributed these findings to the fact that an air stream passing through the vocal folds during phonation creates primarily mechanical vibrations in the direction of the stream. Moreover, because of the lateral symmetry of the head structure, high SPLs produced in the mouth exert their energy mainly in the vertical and medial directions. Another component of bone vibrations may result from rotation of the skull as a whole during speech production (tan-gential component). However, Bekey (1949a) reported that at low frequencies (100 to 200 Hz), bone vibration amplitude in the direction parallel to the head is about 30 to 35 dB greater than in any tangential direction. For higher frequencies, this difference is reduced to 20 dB (400 Hz) when parallel and 15 dB (1000 to 2000 Hz) when tangential (Bekey, 1949a). However, he observed that a tilting of the head reduced the amplitude of skull vibrations on the side to which the head was tilted and increased this amplitude on the opposite side.

Recall that when an individual talks, the vocal fold vibrations are transmitted to the bones of the skull. If we place a contact microphone on the talker's skull, we can isolate, record, and transmit the bone conduction component of the talker's speech. However, this speech has different qualities than the speech transmitted through air and differs from the speech heard by the talker which is a combination of air- and bone-conducted speech. The specific properties of the received (recorded) bone-conducted speech will depend on the technical properties and the location of the contact microphone. For example, in order to capture natural speech-induced vibrations across a certain curved area of the head, the microphone surface needs to follow the curvature of the head, and its resonant frequency needs to be outside the frequency range of the speech signal. Further discussion of bone conduction microphones and bone-conducted speech recording guidelines is covered in section 8.

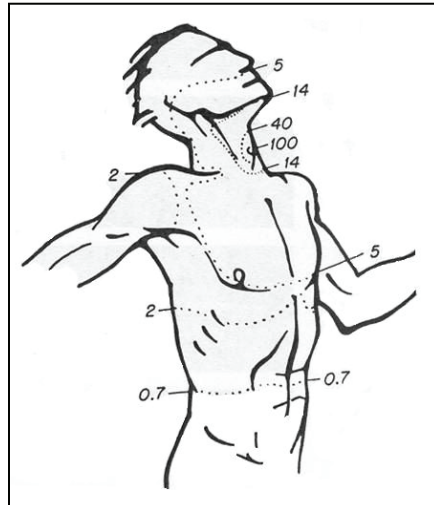

Figure 32. The decline of the amplitude of vibrations from the vocal folds as they travel over the surface of the body. (The numbers show relative amplitudes in percentages of the original 100-Hz vibration [Bekesy, 1949a].)

4.2 Summary and Conclusions

The perception of a talker's own voice through bone conduction provides a unique quality of listening, since only the talker hears his or her own voice in this manner. The provision of a communication system without feedback of the talker's voice to the talker (side tone) sounds unnatural. In situations when talkers are in high-noise environments and forced to speak, the inability to hear their own voices is seen as a negative consequence and is not desirable since it can lead to problems with communication.

5. Hearing Sensitivity

The threshold of hearing for bone conduction is defined as the smallest value of mechanical force (force threshold) or acceleration (acceleration threshold) applied to the skull resulting in an auditory sensation. The use of force threshold (in newtons, N) is recommended over acceleration threshold (in meters per second squared) because of its stability and relative insensitivity to the coupling conditions (Carlsson, Håkansson, & Ringdahl, 1995; Håkansson et al., 1985; Queller & Khanna, 1982).

Mechanical force or acceleration can reach the skull in one of two ways: by direct stimulation through a vibrator in physical contact with the skull and/or by indirect stimulation whereby the

skull picks up vibration from sound sources in the environment. The skull is less sensitive to indirect stimulation than to direct stimulation. Sound waves are absorbed by the skin of the head and stimulate the whole skull structure simultaneously in many directions resulting in an overall low effectiveness of stimulation. The primary mechanism of hearing is air conduction and the role of bone conduction in receiving sound waves is very limited. Thus, because of poor coupling between the air and the bones and head tissue, sound waves would need to be of a very high intensity in order to be perceived through the bones of the skull, regardless whether the ears are covered.

It is important to understand the sensitivity of the human auditory system through air and bone conduction transmission in order to understand the potential benefits and disadvantages of using one method of transmission for communication over another. In this section, we discuss the sensitivity of the human auditory system to both sound transmission pathways.

5.1 Air Conduction Versus Bone Conduction Thresholds

The human ear is sensitive to airborne sounds of frequencies in the range of approximately 20 to 20,000 Hz. The air conduction sensitivity of the ear varies with frequency, with the ear being most sensitive to sounds in the range of 1000 to 3000 Hz and least sensitive to sounds in the low frequency (below 500 Hz) and extremely high frequency ranges (above 5 kHz) (Sivian & White, 1933). Air conduction thresholds are measured in decibels SPL in reference to the pressure of 20 μ Pa (0 dB SPL). The threshold values (defined as the minimum intensity level at which a listener responds 50% of the time) depend on the person being tested, the transducer (e.g., type of headphone or earphone) being used, the calibration procedure used to set output levels to the headphones, and the test conditions. The standardized monaural air conduction thresholds for the sound field (where the sound source is a loudspeaker located at 0 degrees' azimuth) and TDH-39 supra-aural earphones, based on data collected on individuals assumed to have normal hearing, are shown in table 5. Although other earphones are used in clinical audiology, the results from the TDH-39s are provided as an example.

In clinical audiology, we normalized the average thresholds of normal hearing in decibels SPL by assigning to these levels a value of 0 dB HL. The dB HL (hearing level) scale was introduced to facilitate direct comparisons between normal hearing and hearing loss (American National Standards Institute [ANSI], 1995). With normalized threshold levels, a relatively flat line in the 0- to 20-dB HL range indicates normal hearing, and anything deviating from that is easily visualized as hearing loss. The thresholds listed in table 5 are equal to those that have been established as 0 dB HL for a sound field testing and for a standard set of supra-aural headphones used in clinical audiology (ANSI, 1996). Other earphones for clinical audiology are commercially available and include the TDH-49, TDH-50, and ER-3A insert earphones.

The range of intensities to which the human ear is sensitive varies with frequency. On average, the human ear is sensitive to a dynamic range of 150 dB between hearing threshold and the

maximum tolerated sound (threshold of pain). The range of tolerable intensities is greater in the high frequencies and less in the lower frequencies (Wegel, 1932).

Table 5. Normal monaural hearing thresholds for air-conducted sounds at different frequencies for TDH-39 supra-aural headphones and sound field reception (loudspeaker located at 0 degrees' azimuth) conditions (ANSI, 1996).

Frequency (Hz)	dB SPL for 0 dB HL for TDH-39 Earphones	dB SPL for 0 dB HL in Sound Field
125	45.0	24.0
250	25.5	13.0
500	11.5	6.0
750	8.0	4.0
1000	7.0	4.0
1500	6.5	2.5
2000	9.0	0.5
3000	10.0	-4.0
4000	9.5	-4.5
6000	15.5	4.5
8000	13.0	13.5
Speech	19.5	16.5

The sensitivity of the human ear to bone-conducted sounds is much lower than that for air-conducted sounds. The first normative set of bone conduction thresholds obtained on human listeners in reference to the Beltone 5A mechanical coupler (artificial mastoid) was published by Lybarger (1966). These values are known as the Hearing Aid Industry Conference (HAIC) Interim Bone Conduction Thresholds for Audiometry and are listed in table 6. The first ANSI standard recommending the force levels for normal bone conduction thresholds was published in 1981. The recommended values were based on three sets of threshold data summarized by Dirks, Lybarger, Olsen, and Billings (1979) and are listed in table 6. As more information about the bone conduction threshold of hearing was gathered from subsequent studies, another set of values was used in international standards and the ensuing ANSI standard (ANSI, 1984) (see table 6). The force threshold levels recommended in the current International Standards Organization (ISO) (ISO 7566-1987) and ANSI (1996) standards on audiometer calibration are listed in table 6 (partial set of values) and table 8 (full set of values). The ISO and ANSI threshold values apply to unoccluded ears and the use of contralateral (non-test ear) masking during testing. All the values listed in the standards give threshold values in decibels relative to 1 μ N for the bone vibrator calibrated with a mechanical coupler specified in ANSI (1987) and with a P-3333 metal headband, commonly used in clinical audiology. The average force threshold level for speech signals transmitted at the mastoid location is about 55 dB relative to 1 μ N.

Bekesy (1948) showed that for low-frequency sounds, the thresholds of hearing for air- and bone-conducted sounds differ by as much as 60 dB. These values are comparable to the 48- to 53-dB difference in the 200- to 800-Hz range calculated by Bárány (1938) for translational (inertial) movement of the head. Other authors reported values ranging from 50 to 100 dB, depending on the frequency of the signal and the type of earphones used for sound delivery (Bekesy & Rosenblith, 1951; Zwislocki, 1953; Chaiklin, 1967; Sklare & Denenberg, 1987). A recent study by

Ravicz and Melcher (2001) investigating attenuation of functional magnetic resonance imaging (fMRI) noise by various hearing protection systems reported a 55- to 63-dB difference between air conduction and bone conduction thresholds for the most intense fMRI noise which is present in the 1.0- to 1.4-kHz range.

Table 6. Normative bone conduction hearing threshold values (in dB re 1 μ N) listed in various publications for a vibrator on the mastoid bone.

Author	Mastoid Model	Frequency (Hz)					
		250	500	1000	2000	3000	4000
HAIC (Lybarger, 1966)	Beltone 5A	43.0	37.5	23.0	20.0	10.5	15.0
Studebaker (1967)	Beltone 5A	50.4	45.4	29.7	21.7		12.5
Dirks and Kamm (1975)	Beltone 5B	49.8	44.4	29.7	22.0		16.8
Frank and Richards (1980)	Beltone 5B	43.0	44.5	23.5	17.9	14.2	17.2
ANSI (1981, 2001)	B&K* 4930	61.0	59.0	39.0	32.5	28.0	31.0
Houghton and Pardoe (1981)	B&K 4930	68.9	58.1	46.3	32.8	30.9	31.8
ANSI (1992) ¹³	B&K 4930	67.0	58.0	42.5	31.0	30.0	35.5
ANSI (1996)	B&K 4930	67.0	58.0	42.5	31.0	30.0	35.5

B&K = Bruel & Kjaer

5.2 Static Force and Contact Area

The skin lies fairly loosely over the bones of the skull and provides some damping of the transmission of vibration to and from the skull. Bekesy (1960) reported that a force of 250 G (Gram-force) applied over a contact area of 0.5 cm² (0.7 cm diameter) is sufficient to transmit the vibrations through the skin without an excessive loss of the transmitted signal. Any loss of the transmitted signal would be attributable to the thickness of the skin layer over the bone. An additional layer of a 0.5-cm-thick sponge rubber inserted between the head and the external receiver had no impact on the effectiveness of the transmission through the material when the static force of 250 G or higher was maintained (Bekesy, 1960, p. 130). This does not mean that applying higher static force would not change the listener's impression of the loudness of a signal. As shown in figures 33 and 34, the application of greater levels of force results in increases in transmission gain and decreases in the variability of sensations across individual listeners.

Bekesy (1939) reported that for static forces above 500 G and a skin thickness of 2.5 mm, the transmission through the skin exhibits variations of only about 2 dB for frequencies as great as 10,000 Hz. Other authors have recommended the use of similar or slightly larger static forces: 200 to 400 G (Harris, Haines, & Myers, 1953; Watson, 1938), 300 to 600 G (Goodhill & Holcomb, 1955), 350 to 750G (Whittle, 1965) for consistent stimulation. On the other hand, Khanna, Tonndorf, and Queller (1976) demonstrated that gradual improvement in the threshold of hearing can be seen for continued increases in static forces up to 800 G and 1.6 kG. Although large static forces may be desirable for reliable and repeatable coupling of the transducer to the head, forces exceeding 600 to 700 G can cause physical discomfort for the listener and are

¹³ANSI standard S3.43-1992 Standard Reference Zero for the Calibration of Pure-Tone Bone-Conduction Audiometers was withdrawn in 2002 and information included in this standard is covered by the ANSI S3.6-1996 (R2001) Specifications for Audiometers standard.

therefore not practical. Current ANSI standard documents list 550 G (5.4N) \pm 50 G (0.5 N) as a recommended force to be used with bone conduction vibrators for hearing testing in clinical audiology (ANSI, 1996).

The area of contact between the vibrator and the skull should be considered as the second-most important factor affecting the effectiveness of bone conduction transmission. Khanna, Tonndorf, and Quellar (1976) reported that the threshold accelerations become lower with increases in the diameter of the area of contact. This effect is the largest in 800- to 3000-Hz region. The authors used four areas of contact with diameters varying from 16 mm to 53 mm and observed threshold improvements as large as 30 dB with increasing contact area. However, in some cases, the change in the size of the surface area of the transducer may not affect the efficiency of transmission. Transducers with larger contact areas are heavier, more difficult to put in the same location, and poorly accommodate skull curvature. Goodhill and Holcomb (1955) observed better reliability of threshold data with a vibrator that has a contact area of 1 cm² (about the size of a dime) than with a comparative vibrator that has a contact area of 3.2 cm². The effect of the contact area of the vibrator can also vary by frequency. Watson (1938) and Nilo (1968) observed that vibrator contact area (1.1 to 4.5 cm²) had only minimal effect on hearing thresholds at low frequencies, but hearing thresholds improved with larger contact areas for frequencies above 2000 Hz (2000 to 7000 Hz). Watson (1938) noted that a smaller area, on the order of 0.5 cm², was uncomfortable to the wearer even with a relatively small (375 G) amount of contact force. The concentration of pressure on a smaller area increases the feeling of the discomfort.

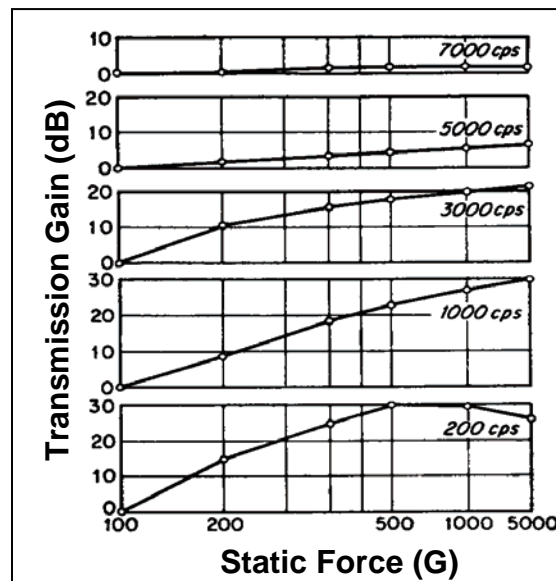

Figure 33. The effect of static force (in grams) on the signal transmission gain (dB) through bone conduction when the amplitude of vibration is kept constant (Bekesy, 1939; modified).

The effect of bone vibrator contact area and size of the transducer for testing near threshold is small, but it does contribute to the amount of sound energy that is transmitted to the skull. For supra-threshold applications (e.g., speech communication), the use of large transducers with large contact areas may be needed to provide a sufficient strength of the signal. Larger transducers may also be needed for applications where the provided signal has an extended low frequency range in order to provide a sufficiently wide bandwidth and acoustic power without unacceptable distortions. The use of a smaller transducer may result in linear and nonlinear distortions of the transmitted signal as well as discomfort to the wearer. The decision about size and contact area of a transducer is based on its intended use. For instance, if bone conduction vibrators are implemented for listening to music, a wide bandwidth is desired and therefore, a larger transducer may be in order. If the intended use is for communication in quiet and in noise, a smaller bandwidth with fewer low frequencies would be desirable, in which case, the size of the transducer may be reduced.

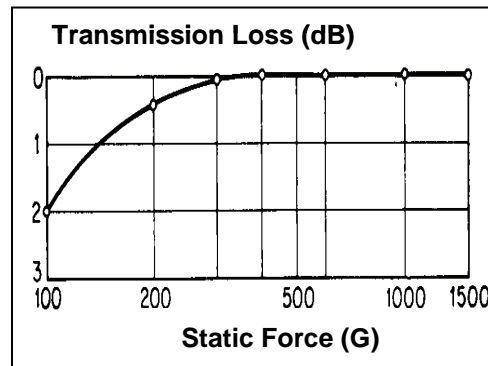

Figure 34. The general effect of static force (in grams) on transmission loss (dB) of vibrations transmitted through the skin when the actual alternating pressure applied to the skin is kept constant (Bekesy, 1939).

5.3 Location of Transducer

Standing waves and modal vibration of the skull make selection of a location for the placement of the bone vibrator on the head a very important decision. The same applies to the placement of bone conduction microphones or accelerometers used to monitor speech-induced vibrations of the skull. Selection of a specific location for either type of transducer affects the spectral content transmitted and the relative level of the effective signal. The level of the effective signal is especially important for the vibrators because of the limited power of the transducers. Selection of a sensitive location may decrease the power needed for communication and minimize the amount of nonlinear distortions at high presentation levels.

In general, the closer the vibrator's location is to the cochlea, the stronger the ipsilateral (same side) cochlea's response to stimulation (Stenfelt et al., 2000). However, overall transcranial attenuation is relatively low and the other cochlea receives a relatively strong signal (see

section 3). The effective transmission of mastoid stimulation is primarily because the temporal bone is a rigid body surrounding the cochlea. In addition, when stimulation is applied to the mastoid bone, as opposed to the forehead (for example), ossicular inertia plays a major role in bone conduction reception at frequencies as high as 4000 Hz (Goodhill et al., 1970; Studebaker, 1962) (see section 3).

Various locations on the human skull are traditionally used for placing a bone vibrator during audiologic hearing testing (discussed in detail in section 11) or for determining the location of a bone conduction hearing aid (discussed in detail in section 12). These locations are listed in table 7. All the locations have advantages and disadvantages regarding sensitivity, wearer comfort, maintenance of placement, ease of placement, and variability in the resultant threshold obtained.

Table 7. Common locations for bone conduction transducers on the human head.

Location	Application
Posterior caudal part of the temporal bone; mastoid bone	Bone conduction audiometry and typical location for bone conduction hearing aids
The center of the frontal bone; 10 mm above the suture of the nasal bone	Bone conduction audiometry
Anterior caudal corner of the parietal bone	Preferred bone anchored hearing aid (BAHA) location

Placing the vibrator in the center of the forehead (frontal bone) seems to be most suitable in terms of repeatability of the test since the bone on the forehead has a uniform thickness and a relatively flat shape that produces a very regular form of vibration. This allows for consistent thresholds to be measured with some tolerance for changes in location. A shift as large “as 3 cm in vibrator placement has no effect upon the loudness of the bone-conducted tone” and would therefore have little effect on the listeners’ threshold (Bekesy, 1960, pp. 131-133). In addition, most researchers have found that there is relatively small inter-subject variability in hearing thresholds for the forehead location (Hart & Nauton, 1961; Dirks, 1964; Studebaker, 1962). Weston, Gengel, and Hirsh (1967) reported that the inter-subject variability for sounds of frequencies larger than 1 kHz is nearly the same at different placement locations across the skull but it varies greatly at lower frequencies. They also found that the intra-subject (test-retest) variability is lower for the forehead position than for the mastoid position, particularly for extreme low and high frequencies, which again supports the selection of the forehead position as prime location for hearing threshold testing. For the mid-frequency range, the difference in test-retest variability for the forehead has been shown to be between 2 and 4 dB (Weston et al., 1967). The tactual sensations arising from the low frequencies are more easily perceived when the vibrator is placed on the forehead (Bekesy, 1960, p. 133). However, tactual sensations from the vibrator do not equate sensations of sound and these two perceptions need to be distinguished (section 3). Listeners with normal hearing, when tested with sensation levels near their thresholds, do not report feeling a tactual sensation. It is only at higher sensation levels that tactual stimulation is experienced. For people with profound hearing losses, the differentiation of the sensations of hearing versus touch is often difficult. For

these people, the intensity levels of sounds presented through vibrators often surpass the tactual threshold.

Dirks (1964) and Studebaker (1962) made measurements of bone conduction hearing threshold for mastoid and forehead locations of the vibrator. They found that when the vibrator was placed on the forehead, stimulation with low to mid-frequencies with longer wavelengths resulted in vibrator amplitude values that were consistent as far away as 4 cm from the location of the vibrator. However, for the mastoid process location, small changes in the point of application resulted in large changes in amplitude.

Although placement of a vibrator on the mastoid bone has been considered by some authors as an unacceptable location because of the hearing threshold dependence on the exact placement of the vibrator, this location does result in lower hearing thresholds than the forehead location (Dirks, Malmquist, & Bower, 1968; Frank, 1982; McBride, Letowski & Tran, 2005; Richter & Brinkmann, 1981; Weston et al., 1967). The average difference has very little dependence on frequency and varies roughly from 10 to 12 dB (Haughton & Pardoe, 1981; Frank, 1982; ANSI, 1996). Lower thresholds for the mastoid placement reflect that this area is more sensitive to bone conduction transmission. Therefore, despite the fact that the placement of the vibrator on the mastoid portion of the head can result in more variability in thresholds because of small changes in location (Bekesy, 1960), audiologists (people trained in hearing assessment) commonly use the mastoid process as the placement for hearing testing because it is more sensitive and more convenient to stimulate. The convenience of this location is attributable to easy availability of various headbands to hold the vibrator in place.

Allowances have been made in the national standards for forehead or mastoid placement through the use of correction values, allowing audiologists and others the option to choose location based on their specific needs. These values, derived from various studies and adopted by ANSI, are shown in table 8. The higher bone conduction sensitivity of the side-of-the-head locations (e.g., mastoid, cheek bone) in comparison to the midline locations (e.g., forehead, vertex) is attributable to activation of the middle ear component of bone conduction transmission. The inertial left-right movement of the ossicular chain is much stronger with the in-axis placement of the driving force than with perpendicular placement (Bárány, 1938). The difference in bone conduction transmission effectiveness between the central forehead and the mastoid placement of the vibrator may therefore be used to assess the contribution of the middle ear to bone conduction transmission in normal ears.

In clinical audiologic hearing testing, the specific location for placement of the bone vibrator on the mastoid bone is typically determined in one of two ways: by visually locating the position of thinnest skin and the most prominent point of the mastoid bone (Robinson & Shipton, 1982; Studebaker, 1962) or by sending a 250-Hz tone through the vibrator and placing it at the point where the listener perceives the tone to be the loudest (Weston et al., 1967). The selection of the method of placing the vibrator can have an impact on the thresholds measured, but the difference

in thresholds obtained from these two methods does not appear to be large (Wright & Frank, 1990), so either method for optimizing placement is deemed acceptable.

Displacement thresholds reported by Bekesy (1948) range from 10^{-6} cm at 100 Hz through 10^{-8} cm at 400 Hz and 2×10^{-9} cm at 1000 Hz to 7×10^{-10} cm at 3000 Hz. These values indicate that only a very small degree of displacement on the part of the vibrator is necessary to stimulate the bones of the skull and elicit an auditory response. Acceleration threshold levels for direct and indirect stimulation of the human skull were reported, among others, by Flottorp (1972) and Håkansson, Tjellström, and Rosenhall (1985). For example, Lenhardt and colleagues (2002) reported an acceleration threshold level at 6000 Hz as equal to about -2.5 dB re 1 m/s^2 .

Table 8. Normal monaural force hearing thresholds for bone-conducted sounds at different frequencies for a B-71 vibrator placed on the mastoid and at the forehead (ANSI, 1996).

Frequency (Hz)	Mastoid (dB re $1\mu\text{N}$)	Forehead (dB re $1\mu\text{N}$)	Forehead Minus Mastoid
250	67.0	79.0	12.0
315	64.0	76.5	12.5
400	61.0	74.5	13.5
500	58.0	72.0	14.0
630	52.5	66.0	13.5
750	48.5	61.5	13.0
800	47.0	59.0	12.0
1000	42.5	51.0	8.5
1250	39.0	49.0	10.0
1500	36.5	47.5	11.0
1600	35.5	46.5	11.0
2000	31.0	42.5	11.5
2500	29.5	41.5	12.0
3000	30.0	42.0	12.0
3150	31.0	42.5	11.5
4000	35.5	43.5	8.0
5000	40.0	51.0	11.0
6000	40.0	51.0	11.0
6300	40.0	50.0	10.0
8000	40.0	50.0	10.0

Most of the studies concerning vibrator placement on the skull have limited their scope to the locations of the mastoid process and forehead. Occasionally, the top of the head (vertex) has also been included. The very limited range of locations used in these studies is justified by the clinical aspect of the comparisons. However, for non-clinical applications, there are additional locations that should be considered, based on theoretical and practical considerations. Therefore, an extensive study was conducted at ARL to examine the differences in hearing thresholds for different locations on the skull. McBride, Letowski, and Tran (2005) examined the effects of different vibrator location on auditory thresholds to pure tones and broadband sounds with ears unoccluded. The authors examined 11 locations around the skull (shown in figure 35) and 11 stimuli (pure tones at octave frequencies 125 to 8000 Hz, white noise, and three speech sounds [“aah,” “eee,” and “ooh”]). Among all the locations tested, the condyle (the bony portion

directly in front of the opening to the EAC) was found to be the most sensitive, followed by the mastoid, jaw angle, vertex (top of the head), and temple locations. The study recommended the condyle as the location of choice for bone conduction vibrators for the purposes of radio communication. One of the reasons that the jaw angle is an effective place for vibratory stimulation of the auditory system is the fact that the anterior wall of the EAC lies adjacent to the TMJ and has good contact with the cartilaginous tissue surrounding the EAC.

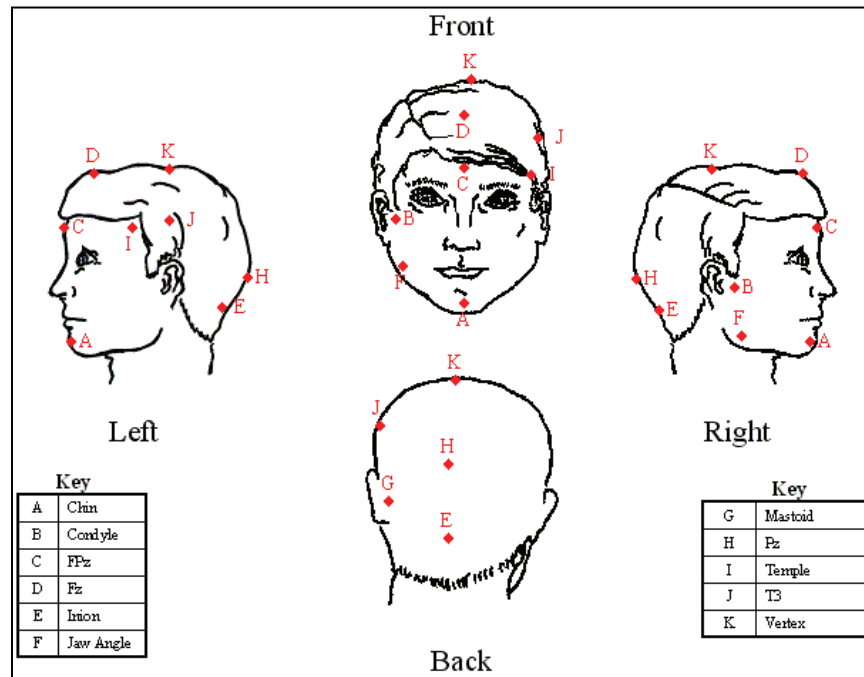

Figure 35. Test locations on the head for optimal bone conduction vibrator placement (from McBride, Letowski, & Tran, 2005).

The authors later repeated the study, maintaining an open ear condition but conducted their test in 50 decibels A weighted (dBA) of background noise. All the thresholds were increased, but the relative sensitivities of various locations did not change (McBride, Letowski, & Tran, 2006).

In general, the studies conducted by ARL confirmed the finding that human hearing is more sensitive to bone conduction stimulation arriving from the side locations on the head than from locations along the median plane. Higher bone conduction sensitivity for the side-of-the-head locations (e.g., mastoid, cheek bone) in comparison to the midline locations (e.g., forehead, vertex) is attributable to activation of the middle ear component of bone conduction transmission. The inertial left-right movement of the ossicular chain is much stronger with the in-axis placement of the driving force than with the perpendicular placement.

The discussion of transducer placements has been limited so far to situations when the vibrator has been placed on the skin surrounding the skull. In some cases, however, the skin can be bypassed and the stimulation can be applied directly to the bones of the skull or the teeth. The former scenario is possible through the use of an implant for bone conduction transmission known as a

BAHA. This device is discussed in further detail in section 10. Because the damping effect of the skin has been eliminated, direct stimulation of the skull bones results in lower hearing thresholds than when the skull is stimulated through the intact skin (Håkansson et al., 1984). The amount of reduction in stimulation level because of skin damping varies by frequency. Essentially, the skin and surrounding tissue provide very limited if any damping for frequencies below 500 Hz. However, above 500 Hz, direct stimulation of the bones of the skull results in thresholds that are 5 to 25 dB better than those obtained through the skull with the skin and tissue intact. The difference in stimulation location diminishes again around 6000 Hz (Håkansson et al., 1984). Although direct stimulation of the bones of the skull is not practical for non-health-related reasons, it is valuable to note how much the skin and tissue contribute to the bone conduction thresholds measured through direct stimulation.

Stimulation of the teeth through a vibratory device to elicit an auditory response has been termed *audiodontics* (Dahlin, Allen, & Collard, 1973). The vibrator, often referred to as a *dentiphone*, sends the signal through the teeth to the jaw, which in turn transmits vibrations to the bones of the skull. Dahlin et al. (1973) measured hearing thresholds to pulsed pure tones presented through a tooth vibrator across frequencies from 500 to 4000 Hz. Thresholds to sounds presented through the teeth were on average 10 dB lower than sounds presented through a vibrator placed on the forehead. The tooth placement threshold values are similar to values found for mastoid placement shown in table 9, and the difference between tooth and forehead placement is the same as the difference between mastoid and forehead placement. Table 9 shows the average values for tooth placement of a vibrator as compared to stimulation on the forehead. Since the teeth appear to be equally or less sensitive to vibrations than the mastoid location, the teeth are only seriously considered for special applications such as scuba diving or lap swimming when the *dentiphone* can be built into the mouthpiece of the breathing apparatus. Two commercially available devices for such purposes are discussed in section 11. Other potential applications would require a power source in the mouth or a pair of cables hanging from the mouth, which is not practical or aesthetically pleasing.

Table 9. Threshold values for forehead versus the average across four tooth location placements. (Values are in decibels re 1 μ N [Dahlin et al., 1973]).

Frequency (Hz)	Forehead (dB)	Teeth (dB)
250	89	78
500	76	68
1000	54	47
2000	51	39
4000	42	45

Just as the size of the vibrator is determined by the intended use, the determination of location of a bone conduction vibrator for the listener must be made on the basis of its intended use. It has been well established that placement of a bone conduction vibrator on the mastoid bone allows for the use of lower intensities since this location is more sensitive to bone-conducted sounds.

However, the forehead placement is more repeatable and reliable, allowing for greater stability over time. In applications for clinical audiologic testing, the choice of location is somewhat arbitrary since the person who has to have the vibrator in contact with his or her head has to do so for only a short period of time. For military and commercial applications, when a listener has to wear the vibrator(s) for extended periods of time, the forehead location may not meet comfort and aesthetic or cosmetic standards. On the other hand, placement on the mastoid bone can cause some discomfort if used with the standard headband designed for clinical audiologic use. The forehead position with the standard audiologic headband is used with typical bone conduction hearing aids for children with atresia (discussed in section 10) and often results in discomfort on the part of the wearer. Alternate locations such as the cheek bone, condyle, vertex, or jaw have been pursued to achieve a balance among sensitivity, comfort, and stability.

5.4 Audible Frequency Range for Bone-Conducted Sounds

Given proper static force levels, the same contact area, and the same location, the bone conduction hearing threshold still depends on the sound frequency, as shown by the threshold values listed in table 9. As is true for air conduction thresholds, the human auditory system is most sensitive to bone-conducted sounds in the mid-frequency range (around 1 to 4 kHz) and least sensitive to sounds in the low frequency range (below 500 Hz) (Richter & Brinkmann, 1981; Robinson & Shipton, 1982; Weston et al., 1967). Figure 36 shows the results from several studies examining bone conduction thresholds across frequency for the Radioear B-70-A transducer placed on the mastoid bone of a human listener with normal hearing.

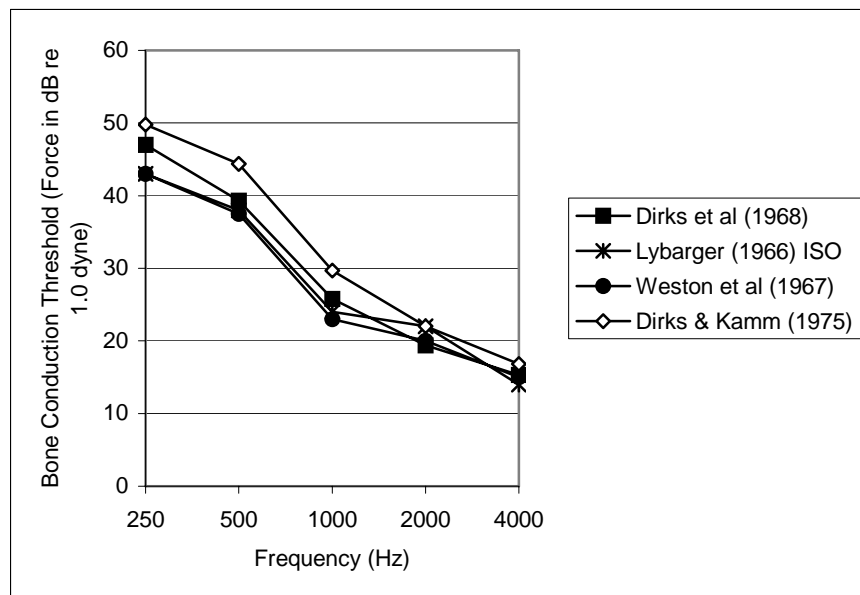

Figure 36. Hearing sensitivity as a function of frequency for bone conduction stimulation on the mastoid bone as found in several research studies. (The Radioear B-70-A bone conduction transducer was used for all measurements.)

The data presented in figure 36 are limited to the frequency range of 250 to 4000 Hz, that is, the range of frequencies used in bone conduction testing in clinical audiology. However, a number of reports and casual observations indicate that people can actually hear a much wider frequency range through bone conduction pathways than the range listed. For example, the study conducted by ARL (McBride, Letowski, & Tran, 2005) reported repeatable bone conduction hearing thresholds for various locations of the vibrator on a person's head for 125- and 8000-Hz frequencies. In addition, many studies have reported auditory sensations caused by bone-conducted ultrasound frequencies as high as 40 to 100 kHz. There is still ongoing debate about whether these sounds are transmitted through the bones to the hearing organs (or vestibular system) or whether they directly affect nerve cells of the brain stem and the brain itself. Some of these controversial studies are reviewed in section 12.

5.5 Summary and Conclusions

The sensitivity of the human auditory system is better for air-conducted sound than for bone-conducted sound. The ear is sensitive to different frequencies to varying degrees, and the frequency range of greatest sensitivity for air- and bone-conducted sounds is in the mid-frequencies, near 1 kHz. The size of the vibrator, the placement of the vibrator on the listener, and the static force applied to it can affect the amount of energy transmitted through the bones and therefore affect the sound perceived by the listener. The optimal location for the placement of a bone conduction vibrator for non-clinical applications is on the side of the head, namely, the condyle, where stimulation is in line with movement of the ossicular chain. The optimal static force is around 500 G. However, other locations may be used, depending on the needs of the particular application.

Although most of the research conducted on hearing through bone conduction has been focused on clinical applications in the field of audiology, the use of bone conduction transmission has been broadened to commercial and military applications. Stimulation on different parts of the skull as well as the teeth allows for the use of bone conduction transmission in specialized applications.

6. Ear Occlusion

The perception and transmission of sound through bone conduction depend on whether the EACs are open (unoccluded) or closed (occluded). This section discusses the differences in sound transmission and auditory perception on the part of the listener when the EACs are open or closed. These differences are important for us to know before we determine whether a device is appropriate for a particular application. For the military, a device that works well with occluded and unoccluded ears is essential for use in noisy and quiet environments.

6.1 The Occlusion Effect

During sound transmission through the bony structures of the human head, part of the sound energy is radiated by the vibrating walls of the EAC and excites the air contained within it. This radiation is especially effective in the outer one-third of the EAC, the walls of which are surrounded by elastic cartilage. The inner two-thirds of the EAC travel through the temporal bone, the walls of which produce much less radiation.

When the EAC is open, the changes in acoustic pressure caused by the vibrating walls are compensated by the air entering and leaving the EAC. The lower the sound frequency, the easier it is for the external air to compensate for the pressure changes in the EAC. The frequency-dependent behavior of the open EAC can be described as a high-pass (low-cut) filter action (Tonndorf, Greenfield, & Kaufman, 1966). When the EAC is closed, the changes in air pressure are not compensated and radiated sound energy stays within the EAC. This resultant energy produces the *occlusion effect*.

The occlusion effect is an increase in the loudness of a bone-conducted sound because of the closing of the EAC by an earphone, earplug, or other object.

When the EAC is occluded, acoustic energy emitted inside the canal cannot escape and the resulting changes in air pressure cause vibrations of the TM. The vibrations of the TM are transmitted by the structures of the middle ear to the inner ear, producing an auditory response. The lower the frequency of the transmitted sound, the stronger is the occlusion effect because the high-pass filter action of the open ear has been removed.

The occlusion effect occurs when the whole external ear (pinna and ear canal) or most of the ear canal is occluded. Numerous studies have demonstrated that plugging the ears during vibratory stimulation results in higher sound pressure in the EAC and greater audibility of bone-conducted sound (e.g., Dirks & Swindeman, 1967; Elpern & Naunton, 1963; Fagelson & Martin, 1998; Watson & Gales, 1943). The increase in sound pressure level in the occluded EAC can be measured by a probe microphone inserted in the EAC and a comparison of its reading with sound pressure measured on the outside. Such measurement can be accomplished with the use of two identical probe microphones or dedicated equipment such as the Occlusion Effect Meter ER-33, by Etymotic Research. Occlusion can also be observed as a decrease of the latency of Wave V in auditory evoked potential measurements after a bone-conducted signal is applied to the vertex of the head (Vogel et al., 1996). Auditory evoked potential measurements are discussed in more detail in section 9.

Bekesy (1932, 1939) attributed sound radiation from bones to the EAC to loose coupling between the cranial bones and the lower jaw that vibrates out of phase with the bone-conducted sound. The condyloid process of the lower jaw is situated just below the cartilaginous portion of the EAC, and its vibration can easily impart acoustic energy to the canal. Zwislocki (1953b) and Howell, Williams, and Dix (1988) observed that the increase in the perceived loudness of a sound because of the occlusion effect is larger when the vibrator is applied to the mandible (chin) than

when it is applied to the skull. This transmission of sound from the mandible to the EAC is most effective at low frequencies because of a local resonance of the lower jaw at about 200 Hz (Franke, Gierke, Grossman, & Wittern, 1952). Thus, it seems like the role of the mandible is especially important for the transmission of very low frequencies through the lateral cartilaginous walls of the EAC. At higher frequencies, the sound can be radiated to the EAC by the cartilaginous (driven by mandible) and the bony (driven by cranial bones) walls of the EAC (Allen & Fernandez, 1960; Tonndorf, 1972, pp. 195-237). Figure 37 presents the view of the human skull showing relative positions of the mandible and the skull.

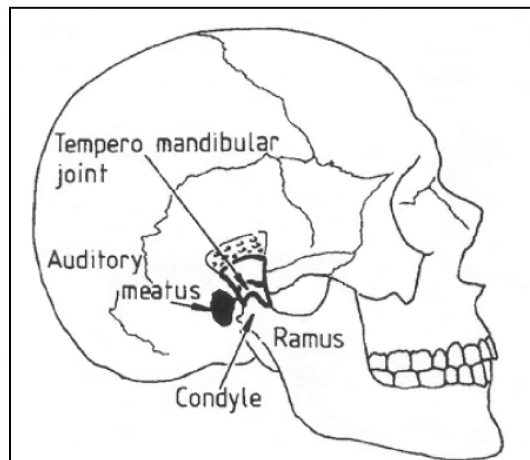

Figure 37. The position of the external ear and the mandible in relation to the opening of the EAC (Howell, Williams, & Dix, 1988).

Bekesy (1932) observed that the occlusion effect is larger when the mandible is in an outward (protruding) position than when it is in its natural position. He credited this increase in the occlusion effect to the fact that in such a position, a larger part of the mandible drives the cartilage surrounding the lateral part of the EAC. Bekesy's observation was later confirmed by Howell, Williams, and Dix (1988), who reported 2-, 8-, 12-, and 18-dB increases in the occlusion effect when the mandible was moved from its *in* (retracted) to *out* (protruding) position by four participants in their study. The importance of the vibration of the lateral (cartilaginous) part of the EAC on the amount of the occlusion can be further demonstrated if we compare the amounts of the occlusion effect produced when the mouth is closed versus when it is open. When the mouth is closed, the skull and mandible are coupled together more strongly than when the mouth is open and there is much less relative movement between the skull and the mandible (Bekesy, 1932). Franke et al. (1952) physically measured the occlusion effect (in dB SPL) with the mouth closed and open and noted an 8- to 9-dB increase at 200 Hz in the later case. These measurements were later repeated by Howell et al. (1988) who found similar results. The authors physically measured the occlusion effect (in dB SPL) in four listeners and reported maximum differences of 16 (180 Hz), 12 (80 Hz), 29 (200 Hz), and 12 (100 Hz) dB for individual listeners. The numbers in parentheses indicate the frequency at which the maximum value was observed. Franke et al. (1952) and Howell et al. (1988) showed that the amount of increase in the occlusion effect attributable to low jaw

position can be predicted from the measurements of the amplitude and phase of the resonances of the upper and lower jaw. Their predictions slightly overestimated the results of the measurements but were usually within 3 dB.

The magnitude of the occlusion effect is typically reported as the difference in the hearing threshold values between the conditions when the ear is occluded and when it is not. This difference is sometimes called the *occlusion index* (Hannley, 1986, p. 100). The magnitude of the occlusion index varies by frequency and ranges from 25 dB at 250 Hz to 0 dB for frequencies above 2000 Hz. In the evaluation of hearing aids, hearing protectors, and in-the-ear devices, the occlusion effect is typically measured at 250 Hz or 500 Hz and is considered negligible if it is less than 10 dB, mild to moderate when it is between 10 and 20 dB, and severe when it is larger than 20 dB. Some data showing the magnitude of the occlusion effect caused by supra-aural earphones are presented in table 10. The physical measure of the occlusion effect does nothing to indicate the degree to which the occlusion can be adversely experienced by the listener. Perceptual effects of the occlusion effect are discussed in section 6.3.

A more comprehensive measure of the occlusion effect was proposed by Sullivan, Gottlieb, and Hodges (1947). The proposed Sullivan Occlusion Index (SOI) is the summed bone conduction threshold shift at 250, 500, and 1000 Hz because of the occlusion of the ear. The typical value of the SOI for people with normal hearing is about 60 dB, and a value of 20 dB or less indicates conductive ear pathology as the occlusion of the ear appears to have no effect on the hearing thresholds, which suggests that a problem is already present.

In the case speech signals, the average occlusion effect is reported to be about 6 to 9 dB, although individual differences can exceed 20 dB (Klodd & Edgerton, 1977; Langford, Mozo, & Patterson, 1989). When the speech signal is presented in noise, the combined effects of noise reduction and the occlusion effect can make substantial improvements in SNR. This effect is discussed in section 6.4.

Table 10. Comparison of occlusion effects (in dB) caused by supra-aural earphones at various audiometric frequencies (a – mastoid stimulation; b – forehead stimulation).

Authors	Frequency (Hz)				
	250	500	1000	2000	4000
Watson and Gales (1943)	22.5	18	7.5	1.5	-
Huizing (1960)	13	15	8	2	-
Elpern and Naunton (1963)	28	20	9	0	0
Goldstein and Hayes (1965)	20	12	8	2	-
Dirks and Swindeman (1967)	23.7	20.2	8.8	-0.6	-
Fagelson and Martin (1998a)	24.8	15.7	7.2	-	-
Fagelson and Martin (1998b)	19.2	16.3	4.6	-	-
Aazh et al. (2005)	27.1	21.3	11.4	4.7	-

Tonndorf (1972) and Fagelson and Martin (1998) measured the extent of the occlusion effect for frontal bone and mastoid bone stimulation. In both studies, the occlusion effect was found to be

smaller for the frontal bone location than for the mastoid bone location at low frequencies and similar at higher frequencies. Fagelson and Martin (1998) also evaluated the relationship between the measured change in SPL in the EAC and the behavioral thresholds obtained in the occluded and unoccluded conditions. They found good agreement ($r = 0.82$) between the two measures, thus indicating that occlusion not only results in higher sound pressure levels in the ear canal, but it also translates to lower thresholds as measured behaviorally. They attributed the less-than-perfect relationship between these two measures to the presence of the middle ear inertial effect.

The magnitude of the occlusion effect depends greatly on the volume of the closed cavity. Watson and Gales (1943) demonstrated the effects of cavity size by using different sized cavities to cover the ears from the outside and determining the bone conduction thresholds for each cavity. In their study, Watson and Gales used cavities varying in volume from 8 to 6700 cm³. The values given in table 10 are for those with supra-aural (over the ear) headphones similar to those used in other studies. They found that the maximum enhancement in bone conduction thresholds occurred with the use of the 8-cm³ cavity created when earphones were placed directly over the listener's ears. Some shift in bone conduction thresholds occurred for all cavities of volumes less than 1000 cm³, but no enhancement was seen with cavities of 6700 cm³. Similarly, Pörschmann (2000) observed no occlusion effect for very large circumaural (around the ear) headphones with a volume of 2000 cm³.

Tonndorf (1972), Killion, Wilber, and Gudmundsen (1988), and Dean and Martin (2000) demonstrated that reducing the volume of the occluded EAC to values of less than 8 cm³ can have a beneficial effect by decreasing the occlusion effect. This effect can be practically eliminated through a deep insertion of an occluding device, such as an insert earphone, into the bony portion of the EAC (Bekesy & Rosenblith, 1951, p. 1109). In this case, the volume of the occluded space is very small and the vibrations produced by the bony portion of the EAC are much smaller in amplitude than those produced by the cartilaginous portion of the canal being in direct contact with inertial movement of the mandible. Tonndorf (1972, pp. 195-237) identified three mechanisms responsible for reduction of the occlusion effect by deep insertion of the occluding device: (a) an increase of the middle ear impedance by additional load of TM caused by the small cavity, (b) an increase of the resonance frequency of the occluded cavity, and (c) the damping of the canal walls by insertion of the earplug and elimination of cartilaginous transmission. Deep insertion means that the occluding object only has contact with the bony portion of the canal walls (Killion et al., 1988). Otherwise, vibrating cartilaginous walls of the EAC would transfer their energy on the occluding object which, in turn, would work like a piston-type source of sound. Figures 38 and 39 present the amount of occlusion effect as a function of the depth of earplug insertion reported by Killion et al. (1988) and Pirzanski (1998).

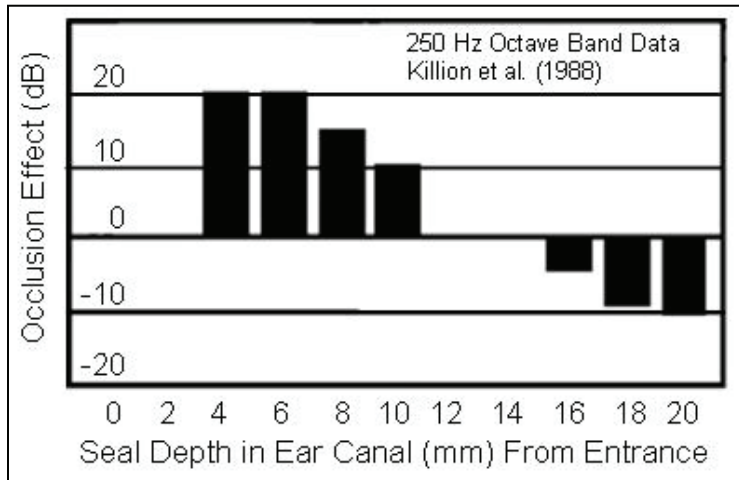

Figure 38. Occlusion effect (dB) as a function of the depth of earplug insertion (probe microphone data).

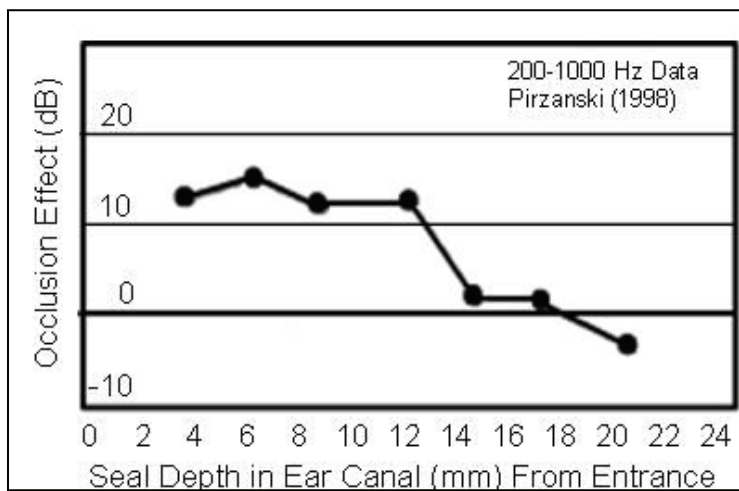

Figure 39. Occlusion effect (dB) as a function of the depth of earplug insertion (probe microphone data).

A review of the literature indicates that the natural volume of the EAC, which is around 8 cm³, causes the strongest occlusion effect. Larger and smaller volumes produce weaker occlusion effects. This means that circumaural earphones and insert ear earphones (earphones that sit in the EAC) will cause less occlusion than supra-aural earphones. The effects of various types of earphones and related volumes of air trapped under the earphones on the amount of the occlusion effect are shown in figure 40.

The relative contribution of the occluded EAC to the bone-conducted excitation at the cochlea measured by Tonndorf et al. (1976) is shown in figure 41. The y-axis displays the SPL that was needed to present a 180-degree out-of-phase signal to the EAC to compensate for the bone conduction excitation (accomplished through a 2-cm disk at the forehead).

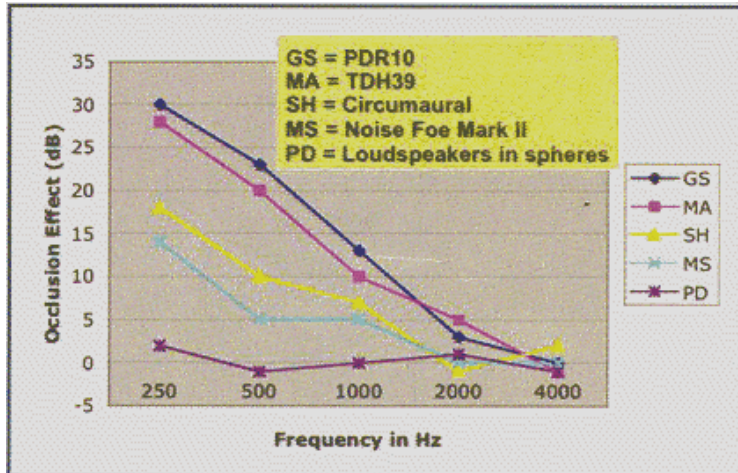

Figure 40. Occlusion effects caused by various types of earphones. (The effects were measured as the bone conduction threshold shift at various frequencies caused by ear occlusion [Staab, Dennis, Schweitzer, & Weber, 2004].)

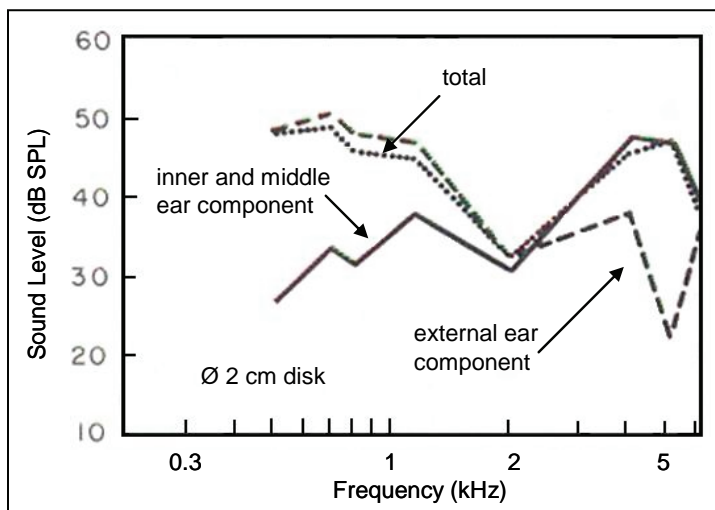

Figure 41. Relative contributions of the external (occluded) ear canal and the inner and middle ears to the loudness of bone conduction signals (adapted from Tonndorf, McArdle, & Kauger, 1976).

The occlusion effect causes a decrease in bone conduction hearing threshold, an increase in the loudness of bone-conducted sounds, and lateralization of sound images toward the ear experiencing the greater occlusion effect. When a single ear is occluded, bone-conducted sounds are perceived as louder or as only being present in the occluded ear.

6.2 Timbral Effects of Ear Occlusion

As discussed, the occlusion effect is the strongest at low frequencies and gradually decreases with increases in frequency. However, the increase of sound intensity below 200 Hz has a relatively mild perceptual effect because of the elevated hearing threshold in this frequency range. The most

perceptually pronounced effect is in the 250- to 500-Hz frequency range, which causes booming and in-the-barrel timbral sensations (Maurer & Landis, 1990). This effect is enhanced by the elimination of the open ear resonance between 2000 to 4000 Hz caused by closing of the EAC. The occluded ear canal functions as a resonant cavity closed on both ends rather than a tube open at one end (the normal characteristic of the open EAC). When the EAC is open, the resonance frequencies, f_n , of the resulting quarter-wavelength resonator are described by the equation

$$f_n = \frac{(2n-1)c}{4L}$$

in which c is the speed of sound in air, L is the effective length of the EAC, and n is a number from 1 to ∞ . When the EAC is closed on both ends, the usual quarter-wavelength resonator becomes a half-wavelength resonator and the resonance frequencies, f_n , are described by

$$f_n = \frac{nc}{2L}$$

Assuming that the length of the ear canal is 25 mm, the resonance frequencies of the occluded EAC are 6800 Hz, 13,600 Hz, and so forth, rather than 3400 Hz, 10,200 Hz, and so forth, when the EAC is open. Thus, sound transmitted in the occluded EAC may lose some presence caused by the missing 3400-Hz resonance of the open EAC but may gain some perceptual brightness caused by the new resonance at 6800 Hz. Reported values have been calculated, assuming that all the boundaries of the EAC, including the TM, are highly reflective and by neglecting the end effect of the canal when it is open (see section 2.2). Therefore, in the real EAC, the actual resonance frequencies will be lower and less different but the character of the described effect will remain. It is also important to realize that the described sound modification does not apply exclusively to bone-conducted sound. When the EACs are occluded by headphones or insert earphones, the sound radiated from the transducers is affected by ear occlusion in the same manner as the sound transmitted through bone conduction. Therefore, the same sound transmitted by the same transducer used as a loudspeaker or as an earphone will sound different to the listener because of different ear canal effects.

6.3 Speech Production and the Occlusion Effect

The occlusion effect affects the perception of a talker's own voice (speaking or singing) as well as the perception of other sounds generated within the human body such as chewing, sneezing, or playing musical instruments (brass, woodwind, kazoo, harmonica). Vibrations of the human body or sounds produced in the back of the mouth during phonation are transmitted through the EAC walls to the air trapped in the canal and stimulate the TM. This causes further amplification of the low frequency energy of the human voice or other sounds, thus making these sounds louder but less clear and less pleasant.

Occlusion of the EAC also decreases the talker's ability to monitor his or her own voice. Articulation, speech intensity, and pitch of a talker's voice are affected by the feedback the talker receives

through the side tone (the air conduction pathways between the mouth and the ear) and, to a lesser degree, by the bone conduction pathway. This ability is compromised when the ears are occluded. Ear closure reduces the audibility of the air conduction side tone that normally supplies some amount of critical high frequency energy to the ear of the talker. In most cases, people report their own voice having a poor quality during times when their ears are occluded (Maurer & Landis, 1990). In such cases, most people describe the quality of their voice as odd, poor, dull, and unintelligible. However, there are some situations when occlusion can have positive perceptual effects. Lack of a side tone and decreases in intelligibility of self-perceived speech caused by ear occlusion make people speak slower and with better articulation. This manner is similar to when someone speaks in the presence of intense background noise (Letowski, Frank, & Caravella, 1993). When someone is in the presence of a high level of background noise, s/he is typically unable to hear his or her own voice well enough to monitor it. In this case, the talker elevates vocal intensity and speaks more slowly, and the spectral content of the talker's voice tends to shift toward higher frequencies. This is beneficial to the listeners because the sounds are better pronounced and the consonants are more intense. The changing of the characteristic qualities of a talker's voice in noise is known as the "Lombard Effect". Similarly, occluded speech may sound bad to the talker but may be more intelligible to others.

6.4 Ear Occlusion and Noise

The effect of ear occlusion associated with wearing hearing protection devices, earphones, hearing aids, and in-the-ear communication devices is usually reported as an undesirable condition by the wearers. However, ear occlusion can be very beneficial to speech communication by bone conduction in noise. Covering or plugging the ears with properly fitted hearing protectors reduces low frequency air-conducted energy affecting the ear by 15 to 20 dB and reduces high frequency air-conducted energy by as much as 45 dB. At the same time, the occlusion effect produced by wearing hearing protectors enhances low-frequency bone-conducted sounds by as much as 15 to 25 dB. Higher frequencies are amplified much less, but the overall speech signal amplification can be in the range of 3 to 8 dB (Klodd & Edgerton, 1977). These two effects working together can improve the SNR of some bone-conducted signals by as much as 30 to 40 dB and can result in a substantial improvement in the intelligibility of transmitted speech signals. Therefore, in cases when speech communication needs to take place in noise, bone-conducted sounds may become one of many contributors or even the principal contributor to auditory perception. The benefit of using bone conduction transmission of speech in the presence of noise with occluded EACs has been clearly demonstrated by Langford et al. (1989) who reported a 27-dB improvement in the SNR. Further discussion of the practical applications of bone conduction for communication in noise is included in section 11.

6.5 Summary and Conclusions

Occlusion occurs when the ear canals are blocked through placement of headphones over the ears or plugs inserted in the ear canals. The amount of occlusion that occurs in any given situation depends on how the ears have been occluded. There is a critical point in the volume needed to

achieve maximum occlusion before which occlusion is reduced and beyond which no additional perception of occlusion occurs. The occlusion effect can be a positive and negative side effect of occluding the EAC. In some cases, the person whose ears are occluded hears his or her own voice as if s/he were talking in a barrel and this is a negative perception. However, when the EACs are closed, the transmission of bone-conducted sound to the listener is optimized, which is a positive side effect, particularly for use in noisy environments.

7. Bone Conduction Spatial Perception

A human listener's ability to know where sound sources are located within his or her environment is essential to his or her being able to effectively interact with people and objects around him or her. This ability, known as spatial hearing, can be exploited for the purposes of presenting multiple sounds to a listener and artificially positioning them at different locations in space. The use of spatial hearing (or spatial audio) in a military application can allow a listener to simultaneously monitor multiple lines of radio communication. In this section, we discuss the incorporation of spatial hearing into multi-channel radio communication with headphones and the potential for the use of bone conduction devices for this purpose.

7.1 Spatial Hearing

Spatial hearing, also called auditory spatial orientation or auditory spatial cognition, is the (human) ability to determine the source of a sound and changes in source location. It includes the acts of sound source localization, movement detection, movement direction recognition, and distance estimation. The two main elements of spatial hearing are localization and distance estimation. Auditory localization is the ability to determine the direction from which the sound is reaching the listener. Auditory distance estimation is the ability to determine the distance to the place from which the sound is arriving at the listener.

In some cases, the perceived sound source location is confined to the head. This effect is common during listening to sound through headphones. In such cases, the sound is heard as a fuzzy event filling the whole space of the head or as a localizable sound source inside the head, typically along an arc connecting the left and right ears. The deviation of the in-the-head sound source away from the median plane is called lateralization. Lateralization is the sensation of hearing a sound source inside the head along an arc connecting the left and right ears. The term *localization* is reserved for the human's ability to identify the sources of sounds that are perceived to be outside the head.

This use of the term *lateralization* has a different meaning in sound perception than in brain physiology where it means location of the brain function (activity) within the left or right hemisphere. The left hemisphere is commonly associated with analytical skills such as logic,

math, and language, processing whereas the right hemisphere is associated with holistic skills such as spatial cognition (visual and auditory) and music.

The human ability to localize objects through hearing in space is poorer by an order of magnitude than the ability to localize objects through sight. The ability to localize sound sources extends over the entire spherical range of 360 degrees whereas the visual space is much smaller. There are a number of physical and psychological phenomena that aid in sound localization. They can be divided into binaural cues, monaural cues, and operational cues. The essential cues aiding in spatial orientation are listed in table 11.

Table 11. Main auditory cues used for spatial orientation by humans.

Type of Cue	Specific Cue
Binaural	interaural time (phase) difference (ITD or IPD ^a)
	interaural intensity (level) difference (IID ^b or ILD ^c)
Monaural	pinna and ear canal effects
	head, shoulders, and torso effects caused by diffraction and reflections of sound waves by the human body
Operational	head movements
	auditory memory

^aIPD = interaural phase difference

^bIID = interaural intensity difference

^cILD = interaural level difference

An ITD is the time delay between the sound reaching the proximal (ipsilateral) and the distal (contralateral) ear. A sound will arrive at the closer ear earlier in time than at the farther ear. The ITD is at its maximum when the sound source is situated along the lateral axis on one side of the head. Assuming that the average male head is spherical and has a circumference of 57 cm (NASA, 1978), then the maximum pathway around the head to the opposite ear (half of the head circumference) would equal 28.5 cm. Assuming further that the sound travels at 340 m/s ($T = 21\text{ }^{\circ}\text{C}$ ($69.8\text{ }^{\circ}\text{F}$) and $p_{\text{atm}} = 1000\text{ mm Hg}$), the maximum ITD results in 838 μs . Assuming that the average female head is spherical and has a circumference of 55 cm (NASA, 1978), the maximum pathway around the head would be 27.5 cm and the maximum ITD would be 808 μs . The angular difference of 1 degree results in an ITD of about 10 μs .

For pure tones (sine waves), the ITD can also be expressed as an IPD. Sine waves are labeled in degree values based on their point in time as well as relative to each other. Thus, a crossing of the horizontal axis represents 0-, 90-, 270-, and 360-degree phases. If two sine waves do not cross the horizontal axis at the same point in time, they are said to be out of phase. As the maximum spatial phase lag between two sine waves approaches 180 degrees, the phase difference between the left and right ear signals becomes ambiguous. Assuming the head diameter of 18.5 cm, the phase lag of 180 degrees or more would appear for frequencies $\geq 1300\text{ Hz}$. For the smaller head with the diameter of 27.5 cm, the phase ambiguity range will start at 1500 Hz. This means that the pure phase IPD cue operates only to 1000 to 1500 Hz. However, in the case of high frequency complex sounds, the absolute IPD may not be perceived by the listener, but the ITD may still be valuable.

This is because humans are sensitive to the fine structure ITD (low frequency) and the envelope fluctuation ITD (high frequency) in a signal (Nuetzel & Hafter, 1976; Bernstein & Trahiotis, 1994; Joris, 2003). Henning (1974) demonstrated that the human ability to localize a 300-Hz pure tone was preserved when the same tone was used to amplitude modulate a 3900-Hz tone. Amplitude modulation refers to the combination of two tones so that they are perceived as a warble (a fluctuating tone) rather than a pure tone. In the amplitude modulated case, all the signal frequencies were above 3000 Hz but the signal envelope was varying at the rate of 300 Hz. Thus, the absolute ITD of a complex sound may not be heard but the ITD of its envelope can still provide a temporal localization cue.

An IID or ILD is the difference in the intensity (level) of the sound reaching the proximal (near) and the distal (far) ear. The difference is caused by an acoustic shadow cast by the head on the distal ear. This means that the proximal ear receives the sound at a higher intensity or level than the distal ear because of the head's blocking the transmission of the sound from one side of the head to the other. The acoustic shadow effect depends on the direction of the incoming sound and its frequency. The effect is largest when the sound source is situated at the side of the head on the lateral axis connecting the ears. The higher the frequency of the sound, the greater the shadow effect of the head and the stronger the IID cue. For example, when a sound source is situated on the lateral axis connecting the ears, the IID values can be around 2 dB at 250 Hz, 5 dB at 1 kHz, and 20 dB at 10 kHz.

The low frequency dominance of the ITD and the high frequency dominance of the IID are reflected in the duplex theory of auditory localization first proposed by Lord Rayleigh (Strutt, 1907). The theory states that the human ability to localize pure tone sounds in the low frequency range depends on the ITD (where there are only small IIDs), and the ability to localize sounds in the high frequency range depends on the IID (there is only an ambiguous IPD or ITD). Lord Rayleigh postulated that the cross-over frequency between the utility of the two cues would be about 1500 Hz, depending on the size of the head. Later studies demonstrated that people have great difficulty localizing pure tones with frequencies in the 1.5- to 4-kHz range, which indicates that neither of these mechanisms operates well in this transitional frequency range (Mills, 1958; Stevens & Newman, 1936).

In the case of real (complex) sounds comprising multiple frequencies, the ITD and IID cues operate together, and it is impossible to separate their effects. However, the values of the ITD and IID cues can be controlled independently when a sound is presented binaurally through headphones. Headphone studies with complex sounds have shown that the minimum noticeable ITD (IPD) and IID are about 10 μ s (2.5 degrees) and 0.7 dB, respectively. Differential thresholds (DL or difference limen), or the ability to determine that a sound has been changed, are somewhat higher. For example, for an IID of 15 dB, the DL is about 1.5 to 2.0 dB, depending on the frequency content of the stimulus (Yost & Dye, 1991). In another kind of experiment, called a trading experiment, both cues can be used in a conflicting manner to determine their trading values. One of the cues is kept constant while the other is manipulated until an equivalent spatial

perception is obtained. Blauert (2001, p. 172) summarized some trading experiments, stating that for sounds with the majority of energy below 1.6 kHz, where localization cues are dominated by ITDs, 1 dB of IID requires an adjustment of about 40 μ s in ITD for equivalent perception. For sounds above 1.6 kHz, where localization cues are dominated by IIDs, 1 dB of IID requires as much as 200 μ s of ITD for equivalent perception.

In normal auditory localization situations, ITDs at frequencies below 1500 Hz are associated with a corresponding phase shift (IPD). However, the ITDs and IPDs can be disassociated when the sounds are presented through headphones. Yost (1981) demonstrated that it is the phase shift (IPD), associated or not with an ITD, that produces the perceived lateralization of the sound image toward the ear leading in phase. If an ITD of 1 ms or less is introduced with no phase shift between the left and right ear signals, no lateralization takes place and the image is always heard in the center of the head (Baruch, Giami, & Botte, 1986; Russolo & Poli, 1985). This finding indicates that the auditory system is relatively insensitive to the fine structure ITD when it is not accompanied by a relevant phase shift.

Presenting sound through headphones also allows the introduction of ITD and IID values that are larger than those heard in the natural open space environment. Therefore, sound lateralization attributable to ITD or IID cues can be heard at frequencies where the normal cues do not operate, e.g., ILD differences at 500 Hz. Such unusual cues can be used for creating special spatial effects in headphone-based virtual reality. For example, if a pure ITD (no phase shift) of more than about 25 ms is introduced between the left and the right headphone signals, the image of the sound is lateralized toward the lagging ear (Baruch, Giami & Botte, 1986; Russolo & Poli, 1985).

The binaural listening cues allow humans to determine the laterality of incoming sounds. However, they provide very limited information about the elevation of the sound source or its front-back position. If one draws a cone extending from an ear along the lateral axis, all the sound sources on the surface of this cone would produce similar binaural cues. This cone is called the cone of confusion. Front-back reversals (where sounds in the front are perceived as coming from the back and sounds from the back are perceived as coming from the front), which are frequent especially for low and mid-frequency sounds below 2000 Hz, are the result of the cone of confusion (Moore, 1997). The more symmetrical the head, the less information there is about the sound source position in the median plane. This missing information is provided mostly by the monaural cues and the operational cues listed in table 11.

Monaural listening cues are the result of sound diffraction and reflections from various parts of the human body affecting the intensity and timing of sounds entering the EACs. All these effects result in direction-dependent spectral filtering of the incoming signal (Musicant & Butler, 1984; Shaw, 1966). The filtering effect is different for the left and right ears and the contribution of monaural localization cues may be considered as a two-stage process involving (Van Wanrooij & Van Opstal, 2005): (a) a spectral-to-spatial mapping stage, and (b) a binaural weighting stage

that determines the contribution of each ear to perceived elevation as a function of sound azimuth.

The monaural cues resulting from sound reflections of various valleys and edges of the pinna operate in the high frequency range, whereas reflections from the head, shoulders, and torso affect the mid-frequencies. Monaural cues are most effective in allowing for the differentiation of sound sources at various elevations (see figure 42), but they also contribute to localization in the horizontal plane (especially in differentiating between sound source locations in the front and rear hemispheres) and thereby aid in reducing reversals.

When the sound source is situated in the horizontal plane, sound arriving from the location 45 degrees off the median plane results in the greatest pressure increase at the TM in the mid to high frequency region compared with a signal arriving directly from the front (0 degrees), directly from the side (90 degrees), or from behind the ear (135 degrees). For example, at the 45-degree source location, reflections from the concha cavity increase the intensity of the incoming sound around 5 kHz by as much as 10 dB, and reflections from the helix and antihelix areas of the pinna increase the sound intensity in the 3- to 4-kHz range by about 3 dB (Shaw, 1974). Hebrank and Wright (1974) observed that localization of a sound source in the median plane is associated with an increase of sound energy in a specific high frequency range. Front, top, and back positions of the sound source are characterized by an increase of sound energy in the 4-to-8-, 7-to-9-, and 10-to-12-kHz frequency bands, respectively. There are practically no monaural listening cues that are effective below 500 Hz.

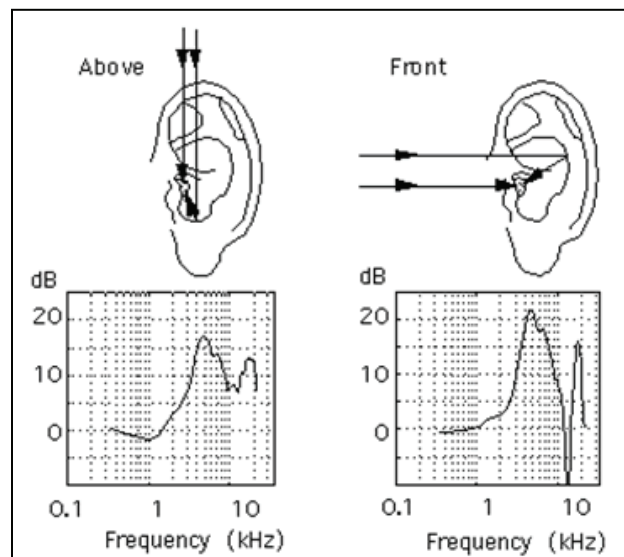

Figure 42. Changes in spectra based on the location of a sound source in the vertical plane.

The filtering effect of monaural localization cues is represented by a head-related transfer function (HRTF). An HRTF is the ratio of the sound pressure at the ear of the listener to the sound pressure that would exist at this point if the listener were not present, expressed as a function of frequency.

The shape of the HRTF does not change with the distance between the sound source and the listener except for very short distances of less than 1 m when the proximity effects and the sound bouncing off the sound source need to be taken into consideration.

HRTFs can be recorded in a number of ways, but the most common method is to place a microphone in the opening of a listener's ear canal and make recordings from the microphones of sounds presented from various azimuths and elevations around the listener (Wightman & Kistler, 1989 a, b). The recordings from the listener are then compared to those obtained from a single microphone in the center of the apparatus with the listener absent. The HRTFs are then converted to digital format and can be applied to any sound through convolution.

A pair of HRTFs for the left and right ears and for a specific angular position of the sound source in space represents the anatomical capabilities of a specific human that are used in identifying this specific direction as the source location of an incoming sound. A set of HRTFs for various angles of incidence captures all binaural and monaural localization cues characterizing a specific person and can be used to synthesize this ability in a virtual environment. For example, a monophonic sound recording convolved with a specific pair of HRTFs and played through headphones to the same person results in real-life sensation of the sound source located in space and outside the head. Attempts have been made to create average HRTF values, but this is not very difficult and experiments comparing performance of particular tasks with average and specific HRTFs nearly always show superior performance when a participant performs the task with his or her own HRTFs (Wenzel, Arruda, Kistler, & Wightman, 1993).

The third group of sound localization cues consists of the head movements and auditory memory cues. Micro (small and unintentional) and macro (large and intentional) movements of the head result in added variability to binaural and monaural cues that resolve some ambiguity. The longer the sound's duration, the more effective the head movements are in determining its source position in space (Müller & Bovet, 1999). This dynamic behavior is enhanced by the person's memory of the sound. If a listener has experience in hearing someone's voice, the listener may have an easier task in determining whether the voice is coming from the front or back location than a person who has never heard this voice before. Similarly, familiarity with the space in which the listener and sound sources are situated may aid in sound localization. The reflections from walls that cannot be resolved by binaural and monaural cues but aid in auditory localization can be grouped together in the process of auditory scene analysis (Bregman, 1990, p. 305). In fact, monaural cues would not be useful if not for our memory (Rogers & Butler, 1994). We must have a reference pattern of the sound in our memory to evaluate its changes caused by different locations of the sound source in space. A number of experiments about re-learning localization cues following the alteration of pinna cues supports this view (Oldfield & Parker, 1984; Hofman, Van Riswick, & Van Opstal, 1998).

One's judgments of the distance to the sound source depend primarily on the sound's intensity (softer sounds are perceived as farther away) and the ratio of the direct sound to the reverberant

(reflected) sound. More reflected energy is perceived as farther away. The first factor is dominant in the open space whereas the second factor dominates the judgments in enclosed spaces. At larger distances, spectral modifications of sounds caused by air absorption and frequency-dependent ground reflections may affect the judgments in that complex sounds will have greater low frequency emphasis at greater distances where the high frequency information has been absorbed.

Auditory distance perception is generally quite poor in humans, and it is highly dependent on specific sounds and specific listening environments. Listeners are more accurate in judging familiar sounds than unfamiliar sounds, and they are more accurate when the sounds are presented in a familiar rather than a strange environment (Blauert, 2001). At short distances, listeners have a general tendency to underestimate the distance to the sound source by about 10%. However, the underestimation of distance has been reported to be as large as 40% for distances as far as 10 meters (Bekey, 1949). However, there is very little information available about auditory distance perception for distances exceeding 3 to 10 meters.

7.2 Human Localization Capabilities

The resolution of the human's auditory localization ability can be measured in a number of ways. One way is through an identification task. In this task, a listener is presented sounds and asked to identify their source location. The listener may be provided with information assisting in the determination of the location, such as a set of loudspeakers, or the listener may be required to identify the location from an infinite set of possible sources. Once a listener has indicated the perceived location of a sound source, the difference between the actual source location and the perceived source location is calculated and the result is known as the localization error. The resolution of the human auditory system is much better in the horizontal plane than in the vertical plane because of the robust binaural cues present in the horizontal plane that are absent from the vertical plane. Typical localization errors in the horizontal plane range from about 10 degrees for the front directions to about 30 degrees in the back directions. The size of the localization error increases with the presence of noise and changes in the elevation of the sound source.

A frequent localization error in a free field (no reference) localization task is the front-back confusion. This type of error is typically observed in 5% to 10% of the cases when the sound source is presented in or close to the median plane (Oldfield & Parker, 1984; Wightman & Kistler, 1989a, b). This error is a result of the front-back ambiguity resulting from the existence of the cone of confusion. The front-back reversals are usually reported in the literature as front-to-back rather than back-to-front confusions, although Oldfield and Parker (1984) reported the opposite trend. One likely explanation for the preponderance of front-to-back reversals reported in the literature is the absence of visual cues in many of the studies. In these cases, the listener is not likely to indicate that a sound came from a location other than one of those that is available. So, if a group of loudspeakers is placed in front of the listener, the listener is not likely to

indicate that the sound came from a position where no loudspeaker is present. The information received through the visual sense overrides information received through the auditory sense.

Another measure of auditory resolution is called the minimum audible angle (MAA) or localization blur. MAA is the barely noticeable difference in sound source location in the horizontal or vertical plane perceived by the listener. It is the detection of a change in location. In the typical MAA task the listener is presented with two successive sounds and is asked to determine whether the two sounds are from the same or different locations. The distance between the two sources is reduced until the listener indicates that the sounds appear to be originating from the same location. The resulting MAA values are plotted as functions of signal frequency as well as the specific azimuth and elevation angles at which the first sound source is located. MAA values measured in the horizontal plane typically vary from ± 1 to ± 4 degrees for sound sources in front of the listener to ± 10 to ± 15 degrees or more for lateral locations (Blauert, 2001; Harris & Sergeant, 1971; Oldfield & Parker, 1984; Strybel, Manligas, & Perrott, 1992). The specific MAA values for pure tone pulses reported by Mills (1972) and white noise pulses reported by Blauert (2001) are shown in figures 43 and 44, respectively.

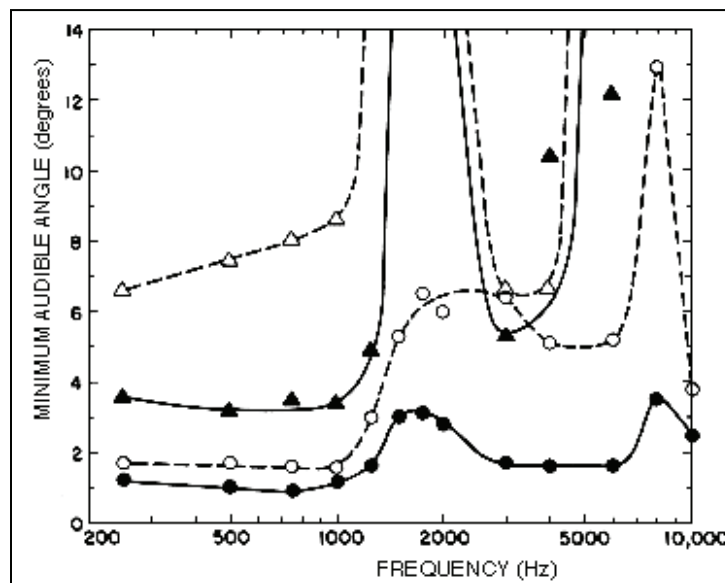

Figure 43. MAA between successive pulses of a pure tone as a function of the frequency and the direction of the source measured for angles (bottom to top at left hand side) 0, 30, 60, and 75 degrees (from Mills, 1972, p. 310).

Boerger (1965) measured MAA thresholds for critical bands of noise to 4000 Hz and reported values that were very similar to those for pure tones reported by Mills (1972). Thus, it is very likely that the data for white noise bursts reported by Blauert (2001) represent the worst case scenario.

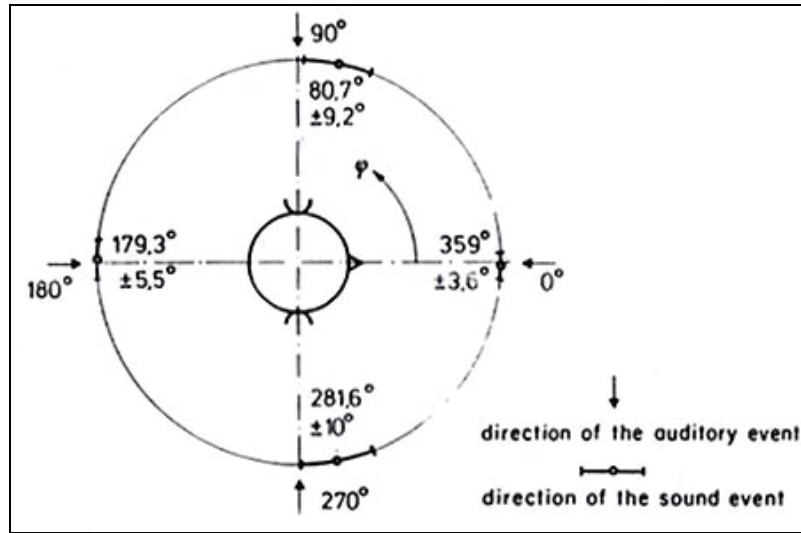

Figure 44. MAA in the horizontal plane for white noise pulses of 100 ms duration (Blauert, 2001, p 41, after Preibisch-Effenberger, 1966, and Haustein & Schirmer, 1970).

MAA values in the vertical plane have been measured by several authors (Damaske & Wagener, 1969; Oldfield & Parker, 1984). The data reported by Damaske and Wagener (1969) and summarized by Blauert (2001) are shown in figure 45. It is important to note that in all reported MAA studies conducted in the horizontal and vertical (median) planes, the head was immobilized or the listeners were instructed not to move their heads. The results from studies where listeners were allowed to move their heads would likely be different if head movements provide additional information about the location of the source.

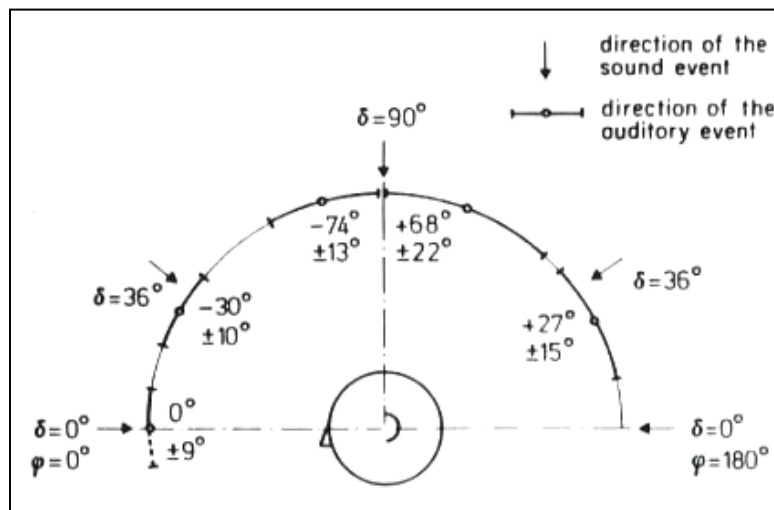

Figure 45. MAA in the median plane for continuous speech produced by a familiar person (Blauert, 2001, p 44, after Damaske & Wagener, 1969).

A measure of the ability to detect movement of a sound source is the minimum audible movement angle (MAMA), which is a measure of the smallest amount of movement that can be detected by a

listener. A sound is played to the listener and the listener is asked to determine if the sound has moved or remained stationary. The duration or distance of travel for the sound source is reduced until the listener responds that the sound did not appear to move. Sounds are presented to the listener from various angles and the MAMA is plotted as a function of presentation angle. Numerous studies (Carlile & Best, 2002; Grantham, 1986; Harris & Sergeant, 1971) have reported that MAMA values for slowly moving sound sources were consistently about two times higher than their corresponding MAA values. The MAMA values increase further with increased velocity (Carlile & Best, 2002; Grantham, 1986). Figure 46 shows results from a MAMA study.

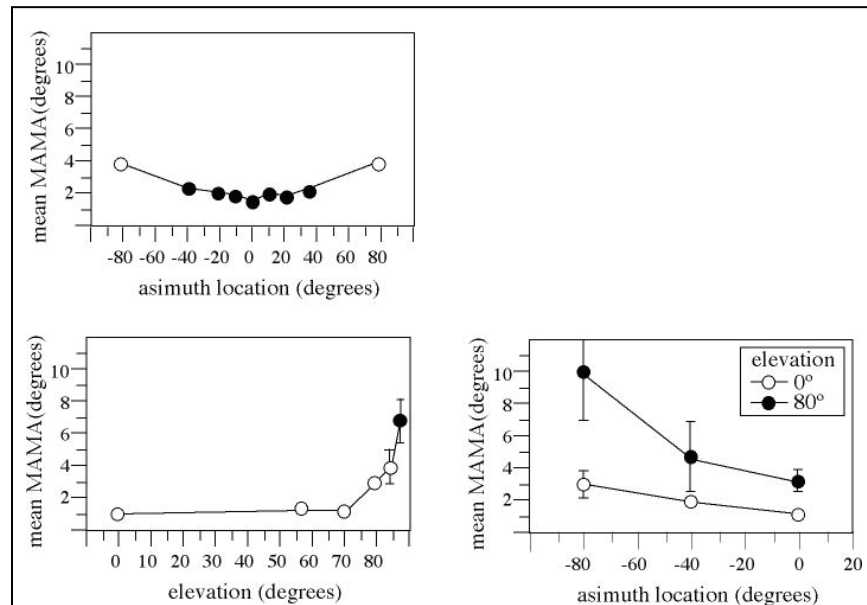

Figure 46. MAMA values reported by Strybel, Manligas, and Perrott (1992).

Blauert (1972) observed that the oscillatory movement of a sound source could be perceptually tracked until a frequency of ~ 3 Hz but not beyond it. When the frequency of oscillations exceeds 10 to 20 Hz, the movement of the sound source becomes completely blurred and the oscillating sound source is heard as one large stationary source (Grantham & Wightman, 1979).

The MAA and MAMA data represent the easiest cases of a sound source localization task when the listener is able to compare two successive locations of the sound source. In the more general case, when the position of the sound source needs to be judged on its own, i.e., without any reference point, the localization uncertainty (error) can be much greater.

7.3 Bone Conduction Spatial Cues

The human head can be considered as a spatial array of multiple pressure sensors that respond to the wavefront arriving at the head (induced bone conduction). The array is symmetrical about the median plane and is more sensitive in the areas where the wave stimulates larger bones than smaller bones since the resulting force is proportional to the sound pressure and the surface area

of the bone. The larger the area of the head exposed to the sound and the less soft tissue covering the exposed area, the stronger the contribution of induced bone conduction (Stenfelt, 1999). As discussed in section 5, during normal free field listening conditions, this array will not contribute much to the auditory sensation created by the arriving sound wave since bone conduction pathways are about 40 to 60 dB less efficient than the air conduction pathway (see section 3).

Let us now consider the spatial properties of bone conduction in a theoretical situation in which the air conduction transmission is eliminated. A frontal sound wave hitting the head causes the same pattern of vibrations on the right and the left hemisphere. Assuming that a person has normal and symmetrical hearing, such stimulation should result in the same physiological process in both ears at the same time and result in a centered auditory image. Since there are no pinna effects and torso and shoulder reflections would affect the whole skull, even large changes in the vertical angle of the wave incidence along the median plane would not produce different responses in the cochleae. Lateral deviations from the median plane in the angle of incidence of the sound wave arriving at the listener would not affect the pattern of vibration of the large frontal bone that dominates the resulting perception. This contention is supported by relative independence of the bone conduction threshold of hearing, depending on the position of the bone vibrator on the forehead. Shifts in the vibrator position as large as 4 cm have been shown to have very little effect on the strength of the received stimulation (Dirks, 1964; Studebaker, 1962). However, the lateral directions of the arrival of a wavefront can theoretically produce some bone-conducted transcranial intensity difference (TID) and transcranial time difference (TTD) cues resulting from an increased stimulation of the bones on the side of the head. This could then result in a temporal delay between the excitations reaching the left and right ears. The TTD and TID cues could then result from finite TA and TD of the sound as described in section 3.

O'Brien and Liu (2005) simulated head vibrations using a computer model of the skull and analyzed patterns of skull vibrations as a function of angle of incidence and frequency of the sinusoidal sound wave originating in the free field. Examples of the data for a 45-degree angle of incidence and a 3-kHz sound wave are shown in figure 47.

The model data presented in figure 47 for the two ears (left panel) show a 400- μ s TTD and a 4-dB TID for the sound waves. The same stimulation observed at the inner skull surface (right panel) showed about a 14-dB TID and no clear TTD. The 14-dB TID corresponds to about a 90-degree angle of incidence that would be observed for the air conduction transmission of a sound and it could be a result of the directional attenuation or enhancement as well as the presence of bone structure resonances. Unfortunately, the data presented by O'Brien and Liu (2005) do not seem to provide any decisive argument for or against the theory that the bone conduction mechanism is sensitive to the direction of an incoming sound wave.

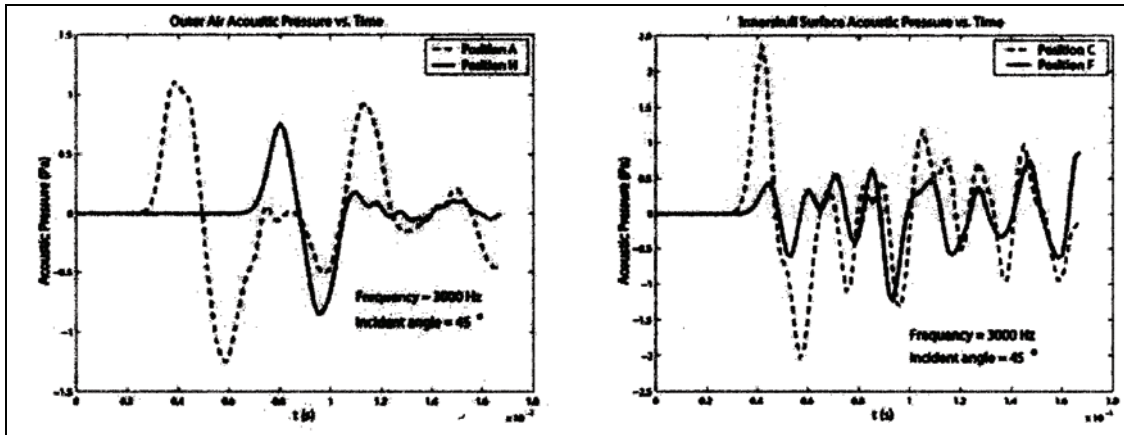

Figure 47. Instantaneous acoustic pressure waveforms recorded at four locations of the human head model. (In the left panel, the two lines represent the approximate left and right ear positions on the head. In the right panel, the two lines represent the same positions as those in the left panel, but located on the inner skull surface [O'Brien & Liu, 2005].)

An important source of information regarding the directional properties of bone conduction hearing is the literature about under-water hearing. Water (particularly salt water) has an impedance value similar to that of the cochlear fluids. Further, the air conduction pathways are practically useless under water. Thus, the auditory information under water is mostly received by the listener via bone conduction. If the bone conduction receiver is not sensitive to the direction of an incoming sound wave, no directional information could be received under water. There are several reasons why typical aerial localization cues do not work under water (Hollien, 1973; Hollien & Feinstein, 1976; Bovet, Drake, Bernaschina & Savel, 1998). First, the speed of sound in water is about four times faster than the speed of sound in air and the maximum under-water ITD is roughly one fourth of its aerial value. Second, the IID are greatly reduced because of much longer wavelengths of sound in the water and a relative transparency of the head in water. Third, the pinna cues are greatly reduced because of the similarity between the impedance of the pinna structure and the impedance of the surrounding water (in addition, scuba divers often wear Neoprene hoods that completely cover their heads, making the pinnae inaccessible to direct stimulation). Therefore, if the skull is an omnidirectional receiver, the scuba divers would not be able to differentiate the directions of water-transported sounds. This is the general assumption made by under-water sound engineers. Musicians designing sound to be played under water call this space the “omniphonic space,” that is, the space in which sounds seem to be coming from all around (Maurer, 1998). However, studies investigating the auditory capabilities of scuba divers have demonstrated that they have the capability to localize sounds, at least above chance level (Feinstein, 1973, a, b; Hollien, 1973; Wells & Ross, 1980; Bovet et al., 1998). This ability is the strongest when short duration sounds are coming from lateral directions or when the duration of the sound is long enough to allow the listener to move his or her head during the duration of the sound (Bernaschina, Bovet, Bader & Quinto, 2000). These findings seem to indicate some

directional properties of the induced bone conduction. Alternatively, they may indicate that some directional information may still be transmitted under water by the air conduction pathways.

The situation is different when the bone conduction pathways are stimulated by a vibrator attached to the head. In this case, the mechanics of the stimulation are similar to those of air conduction stimulation in a sound field. Several studies indicated that the effect of such stimulation can be lateralized (e.g., Weber test, see section 9) supporting the theory that bone-conducted information at one cochlea can arrive earlier or at a higher level than at the other (Huizinga, 1970). The actual differences in the time of arrival and the magnitude of stimulation at both cochleae depend on the specific TTD and TID values that are the functions of the place of stimulation and the signal spectrum. According to Jahn and Tonndorf (1982), the lateralization effect is clearly present in the case of bilaterally presented bone-conducted short duration sounds with abrupt onset times but is much less noticeable for sounds with rise times longer than 1 ms or for continuous pure tones.

TTDs observed for bone-conducted signals transmitted by skulls *in vitro* are much smaller than ITDs through air conduction and do not seem to support the possibility for human listeners to lateralize sounds based on temporal differences. The speed of sound in dry bones is about 2600 m/s which is about 8 times faster than the speed of sound in air (Wigand, 1964). This difference in the speed of sound has the same effect on localization capability of the human auditory system at low frequencies as reducing the size of the human head to the size of a golf ball or less. However, the data collected for skulls *in vivo* do not agree with these findings. The measured time delays observed in heads *in vivo* indicate that the vibratory energy is transmitted through the structures of the head with the speed of 50 to 600 m/s, depending on the frequency of the stimulation (Zwislocki, 1953; Franke, 1956; Tonndorf & Jahn, 1981). This speed causes the energy that reaches the ears to have a time disparity that is comparable to that measured for air-conducted sounds.

The transcranial sound attenuation discussed in section 3 indicates that sound lateralization can be based on the differences in the intensity of stimulation of both cochleae. The TID values increase with frequency of stimulation and can reach 5 dB at 500 Hz and 15 to 20 dB at frequencies of 4000 Hz and above (Kirikae, 1959; Silman & Silverman, 1991; Stenfelt et al., 2000; Stenfelt & Goode, 2005). Alternatively, it is possible that at some frequencies, the stimulation of the contralateral cochlea may be stronger than that of the ipsilateral one. This effect is attributable to the presence of resonances and antiresonances of the human head at low frequencies. Several studies (see section 3) indicated that the resonances of the human skull are highly attenuated and they do not affect transmitted vibrations. This is not the case, however, with respect to the head antiresonances caused by vibrational modes and cancellation effects resulting from multipath transmission of bone-conducted sounds. For example, Håkansson et al. (1986) and Stenfelt et al. (2000) reported a strong lateralization effect to the contralateral ear in normal hearing listeners in the frequency range 100 to 500 Hz with a bandwidth of approximately 150 Hz.

This discussion indicates that bone-conducted signals delivered by a single vibrator placed laterally on the human head can be clearly lateralized by people with normal hearing. This is contrary to a widespread myth that bone conduction signals cannot be used for providing directional information to the listener “regardless of the position of the vibrator on the skull” (Dirks, 1985, p. 209; Sanders, 1978, p. 124). In the case of speech and other complex signals, the bone conduction lateralization effect can be made more pronounced if the frequency range of the transmitted signals is limited to ~ 500 Hz, that is above the range of the main antiresonance of the human head (see section 3).

Further improvement in lateralization accuracy can be obtained with two (left and right) transducers (rather than one) and a stereophonic signal. For example, Snik and colleagues (1998) compared sound source identification accuracy (from a 45-degree angle) by the same listeners with impaired hearing wearing monaural and bilateral BAHA hearing aids (see section 10) and reported a 53% improvement with the bilateral fitting. Dutt and colleagues (2002) reported an advantage of a bilateral BAHA fitting for speech recognition in noise when the noise origin changed in a random manner. These reports agree with a theoretical acoustic analysis conducted by Stenfelt (2005) who hypothesized that because of the effects of HRTFs and skull vibration transfer functions (TTD and TID), the use of two BAHA hearing aids rather than one should result in better directional hearing and spatial perception and better speech recognition in noise.

The only paper that we could find discussing the possibility of an out-of-the-head sound perception for localization using bone-conducted signals was published by Sone, Ebata, and Nimura (1968). The authors investigated the effect of a simultaneous presentation of bone-conducted signals and air-conducted headphone signals. The signals were identical except for a time shift, and the authors reported the possibility of generating the perception of auditory events outside the human head by using such a set of signals. However, to our knowledge, no one has attempted to measure localization ability using spatialized bone-conducted signals. MacDonald, Henry, and Letowski (2006) convoluted stimuli with individualized HRTFs and played them to listeners as stereo signals using Temco Japan Company Limited HG-17 bone vibrators and AKG K240 headphones. They found no significant differences between the two sets of signals in the listeners’ ability to localize sound sources. These data require further verification but the fact that bone-conducted signals could be localized when the signals were convolved with the air conduction HRTFs and perceived as outside the head is very promising.

7.4 Summary and Conclusions

Auditory localization in humans is accomplished through the comparison of auditory information received by the two ears. The duplex theory of source localization indicates that sounds are identified, based on which ear receives them with higher intensity and earlier in time. Auditory localization can be measured through accuracy (e.g., sound identification) or through resolution tasks (e.g., MAA). Recent data obtained by MacDonald et al. (2006) suggest that the spatialization of auditory signals can be accomplished through air conduction transmission of acoustic signals

and through bone conduction transmission of mechanical vibrations to the listener through a pair of vibrators when individualized air conduction HRTFs are used.

8. Bone Conduction Devices

This section is dedicated to the discussion of the physical properties of bone conduction transducers, vibrators and microphones. The most common bone conduction vibrator in use in clinical audiology in the United States and which has also been incorporated into some commercially available bone conduction devices is the B-71 made by Radioear. Therefore, most of the discussion focuses on this device.

8.1 Bone Vibrators

Bone vibrators are the transducers that convert electrical energy of the audio signal into mechanical energy of the vibrating bone (skull). This basic principle is shown in figure 48.

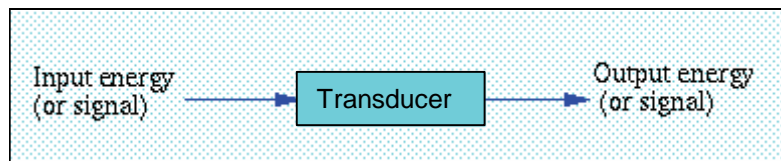

Figure 48. The principle of energy conversion through the use of a transducer.

Bone vibrators are similar in their electromechanical operation to air conduction transducers such as loudspeakers and headphones. The main difference between these two groups of transducers is the impedance of the medium facing the transducer. Loudspeakers and headphones face the air of free space or the air in the EAC that has the impedance of approximately 400 Nsm^{-3} (40 rayls) (see section 2), whereas the impedance of the skull and other head structures is several thousand times larger. For example, sea water (see section 2) has a specific acoustic impedance of about 160,000 rayls. In general, the mechanical impedance of the head at the surface of the skin varies between 30 and 50 dB re 1 Nsm^{-1} (see section 3).

In order to provide effective transmission of energy between the transducer and the head structure, the impedances of both elements should match. The matching requirement calls for a much higher output impedance of bone vibrators than of earphones or loudspeakers. This requirement makes *hard surface* transducers much more effective for transmission of vibrations than *soft surface* transducers.

Since the use of bone vibrators has, until now, been essentially limited to the field of audiology, all basic terminology and classifications that appear in the literature are generated by this field. This is also the case with two basic classes of vibrators used in audiology called moving rod vibrators and hearing aid vibrators. The first type of vibrator is an electromagnetically driven vibrating rod.

The whole system is mounted on the table with a listener leaning the head against the rod (stationary unit) or is hand held (portable unit). An example of the hand-held vibrator belonging to this class is the Sonotone Model 21-308. The advantages of rod vibrators are relatively large power (large displacement of the rod), minimal nonlinear distortions, and an extended range of low frequencies (compared to other transducers) that could be used for testing. The main disadvantages of rod vibrators are their stationary character, large size, cumbersome use, and poor reliability of vibration transmission in the case of the hand-held units. Early attempts to mount the vibrator on the head with a scissor-like holder (Lierle & Reger, 1946) or a helmet-like mount (Harris, Haines & Myers, 1953) decreased the uncertainty of these measurements but created additional resonating structures.

The second type of vibrators (hearing aid type) used almost exclusively outside research facilities, has the form of a small box or a plate that is attached to the head by a headband. Sonotone is credited with patenting the first bone conduction device for use as a hearing aid in the 1930s (Greibach, 1938). The main advantages of such vibrators are their small size, inexpensive and repeatable manufacturing, independence from external instrumentation except for the signal source, possibility for standardized and repeatable application of a static force, and an assistant to the clinician does not need to be in the same room (which was the case with the hand-held version of the moving rod vibrator). Their main disadvantages are low power, some dissipation of acoustic vibration of the air through the vibrating case, potential transmission of vibrations through the mounting headband, and nonlinear distortions appearing at low frequencies and higher signal levels (Sanders & Olsen, 1964; Wilber & Goodhill, 1967). Please note that the advantages and disadvantages of both types of vibrators listed apply only to the field of audiology since no other applications were considered in the development of bone vibrators until now. From the communication equipment point of view, the hearing aid type of bone vibrator, free standing or mounted into headgear, is the only one that can be used despite its current limitations. In addition, some disadvantages of the hearing aid type of vibrator for clinical use may be advantages for communication applications. It is also hoped that the new MEMs technology and the ultrasonic range (above 20 kHz) transducers can improve the power, frequency range, and directionality characteristics of the next generation of bone vibrators.

From the technical point of view, bone vibrators can use the same technologies that are used in headphone and loudspeaker designs. They include magneto-electricity (e.g., dynamic transducers), electromagnetism, piezoelectricity, magnetostriction, etc. The two main types of transducers that are currently used in bone vibrator designs are electromagnetic and piezoelectric transducers. An electromagnetic transducer produces an electromotive force resulting from a magnetic pull produced by an electrical current. Conversely, a magnetoelectric transducer generates electromotive force by the movement of the conductor in a magnetic field. Examples of electromagnetic vibrators are the Radioear B-70, B-71, and B-72 transducers designed for use in clinical audiology. The most commonly used of these models is the B-71. The schematic and external views of the B-71 transducer are shown in figure 49.

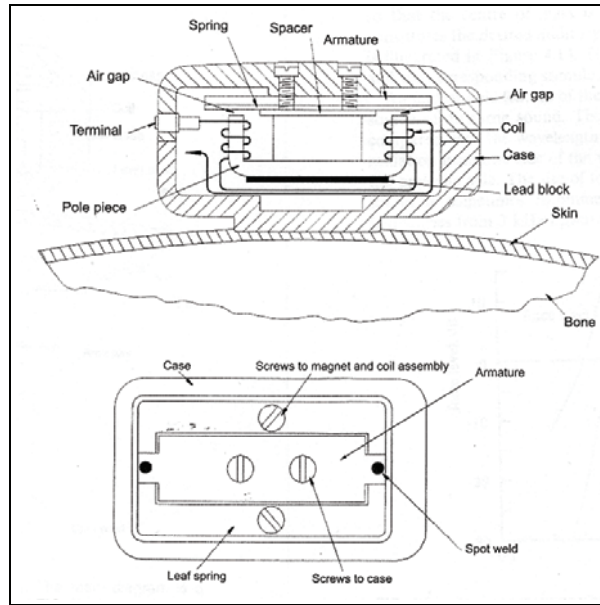

Figure 49. Schematic (upper) and external view (lower) of the Radioear B-71 vibrator.

The vibration produced by the electromagnetic transducer incorporated into the B-71 vibrator is transmitted through a plastic case to the wearer's head. The input audio signal is passed through a coil that is wound on a highly permeable arm (pole) of the permanent magnet. The magnet and coil assembly is attached to a lead block to increase its mass. The whole assembly is suspended from the top of the case on a leaf spring. An armature, screwed to the top of the case, is separated from the pole of the magnet by an air gap. A spring with spacers maintains the required air gap spacing. The electrical current passing through the coils generates a magnetic field that interacts with the magnetic field produced by the permanent magnet. This interaction between the two magnetic fields generates a varying magnetic force that acts across the air gap trying alternately to separate and bring together the armature and the pole of the magnet. Since the armature is screwed to the case, the magnetic force acting on the armature induces case vibration that is transmitted to the head.

The B-70A, B-71, and B-72 transducers have a theoretical 1000-Hz electric impedance of about 10 ohms and a DC resistance of about 3 ohms. Their dimensions are shown in table 12.

Table 12. Geometric dimensions of the Radioear bone conduction vibrators.

Transducer	Transducer Geometric Dimensions (cm)		
	Length	Width	Height
B-70A	3.18	1.82	1.50
B-71	3.16	1.82	1.89
B-72	3.16	1.82	2.85

The frequency responses of all three vibrators are shown in figure 50. The B-72 has a lower frequency response than the B-71. Resonant peaks for the B-71 are present at 450, 1500, and

3800 Hz, whereas for the B-72 they are present at 250, 1250, and 3700 Hz (Richards & Frank, 1982). The B-70A has the largest (rectangular) contact area and the smallest vibrating mass. The B-71 and B-72 transducers have a circular contact area of 1.75 cm² required for clinical audiology applications. The B-72 transducer has greater power and an extended low frequency range but also has the greatest amount of aerial leakage at high frequencies. The higher level of leakage is caused by a higher level of case vibration that has clinical and military disadvantages. For example, Frank and Holmes (1981) reported that the B-72 vibrator radiates aerial sounds at levels that make it unsuitable for threshold testing at frequencies of 2000 Hz and above. The lower power B-71 transducer was also reported to have audible aerial leakage at 3000 and 4000 Hz (Haughton, 1982; Shipton, John, & Robinson, 1980), but according to Frank and Holmes (1981), the aerial leakage has only a very small effect on audiometric threshold measures. Frank and Crandell (1986) noted that of the two Radioear vibrators, the B-72 has a greater amount of acoustic aerial leakage than the B-71. This effect can be further reduced if the EAC is occluded by an earplug during audiometric testing at these frequencies. At high frequencies, the EAC occlusion effect is minimal, and closing the EAC with an earplug should not affect the measurement of bone conduction thresholds (section 6). The aerial leakage of the B-71 and B-72 transducers can also be reduced to some degree if their cases are made more rigid (Haughton, 1982). However, making the cases more rigid may reduce the ability to maintain good contact between the transducer and the wearer's skull.

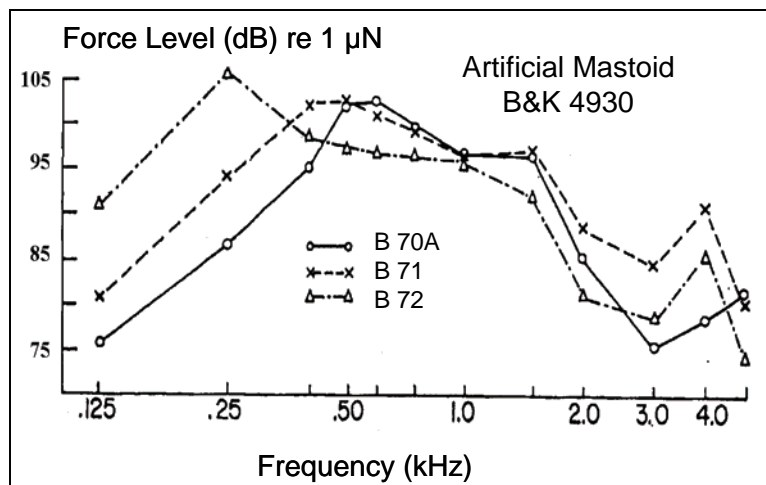

Figure 50. Frequency response of three common Radioear electromagnetic bone conduction vibrators measured with the Bruel & Kjaer 4930 artificial mastoid.

A serious drawback of the B-71 and B-72 transducers for clinical and communication applications is that they are very location sensitive because of their relatively large, flat, and hard contact areas. As a result, it is very difficult to secure good and comfortable contact between the vibrator and the head and to maintain it for a long period of time. Other electromagnetic bone vibrators developed for clinical audiology use are the Oticon A-20, the Pracitronic KH-70, the Radioear B-98 and B-100 (hearing aids), and the PerCom Teardrop. They all have the same principle of operation,

similar shapes, and similar technical problems. All these devices are relatively low power systems operating in the 10- to 50-mW range with a maximum output power not exceeding 500 mW.

The dynamic range of the B-71 vibrator is shown in figure 51. The bottom curve represents the bone conduction hearing thresholds of a listener with normal hearing and the upper curve represents the nonlinear distortion limit of the bone vibrator by frequency. According to the Radioear specifications for the B-71 and B-72 vibrators, both vibrators may generate 5% or more of non-linear distortions at levels of 20 dB HL at 250 Hz and 50 dB HL in the 500- to 4000-Hz range. The maximum output shown in figure 51 is about 20 dB below the levels needed for effective transmission of bone-conducted speech signals in noisy environments for non-clinical applications. Other drawbacks of alternate applications of the clinical transducers are their bulky and uncomfortable shape and the occurrence of some aerial leakage of transmitted signals. On the positive side, the clinical transducers offer good quality signals and sufficient output levels of speech signals to be used as communication devices in quiet environments. Radioear recommends the use of the B-70A vibrator for non-clinical applications and has incorporated it into communication systems used by fire fighters, security agencies, and military forces.

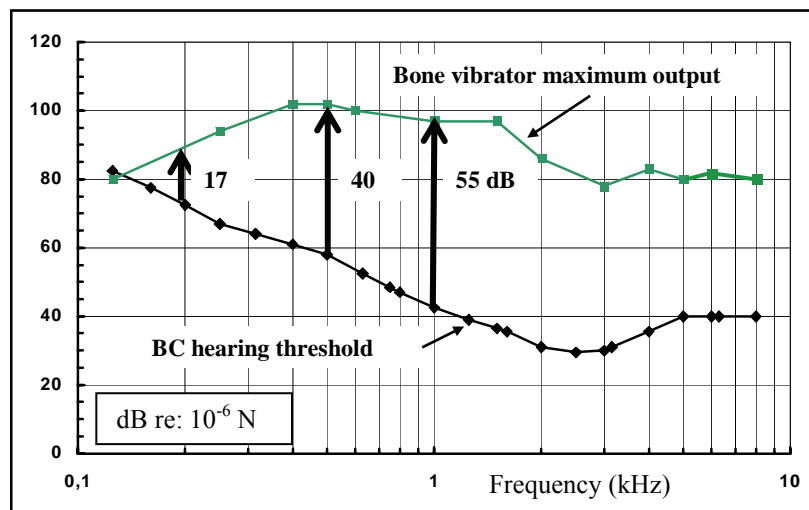

Figure 51. Dynamic range of a typical clinical bone conduction vibrator (Radioear B-71).

The Radioear B-71 and B-72 clinical transducers are normally used with the Radioear lightweight P-3333 metal headband designed to provide a standardized static force of 5.4 N when the vibrator is placed on the mastoid process and the headband extending across the top of the head. This combination meets the requirements of international and national standards for static force but is very difficult to maintain. The headband only comes in one size and is very uncomfortable; its end point is flat and does not conform to the curvature of the human head, and the transducers have a tendency to slip off the mastoid bone. The positioning of the Radioear B-70A vibrator (supported by the Radioear P-1123 headband) is much more stable but this combination provides only 3 N static force and does not meet some other requirements of the audiometric standards.

In summary, there are a small number of bone conduction vibrators that have been designed primarily for use in clinical audiology. The most common vibrator in use is the Radioear B-71 which is used clinically as well as incorporated into some commercially available communication systems.

8.2 Bone Conduction Microphones

Bone conduction microphones are contact transducers designed to detect mechanical vibrations and sound waves transmitted through a solid physical medium, as opposed to sound waves transmitted through the air. They are similar to hydrophones in their impedance and sensitivity requirements. At least one bone conduction microphone (GelMic developed by ARL's Sensors and Electronic Devices Directorate) was patterned on the hydrophone principle. Spike microphones, the contact microphones used for listening through walls, may also be used for bone conduction applications. In addition, all accelerometers can serve as bone microphones as long as they have a sufficiently small mass and proper sensitivity.

Contact microphones are usually piezoelectric but they can also use electret, magnetostrictive, capacitive, or electromagnetic technology. An example of a piezoelectric transducer is shown in figure 52.

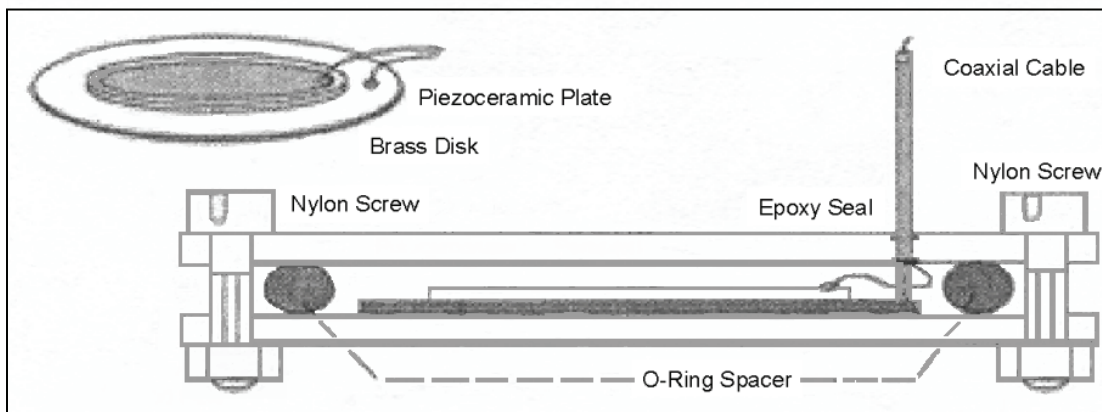

Figure 52. Piezoelectric transducer used as a basis for the DolphinEar hydrophone (Goodson & Lepper, 1995).

To our knowledge, to date, only a few transducers (fewer than five models) have been well designed for specific bone conduction applications. Most of the commercially available contact microphones were designed for musical instruments or for building sensor applications, and they lack proper impedance matching required by the head structures.

One of the first contact microphones developed for bone conduction operation which was used practically was the Surface Laminated Piezoelectric Film Sound Transducer (SLPFST) developed by the Navy Coastal Systems Station for Navy SEALs operations (Downs, 1999). The patent was later licensed to Sensory Devices (Radioear) for their use in bone conduction communication equipment. This is the only bone conduction microphone known to be developed specifically for a military application. The microphone measures about 1-1/4 inches square with a thickness of

about 1/8 inch, is waterproof, and is typically mounted on the forehead under a Navy diver's protective cap or hood. The main drawback of this microphone is its relatively large size and flat surface, which result in fitting problems and discomfort to the user during prolonged use.

An example of a magnetoelectric (dynamic) contact microphone built for bone conduction applications is the MIT-17 inertial transducer developed by PerCom 2000 Ltd in New Zealand. The MIT-17 consists of a magnetic circuit, coil, and a moving contact pin attached to the case. According to its official specifications, it has a frequency range extending from 300 to 7000 Hz and provides clear voice communications in ambient noise levels as high as 120 dB SPL. Its theoretical electric impedance is 2000 ohms.

An example of a capacitive transducer used for music applications is the C-ducer. The C-ducer is a long, flexible, high impedance condenser-like tape transducer that is less than 1 mm thick and has a high immunity to ambient noise. It was designed to conform well to curved surfaces such as a double bass body or a drum shell. Its drawback is its low sensitivity and need for external power.

In summary, there are a number of contact microphones that can be used for bone conduction applications (PerCom MIT-17, Temco HG-17, Sensory Devices HCM, etc.) during quiet and not demanding operational conditions. However, none of these microphones has ever exceeded its prototyping stage and none has been optimized for military use.

8.3 Measurements and Calibration

Measurement is a process of determining the size or magnitude of an object or phenomenon. The result of measurement is a numeric value expressed in predetermined units describing the relative magnitude of an object. Calibration is a process of checking or adjusting a value assigned to a specific object or phenomenon according to specific requirements. These requirements are usually available in the form of standards, specifications, or critical (pass-fail) values. Measurement and calibration are important components to ensuring that devices are functioning properly and are appropriately suited for a particular application.

Measurement and calibration of bone conduction systems have been a long-standing challenge. To calibrate bone conduction transducers appropriately, testing conditions are required that approximate real-world signals with load conditions that simulate the load of the human head at the point of application. The variety of placement locations, the variety of wideband signals used, and the many mounting options make meaningful measurements of bone conduction transducers very difficult. An additional challenge is that, until very recently, bone conduction microphones have not been considered a practical technology. Furthermore, bone vibrators have not typically been used in commercial applications outside the field of audiology. The primary motivation for any progress in the development of bone conduction vibrators was audiologists needing a bone vibrator to replace tuning forks and to be a part of the audiometer. Therefore, their interest and the interest of the bone vibrator industry was limited to pure tone signals and a single position on the head that

could be used for comparative hearing testing. Therefore, it should come as no surprise that existing international and national standards related to bone conduction are only concerned with audiometric transducers and the issues mentioned. The transducers that meet these requirements can be quite limited in their overall capabilities and are not intended to work in any harsh environments. Thus, until recently, there was no real need to develop better transducers or more universal and comprehensive measurement procedures. Therefore, measurement and calibration methods described in this section are not yet the ideal. They are the natural spin-offs of the methods used outside hearing science for measuring accelerometers (contact microphones) or adaptations of the methods used in the field of audiology (vibrators). It is our hope that increasing interest in bone conduction applications will force the industry to develop more robust, simpler, and, most importantly, more physiologically based measurement techniques and dedicated equipment for the purposes of measurement and calibration of these transducers.

8.3.1 Bone Vibrator Measurements and Calibration

To date, the only field of science in which calibration of bone vibrators is considered an issue is audiology. The communication industry has not yet developed any general proposals for how to measure bone conduction transducers that are used in communication and other non-clinical applications. To the best of our knowledge, individual companies are trying to follow the audiometric standards or use some form of perceptual evaluation for measuring transducer function, but their actual testing methods are considered trade secrets. In the following sections, we discuss a number of methods for calibrating vibrators including perceptual calibration, calibration through the use of otoacoustic emissions, and calibration through the use of an artificial mastoid.

8.3.1.1 Perceptual Calibration

Until 1970, measurement and calibration of bone conduction vibrators used in audiology were left to the discretion of the manufacturers of the vibrators and audiologists. There is little information, if any, about how these vibrators were calibrated. In addition, measurement data were limited to the frequencies of pure tone stimuli. Clinicians typically used perceptual testing based on the assumption that individuals with normal hearing should have the same hearing thresholds for bone- and air-conducted sounds. Other potential perceptual calibration techniques are based on loudness balance and phase cancellation between air- and bone-conducted sounds.

Perceptual procedures have several advantages over technical methods in bone conduction testing but in order to provide reliable and repeatable results, they require very large groups of listeners and repeated measurements conducted on individual people. Thus, they are time consuming and costly. They may be used to verify some proposed technical methods but cannot serve as general calibration procedures. Conducting perceptual calibration based on a small group of listeners results in very unreliable and unrepeatable data (Wilber & Goodhill, 1967).

1. Real Ear Method

The real ear (threshold) method relies on a direct comparison between air and bone conduction thresholds in a number of listeners with normal hearing. As stated previously, this calibration procedure is based on the assumption that air conduction and bone conduction thresholds should be equal in listeners with normal hearing (Hood, 1979). In the first step, the air conduction threshold to a particular test stimulus is established. Next, the corresponding SPLs are assigned to the force levels corresponding to the bone conduction threshold sensation obtained with a given bone vibrator. The main problem with this method is that bone conduction and air conduction threshold equivalency is a large group statistical phenomenon and such equivalency cannot be expected to exist for each person or even for small groups of listeners (Studebaker, 1967; Wilber et al., 1967). Results of this calibration method also depend on the location of the vibrator on the skull (i.e., mastoid or forehead). Therefore, this method can only effectively be used to compare two or more vibrators but not to determine absolute effectiveness of any single vibrator.

2. Loudness Balance Method

The loudness balance method is similar in concept to the real ear method (Barry & Vaughan, 1981). The listener listens alternately to an air-conducted and a bone-conducted stimulus and adjusts one of these two signals in intensity to equal the perceptual loudness of the other. All the comments about the advantages and disadvantages of the real ear method apply to this method.

3. Phase Cancellation Method

In the phase cancellation method, the air- and bone-conducted signals are presented simultaneously to the listener. The listener adjusts the phase or time of arrival and magnitude (intensity) of one of these signals to cancel the other. When the signal is completely canceled, both signals are said to have the same magnitude and can be treated as being equivalent (Dempsey & Levitt, 1990; Kapteyn, Snel, & Vis, 1980). Again, the advantages and disadvantages of the real ear method apply to this method.

4. Oto-acoustic Emission Method

The oto-acoustic emission method is similar to the perceptual calibration methods except that rather than requiring a response from the listener, the response signal is measured objectively. Two pure tones, f_1 and f_2 , are presented simultaneously to one ear through air conduction or through a combination of air conduction (f_1) and bone conduction (f_2). During both presentation conditions, most listeners with normal hearing will produce the same recordable oto-acoustic emission of a distortion product (cubic differential tone) $2f_1-f_2$, resulting from the nonlinear processing of the signals by the inner ear. The magnitude of the oto-acoustic emission depends on the relative intensities, L_1 (fixed) and L_2 (variable), of both of the contributing pure tone stimuli. With this procedure, a bone vibrator can objectively be calibrated against the known result from an air-conducted stimulus (Purcell et al., 1999, p. 378).

5. Artificial Mastoid Method

Manufacturers and audiologists realized quite early that the optimal solution for the calibration of bone vibrators would be to develop an artificial head that would simulate the bone conduction capabilities of a normal human head. This challenge has not yet been fully met, although significant progress has been made. In the mid-1950s, data regarding the mechanical impedance of the human mastoid and forehead became available (Dadson, Robinson, & Greig, 1954; Corliss & Koidan, 1955). In the 1960s, the first two artificial mastoids were developed. They were the Beltone 5A (Weiss, 1960) and the B&K 4930 (Stisen & Dahm, 1969). The cross section of the B&K 4930 artificial mastoid and the picture of a bone vibrator being tested on the mastoid are shown in figure 53. In early 1970, the first standards recommending the use of an artificial mastoid and specifying desired mechanical impedance characteristics for the calibration of bone conduction devices were published by the International Electrotechnical Commission (IEC) (1971) and ANSI (1972¹⁴). Both standards required that the bone vibrators have a 1.75-cm² flat round disk contact area and a static force of 5.4 N.

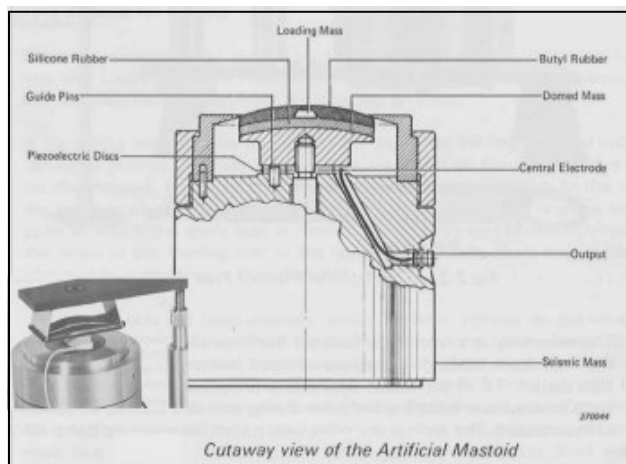

Figure 53. Bruel & Kjaer 4930 artificial mastoid and bone vibrator (<http://som.flinders.edu.au/FUSA/BME/Clin/Audiometry/ArtificialMastoid.htm>).

The IEC and ANSI bone conduction threshold standards (see section 5) were originally based, and continue to be based, on the B&K 4930 artificial mastoid, which was found to be easier to manufacture and more reliable than the Beltone 5A artificial mastoid. The B&K 4930 artificial mastoid is a mechanical simulator of the mechanical impedance of the mastoid process of the human head¹⁵. The device has a built-in force transducer to measure the level of vibration (force

¹⁴The current version of this standard is ANSI S3.13–1987 (R 2002).

¹⁵B&K 4930 artificial mastoids with serial numbers below 526226 should not be used for audiometric calibration purposes because of known problems with repeatability of their mechanical impedance across units (Richter & Brinkmann, 1977; Dirks et al., 1979, Robinson & Shipton, 1982). The units with serial numbers of 526226 and above have been slightly redesigned (new pad) which increased their uniformity but also increased the absolute value of their mechanical impedance compared to previous models.

and acceleration) produced by the attached bone vibrator. However, since the initial bone conduction hearing data (Lybarger, 1966) were based on the Beltone 5A¹⁶ unit that had a larger mechanical impedance, the existing normative threshold data had to be adjusted accordingly to compensate for this difference (Wilber, 1972). The mechanical impedance of the artificial mastoid depends on the surrounding ambient temperature and humidity. Current ANSI and IEC standards require an ambient temperature of 23 ± 1 °C (73 °F) when the artificial mastoid is used to calibrate bone vibrators. According to Dowson and McNeill (1992), results of the same measurements conducted in 18 °C (64 °F) and 23 °C (73 °F) may differ by as much as 3 dB at higher frequencies because of the different temperature of the artificial mastoid. Frank and Richter (1985) reported a 6- to 7-dB difference in force level data at 4000 Hz between ambient temperatures of 17 °C (62 °F) and 29 °C (84 °F).

When the concept of an artificial mastoid is discussed, terminology needs to be clarified. An artificial mastoid should be a device that simulates the real mastoid of the human head with relatively high precision across the whole operational frequency range. If the precision is poor and/or the frequency range is very limited, the device should be called a *mastoid simulator* rather than an *artificial mastoid*. Finally, if the device does not simulate the bone but just serves as a normative mechanical load for calibration of a specific transducer, it should be called a *mechanical coupler*. This means that every artificial mastoid is a mastoid simulator and every mastoid simulator is a mechanical coupler. However, the reverse is not true. The B&K 4930 artificial mastoid only approximates mechanical impedance of the real bone and its operational range extends from 50 to 10,000 Hz. Therefore, it is more like a mastoid simulator than an artificial mastoid, similar to the Beltone 5B simulator. An example of a mechanical coupler used for field calibration of bone vibrators is a Larson-Davis AMC493 mechanical coupler shown in figure 54.



Figure 54. Larson-Davis AMC493 mechanical coupler for bone vibrator calibration: sensor (1), mechanical guide (2), and weight (3).

¹⁶The new Beltone 5B model has a lower impedance (closer to ANSI values) from 500 to 2000 Hz and a slightly higher impedance at 250, 3000, and 4000 Hz in comparison to the newer B&K 4930 device (new pad) (Frank & Richards, 1980).

The next section presents an example of the measurement procedure for measuring effectiveness (dB re 1 μ N/volt) and frequency response of bone vibrators with the B&K 4930 artificial mastoid. The described procedure is a part of a measurement suite used by the authors at ARL for calibrating bone conduction transducers used in their studies. This procedure gives only approximate data when the transducers differ greatly in their physical properties (area of contact, shape, curvature of the contact surface, etc.), but it allows for objective measurement of the output characteristics of the devices.

8.3.1.2 Measurement of Frequency Response of Bone Conduction Vibrators

The measurement of the frequency response of a bone conduction vibrator provides information about how sound is being transmitted to the listener. By knowing the frequency response of the vibrator, we can calculate the amount of the signal that is being received by the listener and the frequency filtering that is occurring.

The equipment that is needed for the frequency response measurements includes a B&K 4930 artificial mastoid, the MLSSA (Maximum Length Sequence System Analyzer) software package, and a computer system upon which it can run, a measuring amplifier (e.g., B&K 2610) or a sound level meter, cords for connections between MLSSA card, amplifier, vibrator, and artificial mastoid, adaptors for RCA and BNC¹⁷ connections. A two-channel oscilloscope is optional.

MLSSA is a software program and computer interface card developed by DRA¹⁸ Laboratories that uses the MLS (minimum length sequence) signal for acoustic measurements. DRA Laboratories can be contacted via the web at <http://www.mlssa.com>. The goal is to estimate the frequency response of the vibrator. In order to do so in an efficient manner, the MLS signal is sent to the vibrator and the response is measured from the artificial mastoid. The operation of MLSSA is documented in the program reference manuals or is available from the web site listed. The intensity level of the signal should be set so that it is above the noise floor of the system but below a level where distortion is heard through the bone conduction vibrator. In our measurements, we obtained a level equivalent to approximately 500 mV peak to peak by setting the intensity level on MLSSA to -20 dB. This level resulted in a clear frequency response measure in our laboratory.

Regarding the characteristics of additional equipment, the amplifier should provide flat amplification across 100 to 10,000 Hz and the optional use of an oscilloscope allows the user to visualize what is happening in a real-time mode. If you would like to view the input signal from MLSSA or the output from the artificial mastoid, connections can be made between the measurement setup and two channels of an oscilloscope. Viewing the output of the MLSSA system is helpful in verifying appropriate intensity levels.

Figure 55 provides a schematic of the setup of the equipment. To assemble the test setup, first connect a cord to the output of MLSSA card. Connect the other end of this cord to the input of

¹⁷not an acronym

¹⁸not an acronym

the bone conduction vibrator. Adaptors may be necessary to change to whatever plug is used for the bone conduction unit. In our case, we wired all bone conduction transducers to 1/8-inch phonograph plugs for ease of interchanging in the measurement system.

Next, place the vibrator on the artificial mastoid with the side intended to contact the skull against the artificial mastoid surface, making certain that it is located in the center of the artificial mastoid surface. The static force applied to the bone conduction transducer should be verified through the use of a pressure sensor or dynamometer. The force applied is typically 500 G. Connect the output of the artificial mastoid to the input of the amplifier. Then connect the output of the amplifier to the input of the MLSSA card. The connections allow for a comparison of what is being sent by the MLSSA card and what is being measured. The difference is calculated as the frequency response of the device.

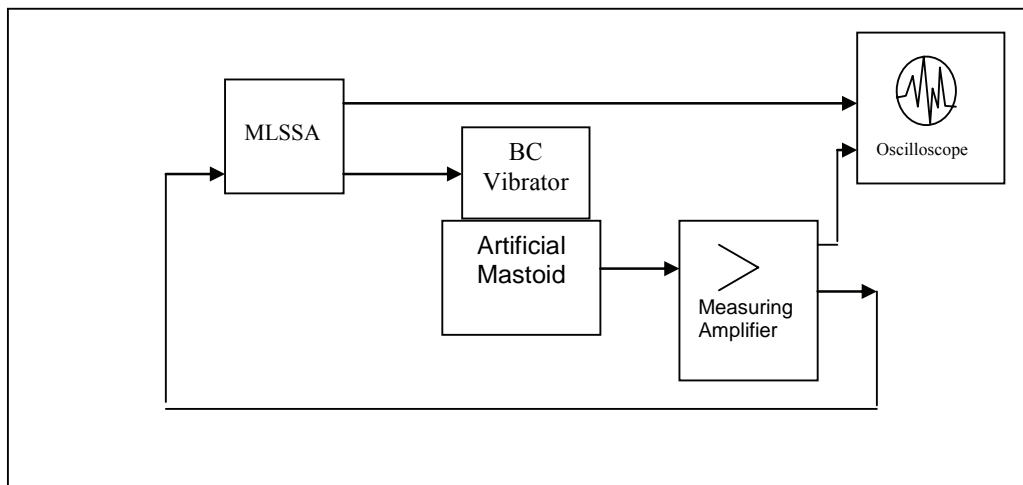

Figure 55. Schematic of the equipment setup for the measurement of the frequency response of a bone conduction vibrator.

Figure 56 shows the computer screen for the MLSSA system following a frequency response measurement. The reference for the decibel scale is 1 volt. As shown in the figure, for this particular device, the response is relatively flat between 300 and 4000 Hz. Outside this range, there is reduced response of the vibrator in response to the sound that is being applied to it. Caution should be taken in interpreting the responses to very low frequencies because of the noise floor of the sound card of the system. Additionally, responses in the high frequency range (above approximately 10 kHz) should be interpreted with caution.

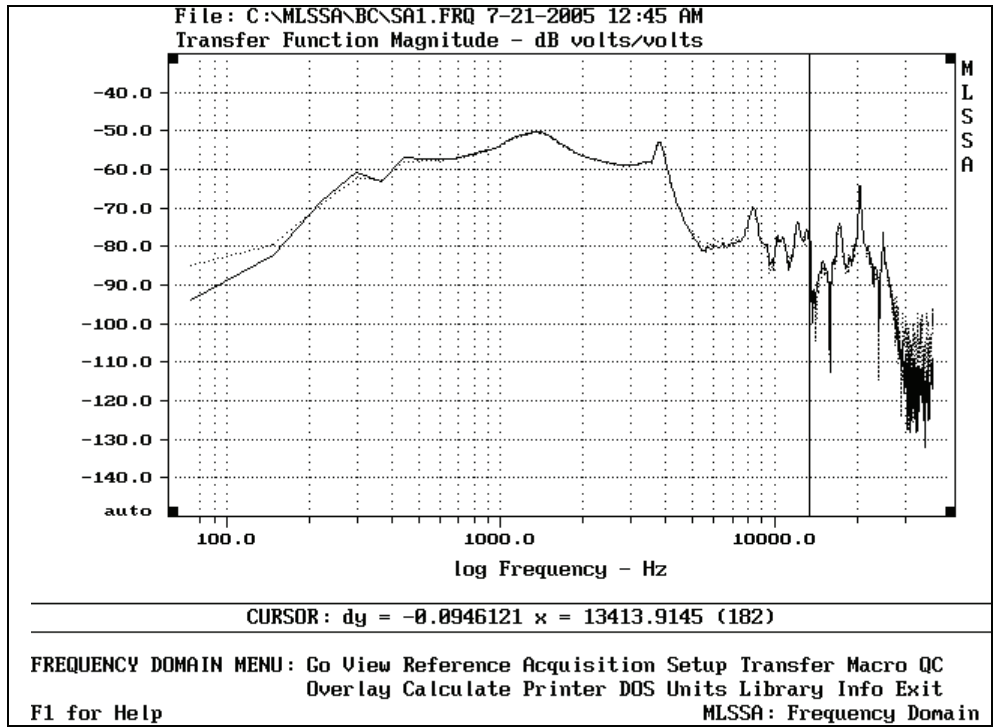

Figure 56. An example screen from the MLSSA system showing the frequency response of a bone conduction vibrator.

8.3.2 Contact Microphone Measurements

Measurement and calibration of contact microphones (accelerometers, force sensors) primarily involve measurements of the transducer sensitivity and frequency response. For some applications, additional parameters such as environmental effects and weight are also very important and should be measured. For speech communication applications, it is important to measure the dynamic range of the microphone as well as the maximum level of stimulation that may be received without excessive distortions.

The most common methods of assessing sensitivity and frequency response of contact microphones are laser interferometry (e.g., Michelson interferometer) and the shaker method. Both methods result in similar accuracy of the measurement data if they are carefully performed, but the shaker method is more common, cheaper, and the easier of the two to use. The next section presents the technical details of the shaker method used by the authors for measurement via contact microphones.

8.3.2.1 Measurement of Frequency Response of Bone Conduction Microphones

The measurement by bone conduction microphones differs from that of vibrators. In both cases, a signal is sent to the device and a comparison is made between what is sent and what is measured. In the case of the vibrator, the measurement is made from the artificial mastoid but in

the case of the microphone, the measurement is made from the microphone itself when it is stimulated by an external source.

Equipment that is needed for the frequency response measurements of the bone conduction microphone includes a vibration calibrating system (e.g., MMF¹⁹ VC110), a computer with interface software to control the VC110, a power supply and amplifier for the bone conduction microphone, a hot glue gun and glue sticks, an amplifier, a serial port cable for connection between the computer and the VC110, cords with adaptors for connection between the bone conduction microphone to the amplifier and between the amplifier and the VC110.

The MMF VC110 is a portable instrument designed for the calibration of various vibration transducers. A software interface allows the user to control the VC110 through a serial port. The shaker is a piezoelectric actuator with its head situated at the upper side of the case. For this device, the vibration level is controlled at a constant value of 1 m/s^2 (rms). There is a built-in signal-conditioning channel for the transducer output. The sensor sensitivity is displayed on the liquid crystal display screen on the front of the VC110 during the measurement. Although the VC110 is designed as a self-contained portable calibrator, the frequency response can only be measured with a computer. The operation of the VC110 is well documented in the manual.

Figure 57 shows a schematic of the setup of the equipment necessary for the measurements. To set up the test equipment, first set the VC110 vibration calibrator on a flat table that is relatively immune to vibration. Next, connect one end of the nine-pin serial cable to the connector at the back panel of the VC 110 calibrator and connect the other end to one of the nine-pin serial ports on the computer. Connect the bone conduction microphone to its power supply. Connect the output of the bone conduction microphone to the amplifier input and connect the output from the amplifier to the input at the back panel of the VC110 calibrator. If the bone conduction microphone has a built-in power supply and amplifier, connect its output directly to the calibrator BNC input.

Place the bone conduction microphone on the top of the shaker head, with the side that would be in contact with the skull face down. Secure the microphone to the accelerometer with a thin layer of hot glue. Ensure that the transmitter is located over the center of the accelerometer.

The goal is to measure the frequency response of the microphone. In order to do so, a sine wave frequency sweep is used to excite the accelerometer with a constant acceleration at 1 m/s^2 . The VC110 allows measurement of the frequency response from 70 Hz to 10 kHz. The graph of the frequency response can be displayed on the computer screen in millivolts per gram force (mV/g) or millivots per meter per second squared (mV/ms^{-2}) or in decibel units, and the data can be saved for later use. The reference for the decibel unit used on the display is the response value measured at the lowest frequency, i.e., the response value measured with a 70-Hz excitation. An example of a bone conduction microphone frequency response graph created by VC110 software is shown in figure 58.

¹⁹Metra Mess-und Frequenztechnik in Radebeul e.k.

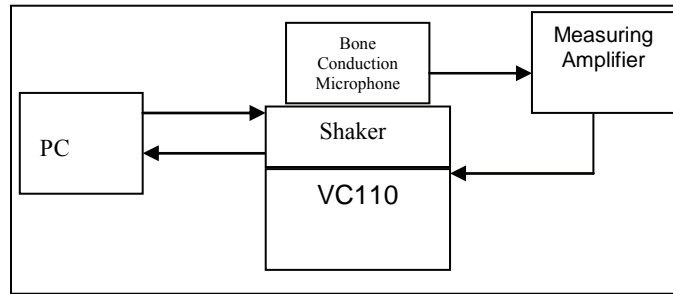

Figure 57. Schematic of the equipment setup for the measurement of the frequency response from a bone conduction microphone.

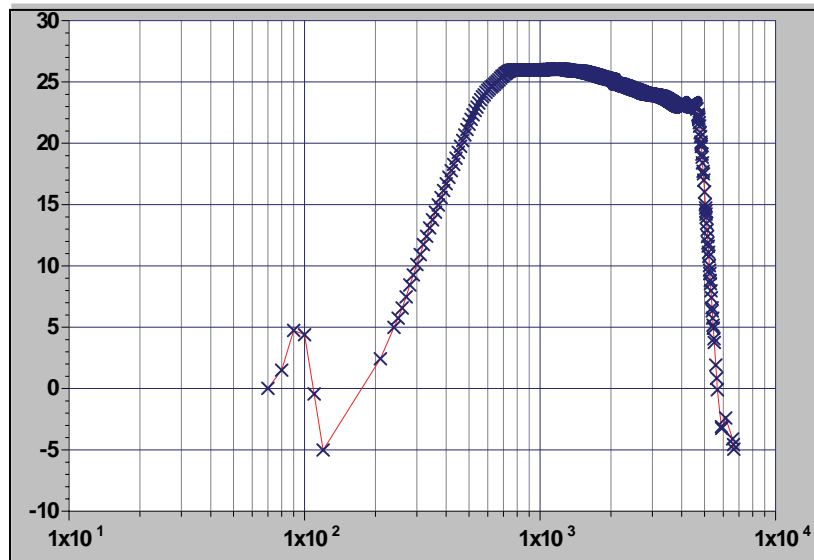

Figure 58. An example of the screen from the MMF VC110 showing the frequency response of a bone conduction microphone.

8.4 Summary and Conclusions

Bone conduction vibrators and microphones are commercially available. The devices that have been developed have been for non-clinical applications and function well in low noise environments. However, apart from the SLPFST microphone used by Navy divers, no such device has been developed specifically for military applications. Development of such a device would require it to function in high levels of noise and for it to have minimal aerial leakage so that it is undetectable in stealth operations.

Bone conduction vibrators can be calibrated in one of two ways: subjectively through perceptual testing with human listeners and objectively through measurement on an artificial mastoid. Bone conduction microphones must be measured on a vibration-producing device in order to get a controlled stimulus. The measurement of the frequency response of bone conduction vibrators and microphones allows for an objective view of the function of the device. Caution should be

taken in making direct comparisons between devices since differences in shape and size can contribute to differences in the measured responses that may not be evident in application.

9. Clinical Applications of Bone Conduction

Clinical audiology is the field that uses bone conduction technology more than any other. The field of audiology is responsible for the development of bone conduction vibrators and the methods for measuring and calibrating them (see section 8). Therefore, this section contains information about the field of audiology in general as well as how audiologists and physicians employ bone conduction in the assessment of hearing function.

9.1 Clinical Audiology

Audiology is the study of hearing and hearing disorders through the evaluation of hearing, the identification of hearing loss and the rehabilitation of those with hearing loss (Venes, Thomas, & Taber, 2001). An audiologist is a health care professional trained to conduct full assessments of the hearing and balance systems, to refer people for medical treatment when necessary, to fit hearing aids and assistive listening devices to people with hearing loss, and to provide habilitative or rehabilitative care (Department of Labor, 2004). These services require in-depth assessment of the hearing function of the patient and differential diagnosis of the potential causes of hearing disorders. In this capacity, audiologists work together with physicians who specialize in medical disorders of the ear, nose, and throat. These physicians are referred to as otorhinolaryngologists or ENT (ear, nose, and throat) doctors. An ENT who specializes in diseases of the ear is referred to as an otologist. Audiologists and ENTs address the same problem of hearing disorders, but their focus is separated by the medical aspects of the disorder which are reserved for physicians.

Evaluation of the air and bone conduction pathways in the hearing system is the main tool in determining the contribution of the outer, middle, and inner ear sections to the process of hearing. Bone conduction testing allows the health care professional to bypass the middle and outer ear system and evaluate the integrity of the inner ear directly. ENTs often conduct global bone conduction tests using tuning forks in order to screen for hearing loss and differentiate between conductive and sensorineural pathologies (Johnson, 1970). A hearing loss that is said to be conductive (mechanical) indicates that there is a problem in the transmission pathway involving the outer or middle ear. A hearing loss that is said to be sensorineural (biochemical) involves the inner ear system and potentially involves the neurological pathways from the ear to the brain. Audiologists conduct more specific hearing testing using a calibrated bone conduction vibrator and a set of calibrated stimuli. In contrast to tuning fork tests, tests using a bone conduction vibrator can result in more precise evaluation in the frequency and intensity domains but require more time and a more controlled testing environment.

Stimulation of the ear through bone conduction is used in a variety of ways in the clinic. Stimulation by bone conduction through the use of tuning forks is used by ENTs to screen for middle ear problems, and audiologists use bone conduction testing to establish thresholds that differentiate between the contributions of the outer, middle, and inner ear sections. Additionally, bone conduction stimulation is used in auditory brain stem response (ABR) testing on infants and in difficult to test populations. In the following sections, we discuss specific bone conduction tests and the use of bone conduction stimulation in a variety of clinical applications.

9.2 Tuning Fork Tests

A tuning fork is a small, two-pronged metal device that generates a tone of a specific frequency when the prongs are set into motion. A tuning fork is usually made of steel or aluminum and consists of a handle (base, stem) and two prongs (tines) forming a U-shaped bar (figure 59). Striking one of the tines with a mallet or another hard object sets the tuning fork into motion and generates a tone of the frequency defined by the length and the mass of the tines. Vibrating tines move alternatively toward and away from one another, resulting in a piston-like movement of the handle. The resulting air-transmitted tone is usually quite faint, but setting the handle on a solid object such as a table greatly amplifies the tone. The frequency of the tuning fork varies slightly with changes in temperature. Contrary to the effects of heat on organ pipes, heat decreases and cold increases the frequency of vibration of tuning forks.

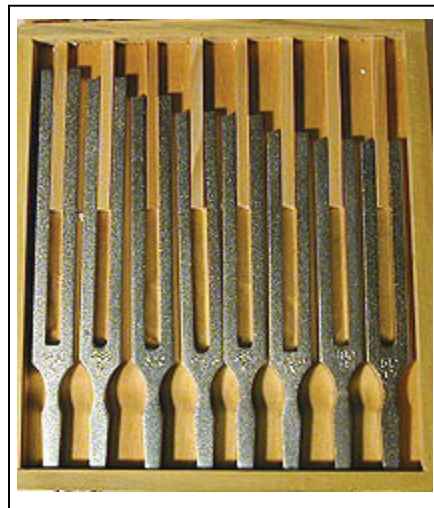

Figure 59. Set of tuning forks used in by musicians for tuning musical instruments (http://www.lehmanscientific.com/p_tunefk.html).

The tuning fork was invented in 1711 by John Shore, sergeant trumpeter to the British Royal Court and a lutenist in the Chapel Royal (Ellis, 1880). The original application of the tuning fork was to provide a calibrated tone for tuning musical instruments. It was originally called the *pitch fork* and

its resonance frequency was 423.5 Hz. This frequency corresponded most closely to the frequency of musical note A (440 Hz). Following this invention, in 1834, Johann Scheibel built a device called a “tuning fork tonometer”. This device consisted of 52 forks tuned from 219.67 to 439.5 Hz, at 20 °C (69 °F) for accurate measurements of musical pitch. Although tuning forks were originally used by musicians, with time, others discovered many non-musical applications. Various forms of tuning forks are currently used (e.g., as examining tools in the pathophysiology of skin, as point-level switches that are designed to detect low or high levels of fluid, as reference instruments in testing the accuracy of traffic radar equipment, and as distance control devices in magnetic and atomic microscopy) (Rozhok & Chandrasekhar, 2002). In the 1860s, Carl Stumpf and Alfred Binet used tuning forks to produce sounds and to register time. Controlled by a “tonometer,” the constantly swinging fork could precisely record fractions of a second on the revolving drum of a kymograph²⁰ (Schmidgen, 2002). The main non-musical application of tuning forks, however, has been in audiology.

The first use of tuning forks for hearing assessment was through the *Weber* test resulting from the early 19th century works of Charles Wheatstone, Caspar Tourtual, and Ernst Heinrich Weber. They discovered that the lateralization effect of bone-conducted sound can have diagnostic value for differentiating between conductive and sensorineural hearing losses (Stenfelt, 1999). Weber originally described the test in 1834 (Ross & Murray, 1996). Other tuning fork tests that have been used in audiology clinics are the Rinne, Schwabach, Bing, and Gellé tests. The Weber, Rinne, and Bing tuning fork tests tend to be the most common (Miltenburg, 1994).

9.2.1 Weber Test

The Weber test is a sound lateralization test designed to discover a unilateral hearing pathology. Lateralization is the perception of a sound being located inside one side of the head or the other (section 7). During the test, the handle of a vibrating tuning fork is placed on the forehead or the vertex (center top) of the skull of a patient and the patient is asked if the sound of the tuning fork is equally loud in both ears. If the answer is “no,” the patient is asked in which ear the sound is louder. The test is usually performed with a 256- or 512-Hz tuning fork. A normal result occurs when the patient reports that the tuning fork is heard equally loud in both ears.

The diagnostic value of the Weber test is based on the phenomenon that sounds will be heard louder in an ear with a conductive pathology (Weber positive) than in a normal ear (Blakley & Siddique, 1999; Hussain et al., 2001). Blakley and Siddique (1999) contend that the Weber test works because of an intensity difference between the sounds arriving at the two cochleae. The cochlea with the conductive component receives greater stimulation by the bone-conducted sound than the other cochlea and therefore, the listener perceives the sound as louder. The greater stimulation can be attributable to

1. an occlusion effect resulting from the presence of cerumen in the EAC,

²⁰The kymograph is a device that graphically records blood pressure or breathing pattern.

2. an occlusion effect attributable to the presence of fluid (infection) in the middle ear cavity,
3. increased effectiveness of sound transmission to the cochlea because of ossicular chain fixation,
4. lower resonance of the ossicular chain because of increased mass loading caused by the stiffened chain, or
5. greater mismatch between the cochlea (liquid) and the EAC (air) because of the interrupted ossicular chain (more of the sound is retained within the fluid rather than reflected to the EAC).

Some investigators have proposed that the lateralization of sound to the pathological ear occurs because of a phase difference in the sounds arriving at the cochleae through vibrations along the ossicular chain resulting from skull vibration as well as the vibrations transmitted through the cerebral spinal fluid (CSF) (Blakley & Siddique, 1999; Sichel, Freeman & Sohmer, 2002). The phase difference refers to the point in time of the cycle of a pure tone. Sichel et al. (2002) proposed that the suggested pathway for bone conduction supported by the Weber test is a summation of all vibrations arriving at the inner ear. Phase differences are likely to occur between the vibrations arriving at the cochlea through vibration across the ossicular chain and through the CSF. In theory, a conductive hearing loss would prevent the transmission of vibrations across the ossicular chain because of the presence of fluid or infection, thereby reducing the out-of-phase vibrations and increasing the intensity of the sound arriving at the cochlea.

Alternatively, the sound may be heard louder in one ear because of a sensorineural hearing loss in the opposite ear. The tone lateralizes in the ear without sensorineural loss because of the Stenger effect that states that the tone presented to both ears is only heard in the ear in which it is louder (Gelfand, 2001; p. 167). Regardless of the basis for the phenomenon, the Weber test remains one of the most popular tuning fork tests for screening for unilateral hearing loss.

9.2.2 Rinne Test

The Rinne test was developed by otologist Friedrich Rinne in 1855. This test is a determination of conductive pathology through comparison of air and bone conduction transmission when stimulated on the same side of the head (Hussain et al., 2001). To conduct a Rinne test, the tester sets a tuning fork (typically 256 Hz) into motion and alternately holds it near the tragus (air conduction) and places the handle on the patient's mastoid bone (bone conduction). The patient is asked to report which location of the tuning fork (mastoid bone or tragus) yields a louder tone. If the tone is heard louder through the air (tragus) than through the bone (mastoid), the result is labeled as normal (Rinne positive). If, on the other hand, the tone is heard louder through the bone than the air (Rinne negative), the result is labeled as abnormal. An abnormal finding supports a conductive hearing loss. For example, the presence of otosclerosis (stiffening of the ossicular chain) is confirmed if a person has (a) elevated air conduction hearing thresholds at low frequencies, (b) reduced bone conduction thresholds, and (c) a negative result of the Rinne test.

The theory behind the Rinne test is that the normal ear will be able to hear the sound equally through the air and through the bone. On the other hand, a person with a conductive hearing loss will be unable to hear the tone through the air because of the presence of fluid in the middle ear or debris in the outer ear, but once the tuning fork is placed on the mastoid, the tone is heard quite clearly through bypassing the conductive pathology. Caution is urged when one is interpreting the results of the Rinne test because of the possibility of a false negative. A patient hearing the tone better through bone than air could also have a large unilateral sensorineural hearing loss in the ear being tested. In this case, the tone is not heard through the air, but when the fork is placed on the mastoid bone, the patient hears the sound through bone conduction by his or her better cochlea (Hussain et al., 2001).

In some cases, people may have difficulty in determining whether the air or the bone conduction signal is louder. In such cases, a timed version of the Rinne test can be used (Johnson, 1970; Sheehy, Gardner, & Hambley, 1971). In the timed version, the patient is asked to judge which of the two sounds lasts longer. The timed Rinne test is reported to be more accurate than the classical test but is more time consuming and cumbersome (Gelfand, 1977).

9.2.3 Schwabach Test

In 1885, Dagobert Schwabach expanded the single frequency Rinne test to five different tuning forks to provide frequency specific information. In the Schwabach test, a tuning fork is set into motion and the handle of it is placed on the patient's mastoid bone. When the patient reports that the sound is no longer heard, the examiner places the handle of the fork on his or her own mastoid. If the examiner hears the sound longer than the patient (presuming that the examiner has normal hearing), the patient is said to have hearing loss. If the patient is able to hear the sound longer than the examiner, the result supports a conductive hearing loss in the patient's ear (Hussain et al., 2001). Obviously, this test is susceptible to examiner error as well as inaccurate diagnosis if the examiner's hearing is abnormal. Therefore, this test is no longer used.

9.2.4 Bing Test

The Bing test is a tuning fork test that makes a comparison between the perceived loudness of a tone when the EAC is open versus when it is closed. The Bing test is a measure of the occlusion effect. During the test, the examiner sets the tuning fork into motion and places the handle of it on the patient's mastoid. When the patient is no longer able to hear the tone, the examiner closes the patient's EAC by pressing gently on his or her tragus. If the sound again becomes audible, the patient is said to have normal hearing function (Bing positive). If the sound does not become audible again, the patient is said to have a conductive hearing loss (Bing negative) (Hussain et al., 2001). The test is based on the hypothesis that the presence of a conductive pathology would provide an additional boost to the amplitude of the tone initially and that when the EAC is plugged, no further boost is experienced. In the case of a listener with normal hearing, the

plugging of the EAC would provide an increase in amplitude of the tone because of the induced occlusion and it would be perceived again.

9.2.5 Gellé Test

The Gellé test is a test of the mobility of the ossicles developed by Marie-Ernst Gellé. The Gellé test is accomplished through a combined test of tympanometry and a tuning fork vibration. Tympanometry is a diagnostic test that looks for the change in position of the TM caused by changes in static air pressure in the EAC. In contrast to the tuning fork tests mentioned, which were concerned with the perceived loudness of a tone with and without the EAC plugged, the Gellé test looks for changes in perceived loudness with the application of varying amounts of air pressure existing in the EAC (MacFarland, 1953; Hussain et al., 2001). The perceived loudness of the tone changes as a function of the stiffening of the ossicular chain through application of pressure to the TM. In the case of normal hearing or sensorineural hearing loss, an increasing amount of positive pressure will decrease the perceived loudness of a bone-conducted tone from what is perceived when the pressure is equal to atmospheric pressure. In the case of stapes fixation, no changes of sound loudness are observed.

9.2.6 Levis (Federici) Test

The Levis test was developed in 1923 and involves comparison of the sound loudness when the handle of the tuning fork is applied to the head just in front of the tragus and to the mastoid process behind the ear. People with normal hearing and with the majority of hearing disorders will hear the vibration applied to the mastoid process as less loud (Levis negative) than when the vibration is applied in front of the tragus. However, in the case of otosclerosis, the handle of the tuning fork touching the mastoid process will sound louder (Levis positive). The test is based on the differences in bone conduction (mastoid process) and cartilaginous conduction (placement in front of the tragus). The Levis test can be used as a substitute for the Gellé test (Chladek, 1968; Pietruski, 1972).

9.2.7 Summary of Tuning Fork Tests

Tuning fork tests screen for hearing abnormalities. They are not intended to provide detailed information about the person's hearing sensitivity across various frequencies and intensities. The sensitivity of tuning fork tests in detecting hearing loss is questionable (Miltenburg, 1994). He evaluated the sensitivity of three tuning fork tests (the Weber, Rinne, and Bing) and compared their results to those obtained through audiologic testing. This was a blind evaluation and the findings supported the notion that the tuning fork tests are not overly sensitive. The Weber and the Bing were accurate only about 50% of the time, and the Weber test resulted in cases of false positive detections of hearing loss. On the other hand, the Rinne had a rather high sensitivity rate ($r = 0.82$ to 0.83), regardless whether the test involved masking (section 3.3). The author concluded that neither the Weber nor the Bing test is reliable enough to be used as

clinical tests. The Rinne test was found to be a sensitive and reliable measure of the hearing system status but it does not offer specific information regarding the type of hearing loss and therefore has limited clinical value.

9.3 Diagnostic Bone Conduction Pure Tone Audiometry

Accurate measurement of thresholds through bone conduction and subsequent differential diagnosis of hearing loss can only be accomplished through calibrated equipment that has the ability to change intensity and frequency of specific stimuli. Although tuning forks provide global information concerning the status of the hearing system and provide information for physicians to screen for conductive and sensorineural auditory pathologies, tuning fork tests do not provide detailed information about the listener's ability to hear tones of different frequencies and intensities.

Audiometric bone conduction testing constitutes an easy and reliable method for obtaining frequency specific differential information about conductive versus sensorineural hearing loss. The testing of the inner ear function without the influence of the outer and middle ear systems is accomplished through the placement of a calibrated bone conduction vibrator on the mastoid of a patient's ear. Bone conduction transducers used in the United States for audiometric testing are required to have a round flat surface area of 1.75 cm² that comes in contact with the skin (ANSI, 1996). The only two such transducers are the B-71 and the B-72 vibrators manufactured by Radioear, a subsidiary of Sensory Devices, Inc. The older Radioear B-70 transducer does not meet the surface area requirement. In Europe, the Oticon A20 and the Pracitronics KH-70 transducers are commonly used. The bone vibrator should be coupled to the head with a static force of at least 400 G in order to achieve adequate repeatability of the measurements (Dirks, 1964) and at least 5.4 N (450 G) to meet ANSI requirements (ANSI, 1996).

The difference between the thresholds measured through air and bone conduction is used in clinical testing to determine the site of lesion causing a hearing loss. This difference is called the *air-bone gap*. The size of the air-bone gap allows for a comparison between the status of the entire hearing system (air conduction threshold) and the status of the outer and middle ear subsystems through evaluation of the inner ear only (bone conduction threshold). A person with normal hearing or with hearing loss that does not involve the outer or middle ears has an air-bone gap close to zero. However, a conductive hearing loss associated with outer and middle ear problems results in the air conduction threshold being significantly worse than the bone conduction threshold (positive air-bone gap). Typically, this difference extends across a range of frequencies rather than just at one test frequency.

If the air conduction thresholds are within the normal hearing range and the bone conduction thresholds match the air conduction thresholds within 10 dB, the hearing is said to be normal. If the air conduction thresholds are abnormal and the bone conduction thresholds match the air conduction thresholds within 10 dB, the person is said to have hearing loss and the hearing loss is

said to be sensorineural. An air-bone gap exceeding 15 dB at any test frequency is considered a sign of outer or middle ear pathology that may require medical intervention (Glasscock, Shambaugh, & Johnson, 1990). If the air conduction thresholds are abnormal but the bone conduction thresholds are normal, the person is said to have hearing loss and the hearing loss is said to be purely conductive. If both the air conduction and bone conduction thresholds are abnormal and the difference in the thresholds is 15 dB or more, the hearing loss is said to be mixed (part conductive and part sensorineural).

Bone conduction thresholds can vary, either better or worse than air conduction thresholds, within approximately 10 dB (Barry, 1994). Results where bone conduction thresholds are poorer than air conduction thresholds can seem at first glance to be theoretically impossible if the assumption is that the bone conduction testing assesses only the function of the cochlea without contributions from the outer and middle ears, whereas the air conduction testing assesses the entire auditory system. However, the variability of air and bone conduction threshold testing may justify this finding (Studebaker, 1967). Obtaining bone conduction thresholds that are poorer than air conduction is likely to occur in a small percentage of the clinical population and this finding is likely attributable to the variability of each of the tests individually. The variability in threshold testing must also be kept in mind when there is a difference in air and bone conduction thresholds whereby the bone conduction thresholds are significantly better than the air conduction thresholds. In most cases, this would suggest a conductive hearing loss, but in a small percentage of the population, the appearance of a conductive loss may only be attributable to test variability (Studebaker, 1967). Repeated tests will provide the correct answer.

The mastoid process is the standard location for placing the bone vibrator in clinical testing (Gelfand, 2001; p. 140). Differences among various head locations were discussed in section 5. This location was selected mainly because of the wide dynamic range of the mastoid stimulation and the fact that this location provides maximal TA. However, some authors advocate using the forehead as the placement location. The forehead provided more repeatable results and smaller inter-subject variability (Studebaker, 1962; Dirks, 1964). Although the forehead has more than 10 dB poorer sensitivity to external vibrations than the mastoid process, it offers a large flat area of contact that provides a relatively large region of uniform sensitivity to vibrations. Forehead sensitivity is also less dependent on the static pressure applied to the vibrator than other more curved locations. Locations other than the two placements discussed are not used in clinical practice because they are deemed impractical.

Low TA for bone-conducted signals (discussed in sections 3 and 5) means that during bone conduction testing, an auditory response could result from either ear. Therefore, bone conduction testing, of a single ear requires masking of the opposite (non-test) ear with a masker (a narrow-band noise masker is sufficient for pure tone signals and a wide-band noise masker is most appropriate for speech signals). This requires occlusion of one or both ears, an action that may alter the threshold and increase uncertainty of the data obtained. If the ear must be blocked, it must be done so with a deeply inserted earplug to minimize the occlusion effect (section 6). The rule of thumb in clinical audiology is that masking should be used when the difference between the air conduction threshold and the unmasked bone conduction threshold exceeds 10 dB

(Gelfand, 2001; p. 298). Typical masking levels used in bone conduction audiometry are 40 to 50 dB HL above the air conduction threshold of the better ear but need to be calculated for each person, taking into consideration the air conduction hearing thresholds in both ears and the listening conditions (occlusion effect) (Gelfand, 2001; p. 304).

The differential diagnosis of hearing loss is essential to proper treatment and management of hearing problems. People with conductive hearing losses typically have a hearing loss that requires medical or surgical treatment. Some reasons for an occurrence of conductive hearing loss may include the presence of excessive amounts of cerumen in the EAC, otitis media (middle ear infections), otosclerosis (fixation of the faceplate of the stapes to the oval window of the cochlea), ossicular discontinuity (a separation of the ossicles), and cholesteatoma (abnormal growth of skin within the middle ear cavity, usually because of multiple middle ear infections). People with conductive hearing losses should be evaluated and treated by a physician. In contrast to conductive hearing loss, a physician cannot typically treat sensorineural hearing losses through medical intervention, and people with sensorineural hearing loss are often candidates for hearing aids. Two exceptions to this are surgical procedures such as cochlear implants for people with profound hearing losses and BAHAs. Audiologists who see patients before their visit to a physician are compelled to refer people with hearing losses who have a conductive component for medical treatment before fitting them with amplification. People who are determined to be candidates for cochlear implants or BAHAs are further referred for this procedure as well.

9.4 Diagnostic Bone Conduction Speech Audiometry

Audiometric testing of bone conduction transmission is most often conducted with pure tone stimuli. However, it is sometimes beneficial to use bone conduction for speech audiometry. Robinson and Kasden (1977) found that the measurement of speech recognition (the ability to understand words) through a bone conduction vibrator resulted in the best agreement between pre- and post-operative stapedectomy (removal of the stapes) scores. They felt that the testing of speech recognition through bone conduction reflected the cochlear function of the hearing system most accurately. The surgical procedure of a stapedectomy is conducted on people with otosclerosis and should have no effect on the function of the cochlea. However, for patients who experience apparent sensorineural hearing loss postoperatively, speech recognition testing through bone conduction transmission was found to be an effective method of assessing cochlear function.

One of the bone conduction speech tests used in hearing evaluation is the Speech Recognition Threshold (SRT) test (Merrill, Wolfe, & McLemore, 1973; Srinivasson, 1974; Edgerton, Danhauer, & Beattie, 1977). The SRT is defined as the lowest hearing level at which an individual can understand 50% of the speech items (American Speech-Language-Hearing Association, 1988). Most SRT measurements are made with spondaic words (spondees), that is, two-syllable words with equal stress on both syllables (e.g., baseball, hotdog, northwest).

Bone conduction (and air conduction) SRT measurements are mainly used with children in determining the integrity of the conductive auditory pathways when pure tone thresholds cannot reliably be obtained. Goetzinger and Proud (1955) reported a high correlation between the bone conduction pure tone average (PTA) at 500, 1000, and 2000 Hz and the bone conduction SRT. Additionally, Hahlbrock (1962) advocated the use of bone conduction SRT as a means to separate auditory from tactile responses in bone conduction testing.

Some audiologists have recommended measuring SRT with bone-conducted sounds, although such testing is only appropriate at lower intensity levels because of technical limitations of existing audiometric vibrators (Barry & Gaddis, 1978; Beattie & Gager, 1980). As discussed in section 8, at high intensity levels, bone conduction vibrators can produce significant amounts of distortion. Barry and Gaddis (1978) found that the maximum output of the Radioear B-70A vibrator for a speech signal without significant levels of distortion was around 70 dB HL. The investigators recorded total harmonic distortion at the output of the transducer and found 20% harmonic distortion at presentation levels of around 60 dBHL which grew to nearly 70% at 70 dBHL. To confirm the effect of distortion on speech recognition, the investigators measured speech recognition in a group of listeners with normal hearing. Speech recognition scores were greater than 90% at 60 dBHL and dropped to around 50% at 70 dBHL. Therefore, although these vibrators can be used for speech testing on some listeners, their output limits dictate the maximum presentation levels that can be used. Dolan and Morris (1990) were able to measure excellent (>90%) speech recognition in listeners with normal hearing through several newer bone conduction transducers (Pracitronic KH-70 and Radioear B-72) at levels equal to 40 dB above the listener's SRT (approximately 60 to 70 dBHL). The investigators did not include higher intensity levels.

Bone conduction threshold measurements may be affected by aerial leakage. This was a substantial problem with older transducers, but modern vibrators seem to have much lower amounts. Additionally, care must be taken to keep the bone vibrator from directly contacting the pinna since vibrations through the pinna can be transmitted to the EAC and heard by the wearer.

9.5 Auditory Brain Stem Response

Bone-conducted sounds have also been used in objective hearing tests such as ABRs and OAEs (Collet et al., 1989). ABR testing is an objective measure of the neurological integrity of the auditory system (e.g., Davis et al., 1985; Ruth et al., 1983). The ABR is an evoked potential that tracks the neural responses to auditory stimulation and is used for diagnostic purposes and for the measurement of auditory thresholds (Hall, 1992). As the cochlea receives sounds, neural impulses are sent along the auditory nerve to the brain stem and onward along the neural pathway to the auditory cortex where sounds are perceived. The auditory system can be evaluated if the neurological system's response to auditory stimulation is measured. Receptor electrodes are placed on the listener's skull, sounds are presented to the listener, and responses are measured through the electrodes with the use of a computer. The patient does not need to actively participate in the test.

ABR testing involves the placement of electrodes on the scalp and in or behind the ears. A transmitter (a headphone or a bone vibrator) provides the auditory stimulus.

As neural responses are obtained through ABR testing, averages of the responses are made and the result is a curve with peaks and valleys where maximal neural firing is represented. The peaks are assigned Roman numerals from I to V. The first peak is derived from the firing of the auditory nerve fibers closest to the cochlea. Subsequent peaks appear following other groups of neurons firing. The tracking of the peaks of neural firing at specific points in time leads to the determination of the status of the auditory neural system.

ABR through bone conduction stimulation is often conducted for individuals with a suspected conductive hearing loss or for those without open EACs (e.g., Callison, 1999; Cone-Wesson & Ramirez, 1997; Stevens, 2001; Tucci, Ruth, & Lambert, 1990; Yang, Rupert, & Moushegian, 1987). For example, when one is evaluating the hearing of an infant, an objective measure is ABR. If the child has an ear infection, fluid in the middle ear will prevent sounds presented through air conduction from reaching the cochlea. In this case, presentation of sounds through bone conduction would allow for evaluation of the child's inner ear by bypassing the presence of fluid in the middle ear. The bone conduction vibrator is placed in the same way as it would be for threshold testing; however, the headband used on adults and older children is often too large for an infant's head. Therefore, a bone conduction transducer is typically held on the mastoid by hand and responses are measured from the electrodes attached to the infant's skull. The fact that the transducer is manually held in place rather than being maintained in place through a headband causes some variability in the stimulation because of variability in the amount of force applied. There is a measurable difference in the ABR obtained through bone conduction with applications using various forces applied to the head (Yang et al., 1991). Because of the variability, several researchers have recommended maintaining a constant force for bone conduction transducers through the use of a soft headband made of hook and loop tape so that the force being applied can be measured through the use of a spring scale and maintained over time (Yang et al., 1991).

The results of ABR tests are frequently used for determining anomalies in hearing thresholds. The ABR measure of interest in the case of threshold estimation is the latency of wave V in the ABR recording. The initial recording is made at a high intensity level and the peak for wave V is tracked in time with gradual decreases in intensity level. As the intensity level is decreased, the latency of wave V increases.

Wave V latencies for adults obtained through bone conduction are longer than those obtained through air conduction and correction factors need to be applied to the results (Gorga & Thornton, 1989; Mauldin & Jerger, 1979). However, for infants, the wave V latencies for bone conduction are shorter than they are for air conduction (Stapells & Ruben, 1989; Yang et al., 1987). In addition, differences between air and bone conduction ABRs are smaller for mastoid placement than for forehead placement so the location of the stimulator should be noted on any test results (Gorga & Thornton, 1989; Yang et al., 1987).

9.6 Oto-acoustic Emissions

OAEs are another objective measure of the hearing status used in audiology. This measure examines the function of the outer hair cells in the cochlea. We perform the test by sending an acoustic signal to the ear through the EAC and measuring the acoustic response to that signal. ABR examines the neural integrity of the human auditory system, while OAEs examine the function of the outer hair cells present in the cochlea. Active outer hair cells demonstrate some mobility and generate their own acoustic signature. This signature is measured by the OAE test. The function of the outer hair cells supports the presence of normal cochlear function. Lack of a response on the OAE test reflects hearing loss. The outer hair cells are susceptible to high levels of noise, so they are the first to stop functioning when hearing loss occurs. Just as ABRs can be elicited through stimulation by bone conduction transmission, so can OAEs (Collet et al., 1989; Purcell et al., 1999). OAEs measured by air and bone conduction have been found to be comparable (Collet et al., 1989; Purcell et al., 1999), although exact comparisons are difficult because of the calibration differences of the two devices and slight changes in stimulation location. Typically, OAEs are measured in each ear individually since a probe must be inserted into the EAC to present the signal and measure the response. One potential advantage of using bone conduction stimulation for OAEs is an efficient use of time in stimulating both ears simultaneously and measuring from each independently. In this way, a measuring probe could be inserted into each EAC, but the signal generator would be placed on the bones of the head.

9.7 Summary and Conclusions

Bone conduction testing is used in ENT and audiology practices as a way of differentiating the contributions of the outer and middle ear sections from those of the inner ear. Tuning fork tests, initially designed for use by musicians, were the initial way in which vibrations were applied to the bones of the head and perceived as sound by the listener. Tuning fork tests evolved into more standardized methods of testing through bone conduction stimulation and now, calibrated bone conduction vibrators are used to measure frequency specific thresholds to bone-conducted sound. More recently, the use of bone conduction stimulation has extended to objective tests such as ABR testing and OAEs.

10. Bone Conduction Hearing Aids

Bone conduction transmission has been used as a hearing aid for children who are born without ear canals or adults who have chronic conductive hearing losses that cannot be corrected surgically. The development of hearing aids for use with people with hearing impairment has prompted the curiosity of this mode of transmission for people with normal hearing. The technology used in bone conduction hearing aids and the implantable BAHA is similar or identical to that used in

clinical audiologic testing. The same devices have been incorporated into commercially available devices marketed to individuals with normal hearing. In this section, we discuss the use of bone conduction devices for people with impaired hearing as a basis for understanding their function for applications with people with normal hearing.

10.1 Introduction to Bone Conduction Hearing Aids

A hearing aid is an acoustic device designed to compensate for hearing loss. Hearing aids can be divided into two major classes: air conduction hearing aids and bone conduction hearing aids. Air conduction hearing aids can be further divided into several classes, based on their size and placement on the ear or in the EAC. The two most common classes of air conduction hearing aids are behind-the-ear (BTE) hearing aids and in-the-ear (ITE) hearing aids. The basic difference between these classes has to do with where the microphone and electronics are housed. For a BTE hearing aid, the main components of the hearing aid are located in the housing that sits behind a person's pinna. An ear mold that fills all or part of the pinna is then custom fit for the person's ear and a tube connects the ear mold with the hearing aid. In the case of an ITE, the components are housed in casing that is custom molded to fit in the person's concha area of the pinna. In both cases, sound is detected by the microphone and sent down the EAC. The smallest version of air conduction hearing aids are completely-in-the-canal (CIC) hearing aids which house all the components in a shell that sits in the EAC. Air conduction hearing aids can be used for people with all types of losses, although they have their limitations for profound hearing loss and some other cases where problems with the EAC or middle ear space need to be unoccluded.

Bone conduction hearing aids are typically used for people with conductive hearing loss where standard air conduction hearing aids are not appropriate. As discussed previously, conductive hearing loss involves hearing loss caused by problems with the anatomical structures of the outer and/or middle ear. Conductive hearing loss involving the EAC prevents the use of standard hearing aids because of the inability to insert something into the EAC. In these cases, a bone conduction hearing aid bypasses the problematic EAC and transmits sound directly to the inner ear by vibrating the bones of the skull.

The EAC can be blocked from birth as in the case of aural atresia (absence of an ear canal) but can also become blocked or problematic over time such as in the case of bony growths within the EAC called exostoses. These are commonly seen in people who are frequently exposed to cold water, such as in the case of surfers in the Pacific Ocean. Frequent drainage into the EAC because of chronic otitis media (middle ear infections) and long-standing TM perforations can also interfere with the electronic components of a standard ITE or BTE hearing aid. A bone conduction hearing aid can be used if surgical intervention of a conductive hearing loss is unsuccessful in restoring an person's hearing.

There are two basic types of bone conduction hearing aids: (a) conventional bone conduction hearing aids that are external devices and (b) implanted bone conduction hearing aids requiring

surgical implantation of part of the device. A conventional bone conduction hearing aid has a bone conduction vibrator that is held onto the outside of the head with a headband (similar to the Radioear P-3333 headband) or an attachment to the earpiece of a pair of eyeglasses. In both cases, the vibrator is held in contact with the head through pressure and transmits the signal through the skin to the bones of the skull. The vibrator is typically located on the mastoid bone but could, theoretically, be placed anywhere on the head. Direct or implanted bone conduction hearing aids are two-part devices that require surgical intervention. Depending on the implementation, they can be classified into two groups:

1. transcutaneous, in which a magnetic plate is implanted in the temporal bone under the skin and a second magnet holds a transmitter in place on the outside of the skin (e.g., Audiant²¹), and
2. percutaneous, in which a metal plate is implanted in the skull with a titanium screw permanently penetrating the skin; a vibrator is attached to the end of the screw (e.g., Auditory System HC 200, by Nobelpharma).

The differences between transcutaneous and percutaneous implanted bone conduction hearing aids are shown in figure 60.

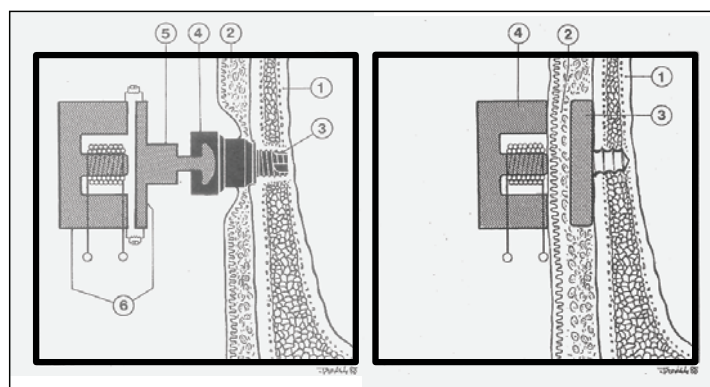

Figure 60. Percutaneous (left) and transcutaneous (right) implanted bone conduction hearing aids. (On the left: skull bone (1), soft tissue (2), titanium fixture (3), titanium abutment (4), bayonet coupling (4), and transducer (5). On the right: skull bone (1), soft tissue (2), implanted plate (3), and transducer (4) [Håkansson, Tjellström, & Carlsson, 1990].)

A special type of implantable hearing aid is known as a middle ear implant where an electromagnet is implanted somewhere along the ossicular chain and enhances the ossicular vibration in response to an electromagnetic signal transmitted from an external unit (e.g., Direct System²²).

²¹Audiant is a trademark of Xomed, Inc.

²²Direct System is a trademark of Soundtec, Inc.

10.2 Conventional Hearing Aids

Conventional bone conduction hearing aids work the same way that air conduction hearing aids work except for the method of sound transmission to the listener. In both cases, a microphone on the outside of the hearing aid detects sound from the environment and feeds it to the amplifier. The amplifier increases the intensity of the sound and sends it to the output transducer. In the case of air conduction hearing aids, the output transducer is a miniature loudspeaker that sends acoustic energy down the user's EAC. In the case of bone conduction hearing aids, the output transducer is a vibrator. The bone conduction vibrator is attached to a flexible headband (similar to the Radioear P-333 headband) or onto the earpiece of a pair of eyeglasses. The headband device looks very similar to the bone conduction headset used for diagnostic hearing testing and the transducer is similar or identical to that used in audiologic testing. In both cases (diagnostic audiology and bone conduction hearing aids), the bone oscillator typically sits on the mastoid bone directly behind the pinna. As opposed to air conduction hearing aids, where the microphone and output transducer are contained in the same case, a bone conduction hearing aid has a microphone on a separate part of the device. The microphone detects environmental sounds and transmits them to the bone oscillator that vibrates against the listener's skull. The pressure required for optimal transmission of vibration is the same as that needed for audiologic testing (see section 5), and this pressure is maintained through the use of spring tension applied to the headband or the stems of the eyeglasses. Like many hearing aids, the device has a volume control and uses batteries.

The most common bone conduction vibrator used on headband devices is the Radioear B-70 or the Oticon A20. In the typical configuration, the headband is nearly identical to that used in bone conduction testing except that the end point of the band opposite the vibrator is flatter in order to sit more comfortably on the opposite side of the head. When the bone conduction vibrators are incorporated into eyeglasses, the amplification circuitry of the hearing aid is typically contained in one case with the vibrator in a separate unit. Figure 61 shows the typical parts of a headband bone conduction hearing aid.

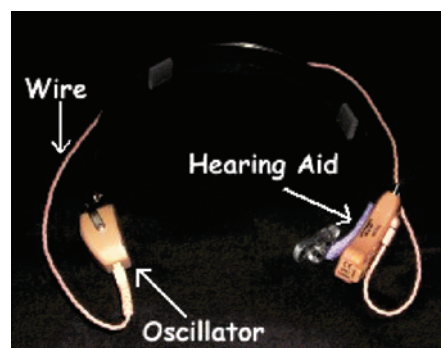

Figure 61. Bone conduction hearing aid showing the headband, hearing aid and oscillator (vibrator). (Photo from <http://www.pde.com/~kazemir/HearingAids.htm>.)

For many children born with aural atresia, the constant wearing of a metal band is uncomfortable. In fact, if the child wears it continually from birth, it is not uncommon to see a depression form in the top of the child's skull. The depression is attributable to the combination of prolonged periods of wear and rapid growth of the skull. The headbands themselves do not typically have multiple sizes, so the listener is forced to "make do" if the band is too small or too large. One alternate method of maintaining contact between the oscillator and the skull is to use an exercise sweatband or other stretch headbands adapted to contain a pocket for the oscillator. A company called Huggie Aids Ltd (Oklahoma) makes a custom headband called a Huggie Head (Janssen & Rowland, 1990) from leather or suede for use with bone conduction hearing aids. These have been used by parents of children with atresia in order to make the bone conduction hearing aid apparatus more comfortable and aesthetically pleasing. The disadvantage of using a softer device such as this is that it will likely affect the degree of force applied to the vibrator and thereby reduce the amount of amplification provided to the wearer.

In the case of eyeglass-worn bone conduction hearing aids (shown in figure 62), the degree of stimulation to the listener's mastoid can vary significantly through re-positioning of the eyeglasses following discomfort. The pressure required for adequate stimulation can cause significant discomfort to the wearer and manifest itself in a headache, skin irritation and potentially necrosis (breakdown of the skin). All these side effects force the wearer to relieve the amount of pressure being applied to the mastoid by loosening the earpiece force or moving the location of the vibrator around from time to time, both of which can affect the effectiveness of the device.



Figure 62. Bone conduction eyeglasses.
(Photo from <http://www.ledesma.com.ph>.)

Historically, the sound quality from bone conduction hearing aids has not been very good; thus, they are typically used as a last resort in special cases. This limitation was in part attributable to the available technologies but mostly because industrial interest (small consumer market) was lacking.

10.3 Direct or Implantable Bone Conduction Hearing Aids

In cases for which conventional bone conduction hearing aids are not powerful enough or feasible for long-term use, an implantable bone conduction hearing aid may be pursued as an option. This would be for cases in which surgical intervention to repair any abnormalities of the outer or middle ear structures were not successful or when air conduction hearing aids do not provide sufficient amplification for a conductive hearing loss (Spitzer, Ghossaini & Wazen,

2002). Implantable bone conduction hearing aids require surgery, and they are not typically considered as a first form of treatment.

The first implantable bone conduction hearing aid was developed by Xomed in the early 1980s and was first approved by the U.S. Food and Drug Administration (FDA) in 1984 (Hough, Himelick, & Johnson, 1986). This device was different from conventional bone conduction hearing aids mainly because it did not require a headband. A metal plate and magnet were implanted into the mastoid bone and a second device with an additional magnet was used on the outside of the head to transmit the signal through the skin and soft tissue to the temporal bone. The first implantable transcutaneous bone conduction hearing aid was the Audiant (Håkansson, 1985; Håkansson et al., 1990; Hough, Richard, Barton, DiCarlo, & Chow, 1986). Xomed provided one of three versions of the external device although the internal device had only one version. The three versions of the external device were the body-level processor (BLP), at-the-ear (ATE) and the BTE processors (Hough, Hough, & McGee, 1995).

Initially, only people with purely bilateral conductive hearing loss were considered candidates for bone conduction hearing aids, but more recent applications have expanded to people with unilateral conductive losses, mixed losses, and sensorineural losses. Initial selection criteria for implantation included a pure tone average of bone conduction thresholds not worse than 25 dB, a pure tone average of air conduction thresholds that not worse than 40 dB HL, speech recognition threshold by air conduction of not worse than 40 dB HL and normal (better than 80%) speech recognition scores (Hough et al., 1986; Hough et al., 1995; Yellin et al., 1997). The presence of normal bone conduction thresholds as well as normal speech recognition scores in candidates once the conductive hearing loss is overcome demonstrates an intact cochlea and a purely conductive hearing loss.

The Audiant device involved the transmission of sound through electromagnetic energy between the external and internal devices. Reports from the results of numerous patients indicated that the device was safe for the user (Gates, Hough, Gatti, & Bradley, 1989). Furthermore, the benefit as demonstrated by improvements in air conduction speech recognition thresholds was on the order of 30 dB (Hough et al., 1995). This reflects near closure of the air-bone gap that was present before surgery. Not all of the implants have resulted in success stories. A retrospective study showed that there were some problems with long-term users of the device (Yellin et al., 1997). Of 24 patients surveyed, only half were using the device after an average of 34 months after being implanted. Of those who were using it, most were quite satisfied, but those that were not using it reported inadequate amplification and problems with weak magnetic attraction between the internal and external units as causes for their non-use of the device.

Although the Audiant device improved the aesthetics of bone conduction hearing aids and demonstrated definite improvement in hearing ability, the wearer had to continually care for the area of skin against which the outer magnet was placed, since the compression of the skin and tissue between the two magnets was found to cause skin irritation (Wade, Tallos, & Naiberg, 1989) and

necrosis (Hough et al., 1995). The Audiant was also found to be inefficient in transmitting sound through the skull (Håkansson et al., 1990). The Audiant is no longer on the market.

Rather than continue with the transcutaneous method of an implantable bone conduction hearing aid, the second device to appear on the market used the percutaneous approach whereby a plate and titanium screw were implanted into the temporal bone of the user's skull and an external device was then attached to an abutment placed over the screw. Many people were initially skeptical about the success of such a device because of the permanent skin penetration and its potential for introducing infection to the user. Despite this skepticism, it has been demonstrated to be successful (Tjellström et al., 1981; Tjellström & Håkansson, 1995). The device was first developed in Europe in the 1970s and was referred to as the HC200. It gained usage in the United States some years later and assumed different model names (Spitzer et al., 2002). The BAHA²³ was approved by the FDA for use in adults in the United States in 1996. Approval by the FDA for use in children took place more recently, around the year 2000. In 2001, the FDA approved another candidacy requirement that allows for the use of the device in people with unilateral hearing loss.

The surgery for the BAHA is similar to that for the Audiant device. For the BAHA, surgical implantation is with a titanium screw rather than a magnet. Post-surgical healing and osseointegration takes approximately 3 months, after which time, the external device can be fitted to the abutment (Tjellström & Håkansson, 1995). Osseointegration refers to the completion of integration of a foreign object into bone. The titanium screw implanted into the wearer's head is integrated into the bone so that vibration impinged on the screw is directly transmitted to the bones of the skull with the opposite end of the titanium screw protruding through the skin and allowing for attachment of the external device to the abutment. As mentioned earlier, great concern was raised about the potential for infection in patients with a permanent skin penetration. In two studies, the occurrence of adverse skin reactions has been reported to be quite low (Portmann, Boudard & Herman, 1997; Wade et al., 2002).

The name BAHA is commercially used for the percutaneous device made originally by Nobel Biocare (later made by Entific Medical Systems) and distributed in the United States. As of March 2005, the BAHA is produced by Cochlear Limited who purchased Entific. There is only one form of the internal portion of this device, but currently there are three versions of the external portion. The BAHA Classic 300 and BAHA Compact are ear-level devices appropriate for fitting to people with bone conduction thresholds no worse than 45 dB HL (Abramson et al., 1989). The BAHA Cordelle is a body-worn device designed to be used in people with greater hearing loss (bone conduction thresholds no worse than 60 dB HL) (van der Pouw, Snik, & Cremers, 1998). The difference between the BAHA Classic 300 and the BAHA Compact has to do with the amplification processing. The BAHA Classic 300 is a linear amplifier whereas the BAHA Compact incorporates compression where the amount of amplification provided depends on the intensity level of the input signal. The BAHA Cordelle is a body-worn device providing

²³BAHA is a registered trademark of Entific Medical Systems.

approximately 13 dB more gain than the ear-level devices. The original body-worn device was named the Superbass.

The BAHA has many advantages over conventional bone conduction hearing aids. One of the primary overall benefits is comfort of the device as compared to the conventional bone conduction hearing aid. One of the primary acoustic benefits is the more efficient transmission of sound to the listener's ears. Hearing thresholds with the BAHA are typically 2 to 10 dB lower than the hearing thresholds for a conventional bone conduction hearing aid. This allows for greater stimulation of the listener's ears in the cases of greater degrees of hearing loss where the conventional hearing aid was not beneficial. The differences between the BAHA and conventional bone conduction thresholds recommended by Carlsson et al. (1995), for frequency specific stimuli as a basis for determining the audiometric zero for direct bone conduction, are shown in table 13. Differences in thresholds as measured with speech stimuli for the BAHA have been reported to be as much as 25 dB (Wazen, Caruso & Tjellstrom, 1998). Differences in thresholds for speech versus frequency-specific stimuli are based on the spectral differences between the two signals.

Table 13. Estimated difference (ΔBC) between direct and conventional bone conduction hearing thresholds (Carlsson et al., 1995). (Negative values reflect better thresholds through direct bone conduction.)

ΔBC	Frequency (kHz)						
	0.25	0.50	1.00	1.50	2.00	3.00	4.00
M (mean)	-7.40	-10.10	2.80	-1.80	-5.10	-1.90	-8.20
SD (stdev)	1.40	1.30	1.30	1.60	1.50	1.50	1.50

Benefits of the BAHA over conventional bone conduction thresholds were also shown by a study conducted by Cremers and colleagues (Cremers, Snik, & Beynon, 1992). In 16 patients, all showed better performance with the BAHA than with a conventional bone conduction hearing aid. The most profound finding was in the improved SNR obtained with the BAHA. The improvements in speech testing as seen with the use of the BAHA were ascribed to the greater high frequency response of the BAHA as opposed to conventional bone conduction hearing aids (Cremers et al., 1992).

Further comparisons between the BAHA and conventional bone conduction hearing aids have shown a preference for the BAHA in terms of the sound quality as perceived by the wearer. Ringdahl, Israelsson, and Caprin (1995) conducted a paired comparison study using speech stimuli between the BAHA Classic 300 and a conventional bone conduction hearing aid (Philips S45B) and found a preference from the listeners for the BAHA based on sound quality and speech recognition ability.

Although comparisons made between implantable and conventional bone conduction hearing aids assist in the determination of the benefit for implantable devices in general, they do not provide evidence for one implantable device to function better than another. Following the emergence of the BAHA, investigators began to compare implantable devices to determine

whether there was an advantage of the BAHA over the previously used Audiant. Håkansson, Tjellström, and Carlsson (1990) compared the HC 200 (the European version of the BAHA) and the Audiant ATE hearing aid and reported that thresholds with the percutaneous HC200 bone conduction hearing aid were about 20 dB lower than with the Audiant ATE transcutaneous device. In addition, the frequency of maximum effectiveness of the percutaneous transmission was around 1 kHz, whereas the transcutaneous transmission was most effective at about 500 Hz. The authors concluded that the only functional advantage of the transcutaneous over percutaneous bone conduction device is that it avoids the permanent skin penetration which puts the patient at risk for infection. A second study by Wade, Halik, and Chasin (1992) showed poor performance of the Audiant device in comparison to the BAHA. These findings contributed to the decline in use of the Audiant device and increased use of the BAHA.

Following the success of the BAHA for use with bilateral conductive hearing loss, the candidacy for the device was expanded to unilateral loss and even mixed losses where air conduction aids did not provide sufficient benefit. Furthermore, bilateral implants have been performed on people with bilateral hearing loss (Snik et al., 1998). The users of bilateral implantable bone conduction hearing aids have demonstrated improved speech perception in quiet as well as improved sound localization, both processes involving binaural hearing (Dutt et al., 2002a,b; Snik et al., 1998; van der Pouw et al., 1998). The beneficial function of people with two devices supports the contentions that stimulation through bone conduction from the sides of the head has the capability of providing differential information to the cochleae (see section 7).

Presently, the BAHA is in common use and the candidacy for use has expanded significantly. No longer is it reserved for the restricted population of people with no other treatments available for their conductive hearing loss but is used for people with unilateral loss and the presence of sensorineural hearing loss (Chasin & Wade, 1998).

The application of an implantable bone conduction hearing aid to a unilateral hearing loss is not without debate. Initially, several investigators expressed skepticism about the need for and potential success with such a device (Browning, 1990; Weber & Roush, 1991; Welling, Glasscock, Woods, & Sheffey, 1991). However, studies have demonstrated a true binaural benefit with the addition of an implanted bone conduction hearing aid on the impaired side for a person with one ear with normal hearing (Chasin & Wade, 1998). In tasks of masking level differences and speech understanding in noise as a function of SNR, listeners functioned significantly better with the implant than with other devices (Chasin & Wade, 1998).

Application of the BAHA to people with sensorineural hearing loss has also met with mixed reviews. A study conducted on people who were borderline candidates because of bone conduction thresholds of greater than 45 dB HL demonstrated benefit from the device (Hartland & Proops, 1996). Although the results from measures of functional gain between the users' old hearing aids and their implant did not differ, their subjective preference based on comfort, loudness, and clarity was significantly greater for the BAHA (Hartland & Proops, 1996).

However, a study conducted on people with unilateral sensorineural hearing loss showed no benefit in binaural tasks through use of the implant (Weber, Roush, & McElveen, 1992). A letter to the editor of *Laryngoscope* agreed with the findings of Weber and colleagues and indicated that in a similar patient pool, although initial benefit had been demonstrated, after three years, 72% of the patients were no longer wearing the device (Welling, 1992). In both studies, the patients had unilateral sensorineural hearing loss.

10.4 Middle Ear Implants

In comparison to conventional bone conduction hearing aids and implantable bone conduction hearing aids, which were designed for people with conductive hearing loss, middle ear implants were designed for people with purely sensorineural hearing loss. The middle ear implant was designed to vibrate the ossicles in the middle ear directly rather than indirectly through the TM. When the ossicles are vibrated directly, greater sound energy can be directed to the cochlea. Currently, two types of middle ear implants have been approved by the FDA for use in adults: the Vibrant Soundbridge (Ball, 1995) from Symphonix and the Direct Drive Hearing System (DDHS) from Soundtec, Inc. A diagram of the Vibrant Soundbridge²⁴ from Symphonix is shown in figure 63. Two more devices are being developed: the Middle Ear Transducer from Otologics LLC and the Envoy Middle Ear Implantable System from St. Croix Medical, Inc.

Ideally, developers of implantable devices sought to design a device that was completely implantable. This would remove the negative aesthetic aspects of the device, leave the EAC open, and provide the optimal amount of comfort for the user. However, the devices would have to be extremely durable and would need to be explanted (surgically removed) in order to replace the battery. Stenfelt (1999) reported several investigators working on totally implantable devices, but none have emerged on the market.

As with the implantable bone conduction hearing aids, middle ear implants have two parts, one interior and one exterior. The interior portion is connected to the ossicles in the middle ear, typically the incus or the joint between the incus and the stapes. The external portion houses the amplifier for the device as well as the microphone that detects sound from the environment. The external device comes in a variety of models, depending on the manufacturer. For the Symphonix DDHS, the external device is a BTE unit or an ITE unit. The BTE version was approved in 2001 and the ITE unit was approved in 2002.

The coupling between the two parts of the device differs across manufacturers. In the case of the DDHS, the devices communicate through electromagnetic energy. The ITE or the BTE transmits energy through an electromagnetic coupling to the implanted device. The external unit houses the electronics necessary to amplify the sound and it contains the battery and volume control.

²⁴Vibrant and Soundbridge are registered trademarks of Vibrant-Med-El.

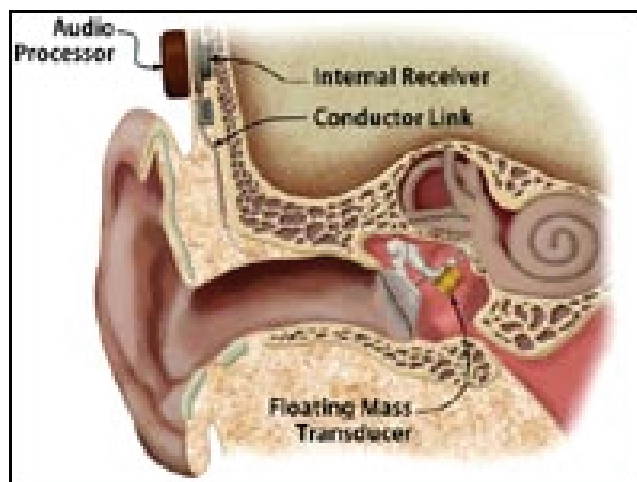

Figure 63. Diagram of the Vibrant Soundbridge middle ear implant from Symphonix. (Downloaded from <http://www.hearingcenteronline.com/newsletter/august00c.shtml>, June 15, 2005.)

In the case of the Vibrant Soundbridge, the two devices communicate transcutaneously. The transducer that imposes the vibration on the ossicular chain is called the Floating Mass Transducer²⁵, and it is a magnet with two inductor coils that is attached to the incus by a clip (Stenfelt, 1999). Inertia of the magnet causes movement of the ossicular chain. A wire connects the transducer to an internal coil that is implanted in the mastoid bone of the wearer. The external unit contains a second coil and the electronics for the device. It sits on the mastoid bone behind the wearer's ear directly over the internal receiver (Stenfelt, 1999).

Hundreds of patients have been fit with the Vibrant Soundbridge, and studies examining the success of the device have returned favorable results. A study conducted on the first 125 patients implanted in France showed that 83% of the patients were satisfied or very satisfied with the performance of the device (Sterkers et al., 2003). These results are very promising for this and other middle ear implantable devices.

The presence of bone-anchored or implanted bone conduction hearing aids precludes the user from undergoing magnetic resonance imaging (MRI) because of the presence of metal in the device. However, the middle ear implants are much smaller and metal content than the implantable bone conduction devices. Two studies investigated the safety of undergoing an MRI with a middle ear implant in place. Both studies concluded that it would be safe for a wearer of the device to undergo an MRI, which gives the middle ear implant a slight advantage over the implanted bone conduction devices (Todt, Seidl, Mutze & Ernst, 2004; Tohme, Karkas, & Romanos, 2003).

On the other hand, middle ear implants carry risks that are not present with implantable bone conduction hearing aids. These risks include facial paralysis and changes in the sense of taste.

²⁵The Floating Mass Transducer is a trademark of Vibrant-Med-El.

These risks occur because a branch of cranial nerve VII travels through the middle ear space. If the surgeon damages the nerve in the process of implantation, permanent alterations can result. Middle ear implants are still in the early stages of development and implementation. With improvements in technology, we are likely to see many more on the market.

10.5 HiSonic Hearing Aid

The HiSonic²⁶ hearing aid shown in figure 64 was developed as a way of providing hearing to people with severe to profound sensorineural hearing loss. The device provides ultrasonic (above 20 kHz) vibrations through bone conduction to the listener's skull, which are perceived by the listener as sound (see section 12). It has been produced by Hearing Innovations International, which was recently purchased by Misonix, a company that specializes in ultrasonic medical devices. Historically, the device has only been available in Tucson, Arizona, but this could soon change. The device consists of a bone conduction vibrator placed on the mastoid bone of the wearer. A study conducted by Staab et al (1998) demonstrated that, for people with profound hearing loss, the HiSonic was useful. Although there was considerable variability among the performance of the individual listeners, usefulness of the device was demonstrated in 65% to 70% of the participants (Staab et al., 1998).

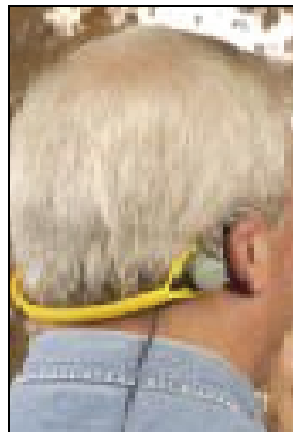

Figure 64. Photo of the Hi-Sonic Hearing device. (Downloaded from <http://www.misonix.com/medical/Intl/IntlProductInfo/intlAudiology>, June 15, 2005.)

The FDA provided marketing approval for the HiSonic-TRD (tinnitus relief device) in 2003, following positive results from clinical trials showing relief from tinnitus (Holgers & Håkansson, 2002). The device, similar in design to the original HiSonic, functions by transmitting ultrasonic

²⁶HiSonic is a registered trademark of Misonix.

sound by bone conduction to the user. However, there have been some reports in the literature that exposure to ultrasonic frequencies can cause tinnitus (Corso, 1963; Deatherage, Jeffress, & Blodgett, 1954), so long-term use of such a device may not be appropriate for some people.

10.6 Vibro-Tactile Communication Aids

Vibro-tactile communication aids are auxiliary communication devices originally designed for people with profound hearing impairment. Vibro-tactile devices have also been designed for use in people with normal hearing for specific applications such as navigation (see section 3). The devices designed for people with profound hearing loss convert acoustic signals into tactual and vibratory signals transmitted to the skin of the user. Vibro-tactile devices are not bone conduction hearing aids since they do not produce auditory sensation. They are tactual devices that communicate by touch and body vibration. Tactual perception and the concept of vibro-tactile communication have been described in section 3. Here, some examples of vibro-tactile aids to augment hearing are briefly described to demonstrate operational differences between bone conduction hearing aids and vibro-tactile aids. The discussion is limited to the multichannel aids that belong to the Tactaid family (<http://www.tactaid.com>).

The Tactaid is a vibro-tactile device designed to give people with profound hearing loss a secondary input from sounds occurring in their environment. The device, which is manufactured by Audiological Engineering Corporation, is multichannel and battery operated and contains multiple vibrators. The wearer attaches the device to his or her chest or the back of the neck. A microphone on the outside of the device detects sounds from the environment. The sounds are processed, a signal is sent to the vibrators, and the device vibrates in a particular pattern in response to the sound. The device is not intended to provide sound to the wearer but to provide an alternate means of experiencing sounds that occur in the environment. The manufacturers of the device recommend its use as an auxiliary aid in speech reading.

The simple version of the Tactaid (known as the Tactaid II or Little Tactile Device [LTD]) uses only two channels (vibrators) responding to low and high frequency signals. The signal is received by a single microphone and filtered into two channels. The main purpose of this device is to assist in speech reading, although the device is also helpful as an aid for auditory awareness of environmental sounds and as an auxiliary device for music perception. The low frequency channel transmits information about the vowel sounds and the rhythmic pattern of speech. The high frequency channel transmits information about the consonants.

The Tactilator was developed collectively by David Franklin (President of Audiological Engineering Corporation), Geoff Plant from Australia, and Gustaf Soderland from Sweden. Gustaf Soderland, who lost his hearing as a child through meningitis, uses a method that he refers to as tactiling where he feels the vibrations of a talker's voice in order to understand what s/he is saying. It was through the use of this method that the idea for a device emerged

(<http://www.tactaid.com>). The device was developed in the United States under a National Institutes of Health (NIH) grant in the 1990s.

The most current model of the Tactaid is the Tactaid 7. The device is primarily intended to be used by infants and young children for speech training. It includes seven vibrators that provide unique vibration patterns for each sound, based on the first two formants (frequencies with primary energy). The vibration patterns differ based on the place of vibration (which vibrator is set into motion), the movement of the vibration, the strength of the vibration and the duration of the vibration. The frequency of stimulation of the vibrators is 250 Hz. In addition, the device has a built-in automatic noise suppression circuit to reduce background noise. The device is intended to be placed on the user's chest or the back of the neck. An advanced user can place a hand across the array of vibrators to increase the clarity (intelligibility) of the transmitted messages.

10.7 Summary and Conclusions

Conventional bone conduction hearing aids and implantable bone conduction hearing aids have been discussed in this section. Although conventional bone conduction hearing aids were originally developed for people with conductive hearing loss, the implantable version has been used for people with sensorineural and mixed (conductive and sensorineural) hearing loss. Middle ear implants have been designed for use by people with conductive or sensorineural hearing loss. The recent advancements in implantable devices have made them more popular in recent years. However, implantable devices by definition require surgery, and no surgery is without risks and should therefore not be used as a first alternative for treatment. All the implantable devices that were discussed in this section have some substantial drawbacks. The presence of a bone conduction implant with a high amount of metal precludes the patient from undergoing an MRI; however, this is not the case with middle ear implants. Also, the implantation of a device would require surgery to remove it. Although the rate of surgical removal has been low for all devices, the potential for its need still exists.

An alternate method of vibratory stimulation is through a vibro-tactile device. This was designed specifically for people with profound hearing loss to enable them to obtain information from their environment about sound. The most common device on the market is the Tactaid. Vibro-tactile stimulation has also been used in specific applications with people with normal hearing, as was discussed in section 3.

11. Commercial Applications of Bone Conduction

Although transmission of sound through bone conduction has been known for a long time, the potential for its application has only been minimally used. Generally speaking, bone conduction technology has not been used in public interfaces (Belinky & Jeremijenko, 2001). Bone

conduction transmission has primarily been used in hearing aids and the clinical testing of hearing. As discussed in section 9, transmission of sound through bone conduction can be used clinically for the differential diagnosis of hearing disorders. By testing hearing thresholds through air and bone conduction, we can use differences in thresholds to determine the nature of a person's hearing loss as well as guide its treatment. In section 10, the use of bone conduction hearing aids was discussed for individuals with chronic middle ear pathologies or for those who are born without ear canals. All other applications of bone conduction transmission have not had a long history and were treated more like toys and gadgets. Recently, the use of bone conduction technology for people with normal hearing has gained some popularity in military and civilian environments. The present section discusses two-way bone conduction communication systems, hybrid systems that use bone conduction in the transmission or reception of auditory signals and air conduction for the other, and various special commercial applications.

11.1 General Characteristics of the Commercial Market

Bone conduction communication systems are available from several internet vendors but are not available in regular retail stores. The companies that make these devices are targeting potential users in the public safety (e.g., security forces, police, fire fighters), telemarketing, military, and paint ball game markets. The main problems with existing systems are that their technical aspects are poorly described and they are not optimized for specific applications. Because of the limited demand for these systems, which results from very limited public awareness about the benefits and capabilities of bone conduction transmission, they are also priced well above the level that would trigger wide public interest. Potential users may not be convinced to invest this amount of money in a device that they do not expect to provide specific advantages or benefits over what they are currently using.

Most of the available special purpose commercial systems are very new to the market, and the number of novelty items using bone conduction is growing fairly rapidly. Because of the novel character of the special purpose items and the fact that they are targeting quite narrow markets, their public acceptance levels are yet unknown. In many cases, such devices are used to attract buyers' attention to other items (e.g., communication equipment) and are not sufficiently well developed to be an operational option of choice. The minimal amount of technical information publicly available about most of the devices suggests that they may be products of novelty and commercial insight rather than extensive technical developments.

11.2 Bone Conduction Communication Systems

Bone conduction vibrators and contact microphones have recently been incorporated into several communications systems. Most of the systems incorporate air microphones and bone vibrators whereas others combine a contact bone conduction microphone with a pair of headphones. A very limited number of systems use both types of bone conduction transducers, and those systems are referred to as two-way bone conduction communication systems. Systems that incorporate bone

conduction into only one half of the transmission pathway (microphone or vibrators) are referred to as hybrid systems. Table 14 lists the main commercially available two-way bone conduction communication and hybrid systems along with the contact information for the company or its distributor.

Table 14. Listing of commercially available bone conduction communication and hybrid systems.

Company	Product Name	Uses	Contact Information
Temco Japan Company Limited	HG-17 (bone mic), HG-18 (boom mic), HG-20, HG-21, FM-200, SK-1, EM series voiceducer in-the-ear communication system	NBC, gas masks	http://www.temco-j.co.jp http://www.canadianwireless.ca/temco.html
Radioear / New Eagle / Sensory Devices	MH-3, MH-180S, MH-180H, MH-180	Special Forces and police	http://www.mhseriestacticalheadsets.com
PerCom / Audio Communications	HB-1 (communication system); 31MIT, 17MIT, inertial teardrop (bone conduction transducers)	firefighters	http://www.audiocomms.co.nz http://www.percom2000.com/home.htm
Duwomi Vonia	PH-80/PH-80S, PH-3050/EZ-D50, EZ-3300/EZ-D60, EZ-3000S, EZ-3300, EZ-4100S, EZ-4200S, BH-80PS, BH-20M, BH-20M-TM (throat mic), BH-10R (receiver), BH-11TR (transmitter), BH-70MB (communication headset), EZ-4100S, EZ-4200S, EZ-3000S	telemarketing, cell phones, personal computers, tactical communications	http://www.vonia.co.kr
Tactical Command Industries	Tactical Assault Bone Conduction Headset;	law enforcement	http://www.merchantmanager.com/tactical/headset_products.htm http://www.tacticalcommand.com
Savox Communications	HS-C (helmet communication with bone conduction microphone); E-C (ear bone conduction microphone and air conduction speaker)	law enforcement, firefighters	http://www.savox.com

Figures 65 through 72 show examples of the products listed in table 14 and include descriptions of their features. Figure 65 shows three of the bone conduction communication systems available from Temco, a company based in Japan with some offices in the United States. The HG-17, FM-200, and SK-1 are all full bone conduction communication systems. The HG-17, FM-200, and SK-1 are all two-way bone conduction communication systems. The HG-17 is a headset with a bone conduction microphone that sits on the vertex of the skull. It has two vibrators that sit on either side of the wearer's head near the temples. The headset is adjustable for individual user comfort and can be worn with or without a helmet. Both the FM-200 and the SK-1 were designed for use with nuclear, biological, and chemical (NBC) protective gear. Both systems have a single bone conduction vibrator and microphone encapsulated into a single piece. The FM-200 attaches to the straps of a gas mask, and the SK-1 adheres to the jaw of the wearer through the use of an adhesive.



Figure 65. Three of the Temco bone conduction systems: the HG-17 (left panel), the FM-200 face mask (center panel) and the SK-1 (right panel). (Downloaded from <http://www.temco-j.co.jp>, July 24, 2006.)

Figure 66 shows two hybrid systems also available from Temco. The HG-21 headset has a napeband that rests on the back of the user's head. The EM series of the Voiceducer²⁷ device is an ITE system that detects the wearer's voice through bone conduction transmission through the EAC. An air conduction loudspeaker delivers the radio signal down the EAC of the wearer. The shape of the Voiceducer EM is not custom made, so it is essentially one size fits all. A third hybrid system is the HG-18 (not shown in the figure) which is the hybrid version of the HG-17. The only difference between the two is the microphone. The HG-18 uses an air conduction boom microphone and the HG-17 uses a bone conduction microphone.



Figure 66. Two hybrid systems from Temco. (The left panel shows the HG-21 headset which uses a pair of bone conduction vibrators with an air conduction boom microphone. The right panel shows one of the Voiceducer EM ITE devices with a bone conduction microphone and an air conduction loudspeaker. Downloaded from <http://www.temco-j.co.jp>, July 24, 2006.)

Figure 67 shows two bone conduction hybrid systems from Radioear. Both systems use bone conduction vibrators along with an air conduction noise-canceling boom microphone. There are three versions of the MH180 system with the only difference being the headband configuration. In the standard configuration, the headband goes across the top of the head (as shown in figure 67); in the "H" version, the headband is a napeband (horizontal) that rests on the back of the user's head. In the "S" version, marketed for snipers, the headset has only one bone conduction vibrator.

²⁷Voiceducer is a trademark of Temco Japan Company Limited.

Figure 68 shows a system using transducers from PerCom. PerCom is a company based in New Zealand whose products are distributed through various companies within the United States. In this figure, the product shown is the HB-1 hybrid system distributed by FireCom incorporating a PerCom bone conduction microphone with an ear piece for reception of radio communication. PerCom also makes bone conduction vibrators, as shown in figure 69, which can be incorporated into a system such as the HB-1 resulting in a two-way bone conduction communication system.



Figure 67. Two hybrid bone conduction devices from Radioear/New Eagle/Sensory Devices. (The left panel shows the MH3 system and the right panel shows the standard MH180 system. Downloaded from <http://www.mhseriestacticalheadsets.com>, July 24, 2006.)



Figure 68. The HB-1 hybrid system incorporating the PerCom 17MIT bone conduction microphone. (The system is designed to be placed in contact with the head through a cloth band. This can be worn under a helmet or as a stand-alone system. The device is currently distributed in the United States by FireCom. Downloaded from <http://www.firecom.com>, September 20, 2006.)

Figure 69 shows three of the bone conduction transducers available from PerCom. The 17MIT was designed for use as a microphone and the 31MIT was designed for use as a vibrator. However, the inertial teardrop transducer can function as a microphone or a vibrator.



Figure 69. Bone conduction transducers available from PerCom: 17MIT (left panel), 31MIT (center panel), inertial teardrop transducer (right panel). (Downloaded from <http://www.percom2000.com/home.htm>, July 24, 2006.)

Figure 70 shows two examples of bone conduction devices available from Duwomi Vonia. Based on information from their web site, most systems from Duwomi Vonia incorporate bone conduction vibrators and when needed, use air conduction or throat microphones. They do, however, have a bone conduction microphone named the BCT (bone conduction technology). Their devices are designed differently, depending on the intended application. Their intended applications include personal computers (PCs), internet chat, playing computer games, public safety (fire, police), cellular phones and call centers. Duwomi Vonia is one of the few companies marketing their product for use by individual consumers. The PH-80/PH-80S, PH-3050/EZ-D50, and EZ-3300/EZ-D60 are marketed for use with PCs or cellular phones.



Figure 70. Two bone conduction devices from Duwomi Vonia: the EZ-3000S (left panel) and the BH-70MB (right panel). (The EZ-3000S is a hybrid system with bone conduction vibrators and an air conduction boom microphone, and the BH-70MB is a full bone conduction communication system with the bone conduction microphone located on the side of the head. Downloaded from <http://www.vonia.co.za>, September 20, 2006.)

Figure 71 shows a hybrid bone conduction communication system available from Tactical Communication Industries. This product is specifically marketed for military and tactical applications. The device has two bone conduction vibrators and a boom air conduction microphone.



Figure 71. A hybrid bone conduction communication device from Tactical Communication Industries. (The left panel shows the device on a manikin head and the right panel shows the device itself. Downloaded from <http://www.tacticalcommand.com>, September 20, 2006.)

Figure 72 shows two hybrid bone conduction communication systems available from Savox Communications. These products are marketed to fire fighters and law enforcement officers. The HS-C is marketed to fire fighters as a helmet-mounted communication system and the EC is marketed to law enforcement officers as a hands-free device that is worn in the ear. Each device has a single air conduction loudspeaker with a bone conduction microphone.



Figure 72. Two hybrid bone conduction communication devices from Savox Communications. (The left panel shows the HS-C and the right panel shows the EC. Both have a bone conduction microphone and an air conduction loudspeaker. The HS-C is designed to be mounted in a helmet and the EC is worn in the ear canal. Downloaded from: <http://www.savox.com>, October 6, 2006.)

Almost all the systems listed in table 14 have been marketed to and used by some military or paramilitary groups. For example, some groups in the Australian military use PerCom bone conduction components in their helmet-mounted communication systems (Ramsey, 2004). In the United States and in Europe, special operations forces have been known to use two-way or hybrid bone conduction communication systems in some of their operations. Additionally, the U.S. Army Technical Escort Unit (NBC rescue group) has used the SK-1 version of the Temco bone conduction communication system shown in figure 65.

Some Army groups (e.g., U.S. Army Rangers) have previously tried bone conduction communication systems but have decided not to incorporate them into their technical base at this time. In general, the bone conduction communication systems are still not very popular among the military because of their poor performance during adverse listening conditions, lack of acceptable interfaces to various forms of headgear, and lack of general knowledge about their proper use. Because of the low demand for bone conduction communication systems, these products have been designed without specific considerations for military applications since the companies have been successful in marketing them to other groups (police, fire fighters, etc.). With further progress in basic research on the pathways of bone conduction transmission and increased quality of available transducers, commercial and military use of bone conduction technology for communication purposes can rapidly accelerate.

11.3 Advantages and Limitations of Bone Conduction Communication Systems

As the phenomenon of sound transmission through bone conduction becomes better understood, it can be used in environments when the listener does not want to have his or her ears covered, when the listener does not want someone to know that s/he is listening to something, or when the listener needs to wear hearing protection. In these situations, listening through bone conduction allows for stimulation to the ears without interfering with the pinnae. However, listening through bone conduction has advantages and limitations that are different in quiet and noisy environments. We discuss those aspects in the next sections.

11.3.1 Quiet Environments

In quiet environments, the use of headphones for communication systems has historically been the preferred method because other viable alternatives were not available. Typically, sounds presented to a listener through headphones are perceived as being located somewhere within the head. However, sounds can be spatially separated when delivered to the left and right ears and differ to a sufficient degree. Spatial separation is beneficial in multi-channel communication because it allows sounds to be perceived as originating from locations outside the head. Such sound externalization can be obtained if we apply transfer functions to the transmitted signals, which compensate for the loss of pinna cues such as in the case of HRTFs. Until recently, the thought has been that spatial separation cannot be accomplished through bone conduction communication. The lack of spatial separation was used as a main argument against the use of bone conduction for commercial multi-channel applications. However, as discussed in section 7, recent data suggest that this is not the case (MacDonald, Henry, & Letowski, 2006). Spatial separation of multi-channel input is possible with bone conduction transducers, and therefore, bone conduction transmission is a viable alternative to headphones even when spatialization is desired.

The primary advantage of the use of bone conduction communication systems in quiet environments is that they allow the listener to maintain open EACs. Open EACs allow for the simultaneous perception of soft environmental sounds and reception of communication information.

One of the primary disadvantages of the use of bone conduction in quiet environments is that vibrators can demonstrate undesirable amounts of aerial leakage. This sound, depending on its intensity, can be heard by listeners in the immediate vicinity of the person receiving the message. The receipt of sound by unintended listeners could be detrimental if the information needs to be protected, as is typically the case in military applications. This would be especially important in covert operations where the individuals would not want others to know their location. Fortunately, aerial leakage is not necessarily inevitable and the goal of the development of an optimal bone conduction communication system for use by the military is to significantly reduce or eliminate it.

In listening situations when simultaneous remote communications (such as by radio) and interaction with the immediate environment are desired, the use of bone conduction for radio communication can offer a supplement to normal, natural listening without occluding the ears. This advantage is useful for military personnel but can be useful to civilians as well. For example, cellular phone users already use air conduction hands-free headsets in order to communicate over the phone while maintaining awareness in their environment. However, the hands-free devices on the market all involve an earphone that is worn over or in the ear, which may affect the wearer's safety if a sudden decision based on sound localization is needed. If a hands-free headset used bone conduction, perhaps the listener would have greater awareness of environmental sounds.

Another example of potential users of bone conduction listening systems is people with hearing loss who wear hearing aids. For these people, an assistive listening device (ALD) is helpful for difficult listening situations. ALD is a general term applied to any device that is used to improve communication, except hearing aids. These devices include amplified telephones, teletype-writers (TTYs) and telecommunications devices for the deaf (TDDs), amplified or vibrating alarm clocks, flashing lights, etc. One type of ALD for use with the television involves headphones that are hard wired or wireless (through infrared or FM transmission) to allow the listener to hear the television directly. However, the use of these devices often eliminates the person's ability to communicate with other people in the room because his or her ears are occluded. What if the user of the ALD also wanted to talk with his or her spouse, perhaps during commercials? In this case, the user of an ALD with headphones would have to remove the headphones and possibly re-insert hearing aids in order to communicate with someone else. If the ALD used bone conduction, it might be possible for the wearer to retain the hearing aids and listen to both the television and a companion and to be aware of sounds in the environment such as the telephone or doorbell.

11.3.2 Noisy Environments

Noise has less of an effect on the perception of bone-conducted sound than air-conducted sound (Knudsen & Jones, 1931). Perception of acoustic signals transmitted through headphones and

noise leaking into the EAC usually coincide with each other. The covering of the ear prevents any impression of distance for the noise, which is therefore localized in the EAC. When the acoustic signal is transmitted through the bones, its auditory image is positioned in the center of the head and is consequently separated from the noise image outside the head. Spatial separation between the sounds improves the detection of the signal.

When a person is in the presence of high noise levels and is asked to communicate across a radio or telephone, the transmission and reception of information can be challenging. In high noise levels, the risk of hearing damage presents an additional problem. The wearing of hearing protection devices (HPDs) is essential in order to protect a person from hearing damage from high levels of noise. HPDs are typically made in the form of earplugs or earmuffs. Earplugs are inserted into the EAC and earmuffs are worn over the ears. The presence of HPDs makes listening through headphones difficult if not impossible. Bone conduction vibrators can be worn on the head without interfering with the use of either type of HPD. In fact, as discussed in section 6, the presence of HPDs that plug or cover the ears makes sounds transmitted by bone conduction to be perceived as louder or higher in intensity because of the occlusion effect; the same phenomenon is present in conductive hearing loss.

The presence of noise also interferes with verbal communication and transmission of voices over distance. A typical air conduction microphone is designed to detect sound within the environment without differentiating between speech and background noise. In this case, the talker's voice can be masked out by the noise at the same point of the microphone. There are several technologies designed to cancel the noise while allowing the speech to be transmitted. These technologies work through algorithms known as noise cancellation and active noise reduction (ANR). The military currently employs such technologies in various forms of headgear used by the operators of vehicles (both ground and airborne). Although these technologies work well in noise, they require power and are quite expensive. A less expensive and less power-consuming option for transmitting the voice in the presence of noise is through the detection of the vibrations of the vocal folds by a throat microphone or a bone conduction microphone. Both types of microphones detect much less noise from the environment than an air conduction microphone does. A throat microphone detects the vibrations made by the vocal folds through the skin covering the larynx. The clarity of the received speech can be good, but wearing a throat microphone in physically demanding military operations, especially those conducted in cold, heat, or excessive humidity, is not an acceptable solution. In addition, most people do not like to wear anything in the ears or around the neck because it can make them feel as though it interferes with their normal ability to hear their surroundings. Conversely, a bone conduction microphone can be positioned on the talker's head. This microphone works in the same way as a throat microphone except that in this case, it detects the vibrations of the skull that are caused by the vocal folds and transmitted to the skull. Placing the microphone on the head has many advantages for covert and normal military or security operations since it can be covered with the person's hair or hidden in a casual hat or cap. Bone-

conducting microphones combined with bone vibrator technology can provide a complete communication system that is very robust and independent of platform and environment.

11.4 Special Purpose Commercial Systems

Bone conduction transmission has been incorporated into a variety of special purpose devices. Table 15 shows several commercially available products that incorporate bone conduction transmission, including the name of the manufacturer or distributor and their respective contact information. These devices can be separated into five general categories: telephone devices, toys, devices for swimmers, devices for listening to music, and assistive devices for people with hearing and vision disabilities (including two for tinnitus relief).

Table 15. Special purpose commercially available devices incorporating bone conduction.

Company	Product Name	Uses	Contact Information
Mirafone	OP201	Bone conduction telephone	For sale by multiple companies
Tu-Ka Cellular Tokyo, Inc. (subsidiary of KDDI Corp.)	Sanyo TS41	Bone conduction cellular phone	Available in Japan
Aquasphere	AquaFM and AquaFM pro	Listening to FM radio or talker through teeth while swimming; bone conduction vibrators in mouthpiece; pro unit marketed for swim teams with a transmitter carrying the coach's voice	http://www.aquasphereusa.com ; 800-854-7066
ATS International Co. Ltd.		Bone conduction TV/telephone headset	http://www.atk.com ; available in southeast Asia
NTT DoCoMo Group (Yokosuka R&D Center)	FingerWhisper	Hands-free option for cell phones	http://www.nttdocomo.com
Misonix	HiSonic, HiSonic-TRD (for tinnitus relief)	Only FDA-approved tinnitus relief device (TRD)	http://www.hearinginnovations.com ; (800) 694-9612
Tiger Electronics	Tooth Tunes	toothbrush for children	http://www.hasbro.com
Tiger Electronics	Sound Bites	candy/toy for children	http://www.hasbro.com ; no longer available
Finis, Inc.	SwiMP3	Listening to music while swimming - MP3 player	http://www.finisinc.com ; available through distributors
Aliph	Jawbone	Hands-free option for cell phones	http://www.jawbone.com
Duwomi Vonia	EZ-80P/S20, EZ-3200P/S20, EZ-500P/S20	listening to music	http://www.vonia.co.za

11.4.1 Telephone Devices

Mirafone has developed a bone conduction land line telephone for use by people with hearing loss. The handset of the phone contains a vibrating ball called the DirectVibe²⁸ pulsator as part of the receiver. This device was designed to provide audio information through bone conduction and air

²⁸DirectVibe is a trademark of Mirafone.

conduction (through a combination of a bone vibrator and a standard loudspeaker), which allows people with normal and impaired hearing to use the same telephone. The company has promoted the phone as useful to those with impaired hearing and directs the user with hearing loss to press the receiver portion of the handset against his or her temple in order to hear the person speaking. The DirectVibe technology was awarded the honor of “Best of What’s New in 1998” by Popular Science magazine. As shown in figure 73, the vibrator is located in the center of the receiver portion of the handset. This requires placement of the phone in front of the face and may not be appealing to many people.



Figure 73. Mirafone telephone with bone conduction vibrator in receiver. (Downloaded from <http://www.hella.ru> September 1, 2006.)

Along the lines of the Mirafone, in 2003, a Japanese company called Tu-Ka Cellular Tokyo Incorporated developed a cellular phone that uses bone conduction technology. The Sanyo TS41, shown in figure 74, uses a bone conduction vibrator that replaces the traditional loudspeaker receiver in the handset. The listener presses the phone against a bony portion of his or her head in order to hear. Marketing photographs of the device show a user holding the phone against her jaw, but actual user reports indicate better quality when the receiver is placed closer to the ear. Although the device provides what is deemed a novel approach by some, the application has not been readily accepted by a large number of users.

A promising aspect of the incorporation of bone conduction technology with cellular phones lies in the desire to have hands-free capabilities. Bone conduction transmission bypasses the traditional loudspeaker to direct the sound to the listener’s ears. An air conduction microphone transmits the wearer’s voice to the person on the other end of the call. For the purposes of driving, unoccluded ears allow the user to monitor sounds within and outside the vehicle while simultaneously using a cellular phone. Theoretically, any device that has been designed for use with a radio could be used with a cellular phone; however, only a small number of companies have specifically marketed their products for that use.



Figure 74. Sanyo TS41 bone conduction cellular phone (downloaded from <http://www.i4u.com/article942.html>, July 28, 2005.)

Hands-free devices for cellular phones include the FingerWhisper developed by the NTT²⁹ DoCoMo Group (Yokosuka R&D Center) in Tokyo, Japan. In this system, the microphone is located on the inner side of the wrist and the vibrations from the caller are transmitted from the wrist to the user's index finger (see figure 75). Users place their index fingers on their heads near their EACs. The sound is transmitted through vibration to the index finger to the skull of the user. The user's hand is in a position very similar to what would be observed if the user were using a regular cellular phone, so the company believes that it will be more acceptable than other bone conduction devices that are held in front of the face. Although it is marketed as a hands-free device, it requires the hand to be in contact with the head and is therefore not truly hands free. This device is still in the developmental stage but could hit the market in a few years.

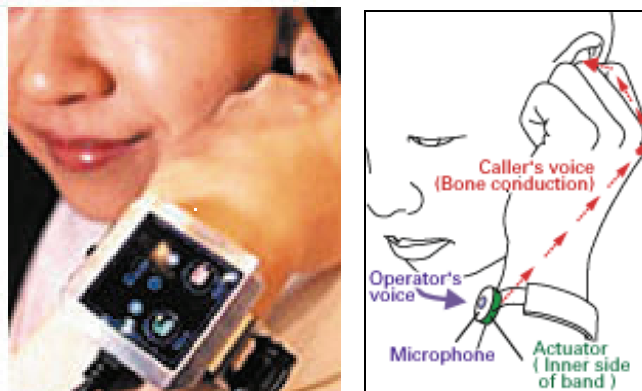

Figure 75. Photograph of the FingerWhisper and accompanying schematic. (Downloaded from <http://www.nttdocomo.com/corebiz/rd/fingerwhisper.html>, July 28, 2005.)

²⁹not an acronym

Another device that has been marketed for use with cellular phones was developed by Duwomi Vonia. This device, shown in the left panel of figure 70, uses bone conduction vibrators and an air conduction boom microphone for communication. This system is also appropriate for use in general radio communication, but the fact that it is being marketed to the individual consumer for use with cellular phones is promising for the acceptance of bone conduction technology by the general public.

11.4.2 Toys/Entertainment

The applications of bone conduction technology in the entertainment and toy industries are probably the first non-medical applications of bone conduction. Although no longer in production, a candy called Sound Bites³⁰ from the Tiger Electronics division of Hasbro, Inc., was marketed in local toy stores in the 1990s. The candy device emitted sounds that were transmitted through the teeth when a lollipop was inserted into the device and a child chewed on it. The sounds were then transmitted through the teeth to the ears of the user.

In 2005, the Tiger Electronics division of Hasbro, Inc., announced the development of a toothbrush called “Tooth Tunes” that would play music transmitted to the listener through his or her teeth and jawbone to the inner ears (Filo & Capper, 2000). The toothbrush is designed to play a 2-minute clip of a song in order to encourage brushers to brush for the recommended period of time.

11.4.3 Devices for Swimmers

Bone conduction transmission has been used by people listening to music while swimming. Since water is incompatible with traditional personal stereos, the use of bone conduction vibrators allows for transmission to the ears of the listener without posing damage to the system. Two such systems exist on the market: the AquaSphere Aqua FM³¹ Snorkel and the Finis SwiMP3. The AquaSphere Aqua FM Snorkel shown in figure 76 uses the teeth as the bone conduction interface. The user places the snorkel in his or her mouth and the mouthpiece contains bone conduction vibrators. The sounds are then sent through the teeth to the bones of the skull. The device allows for FM transmission of a radio signal (Aqua FM) or the voice of a talker wearing a microphone (Aqua FM pro). The Aqua FM pro was marketed for use by swimming teams so that the coach could communicate with the swimmers during practice. This device is waterproof to 10 meters (33 ft) and weighs 9.3 oz (without batteries).

³⁰Sound Bites is a trademark of Tiger Electronics.

³¹Aqua FM is a trademark of AquaSphere.

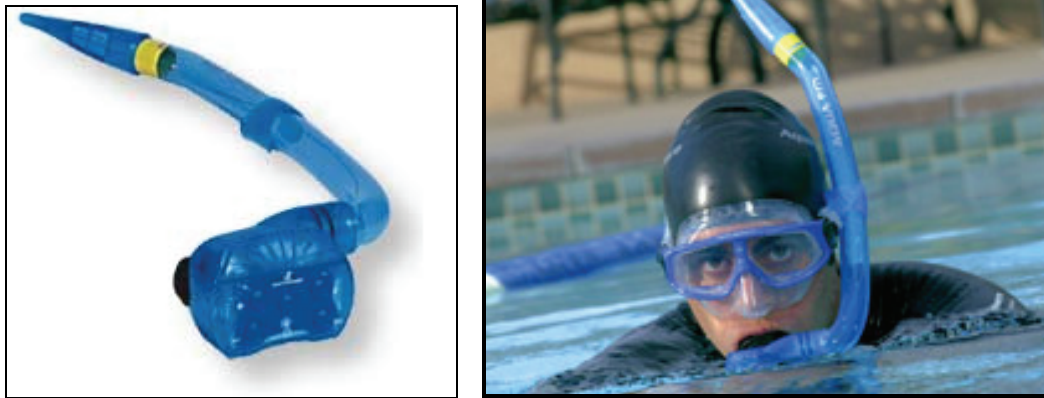

Figure 76. A photograph of the AquaSphere Aqua FM system (left panel) and a photograph of a person using the Aqua FM. (Downloaded from <http://www.aquasphereusa.com>, September 20, 2006. The mouth-piece contains a bone conduction vibrator that transmits the radio signal to the listener through their jaw <http://www.beachcomber.com>.)

The SwiMP3 by Finis shown in figure 77 was first placed on the market in the fall of 2004. It is an MP3 player that uses bone conduction vibrators to transmit music to the listener. The device has bone conduction vibrators that are positioned on the user's temples beneath the straps of his or her goggles. The strap from the goggles maintains the pressure on the vibrators, which is needed for optimal transmission. This product is marketed to competitive swimmers for use during their "workouts" at the pool. The MP3 player is encased in a water-resistant material with buttons on the outside for control of the system, and the interface component attaches to the back of the strap on a pair of goggles. According to the company, the device is wired to present stereo sound through the transducers rather than split monaural, as is done with many other commercially available devices. Its advertisement that it presents true stereo sound provides further evidence that sounds presented through two vibrators on the sides of the head can be perceived spatially (see section 7). The SwiMP3 is stated to be completely waterproof, but the company indicates that using it at depths of greater than 10 feet can reduce the transmission effects of the vibrators.

Young adults are a good target market for these technologically novel devices since they combine a much loved pasttime (listening to music) with exercise. Young adults tend to be drawn to more gadgets, so as bone conduction technology is more widely accepted, it is likely to be adapted to more and more devices.



Figure 77. A photograph of the SwiMP3 from Finis. (The box positioned on the back of the wearer's head allows for interface with the MP3 player and the two vibrators, located on the temples of the wearer are used to receive the signal from the player. Downloaded from <http://www.store.finisinc.com>, September 20, 2006.)

11.4.4 Assistive Devices

There are many devices on the market to assist in the communication and daily function abilities of individuals with disabilities. As a group, these devices are referred to as assistive devices. Devices designed to assist or supplement hearing are referred to as ALDs. They include telephones, devices for listening to the television, alerting devices (for doorbells, alarm clocks, watches, etc.), FM systems used by children in school and anything else that enhances function in daily life. Some devices that have traditionally used headphones have been adapted to include bone conduction technology. One such example is a television headset device that uses bone conduction technology. The use of bone conduction on such a device allows for the EACs to be unoccluded and therefore allows the user to receive environmental sounds in combination with the desired signal (the television). Such a device was developed by ATS³² International Company Ltd in Korea and is available in southeastern Asia.

Alarm clocks have been adapted with bed shakers that are placed under the mattress or under the pillow of the sleeper. Traditionally, alarm clocks for deaf people use blinking lights, but vibration is more useful when one is setting an alarm to go off during daylight hours. When the vibratory alarm goes off, the device vibrates rather than making an audible signal which the individual with hearing loss may not hear. Since it is intended to be an alerting device, the vibration is more of a thumping than anything that would be considered pleasant.

³²not an acronym

Vibrating watches are also available on the market for use by people with hearing and visual disabilities. Although a person with a visual disability only could hear a watch alarm, it is sometimes more desirable to have a subtle alarm.

Tinnitus is defined as the perception of ringing in the ears when no external ringing is present. The etiology for tinnitus is not often known. For some, it is related to damage caused in the inner ear; for others, there is no definitive cause and, even more frustrating for the patient, there is no known cure. As discussed in section 10, one device that has been marketed for the treatment of tinnitus is the HiSonic device developed by Hearing Innovations. This TRD has only been available in Tucson, Arizona, and provides ultrasonic stimulation to the wearer in an attempt to eliminate tinnitus. It is currently the only product approved by the FDA for this purpose. In addition to the TRD, HiSonic has an ultrasonic bone conduction hearing aid on the market (see section 10).

In summary, there are many devices on the market for use by consumers as well as professionals. As people become more technologically savvy, more devices using bone conduction technology are likely to appear on the market. As the saying goes, what was old is new again. Bone conduction transmission has been used for centuries to provide sound to people with impaired hearing. Only recently has there been a resurgence of this technology for use with people with normal hearing.

11.4.5 Devices for Listening to Music

Although AquaSphere and Finis have developed technologies for listening to music and swimming, Duwomi Vonia is the only company known to specifically market its device for listening to music during occasions other than swimming. The device produced by Duwomi Vonia is simply designed as a replacement for a standard pair of headphone. Three different versions of these devices are shown in figure 78. The intended use of a bone conduction device for listening to music implies that the company is using a true stereo signal presented to two bone conduction vibrators. Again, this application is promising for the acceptance of bone conduction technology by future users as well as the application of spatialized audio through a bone conduction interface.



Figure 78. Three versions of the Duwomi Vonia devices designed for listening to music: EZ-80P/S20 (left panel), EZ-3200-S20 (center panel), and EZ-500P/S20 (right panel). (Downloaded from <http://www.vonia.co.va>, September 20, 2006.)

11.5 Summary and Conclusions

Bone conduction technology has recently been incorporated into a variety of commercial products including communication systems and other devices. Some of the products, such as the Sound Bites toy, have exploited the phenomenon of bone conduction transmission and used it for entertainment to sell their product. Other products such as the Mirafone telephone have attempted to apply bone conduction transmission to assist people who are not able to use other devices.

Belinky and Jeremijenko (2001) suggested the use of bone conduction technology in headrests to facilitate hands-free cellular phone operation or for listening to music without disturbing other people in the same room. Other potential applications may include incorporating bone vibrators mounted in chairs in conference rooms or a movie theater to provide an additional channel of information when needed.

Although some communication systems using bone conduction transmission have been targeted to military and public safety groups, they have not been specifically designed for these applications. In order to successfully apply bone conduction transmission to military applications, modifications of the transducers themselves will need to be made in order to increase their power output to allow for better communication in noise and reduce their aerial leakage for use in quiet environments.

Regardless of the need for improvements for specific applications, the public is becoming more familiar with the potential applications of bone conduction transmission and is likely to become more accepting of its incorporation into commercial products in the future.

12. Perception of Ultrasonic Sounds

The frequency range of human hearing is normally defined as extending from 20 Hz to 20 kHz (Newby & Popelka, 1985). This range is commonly referred to as the sonic range. The lower limit of hearing (20 Hz) is defined by the lowest frequency at which the listener hears one continuous sound. The upper limit of hearing (20 kHz) is defined by the highest frequency at which the listener still has an auditory sensation, regardless of sound intensity. The highest frequency perceptible differs greatly among individuals and is difficult to determine because some high frequency sounds can cause a painful or a tactile sensation but not an auditory sensation. In addition, some investigators have noted that the operational (normal) range of human hearing may be extended to frequencies beyond 20 kHz when the ear is stimulated by bone conduction as opposed to air conduction. Ultrasonic frequencies refer to frequencies above the range of air conduction hearing (greater than 20 kHz), and the human ability to hear sounds in this frequency range is normally referred to as ultrasonic hearing.

Although air-conducted sounds cannot be heard at frequencies above 20 kHz (Wever, 1949), ultrasonic hearing as high as 100 kHz has been demonstrated through bone conduction stimulation.

Ultrasonic hearing has been found to be capable of supporting frequency discrimination and speech detection in normal and older people with severe and profound hearing loss. One of the first groups of investigators to report perception of ultrasonic frequencies by bone conduction demonstrated this phenomenon by generating ultrasound waves in water (Deatherage et al., 1954). First, auditory perception was noted when a listener's jaw bone was placed in contact with a container filled with water in which a transducer produced a signal of 50 kHz. The threshold for this signal was approximately 2000 dynes/cm², which equates to about 140 dB SPL. Second, auditory perception was demonstrated through submersion of the listener in a container of water containing the transducer. In this condition, the threshold was approximately 1000 dynes/cm² at 50 kHz, which equates to about 134 dB SPL. To support their claims that the vibrations were being perceived by bone conduction, Deatherage et al. (1954) showed perception of a 7-kHz signal in a body of water at a threshold of 12 dynes/cm², which agreed well with previous bone conduction threshold data obtained by Bekesy using direct mechanical stimulation.

Since this early report of auditory perception of ultrasonic stimuli delivered through bone conduction, several investigators have pursued measurement of the human auditory system's sensitivity and discrimination ability in the ultrasonic range. For example, Corso (1963) evaluated high frequency sensitivity to bone-conducted sounds by people with normal air conduction hearing. Placing vibrators on the mastoid bone, Corso measured bone conduction thresholds for frequencies between 6 and 95 kHz and reported good sensitivity for frequencies below 14 kHz and poor or no sensitivity to sounds of frequencies between 20 and 95 kHz. In contrast, a later study demonstrated that the sounds in the ultrasonic range can be heard by listeners (Lenhardt, Skellet, Wang, & Clarke, 1991).

The mechanism through which ultrasonic sound is perceived by the listener is not known, although several theories exist. These theories include

- Perception by the saccule within the vestibular system,
- Demodulation of the ultrasonic stimulus through the bones of the skull, which is then perceived by the cochleae,
- Direct stimulation of the brain matter and cerebrospinal fluid, and
- Direct stimulation of the cochleae through the brain.

The first theory is that the bone-conducted sound is perceived by the saccule, one of the three vestibular canals present in the inner ear, as demonstrated through the perception of ultrasound in people with nonfunctional cochleae (Lenhardt et al., 1991). Figure 79 is a diagram of the cochlea for review. In order to accept the saccule theory, the traditional pathways need to be eliminated first (Dobie, Wiederhold, & Lenhardt, 1992). In support of this effort, several investigators have demonstrated that ultrasonic stimulation through bone conduction cannot be masked through air conduction which leads away from a cochlear-based process. Furthermore, ultrasonic signals presented through bone conduction cannot be measured in the EAC (Staab et al., 1998).

A second theory about the perception of ultrasound is that the bone conduction process is sufficiently nonlinear to demodulate the signal (Dobie et al., 1992; Lenhardt et al., 1991). Demodulation refers to the perception of a frequency that is within the audible range that represents the fluctuations of the carrier signal. According to this theory, the presentation of ultrasonic vibrations to the skull does not allow for transfer of these vibrations through the middle ear to the cochlea but to the cochlea directly. The cochlea then demodulates the signal into a range where it can be heard.

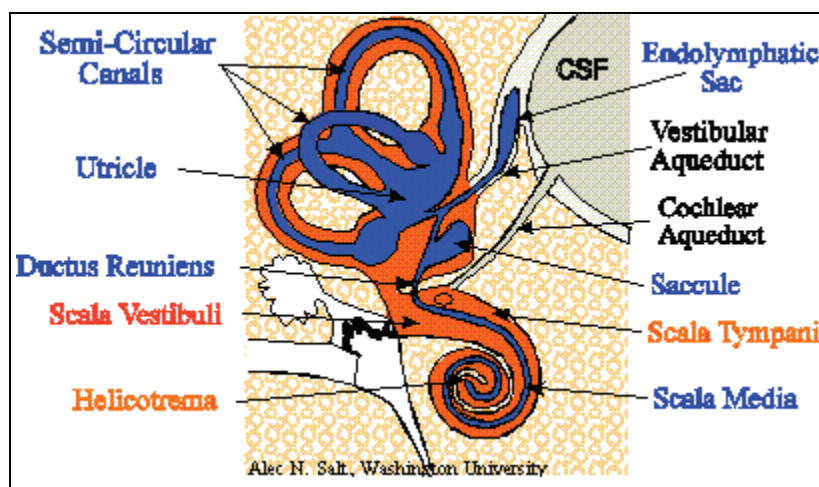

Figure 79. Spatial relationship between the structures of the vestibular system, the cochlea, and the cerebrospinal fluid (CSF) spaces (Salt, 1996).

Several investigators have argued against the theory of the bone conduction pathway for ultrasonic perception following an examination of ultrasonic stimulation through the use of magnetoencephalography (MEG) (Hosoi et al., 1998). In this procedure, areas of the brain are examined through a scanning device to determine where neurons are activated in response to a particular stimulus. Hosoi and colleagues (1998) stimulated listeners who had normal hearing with ultrasonic sounds by placing a vibrator on their sternocleidomastoid muscle (between the neck and shoulder). They found brain activity in response to these stimuli in the auditory cortex. This was true for people with normal hearing and for those with profound hearing loss. Imaizumi et al. (2001) found the same results using positron emission tomography scans. Again, stimulation in people with normal hearing or profound hearing loss resulted in activation of the auditory cortex. This activation occurred through stimulation by air conduction, bone conduction, ultrasound and vibro-tactile methods (Imaizumi et al., 2001). Regardless of the pathway or mechanisms behind the phenomenon, it has been demonstrated that ultrasound can be perceived by the listener when vibrations are applied directly to the human head or neck.

When an ultrasonic carrier signal, which is presented to the listener through bone conduction, is amplitude modulated by a speech signal, the result is a clear perception of the speech stimuli and not a sense of high-frequency vibration. In a study by Lenhardt and colleagues (1991), speech recognition rates through this method for people with normal hearing were on the order of 83%

for the WIPI (word-identification through picture identification) task. For people with profound hearing losses (pure tone averages of greater than 90 dB HL), performance in the same test was between 20% and 30%. These results support the belief that ultrasonic hearing may be used as a communications channel and thus as a non-surgical approach in the rehabilitation of profound hearing losses. The results also imply that ultrasonic stimulation for speech communication may be applicable for people with normal hearing.

An amplification device using ultrasonic stimulation through bone conduction called HiSonic was developed by a group of investigators in Arizona (Staab et al., 1998). This device was developed for use with people with profound hearing loss for whom standard hearing aids would not provide sufficient amplification. Such a device would allow a non-surgical alternative to cochlear implants as a hearing solution (see section 10). The device consists of a bone conduction vibrator that is positioned on the mastoid bone of the wearer. In the Staab et al. (1998) study, pure tone stimuli in the range of 500 to 2000 Hz were shifted in frequency to the ultrasonic range, and thresholds were measured for listeners with normal hearing as well as those with profound hearing loss. For the people with profound hearing loss, a comparison of thresholds measured with and without the ultrasonic shift showed a clear advantage of using the HiSonic device in that thresholds obtained with the device were considerably lower than those obtained without the device. Although there was considerable variability among the performance of the individual listeners, benefit through use of the device was demonstrated in 65% to 70% of the participants (Staab et al., 1998).

The third theory about a mechanism for ultrasonic perception is that the skull vibrations are being transmitted directly to the brain and surrounding CSF, including direct stimulation of the auditory cortex. Skull vibrations can be transmitted to the cochlear fluids and to the non-compressible brain matter and the surrounding CSF. The resulting changes in fluid pressure can be transmitted through the internal auditory meatus and cochlear aqueduct to the perilymph of the scala tympani or through the vestibular aqueduct to the endolymphatic sac of the vestibular system and further to the saccule (see figure 79). This mechanism of bone conduction was proposed as an alternate pathway explaining the presence of auditory sensation during direct stimulation of brain tissue and the CSF. However, the hypothesis of the vibration transmission from the CSF to the cochlear fluids is contradicted by relatively high mechanical damping of structures (neurons, blood vessels, connective tissue) occupying the aqueducts (Bystrzanowska, 1963, p. 19).

The fourth theory about the mechanism for ultrasonic perception is a mechanical conduction of sound to the cochlea proposed by Freeman et al. (2000) and Sichel, Freeman, and Sohmer (2002). This mechanism involves direct excitation of the CSF in the skull cavity. The CSF is the watery fluid that occupies the spaces around the brain and the spinal cord providing shock absorption protection to these organs. During some conditions, this fluid can enter the cochlea from the subarachnoid space that is connected to the scala tympani through the cochlear aqueduct (diameter ~ 0.5 mm). The investigators in these two studies directly vibrated the brain matter of rats, guinea pigs, and fat sand rats and demonstrated that direct stimulation of the brain

through a bone oscillator resulted in measurable ABRs. Progressive elimination of potential bone conduction mechanisms (i.e., ossicular chain, meatus, and skull through craniotomy) did not result in complete elimination of the ABR. This finding supports the notion that an auditory sensation can arise from direct vibration of the brain and CSF. The difference in the interpretation of the mechanism involved is in the identification of the location of perception. The hypothesis that auditory stimulation of the brain and CSF is possible is also supported by some results of human studies (Sohmer et al., 2000). The studies did not eliminate direct stimulation of the auditory cortex as was theorized by others but theorized that the stimulation was directly detected by the cochleae.

The use of ultrasonic stimulation is not without its contraindications. Several investigators have noted tinnitus of several days' duration as a side effect associated with the ultrasonic stimulation, which could be an early sign of hearing damage (Corso, 1963; Deatherage et al., 1954). This side effect is not to be taken lightly. In order to consider the use of ultrasonic stimulation for any person, the safety of that provision must be carefully considered. To our knowledge, there are no reports about the safety aspects of the provision of ultrasonic stimulation of the bones of the skull. Until those data are made available, long-term use of ultrasonic stimulation should be avoided.

In summary, there is evidence to suggest that ultrasonic frequencies can be perceived as sound by the listener when they are transmitted through bone conduction vibration on the skull. The pathway for such perceptions is not clear, but four theories have been proposed, ranging from demodulation by the auditory mechanism to the detection of sound by the CSF within the skull cavity. Caution should be used when one is attempting to implement ultrasonic stimulation since there is little known regarding the safety limitations. There have been some reports of the onset of tinnitus following stimulation by ultrasound.

13. Effects of Extraneous Vibrations

The use of bone conduction technology for the transmission of communication information has been considered for military applications for mounted and dismounted Soldiers. In the mounted situation, vehicles transmit vibrations through the bodies of the individuals riding in them. The presence of these vibrations would augment and could potentially interfere with the vibrations being transmitted to a Soldier's head through a bone conduction transmitter. Any interference in communication through vehicle vibration would be detrimental to military operations. ARL conducted two studies in order to determine if vehicular vibrations would interfere with bone conduction transmission for communications.

13.1 Pilot Study

The initial study of the effects of vehicle vibration on bone conduction communication was a pilot study involving five participants who communicated across radios using a bone conduction interface inside and outside an M113 armored personnel carrier (APC) vehicle (Letowski, Mermagen, Vause, & Henry, 2004). The study was conducted in early spring of 2004. The listeners were inside the vehicle wearing different headgear whereas the talker could be inside or outside the vehicle. Listeners wore two variations of the Temco HG-16 communication system (see section 11 for details of the system) for reception of radio communication using a modification of a Motorola military radio. The vibrators of the HG-16 were mounted into the pads of a Personnel Armor System for Ground Troops (PASGT) helmet or into a soft military-style field cap. The listeners were inside the APC riding around a gravel track while the talkers were on a wooden deck of a control building next to the vehicle track or traveling together inside the APC. An external antenna was mounted on the outside of the APC to enhance radio transmission.

In turn, each participant served as a talker and read a list of call sign acquisition test (CAT) items to the listeners. The CAT was developed by ARL in order to have a military-relevant test for the purposes of evaluating communication systems (Rao & Letowski, 2003; Rao, Letowski, & Blue, 2002). The listeners wrote what they heard in the form of a letter followed by a number. After the test was completed, the response sheets were hand scored and the data were summarized. Figure 80 shows the results for the study for the conditions in which the talker was outside the vehicle. Figure 81 shows the results for the study for the conditions in which the talker was on the inside of the vehicle. The noise levels for the vehicle condition were 85, 95, and 105 dBA for the idle, 5-mph, and 10-mph conditions, respectively.

As shown in figures 80 and 81, performance decreased for both types of headgear as the noise level increased. The effect was greater for the PASGT helmet than for the soft cap because of poorer contact between the vibrator and the head under the helmet. However, even at the condition where the vehicle was traveling at 10 mph and the background noise level was at a level of 105 dBA, communication was still adequate. The difference in performance attributable to the location of the talker is likely because the talker outside the vehicle was talking in a quiet environment and the talker inside the vehicle was talking in the presence of noise. A small amount of noise could have been detected by the bone conduction microphone worn by the talker in the vehicle and transmitted to the listeners.

This study indicated that the use of a bone conduction communication for reception in a vehicle was feasible, but there was a decrease in performance when the talker was riding inside the vehicle as opposed to sitting outside. Further, this study suggested that vehicle vibration did not have a large effect on communication and led to a more systematic and thorough study to investigate the effects of vibration on bone conduction transmission.

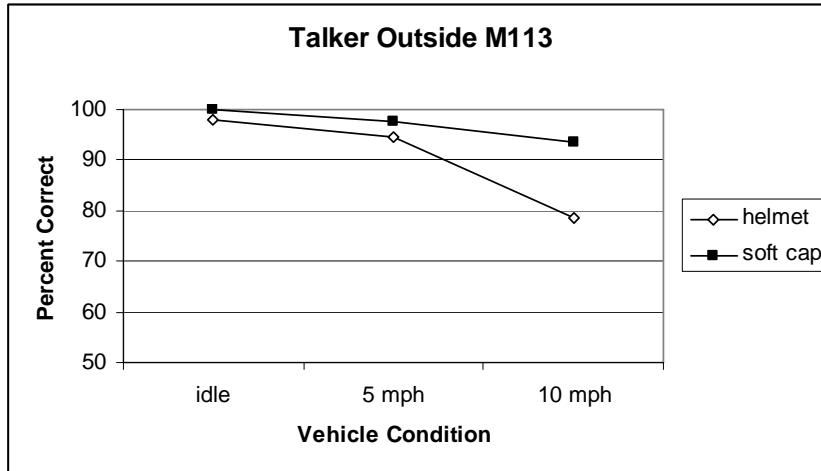

Figure 80. Summary of data from the vehicle study where the talker was outside the vehicle. (The open symbols indicate the listeners' performance when they wore the PASGT helmet, and the solid symbols indicate the listeners' performance when they wore the soft field cap.)

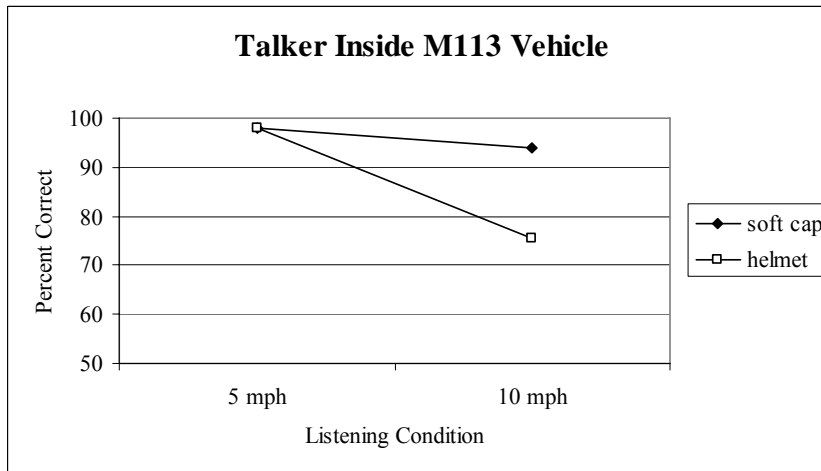

Figure 81. Summary of data from the vehicle study where the talker was inside the vehicle. (The open symbols indicate the listeners' performance when they wore the PASGT helmet, and the solid symbols indicate the listeners' performance when they wore the soft field cap.)

13.2 Full Study of Bone Conduction Communication in Vehicles

The second study (Henry & Mermagen, 2004) was a full study developed on the basis of the pilot study described. The results of the study were presented at the North Atlantic Treaty Organization Research and Technology Organization Applied Vehicle Technology Symposium in Prague, Czech Republic, in October 2004. The results of the study are discussed briefly next. For full details, the reader should refer to the full report.

The purpose of the study was to determine the effects of vehicle noise and body vibration on the effectiveness of bone conduction communication. People with normal hearing, wearing integrated or applied hearing protection, served as listeners in two environments (in an M113 APC or in a sound booth). The participants wore three different headgear configurations and completed the recorded and live voice versions of the CAT.

Twelve participants (seven male and five female) with normal hearing between the ages of 22 and 40 completed the study. The data were collected in two environments: in an APC and in a sound booth. The testing environment of the moving vehicle subjected the participants to noise and vibration. Thus, the data obtained from this environment provided information about performance of the communication systems in noise and steady vibration. The sound booth was a sound-treated room that had two loudspeakers that emitted the pre-recorded internal noise of the M113 operating at 10 mph at the original sound intensity level. This environment allowed for the evaluation of the communication systems in a noisy environment without the presence of vehicular vibration.

Three different headgear configurations were used: the current combat vehicle crewman (CVC) communication helmet worn by crew members of the M113, the CVC with bone conduction vibrators (CVCBC), and a PASGT helmet with bone conduction vibrators. Figure 82 shows the two helmets and the bone conduction headgear.

The participants' task was to listen to the CAT spoken by a male voice. The test stimuli were presented in two voice conditions: recorded and live. For the recorded listening conditions, participants listened through a digital audio player whose output was split to the three listeners' helmet configurations. For the live conditions, participants listened to the talker's voice which was transmitted from a bone conduction microphone on top of the talker's head. The bone conduction microphone was part of the HG-17 headset made by Temco, Inc.



Figure 82. The two helmets used in the current study: PASGT (left) and CVC (middle) as well as the bone conduction headgear (right) worn by the talker whose transducers were integrated into the helmets.

Figure 83 shows the average speech recognition scores for each of the listening conditions. As seen in the graph, performance was best with the CVC system, followed by the PASGT with

bone conduction. Performance was poorest with the CVCBC. Across listening conditions, there did not appear to be large differences between the M113 and sound booth listening locations, which indicated that the sound booth was a good replication of the noise environment of the M113 APC and that vibration and movement experienced in the vehicle did not adversely affect the ability to communicate through any of the headgear systems.

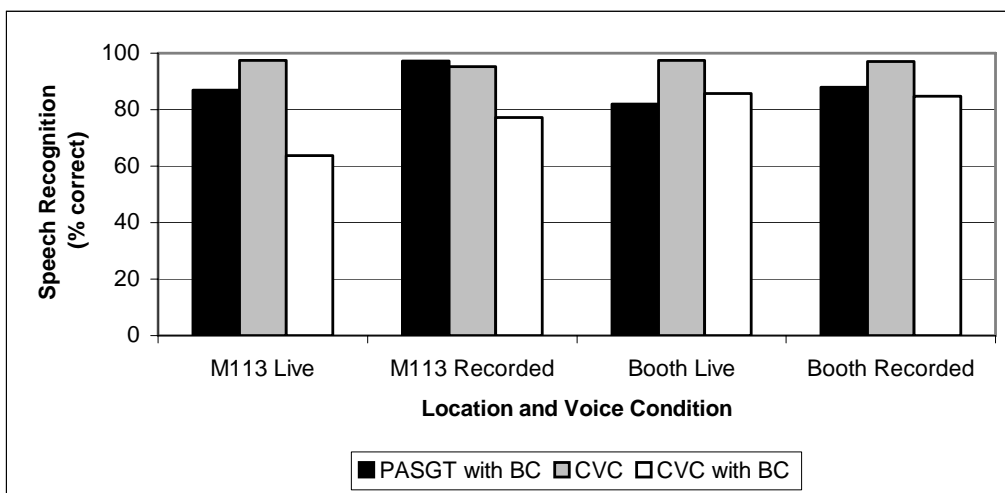

Figure 83. Speech recognition performance across the headgear and environment conditions. (Each bar indicates the average performance across participants.)

As expected, participants performed best in both listening environments when they wore the CVC helmet. This helmet was designed for crew members of combat vehicles and has been optimized for this type of noise environment. The other two configurations performed slightly (PASGT) or substantially (CVCBC) worse during most of the test conditions. This indicates that the bone conduction transducers functioned well in the high-noise and high-vibration environments.

The differences across headgear underscore the operational differences among the three configurations. First and foremost, the fit of the headgear to different sized heads was imperfect at best. The CVCBC headgear caused the greatest challenge for most of the participants. Recall that the same set of three helmets was used for all participants. Since the contact between the bone conduction transducers and the listener’s head is critical, the lack of a good fit contributed to the listener’s inability to hear the test items optimally. The fit was not an issue for the CVC because it was quite simple to align the earphones to the listeners’ ears, and fit around the head was unimportant. Modular integrated communications helmet pads were used in the PASGT configuration. These pads were comfortable and provided effective static force on the bone conduction transducers. Therefore, the speech communication effectiveness with the PASGT configuration was not much worse than that with the CVC helmet and was in the range of 85% to 95%.

A second potential contributor to the lower performance of bone conduction systems in comparison to the CVC helmet is insufficient output power of the bone conduction vibrators used in this study. The comfortable listening levels required for these transducers were at the edge of intro-

ducing amplitude distortions to the signals. The highest undistorted levels that could be produced by the transducers were used in the study, and the transducers were set at their highest output. If greater undistorted output could have been obtained from the bone conduction transducers, the reported speech recognition scores might have been greater.

No general effects of vibration on speech communication effectiveness were observed in the present study. This supports the notion that vibration levels present in military vehicles do not significantly interfere with communication through bone conduction transmission. The bone conduction microphone performed fairly well in noise and vibration but was susceptible to both, resulting in poorer performance in the live voice conditions than in the recorded conditions.

The most important factor in ensuring successful communication through bone conduction transmission is a proper fit of the communication system to the listener's head. For higher noise environments, there exists a need for higher power transducers for greater output and a contact microphone with greater resistance to external noise. The transducers used in this study were parts of a commercially available device. The output levels of the transducers may not have been sufficient for some of the listeners to perform optimally. Furthermore, the contact microphone was susceptible to noise and the headset that contained it may have been susceptible to movement.

13.3 Summary and Conclusions

The two studies that were conducted on the effect of vibrations on bone conduction transmission for communication purposes show no significant effect of vibration, which was a concern expressed by some people who were skeptical about the application of bone conduction communication systems in military vehicles. Vibration that is present in moving vehicles is not within the frequency range of speech. In fact, measurements of vibration on vehicles show that they are well below 100 Hz (Nakashima, 2005). Therefore, vehicle vibration will not interfere with the vibrations transmitted to the human skull through a bone conduction communication system for the purposes of communication. However, both studies demonstrated that the bone conduction communication used has not been optimized for military applications, and advances in both the microphone and vibrators need to be made to improve performance.

14. Summary and Conclusions

Audiologists have long felt that the phenomenon of hearing through bone conduction was well understood. Simply put, the bones of the skull are set into motion, which vibrates the cochleae that are surrounded in bone, and these vibrations are translated into neural impulses that are perceived in the brain as sound. Since both cochleae are surrounded in bone, vibration of any part of the skull is assumed to stimulate both ears with very little attenuation and small time

delays. Therefore, the common assumption is that time and intensity differences between the two cochleae, when stimulated by bone vibration, are negligible for all the practical purposes and that bone conduction applications are likewise very limited.

However, after a thorough review of the literature, it becomes clear that the phenomenon of bone conduction is not yet well understood. If the problem is as simple as described, then spatial perception through bone conduction should not be possible. Furthermore, auditory localization with bilateral BAHAs should not be possible. More importantly, the range of frequencies perceived through bone conduction should be very limited. There is no clear understanding of how listeners with normal and impaired hearing are able to perceive ultrasonic (above 20 kHz) stimuli presented through vibrations of the skull. Clearly, there is more to hearing through bone conduction than what has been believed to date. Further work in the areas of anatomy and physiology needs to be done for us to fully understand the mechanisms behind the transmission of vibrations and subsequent perception of sounds through bone conduction.

As shown in this report, the phenomenon of hearing through bone conduction has experienced ebbs and flows in its exploitation. In the early ages, hearing through bone conduction was seen as a novel trick used secretly by those who wanted to hear better than normal or to hear better because of a hearing loss that they did not want others to know about. At that time, hearing through bone conduction was used as an assistive device designed for those with hearing loss. This application for use with people with impaired hearing continued for a long time and people with normal hearing lost sight of its usefulness to them. In modern times, however, bone conduction transmission is again being used by those with normal hearing to allow for communication across distances through radios and for listening to music while allowing the listeners to hear sounds in their environment or protect their ears from excessive levels of noise. The technology is being rejuvenated through its coupling with new technology such as cellular phones and MP3 players. The concept of hearing through the bones of the skull has become novel once again and is receiving increased popularity.

Devices such as vibrational wristwatches (for visually and hearing impaired people) and snorkels (AquaFM) and swim goggles (SwiMP3) with bone conduction receivers show the potential for a broad range of applications. The more technologically oriented society becomes, the more receptive people are to explore new ways to sense the world and communicate during adverse listening conditions. There are many potential future applications of bone conduction as a method of sound transmission.

Applications of bone conduction for the military have not changed much since the military's early attempts to use bone conduction in the 1990s. The limited popularity and acceptance of bone conduction systems are attributable to the limitations of commercially available devices that were not designed for military use (as discussed in section 11). Devices that have been designed for communication in low levels of noise do not necessarily function well in high levels of noise and have numerous drawbacks preventing them from use by military. Needed improvements in bone conduction technology to meet military specifications require large amounts of funding since the design goals of the clinical and commercial equipment are vastly different from

the design requirements of military communication systems. As the general interest and expertise in the use of bone conduction technology increase, further advancements in the design of transducers and related stealth technology will allow for successful use of bone conduction technology across many military platforms.

This report has summarized the basic information regarding bone conduction and its application as a viable transmission pathway for communication for the military. Results from studies conducted by ARL, along with those reported by others, support the notion that bone conduction transmission offers many operational and tactical advantages for military use. Our hope is that this report provides a good foundation for the understanding of the capabilities and challenges of bone conduction transmission. Appropriate human and financial resources need to be allocated to develop bone conduction communication systems that meet the requirements of the military user.

15. References

- Aazh, H.; Moore, B.; Peyvandi, A.; Stenfelt, S. Influence of Ear Canal Occlusion and Static Pressure Difference on Bone Conduction Thresholds: Implications for Mechanisms of Bone Conduction. *International Journal of Audiology* **2005**, *44*, 302-306.
- Abramson, M.; Fay, T.H.; Kelly, J.P.; Wazen, J.J.; Liden, G.; Tjellstrom, A. Clinical Results With A Percutaneous Bone-Anchored Hearing Aid. *Laryngoscope* **1989**, *99*(7 Pt 1), 707-710.
- Allen, G.; Fernandez, C. The Mechanism of Bone Conduction. *Annals of Otolology, Rhinology, and Laryngology* **1960**, *69*, 5-28.
- American National Standards Institute. *Reference Zero for the Calibration of Pure-tone Bone Conduction Audiometers*; ANSI S3.43-1984, New York, 1984.
- American National Standards Institute. *Mechanical Coupler for Measurement of Bone Vibrators*; ANSI S3.13-1987 (R 1993), New York, 1987.
- American National Standards Institute. *Reference Equivalent Threshold Levels for Audiometric Bone Vibrators*; ANSI S3.26-1989; New York, 1989.
- American National Standards Institute. *Bioacoustical Terminology*; ANSI S3.20 – 1995; New York, 1995.
- American National Standards Institute. *Specifications for Audiometers*; ANSI S3.6 – 1996 (R2004); New York, 1996.
- American Speech-Language-Hearing Association. Guidelines for Determining the Threshold Level for Speech. *Asha* **1988**, *21*, 353-356.
- Andringa, T.; Niessen, M.; Nillesen, M. Continuity Preserving Signal Processing. Webpage [<http://tcw2.ppsw.rug.nl/~tjeerd/CPSP/intro.html>] 2004.
- Anonymous. Audiphone. *Manufacturer and Builder* **1880**, *12*, 7-8.
- Arlinger, S.; Kylan, P.; Hellqvist, H. Skull Distortion of Bone Conducted Signals. *Acta Otolaryngologica* **1978**, *85*, 318-323.
- Baken, R. *Clinical Measurement of Speech and Voice*; London (UK): Taylor and Francis Limited, 1987.
- Ball, G.R. *Implantable Magnetic Hearing Aid Transducer*, U.S. Patent 5,456,654, 1995.

- Bárány, E. A Contribution to the Physiology of Bone Conduction. *Acta Oto-laryngologica, Supplement* **1938**, 26, 1-129.
- Barry, S. Can Bone Conduction Thresholds Really be Poorer than Air? *American Journal of Audiology*, **November 1994**, 21.
- Barry, S.; Gaddis, S. Physical and Physiological Constraints on the use of Bone-Conduction Speech Audiometry. *Journal of Speech and Hearing Disorders* **1978**, 43, 220-226.
- Barry, S.; Vaughan, R. Loudness Balance Calibration of Bone Conduction Vibrators. *Journal of Speech and Hearing Research*, **1981**, 24, 454-459.
- Baruch, G.; Giami, S.; Botte, M-C. Lateralization Shift as a Function of Interaural Delay and Tone Duration. *Proceedings of the 12th International Congress on Acoustics*, paper B2-8. Toronto, Canada: ICA, 1986.
- Batteau, D.W. The Role of the Pinna in Human Localization. *Proceedings of the Royal Society of London. Series B, Containing Papers of a Biological Character* **1967**, 168(11), 158-80.
- Beattie, R.; Gager, D. Bone-Conduction Speech Testing: Calibration Force and Voltage Levels for Two Vibrators. *Ear and Hearing* **1980**, 1, 75-82.
- Bekesy, G. V. Zur Theorie des Hörens bei der Schallaufnahme durch Knochenleitung. *Ann. Physik* **1932**, 8, 111-136.
- Bekesy, G. V. Über die piezoelektrische Messung der absoluten Hörschwelle bei Knochenleitung. *Akust Zeits* **1939**, 4, 113-125.
- Bekesy, G. V. Über die Messung der Schwingungsamplitude der Gehörknöchelchen mittels einer kapazitiven Sonde. *Akust. Zeist* **1941**, 6, 1-16.
- Bekesy, G. V. Vibration of the Head in a Sound Field and its Role in Hearing by Bone Conduction. *Journal of the Acoustical Society of America*, 20 **1948**, 749-760.
- Bekesy, G. V. The Structure of the Middle Ear and the Hearing of One's Own Voice by Bone Conduction. *Journal of the Acoustical Society of America* **1949a**, 21, 217-232.
- Bekesy, G. V. The Moon Illusion and Other Similar Auditory Phenomena. *American Journal of Psychology* **1949b**, 62, 540-552.
- Bekesy, G. V. *Experiments in Hearing*. McGraw-Hill Book Company: New York, 1960.
- Bekesy, G. V.; Rosenblith, W. The Mechanical Properties of the Ear; *In Handbook of Experimental Psychology* (S.S. Stevens, ed.), New York (NY): John Wiley and Sons, 1951.
- Belinky, M.; Jeremijenko, N. Sound Through Bone Conduction in Public Interfaces. *Proceedings of the Computer-Human Interaction (CHI) 2001 Conference*. Interactive poster, Seattle (WA): April 3-5, 2001.

- Berger, K. Early Bone Conduction Hearing Aid Devices. *Archives of Otolaryngology* **1976**, *102*, 315-318.
- Bernaschina, F.; Bovet, P.; Bader, R.; Quinto, D. Underwater Sound Localization: Effect of Stimulus Duration. Paper presented at the Congrès Française d'Acoustique (Lousanne, Switzerland) [also: http://www.unige.ch/fapse/PSY/persons/bovet/bernaschina/web_CFA_2000/CFA_2000.pdf#search='Bernaschina%20underwater%20localization'] 2000.
- Bernstein, L.; Trahiotis, C. Detection of Interaural Delay in High-Frequency Sinusoidally Amplitude-Modulated Tones, Two-Tone Complexes, and Bands of Noise. *Journal of the Acoustical Society of America* **1994**, *95*, 3561–3567.
- Blakley, B.; Siddique, S. A Qualitative Explanation of the Weber Test. *Otolaryngology – Head and Neck Surgery* **1999**, *120*, 1-4.
- Blauert, J. On the Lag of Lateralization Caused by Interaural Time and Intensity Differences. *Audiology* **1972**, *11*, 265–270.
- Blauert, J. *Spatial Hearing*; Cambridge (MA): MIT Press, 2001.
- Blauert, J.; Els, H.; Schroeter, J. A Review of the Progress in External Ear Physics Regarding the Objective Performance Evaluation of Personal Ear Protectors. *Proceedings of INTER-NOISE 80*, Florida, 653-658, 1980.
- Boerger, G. On the Persistence of the Directional Sensation in Hearing. *Proceedings of the 5th International Congress on Acoustics (ICA)*, Paper B27. Liege (Belgium): ICA, 1965.
- Boezeman, E.; Bronkhorst, A.; Kapteyn, T.; Houffelaar, A.; Snel, A. Phase Relationship Between Bone and Air Conducted Impulse Signals in the Human Head. *Journal of the Acoustical Society of America* **1984**, *76*, 111-115.
- Bovet, P.; Drake, C.; Bernaschina, F.; Savel, S. Underwater Sound Localization: Role of Interaural Time and Intensity Difference. *Journal of the Acoustical Society of America*, *103*, 2844. [also: http://www.unige.ch/fapse/PSY/persons/bovet/bernaschina/web_ASA_1998/ASA_1998.pdf#search='Bernaschina%20underwater%20localization'] 1998.
- Bregman, A. *Auditory Scene Analysis*; Cambridge (MA): MIT Press, 1990.
- Brenkman, C.J.; Grote, J.J.; Rutten, W.L. Acoustic Transfer Characteristics in Human Middle Ears Studied by a SQUID Magnetometer Method. *Journal of the Acoustical Society of America* **1987**, *82*(5), 1646-1654.
- Brownell, W.; Bader, C.; Bertrand, D.; Ribaupierre, Y. Evoked Mechanical Responses of Isolated Cochlear Outer Hair Cells. *Science* **1985**, *227*, 194-196.

- Browning, G. The British Experience of an Implantable Subcutaneous Bone Conduction Hearing Aid (Xomed Audiant). *Journal of Laryngology and Otology* **1990**, *104*, 534-538.
- Buckingham, R.; Valvassordi, G. Inner Ear Fluid Volumes and Resolving Power of Magnetic Resonance Imaging: Can it Differentiate Endolymphatic Structures? *Annals of Otology, Rhinology, and Laryngology* **2001**, *110* (2), 113-117.
- Burkhard, D. A Manikin Useful for Hearing Aid Tests – Revisited. *Proceedings of the 18th International Congress on Acoustics* (pp. V3443-V3446). Kyoto (Japan): April 4-9, 2004.
- Buser, P.; Imbert, M. *Audition*. The MIT Press: Cambridge, MA, 1992.
- Bystrzanowska, T. *Audiologia Kliniczna*; Warszawa (Poland): Państwowy Zakład Wydawnictw Lekarskich, 1963.
- Callison, D. Audiologic Evaluation of Hearing-Impaired Infants and Children. *Otolaryngological Clinics in North America* **1999**, *32*, 1009-1018.
- Carhart, R. Clinical Applications of Bone Conduction. *Archives of Otolaryngology* **1950**, *51*, 109-115.
- Carhart, R. Effect of Stapes Fixation on Bone Conduction. In: H. Schuknecht (Ed), *International Symposium on Otosclerosis*; Boston (MA): Little, Brown, & Co, 1962.
- Carhart, R. Effects of Stapes Fixation on Bone-Conduction Response; In I.M. Ventry, J.B. Chaiklin, & R.F. Dixon (Eds.), *Hearing measurement: A book of readings* (pp. 116-129). New York (NY): Appleton-Century-Crofts, 1971.
- Carhart, R.; MacConnell, F. Influence of Fenestration Surgery on Bone Conduction Measurements. *Laryngoscope* **1952**, *70*, 1265-1292.
- Carlile, S.; Best, V. Discrimination of Sound Source Velocity in Human Listeners. *Journal of the Acoustical Society of America* **2002**, *111*, 1026-1035.
- Carlsson, P.; Håkansson, B.; Ringdahl, A. Force Threshold for Hearing by Direct Bone Conduction. *Journal of the Acoustical Society of America* **1995**, *97*, 1124-1129.
- Chaiklin, J.B. Interaural Attenuation and Cross-Hearing in Air Conduction Audiometry. *Journal of Auditory Research* **1967**, *7*, 413-424.
- Chasin, M.; Wade, P. Bone Anchored Hearing Aids (BAHA) and Unilateral Conductive Losses. *The Hearing Review* **1998**, *5* (8), 3434, 43.
- Chladek, V. Federici-Lewis Test and its Application in Audiometry. *Cesk Otolaryngol* **1968**, *17*, 149-151 (in Czech).
- Ciocco, A. Conduction Deafness. Statical Observations. *Archives of Otolaryngology* **1936**, *24*, 723-730.

- Collet, L.; Chanal, J.; Hellal, H.; Gartner, M.; Morgon, A. Validity of Bone Conduction Stimulated ABR, MLR and Otoacoustic Emissions. *Scandinavian Audiology* **1989**, *18*, 43-46.
- Cone-Wesson, B.; Ramirez, G. Hearing Sensitivity in Newborns Estimated from ABRs to Bone-Conducted Sounds. *Journal of the American Academy of Audiology* **1997**, *8*, 299-307.
- Corliss, E.; Koidan, W. Mechanical Impedance of the Forehead and Mastoid. *Journal of the Acoustical Society of America* **1955**, *27*, 1164-1172.
- Corso, J. Bone Conduction Thresholds for Sonic and Ultrasonic Frequencies. *Journal of the Acoustical Society of America* **1963**, *35*, 1738-1743.
- Cremers, W.; Snik, F.; Beynon, A. Hearing with the Bone-Anchored Hearing Aid (BAHA, HC200) Compared to a Conventional Bone-Conduction Hearing Aid. *Clinical Otolaryngology* **1992**, *17*, 275-279.
- Dadson, R.; Robinson, D.; Greig, R. The Mechanical Impedance of the Human Mastoid Process. *British Journal of Applied Physiology* **1954**, *5*, 435-442.
- Dahlin, G.; Allen, F.; Collard, E. Bone-Conduction Thresholds of Human Teeth. *Journal of the Acoustical Society of America* **1973**, *53*, 1434-1437.
- Dallos, P. *The Auditory Periphery*; New York (NY): Academic Press, 1973.
- Damaske, P.; Wagener, B. Richtungshörversuche über einen nachgebildeten kopf. *Acustica* **1969**, *21*, 30-35.
- Davis, H.; Hirsh, S.; Turpin, L.; Peacock, M. Threshold Sensitivity and Frequency Specificity in Auditory Brainstem Response Audiometry. *Audiology* **1985**, *24*, 54-70.
- Dean, M.S.; Martin, F.N. Insert Earphone Depth and the Occlusion Effect. *American Journal of Audiology* **2000**, *9*(2), 131-134.
- Deatherage, B.; Jeffress, L.; Blodgett, H. A Note on the Audibility of Intense Ultrasonic Sound. *Journal of the Acoustical Society of America* **1954**, *26*, 582.
- Dempsey, J.; Levitt, H. Bone Vibrator Placement and the Cancellation Technique. *Ear and Hearing* **1990**, *11*, 271-281.
- Department of Defense. *Human Engineering Design Criteria for Military Systems, Equipment and Facilities*; Military Standard (MIL-STD-1472D); Department of Defense: Washington, D.C., 1981.
- Department of Defense. *Human Engineering Design Data Digest*; Department of Defense: Washington, D.C., April, 2000.

Department of Labor. www.dol.gov/search/Search.aspx?search_term=audiologist&offset=0, 2004.

DiBartolomeo, J.; Henry, D. A New Medication to Control Patulous Eustachian Tube Disorder. *American Journal of Otolaryngology* **1992**, *13*, 1-12.

Dirks, D. Factors Related to Bone Conduction Reliability. *Archives of Otolaryngology* **1964**, *79*, 551-558.

Dirks, D. Bone-Conduction Testing; *In: Handbook of Clinical Audiology* (J. Katz, ed.). Third edition, Baltimore (MD): Williams and Wilkins, 1985.

Dirks, D.; Kamm, C. Bone-Vibrator Measurements: Physical Characteristics and Behavioral Thresholds. *Journal of Speech and Hearing Research* **1975**, *18*, 242-260.

Dirks, D.; Lybarger, S.; Olsen, W.; Billings, B. Bone Conduction Calibration: Current Status. *Journal of Speech and Hearing Disorders* **1979**, *44*, 143-155.

Dirks, D.; Malmquist, C.; Bower, D. Toward the Specification of Normal Bone-Conduction Threshold. *Journal of the Acoustical Society of America* **1968**, *43*, 1237-1242.

Dirks, D.; Swindeman, J. The Variability of Occluded and Unoccluded Bone-Conduction Thresholds. *Journal of Speech and Hearing Research* **1967**, *10*, 232-249.

Dobie, R.; Wiederhold, M.; Lenhardt, M. Ultrasonic Hearing. *Science*, *255* **1992**, 1584-1585.

Dolan, T.; Morris, S. Administering Audiometric Speech Tests via Bone Conduction: A Comparison of Transducers. *Ear and Hearing* **1990**, *11*, 446-449.

Donaldson, J.A.; Miller, J.M. Anatomy of the Ear. *In Otolaryngology*; Paparella, M., Shumrick, D., Eds.; Vol. 1: *Basic Sciences and Related Disciplines*. Saunders: Philadelphia, PA, 1980; pp. 26-42.

Downs, E.F. *Surface-Laminated Piezoelectric Film Sound Transducer*. U.S. Patent 5,889,871, 1999.

Dowson, S.; McNeill, H. The Effect of Temperature on the Performance of Audiometric Mechanical Coupler Systems. *British Journal of Audiology* **1992**, *26*, 275-81.

Dutt, S.; McDermott, A.; Burrell, S.; Cooper, H.; Reid, A.; Proops, D. Patient Satisfaction with Bilateral Bone-Anchored Hearing Aids: The Birmingham Experience. *Journal of Laryngology Otolaryngology Supplement* **2002a**, *28*, 37-46.

Dutt, S.; McDermott, A.; Burrell, S.; Cooper, H.; Reid, A.; Proops, D. Speech Intelligibility with Bilateral Bone-Anchored Hearing Aids: The Birmingham Experience. *Journal of Laryngology Otolaryngology Supplement* **2002b**, *28*, 47-51.

- Edgerton, B.; Danhauer, J.; Beattie R. Bone Conduction Speech Audiometry in Normal Subjects. *Journal of the American Auditory Society* **1977**, *3*, 84-87.
- Elpern, B.; Naunton, R. The Stability of the Occlusion Effect. *Archives of Otolaryngology* **1963**, *77*, 376-384.
- Ellis, A. On the History of Musical Pitch, *Journal of the Society of Arts*, (March 5). Reprinted in *Studies in the History of Music Pitch*, Amsterdam: Frits Knuf, 1968, p. 44, 1880.
- Evans, F.; Lebow, M. Regional Differences in Some of the Physical Properties of the Human Femur. *Journal of Applied Physiology* **1951**, *3*, 563-572.
- Fagelson, M.; Martin, F. The Occlusion Effect and Ear Canal Sound Pressure Level. *American Journal of Audiology* **1998**, *7* (2), 50-54.
- Feilding, Ch. College of Santa Fe Auditory Theory. Webpage [http://www.santafevisions.com/csf/html/lectures/006_hearing_I.htm] 2005.
- Feinstein, S. Acuity of the Human Sound Localization Response Underwater. *Journal of the Acoustical Society of America* **1973a**, *53*, 393-399.
- Feinstein, S. Minimum Audible Angle Underwater: A Replication under Different Acoustic and Environmental Conditions. *Journal of the Acoustical Society of America* **1973b**, *54*, 879-881.
- Filo, A.; Capper, D.G. *Denta-mandibular Sound-Transmitting System*. U.S. Patent No. 6,115,477, 2000.
- Flottorp, G.; Solberg, S. Mechanical Impedance of Human Headbones (Forehead and Mastoid Portion of Temporal Bone) Measured Under ISO/IEC Conditions. *Journal of the Acoustical Society of America* **1976**, *59*, 899-906.
- Fournier, J. The “False-Bing” Phenomenon: Some Remarks on the Theory of Bone Conduction. *Laryngoscope* **1954**, *64*, 29-34.
- Frank, T. Forehead versus Mastoid Threshold Differences with a Circular Tipped Vibrator. *Ear and Hearing* **1982**, *3*, 91-92.
- Frank, T.; Crandell, C. Acoustic Radiation Produced by B-71, B-72, and KH 70 Bone Vibrators. *Ear and Hearing* **1986**, *7*, 344-347.
- Frank, T.; Holmes, A. Acoustic Radiation from Bone Vibrators. *Ear and Hearing* **1981**, *2*, 59-63.
- Frank, T.; Richards, W. The Beltone 5b Artificial Mastoid: Theoretical Characteristics and Performance Measurements. *Ear and Hearing* **1980**, *1*, 310-318.

- Frank, T.; Richter, U. Influence of Temperature on the Output of a Mechanical Coupler. *Ear and Hearing* **1985**, *6*, 206-210.
- Franke, E. Response of the Human Skull to Mechanical Vibrations. *Journal of the Acoustical Society of America* **1956**, *28*, 1277-1284.
- Franke, E.; Gierke, H.; von Grossman, F.; Wittern, W. The Jaw Motions Relative to the Skull and their Influence on Hearing by Bone Conduction. *Journal of the Acoustical Society of America* **1952**, *24*, 142-146.
- Freeman, S.; Sichel, J.Y.; Sohmer, H. Bone Conduction Experiments in Animals - Evidence for a Non-Osseous Mechanism. *Hearing Research* **2000**, *146*(1-2), 72-80.
- Gardner, M.; Gardner, R. Problem of Localization in the Median Plane: Effect of Pinna Cavity Occlusion. *Journal of the Acoustical Society of America* **1973**, *53*, 400-408.
- Gates, G.; Hough, J.; Gatti, W.; Bradley, W. The Safety and Effectiveness of an Implanted Electromagnetic Hearing Devices. *Archives of Otolaryngology – Head and Neck Surgery* **1989**, *115*, 924-930.
- Gelfand, S. Clinical Precision of the Rinne Test. *Acta Otolaryngologica* **1977**, *83*, 480-487.
- Gelfand, S. *Hearing*; Marcel Dekker, Inc.: New York, p.113, 1991.
- Gelfand, S. *Essentials of Audiology*; (2nd ed.) New York (NY): Thieme, 2001.
- Glasscock, M.; Shambaugh, G.; Johnson, D. *Surgery of the Ear*; (4th ed.) Philadelphia (PA): Saunders, 1990.
- Goetzinger, C.; Proud, C. Speech Audiometry by Bone Conduction. *Archives of Otolaryngology* **1955**, *62*, 632-635.
- Goldstein, D.; Hayes, C. The Occlusion Effect in Bone Conduction. *Journal of Speech and Hearing Research* **1965**, *8*, 137-148.
- Goode, R.L. Middle Ear Function, Biologic Variation, and Otosurgical Alchemy. Can We Turn Tin Ears Into Gold? *Archives of Otolaryngology -- Head and Neck Surgery* **1986**, *112*(9), 923-924.
- Goodhill, V.; Holcomb, A. L. Cochlear Potentials in the Evaluation of Bone Conduction. *Annals of Otolaryngology, Rhinology and Laryngology* **1955**, *64*(4), 1213-1233.
- Goodson, D.; Lepper, P. A Cheap Sensitive Hydrophone for Monitoring Cetacean Vocalizations. Loughborough University of Technology, UK. fs.lboro.ac.uk/uag/downloads/bender2.pdf 1995.
- Gorga, M.; Thornton, A. The Choice of Stimuli for ABR Measurements. *Ear and Hearing* **1989**, *10*, 217-230.

- Grantham, D. Detection and Discrimination of Simulated Motion of Auditory Targets in the Horizontal Plane. *Journal of the Acoustical Society of America* **1986**, 79, 1939–1949.
- Grantham, D.; Wightman, F. Detectability of a Pulsed Tone in the Presence of a Masker with Time-Varying Interaural Correlation. *Journal of the Acoustical Society of America* **1979**, 65, 1509–1517.
- Greibach, E.H. *Bone Conduction Hearing Device*. U.S. Patent 2,127,468, 1938.
- Guild, S. Hearing by Bone Conduction: The Pathways of the Transmission of Sound. *Annals of Otolaryngology Rhinology and Laryngology* **1936**, 45, 736-754.
- Guinan, J.J.; Peake, WT. Middle-Ear Characteristics of Anesthetized Cats. *Journal of the Acoustical Society of America* **1967**, 41, 1237-1261.
- Gunderson, T. *Prostheses in the Ossicular Chain – Experimental and Clinical Studies*. University Park Press: Baltimore, MD, 1971.
- Gyo, K.; Aritomo, H.; Goode, R.L. Measurement of the Ossicular Vibration Ratio in Human Temporal Bones by Use of a Video Measuring System. *Acta Otolaryngologica* **1987**, 103 (1-2), 87-95.
- Gyo, K.; Goode, R.L.; Miller, C. Effect of Middle Ear Modification on Umbo Vibration. Human Temporal Bone Experiments With a New Vibration Measuring System. *Archives of Otolaryngology -- Head and Neck Surgery* **1986**, 112(12), 1262-1268.
- Hahlbrock, K. Bone Conduction Speech Audiometry. *International Audiology* **1962**, 1, 186-188.
- Håkansson, B. *The Bone-Anchored Hearing Aid – Engineering Aspects*; Technical Report 144 (Thesis), School of Electrical Engineering, Chalmers University of Technology; Göteborg, Sweden, 1984.
- Håkansson, B. Coupling to a Bone-Anchored Hearing Aid. United States Patent 4,498,461, 1985.
- Håkansson, B.; Brandt, A.; Carlsson, P. Resonance Frequencies of the Human Skull in Vivo. *Journal of the Acoustical Society of America* **1994**, 95, 1474-1481.
- Håkansson, B.; Carlsson, P.; Brandt, A.; Stenfelt, S. Linearity of Sound Transmission through the Human Skull in Vivo. *Journal of the Acoustical Society of America* **1996**, 99, 2239-2243.
- Håkansson B.; Carlsson, P.; Tjellström A. The Mechanical Point Impedance of the Human Head, With and Without Skin Penetration. *Journal of the Acoustical Society of America* **1986**, 80, 1065-1075.

- Håkansson, B.; Tjellström, A.; Carlsson, P. Percutaneous vs. Transcutaneous Transducers for Hearing by Direct Bone Conduction. *Otolaryngology – Head and Neck Surgery* **1990**, *23*, 339-344.
- Håkansson, B.; Tjellström, A.; Rosenhall, U. Hearing Thresholds with Direct Bone Conduction Versus Conventional Bone Conduction. *Scandinavian Audiology* **1984**, *13*, 3-13.
- Håkansson, B.; Tjellström, A.; Rosenhall, U. Acceleration Levels at Hearing Threshold with Direct Bone Conduction versus Conventional Bone Conduction. *Acta Otolaryngologica* **1985**, *100*, 240-252.
- Hall, J. *Handbook of Auditory Evoked Responses*; Boston: Allyn & Bacon, 1992.
- Hannley, M. *Basic Principles of Auditory Assessment*; San Diego (CA): College-Hill Press, 1986.
- Harris, J.; Haines, H.; Myers, C. A Helmet-Hold Bone Conduction Vibrator. *Laryngoscope* **1953**, *63*, 998-1007.
- Harris, J.; Sergeant, R. Monaural/Binaural Minimum Audible Angles for a Moving Sound Source. *Journal of Speech and Hearing Research* **1971**, *14*, 618–629.
- Hart, C.; Nauton, R. Frontal Bone Conduction Tests in Clinical Audiometry. *Laryngoscope* **1961**, *71*, 24-29.
- Hartland, S.; Proops, D. Bone-Anchored Hearing Aid Wearers with Significant Sensorineural Hearing Losses (Borderline Candidates): Patients' Results and Opinions. *Journal of Laryngology and Otology, Supplement* **1996**, 41-46.
- Haughton, P. A System for Generating a Valuable Mechanical Impedance and its Use in Investigation of the Electromechanical Properties of the B-71 Audiometric Bone Vibrator. *British Journal of Audiology* **1982**, *16*, 1-7.
- Haughton, P.; Pardoe, K. Normal Pure Tone Thresholds for Hearing by Bone Conduction. *British Journal of Audiology* **1981**, *15*, 113-121.
- Haustein, B.G.; Schirmer, W. Messeinrichtung zur Untersuchung des Richtungslokalisationsvermögens (a measuring apparatus for the investigation of the faculty of directional localization). *Hochfrequenztech. u. Elektroakustik* **1970**, *79*, 96-101.
- Hawkins, D.; Alvarez, E.; Houlihan, J. Reliability of Three Types of Probe Tube Microphone Measurements. *Hearing Instruments* **1991**, *42*, 14-16.
- Hebrank, J.; Wright, D. Spectral Cues Used in the Location of Sound Sources on the Median Plane. *Journal of the Acoustical Society of America* **1974**, *56*, 1829-1834.

- Heffner, R.; Heffner, E. Hearing in the Elephant (*Elephas Maximus*). *Science* **1980**, *208*, 518-520.
- Henning, G. Detectability of Interaural Delay in High-Frequency Complex Waveforms. *Journal of the Acoustical Society of America* **1974**, *55*, 84–90.
- Henry, P.; Mermagen, T. Bone Conduction Communication in a Military Vehicle. *North Atlantic Treaty Organization (NATO) Research and Technology Organization (RTO) Applied Vehicle Technology (AVT) Panel Symposium*, 13-1:13-12, Prague (Czech Republic), 5 October 2004.
- Herzog, H.; Krainz, W. Knochenleitungsproblem. Theoretische Erwägungen. *Zeitschrift für Hals-, Nasen-, und Ohrenheilkunde* **1926**, *15*, 300-313.
- Hirsh, I. *The Measurement of Hearing*; New York (NY): McGraw-Hill, 1952.
- Hofman, P.; Van Riswick, J.; Van Opstal, A. Relearning Sound Localization with New Ears. *Nature Neuroscience* **1998**, *1*, 417-421.
- Holgers, K.; Håkansson, B. Sound Stimulation via Bone Conduction for Tinnitus Relief: A Pilot Study. *International Journal of Audiology* **2002**, *41*, 293-300.
- Hollien, H. Underwater Sound Localization in Humans. *Journal of the Acoustical Society of America* **1973**, *53*, 1288-1295.
- Hollien, H.; Feinstein, S. *Hearing in Divers*; In: Underwater Research, E. Drew, J. Lythgoe, & J. Woods (Eds.), pp. 81-138. London: Academic Press, 1976.
- Hood, J.D. Bone Conduction: A Review of the Present Position with Special Reference to the Contributions of Dr. Georg von Békésy. *Journal of the Acoustical Society of America* **1962**, *34*, 1325-1332.
- Hood, J. D. Clinical Implications in Calibration Requirements in Bone Conduction Standardisation. *Audiology* **1979**, *18*(1), 36-42.
- Hosoi, H.; Imaizumi, S.; Sakaguchi, T.; Tonoike, M.; Murata, K. Activation of the Auditory Cortex by Ultrasound. *The Lancet* **1998**, *351*, 496-497.
- Hough, J.; Himelick, T.; Johnson, B. Implantable Bone Conduction Hearing Device: Audiant Bone Conductor. *Annals of Otolaryngology, Rhinology and Laryngology* **1986**, *95*, 498-504.
- Hough, J.; Hough, D.; McGee, M. Long-Term Results for the Xomed Audiant Bone Conductor. *Otolaryngologic Clinics of North America* **1995**, *28*, 43-52.
- Hough, J.; Richard, G.; Barton, K.; DiCarlo, P.; Chow, R. *Direct Bone Conduction Hearing Aid Device*. U.S. Patent 4,612,915, 1986.

- Howell, P.; Williams, M.; Dix, H. Assessment of Sound in the Ear Canal Caused by Movement of the Jaw Relative to then Skull. *Scandinavian Audiology* **1988**, *17*, 93-98.
- Huizing, E.H. Bone Conduction. The Influence of the Middle Ear. *Acta Otolaryngologica, Supplement*. **1960**, *155*, 1-99.
- Huizing, E.H. Lateralization of Bone Conduction Into the Better Ear in Conductive Deafness. Paradoxical Weber Test in Unilaterally Operated Otosclerosis. *Acta Otolaryngologica* **1970**, *69*(6), 395-401.
- Hurley, R.; Berger, K. The Relationship between Vibrator Placement and Bone Conduction Measurements with Monaurally Deaf Subjects. *Journal of Auditory Research* **1970**, *10*, 147-150.
- Hussain, A.; Blakley, B.; Buelow, B.; Schilling, H. Acoustic Basis of Tuning Fork Tests. *The Journal of Otolaryngology* **2001**, *30*, 347-351.
- International Electrotechnical Commission. *Mechanical Coupler for Measurements of Bone Vibrators*; Recommendation IEC R373-1971 (1st edition); Geneva: IEC, 1971.
- Imaizumi, S.; Hosoi, H.; Sakaguchi, T.; Watanabe, Y.; Sadato, N.; Nakamura, S.; Waki, A.; Yonekura, Y. Ultrasound Activates the Auditory Cortex of Profoundly Deaf Subjects. *NeuroReport* **2001**, *12* (3), 583-586.
- International Standards Organization 7566:1987 Acoustics -- Standard reference zero for the calibration of pure-tone bone conduction audiometers. Withdrawn 1995-10-05. Replaced by ISO 389-3:1994
- Jahn, A.F.; Tonndorf, J. Lateralization of Bone-Conducted Sounds. *American Journal of Otolaryngology* **1982**, *3*(2), 133-140.
- Janfaza P.; Nadol, J. B.; Galla, R.J.; Fabian, R.L.; Montgomery, W.M. *Surgical Anatomy of the Head and Neck*; Lippincott Williams & Wilkins: Philadelphia, 2000.
- Janssen, G.; Rowland, R. *Hearing Aid Headband Support*. U.S. Patent 4,918,757, 1990.
- Johnson, E. Tuning Forks to Audiometers and Back Again. *Laryngoscope* **1970**, *80*, 49-68.
- Joris, X. Interaural Time Sensitivity Dominated by Cochlea-Induced Envelope Patterns. *Journal of Neuroscience* **2003**, *23*, 6345-6350.
- Kapteyn, T.S.; Snel, A.M.; Vis, E.C. The Cancellation Method for an Accurate Determination of an Air-Bone Gap. *Archives of Otorhinolaryngology* **1980**; *228*(3), 199-204.
- Kelly, D.; Prendergast, P. An Investigation of the Middle-Ear Biomechanics Using Finite Element Modeling. *Proceedings of the ASME 2001 Bioengineering Conference* **2001**, *BED* *50*, 369-370.

- Kemp, D. Stimulated Acoustic Emissions From Within the Human Auditory System. *Journal of the Acoustical Society of America* **1978**, *64*, 1386-1391.
- Khalil, T.; Viano, D.; Smith, D. Experimental Analysis of the Vibrational Characteristics of the Human Skull. *Journal of Sound & Vibration* **1979**, *63*, 351-376.
- Khanna, S.; Tonndorf, J.; Queller, J. Mechanical Parameters of Hearing by Bone Conduction. *Journal of the Acoustical Society of America* **1976**, *60*, 139-154.
- Killion, M.; Wilber, L.; Gudmundsen, G. Zwislocki was Right...A Potential Solution to the "Hollow Voice" Problem of the Amplified Occlusion Effect with Deeply Sealed Earmolds. *Hearing Instruments* **1988**, *39*, 14-18.
- Kimball, J. Kimball's Biology Pages: The Human Central Nervous System. (<http://users.rcn.com/jkimball.ma.ultranet/BiologyPages/C/CNS.html>) 2005.
- Kirikae, I. An Experimental Study on the Fundamental Mechanism of Bone Conduction. *Acta Oto-laryngologica, Supplement* **1959**, *145*, 1-110.
- Klodd, D.; Edgerton, B. Occlusion Effect; Bone Conduction Speech Audiometry using Forehead and Mastoid Placement. *Audiology* **1977**, *16*, 522-529.
- Knudsen, V.O.; Jones, I.H. Bone Conduction. *Archives of Otolaryngology* **1931**, *31*, 489-505.
- Langford, T.; Mozo, B.; Patterson, J. *Evaluation of Speech Intelligibility through a Bone Conduction Stimulator*; USAARL Technical Report No. 89-13: 1-10; USAARL: Ft. Rucker, AL, 1989.
- Lenhardt, M.; Richards, D.; Madsen, A.; Goldstein, B.; Shulman, A.; Guinta, R. Measurement of Bone Conduction Levels for High Frequencies. *International Tinnitus Journal* **2002**, *8*, 9-12.
- Lenhardt, M.; Skellett, R.; Wang, P.; Clarke, A. Human Ultrasonic Speech Perception. *Science* **1991**, *253*, 82-85.
- Letowski, T.; Frank, T.; Caravella, J. Acoustic Properties of Speech Produced in Noise Presented Through Supra-Aural Earphones. *Ear and Hearing* **1993**, *14*, 332-338.
- Letowski, T.; Mermagen T.; Vause N.; Henry, P. Bone Conduction Communication in Noise: A Preliminary Study. *Proceedings of the 11th International Congress on Noise and Vibration*, St. Petersburg (Russia): 5-8 July 2004.
- Lierle, D.; Reger, S. Correlations between Bone and Air Conduction Acuity Measurements Taken Over Wide Frequency Ranges in Different Types of Hearing Impairment. *Laryngoscope* **1946**, *56*, 187-224.

- Linstrom, C.; Silverman, C.; Rosen, A.; Meiteles, L. Bone-Conduction Impairment in Chronic Ear Disease. *Annals of Otolaryngology, Rhinology, & Laryngology* **2001**, *110*, 437-441.
- Lowy, K. Cancellation of the Electrical Cochlear Response with Air- And Bone-Conduction. *Journal of the Acoustical Society of America* **1942**, *14*, 156-158.
- Lybarger, S. Interim Bone Conduction Thresholds for Audiometry. *Journal of Speech and Hearing Research* **1966**, *9*, 483-487.
- Lynch, T.; Nedzelnitsky, V.; Peake, W. Input Impedance of the Cochlea in Cat. *Journal of the Acoustical Society of America* **1982**, *72*, 108-130.
- MacDonald, J.; Henry, P.; Letowski, T. Spatial Audio through a Bone Conduction Interface. *International Journal of Audiology* 2006.
- MacFarland, D. Testing for Otosclerosis, and a Description of a Quantitative Gelle Test. *Journal of Laryngology and Otolaryngology* **1953**, *67*, 740-744.
- Maspétiol, R. L'audiométrie et son interprétation clinique. *Revue du Praticien - Médecine Générale* **1963**, *13*, 2539-2547.
- Mauldin, L.; Jerger, J. Auditory Brainstem Evoked Responses to Bone-Conducted Signals. *Archives of Otolaryngology* **1979**, *105*, 656-661.
- Maurer, D.; Landis, T. Role of Bone Conduction in the Self-Perception of Speech. *Folia Phoniatrica* **1990**, *42*, 226-229.
- Maurer, J. Research in Underwater Sound with Focus on Musical Applications and Computer Synthesis. Underwater Acoustics Research Report. Stanford University. Retrieved 26 November 2005 from the World Wide Web [<http://ccrma-www.stanford.edu/~blackrse/h20.html>] 1998.
- McBride, M.; Letowski, T.; Tran, P. *Bone Conduction Head Sensitivity Mapping: Bone Vibrator*; ARL-TR-3556; Army Research Laboratory: Aberdeen Proving Ground, MD, July 2005.
- McBride M.; Letowski T.; Tran P. Comparison of Bone Conduction Hearing Thresholds in Quiet and Noise Environments. *The 4th Annual Meeting of the Society for Human Performance in Extreme Environments*, San Francisco (CA), Oct. 15-16, 2006.
- McElveen, J.T.; Goode, R.L.; Miller, C.; Falk, S.A. Effect of Mastoid Cavity Modification on Middle Ear Sound Transmission. *Annals of Otolaryngology, Rhinology, and Laryngology* **1982**, *91*(5), 526-532.
- Merrill, H.; Wolfe, D.; McLemore, D. Air and Bone Conducted Speech Reception Thresholds. *Laryngoscope* **1973**, *83*, 1929-1939.

- Middlebrooks, J.C.; Makous, J.C.; Green, D.M. Directional Sensitivity of Sound-Pressure Levels in the Human Ear Canal. *Journal of the Acoustical Society of America* **1989**, *86*(1), 89-108.
- Mills, A.W. On the Minimum Audible Angle. *Journal of the Acoustical Society of America* **1958**, *30*, 237-246.
- Mills, A.W. Auditory Localization, in Tobias, J (ed.) *Foundations of Auditory Theory*, Academic Press, 1972.
- Miltenburg, D. The Validity of Tuning Fork Tests in Diagnosing Hearing Loss. *The Journal of Otolaryngology* **1994**, *23*, 254-259.
- Moller, A.R. [Stereophonic hearing spectacles or a classical hearing aid.] [Article in Danish] *Ugeskr Laeger*, **1961**, *123*, 261-263.
- Moller, A.R. Transfer Function of the Middle Ear. *Journal of the Acoustical Society of America* **1963**, *35*, 1526-1534.
- Moller, A.R. Responses of Units in the Cochlear Nucleus to Sinusoidally Amplitude-Modulated Tones. *Experimental Neurology* **1974**, *45*, 105-117.
- Moore, B.C.J. *Introduction to the Psychology of Hearing* (4th edition). Academic Press: London, 1997.
- Müller, B.; Bovet, P. Role of Pinnae and Head Movements on Localizing Pure Tones. *Swiss Journal of Psychology* **1999**, *58*, 170-179.
- Musicant A.; Butler R. The Influence of Pinnae-Based Spectral Cues on Sound Localization. *Journal of the Acoustical Society of America* **1984**, *75*, 1195-1200.
- Nakashima, A. Whole Body Vibration in Military Vehicles: A Literature Review. *Canadian Acoustics* **2005**, *33*, 35-40.
- National Aeronautics and Space Administration. *Anthropometric Source Book* (vol 1-3); Yellow Springs (OH): NASA, 1978.
- Newby, H.; Popelka, G. *Audiology*; (5th edition.) Englewood Cliffs (NJ): Prentice-Hall Inc, 1985.
- Niemoeller, A. *Complete Guide for the Deafened*; New York (NY): Harvest House, 1940.
- Nilo, E.R. The Relation of Vibrator Surface Area and Static Application Force to the Vibrator-to-Head Coupling. *Journal of Speech and Hearing Research* **1968**, *11*(4), 805-810.
- Nolan, M.; Lyon, D. Transcranial Attenuation in Bone Conduction Audiometry. *Journal of Laryngology and Otology* **1981**, *95*, 597-608.

- Nuetzel, J.; Hafter, E. Lateralization of Complex Waveforms: Effects of Fine Structure, Amplitude, and Duration. *Journal of the Acoustical Society of America* **1976**, *60*, 1339–1346.
- O'Brien, W.; Liu, Y. Evaluation of Acoustic Propagation Paths into the Human Head. In *New Directions for Improving Audio Effectiveness* (pp. 15-1 to 15-24). Meeting Proceedings RTO-MP-HFM-123, paper 15. Neuilly-sur-Seine, France: RTO, 2005.
- Oldfield, S.; Parker, P. Acuity of Sound Localization: A Topography of Auditory Space. II. Pinna cues absent. *Perception* **1984**, *13*, 601-617.
- Ore, O. *Cardano, the Gambling Scholar*; Princeton Press: Princeton, 1953.
- Pickles, J. *An Introduction to the Physiology of Hearing*; New York (NY): Academic Press, 1988.
- Pietruski, J. The Lewis-Federici Test in the Diagnosis of Stapedial Ankylosis. *Otolaryngologia Polska* **1972**, *26*, 613-617.
- Pirzanski, C. Diminishing the Occlusion Effect: Clinical/Manufacturer-Related Factors. *Hearing Journal* **1998**, *51*, 66-78.
- Pollack, M. *Amplification for the Hearing-Impaired*; New York: Grune & Stratton, 1975.
- Pörschmann, C. Influence of Bone Conduction and Air Conduction on the Sound of One's Voice. *Acustica with Acta Acoustica* **2000**, *86*, 1038-1045.
- Portmann, D.; Boudard, P.; Herman, D. Anatomical Results With Titanium Implants in the Mastoid Region. *Ear, Nose, And Throat Journal* **1997**, *76*(4), 231-234, 236.
- Preibisch-Effenberger, R. *Die Schallokalisationsfähigkeit des Menschen und ihre audiometrische Verwendung zur klinischen Diagnostik* (the human faculty of sound localization and its audiometric application to clinical diagnostics). Dissertation, Technische Universität, Dresden, 1966.
- Pumford, J.; Sinclair, S. Real-Ear Measurement: Basic Terminology and Procedures. Audiology Online [http://www.audiologyonline.com/articles/arc_disp.asp?article_id=285] (May 7, 2001) 2001.
- Purcell, D.; Kunov, H.; Madsen, P.; Cleghorn, W. Distortion Product Otoacoustic Emissions Stimulated Through Bone Conduction. *Ear and Hearing* **1999**, *19*, 362-370.
- Queller, J.; Khanna, S. Changes in Bone Conduction Thresholds with Vibrator Contact Area. *Journal of the Acoustical Society of America* **1982**, *71*, 1519-1526.

- Rado, M.; Himelfarb, M.; Arensburg, B.; Terkel, J.; Wollber, Z. Are Seismic Communication Signals Transmitted by Bone Conduction in the Blind Mole Rat? *Hearing Research* **1989**, *41*, 23-30.
- Raj, A. K.; McGrath, B. J.; Rochlis, J.; Newman, D. J.; Rupert, A. H. The Application of Tactile Cues to Enhance Situation Displays. The 3rd Ann Symp Exhibition on Situational Awareness in the Tactical Air Environment (pp. 77-84), Patuxent River, MD, June 1998.
- Ramsey, D. Personal communication (PerCom), 2004.
- Rao, M. D.; Letowski, T. R. Speech Intelligibility of the Call Sign Acquisition Test (CAT) for Army Communication Systems. Audio Engineering Society Convention Paper 5835. Presented at the 114th Convention 2003, May 22-25, Amsterdam, The Netherlands, 2003.
- Rao, M. D.; Letowski, T. R.; Blue, M. Subjective-Objective Assessment of Speech Intelligibility for the Callsign Acquisition Test (CAT). Unpublished data analysis, 2002.
- Ravicz, M.; Melcher, J. Isolating the Auditory System from Acoustic Noise during Functional Magnetic Resonance Imaging; Examination of Noise Conduction through the Ear Canal, Head, and Body. *Journal of the Acoustical Society of America* **2001**, *109*, 216-231.
- Reed, C. ; Delhorne, L. The Reception of Environmental Sounds Through Wearable Tactual Aids. *Ear and Hearing* **2003**, *24*, 528-538.
- Reuter, T.; Nummela, S.; Hemila, S. Elephant Hearing. *Journal of the Acoustical Society of America* **1998**, *104*, 1122-1123.
- Reyes, S. The Auditory Central Nervous System. (<http://serous.med.buffalo.edu/hearing/>) 1998.
- Richards W. D.; Frank T. Frequency Response and Output Variations of Radioear B-71 and B-72 Bone Vibrators. *Ear and Hearing* **1982**, *3*, 37-8.
- Richter, W.; Brinkmann, K. Threshold of Hearing by Bone Conduction. A Contribution to International Standardization. *Scandinavian Audiology* **1981**, *10*, 235-237.
- Ringdahl, A.; Israelsson, B.; Caprin, L. Paired Comparisons Between the Classic 300 Bone-Anchored and Conventional Bone-Conduction Hearing Aids in Terms of Sound Quality and Speech Intelligibility. *British Journal of Audiology* **1995**, *29*, 299-307.
- Robinson, M.; Kasden, S. Bone conduction Speech Discrimination: An Indication of Cochlear Function in the Immediate Postoperative Period. *Archives in Otolaryngology* **1977**, *103*, 238-240.
- Robinson, D.; Shipton, M. A Standard Determination of Paired Air- and Bone-Conduction Thresholds under Different Masking Noise Conditions. *Audiology* **1982**, *21*, 61-82.

- Robinson, G.; Solomon, D. Rhythm is processed by the Speech Hemisphere. *Journal of Experimental Psychology* **1974**, *102*, 508-511.
- Rogers, M. E.; Butler, R. A. The Linkage Between Stimulus Frequency and Covert Peak Areas as it Relates to Monaural Localization. *Perception and Psychophysics* **1992**, *52*, 536-546.
- Ross, H.; Murray, D. *E. H. Weber on the Tactile Senses (2nd edition)*. Hove (East Sussex): Erlbaum (UK) Taylor & Francis. This is a reprint with a revised historical introduction of: Weber, E.H. (1978). *The Sense of Touch*. [Combines: Weber, E.H. (1834). *De pulsu, esorptione, auditu et tactu. Annotationes anatomicae et physiologicae* (translated from the Latin by Helen E. Ross) and Weber E. H. (1851). *Der Tastsinn und das Gemeingefühl* (translated from the German by David J. Murray)]. New York: Academic Press for the Experimental Psychology Society, 1978, pp. 1-278, 1996.
- Rozhok, S.; Chandrasekhar, V. Application of commercially Available Cantilevers in Tuning Fork Scanning Probe Microscopy (SPM) Studies. *Solid State Communications* **2002**, *121*, 683-686.
- Russell, R. Sonotone Hearing Aid History, (<http://home.earthlink.net/~rogerr7/sonoha.htm>), 3/21/04, 2003.
- Russolo, M.; Poli, P. Temporal (Phase and Time) Disparities in Lateralization. *Audiology* **1985**, *24*, 186-194.
- Ruth, R.; Horner, J.; McCoy, G.; Chandler, C. Comparison of Auditory Brainstem Response and Behavioral Audiometry in Infants. *Scandinavian Audiology Supplement* **1983**, *17*, 94-98.
- Salt, A. Cochlear fluid space areas, lengths and volumes. (<http://oto.wustl.edu/cochlea/mrhmvol.htm>). Last updated in August 2005, 1996.
- Sanders, J. Masking. In: *Handbook of Clinical Audiology*; (J. Katz, ed.) Second edition, Baltimore (MD): Williams and Wilkins, 1978.
- Sanders, W.; Olsen, W. An Evolution of New Artificial Mastoid as an Instrument for the Calibration of Audiometer Bone Conduction Systems. *Journal of Speech and Hearing Disorders* **1964**, *29*, 247-263.
- Sauren, A.; Classens, M. Finite Element Modeling of Head Impact: The Second Decade. *Proceedings of the International IRCOBI Conference on Biomechanics of Impacts*, Eindhoven, the Netherlands; September 8-10, 1993.
- Schmidgen, H. Constructing Time. Conference on "The Materiality of Time Relations in Life Sciences, Art, and Technology (1830-1930)". Weimar (Germany). May 24-26, 2002.
- Seikel, J.; King, D.; Drumright, D. *Anatomy and Physiology for Speech, Language, and Hearing*; (2nd ed.). San Diego (CA): Singular Publishing Group, 2000.

- Shaw, E.A.G. Ear Canal Pressure Generated by a Free Sound Field. *Journal of the Acoustical Society of America* **1966**, *39*, 465-470.
- Shaw, E.A.G. The External Ear. In W. D. Keidel, & W. D. Nef, (Eds.). *Handbook of Sensory Physiology, Vol 1*; Berlin, Germany: Springer-Verlag, 1974.
- Shaw, E.A.G.; Vaillancourt, M.M. Transformation of Sound-Pressure Level From the Free Field to the Eardrum Presented in Numerical Form. *Journal of the Acoustical Society of America* **1985**, *78*, 1120-1123.
- Sheehy, J.; Gardner, G.; Hambley, W. Tuning Fork Tests in Modern Otology. *Archives of Otolaryngology* **1971**, *94*, 132-138.
- Shipton, M.; John, A.; Robinson, D. Air-Radiated Sound from Vibration Transducers and Its Implication for Bone Conduction Audiometry. *British Journal of Audiology* **1980**, *14*, 86-99.
- Sichel, J.Y.; Freeman, S.; Sohmer, H. Lateralization During the Weber Test: Animal Experiments. *Laryngoscope* **2002**, *112*, 542-546.
- Silman, S.; Silverman, C. *Auditory Diagnosis: Principles and Applications*; San Diego (CA): Academic Press, 1991.
- Sivian, L.; White, S. On Minimal Audible Fields. *Journal of the Acoustical Society of America*, *4* **1933**, 288-321.
- Sklare, D.; Denenberg, L. Technical Note: Interaural Attenuation for Tubephone Insert Earphones. *Ear and Hearing* **1987**, *8*, 298-300.
- Snik, F.; Beynon, A.; Mylanus, E.; van der Pouw, C.; Cremers, C. Binaural Application of the Bone-Anchored Hearing Aid. *Annals of Otolaryngology, Rhinology and Laryngology* **1998**, *107*, 187-193.
- Snyder, J. Interaural Attenuation Characteristics in Audiometry. *Laryngoscope* **1973**, *83*, 1847-1855.
- Sohmer, H.; Freeman, S.; Geal-Dor, M.; Adelman, C.; Savion, I. Bone Conduction Experiments in Humans – A Fluid Pathway From Bone to Ear. *Hearing Research* **2000**, *146*, 81-88.
- Sone, T.; Ebata, M.; Nimura, T. On the Difference between Localization and Lateralization. *Proceedings of the 6th International Congress on Acoustics (ICA)*, paper A 3-6. Tokyo (Japan): ICA, 1968.
- Spitzer, J.; Ghossaini, S.; Wazen, J. Evolving Applications in the Use of Bone-Anchored Hearing Aids. *American Journal of Audiology* **2002**, *11*, 96-103.

- Srinivasson K. Bone Conduction Reception Threshold: An Investigation with the Oticon A20 Bone Vibrator Calibrated on the Brüel and Kjaer Artificial Mastoid. *Scandinavian Audiology* **1974**, 3, 145-148.
- Staab, W.; Dennis, M.; Schweitzer Ch.; Weber, J. Measuring the Occlusion Effect in a Deep-Fitting Hearing Device. *The Hearing Review* **2004**, 12, 44-50.
- Staab, W.; Polashek, T.; Nunley, J.; Green, R.; Briskin, A.; Dojan, R.; Taylor, C.; Katz, R. Audible Ultrasound for Profound Losses. *The Hearing Review* **1998**, Feb, 28, 30, 32, 36.
- Stapells, D. R.; Ruben, R. J. Auditory Brainstem Responses to Bone-Conducted Tones in Infants. *Annals of Otolaryngology, Rhinology and Laryngology* **1989**, 98, 941-949.
- Stenfelt, S. *Hearing by Bone Conduction: Physical and Physiological Aspects*. Doctoral thesis, Chalmers University of Technology, Göteborg, Sweden, 1999.
- Stenfelt, S. Bilateral Fitting of BAHAs and BAHA Fitted in Unilateral Deaf Persons: Acoustical Aspects. *International Journal of Audiology* **2005**, 44, 178-189.
- Stenfelt, S.; Goode, R. Transmission Properties of Bone Conducted Sound: Measurements in Cadaver Heads. *Journal of the Acoustical Society of America* **2005**, 118, 21373-2391.
- Stenfelt, S.; Håkansson, B. A Miniaturized Artificial Mastoid Using Skull Simulator. *Scandinavian Audiology* **1998**, 27, 67-76.
- Stenfelt, S.; Håkansson, B. Sensitivity to Bone-Conducted Sound: Excitation of the Mastoid Versus Teeth. *Scandinavian Audiology* **1999**, 28, 190-198.
- Stenfelt, S.; Håkansson B.; Tjellström A. Vibration Characteristics of Bone Conducted Sound In Vitro. *Journal of the Acoustical Society of America* **2000**, 107, 422-432.
- Sterkers, O.; Boucarra, D.; Labassi, S.; Bebear, J.; Dubreuil, C.; Frachet, B.; Fraysse, B.; Lavieille, J.; Magnan, J.; Martin, C.; Truy, E.; Uziel, A.; Vaneecloo, F. A Middle Ear Implant, the Symphonix Vibrant Soundbridge: Retrospective Study of the First 125 Patients Implanted in France. *Otology and Neurotology* 2003, 24, 427-436.
- Stevens, J. State of the Art Neonatal Hearing Screening with Auditory Brainstem Response. *Scandinavian Audiology Supplement* **2001**, 52, 10-12.
- Stevens, S.S.; Newman, E. The Localization of Actual Sources of Sounds. *American Journal of Psychology* **1936**, 48, 297-306.
- Stinson, M.; Daigle, G. Comparison of an Analytic Horn Equation Approach and a Boundary Element Method for the Calculation of Sound Fields in the Human Ear Canal. *Journal of the Acoustical Society of America* **2005**, 118, 2405-2411.

- Stisen, B.; Dahm, M. Sensitivity and Mechanical Impedance of Artificial Mastoid Type 4930. B&K Technical Report, 1969.
- Strutt, J.W. (Lord Rayleigh). On Our Perception of Sound Direction. *Philosophical Magazine* **1907**, *13*, 214-232.
- Strybel, T.; Manligas, C.; Perrott, D. Minimum Audible Movement Angle as a Function of the Azimuth and Elevation of the Source. *Human Factors* **1992**, *34*, 267-75
- Studebaker, G. Placement of Vibrator in Bone Conduction Testing. *Journal of Speech and Hearing Research* **1962**, *5*, 321-331.
- Studebaker, G. Interest Variability and the Air-Bone Gap. *Journal of Speech and Hearing Disorders* **1967**, *32*, 82-86.
- Sullivan, J.; Gottlieb, M.; Hodges, W. Shift of Bone Conduction on Occlusion of the External Ear Canal. *Laryngoscope* **1947**, *57*, 690-703.
- Švec, J.; Titze, I.; Popolo, P. Estimation of Sound Pressure Levels of Voiced Speech from Skin Vibration of the Neck. *Journal of the Acoustical Society of America* **2005**, *117*, 1386-1394
- Teranishi, R.; Shaw, E.A.G. External-Ear Acoustic Models with Simple Geometry. *Journal of the Acoustical Society of America* **1968**, *44*, 257-263.
- Ternström, S. Acoustical Aspects of Choir Singing. *Speech Transmission Laboratory Quarterly Progress and Status Report*, 3. Stockholm (Sweden): Royal Institute of Technology, 1989.
- Tjellström, A.; Håkansson, B. The Bone-Anchored Hearing Aid: Design Principles, Indications, and Long-Term Clinical Results. *Otolaryngologic Clinics of North America* **1995**, *28*, 53-72.
- Tjellström, A.; Lindstrom, J.; Hallen, O.; Albrektsson, T.; Banemark, P. Integrated Titanium Implants in the Temporal Bone: A Clinical Study on Bone-Anchored Hearing Aids. *American Journal of Otology* **1981**, *2*, 304-310.
- Tohme, S.; Karkas, A.; Romanos, B. Safety of MRI with Metallic Middle Ear Implants. *Journal of Med Liban* **2003**, *51*, 127-131.
- Todt, I.; Seidl, R.; Mutze, S.; Ernst, A. MRI Scanning and Incus Fixation in Vibrant Soundbridge Implantation. *Otology and Neurotology* **2004**, *25*, 969-972.
- Tonndorf, J. Compressional Bone Conduction in Cochlear Models. *Journal of the Acoustical Society of America* **1962**, *34*, 1127-1132.
- Tonndorf, J. Bone Conduction Studies in Experimental Animals. *Acta Otolaryngologica* **1966**, Supplement, 213, 1-132.

- Tonndorf, J. Bone Conduction, in *Foundations of Modern Auditory Theory*, Vol. II (ed. J. V. Tobias), New York (NY): Academic Press, 1972.
- Tonndorf, J.; Greenfield, E.; Kaufman, R. The Occlusion of the External Ear Canal. *Acta Otolaryngologica, Supplement* **1966**, 213, 10-39.
- Tonndorf, J.; Jahn, F. Velocity of Propagation of Bone-Conducted Sound in a Human Head. *Journal of the Acoustical Society of America* **1981**, 70, 1294-1297.
- Tonndorf, J.; Khanna, S.M. The Role of the Tympanic Membrane in Middle Ear Transmission. *Annals of Otology, Rhinology and Laryngology* **1970**, 79(4), 743-753.
- Tonndorf, J.; McArdle, F.; Kruger, B. Middle Ear Transmission Losses Caused by Tympanic Membrane Perforations in Cats. *Acta Otolaryngologica* **1976**, 81(3-4), 330-336.
- Tucci, D.; Ruth, R.; Lambert, P. Use of the Bone Conduction ABR Wave I Response in Determination of Cochlear Reserve. *American Journal of Otology* **1990**, 11, 119-124.
- Van der Pouw, K.; Snik, A.; Cremers, C. Audiometric Results of Bilateral Bone-Anchored Hearing Aid Application in Patients with Bilateral Congenital Aural Atresia. *Laryngoscope* **1998**, 108, 548-553.
- Van Wanrooij, M.; Van Opstal, A. Relearning Sound Localization with a New Ear. *Journal of Neuroscience* **2005**, 25, 5413-5424.
- Venes, D.; Thomas, C. L.; Taber, C. W. Taber's Cyclopedic Medical Dictionary (17th ed). Philadelphia (PA): F.A. Davis Publishing Company, 2001.
- Vogel, U.; Zahnert, T.; Gofmann, G.; Huettenbrink, K. Approach to Evidence of Middle Ear Occlusion Effect by Laser Vibrometry. The International Society for Optical Engineering (SPIE) Conference on "Optical and Imaging Techniques for Biomonitoring II"; Vienna (Austria, SPIE Proceedings, Vol. 2927; paper 2927-09. Bellingham (WA): SPIE, 1996.
- Wade, P.S.; Halik, J.J.; Chasin, M. Bone Conduction Implants: Transcutaneous Vs. Percutaneous. *Otolaryngology -- Head and Neck Surgery* **1992**, 106(1), 68-74. Erratum in *Otolaryngology -- Head and Neck Surgery* **1992**, 106(4), 412-413.
- Wade, P.; Halik, J.; Werger, J.; Vosu, L. Ten-Year Experience with Percutaneous Bone Anchored Hearing Aids: A 3- to 10-year Follow-Up – Markham Stouffville Hospital, 1990-2000. *The Journal of Otolaryngology* **2002**, 31, 80-84.
- Wade, P.; Tallos, S.; Naiberg, J. Clinical Experience with the Xomed Audiant Osseointegrated Bone Conduction Hearing Device: A Preliminary Report of Seven Cases. *The Journal of Otolaryngology* **1989**, 18, 79-84.
- Watson, N. Limits of Audition for Bone Conduction. *Journal of the Acoustical Society of America* **1938**, 9, 294-300.

- Watson, N.; Gales, R. Bone-Conduction Threshold Measurements: Effects of Occlusion, Enclosures, and Masking Devices. *Journal of the Acoustical Society of America* **1943**, *14*, 207-215.
- Wazen, J.; Caruso, M.; Tjellstrom, A. Long-Term Results with the Titanium Bone-Anchored Hearing Aid: The U.S. Experience. *American Journal of Otolaryngology* **1998**, *19*, 737-741.
- Weber, B.; Roush, J. Implantable Bone-Conduction Hearing Device: Practical Considerations. *Journal of the American Academy of Audiology* **1991**, *2*, 123-127.
- Weber, B.A.; Roush, J.; McElveen, J.T., Jr. Application of an Implantable Bone Conduction Hearing Device to Patients With Unilateral Sensorineural Hearing Loss. *Laryngoscope* **1992**, *102*(5), 538-542.
- Webster, A.G. Acoustical Impedance and the Theory of Horns and of the Phonograph. *Proceedings of the National Academy of Science (USA)* **1919**, *5*, 275-282.
- Wegel, R. Physical Data and Physiology of Excitation of Auditory Nerve. *Annals of Otolaryngology* **1932**, *41*, 740-779.
- Weinkove, R. Aids to Hearing. From Julius Caesar to Julius Lempert. (<http://website.lineone.net/~rweinkove/hearing/#bone>), 3/21/04, 1998.
- Weiss, E. An Air Damped Artificial Mastoid. *Journal of the Acoustical Society of America* **1960**, *32*, 1582-1588.
- Welling, F. Implantable Bone Conduction Hearing Devices. *Laryngoscope* **1992**, *102*, 1200.
- Welling, F.; Glasscock, M.; Woods, C.; Sheffey, R. Unilateral Sensorineural Hearing Loss Rehabilitation. *Otolaryngology – Head and Neck Surgery* **1991**, *105*, 771-776.
- Wells, M.; Ross, H. Distortion and Adaptation in Underwater Sound Localization. *Aviation, Space, and Environmental Medicine* **1980**, *51*, 767-774.
- Wenzel, F.; Arruda, M.; Kistler, D.; Wightman, F. Localization Using Nonindividualized Head-Related Transfer Functions. *Journal of the Acoustical Society of America* **1993**, *94*, 111-123.
- Weston, P.; Gengel, R.; Hirsh, I. Effects of Vibrator Types and Their Placement on Bone-Conduction Threshold Measurements. *Journal of the Acoustical Society of America* **1967**, *41*, 788-792.
- Wever, E. *Theory of Hearing*. New York (NY): Wiley and Sons, 1949.
- Wever, E.; Lawrence, M. *Physiological Acoustics*. Princeton (NJ): Princeton University Press, 1954.
- Whittle, L.S. A Determination of the Normal Threshold of Hearing by Bone Conduction. *Journal of Sound and Vibration* **1965**, *2*, 227-248.

- Wigand, M. Unpublished results. Reported by Tonndorf and Jahn (1981), 1964.
- Wightman, F.; Kistler, D. Headphone Simulation of Free-Field Listening I: Stimulus Synthesis. *Journal of the Acoustical Society of America* **1989a**, 85, 858-867.
- Wightman, F.; Kistler, D. Headphone Simulation of Free-Field Listening II: Psychophysical Validation. *Journal of the Acoustical Society of America* **1989b**, 85, 868-878.
- Wilber, L. Compatibility of Two Commercially Available Artificial Mastoids. *Journal of the Acoustical Society of America* **1972**, 52, 1265-1266.
- Wilber, L.; Goodhill, V. Real Ear versus Artificial Mastoid Methods of Calibration of Bone-Conduction Vibrators. *Journal of Speech and Hearing Research* **1967**, 10, 405-416.
- Willi, U.; Ferrazzini, M.; Huber, A. The Incudo-Malleolar Joint and Sound Transmission Losses. *Hearing Research* **2002**, 174, 32-44.
- Wilska, A. On the Vibrational Sensitivity in Different Regions of the Body Surface. *Acta Psychologica Scandinavica* **1954**, 31, 285-289.
- Wilson, J. Basilar Membrane Vibration Data and their Relation to Theories of Frequency Analysis. In: E. Zwicker and E. Terhardt (Eds.), *Facts and Models in Hearing*. Berlin, Germany: Springer Verlag, 1974.
- Wright, D.; Frank, T. Bone Conduction Thresholds for Different Mastoid Placement Sites. *Journal of the Acoustical Society of America* **1990**. (ASA meeting in State College, PA).
- Yang, E.; Rupert, A.; Moushegian, G. A Developmental Study of Bone Conduction Auditory Brain Stem Response in Infants. *Ear and Hearing* **1987**, 8, 244-251.
- Yang, E.; Stuart, A.; Stenstrom, R.; Hollett, S. Effect of Vibrator to Head Coupling Force on the Auditory Brain Stem Response to Bone Conducted Clicks in Newborn Infants. *Ear and Hearing* **1991**, 12, 55-60.
- Yellin, W.; Roland, P.; Culbertson, M.; Meyerhoff, W. Use of an Implantable Hearing Device. *American Journal of Otolaryngology* **1997**, 18, 33-37.
- Yost, W. Lateral Position of Sinusoids Presented with Interaural Intensive and Temporal Differences. *Journal of the Acoustical Society of America* **1981**, 70, 397-409.
- Yost, W.; Dye, R. Properties of Sound Localization in Humans. In: *Neurobiology of Hearing: The Central Nervous System*, R. Altschuler, D. Hoffman, R. Bobin, and B. Clopton (Eds.). New York (NY): Raven Press, 1991.
- Yost, W.; Nielsen, D. *Fundamentals of Hearing: An Introduction*. New York (NY): Holt, Rinehart and Winston, 1977.

Zemlin, W.R. *Speech and Hearing Science: Anatomy and Physiology* (3rd edition). Prentice-Hall: Englewood Cliffs, NJ, 1988.

Zwislocki, J. Acoustic Attenuation Between the Ears. *Journal of the Acoustical Society of America* **1953a**, 25, 752-759.

Zwislocki, J. Wave Motion in the Cochlea Caused by Bone Conduction. *Journal of the Acoustical Society of America* **1953b**, 25, 986-989.

Zwislocki, J. The Role of the External and Middle Ear in Sound Transmission. In D. B. Tower (Ed.). *The Nervous System. Volume 3: Human Communication and Its Disorders*. Raven Press: New York, NY, 1975.

Acronyms

ABR	auditory brain stem response
ALD	assistive listening device
ANR	active noise reduction
ANSI	American National Standards Institute
APC	armored personnel carrier
ARL	Army Research Laboratory
ATE	at the ear
ATO	Army Technology Objective
B&K	Bruel & Kjaer
BAHA	bone-anchored hearing aid
BLP	body-level processor
BTE	behind the ear
CAT	call sign acquisition test
CF	characteristic frequency
CIC	completely in the canal
CNS	central nervous system
CSF	cerebral spinal fluid
CVC	combat vehicle command
DDHS	direct drive hearing system
DoD	Department of Defense
EAC	external auditory canal
ENT	ear, nose, and throat
FDA	Food and Drug Administration
fMRI	functional magnetic resonance imaging
HAIC	Hearing Aid Industry Conference
HL	hearing level
HPD	hearing protection device

HRTF	head-related transfer function
IA	interaural attenuation
IHC	inner hair cell
IID	interaural intensity difference
ILD	interaural level difference
IPD	interaural phase difference
ISO	International Standards Organization
ITD	interaural time difference
ITE	in the ear
LTD	Little Tactile Device
MAA	minimum audible angle
MAMA	minimum audible movement angle
MEG	magnetoencephalography
MEMS	micro-electro-mechanical system
MGB	medial geniculate body
MLS	minimum length sequence
MLSSA	maximumlength sequence system analyzer
MRI	magnetic resonance imaging
NAMRL	Naval Aerospace Medical Research Laboratory
NBC	nuclear, biological, and chemical
NIH	National Institutes of Health
OAE	oto-acoustic emission
OHC	outer hair cell
PASGT	Personnel Armor System for Ground Troops
PC	personal computer
PNS	peripheral nervous system
PTA	pure tone average
SLPFST	Surface Laminated Piezoelectric Film Sound Transducer
SNR	signal-to-noise ratio
SOC	superior olivary complex

SOI	Sullivan Occlusion Index
SOR	self-to-others ratio
SPL	sound pressure level
SRT	Speech Recognition Threshold
TA	transcranial attenuation
TD	transcranial delay
TDD	telecommunications devices for the deaf
TES	Tactile Effects System
TES	Tactor Evaluation System
TID	transcranial intensity difference
TM	tympanic membrane
TMJ	temporal-mandibular joint
TRD	Tinnitus Relief Device
TSAS	Tactile Situation Awareness System
TTD	transcranial time difference
TTY	teletypewriter

<u>NO. OF COPIES</u>	<u>ORGANIZATION</u>	<u>NO. OF COPIES</u>	<u>ORGANIZATION</u>
1 (PDF ONLY)	DEFENSE TECHNICAL INFORMATION CTR DTIC OCA 8725 JOHN J KINGMAN RD STE 0944 FORT BELVOIR VA 22060-6218	1	COMMANDANT USAADASCH ATTN AMSRD ARL HR ME A MARES 5800 CARTER RD FT BLISS TX 79916-3802
1	US ARMY RSRCH DEV & ENGRG CMD SYSTEMS OF SYSTEMS INTEGRATION AMSRD SS T 6000 6TH ST STE 100 FORT BELVOIR VA 22060-5608	1	ARMY RSCH LABORATORY - HRED ATTN AMSRD ARL HR MO J MINNINGER BLDG 5400 RM C242 REDSTONE ARSENAL AL 35898-7290
1	DIRECTOR US ARMY RESEARCH LAB IMNE ALC IMS 2800 POWDER MILL RD ADELPHI MD 20783-1197	1	ARMY RSCH LABORATORY - HRED ATTN AMSRD ARL HR MM DR V RICE-BERG BLDG 4011 RM 217 1750 GREELEY RD FT SAM HOUSTON TX 78234-5094
1	DIRECTOR US ARMY RESEARCH LAB AMSRD ARL CI OK TL 2800 POWDER MILL RD ADELPHI MD 20783-1197	1	ARMY RSCH LABORATORY - HRED ATTN AMSRD ARL HR MG R SPINE BUILDING 333 PICATINNY ARSENAL NJ 07806-5000
2	DIRECTOR US ARMY RESEARCH LAB AMSRD ARL CS OK T 2800 POWDER MILL RD ADELPHI MD 20783-1197	1	ARL HRED ARMC FLD ELMT ATTN AMSRD ARL HR MH C BURNS BLDG 1467B ROOM 336 THIRD AVENUE FT KNOX KY 40121
1	ARMY RSCH LABORATORY - HRED ATTN AMSRD ARL HR M DR M STRUB 6359 WALKER LANE SUITE 100 ALEXANDRIA VA 22310	1	ARMY RSCH LABORATORY - HRED AVNC FIELD ELEMENT ATTN AMSRD ARL HR MJ D DURBIN BLDG 4506 (DCD) RM 107 FT RUCKER AL 36362-5000
1	ARMY RSCH LABORATORY - HRED ATTN AMSRD ARL HR ML J MARTIN MYER CENTER RM 2D311 FT MONMOUTH NJ 07703-5601	1	ARMY RSCH LABORATORY - HRED ATTN AMSRD ARL HR MK MR J REINHART 10125 KINGMAN RD FT BELVOIR VA 22060-5828
1	ARMY RSCH LABORATORY - HRED ATTN AMSRD ARL HR MZ A DAVISON 199 E 4TH ST STE C TECH PARK BLDG 2 FT LEONARD WOOD MO 65473-1949	1	ARMY RSCH LABORATORY - HRED ATTN AMSRD ARL HR MV HQ USAOTC S MIDDLEBROOKS 91012 STATION AVE ROOM 111 FT HOOD TX 76544-5073
1	ARMY RSCH LABORATORY - HRED ATTN AMSRD ARL HR MD T COOK BLDG 5400 RM C242 REDSTONE ARSENAL AL 35898-7290	1	ARMY RSCH LABORATORY - HRED ATTN AMSRD ARL HR MY M BARNES 2520 HEALY AVE STE 1172 BLDG 51005 FT HUACHUCA AZ 85613-7069
		1	ARMY RSCH LABORATORY - HRED ATTN AMSRD ARL HR MP D UNGVARSKY BATTLE CMD BATTLE LAB 415 SHERMAN AVE UNIT 3 FT LEAVENWORTH KS 66027-2326

<u>NO. OF COPIES</u>	<u>ORGANIZATION</u>	<u>NO. OF COPIES</u>	<u>ORGANIZATION</u>
1	ARMY RSCH LABORATORY - HRED ATTN AMSRD ARL HR MJK J HANSBERGER JFCOM JOINT EXPERIMENTATION J9 JOINT FUTURES LAB 115 LAKEVIEW PARKWAY SUITE B SUFFOLK VA 23435	1	TOWSON UNIVERSITY ATTN D EMANUEL 8000 YORK ROAD TOWSON MD 21252-0001
1	ARMY RSCH LABORATORY - HRED ATTN AMSRD ARL HR MQ M R FLETCHER US ARMY SBCCOM NATICK SOLDIER CTR AMSRD NSC SS E BLDG 3 RM 341 NATICK MA 01760-5020	1	NEW EAGLE COMMUNICATIONS ATTN W PIROTH 205 MAIN STREET NEW EAGLE PA 15067
1	ARMY RSCH LABORATORY - HRED ATTN AMSRD ARL HR MY DR J CHEN 12423 RESEARCH PARKWAY ORLANDO FL 32826	1	TEMCO COMMUNICATIONS INC ATTN B MURAKAMI 13 CHIPPING CAMPDEN DRIVE SOUTH BARRINGTON IL 60010
1	ARMY RSCH LABORATORY - HRED ATTN AMSRD ARL HR MS MR C MANASCO SIGNAL TOWERS 118 MORAN HALL FORT GORDON GA 30905-5233	1	OFC OF NAVAL RESEARCH ATTN LTC R SHILLING MEDICAL & BIOLOGICAL SCIENCE & TECHNOLOGY DIV CASUALTY PREVENTION/HEALTHY & FIT FORCE OFFICE OF NAVAL RSCH - CODE 341 800 N QUINCY STREET ROOM 817-6 ARLINGTON VA 22217-5860
1	ARMY RSCH LABORATORY - HRED ATTN AMSRD ARL HR MU M SINGAPORE 6501 E 11 MILE RD MAIL STOP 284 BLDG 200A 2ND FL RM 2104 WARREN MI 48397-5000	1	NAVAL AIR SYSTEMS CMD ATTN V BJORN AEDC/DOF (NAVY LIAISON) 740 FOURTH STREET ARNOLD AFB TN 37389-6000
1	ARMY RSCH LABORATORY - HRED ATTN AMSRD ARL HR MF MR C HERNANDEZ BLDG 3040 RM 220 FORT SILL OK 73503-5600	1	USAARL BOX 620577 ATTN MCMR UAC D W AHROON FT RUCKER AL 36362-0577
1	ARMY RSCH LABORATORY - HRED ATTN AMSRD ARL HR MW E REDDEN BLDG 4 ROOM 332 FT BENNING GA 31905-5400	1	PEO SOLDIER ATTN LTC R PASTEL 10125 KINGMAN RD BUILDING 317 FT BELVOIR VA 22060
1	ARMY RSCH LABORATORY - HRED ATTN AMSRD ARL HR MN R SPENCER DCSFDI HF HQ USASOC BLDG E2929 FORT BRAGG NC 28310-5000	1	GEORGIA INST OF TECHNOLOGY ATTN B WALKER SCHOOL OF PSYCHOLOGY ATLANTA GA 30332-0170
1	ARMY G1 ATTN DAPE MR B KNAPP 300 ARMY PENTAGON ROOM 2C489 WASHINGTON DC 20310-0300	1	CON-SPACE COMMUNICATIONS ATTN E POPPERT 2606 PARK BOULEVARD SUITE 2 LINCOLN NE 68502-3349
1	US AIR FORCE RSCH LABORATORY ATTN R MCKINLEY AFRL/HECB 2610 SEVENTH STREET WRIGHT PATTERSON AFB OH 45433-7901		

<u>NO. OF COPIES</u>	<u>ORGANIZATION</u>	<u>NO. OF COPIES</u>	<u>ORGANIZATION</u>
1	US ARMY NATICK SOLDIER RSCH ATTN DR LYNNE SAMUELSON KANSAS STREET NATICK MA 01760	1	PRIN ASST FOR RSCH AND TECHNOLOGY ATTN DR F GLENN USA MPMC FT DETRICK MD 21701
1	SILYNX COMMUNICATIONS INC ATTN GIL LIMONCHIK 9901 BELWARD CAMPUS DRIVE SUITE 150 ROCKVILLE MD 20850		<u>ABERDEEN PROVING GROUND</u>
1	US ARMY SOLDIER CENTER ATTN AMSRD NSC SS E ATTN K ALLAN NATICK MA 01760-5020	1	DIRECTOR US ARMY RSCH LABORATORY ATTN AMSRD ARL CI OK (TECH LIB) BLDG 4600
1	US ARMY SOLDIER CENTER ATTN AMSRD NSC SS E ATTN K ALLAN NATICK MA 01760-5020	1	USACHPPM HEARING CONSERVATION PROGRAM ATTN MCHB-TS-CHC C JOKEL APG MD 21010-5403
1	UNITED SPACE ALLIANCE ATTN D GOHMERT 600 GEMINI HOUSTON TX 77058-2783	1	DIRECTOR US ARMY RSCH LABORATORY ATTN AMSRD ARL CI OK TP S FOPPIANO BLDG 459
1	NATL GROUND INTEL CTR ATTN IANG IA MM/MD404 ATTN DR JOHN MONROE JR 2055 BOULDERS ROAD CHARLOTTESVILLE VA 22911-8318	1	DIRECTOR US ARMY RSCH LABORATORY ATTN AMSRD ARL HR MR F PARAGALLO BLDG 459
1	EMBRY-RIDDLE AERONAUTICAL UNIV ATTN DR MARANDA MCBRIDE 600 S CLYDE MORRIS BLVD DAYTONA BEACH FL 32114-3900	100	DIRECTOR US ARMY RSCH LABORATORY ATTN AMSRD ARL HR SD P HENRY T LETOWSKI BLDG 520
1	AUSIM ENGINEERING SOLUTIONS ATTN W CHAPIN 3239 EL CAMINO REAL SUITE 205 PALO ALTO CA 94306		
1	BOSE CORPORATION ATTN D GAUGER MS 271E (RES) 145 PENNSYLVANIA AVENUE FRAMINGHAM MA 01701		
1	ADAPTIVE TECHNOLOGIES INC ATTN M VAUDREY 2020 KRAFT DRIVE SUITE 3040 BLACKSBURG VA 24060		
1	NAVAL SUBMARINE MED RSCH LAB ATTN DR L MARSHALL NAVAL SUBMARINE BASE NEW LONDON BOX 900 GROTON CT 06349-5900		

FOREIGN ADDRESSES

- 1 PERCOM 2000 AUDIO COMS LTD
ATTN D RAMSAY
16 BENTINCK STREET
NEW LYNN AUCKLAND 1007
NEW ZEALAND

- 1 ISL GRUPPE APC
ATTN K BUCK
BP 70034
F 68301 SAINT-LOUIS CEDEX
FRANCE

- 1 TOBIAS GOOD
OIIDO AB
1A FLOOR NR ERIK DAHLBERGSG 11A VÅN 2
123 45 CITY 411 26 GÖTEBORG
SWEDEN