

AUG 11 2006

REPORT DOCUMENTATION PAGE			Form Approved OMB No. 0704-0188	
Public reporting burden for this collection of information is estimated to average 1 hour per response, including the time for reviewing instructions, searching existing data sources, gathering and maintaining the data needed, and completing and reviewing the collection of information. Send comments regarding this burden estimate or any other aspect of this collection of information, including suggestions for reducing this burden, to Washington Headquarters Services, Directorate for Information Operations and Reports, 1215 Jefferson Davis Highway, Suite 1204, Arlington, VA 22202-4302, and to the Office of Management and Budget, Paperwork Reduction Project (0704-0188), Washington, DC 20503.				
1. AGENCY USE ONLY (Leave blank)	2. REPORT DATE 14.Apr.06	3. REPORT TYPE AND DATES COVERED DISSERTATION		
4. TITLE AND SUBTITLE ECHOES THAT NEVER WERE: AMERICAN MOBILE INTERCONTINENTAL BALLISTIC MISSILES, 1956-1983.			5. FUNDING NUMBERS	
6. AUTHOR(S) LT COL POMEROY STEVEN A				
7. PERFORMING ORGANIZATION NAME(S) AND ADDRESS(ES) AUBURN UNIVERSITY MAIN CAMPUS			8. PERFORMING ORGANIZATION REPORT NUMBER CI04-1762	
9. SPONSORING/MONITORING AGENCY NAME(S) AND ADDRESS(ES) THE DEPARTMENT OF THE AIR FORCE AFIT/CIA, BLDG 125 2950 P STREET WPAFB OH 45433			10. SPONSORING/MONITORING AGENCY REPORT NUMBER	
11. SUPPLEMENTARY NOTES				
12a. DISTRIBUTION AVAILABILITY STATEMENT Unlimited distribution In Accordance With AFI 35-205/AFIT DISTRIBUTION STATEMENT A Approved for Public Release Distribution Unlimited			12b. DISTRIBUTION CODE	
13. ABSTRACT (Maximum 200 words)				
14. SUBJECT TERMS			15. NUMBER OF PAGES 316 307	
			16. PRICE CODE	
17. SECURITY CLASSIFICATION OF REPORT	18. SECURITY CLASSIFICATION OF THIS PAGE	19. SECURITY CLASSIFICATION OF ABSTRACT	20. LIMITATION OF ABSTRACT	

ECHOES THAT NEVER WERE: AMERICAN MOBILE INTERCONTINENTAL
BALLISTIC MISSILES, 1956-1983

Steven Anthony Pomeroy

A Dissertation

Submitted to

the Graduate Faculty of

Auburn University

in Partial Fulfillment of the

Requirements for the

Degree of

Doctor of Philosophy

DISTRIBUTION STATEMENT A
Approved for Public Release
Distribution Unlimited

Auburn, Alabama
May 11, 2006

20060818040

ECHOES THAT NEVER WERE: AMERICAN MOBILE INTERCONTINENTAL
BALLISTIC MISSILES, 1956-1983

Except where reference is made to the work of others, the work described in this dissertation is my own or was done in collaboration with my advisory committee. This dissertation does not include proprietary or classified information. The views expressed herein are those of the author and do not reflect official policy or position of the United States Air Force, Department of Defense, or the U.S. Government.

Steven Anthony Pomeroy

Guy V. Beckwith
Professor
History

William F. Trimble, Chair
Professor
History

James R. Hansen
Professor
History

Stephen L. McFarland
Acting Dean
Graduate School

ECHOES THAT NEVER WERE: AMERICAN MOBILE INTERCONTINENTAL
BALLISTIC MISSILES, 1956-1983

Steven Anthony Pomeroy

Permission is granted to Auburn University to make copies of this dissertation at its discretion, upon the request of individuals or institutions and at their expense.
The author reserves all publication rights.

Signature of Author

Date of Graduation

DISSERTATION ABSTRACT

ECHOES THAT NEVER WERE: AMERICAN MOBILE INTERCONTINENTAL
BALLISTIC MISSILES, 1956-1983

Steven Anthony Pomeroy

Doctor of Philosophy, May 11, 2006
(M.A., California State University, 1994)
(B.A., Pennsylvania State University, 1989)

316 Typed Pages

Directed by William F. Trimble

Using a contextual, inside-outsider perspective, this study of mobile intercontinental ballistic missiles (ICBMs) addresses a gap in the history of American technology. An unheralded part of space history, mobile ICBM research complemented the deployment of operational ICBMs in seventeen American states. A child of systems engineering, a powerful innovation that extended human capabilities to research, develop, operate, maintain, and sustain complex technological systems, ICBMs were--and remain--a system blending technical matters, scientific laws, economic principles, political forces, and social concerns. Because technology embeds itself within culture, the ICBM possessed momentum, force, and direction that reflected the changing resources and aspirations of groups, organizations, and individuals. Despite its historical anonymity, the mobile ICBM was not an exception. By shaping the ICBM force, it

played a major role in the space history of the United States.

The dominant mode of ICBM deployment was the hard and dispersed launch facility, and the United States has never deployed a mobile ICBM. This history is the tale of a technological failure, that is, it follows a road not taken and is inconsistent with a whiggish metanarrative of technology's progressive forward march. Nonetheless, throughout the past half-century of ICBM innovation, dreams of mobile ICBMs have profoundly influenced long-range ballistic missile technology because they affected a cornerstone of American nuclear deterrence, the land-based ICBM. The mobile ICBM did so by providing cause to reaffirm the utility of hard and dispersed launch facility basing. That the nation accomplished this reaffirmation unintentionally does not lessen its importance. This dissertation demonstrates that the hitherto unstudied American research into mobile ICBMs has a long history that influenced the nature of the present ICBM force.

The views expressed in this article are those of the author and do not reflect the official policy or position of the United States Air Force, Department of Defense, or the U.S. Government.

VITA

Born on Friday in Camp Hill, Pennsylvania, Steven Anthony Pomeroy is the son of Elisa Carmella Griggs. In 1989, he graduated with high distinction from the Pennsylvania State University, where he earned a Bachelor of Arts degree in history, a minor in anthropology, and a regular commission as an air force officer. While on active duty in 1994, he completed his Masters of Arts in the humanities from the California State University. He has had extensive experience in missile and space launch operations, education, training, evaluation, and has co-authored a technical order on launch range safety operations. In August 2003, the faculty of the military strategic studies department at the United States Air Force Academy selected him to pursue a history of technology doctoral program at Auburn University. Married since 1992, they have two children.

DISSERTATION ABSTRACT

ECHOES THAT NEVER WERE: AMERICAN MOBILE INTERCONTINENTAL
BALLISTIC MISSILES, 1956-1983

Steven Anthony Pomeroy

Doctor of Philosophy, May 11, 2006
(M.A., California State University, 1994)
(B.A., Pennsylvania State University, 1989)

316 Typed Pages

Directed by William F. Trimble

Using a contextual, inside-outsider perspective, this study of mobile intercontinental ballistic missiles (ICBMs) addresses a gap in the history of American technology. An unheralded part of space history, mobile ICBM research complemented the deployment of operational ICBMs in seventeen American states. A child of systems engineering, a powerful innovation that extended human capabilities to research, develop, operate, maintain, and sustain complex technological systems, ICBMs were--and remain--a system blending technical matters, scientific laws, economic principles, political forces, and social concerns. Because technology embeds itself within culture, the ICBM possessed momentum, force, and direction that reflected the changing resources and aspirations of groups, organizations, and individuals. Despite its historical anonymity, the mobile ICBM was not an exception. By shaping the ICBM force, it

played a major role in the space history of the United States.

The dominant mode of ICBM deployment was the hard and dispersed launch facility, and the United States has never deployed a mobile ICBM. This history is the tale of a technological failure, that is, it follows a road not taken and is inconsistent with a whiggish metanarrative of technology's progressive forward march. Nonetheless, throughout the past half-century of ICBM innovation, dreams of mobile ICBMs have profoundly influenced long-range ballistic missile technology because they affected a cornerstone of American nuclear deterrence, the land-based ICBM. The mobile ICBM did so by providing cause to reaffirm the utility of hard and dispersed launch facility basing. That the nation accomplished this reaffirmation unintentionally does not lessen its importance. This dissertation demonstrates that the hitherto unstudied American research into mobile ICBMs has a long history that influenced the nature of the present ICBM force.

ACKNOWLEDGMENTS

Having enjoyed history since my youth, by the summer of 2003, I could deny no longer Clio's call, and deeply desirous of a new direction in career, I became a prospective historian. It was with a measure of trepidation that I embarked on this intellectual journey. The trials are arduous, as they should be, and success is impossible without the love and understanding of one's family. It is with humility that I thank my radiant and patient wife Marnie, son Luke, and daughter Sarah for having understood and accepted my desire to subject them to such travails.

Professors William F. Trimble, Guy V. Beckwith, and James R. Hansen provided mentorship throughout the project. As department head, Professor Trimble's good cheer, clear thought, and open door policy made an enjoyable, stimulating, and effective combination. I thoroughly enjoyed his direction and appreciated his teachings. Professor Beckwith's questioning has enriched my appreciation of history to a substantial degree. There are few, if any, better teachers of historical philosophy; he is a gem. Also impressive was the professional grace of Professor Hansen, who in the midst of his own physical travels took extra time to help refine this tome. Never did they hesitate to assist. Equal to this task were two additional mentors, Professors David A. Carter and Kenneth W. Noe, whose training provided an invaluable role model. It is to such professionals that I owe a measure of gratitude.

Style manual used: *The Chicago Manual of Style*, 15th ed. Chicago: University of Chicago Press, 2003.

Computer software used: Microsoft Word 2002.

TABLE OF CONTENTS

INTRODUCTION.....	1
1. TOWARD A NEW HORIZON.....	15
2. EARLY AMERICAN ICBMS AND MOBILITY.....	52
3. CHANGING RELATIONSHIPS AND A TOUCH OF PRESCIENCE.....	104
4. PARITY, SALT, AND INDECISION.....	149
5. A FRUITLESS SEARCH.....	193
6. CONCLUSIONS.....	242
GLOSSARY OF ACRONYMS.....	257
BIBLIOGRAPHY.....	259
APPENDICES.....	282
A. PHOTOGRAPHS OF MOBILE MINUTEMAN MODELS.....	283
B. GOLDEN ARROW AND MULTIPLE POOL BASING.....	287
C. MX AIR MOBILE.....	294
D. MX POOL BASING AND BURIED TRENCH WEAPON SYSTEM..	298
E. MX MULTIPLE PROTECTIVE SHELTER CONCEPTS.....	303

INTRODUCTION

Someday, not too far distant, there can come streaking out of somewhere (we won't be able to hear it, it will come so fast) some kind of a gadget with an explosive so powerful that one projectile will be able to wipe out completely this city of Washington. . . . But I'll tell you one thing, there won't be a goddamn pilot in the sky!

-- General Henry H. Arnold, 1943¹

In 1973, when I was a young boy, my grandparents gave me a set of Lionel electric trains that included a copy of an old 1961 catalog. More than just locomotives and boxcars rode through those magical pages. One four-color, two-page spread proclaimed the arrival of "the mobile missile launcher with a cargo of fighting cars," and the train included a new Minuteman missile-launching car as its first piece of rolling stock. The Lionel toy was a stubby boxcar complete with Strategic Air Command livery and a double-sided hinged roof. Inside was a two-stage, spring-fired rocket that looked less like the sleek, finless Minuteman missile and more like the winged German A-4b of 1944. As a young engineer, I pulled the train onto a siding, stopped it, pressed a button, watched the missile elevate through the roof, and unleashed a "guardian of peace" against erstwhile enemies, notably the Soviet Union. Then, I powered the train down the rails to hide from any incoming enemy warheads. It was heady stuff for a little boy.²

¹Quoted in Jacob Neufeld, *Ballistic Missiles in the United States Air Force: 1945-1960* (Washington, D.C.: Government Printing Office, 1989), 35. A dedicated pilot and the head of the Army Air Forces, Arnold was a farsighted thinker who understood that air power was a malleable and evolving concept.

²Joe Algozzini, *Lionel's Postwar Space and Military Trains*, Toy Train Reference Series, no. 2 (Waukesha, WI: Greenberg Books, 1996), 17. Toy trains are another example of the relationship between

Eventually, that little boy grew up and became an air force officer who worked not with toys but the real thing. None of this was my design, but that is how my life unfolded. Over the years, I served in a variety of roles, including many with operational nuclear weapon systems including intercontinental ballistic missiles (ICBMs). As is true of most historians, my experiences have filtered my perception of the past. Because you are about to read a history of a military-related topic written by someone with a military background, this deserves an explanation, so I will begin with a question. Typically, if you ask an air force officer what he does, the reply will more than likely be something to the effect of “I fly F-15s” or “I’m a missileer, pilot, navigator, personnel manager, or other specialist.” This standard response informs the interrogator what kind of weapon system or day-to-day function the person fulfills rather than him simply stating that he is an officer. For many years, service leaders have frowned upon this misplaced sense of identification, but it remains. When asked this question, I typically reply that I am a teacher, despite my years of experience with ICBMs and similar systems in the operational, training, evaluation, planning, and programming arenas. If pressed for my operational background, I categorize myself as what the air force once called a range safety officer. As it regards my topic, the role of American mobile ICBM technology in structuring the ICBM force, my perspective is that of the “inside-outsider.”

A superb representation of the historical inside-outsider dynamic occurred in the motion picture *Patton* where the actor Karl Malden, playing army General Omar Bradley, informed General George S. Patton that the difference between the two men was that

technology and society. Technology and culture affect each other in many ways, and the reproduction of transportation systems and military weaponry as toys is an interesting expression of the acceptance of technology in childhood.

Patton did his job because he loved it while Bradley did his because it was what he was trained to do. Bradley was an insider who retained an outsider's perspective. For purposes of this study, this is not to say that I was unaware of the ICBM's capability to annihilate space, time, and lives; indeed, those who were prepared to launch such weapons are the people most aware of such consequences. Rather, being an inside-outsider provided a perspective useful for historical analysis because it offered a firm understanding of the internal workings of ICBM technology as seen from the operator's perspective; it illuminated the relationship of that technology to the directions received from national leadership, and it opened avenues of investigation and questioning that I otherwise would have missed. It has thus sharpened my historical perspective of mobile ICBM technology and shaped my handling of the internal and external approaches to the topic.

Historians of technology are not supposed to be strict internalists, that is, the profession's predominant paradigm demands that they uncover more than the details of how things worked. They also retreat from progressively whiggish tales of technology's forward march; rather, they seek to portray the historical significance of a technology in relation with its time and culture to answer the big question of "so what?" This is the approach of a contextualist, which my perspective informs, although I admit that I consider it disingenuous to study critically a technology's role in history without communicating an understanding of how it actually functioned. When discussing mobile ICBM technology, I relied upon my experience, particularly that as an operator, to filter the evidence and discern the crucial elements. Doing so provided the perspective of how those ultimately responsible for launching such weapons would have seen their interface

with the technology. This required detailed study and explanation of many proposed weapon systems, and the results of those efforts are herein included.

Elements external to technological artifacts are crucial to forming a historical interpretation. From the start of the Manhattan Project, the famous effort to build a fission weapon, the United States tried to build a nuclear strike force. The first such weapons were bomber-carried gravity bombs, and by the fifties, the Department of Defense (DoD) sought to operate long-range cruise missiles and, eventually, long-range ballistic missiles. The United States based its first ICBMs in stationary launch sites, but mobility was never far from the designers' minds; however, even when deployment of a mobile ICBM seemed imminent, the stationary deployment mode represented a competing and successful alternative. Therefore, the mobile ICBM was part of a broader national program not just to build an ICBM force but also to build a nuclear strike and deterrent force, and one must so contextualize it. Understanding the context of all of this activity is necessary to comprehending the significance of mobile ICBM technology.

ICBMs were (and remain) a technological system that blended scientific laws, economic realities, political forces, and social concerns that included environmentalism and institutional trust or distrust; moreover, ICBM technology reflected the changing resources and aspirations of individuals, groups, and organizations. These historical agents included presidents, cabinet members, senators and congressional representatives, military officers and organizations, industry, and public action groups. It is impossible to understand the contribution of mobile ICBM technology to American history without examining the connections among these agents. Often, the presumed capabilities of the technology influenced how these agents acted. The discourse that these agents held on

mobile ICBMs relied upon their understanding of the internal workings of the technology, and because of that, it is necessary to study both internal and external factors to contextualize the topic.

One realization from my inside-outsider perspective was that one cannot study mobile ICBM technology without political contextualization, with the result that this dissertation pays particular attention to the involvement of political leaders with ICBM technology. Although many people were involved with mobile ICBM development, the buck, as President Harry S. Truman noted, stopped at the Oval Office. As any missile crewmember knows, operations involving nuclear weapons use a top-down approach. This is not to say that low-ranking industry, military, political, or members of the public did not influence the development of mobile ICBM technology. They did. Nonetheless, the historian of technology interested in this topic cannot ignore the top-down perspective if for no other reason than that only the president may decide whether to launch or not launch an American ICBM equipped with a nuclear weapon. Ultimately, the president had to decide what kind of nuclear force he wanted; whether he received that force was another matter. ICBM operators drill this thought continuously, and it enriched my historical investigation by providing a useful perspective with which to understand mobile ICBM technology and its role in history.

Most properly, ICBM history is part of space history; after all, each deployed ICBM is a suborbital launch vehicle designed to fire from a moving location to strike a moving target. ICBM apogees carry them hundreds of miles into space, and in this sense, they are space weapons whose orbits purposely rendezvous with a moving spot on the Earth's surface. Space historians recognize the importance of ICBM technology to the

peaceful exploration of space, and nearly all the books on early civilian space programs refer to the use of ICBMs as boosters. From Eugene Emme's *The History of Rocket Technology: Essays on Research, Development, and Utility* (1964) and Wernher von Braun and Frederick Ordway's *History of Rocketry and Space Travel* (1966) to recent books such as Roger D. Launius and Dennis R. Jenkins's *To Reach the High Frontier: A History of U.S. Launch Vehicles* (2002), commentators and historians of space technology have maintained the theme of explaining how former ICBMs have played a role in the development of space launch vehicle technology.

The approach is not unique to histories of American space technology. In *The Soviet Space Race with Apollo* (2000), Asif Siddiqi demonstrated the significance of ICBMs to Soviet spaceflight efforts. Walter McDougall's earlier book, *The Heavens and the Earth: A Political History of the Space Age* (1985), considered ICBM and other military space technologies within a wider space history of civilian and military purposes, as did David Spires's *Beyond Horizons: A Half Century of Air Force Space Leadership* (1998). Within these books possessing a broader topical focus, the ICBM played a background role to permit other technologies to claim center stage.

The leading works on ICBM history have emphasized the importance of politics to nuclear weapon system development, as well as systems engineering, management, and leadership innovation. Many have taken this path, notably Thomas Hughes in *Rescuing Prometheus* (1998), Harry Stine in *ICBM: The Making of the Weapon that Changed the World* (1991), Jacob Neufeld's superb *Ballistic Missiles in the United States Air Force, 1945-1960* (1990), Edmund Beard's *Developing the ICBM: A Study in Bureaucratic Politics* (1976), and Harvey Sapolsky's *The Polaris System Development:*

Bureaucratic and Programmatic Success in Government (1972), although the latter treated the navy's sea-launched ballistic missile (SLBM) Polaris program. These studies have explained how the United States created its first generation of ICBMs and SLBMs.

Detailed studies of missile and rocket subsystems exist. Donald MacKenzie's 1990 book, *Inventing Accuracy: A Historical Sociology of Nuclear Missile Guidance*, examined the role of innovation in developing ICBM and SLBM guidance systems and questioned the values associated with the zeal for ever-more accurate weaponry. Ted Greenwood's *Making the MIRV: A Study of Defense Decision Making* (1975) discussed the policy implications of the decisions that led to multiple independent reentry vehicles. Other historians focused on specific ICBM systems, such as David Stumpf's *Titan II: A History of a Cold War Missile Program* (2000), and while such books illuminated the invention, development, and innovation of ICBM technology, the mobile ICBM remained unstudied. The authors of books on ICBM history have mentioned mobile systems, but because they had other research agendas, they did not develop the subject, and despite their value as histories of ICBM technology, these works have left a gap. Although the canon has described much of the ICBM's history, the mobile ICBM is largely missing, inaccurately leading one to believe that mobile ICBMs had little effect on history or that they were merely afterthoughts.

Most books covering ICBM history focus on the early years of development, drawing upon the Atlas, Titan, and Minuteman I ICBM systems as examples. This is natural because these systems deployed successfully; moreover, the second generation Titans and Minutemen dispersed operationally in the hardened underground launch facilities that most persons inappropriately call "silos" and that became the dominant

mode of ICBM deployment. Images of underground-based ICBMs are common, and they are familiar. In such histories, mobile ICBMs played a minor role. Typically, mobile Minuteman, an early 1960s program and MX multiple protective shelters, a late 1970s program, received at most a few pages of discussion. Mobile Minuteman fares best, if for no other reason than that its days fell in the period covered by the bulk of published literature. Historians have not performed an analysis of the mobility schemes for the MX ICBM beyond those done for books that discussed nuclear policy or arms limitation agreements.³

Researchers other than historians of technology wrote much of the literature dealing with the MX, including correspondent John Edwards, whose 1982 book *Superweapon: The Making of MX* presented a narrative of MX program approval but did not examine the details of the operational concepts and technology beyond general description. The contemporary literature on the MX is voluminous, served by many authors with a heavy dose of personal political preference, and as a result, these books presented a political argument for or against its deployment instead of a history of its development. Historians of technology have not written about this weapon system. As it regards mobile ICBM technology, there are many possible reasons why this is so, but three considerations stand out: the mobile ICBM was a road not taken; most of the sources needed to discuss mobile ICBM programs have remained classified or unnoticed in archival boxes; and in the case of MX, the history is fairly recent, and historians tend not to write on topics less than thirty years past.

³The correct term for an underground shelter containing a nuclear-tipped ICBM is “launch facility.” As any good air force missileer will state, corn goes in silos. Nuclear missiles stand alert in launch facilities.

The result is that a major part of the history of American nuclear weapons and space history has remained unaddressed, and because of this, the astute reader interested in military space history will see a gap between the early sixties and late seventies. He or she will learn that in the sixties, the air force planned originally to deploy the Minuteman ICBM on trains before that system suffered cancellation, and he or she will learn that late in the seventies, the MX ICBM was to play a shell game in the deserts of Nevada and Utah. Left unsaid is how these ideas relate and how engineers, military officers, and political leaders went from supporting a mobile Minuteman to the deployment of 1,000 such missiles in stationary launch facilities. Also left unknown is how extensive mobile ICBM development was and why the idea persisted. For Minuteman and MX, weapon system planners did not grab deployment modes out of the sky; rather, there was a continuous line of thought on mobile missiles from the earliest stirrings of the long-range ballistic missile effort through the MX program. This dissertation addresses these issues.

Even for a wealthy nation such as the United States, the ICBM effort was costly. In a July 3, 1957, meeting of the National Security Council, Deputy Secretary of Defense Donald Quarles, formerly a secretary of the air force, briefed President Dwight Eisenhower that through fiscal year 1957, the government had spent \$11.8 billion on military missile development (in fiscal year 1957 dollars). To continue development at the same rate through fiscal year 1963 would cost an additional \$36 billion, for a total of nearly \$48 billion. Translated into year 2000 dollars, the total cost was \$230 billion. As it turned out, not all of the projects discussed at this meeting came to fruition; many were

cancelled, that national leaders contemplated such an investment demonstrated the seriousness with which they viewed missile development.⁴

An important aspect of ICBM development was the speed with which the technology spread. The first successful Soviet ICBM test occurred in 1957, and in response by the end of 1964, the United States had deployed 931 ICBMs throughout seventeen states including Arizona, Arkansas, California, Colorado, Idaho, Kansas, Missouri, Montana, Nebraska, New Mexico, North Dakota, New York, Oklahoma, South Dakota, Texas, Washington, and Wyoming. The mobile ICBM was part of this process. In some ways, the ICBM, particularly the mobile ICBM, was an effort to solve problems by technology and to stabilize what American leadership perceived as a dangerous situation. Paradoxically, it was potentially destabilizing to the world political environment. It has historical significance because it helps to explain the development of the American ICBM force, a little-known and even less-appreciated instrument of national power.⁵

Mobile ICBM technology was an instrumental part of the context that shaped these developments. The result was the creation of the most destructive American instrument of national power ever assembled, and it was a technology central to major debates in American society during the Cold War. Despite this, within the history of

⁴S. Everett Gleason, "Memorandum of Discussion at the 329th Meeting of the National Security Council, July 3, 1957," prepared on July 5, 1957, in Department of State, *Foreign Relations of the United States* (hereafter cited as *FRUS*), 1955-1957, vol. 19, *National Security Policy* (Washington, D.C.: Government Printing Office, 1990), 536. Year 2000 cost estimate from Roger D. Launius and Dennis R. Jenkins, "Introduction" in Launius and Jenkins, eds., *High Frontier: A History of U.S. Launch Vehicles* (Lexington, KY: University Press of Kentucky, 2002), 7.

⁵Missile numbers from Office of the Historian, Headquarters Strategic Air Command, *Alert Operations of the Strategic Air Command, 1957-1991* (Offutt Air Force Base, NE: Office of the Historian, 1991), 87. This document hereafter referred to as SAC Historian, *Alert Operations*. As the list indicates, over one-third of American states contained ICBMs.

technology, the ICBM has remained relatively unknown except as an application of systems engineering, a provider of boosters for the civilian space program, or for the role of innovation in developing its guidance systems. Simon Ramo, an important figure in the development of American missiles, believed that the ICBM project was “the biggest project we [the United States] have ever had.” Historian Thomas Hughes contended that the ICBM program was the “largest and most costly military-funded research and development program in history--the Manhattan Project notwithstanding.” Perhaps, Hughes asserts, the “Apollo moon project might have been larger if it had not been able to use the industrial base laid down by the ICBM project.” In comparing the ICBM effort with the Manhattan Project to build an atomic bomb and the Apollo lunar landing program, Ramo and Hughes believed that it represented an important part of American history. The mobile ICBM is an unknown portion of that history.⁶

A practical problem with studying mobile ICBMs is that their designers engineered them to carry nuclear weapons, and the United States, like many other nations, closely guards its nuclear and ballistic missile secrets, particularly in a post 9-11 world. To write a history of mobile ICBM technology required the declassification of previously controlled information. Because, thanks to my status as an active duty officer, I possessed an appropriate security clearance, I could survey thousands of pages of classified documents dealing with mobile ICBMs dating back to the early 1950s; however, I could not use these documents unless they were formally declassified. To obtain release of this information, I presented the materials that I desired to the

⁶Thomas P. Hughes, *Rescuing Prometheus* (New York: Pantheon Books, 1998), 83. See also n. 39, p. 323. The interstate highway system, and not the Manhattan or Apollo projects, was the largest American public project.

declassification officer at the Air Force Historical Research Agency (AFHRA) in Montgomery, Alabama. A graduate of Auburn's history program, Archangelo ("Archie") DiFante is a dedicated public servant who attends to all such requests from all of the researchers using the AFHRA's collections. A busy man, he reviewed and then released the documents whenever possible. The result was the extensive use of previously classified material in this study, without which chapters two and three would have differed significantly. Nonetheless, whenever it was possible, I eased his and my research and administrative toils by drawing upon a wide range of unclassified documents.

In addition, the courteous professionals of the AFHRA, in particular Dennis Case, Joseph Caver, and Mrs. Tony Petito, generously allowed me to study unaccessioned collections, notably those of the former air force Ballistic Missile Office (BMO), its antecedents, and successors. The BMO archives consist of thousands of linear feet of documentation on military space and missile systems development. It is a rich resource consisting of classified and unclassified collections containing not only air force-generated documentation but also extensive materials from other government agencies and most important, the aerospace contractors who did so much to shape ICBM programs. For example, through the years that this dissertation covers, the amount of unclassified material concerned with mobile basing options for the MX missile consists of what I estimate conservatively as well over 300 linear feet of material. There is a comparable amount of classified archival papers. On several occasions, AFHRA archivists informed me that I was the first person to study certain boxes since their arrival. Formerly, scholars had to travel to BMO and obtain permission to examine this

resource. Although permission is required still to access it, the material now properly lies with the rest of the air force's archival collections. I am thankful for the dedication of the staffs at the AFHRA and former BMO.

The BMO staff chronologically sorted this information by missile system. Because these collections were unaccessioned, I used their shipping manifests as an index. These manifests fill a three-inch thick binder that now sits on one of my bookshelves. For the unclassified collections, this posed little problem because the manifests precisely stated the title of the individual documents. For the classified portions, the manifest listed unclassified titles, and this sometimes forced an educated guess at which boxes to examine. This situation resulted sometimes in serendipitous and fascinating but also unrelated discoveries. Nonetheless, it was one of the joys of this project.

As a result, I have drawn upon thousands of pages of previously unavailable documents to write this history, which has allowed me to move beyond the general descriptions of technical capabilities found in aerospace trade journals, newspapers, or magazines, excellent and helpful though many of these were. Many historians have used previously classified information to write notable histories of the ICBM, notably Edmund Beard's treatment of the early years of ICBM development. He noted that his publication would have been impossible without the aid of declassified material. What sets this dissertation apart is that the newly released and detailed technical data on mobile ICBM

systems permitted me to illustrate in detail how the extensive efforts put into building an American mobile ICBM force reified the dominant paradigm of ICBM deployment.⁷

This history is the tale of a technological failure, that is, it follows a road not taken and is inconsistent with a whiggish metanarrative of technology's march. Nonetheless, throughout the past half-century of ICBM innovation, dreams of mobile ICBMs have profoundly influenced long-range ballistic missile technology because they affected the cornerstone of American nuclear deterrence, the land-based ICBM, by providing cause to reaffirm the utility of hard and dispersed launch facility basing. That the nation accomplished this reaffirmation unintentionally does not lessen its importance to historians and others interested in military space technology.

⁷Edmund Beard, *Developing the ICBM: A Study in Bureaucratic Politics* (New York: Columbia University Press, 1976), viii.

CHAPTER 1

TOWARD A NEW HORIZON

The Soviet Army today possesses such armaments and such firepower as no army has ever had. I want to re-emphasize that we already have such an amount of nuclear weapons--atomic and hydrogen weapons and an appropriate number of rockets to deliver them to the territory of a potential aggressor--that if some madman were to provoke an attack on our country or on other socialist countries, we could literally wipe the country or countries attacking us off the face of the earth.¹

-- Nikita S. Khrushchev, 1960

Nikita Khrushchev was bluffing. In 1960, the Soviet Union had two ICBMs, and each of those carried one warhead. He did have sixty-three SLBM launchers and warheads, but the best of these missiles had a range of no more than 600 kilometers; moreover, his bomber force consisted of 138 aircraft and 239 weapons, not an insignificant number but hardly large when compared to its American counterpart. The American air force's Strategic Air Command (SAC) possessed 1,735 long-range bombers, 1,178 of which were the sleek but soon-to-be retired B-47 Stratojets and 538 B-52 Stratofortress heavy bombers accompanied by nineteen supersonic B-58 Hustlers. Additional B-52s and B-58s were on the way. To top off the bombers' fuel tanks for the long flight to the Soviet Union and other targets, 689 KC-97 and 405 KC-135 aerial tankers stood ready. The bomber was the United States' primary long-range nuclear attack weapon, but in a sign that times were changing, SAC also owned twelve Atlas

¹Nikita S. Khrushchev, "Disarmament for Durable Peace and Friendship," in *The Soviet Art of War: Doctrine, Strategy, and Tactics*, ed. Harriet Fast Scott and William F. Scott (Boulder, CO: Westview Press, 1982), 162. In 1960, Khrushchev was the First Secretary of the Communist Party of the Soviet Union.

ICBMs, had five on alert by year's end, and expected delivery of more, along with its Titan and Minuteman ICBMs. It anticipated basing a portion of its Minuteman force on trains that would roam the national rail network, while at sea, the American navy did not yet have Polaris SLBMs prowling, but they were well on their way to operational capability. The United States, a nation slow to develop ballistic missiles, had not only plunged feet-first into a crash missile program but also had readily accepted mobile versions. Khrushchev played with fire.²

Khrushchev knew he was bluffing, but the Americans, whose perceptions of Soviet power rested on dramatic technological achievements such as Sputnik and propaganda including Khrushchev's speech, were not so certain. Soviet achievement and rhetoric had led American leaders to believe that the Soviets could threaten the United States with an indefensible nuclear attack. In response, the United States terminated the development of its intercontinental cruise missiles and initiated a crash ballistic missile program, which provided military planners such as air force General Bernard Schriever the opportunity to research mobile missiles while developing their first ICBMs.

²SAC numbers from SAC Historian, *Alert Operations*, 79, 81, 87, 97. Even the best counts of Soviet nuclear forces sometimes differ. These numbers provided by Pavel Podvig, ed., *Russian Strategic Nuclear Forces* (Cambridge, MA: MIT Press, 2001), 6-7, 136-139, 246-251, 350-351. Podvig's numbers rely chiefly upon on the Strategic Arms Reduction Talks (START) Treaty Memorandums of Understanding Data, and his book resulted from cooperative research between American, former Soviet, and Russian scholars. Suggestive of its accuracy is a tale in the book's foreword (p. xiii). Princeton's Frank von Hippel explained that "although the book was very well received by Russian experts . . . in October 1999 the Russian Security Service (FSB) seized all the remaining unsold Russian copies . . . along with the hard disks of the computers on which the book had been edited. The FSB seems to believe that the volume contains classified information and launched an investigation into its sources. The fact that none of the authors had access to classified information does not appear to be an adequate protection--even though it would be in the United States." Podvig et al. had touched a nerve. Steven J. Zaloga, *The Kremlin's Nuclear Sword: The Rise and Fall of Russia's Strategic Nuclear Forces, 1945-2000* (Washington, D.C.: Smithsonian Institution Press, 2002), 247, reports the total number of Soviet long-range bombers as 141 and the number of SLBMs as thirty. When sources differ on ICBM, SLBM, or bomber counts, this dissertation defaults to Podvig because he based his data on START memoranda acceptable to the governments of the United States and the former Soviet Union.

This startling situation was remarkable because at the end of World War II, the Soviet Union was in ruins, although it possessed a large army. For many years, the Soviets had been alone in withstanding the worst of the Nazi onslaught, and they had suffered for it. The United States, virtually untouched by enemy arms, emerged from the war an industrial, economic, and military superpower. A nation that had always prided itself on its technology and industry, America possessed the world's largest navy, a victorious army, and a powerful air force capable of delivering the uniquely American atomic bomb. The populace demanded that the troops come home and expected a quick return to normalcy. Allied might had vanquished Germany and Japan, but the Anglo-Soviet-American alliance remained uneasy throughout the war. Nonetheless, American confidence was such that should the postwar Soviet Union uncomfortably press the United States on an issue, the American fallback could be unilateral atomic superiority. President Harry Truman thus sought to contain the Soviet Union's influence by limiting the availability of nuclear weapons and by leveraging a secure atomic advantage. Technology, Truman felt, could contribute to national security.³

In light of the devastation suffered in two World Wars, the travails of revolution, and a humiliating defeat in the Russo-Japanese war of 1904-1905, the Soviet Union emerged from World War II understandably concerned for its security. It had the world's mightiest army and ground-support air force, but their wartime modernization was uneven. The Red Army had superb tanks and combat experience, but their air force was

³See S. David Broscious, "Longing for International Control, Banking on American Superiority: Harry S. Truman's Approach to Nuclear Weapons," in *Cold War Statesmen Confront the Bomb: Nuclear Diplomacy Since 1945*, ed. John Lewis Gaddis et al. (Oxford: Oxford University Press, 1999), 15-39. Broscious describes Truman as a man who understood the importance of what nuclear technology meant to society. Furthermore, he contends that Truman appreciated the humanistic aspect of nuclear technology but also presented ambiguity because he felt that nuclear weapons were "a gateway to Armageddon and a deterrent to aggression."

the only major allied air arm that failed to develop a jet fighter during the war, and it lacked strategic bombers. Nonetheless, the victorious end to the Great Patriotic War resulted in exaltation well described by Britain's ambassador to the Soviets, Sir Archibald Clerk Kerr: "Russia could be made safe at last. She could put her house in order, and more than this from behind her matchless 300 divisions, she could stretch out her hand and take most of what she needed and perhaps more. It was an exquisite moment, all the more so because the resounding success under their guidance justified at last their faith in the permanence of their system."⁴

The American atomic bomb rudely affected this Soviet sublime: "At a blow the balance which had now seemed set and steady was rudely shaken. Russia was balked by the West when everything seemed to be within her grasp. The 300 divisions were shorn of much of their value," because the United States proved unwilling to share atomic technology, and the exquisite Soviet moment evaporated into humiliation. Stalin, whose country had learned the hard way about the inequities of an inadequate military, could not permit the Americans to monopolize a technological development of such dramatic capability, and shortly after Hiroshima, he initiated a fission weapon project that yielded a 1946 Christmas present when the first Soviet nuclear chain reaction occurred. A major world political surprise followed on August 29, 1949, when the Soviets exploded "Joe I," their first atomic fission device. While the United States rested on a perceived atomic

⁴"The British Ambassador in the Soviet Union (Kerr) to the British Secretary of State for Foreign Affairs (Bevin), December 3, 1945," in Department of State, *FRUS, 1945*, vol. 2, *General: Political and Economic Matters* (Washington, D.C.: Government Printing Office, 1967), 83.

monopoly and sought to reduce defense expenditures accordingly, the Soviets eliminated the unilateral American advantage.⁵

Without an accurate and reliable delivery system, the bomb was useless. In 1947, the first flight of the R-1, a Soviet copy of the German V-2, occurred. It was not a particularly impressive vehicle when compared to later Soviet successes, but it demonstrated the evolution of a native missile program. Aware that this weapon could threaten Western Europe but realistic enough to know it provided little political advantage against the United States, Gyorgi Malenkov, the Politburo's representative for rocket development, stated on March 14, 1947, that he was "not happy with our V-2s. We cannot rely on such a primitive weapon; besides, should there be another war . . . our strategic needs are predetermined by the fact that our potential enemy is to be found thousands of miles away." The Germans had dreamed of intercontinental missiles with which to strike New York, but the Soviets did not just dream; they were the first to possess such missiles.⁶

The American Hiroshima and Nagasaki weapons, known as the "atomic bombs," were fission bombs. When atoms split, they release an enormous amount of energy

⁵Kerr quote, *Ibid.* On how Stalin perceived the atomic bomb, see Vladislav M. Zubok, "Stalin and the Nuclear Age," in *Cold War Statesmen Confront the Bomb*, 39-61. Zubok believed that the Hiroshima bomb frightened Stalin because its yield and potential effects on warfare surprised him. See also David Holloway, *The Soviet Union and the Arms Race* (New Haven: Yale University Press, 1983), 18-23, and Zaloga, *The Kremlin's Nuclear Sword*, 6-12. On early Soviet atomic weapons testing, see Thomas B. Cochrane et al., *Nuclear Weapons Databook*, vol. 4, *Soviet Nuclear Weapons* (New York: Harper and Row, 1989), 5-6, and Thomas B. Cochrane, Robert S. Norris, and Oleg A. Bukharin, *Making the Russian Bomb: From Stalin to Yeltsin* (Boulder, CO: Westview Press, 1995), 1-16.

⁶In regards to missile designations, the letter "R" prefixes a Soviet designation, and the letter "S" indicates a Western designation. The West referred to the R-1 as the SS-1a Scunner. Malenkov quoted in G. A. Tokaty, "Soviet Rocket Technology," in Eugene M. Emme, ed., *The History of Rocket Technology* (Detroit: Wayne State University Press, 1964), 271, 280-281. According to Emme, "Dr. Tokaty was former chief of the aerodynamics laboratory of the Zhukovskiy Academy of Aerodynamics of the Soviet Air Forces in Moscow and Chief Rocket Scientist of the Soviet Government in Germany (1947-1947)." Tokaty then made his way west and settled in London, and his memory is the source of Malenkov and Stalin's statements.

useful for diverse purposes such as generating electricity or destroying a target. "Fission" denotes weapons whose explosive yield depends upon the splitting of the nucleus of a plutonium or uranium atom into two or more parts. The energy yielded is "about ten million times as much, atom for atom" as is obtained from conventional energy sources, a stunning advance in capability. In a conventional bomb, pounds of trinitrotoluene (TNT), measured the explosive yield, but the fission bomb measured yield in kilotons, the explosive force of one thousand standard tons of TNT. The Hiroshima bomb, known as "Little Boy," yielded from twelve-to-fifteen kilotons, and the Nagasaki "Fat Man" bomb yielded approximately twenty-two, plus or minus two, kilotons.⁷

The terms "hydrogen" or "thermonuclear bomb" describe a fusion bomb that joins the nuclei of two hydrogen atoms together to form a single heavier atom. To do so, a fission reaction provides the energy required to overcome the tendency of atomic nuclei to repel each other. The energy released is actually less than that from fission, but the process is more efficient because hydrogen atoms, the lightest element, are used, resulting in an energy yield "about three or four times as great per unit weight" as from nuclear fission. At yields above fifty kilotons, fusion weapons are cheaper and weigh significantly less than fission weapons; moreover, they produce yields in the megaton range, that is, the explosive force of one million standard tons of TNT. The United States' first fusion bomb, known as "Mike," detonated at Eniwetok Atoll on October 31, 1952, yielded a whopping 10.4 megatons. The step from fission to fusion weapons represented another exponential leap in weapons technology. In a military sense, these

⁷Thomas B. Cochrane, William M. Arkin, and Milton M. Hoenig, *Nuclear Weapons Databook*, vol. 1, *U.S. Nuclear Forces and Capabilities* (Cambridge, MA: Ballinger Publishing Company, 1984), 22, 25-26, 32. According to Cochrane et al., 34, "the largest fission device ever detonated, the Super Oralloy Bomb, had a yield of 500 kilotons."

weapons possessed economy of force because so much firepower resulted from the expenditure of one weapon; one bomb replaced thousands of airplanes and airmen, but the problem of delivery remained.⁸

Toward a New Horizon

In 1945, the primary long-range delivery method was the bomber because the size and weight of early fission weapons precluded any other vehicle. The available rockets, whether Soviet or American, were not powerful enough to serve as delivery vehicles, and in any case, American missile programs were fragmented and decidedly small scale. Nonetheless, by November 1944, the commander of the Army Air Forces, General Henry H. ("Hap") Arnold, believed that the service needed to plan for the future. Without the aggressive pursuit of new technologies, he feared that the nation would "let the American people down" by slipping "back to our 1938 position," and he wanted to capitalize upon wartime scientific and technological developments, wherever the source. Arnold appreciated the relationship of science to technological development, and as he put it: "The long-haired professors . . . [need to] see all the gadgets and data and drawings so as to give us a Buck Rodgers program to cover the next twenty years. . . . Accordingly, we must make accessible to the . . . boys all information available from all sources from all nations." He assembled a crack team and charged it with gathering data on Axis aeronautical technology. Headed by Theodore von Karman, Director of the California Institute of Technology's Guggenheim Aeronautical Laboratory and the Army Air Force Scientific Advisory Group, Arnold's longhaired professors swept through postwar

⁸Cochrane et al., *Nuclear Weapons Databook*, vol. 1, 22, 26-28, 34.

Germany conducting the euphemistically named Operation Lusty, and they compiled mounds of data. Nazi jets, cruise, and ballistic missiles captured most of their attention.⁹

Von Karman's team discovered a wealth of scientific and technological data that they distilled into a series of reports. The first, an assessment of "Where We Stand," measured the progress of American and British aerospace technology against those of the Axis Powers, in particular, Germany. According to von Karman, the German V-2 was "the most outstanding technical achievement" of wartime aeronautics. He identified Wernher von Braun's management and organization as an important reason for this, which provided "under a single leadership in one organization, experts in aerodynamics, structural design, electronics, servomechanisms, gyros and control devices, and propulsion; in fact, every group required for the development of a complete missile." Nonetheless, he felt that "the most important result of the German effort in this field [rocketry] was to show that winged missiles are superior in performance to finned missiles," which was a conclusion consistent with wartime American efforts to develop glide and cruise missiles but to ignore ballistic missiles. These conclusions significantly effected the direction of American missile research for many years. Until the initiation of a crash program to build the Atlas ICBM, the United States concentrated its missile research and development on cruise missiles, but once it had accepted the necessity of a

⁹John W. Huston, ed., *American Airpower Comes of Age: General Henry H. "Hap" Arnold's World War II Diaries*, vol. 2 (Maxwell Air Force Base, AL: Air University Press, 2002), 367. Arnold wrote this entry, dated Friday, July 13, 1945, while in Paris enroute to a stay at Berchtesgaden, Germany, the site of Hitler's mountain top retreat. See also Dik Alan Daso, *Hap Arnold and the Evolution of American Airpower*, Smithsonian History of Aviation Series, ed. Von Hardesty (Washington, D.C.: Smithsonian Institution Press, 2000), 196-197.

long-range ballistic missile, it developed management techniques consistent with von Karman's observations.¹⁰

Through the end of World War II, the United States had duplicated successfully the German V-1 cruise missile, but von Karman cautioned Arnold that "the task is far beyond the scope of inventing gadgets and trying to make them work." Rather, there was an "urgent need of a systematic analysis of the various tasks which manned airplanes equipped with bombs, guns, and rockets perform, and which now may be performed by pilotless craft." Von Karman cautioned that it was insufficient to copy Nazi technology without serious contemplation of future wartime requirements. For future long-range strategic bombers, he envisaged "two types of pilotless aircraft, both with wings, one with a high trajectory reaching far into the outer atmosphere, and the other designed for level flight at high altitudes." For the first, he planned a multiple-stage rocket that lifted a aircraft-like vehicle into space to conduct long-range bombing missions, and for the second, he foresaw "a supersonic pilotless aircraft flying at altitudes of from 20,000 to say, 60,000 feet," but believed that a more achievable "intermediate step might be a pilotless aircraft traveling at high subsonic speeds . . . about 600 miles per hour at 40,000 feet," parameters that in the future matched the capabilities of the first American intercontinental cruise missile.¹¹

In a February 1946 piece written for *National Geographic Magazine*, Arnold explained these ideas to the American public. He stressed the great importance of the long-range ground-to-ground ballistic missile, noting that it was certain to become "the

¹⁰Michael H. Gorn, ed., *Prophecy Fulfilled: "Toward New Horizons" and Its Legacy* (Washington, D.C.: Air Force History and Museums Program, 1994), 30-33. Gorn's volume reproduced the von Karman's famous reports.

¹¹*Ibid.*, 35, 37.

strategic long-range bombardment airplane of the future.” At once recognizing the inherent offensive and defensive aspects of the ballistic missile, he commented that the V-2 was “ideally suited to deliver atomic explosives because effective defense against it is extremely difficult. Now and for the moment, the only defense seen for the future is its destruction prior to launching.” Arnold believed that the United States had to have such offensive weapons, and he cautioned that to protect them against enemy attack, the air force would “make them harder to detect and destroy.” He did not mention mobility as a means to do this, but he foresaw extending the range of the early missiles from the V-2’s 250 miles to over 3,000 miles and assigning them a polar trajectory because that was the shortest path to Soviet targets. Arnold envisioned the nuclear-armed ICBM, but neither he nor von Karman specified whether they thought mobility a useful operational concept.¹²

Because of economic restraints and an anticipated development period of no less than ten years, ballistic missiles were too far off in the future to have immediate military use. Meanwhile, in September 1947, the Army Air Force became a separate service, the United States Air Force, which continued to hold faith in the bomber, a familiar and proven technology; moreover, the money it spent on missiles went into winged cruise missiles such as those that von Karman believed held great potential. Historian Edmund Beard contended that something beyond budget and technical limitations was at work here. Believing that the air force had a cultural preference for winged vehicles, he noted how during the World War II, the air force had emphasized strategic bombing and that its basic doctrine stressed the indivisibility of air power to exploit its characteristics of mass

¹²H. H. Arnold, “Air Power for Peace,” *National Geographic Magazine* 89 (February 1946), 139, 187. Page numbers refer to *National Geographic’s* bound index edition for vol. 89.

and maneuver. Bombing from winged aircraft was central to the air force's bureaucratic existence, and although missiles might augment the bomber, they would not replace it, making von Karman and Arnold's winged bombers an extension of such preferences.¹³

A review of missile development illustrates technological reasons why Arnold, von Karman, and the air force believed that ICBMs were a decade from operational utility. The typical ballistic missile propelled and guided itself during the first portion of its flight but once the warhead released, it traveled a free and uncontrolled trajectory. To obtain ranges of thousands of miles, ballistic missiles had to be large and massive with complex and as-yet unreliable components. Unlike cruise missiles, they did not fly like airplanes or rely on aerodynamic lift. Bombers and cruise missiles were familiar, and until later in the 1950s, the cost and technological limitations of ICBMs and the size and weight of the available atomic and nuclear weapons rendered them inappropriate delivery vehicles because the rockets were not accurate, reliable, nor powerful enough to ensure target destruction.¹⁴

Although medium-range cruise missiles had aircraft-like sizes and characteristics, they were a challenge to deploy to field operating locations. The air force learned that transporting missiles, even small missiles that utilized familiar technologies, was difficult; moreover, the ability to transport a missile was often incompatible with operational responsiveness, that is, the time required to deploy, set-up, and respond to a launch order. An example was the Matador cruise missile sent to Europe in 1954. Built by the Martin Corporation, the same contractor who later built the Titan ICBM, this was

¹³Beard, *Developing the ICBM*, 216, 223-225. Neufeld, *Ballistic Missiles*, 7-27.

¹⁴Eventually, some ballistic missile systems had maneuvering warheads or terminal-area guidance. This discussion describes only pure ballistic weapons such as the American Atlas, Titan, and Minuteman systems.

a tactical weapon with a range of 700 miles, much shorter than an ICBM. Costing only a quarter of the price of a 1950s fighter aircraft (which it looked like) the air force used it in place of manned aircraft to attack heavily defended targets. It was a mobile but not a responsive system because it did not travel to its launch site in a ready-to-launch configuration. Crews towed the unassembled Matador to a field launch site in four pieces, and once there, it took ten people using a crane ninety minutes to assemble the fuselage, wings, warhead, and booster. Once launched, remaining on course meant that the guidance system required updates from a ground-based radio transmitter, which added a level of operational complexity and provided the enemy with the opportunity to jam the signal and force the Matador off target.¹⁵

With a mobile ballistic missile, the problems were more complex. When deployed on land, transporting the missile was problematic because the entire launch base had to move with the rocket. Even the relatively small German V-2 required significantly more labor and time than cruise missiles to deploy to field operating locations, a demanding exercise that involved setting up the launch pad, erecting and fueling the rocket, connecting the command and control system, and conducting a full countdown at a dispersed location under threat of enemy attack. One trailer-mounted missile required thirty support vehicles, including a transportation trailer, launch platform trailer, propellant vehicles, and a command and control truck. Although a small missile by ICBM standards, a fueled V-2 and its warhead weighed 28,373 pounds and was forty-five feet long and nearly twelve feet wide at the base of its fins. Although the German

¹⁵Matador technical details from James N. Gibson, *Nuclear Weapons of the United States: An Illustrated History* (Atglen, PA: Schiffer Publishing Ltd., 1996), 145-147. On cruise missile history through the rise of ICBMs, see Kenneth P. Werrell, *The Evolution of the Cruise Missile* (Maxwell Air Force Base, AL: Air University Press, 1985), 79-128.

designers believed responsiveness important, from arrival at an unprepared site, V-2 troops required four-to-six hours to launch a rocket.¹⁶

Along with its shorter-ranged cruise missiles, the air force tried to develop multiple long-range versions and until 1954, pursued intercontinental cruise missiles instead of ICBMs because it did not seem technologically possible to build an ICBM capable of accurately delivering the heavy warheads that were available. Although the air force nominally funded ballistic missile research, the two long-range cruise missiles it pursued, Snark and Navaho, received greater funding. The numbers are revealing: Between 1951 and 1954, Snark received \$226 million and Navaho \$248 million, whereas the Atlas ICBM received \$26.2 million, of which \$18.8 million was fiscal year 1954 funds. Even in the fifties, \$26 million spread over three years did not achieve much; the fiscal competition from Navaho and Snark hurt the ballistic missile program, causing multiple cancellations, delays, and restarts. The technological challenges of building intercontinental cruise missiles were significantly greater than those of shorter-range missiles such as the Matador because the longer-range missiles needed more fuel, were larger, and demanded greater guidance accuracy. As a result, Navaho and Snark did not enjoy much success and often crashed into waters surrounding their test sites, forcing

¹⁶The size characteristics of the V-2 are found in Bill Gunston, *The Illustrated Encyclopedia of the World's Rockets and Missiles* (New York: Crescent Books, 1979), 48-49. Information on V-2 mobility is from Michael J. Neufeld, *The Rocket and The Reich: Peenemunde and the Coming of the Ballistic Missile Era* (New York: Free Press, 1995), 170-171, 192, 220, 252; von Braun and Ordway, *History of Rocketry and Space Travel*, 108, provide information on the composition of the V-2's mobile convoy. Walter Dornberger, *V-2*, trans. James Cleugh and Geoffrey Halliday (New York: Viking Press, 1955) provides an insider's memoirs of the entire German rocket program of World War II.

program managers to suffer jests such as “Snark-infested waters” and “never go, Navaho.”¹⁷

The air force only deployed one model of an intercontinental cruise missile, the Snark, which Northrop Aircraft Company built. A good match for von Karman’s original unpiloted bomber specifications, it was sixty-nine feet long, weighed 51,000 pounds, and possessed a wingspan of forty-two feet. Once lofted into the air by two solid-fueled rockets, it reached altitudes of 50,000 to 60,000 feet via its single turbojet and carried a four-megaton warhead. Air force transport aircraft could lift it to another location, but mobility was not part of its operations because its deployments were aircraft-like. By 1960, the air force had deployed thirty Snarks to Presque Isle Air Force Base in Maine, where the missiles were sheltered in long, hangar-like buildings that housed five weapons each. Upon a launch order, the missiles, already on their fifteen-ton, sixteen-wheel, hydraulically powered launchers, rolled out to presurveyed points near the shelter and launched. The process was similar to bombers standing an airstrip alert--once a launch order was received, the bombers would fly off the runway to attack their targets.¹⁸

Unlike the shorter-ranged Matador, the air force never operated the Snark as a mobile missile. The Matadors and their kin were theater weapons that an enemy would

¹⁷Senate Committee on Armed Services, Preparedness Investigating Subcommittee, *The United States Guided Missile Program*, 86th Cong., 1st sess., 1959, 12-14. See also Neufeld, *Ballistic Missiles*, 35-92; Snark, Navaho, and Atlas budget figures come from Neufeld, *Ballistic Missiles*, 77. The program total for Navaho from fiscal year 1958 through fiscal year 1963 comes from “Letter From the Secretary of Defense (Wilson) to the President, August 9, 1957,” in *FRUS, 1955-1957*, vol. 19, 580-581. On July 8, 1957, the air force recommended canceling Navaho, and on the same day, Secretary of Defense Wilson approved the recommendation. It is unusual for a service department to recommend canceling a program and receive secretary of defense approval on the same day.

¹⁸Gibson, *Nuclear Weapons of the United States*, 151-154; Gunston, *The World’s Rockets and Missiles*, 58-59; Werrell, *Evolution of the Cruise Missile*, 82-97; Office of the Historian, Headquarters Strategic Air Command, *From Snark to Peacekeeper: A Pictorial History of Strategic Air Command Missiles* (Offutt Air Force Base, NE: 1990), 1-5. Hereafter referred to as SAC Historian, *A Pictorial History*.

quickly target for destruction, and proximity to the threat demanded increased survivability through mobility. The air force saw no such threat for the Snark and did not believe an attacker could destroy the missiles before the nation received an adequate warning. At the time, the only way for the Soviets to attack the United States was with long-range bombers, a relatively slow weapon system that the Americans countered with high-speed interceptors. There was simply no perceived need to provide for mobility, and in any case, even the bomber force sat its alerts on the ground--why not the missiles? Although cruise missile research provided important hardware components including engines and guidance systems, it did little to help design a mobile ICBM.

Building Ballistic Missiles

From 1953 through 1954, the Eisenhower administration, with an eye towards reducing defense costs, had reviewed defense research and development. Eisenhower based his national defense policy upon a strategy called the New Look, which relied on the American ability to deliver overwhelming nuclear destruction to deter aggressors from attacking. For the New Look to be credible, the United States had to possess an effective strike force that could survive a Soviet attack and deliver a debilitating counterstrike. Better yet, American strength would make any rational opponent realize the futility of an attack and deter it before it happened. Within the air force, the bomber reigned supreme, but ballistic missiles received close attention due to three critical circumstances. First, the United States learned that the Soviet Union was working on a long-range rocket weapon, and it did not want to fall behind. Equally important was the feasibility of lighter-weight nuclear weapons, which increased the number of bombs a

bomber could carry and raised the possibility of using a rocket as a delivery vehicle. Last, key individuals emerged who were interested in new methods and tools of warfare. There converged perceived need, innate technical capability, and interest in new ways to use military technology.¹⁹

In June 1953, Wilson responded to Eisenhower's desire to reduce defense spending but improve national security by directing Secretary of the Air Force Harold E. Talbott to form a committee to conduct a comparative analysis of all military guided missiles. At this time, the cruise missile program had little to show for its efforts, despite the generous funding. When Talbott looked around to find a leader to accomplish this task, he chose wisely by selecting Trevor Gardner, his assistant for research and development. General Jimmy Doolittle once described Gardner as a "sparkplug," a man of action uninterested in roles and missions controversies. Gardner focused on missile performance and program improvement by pursuit of promising technologies, standardization of production, and elimination of waste; he cared little for making friends, a trait that led some to describe him as "sharp, abrupt, irascible, cold, unpleasant, and a bastard." Not a cruise missile advocate, he favored ballistic missiles, and his reforms aided an efficient reorganization of the American ICBM effort into an effective crash program. Top-down direction provided a new sense of urgency to develop ICBMs.²⁰

¹⁹Robert L. Perry, "The Atlas, Thor, Titan, and Minuteman," in *The History of Rocket Technology*, 143-144. See also Neufeld, *Ballistic Missiles*, 97-99.

²⁰Neufeld, *Ballistic Missiles*, 93-96. The quote describing Gardner's personality comes from Neufeld, page 96. Beard, *Developing the ICBM*, 166, adds that Gardner, a thirty-seven-year-old civilian, was not only "suddenly giving orders to . . . general officers . . . on how to run the air force, but they were also contrary to the way the air force had been operating." As Beard suggests, Gardner won few friends, but he did get the job done.

In 1954, ten years after Hap Arnold first asked von Karman to study Axis technology, Gardner convinced the brilliant mathematician John von Neumann to chair a remarkable working group known as the Teapot Committee. The committee brought together the major players of the soon-to-be reinvigorated American ICBM effort, among them air force Brigadier General-select Bernard A. Schriever, a disciple of Hap Arnold and a man sharing Gardner's vision of management efficiency. Delivered in February 1954, von Neumann's report recommended the air force create a crash program to produce the ICBM, which resulted in a complete restructuring of the Atlas missile program and sounded the beginning of the end for the intercontinental cruise missile. The personnel and organizations involved, including the Ramo-Wooldridge Corporation, became the foundation of the revamped American ICBM effort. Their desire to accelerate the Atlas missile program into a crash effort, and their use of smaller payloads and smaller rockets had profound effects on later missile programs, including the Minuteman. Aware of von Karman's approbation for the V-2's program management, the Teapot Committee reorganized the American effort to gather the disciplines needed to build an ICBM. Three years before Sputnik flew and the public worried about an apparent Soviet lead in long-range rocketry, American planners and designers prepared to ensure American dominance in the field.²¹

A tangible result of the Teapot Committee's work was to place General Schriever in charge of the air force's newly created Western Development Division, an organization dedicated to the ICBM program. On August 2, 1954, Schriever,

²¹The work of Gardner, the Teapot Committee, and several other efforts is well covered by Neufeld in *Ballistic Missiles*, 96-107; Perry, "Atlas, Thor, Titan, and Minuteman" in *The History of Rocket Technology*, 142-149, and Beard, *Developing the ICBM*, 164-182.

acknowledged as the air force expert in long-range ballistic missiles, assumed command with unique authority and control over air force weapon system acquisition and procurement. He had authority over system engineering responsibilities from operations, maintenance, logistics, and civil engineering--everything related to ICBMs, from launch pads to communications equipment to the rockets, both present and future systems, fell under Schriever's capable leadership. In contrast, the air force managed its cruise missile programs in the same way as its aircraft procurement, that is, as individual programs instead of a family of systems. Long a believer in the value of scientific research, he did not believe the air force possessed the scientific expertise to build ICBMs. During World War II, Hap Arnold had charged him to be the liaison between the Army Air Force and the scientific community, and Schriever, relishing the role, nurtured this relationship throughout his career to develop methods of applying science to technological development. Summarizing his admiration for the scientific community, he commented that he became a "disciple of the scientists who were working with us in the Pentagon . . . I felt very strongly that the scientists had a broader view and had more capabilities. We needed engineers . . . but engineers were trained more in a, let's say a narrow track having to do [more] with materials than with vision."²²

Consistent with the earlier ideas of Arnold and von Karman, Schriever wanted to lead and direct technological change. From early in his career, he "combined operational requirements with technologies, strategies, and objectives to establish objectives for future systems." To assist the air force's ICBM effort, he hired the Ramo-Wooldridge

²²Quoted in Stephen B. Johnson, *The United States Air Force and the Culture of Innovation: 1945-1965* (Washington, D.C.: GPO, 2002), 65. Johnson's source is an interview he conducted with Schriever on March 25, 1999.

Corporation to be the air force's scientific and engineering advisory body. He used the company as an associate contractor to create specifications, oversee development, and coordinate between the air force and the numerous subcontractors building the various pieces of the ICBM, which provided the project with an industrial unity that the intercontinental cruise missile program had lacked. The air force had ultimate authority and oversight for the effort, but Schriever gambled that the vision of the scientists, if properly guided and supported, would deliver a viable missile in the shortest amount of time. He retained central control and direction but let his scientific and engineering brain trust solve the thorny problems, which became a management technique critical to the concurrent development of multiple ICBM systems. Within the air force, this approach was revolutionary, and the bureaucratic fight to install it was a hard one that Schriever described as "a hell of a struggle [with] . . . lots of blood on the floor."²³

Aware that the first models of a complex and never-before-built missile could not represent mature capabilities, Schriever and Gardner wanted multiple ICBM systems to guard against failures that would endanger the early deployment of a usable weapon. It was a classic instance of not putting all of one's eggs in the same basket. To move the eventual deployment date forward, Schriever employed parallel rather than linear management of research, development, production, installation, checkout, and operations. Additionally, the air force produced multiple missiles that served as backups to each other not only as complete systems, but also at the subsystem level to minimize the risk

²³See Jacob Neufeld, "General Bernard A. Schriever: Technological Visionary," *Air Power History* 51 (Spring 2004): 39-40. See also Johnson, *Culture of Innovation*, 59-116 and Werrell, *Evolution of the Cruise Missile*, 101-108. "Blood on the floor. . . ." see Jacob Neufeld, *Reflections on Research and Development in the United States Air Force: An Interview with General Bernard A. Schriever and Generals Samuel C. Phillips, Robert T. Marsh, and James H. Doolittle, and Dr. Ivan A. Getting* (Washington, D.C.: Center for Air Force History, 1993), 39, 53-60.

of a program-stopping failure. An example of this occurred when the Atlas program hijacked the Titan I ICBM's original inertial guidance system for use in the Atlas E-model ICBM, leaving Titan I with a radio guidance unit. This approach permitted maximization of technical convergence between different contractors and industries and minimized risk but maximized expense.²⁴

To support of his defense reviews, in early 1954, President Eisenhower asked DoD's Science Advisory Committee to study how science and technology could protect the United States from attack and lower defense costs. The resulting panel, known as the Killian Committee after its director, Massachusetts Institute of Technology President James R. Killian, Jr., began its work, and reported to Eisenhower on February 14, 1955. In comparing the United States and the Soviet Union, Killian stated that the "intercontinental ballistic missile can profoundly affect the military posture of either country . . . if the U.S. were to achieve an intercontinental ballistic missile capability first, it could maintain that position of advantage . . . so long as the Soviets did not have this missile capability. If the Russians achieve an intercontinental ballistic missile capability first, they might gain a comparable position of advantage." Telling the president that the United States had to be first to develop an ICBM lest it lose the military advantage that made the New Look a viable defense strategy, the report further jump-started long-range ballistic missile efforts but said nothing about mobile systems.²⁵

²⁴Johnson, *Culture of Innovation*, 78-79; Gibson, *Nuclear Weapons of the United States*, 15.

²⁵"Report by the Technological Capabilities Panel of the Science Advisory Committee," in *FRUS, 1955-1957*, vol. 19, 41, 44, 48. Killian discusses the operation of the Science Advisory Board and its preparation of the Technical Capabilities Report in James R. Killian, *Sputnik, Scientists, and Eisenhower: A Memoir of the First Special Assistant to the President for Science and Technology* (Cambridge, MA: MIT Press, 1977), 67-93.

Proponents of ICBMs could not have asked for a better gift than this because it paved the way to secure the importance of the ICBM within political and military circles. Active behind-the-scenes campaigning by Gardner and Schriever won key support and increased pressure on the administration to support ICBM programs. On July 28, 1955, Gardner, von Neumann, and Schriever briefed Eisenhower and the National Security Council on the importance of the ICBM. Schriever later recalled this briefing as “the one event that stands out,” and the information provided to the president on the state of American missile developments made an impression. On September 13, 1955, after missile development came up in a series of National Security Council meetings, Eisenhower approved the ICBM as “a research program of the highest national priority, second to no others,” with any change to the program occurring only at his behest. On the same day, he reaffirmed the air force’s preeminence within long-range ballistic missile development by rejecting a request to transfer the ICBM to another agency. The air force securely owned the ICBM mission, and it had the presidential backing that prevented the dispersal of its resources to other agencies.²⁶

Having secured political support, Trevor Gardner and the air force deftly worked to improve program management, moving beyond simple restructuring by creating a procurement and acquisition structure unique within the air force. When Secretary of

²⁶See “Memorandum From the Director of the Policy Planning Staff (Bowie) to the Acting Secretary of State, September 7, 1955,” in *FRUS, 1955-1957*, vol. 19, 110-111. This memorandum discusses the July 28, 1955, meeting at which the air force proposed elevating the ICBM’s priority. Schriever’s recollection of the July 1955 briefing as “the one event that stands out,” is from Ernest G. Schwiebert, *A History of the U.S. Air Force Ballistic Missiles* (New York: Frederick A. Praeger, 1965), 22. Schwiebert’s source is an interview that John F. Loosbrock, editor and assistant publisher of *Air Force/Space Digest*, conducted with Schriever. “Memorandum of Discussions at the 258th Meeting of the National Security Council, Washington, September 8, 1955,” in *FRUS, 1955-1957*, vol. 19, 111-122, provides a wealth of detail on what the council discussed and knew about American ICBM programs. Pages 121-122 explain Eisenhower’s actions of September 13, 1955, but no separate entry exists in *FRUS* for that date. See also Neufeld, *Ballistic Missiles*, 134-135.

Defense Wilson authorized Secretary of the Air Force Donald Quarles to act upon Eisenhower's September directive, Quarles immediately put Gardner to work. Gardner had Hyde Gillette, DoD's Deputy Secretary for Budget and Program Management, streamline missile acquisition and procurement procedures. The Gillette Committee's recommendations, appropriately known as the Gillette Procedures, reduced the number of "onerous" program reviews from forty-two to ten, which saved an immense amount of time. Quarles not only approved these procedures, a further deviation from the normal acquisition and procurement process, but went beyond them by establishing a new ballistic missiles committee. On November 8, 1955, he formed his own ballistic missiles committee, of which Gardner was a member, followed shortly thereafter on November 14, 1955, by the air force's own ballistic missiles committee. These two bodies developed an annual plan for ICBM development that ensured consistent backing for ICBM programs at all levels of the DoD. In addition, Gardner's long-standing von Neumann-chaired ICBM Scientific Advisory Committee became an advisory body to the Department of Defense. In practical terms, Schriever had "the single plan with a single budget and was responsible to a single authority, the Ballistic Missile Committee of the Office of the Secretary of Defense," or as the general put it: "Two things really are absolutely essential in a major program of this type: that you have control of your people, and you have control of the money." Schriever had both, and the ICBM program had developed managerial momentum.²⁷

²⁷Schriever quote from interview in Neufeld, *Reflections on Research and Development*, 64. See also Neufeld, *Ballistic Missiles*, 136-139; Beard, *Developing the ICBM*, 154-194. See also Johnson, *Culture of Innovation*, 73-76, 230. The air force shortly adopted Schriever's streamlined systems engineering approach service-wide as the model for all major systems. For the perspective of Simon Ramo, co-founder of Ramo-Wooldridge, the air force's systems engineering contractor for ICBMs, see

It had also developed operational momentum because in 1955 Air Force Chief of Staff General Thomas D. White understood the ramifications of having an ICBM. How quickly this occurred showed in a November 18, 1955, letter from White to Lieutenant General Thomas S. Power, then commander of the Air Research and Development Command (ARDC, the air force's major command-level organization whose responsibility it was to obtain new weapon systems). White's letter was a clearly written set of directions to develop a new and complex weapon system. He directed that "the immediate goal of the ICBM effort is the earliest possible attainment of an initial operational capability. . . . [which] is envisaged as one which would provide a capability of operationally employing prototype weapons during the latter phase of the development program." Considered a "Ph D" capability, that is, prototype missiles launched by developmental test crews, the use of prototypes in an operational environment indicated how important the program was to national leadership. White's realism was remarkable. He commented that "initially, the ICBM will probably incorporate certain marginal technical features. Early systems undoubtedly will undergo a great deal of revision and change," and he acknowledged the "dictatorial influence" that developmental considerations would have on attaining operational capability.²⁸

On December 29, 1955, General White clarified his orders. He directed construction of three Atlas missile bases with storage for forty missiles and launch facilities for twenty missiles each. Each base was to have the capability to launch twenty

Simon Ramo, "The Guided Missile as a Systems Engineering Problem," reprint from the *Canadian Aeronautical Journal* 3 (January and February 1957): 3-9, 37-43, unaccessioned, unclassified collections. BMO box F-4, AFHRA.

²⁸General Thomas D. White to Commander, Air Research and Development Command, November 18, 1955. Contained in "The Initial Operational Capability (IOC) and IOC Instructions Received by AFBMD, 1955-1957," unaccessioned, unclassified collections. BMO box F-2, AFHRA.

missiles within two hours, and “have the capability to fire a salvo of two missiles within fifteen minutes of the first order to fire.” Operational control of the missiles would pass to SAC as soon as the system had the complete ability and equipment to conduct launches. He wanted the first ten missiles to be “in place with ten launch positions” by April 1, 1959, and 120 missiles in place with sixty launchers by January 1, 1960. Considering that Atlas had yet to fly, this ambitious schedule only allowed for missiles launched from a stationary base, and the air force did not yet foresee mobility as an ICBM operating characteristic.²⁹

White’s specification of reaction time is revealing. The Atlas was a large, untested, liquid-fuel rocket, and even under the best of circumstances, which nuclear war was not, it took time to launch such a missile. In 1955, launching two missiles within fifteen minutes and twenty missiles within two hours was a difficult challenge. If all three bases launched their two missiles within fifteen minutes, then if all went well, forty-five minutes after the war began, only six American bombs would fall on the Soviet Union. After two-and-a-half hours--assuming the Soviets had not destroyed the American bases--a maximum of sixty missile-borne bombs would fall on the Soviets, not very many compared to what SAC’s 1,309 bombers could carry (assuming all reached their targets). Clearly, the ICBM was not going to carry the burden of deterrence at this time, but White’s orders demonstrated American resolve. From a military point of view, the air force needed missiles with a faster reaction time for the ICBM to be a viable deterrent. White’s letters did not mention mobility because the plan was to get as many

²⁹ General Thomas D. White to Commander, Air Research and Development Command, December 29, 1955. Contained in “The Initial Operational Capability (IOC) and IOC Instructions Received by AFBMD, 1955-1957,” unaccessioned, unclassified collections. BMO box F-2, AFHRA.

missiles on alert as quickly as possible, and the best way to do this was to save time by building stationary launch facilities. This decision was prudent because the United States had yet to launch an ICBM. Mobility was asking too much too soon.³⁰

While the air force struggled with Atlas, the navy faced its own challenges with its submarine-launched Polaris, and interservice mission needs converged. During this period, the air force-navy relationship was complex. The two services had to work together as partners in national security, but they were also bitter rivals for military roles, missions, and funding. The navy knew from its earlier work with shipboard liquid-fuel rockets that its path to ballistic missiles required solid-fuel technology, and within the air force, a growing minority considered the same technology for its second-generation ICBMs. The most significant limiter was the casting of large solid propellant motors with a high-energy propellant, and although the navy and air force shared a need for solid-fuel propulsion, their operational requirements were dramatically different. Much development work was required before the Polaris became a two-stage solid-propellant rocket, while the air force settled on three stages for its first solid-fuel ICBM. To traverse intercontinental distances, the air force missile had to fly 4,000 miles farther than the navy weapon, and because unduly large submarines were more difficult to hide, the space available on a submarine limited the size and range of the navy's missile. General Schriever, who was sensitive to such differences, summarized the situation in April 1957: "You have got to have very, very close tie-in between the characteristics of the weapon and the characteristics of the facilities from which the weapon is going to operate. You

³⁰SAC 1955 bomber strength from SAC Historian, *Alert Operations*, 79. This figure is the total strength of SAC's assigned bomber force and does not reflect the number prepared to respond at the time of an attack.

have to marry the two. You can't do it any other way," a caveat that applied to fixed-base and mobile ICBMs.³¹

As early as 1956 the air force and navy saw the potential of cooperation. A March 1956 letter from Richard E. Horner, the DoD's Acting Assistant Secretary, Research and Development, to Clifford C. Furnas, the Assistant Secretary of Defense for Research and Development, oversimplified the joint-service work on solid propellants by asserting that "there are no significant differences between solid rocket engine requirements for land or sea-based use," which in terms of propellant mixtures was correct but overlooked the missile design needs of each service's missions. Regardless, air force General Donald Putt, Deputy Chief of Staff for Development, and navy Admiral William F. Raborn, head of the Polaris program, agreed not to block each other's programs, probably because the navy pursued an intermediate-range missile for use in submarines but the air force sought a land-based long-range missile. Horner directed that "to keep the two programs complementary, the air force will avoid duplicating the navy effort to bring forth a solid propellant IRBM [intermediate-range ballistic missile] engine using presently available technology. On the other hand, the navy must avoid duplicating the air force program." The services could cooperate and pursue separate programs, which made sense given the requirements differences between the two weapon systems.³²

For the air force, the challenges of creating the Atlas weapon system slowed the rush to any ICBM operating capability. On March 5, 1957, in recognition of these

³¹"The Ballistic Challenge . . . as seen by Major General Bernard A. Schriever, Chief, Western Development Division of ARDC," *Missiles and Rockets* 2 (April 1957), 96.

³²Acting Assistant Secretary, Research and Development Richard E. Horner to the Assistant Secretary of Defense (Research and Development), March 21, 1956, unaccessioned, unclassified collections. BMO box M-1, AFHRA.

problems, air force Major General Jacob E. Smart, the Assistant Vice Chief of Staff, redefined the previous guidance from air force headquarters. Smart directed a change in force structure, stating that the first ICBM groups would include one group of forty Atlas missiles and another group of forty Titan I missiles. This directive reflected the air force interest in the concurrent development of multiple systems, which almost became a mini-missile race between air force systems. Other changes included modifying the number of launchers at each base, the construction of what would become Vandenberg Air Force Base, and one of several forthcoming changes to the initial operating capability date, which now provided for eighty missiles by July 1961, which was the same number of Polaris A-1 missiles sought by the navy. A minimum of one Atlas launch complex, consisting of three launchers, one guidance station, and a minimum of six missiles was required by March 1959.³³

General Smart's March 1957 letter clarified survivability and responsiveness requirements. To improve ICBM survivability, "dispersion, hardened facilities, local ground and air defense measures, and the ability to launch missiles before bases can be attacked by bombers," was vital. Within four years, hardened and dispersed shelters became the standard mode of ICBM deployment. Because a force destroyed on the ground was useless, twenty-five percent of the missiles were required to launch within fifteen minutes of the first launch order, followed by an additional twenty-five percent within the subsequent two hours. All remaining missiles were to launch no later than four hours after the first launch order. Officers assigned missiles against targets based on

³³General Jacob E. Smart to Commander, Air Research and Development Command, March 5, 1957. Contained in "The Initial Operational Capability (IOC) and IOC Instructions Received by AFBMD, 1955-1957," unaccessioned, unclassified collections. BMO box F-2, AFHRA.

the location of their launch bases, “keeping in mind that the full 5,500 nautical mile range may not be attained with early missiles.” Target selection required careful analysis so that missiles did not fly over densely populated areas and that the rockets did not drop spent stages near inhabited areas. The problems shared by Atlas and Titan I, both first-generation American ICBMs, were similar. The missiles lacked storable propellants, meaning that the oxidizer and fuel had to be loaded shortly before launch. Because they were radio-guided, the early ICBMs depended upon a ground network of radars, transmitters, and tracking systems to conduct a mission. An examination of an Atlas mission illustrates the limitations of early ICBMs and underscores the emerging air force desire for simplicity, reliability, resiliency, and responsiveness within the ICBM force, requirements that supporters of solid-fueled ICBMs believed their system offered, while demonstrating the near-impossibility of a mobile system with these early missiles.³⁴

Atlas was a massive, liquid-fueled rocket carrying a single large reentry vehicle. It was radio-guided (except for the final versions equipped with inertial guidance), which accounts for General Smart requiring one guidance station along with three Atlas launchers by March 1959. Although the promise of small fusion weapons in 1953 led the air force to elevate its priority, the 1954 Teapot Committee jump-started Atlas development. It was dramatically different from other missiles, then or now, because it was not traditionally staged rocket, in which the bottom-most stage furnished all thrust until it burned out, at which time it was discarded and the next stage took over. At the time of the Atlas’s design, engineers did not want to risk the possibility of failure during a staging event, so they developed the stage-and-a-half vehicle. The Atlas had three

³⁴Ibid.

engines but only one set of oxidizer and fuel tanks. When it launched, three main engines, arranged side-by-side, ignited by burning liquid oxygen and RP-1, a rocket propellant comparable to refined kerosene. The two outboard engines, called booster engines, and the center engine, known as the sustainer, powered the vehicle. The boosters operated for less than half the time of powered flight, after which they slid off the missile, which continued flight under the single sustainer engine and some smaller vernier engines. Because the Atlas had used much of its fuel and discarded the boosters, it was much lighter and the single sustainer was more than capable of continuing flight.³⁵

The revolutionary aspect of the Atlas was its body construction. Unlike most rockets, it did not have internal bracing. To save weight, the Atlas was a large metal balloon whose skin thickness measured in thousandths of an inch. Seventy-five feet long, ten feet in diameter at its smallest point, and sixteen feet at the engine base, the Atlas required pressurization by gaseous nitrogen lest it collapse. This structure, the only ICBM ever to use such a design, was very strong. A popular tale about the Atlas's strength is that of an army engineer who doubted the design. Invited to strike the side of the rocket with a sledgehammer, the recoil nearly broke his arm. The design meant that handling an Atlas required the missile to be pressurized, which further complicated the missile's operation.³⁶

The earliest Atlases stood alert on launch pads, and three such pads, each complete with a nuclear-armed missile, launch tower, and support facilities, made a launch complex. The open-air pads were vulnerable to sabotage, so later versions used a

³⁵Department of the Air Force, *T. O. 21-SM65D-1-2, USAF Model SM-65D Missile Weapon System, General Manual* (Culver City, CA: Kerr Litho, April 1, 1960), 1-1 to 1-2, unaccessioned, unclassified collections. BMO box J-3, AFHRA. Hereafter abbreviated as *Atlas Technical Order*.

³⁶*Ibid.*, 1-1.

coffin shelter, a long horizontal structure in which the Atlas lay until required to launch. Upon receipt of a launch order, the launch control officer warned the complex and applied electrical power to the selected launcher. The roof rolled back, the support system raised the Atlas to a vertical position, and high-pressure gas forced the oxidizer and propellant into the rocket's tanks. Whereas fast aircraft refueling typically occurred at a rate of 600 gallons per minute, the Atlas required 5,000 gallons per minute of liquid oxygen at a pressure of 6,000 pounds per square inch. The missile held 11,500 gallons of RP-1 fuel and 18,600 gallons of liquid oxygen, all of which was loaded in under five minutes. A cryogenic substance that requires cold temperatures (less than -183 degrees Celsius), liquid oxygen contains a great deal of potential energy but safe use demands specialized ground support equipment and handling. The air force cautioned operators that "human tissue will freeze instantly on contact with liquid oxygen and may be permanently damaged. When liquid oxygen is combined with . . . RP-1 fuel or other combustible materials, the mixture forms a gel that will explode on the slightest impact." This was a dangerous operation. In addition, the loading process had to be exceptionally clean because even trace amounts of contaminants could clog the missile's propulsion system and cause an in-flight explosion.³⁷

Meanwhile, programmers transmitted the targeting information needed to guide the rocket during flight into the guidance system and programmed the warhead for either an air burst or ground burst. In a separate guidance operations building, controllers tested and calibrated the guidance radar to provide accurate data to the radio guidance system.

³⁷Department of the Air Force, *Atlas Technical Order*, iii. Atlas flow rate data from Neufeld, *Ballistic Missiles*, 202-203. For a discussion of the various Atlas and Titan I deployment configurations, see Neufeld, *Ballistic Missiles*, 186-199, 212-214.

At forty seconds before launch, the launch control officer depressed a button marked “start” and the terminal launch sequence initiated. The engines fired, thrust built up, the launcher arms flung back, and the Atlas slowly accelerated into the atmosphere. Two minutes after launch, a ground station transmitted a command for the booster engines to cease firing and fall away, but the single sustainer engine continued to thrust for a few more minutes until it was on a trajectory that intersected the target. Another command from a ground station caused a separation mechanism to fire, releasing the reentry vehicle from the missile body. The Atlas, now freed from its payload, fired rockets to back away from the warhead and fell back into the atmosphere to burn up, while the unguided reentry vehicle plummeted towards the target. Subsystems onboard the reentry vehicle maintained its nose-forward descent, and the warhead “exploded either above or upon the target as scheduled.”³⁸

An Atlas mission was a complex undertaking. Thousands of parts and sequential steps had to be performed perfectly for a successful attack and because of the radio guidance, the operation depended upon outside inputs. Many things could go wrong, and one obvious weakness, even if the missile worked perfectly, was the ground stations. If attacked, jammed, or otherwise eliminated, the radio-guided Atlas became unusable. As Bernard Schriever recalled, “obviously the self-contained [inertial guidance] system was a hell of a lot better from a military standpoint . . . the radio . . . system required a very

³⁸Department of the Air Force, *Atlas Technical Order*, 1-4.

substantial ground installation which was highly vulnerable and we wanted to get rid of that as soon as we could.”³⁹

The distance between a missile warhead and its target at impact measures the accuracy of the ICBM’s guidance. Circular Error Probable (CEP) is the unit of measurement defined as “the radius of the circle around the target within which fifty-percent of the warheads will fall in repeated firings.” Another way of looking at CEP is as “the distance from a target in which there is a fifty-percent chance of a warhead directed at that target exploding.” This does not ensure target destruction, which depends upon the ability, or hardness, of that target to resist a nuclear detonation, as well as any defensive measures that might be in place. CEP is the standard unit of measurement for missile accuracy. Any unit of distance measurement applies to CEP, but the nautical mile measured early ICBM CEPs. As accuracy improved, feet became the standard unit of CEP measurement. A smaller CEP indicates better accuracy than a large CEP.⁴⁰

The problems of raising the missile out of the coffin shelter, loading fuels, trajectory data, and use of radio guidance facilities to minimize CEP necessitated a large operations and support force. An exposed missile also presented a target for sabotage. If the Soviets attacked and the United States had insufficient warning time, then the inbound warheads might destroy the Atlas force on the ground while conducting its countdown. Given the ICBM’s thirty-minute flight time between the Soviet Union and the United States, and Generals White and Smart’s fifteen-minute requirement for the

³⁹Schriever quoted in Donald MacKenzie, *Inventing Accuracy: A Historical Sociology of Nuclear Missile Guidance* (Cambridge, MA: The MIT Press, 1990), 121-122. The quotation’s source is an interview MacKenzie conducted with Schriever.

⁴⁰The first definition of CEP is from MacKenzie, *Inventing Accuracy*, 348. MacKenzie discusses disputes over the interpretation of CEP on pages 352-357. The second definition of CEP is from Barbara G. Levi, Mark Sakitt, and Art Hobson, eds., *The Future of Land-Based Strategic Missiles* (New York: American Institute of Physics, 1989), xiii.

launch of two missiles, the nation's leadership had only fifteen minutes to identify, track, and confirm an attack. In addition, the president had to decide what to do and give the appropriate orders in a timely fashion so dissemination throughout the alert force could occur to allow the Atlas missileers enough time to launch. Any missile system that saved time by increasing survivability, responsiveness, or simplicity would significantly contribute to a national deterrent.

Within the air force, concurrent management worked so fast that Western Development Division did second-generation work before deploying the first generation ICBMs. Schriever's head of propulsion, Colonel Edward N. Hall, had preached the benefits of solid-fuel technology since 1953 and deserves much of the credit for the technology's progress. His mantra was "go ahead with liquids, for go ahead we must . . . but in planning for the future, remember the solids. They offer the chance of simplification [sic], of speed-up, and of smaller, cheaper missiles." By December 1954, Hall, who was responsible for the Atlas propulsion system, had moved ahead with solid-fuel research and had invited the major solid-propellant manufacturers to discuss the state of the technology. The outcome was the Air Force Large Rocket Feasibility Program, a group dedicated to building solid-fuel ICBMs. Hall was an abrasive man of deeds who preferred to build, not study, commenting, "I am the antithesis of studies." He believed that one did not solve technological problems through analytical study: "You arrive at them intuitively, ingeniously, and then analyze. . . . You can sit down and study till hell freezes over and you'll wind up with nothing. . . . I know my field. . . . And I know because I've flown a lot of rockets." Hall was not the scientist most admired by Schriever, but he knew propulsion. Skeptical of the newer technology, Schriever was not

an immediate convert to solid propellants, but the tireless Hall and his supporters eventually won his support and on December 27, 1957, the air force approved a new ICBM powered by solid fuels and designated the "Q" weapon system, which within a year, became the Minuteman program.⁴¹

Not until 1956, as Schriever worked on making the Atlas a viable weapon system, did he raise the question of a mobile ICBM. Perhaps influenced by the service's experience with the cruise missile or thinking about the army's shorter-range missiles, Schriever asked Colonel William Sheppard to investigate the possibility of a mobile long-range ballistic missile. The air force had the Research and Development (RAND) Corporation study the issue, along with Air University and Convair, the Atlas contractor, but ICBM mobility was a difficult challenge. Technical limitations made it difficult to protect a mobile, land-based ICBM against enemy attack. To survive, it had to hide and launch before the Soviets targeted it. The Atlas's guidance limitations, body construction, and use of liquid fuels increased reaction time and support requirements, making mobility difficult and lessening missile survivability. After digesting the information at his disposal, Sheppard did not believe a mobile ICBM was practical and replied that "we are not very hopeful about a completely mobile ICBM system," at which point Schriever dropped the idea for about a year and a half.⁴²

⁴¹Hall, quoted in Roy Neal, *Ace in the Hole: The Story of the Minuteman Missile* (Garden City, NY: Doubleday and Company, Inc., 1962), 67, 83. Pages 63-101 summarize Hall's efforts to bring solid propulsion to the air force. Pages 83-86 illustrate how Hall worked out the initial parameters of the three-stage, solid-fueled Minuteman. For another review of Hall's activities in the mid-late fifties, see J. D. Hunley, "Minuteman and Solid-Rocket Launch Technology," in *To Reach the High Frontier*, 243-251. Largely overlooked is the technological importance of the Minuteman program to the overall American space effort; pp. 229-300 review solid-propellant development and the technological carryovers from the Minuteman program to later large American solid boosters including those used on the space shuttle.

⁴²See David A. Byrd, *Rail-Based Missiles from Atlas to Peacekeeper* (Los Angeles Air Force Station, CA: Ballistic Missile Organization Historian, 1991), x, 4. Courtesy Air Force Space Command

On June 1, 1957, in growing recognition of the titanic requirements of the ICBM effort, the air force reorganized Western Development Division as the Air Force Ballistic Missile Division (AFBMD). During the same month, President Eisenhower reaffirmed deterrence as the political strategy of the United States and that one of the key military elements of that strategy was to “place main, but not sole, reliance on nuclear weapons . . . and to use them when required to achieve national objectives.” Earlier in June, the Atlas flight test program began at Cape Canaveral, Florida, and in July, an advisory panel met to discuss future developments in ballistic missiles. The Bacher Panel, named after Chairman Robert F. Bacher, a physicist at the California Institute of Technology, included several notable scientists and weapons designers such as physicist Clark Millikan, also of Cal Tech, and presidential advisor and chemist George Kistiakowsky. The Bacher Panel met at the invitation of Dr. Simon Ramo of Ramo-Wooldridge, who on June 1, reported the findings back to Schriever and laid out the air force’s first substantial thoughts on a mobile ICBM since the initial round of questioning in 1956.⁴³

Nonetheless, to have a mobile ICBM, first one had to have an ICBM, and technological dialogue, convergence, and innovation eventually contributed to a reliable missile that could carry an acceptable weapon. The effort that this required overshadowed any thoughts by the air force to make the system mobile, and in any case, the service was only recently committed to ballistic missiles. The one intermediate range ballistic missile that it had developed, the Thor, was immobile, and the single mobile

Historian’s Office (hereafter abbreviated as AFSPC Historian) and George A. Reed, “U.S. Defense Policy, U.S. Air Force Doctrine and Strategic Nuclear Weapon Systems, 1958-1964: The Case of the Minuteman ICBM” (Ph. D. diss., Duke University, 1986), 59. The RAND study remains classified.

⁴³“National Security Council Report, NSC 5707/8, Basic National Security Policy June 3, 1957,” in *FRUS, 1955-1957*, vol. 19, 507-509.

ballistic missile that it had, the medium-range Jupiter, came from the army, but it required a tedious and time-consuming set-up. Although it had experience with mobile medium-range cruise missiles, the air force used its intercontinental cruise missiles in fixed, not mobile, deployments, reflecting the operations of bombers, which, until SAC initiated an airborne alert, remained motionless on the ground until ordered to launch. Despite the flurry of rocket testing and advanced aerodynamic work by the United States after World War II, including the testing of captured German V-2s, up to 1954 overall American ICBM development languished and the air force never seriously considered mobility for long-range missiles.

In 1954, political and technological events converged. Increasing concern within the Eisenhower administration demanded that the United States not fall behind Soviet long-range rocket technology because the credibility of American deterrence depended upon the survivability of its striking force. With the advent fusion bombs, scientists and engineers realized that lighter-weight weapons were feasible, and these weapons could be light enough for rockets to carry. Equally important, leaders emerged who were interested in new methods and tools of warfare as a means to leverage technological and economic superiority against the Soviets, and the synergy of these factors aided construction of the ICBM. Despite this, by 1956, not many people thought in terms of a mobile ICBM because building a flyable Atlas was challenge enough. Existing mobile missiles were transportable but took a long time to configure for launch. The big, heavy, and complex liquid-fueled rockets required complex support infrastructure and time-consuming launch preparations, characteristics incompatible with movement and responsive launch. Their guidance systems required outside inputs, which lessened the

resiliency of the weapon and made it susceptible to hostile actions. Given the thirty-minute flight time of an ICBM from launch to target, any mobile system would have to transition from motion to missile engine ignition within minutes, and a better solution would be a missile that could conceal its location through random movements and provide the capability for a near-instantaneous launch, no matter what its location. A large number of dispersed, moving missiles would make a potential adversary pause, and soon the air force began to plan such a system.

CHAPTER 2

EARLY AMERICAN ICBMS AND MOBILITY

The best kind of deterrent is not only one that is difficult to locate, but it is also difficult to determine just where and how it will come. Therefore, you should, I think look toward having your deterrent missiles on every vehicle and every location in the most variety of situations you could imagine.¹

-- Dr. James W. McRae, July 29, 1959

On July 15, 1957, the Bacher Panel discussed "the second generation of missiles, including their components, anticipated performance, and use to accomplish air force objectives." The second week of meetings involved discussions on scientific uses of ICBMs, including satellites and moon rockets, as well as more detail on ICBM subsystems. The panel's number one general recommendation was for the air force to research "several vital areas" including nose cones, storable liquid propellants, solid propellants, and very stable oscillators to avoid future delays and greater costs. Another "vital area" of concern was "ICBM force survival in the era of advanced systems," and with the identification of this concern, mobility became central to discussions of ICBM deployment.²

¹House Committee on Science and Astronautics, *Progress of Atlas and Polaris Missiles*, 86th Cong., 1st sess., 1959, 181. McRae was the vice president of American Telephone and Telegraph and a member of the DoD ICBM scientific Advisory Committee.

²R. F. Bacher to S. Ramo, August 8, 1957, "Report of a panel which met to study the future developments in ballistic missiles," unaccessioned, unclassified collections. BMO box F-4, AFHRA. The air force organization responsible for ballistic missiles and space systems underwent several name and organization changes. From July 1, 1954, to May 31, 1957, it was the Western Development Division. From June 1, 1957, to March 31, 1961, it was the Air Force Ballistic Missile Division or AFBMD. On April 1, 1961, AFBMD split into two divisions, one for space systems such as satellites, the Space Systems

Survivable forces were crucial to Eisenhower's reliance on nuclear weapons. In 1957, the United States possessed a powerful bomber force consisting of 2,421 bomber and tanker support aircraft, but these were useless if destroyed on the ground, a possibility given the ICBM's short flight time and delays in American recognition of an attack. Early ICBMs were as vulnerable as bombers and Snark cruise missiles. The first Atlas and Titan bases were not significantly hardened against attack because the missiles stood alert in the open, or in the case of other early Atlas models, in lightly hardened shelters. Later, some ICBM systems stored the missile and launch pad underground but elevated the entire launch platform to a surface position before launch, but the most promising plans called for underground, hardened concrete shelters, the forerunner of today's launch facilities (the "silos" in popular parlance).³

To address these concerns, the Bacher Panel recognized "the great urgency" of creating a force capable of surviving a sudden all-out attack, a scenario the air force called a "bolt out of the blue." Since World War II, American military leaders had feared a Pearl Harbor-style surprise attack, and in the nuclear era, the stakes were higher. Bacher felt that "serious doubts" existed in using hardened sites as "the ultimate solution for an indestructible 'massive retaliation' force." Even with concrete and steel shelters capable of withstanding over 100 pounds per square inch, the panel foresaw the day when enemy warheads could destroy a stationary target. Improvements in guidance accuracy,

Division (SSD), and the other for ballistic systems such as ICBMs, the Ballistic Systems Division (BSD). This arrangement lasted until June 30, 1967, when the entire organization became the Space and Missile Systems Organization, or SAMSO. On October 1, 1979, SAMSO ceased to exist, replaced by Space Division and the Ballistic Missile Office, each equivalent to SSD and BSD, respectively. See Timothy C. Hanley and Harry N. Waldron, *Historical Overview: Space and Missile Systems Center* (Los Angeles AFB, CA: SMC History Office, 1996), v. The Bacher Panel's concern for investigating the use of ICBMs as space launch vehicles illustrates the diffusion of military ICBM technology to "civilian" purposes. Even today, ICBMs continue to form the foundation of American expendable space launch vehicles.

³Bomber force strength from SAC Historian, *Alert Operations*, 77.

warhead yield, and intelligence data would lessen ICBM survivability. From studying missile and basing mode as one system, emerged an "urgent need for careful comparative analysis, from the operational point of view, of the hard base concept versus the mobility concept." Mobility placed "an intolerable burden" on an enemy's intelligence gathering system by rotating missiles among a number of locations. The disadvantage of a stationary launch site was that although it could be super-hard, once the enemy knew where it was, it would be only a matter of time before they built an accurate weapon to hold it at risk. Locating Soviet ICBM sites forced the United States to develop new national means of gathering information, but the solution to this problem was simpler for the Soviets because America's open society made it immeasurably easier to initiate espionage efforts. Moving American ICBMs presented the Soviets with a nearly unsolvable targeting problem.⁴

The Bacher Panel questioned the air force's standard of a fifteen-minute reaction for the launch of retaliatory Atlas and Titan ICBMs. Concerned over delays "in the issuance of orders on the basis of early warning signals," the panel investigated riding out an attack and launching an overwhelming retaliatory strike with "the highest possible rate of fire." The implication of this recommendation was that the United States needed a second-strike capability, an asset evidently provided only by a survivable ICBM force (no mention was made of SLBMs). This survivable force depended upon "small size, simplicity, and reliability of the missiles and their compatibility with mobile or semi-

⁴Bacher Report, August 8, 1957, 4-5, unaccessioned, unclassified collections. BMO box F-4, AFHRA. Neufeld, *Ballistic Missiles*, 214, summarizes the relative hardness of Atlas and Titan missile sites. See also AFBMD, January 27, 1961, "Evolution of ICBM Operational Deployment Configurations," unaccessioned, unclassified collections. BMO box F-13, AFHRA. The later document provides diagrams with hardness levels expressed in pounds per square inch.

mobile base systems.” The panel wanted a new missile with a CEP of less than one statute mile and “a multi-stage solid propellant ICBM with payloads of the order of 1,000-2,000 lbs.” Seeing solid-fueled missiles as the future, the panel wanted the air force to “take advantage of the existing development effort related to Polaris and to base the development of a solid fuel ICBM on Polaris-type rocket engines.” Besides solid fuels, a mobile ICBM required convergence from multiple areas of rocket technology but, as the panel pointed out, guidance and propulsion were critical. These recommendations meshed with the desires of internal air force constituencies such as Colonel Ed Hall’s large rocket feasibility program.⁵

American leadership knew of Soviet programs to build long-range rockets. The Killian Report stressed the implications of losing the race to develop a missile capability. Further intelligence reports confirmed continuation of Soviet efforts, which culminated on August 21, 1957, when an R-7 ICBM successfully flew over the Soviet Union’s test range to Kamchatka. The R-7 was as complicated and unwieldy as early American ICBMs, requiring thirty-two engines to ignite at liftoff, but it flew fifteen months before the Atlas successfully flew 2,500 miles on December 17, 1958. The R-7 test was not a complete success because upon reentry, the dummy warhead disintegrated at an altitude of ten kilometers, but the Soviets had not yet completed the re-entry vehicle design, and in any event, it was enough to show that the rocket worked. The *New York Times* reported the DoD reaction as calm. Defense officials stressed that four years was the typical amount of time required to develop an operational system from a test vehicle, which provided the United States enough time to complete its own missile programs.

⁵Ibid., 5-10.

President Eisenhower minimized the effects of the Soviet claim, as did Secretary of Defense Quarles. *Pravda* claimed that the missile changed the balance of world power and emphasized that the West was second best. It is impossible to know how the American public would have reacted to the R-7's flight as an event isolated from the Sputnik spectacle, but it is doubtful that a ballistic flight test would have alarmed the man on the street or made as fine press copy as did the moderately visible moving point of light that flew from horizon to horizon through the night.⁶

A Hunk of Iron?

On October 4, 1957, the *New York Times* ran a three-line headline that declared, "Soviet fires earth satellite into space; it is circling the globe at 18,000 m.p.h; sphere tracked in 4 crossings over U.S." Sputnik lofted over American skies, not only shocking the American public but also representing a capability few Americans wished to believe the Soviet Union possessed. The success of Soviet science and technology forced a pause on Americans to consider that their science might not be the world's best. The *Times* reported that navy Admiral Rawson Bennett, Chief of Naval Research, belittled the satellite as a "hunk of iron," but in one sense, Bennett's sour grapes comment was correct. There was a difference between orbiting Sputnik and accurately delivering a nuclear weapon to a target via an ICBM, but such subtleties were lost in the hubbub surrounding the headlines. The perception was that not only had the Soviets kept pace

⁶Data on the first long-range Atlas flight, an Atlas B model missile, from J. C. Hopkins and Sheldon A. Goldberg, *The Development of Strategic Air Command: 1946-1986* (Offutt Air Force Base, NE: Office of the Historian, Headquarters Strategic Air Command, 1986), 86 and von Braun and Ordway, *History of Rocketry*, 133. Description of first R-7 flight from Zaloga, *The Kremlin's Nuclear Sword*, 47 and James Harford, *Korolev: How One Man Masterminded the Soviet Drive to Beat America to the Moon* (New York: John Wiley and Sons, Inc., 1997), 110.

with American science and technology, they had demonstrated superiority, and because they had fission and fusion weaponry, they could launch nuclear-armed missiles at American soil. In 1946, none other than Hap Arnold had told the public that defense against the long-range ballistic missile was impossible unless the air force could destroy them prior to launch, and now, as Americans gazed at their night sky, they had a tangible reminder of the power of Soviet rocketry. This beeping globe symbolized more than a hunk of iron.⁷

Historian Walter McDougall described the public outcry after Sputnik as an earsplitting din unmatched “since Pearl Harbor,” and the press exploded a media riot upon the national scene. The “lengthy, loud, and imposing” outcry made Sputnik a goldmine for politicians. Senator Lyndon Johnson held well-publicized committee hearings on American defense preparedness and blamed the mess on Republican ineptitude and neglect of national security. Also decried was the Eisenhower administration’s fiscally limited support of education; blame was heaped upon complacent scientists; resented was consumerism; and Americans wondered what their government would do about it. To a public audience, President Eisenhower remained calm and downplayed the military significance of the achievement, but within the White House, debate focused on how the Soviet space spectacular affected international political allegiances.⁸

⁷Arnold, “Air Power for Peace,” 139.

⁸Walter A. McDougall, “Technocracy and Statecraft in the Space Age--Toward the History of a Saltation,” *The American Historical Review* 87 (October 1982): 1016-1017, 1030. For further treatment of Sputnik’s effects, see Walter A. McDougall, *The Heavens and The Earth: A Political History of the Space Age* (New York: Basic Books, Inc., 1985), 141-145.

The R-7's August test flight had caused nothing like this, but now the new horizons of science and technology lay wide open for Cold War political banter. In an October 10, 1957, meeting of the National Security Council, Allen Dulles, Chief of the Central Intelligence Agency, made clear that the satellite was a propaganda success for the Soviets. He believed that Sputnik was one of three well-coordinated Soviet propaganda moves, the other two being the R-7 flight and a successful test of a large hydrogen bomb. Dulles also considered that American intelligence had observed fewer Soviet bombers on their airfields, and he wondered whether this indicated a Soviet shift towards missiles but admitted that he did not have enough data to know. Defense Secretary Quarles believed that the Soviets had demonstrated missile competence beyond what the administration had previously granted them but stated, "we had always given them the capability of orbiting an earth satellite." Undersecretary of State Christian Herter described the foreign policy ramifications as "pretty somber" because non-aligned nations insisted that the Soviet achievement validated their neutral stance.⁹

By mid-November, the Soviets launched Sputnik II, a massive satellite carrying a passenger, the dog Laika, and American worries deepened. Within the State Department, Secretary John Foster Dulles mulled over staff memoranda that emphasized "the gap between the U.S. and the USSR was wider than first realized. . . . Sputnik II raised at least some doubts as to U.S. ability to catch up quickly." Because American leaders did not have clear insight into the workings of the Soviet government, they dealt with perceptions and informed estimates, but the general feeling was that the United States had

⁹S. Everett Gleason, "Memorandum of Discussion at the 339th Meeting of the national Security council, Washington, October 10, 1957," prepared on October 11, 1957, in Department of State, *FRUS*, vol. 11, *United Nations and General International Matters* (Washington, D.C.: Government Printing Office, 1988), 757, 759, 762.

suffered “a serious, although not decisive, setback. World opinion tends to hold that the Sputniks per se have not altered the strategic balance of forces in the short run, since Soviet ICBMs are not yet thought to be in mass production.” Nonetheless, Soviet thrusts carried new weight, and one of the best ways for the United States to parry was to “present [the] effectiveness of U.S. and free world military capability.”¹⁰

Sputnik energized public and political thought on long-range missiles, but within the DoD, business proceeded on the lines already set in motion. On December 16-17, 1957, the air force’s ICBM Scientific Advisory Committee met. This body, a successor to the original von Neumann committee, believed that development of a second-generation ICBM should unfold along two paths, one of which resulted in a larger, more powerful rocket operated from fixed installations to provide “missiles of much larger payloads and . . . first stages for advanced satellite and space vehicles.” The committee foresaw the Titan fulfilling this role, adding that even though Titan had not yet flown, “we have no doubts of its success.” As a result, the Titan was concurrently programmed to undergo “product improvement and future development” to replace the Atlas before either rocket had demonstrated much. This approach capitalized on the work already accomplished in the ICBM program.¹¹

The other developmental path was towards a missile possessing “simplicity, small size, mobility, quick readiness, and similar characteristics to further true operational capability.” These words echoed the Bacher Panel’s final report, and a cynical

¹⁰“Memorandum From the Deputy Director of Intelligence and Research (Arneson) to the Secretary of State, November 14, 1957,” in *Ibid*, 768; “Circular Airgram From the United States Information Agency to All Principal United States Information Service Posts, December 17, 1957,” in *Ibid*, 780.

¹¹Meeting minutes, Intercontinental Ballistic Missile Scientific Advisory Committee to the Secretary of the Air Force, December 16 and 17, 1957, 2-3, unaccessioned, unclassified collections. BMO box F-13, AFHRA.

conclusion might be that this was so because Clark Millikan, a Bacher Panel member, signed the final minutes, but these characteristics were desired by the air force throughout ICBM development because they increased a weapon's flexibility, responsiveness, and reliability. Thus, the final recommendation emphasized "a small, highly reliable, and operationally simple ICBM, probably using solid propellant" because it made military sense to do so. By this time, Secretary of the Air Force James H. Douglas, Jr., had heard enough. Internal air force pressure from the Schriever-Hall portion of AFBMD and his own ICBM Scientific Advisory Committee combined with external pressure from the Bacher Panel to help Douglas approve development of the Minuteman on December 27, 1957.¹²

This decision was important to the air force for another reason. Despite its apparent 1954 victory for control of the long-range ballistic missile mission, the air force and navy continued to feud for missile funding. Historian Harvey Sapolsky contends that in late 1957, the air force, upset about Pentagon rumors that the navy had quietly advertised the Polaris as an ICBM, asked the admirals for information to determine whether the missile might match the air force's requirements for a land-based missile. If Polaris was not yet a threat as the basis of a new ICBM, it was a threat as a land-based intermediate-range missile, a mission that now belonged to the air force, and as budget squabbles escalated, the air force's control of ICBMs and other missiles became insecure. Sapolsky asserts that once the air force received the navy data, it publicized only the disadvantages of the Polaris, which at any rate evened out the navy's equally one-sided pro-Polaris publicity. Air force personnel believed that the Polaris, while well-suited to

¹²Ibid.

the SLBM role, was not adequate as a land-based missile. According to air force Colonel Charles Terhune, Schriever's deputy commander for technical operations, the Polaris's staging ratio was inadequate for duty as an ICBM (Polaris also only had two stages as opposed to Minuteman's three) or land-based intermediate-range missile. Despite Terhune's analysis, Polaris worried General Schriever. Terhune recalled Schriever's concern over the navy's moves, commenting that his boss told him, "Terry, we're going to have to do something about this." The navy had also begun to massage its argument in favor of Polaris's deterrent value, calling for more Polaris missiles and fewer ICBMs. The air force-navy missile rivalry never fully disappeared, and even as late as 1959, while testifying to Congress on the state of the Atlas program, Schriever had to confront aggressive navy supporters including New York's Democratic Representative Victor Anfuso as to why a land-based ICBM was better than a ship-based system.¹³

In 1956, in order to avoid conflict with the air force over roles and missions, the navy first said the Polaris would support offensive fleet operations against naval targets, an argument parallel to the air force saying that it would use cruise missiles to destroy air defense concentrations, and by 1957, the admirals rightly emphasized the mobility and survivability of the submarine-based missile against Soviet attack. Another idea that they brought forward played upon fears that eventually the Soviet ICBM force would become so large as to overwhelm American ICBMs in a preemptive attack and thus prevent the destruction of Soviet missiles in their launch facilities. If this happened, then the only

¹³Harvey M. Sapolsky, *The Polaris System Development: Bureaucratic and Programmatic Success in Government* (Cambridge, MA: Harvard University Press, 1972), 39-40; Neal, *Ace in the Hole*, 88-89. Throughout two days of hearings, Representative Anfuso, a World War II veteran of the Office of Strategic Services (the forerunner of the Central Intelligence Agency) tried to have someone make the point that a ship-based missile was better than a land-based deployment. He succeeded in having Dr. James W. McRae make such a statement. See U.S. Congress, *Progress of Atlas and Polaris Missiles*, 181.

way for American bombers and ICBMs to survive would be to attack first or have a survivable basing mode. Because American presidents did not advocate a first-strike policy, the navy essentially argued that Soviet force structure increases would render land-based American forces obsolete. To solve this dilemma, the navy thought that a finite amount of SLBMS would deter the Soviets from attacking, and if they did attack, lessen their interest in destroying American cities. By destroying Soviet cities from invincible Polaris submarines, the admirals reasoned that deterrence could be maintained without the expense of a land-based ICBM force, perhaps even without a bomber force.¹⁴

In January 1958, the National Security Council asked the military for help in responding to the recommendations of the Gaither Committee, another presidentially-appointed committee that studied science, technology, and American defense needs. Chaired by H. Rowan Gaither, appointed by Eisenhower and a San Francisco lawyer who headed the Ford Foundation and RAND Corporation, the committee did not share Eisenhower's responsibility or accountability to manage a fiscally responsible federal budget, but it reflected the mood of the country regarding defense. Gaither challenged the administration's defense policies and called for over \$19 billion worth of defense improvements while recommending the deployment of 80 Atlas and 600 Titan ICBMs. In calling for a massive deployment of Titans, the Gaither Committee did not take into account the technological solutions sought by the air force to address the need for a survivable ICBM force, but it did turn up the heat on administration leaders to respond to alleged Soviet missile superiority.¹⁵

¹⁴Reed, *U.S. Defense Policy*, 62, 77-81.

¹⁵Robert A. Divine, *The Sputnik Challenge*. (New York: Oxford University Press, 1993), 35-41.

On February 10, 1958, the work of the DoD and air force ICBM Scientific Advisory Committees, intense briefings from AFBMD, and political pressures paid off when the secretary of the air force asked Secretary of Defense Neil H. McElroy to commit to the Minuteman program. Previously, continued air force lobbying and testimony had convinced Assistant Secretary of Defense William Holaday, McElroy's point man on missiles, to eliminate competing programs to the Minuteman, and on February 27, 1958, the air force put its money where its mouth was by authorizing \$50 million in research and development funds to support the air force "Q" weapon system. Before that date, the service only spent its own money because the DoD had not yet approved the program, which meant that the air force had to wait until it secured DoD-level support before reprogramming large sums to support development. One day later, Secretary McElroy eliminated any thoughts about a land-based Polaris by issuing a terse memorandum to each of the service secretaries that stated, "it should be understood that this function [long-range ballistic missiles] is the responsibility of the Department of the Air Force." McElroy limited the Minuteman effort to research and development, but more importantly, his actions solidified blue-suit control of land-based missiles.¹⁶

On June 15, 1958, the *New York Times* declared that by 1965, solid-fuel missiles like Minuteman would carry the burden of American nuclear deterrence. At this time, the air force did not anticipate a Minuteman deployment until 1962, when its arrival would help the United States alter the strategic imbalance widely reported by the press. Meanwhile, the Polaris program had flight-tested various components. By the end of the year, public furor over the missile gap had heightened following more Soviet space

¹⁶Neal, *Ace in the Hole*, 91-95; Neufeld, *Ballistic Missiles*, 227; McElroy quoted Byrd, *Rail-Based Missiles*, x. See also Hopkins and Goldberg, *The Development of Strategic Air Command*, 79.

launches and a string of Atlas ICBM test flights that ended in failures. Making things worse was an image of Soviet growth: as early as January 1959, *The Reporter* stated that the Soviets had 100 ICBMs to none for the United States, and the *New York Times* repeated this piece of doggerel, estimating that by 1963, the Soviets would hold a 2,000 to 130 edge. The Gaither Report had earlier stated that the Soviets “probably surpassed us in ICBM development” but that by 1959, the “USSR will probably achieve a significant ICBM delivery capability with megaton warheads” while the “U.S. will probably not have achieved such a capability.” Unknown to the public was a November 12, 1957, national intelligence estimate that allowed the Soviets only ten prototype ICBMs ready for use in 1959.¹⁷

An Early Look at ICBM Mobility

In response, the air force proposed sizing the initial Minuteman force at 150 missiles deployed in underground, hardened launch facilities at one base. The air force further upped the ante to 445 missiles at three bases by January 1965 and 800 Minutemen at five bases by June 1965. These numbers dwarfed what the air force had planned for Atlas and Titan deployments (eventually the air force deployed more than 1,000 Minuteman missiles, compared to only fifty-four Titan II missiles). Eventually, but not until each service connected with a few more jobs, the Polaris and Minuteman supporters saw that each system offered unique advantages. Nestled in its submarine, the shorter-

¹⁷Press-reported missile gap estimates from Edgar M. Bottome, *The Missile Gap: A Study of the Formulation of Military and Political Policy* (Rutherford, NJ: Fairleigh Dickinson University Press, 1971), 224-234 trace the evolving estimates of American and Soviet ICBM numbers as reported in various media during the late fifties and early sixties. Gaither report from *FRUS*, vol. 19, 651; “National Intelligence Estimate, NIE 11-4-57, November 12, 1957,” *FRUS*, vol. 19, 670.

range Polaris was nearly invulnerable, and the Minuteman offered a cheap and sizeable long-range attack force. To counter the navy's claim that mobility made the Polaris a superior weapon, the air force advertised how a train-based Minuteman was equally invulnerable and played the civilian economy card by suggesting that a rail-mobile Minuteman was a "heck of a good use for the poor old railway system."¹⁸

Through the summer of 1958, the air force organized its thoughts on Minuteman deployment. The missile was a technological risk demanding new propulsion and guidance technologies, and it needed lighter nuclear weapons than those used for Atlas and Titan. It was also a direct competitor for budget dollars with these programs. The air force evaluated various force-mix schemes, and the two dominant positions that emerged placed the Minuteman in hardened, dispersed, underground launch facilities and on a train. Colonel Ed Hall did not favor mobility because he felt it would dramatically increase costs, thus putting the overall program at risk, which was a viable concern in the middle of efforts to develop multiple liquid-fueled missiles capable of launching heavier warheads than the Minuteman. Hall found himself outgunned by Generals Thomas S. Power, now the SAC commander, and Schriever. Power, a pilot whose command was the ultimate user of the missile, believed that the deception afforded through mobility, was an important military asset. Schriever, in charge of all air force ICBMs, balanced the heavier throw-weight of the big liquid-fueled missiles against the unproven Minuteman.

¹⁸Unnamed air force personnel quoted in "U.S. Likely to Make Solid-Fuel Missiles Key Defense by '65," *New York Times*, June 15, 1958, 24. The Minuteman force structure data is from Neufeld, *Ballistic Missiles*, 229. Divine, *The Sputnik Challenge*, 115-127, details budgeting and liquid-fuel missile force structure changes resulting from worries over the missile gap.

Power asked AFBMD to study mobility, and on September 9, 1958, Schriever ordered a joint AFBMD-SAC committee to study the issue.¹⁹

Power and Schriever wanted to know if Atlas, Titan, or Minuteman could become a mobile system, and their investigators produced two reports, one on Minuteman and the other on Atlas and Titan. The Minuteman study group was SAC-heavy with five of the eight active members (the ninth member was an alternate) coming from SAC. In October 1958, they issued the first report, on Minuteman, and followed in December with the report on Atlas and Titan. The Minuteman report considered force size, hardness, dispersal, fast reaction, deception through decoys, and mobility. The only investigated mode of movement was by train. Having discussed the problem with the president of the Burlington Northern railroad and concluding that the railroads would support the air force, Schriever, sensitive to the economic woes of a railroad industry facing stiff competition from personal automobiles, trucking, and air transportation, believed the railroads would be eager to participate, and he was right. Demonstrating himself to be an adroit gatherer of support, Schriever surmised that because a rail system was important to the national economy, linking Minuteman to the railroads would unite the system "with an essential national industry possessing a powerful lobby and a commitment of government support." This strategy proved effective, for a while.²⁰

¹⁹Neal, *Ace in the Hole*, 92-97; Byrd, *Rail-Based Missiles*, xi. See also Reed, "U.S. Defense Policy," 56-71.

²⁰Advanced Planning Office, Deputy Commander Ballistic Missiles, Air Force Ballistic Missile Division, "Future for Ballistic Missiles, November 1959, Revised January 1960," slide 27, unaccessioned, declassified document. BMO document 02056295, file 13J-4-4-13, AFHRA. Byrd, *Rail-Based Missiles*, 13; Quote from Frederick J. Shaw and Richard W. Sirmons, "On Steel Wheels: The Railroad Mobile Minuteman," *SAC Monograph No. 216* (Offutt Air Force Base, NE: Office of the Historian, Strategic Air Command, 1986), 5. Declassified historical monograph excerpt, IRIS no. K416.01-216, AFHRA.

The air force had previously studied barges and trucks as ways to mobilize its ICBMs and concluded that barges were unsatisfactory because lakes and rivers did not provide sufficient space for the planned force and were too close to population centers. Truck-based systems were too expensive, no doubt, because of the cost and complexities of moving a 65,000-pound missile by highway. Railroads offered a wonderful economic advantage because private industry had already built them, which meant they existed at no cost to the air force; moreover, private corporations also maintained the national railroad infrastructure. All the air force had to do was build the railcars to contain the weapon system and provide the crews to control it, but private railroad crews and their locomotives could operate the train. Railroads also possessed expertise in moving heavy and bulky objects and were in business to deliver goods undamaged to their customers. Unlike the navy, which had to buy and build its own transportation network, the air force could rent services at a cheaper cost than that required to operate and maintain a submarine fleet. A railroad-based system eradicated the truck convoys previously needed to support a mobile missile and virtually eliminated the cost of developing a transportation system to move the missile. Trains were a simple and elegant solution to a demanding problem.

The investigators made a number of assumptions, a necessity given the near-daily changing force size and composition of the ICBM program. Assuming a 1963 total force size of 1,200 Minuteman missiles and cooperation of the railroads, the study assumed that a quarter of the force, 300 missiles, would be rail mobile. Originally, one train, called a mobile missile task force, contained three missiles and operated over 600 miles of track with task force support centers located at existing air force bases. For a force of

300 missiles, 100 trains were required, and the investigators optimized each train's operational trackage at 600 miles. The air force changed these numbers over the ensuing years, but fewer trains meant that the remaining task forces had more miles of track to roll over.²¹

Imagine a line of railroad track. According to the air force study, using two pounds per square inch of atmospheric overpressure as the amount needed to destroy a mobile Minuteman train of three missiles operating over 600 miles of track, the Soviets required thirty reentry vehicles delivered down the rail line (if they knew which ones to hit) to ensure the destruction of one train. Based on an assumed Soviet CEP of two nautical miles and a five-megaton warhead's radius of destruction, this forced the Soviets into an uneconomical kill ratio of ten to one; that is, the Soviets had to expend ten warheads for every one American Minuteman. Destroying the mobile Minuteman was an expensive problem for the Soviet Union because it required a minimum of thirty Soviet missiles to destroy one Minuteman train, adding up to 3,000 perfectly working Soviet missiles to destroy the entire mobile force of 300 Minuteman missiles, which did not take into account the underground-based Minuteman force of 900 missiles. By using trains, the air force could address all of the Bacher Panel's recommendations with one system; moreover, a mobile system effectively eliminated any Soviet numerical advantage with fewer American weapons.²²

²¹SAC/AFBMD, "Minuteman Mobility Concept Report, October 1958," 10-12, unaccessioned, unclassified collections. BMO box M-1, AFHRA.

²²Ibid., 12. Calculations involving target destruction and missile survivability are complex and time consuming. Changes to force sizes and mixtures meant that analysts had to recompute these values. A brief discussion may be found in Robert D. Bowers, "Fundamental Equations of Force Survival," in Kenneth F. Gantz, *The United States Air Force Report on Ballistic Missiles* (New York: Doubleday and Company, Inc., 1958), 249-260. See also James Baar, "Hard-based Minutemen vs. Mobility," *Missiles and Rockets* 7 (October 17, 1960), 24.

Putting the Minuteman on a train was not exactly simple. The cars containing the missiles had to protect delicate missile components including the guidance system and solid propellant by providing an environmentally controlled, air-conditioned, shock-free environment that minimized vibrations. The missile needed a controlled temperature range of eighty degrees plus or minus twenty degrees to protect its electronics from heat and humidity, and shock isolation was required because vibrations could crack the missile propellant. Solid propellants are liquids when poured; they dry hard inside the casing of the missile stage. Shock and vibration can crack the solidified propellant, which leads to uneven motor performance or forces chunks of unburned propellant through the nozzles and throat assemblies, which could cause in-flight failure.²³

When launching, three fast-reacting, hydraulic leveling jacks lowered to stabilize the car before erecting the missile. Additionally, the missile car provided an erecting mechanism to raise the missile to a vertical position for launch and rotated the missile to the required prelaunch azimuth for accurate guidance. Building a flame deflector into the launch car's bottom prevented exhaust gas damage to the railroad right-of-way and thus permitted the train to move quickly after the missile launch. Because a railroad car typically handled up to forty tons, the Minuteman's heft posed no serious problem. By 1960, a pre-prototype missile car existed, and in January 1961, American Car and Foundry of Berwick, Pennsylvania, built the first prototype Minuteman launch car at a cost of one million dollars. Painted air force blue, the car traveled across America by rail to the Boeing Company in Seattle, Washington, where Boeing's engineers completed the

²³SAC/AFBMD, Minuteman Mobility Report, 16, 20-21.

interior outfitting of the eighty-five foot-long, ten-foot wide, fifteen-foot-high rail car that was no larger than the standard passenger car of the previous thirty years.²⁴

The committee proposed thirteen units in the train, including one diesel locomotive, a fuel tank car for the locomotive, a generator car, a water car, a Pullman sleeper, a diner car, a control car, three missile cars, one missile support car, a general-purpose support car, and a caboose. The train's composition varied over the next three years as the number of missiles per train varied between three and six. The air force made allowances for variations in the support cars as well, but the study established the basic pattern. The committee made no recommendations as to special requirements for the railroad-provided locomotive, although one would expect that locomotives hauling nuclear weapons, a national asset, through remote areas would have to meet higher standards of reliability and maintenance than generic freight engines.²⁵

The missile support car contained checkout equipment and general maintenance supplies, while the general support car contained a jeep or truck and routine supplies. The control car was the nerve center of the air force mission, holding the command and control electronics, communication systems to receive launch orders from higher authority, and a small armory for defense. The caboose, required by Interstate Commerce Commission regulations, was home to the civilian train crew of five to fifteen personnel. Federal regulations required five crewmen, but the air force estimated as many as fifteen might be required, and the total personnel assigned to a task force was set at twenty-two.

²⁴Appearance of missile car from "Transportation Depot Maintenance Division Estimated Cost for Construction of Mobile Missile Train (S-70-61), Utah General Depot, U.S. Army, Ogden Utah, 1960, unaccessioned, unclassified collections. BMO box M-22, AFHRA. Information on construction and outfitting of missile car from "New \$1,000,000 Freight Car Launches Missiles," *New York Times*, January 26, 1961, 37.

²⁵SAC/AFBMD, Minuteman Mobility Report, 17.

This included the five-member civilian train crew, one air force task force commander, three controllers, three communications technicians, two dining stewards, two custodians, three maintenance and checkout specialists (one per missile), two refrigeration and heating specialists, and an administrative clerk. The air force desired three eight-hour shifts each day. During a typical month, a Minuteman train crew would have spent fourteen days on the rails, seven days on rest status, and nine days completing assignments at their home base. The average crewmember could expect to be away from home at least six months out of the year.²⁶

The study group developed five concepts of operation, designated "A" through "E" that varied the balance between train movement, launch reaction time, and ease of operation. Efforts were made to balance the need to move the missiles frequently enough to avoid detection and the need to stop the train to launch the missiles. Complicating matters was that the Minuteman train had to contend with the routine traffic of the railroad, and to be a good partner, the air force could not dominate the nation's rail system. The missiles required known launch site coordinates in their guidance systems before liftoff; thus, to minimize reaction time upon receipt of a launch order, this meant a train had to remain close to a previously surveyed launch site.

Under Concept "A," the study group proposed moving the train 70 percent of the time. The limiting factor was commercial freight and passenger schedules, which required the air force train be immobile 30 percent of the time, or seven-and-one-quarter

²⁶Ibid., 16-19, 57. See also Space Technology Laboratories, "Mobile Weapon System Design Criteria, WS 133A-M (Minuteman), May 19, 1960, 4-6, unaccessioned, unclassified collections. BMO box M-1, AFHRA. The design criteria, submitted by Dr. R. R. Bennett, the Minuteman Program Director of Space Technology Laboratories, an offshoot of Ramo-Woodlridge, won air force approval from Colonel Samuel C. Phillips, the air force Minuteman program director. Phillips had a distinguished air force career that included service as the Apollo program manager after the disastrous 1967 Apollo 1 fire.

hours per day. The advantages of this combination included a “fair” reaction time of no more than twenty minutes and increased difficulty in the enemy’s ability to locate and predict the train’s location after their ICBMs made their thirty-minute flight to the United States. The technological challenge was that missiles would launch from a moving train, a difficult proposition. The image of three Minuteman missiles standing upright inside a railroad car as it rolled down the tracks provides an idea of the problems with this approach. The car would be susceptible to toppling over and required gyroscopic stabilization mechanisms; missile elevation was possible only in areas free of obstruction, and there was the problem with guidance accuracy when launched from a moving platform. The missile needed a yet-to-be invented, train-based computer system to compute the trajectory based on its moving launch platform so that the guidance set could navigate to the target. This required a minimum of twenty minutes, which reduced reaction time. Lastly, the continuous motion of the train (seventeen hours a day) increased wear and tear on the missiles and necessitated expensive maintenance. Overcoming these challenges required a substantial commitment of resources. At best, the committee concluded that the reaction time of this approach offered no significant advantage given the potential disadvantages.²⁷

The second method of operations, concept “B,” paralleled “A” with the train moving seventeen hours a day, but differed in that upon receipt of a launch order, the train stopped and immediately started the launch sequence. This eliminated the stabilization problems inherent in the launch-while-moving concept “A,” but it meant that a computer was still required to compute the missile trajectory from the unsurveyed

²⁷SAC/AFBMD, Minuteman Mobility Report, 22-23.

launch point in order to provide the guidance set with the data it needed for a successful mission. The committee estimated that this process introduced a two-to-three-mile error in targeting, an unacceptable outcome. As a result, the disadvantages outweighed the advantages.

Concept "C" improved system reliability because it reduced the train's travel time to five hours a day, with the remainder of the day spent on presurveyed spurs and sidings that were the launch sites. Under concept "C," the air force consist, minus a locomotive, sat on a spur or siding until a scheduled train rolled by, at which time the air force would hitchhike a ride. The task force suffered from a lack of positive control because it depended upon prescheduled freight and passenger trains, which lessened manpower requirements, but with only twenty-two persons required per train, this savings was dubious. Under concept "C," the air force lost virtually all of the advantages of mobility and depended upon routine traffic for the survivability of its ICBM force. In addition, there was no guarantee that the train crew picking up the air force unit would stop if air force personnel received a launch order. There were too many risks involved with concept "C."²⁸

Concepts "D" and "E" were more realistic. Concept "D," known as the "very mobile" concept, stressed movement. The air force train once again had a locomotive and moved seventeen hours a day, stopping at presurveyed points on the mainline to launch. Launch reaction time was slow because the near-continuous motion of the train meant that extra launch preparations were needed to ensure an accurate strike. The continuous motion made life difficult for Soviet missileers but only at the cost of

²⁸Ibid., 27.

American reliability and reaction time. Making the train an effective weapon system required a better balance of factors that recognized its technological limitations.

Concept "E" improved the balance. Under concept "E," known as the "mobile concept," the train moved on the same schedule as in concept "C" (only five hours a day), but it had its own locomotive and civilian train crew. This provided a "minimum" level of acceptable mobility with the potential for more, and because the train stopped at presurveyed launch points, the air force crew could prepare a missile for launch during the times the train stopped. This decreased reaction time and increased missile availability time so that the missiles were ready for launch 80 percent of the day, meaning that given a 300 missile force, 240 sorties would be ready at any given time. Because the train was motionless most of the day, there was less stress on the missile components, which increased reliability. The disadvantage was that it was easier for the Soviets to locate a train and thus potentially destroy it, but concept "E" was tested in a series of train deployments (without the missile cars) in 1960.²⁹

The air force planned to rely on existing air force bases to provide system and administrative support but realized that special mobile unit support bases were required. Each mobile support base was similar to a railroad yard but was also a stationary logistics support unit with the capacity to support approximately 100 mobile missiles. Arriving trains had eight-hours to provision and refit before returning to the national rail network. Within the support base, maintenance personnel placed missiles into launch cars and made general repairs while crews changed. The support base further duplicated the maintenance capabilities available at a fixed-site Minuteman wing, including changing

²⁹Ibid., 30-31; Byrd, *Rail-Based Missiles*, 19.

missile stages, guidance sets, and bombs, while adding the maintenance of train-unique items such as couplers, brake lines, and wheel sets.³⁰

The study committee recognized that the biggest problems facing air force engineers were missile alignment and guidance. Presurveying a launch point was necessary so that the missile crew had an accurate benchmark from which to ascertain missile azimuth before launch. If a train stopped at an unsurveyed location, then a time-consuming procedure would be required, and reaction time, a major Minuteman selling point, lessened. The committee recommended that a crewmember use a theodolite to sight an illuminated benchmark to provide the offset angle needed to align the missile against true north, an essential step to establish the missile's azimuth trajectory. The air force estimated this process to take five minutes. The study group considered the use of gyrocompasses and inertial navigators to establish azimuth, but both devices cost too much and neither was as accurate as the benchmark and theodolite. By establishing presurveyed locations 10 miles apart over the 600 miles assigned to each task force, each train had 60 presurveyed launch points. Given a speed of thirty miles per hour, this reduced the time needed to reach any launch point to ten minutes or less. If a train was parked at a presurveyed site when a launch order came, this delay was eliminated, and if it was in motion, because five miles was the train commander's decision point, the train merely went forward or backwards to the nearest launch point to arrive within ten minutes.³¹

With azimuth alignment accounted for, guidance became the overriding challenge. Compared to the conditions of the stationary Minuteman missile, the mobile

³⁰Space Technologies Laboratories, Mobile Weapon System Design Criteria, 7.

³¹SAC/AFBMD, Minuteman Mobility Report, 32-34, 38, 47.

environment was harsh. Railroads are not smooth, and it is difficult to cushion heavy loads. Shock, vibration, and handling reduced the life expectancy of the guidance equipment from three years to one. Improved reliability required a guidance set designed for a mobile environment, further complicating a weapon system program that already necessitated a new guidance system for the stationary missile. Computing power limitations were another concern, and if this were not enough, target and trajectory computation differed for each launch site. The air force addressed this by having the train crew use the same presurveyed benchmarks used for azimuth determination as its launch sites. With the train stopped at a known location, the data could be loaded into control car's computers for trajectory computation and transfer to the missile. This lessened flexibility, but if one used presurveyed benchmarks to establish azimuth, no greater amount was lost by doing so for site location. The study group had considered but rejected maps and inertial navigators because maps introduced reading errors and an inertial navigator required a three-to-five-hour alignment process with a starting error of 0.7 nautical miles. By launching at a presurveyed site, missile trajectories could be precalculated, stored on tapes, and then loaded into the missile.³²

The SAC-AFBMD study on Minuteman mobility was remarkably complete in its assessment of communications, personnel, and missile support. Not surprisingly, the report stated that by nearly every measure, the mobile units, whether the very mobile version of concept "D" or the mobile variety of concept "E," cost more per missile than a stationary deployment. An estimate of system costs over a five-year period that averaged the initial investment costs of research, development, and procurement with the annual

³²Ibid., 40-43, 45; R. F. Nease and D. C. Hendrickson, *A Brief History of Minuteman Guidance and Control* (Rockwell Defense Electronics, Autonetics: 1995), 1-15.

costs of operating and maintaining the system indicated that a fixed force of 900 stationary Minuteman missiles would cost \$1.256 million per missile, a veritable bargain. The 300-missile mobile force of concept "E" would cost \$2.275 million per missile, and the very mobile force of concept "D" would cost \$3.613 million per missile. The total estimated costs were revealing. Nine hundred stationary Minuteman missiles would cost \$1.13 billion, but a mobile concept "C" force would cost \$682.5 million and the very mobile concept "D" force cost \$1.08 billion. These costs were soft estimates because analysts needed to accomplish more research and development, which would likely increase costs. In a comparison of personnel needed for a 300 fixed versus mobile missile force, the fixed missiles required 1,931 people, but the mobile missile force needed 5,798, which demonstrated that when all support functions were included, mobility required approximately three times as many people per missile.³³

Numerous variables entered into determining the survivability of mobile Minuteman in the face of an attack, including the quality of Soviet intelligence gathering and the style of attack. Would the Soviets attempt an area attack that blanketed swaths of countryside with nuclear detonations or would they attack fixed launch points, key rail nodes, or occupied task force locations? If the Minuteman trains moved frequently enough to overcome the locating, report-back, and retargeting of Soviet weapons, they would defeat any Soviet attempt to hold them at risk. The study group estimated that the mobile force of concept "E" was approximately 70 percent targetable, but the very mobile force of concept "D" was less than 30 percent targetable. Greater mobility and preserving location uncertainty increased survivability. The committee also measured the

³³SAC/AFBMD, Minuteman Mobility Report, 85; Byrd, *Rail-Based Missiles*, 20.

estimated effectiveness of the American weapon based on its reliability, accuracy, yield, reaction time, and the friendly intelligence cycle. Mobile Minuteman was expected to suffer reliability degrade, but lacking hard data, the air force admitted that any reliability figure was “pulled out of the air” and assigned it a value of between .50 and .85, with 1.0 meaning perfect reliability. Because the guidance system was the limiting factor, the expectation was that it would suffer a component failure rate two to three times higher than that expected for the stationary system. The committee finally decided on a reliability of 0.8 for the stationary missiles and .68 for the mobile missiles.³⁴

Using a standard force of 300 missiles, the study estimated the number of stationary and mobile missiles that would survive an attack of between one and 1,200 Soviet ICBMs. Because Minuteman was still nothing more than an idea, these estimates mandated numerous assumptions, one of which was to assign the Soviet intelligence cycle a seven-day reaction. By analyzing a number of scenarios that accounted for the degree of American mobility (concepts “D” and “E”), the ratio of the Soviet attack force to the American force, the relative reliability and available in-commission rate of stationary versus mobile Minutemen, various degrees of hardness for the yet-to-be-built stationary force, and varying degrees of Soviet accuracy, the general conclusion was that the superior deployment mode was a fixed and hardened system. The turning point was when the Soviets deployed enough missiles with warheads possessing sufficient yield to make area bombing practical. Once the Soviets had enough missiles to blanket the American rail lines with 2-5 pounds per square inch of overpressure, they could destroy all 100 Minuteman trains. At that time, train-based ICBMs would lose their military

³⁴SAC/AFBMD, Minuteman Mobility Report, 93-103.

utility. Once the Soviets had the accuracy to destroy underground launch facilities, then the only survivable American missile force would be the SLBM.³⁵

Although the study did not address the SLBM, the conclusion that a fixed system was superior did not bother air force officials. After all, the study's purpose was to indicate the feasibility and not the desirability of a mobile system. It was technically possible, although challenging, to build a mobile system. The biggest drawbacks, compared to a fixed system, were its increased reaction time, cost, and reduced accuracy. Further, once the Soviets had enough missiles to make area bombing practical, mobility lost all of its advantages. Manpower and funding requirements were two to three times greater for a mobile system, which led the committee to slip a recommendation into the last line of the 119-page report: "On the basis of cost and effectiveness a fixed hardened system is preferable."³⁶

While support for the general Minuteman program continued to build, a second SAC-AFBMD study group reported on the feasibility of building a mobile Atlas or Titan I system. This group was even more SAC-heavy than the Minuteman group, consisting of thirteen representatives from SAC and three officers from AFBMD. This group finished its report in December 1958 and compared mobile Atlas and Titan I to mobile Minuteman. Recognizing that a mobile system for Atlas or Titan I would delay fixed-site deployment of these missiles, the committee assumed that rail mobility was preferable to truck or barge systems, inertial guidance was available, and that minimal redesign of the

³⁵Ibid., 104-119.

³⁶Ibid., 119.

current rockets best met air force interests. Considering the size, weight, and intricacy of these missiles, a mobile version proved to be an enormously complex proposal.³⁷

The types of railcars were the same as those proposed for the Minuteman, but with major differences in missile handling and support. The Atlas train required two cars for the missile, one to carry the rocket and a separate car for the erector. The Atlas also had to remain pressurized lest it collapse. The Titan I required two cars, one for each stage because the Titan's first-to-second stage joint was not strong enough to withstand continuous rail transport. To erect the missile, it was necessary to join the stages and then raise it vertically for fueling and launch. Additionally, both rockets required more than 15,000 gallons of RP-1 and more than 18,000 gallons of liquid oxygen, which had to remain cold so that it would not boil away, plus the associated pumping gear. In a field environment, contamination was a concern because the potential for debris to enter fuel and liquid oxygen lines was high. A contaminated line might clog during flight and lead to the explosion of the rocket, which if it happened near the train, would be catastrophic. A one-missile train required twenty-one cars, a two-missile train needed twenty-nine cars, and a four-missile train required fifty cars. The advantages of a solid-fuel rocket starkly stood out in comparison because its operational requirements were significantly less complex than those for Atlas or Titan were.³⁸

Missile alignment and guidance presented the same problems as Minuteman, but Atlas and Titan were radio-guided, and that type of guidance would not work in a mobile system without a nationwide radar and transmitter network; new inertial systems were

³⁷SAC/AFBMD, "Atlas/Titan Mobility Report, December 1958" 1-15, unaccessioned, unclassified collections. BMO box J-2, AFHRA.

³⁸Ibid., 14-28.

required, but these were already under development. Other problem areas were environmental control, including shock, vibration, launch acoustics, and contamination; modifying the missile structure; flame deflector design; fluid transfers; all of which equaled poor reliability, which the committee initially projected as 35 to 50 percent, with an improvement to 50-60 percent in 1965. Needless to say, these were dismal estimates.³⁹

The study group prepared three operational concepts for the Atlas and Titan I, each of which adjusted the variables of movement and stationary time against expected reliability and survivability. The less the train moved, the more reliable the rocket but at the cost of less survivability. Using presurveyed sites lessened the time needed for missile azimuth alignment and guidance data upload, but reaction time from receipt of a launch order to liftoff varied from three hours for a moving train to a minimum of forty minutes. Using the same assumptions as in the Minuteman study, the air force projected higher costs for fifty mobile Atlas and Titan missiles than for the 300 Minutemen. Fifty mobile Atlas missiles cost \$1.24 billion, and the same number of mobile Titans cost \$1.32 billion, whereas 300 mobile Minutemen cost between \$682.5 million and \$1.08 billion, depending upon the operational concept selected. Cost, ease of operation, and practicality favored Minuteman. The mobile Atlas died on the report's final page where the committee recommended that any mobile ICBM should derive from an entirely new system--an obvious reference to the Minuteman. Thoughts on mobile Titan lingered until March 1960 when air force General Osmond J. Ritland, Schriever's successor as the commander of AFBMD, requested an update on Titan mobility. Colonel Albert J.

³⁹Ibid., 29, 31.

Wetzel, the Titan program director, replied that “while technically feasible to build a mobile Titan system, it appears to have very little wisdom or logic. . . . My recommendation [is] that we not proceed with this development.” Mobile Titan died with that comment.⁴⁰

Two Minuteman Programs

Considering that Schriever had Atlas, Titan I, Titan II, fixed Minuteman, and now mobile Minuteman under development, not counting the space satellite projects he was responsible for, it is amazing how quickly mobile Minuteman accumulated bureaucratic momentum, particularly in light of its own technical challenges. The early problems in the overall Minuteman missile program were propulsion, guidance, and computers. The three-stage, solid-fueled Minuteman required nearly thirty tons of fuel, of which twenty-two were in the first stage, but in early 1959, industry considered a 500-pound solid motor large. It required new ignition and flight control systems, guidance, and a reliable on-board computer, but the missile was not the only element of the weapon system. The basic fighting unit of a stationary Minuteman deployment was the squadron of fifty missiles. Each missile required a hardened, underground launch facility. Within each squadron, five hardened, underground launch control centers controlled the missiles, each with primary responsibility for ten missiles. One launch control center with its ten launch facilities comprised a flight of missiles. All fifty launch facilities and ten launch control centers were interconnected so that redundant underground command lines went to each missile, and any control center could launch any missile within the squadron. Three or

⁴⁰Ibid., 35-41, 46, 69, 75. Colonel Albert J. Wetzel to General Osmond J. Ritland, “Titan Mobility,” March 23, 1960, unaccessioned, unclassified collections. BMO box L-2, AFHRA.

four such squadrons comprised a Minuteman wing of 150 to 200 missiles, but national and air force leadership continually changed the number of missiles Schriever had to produce, along with the funding he needed. The design, construction, and command, control, and communications (C3) integration of such a complex system demanded attention, as did the mobile train task forces.⁴¹

In early February 1959, while it proceeded with developing its stationary Minuteman force, the air force gave preliminary specifications for mobile Minuteman to Boeing, the missile's prime contractor. By the summer of 1959, the popular press had reported on the program in detail. A June 1959 *Missiles and Rockets* article reported that when asked if whether the air force's mobile missile program was a "countermeasure" to the Polaris, Schriever replied, "No. We are just getting tired of being accused of having our feet set in concrete." By this time, the composition of the rail system had evolved into a fifteen-car train with six missiles. The American Association of Railroads estimated the total expected cost of converting civilian railcars for military purposes, not counting the missiles but including a \$250,000 locomotive, at \$1.25 million, which compared favorably to the \$2.7 million needed to buy a twin-diesel, thirteen-car luxury streamlined passenger train. By November 1959, General White, the air force's chief of staff, added his voice in support of a mobile ICBM by stating that "it will be entirely feasible to deploy Minuteman missiles on railroad cars." In April 1960, the air force issued a revised set of design criteria. The planned force structure now included ten squadrons comprised of ten mobile units, each containing one to five missiles. The train-based missile was to be identical to the fixed-site missile, with a CEP of 1.5 nautical

⁴¹Reed, *U.S. Defense Policy*, 84-85.

miles. For a train in motion, the air force specified a reaction time of one hour or less, but when a train was parked and the missiles in a strategic alert configuration, defined as the missile and launch facilities ready to begin the launch sequence, the reaction time was the same as for the fixed force--an astonishing one minute.⁴²

SAC headquarters wanted train movements to appear random, and the concept of operation was the same as that of the mobile concept "E" of the initial study report, but the air force retained the capability to exercise the very mobile provisions of concept "D." Trains were capable of launching missiles individually, and the entire mobile force could launch sequentially to avoid exposing any unused missiles. The trains carried a library of targeting information necessary for all launch positions on their assigned stretch of track, which allowed the missiles to maintain the same target, regardless of the launch site. At any given time, a portion of the operating mobile units would be relocating while other trains were at varying degrees of alert readiness at presurveyed launch sites, which balanced well survivability, mobility, and response time.

Within the Minuteman development community, concerns emerged over resource conflicts between the hard and dispersed Minuteman and the mobile version. In June 1959, Louis Dunn of Space Technology Laboratories, sent air force General Osmond Ritland, now in charge of AFBMD, a memorandum that voiced concerns over the proposed schedule. Dunn, a former director of the Jet Propulsion Laboratory, believed that AFBMD had jeopardized the Minuteman program by directing the concurrent development of both the underground and train-based missiles, leading to an overly-

⁴²William E. Howard, "Minuteman Rail Concept Pushed," *Missiles and Rockets* 5 (June 1, 1959), 19-20; Byrd, *Rail-Based Missiles*, 22. General White quoted in Carl Berger, *History of the 1st Missile Division* (Vandenberg AFB: CA, 1960), 66. Space Technologies Laboratories, *Mobile Weapon System Design Criteria*, 4, 14.

compressed developmental schedule that risked unnecessary failures. Dunn was convinced this was unwise because “the mobile configuration will be in many respects significantly different from the fixed version,” even though the air force planned to use as much common equipment as possible. He clearly believed that the fixed and dispersed system was the priority because the mobile system had so “many technical problems which will face us with the prospect of either making a significant change or alternatively compromising the fixed version in an attempt to provide a dual-purpose function.” When Dunn, a highly respected member of the missile community, stated that he did not believe a “mobile firing could be made before late 1961 or early 1962 without undue interference between the two versions,” he caught General Schriever’s attention.⁴³

In May 1960, Schriever, recently made ARDC commander, directed an ad hoc review of the ICBM program. The Lauritsen Committee, a five-scientist panel that included Cal Tech physicist Charles C. Lauritsen, the chairman who had previously helped Schriever solve a pressure problem in the Atlas’s liquid oxygen system, and Trevor Gardner and Jerome Wiesner as additional members, had Schriever’s blessing to search for problems and speed up ICBM progress. Each of the members was well versed in ICBMs, having served on the original von Neumann committees. They concluded that the air force needed to accelerate the Minuteman program, but the mobile system had enough problems to cause a four-to-twelve month slip, if not more, to the first Minuteman deployments, tentatively set for 1962. The challenges of building a mobile system showed themselves to be tougher than originally anticipated. The committee also

⁴³Louis G. Dunn to O. J. Ritland, “Minuteman Acceleration,” June 22, 1959, unaccessioned, declassified document. BMO document ICBM-4-38, file 13J-4-4-13, AFHRA.

recommended the concurrent development of backups in several guidance and propulsion components and management improvements to Atlas E and Titan I deployment.⁴⁴

Meanwhile, in late December 1959, air force headquarters had approved Hill Air Force Base, Utah, as the home of the first mobile Minuteman squadron, and a second squadron was approved on July 15, 1960. Finally, in December 1960 the air force stood up the 4062d Strategic Wing at Hill and charged it to develop a “combat capability, at the earliest possible date, with assigned mobile SM-80 [Minuteman] forces.” As the engineers sweated the design and construction of Minuteman trains and Schriever worried about building two types of Minutemen, SAC and AFBMD set out to test the trains. In early May 1960, SAC activated a task force and a control center at Hill to control a series of tests, placing Colonel Virgil M. Cloyd, Jr., the former director of operations for SAC’s 1st Missile Division at Vandenberg Air Force Base, California, in command. Cloyd’s mission was to direct the testing of Minuteman trains to validate the operational concepts, including the feasibility of random rail movement over a wide base of deployment and the ability of the railroads to support the mobile missile concept. The air force wanted to confirm the use of rail sidings for parking trains on a random and unscheduled basis and identify any problems with control and communications. To plan future operations, Cloyd also wanted to determine the average speed of movement for mobile units over all classes of railroads, evaluate the factors associated with personnel support, and identify problems in securing the train while deployed. Originally, the air force planned six test train runs but needed only four to satisfy the test objectives. The

⁴⁴Lauritsen Committee Report to Lt. General Bernard A. Schriever Concerning the United States Air Force ICBM Program, May 31, 1960, unaccessioned, unclassified collections. BMO box M-1, AFHRA.

tests, known as Operation Big Star, began on June 20, 1960, and concluded on August 27.⁴⁵

In order to test as much of the national rail network as feasible, four test trains, designated Big Star-1 through Big Star-4, traveled different regions of the United States. The first train left Hill Air Force Base on June 20, 1960, and operated in the Rocky Mountains on a seven-day run. Big Star-2 included six different railroad companies in a 2,320-mile test through Wyoming, Nebraska, Montana, and Idaho. These first two trains did not include a launch car, but the last two trains included a pre-prototype (Boeing had not yet completed the prototype launch car), and a flatcar carrying a Minuteman third stage to test the effects of vibration on solid rocket motors. The trains also included a command car that Boeing modified from a hospital car and quarters and diner cars supplied by the Army Transportation Corps. Also included were a 10,000-gallon water tank car, a 10,000-gallon fuel tank car, and a standard boxcar that housed maintenance spares and a jeep.⁴⁶

Big Star-3 rolled on July 26, 1960, and continued for fourteen days, the length of an actual deployment. This run covered 3,000 miles, involved seven different railroads in

⁴⁵Boeing Airplane Company, "Final Test Report, Mobile Minuteman Train Test Program, December 1960," i, 3-4, unaccessioned, declassified document. BMO document 02054115, file 13J-8-5, AFHRA (hereafter cited as Boeing Mobile Minuteman Report). Strategic Air Command Directorate of Operations, "Final Report of SAC Task Force, Project Big Star, Section IV, Communications, September 10, 1960," 1-2, unaccessioned, declassified document. BMO document 02054407, file 13J-8-5, AFHRA (hereafter referred to as "SAC Mobile Minuteman Report"). See also "Minuteman Ready for Rail Mobility Tests," *Aviation Week and Space Technology* 72 (May 9, 1960): 28-29; SAC Historian, *From Snark to Peacekeeper*, 29; Hopkins and Goldberg, *The Development of Strategic Air Command*, 94; Message from SAC dated July 15, 1960, unaccessioned, unclassified collections. BMO box M-1, AFHRA. *Aviation Week and Space Technology* hereafter cited as *AWST*.

⁴⁶See Byrd, *Rail-Based Missiles*, 29-31 and SAC Mobile Minuteman Report, Section I, Narrative Summary, 2-7, for a description of the four Big Star trains. See also Neal, *Ace in the Hole*, 140-143. Additional information may be gleaned from "Minuteman Ready for Rail Mobility Tests," *AWST* 72 (May 9, 1960), 28-30; "SAC Shapes Missile Force for Survival, Fast Reaction," *AWST* 72 (June 20, 1960), 109; and "Mobile Minutemen to Be Randomized," *Missiles and Rockets* 7 (September 19, 1960), 29-30.

California, Idaho, Oregon, Washington, Wyoming, and Utah. Because the first three tests exercised western railroads, the final Big Star train, Big Star-4, headed east on August 16, 1960, and returned on August 27, 1960. This train traveled to Iowa and Illinois, delivered the pre-prototype launch car to Omaha, the home of SAC, and covered 3,200 miles. General Power, SAC commander, declared that the four tests concluded “a completely successful test program” that provided the information necessary to “make firm plans for future mobile trains.”⁴⁷

Each train deployment tested varying degrees of central direction of train movements and preplanned scheduling. A lesson that SAC learned was that control from a central command post was unsatisfactory. The necessity of informing the railroad and command post where the trains were required extensive communications for even one train, and sixty trains would worsen the problem. If SAC held the trains to a preplanned schedule, communications traffic and workload on train and command post crews would grow as each unit reported its location, status, delays, and the like. Increased communications also lessened security by increasing the chance that the Soviets could monitor the traffic and determine train locations. On the first test train, the administrative duties of the train commander were so strenuous that test officials added an executive officer, first sergeant, and clerk to the crew, which necessitated required further definition of the personnel requirements. As a result, allowing the train commander to control movements without a preplanned schedule but within a designated operating area was the most effective operational concept, an idea similar to SLBM operations. The test team noted that this lessened the pressure on crews, increased security because fewer

⁴⁷General Power quoted in Byrd, *Rail-Based Missiles*, 31.

individuals knew where the train was going, and did not lessen the degree of randomness in train movements.⁴⁸

The most important exercise conducted during the tests measured response times to a simulated launch order. Interpretation of the results was difficult because the trains lacked missiles, operational launch cars, and command cars. Even given the recognition of these limitations, the results were disappointing. During Big Star-3, response times were between twenty-seven and thirty-six minutes. On Big Star-4, the best time was four minutes and the longest was thirty-six minutes, which occurred when the train received a launch order during a crew change. The longer response times resulted from the necessity of having the conductor contact a dispatcher to set the appropriate siding selected by the train commander for the launch site. One suggested solution was to upgrade the train's priority in response to certain defense conditions, but the test team recognized that they needed further research to refine response time estimates. The four test trains averaged twenty-four miles per hour, six shy of the thirty specified in the 1958 study on Minuteman mobility, but the air force accepted this speed. Military personnel proved themselves adaptable to working on trains, and they had no problems with the railroad-supplied crews. Boeing believed that evaluation of security procedures was not possible because the criteria remained inadequately defined but felt that it was possible to utilize some standard procedures associated with nuclear weapons control. Another

⁴⁸Boeing Mobile Minuteman Report, 12-16; SAC Mobile Minuteman Report, Section I, Narrative Summary, 7; Section II, Operational Concept, 1-4; Section III, Command Control, 1-10 and Section VI, Mobile Minuteman Crew Complement, 1-12.

limitation was that the trains operated at a time of favorable weather, so there was no data on winter operations.⁴⁹

When the air force transmitted messages to the trains from its high frequency radios at Hill Air Force Base, several messages went unheard. SAC believed that equipment failures, propagation problems, lack of a distinctive warning tone prior to message broadcast, and the high level of noise in the command car were the culprits, but had this occurred on an operational train, it meant that “a multi-million dollar weapons system, with fast reaction capability, [was] unable to receive the ‘Go to War’ message.” Boeing knew that reliable communications were essential and that those systems had to fit into existing control procedures, and SAC concluded that improved communications were a necessity. Test personnel also discovered that crew report requirements overwhelmed the network dedicated to support functions, as did overvoltages in the deployment control radios, which hindered SAC’s ability to track the trains. While riding the rails, the train crews found that intra-train communications between the train commander, conductor, and engineer were inadequate. The Big Star tests indicated that a reliable communications system for an operational train not only required additional design and development but so did procedures for its use.⁵⁰

The Big Star tests were successful in some important areas. Railroad cooperation was effective, as was the ability to control the test trains, but communications were weak. The air force proved that with the cooperation of several private companies, it could operate at least one missile train on a national rail network and that if given better

⁴⁹Boeing Mobile Minuteman Report,” 5, 20.

⁵⁰Boeing Mobile Minuteman Report, 4-5, 17-20; SAC Mobile Minuteman Report, Section IV, Communications, 1-12.

communications, command and control of these missiles could be effective. Reflecting the fluctuating budget of Mobile Minuteman, the test officials now recommended assignment of five missile cars per train, which meant sixty trains for a 300-missile force. As stated in the Boeing Airplane Company's final report, the "random movement of mobile missile trains over large portions of the United States railway network is feasible," a conclusion with which the air force concurred. Not only was random movement feasible, but the tests indicated that the best method of movement control was when the train's commander determined movements and park sites within a specified operating area. This result might have been a surprise because SAC tightly held the operational reigns of its nuclear missiles; however, it culturally fit with the air force doctrine of centralized control and decentralized execution of its winged assets. An important related conclusion was that to make "control by train commander without preplanned schedule" an effective operational concept, all railroad sidings had to be presurveyed, a conclusion presaged in the air force's 1958 study on Minuteman mobility. Operating sixty trains was a tougher task, but the Big Star tests had developed the rudiments.⁵¹

What would nuclear war have looked like from the perspective of the Minuteman train crew? Fifteen minutes after a Soviet launch, the American government was well aware of the attack and had made its decision: retaliate at once and launch missiles before their destruction. The execution order issued, SAC relayed the alert to all trains as the Atlas and Titan crews ran their countdown checklists, raised, fueled, and targeted their missiles. Bomber crews sprinted to their waiting aircraft as others screamed down

⁵¹Boeing Mobile Minuteman Report," 4; SAC Mobile Minuteman Report, Section I, Narrative Summary, 1-9 and Section V, Missile Train Configuration, 1.

runways. North of Cheyenne, in the Wyoming coal country, a Minuteman train rolled down a quiet track, its General Motors F-unit diesels throbbing. Inside the command and control car, the train commander's head perked up as a message alarm sounded and his partner handed him a launch order, no doubt believing it was another exercise, but this time his day would be different. He directed the train to stop, and after taking ten minutes to travel five miles at thirty miles per hour, stopped at a presurveyed launch point. By now, the crew realized this was no exercise; they were launching live missiles, and the act would be their last. The commander selected the appropriate targeting and reentry vehicle fusing tape from command and control car's library. By now, the Soviet ICBMs had completed their powered flight and their warheads were following precomputed ballistic arcs towards their targets in the American mainland.

The ground crew tested the firing system, positioned the launch stand and blast deflectors, and activated the missile car leveling and stabilization equipment. Assuming the same timing standards for national reaction as Generals White and Smart issued for Atlas in 1955 and 1957, in three minutes the Atlas and Titan force would unleash a volley against the Soviets. Twelve minutes had passed since reception of the launch order, which meant that in no more than three minutes, Soviet warheads would strike the United States. The train commander stared at the analog clock mounted on his status display console, and he waited. Meanwhile, a crewmember used his theodolite to shoot the benchmark and passed the data to the command and control car. At times of great stress, even simple tasks become difficult, but without an accurate siting, the Minuteman would miss its target; the surveyor had to do his job right. Over the next five minutes, the missile car's hydraulic systems fully opened the shelter doors and extended the three

stabilizing legs (all located in a triangular pattern at or near the bottom of the elevated missile). Crewmembers scrambled to connect command and control cables between the command and control and missile cars. The control car transmitted the signal to activate the missile's alignment equipment, and the missile car elevated the missile to the vertical. As the missile elevated, computers transmitted the fuse settings to the reentry vehicle. The missile, elevated inside a support covering, exposed itself as the clamshell casing opened, the launch stand and missile leveled, and the crew manually performed an azimuth orientation of the missile, accurate to within one degree.

The launch crew busily ran checks of the missiles and support equipment. Was everything working? Was the system configured properly? Has the proper target been set? How much time do we have--when do we need to launch? Train personnel prepared for the deafening thunder of not one, but multiple rocket launches. Once launch azimuth calculations were completed, the missiles rotated automatically to their final heading. Approximately seventeen minutes had passed since the launch order. Two minutes earlier, the first Soviet bombs had destroyed their targets. If the attack was against cities, they were gone. Over the next twenty-five minutes or so, computers passed information to the missile, trajectory constraints relayed, and the guidance platform stabilized. The crew evacuated the area around the missile car and the missile attained strategic alert. It was now possible to launch. The commander gave the final order, the crew turned launch keys, and the Minuteman entered terminal countdown. By now, the initial Soviet strike was finished, and the crew, living in a pre-Cable News Network era, had no idea of what had happened. Who attacked first and why? The Minuteman entered the final seconds of its countdown, the first stage igniters fired a tongue of flame through the cast propellant,

and the rocket lifted off. The train crew then attempted to recover its train and move on before any incoming Soviet warheads could destroy it.⁵²

Establishing a Force Structure

The air force could not rest on its laurels because on July 20, 1960, the crew of the submarine *George Washington* accomplished the first launch of a submerged missile, and the navy's Polaris flew flawlessly. The navy was on the verge of an operational system, but the air force had not even flight-tested a Minuteman. In October 1960, after a long funding battle, SAC increased the proposed number of missiles per train to six and lessened the overall number of trains, a move that permitted the air force to save funds for the first fixed Minuteman deployment, which AFBMD had scheduled for October 1962. The first Minuteman finally flew on February 1, 1961, and it was a tremendously successful gamble. For this test, the air force flew the entire missile without any previous flight tests of the subsystems, and it was the first time that a complete missile with all systems operating had an unqualified success on its initial flight. A failure would have devastated the program, but the air force had no choice. The navy had sent the *George Washington* on its first patrol with sixteen Polaris missiles in November 1960. Despite impressive successes, the Minuteman was running behind.⁵³

⁵²Timing and launch sequence for mobile Minuteman based on SAC/AFBMD, Minuteman Mobility Report, 46-47 and Space Technologies Laboratories, Mobile Weapon System Design Criteria. 9-12.

⁵³Neal, *Ace in the Hole*, 158, 164; Perry, "Atlas, Titan, Thor, and Minuteman," in *The History of Rocket Technology*, 158. The "all-up" flight-testing of a complete missile without previously testing major components via a stepping-stone approach was risky, but it saved time and money. The flight testing of a complete missile became an important part of the Apollo program, notably in the testing of the Saturn V launch vehicle. See Ray A. Williamson, "The Biggest of Them All: Reconsidering the Saturn V," in *To Reach the High Frontier*, 318.

In November 1960, the people of the United States elected a new president, Democrat John F. Kennedy. During the campaign, Kennedy set himself apart on defense issues from the Republican nominee, Vice President Richard M. Nixon, by stating that he would recast military capabilities to provide weapons of a “diversity, balance, and mobility” sufficient to deter limited and general aggression. Kennedy charged that the “Communists will have a dangerous lead in intercontinental missiles through 1963,” the Eisenhower administration had no plans to catch up, and that the American-Soviet military position was “measured in terms of gaps--missile gap, space gap, limited war gap.” Although President Eisenhower, by virtue of U-2 spy plane intelligence, did not stress the Soviet ICBM threat and had done a great deal to ensure an American nuclear deterrent lead, the missile gap remained amorphous and difficult to quantify for the electorate. In 1959, one study utilized by Eisenhower Secretary of Defense Neil McElroy predicted a Soviet lead of 1,500 ICBMs to 130 American missiles by 1963, but improved intelligence quickly downgraded this to 500 Soviet missiles to 100-300 American missiles. Kennedy played this undefined missile gap to his political advantage.⁵⁴

Once in office, Kennedy adopted a defense strategy of flexible response. He relied on nuclear weapons as a deterrent, but he would not threaten their use in every possible situation that required military force. To make this a viable strategy, he needed more nuclear and conventional forces and inaugurated a \$17 billion defense buildup, with most of those funds going to strategic nuclear forces. Although the Eisenhower administration oversaw the development of ICBMs and initiated a huge force buildup, only five Atlas ICBMs were on alert at the end of 1960, and no other long-range missiles

⁵⁴Desmond Ball, *Politics and Force Levels: The Strategic Missile Program of the Kennedy Administration* (Berkeley: University of California Press, 1980), 18; Bottome, *The Missile Gap*, 103.

were available besides the thirty Snarks at Presque Isle. By the close of 1963, following the assassination of Kennedy, the air force owned 118 Atlas ICBMs, with 75 of those being the advanced "F" model; 119 Titan ICBMs including 56 Titan IIs possessing storable liquid propellants; and 372 Minuteman missiles, of which 221 were the upgraded "B" model. By the end of 1964, the Minuteman force had 698 missiles on alert, in addition to the liquid-fueled missiles. Concurrency had borne its fruits. Even without accounting for bombers, tankers, reconnaissance aircraft, cruise missiles, warning systems, command and control aircraft, and SLBMs, President Kennedy and his Secretary of Defense, Robert S. McNamara, completed the largest buildup of American nuclear deterrent forces in history.⁵⁵

Early in his tenure, McNamara initiated sweeping financial reforms and defense reviews that demanded cost effectiveness and cost-benefit analyses across the spectrum of DoD procurement, which meant that the capability provided by one service precluded a duplicate role in a second. The reforms culminated with the introduction of the planning, programming, budgeting system, which unified DoD procurement, acquisition, and budgeting and allowed detailed financial analyses of system cost-benefits. The mobile Minuteman program soon discovered what this meant. Kennedy had promised a defense review, and on March 4, 1961, McNamara visited AFBMD and listened to a Minuteman program presentation briefing. One can imagine the importance of this briefing to the air force, the pitchers of coffee and ice water carefully positioned on the conference table, the briefer's mounting tension as the new secretary strode into the

⁵⁵Ball, *Politics and Force Levels*, ix-xx; SAC Historian, *Alert Operations*, 89, 97. For Kennedy's approach to nuclear deterrence and his role in promoting the arms race, see Phillip Nash, "Bear Any Burden? John F. Kennedy and Nuclear Weapons," in *Cold War Statesmen Confront the Bomb*, 120-140.

room, as the stars and eagles gleamed on the shoulders of the generals and colonels eager to impress. The air force knew that Minuteman was its missile future and planned a simple, direct briefing that stressed the key selling points of the missile as an economical means of nuclear deterrence. The briefing provided the basic characteristics of the missile, including its size, number of stages, and state-of-the-art features incorporated since its inception in late 1957. Included among the latter were movable nozzles for thrust vector control to steer the rocket, integrated inertial guidance and control, an on-board computer able to complete all necessary checkouts for the operational missile, an emphasis on reliability and simplicity, and a missile common to the hard and dispersed and mobile deployment modes.⁵⁶

The air force stressed that the fixed Minuteman had a thirty-second reaction time in a strategic alert state, which was an exaggeration because this time represented the terminal countdown of the missile only after a crew commanded it to launch. The briefing made it clear that the reliable, fixed-site Minuteman had a redundant launch control system and was survivable in an underground, hardened shelter. The mobile system possessed "survivability by random movement of trains," and the air force emphasized its sixty-second reaction time from a strategic alert condition. Also highlighted was the successful nature of the test program, but the service admitted some managerial problems including controlling system changes. It was an optimistic presentation based on what was a successfully developing program.⁵⁷

⁵⁶James M. Roherty, *Decisions of Robert S. McNamara: A Study of the Role of the Secretary of Defense* (Coral Gables, FL: University of Miami Press, 1970), 71-88. AFBMD, "4 March 1961 Minuteman Program Presentation to the Secretary of Defense," 1-4, unaccessioned, unclassified collections. BMO box M-2, AFHRA.

⁵⁷AFBMD, "4 March 1961 Minuteman Program Presentation to the Secretary of Defense," 5-13.

Secretary McNamara also received briefings from the navy on the Polaris, which received 14 percent of the navy's fiscal year 1961 appropriations and had provided the nation a survivable mobile nuclear deterrent, even though it lacked intercontinental range. The apprehension the air force felt when briefing McNamara was well founded because he wanted a survivable deterrent; he wanted it as soon as possible, and he did not want to pay more for it than necessary. In a February 20, 1961 letter to Kennedy, McNamara lamented that "our strategic deterrence is almost totally dependent on our bomber force. This force is soft and concentrated. . . . The programmed warning systems and the decision-making part of the alert response are unreliable. Moreover, this posture contributes to the kind of instability which it is one of our objectives to avoid." For bombers to survive, they had to launch upon notification of an attack so that they could fly away from incoming warheads, and McNamara worried that a false alert might provoke an attack. Furthermore, he believed that the existing American ICBMs were unreliable; therefore, he recommended accelerating the Polaris program and expanding the production capability for Minuteman to double its rate of production as a hedge against a mass Soviet ICBM deployment. He believed that doing so gave the administration the future flexibility by 1964 to place 50 percent more Minutemen on alert and he explained, "hardened or mobile ICBMs and Polaris at sea have much greater survival potential in the face of attack than the rest of the force."⁵⁸

On March 17, 1961, Secretary of the Air Force Eugene Zuckert decided to delay mobile Minuteman to insure the early deployment of hard and dispersed Minuteman.

⁵⁸Polaris funding data from Sapolsky, *The Polaris System Development*, 169. See also Robert S. McNamara, "Letter From Secretary Defense McNamara to President Kennedy, Washington, February 20, 1961," in Department of State, *FRUS, 1961-1963*, vol. 8, *National Security Policy* (Washington, D.C.: Government Printing Office, 1996), 40, 41, 45.

Zuckert's decision presaged President Kennedy's March 28, 1961, special message to Congress in which he presented his defense program. Kennedy stated that Polaris had "a very high degree of mobility and concealment, making it virtually immune" to attack and that Minuteman would play a "major role in our deterrent force," but he deferred the currently funded three mobile Minuteman squadrons and replaced them with three fixed squadrons. From an air force perspective, the greater the number of Soviet ICBMs, the better the chances of building more Minutemen, but in June, a recently completed national intelligence estimate provided that in mid 1961, the Soviets had "fifty to one-hundred ICBM launchers, together with the necessary operational missile inventories and trained crews," and estimated that 200-400 Soviet ICBMs was the best guess for 1964. The navy believed that no more than 300 would be available for that year, but the air force disagreed. Its Assistant Chief of Staff for Intelligence believed that by then the Soviets would have 850 ICBMs. These disparate estimates made force sizing a near-impossible and frustrating task for McNamara. It was a challenge to develop a rational defense package amidst such uncertainty, but the secretary had made one thing clear: hardened ICBMs and Polaris helped him provide a stable and secure American deterrent.⁵⁹

A September 21, 1961, intelligence estimate further lowered the number of Soviet ICBMs to ten-to-twenty-five launchers and stated that by mid-1963, they might have as many as 125 missiles. It allowed that "the low present and near-term ICBM force level probably results chiefly from a Soviet decision to deploy only a small force of the

⁵⁹"Text of President Kennedy's Special Message to Congress on Defense Spending," *New York Times*, March 29, 1961; "Plan for Missile on Rails Killed in Favor of Underground Sites," *New York Times*, December 14, 1961. "National Intelligence Estimate, NIE 11-8-61, Annex C, Washington, June 7, 1961," in *FRUS, 1961-1963*, vol. 8, 93, 94, 100, 101.

cumbersome, first generation ICBMs, and to press the development of a smaller, second generation system.” Two days later, McNamara downsized his Minuteman force to 900 hard and dispersed missiles by 1967, 1,000 at the end of 1968, and capped the number at 1,100 thereafter. For the same years, the air force wanted 1,200, 1,700, and 2,300 Minutemen. McNamara allowed the purchase of fifty mobile Minuteman for 1963 but capped the overall force size at 100 (the air force wanted 300). The navy had desired 160 Polaris missiles but had to make due with ninety-six. McNamara defended his position on mobile Minuteman by declaring it “a hedge against our being heavily outnumbered by the Soviet ICBM force, a low Soviet CEP, or unexpected failure of the hardened Minuteman to meet estimated blast resistance. . . . It would also serve as a hedge against unexpected advances in Soviet anti-submarine warfare capability that would reduce the security of Polaris.” McNamara had accepted the hard and dispersed ICBM and an SLBM force as essential elements of a nuclear force posture but thought of train-based ICBMs only as a hedge, and if the need for that hedge evaporated, so too would mobile Minuteman.⁶⁰

On September 26, 1961, an air force team briefed McNamara and recommended that he approve a reduced program yielding the first operational train by July 1962 and a sixty-train force before December 1966. The air force promised a CEP between 1.0 to 1.4 nautical miles (fixed-site Minuteman had an estimated CEP of .74 to .91 nautical miles) and a reaction time of thirty minutes, compared to fixed-site Minuteman’s one minute. To what would have been the chagrin of the crews, the briefing stated that the

⁶⁰National Intelligence Estimate, NIE 11-8/1-61, Washington, September 21, 1961,” in *FRUS, 1961-1963*, vol. 8, 132; Robert S. McNamara, “Draft Memorandum From Secretary of Defense McNamara to President Kennedy, Washington, September 23, 1961,” in *Ibid*, 138-141, 151.

trains were capable of three-month deployments, comparable to submarine cruises. Hardware deliveries included a missile car, command car, and a power car, along with their pre-prototypes, and various pieces of missile and ground equipment. Plans through the end of 1961 included improved guidance, maintenance facilities, and additional deliveries of rolling stock. To meet the revised schedule, the air force requested \$92.5 million in fiscal year 1962 and \$290.2 million for fiscal year 1963. To bolster its case, the service stressed the launch and targeting capabilities of the system, which was a delicate balance because the service could ill-afford to weaken its case for the fixed Minuteman.⁶¹

A November 1961 special intelligence estimate suggested that the USSR “will have an ICBM force of several hundred operational launchers in the period 1964-1967,” along with a bomber force and an expanding SLBM force. Based on the downward trend of numbers of Soviet ICBMs, Carl Kaysen, Kennedy’s Deputy Special Assistant for National Security Affairs, told the president that McNamara’s proposed forces were too large, arguing that McNamara’s staff had based its conclusions on conservative targeting estimates that failed to account for theater nuclear forces, and Kaysen recommended cutting Minuteman by 150 missiles beginning in 1965. One week later, Seymour Weiss of the State Department noted that certain theater nuclear weapons would receive increased budget authorizations to “offset the loss of the mobile Minutemen program.” Subsequently, Kaysen sought to eliminate mobile Minuteman and on December 9, recommended so to Kennedy; McNamara agreed, but he wanted to compensate for the

⁶¹AFBMD, “September 26, 1961 Briefing to Secretary McNamara.” unaccessioned, unclassified collections. BMO box M-2, AFHRA; Space Technology Laboratories, Inc., “Accuracies of Air Force Ballistic Missiles (CEP Status Report)” (Los Angeles: February 1, 1960), unaccessioned, unclassified collections. BMO box J-3, AFHRA.

loss of the 100 mobile missiles by transferring them into the hard and dispersed deployment. The eventual number of deployed Minutemen was set at 1,000 missiles in underground launch facilities.⁶²

On December 14, 1961, McNamara cancelled the mobile Minuteman program, on which the *New York Times* reported that the air force had spent \$108 million. Based on smaller estimates of Soviet strength and the problems of developing an accurate, rapidly reacting mobile system that duplicated the capabilities of the already-deployed Polaris, mobile Minuteman was extraneous. If given a choice between fixed or mobile Minuteman, the air force, as Zuckert's March 17, 1961, deferment indicated, would have chosen the fixed missile because it offered faster reaction, higher reliability, more missiles, and lower cost per missile. It was also easier to develop, operate, and maintain than the fleet of Atlas and Titan missiles. To stay in the long-range missile business, the air force needed a viable ICBM force, and the air force needed fixed Minuteman more than it needed mobile Minuteman.⁶³

A few actions remained. General Schriever felt that despite its challenges, rail-mobile Minuteman was a viable weapon system that could have deployed in less time than was required for fixed Minuteman. He also believed that the cancellation was an arbitrary action of McNamara, and he faulted the secretary for not foreseeing the day when a large number of Soviet ICBMs could hold a stationary American ICBM force at

⁶²“Special National Intelligence Estimate, SNIE 11-14-61, Washington, November 21, 1961,” in *FRUS, 1961-1963*, vol. 8, 206; Carl Kaysen, “Memorandum From the President’s Deputy Special Assistant for National Security Affairs (Kaysen) to President Kennedy, Washington, November 22, 1961,” in *Ibid*, 210-211; Seymour Weiss, “Memorandum for Record, Washington, November 29, 1961,” in *Ibid*, 221; Carl Kaysen, “Memorandum From the President’s Deputy Special Assistant for national Security Affairs (Kaysen) to President Kennedy, Washington, December 9, 1961,” in *Ibid*, 225, 226.

⁶³“Plan for Missile on Rails Killed in Favor of Underground Sites,” *New York Times*, December 14, 1961.

risk. Mobility could negate a numerical disadvantage, but only up to a point because eventually, the race came down whether an enemy built enough missiles to overwhelm a mobile system's land deployment area. Regardless, the air force inactivated the mobile Minuteman's 4062d Strategic Wing on February 20, 1962 (it was never equipped), and on March 10th, Air Force Chief of Staff, General Curtis LeMay, told General Power, SAC commander, that he supported the cancellation to obtain higher force levels of fixed Minuteman. During this time, the nation realized that the missile gap was not one-sided in favor of the Soviets. By the end of 1962, the United States had purchased 142 Atlas, 62 Titan, and 20 Minuteman missiles, but of these, on December 31, only five Atlas and forty-eight Titans were on alert, accompanied by 625 bombers. The Soviets, according to press estimates had 75-100 ICBMs, but the actual number consisted of six R-7s and thirty-two R-16s. Khrushchev's empty threat to bury the United States had turned into Kennedy's very real ability to dominate the Soviets.⁶⁴

⁶⁴Schriever's recollection from an interview Byrd conducted on May 14, 1990, and by this late date, General Schriever had advised Secretary of Defense Caspar Weinberger on how to base the MX missile. One wonders whether Schriever's later experience unfairly influenced his comment about McNamara's lack of foresight. See Byrd, *Rail-Based Missiles*, 38-40. Information on the 4062d from Hopkins and Goldberg, *The Development of Strategic Air Command*, 103; General LeMay's reaction from Shaw and Sirmons, *On Steel Wheels*, vii, 46; American ICBM strength for 1962 from SAC Historian, *Alert Operations*, 87, 97; press estimate of Soviet ICBM strength from Bottome, *The Missile Gap*, 234, and is originally from *The New York Times*, December 20, 1962; data on actual Soviet ICBM strength from Podvig, *Russian Strategic Nuclear Forces*, 136.

CHAPTER 3

CHANGING RELATIONSHIPS AND A TOUCH OF PRESCIENCE

National safety would be endangered by an air force whose doctrines and techniques are tied solely on the equipment and process of the moment. Present equipment is but a step in progress, and any air force which does not keep its doctrines ahead of its equipment, and its vision far into the future, can only delude the nation into a false sense of security.¹

-- General Henry H. Arnold, 1945

Despite the loss of mobile Minuteman, the air force had deployed a significant ICBM force, and its leaders understood that presently mobile ICBMs could not be more than concept studies. Using the experience gained from the train-based Minuteman as a starting point, the service entered a creative ten-year period during which it conducted detailed technical studies, which later influenced several new mobile ICBM proposals. Although the air force had yet to finish building its complement of missiles, the president had set the structure of the American nuclear deterrent force, ultimately consisting of a strategic triad composed of aircraft and land and submarine-based missiles. The air force operated the long-range bombers and underground-based ICBMs, while the navy owned the mobile SLBMs.

Changing Relationships

By 1961, the rivalry between the air force and the navy paled in comparison to the struggle between the services and the Secretary of Defense, a struggle to which clashing

¹General Arnold is quoted in Werrell, *Evolution of the Cruise Missile*, 1.

leadership and management styles had contributed. Given his business background and the grafting of systems analysis onto the DoD, McNamara approached planning nuclear policy and force structures as “the ultimate intellectual exercise, part pragmatic, part theoretical.” In his vision, mathematical calculation replaced wartime experience. Analysts such as Alain Enthoven, who played a key role in McNamara’s nuclear planning, believed that “in sharp contrast to most other types of military requirements, those for strategic forces lend themselves to calculation.” He summarized the problem of determining the nuclear force structure as one “of finite dimensions, measurable in terms of the number and type of weapon systems required to do the job under various sets of conditions.” The air force’s World War II bomber culture faced a new breed of civilian leader and manager, which meant that the future of mobile ICBMs depended upon the policy of Kennedy and McNamara and what type of weapons the analysts said best met national needs.²

One of the lessons that Kennedy and McNamara drew from the 1962 Cuban Missile Crisis was that the American nuclear war plan, the Single Integrated Operational Plan (SIOP), lacked flexibility. McNamara had already begun a review of nuclear war planning in early 1961, and his February visit to SAC headquarters at Offutt Air Force Base, Nebraska, was cause for distress when he witnessed command and control problems. The failure of a SAC unit to acknowledge a test message sent from headquarters upset him, as did his discussions with the SAC commander, General Thomas Power. McNamara felt that not only was the SIOP inflexible but that Power had

²Henry L. Trewhitt, *McNamara* (New York: Harper and Row, Publishers, 1971), 109. Alain C. Enthoven and K. Wayne Smith, *How Much is Enough: Shaping the Defense Program, 1961-1969* (New York: Harper and Row, Publishers, 1971), 176.

made a “stupid statement” about the amount of collateral damage that would result from its execution. Power’s admission of the necessity for improved targeting options also upset McNamara, who believed air force leaders had not done their job. In September, General Maxwell D. Taylor, Kennedy’s military representative, summarized the SIOP as a rigid and “blunt instrument” whose “tactics almost make certain . . . that [the] enemy will be able to launch some weapons.”³

The two sides did not understand each other, a dynamic that had significant implications for ICBM development. General Thomas White, the air force’s chief of staff, summarized the feelings of many military leaders when he stated (after his retirement) that, “I am profoundly apprehensive of the pipe-smoking, tree-full-of-owls type of so-called professional defense intellectuals I don’t believe a lot of these often over-confident, sometimes arrogant young professors, mathematicians and other theorists have sufficient worldliness or motivation to stand up to the kind of enemy we face,” which was a long way from Hap Arnold’s appreciation of what he amicably called his “long-haired professors,” such as von Karman and von Neumann, men who had fought against horrific enemies. An older generation of flying combat veterans who used their personal experiences to prepare for war now encountered leaders whose military experience was nil, significantly less, or at a much lower level of responsibility. To the old warhorses, war meant the massive application of force at the earliest opportunity, and

³“Memorandum From the President’s Military Representative (Taylor) to President Kennedy, September 19, 1962,” in *FRUS, 1961-1963*, vol. 8, 129. Ball, *Politics and Force Levels*, 119.

its preparation was art and science, but to the systems analysts, war was a mathematical problem of surgical precision in which economy and flexibility were equally important.⁴

By the middle of 1961, McNamara had made his influence felt upon SIOP planning, and although changing the plan would take some time, he clearly believed that by late 1962, the air force would have the modifications done. He underestimated the inertia inherent to new bureaucratic processes such as the Joint Strategic Target Planning Staff, a one-year-old body through which the air force and navy assigned their nuclear assets to targets. The targeting staff had to coordinate targets with each service's lower-level commanders and that process took time, meaning that new planning guidance could not be developed into a war plan without time-consuming staff work. In 1960, the SIOP had required the delivery of all warheads in one massive attack, providing little flexibility in response, and to remedy this, defense department planners produced a revised set of targeting guidelines from which the targeteers could improve the war plan. By the early spring of 1961, McNamara had approved the new guidelines, which had a number of novel features designed to provide the president with attack options other than the total destruction of Soviet society, which invited a comparable response. These included: targeting the Soviet Union separately from its satellite countries or China; separating Soviet strategic forces from cities on target lists; withholding a certain segment of the American nuclear force as a reserve; protecting American command and control systems to ensure positive control of forces during war; and preserving Soviet command and

⁴White quoted in Arthur Schlesinger, Jr., *A Thousand Days: John F. Kennedy in the White House* (Boston: Houghton Mifflin Company, 1965), 319.

control (at least at the outset) to provide them with a means of surrender. From these guidelines, planners developed new attack options.⁵

In priority order, the new plan incorporated five main options for attacks, including: Soviet nuclear forces; air defenses protecting against bomber attacks; air defenses near cities; command and control systems; and an all-out attack. The prioritization engineered by McNamara's "whiz kids" called first for counterforce attacks, that is, attacks on Soviet missiles, submarines, and bombers, which demanded accurate weapons capable of penetrating Soviet defenses. To aid this, McNamara planned separate attack options against air defenses along American bomber routes and those protecting Soviet cities. Suppressing the defenses along the attack routes aided the bombers that would perform a counterforce mission. The SIOP planners gave Kennedy flexibility by separating the all-out attack from various types of counterforce options. On May 5, 1962, at a secret meeting of NATO ministers in Athens, Greece, McNamara stated that in the event of a nuclear war, America's principal objective "should be the destruction of the enemy's military forces while attempting to preserve the fabric as well as the integrity of allied society," and a month later, on June 16, 1962, at Ann Arbor for the University of Michigan's commencement exercise, he asserted that the reason for a counterforce strategy was to give "a possible opponent the strongest imaginable incentive to refrain from striking our own cities." The administration believed that American

⁵A superb discussion of SIOP evolution is Desmond Ball, *Targeting for Strategic Deterrence* (London: The International Institute for Strategic Studies, 1983), Adelphi Papers no. 185. For Ball's discussion of the early Kennedy-McNamara SIOP, see pages 10-15.

willingness not to target cities equated to Soviet willingness to do the same but left unanswered was whether the Soviets agreed.⁶

Counterforce was an attempt to place analytical precision on a process that was not completely analytical, and this caused confusion. Destruction of hardened military targets such as an ICBM launch facility required a balance between accuracy and yield, but because the accuracies of the era necessitated relatively high-yield weapons, collateral damage was likely, which undermined McNamara's desire to limit damage to Soviet and American cities. For example, if an airstrip was long enough to land Soviet bombers, it was a logical target, but what if that airstrip was located in the middle of a city without an associated military base--was it still considered a counterforce target? In World War II, the air force did not hesitate to attack war-related urban industries such as the Ploesti oil fields or Schweinfurt ball bearing factories, but now such targets were questionable. Buried deeply in the debate was an unspoken reality of nuclear war technology, that is, regardless of the type of target or the accuracy of the delivery system, if the target was collocated with an urban population center, designation of the ground zero as a "counterforce target" was meaningless because the weapon's detonation would wreak havoc with the city.

Policy makers sought to make "a sensible adjustment in our ways of thought to deal with rapid changes in technology and in international circumstances," but the flexibility of the ICBM worked against this. For example, to support the SIOP's assured

⁶"Address by Secretary of Defense McNamara at the ministerial Meeting of the North Atlantic Council, May 5, 1962," in *FRUS, 1961-1963*, vol. 8, 275-276. William W. Kaufmann, *The McNamara Strategy* (New York: Harper and Row, 1964), 115-120, reproduced a large segment of the Ann Arbor speech; page 116 contains the quoted passage. Ball, *Politics and Force Levels*, 191; Peter Pringle and William Arkin, *SIOP: The Secret U.S. Plan for Nuclear War* (New York: W. W. Norton and Company, 1983), 101-126, particularly 116 and 121. See also "Paper Issued by the Joint Chiefs of Staff, undated," in *FRUS, 1961-1963*, vol. 8, 181-187.

destruction option, missiles targeted against Soviet cities provided deterrence in a countervalue role by assuring the destruction of Soviet society. If, however, the planners targeted the missiles against Soviet ICBMs, the missiles clearly had a counterforce role that the Soviets could interpret as a first-strike mission to eliminate their ability to destroy American society, which undermined the presumed Soviet policy of deterrence. Because the other side had no way to know what its rival had planned, understanding intentions was as important as capabilities. In addition, new guidance sets and flight control systems offered improved accuracy, making definitions hazier. A planner could use a highly accurate weapon to destroy an area target such as a city just as easily as he could to destroy an ICBM launch facility or command and control bunker. If the target was in or near a city, then one warhead fulfilled both roles. Furthermore, if rapid, remote retargeting of missiles from their launch control centers became possible, national leaders could reconfigure their ICBM forces from countervalue to counterforce roles with a few flicks of some switches. Technology overwhelmed doctrinal distinctions.⁷

According to George Reed, the air force misinterpreted counterforce by focusing on numbers and types of weapons and not as part of a broader political strategy, and the climate of poor relations between the service and McNamara's office contributed to the misunderstanding. Thus, counterforce became a bureaucratic buzzword lacking precise definition but was "grafted upon our whole strategic body of doctrine." McNamara had sought counterforce capability to add flexibility to nuclear war planning, but any flexibility gained was in the eye of the beholder. The combination of traditional air force targeting and McNamara's own decisions contributed to the confusion. For example, in

⁷Kaufmann, *The McNamara Strategy*, 244; Enthoven and Smith, *How Much is Enough*, 172-184.

September 1961, McNamara projected a list of top-priority targets that included 200 “urban-industrial aim points,” but these were city targets that would have invited a comparable Soviet counterattack; thus, although he desired a “no cities” strategy, he continued targeting urban centers, which was the opposite of the directions he gave the military chiefs. If the political basis of the counterforce targeting policy was to avoid unnecessary civilian casualties, American leaders asked too much because nuclear weapons could not execute such a policy. Even if accurately placed on target, high yields are anything but precise, although they will destroy. Over the next two decades, American presidents increasingly desired improved counterforce capabilities, which became critical to subsequent missile programs and arms control treaties.⁸

By heavily outnumbering Soviet forces, the United States theoretically could attack first, using accurate counterforce weapons to destroy Soviet retaliatory forces and win the war. A pure counterforce strategy destabilized an already delicate situation, but charges of planning first strikes were a bit disingenuous because effective ballistic missile defense was impossible; therefore, any ICBM was a potentially indefensible first strike weapon. Thus, despite the new attack options incorporated into the SIOP, the Kennedy administration quickly moved away from a pure counterforce strategy and back towards assured destruction. In the end, admitting that no one strategy sufficiently encompassed the vagaries of nuclear war, the United States combined the strategies of counterforce and assured destruction with a high-level of finite deterrence. The United States would have the capability to destroy enemy nuclear forces, but it also needed assurance that should

⁸“Draft Memorandum From Secretary of Defense McNamara to President Kennedy, September 23, 1961,” in *FRUS, 1961-1963*, vol. 8, 143. Reed, *U.S. Defense Policy*, 177-178; Perry, *Ballistic Missile Decisions*, 20-23.

the Soviets launch a successful first strike, the United States would retain sufficient forces to destroy and thus deter its enemy.⁹

TOUCHES OF PRESCIENCE

If the political leadership of the United States had a hard time coming to grips with the implications of counterforce strategy, the services responsible for acquiring the weapons to implement the strategy also struggled. It takes time for leaders to understand the implications of developing technologies because the relationship among strategy, policy, and weapon system capabilities is symbiotic. Ideally, strategy drives policy development, which in turn supports the procurement of weapons with the capabilities to achieve strategic goals. Given the long lead times required to investigate, test, and develop new technologies into deployable weapons, this is often not the case. When technological development accelerates, a gap between capabilities and policies may result, and by 1965, Secretary of the Air Force Eugene Zuckert believed that missile technology had caused such a gap. He commented that "I think at the moment we are in a little bit of what might be called technological shock because the missile development has come upon us and come to fruition so quickly the people have not really had the time to digest this situation." In the case of counterforce and nuclear weapon delivery systems

⁹See Ball, *Targeting for Strategic Deterrence*, 112-113 for an analysis of changes in American targeting strategy. Ball, *Politics and Force Levels*, 196-197, provides additional analysis of McNamara's shifting strategic thinking. Trewhitt, *McNamara*, 123, casts the evolution of American strategy in the context of weapon system procurement decisions.

development, it appears that emerging technological capabilities preceded policy development. The mobile ICBM illustrates this.¹⁰

In 1959, two years before Minuteman's first successful flight in 1961, AFBMD investigated the concepts of counterforce targeting and flexible response. AFBMD Commander General Osmond Ritland's advanced planning office had studied the future of ballistic missiles and concluded that "missiles have caused another revolution in that the enemy's missile force represents an entirely different class of targets that we must threaten," which is a clear statement of a pure counterforce strategy and is all the more noteworthy because it came from the organization building a missile force dedicated to destroying cities. This showed that, despite the conflict between military and civilian leadership, an important element of the air force missile community sought to address the same counterforce problems that McNamara had identified when he became secretary of defense two years later.¹¹

For example, in 1959 AFBMD addressed both offensive and defensive counterforce, that is, what a weapon system needed to destroy Soviet missiles and to survive an enemy attack. Here the mobile ICBM entered into the air force's shift to counterforce targeting. The advanced planners based the military effectiveness of an ICBM upon its survivability and destructive potential, that is, its defensive and offensive capabilities. They linked the survivability that mobility provided with increasing accuracy and blueprinted an outstanding first-strike weapon. During the debate on the

¹⁰For a discussion of the strategy-policy-procurement cycle, see Richard J. Stoll, *U.S. National Security Policy and the Soviet Union: Persistent Regularities and Extreme Contingencies*, Studies in International Relations, ed. Charles W. Kegley, Jr. and Donald J. Puchala (Columbia, SC: University of South Carolina Press, 1990), 99-118. Secretary Zuckert quoted in House Committee on Appropriations, *Department of Defense Appropriations for 1965, Part 4*, 88th Cong., 2d sess., 1965, 479 (hereafter referred to as *DoD Appropriations for 1965, Part 4*).

¹¹AFBMD, "Future for Ballistic Missiles," unnumbered page.

mobile Minuteman, the air force stressed the survivability of the weapon but ignored its accuracy shortcomings. This was a factor in its cancellation because the navy already provided a mobile and survivable alternative, and hard and dispersed Minuteman provided a large missile force with sufficient accuracy to diversify targeting. If mobile Minuteman was significantly more accurate than its underground counterpart, it might have survived McNamara's budget axe because it would have possessed the survivability and accuracy commensurate with flexible response. Had that happened, hard and dispersed Minuteman would have become a smaller program. Regardless, many of the ideas that AFBMD investigated became reality in subsequent versions of the Minuteman and even resurfaced during debates in the 1970s and 1980s on the Missile-X (MX) ICBM. They presaged elements of what Secretary McNamara wanted in a weapon system designed to support flexible response.

AFBMD correctly concluded that missiles used in a counterforce role required larger numbers of warheads than missiles targeting cities. The reason for this was that a target such as an underground launch facility was, at a minimum, protected by hardened concrete and steel, which resisted nuclear blast, shock, and overpressure. To use a Minuteman, which carried only one warhead, to destroy such targets required several missiles because the early Minuteman's accuracy and yield did not permit the application of one warhead per target. To ensure target destruction, a counterforce planner had to assign multiple warheads against protected military targets. Accuracy was important to threaten hard targets because it translated into smaller nuclear blasts, an important consideration if one wanted to control a war's escalation. Indiscriminate high yields caused more collateral damage, which was a political liability, and AFBMD presciently

identified accuracy, smaller yields, and the economical application of weapons as important elements of counterforce warfare.¹²

Other important weapon characteristics that AFBMD identified were the ability to hold mobile targets at risk, penetrate active and passive defenses, and perform rapid retargeting of missiles. Planners desired “a hunt and kill capability . . . to challenge hidden and mobile targets. . . . Penetration aids will be necessary as he [the Soviet Union] develops an active defense capability.” Penetration aids similar to the chaff used by aircraft could confuse enemy radars and antiballistic missiles. AFBMD also asserted that rapid retargeting of American missiles was necessary so that in the event of a Soviet launch, the missiles previously dedicated to destroying the incoming Soviet missiles could be retargeted so they were not wasted in attacks against empty launch facilities. Rapid retargeting had another benefit. As AFBMD observed, “the ability to retarget rapidly broadens the spectrum of possible wars in which the system is effective,” and this meant that “even systems primarily designed for counterforce should adopt to a degree the requirements of retaliatory systems.” The implication is that retargeting capability increased a weapon’s flexibility, particularly if it could serve as a second-strike weapon that survived an enemy attack. The advanced planning office considered mobility important to survival but stated plainly that mobile Minuteman was not the answer.¹³

The advanced planners considered four classes of ICBM deployment, including mobile missiles, superhardened missiles, large missiles, and more hardened and dispersed Minutemen. The large missile concept is not important to the history of mobile ICBMs because it emphasized not mobility, but a large Atlas or Titan-sized missile capable of

¹²AFBMD, “Future for Ballistic Missiles,” 17.

¹³Ibid.

heaving a wide variety of payloads. The other concepts are significant. Beginning with the mobile missiles, AFBMD examined land, air, and water-based deployments. As indicated in the 1958 mobility studies, problem areas included missile size and transportability, command and control, guidance, and cost. Despite that in 1959, when AFBMD wrote this report, the air force had heavily invested in the fight for mobile Minuteman, AFBMD's advanced planners stated that it was ill suited to a mobile role. It was "sized and developed primarily for [the] hard and dispersed concept," and its solid-fueled engines were a disadvantage to mobility because they were temperature and shock sensitive, heavier than an equivalent storable liquid and possessed a limited roll capability. The latter meant that planners had to select targets carefully because guidance platform, computer, and rocket engine directional control limitations meant that it was possible to assign a Minuteman against a target to which the guidance system could not align or the flight controls could not direct the missile. If this happened, the warhead missed, and the enemy target survived. In light of what the service had said in support of Minuteman production, these were heretical views.¹⁴

As with the first generation of ICBMs, propulsion and guidance and control systems were the important factors. Minuteman's solid propellant required environmental protection to prevent the propellant grain from cracking, so the missile cars had to protect the missile from the causes of cracked propellant such as humidity, temperature extremes, and vibrations. Cracked propellant could cause chunking, a phenomenon in which large pieces of unspent solid fuel passed through the engine nozzles and diminished overall performance. These problems increased the complexity

¹⁴Ibid., 27-28, 37.

of missile handling, but the design choice of solid fuel had eliminated the problems associated with liquid fuels; nonetheless, the report authors evidently felt that solid-fuel missiles had operational problems left unemphasized in the current air force debate. Minuteman I had four movable nozzle control units, one each per first-stage engine nozzle, with which to control the missile's yaw, pitch, and roll. Without the vernier engines of Atlas and Titan, this meant that there were limitations to the extent of in-flight azimuth adjustments that the missile could make and retain acceptable accuracy. The Minuteman I could only cope with a specific range of azimuth changes because its NS-10 guidance platform possessed limited rotational freedom. This was one reason why long calibrations and prestored target data were necessary to ensure accuracy. AFBMD noted that the mobile Minuteman's guidance set could only accommodate a single preset target and required six hours to change targets because, as its builders, Rockwell's Autonetics Division, admitted, computer limitations necessitated that "the alignment, calibration, and guidance schemes were rather unsophisticated." When combined with control limitations, Minuteman's shortcomings as a mobile missile became apparent.¹⁵

The added stresses of mobile deployment further degraded accuracy because hardening, which protected the delicate features of the guidance system against the vibrations that mobility incurred, was a weakness of the design. Designed for a stationary deployment in a vertical posture, the gyroscopes of the Minuteman I did not maintain physical contact with a bearing because they floated on a thin layer of gas, comprising what Autonetics called a gas-activated bearing. When these gyroscopes were on their side, such as in a moving rail car, and elevated within the missile a number of

¹⁵Ibid., 28. Nease and Hendrickson, *Minuteman Guidance and Control*, 1-6, 1-15 to 1-16.

times, there was a risk of damage, which lessened accuracy and reliability. Additionally, in a hard and dispersed Minuteman, the gyroscopes spun continuously, which improved launch readiness. In a mobile Minuteman, they only moved when the crew configured the missile for alert or launch, making it necessary to “spin-up” the gyros for a launch. The effect of these requirements (necessitated by a mobile system) equated into lessened accuracy. AFBMD’s future thinkers understood engineering, and they foresaw problems with a mobile Minuteman.¹⁶

AFBMD believed that a new missile with pressure-fed, storable liquid-fuel propulsion was superior (Atlas and Titan had pump-fed and not pressure-fed systems), because this kind of propulsion lent itself to the mobile environment. It would be lighter and smaller than the existing Minuteman or a pump-fed, liquid-fueled missile of comparable capability. AFBMD’s advanced planning office contended that a small missile made handling and transportation so easy that “they allow us to conceive a truck mobile system that is not excessively expensive;” furthermore, predictions for system availability ranged from as early as 1963 to as late as 1965. Pressure-fed propulsion systems were not difficult to build; in fact, for manned spaceflight applications they were preferred because of their reliable simplicity. The major problem was guidance. In a mobile environment, the Minuteman I’s inertial guidance system required time-consuming preparations. To speed system development, the advanced planning office thought that deployment of a truck-mobile system with a “crude guidance system” whose accuracy was improved by outside input and might allow an early deployment. AFBMD explored three sources of outside input including terminal-area guidance, star tracking

¹⁶MacKenzie, *Inventing Accuracy*, 158-159.

inertial systems, and auxiliary radio guidance. Unfortunately, the advanced planners' report did not address the details of stellar tracking or terminal area guidance, but in a case of back-to-the-future, they did explore radio guidance.¹⁷

The proposed radio-guidance system had the advantages of accuracy and adaptability as measured against the disadvantages of availability and vulnerability. AFBMD proposed a variation of a long base line radio guidance system, orders of magnitude greater than that of the early Atlas ICBMs. By using transponders 100 to 150 miles apart, ground stations (perhaps mobile) would measure a missile's range and range rate. Range rate is "the rate of change of range" of one transponder from the interrogating unit, and it is critical to the precise determination of a missile's position. A transponder is simply a device that uses a known frequency in reply to a radio interrogation. By placing the interrogating transponder on the missile, the system would interrogate ground transponders, and based on the returned signal, a computer would calculate the missile's position. Radio signal phase shifts and Doppler frequency changes provided the range rate necessary to compute the missile's exact location, and the missiles and ground stations communicated only during moments of interrogation and reply. There was not a constant stream of radio communication, which reduced the possibility of interference or jamming. To process the data and determine course adjustments, the system needed a computer, which AFBMD proposed could either be on the missile or on the ground. A ground computer could service more than one missile, which saved weight and increased missile performance. Potential problems included radio signal propagation, interference, enemy countermeasures, and signal strength

¹⁷AFBMD, "Future for Ballistic Missiles," 29-30.

degradation as the aspect angle between the rocket's tail and ground stations increased, but AFBMD proposed "divorcing the guidance function from the missile transport and handling function" as a new way to solve an old problem.¹⁸

The planners' superhard concept was a basing mode that protected a missile against 1,000 pounds per square inch of pressure. In comparison, a Minuteman I launch facility was originally hardened to 100 pounds per square inch. They investigated two modes of superhard basing including a slow-reacting, tunnel-based system and a fast-reacting, water-based system. The tunnel-based system used a mobile system stored in hardened, long tunnels. When higher authority needed the missile, it moved out of the tunnel and then launched, which took some time. The water-based fast-reaction system duplicated elements of the hard and dispersed Minuteman. It placed a "ruggedized" missile in a watertight capsule positioned somewhere off the coast and anchored to the ocean floor. By placing the capsule below an unspecified depth, the ocean protected it from destructive shock levels, but it had to be near enough to the surface so that the missile could launch. Upon launch, the missile ejection occurred in a manner that was probably similar to an SLBM, meaning that a gas generator supplied gaseous pressure sufficient to boost the missile out of its canister. Both modes required a small missile of "less than 50,000 lbs."¹⁹

Having reviewed the various deployment modes for future ICBMs, AFBMD reasserted the value of large numbers of hardened and dispersed Minuteman missiles as low cost per missile. The advantages of a numerically large force included "survivability through sheer numbers and a willingness to utilize a fraction of the force in limited

¹⁸AFBMD, "Future for Ballistic Missiles," 20-30.

¹⁹Ibid., 31.

engagements.” Nonetheless, AFBMD stressed desires that Secretary McNamara would come to prefer, including a premium on accuracy to destroy hard targets. Other Minuteman improvements hoped for by the advance planning office were lifting reentry vehicles that could extend their range by using aerodynamic lift, terminal area guidance, and even theater control of a missile once it entered the target area. Some of these ideas never made it past the drawing board, but they illustrate the diverse nature of the air force’s future planning. Most important, the report closed with the comment that “a ballistic missile system designed specifically for mobility is desirable. However, further examination is required to determine the trade-offs between cost of a new development and increased numbers of programmed missiles.”²⁰

As early as 1958, AFBMD had made cost comparisons between mobile and fixed deployment ICBMs. In April 1960, the Advanced Systems Planning and Analysis Directorate, the successor to the office that produced the “Future for Ballistic Missiles” study, conducted an analysis entitled “USAF ICBM Force Mix” to determine the optimum mix of fixed and mobile continental United States-based ICBM forces. Using an estimated American force of 1,000 missiles, the planners discovered that the American force’s survival increased as the number of mobile missiles increased, but that when “a mobile missile cost twice as much as a fixed missile, the mixed force would not be justified even if both missiles were equally effective.” The absence of complete knowledge of the Soviet threat impeded survivability calculations, but AFBMD concluded that “the best force . . . contains 300 to 500 mobile missiles, the remainder being fixed and hard.” Should the enemy obtain a substantial superiority in the number

²⁰Ibid., 38 and “Conclusions,” (unnumbered).

of missiles, the report concluded that overall American missile survivability was so low that mobile missiles made no difference. Thus, given a 1,000 missile force, the eventual size of the Minuteman force, mobile missiles were useful only to a point. Once the enemy had numerical superiority, their utility decreased, but if designers could lower their cost and increase their effectiveness, a mobile ICBM might be useful.²¹

The Golden Arrow of Aerospace

Throughout the development of the ICBM, the air force sought industry's help. General Schriever had used the engineering expertise of Ramo-Wooldridge (which became Thompson-Ramo-Wooldridge or TRW) and later TRW's Space Technologies Laboratory branch to accelerate the development of air force missiles. As the number of space and missile projects blossomed, the company's involvement grew, which created a difficult situation. Other aerospace corporations feared these relationships and the potential misuse of their proprietary information for TRW's advantage, and to assuage these fears, the air force prohibited Space Technologies Laboratory from developing missile hardware. Congressional pressure mounted to ensure fair competition, forcing the air force to create a nonprofit corporation legally designed to provide independent analysis and to advocate air force planning positions within industry. Because it was nonprofit, the new corporation could manage technical risk and ensure a low-cost product without using proprietary information to its advantage. On June 25, 1960, the Aerospace Corporation incorporated in California with several ICBM notables serving in board of

²¹AFBMD, Advanced Systems Planning and Analysis Directorate, "USAF ICBM Force Mix, April 1960," unaccessioned, declassified document. BMO document 02056301, file 13J-4-4-13, AFHRA. The declassified extract does not contain page numbers or chart numbers.

trustee roles, including Charles Lauritsen, Trevor Gardner, and Jerome Wiesner. The new corporation had systems engineering responsibility for several programs, including the air force's manned Dynasoar vehicle, NASA's Mercury spacecraft, and new ICBMs.²²

In 1960, military observers did not anticipate that the hardened and dispersed Minuteman ICBM would remain the nation's primary nuclear deterrent for forty years. The air force expected to replace the Minuteman by the early 1970s, and as the 1960 AFBMD advanced planning study indicated, planners were exploring multiple ideas. Through the sixties, Aerospace investigated new missile concepts, several of which combined mobility with emerging materials technologies. Not surprisingly, Aerospace built upon AFBMD's ideas, and one example of this was a 1961 proposal that placed Minuteman ICBMs on slow-moving barges or ships in the Great Lakes, the Finger Lakes, or coastal waters. Referred to as the "lethargic missile," one might imagine the navy's reaction to this scheme. Another proposed missile utilized a land vehicle possessing off-road capability, but given mobile Minuteman's recent cancellation, these exercises did not exert any budget pressure but served to build Aerospace's internal expertise regarding mobile missiles.²³

On April 21, 1964, the ICBM became the centerpiece of American nuclear deterrence because the number of ICBMs on alert equaled the alert bombers, and the bomber never regained its former status. Less than a decade before, the ICBM languished as a poorly funded program dangerously close to cancellation, but now

²² Aerospace Corporation, *The Aerospace Corporation: Its Work, 1960-1980* (Los Angeles: Times Mirror Press, 1980), 15-23.

²³ Aerospace Corporation, *The Aerospace Corporation*, 134.

service leaders believed it indispensable. Concerned about the future of its new Minuteman ICBMs, the air staff asked Aerospace for a detailed study on ICBM force survivability. Known by the code name Golden Arrow, this study built upon previously circulated concepts and introduced several others, and even though the air force requested the studies, the final reports carried the "circle-A" logo of Aerospace and not the air force's bar, star, and roundel. Minuteman's deployment helped because by the close of 1964, it was a fiscally secure weapon system with 678 missiles on alert, which allowed the futurists to consider new ideas without worrying about endangering current programs. The studies examined land, sea, and air-based deployment modes, and they introduced new ideas, including a comprehensively treated proposal known as the continuous road mobile ICBM.²⁴

Aerospace proposed a force of 200 to 600 road-mobile ICBMs to patrol the continental United States, preferably within lands of low population density west of the Mississippi River. By stationing the missiles in low population areas, Aerospace sought to reduce American casualties by drawing enemy warheads away from cities. A single three-stage, solid-propellant missile rode on a transporter-launcher vehicle, which was assigned a patrol area using the nation's highways. In a significant departure from Minuteman, Aerospace canisterized the missile, which was ejected by gas pressure before first stage ignition. Hardened to ten pounds per square inch, about the maximum possible for a vehicle, the transporter launcher was configured as a tractor-trailer with two men in the cab to drive and two others on the trailer to launch the missile. To prevent "bonus kills," the deployment provided enough mileage and distance between missiles so that the

²⁴SAC Historian, *The Development of Strategic Air Command*, 126. See also SAC Historian, *Alert Operations*, 97.

enemy could not destroy more than one missile with a single warhead. The transporter contained its own ground navigation system that passed launch site coordinates to the missile's guidance set, eliminating the need for presurveyed launch sites and reducing reaction time to thirty minutes. Higher authority exercised command and control through normal channels, but, in the event an attack destroyed ground-based networks, an airborne command post (also desired for the stationary Minuteman) furnished command and control. By integrating the C3 equipment, missile, and launch support equipment onto one vehicle, the transporter launcher provided an advantage that all previous mobile ballistic missiles lacked because it made each missile-launcher combination a self-contained launch base with a minimal crew of four. Much like SAC's bombers, the launchers operated as soloists. For American mobile ICBMs, this was a new consideration because it eliminated the large numbers of people, vehicles, and rail cars associated with previous mobile missile concepts, but like the mobile Minuteman, it used an existing transportation network as its operational patrol area.²⁵

By addressing weight and guidance limitations, Aerospace designed a new missile tailored for mobility, which possessed several advantages over the Minuteman. The new missiles, available in 29,000- and 36,000-pound versions, utilized advanced solid propellants, including beryllium additives, which provided greater power over state-of-the-art propellants because they contained a higher percentage of metal than did standard American solid-fuels. This chemical mixture was a more powerful fuel that increased missile range, payload, and "could result in higher-mass-ratio boosters." Nonetheless,

²⁵Aerospace Corporation, *Golden Arrow Technical Panel Systems Descriptions, Volume II, December 3, 1964*, "Continuous Road Mobile ICBM, December 3, 1964," 1,4, 6, 17, 23, 35, 43, 45, unaccessioned, declassified document. BMO document 02054506, file 13J-4-4-17, AFHRA. Hereafter referred to as Aerospace, "Continuous Road Mobile ICBM." Aerospace, *The Aerospace Corporation*, 134.

the fuel technology (called “thixotropic”) was new, and it involved tradeoffs. One drawback was that it tended to stick to the walls of tanks and fuel lines, a condition that would cause a catastrophic failure. The combined weights of the missile-launcher combinations were 60,000 lbs and 71,500 lbs, respectively, an important consideration because some roads could not handle the weight of the larger missile, restricting its deployments. Both missiles had three stages and were made of filament-wound, reinforced fiberglass plastic. The first stage provided flight control of yaw, pitch, and roll movements via gimballed nozzles (similar to Minuteman I), but stages two and three used liquid injection for steering, which permitted significant refinements to the trajectory and accuracy. The major difference between the two versions was that the heavier rocket had a longer range and could carry a larger warhead or multiple smaller warheads.²⁶

Planning for multiple warheads represented an important element of counterforce targeting because it stressed the need for accuracy. Aerospace’s engineers planned to use a guidance system that was under development for the new Minuteman II ICBM, the NS-17 (an inertial system with “significant, but traceable, evolution from the Minuteman I”), which had a CEP of .24 nautical miles. Furthermore, this guidance set allowed in-flight calibration, which permitted the missile to align to a new target while in flight (although the target had to be selected before launch), eliminated long waits for ground calibrations, and increased flexibility in target selection and assignment. In comparison to the proposed Aerospace missiles, the Minuteman I weighed 65,000 lbs (over 100,000 lbs when in its transport vehicle); its fuel did not use exotic elements; its first stage was made of steel, the second stage of titanium, and the third stage was fiberglass. It carried a

²⁶Ibid., 6-7, 13. Description of thixotropic fuel from Irving Stone, “ICBM Studies Focus on 156-in. Motors,” *AWST* 11 (March 15, 1965), 141-142.

single warhead, had a CEP closer to a nautical mile, could not make significant in-flight trajectory adjustments, and had limited flexibility for changes to assigned targets. It was road-transportable but not road-mobile. The proposed missiles capitalized on advancements, actual and predicted, in materials, propulsion, and guidance to represent what the air force desired in an all-new ICBM specifically designed for a mobile deployment.²⁷

Aerospace then modified this concept into a mode termed the road-mobile hardened garage. In this concept, launcher vehicles drove to underground, hardened garages located at intervals throughout the United States where they remained for up to two weeks. If required to launch, the transporter-launcher operators exited the garage and fired the missile. The garages provided power and allowed a certain level of missile readiness, which streamlined prelaunch procedures and reduced reaction time from thirty to seven minutes. By use of a randomized schedule, SAC controllers could rotate missiles throughout the shelters while keeping a portion of the force on the road, which increased overall survivability.²⁸

A related alternative was the triggered random mobile Minuteman. In a cost-saving move, Aerospace proposed using a Minuteman II ICBM with the NS-17 guidance set and a modified Minuteman transporter-erector vehicle (used to place the missiles into their launch facilities) as the launcher. Plans were made to station these at a soft support facility that duplicated SAC's alert shacks, but instead of airplanes, transporter-launchers,

²⁷Nease and Hendrickson, *Minuteman Guidance and Control*, 2-6; Space Technologies Laboratories, Inc., "Accuracies of Air Force Ballistic Missiles (CEP Status Report), February 1, 1960," 4, unaccessioned, unclassified collections. BMO box J-3, AFHRA and Aerospace, "Continuous Road Mobile ICBM," 6-7, 13.

²⁸Aerospace, "Continuous Road Mobile ICBM," 42, 44.

missiles, and their crews sat at the ready. While waiting in the support facility, the launch crews maintained their missiles in a state of readiness, and upon receipt of an appropriate order, the transporter launchers, each with one missile, dispersed over a network of government-owned roads to a hardened garage located no more than thirty minutes distant. The garage's 100 pound per square inch hardness and geographic separation prohibited bonus kills. Aerospace suggested building a larger number of garages than missiles, which meant that in order to destroy the force, an enemy had to either target all of the garages or know which garages contained missiles; thus, dispersal to the garages provided survivability through deception. In the late 1970s, a similar concept emerged as President Carter's proposal for the MX multiple protective shelter system.²⁹

The three land-based systems placed one missile on a single road-mobile, self-contained launcher and differed on whether pure mobility or deceptive sheltering provided survivability. The continuous road mobile and hardened garage proposals required a new, lightweight missile designed for mobile operations, which accounted for the advanced casing materials and propulsion mixtures to increase range and payload capability while decreasing weight. New inertial guidance and control systems, such as the NS-17 and thrust vector controls, were capable of significant in-flight adjustments, which eliminated the radio stations required by AFBMD's earlier proposals for a liquid-fueled, pressure-fed, radio-guided small rocket. The triggered random concept was

²⁹Aerospace Corporation. *Golden Arrow Technical Panel Systems Descriptions, Volume II, December 3, 1964*. "Triggered Random-Mobile Minuteman, December 15, 1964," 1-2, 15, unaccessioned, declassified document. BMO document 02054509, file 13J-4-4-17, AFHRA. Hereafter cited as Aerospace, "Triggered Random-Mobile Minuteman."

mobile but enhanced survivability through deception. Because it used Minuteman missiles, it offered cost advantages that the two road mobile concepts lacked.

Although the air force had previously rejected sea-based schemes, Golden Arrow's Advanced Basing Concept stationed missiles "carried on slow moving, minimally manned underwater launch platforms" in American waters. Possible deployment areas included the continental shelves of the Atlantic and Pacific coasts, the Alexander Archipelago in southern Alaska, the Gulf of Mexico, and the Great Lakes. The report stated that Lakes Michigan and Superior offered over 33,000 square miles of water deeper than 120 feet, which, given approximately 250 square miles per launcher, permitted a force of 100 to 130 launcher units, a force size described as "typical." Upon leaving their base, launchers submerged and randomly moved within an assigned patrol box or sat on the bottom. Unlike Aerospace's 1961 "lethargic missile" proposal, this proposal did not include the Finger Lakes.³⁰

Each launch unit (Aerospace was careful not to call them submarines) carried one missile. Upon receipt of a launch order, the launch unit descended to the bottom to align the missile's guidance platform. After the crew inserted the appropriate launch votes, a canisterized missile released. While the missile floated to the surface, the launch unit moved a safe distance away. Upon reaching the surface, the canister top opened, and the missile launched. Unlike the road-mobile missiles, the advanced basing concept missile experienced a hot, rather than a cold launch, that is, the first stage ignited while in the container. As with submarines, survivability derived from mobility, dispersal, and

³⁰Aerospace Corporation. *Golden Arrow Technical Panel Systems Descriptions, Volume II, December 3, 1964*. "Advanced Basing Concept, December 3, 1964," 1, 13-14, unaccessioned, declassified document. BMO document 02054506, file 13J-4-4-17, AFHRA. Hereafter cited as Aerospace, "Advanced Basing Concept." In 1960, AFBMD had studied basing missiles on barges, as had Aerospace in 1961.

concealment, which negated enemy accuracy and mandated an area attack, believing that the launch units could survive an attack so long as they remained submerged below 100 feet and if enemy warheads detonated no lower than 300 feet above the surface.

Aerospace proposed ninety-day deployment cycles, and each launch unit had a nine-man crew, which a helicopter or surface ship changed every twenty-eight days. Naval submariners, used to far longer patrols, would have been envious.³¹

Aside from the certain challenge the navy would mount to an air force submarine fleet, cost, which Aerospace did not estimate, would have been prohibitive. It required 11,500 military personnel per launch wing of 100 launchers, a vastly larger number than what a wing of 150 Minuteman ICBMs needed. In addition, support requirements necessitated the use of twenty-four helicopters and ten surface ships--two tenders, two icebreakers, and six refueling barges--per wing, plus a new missile, and spares for all system components. Aerospace proposed copying the navy's submarine fleet by building hundreds of small vessels, and nautical skills different from any in the air force were required. Nonetheless, the contribution of advanced basing to mobile missile thinking was that it demonstrated that missile deployment was possible on inland or coastal American waterways, and the idea resurfaced during debates over how to base the MX missile.³²

Continuous road mobile and the submarine deployment modes presented difficult targeting problems for an enemy to solve because they never knew where the missiles were. The same applied to Golden Arrow's examination of the airborne systems equipped with air-launched ballistic missiles (ALBM). So long as a missile was airborne,

³¹Ibid., 1-2, 13-14, 26.

³²Ibid., 19.

it was nearly impossible to target it with an ICBM. An aircraft-based missile suffered the same limitations as its carrier, but once airborne, it had global deployment capability and could relocate more rapidly than a truck or submarine. The choice of an ALBM was risky because in 1962, Secretary McNamara had cancelled the air force's proposed Skybolt ALBM. The Skybolt had a range of 1,000 miles, but according to McNamara, it "offered no unique capability" because it combined the weaknesses of the bomber without the strengths of the ICBM or SLBM (such as accuracy and rapid reaction). This meant that Skybolt's only role was defense suppression, a role that existing air force or navy missiles could handle. To make an ALBM palatable, Aerospace had to develop concepts that exceeded or equaled the performance of existing aircraft and missiles, which is what they proposed by basing multiple 2,000 nautical mile range ballistic missiles on a carrier aircraft.³³

Mating a long-endurance aircraft capable of carrying an ALBM with a 2,000-mile range was not going to be easy or cheap. Aerospace maintained that this program required a new "large subsonic turbulent wing" aircraft with a gross weight of 600,000 pounds, payload capacity of 100,000 pounds, and unrefueled endurance of two days while internally carrying an unspecified number of ALBMs. "Low fuel consumption regenerative turboprop power plants" propelled the plane, and to extend its airborne endurance, it had air-to-air refueling capability from KC-135 tanker aircraft. The advantages of an ALBM over existing air force weapons such as air-launched cruise

³³Gibson, *Nuclear Weapons of the United States*, 110; Kaufmann, *The McNamara Strategy*, 219; Enthoven and Smith, *How Much is Enough*, 258-60; Aerospace Corporation, *Golden Arrow Technical Panel Systems Descriptions, Volume II, December 4, 1964*, "The Airborne Alert Weapon System (AAWS) equipped with Air-Launched Ballistic Missiles (ALBM), December 4, 1964," 1, unaccessioned, declassified document. BMO document 02054506, file 13J-4-4-17, AFHRA. Hereafter referred to as Aerospace, "Airborne Alert Weapon System."

missiles included greater ranges and faster flight speeds, which permitted longer stand-off attack distances and complicated defensive efforts. In cruise mode, the carrier aircraft would fly at an altitude of 15,000 feet at 190 knots, riding its 325-foot wingspan that supported a 118-foot long fuselage. The missile bay was 112 feet long and sixteen feet in diameter and held up to eight missiles. To gain a sense of these proportions, the largest bomber the air force ever had was the B-36, which was 162 feet long, had a wingspan of 230 feet and weighed 357,500 pounds. This proposal pushed the boundaries of both missile and aircraft technology.³⁴

The United States had nothing in its military inventory like the proposed long-endurance aircraft or its ALBM, and a great deal of uncertainty surrounded the missile requirements that Aerospace examined, but the relationship between the carrier aircraft and missile were complimentary. One set of studies indicated that if the air force wanted eight ALBMs per aircraft, it was possible to provide a missile grossing 13,400 pounds, a range of 2,000 miles, and a payload of 950 pounds, enough for a small weapon. These missiles had two stages and utilized an advanced beryllium-loaded solid fuel and fiberglass casings, but required terminal-area guidance, something that even today ICBMs do not possess. Aerospace estimated the total projected cost, including research, development, testing, evaluation, production, and the first five years of operations for a force of 150 long-endurance aircraft (but not the 21,900 support personnel) at over \$15 billion (in 1964 dollars).³⁵

³⁴Aerospace, "Airborne Alert Weapon System," 1, 20-21; Gibson, *Nuclear Weapons of the United States*, 59.

³⁵Aerospace, "Airborne Alert Weapon System," 7-9, 13, 33.

Aerospace suggested deployments from bases within the American interior and mentioned Robbins Air Force Base in Georgia and Travis Air Force Base in Oklahoma as possible choices, as well as overseas staging bases in Spain and Okinawa that could support “random patrol routes and patterns outside of enemy radar cover . . . over the North Atlantic, North Polar regions, Mediterranean Sea, and the Pacific Ocean.” In peacetime, Aerospace planned randomly selected patrol routes, but as international tensions increased, each aircraft flew a predetermined route spaced fifty to 200 miles apart. Once airborne, the long-endurance aircraft possessed many of the virtues sought by proponents of mobile ICBMs. Although it was big, it was hard to destroy because its long stand-off attack range afforded by the ALBM kept it outside the range of enemy radars and fighters, which was fortunate given its low and slow performance. Its two-day airborne endurance enabled deception by flying anywhere it could go. In the early 1980s, Secretary of Defense Caspar Weinberger desired a similar system with which to deploy the MX missile.³⁶

A much more reasonable marriage of airplane and ballistic missile was Golden Arrow’s air transportable missile system, which mated a new ballistic missile with existing C-141 transport aircraft. As long as the missile weighed 27,000 pounds or less, a C-141 could carry two and their associated launch vehicles. Similar to the road-mobile transporter launcher, this launcher was a self-contained launch platform and launch control center. Aerospace envisioned a fleet of seventy-five C-141s, each carrying two missiles and launchers as cargo. The aircraft moved randomly between airfields that American planners hoped the Soviet Union had not targeted. Because a C-141 could land

³⁶Ibid., 17.

at many American airfields and because a missile-equipped C-141 appeared the same as any other, planners could move the missiles virtually anywhere there was sufficient runway, and even the best spy network would struggle to know what was on the aircraft.³⁷

Aerospace proposed four variations of operations. The first mode located the aircraft randomly throughout a worldwide network of airfields. The missiles stayed on the C-141 because every twenty-four hours, the aircraft moved to a new location. A second concept stationed an aircraft at a randomly selected airfield for one week. The launchers vacated the aircraft and maintained an alert configuration on the airfield. The third mode was similar to bomber scrambles because the missile aircraft remained at a centrally located air base until the alert klaxon sounded, at which time the C-141s departed for a preassigned location to conduct whatever launch operation was required. Last, Aerospace proposed that missile-carrying aircraft fly in the Military Air Transport Service schedule. This option was a copy of the first, except that it afforded additional deception by concealing movements within regularly scheduled military air transport traffic. Total system costs, including research, development, testing, evaluation, procurement, and five years of operations ranged from a low of \$15 billion to a high of \$19 billion, the differences based upon the amount of time that the aircraft flew. Moving the missiles meant that the C-141s had to fly, which demanded more maintenance, fuel, and trained aircrews. This was expensive, and the missiles did not exceed the capabilities

³⁷ Aerospace Corporation, *Golden Arrow Technical Panel Systems Descriptions, Volume II, December 3, 1964*, "The Air Transportable Missile System (ATMS) equipped with C-141 Aircraft/MGM-5200 Missile, December 11, 1964," 1-2, unaccessioned, declassified document. BMO document 02054507, file 13J-4-4-17, AFHRA. Hereafter cited as Aerospace, "Air Transportable Weapon System."

of hardened and dispersed Minuteman; nonetheless, elements of the proposal reappeared in the late seventies and early eighties.³⁸

Aerospace's Golden Arrow team made another proposal that was conceptually different because it stressed a form of survivability not from mobility-based deception but through mobility-enhanced super hardness. As ICBM accuracy increased, hardness had become an important subject. For fixed-site American missiles to survive an attack, their launch facilities and launch control centers had to withstand a direct hit. Aerospace addressed this concern with the superhard basing system, but cautioned that "due to the early status of the superhard basing concept development, no specific conclusion in terms of a best system definition is in hand." Nonetheless, the team believed that superhard, a form of deep underground basing, provided almost total survivability by burying ICBMs in tunnels and shafts deep underground with a minimum of 5,000 feet of hard granite top cover. Aerospace thought that the Sierra Nevada Mountains were an excellent location for a base because this range met the requirements for linear exits and granite composition. This required burrowing into a mountain but doing so provided a level of hardness equivalent to 15,000 pounds per square inch. Aerospace proposed a total force of 100 missiles stationed at three superhard bases.³⁹

A superhard base resembled a spider's web inside a mountain with many miles of underground tunnels. Missiles contained within a transporter launcher moved within spoke-like tunnels to launch locations near the mountain's outer rim. By carefully

³⁸Ibid., 5, 15.

³⁹Aerospace Corporation, *Golden Arrow Technical Panel Systems Descriptions, Volume II, December 3, 1964*, "Superhard, November 20, 1964," cover page, 2, 14, 16, unaccessioned, declassified document. BMO document 02054506, file 13J-4-4-17, AFHRA. Hereafter referred to as Aerospace Corporation, "Superhard." The quoted passage may be found on an unnumbered cover page.

locating launch positions one mile apart in ravines or ensuring that ridges protruded between openings, the terrain protected against bonus kills. Before the war, the launch positions remained covered by rock, which meant that if a superhard-based missile had to launch, special machinery first dug through the ground, after which the missile, which was stored on its launcher in a central storage facility, moved into position. A cantilever mechanism anchored itself into the tunnel's rock foundation, and the other end extended out over the mountain's slope. The missile moved longitudinally along the anchored cantilever and erected into a vertical position. After completing final checkout, the missile launched. Digging out after an attack required a great deal of time, probably up to several days, which meant that reaction time was slow and there was no reason to use a superhard-based missile as a counterforce weapon. It was purely a countervalue, post-attack weapon, that is, it existed to destroy whatever was left of an enemy state after the initial salvos. Elements of this concept, such as the use of a cantilever and the reconfiguration of thousands of square miles of land for a missile base resurfaced in various MX proposals in the late seventies and early eighties.⁴⁰

If the missiles carried one warhead, a force of 100 missiles was not powerful enough to justify the cost of turning a mountain into a doomsday missile base. To bring military capability into line with cost, Aerospace proposed a huge new missile known as ICBM-X, a weapon with destructive potential that matched well with the cost of superhard basing. Developed under a separate Golden Arrow investigation for a new hardened and dispersed missile, ICBM-X had a massive 156-inch diameter (Minuteman I was sixty-six inches at its widest), an unspecified number of stages, a CEP of .16 to .20

⁴⁰Ibid., 6-7, 14.

nautical miles, thixotropic propellants, a gross weight of 1,100,000 pounds, and multiple independently targetable reentry vehicles (MIRVs). Given a payload capacity of 24,000 pounds, this meant that it could have carried twenty or more MIRVs, a staggering number. Aerospace believed that it could not provide accurate cost figures for the superhardened ICBM-X weapon system, but construction efforts alone qualified the proposal as monumental architecture and made other options look relatively cheap.⁴¹

The Golden Arrow proposals were imaginative, and they reflected Aerospace's attempt to address the breadth of ICBM mobility in an atmosphere of free inquiry. As an attempt to address air force concerns over the future survivability of the Minuteman, the crucial question was determining the utility in these options, and in the era of McNamara analysts, economics hovered on an equal plane of importance. Did the offered survivability outweigh the cost of a new system, as well as the survivability offered by the already deployed and comparably inexpensive hardened and dispersed Minuteman or the navy's Polaris? Because the air force never sought to secure funding for any of these proposals, it clearly believed that the answer was not yet. As McNamara's Assistant Secretary of Defense for Systems Analysis Alain Enthoven declared, "our gross national product, though large, is limited. If we attempted to develop and procure a dozen or more distinctly different strategic nuclear delivery systems . . . we doubtless would end up squandering our resources and not doing a good job on any of them. Therefore, we have to choose." This did not mean that Golden Arrow was a waste. On the contrary, it

⁴¹Aerospace Corporation, *Golden Arrow Technical Panel Systems Descriptions, Volume II, December 3, 1964*, "ICBM-X Missile System 156, Solid Propellant Configuration Thixotropic Propellant Configuration, December 16, 1964," 2, unaccessioned, declassified document. BMO document 02054504, file 13J-4-4-17, AFHRA. Hereafter cited as Aerospace, "ICBM-X." See also Aerospace, "Superhard," 6.

provided a fertile intellectual exercise from which sprouted concepts for future development.⁴²

Upgrades to Existing Forces

The military and aerospace industry continued to develop missile technology, and as the air force investigated new modes of ICBM mobility, it improved the hardened and dispersed Minuteman force. Aerospace had considered the Minuteman II for mobile roles, but it was destined for a fixed deployment. On November 8, 1963, Secretary McNamara approved the Minuteman II ICBM for a 1966 deployment as a replacement for the existing 150 "A" version and 650 "B" version Minuteman I ICBMs. Known as the Minuteman Force Modernization Program, the Minuteman II deployment necessitated a complete retrofit of the Minuteman I launch facilities and launch control centers. The new missile featured improved first stage reliability, a larger second stage, the NS-17 guidance system, a more powerful on-board computer, greater range, increased payload capacity and greater flexibility.⁴³

Minuteman II appealed to the secretary because its targeting flexibility allowed it to perform multiple roles. Armed with a powerful 1.2 megaton Mark II reentry vehicle and accurate enough to destroy moderately hard targets, the Minuteman II's computer retained target data for eight separate targets, one of which was the designated primary. Flicking a few switches changed between these targets, but it did not possess rapid

⁴²Enthoven quoted in Kaufmann, *The McNamara Strategy*, 242. In 1963, Enthoven made his remarks in a speech at the Naval War College. For a discussion of the relationship among strategy, policy, and nuclear weapons procurement, see Enthoven, *How Much is Enough*, 165-210.

⁴³Nease and Hendrickson, *Minuteman Guidance and Control*, 2-1 to 2-4; SAC Historian, *From Snark to Peacekeeper*, 37; Cochran et al., *Nuclear Weapons Databook*, vol. 1, 113-115.

retargeting capability for an uncataloged target. Reprogramming the missile computer with completely new targeting data required a maintenance team to load the new coordinates at the missile using a magnetic tape, a process that could take up to thirty-six hours. Nonetheless, although Minuteman II suffered some growing pains, it provided an improved weapon system capable of assured destruction, increased targeting flexibility and survivability (the missile carried chaff to confuse Soviet defenses and the refurbished launch facilities were hardened to between 1,200 and 2,200 pounds per square inch). By the end of April 1967, the air force had deployed its 450th Minuteman II, which was also the 1,000th Minuteman to stand alert.⁴⁴

Missile technology had momentum, and in July 1965, one month after the first 800 Minuteman Is were operational and less than two years after McNamara had approved Minuteman II, the air force asked industry to conduct research and development for another new ICBM, the Minuteman III. The new missile drew upon developmental work done for but not incorporated into the Minuteman II, which permitted substantial improvements to guidance accuracy, multiple reentry vehicle deployment, and payload capacity. By increasing the size of the third-stage motor and equipping it with liquid-injection thrust vector control, Minuteman III gained a substantial range increase. Engineers also added a liquid-fueled fourth stage, commonly known as the post-boost vehicle, which contained restartable maneuvering engines to control movement along the three axes, extended range, and permitted deployment of up to three reentry vehicles with great accuracy. It could also deploy penetration aids such

⁴⁴Cochran et al., *Nuclear Weapons Databook*, vol. 1, 113-115; Nease and Hendrickson, *Minuteman Guidance and Control*, 2-4.

as chaff. In December 1970, the first Minuteman III went on alert at Minot Air Force Base, North Dakota, three years before Minuteman II finished replacing Minuteman I.⁴⁵

Minuteman III used another new guidance set, the NS-20, which offered improved reliability, a CEP of .12 nautical miles, and eliminated the restrictive azimuth alignment limitations of earlier Minuteman missiles. Because of its increased accuracy, the Minuteman III used smaller-yield warheads, and the combination of improved guidance, propulsion, computing power, payload capacity, and a maneuverable fourth stage provided MIRV capability, that is, each warhead was independently targetable. Despite cross-range and downrange limitations, a single Minuteman III could attack up to three different targets. It was also possible to cross-target, that is, attack a single target from multiple different trajectories by reentry vehicles from the same missile or a combination of warheads from several missiles, thus complicating and saturating enemy defenses by overwhelming them. When first deployed (and through the 1970s), the Minuteman III carried three Mark 12 reentry vehicles, each of which yielded 170 kilotons.⁴⁶

As with Minuteman II, it was possible to change between preloaded targets, but in 1972, the air force gained remote retargeting capability. By 1978, the entire Minuteman III force of 550 missiles had received this modification, called command data buffer, whose significance cannot be overstated. SAC could finally update target coordinates that were preloaded at its missiles to previously unknown or uncovered targets. In no

⁴⁵Nease and Hendrickson, *Minuteman Guidance and Control*, 3-1 to 3-10; SAC Historian, *From Snark to Peacekeeper*, 37; Cochran et al., *Nuclear Weapons Databook*, vol. 1, 116-119; Ted Greenwood, *Making the MIRV: A Study of Defense Decision Making* (Cambridge, MA: Ballinger Publishing Company, 1975), 167-169.

⁴⁶Nease and Hendrickson, *Minuteman Guidance and Control*, 3-4 through 3-7, 3-34 through 3-38, 3-46 through 3-4. and Greenwood, *Making the MIRV*, 1-11, 27-49, 58-62, 66.

more than twenty-five minutes, a proficient crew could retarget a single missile with completely new data not previously resident in the missile's computer. If SAC headquarters needed to provide fresh data to all of its Minuteman IIIs, ten hours was sufficient time to complete the job. The flexibility desired by McNamara had arrived; the air force could hold at risk surprise or emergent targets of opportunity, and a president could control, in theory, the escalation of a nuclear war by attacking targets with more selectivity and restraint than was previously possible. Since its original deployment, Minuteman had become a highly capable weapon system whose crews could configure it rapidly to meet national needs.⁴⁷

Additional Mobility Studies

The development and deployment of hardened and dispersed Minuteman II and III accounted for the majority of the air force's ICBM resources. Within the broader confines of air force budgeting, the ICBM program grew as it survived several acrimonious weapon system cancellations, including the Skybolt ALBM, the North American F-108 fighter, the Martin P6M flying boat, and the North American B-70 high-speed, high-altitude bomber. In this fiscal environment, additional mobile ICBM research consisted of paper studies, including a December 1966 study done by the Air Force's Ballistic Systems Division (BSD), the successor to AFBMD. Multiple pool

⁴⁷Cochran et al., *Nuclear Weapons Databook*, vol. 1, 116, 118 (crew reaction time on page 118); MacKenzie, *Inventing Accuracy*, 214-217; Hopkins and Goldberg, *The Development of Strategic Air Command*, 182, 200. For a description of Minuteman crew activities, see John Edwards, *Superweapon: The Making of the MX* (New York: W. W. Norton and Company, 1982), 83-86. For crew retargeting procedures, see "Targeting Flexibility Emphasized by SAC," *AWST* 104 (May 10, 1976), 31-34. See also Hopkins and Goldberg, *The Development of Strategic Air Command*, 182. By September 1978, all Minuteman III ICBMs became CDB-capable. In 1975, F. E. Warren AFB became the first wing to have its entire Minuteman force equipped with the CDB modification.

basing provided survivability through mobility, concealment, and deception. BSD proposed a large grid-like network of 350 pools, each separated by 3,000 feet and large enough to serve as a Minuteman's launch facility with some large enough for a Minuteman ICBM to be turned. Fifty caisson-encased Minuteman ICBMs floated in the canal network that connected the pools, and twelve mobile launch control centers provided redundant C3. A metal roof covered the canals and a frangible cover lay over the launch pools.⁴⁸

The caisson was a canisterized Minuteman ICBM that relied on an unmanned utility barge for mobility through the system of canals and locks. The utility barge towed the caisson transporter, a floating dock that contained the caisson. Every thirty days, random movement among pools by the fifty caissons and twelve launch control centers provided mobility-enhanced survivability, deception, and concealment. Once a caisson arrived at a pool, it rotated from the horizontal plane to a vertical position and tethered itself to the bottom. In such a configuration, the caisson was capable of withstanding a 3,000 pounds per square inch overpressure. BSD believed that a squadron of fifty multiple-pool based Minutemen cost between \$1.2 and \$1.4 billion, with the cost for a wing of 150 such missiles running to nearly \$4 billion. Cost differences resulted from the amount of rock present in the soil, and BSD proposed two basing locations, one east and one west of Wichita, Kansas. The advantage to this system was that an attacker would not know where the missiles lay, and would be forced to target all of the pools without

⁴⁸BSD, "Multiple Pool Basing Concept Facility Cost Study, December 6, 1966," unnumbered pages. unaccessioned, declassified document. BMO document 02054173, file 13-J-8-11, AFHRA (hereafter cited as BSD, "Multiple Pool Basing." On April 1, 1961, the air force divided the old AFBMD organization into two divisions. One division, the Ballistic Systems Division, was responsible for ICBMs. The second, Space Systems Division, had responsibility for the rising number of air force space systems, including launch vehicles, satellites, and early warning systems. See Hanley and Waldron, *Space and Missile Systems Center*, v.

massing an area attack against American cities. This forced him into an uneven and costly attack that required at least 350 warheads to ensure the destruction of fifty American missiles, and it helped damage limitation by drawing enemy fire away from cities. An important conceptual advance was at the heart of this basing mode. Whereas earlier mobile missile proposals utilized large regional or worldwide operating arenas, multiple pool basing provided a geographically restricted site in which mobile ICBMs roamed a dedicated transportation network. Elements of this proposal presaged various MX missile deployment schemes of the 1970s.⁴⁹

Another study for a new large ICBM was Weapon System 120A (WS120A), which was an investigation into a missile to replace the Minuteman ICBMs in the 1975 timeframe. Smaller than Golden Arrow's ICBM-X, the proposed missile was larger than Minuteman III and carried ten to twenty warheads. The preferred deployment mode was hardened and dispersed launch facilities, but Aerospace also investigated various mobile options, including an off-road version and defended dispersed modes. In late 1967, to the chagrin of those researching WS120A, the air force, given the needs of the Vietnam War, the deployments of Minuteman II and III, and a belief that Soviet ICBMs could not threaten the existing or planned ICBM force for several years, cancelled further study of WS120A.⁵⁰

⁴⁹Ibid.

⁵⁰Aerospace, *The Aerospace Corporation*, 136. Throughout the mid-sixties to early seventies, trade journals such as *AWST* reported information snippets on these and various other studies. Most references to WS 120A were contained in the "Industry Observer" column. A typical comment read, "Air Force Ballistic System Div. planners are studying both road and off-road mobility for WS-120A, the next generation ICBM. Mobility characteristics are considered essential to make it a difficult target for hostile ICBMs. Martin/Denver will conduct a preliminary design for an off-road transporter/launcher. The weapon will have a 20-min. alert time, high survivability, and a 7,000 naut. mile range." See "Industry Observer," *AWST* 86, no. 6 (February 6, 1967), 19. In general, such journals were aware of these classified studies and captured the essence, if not the specifics, of such work.

Another study that has surfaced often in descriptions of ICBM development was Strat-X. This was a "top-level" military-industrial review of future ICBM requirements. Fred A. Payne, Jr., a vice president of Marquardt Industries and a former deputy director for strategic systems in the Office of the Secretary of Defense's Defense Research and Engineering division, chaired the committee. Besides examining the strategic nuclear needs of the 1970s, Strat-X studied the various advanced ICBM proposals and recommended a force of 100 large, MIRV-equipped ICBMs based in a deceptive mode with missiles roaming between a larger number of shelters. Boeing, General Dynamics, Douglas, Thiokol, and the University of Michigan all received various contracts for engineering services and front-end configuration studies, but political and fiscal support soon dried up. By the end of 1967, the Department of Defense cut the Strat-X advanced ICBM configuration contracts by 50 percent. Defense Secretary McNamara believed that the present ICBM force and its planned improvements were sufficient to counter any Soviet threat, admitting that if he had known in 1961 the exact nature of the Soviet threat "we simply would not have needed to build as large a nuclear arsenal as we have today." The new Nixon administration agreed, and in 1969, Dr. John S. Foster, Jr., DoD's director of defense research and engineering, told the House Armed Services Committee that because the advanced ICBM was not "significantly better than Minuteman III," the administration believed "a substantially better concept is needed to justify such large expenditures," and with that, Strat-X suffered quick cancellation.⁵¹

⁵¹Robert S. McNamara, "Nuclear War and Missile Defense: Address by Secretary of Defense Robert S. McNamara to Editors and Publishers of United Press International, San Francisco, September 18, 1967," contained in Richard P. Stebbins, ed., *Documents on American Foreign Relations 1967* (New York: Simon and Schuster, 1968), 71. Full text of the address reproduced on pages 65-81. Edwards, *Superweapon*, 59; "Industry Observer," *AWST* 86 (April 3, 1967), 23; Edward H. Kolcum, "Strategic

For those whose hearts were close to the ICBM program, the frustration was palpable. Retired General Schriever stated that “the advanced ICBM program the air force has been advocating for years is nothing more than a thick bundle of papers,” and others agreed with him. Robert Hotz, a strong advocate of new defense programs and editor of *Aviation Week and Space Technology*, asserted that “the tons of paper accumulated in these studies will prove to be no adequate substitute for the technology spawned by a sound research and development program when the U.S. faces the challenge of new generations of Soviet weapons,” but these lamentations were hard to fathom in the light of the Minuteman II and III programs.⁵²

Despite the mounds of paper, air force leadership retained an interest in how mobility increased ICBM survivability. On October 31, 1969, the air force’s assistant chief of staff for studies and analysis, Major General Glenn A. Kent, reported on ICBM survivability. By this time, air force leadership knew that there were four ways to ensure that sufficient American warheads survived an enemy first strike, including MIRV, increased hardness or number of launch facilities, and mobility. Kent concluded that “for a wide range of opposing force sizes and vulnerability combinations . . . the best mix force is a combination of the two missile types [hard and dispersed and mobile] rather than a pure force of either type.” This was true even if some missiles had fixed-silo deception, that is, empty launch facilities as part of an elaborate shell game similar to what Aerospace proposed for triggered random-mobile Minuteman. The use of fixed-silo

Planning Centers on Missiles,” *AWST* 86 (March 6, 1967), 69-70. “Industry Observer,” *AWST* 87, (November 6, 1967), 13 and (December 18, 1967), 13. See also Donald C. Winston, “Nixon Delays Advanced ICBM Development,” *AWST* 90 (May 12, 1969), 26.

⁵²General Schriever quoted in Cecil Brownlow, “Dollar Drain Saps U.S. Strategic Stance,” *AWST* 88 (March 18, 1968), 71. See also Robert Hotz, “Mr. McNamara’s Legacy,” *AWST* 88 (March 25, 1968), 11.

deception permitted a smaller number of mobile missiles as opposed to a force without such a ruse, but Kent believed mobility held the solution to increased survivability. At least to some air force leaders, the air force needed a mobile ICBM.⁵³

SAC and the recently created Space and Missile Systems Organization (SAMSO) responded to this interest with a joint SAC-SAMSO task force, although the resultant "Minuteman Rebasing Task Force Report" was released as a SAMSO product. In addition to examining older modes of ICBM mobility, including a concept similar to triggered-random mobile Minuteman, the rebasing task force studied the use of off-road vehicles including an air-cushioned launcher with a top speed of ninety knots. The task force recognized that deterrence could fail and a nuclear war could happen. They developed basing modes to ensure that "the surviving balance of military power will be advantageous to the United States and that the ratio of surviving population and industry will not be adverse to the United States." SAMSO and SAC hoped to discover a way to win a nuclear war.⁵⁴

Because the Nixon administration had little interest in expanding the size of the ICBM force, SAMSO assumed a future ICBM force size of 1,000 missiles. Any mobile missile came at the expense of a hardened and dispersed ICBM. They clearly recognized

⁵³United States Air Force Assistant Chief of Staff, Studies and Analysis, "A Comparison of the Survivability of Fixed-Silo ICBMs and Land-Mobile ICBMs, October 31, 1969," 35, declassified staff study excerpt, IRIS No.K143.044-18, AFHRA. Kent was an early proponent of MIRV technology. See Greenwood, *Making the MIRV*, 60.

⁵⁴SAMSO, "Minuteman Rebasing Task Force Report, vol. 2, March 1970," III-C-3 and III-D-1, unaccessioned, declassified document. BMO document 02054268, file 13-J-8-15, AFHRA (hereafter cited as SAMSO, "Minuteman Rebasing). SAMSO re-unified BSD and the Space Systems Division on July 1, 1967. SAMSO retained responsibility for acquisition and procurement of all air force space and ballistic missile systems until September 30, 1979, when it once again became two separate organizations, the Space Division and the Ballistic Missile Office, each holding essentially the same responsibilities as once had Space Systems Division and Ballistic Systems Division. In March 1970, Lieutenant General Samuel C. Phillips, the former Minuteman program manager and a key figure in NASA's Project Apollo, commanded SAMSO. See Hanley and Waldron, *Space and Missile Systems Center*, v.

that “increasing Soviet offensive nuclear capability” threatened the 1,000-missile American ICBM force because even if the Soviet Union did little more than build single-warhead missiles, they could eventually overwhelm the passive defenses of the hardened and dispersed ICBM. In addition, any rebasing proposal had to support American policy with “a credible ability to engage in nuclear counterforce operations while withholding sufficient forces for effective city or urban industrial attack.” Thus, any mobile ICBM force had to possess adequate survivability to absorb a Soviet first strike and provide a successful American retaliatory attack. Based on estimations of growing Soviet capabilities and an American ICBM force limited to 1,000 missiles, the group concluded that mobile ICBMs did not yet provide greater retaliatory capability than the hardened and dispersed Minuteman force, at least not until American forces were outgunned.⁵⁵

In December 1964, when Aerospace completed its Golden Arrow studies, the air force had secured the future of the hardened and dispersed ICBM with the Minuteman II. Eight months later, it initiated the Minuteman III program, and by 1970, the air force had two versions of Minuteman on alert for a total of 936 missiles plus the Titan IIs. The MIRVed and remotely retargetable Minuteman III, based in a silo hardened to approximately 2,000 pounds per square inch, provided capabilities and potential future growth that made a new mobile ICBM unlikely to get past the drawing board. The hardened and dispersed ICBM dominated American ICBMs because in true systems analysis fashion, it was seemingly invulnerable, provided adequate assured destruction

⁵⁵SAMSO, “Minuteman Rebasing Task Force Report,” III-D-2 through D-8.

and targeting flexibility, and was relatively inexpensive. For some time, its dominance appeared secure--until the Soviet Union found a way to threaten it.⁵⁶

⁵⁶Cochran et al., *Nuclear Weapons Databook*, vol. 1, 117; SAC Historian, *Alert Operations*, 97.

CHAPTER 4

PARITY, SALT, AND INDECISION

The way people operate and the way systems operate, they institutionalize almost anything that comes along. I have felt that you are lucky if any real good management approach in the bureaucracy lasts for five years. You are exceptionally lucky if it lasts for seven; then you ought to throw it all away and start all over again. . . . Fortunately for the ICBM program, we had about seven years where we had the kind of authority, procedures, and policy that I mentioned in the evolution of the management for the ballistic missile. It lasted about seven years. . . . I was in complete opposition to the way in which McNamara was attempting to manage R & D in systems acquisition, starting about 1962. The micromanagement started then and has continued to worsen.¹

-- General Bernard A. Schriever, 1993

As the United States modernized its ICBMs with the Minuteman II and III, the Soviets substantially upgraded their corresponding forces, the bulk of which were ICBMs. Following the deployment of its earliest missiles, the Soviet Union sought greater survivability and striking power, and by the end of 1965, they had deployed 226 long-range ballistic missiles. Similar to the first generation of American missiles, they placed most of these in closely spaced and minimally hardened launchers, which made them easier to destroy, and then worked to improve their survivability, responsiveness, accuracy, and operability. By 1972, the Soviet ICBM fleet had 1,502 missiles, each carrying a single warhead, in addition to a small but not insignificant bomber force that counted 152 long-range aircraft equipped with 234 long-range cruise missiles, and an SLBM force of 540 missiles. In addition, the Soviets were working on a new Polaris

¹Schriever comment from interview in Neufeld, *Research and Development*, 65-67.

counterpart--the Project 667A (known in the West as the Yankee class) submarines that carried sixteen R-27 SLBMs. Since the mid-1950s, they had been working on a ballistic missile defense system, deploying a prototype around Moscow and hoping it would lead to a nationwide system, but it was clear that a strong American attack could overwhelm it. The reality of the nuclear balance of terror was that in the event of a surprise first strike by the other side, either the Americans or the Soviets would retain sufficient forces to devastate the other.²

The new Red weapons had their roots in the sixties, an era of unparalleled American nuclear superiority, and by the early seventies, they provided the Soviets a rough parity with the United States. Earlier, Secretary of Defense McNamara had recognized this and concluded that because of survivable retaliatory forces, "each of us can deny the other a first-strike capability." Although Soviet ICBMs outnumbered American missiles, their accuracy was not as good, which was compensated for with larger warhead yields. Both sides had multiple reentry vehicle capability, but only the United States possessed MIRVs; moreover, in 1972, the Americans had begun to provide their missile crews with a true remote retargeting capability that could address ad hoc targets to "construct attacks that are not among the preplanned options of the SIOP." Increasingly, the Americans had placed all of their ICBM eggs in the basket of an improved 1,000-missile Minuteman force whereas the Soviets had employed a variety of systems, each with multiple variants suited for a given purpose that in aggregate constituted a large and powerful adversary.³

²Podvig, *Russian Strategic Nuclear Forces*, 6-7, 136-139, 246-251, 350-351.

³Ad hoc targeting definition from Office of Technology Assessment, *MX Missile Basing* (Washington, D.C.: Government Printing Office, 1981), 285. McNamara address of September 1967

By the early 1970s, President Richard M. Nixon had recognized the growing strength of Soviet nuclear and conventional military power while simultaneously confronting the American public's discontent with the Vietnam War and an increasingly glum domestic economic outlook. On February 20, 1970, Secretary of Defense Melvin R. Laird reported that American strategic forces were expensive, costing "twelve percent of the total FY 1971 defense budget" but that "these forces unquestionably provide the basic foundation of our deterrent." He contended that the growth of Soviet forces was "a matter of serious concern" and that "for some time, the Soviet Forces which became operational in a given year have often exceeded the previous intelligence projections for that year," an alarming trend. Understanding the limits of American power and the growth of Soviet capabilities, Nixon wanted to "foster and encourage the capabilities of our allies." His so-called Nixon Doctrine was an attempt to increase Western security by having allied nations share defense burdens while reducing the American defense budget, or as he explained: "I have decided on defense strategy and budget guidelines for the next five years that are consistent not only with our national security but with our national priorities as well." Translated into military forces, this meant that deterrence required strong enough forces to prevent general nuclear war but that the days of overwhelming American nuclear superiority were finished. Aware of the nuclear arsenal's deterrent

contained in Stebbins, *Documents on American Foreign Relations 1967*, 73. McNamara echoed nearly verbatim sentiments in his statement on the fiscal year 1969 defense budget and 1969-1973 defense program. See Department of Defense, *Statement by Secretary of Defense Robert S. McNamara Before the Senate Armed Services Committee on the Fiscal Year 1969-73 Defense Program and the 1969 Defense Budget* (Washington, D.C.: Government Printing Office, 1968), 46. In 1977, Secretary of Defense Harold Brown reported that "current U.S. employment policy directs that survivable strategic forces be taken from forces generated by other requirements and be held back for trans and post attack protection." See Harold Brown, "PRM/NSC-10 Military Strategy and Force Posture Review Final Report, June 5, 1977" (Washington, D.C.: Office of the Secretary of Defense, 1977), 38. Available on-line; from the Jimmy Carter Presidential Library at <http://jimmycarterlibrary.org/documents/prmemorandums/prm10.pdf>, accessed on January 31, 2006. Hereafter cited as "PRM/NSC-10."

limits, Laird stated, "as the last two decades have demonstrated, reliance on a nuclear capability alone is by no means sufficient to inhibit or deter aggression," which required the United States to confront growing Soviet power while balancing its need for an adequate nuclear deterrent against a desire to trim defense budgets.⁴

Despite Soviet gains in strategic weaponry, Nixon firmly believed he had inherited a qualitative advantage. In the last days of the Johnson administration, outgoing Secretary of Defense Clark M. Clifford stressed how reasonable it was "to conclude that even if the Soviets attempt to match us in numbers of strategic missiles we shall continue to have, as far into the future . . . a very substantial qualitative lead and a distinct superiority in the numbers of deliverable weapons and the overall combat effectiveness of our combat forces." Clifford correctly characterized the state of American strategic forces; even at the lowest points of the Vietnam War, the Defense Department had not emptied the nuclear cupboard because the United States did not depend solely on ICBMs. American modernization programs included a 1971 deployment of the new navy Poseidon submarines equipped with the three-MIRV C-3 SLBMs, as well as the future Trident SLBM, B-1 bomber, and continuing upgrades to the Minuteman III. In addition, SAC had more than 400 nuclear-capable B-52 bombers, an impressive number considering that the air force needed many of them to fight in the Vietnam War. The United States had also researched numerous ballistic missile defense programs to provide

⁴Department of Defense, *Statement of Secretary of Defense Melvin R. Laird Before a Joint Session of the Senate Armed Services Committee and the Senate Subcommittee on Department of Defense Appropriations on the Fiscal Year 1971 Defense Program and Budget* (Washington, D.C.: Government Printing Office, 1970), 34. See also Statement of Secretary of Defense Melvin R. Laird contained in House Committee on Armed Services, *Hearings on Military Posture and H.R. 3818 and H.R. 8687 to Authorize Appropriations During the Fiscal Year 1972*, 92d Cong., 1st sess., 1971, 2330, 2333. See also "Shift to Strategic Force Emphasis tied to Nixon Domestic Priorities," *AWST* 92 (February 23, 1970), 19. Terry B. Terriff, *The Nixon Administration and the Making of U.S. Nuclear Strategy* (Ithaca: Cornell University Press, 1985), 18-22.

varying levels of defense for the nation and its strategic weapons. Although the Soviet forces had grown, American forces were not weak.⁵

A Taste of SALT and Survivability

Until 1972, dreamers of mobile ICBMs paid arms control little heed, but the limits on strategic armaments associated with President Nixon's policy of détente forced a pause for reflection. The 1972 Treaty on the Limitation of Anti-Ballistic Missile Systems and the Interim Agreement on Certain Measures with Respect to the Limitation of Strategic Offensive Arms culminated the first round of Strategic Arms Limitations Talks (SALT I) and had implications for mobile ICBM design. Under the terms of the Anti-Ballistic Missile Treaty, the Soviets and Americans agreed that each side would only protect two sites--its capital and an ICBM field. Regarding the latter, the treaty specified one anti-ballistic missile system "deployment area having a radius of one hundred and fifty kilometers and containing ICBM silo launchers," which did not permit protecting a mobile ICBM system. Consequently, any future mobile ICBM had to rely upon passive means of defense. In any case, the treaty also restricted the maximum protection radius to 150 kilometers, large enough to be susceptible to area attack but too small a deployment area for a mobile system.⁶

For future mobile ICBMs, the Interim Agreement, signed on May 26, 1972, was equally significant but considerably more vague. It was not a formal treaty but an

⁵Department of Defense, *Statement of Secretary of Defense Clark M. Clifford, The Fiscal Year 1970-74 Defense program and 1970 Defense Budget* (Washington, D.C.: Government Printing Office, 1969), 46. SAC Historian, *Alert Operations*, 79.

⁶Richard P. Stebbins and Elaine P. Adam, eds., *American Foreign Relations 1972: A Documentary Record* (New York: New York University Press, 1976), 89-92. Text of ABM Treaty reproduced on pages 90-95.

agreement between the two national leaders to limit the expansion of their nuclear arsenals. For five years after July 1, 1972, both sides agreed to cease “construction of additional fixed land-based intercontinental ballistic missile . . . launchers.” The agreement did not define the meaning of the word “launcher,” but American leaders believed it meant the launch facilities in which the air force had deployed its ICBMs. At this time, the Americans believed that mobility was inconsistent with the spirit and intent of the agreement, but the understanding permitted the deployment of improved missiles within existing launchers, which solidified a Soviet advantage because the United States had 1,054 launchers to 1,502 for the Soviets. In theory at least, this meant that the Soviets could target more than one warhead for every one American ICBM, effectively decreasing missile survivability. Americans gained some solace in knowing that if one counted SLBM, ICBM, and bomber-delivered nuclear warheads, they had more weapons than did the Soviets. Washington believed that its qualitative advantage in MIRV, guidance, solid-fuel, and retargeting technology sufficiently countered the Soviet numerical advantage, but this comfort zone shrank once Soviet technology developed further.⁷

Limits on ICBMs raised the intricate issues of missile accuracy and survivability to new levels of visibility. Because a numerically constrained American ICBM force was survivable only “if its destruction by a Soviet first strike is infeasible,” any situation in which the destruction of those forces rested simply upon the likelihood of an adversary improving his missiles was unacceptable. As long as Soviet missiles had poor accuracy, the survivability of American ICBMs was satisfactory, but as their accuracies improved

⁷Ibid., 96-98. Text of the Interim Agreement reproduced on pages 97-100.

and numbers of Soviet missiles increased, American survivability decreased, eventually reaching a point at which the Minutemen were vulnerable to a first-strike. As the Soviet build-up continued, the Office of Technology Assessment predicted that existing accuracies and a one-megaton detonation virtually assured target destruction, meaning that given the current state of technology, the vulnerability of American ICBMs was likely. Furthermore, based on trends, projected accuracies made target kill probabilities so close to one that they would be “approximately equal to the reliability of the attack missile,” implying that a numerically capped ICBM force might not survive a first strike from a numerically superior opponent.⁸

Most analysts accepted the theoretical framework for these calculations, but uncertainties arose from the values assigned to equation parameters. Lacking specific data, analysts estimated important factors, including: Soviet ICBM and reentry vehicle accuracy and reliability (itself a complex calculation involving its own set of assumptions); the effects of blast overpressure, shock, heat, and radiation; terrain surrounding the target; and the weather. Other sources of potential errors were unknown concentrations of mass in the earth that diminished guidance accuracy; under- or over-performance of rocket engines; and most important, no Soviet or American ICBM had ever flown the wartime ballistic North Pole route. Depending upon one’s position as a pessimist or optimist vis-à-vis the Soviet first-strike threat, predictions about the

⁸The Office of Technology Assessment (OTA) presented an easy-to-understand survivability calculation in *MX Missile Basing*, 25, 41. Congress had commissioned this study. According to the tasking letter that Senator Morris K. Udall, Chairman of the Senate Technology Assessment Board, sent to Dr. John H. Gibbons, OTA Director, the latter was to “present a clear analysis of the options available to Congress regarding the MX basing, an explanation of why these particular options are worthy of consideration, and a statement of the major advantages and disadvantages of each option.” The requirement to simplify complex information for high-level executives accounts for OTA’s simplification. See OTA, *MX Missile Basing*, 326.

survivability of American ICBMs ranged from as low as 10 percent to as high as 50 percent. As with all war-gaming, estimates, guesses, and uncertainties riddled nuclear strike planning, making it an exercise with many possibilities, few certainties, and resulting in a fog for the political and military leaders deciding whether to build a mobile ICBM.⁹

Within the operations of nuclear weapons, planners did not publicly discuss the likelihood of a perfect response by crews to a launch order. A mass attack on an ICBM force demanded precise and timely responses by crews because if they failed to launch the missiles exactly when planned, there was possibility of fratricide, which was the destruction of incoming weapons by the radiation, air blast, fireball, or debris effects from a previous detonation. To ensure peak performance, each month, Minuteman crews received, in addition to as many as eight alert tours, a four-hour simulator session to practice emergency and wartime procedures. They also attended multiple days of classroom training and took three examinations that tested their knowledge of weapon system operations, coding systems, and wartime procedures. The SAC standard on these tests was 100 percent, which paradoxically made perfection average. The competitive environment of the SAC officer corps ensured that tests and simulator evaluations contained numerous false leads intended to trap the unwary. Those who had a bad day appeared before the wing commander dressed in their class-A uniforms to present a formal briefing explaining why their performance was substandard. On one occasion, an

⁹Peter Zimmerman, "Rail-based MX," in Levi, Sakitt, and Hobson, *The Future of Land-Based ICBMs*, 223. For an excellent systematic explanation of these calculations, see Art Hobson, "Minuteman/MX System: Becoming Vulnerable," in Levi, Sakitt, and Hobson, *The Future of Land-Based Strategic Missiles*, 124-128. Hobson concluded that "U.S. ICBMs may be highly vulnerable to ICBM attack today."

irate red-faced colonel, while screaming “get out!” threw an ashtray at the hapless crew. SAC summarily fired wing commanders whose units failed inspections and moved their families off the base within twenty-four hours. Often times, units held additional exercises to maintain crew readiness. Missile crew life mixed boredom with the stress of constant evaluation and the ever-present danger of nuclear war.¹⁰

Despite this mental discipline, there were breakdowns. A missile officer of three years experience recalled that “a controller at SAC headquarters once mumbled a missile alert message over a live mike while practicing. Realizing his error, he closed with ‘oh, shit.’ Less than half the missile wings responded, even though we were taught to react to any correctly decoded message, no matter how received.” Because of well-designed safeguards, this mistake did not bring, even remotely, the nation closer to nuclear war, but it demonstrated that thinking human beings might do the unexpected to include ignoring messages from higher headquarters. Working in a physically dynamic environment and dealing with a different set of concerns than their underground brethren, a mobile missile crew faced additional problems that a survivability equation could never quantify, particularly under the immense strain of initiating nuclear war.¹¹

No one outside the Kremlin truly understood Soviet ambitions, and much worry surrounded what intentions lay behind their arms buildup. As a result, some Americans

¹⁰After March 31, 1978, eight alerts per month was the normal maximum for Minuteman crews. Before that date, two sets of crews performed a thirty-six hour alert tour at a launch control facility. One crew would work in the underground launch control center while the second crew rested in the aboveground structure. By April 1, 1978, one crew performed a twenty-four hour alert inside the underground center. This cost-cutting move saved an estimated \$14 million and reduced the authorized Minuteman crew force by approximately 600 people. See Hopkins and Goldberg, *The Development of Strategic Air Command*, 215. For an air force-sanctioned view of 1970s missileer life, see Robert G. H. Carroll, “Making the Mark with Missiles,” *Air Force Magazine* 59 (June 1976), 50-54.

¹¹Edwards, *Superweapon*, 86. ICBM circles often repeat this tale, which is at least as old as Edwards’s 1982 publication date. In the early 1990s, I used it as a training aid when teaching young lieutenants to consider the ramifications of their actions while performing alert duties.

projected their own understanding of deterrence onto the Soviets, believing them to be rational and not inclined to seek nuclear war. The basis for this was the assumption that only mutually assured destruction resulted from a nuclear war, meaning that limited nuclear conflict was not possible, and any sane opponent would avoid it. By the mid-seventies, a competing argument considered that even if the Soviets might not desire it, they believed that they could fight and win a nuclear war, no matter how nasty it would be. Proponents of this interpretation argued that the Soviets had never accepted the idea of mutual deterrence and that their nuclear planning utilized the Clausewitzian perspective of war as an extension of politics, meaning that Soviet military doctrine did not distinguish between conventional and nuclear conflict, viewing them as coexisting on an escalating continuum of conflict. Thus, the Soviets' increasing quantitative superiority, rapidly improving counterforce targeting capabilities, and civil defense measures indicated preparations for at worst, a potential first strike and at best, a commitment to survive a nuclear conflict. The aggressive Soviet posture demanded an appropriate American response.¹²

The MX Missile and Soviet Strength

The air force had studied a larger, more powerful ICBM since the mid-sixties and had thoroughly considered mobility, but the hard and dispersed launch facility was the dominant--and successful--technological pattern of ICBM deployment. Continuous

¹²Richard Pipes, "Why the Soviet Union Thinks It Could Fight and Win a Nuclear War," *Commentary* 64 (July 1977), 21-34; Colin S. Gray, "Nuclear Strategy: The Case for a Theory of Victory," *International Security* 4 (Summer 1979), 55, 57, 61-65; Colin S. Gray, "Strategic Stability Reconsidered," *Daedalus* 109 (Fall 1980), 140-144; Jan M. Lodal, "Deterrence and Nuclear Strategy," *Daedalus* 109 (Fall 1980), 158-164.

upgrades to the Minuteman had made it an extremely capable weapon system, and to argue for a new ICBM when confronted with Minuteman's success worked against air force desires because it simultaneously argued the conflicting points of the viability and vulnerability of its premier ICBM. Furthermore, doing so in a bureaucratic context of shrinking budgets risked the loss of funds. The intellectual fabric that wrapped the quest for a new ICBM was torn, and Janus-faced, the situation profoundly influenced deterrence and arms control stability. From a technological perspective, the major rent separated the missile's offensive strike and defensive survival capabilities that determined missile form and basing mode and from a political perspective, the break lay between desires for arms control and presenting the electorate with clear evidence of at least nuclear parity with the Soviet Union. When the air force had planned mobile Minuteman, such concerns did not restrict weapon system designers.

The new ICBM, designed for offensive punch and defensive survivability, was called MX, short for Missile-X. Despite claims that it had descended from various analyses, a long line of studies, including the Golden Arrow ICBM-X, WS-120A, and Strat-X advanced ICBM, had influenced thought on a new long-range missile. The weapon that emerged followed the technological pattern of the Minuteman III, but its capabilities far exceeded those of the earlier missile. In November 1971 (before the SALT I agreements), the MX program began formally when the air force issued a requirement stating that "to offset future Soviet ICBM capabilities, a new ICBM would have to be developed to improve the survivability, accuracy, range, payload, and target flexibility of the U.S. ICBM force." Although the program did not begin with any particular deployment concept, from the outset the principle for achieving greater

survivability was to move the missile so that its location remained unknown. The program's objectives required improving the ICBM's offensive capabilities and survivability while retaining its traditional advantages of quick reaction, high accuracy, and robust C3.¹³

Beyond representing a simple Pentagon grab for more weapons, these desires were consistent with the upgrades to the Minuteman III and were consistent with growing concern over ICBM survivability and offensive capability. Despite this, Secretary of Defense Laird's report to the Senate on the FY 1973 defense budget (prepared on February 8, 1972) did not mention the new ICBM, an acceptable omission because at this moment, the program consisted of studies internal to the air force not yet deemed worthy of mention, particularly in light of the administration's détente efforts. Nonetheless, by May 1972, the month of SALT I, AFSC commanding General George S. Brown publicly supported a new ICBM, but coyly stated that he "saw no pressing need to pursue an effort comparable to the navy's top-priority" Trident. Brown admitted that the air force had underway a preliminary search for "viable options and concepts" that could be ordered into production when necessary, emphasizing that he was "not out fishing for a new ICBM" because the Minuteman III was a "brand new weapon . . . performing far better than we anticipated [and] has enormous growth potential." He stressed that the nation needed research on a new ICBM because President Nixon had told the military that he "must not be limited . . . to the indiscriminate mass destruction of enemy civilians as the sole possible response to challenge." What Brown meant was that he did not know if in

¹³BMO, "M-X Program Management Plan, June 21, 1982," 1-3, unaccessioned, unclassified collections. BMO box D-30, AHFRA; Gibson, *Nuclear Weapons of the United States*, 29. See also Lauren H. Holland and Robert A. Hoover, *The MX Decision: A New Direction in U.S. Weapons Procurement Policy?* (Boulder, CO: Westview Press, 1985), 124-128.

the future whether Minuteman III would survive to provide the accurate counterforce capability that Nixon required.¹⁴

Accuracy worked hand-in-hand with survivability, and Brown understood that it was only a matter of time before the Soviet Union's ICBMs were accurate enough to ensure destruction of their American counterparts. Since the sixties, AFBMD and Aerospace had proposed mobile ICBM deployments relying upon concealment and deception as exemplified by Minuteman multiple pool basing, triggered random mobile, and other similar concepts. These nuclear shell games multiplied "the number of the attacker's aim points" and forced the enemy to waste weapons in attacks on empty launch sites. Designing such a system was not simple, and a number of engineering problems had surfaced, one of which was the design, construction, and operation of a transporter launcher speedy enough to get away from an incoming reentry vehicle. Because of the apparent difficulty in transporting a land-based ICBM, General Brown admitted that the air force had undertaken "a number of conceptual studies of other mobile systems including air mobile."¹⁵

When Brown spoke, Nixon was in the process of rethinking American nuclear weapons employment policy and wanted to preserve his options on the use of nuclear weapons to avoid hollow threats of mutually assured destruction. Clearly, an American

¹⁴Edgar Ulsamer, "Strategic Options and Total Force Concepts, Interview with AFSC's Commander," *Air Force Magazine* 55 (May 1972), 39-40. General Brown had an eventful career. A World War II veteran who won a Distinguished Service Cross for a mission over Ploesti, he was a successful numbered air force commander, an assistant to Secretary of Defense McNamara, the air force's Chief of Staff, and in 1972, he became the Chairman of the Joint Chiefs of Staff. In this role, he experienced the fall of Vietnam, SALT II negotiations, the *Mayaguez* incident, and even found the time to deliver a handful of speeches deemed as "anti-Israel." Having survived so much, in late 1978, he succumbed to cancer. No satisfactory full-length biography exists for this interesting man. See Brown's official air force biography, available at <http://www.airpower.maxwell.af.mil/airchronicles/cc/brown.html>, accessed on January 25, 2005.

¹⁵*Ibid.*

president would not launch all of his ICBMs because the Soviets had detonated a single battlefield nuclear weapon. The response was inappropriate and the risk too great. By 1974, three years after the official start of the MX program, high-level government guidance on how to plan a limited nuclear war existed in the form of National Security Decision Memorandum (NSDM) 242. The memorandum directed that in the event of nuclear war, “the most critical objective is to seek early war termination, on terms acceptable to the United States and its allies, at the lowest level of conflict feasible. This objective requires planning a wide range of limited nuclear employment options . . . to control escalation.” Although the White House did not issue NSDM 242 until January 1974, this statement summarized years of thought on this issue. Because Nixon wanted the air force to generate additional limited nuclear options beyond those done during the McNamara era, Brown had a valid concern about having surviving weapons to fulfill that role.¹⁶

Despite the anesthetized language of NSDM 242, the concepts of a limited nuclear attack and escalation control were at best rhetorical. Consider what would happen if the Soviets had launched a counterforce strike against selected American military installations. Even if the Soviets had not intended to destroy American society, their attack would have caused large numbers of casualties because many American military facilities were near civilian populations, and the attack would have destroyed those cities. It was impossible to confine the effects of detonating nuclear weapons solely to collocated military targets, making the pressure on a president to respond in

¹⁶Terriff, *The Nixon Administration and the Making of U.S. Nuclear Strategy*, 51-96. Escalation control of nuclear conflict was a subject of intense interest during the Nixon and Carter administrations. See also Senate Committee on Foreign Relations, *Nuclear War Strategy*, 96th Cong., 2d sess., September 16, 1980, 4-9.

kind immense. If he wanted to attack Soviet military targets such as their remaining ICBMs or bomber bases, he had to consider that the use of the American nuclear arsenal risked another Soviet attack. To prevent further escalation of the war, the American counterattack had to communicate clearly American intentions that the response did not target the bulk of Soviet society. To provide him with the necessary flexibility, Nixon wanted, in addition to the larger SIOP, a preplanned and clearly defined but limited in scope set of nuclear responses that lessened the risk of mutually assured destruction. Accurate counterforce targeting using smaller-yield weapons that could survive a Soviet first-strike was necessary, and with Minuteman's future survivability in question, only a new ICBM designed for the new strategic environment would fulfill that role.¹⁷

The MX was designed to fulfill Nixon's desires, and it featured new propulsion stages, guidance, and reentry vehicles. Like the Minuteman III, the MX was a four-stage rocket of which the first three stages were solid-fueled and the fourth a liquid-fueled post-boost vehicle. MX used more powerful solid fuels and lighter materials for its motor casings than the Minuteman. In-flight extendible engine nozzles optimized motor performance for the differences in exhaust plume expansion at changing altitudes and shrank the rocket's length to seventy feet. Design choices such as these ensured that the

¹⁷Casualty estimations for nuclear conflicts varied as widely as did opinions on the validity of limited nuclear conflict. A useful study is Office of Technology Assessment, *The Effects of Nuclear War* (Washington, D.C.: Government Printing Office, 1979), 85. See also Senate Committee on Foreign Relations, *Effects of Limited Nuclear Warfare: Possible Effects on U.S. Society of Nuclear Attacks Against U.S. Military Installations*, 94th Cong., 1st sess., 1975, 1, 3, 7-11, 20-21, 29-31. Any nuclear attack would have resulted in widespread destruction and death. The ability of any society to cope with immediate losses on such a scale is questionable, particularly given the historical experiences in responding to more localized natural disasters that lacked the after-effects of nuclear detonations, including Hurricane Katrina. Nonetheless, some persons believed that recovery from such a war was possible. One correspondent to *AWST* wrote that "extensive studies have shown that even in massive attacks on the U.S., about half of the population would survive. Furthermore, sufficient industry and other sources would remain to permit the survival and recovery of the nation." See Richard L. Goen, "Nuclear Survival," *AWST* 97 (November 6, 1972), 62.

missile fit into existing Minuteman launch facilities. In its final form, the ninety-two inch diameter MX weighed more than 192,000 pounds, nearly 114,000 pounds more than Minuteman III but significantly less than ICBM-X or WS120A. It did not have the tapered appearance of a Minuteman. Whereas the Minuteman III carried three reentry vehicles, the MX typically carried ten, and depending upon the mass of the warheads, it could carry as many as twelve. To improve accuracy even more, the air force wanted a new reentry vehicle, the Mark 12A.¹⁸

The MX guidance assembly and computer held many more prestored target sets, each with enough data to direct as many as twelve warheads to their targets. The computer possessed 12,000 words of read-only memory, 16,000 words in a core memory for ground computations, and 4,000 words of programmable plated wire memory for protection against electromagnetic pulses. Simultaneous functions included status monitoring, guidance platform calibrations and alignments, prelaunch sequencing, and flight control, and the MX could align to a newly changed target faster than a Minuteman. Rather than gimbals, the MX guidance set, affectionately termed the "beryllium baby," contained gyroscopes and accelerometers within a sphere, which floated on a fluid and was held inside another sphere. The "floated ball" was ten inches in diameter, and the entire package weighed a mere 115 pounds. Moreover, the beryllium baby did not require the time-consuming calibration and alignments needed by

¹⁸Gibson, *Nuclear Weapons of the United States*, 29. Donald E. Fink, "Minuteman Experience Aiding MX," *AWST* 105 (July 19, 1976), 119.

Minuteman, which not only increased the missile's wartime usefulness but decreased its peacetime off-alert time, which helped the air force to tout its ICBM readiness rates.¹⁹

Designed to have accuracy twice that of the Minuteman III with a CEP of .06 nautical miles, MX's specifications made it a potent first-strike weapon, even without consideration of its basing mode. Such characteristics also made the MX an arms control and stability chimera. On one hand, an argument held that these capabilities were destabilizing because they provided an incentive for the Soviets to attack American missiles via a first strike. In short, they had to target the MX because of its accuracy. On the other hand, a counter argument contended that these capabilities were stabilizing because if the Soviet attack failed, the surviving MX retaliatory strike would be devastating. The debate hinged on missile survivability because if deployed in non-survivable launch facilities, the Soviets could contend that the United States built MX solely as a first-strike weapon because it had to "use it or lose it," but if deployed in a survivable mode, the MX provided a second-strike deterrence force capable of striking with high accuracy.²⁰

¹⁹MX on-board computer described in Barry Miller, "MX Guidance Elements in Development," *AWST* 105 (December 13, 1976), 69 and Bruce A. Smith, "MX Missile Performance, Throw Weight Improved," *AWST* 112 (June 16, 1980), 131. "Beryllium baby" data from Mackenzie, *Inventing Accuracy*, 216-224; physical characteristics from Alton D. Slay, "MX, A New Dimension in Strategic Deterrence," *Air Force Magazine* 59 (September 1976), 47. Lieutenant General Alton D. Slay was the air force's Deputy Chief of Staff for Research and Development at Headquarters Air Force. Martin Marietta was the prime contractor for the MX missile.

²⁰MX CEP from MacKenzie, *Inventing Accuracy*, 167. Art Hobson estimated MX's CEP at 90 meters. See Art Hobson, "Minuteman/MX System: Becoming Vulnerable," in Levi, Sakitt, and Hobson, *The Future of Land-Based Strategic Missiles*, 132. On stability, see OTA, *MX Missile Basing*, 29 and John D. Steinbrunner, "National Security and the Concept of Strategic Stability," *The Journal of Conflict Resolution* 22 (September 1978), 411-415, 426-7. The procurement history and politics associated with the MX were a topic of extensive contemporary examination. For differing opinions on the validity of arguments for and against the disruption or provision of arms race stability as related to the MX, see Holland and Hoover, *The MX Decision* and Colin S. Gray, *The MX ICBM and National Security* (New York: Praeger Publishers, 1981) 3-42, 119-122; Robert A. Hoover, *The MX Controversy: A Guide to Issues and References, Guides to Contemporary Issues*, ed., Richard Dean Burns (Claremont, CA: Regina Books,

By March 1974, the air force had convinced national leaders that it needed the MX. In reference to the SALT I agreements, Secretary of Defense James Schlesinger informed Congress that the Soviets were “determined to exploit the asymmetries in ICBMs, SLBMs, and payload we conceded to them at Moscow. Apparently, they are considering the deployment of large numbers of heavy and possibly very accurate MIRVs. . . . [that] in time could come to threaten both our bombers and our ICBMs.” Furthermore, Schlesinger claimed that the scope of the Soviet buildup was “far more comprehensive than estimated even a year ago.” Alarm was in the air because “the new Soviet ICBM program represents a truly massive effort--four new missiles, new bus-type dispensing systems, new MIRVed payloads, new guidance, new-type silos, new launch techniques, and probably new warheads.” Such rhetoric played into the air force’s hand.²¹

The Soviet buildup was indeed sobering. True, the Soviets faced an additional threat of Western European intermediate-range nuclear forces that they countered with a range of complementary weapons. Nonetheless, in the strategic competition with the United States, the Soviets sought to move “beyond parity.” The third generation of Soviet ICBMs employed upgraded liquid-fuel systems and improvements to their hard and dispersed launch facilities. The R-36 had many versions, the most fearful of which was the more powerful and flexible R-36MUTTH (SS-18), for which the West granted

1982); Colin S. Gray, *Missiles Against War: The ICBM Debate Today*, Issues in National Security (Fairfax, VA: National Institute for Public Policy, 1985); Barry R. Schneider, Colin S. Gray, and Keith B. Payne, eds., *Missiles for the Nineties: ICBMs and Strategic Policy* (Boulder, CO: Westview Press, 1984); Herbert Scoville, Jr., *MX: Prescription for Disaster* (Cambridge, MA: MIT Press, 1981).

²¹Department of Defense, *Report of the Secretary of Defense James R. Schlesinger to the Congress on the FY 1975 and FY 1975-1979 Defense Program* (Washington, D.C.: Government Printing Office, 1974), 43, 45-46. Hereafter cited as *Schlesinger Report FY 1975*. Released on March 4, 1974, Secretary Schlesinger’s report preceded the Vladivostok Accord of November 1974.

the sobriquet of "Satan," an accurate categorization of an ICBM's destructive capabilities. The R-36MUTTH carried up to ten MIRVs, each with a yield of 550-750 kilotons. The UR-100 developed into multiple ICBMs, one of which became the MR-UR-100 (SS-17) that sported a solid-fuel post-boost vehicle and carried four MIRVs and the UR-100N (SS-19) that carried six 550 kiloton MIRVs. By focusing on improved guidance, accuracy, propellants, survivability, and MIRV, the Soviets qualitatively improved their forces in a similar manner to the Americans, while quantitatively outstripping them.²²

To counter this Red menace, Schlesinger noted that "we are considering the technologies for both a new large, payload fixed-base missile which could be launched from the existing Minuteman silos, and a new mobile missile, either ground or air launched." He noted that the Interim Agreement did not prohibit mobile ICBMs but that the United States had asserted that such weaponry was inconsistent with the agreement's objectives. Accordingly, he asked for \$37 million "for advanced technology leading to the development of an entirely new ICBM," adding that "we intend to pursue this new development at a very deliberate pace, pending the outcome of the current SALT negotiations." The secretary added that the money would lead to the "selection of the preferred basing mode, to guidance requirements which are unique to mobile missiles, both air-launched and ground-launched" and to the development of the propulsion and guidance necessary to "give the new ICBM a very good capability against hard targets." Clearly, the air force and DoD wanted a survivable ICBM with counterforce capability.²³

²²Zaloga, *The Kremlin's Nuclear Sword*, 135-149; Podvig, *Russian Strategic Nuclear Forces*, 212-217, 215-223.

²³Department of Defense, *Schlesinger Report FY 1975*, 56-57.

Basing the MX

As General Brown had indicated, land-mobile ICBMs were difficult to build, and as Secretary Schlesinger noted, thoughts of mobile ICBMs unnerved American arms negotiators. Meanwhile, within the air force support gathered for mobility. By 1973, Lieutenant General Otto J. Glasser, a Schriever protégé and an individual continually associated with air force research and engineering, had become the Deputy Chief of Staff for Research and Development. Glasser stated that “all our calculations lead to the conclusion that the most cost-effective way to achieve strategic deterrence is through proliferation” of aim points, a statement that suggested a deceptively-based land system. Surprisingly, he then added that “the obvious way to ameliorate future vulnerabilities of ICBM systems is to change from fixed hardened sites to mobile basing. It is equally obvious . . . that no mobile system shows greater operational and cost-effective advantages than an air-mobile strategic system.”²⁴

Glasser’s statement must have surprised those who in 1964 had reported that the Golden Arrow air-mobile ballistic missiles offered some advantages. Most important, Glasser and others believed that air-mobile platforms were achievable in the years 1975-1980, the earliest time of predicted Minuteman vulnerability. In contrast, industry insiders, including Lockheed Missiles and Space Company, believed that land-mobile basing modes required extensive development, which pushed their earliest deployment into the 1980s. Aside from an early deployment date, air-mobile missiles had other advantages over land-mobile systems, including alert scrambles that provided a faster exit

²⁴ Glasser quoted in Edgar Ulsamer, “M-X: The Missile System for the Year 2000,” *Air Force Magazine* 56 (March 1973), 39-40. Data on General Glasser from his official air force biography available at <http://www.af.mil/bios/bio.asp?bioID=5554>. Accessed on January 26, 2005. See also “USAF Hopes to Press Advanced ICBM,” *AWST* 100 (February 11, 1974), 60.

from predicted impact zones and the possibility of recalling the attacking aircraft before missile launch, which was an important consideration if a false alarm necessitated a scramble. Another potential advantage was a missile size decrease. Because the carrier aircraft lifted the missile into the air to approximately 30,000 feet, the missile required less fuel. These advantages appealed to a service still wedded to long-range strategic bombers.

In 1970, Lockheed Missiles and Space Company, manufacturer of SLBMs and other military equipment, hoped to entice the air force with an unsolicited proposal to deploy navy Poseidon missiles from the air force's giant C-5 transport aircraft that it also built. Believing this was achievable by the mid-seventies, Lockheed minimized cost and engineering development by limiting changes to both C-5 and missile. To carry the missile, engineers designed a platform module that cradled a Poseidon SLBM and its launch support equipment. The C-5 flew to launch altitude and performed a conventional airdrop parachute extraction of the horizontal missile and platform, which, upon release, jettisoned from the now upright Poseidon. With the aircraft a safe distance away, the missile motor ignited. The C-5A could carry three Poseidons, each of which carried three MIRVs. Although air dropping ballistic missiles was technically feasible, achieving counterforce accuracy with this deployment required improved and unavailable guidance systems. Lockheed had developed a slick proposal for its air force aircraft and a navy missile, and although the blue suits were not interested in Poseidon, they were interested in air mobility.²⁵

²⁵Lockheed Missiles and Space Company, "The Greyhound Concept" (Sunnyvale, CA: 1970), 1-1 to 2-14, unaccessioned, unclassified collections. BMO box B-62, AFHRA.

By 1975, many proposals for ALBMs existed, including some similar to the Golden Arrow air-transportable missile system, and many with aircraft larger than the Golden Arrow long-endurance aircraft. At a meeting of the American Institute of Aeronautics and Astronautics (AIAA), Ben T. Plymale, vice president and general manager of space and missiles for the Boeing Company, a Lockheed competitor, briefed the gathering on four types of aircraft. The first was a 747-based system known as the MC-747. A derivative of the new wide-body jet's cargo version, the aircraft carried four 100,000-pound ICBMs (heavier than a Minuteman III) or eight 50,000-pound class missiles. The air force had studied previously missiles of that class. A fuselage bomb bay opened to release the missiles. Designing a bomb bay and managing such massive weapons on large aircraft was a difficult engineering proposition; a 1975 TRW analysis of a Lockheed proposal to modify a C-5A with a bomb bay concluded that "severe limit and aft structural problems are envisioned in the supporting and launching of a large, heavy missile located so very far aft." Also required were a fleet of support tankers that Boeing desired to make out of 747s. The numbers of aircraft and missiles required varied, but Boeing suggested an alert force of twenty-five MC-747s out of a total fleet of thirty-six such aircraft supported by twelve tankers.²⁶

²⁶On converting large aircraft into missile bombers, see W.G. Korner to A. Dean, TRW Interoffice Correspondence, "Simulated Bomb Bay Drop of a Missile from the C-5A Aircraft, August 4, 1975," 1-2, unaccessioned, unclassified collections. BMO box B-60, AFHRA. Details on numerous air-mobile aircraft are contained in Aerospace Corporation, "M-X Program Aircraft Design Study for Airmobile Missile System" (El Segundo, CA: The Aerospace Corporation, 1973), unaccessioned, unclassified collections, BMO box B-61, AFHRA. Another useful summary is SAMSO, "MX Air Mobile Third Initial Screening Meeting Minutes, December 19, 1973," slides 1-49, unaccessioned, unclassified collections. BMO box B061, AFHRA. On the MC-747, see Boeing, "747 M-X Air Mobile System Concept, September 1973," 6, 8, 10-11, unaccessioned, unclassified collections, BMO box B-63, AFHRA. See also "USAF Hopes to Press Advanced ICBM," 60; "USAF Pushes Advanced ICBM Studies," *AWST* 101 (July 15, 1974), 100.

Soon, other manufacturers touted their wide-body jets for this mission, including the McDonnell Douglas DC-10. Lockheed also envisioned using the C-5 in a mission similar to the air-transportable weapon system, that is, the transports would deploy to a forward location and transporter launchers would drive off the aircraft to conduct a missile launch. Even more esoteric proposals included the use of heavy-lift helicopters, short-takeoff-and-landing aircraft, rocket or space shuttle boosted weapons, missiles carried onboard towed gliders, stretched FB-111s, or the yet-to-be deployed B-1 bomber. One upstart company proposed a craft that combined lighter-than-air technology and traditional wings. The Goodyear Company felt that either blimps or rigid airships made satisfactory missile carriers, but leaned towards a rigid frame that simplified construction but added expense. Ground handling procedures for such a vehicle were not difficult but maintaining even buoyancy was. When an airship released a massive ballistic missile, it rapidly gained altitude, which required venting helium at a compensatory rate simultaneous with missile release. Airships were also slow. By 1976, citing low technical feasibility and threat survivability, the air force rejected lighter-than-air craft for MX air-mobile deployment.²⁷

²⁷Lockheed-Georgia Company, "Air Mobile/Ground Launch: A Survivable ICBM Operational Concept, November 1975," 1-6, unaccessioned, unclassified collections. BMO box B-62, AFHRA. One year later, Lockheed marketed this idea as "Air Movable/Ground Launch: A New Minuteman Operational Concept, September 1976," unaccessioned, unclassified collections. BMO box M-11, AFHRA. On airships, see W.G. Korner to A. Dean, TRW Interoffice Correspondence, "MX Program-Trip Report to Goodyear Akron, June 4, 1974, 1-4, and J. M. Schwarzbach to I. J. Adleson, TRW Interoffice Correspondence, "Trip Report-NASA Ames Feasibility Study of Modern Airships Phase II and WPAFB MX Airborne Missile Launch System Studies and Analyses Coordination, June 3, 1976," 1-4. For gliders and tow aircraft, see R. A. Lahs to W.R. Williams, TRW Interoffice Correspondence, "Preliminary Design Performance Analysis for a Proposed MX Towplane/glider System, July 11, 1974," 1-11. Airship and glider memos from unaccessioned, unclassified collections. BMO box 106, AFHRA. See also "Heavy-Lift Platform for ICBM Studied," *AWST* 102 (March 3, 1975), 12.

From the air force studies, various types of new advanced aircraft emerged as potential missile carriers, some with four and others with six-engines. These included a high-wing, four-engine model with a takeoff weight of 1.2 million pounds, internal missile stowage, and limited fifteen-hour endurance. A six-engine version weighing 1.8 million pounds carried the ALBMs in wing-mounted pods. Another Boeing proposal was a high-wing seaplane. This aircraft would launch from a land SAC base and deploy to points as far as 4,000 nautical miles from its home. Hiding in isolated waterways and hoping that the Soviets did not notice the aircraft provided survivability. The navy previously had examined a similar concept, but tight fiscal constraints forced a 1959 decision to cancel the project. Other proposals included exotic-fueled aircraft relying upon liquid hydrogen and nuclear power. Whatever the type of aircraft, the air-mobile concept shared similar strengths and weaknesses with the bomber force. Nonetheless, in early 1974 an air force-commissioned study concluded that "a continuous air mobile system is reasonable and achievable when compared with current and forecasted air carrier and military fleet operations."²⁸

The variety of proposed aircraft illustrated the high-level air force enthusiasm for ALBMs, which sprang partly from overemphasizing their aircraft-like operations, but there were problems. Glasser described how launching "outside the enemy's detection range" precluded detection of the attacking aircraft, but that advantage was inherent to cheaper land-based systems or air-launched cruise missiles, although an ALBM flew

²⁸TRW, "MX Air Mobile Activities, February 15, 1974," unnumbered conclusion page (original missing intervening pages), unaccessioned, unclassified collections. BMO box B-61, AFHRA. Boeing seaplane information in "USAF Hopes to Press Advanced ICBM," 60. Additional seaplane information from is SAMSO, "MX Air Mobile Third Initial Screening Meeting Minutes, December 19, 1973," 34-39. On the navy's Seaplane Striking Force, see William F. Trimble, *Attack from the Sea: A History of the U.S. Navy's Seaplane Striking Force* (Annapolis, MD: Naval Institute Press, 2005), 131-135. See also Jeffrey M. Lenorovitz, "Air Force Restudying MX Basing Plan," *AWST* 110 (January 29, 1979), 21.

much faster than the latter. He postulated that a carrier aircraft that “doesn’t do much more than lift the missiles off the ground and circle around North America,” provided a “zero reaction time,” but the existing ICBM force already provided a “zero reaction time” without needing carrier aircraft. He also contended that studies showed that it was possible for an air-mobile force to survive a surprise attack, even if caught on the ground, but such survivability was no better than that of the bomber force.²⁹

Glasser stated that “the costliest way to transport payloads is by rocket power,” by which he meant that it was more expensive per pound to transport reentry vehicles by ICBMs than it was to do so with an airplane that transported “its missiles for an extra 2,000 miles or so by the more economical jet power.” In terms of simple cost per pound per mile, he was correct but only by virtue of oversimplifying the problem. He had stacked his cost-projection cards in favor of aircraft and overlooked the procurement, operations, training, personnel, maintenance, and sustainment costs of an air-mobile system. Solid-fueled ICBMs such as Minuteman cost less to procure, operate, and maintain than a fleet of aircraft. The cost benefits of such an argument had to address responsiveness, and on this point, he recognized that a 2,000-mile flight to a launch point took longer than the entire thirty-minute ICBM flight time from launch to warhead impact.

Aircraft were not immune to Soviet attacks, and the threat to nuclear alert aircraft was not the ICBM but the SLBM whose less accurate warheads were sufficient to destroy large bomber or ALBM bases. Because a submarine moved close to its target, SLBMs had short flight times of fifteen-minutes or less, which dramatically decreased reaction

²⁹Ulsamer, “M-X: The Missile System for the Year 2000,” 40.

time and put a premium on aircraft alert readiness and warning. Moreover, if aim point proliferation was the key to ICBM survivability, basing ballistic missiles on aircraft merely added to the standoff attack capabilities of the bomber fleet and did nothing to improve ICBM survivability. Any air-based ballistic missile system duplicated the limitations of the bomber force, including a slower reaction time and less accuracy than ground-based ICBMs. Lastly, the air force's enthusiasm for this idea ignored the 1962 rejection of the Skybolt ALBM system. Glasser said that he supported an ALBM but equivocated by asserting that the "best option, in case we decide to build an air-mobile system, would be to use it to augment the already existing force."³⁰

To ensure accurate weapons delivery, an ALBM's inertial guidance system required a time-sensitive update of its present location. If a missile launched shortly after its carrier aircraft took off, the problem was not too severe, but due to gravity model uncertainties, the longer the aircraft flew, the more significant the error became. To solve this, General Glasser favored stellar updating, that is, a process in which after launch, the missile would sight a known star as a reference point and then make course corrections based on a comparison of the star's actual and predicted positions. He pointed out that "we know that this is possible," because the navy planned to use stellar-inertial guidance for its Trident missiles, but air force ICBMs relied upon pure inertial guidance and never used stellar-updating. Guidance engineers knew that air-launched ICBMs demanded supplemental guidance beyond star tracking. In an air-launch mode, unaided inertial systems such as the MX guidance set would demonstrate inaccuracies of thousands of feet "in a fraction of an hour of cruise time." SLBMs had a lesser problem because of

³⁰Ulsamer,"MX: The Missile System for the Year 2000," 39-40.

their shorter ranges, but the longer ICBM trajectories multiplied the effects of guidance errors. Stellar updating reduced the error by approximately 70 percent, but without vastly improved gravity maps covering every possible aircraft launch point or external aid, ICBM counterforce accuracy was unobtainable. One possible solution was supplemental position and velocity data from an aircraft-mounted Doppler and altimeter radar, but engineers found this approach to have a minor effect on accuracy no better than stellar updating. The best solution appeared to be either use of a space-based global positioning system or ground-based stations similar to the radio network that early ICBMs used, but space-based weapons guidance was years away and the accuracy provided by ground-based stations approached but did not equal that of an inertially-guided ICBM. In any case, sufficient ALBM accuracy demanded a specific solution that integrated a variety of approaches.³¹

Besides guidance, one of the thorny problems associated with air mobility was the separation dynamics of missile deployment from the aircraft. Upon release, the missiles had to maintain a steady orientation so that the inertial guidance platform could align correctly to its target. To help solve this problem, the air force conducted a series of drop tests. In September 1974, a C-5A transport aircraft dropped a series of inert missile shapes. The incremental test program flew ten flights, and the first seven dropped "bathtubs," that is, concrete slabs of increasing size and weight up to 86,080 pounds. The eighth drop tested the separation dynamics of a training missile from the platform cradle, and the ninth released an inert missile with active guidance and control systems. Last

³¹Ibid., 39; Gibson, *Nuclear Weapons of the United States*, 38. On ALBM accuracy, see G. B. Green and L.N. Jenks, "Guidance System Application to Missile Basing Alternatives" (Los Angeles: SAMSO and TRW, 1980, photocopied), 3-8, unaccessioned, unclassified collections, BMO box B-3, AFHRA.

was the drop and firing of a fueled missile, which occurred on October 24, 1974, from an altitude of 20,000 feet. The Minuteman fired its first stage, but the ten-second burn was considerably shorter than a typical test flight. The tests had demonstrated the feasibility of air launching an ICBM, but despite the considerable enthusiasm, much work was required to validate air-mobility as a viable basing concept. Despite further intensive studies, the air force never would deploy an air-mobile ICBM.³²

At this stage of the MX program, air-mobility was something of a darling, but the air force did not ignore studies of land-mobile systems. General Glasser believed that three types of land-mobile systems held promise, including an off-road system that "wanders around the countryside," which was particularly costly and required a special transporter. He described a shell game based on multiple shelters between which a lesser number of missiles moved--also expensive because each shelter had its own launch crew. Another idea was a "garage" system. Here, a missile storage center was located at the hub of a huge wheel with thirteen garages at the end of each spoke. Upon notification of an attack, a launch crew and missile rushed from the central hub to one of the garages. The enemy did not know which garage contained the missile; thus, he had to target all of them. The hub and spoke provided multiple aim points and minimized cost by maintaining crew facilities only at the central hub. At this time, the air force ignored

³²SAMSO, Minuteman System Program Office, "Summary Report: Advanced ICBM Technology Program Air Mobile Feasibility Demonstration, December 18, 1974," 1-16, unaccessioned, unclassified collections. BMO box B-60, AFHRA. Daniel J. Kolega and James E. Leger, "Airborne Minuteman," in *AIAA 5th Aerodynamic Deceleration Systems Conference, Albuquerque, New Mexico, November 17-19, 1975*, by the American Institute of Aeronautics and Astronautics (New York: AIAA, 1975), 1-8. See also Cecil Brownlow, "USAF Weighs Delivery Modes for MX Advanced ICBM Use," *AWST* 99 (September 1973), 16; "Drop of Minuteman by C-5A Tests Air-Mobile ICBM Concept," *AWST* 101 (November 11, 1974), 20-21; Department of Defense, *Report of Secretary of Defense James R. Schlesinger to the Congress on the FY 1976 and Transition Budgets, FY 1977 Authorization Request and FY 1976-1980 Defense Programs* (Washington, D.C.: Government Printing Office, 1975), II-28 to II-29.

train-based systems, possibly because it feared a negative public reaction in an era of increased environmental awareness. None of these ideas was new. Continuous road-mobile, garages, and triggered random-mobile concepts had existed since the mid-sixties.³³

Speaking before a California audience at a May 1974 Air Force Association convention, air force General Samuel C. Phillips assured listeners of ICBM invulnerability, but he did not oppose the acquisition of a new missile. A respected man whose successful career included managing the Minuteman and Apollo programs, Phillips told his audience that “85 to 90 percent of the Minuteman force would survive a nuclear attack,” but despite upgrades, Minuteman would not be invulnerable forever. When Phillips had finished, Lieutenant General Kenneth W. Schultz, his subordinate and commander of SAMSO (Phillips’s old stamping grounds), took the floor to recommend a new ICBM designed to “go into silos but at the same time give us the option to shoot it from a truck or other mobile launcher . . . or most important, to launch it from an aircraft.” Schultz echoed Glasser’s earlier comments. He stated that an airborne system was impossible to hit from 5,000 miles distance, and noted that “it shouldn’t be necessary to put the missile-launching aircraft into the air until somebody starts launching ICBMs at it.” Advocating a launch-on-warning posture, Schultz felt that such an approach was survivable because the only way to assure its defeat was through barrage bombing. Area bombing required a large number of warheads; thus, survivability hinged on the Soviet’s unwillingness to build enough bombs and missiles to create the pressures necessary over large geographic spaces to destroy the aircraft. Believing that a mix of fixed-site and air-

³³Ulsamer, “MX: The Missile for the Year 2000,” 42.

mobile ICBMs was the best force, Schultz stressed that “we need a new, airborne system” compatible with the current Minuteman.³⁴

Despite the air force’s enthusiasm, the DoD voiced a cooler opinion. In his 1976 annual report to Congress, Secretary of Defense Schlesinger agreed that a new ICBM was necessary to fulfill counterforce planning for limited nuclear options, but he also felt that the fixed-site Minutemen were basically invulnerable. He equivocated by admitting to the possibility of future vulnerability and tempered his words on mobile missiles. Unlike the air force generals, Schlesinger reported that the air-mobile system “would be the most expensive to acquire and operate.” He did not like deceptive sheltering, contending that while such a “system would retain the accuracy of a silo-based system, its costs and operating problems are immediately apparent.” Because he was unconvinced that the launch facilities were vulnerable, he proposed that MX “be deployed in the existing Minuteman silos, since that is the least expensive mode, until such time as the threat to those silos has been definitely ascertained.” This position merely pushed the problem down the road. He believed that “the economic feasibility of all three mobile systems needs a great deal of additional study,” and for the time being, the air force made temporary plans to base part of the MX force in existing launch facilities.³⁵

Early indecision had caused programmatic instability, leaving MX’s basing mode undecided after years of work. Despite the numerous studies on mobile ICBMs and force survivability that dated back to the fifties, leadership vacillated on how to base the

³⁴Edgar Ulsamer, “Our ICBM Force: The Vulnerability Myth,” *Air Force Magazine* 57 (August 1974), 65-69. The Air Force Association symposium occurred at Vandenberg Air Force Base. Its attendees included present and former air force, navy, and army nuclear force planners, including retired air force General Curtis LeMay. Over 600 industry executives and civic leaders attended the two-day event. On the vulnerability of ALBMs to barrage attacks, see OTA, *MX Missile Basing*, 222-230.

³⁵Department of Defense, *Defense Report FY 1976 and Transition*, II-28 through II-29.

missile. Launch facility basing offered the hope of rapidly deploying the powerful weapon, and mobility provided survivability into the future, but no one agreed on how to do this. Planners retained air- and ground-mobile options, forcing missile designers to develop a rocket capable of operating in all three modes. In terms of the dollar cost, environmental issues, political worries of nuclear stability, arms control, and verification, no single option was perfect. Furthermore, the longer it took to decide upon a basing mode, the farther into the future moved the date at which an operational weapon system achieved its initial capability. Now that officials predicted an ICBM vulnerability window for the early-to-mid-eighties, they required a decision that allowed time to develop, produce, and deploy the new system. In contrast, five years after Minuteman became an official program, the air force had sorties on alert, and it had done so while developing three different ICBM systems. The MX seemed doomed to undergo study after study.

Colonel Donald R. Griesmer, director of the MX program office, explained some of the problems this indecision caused. By mid-1974, Griesmer's colleagues had moved the MX missile's configuration closer to its final ninety-two-inch diameter, but not until 1979 was the missile's size finalized. Because no one had selected a basing mode, they decided to canisterize the missile and to use a cold-launch ejection technique. Because the MX was too large to hot launch from a Minuteman launcher, canisterization was necessary, and a standard-size canister preserved mobile deployment options. Griesmer said that although the air force continued to study air-mobility, there was not sufficient money or time to evaluate carrier aircraft designs, an indication that air-mobility was falling out of favor. He added that many categories of land-mobile deployment remained

under review, including multiple shelters, deep pools of water, and a network of covered trenches in which transporters roamed. Common to all of these was deceptive movement or presenting the enemy with multiple aim points. Consistent with the earlier studies of ICBM survivability, he believed that the final decision on how to base the missile might be a mixture of hard and dispersed and mobile MX missiles.³⁶

During the Ford administration, MX had enjoyed enough political support to allow missile developmental work to proceed, even though the basing mode remained undecided. At first desiring to continue Nixon's arms limitations work, Ford concluded the Vladivostok Agreement with Soviet General Secretary Brezhnev and opened the way for continuing the SALT negotiations. In a December 2, 1974, news conference, Ford informed the nation that he and Brezhnev had agreed to limit the total of long-range bombers, ICBMs, and SLBMs to 2,400 per side. Furthermore, they had agreed that only 1,320 of each side's strategic weapons launchers could have MIRV capability. Ford and Brezhnev did not limit how many reentry vehicles a given platform could mount. Thus, this agreement placed a premium on survivable MIRV systems, and after concluding the agreement with the Soviets, Ford increasingly worried about Soviet intentions, as well as his electorate's opinion of the nuclear imbalance. His Secretary of Defense, Donald H. Rumsfeld, wrote that since 1965, the Soviets had developed seven new ICBMs to one for the United States, an inaccurate statement because the United States had deployed both Minuteman II and III. Nonetheless, Rumsfeld spoke for the administration when he

³⁶"USAF Pushes Advanced ICBM Studies," 101. At one point, Congress had desired that the air force and navy use a common missile for the new ICBM and Trident programs. Although such practice sounded effective on paper, significant differences existed between ICBM and SLBM design requirements. The resultant debate delayed a decision on the final size of the MX. The missile's size affected its throw-weight, guidance, and basing mode. See "Study Finds Joint MX/Trident Impractical," *AWST* 103 (October 13, 1975), 17. See also Edwards, *Superweapon*, 184-188.

asserted that “the Kremlin is behaving as though it is determined to increase Soviet military power whether we show restraint or not.” He believed that MX mobility was a potential wedge upon which to leverage a SALT II agreement with the Soviets, and he convinced the president that the program warranted increased support. Moreover, if American ICBM launch facilities were indeed vulnerable, the developmental work done for a mobile ICBM would pay dividends by shortening the time needed to introduce a better system. Three days before the inauguration of President Jimmy Carter, Ford urged the passage of a defense budget that included \$49 million to support “MX advanced development, particularly emphasizing mobile basing modes,” and an additional \$245 million to initiate engineering development and construction of missile prototypes.³⁷

Meanwhile in March 1976, the air force had convinced the Defense Systems Acquisition Review Council that the MX program was proceeding well enough to enter the program validation phase, an important milestone that allowed funding to build prototype hardware to permit the testing of critical components. This work was necessary to minimize technical and cost uncertainties and to demonstrate concept feasibility. It also lay the foundation to define the system’s deployment mode to refine its engineering development. Five years after the release of the MX operational requirements, the air tingled with optimism. To facilitate the plan to emplace the missile in existing Minuteman launchers, MX’s design ensured compatibility with the new Minuteman command data buffer system. Environmental and electrical support

³⁷Richard P. Stebbins and Elaine P. Adam, eds., *American Foreign Relations 1974: A Documentary Record* (New York: New York University Press, 1977), 513. Department of Defense, *Report of Secretary of Defense Donald H. Rumsfeld to the Congress on the FY 1978 Budget, FY 1979 Authorization Request and FY 1978-1982 Defense Programs* (Washington, D.C.: Government Printing Office, 1977), 10, 131.

requirements differed from Minuteman but did not necessitate major ground equipment modifications. The canister approach had proven its utility.³⁸

By October, three potential categories of mobile deployment modes were under consideration, including air mobile, continuous road- or off-road roaming missiles, and alternative mobile deployments based upon multiple aim points. Lieutenant General Alton D. Slay, the air force general in charge of research and development, commented that "reasons of cost, technical feasibility, public reaction, and vulnerability had eliminated the ground-based random movement concepts. It was impractical to haul a large ICBM over unimproved ground. The missile's size and associated launch equipment "might weigh 250,000 to 300,000 pounds, meaning a 500,000 to 600,000-pound road mobile vehicle. To distribute this weight . . . could require some twenty axles with eight wheels each, spaced eight feet apart for a total vehicle length of some 160 feet." Most states permitted a maximum load of 100,000 pounds (only with special permission), bridges and overpasses could not support the MX, and the height of the launcher was too much for existing underpasses. By 1981, the largest load moved by road was 335,000 pounds. Another worry was accidents, which would be disastrous in settled areas. Although a nuclear weapon would not detonate in a crash, solid fuel would burn furiously until spent and liquid-fueled post-boost vehicles contained toxins. As the air force had learned in its 1958 studies on Atlas and Titan mobility, big missiles were more difficult to move than were smaller ones.³⁹

³⁸BMO, "M-X Program Management Plan," 1-3 to 1-4; Fink, "Minuteman Experience Aiding MX," 119.

³⁹Slay, "MX, A New Direction in Strategic Deterrence," 47; OTA *MX Missile Basing*, 263.

The Evolution of Multiple Protective Shelters

When the defense review council approved MX for further development, the leading air-mobile concept was to place two MX missiles on board a “modified wide-body jet aircraft.” These aircraft would maintain a “flexible mode” of operations, in which a combination of airborne- and ground-alert aircraft blended high survivability with lower operations and maintenance costs. As international tensions increased, the aircraft would disperse from their main operating bases to “austere bases in the North Central U.S.” As nuclear force alert levels increased, more aircraft performed airborne alerts. The air force believed that this concept, which relied upon adequate strategic warning, provided “exceptionally high force survivability.” What Slay termed “alternative ground-basing concepts” remained under consideration, each a variation on the multiple aim point concept. A shell game of rotating a small number of missiles among a large number of shelters and the use of decoys confused the enemy. Because mobility-enhanced deception protected the missiles, multiple protective shelters (MPS) did not have to be highly hardened. Each shelter housed a missile and its launch equipment or was a decoy. As the threat grew with the number of Soviet missiles and warheads, the number of shelters increased, although the number of missiles remained more or less the same. Over the next several years, MPS-style deployments were central to mobile ICBM development.⁴⁰

One such MPS proposal was multiple pool basing. Similar to the 1966 Minuteman pool-deployment scheme, water protected a missile from radiation and provided concealment from infrared, visual, electromagnetic, and acoustic detection,

⁴⁰Slay, “MX, A New Direction in Strategic Deterrence,” 47.

while earthen barriers surrounded the pools to help protect against blast waves and intruders. Unlike the earlier Minuteman concept, roads, not canals, connected the launch pools. A special amphibious vehicle, the platform transporter, carried the missiles and randomly relocated them in the pools. Fully loaded, the 30-foot wide vehicles weighed 1.4 million pounds, rode a 110-foot wheelbase, and had a length of 153 feet. For protection and support, a 100-foot long, 670,000-pound platform contained the missile and its operational support and launch equipment, which rode on the platform transporter. The transporter drove into a pool and aligned with a set of vertical tracks, down which the mobile launch platform descended twenty-four feet to the bottom. The transporter maintained constant buoyancy by assuming the water displaced by the missile platform. When randomly moving about the pool complex, the payload transporter carried the displaced water to maintain the appearance of a fully loaded vehicle, and system design requirements necessitated that a missile move to a different pool within the flight time of a Soviet ICBM. During peacetime, an operations control center located on the main base controlled operations and monitored system status. In wartime, planners assumed destruction of the relatively soft control center; thus, higher authorities remotely controlled the system by a variety of redundant C3 means.⁴¹

Other applications of the MPS concept used not pools but horizontal or vertical shelters to house the missiles. The difference between the two was the ease of missile emplacement because it was faster and easier to transport and store a missile horizontally than it was to transport it, elevate it, and lower it into a vertical, underground shelter. As

⁴¹ William V. Coates, "MX Baseline Pool Based Weapon System Summary, January 1978," unaccessioned, unclassified collections. BMO box 106, AFHRA; TRW, "Earth Pool Weapon System Characterization Pool Basing, 20 March 197," unaccessioned, unclassified collections. BMO box 106, AFHRA. See also BMO, "M-X Program Management Plan," 1-5.

early as 1976, TRW had studied this scheme, and the air force was comfortable with vertical shelters because of its successful ICBM launch facility deployments. These vertical shelters were not hardened to the same degree as the SALT I-limited Minuteman launch facilities, and they looked too much like them, which raised Soviet suspicions. Also, no one knew how to move and rapidly emplace ICBMs in vertical shelters. One estimate held that it took fifty hours to shuffle randomly 200 missiles among 4,600 vertical shelters but that the same task took a few hours with horizontal shelters. In an MPS scheme, whether using horizontal or vertical shelters, decoy missiles roamed the complex to compound Soviet targeting even more. The early MPS schemes had two-person crews working inside mobile launch control centers and had manned transport vehicles to move them, the missiles, and decoys. Later concepts replaced the human crews with computerized and automated systems.⁴²

Another MPS scheme transported either Minuteman or MX missiles among thousands of additional launch facilities located throughout the Midwest, perhaps as many as twenty-nine launchers per missile. Such a system was not truly a mobile ICBM because it merely transported the missiles as covertly as possible between operational launch facilities and then required the time-consuming procedure of vertical missile emplacement. Missile transport would be difficult in the winter; blizzards could prevent missile repositioning or worse yet, strand missiles undergoing movement. Many details were unclear, but common to all of the MPS variations, transporters, security, daily

⁴²See TRW, "MX Ground Mobile System Shelter Based Option Summary Characterization, March 15, 1976," 1-51, unaccessioned, unclassified collections. BMO box 22, AFHRA. See also Jeffrey M. Lenorovitz, "Air Force Eyes ICBM Basing Options," *AWST* 109 (August 28, 1978), 18-19. Time estimate for missile shuffling from Clarence A. Robinson, Jr., "MX Racetrack Questioned in Congress," *AWST* 111 (November 12, 1979), 17.

operations, weather and maintenance were challenges. Another problem was that the Soviets might build more missiles and reentry vehicles to cover the proliferated targets. Nonetheless, many such concepts enjoyed short moments of ascension.⁴³

Amid the multitude of MPS-like deployment concepts, support gathered for the “continuous hardened underground facility or trench” which placed 300 missiles underground within a buried, contained, and dedicated transportation network that eliminated many of the problems associated with above-ground MPS deployments. Originally proposed by TRW, the buried trench concept marked the return of trains as potential mobile ICBM bases, but with a twist. The buried trench was in effect a subway, an underground basing system for a mobile missile launch vehicle that ran in a shallowly buried tube to conceal its movement. Each missile moved in an eleven-nautical-mile tube with preselected stopping points established every half mile. Considering that hundreds of missiles could have been required, constructing the tunnels would have been a monumental project. Because they were buried five-feet below the surface, destruction was certain within a reentry vehicle impact crater, but a series of explosive tests conducted by the air force and the Defense Nuclear Agency confirmed the tunnel might survive a near miss. The tunnels had an inside diameter of thirteen feet with a sixty-four-inch-wide flat bottom. This size, based upon the as-yet undecided final diameter of the MX missile, permitted adequate “rattle space” in the event of an enemy attack. Built out of steel and glass fiber-reinforced concrete, the tunnels rippled with six-inch-high, two-foot wide internal protrusions spaced five feet apart. These ribs attenuated the strength of

⁴³Edward W. Bassett, “MX Missile, Vertical Shelters Urged by U.S. Defense Chief,” *AWST* 109 (July 31, 1978), 15; See also Strobe Talbott, *Endgame: The Inside Story of SALT II* (New York: Harper and Row, Publishers, 1979), 168-171.

an airblast moving through the structure, acted as bearing areas for blast restraining devices, and strengthened the tunnel walls. The top 110 degrees of the tunnel was segmented into ten-foot longitudinal segments that the transporter's protective strong back crashed through during missile erection and launch. Within this tube, the MX missile and its transporter moved at random intervals, distances, and directions.⁴⁴

The basic units of movement were trackless trains that consisted of a transporter and two air blast deflector plugs, while a mobile launch control center joined every tenth train. The missile transporter was a self-propelled, unmanned vehicle that carried the missile and its erection and launch equipment. During an attack, the transporter's aircraft-style tires and suspension springs provided protection from ground shock, which was three gs vertically and one g horizontally. The mobile launch control center was a manned, self-propelled vehicle that carried a two-person crew, life support, and launch-essential C3 equipment. Two deflector plugs, one at each end, sealed the train consist from incoming air blasts. Each flight of ten missiles had one mobile launch control center; the remaining missile consists in that flight had only a transporter and protective deflector plugs.⁴⁵

⁴⁴TRW, "MX Buried Trench Weapon System Characterization Study: Transporter Launcher, Mobile Launch Control Center, Mobile Launch Control Center Transporter, September 15, 1975" (Redondo Beach, CA: TRW Mechanical Systems Design Department, 1975), 1-1 to 1-5, unaccessioned, unclassified collections. BMO box B-5, AFHRA. Details on fiber-reinforced concrete from Ralph M. Parsons Company, "MX Buried Trench Construction and Test Project Concrete Test Program, March 29, 1978," 1-1 and 3-1 to 3-2 and Ralph M. Parsons Company, "MX Buried Trench Construction and Test Project, February 10, 1978," 6. Both Parsons references unaccessioned, unclassified collections. BMO box B-11, AFHRA. Tube dimensions from TRW, "Buried Trench Characterization Summary Report, April 1976" (Redondo Beach, CA: 1976), 21, unaccessioned, unclassified collections. BMO box B-5, AFHRA. See also Talbott, *Endgame*, 47, 49. Jeffrey M. Lenorovitz, "MX Basing Mode Concepts Analyzed," *AWST* 107 (November 21, 1977), 66 and Timothy C. Hanley and others, "History of Space and Missile Systems Organization, 1 January-31 December 1977" (Los Angeles: History Office Los Angeles Air Force Station, 1978, photocopied), 362-369. Accessioned collections, declassified extract. IRIS K243.012, AFHRA.

⁴⁵The trench description draws upon TRW, "MX Buried Trench Weapon System Characterization Study," 1-1 to 1-6 and TRW, "Buried Trench Characterization Summary Report," 1-104, passim.

Two modes of movement defined system operations: random movement or launch operations. In peacetime, the trench trains performed automated random movements within their assigned trenches at five miles per hour, but when moving, they were not survivable; thus, it was important to minimize movement, which meant that survivability depended on protecting the location uncertainty of the trench train. When the trains occasionally stopped at one of the twenty-one connect points spaced a half-mile apart, C3 was possible because an automated umbilical connected to a ground network. Whenever motionless, the deflector plugs deployed their restraint and shock attenuation systems, which allowed the train to ride out an attack and survive to launch its missile. Every eight hours, the launch control center crews changed over, and in the event that a train was stuck, designers had provided the crews with an emergency egress device. Every two to thirty days, a special transporter randomly moved the mobile launch control center and its crew between trenches.

A Boeing version of this weapon system closely resembled the TRW design definition with a wheeled three-piece transporter powered by four ninety-five horsepower electric motors. The unit vehicles rolled on fluid-filled rubber tires to simplify shock attenuation, and the transporter had a strong back assembly on top of the missile canister, which rode upon a lateral shock isolator unit. The launch control center was smaller than the transporter, but Boeing believed that it "provided adequate space and life support for its two-man crew." The transporter with missile weighed 661,000 pounds and was 172 feet long, whereas the mobile launch control center weighed 300,000 pounds, much of it from standby and survival power batteries, and was 102 feet long. Coupled at each end of the canister were what Boeing engineers considered the most challenging aspect of the

design, an independent set of powered drive axles and blast plugs designed to seal off the tunnel section in the event that nuclear overpressure breached the structure. To close this seal, the blast plugs engaged the ribs lining the tunnel walls. Boeing also planned spur tunnels to help deflect blasts. The tunnel vehicles had a pickup shoe that pulled power from a three-rail, 4,160-volt three-phase power source mounted near the top of the trench, and they had batteries for extended wartime survival. To steer the trackless vehicle, metallic sensors followed a ferrous paint strip on the tunnel floor. For launch, a hot-gas actuator forced the strong back through the tunnel top and past any covering debris, while a second gas actuator raised the missile canister to a fifteen-degree angle, after which a third pair of actuators brought the missile to its launch angle. The missile launched at fifty-to fifty-five degrees; anything less and the rocket would crash. Missile elevation took forty-one to fifty-five seconds.⁴⁶

The rail and flange had not returned to air force drawing boards since mobile Minuteman, but Martin Marietta Aerospace proposed them because they believed a rail system permitted a cheaper total cost for the project. Tracks eliminated steering and guidance hardware, allowed for smaller tunnels, and because there was less resistance for a steel wheel on track than a rubber tire on concrete, the trains needed less power to move. Martin's solid-propellant gas generators elevated a 360,000-pound missile canister through a tunnel trench in twenty-two seconds. Based on the work of TRW, Boeing, and Martin, the air force concluded that the trench provided superior survivability and eliminated security and environmental concerns associated with

⁴⁶Boeing, "Buried Trench Weapon System Studies Summary Report, June 1977," 1-33, unaccessioned, unclassified collections. BMO box B-6, AFHRA. See also Lenorovitz, "MX Basing Mode Concepts Analyzed," 66.

aboveground systems. By December 1977, the buried trench was the air force's favored deployment mode.⁴⁷

Meanwhile, on February 19, 1977, President Carter had directed a comprehensive review of United States national strategy and capabilities. He wanted guidance on choosing defense programs commensurate with deterrence in an age of parity. Six months later, Secretary of Defense Harold Brown provided a top-secret force posture study to frame the administration's review of program and budget issues. In the event of a nuclear war, Brown asserted that United States policy was to preserve American power and to ensure that the Soviet Union experienced a prolonged recovery. To ensure this, he directed the air force and navy to detonate at least one weapon on major centers of Soviet government. Because American strategic nuclear forces were to damage at least 70 percent of the Soviet Union's war-supporting economic base, at least one weapon had to be exploded on an industrial facility in that country's top 250 urban areas. Lastly, the SIOP planners were to neutralize other targets including military assets critical to postattack recovery. These goals supported a strategy of deterrence based upon mutually assured destruction.⁴⁸

Although Brown reemphasized the countervalue targeting of American planning that previous administrations had defined, he acknowledged that the relative probability of achieving national security objectives improved with effective counterforce capability and by preventing clear-cut Soviet superiority. Nonetheless, the joint chiefs objected that

⁴⁷Martin Marietta, "Rail Installation Costs MX BTWS, Rail Installation Cost Validation Meeting, March 3, 1977," 14-15, unaccessioned, unclassified collections. BMO box 106, AFHRA. "USAF Plans Test of MX Trench Concept," *AWST* 107 (October 17, 1977), 17; "MX Shelter Blast Survivability Evaluated," *AWST* 108 (January 9, 1978), 24 and "Test Blast Yields MX Basing Data," *AWST* 109 (July 10, 1978), 25; "USAF Tests MX Breakout From Trench," *AWST* 109 (November 20, 1978), 23. Edwards, *Superweapon*, 133.

⁴⁸Brown, "PRM/NSC-10," 1, 3, 34, 36, 153.

Brown underestimated the complexities of nuclear strike planning. Planners accounted for MIRV footprint size, target base growth (that is, new industrial or government facilities), cross-targeting or timing considerations, bomber payloads, and the like, all of which increased the number of weapons required. Nonetheless, Brown maintained that without a revised nuclear weapons employment strategy, existing forces were more or less satisfactory to fulfill needs. Only if Carter determined the failure of a deterrence strategy based on mutually assured destruction would he desire a counterforce ICBM. Because he sought arms negotiations, it was to Carter's advantage to delay the MX missile's development, and the program soon lost whatever momentum it had gained.⁴⁹

The question of whether launch facility-based ICBMs were vulnerable to a Soviet attack focused attention on intentions, accuracy, and survivability, but the advent of the accurate MIRV-tipped ICBM increased the probability of destroying a missile as it sat in its launch facility. In times of increased tensions, a nation might decide to use its weapons before the enemy destroyed them. This situation led many to believe that a hard and dispersed counterforce ICBM tempted a first strike, which destabilized the international situation. Making the missile mobile was an obvious solution, but the recent SALT agreement and the desire for future negotiations raised questions about this idea. In addition, doubts existed about the true state of ICBM vulnerability because many factors associated with such calculations used intelligence estimates; moreover, neither the United States nor the Soviet Union had ever tested an ICBM on its wartime attack route. Nonquantifiable factors such as crew response lessened the reliability of such predictions. Still, the potential existed for the Soviet Union to destroy a large fraction of

⁴⁹Ibid., 36, 153.

the American ICBM force, and the air force prepared to take action to prevent this occurrence.

President Carter had little desire to engage in expensive weapons procurement, and knew the MX program had muddled through repeated reviews of basing options and calls for justification. The administration wanted to continue the arms control momentum initiated by the Nixon and Ford regimes and understood that a full-scale development of a new, accurate, and survivable counterforce ICBM was inimical to this goal. Belatedly, the Ford administration had sped up MX development, but the Carter administration, seeking to achieve its goals through arms control and not weapons procurement, was disinclined to fast-track the MX. After years of effort, MX planners had not received approval of either a missile configuration or a basing mode. In 1977, the new mobile ICBM remained little more than a thick bundle of paper.

CHAPTER 5

A FRUITLESS SEARCH

Senator, if we had the mobility in the Minuteman force that we are building into the MX force, we would not need the MX force.¹

-- General Richard T. Ellis, Commander, Strategic Air Command, February 18, 1981

I assume part of your feeling about the MX was due to the ridiculous idea of running it around a racetrack with 4,600 silos. I've always been opposed to that.²

-- President Ronald Reagan, October 5, 1981

When large organizations cannot solve a problem, the danger exists of losing control of disciplined debate and discussion as each interested agency seeks to end the impasse. This prevents the clear thought needed to weed out complicated issues, breeds half-baked solutions, and ultimately forces reevaluation of the problem. In the case of MX during the Carter and Reagan administrations, the air force, DoD, internal White House councils, and various offices within the concerned agencies offered opinions and plans on missile basing. In such situations, a solution might emerge, but anger, confusion, wasted time, and lost resources also result. Such was the case with the mobile MX ICBM program. The MX was to satisfy every possible demand, including arms control, counterforce, survivability, and political and environmental acceptability. It had to meet all these criteria whether it was based in the air, land, or sea. Both Republican

¹General Ellis quoted in Senate Committee on Armed Services, *MX Missile Basing System and Related Issues*, 98th Cong, 1st sess., 1983, 132.

²Ronald Reagan to Ann Landers, October 5, 1981, reprinted in Kiron K. Skinner, Annelise Anderson, and Martin Anderson, eds., *Reagan: A Life in Letters* (New York: Free Press, 2003), 404.

and Democratic presidents desired a technological panacea with which to deliver them unto a political utopia. Naturally, this was impossible, but at the very least, partial fulfillment of the fantasy demanded realistic and decisive action that the existent discussion lacked. By 1983, political influences lessened the significance of ICBM vulnerability and with it, the desire for a mobile ICBM evaporated.

President Carter deeply desired a SALT II agreement, and he did not share the alarmism of former Secretary Rumsfeld and air force generals about American strategic vulnerability. He was willing to delay decisions on basing MX until he had a treaty. In support, Defense Secretary Brown affirmed that “a strategic nuclear attack is the least likely military contingency we face” and described the situation as “one of standoff or stalemate.” The administration wanted to maintain the status quo “through equitable and verifiable agreements for arms limitations and reductions.” Carter and his advisors did not wish to misjudge an adversary about which they had little insight. Brown believed “great caution and careful hedging” were essential in dealing with the Soviets, while Carter, thinking the likelihood of nuclear war unlikely, tried to maintain a rough strategic parity and did not desire to push a new ICBM. The administration preferred to “reach our goals through arms control agreements.” To the analysts who had conceded the possibility of American ICBM vulnerability and who had watched the Soviet arms buildup, such rhetoric was worrisome.³

When Carter delayed the air force’s plan for full-scale MX development, the optimism that pervaded the program in early 1976 collapsed. Brown initially cut the MX

³Department of Defense, *Annual Report Fiscal Year 1979, Harold Brown Secretary of Defense* (Washington, D.C.: Government Printing Office, 1978), 4-5. Brown issued the report on February 2, 1978. Hereafter cited as DoD, *Annual Report FY 1979*.

budget by \$100 million and in early 1978 redirected the service to conduct “a modest level of effort” to retain the option of quick acceleration of the program if there was an unexpected Soviet breakthrough. He also permitted construction of a pre-prototype MX guidance set and test trenches. In addition to his concerns about how the new missile would affect strategic arms negotiations, it was apparent that the president was unhappy with the state of deployment decision-making. Brown wrote that he “had hoped that the MX basing concept would be sufficiently well determined by now so that we could proceed in the FY [fiscal year] 1979 budget with full-scale development. But it is not, in terms of costs, survivability, and geographic location of a mobile version.” In effect, the air force’s bosses had been told to go back to the drawing board because of delays and indecision about mobile basing. The MX decision stung the air force, which also had to swallow the bitter pill of the unexpected cancellation of the B-1 strategic bomber program. The delay meant that the date of operational capability moved farther away, and because it was not easy or quick to deploy an operational weapon system, American security might be at risk. Nonetheless, by not killing the program, Brown retained future options including the use of MX as an arms control-negotiating chip.⁴

A Struggle to Decide

When the air force reexamined MX basing, the buried trench did not long remain its preferred system. Brown’s directive had essentially killed it, and in the reexaminations that followed, the air force reconsidered MPS vertical shelters. In November 1978, Illinois Democratic Representative Melvin Price, chair of the

⁴DoD, *Annual Report FY 1979*, 109.

Committee on Armed Services, asked the air force to clarify the situation. Price wrote to General Lew Allen, the air force chief of staff, and asked a number of questions, the most pointed of which was, "does the air force have a preferred basing mode?" Price appealed for insight into the "technical--as opposed to political--issues." His closing statement suggested his belief in the issue's importance: "We are facing a critical decision in regard to our future national security," and his responsibility was to get the facts "necessary to a proper decision." For a powerful congressman of the same party as his president to write a four-page request underscored the confusion and complexities surrounding the MX issue.⁵

General Allen responded with a nine-page letter. After reaffirming the value of ICBMs and the triad, he told Price that "the vertical shelter MPS mode is preferred by the air force." Less than a year earlier, this alternative was rejected, but now Allen believed it was the option most consistent with Carter's arms control goals, as well as budgets, military effectiveness, and available technology. MPS offered high survivability, compatibility with SALT negotiations, and lower cost than buried trench basing or air-mobile options. True, the vertical shelters cost more than horizontal garages, but once the missiles were in the shelters, launch responsiveness and reliability improved by eliminating missile elevation. Because concealment and deception made MPS viable, Allen explained to Price that the crucial new technology was the preservation of location uncertainty, which he hoped would protect the missiles by defeating attempts to locate them. If the Soviets could distinguish between real missiles and decoys as they shuttled between shelters, they would target the actual ICBMs, ignore the fakes, and retain a

⁵Representative Melvin Price to General Lew Allen, Jr., November 8, 1978, 2, 4, unaccessioned, unclassified collections. BMO box B-1, AFHRA.

significant postattack force. He estimated that for a force of 200 missiles, the air force needed 4,500 shelters.⁶

Because of SALT I, MPS was the first ICBM system designed for verification, and the air force copied procedures used for submarines. Soviet satellites observed shipyard submarine missile loads and counted the missiles, but after the vessel left port, it vanished. MPS had an assembly point where MX missiles were placed onto their transporter vehicles. Following assembly, the missile-bearing vehicles traveled over a dedicated rail network (later replaced by a cheaper road) to their assigned cluster, where they disappeared among shelters and decoys. To demonstrate that the air force was not cheating by slipping additional missiles into the shelter clusters, system personnel periodically opened four removable viewing ports installed on the roof of each shelter so that Soviet satellites could verify the presence of no more than one missile per cluster. The process was slow enough for satellites to observe and count missiles. If for some reason, the Soviets could not count them, the United States had no obligation to tell them anything beyond the number deployed. It did not have to say where the actual MX missiles lay. General Allen did not worry about a Soviet MPS system because he believed that the United States had strong satellite intelligence and in any case, would have set the precedent for ICBM MPS deployments.⁷

Even as Allen drafted his reply to Price, the first of several second-round defense systems acquisition reviews delayed program progress. Indicative of air force frustration

⁶General Lew Allen, Jr., to Representative Melvin Price, December 29, 1978, 4, unaccessioned, unclassified collections. BMO box B-1, AFHRA.

⁷Ibid., 5, 7. Strategic arms limitation monitoring methods discussed in Boeing Company, "SAL Design Constraints and Potential Verification Methods, August 25, 1980," 12-15, unaccessioned, unclassified collections. BMO box 28, AFHRA.

was the December 5 session, described as a “ritualistic exercise culminating in the decision to hold a *substantive* DSARC [Defense Systems Acquisition Review Council] (full engineering development) by April 1, 1979.” In other words, the December review was useless. Nonetheless, despite causing delays by his reviews and requests for more analysis, Brown gradually accepted vulnerability. In late January 1979, he informed Congress that “Soviet ICBMs can threaten our ICBMs” and categorized ICBM survivability in the early 1980s as “very low.” Wanting arms control, but recognizing the need for a new ICBM system, Brown told the air force to restudy air-mobile and MPS-- after the service had just done so and announced MPS vertical shelters as its choice. Brown further confused the situation when he opened the door wider, stating that he wanted a missile “flexible enough to be used either with an MPS, an air-mobile system or a Minuteman silo--or a land-mobile or underwater barge-mounted system.” Just as one aircraft cannot perform every mission, one ICBM cannot be everything to everybody; moreover, to address even one aspect of these concerns required a go-ahead decision. Brown may have wanted to address ICBM vulnerability, but MX remained mired in studies.⁸

Although Brown had approved neither the final size nor basing mode of the missile, he increased the MX budget, creating further confusion and opening the program to criticism as a fiscal black hole. In the FY 1978 budget, Carter had asked for \$134 million in advanced technology research money and nothing for MX engineering

⁸Department of Defense, *Report of the Secretary of Defense Harold Brown to the Congress on the FY 1980 Budget, FY 1981 Authorization Request and FY 1980-1984 Defense Programs* (Washington D.C.: Government Printing Office, 1979), 114, 117, 119. DoD dated this report January 25, 1979. *Air Force Magazine* senior editor Edgar Ulsamer provided the sarcastic Defense Systems Acquisition Review Council description in “MX Still Zigzagging,” *Air Force Magazine* 62 (February 1979), 14.

development. The FY 1980 request more than reversed that decision. Brown asked Congress for \$670 million for MX missile engineering development but only \$5.7 million for advanced technology research. He expected to make a basing mode decision by the spring of 1979, eight years after the air force had issued the operational requirements for a new ICBM. This was hardly responsible program management, and things were to get worse. Nonetheless, with dutiful but frustrated resignation, in December 1978 the air force reevaluated air-mobile and MPS. Poor General Allen; despite just having assured Price that he preferred vertical shelter MX MPS, he now admitted that basing "remains in question." Colonel Aloysius Casey, the assistant deputy for the MX program commented in his personal notes that "the direction was not practical and seemed to be somewhat contradictory. It seems impossible to me to provide an air-mobile study on that short of schedule. . . . Since the plan is to contract for some of the work, completion in March is not possible." Casey also noted that "it is necessary to decide on the missile diameter in order to not waste significant resources." Shortly thereafter, the study that Brown wanted appeared at a March 31, 1979, defense review council briefing in which the air force presented a plan for a fleet of ICBM-laden aircraft.⁹

This was the air force's--but not the White House's--last fling with air-mobile basing, and the USAF proposed an air-mobile ICBM force whose operations duplicated those of MPS by replacing transporters and shelters with 150 missile-carrying aircraft, each with one MX missile. To support the aircraft, the service envisaged a pyramid of bases and airfields consisting of main support bases, alert bases, and 4,600 austere bases

⁹Ibid., 120. General Allen's comments from Lew Allen, Jr., "Window to the World," *AWST* vol. 110, no 9 (February 26, 1979), 9. Aloysius G. Casey, "Reference Telecon Marv Atkins, December 13, 1978," unaccessioned, unclassified collections. BMO Box B-60, AFHRA.

for wartime use. In normal peacetime operations, a main base supported the aircraft, which dispersed to several alert bases located throughout the central United States. Day-to-day alerts were conducted at the alert bases, with the aircraft and missiles returning to their main base only for maintenance, repairs, and crew rotations. As war approached and authorities expected an attack within the next several days, the aircraft further dispersed from their alert bases to the 4,600 austere support airstrips, each with sufficient resources to fuel, launch, and recover one aircraft. To provide missile location uncertainty and dilute Soviet warheads against a large number of targets, the aircraft randomly moved between the dispersal sites "at periods less than the attacker's intelligence/retargeting cycle." During normal day-to-day operations, a small contingent manned these bases to ensure their security and operability, an important consideration because they were subject to the harsh weather of the Northern Midwest, including blizzards, which meant the regular removal of snow, ice, and melt water. If warned of an imminent attack such as the feared "bolt out of the blue," the planes took off from their alert bases and launched missiles, after which they landed at one of the emergency facilities.¹⁰

Surviving a surprise SLBM attack required that 75 percent of the planes maintain an alert posture and that crews took off upon first warning of an attack. This "dash-on-warning" concept was risky because a false alarm would concern the Soviets, who might assume an American first strike and thus launch their own attack. In any event, because the Soviets would attack the alert bases, making it impossible to return, the aircraft would

¹⁰SAMSO, "Air Mobile MX Weapon System Test and Evaluation Master Plan, March 16, 1979," 1-5 to 1-14, unaccessioned, unclassified collections. BMO box B-63, AFHRA. OTA, *Missile Basing*, 217-232.

crash unless provided with emergency facilities such as the austere airstrips. If spaced twenty-five miles apart, the 4,600 landing strips covered the three-million square miles of the continental United States, and if they were built outside of urban centers, they would limit damage to American society by drawing Soviet warheads away from cities. In addition, because the number of airfields equaled the number of shelters proposed for MPS vertical shelters, it provided a useful comparison with which to debate the basing modes.

The construction and procurement costs to support operations for this concept were hefty. C3 was largely responsible because to ensure counterforce accuracy, an inertially-guided, air-launched ballistic missile needed supplemental inputs, for which the air force proposed a ground-based radio system that required Canadian bases. The cost of building an air-mobile system with 4,600 dispersal airstrips and the necessary C3 infrastructure ran as high as \$25 billion, over a third of the program's estimated total lifecycle cost of \$62 billion. Eliminating the airfields and their security, environmental, and C3 needs saved money, so the air force considered a launch-on-warning approach that lacked the emergency strips. Service leaders ruled this out because they predicted high aircrew fatalities. They also considered a continuously airborne force, but rejected it because its estimated lifecycle cost was exceptionally high, nearing \$91 billion. In comparison, the MPS vertical shelters program cost an estimated \$30 billion.¹¹

For candidate carrier aircraft, an important factor in computing procurement and operations costs, the blue suits settled on prototypes from the moribund advanced medium short takeoff and landing program, a four-engine jet designed for battlefield

¹¹OTA, *MX Missile Basing*, 221, 230-231; Ulsamer, "MX Still Zigzagging," 14.

tactical airlift. Use of these planes allowed shorter airfields containing less supplies than those needed to support large aircraft such as the previously considered 747 or C-5; moreover, the smaller aircraft had a faster reaction time and cost less to operate (one estimate placed the cost at \$28 billion over thirteen years). The small transport was too short to hold an MX missile and its monitoring equipment, which necessitated stretching the fuselage, as well as modifying the landing gear, wings, and engines. In addition, mating the MX to the advanced medium short takeoff and landing program helped a politically failing aircraft effort, but such a transparent programmatic sleight-of-hand also suggested a lack of air force enthusiasm for the idea. Citing cost and the potential for the Soviets to build eventually enough weapons to target all 4,600 airfields, the defense review council rejected it.¹²

As a result, MX MPS returned as the preferred basing option at the same time as the White House befuddled the situation with its own ideas. The president's inner circle was never far from this issue, and on May 4, Secretary Brown chaired one of several invitation-only National Security Council meetings not open to the full body. The attendees, which included among others, Brown and Central Intelligence Agency Director Stansfield Turner, developed additional options that ranged from launch facility-basing, MPS, and the recently rejected air-mobile with AMST aircraft. They combined these with various modifications to other triad forces, including reliance on a dyad of bombers and SLBMs. Meanwhile, the White House director of science and technology

¹²The AMST competitors were the Boeing YC-14 and McDonnell Douglas YC-15. The air force designated the mobile MX carrier version as the C-1XA. See SAMSO, "Air Mobile MX Weapon System Test and Evaluation Master Plan" and Clarence A. Robinson, Jr., "U.S. to Test ABM System with MX," *AWST* 110 (March 19, 1979), 23-26, OTA, *MX Missile Basing*, 218-231 and Edgar Ulsamer, "Airmobile MX," *Air Force Magazine* 62 (April 1979), 16 and "MX Still Zigzagging," 14.

policy, Frank Press, briefed the National Security Council on his favorite MX basing scheme, a repeat of Lockheed's 1976 air-mobile scheme using C-5s stationed at existing SAC bases. This was, in turn, a repeat of the 1964 Golden Arrow air-transportable missile system. Seymour L. Zeiberg, the deputy undersecretary of defense, created a hybrid trench-basing plan that combined features of MPS and the earlier trench scheme by switching missiles between parallel trenches in a manner analogous to railroad engines on a transfer table. He generated sufficient support that on May 15, William J. Perry, Brown's deputy for research and engineering and an increasingly important figure in MX decision-making, briefed it to the Senate and the House. Other ideas that enjoyed momentary popularity included shallow underwater missiles, a plan for a fleet of small submarines that operated within a thousand miles of the continental shelf. The situation fit the old air force truism "all thrust and no vector."¹³

SALT II and MX Basing

On June 18, 1979, Carter signed the SALT II treaty with the Soviet Union. Article IX of this controversial agreement banned "mobile launchers of heavy ICBMs," a dire concern of the United States because the big Soviet boosters had larger payload

¹³Edwards, *Superweapon*, 184-188; "Washington Roundup," *AWST* 110 (April 9, 1979), 13; Clarence A. Robinson, Jr. "SALT 2 Approval Hinges on MX," *AWST* 110 (May 14, 1979), 15; Clarence A. Robinson, Jr., "Acceptable Basing Mode for MX Sought," *AWST* 110 (May 21, 1979), 14-16; Talbot, *Endgame*, 171. Zeiberg described his air-mobile option in Seymour L. Zeiberg, "MX: The Major Strategic Defense Issue" (address, joint meeting of the American Institute of Aeronautics and Astronautics and others, Salt Lake City, UT, June 12, 1980). Photocopy from Fact Sheet, AFSC PA No. 045.80 (Andrews AFB, MD: Office of Public Affairs, AFSC, 1980), 12, unclassified extract from "History of Air Force Systems Command, 1 October 1979 - 30 September 1980, vol. 7 Supporting Documents, accessioned collections IRIS K243.01, AFHRA. Hereafter cited as Zeiberg, "MX: The Major Strategic Defense Issue." For information on shallow-water missiles, see Ulsmaer, "Airmobile MX," 16 and OTA, *MX Missile Basing*, 20-22 and 167-214. Neither the air force nor the navy expressed enthusiasm over shallow-water missiles.

capacities, and they could carry more MIRVs than could American ICBMs. It also banned ICBMs on surface ships, mobile ICBMs “which move only in contact with the ocean floor, the seabed, or the beds of internal waters and inland waters, or missiles for such launchers,” and ALBMs larger than existing light ICBMs (the treaty considered Minuteman light). The treaty also limited the total of ICBMs, SLBMs, and air-launched cruise missile-carrying bombers to 2,400, with a provision that in 1981 lowered the number to 2,250 for each side. It permitted each side to have 820 MIRV-capable land-based ICBMs and prohibited deploying more than ten reentry vehicles on a land-based ICBM. Carter touted the treaty as equitable, verifiable, and important for enhancing strategic stability.¹⁴

By this time, the Soviets had deployed 330 R-36M and R-36MUTTH ICBMs that carried 1,768 reentry vehicles, in addition to 240 UR-100Ns mounting 1,140 warheads. Accuracy improvements further threatened American launch facilities. Counting only these missiles, the Soviets had 2,908 ICBM-based warheads matched against the 1,054 American ICBMs, and because the heavy Soviet ICBMs had a larger throw-weight than did American Minutemen, the treaty codified a measure of Soviet ICBM superiority. In recognition of this and in a nod towards MX, SALT II permitted each side to deploy one new ICBM that carried no more than ten warheads. Without MX, the American ICBM force would suffer increased vulnerability as the Soviets built up to the SALT limits. The spirit of the treaty clearly favored basing the missile in launch facilities, but if these were vulnerable, there was little sense in such a deployment. The issues were complex, and

¹⁴SALT II Treaty reproduced in Talbott, *Endgame*, 279-310. Article IX on pp. 284-285.

Congress, as Price's interest indicated, took the initiative to question the administration's actions.¹⁵

The qualitative advantage upon which three American presidents had based arms negotiations had been overwhelmed by Soviet numbers. Many in Congress, worried about the survivability of American ICBMs, considered the MX a must-have weapon, but the lack of a basing mode instilled small confidence in Carter. Ohio Democrat Senator John Glenn believed that the president used MX "as a bargaining chip to attract votes for the [SALT II] treaty." One month before the treaty signing, an anonymous senator stated that without a White House commitment to MPS, "Jimmy [Carter] has no chance for senate ratification And if senate ratification of SALT II is lost, Carter is not likely to get the [Democratic] party's renomination in 1980." The unnamed senator was wrong about Carter winning his party's nomination, but he captured the feeling of many Americans, including those of the same party, towards a president who permitted perceived nuclear inferiority. Utah Senator Jake Garn was more blunt, charging that SALT II gave the "USSR absolute nuclear weapons superiority by 1980." One pro-MX observer compared Carter's dilemma to that of Sisyphus, the deceitful king of Greek mythology whom Hades condemned to roll a huge stone up a hill, only to have it fall back down each time he neared the crest. The senate never approved SALT II.¹⁶

In June 1979, President Carter announced the go-ahead for full-scale engineering development of a ninety-two-inch-wide MX missile, but he had still not decided upon a basing mode. By selecting the large-diameter version of the missile, Carter provided a

¹⁵Podvig, *Russian Strategic Nuclear Forces*, 136-140.

¹⁶Clarence A. Robinson, Jr., "SALT 2 Approval Hinges on MX," 14. John L. Frisbee, "The SALT II Debate," *Air Force Magazine* 62 (May 1979), 6; Senator Glenn quoted in Edgar Ulsamer, "More Gyration Over MX Decision," *Air Force Magazine* 62 (July 1979), 15.

weapon that carried ten warheads, helping to address the strategic imbalance, and demonstrating a commitment to build American forces up to the SALT II limits. On the surface, this was a step forward, but the news left many unfulfilled. Paul H. Nitze, a former SALT negotiator, commented that “the newsworthiness is that there was no decision” on deployment. By July, reports surfaced of a forthcoming basing decision. Trade journals anticipated a 200-missile force deployed among 4,600 horizontal shelters. Air force Major General Kelly Burke, who directed operational requirements for the service’s research and development and who worked closely with Undersecretary Perry, defended the president, stating that, “this is not vacillating. The president has already made 85 percent of the decision. He’s knocked out airborne basing, the dyad and vertical deployment, and the common missile.”¹⁷

On September 7, 1979, Carter proclaimed his choice at a press conference. Equating the decision to Harry S. Truman’s creation of SAC and John F. Kennedy’s approval of the Minuteman, Carter stated that Minuteman’s increasing vulnerability necessitated the “full-scale development and deployment of a new, large mobile ICBM.” He based his choice on survivability, verifiability, minimal environmental effects, cost, and consistency with present and future SALT negotiations, and he ordered the MPS deployment of 200 MX missiles in an unmanned complex of 4,600 shelters. Above all,

¹⁷Fact Sheet, “MX: Its History,” PA No. 038.80 (Andrews AFB, MY: Office of Public Affairs, AFSC, 1980), 2, accessioned collections. IRIS K243.01, AFHRA; David R. Griffiths, “MX Decision Spurs Pressure on Basing,” *AWST* 110 (June 18, 1979), 27; “MX Basing Approval Expected,” *AWST* 111 (July 30, 1979), 12-13.

said the president, "this system is not a bargaining chip. It's a system that America needs and will have for its security." This was the first of two Carter-era MX MPS systems.¹⁸

Each missile had a cluster of twenty-three shelters connected by a closed fifteen-mile loop nicknamed the "racetrack," a short distance off of which were the missile shelters. These hardened "garages," spaced 7,000 feet apart, were flush with the ground for blast protection with short roads gently descending to their entrances. Once a month, mobile launch platforms "over 100 feet long and . . . 600,000 pounds or so" with twenty-four tires moved horizontal missiles between shelters. With a 3,000 horsepower diesel or gas-turbine engine, they traveled at a maximum speed of thirty miles per hour, which provided a dash capability, that is, within a thirty-minute ICBM flight time, one could race to a different shelter. The transporters could launch a missile anywhere, but if inside a shelter, the protective strong back elevated the missile through the roof (or anything else in its way). As it moved, an independently transportable shield covered it. Rapid reshuffle capability and deceptive, sheltered movement among multiple aim points provided survivability.¹⁹

In 1980, Boeing finished a prototype launcher. Believed to be one of the world's largest vehicles, it was a monstrosity: 165-and-a-half feet long, twenty-nine feet, eight-and-three-quarters inches high (when erected for launch 140 feet high); weight: 1.1

¹⁸White House, "Press Announcement by the President on MX Basing," (September 7, 1979), 1-2. Copy contained in "History of Air Force Systems Command, 1 October 1979 – 30 September 1980, vol. 7 Supporting Documents, accessioned collections IRIS K243.01, AFHRA.

¹⁹White House. "Press Briefing by Harold Brown Secretary of Defense," (September 7, 1979), 3-8 Copy contained in "History of Air Force Systems Command, 1 October 1979 – 30 September 1980, vol. 7 Supporting Documents, accessioned collections IRIS K243.01, AFHRA. See also Office of the Secretary of Defense (OSD), "News Conference by Dr. William Perry, Under Secretary of Defense," (September 7, 1979), 7. Copy contained in "History of Air Force Systems Command, 1 October 1979 – 30 September 1980, vol. 7 Supporting Documents, accessioned collections IRIS K243.01, AFHRA. At the time of the press conferences, designers had not decided whether to use a diesel or gas-turbine engine. Perry thought that "one candidate certainly would be the turbine engine used in the XM-1 tank."

million pounds empty (1.4 million pounds loaded with a canisterized MX), and it rode on twelve eight-and-a-half-foot-diameter radial tires. Boeing used two tractors, each powered by a 1,000 horsepower diesel motor to pull it. Speeds varied between thirteen and thirty-six miles per hour, depending whether it carried a missile and the fuel mileage was unadvertised. The dimensional differences between Secretary Brown's briefing and the prototype transporter suggest how much more development mobile MX demanded, even after eight years of research.²⁰

In daily operations, the actual launcher remained inside a shelter, perhaps for months, and to confuse the Soviets, shields and mass simulators continuously moved throughout the cluster. The simulator duplicated the physical signatures of the launcher, including its seismic vibrations and ground tilt, thermal, acoustic, optical, chemical, electromagnetic, and radiation emissions. Persons associated with missile or simulator movement had to act the same way, regardless of the situation and whether they moved a decoy or actual missile. In his September 7 press conference, Perry admitted that discussion of decoys was a sensitive issue that had sparked debate among designers. He did not believe that a mass simulator was necessary, but conceded that anytime "we become nervous" about Soviet espionage, "we would add the simulator to the system." The 4,600 shelters used at least one decoy per missile. Assuming effective location uncertainty, any missile, once in the cluster, was lost to observers.²¹

²⁰"MX Transporter/Emplacer Being Tested," *AWST* 112 (February 18, 1980), 65-67.

²¹OSD, "News Conference by Dr. William Perry, Under Secretary of Defense," 7-9; White House, "Press Briefing by Harold Brown Secretary of Defense," 2. See also OTA, *MX Missile Basing*, 35-40; SAMSO, "Preliminary MX Weapon System Preservation of Location Uncertainty Program Plan, December 1978" (Los Angeles: SAMSO, 1978), 2-1 to 2-5, 4-1 to 4-10, unaccessioned, unclassified collections. BMO box B-23, AFHRA.

All movements had to appear random; thus, when the air force suspected a missile location compromise, it could not immediately move the missile but had to work its movement into daily operations. Over time, the Soviets likely would determine some missile locations, although their confidence in this knowledge would vary between clusters. If in one year they eliminated half of the clusters as targets, then the Soviets had lessened their targets from 4,600 to 2,300, and lacking an MPS shuffle, they would continue to eliminate the wheat from the chaff. To be effective, MX MPS movements had to maintain a level of uncertainty necessitating Soviet coverage of 4,600 shelters. Early calculations indicated that a complete visit of all 4,600 shelters was necessary every sixteen weeks, meaning that all missiles were moved within that interval. Nonetheless, even if the Soviets observed a non-random movement, they would not know which shelters contained the missiles, and it was possible to move a missile to another shelter within thirty minutes.²²

According to the American interpretation of the SALT II treaty, shelters were not accountable. If necessary, the United States could increase the survivability of its numerically constrained ICBM force by increasing the number of shelters per missile, thus spreading out an attacking force and lessening the probability of a kill. William Perry claimed that the United States could build 2,000 shelters per year on an emergency footing, which meant that based on a 1986 initial operational capability for the first ten missiles and 230 shelters, the United States could have 10,000 shelters by 1989. Because the Soviets preferred to target two warheads per shelter, proliferating shelters presented

²²Kenneth Baker and others, *Methodology for MX Movement Evaluation* (Arlington, VA: ANSER Analytic Services Inc., 1980), 1, 3-8, unaccessioned, unclassified collections. BMO box B-28, AFHRA. MX movements also had to consider operations cost and the wear and tear on equipment.

Moscow with a choice. If the Soviets decided to build more missiles (a costly proposition), eventually they would reach SALT limits and stop or violate the treaty, a condition known as breakout, or they could agree to a new treaty, as Perry hoped. He suggested that "what motivates the Soviets to not engage in this race . . . is the realization they must have that this system makes their silos as obsolete as their missiles made our silos obsolete. Therefore, it is a foolish race for them to engage in."²³

Mobile Basing: An Albatross

In the American democracy, public support for such monumental undertakings as MPS construction was imperative. For a relatively small force of 200 ICBMs, the size of the operational deployment area, support bases, and infrastructure were staggering. Sensitive to public desires, the air force advertised that the public exclusion zone was only thirty-three statute square miles, of which shelters and maintenance areas (4,600 shelters and 200 maintenance areas--one per missile) needed nineteen square miles, and the support base required fourteen more. This total represented the actual ground space used by all of the cluster facilities minus roads if squashed into one square package of real estate, but this figure misled because MPS needed an additional sixty square miles of land for support facilities and an additional 122 square miles more for service roads. Also left uncounted were the 10,000 miles of roads that connected the shelter networks, although these were to remain open for public access 99 percent of the time, and the air force did not count this land area in the total advertised to the public.²⁴

²³White House. "Press Briefing by Harold Brown Secretary of Defense," 7-8, 12.

²⁴Ibid., 1; OTA, *MX Missile Basing*, 64.

These figures applied only if point security, that is, close-in security by the shelters and maintenance areas, was in force. If operational needs necessitated area security, the closure of thousands of square miles of land was possible, which was one reason why the air force wanted Nevada, where the federal government owned 86 percent of the state's 110,567 square miles, and Utah, of which 64 percent of the available 84,943 square miles belonged to Uncle Sam. The total land area contained within the perimeter of the individual clusters was approximately 8,000 square miles, and the total deployment area ranged from 12,000 to 15,000 square miles, depending upon how one surveyed the clusters. This made MPS the nation's forty-second largest state, outranking its next-nearest competitor, Maryland and its 12,407 square miles (which included water surface area). A small Soviet special forces team could have eliminated the geographic territory of an American state by forcing a move to area security. Air force policy was to "guarantee civilian access to all but the fenced portions of the MX deployment area," a policy similar to that used with traditional ICBM fields; however, the scale of MX MPS dwarfed in size any previous missile deployment, and environmental issues and opposition were significant.²⁵

A variety of Great Society legislation covering cultural artifacts, water quality and resources, wildlife, public lands, transportation, and air quality affected the program. One study listed thirty-eight major laws that pertained to MX, but this was an underestimate because hundreds of other federal, state, local, and military regulations

²⁵Ibid. According to the U. S. Department of Commerce, Bureau of the Census, *Statistical Abstract of the United States, 1980* (Washington, D.C.: Government Printing Office, 1980), 238, only Alaska (98.3 percent) contained more federal land than Nevada and Utah. The MPS deployment area would also have outranked (in square miles including water surface area) Hawaii (10,932), Massachusetts (10,555), Vermont (9,615), New Hampshire (9,351), New Jersey (8,722), Connecticut (5,544), Delaware (1,954), and Rhode Island (1,545).

applied. Because MX MPS was going into a desert, water was a concern. Residents, incoming military personnel, and construction demanded copious amounts. The air force estimated that it needed up to 570,000 acre-feet of water for construction and an average of 15,000 to 18,000 acre feet per year during operations. The deleterious effects on soil and vegetation could “prevent reestablishment of native vegetation and irreversibly degrade the value of vegetation for future wildlife and livestock use,” leading to desertification of previously productive lands. The dust emitted by MPS construction would have violated Clean Air Act standards and possibly caused effects similar to the Great Dust Bowl of the 1930s plains. Electrical power requirements had to increase to support MPS, as did transportation infrastructure to sustain the work force, construction, and operations. The air force estimated that on-site construction required from 15,000 to 25,000 people; other studies said it needed 40,000. Whatever the figure, the nature of the region would change from desert range to a human-built world. Democratic Governor Scott M. Matheson asserted that Utah would assume an adversarial stance towards the air force’s environmental data. He added that “unlike the Minuteman project, where little of the system is visible to the public, the missile X system will be as permanent as the pyramids.” As more lawmakers absorbed the scale of the project, opposition steadily mounted.²⁶

Compared to other mobile basing schemes, MX MPS cost less, but its \$33 billion price tag (fiscal year 1980 dollars) was not cheap. Because of indecision on basing, the fidelity of the cost estimates was not high. Air force General John Hepfer announced that

²⁶Governor Matheson quoted in Bruce A. Smith, “Nevada, Utah Study Impact of MX,” *AWST* 111 (November 26, 1979), 15. See also OTA, *MX Missile Basing*, 75, and Hoover and Holland, *The MX Decision*, 116-118; OTA, *MX Missile Basing*, 67-72.

“the \$33 billion figure was produced from air. By that time, we had gone through so many iterations we were no longer certain of costs.” Of the \$33 billion, \$7.5 billion went to research and development, \$12.5 billion for design and construction, and \$13 billion for procurement. Critics contended that costs might run as high as \$55 billion. As with any program, research and development received the bulk of the near-term (through fiscal year 1982) dollars, with construction and procurement taking the bulk of the middle-year dollars. Last, as the system came on line, operations and maintenance funding increased as construction finished, procurement tailed off to a sustainment level, and personnel costs climbed as the system reached full operational capability. A project as large as MX that involved thousands of square miles of land, a new missile, C3, and complicated vehicles could not avoid cost overruns.²⁷

Within the realm of military budgeting, program element monitors tended to the fiscal care and feeding of their assigned program. As many program monitors have learned, budgets flex for a variety of reasons beyond pure military needs. In his fiscal year 1982 budget request, the MX program monitor noted that in comparison with his 1981 prognostication, unexpected cost increases “were caused by the basing mode refinements directed by SecDef in the spring of 1980, and adding the renewable energy sources program. . . .” Renewable energy was a presidential initiative to reduce dependence on foreign oil, a concern for a weapon system dependent upon fuel-guzzling vehicles. The air force hoped that geothermal technologies would power the shelters and other permanent facilities to alleviate dependence upon commercial utilities. Moreover,

²⁷OSD, “News Conference by Dr. William Perry, Under Secretary of Defense,” 18-19; David R. Griffiths, “MX Flexibility Allows Doubling Shelters,” *AWST* 111 (September 17, 1979), 16; General John W. Hepfer, head of the MX Program Office, quoted in Edwards, *Superweapon*, 204. See also Robinson, “MX Racetrack Questioned in Congress,” 19.

the United States was in an inflationary era; thus, MPS would cost more in future year dollars. Many other unknowns lurked about, particularly assurance that missile locations could be adequately hidden, and no one could accurately estimate the final funding required.²⁸

In terms of Carter's five criteria, MX was survivable if the missiles could be shuffled around, but producing a speedy launcher, mobile shelters, and mass simulators was not going to be easy. No one had yet built, let alone flight-tested an MX missile. Nonetheless, because of its success with Minuteman and other programs, the air force had high confidence in developing new aerospace equipment. MPS was SALT verifiable and depending upon how one defined a launcher, was treaty compliant. The goals of minimal environmental effects and affordability were more elusive. Despite pronouncing that American security necessitated MPS, the administration clung compulsively to its obsessive desire for program options. Secretary Brown noted that "the final mix of missiles and shelters need not be decided at least until the initial production decision is made, and will then reflect the conditions existing at the time such as the threat, SAL [strategic arms limitation] agreements, and prospects for future agreements." Even when desiring to be bold, the White House cautiously hedged all bets.²⁹

Even though the president had advertised MX as mobile, it was not, strictly speaking, a mobile ICBM system, at least not to the same degree as earlier concepts.

²⁸MX PEM Worksheets, FY 1982. Copy contained in "History of Air Force Systems Command, 1 October 1979 – 30 September 1980, vol. 7 Supporting Documents, accessioned collections IRIS K243.01, AFHRA. On geothermal power, see HQ AFSC message to BMO, "MX-Renewable Energy System Project, March 31, 1980, 2100Z," 1, unaccessioned, unclassified collections. BMO box B-22, AFHRA. See also David R. Griffiths, "Renewable Energy Pushed for MX Net," *AWST* 113 (November 17, 1980), 45-46.

²⁹Department of Defense, *Report of Secretary of Defense Harold Brown to the Congress on the FY 1981 Budget, FY 1982 Authorization Request and FY 1981-1985 Defense Programs* (Washington, D.C.: Government Printing Office, 1980), 130. Hereafter cited as Department of Defense, *FY 1981 Defense Report*.

Unlike with mobile Minuteman, MPS mobility was not essential for survival. MX MPS missiles moved within a large but confined space where survival depended mostly upon random movement, concealment, and deception. General Allen wordily explained that “the purpose of adding mobility to the normal concealment mode is to deny the Soviets the prospect of executing a successful attack even in the unlikely case that they could gather sufficient knowledge of the location of a significant number of the MX missiles.”³⁰

Once the public had digested the president’s decision, forces mobilized to put teeth into Governor Matheson’s promise of an adversarial relationship with the air force. Federal law required the filing of environmental impact statements that explained in detail what effects MX would have on the landscape and communities therein. Despite their numbers, length, and detail, the studies pleased no one. Residents supported the MX ICBM but did so with an attitude of “not in my backyard.” A typical comment came from the 600-person community of Pioche, Nevada, where Connie Simkins compared MPS to the development of nearby aircraft bombing ranges. She stated that “they’re telling us . . . [it] will be fully accessible. We have first-hand knowledge of a promise like this about twenty-five years ago on the Nellis bombing range in which they didn’t do what they said they would. A lot of us have serious reservations that this is exactly the sort of thing that is going to snowball in these loop areas here.”³¹

As public wariness of federal institutions mounted against MPS, Nevada created a special state legislative committee to deal with the issue. The chair, Representative Richard Blakemore, asked BMO’s vice commander to attend hearings because of the

³⁰General Allen quoted in in Senate Committee on Armed Services, *MX Missile Basing System*, 132.

³¹Smith, “Nevada, Utah Study Impact of MX,” 14.

feeling “among many people that the air force knows a lot more than it is telling about MX missile impacts.” In a February 2, 1980, hearing, the Reno, Nevada, citizens alert committee summarized its fear that Nevadans, “more than anyone else in this hemisphere, would feel the horrible and ever present threat of nuclear war. If we accept the MX missile, we will be committing Nevada to an extensive and virtually permanent military presence which will dominate the image and the lifestyle of our state.” At-large Congressman James Santini, a Democrat but later a Reagan-era Republican, pointed to changing program requirements such as the increase in launcher size as evidence that the air force did not know how the program would affect his state, and he asserted that “the facts which are known seem to fluctuate wildly.” He promised to fight any legislation that circumvented congressional approval of land withdrawals for MPS.³²

After years of waiting for a basing decision, MX supporters now found that MPS did not have a home. Utahans and Nevadans mobilized their congressional leaders, who found willing allies among the president’s political foes, military doves, and opponents of the SALT II Treaty. Even legislators such as Utah’s Republican Senator Orrin Hatch, a strong supporter of the MX missile and other military programs, fought MPS. Hatch summed up his constituents’ feelings: “I don’t like it; frankly, I don’t want it. I think that it would not be good for Utah, and I hope that we’ll change the system.” Other powerful congressional leaders including Nevada’s Republican Senator Paul Laxalt mixed support for the MX missile with opposition to MPS. Nevada Governor Robert List, a

³²Richard E. Blakemore to Brigadier General Forrest McCartney, January 2, 1980, 1, unaccessioned, unclassified collections, BMO Box D-33, file: Nevada Legislative Commission’s Special Committee on MX, AFHRA. See also Greg McKenzie, “Testimony Prepared for the Nevada Legislative Oversight Committee Hearing on February 2, 1980,” 2 and Nevada Legislature’s Special Committee on MX Missile Matters, “Meeting Notice and Agenda, February 2, 1980, Statement of Congressman Jim Santini” 4,5, same collection

Republican, desired to replay John C. Calhoun on nullification by insisting that he had veto power over any federal decision to expand MPS into his state. Hundreds of citizens voiced their ire at hometown briefings by air force personnel. MPS opponents drew upon burgeoning environmental, state, and economic worries to derail mobile deployment.³³

SALT notwithstanding, United States-Soviet relations reached a nadir when on December 27, 1979, the Soviet Union invaded Afghanistan. President Carter feared this move was a precursor to an aggressive Soviet swing into the oil-producing regions of the Middle East. In his January 1980 state-of-the-union address, Carter declared that the Soviets had “taken a radical and an aggressive new step” whose implications posed “the most serious threat to the peace since the Second World War.” The debate over what intentions lay behind the Soviet arms buildup now turned towards Soviet military expansionism. Even with the promised SALT II reductions, they were mathematically much closer to destroying American ICBMs, and their recent belligerence made Americans wonder if they planned to do just that. Defense Secretary Brown told Congress: “We must decide now whether we intend to remain the strongest nation in the world.” Brown feared that in a world dominated by power and not principle, failure to address weakness meant that the United States would “become a nation with more of a past than a future.”³⁴

Despite facing “the most serious threat to peace” since World War II, presidential direction to build MPS and the congressional release of funds were two separate

³³“MX Basing Doubts Voiced in Utah, Nevada,” *AWST* 112 (February 11, 1980), 15-16.

³⁴Jimmy Carter, “State of the Union Address 1980” (national address, the Capitol, Washington D.C., January 23, 1980). Accessed on January 31, 2006 from Jimmy Carter Presidential Library and Museum <http://jimmycarterlibrary.org/documents/speeches/su80jec.phtml>. For Harold Brown’s statement, see Department of Defense, *FY 1981 Defense Report*, 14.

phenomena. Well into early 1980, the air force, DoD, and White House confronted their opposition. The air force was in a tricky position because it took its orders from a president who found himself alienated from Congress. Service leaders could not defy the president, and at the same time, they had no desire to make congressional enemies. Congress protected its interests by passing the Stevens Amendment, an appropriations bill rider sponsored by Republican Senator Ted Stevens of Alaska, the state with the largest percentage of federally-owned land, which prevented the air force from committing the nation to a single basing mode. This complicated things because the persons assigned to the MX program had to develop it in accordance with the president's order, but they had to appease Congress by continuing to study other basing modes. Needing to get on with its work, the air force went ahead with developing the baseline MPS program ordered by the president. To comply with the Stevens Amendment and secure funding, the service studied other basing modes, including vertical shelters, which the DoD and air force had previously rejected. Engineers still could not determine how to emplace and reshuffle 200 missiles in less than forty-eight hours, by which time the Soviets would defeat the system by knowing where the actual missiles were. Congressional leaders, as much as the White House, DoD, and air force, deserve their share of blame for the confusion.³⁵

What the air force needed was a smaller deployment area and lower cost. MX project officials hoped that by lessening the environmental and economic opposition, Congress would release the funding needed to build the hardware necessary to close the mid-eighties ICBM vulnerability window. In response, proponents developed multiple

³⁵See Edwards, *Superweapon*, 212. See also "Air Force Reverses Position, Backs Horizontal MX Basing," *AWST* 112 (March 10, 1980), 21-22.

themes on the MPS option, including a cheaper concept explored originally in 1978 known as the loading dock. A powerful ally was Undersecretary Perry's Defense Science Board, which approved of this new method. On May 1, 1980, the air force directed its prime MPS contractor, Boeing, to develop the loading dock, known also as "horizontal shelter with separate transporter and mobile launcher."³⁶

According to Secretary Brown, the loading dock simplified MPS and had three economic advantages, including smaller and therefore cheaper shelters; elimination of shield vehicles; and simpler mass simulators because the transporter vehicles no longer served as launch platforms. In lieu of a transporter launcher, a missile, canister, and stationary launcher rolled off a transporter vehicle into a horizontal shelter, which was 180 feet long and fifteen feet high, smaller and cheaper than the original shelters, and spaced 5,200 feet apart rather than 6,300 feet as in the original MPS concept. The launcher was a self-contained missile erector-launcher equivalent to the launch and erecting mechanism on a transporter launcher. The lack of transporter launchers forfeited a dash capability, but random reshuffling remained possible, estimated by Boeing to take twelve hours. Because the launcher mechanism shielded the missile during transport,

³⁶One of the early studies on loading dock was Boeing Company, "MX Loading Dock Concept Design Study, September 20, 1978," unaccessioned, unclassified collections. BMO box 22, AFHRA. The air force was ready for the shift to loading dock. In March 1980, BMO's contracting officer told Boeing to cease development of the original MPS baseline and to start characterizing the loading dock scheme. See Betty I. Hane, Contracting Officer, to Mr. Robert Ingersoll, Boeing Aerospace Company, "Redirection of MX Basing Concepts, Contract F04704-78-C-0035, March 3, 1980," 1 and R. J. Ingersoll, Contracts Manager, MX Program, to air force plant representative-Seattle, "Redirection of Basing concepts, Contract F04704-78-C-0035, May 8, 1980," 1-2. Both letters unaccessioned, unclassified collections. BMO box B-22, AFHRA.

there was no need for the shield vehicle. SALT viewing ports remained necessary for postdeployment verification.³⁷

The deployment fields consisted of parallel roads, each with twenty-three shelters, forming what was nicknamed a "grid." Rather than build new roads, the air force planned to use existing state roads, making the deployment area slightly smaller, but the change did little to satisfy the opposition. To alleviate further the worries of Utah and Nevada residents, the air force investigated the possibility of split basing the MX force in Texas and New Mexico, whose residents, representatives, and senators reacted predictably. Doing so cost \$3.4 billion more to procure and construct, duplicated facilities, and caused greater future operations costs. According to the DoD, it offered "no overriding environmental, operational, strategic arms limitation, or schedule advantages or disadvantages over full basing." Split basing was little more than a half-hearted attempt to mollify Utah and Nevada, and it only served to stir opposition in Texas and New Mexico. Although the location remained uncertain, the Carter administration approved of replacing the racetrack with the grid.³⁸

MX MPS loading dock operations differed from Minuteman in that MPS crews did not man underground launch control centers; the system design eliminated as many

³⁷Harold Brown to Senator John C. Stennis, April 29, 1980, 2, unaccessioned, unclassified collections. BMO box, B-1, AFHRA. TRW, "MX Basing Concept Update: Separate Transporter and Mobile Launcher, 12 May 1980, slides 3-23, unaccessioned, unclassified collections. BMO box B-3, AFHRA. Random shuffle time from R. J. Ingersoll, "Redirection of Basing Concepts," attachment A, 4. Bruce A. Smith, "USAF Changes MX Missile Launch Mode," *AWST* 112 (March 17, 1980), 20-21; OTA, *MX Missile Basing*, 33-58.

³⁸Department of Defense, "MX Split Basing Report, January 19, 1981," 1-1 to 1-5 and 6-6 to 6-12. Later studies found that arranging the shelters so that each group of six formed the vertices of a hexagon improved survivability by creating zones in which blast overpressure was insufficient to destroy the shelters contained therein. See TRW, "MX Basing Concept Update," 10-11; OTA, *MX Missile Basing*, 52. The air force examined multiple variants of split basing; all provided minimal gains against facility and cost duplication. See also "MX Loading Dock Concept Chosen by Defense Dept," *AWST* 112 (May 5, 1980), 26-27.

people as possible. A single centrally located operations center located outside of the clusters on the main support base provided peacetime status monitoring and C3. It was not an underground control center, and air force officials did not expect it to survive a Soviet attack. During peacetime, the operations center had a communications network comprised of fiber optics cable that connected the missile launchers to its status monitoring computers, which monitored the 200 MX missiles and 4,400 mass simulators. Uniform message formatting and protocols carried C3 between the operations center, missiles, and mass simulators and contributed to location uncertainty. The operations center also performed SIOP targeting updates, controlled code changes, missile tests, retargeting, launch operations, and dispatched maintenance and security teams.³⁹

In a wartime environment, assuming the Soviets had destroyed the operations center, an airborne launch control system similar to the one used for backing up the Minuteman control centers launched the missiles via a two-way medium frequency radio link. Because launch control aircraft had a limited fourteen-hour endurance, SAC planned direct wartime C3 access via high and very low frequency communications. If the Soviets attacked and the president decided to launch MX missiles, higher authority such as SAC would broadcast the launch order to the unmanned missile shelters. To ensure message reception, the first launcher to receive a message rebroadcast it via very low frequency throughout the deployment area. Surviving shelters rebroadcast the message until the original launcher had determined which missiles survived. At that

³⁹OSD, "News Conference by Dr. William Perry, Under Secretary of Defense," 18; OTA, *MX Missile Basing*, 52-58. Number of mass simulators from R. J. Ingersoll, "Redirection of Basing Concepts," attachment A, 1. Operations center operational details from Boeing Company, "MX Vertical Shelter Ground System Definition, Configuration Description, and Operation and Support Concepts, March 14, 1979," 13, unaccessioned, unclassified collections. BMO box 100, AFHRA. This description is consistent with that required for other MPS deployments. American nuclear forces, including SLBMs and hard and dispersed-based ICBMs utilized very-low-frequency communications.

time, a computer logarithm “reallocated and reoptimized” preselected targets among the surviving MX missiles. The launcher then retracted its shock isolation bars and the loading dock deployed rollers, the shelter doors unlocked and opened, and the launcher rolled the launch canister onto its cantilever. The launcher erected the missile to an angle of eight-five to ninety degrees. The steam generator built into the base of the MX canister expelled the missile, and once clear (about 100 feet into the air), the stage one motor fired. The entire sequence took several minutes.⁴⁰

In agreeing to support MPS, President Carter had bowed to the reality of nuclear parity. He had also accepted the potential of Soviet aggression to include limited nuclear war, and in July 1980, issued Presidential Directive 59, to provide guidance on the flexible employment of nuclear weapons in conflicts short of an all-out exchange. He reaffirmed that the primary purpose of nuclear forces, including MPS, was deterrence but that should it fail, the United States must fight “successfully so that the adversary would not achieve his war aims and would suffer costs that are unacceptable, or in any event greater than his gains, from having initiated an attack.” Presidential Directive 59 then described a series of preplanned nuclear strike options. In his strategy, the president carefully explained that mobile MX was not a first-strike weapon, asking “which is the first-strike system, the SS-18, massive and lethal but vulnerable, or the mobile MX, much

⁴⁰OTA, *MX Missile Basing*, 52-58. MX MPS horizontal shelter operations paralleled those for MPS loading dock, the major difference being the use of transporters and the potential for unmanned, 1.2 million-pound vehicles dashing between shelters while Soviet RVs were in-bound. Regarding missile ejection, previous MX cold-launch designs burned solid propellant to pressurize the canister and push out the missile. The switch to steam simplified construction by eliminating protective devices. A smaller amount of solid propellant boiled water in a tank to create steam pressure that popped the missile out. Temperatures were 2,000 degrees cooler. This switch eliminated the need for protective baffling, known as a sabot, which lowered the weight of the missile canister. The process was similar to SLBM launches, and was used for hard and dispersed MX deployments. See “MX Launch Technique Changed, *AWST* 112 (June 16, 1980), 28.

of whose cost will go to being able to survive a first-strike by the other side?"

Grudgingly, the administration had accepted ICBM vulnerability as real and had embraced the MX.⁴¹

A program in crisis and a major news story, MX MPS was also a political liability, and ahead of the White House loomed a presidential election. Carter's desire to retain multiple--and conflicting--options, plus environmental, state, and economic objections, and add to this the complications of arms control agreements, had conspired against MPS deployment and made it an election-year liability that the Republicans could exploit. In mid-1980, Undersecretary of Defense Perry responded to this and reported on ICBM basing options to a public audience. He listed the pros and cons of dozens of basing schemes to justify the tortuous path leading to Carter's MPS announcement. He emphasized careful and deliberate attention given the problem by the administration, demonstrating in the process a flippant disregard of reality.

Perry described only those options that had "received serious attention." Before MX MPS, the most successful mobile ICBM concept had been rail-mobile Minuteman, which planners had reconsidered but rejected because they believed public safety and missile security insurmountable problems. Perry asserted that "simultaneous operation of commercial and nuclear missile trains within or near populated areas poses an unacceptable hazard to the civilian population," a reasonable statement coming on the heels of the reactor accident at Pennsylvania's Three Mile Island. He feared that enemy agents would recognize and then sabotage the missile cars. The mobile Minuteman

⁴¹White House, "Presidential Directive 59, Nuclear Weapons Employment Policy, July 25, 1980," 1-5. Declassified copy received from the Jimmy Carter Presidential Library. See also Senate Committee on Foreign Relations, *Nuclear War Strategy*, 32.

designers simply had not shared these concerns. Perry rejected a dedicated MX rail network as too costly because it required 22,000 miles of new track and necessitated closure of vast land tracts. Later, in the Reagan administration, rail-mobile became the leading option for mobile MX deployment, but it never achieved more than the construction of prototype missile cars, and in any case, the end of the Cold War forced its cancellation.⁴²

To Perry, MX MPS was not a “complex, expensive ‘Rube Goldberg’ approach” and was less of a technical challenge than were the first SLBM systems. According to Perry, MX MPS had “no major technical difficulties. The missile, shelter, road, transporter, security, communication, test, construction, maintenance, and operation all are similar to well known Minuteman designs and methods. The principal technical problem is careful design of the system to ensure maintaining position location uncertainty.” This was nonsense. In addition to the problems of location uncertainty, there were many others; moreover, the MPS concept of operations and equipment differed radically from Minuteman, which relied upon hard and dispersed launch facilities and two-man crews located in dispersed, underground launch control centers. Minuteman needed humans to launch missiles, and MX MPS did not. It was not at all similar to the “well-known Minuteman.” Perry’s misleading conclusions about the

⁴²Department of Defense, *ICBM Basing Options: A Summary of Major Studies to Define a Survivable Basing Concept for ICBMs, December 1980* (Washington, D.C.: Office of the Deputy Under Secretary of Defense for Research and Engineering Strategic and Space Systems, 1980), 55, 57. This study revised an earlier draft dated August 1980. The earlier study was not as comprehensive. See Department of Defense, *ICBM Basing Options: A Summary of Major Studies to Define a Survivable Basing Concept for Land Based ICBMs, August 1980* (Washington, D.C.: Office of the Deputy Under Secretary of Defense for Research and Engineering Strategic and Space Systems, 1980).

advantages and feasibility of MX MPS did little to sway public disenchantment with the program.⁴³

A Change: Ronald Reagan, Arms Elimination, and ICBM Basing

In the 1980 presidential election, Republican candidate Ronald Reagan attacked President Carter's national security program, finding MPS a convenient platform to separate his campaign positions from those of Carter and to demonstrate his toughness on national defense. A staunch defense advocate, Reagan appealed to MPS opponents by re-examining alternative MX deployments. He favored building the missile but preferred a shell game using traditional launch facilities, an older idea whose time was renewed. In this scheme, known as valley cluster basing, ten missiles shared 230 shelters inside a large valley; thus, a 200-missile force needed twenty valleys. Maintenance crews would, on occasion, pull and then emplace the missiles in different launchers. Reagan criticized Jimmy Carter for dragging out MX basing and weakening American national security, but his scheme further delayed MX deployment. Nonetheless, Reagan shrewdly drew support from both sides of the issue by supporting a new ICBM without favoring MPS. The air force saw little value in this and knew that any re-examination of basing would further delay the MX program.⁴⁴

Politically, valley clustering satisfied Reagan's desire to ensnare Carter with MPS while demonstrating his own belief in a strong ICBM force. To amplify his position, his

⁴³Ibid., 82. See also Brigadier General Forrest S. McCartney to BMO, "Dr. Perry's Statement on MX of April 25, 1980, May 28, 1980," 4-5, unaccessioned, unclassified collections. BMO box B-22, AFHRA.

⁴⁴Clarence A. Robinson, Jr., "Alternate MX Basing Concepts Weighed," *AWST* 113 (October 27, 1980), 19-20; See OTA, *MX Missile Basing*, 111-146, 235-256, and 269-276.

advisors proposed retrofitting immediately 100 MX ICBMs into existing launch facilities, thus adding 1,000 reentry vehicles to the American arsenal--a significant gain. But, as Harold Brown had correctly told Congress, this would not solve the problem of launch facility vulnerability and only increased American first-strike capability or tempted the Soviets to destroy the vulnerable missiles. Surprisingly--and confusingly--despite his opposition to MPS, Reagan briefly considered deploying the dislocated Minutemen in an MPS scheme using nine-to-eighteen shelters per missile. It was a sign of his distaste for Carter's handling of MX basing that he considered MPS for Minuteman but not MX. Nonetheless, despite his tough campaign rhetoric, Reagan had begun tentatively to back away from endorsing the idea that there was a window of ICBM vulnerability.⁴⁵

Reagan won the 1980 election in an electoral--if not popular--vote landslide, and leading his defense transition was William R. Van Cleave, who had served President Ford's national security team and who believed the Soviet Union was an expansionist threat to American interests. His deputy was Ben Plymale, the Boeing vice-president who in 1974 had pitched his company's original air-mobile deployment scheme at an AIAA meeting. These men sought to "close the window of [ICBM] vulnerability as expeditiously and effectively as we can" without pushing any "particular programs, systems, or policies." Separating policies from programs was impossible--a president had to have policies and the weapons with which to execute them. As a solution, Van Cleave and Plymale supported MX valley clustering but wanted also to improve

⁴⁵Clarence A. Robinson, Jr., "Reagan Details Defense Boost," *AWST* 113 (November 10, 1980), 15. Harold Brown statement in Department of Defense, *Report of Secretary of Defense Harold Brown to the Congress on the FY 1982 Budget, FY 1983 Authorization Request and FY 1982-2986 Defense Programs* (Washington, D.C.: Government Printing Office, 1981), 111. Dated January 19, 1981, Brown's report read as a Carter administration mea culpa on defense issues.

Minuteman's survivability. Calling Minuteman "a tremendous resource" costing \$20 billion, Plymale argued that it was wasteful not "to fix it so it isn't vulnerable, whatever we do with MX." It helped that Boeing had built Minuteman. Any fixes surely would require the company's services and recoup dollars lost on cancelled MX MPS contracts.⁴⁶

In contrast to Carter, Reagan's opposition to SALT II was emphatic. Before his victory, he told Donald Rumsfeld that "passage of this treaty will be a serious blow to our security." To another correspondent Reagan stated, "I don't really trust the Soviets, and I don't really believe that they will really join us in a legitimate limitation of arms agreement." Reagan believed that the only way to reduce nuclear arms was to approach the Soviets from a position of strength. He dismissed Carter's reaction to the Soviet invasion of Afghanistan as tragic, if not laughable, because the president said that while he distrusted the Soviets, he still desired arms negotiations, which could succeed only on the basis of secure, trustful relationships. Capitalizing on this sentiment, Reagan's advisors recommended that he reenergize the cancelled B-1 bomber, improve conventional forces, and modernize other nuclear forces, which meant continued reexamination of MX basing and less enthusiasm for mobile modes.⁴⁷

Reagan's inauguration did little to dissipate the atmosphere of opposition swirling about MPS basing. Until Reagan told the air force otherwise, it had to follow orders and

⁴⁶Clarence A. Robinson, Jr., "Reagan Team Asks Capabilities, Priorities of Services," *AWST* 113 (December 8, 1980), 16-17. Plymale was probably the source for Reagan's flirtation with Minuteman MPS. Boeing had researched MPS-like systems for Minuteman and initially hoped for a 1980 initial operating capability. A Boeing briefing concluded that "adding a wing of 100 mobile MM [Minuteman] IIIs is the only system which works the near term strategic missile balance." See Boeing Company, "Early Multiple Aim Point Systems Deployment MM-III IOC 1980," unaccessioned, unclassified collections. BMO box M-11, AFHRA.

⁴⁷Robinson, "Reagan Details Defense Boost," 14. Letters to Donald Rumsfeld, October 26, 1979, and Charles Burton Marshall, April 8, 1980, reproduced in Skinner et al., *Reagan: A Life in Letters*, 398-399. For Reagan on Carter and Afghanistan, see page 400.

build MPS; that remained priority one. Meanwhile, opponents bludgeoned MX environmental impact statements and questioned every air force cost estimate, which drowned in a tide of hearings, protests, and legislative attacks. To ease its transcription burden, the air force videotaped public hearings only to have meeting attendees claim the military planned to use the tapes to intimidate them. Soon, Secretary of Defense Caspar ("Cap") Weinberger lamented being "snarled in a lawsuit over each silo shelter." The Mormon Church even came out in opposition to MPS on moral grounds. Missile testing, though, had greater success; by February 1981, the third stage motor fired successfully, but even then, environmentalists protested and secured a temporary restraining order from a Los Angeles judge that prohibited stage four test firings. The fourth stage, a liquid-fuel post-boost vehicle, used toxic propellants, and the San Fernando Valley Alliance for Survival claimed the exhaust was dangerous to residents. It was not, but the environmentalists had gained the upper hand in the public and legal debate.⁴⁸

Doubtful about MPS in his own thoughts and minding the opposition, Reagan directed another MX basing mode study, known as the Townes Panel after its chair, 1965 Nobel laureate physicist Professor Charles Townes of the University of California, Berkeley. The panel, whose influential members included Simon Ramo, Bernard Schriever, and retired air force Lieutenant General Brent Scowcroft (in 1983 the chair of Reagan's Commission on Strategic Forces), received testimony from those involved in what critics disparaged as the "mode-of-the-month club." When the air force talked to the panel, it attempted to save MPS by adding its features to valley cluster basing,

⁴⁸"MX Missile Motor Fired Successfully," *AWST* 114 (February 2, 1981), 19; "Judge Halts MX Engine Tests," *AWST* 116 (February 9, 1981), 26 and "Environmental Action May Slow MX Basing," *AWST* 116 (February 9, 1981), 27. On videotaping, see Bruce A. Smith, "MX Basing Impact Report Criticized," *AWST* 114 (April 6, 1981), 22.

retaining MPS-like but smaller, hardened horizontal shelters among which the missiles moved but only for infrequent maintenance. It cited a \$2 billion savings made possible by eliminating the SALT viewing portals (satellites easily verified valley basing without these devices). A line drawing of a compact shelter deployment overlaid on an aerial photo of Dry Lake Valley, Nevada, demonstrated the continuing air force commitment to the basic MPS concepts, and the attempt was transparent to the new administration, which was not pleased.⁴⁹

The Townes Panel agreed with Reagan that although MPS "can extract a substantial price, the Soviet Union can readily compete in a U.S. shelter versus Soviet ICBM warhead race." The committee eased the sting by graciously complimenting the air force for "the quality and technical competence of the air force MX personnel; by all appearances, MX/MPS is a well managed program." The real blow was that the committee found "no practical basing mode for missiles deployed on the land's surface available at this time that assures an adequate number of surviving ICBM warheads." Not entirely desiring to dispose of the ICBM leg of the triad, the Townes Panel held that "the most promising approach to a new secure ICBM retaliatory force appears to be continuous airborne patrol." As a long-term solution to the problem of survivability, the committee unanimously recommended developing a small, mobile ICBM unfettered by MPS opposition before splitting on the immediate problem of vulnerability. A majority of the members recommended the deployment of 100 launch facility-based MX missiles

⁴⁹Townes Panel, "Report of the Committee on M-X Basing, July 1981," 10, unaccessioned, unclassified collections. BMO box B-125, AFHRA. Clarence A. Robinson, Jr., "MX Missile Concealment Investigated," *AWST* 114 (April 13, 1981), 21-23; Clarence A. Robinson, Jr., "ICBM, Bomber Decisions Due in Late July," *AWST* 115 (July 13, 1981), 18-20. The 1983 President's Commission on Strategic Forces, also known as the Scowcroft Commission, recommended the temporary basing of MX in launch facilities and the development of a new, small, and mobile ICBM. BMO, "ICBM Basing, August 17, 1981," passim, unaccessioned, unclassified collections. BMO box B-3, AFHRA.

as an interim hedge against Soviet superiority, but a minority contended that it was wasteful to deploy MX ICBMs on land, arguing that it was better to spend the money on upgrading other strategic systems.⁵⁰

Meanwhile, without the air force's knowledge, Weinberger decided to push two air-mobile schemes, one an interim solution similar to the Golden Arrow air-transportable missile system and the other a permanent answer--the Boeing version of the Golden Arrow long-endurance aircraft, nicknamed "big bird." For the air-transportable look-alike, Weinberger preferred C-5s, but he was ready to accept 747s until big bird was ready. This latest iteration of a long-endurance missile carrier had four propeller-driven engines and a 360-foot wingspan, but carried an estimated procurement cost of \$20 billion for 140 aircraft with seventy maintaining a continuous airborne, not counting the missiles, support facilities, or operation and sustainment needs. Weinberger also wanted deep--thousands of feet deep--underground launch facilities. The air force was stunned; despite its earlier embrace of air mobility, it protested the big bird concept and opposed deep basing, preferring MPS. Adding insult to injury, Weinberger even reconsidered a common air force-navy missile, which if ordered, would retard MX by two years and delay the Trident program. MX foundered.⁵¹

Adversarial best described the relationship between MPS and Congress, but most legislators found Weinberger's air-mobile schemes ridiculous. The ranking Republican on the House Armed Services Committee, Representative William Dickinson, from

⁵⁰Townes Panel, "Report of the Committee on M-X Basing, July 1981," i-iv, 5-7, 17.

⁵¹Big bird data from BMO, "Technical Assessment of Big Bird 6800 Long-Endurance Airborne Strategic Missile Carrier, June 13, 1981, unaccessioned, unclassified collections. BMO box B-64, AFHRA. Clarence A. Robinson, Jr., "Weinberger Pushes Strategic Airmobile MX Concept," *AWST* 115 (August 3, 1981), 16-19.

Opelika, Alabama, was “a lot less enthusiastic about an airmobile concept than MPS, and I don’t think much of MPS.” Wisconsin Representative Les Aspin, a Democratic colleague on the committee, insightfully understood that “air-mobile is a nonstarter. . . . if the service involved objects to it, it will be a mess.” Others thought differently, including New Jersey Republican Representative Millicent Fenwick, who felt that anything was “better than the racetrack scheme.” Disregarding the navy’s advice, she favored shallow-water submarines, and irrespective of the air force, concluded that “an air-mobile would suit me just fine. Common sense has pushed me against these land basing schemes.” So much for common sense. Florida’s Democratic Representative Charles E. Bennett wanted “some kind of underwater mode,” but could not further define his wishes. Confusion and frustration abounded, and the Reagan administration had caused much of it. Having pledged to cut, slash, and chop wasteful spending, the Reagan team spoke now not of permanently basing MX but of multiple solutions--two types of airmobility, deep underground launch facilities, and existing launch facilities, not to mention ballistic missile defenses--and that meant spending more money on temporary fixes. Moreover, Reagan supported deployments that the air force did not want. Even more so than Carter indecision, the less-than-a-year old Reagan team had destroyed whatever credibility MX had left on Capitol Hill and with the general public.⁵²

By September, the administration’s internal divisions over MX basing had widened, adding even more confusion. In July, Weinberger held a National Security Council meeting in California, where an air force official described the atmosphere as “Caspar Weinberger against the world.” The air force attacked Weinberger’s air-

⁵²Legislators quoted in “Congress Reacts Against Airmobile Basing of MX,” *AWST* 115 (August 17, 1981), 30.

launched concepts for not providing adequate tactical warning, the need for external guidance aids, sensitivity to SLBM and ICBM barrage attacks, and limited aerial endurance. The air force also attacked basing MX in Minuteman launchers and the secretary's ideas for ballistic missile defense. Whereas the air force and Harold Brown had eventually agreed upon MPS, no such good will appeared possible between the service and Secretary Weinberger, who was upset with its opposition to an air-mobile missile and its support of Carter-era MPS. Attendees discussed numerous options, each with variations in numbers of missiles (a briefly popular proposal emplaced 100 MXs in 1,000 MPS shelters), shelter types, carrier aircraft, and so forth, but they did not reach consensus. The number of proposals confirmed that one technological wonder could not address all aspects of the ICBM survivability problem. Political, not technological, economic, or military reasons would decide MX basing.⁵³

Concurrent with the discussions on ICBM force structure, Ronald Reagan, as all full-term American presidents since Nixon had done, issued directives governing the limited employment of nuclear weapons. Since then, presidential thinking had accepted the use of nuclear weapons outside of a full-scale exchange, but Reagan went a step further. National Security Decision Directive (NSDD) 13, dated October 19, 1981, replaced Presidential Directive 59 and placed nuclear weapons on a continuum of conflict with conventional arms, meaning that if deterrence failed, "the employment of nuclear forces must be effectively related to the operations of our general purpose forces," which gave wide latitude to nuclear war planners. Achieving synergy between conventional and nuclear forces required improvements to C3 and intelligence, including damage

⁵³David R. Griffiths, "MX Basing Problem Unresolved," *AWST* 115 (August 24, 1981), 16. BMO, "ICBM Basing," passim.

assessment, the utilization of surviving retaliatory forces, and improved communications systems. Reagan also wanted to improve wartime coordination and planning, specifying new employment plans and policies. He feared the devastation of American society, and to protect the United States, he wanted active defenses such as satellites capable of shooting down ICBMs and passive means like hard command facilities. These guidelines were the basis of Reagan's strategic force modernization program, and his advisors rushed to have their views made policy.⁵⁴

Cap Weinberger, whose ideas meshed with Reagan's strategic forces program described in NSDD 13, won the race to influence the president. In NSDD 12, approved October 1, 1981, Reagan approved five "mutually reinforcing" directions for weapons procurement, including robust C3 to permit postattack communications with surviving forces. He wanted two new types of bombers, increased SLBM accuracy and payload, strategic defenses; and "a new, larger and more accurate land-based ballistic missile." Wanting to address as quickly as possible the ICBM imbalance, Reagan ordered the "development of MX will be completed and sufficient units produced to support 100 operational missiles. All work will be stopped on the Multiple Protective Shelter basing. . . . A limited number of MX missiles will be deployed as soon as possible in reconstructed Minuteman III or Titan silos." He further directed pursuit of three options for the long-term basing of MX: use of ballistic missile defenses to increase launch facility survivability, air-mobile basing, and deep underground basing. He wanted a selection made by 1984 so that he could permanently deploy another 100 MX missiles.

⁵⁴White House, "National Security Decision Directive Number 13, Nuclear Weapons Employment Policy, October 19, 1981," 1-5. Declassified photocopy received from the Ronald Reagan Library.

Against the air force's advice, Reagan and Weinberger defined MX mobility as airmobile.⁵⁵

Shortly thereafter, on October 2, plans for MX MPS publicly collapsed. At a press conference oft remembered for announcing the infamous strategic defense initiative nicknamed "star wars," Reagan "ordered the completion of the MX missiles," but not in any "scheme for multiple protective shelters. We will not deploy 200 missiles in 4,600 holes, nor will we deploy 100 missiles in 1,000 holes." Three days later, the president added to his earlier remarks. He wanted the first thirty-six MX missiles emplaced in existing but hardness-upgraded launchers. Doing so would not "render them invulnerable in perpetuity," but would "buy us some time in which the Soviet Union would have to increase its ability at targeting, and its power, in order to overcome this hardening." Reagan implied that launch facilities were not currently vulnerable.⁵⁶

The press wanted to know why, if a window of vulnerability existed by the mid-eighties, the MX was now safer in launchers whose precise locations the Soviets already knew. Even if the MX was put underground, 1986 was the earliest possible date for missile deployment. What good could this token force bring? ABC News's Sam Donaldson asked Reagan if he opposed MPS because it was a Carter plan and if whether opposition from Utah's Mormon Church and personal friend Nevada Senator Paul Laxalt

⁵⁵White House, "National Security Decision Directive Number 12, Strategic Forces Modernization Program, October 1, 1981," 1-3. Declassified photocopy received from the Ronald Reagan Library. The survivable C3 included many systems now standard in American nuclear forces. The bombers were the B-1, begun back in the Nixon era and the B-2 stealth bomber, a Carter-era concept. Trident I and II increased SLBM lethality. Strategic defenses referred, of course, to the soon-to-be-announced Strategic Defense Initiative, and the new ICBM was the MX.

⁵⁶White House, "Remarks and a Question-and-Answer Session with Reporters on the Announcement of the United States Strategic Weapons Program, October 2, 1981," in *Public Papers of the Presidents, Ronald Reagan: January 20 to December 31, 1981* (Washington, D.C. Government Printing Office, 1982), 880. See also "Remarks and a Question-and-Answer Session with a Group of Out-of-Town Editors, October 5, 1981," 896.

had changed his plans. Reagan denied this was so and cited the Townes Panel, which had concluded that the Soviets could overwhelm MPS by deploying additional missiles and warheads beyond SALT limits. Reagan did not mention that the Townes Panel had favored a small, single-reentry vehicle mobile missile over the big MIRVed MX. He also did not add that in 1979 William Perry had suggested this same concept to force a SALT III treaty. MPS proponents had brought the Soviets to the negotiating table with shelters, but Reagan sought the same with missiles in existing launchers. Moreover, if a window of vulnerability truly existed, then the deployment of Soviet MIRVs had already overwhelmed existing launchers. SALT I had prohibited the construction of new launch facilities, and Reagan's thirty-six MX missiles replaced Minuteman or Titans on a one-for-one basis. Donaldson and the rest of the press saw that interim launch facility-basing was a red herring. Taking no more questions, the president deftly "turned it over to Cap" and left.⁵⁷

The military felt they had also been "turned over to Cap." Because he believed that launchers were vulnerable, air force General David C. Jones, Chairman of the Joint Chiefs of Staff, opposed Reagan's new MX deployment scheme. To Jones, toying with existing launchers wasted time and money better spent on other service needs. The Reagan defense team knew this; why else launch facility-base a limited number of missiles and not all of them? Boldly stating his position, Jones recommended MPS to Reagan but was unable to convince him to accept what he considered Carter's albatross. Nonetheless, the general was willing "to be convinced that there is a system other than the multiple protective shelter system that is survivable." Weinberger, sharing the insight

⁵⁷White House, "Remarks . . . Out-of-Town Editors," 897.

of Representative Aspin, knew that without service support, Reagan's MX basing plan was doomed. To prevent this, Weinberger ordered the air force, which he had ignored during the administration's internal debate, to "complete development of MX, produce 100 operational missiles and deploy as soon as possible a limited number" in refurbished Titan II and Minuteman II launchers (Reagan had already decided to retire the Titan IIs). He wanted a detailed execution plan by October 23. With no choice but compliance and little time with which to act, the air force dutifully did as told.⁵⁸

The air force response pleased Weinberger, who further directed the service to "proceed with a silo program that preserves the option for hardening compatible with permanent basing modes to be developed." To ensure that the air force understood his desires, he emphasized that launch facilities were compatible with ballistic missile defense programs and provided flexibility for future expansion. He believed that launchers maximized operational effectiveness because they permitted MX deployment in a single existing ICBM wing. He then wanted the service to prepare detailed studies on deep basing, continuous patrol aircraft, and missile defense options. He stipulated that "all activities within the MX program which are related to the Multiple Protective Shelter . . . concept and not required by this memorandum will be terminated as economically as possible." The secretary's desires were unequivocal and clearly received; the air force might not have liked its orders, but it had to carry them out.⁵⁹

Reagan's arms control desires were central to his decisions and handling of MX. Rather than seeking numerically high limits on nuclear weapons, he desired deep cuts and

⁵⁸Clarence A. Robinson, Jr., "Decisions Reached on Nuclear Weapons," *AWST* 115 (October 12, 1981), 18, 22-23.

⁵⁹Caspar Weinberger to Secretary of the Air Force Verne Orr, December 31, 1981, 1-3, unaccessioned, unclassified collections. BMO box B-3, AFHRA.

the elimination of whole classes of weapons--goals he finally met during his second term. A prolific scribbler, diarist, and letter writer, he revealed his belief that "the Soviets won't really negotiate on arms reductions until we . . . go forward with the MX." To one correspondent, he wrote "I believe our intention to build the MX might offer an incentive to them to think of a mutual reduction in nuclear weapons." Debates over ICBM mobility only impeded this goal. Reagan needed a missile, he needed it quickly, and hard and dispersed basing was the best way to meet those needs. In September 1979, Carter had publicly declared that MX MPS was not a bargaining chip, but to Reagan, then and now, MX was always a bargaining chip.⁶⁰

Compelled to quiet the tremors emanating from his October bombshells, on May 17, 1982, Reagan authorized NSDD 35, an MX-specific directive. He repeated his order to cease MPS development, believing it "absolutely essential that we maintain the momentum of the MX program and that we achieve initial operational capability in 1986" of the first launch facility-deployed missiles. He stated "the MX missile . . . [was] absolutely essential . . . to support our national security needs and our commitments to friends and allies." Reagan had clarified his thoughts on mobile basing: no longer were continuously airborne aircraft an option; closely spaced basing was "the most promising route to pursue." Six months later, on November 22, he ordered that the missile "be completed on a priority basis" based in "superhardened silos," and shortly after this, began publicly to refer to the missile as the "Peacekeeper." Congress, unhappy with

⁶⁰Ronald W. Reagan, *An American Life: The Autobiography of Ronald Reagan* (New York: Simon and Schuster, 1990), 586; Skinner et al., *Reagan: A Life in Letters*, "404-405.

closely spaced basing, refused funding for MX deployment, which frustrated the president because continuing debate endangered his hedge against Soviet power.⁶¹

Also on November 22, Reagan issued NSDD 91, updating the nuclear force priorities outlined in NSDD 12 and the fourth such directive dealing with MX since October 1981--an unusual practice but one indicating its importance to him. Reagan ordered fifty MX missiles emplaced in the 400th Strategic Missile Squadron at Francis E. Warren Air Force Base, Wyoming, with another fifty to follow for the 319th Strategic Missile Squadron. There was no mention of MX mobility or even valley clusters. In July 1985, Congress refused to fund the additional fifty missiles, which never deployed. By then fourteen years in the making and without a single missile on alert, congressional patience had evaporated, and for now, mobile MX was finished.⁶²

On January 3, 1983, Reagan had established the President's Commission on Strategic Forces and appointed retired air force Lieutenant General Brent Scowcroft as its chair to make recommendations for coping with "Soviet expansionism while preventing the devastation of nuclear war." This group, known as the Scowcroft Commission, finished its work by early spring, and on April 19, 1983, Reagan endorsed its recommendations, which clarified his position on ICBM vulnerability. Regarding MX, the commission recommended launch facility deployment, followed by the development

⁶¹White House, "National Security Decision Directive Number 35, The MX Program, May 17, 1982," 1-2; White House, "National Security Decision Directive Number 69, The MX Program, November 22, 1982," 1-2. Declassified photocopies received from the Ronald Reagan Library. To avoid confusion, this dissertation uses the name MX.

⁶²White House, "National Security Decision Directive Number 91, Strategic Forces Modernization Program Changes, November 22, 1982," 2. Declassified photocopy received from the Ronald Reagan Library. See also White House, "Remarks Endorsing the Recommendations in the Report of the President's Commission on Strategic Forces, April 19, 1983," in *Public Papers of Public Papers of the Presidents, Ronald Reagan: 1983, Book I - January 1 to July 1, 1983* (Washington, D.C.: Government Printing Office, 1984), 555-557.

of a new mobile ICBM with one reentry vehicle. Believing MX's deployment "essential to induce the Soviets to negotiate away what is currently a favorable strategic position for them in ICBM forces," the commission contended deploying "MX in existing LFs [launch facilities was] an adequate deployment at reasonable cost." To answer Congressional criticism of the administration's handling of the ICBM vulnerability window, Scowcroft explained: "The fundamental requirement for survivability of our ICBM force is as a hedge against a Soviet breakthrough on antisubmarine warfare which could endanger our submarine-launched ballistic missiles. We do not see that on the horizon at the present time. For the longer run, we are proposing the small [mobile] missile to provide that hedge by enhancing the survivability of the ICBM force. For the present, we believe that silo vulnerability is not so dominant a part of the overall problem as to require other immediate steps."⁶³

Force improvements to the submarine and bomber legs of the triad had shaded the ICBM vulnerability problem. By 1985, the navy had deployed numerous Trident I SLBMs, an eight-MIRV missile with a range of 4,600 miles. In addition, the service anticipated deploying the eight-MIRV Trident II that was as accurate as MX and shared many--but not all--of the advantages previously held by ICBMs. The air force had deployed air-launched cruise missiles and procured the B-1 bomber and had the B-2 under development. Ground-launched cruise missiles and army Pershing intermediate-range missiles were operational in Europe. MX was important, but it had slipped down the priority list. The vulnerability window, if it had truly existed, closed partially, and finally locked shut at the end of the Cold War.

⁶³Senate Committee on Armed Services, *MX Missile Basing*, 5-6.

The complex issues of ICBM survivability, accuracy, and deployment had merged with the Washington political realities. Begun in 1971 as an attempt to prevent a predicted Soviet ICBM superiority, the MX program writhed under bureaucratic exposure. President Kennedy had cancelled mobile Minuteman because he had a cheaper and better solution already in existence--the hard and dispersed launch facility, and Ronald Reagan came to a similar conclusion. By the mid-seventies, American defense planners believed that launch facility deployment was no longer survivable, an idea that many, although not all, political leaders eventually accepted. Defense thinkers knew that a mixture of mobile and underground-based missiles provided a survivable force, but once the Soviet ICBM force increased in size and quality and the American understanding of the intentions behind Soviet growth vaporized, disciplined rationale for a mobile ICBM slipped. The continuous study of ICBM mobility that trickled through the sixties and into the seventies influenced the dozens of schemes proposed for mobile MX. Initially, the air force proposed air-mobility schemes that its own research had proven deficient. Challenges never before considered, including environmentalism and institutional distrust, mounted against MX MPS, a monumental affair that could only be built with steady public support.

A product of Cold War fears, paradoxes, and conflicting service, political, and public interests, the MPS proposals were controversy's lightning rod. It was the most grand scheme for American mobile ICBMs, around which swirled the most intense debates. Four presidential administrations--Nixon, Ford, Carter, and Reagan--failed to control the associated controversy with the result that a mobile MX never became a reality. Later in the eighties, Reagan supported a rail-mobile MX and a small mobile

ICBM, and the air force dutifully went about developing proposals, but neither deployed. With the end of the Cold War, twenty years after the start of the MX program, President George H. W. Bush cancelled both. On October 10, 1986, the air force finally placed the first of fifty MX missiles on alert. Based in surplus Minuteman launchers at Warren Air Force Base, these missiles remained operational until maintenance personnel removed the last and the system deactivated in October 2005 in accordance with the second Strategic Arms Reduction Treaty signed on January 3, 1993. Explosive experts disposed of the launchers by detonating charges around the upper one-third of the launch tubes, which collapsed inward, and the remainder was bulldozed over. The launch control centers shared the same fate; partially stripped of usable equipment, their blast doors welded shut and in perpetual darkness, they await future archaeologists, whose interpretations will prove interesting. In 1968, Bernard Schriever described the state of advanced ICBM research as no more "than a thick bundle of papers," and as far as mobility was concerned, this piece of insight has proved accurate. ICBM mobility, banished to the netherworld of paper studies from which it never truly escaped, has once more slipped below the national horizon.⁶⁴

⁶⁴Brownlow, "Dollar Drain Saps U.S. Strategic Stance," 71.

CHAPTER 6

CONCLUSIONS

Rarely does a machine, once invented, actually disappear. It tends rather to be forgotten or to have its role transformed by another machine, which does the original job more speedily, more economically, or more interestingly. . . . Bringing a new machine into the world, then, like bringing a child into the world, is a serious matter, with incalculable consequences. The power to make machines is a power to accomplish more than we can imagine, in ways we cannot predict.¹

-- Historian Daniel J. Boorstin, 1978

On the road north to Minuteman beach on Vandenberg Air Force Base, one passes the remains of three old launch facilities now surrounded by the ubiquitous ice plant and sweet-smelling wildflowers of the California chaparral. Standing there is a faded and weather-beaten historical marker, and those who stop to read it learn that this was launch complex 576A. Here in 1959, the nation's first ICBM nuclear alert occurred with the Atlas missile. Laid nearby were train tracks, which the Union Pacific Railroad still uses. Local lore has it that during his 1959 California visit, Nikita Khrushchev's hosts ensured that his train passed by the complex so that he could see a fully fueled Atlas missile as it maintained its vigil. Glistening in the golden sunlight of the central Pacific coast, the

¹Daniel J. Boorstin, *The Republic of Technology: Reflections on Our Future Community* (New York: Harper and Row, Publishers, 1978), 92-3.

missile must have been an impressive sight; alas, Khrushchev acted indifferent and denied his hosts any immediate gratification.

Similar to these derelicts, the remains of various mobile ICBM programs sit forlorn. Although a handful of launch cars and pieces of control equipment rest in museums, mounds of paper remain stored in boxes, an important but forgotten part of the nation's military space history. That historians have overlooked ICBM mobility is not unusual because this is a tale of a technological failure, a road not taken inconsistent with a whiggish metanarrative of technology's progressive march forward. In this case, the technology did not determine the outcome; the conscious decisions of national leaders arrested mobile ICBM development. Nonetheless, the mobile ICBM profoundly influenced American national security because it affected development of the cornerstone of the nation's nuclear deterrence, the land-based ICBM, by providing reaffirmation of launch-facility basing. That this came about unintentionally and at great expense does not lessen its importance.

ICBMs are a technological system both affecting and affected by society. Historian Thomas Hughes maintained that technological systems contain a mixture of technical matters, scientific laws, economic principles, political forces, and social concerns. He asserted that sociotechnical systems are cultural artifacts possessing momentum, force, and direction while reflecting the changing resources and aspirations of organizations, groups, and individuals. They do not live in a vacuum. External and internal influences cause sociotechnical systems to evolve; furthermore, a technology's style manifests nontechnological factors including geography (both human and natural), economics, organizational forms, politics, and legislation. As shown during the ICBM

era, the development of technological systems depends equally upon the supporting culture and the hardware itself. At different times and under certain conditions, one factor or another may become dominant.²

The Minuteman ICBM began as a replacement for the ponderous first generation of American ICBMs and their expensive support facilities, and from the outset, a mobile deployment was planned. It ended up dispersed among 1,000 launch facilities in the upper Midwest. The question is why the United States government never deployed a mobile ICBM, and the answer relates directly to the force size established by Secretary of Defense McNamara and President Kennedy. Given a force limited to 1,000 missiles, the composition of the triad, and the size of the Soviet threat, studies indicated that mobility offered little improvement to survivability or offensive capability over that provided by a hardened and dispersed system. Mobile ICBMs were technologically possible, but once the United States had attained decisive nuclear superiority, they did not offer significant military advantages that outweighed the programmatic cost of researching, developing, testing, deploying, and operating such a system. The navy provided a survivable and effective mobile ballistic missile deterrent, and the air force placed its mobile nuclear weapons on recallable bombers. The ICBMs' role became fast and accurate reaction.

Understanding the American mobile ICBM is impossible outside of the greater socio-political context within which it lay. The mobile ICBM was never separate from the broader ICBM program, which was, in turn, subject to the needs of the air force, a service with many roles and missions, including responsibility for the air-breathing element of the triad, as well as significant conventional forces. The navy had ensured its

²Hughes, *Rescuing Prometheus*, 4-13.

place in the nuclear arena with Polaris and a series of successful missile projects. The Department of Defense, to which the air force and navy belonged, had strong-minded leaders with their own ideas. The president, his staff, advisors, cabinet, and congressional leaders also wanted their voices heard, as did the public. Thirty minutes distant by the length of an ICBM flight lay the Soviet Union, whose actions in building its own strategic nuclear forces affected American decisions. The history of the mobile ICBM demonstrates how the interaction between these elements shaped the ICBM force that the United States currently retains.

Technologies do not burst suddenly into the world. Complex systems such as ICBMs result from hard work, study, and foundations laid by earlier and often unrelated efforts. One such example was MX MPS. Throughout the sixties, the air force and its industry partners studied ICBM survivability with focus on mobility. By the dawn of the seventies, the basics had emerged. To be mobile, an ICBM should be as small as possible with an accurate and autonomous guidance system. It had to possess redundant C3, respond quickly to launch orders, and be robust. The more freedom it had to operate, that is, the more space it could use to hide, the more survivable it would be. For optimum effectiveness, the launch base had to be tidy. A minimum of equipment, a self-contained launch platform, and missile on one vehicle made mobility easier to achieve. In times of restricted budgets, the system had to be cost effective. Tradeoffs between dollars, range, weight, length, accuracy, and support equipment invariably intruded upon the daydreams of missile engineers, as did the desires of presidents and others for arms control, nuclear stability, and nuclear superiority.

These tradeoffs were not unique to long-range ballistic missiles. Early in the post-World War II era, Hap Arnold wrestled with comparable choices. With sound advice, Arnold, as farsighted a thinker as the air force has ever had, decided that the service should not develop the long-range ballistic missile. He understood that future wars would use unmanned weapons of destruction, but he believed that the ICBM was too far in the future to warrant a share of sparse funding. Winged cruise missiles promised more delivery capability sooner, and they readily fit air force concepts of weapon system operations. Even after the government decided to develop ballistic missiles, the Navaho and Snark intercontinental cruise missiles received large amounts of funding, but by 1955, the mood had changed, and the United States had committed itself to building an ICBM. The Eisenhower administration cast this die two years before Sputnik.

In the early 1950s, partly due to the immature level of rocket technology, as well as the large size of nuclear weapons, the United States was not interested in rockets. Because bombers were the only delivery platform capable of nuclear attack, the air force developed a large bomber fleet, researched long-range cruise missiles, and dabbled with ballistic missiles. The navy investigated launching liquid-fueled missiles from ships, but it too eventually pursued the cruise missile route. As the years passed and the Cold War deepened, national leadership understood the importance of long-range missile technology. A sharp bureaucratic battle between the services resulted in the air force owning the long-range ballistic missile mission. The resultant acceleration of the Atlas program, then the nation's only ICBM effort, drove the air force to make choices contrary to its air-breathing aerodynamic heritage and to reassess the force composition

recommendations of General Arnold and von Karman. The step forward to do this was difficult, but the service committed itself to the task as pressures mounted. For the time being, the exigencies of building a new family of technologies and the attempt to manage those technologies required intense efforts and innovations that would begin to bear results even as Sputnik soared overhead.

Despite this, by 1956, not many people thought in terms of a mobile ICBM because building a flyable Atlas was challenging enough. American medium-range ballistic missile systems were transportable but took a long time to deploy into a launch configuration. Given the thirty-minute flight time of an ICBM from launch to target, any mobile missile system would have to transition from motion to missile engine ignition within minutes; thus, a better solution was a missile that could conceal its location through random movements and provide the capability for a near-instantaneous launch, no matter what its location. A large number of dispersed, moving missiles would make any potential adversary pause. To create such a system, engineers had to improve several technologies, including propulsion and guidance, as well as reduce the size and support requirements of the ICBM. The era's liquid-fueled rockets were cantankerous machines that required time-consuming launch preparations and handling procedures. Big, complex, and heavy, characteristics that did not lend themselves to movement and responsive launch, a simpler and smaller rocket like Minuteman promised more.

The small, solid-fueled, and inertially-guided Minuteman offered several advantages as a mobile missile, but its development was a step or two behind political realities. McNamara, realizing the Soviet ICBM threat to be less significant than previously believed, limited the Minuteman to 1,000 missiles and cancelled the mobile

version. In the late fifties and early sixties, planners believed that missile mobility was essential, but the navy fulfilled that role with SLBMs, which made a train-based Minuteman redundant. Knowing that its first-generation ICBMs were inadequate weapons, the air force realized that if it was to retain the ICBM mission, it needed the Minuteman and supported McNamara's decision, which established underground launch facilities as the dominant mode of ICBM deployment.

Even as the service deployed the missiles, it foresaw the day when sufficient numbers of accurate Soviet ICBMs would threaten their existence, resulting in studies of survivable ICBMs that influenced later proposals. Throughout the sixties, air force and industry planners redefined the mobile ICBM. New land-based options, including the Golden Arrow continuous road-mobile, hardened garage road-mobile, and triggered random-mobile Minuteman, offered survivability through mobility and varying degrees of deception and concealment. The land-based options also offered the simplest ways to increase missile survivability. For example, the use of dummy garages enhanced the nuclear shell game that planners played by complicating enemy targeting and force size. Dedicated government road networks and deployment zones alleviated possible civilian community concerns about nuclear weapons passing through their boundaries, and held promise for future systems.

Other concepts, such as Superhard, WS-120A, and ICBM-X proposed not smaller missiles but larger MIRVed weapons and required significant civil engineering and aeronautical investments. Superhard basing required miles of large underground tunnels, personnel life support systems, power, communications, and specialized vehicles to turn mountains into missile bases. Significantly more advanced than the Minuteman, the

MIRVed, 156-inch diameter ICBM-X would have pushed the state of solid-fuel missile technology, but on May 28, 1964, Lockheed successfully tested a motor of that size. The combination of large and powerful weapons with a survivable basing mode opened the potential for a survivable missile possessing tremendous offensive capabilities. As guidance accuracy continued to improve and the Minuteman III gained MIRV and remote retargeting capabilities, the offensive promise revealed by these studies became an operational reality.³

Air-mobile deployments held a certain romance within the air force, but they were expensive and demanded the creation of a new missile and launch operations equipment. The Golden Arrow airborne alert weapon system and similar 1970s and 1980s proposals required a massive long-endurance carrier aircraft and an air-launched ballistic missile with terminal-area guidance. It was a challenging technological proposition with a prohibitive cost, and it would have detracted from other aircraft programs. Given the fate of Douglas Aircraft's Skybolt, such a program would have had little support outside of the air force; moreover, the intermediate-range missile encroached upon the capabilities of the navy's Polaris and the air force's air-launched cruise missiles. Air-transportable missile systems would have used launcher technology developed for land-mobile programs, but it offered almost no advantages over the existing Minuteman force. There was no point in stationing an ICBM on an airplane. It was cheaper to use an SLBM or bomber to attack targets outside an ICBM's range than it was to develop a new airborne ballistic missile system. As compared to hardened and dispersed Minuteman, they were complicated, costly, less survivable, and risked accidents through the handling and

³Hunley, "Minuteman and Solid-Rocket Launch Technology," in *High Frontier*, 274.

movement of the weapons. In 1964, the most expensive air-transportable option cost \$19 billion, which translates into \$314 billion in 2004 when expressed as a relative share of the gross domestic product. Both options offered mobility and degrees of deception, but they did not possess greater military or economic attraction than hardened and dispersed ICBMs.⁴

Through the 1960s and into the 1970s, ICBMs became more accurate and deadly. In the mid-sixties, ICBM development continued at a frenetic pace, but the public's attention had shifted elsewhere, notably to the space race, civil rights, and Vietnam. Nonetheless, it was during this period that the Minuteman became a true counterforce weapon, all the while retaining the ability to destroy cities as part of the concept of mutually assured destruction. By the mid-seventies, the new Minuteman III was providing accuracy and targeting flexibility that fulfilled the once-distant dreams of those who had engineered the Atlas, and the American electorate had accepted these weapons. The missiles maintained their alerts in quiet and sparsely populated areas of the country's northern tier of states, shadowy forms representing the ultimate technological achievement.

As the surface ICBM grew into a narrowly defined role, it became, in this sense, a victim of its own success. It was accurate, secure, had redundant C3, and responded quickly to launch orders. No one could recall it once launched, but in terms of crew response and flight time from launch to reentry vehicle impact, it was the fastest

⁴Cost calculation accomplished using the relative share of gross domestic product method on the "What is its Relative Value in US Dollars?" website, sponsored by the Economic History Service's Economic History Resources website at <https://www.eh.net/hmit/compare>, accessed on October 21, 2004. This service utilizes some of the economic data contained within John J. McCusker's *How Much is That in Real Money: A Historical Price Index for Use as a Deflator of Money Values in the Economy of the United States*, 2d ed. (Worcester, MA: American Antiquarian Society, 2001).

responding element of the triad. Furthermore, the deployment of the MIRV increased force size and striking power without the need to deploy more missiles or create additional infrastructure. So long as the Soviet Union did not have large numbers of accurate ICBMs, the American force was relatively safe, cheap, and ready. Despite the number of densely written staff studies that the air force and other agencies conducted, no mobile ICBM, no matter what its technological wizardry and creativity, could overcome the cost-risk benefits of the existing strategic triad.

The decision of American political leaders such as Secretary of Defense McNamara and his successors to freeze the ICBM force size at 1,054 missiles, gave the Soviet Union an opportunity to catch up to and surpass its American rival. The Soviets did just that. By the early seventies, worries about the present and future vulnerability of ICBMs reinvigorated the study of mobility. At the same time, Presidents Johnson, Nixon, Ford, Carter, and Reagan sought arms limitations agreements, although they differed significantly on the details. Assuming the worst, air force planners looked ahead for an eventual Soviet capability to destroy American launchers. In 1971, as the Soviet Union gained nuclear parity and slowly tilted the strategic balance into its favor, the air force initiated the MX program, a missile designed to exceed the Minuteman's capabilities and be survivable in the face of a large--and accurate--Soviet force. As an offensive missile, MX represented further refinement of what Minuteman had achieved, but its defensive deployment mode opened Pandora's Box.

Central to worries that the Soviets were a threat to American security, if not survival, was the vulnerability of the American ICBM force to destruction by a first strike. The factors involved in calculating ICBM survivability were complex, rife with

assumptions, and always debatable. There never was complete consensus on the vulnerability of American ICBMs or Soviet intentions, but enough presidents, cabinet members, generals, industry leaders, and members of the voting public lost sleep over this worry to support a new ICBM. When by the summer of 1978 American intelligence sources had “concluded that [the Soviets] had indeed developed a guidance system that improved the accuracy of the SS-18 by almost a factor of three” allowing them to “detonate close enough to Minuteman silos to destroy them,” even the Carter White House had to act. In response, the air force sought to procure a missile possessing great offensive capability and superior defensive survivability. It took eight years from the initial issue of the MX’s operational requirements to decide how large the missile should be, and the debate on how to base it attained new heights of bureaucratic absurdity.⁵

Strife-ridden from its early years, the MX program suffered from programmatic instability. Funding came and went. By the time the project was eight years old, high-level White House officials were deciding upon weapon system configurations. For example, in mid-1979, President Jimmy Carter decided that the final diameter of the missile would be ninety-two inches. One can only imagine how Bernard Schriever would have reacted had President Kennedy mandated the diameter of Minuteman. Carter also made the final decision on the basing mode, but by this time, the number of modes discussed was so great and design requirements had changed so frequently that confusion abounded. Congress made it illegal for the air force to pursue only one avenue of deployment, and Congress controlled MX funding. Despite hand-wringing that the nation’s ICBM force was vulnerable to Soviet attack, the 1,000 Minutemen and fifty-four

⁵McCartney to BMO, “Dr. Perry’s Statement on MX of April 25, 1980, May 28, 1980,” 2-3.

obsolescent Titan IIs continued in service without replacements. In the early years of the ICBM program, the air force had retained greater control of the ICBM design process, but by the late seventies, the political leadership, intent on attaining a SALT III agreement, handicapped MX development by inserting itself in the process. MX became the first missile system designed for arms agreement verification.

The irony of MPS was that the air force initially opposed it, came to accept this Carter-era compromise, and then fought for it against the wishes of President Ronald Reagan and his defense secretary, Caspar Weinberger. The air force, which had initially embraced air-basing MX, moved towards multiple aim point schemes that included trenches and other varieties of MPS. Throughout this process, 1960s basing modes reappeared. By 1980, the air force and joint chiefs had convinced themselves that MPS was the only basing scheme that offered survivability and verifiability. When Reagan's defense team attacked MPS, the air force revolted. In a bizarre turnabout, Weinberger wanted an air-mobile ICBM that the air force had previously advocated but now opposed. Congress, upset with the state of affairs, refused to fund any basing schemes and opposed MPS deployment. By the time the Townes Panel issued its report, there was a general feeling that the launch facility-based ICBM had entered its twilight years. Nonetheless, the Reagan administration managed to base fifty MX missiles in surplus Minuteman launch facilities at Warren Air Force Base in Wyoming. For all the rhetoric and research, the launch facility-based ICBM remained after years of political twists and turns.

The denouement of ICBM mobility occurred swiftly when the curtain finally fell with the collapse of the Soviet Union. In 1986, coinciding with an announcement about the initial operational capability of the launch facility-based MX, President Reagan

approved rail-mobile deployment of MX using twenty-five trains of two missiles each. Plans were to base the trains at nine different air force bases and allow them to roam the national rail network, much like the mobile Minuteman of 1961. When it was finally cancelled in 1991, Boeing had built prototype missile cars, one of which lies at the United States Air Force Museum in Dayton, Ohio, another artifact of the Cold War.

Also in 1986, Reagan authorized the mobile small ICBM, nicknamed "Midgetman," following recommendations of the Townes Panel and the Scowcroft Commission. Designed for off-road truck mobility, Midgetman had two successful test launches from Vandenberg. Boeing again built prototypes of launcher vehicles, delivered them in 1988, and the air force tested them at Malmstrom Air Force Base in Montana before the demise of the Soviet Union brought swift cancellation of the program. One remains on display at the ICBM System Program Office in Ogden, Utah. By 1992, the mobile ICBM concept had disappeared from the American defense scene. That same year, President George H. W. Bush removed Minuteman II, air force bombers, and naval surface vessels from the nuclear alert mission. Although 500 Minuteman III ICBMs remained on alert in 2006, all of these had been de-MIRVed to one reentry vehicle. At its smallest size since 1964, the ICBM force remains, but mobility is a word not heard at headquarters or at any of the missile sites.

The American mobile ICBM never deployed because the consistent conclusion of political and military leadership--and eventually the public--was that given the nation's strategic triad, the capabilities of the hard and dispersed missile force, and desires to lessen the anxiety of the arms race, mobility provided no advantage over other goals, be they arms limitation, arms reduction, or political capital. Mobile ICBMs were

technologically feasible, but they were costly and offered limited overall gains. As Soviet capabilities grew, they became politically risky. Unwilling to rely on a strategic dyad composed solely of bombers and SLBMs, the United States accepted the vulnerability of its ICBMs and moved on to other issues. A technology's diffusion depends upon on how well it meets the political, economic, and social conditions that it is supposed to address. In the American context, the mobile ICBM could have addressed military needs, but it failed in the political and public arenas.

Since the beginning of the ICBM era, the United States put forth an enormous developmental effort into the technologies required to design, develop, operate, and maintain mobile ICBMs. An essential enthusiasm existed for the idea of mobility that was never far from the minds of those involved in the ICBM program. Nonetheless, the United States has never deployed mobile ICBMs because even when the technology was within reach and the nation's political leaders wanted them, a combination of factors forced those leaders to find other solutions to their problems. Throughout the period studied, mobile ICBM deployments encountered a dynamic political, economic, and cultural context. In the early sixties, mobile Minuteman advanced towards deployment, but the success of the navy's Polaris and its competing air force sibling, the hard and dispersed launch facility-based Minuteman, rendered the missile trains superfluous. Over the next ten years, the air force and industry continually studied ICBM mobility. Meanwhile, the world had changed as Cold War realities, Vietnam, and American social unrest unfolded. Once the MX program began, the air force fought bureaucratic battles for a mobile system, but the effort was in vain. By the early 1980s, MX MPS died stillborn, due mainly to environmentalism, distrust of federal institutions, arms control,

budgets, confusion, and indecision within the air force and domestic politics. The hard and dispersed launch facility-based ICBM was secure in its position as the dominant mode of ICBM deployment. Another echo had vanished quietly into the wind, its ripples as still as those of the childhood memories of Lionel trains clattering around a Christmas tree.

GLOSSARY OF ACRONYMS

AFBMD	Air Force Ballistic Missile Division
AFHRA	Air Force Historical Research Agency
AFSC	Air Force Systems Command
AIAA	American Institute of Aeronautics and Astronautics
ALBM	Air Launched Ballistic Missile
ARDC	Air Research and Development Command
BMD	Ballistic Missile Division
BMO	Ballistic Missile Office
BSD	Ballistic Systems Division
CEP	Circular Error Probable
C3	Command, Control, Communications
DoD	Department of Defense
FRUS	Foreign Relations of the United States
ICBM	Intercontinental Ballistic Missile
JCS	Joint Chiefs of Staff
MPS	Multiple Protective Shelter
MX	Missile-X, also known as the Peacekeeper, ICBM
NSDD	National Security Decision Directive
NSDM	National Security Decision Memorandum
OSD	Office of the Secretary of Defense
OTA	Office of Technology Assessment
SLBM	Sea-Launched Ballistic Missile

SAC	Strategic Air Command
SALT	Strategic Arms Limitation Talks
SAMSO	Space and Missile Systems Organization
SIOP	Single Integrated Operational Plan
TNT	Trinitrotoluene
TRW	Thompson-Ramo-Wooldridge, Inc.

Bibliography

Archival Collections

The unaccessioned, unclassified collections of the archives of the Ballistic Missile Organization (BMO) are contained within their original shipping boxes at the AFHRA. Special permission is required to access this collection. The following boxes were cited:

B-1, B-3, B-5 B-6, B-11, B-21, B-22, B-23, B-28, B-59, B-60, B-61, B-62, B-63,
B-64, B-106, B-125
D-30, D-33
F-2, F-4, F-13,
J-2, J-3
L-2,
M-1, M-2, M-11, M-22.

AFHRA declassification specialists declassified numerous documents from the unaccessioned BMO classified archives for the researcher's use. These documents are listed with their BMO tracking numbers and file numbers. The AFHRA does not maintain the declassified portion of these documents on file. Researchers who wish to view these documents need to have a current security clearance on file with the AFHRA. The following files were utilized:

13-J-4-4-13
13-J-4-4-17
13-J-8-5,
13-J-8-11
13-J-8-15

Items from accessioned AFHRA archive boxes are designated with the AFHRA IRIS catalog number in their individual document citation. Declassified documents that are part of the accessioned AFHRA collections are identified under the appropriate subheading. Declassified, unaccessioned documents are identified by file and collection.

Public Documents Including Government Documents, Reports, Briefings

AFBMD. Advanced Planning Office, Deputy Commander Ballistic Missiles, "Future for Ballistic Missiles, November 1959, Revised January 1960." Unaccessioned, declassified document. BMO document 02056295, file 13J-4-4-13, AFHRA.

_____. "Evolution of ICBM Operational Deployment Configurations, January 27, 1961." Unaccessioned, unclassified collections. BMO box F-13, AFHRA.

_____. "4 March 1961 Minuteman Program Presentation to the Secretary of Defense." AFHRA, unaccessioned, unclassified collections. BMO box M-2.

_____. "September 26, 1961 Briefing to Secretary McNamara." Unaccessioned, unclassified collections. BMO box M-2, AFHRA.

_____. Advanced Systems Planning and Analysis Directorate, "USAF ICBM Force Mix, April 1960." Unaccessioned, declassified document. BMO document 02056301, file 13J-4-4-13, AFHRA.

Bacher Report. R. F. Bacher to S. Ramo. "Report of a panel which met to study the future developments in ballistic missiles, August 8, 1957." Unaccessioned, unclassified collections. BMO box F-4, AFHRA.

BMO. "DC-10 Configuration Design Study for the Air Mobile Missile System, September 4, 1975." Unaccessioned, unclassified collections. BMO box B-63, AFHRA.

_____. "Binder, Buried Trench Concept, Newspaper Articles." Cover illustration. Unaccessioned, unclassified collections. BMO box B-21, AFHRA.

_____. "Technical Assessment of Big Bird 6800 Long-Endurance Airborne Strategic Missile Carrier, June 13, 1981." Unaccessioned, unclassified collections. BMO box B-64, AFHRA.

_____. "ICBM Basing, August 17, 1981." Unaccessioned, unclassified collections. BMO box B-3, AFHRA.

_____. "MX-Renewable Energy System Project, March 31, 1980, 2100Z." Unaccessioned, unclassified collections. BMO box B-22, AFHRA.

_____. "M-X Program Management Plan, June 21, 1982." Unaccessioned, unclassified collections. BMO box D-30, AFHRA.

Brown, Harold. "PRM/NSC-10 Military Strategy and Force Posture Review Final Report, June 5, 1977." Washington, D.C.: Office of the Secretary of Defense, 1977. Accessed on-line from Jimmy Carter Presidential Library at <http://jimmycarterlibrary.org/documents/prmemorandums/prm10.pdf>, on January 30, 2006.

BSD. "Multiple Pool Basing Concept Facility Cost Study, December 6, 1966." Unaccessioned, declassified document. BMO document 02054173, file 13-J-8-11, AFHRA.

Carter, Jimmy. "State of the Union Address 1980." National address, the Capitol, Washington D.C.: January 23, 1980. Accessed on-line from Jimmy Carter Presidential Library at <http://jimmycarterlibrary.org/documents/speeches/su80jec.phtml> on January 30, 2006.

Department of the Air Force. *T. O. 21-SM65D-1-2, USAF Model SM-65D Missile Weapon System, General Manual*. Culver City, CA: Kerr Litho, April 1, 1960. Unaccessioned, unclassified collections. BMO box J-3, AFHRA.

Department of Defense. *Statement by Secretary of Defense Robert S. McNamara Before the Senate Armed Services Committee on the Fiscal Year 1969-73 Defense Program and the 1969 Defense Budget*. Washington, D.C.: Government Printing Office, 1968.

_____. *Statement of Secretary of Defense Clark M. Clifford, The Fiscal Year 1970-74 Defense program and 1970 Defense Budget*. Washington, D.C.: Government Printing Office, 1969.

_____. *Statement of Secretary of Defense Melvin R. Laird Before a Joint Session of the Senate Armed Services Committee and the Senate Subcommittee on Department of Defense Appropriations on the Fiscal Year 1971 Defense Program and Budget*. Washington, D.C.: Government Printing Office, 1970.

_____. *Report of the Secretary of Defense James R. Schlesinger to the Congress on the FY 1975 and FY 1975-1979 Defense Program*. Washington, D.C.: Government Printing Office, 1974.

_____. *Report of the Secretary of Defense James R. Schlesinger to the Congress on the FY 1976 and Transition Budgets, FY 1977 Authorization Request and FY 1976-1980 Defense Programs*. Washington, D.C.: Government Printing Office, 1975.

_____. *Report of Secretary of Defense Donald H. Rumsfeld to the Congress on the FY 1978 Budget, FY 1979 Authorization Request and FY 1978-1982 Defense Programs.* Washington, D.C.: Government Printing Office, 1977.

_____. *Annual Report Fiscal Year 1979, Harold Brown Secretary of Defense.* Washington, D.C.: Government Printing Office, 1978.

_____. *Report of the Secretary of Defense Harold Brown to the Congress on the FY 1980 Budget, FY 1981 Authorization Request and FY 1980-1984 Defense Programs.* Washington D.C.: Government Printing Office, 1979.

_____. *Report of Secretary of Defense Harold Brown to the Congress on the FY 1981 Budget, FY 1982 Authorization Request and FY 1981-1985 Defense Programs.* Washington, D.C.: Government Printing Office, 1980.

_____. *Report of Secretary of Defense Harold Brown to the Congress on the FY 1982 Budget, FY 1983 Authorization Request and FY 1982-1986 Defense Programs.* Washington, D.C.: Government Printing Office, 1981.

_____. *ICBM Basing Options: A Summary of Major Studies to Define a Survivable Basing Concept for Land Based ICBMs, August 1980.* Washington, D.C. : Office of the Deputy Under Secretary of Defense for Research and Engineering, 1980. Unaccessioned, unclassified collections. BMO box B-3, AFHRA.

_____. *ICBM Basing Options: A Summary of Major Studies to Define a Survivable Basing Concept for ICBMs, December 1980.* Washington, D.C.: Office of the Deputy Under Secretary of Defense for Research and Engineering Strategic and Space Systems, 1980. Unaccessioned, unclassified collections. BMO box B-3, AFHRA.

_____. "MX Split Basing Report, January 19, 1981." Unaccessioned, unclassified collections. BMO box B-3, AFHRA.

Department of State. *Foreign Relations of the United States, 1945.* Vol. 2: *General: Political and Economic Matters.* Washington, D.C.: Government Printing Office, 1967.

_____. *Foreign Relations of the United States, 1955-1957.* Vol. 11: *United Nations and General International Matters.* Washington, D.C., Government Printing Office, 1988.

_____. *Foreign Relations of the United States, 1955-1957.* Vol. 19: *National Security Policy.* Washington, D.C.: Government Printing Office, 1990.

- _____. *Foreign Relations of the United States, 1961-1963. Vol. 8: National Security Policy.* Washington, D.C.: Government Printing Office, 1996.
- Fact Sheet. "MX: Its History." PA No. 038.80. Andrews AFB, MY: Office of Public Affairs, AFSC, 1980. Accessioned collections. IRIS K243.01, AFHRA.
- Green G. B. and L.N. Jenks. "Guidance System Application to Missile Basing Alternatives." Los Angeles: SAMSO and TRW, 1980. Photocopied. Unaccessioned, unclassified collections, BMO box B-3, AFHRA.
- Intercontinental Ballistic Missile Scientific Advisory Committee to the Secretary of the Air Force, Meeting minutes, December 16 and 17, 1957. Unaccessioned, unclassified collections. BMO box F-13, AFHRA.
- Hanley Timothy C. and others. "History of Space and Missile Systems Organization, 1 January - 31 December 1977." Los Angeles: History Office Los Angeles Air Force Station, 1978), 362-369. Photocopied. Accessioned collections, declassified extract. IRIS K243.012, AFHRA.
- Lauritsen Committee Report to Lt. General Bernard A. Schriever Concerning the United States Air Force ICBM Program, May 31, 1960. Unaccessioned, unclassified collections. BMO box M-1, AFHRA.
- Message from SAC dated July 15, 1960. Unaccessioned, unclassified collections. BMO box M-1, AFHRA.
- MX PEM Worksheets, FY 1982. Copy contained in "History of Air Force Systems Command, 1 October 1979 - 30 September 1980, Vol. 7 Supporting Documents. Accessioned collections IRIS K243.01, AFHRA.
- Nevada Legislature's Special Committee on MX Missile Matters. "Meeting Notice and Agenda, February 2, 1980, Statement of Congressman Jim Santini." Unaccessioned, unclassified collections. BMO box D-33, file: Nevada Legislative Commission's Special Committee on MX, AFHRA.
- Office of Technology Assessment. *The Effects of Nuclear War.* Washington, D.C.: Government Printing Office, 1979.
- _____. *MX Missile Basing.* Washington, D.C.: Government Printing Office, 1981.
- Office of the Secretary of Defense. "News Conference by Dr. William Perry, Under Secretary of Defense." September 7, 1979. Copy contained in "History of Air Force Systems Command, 1 October 1979 - 30 September 1980, Vol. 7 Supporting Documents. Accessioned collections IRIS K243.01, AFHRA.

SAC/AFBMD. "Minuteman Mobility Concept Report, October 1958." Unaccessioned, unclassified collections. BMO box M-1, AFHRA.

_____. "Atlas/Titan Mobility Concept Report, December 1958." Unaccessioned, unclassified collections. BMO box J-2, AFHRA.

SAMSO. "Minuteman Rebasing Task Force Report, Vol. 2, March 1970." Unaccessioned, declassified document. BMO document 02054268, file 13-J-8-15, AFHRA.

_____. "MX Air Mobile Third Initial Screening Meeting Minutes, December 19, 1973." Unaccessioned, unclassified collections. BMO box B-61, AFHRA.

_____. Minuteman System Program Office, "Summary Report: Advanced ICBM Technology Program Air Mobile Feasibility Demonstration, December 18, 1974." Unaccessioned, unclassified collections. BMO box B-60, AFHRA.

_____. "Preliminary MX Weapon System Preservation of Location Uncertainty Program Plan, December 1978." Unaccessioned, unclassified collections. BMO box B-23, AFHRA.

_____. "Air Mobile MX Weapon System Test and Evaluation Master Plan, March 16, 1979." Unaccessioned, unclassified collections. BMO box B-63, AFHRA.

_____. "MX Horizontal Shelter Kickoff Meeting, August 31, 1979." Unaccessioned, unclassified collections. BMO box B-59, AFHRA.

Strategic Air Command Directorate of Operations. "Final Report of SAC Task Force, Project Big Star, September 10, 1960." Unaccessioned, declassified document. BMO document 02054407, file 13J-8-5, AFHRA.

Townes Panel. "Report of the Committee on M-X Basing, July 1981." Unaccessioned, unclassified collections. BMO box B-125, AFHRA.

United States Air Force Assistant Chief of Staff, Studies and Analysis. "A Comparison of the Survivability of Fixed-Silo ICBMs and Land-Mobile ICBMs, October 31, 1969." Declassified staff study excerpt, IRIS K143.044-18, AFHRA.

Utah General Depot, U.S. Army. "Transportation Depot Maintenance Division Estimated Cost for Construction of Mobile Missile Train (S-70-61)." Ogden, Utah: 1960. Unaccessioned, unclassified collections. BMO box M-22, AFHRA.

U.S. Congress. House. Committee on Appropriations. *Department of Defense Appropriations for 1965, Part 4*. 88th Cong., 2d sess., 1965.

- _____. House. Committee on Armed Services. *Hearings on Military Posture and H.R. 3818 and H.R. 8687 to Authorize Appropriations During the Fiscal Year 1972*. 92d Cong., 1st sess., 1971, 2330.
- _____. House. Committee on Science and Astronautics. *Progress of Atlas and Polaris Missiles*. 86th Cong., 1st sess., 1959.
- _____. Senate. Committee on Armed Services. *The United States Guided Missile Program*. 86th Cong., 1st sess., 1959.
- _____. *MX Missile Basing System and Related Issues*. 98th Cong., 1st sess., 1983.
- _____. Senate. Committee on Foreign Relations. *Effects of Limited Nuclear Warfare: Possible Effects on U.S. Society of Nuclear Attacks Against U.S. Military Installations*. 94th Cong., 1st sess., 1975.
- _____. Senate. Committee on Foreign Relations. *Nuclear War Strategy*. 96th Cong., 2d sess., September 16, 1980.
- U. S. Department of Commerce, Bureau of the Census. *Statistical Abstract of the United States, 1980*. Washington, D.C.: Government Printing Office, 1980.
- White House. "Presidential Directive 59, Nuclear Weapons Employment Policy, July 25, 1980." Declassified copy received from the Jimmy Carter Presidential Library.
- _____. "National Security Decision Directive Number 12, Strategic Forces Modernization Program, October 1, 1981." Declassified photocopy received from the Ronald Reagan Library.
- _____. "National Security Decision Directive Number 13, Nuclear Weapons Employment Policy, October 19, 1981." Declassified photocopy received from the Ronald Reagan Library.
- _____. "National Security Decision Directive Number 35, The MX Program, May 17, 1982." Declassified photocopy received from the Ronald Reagan Library.
- _____. "National Security Decision Directive Number 69, The MX Program, November 22, 1982." Declassified photocopy received from the Ronald Reagan Library.
- _____. "National Security Decision Directive Number 91, Strategic Forces Modernization Program Changes, November 22, 1982." Declassified photocopy received from the Ronald Reagan Library.

_____. "Press Announcement by the President on MX Basing, September 7, 1979." Copy contained in "History of Air Force Systems Command, 1 October 1979 - 30 September 1980. Vol. 7 Supporting Documents. Accessioned collections IRIS K243.01, AFHRA.

_____. "Press Briefing by Harold Brown Secretary of Defense, September 7, 1979." Copy contained in "History of Air Force Systems Command, 1 October 1979 - 30 September 1980. Vol. 7 Supporting Documents. Accessioned collections IRIS K243.01, AFHRA.

_____. *Public Papers of the Presidents, Ronald Reagan: January 20 to December 31, 1981*. Washington, D.C.: Government Printing Office, 1982.

_____. *Public Papers of the Presidents, Ronald Reagan: 1983, Book I - January 1 to July 1, 1983*. Washington, D.C.: Government Printing Office, 1984.

Zeiberg, Seymour L. "MX: The Major Strategic Defense Issue." Address, joint meeting of the American Institute of Aeronautics and Astronautics and others, Salt Lake City, UT, June 12, 1980. Photocopy from Fact Sheet, AFSC PA No. 045.80. Andrews AFB, MY: Office of Public Affairs, AFSC, 1980. Unclassified extract from "History of Air Force Systems Command, 1 October 1979 - 30 September 1980, Vol. 7 Supporting Documents. Accessioned collections IRIS K243.01, AFHRA.

Contractor Documents, Reports, Briefings, and Published Private Reports

Aerospace Corporation. *Golden Arrow Technical Panel Systems Descriptions, Volume II, December 3, 1964*. "Superhard, November 20, 1964." Unaccessioned, declassified document. BMO document 02054506, file 13J-4-4-17, AFHRA.

_____. *Golden Arrow Technical Panel Systems Descriptions, Volume II, December 3, 1964*. "Continuous Road Mobile ICBM, December 3, 1964." Unaccessioned, declassified document. BMO document 02054506, file 13J-4-4-17, AFHRA.

_____. *Golden Arrow Technical Panel Systems Descriptions, Volume II, December 3, 1964*. "Advanced Basing Concept, December 3, 1964." Unaccessioned, declassified document. BMO document 02054506, file 13J-4-4-17, AFHRA.

_____. *Golden Arrow Technical Panel Systems Descriptions, Volume II, December 4, 1964*. "The Airborne Alert Weapon System (AAWS) equipped with Air-Launched Ballistic Missiles (ALBM), December 4, 1964." Unaccessioned, declassified document. BMO document 02054506, file 13J-4-4-17, AFHRA.

- _____. *Golden Arrow Technical Panel Systems Descriptions, Volume II, December 3, 1964.* "The Air Transportable Missile System (ATMS) equipped with C-141 Aircraft/MGM-5200 Missile, December 11, 1964." Unaccessioned, declassified document. BMO document 02054507, file 13J-4-4-17, AFHRA.
- _____. *Golden Arrow Technical Panel Systems Descriptions, Volume II, December 3, 1964.* "Triggered Random-Mobile Minuteman, December 15, 1964." Unaccessioned, declassified document. BMO document 02054509, file 13J-4-4-17, AFHRA.
- _____. *Golden Arrow Technical Panel Systems Descriptions, Volume II, December 3, 1964.* "ICBM-X Missile System 156, Solid Propellant Configuration Thixotropic Propellant Configuration, December 16, 1964." Unaccessioned, declassified document. BMO document 02054504, file 13J-4-4-17, AFHRA.
- _____. "M-X Program Aircraft Design Study for Airmobile Missile System." El Segundo, CA: The Aerospace Corporation, 1973. Unaccessioned, unclassified collections, BMO box B-61, AFHRA.
- Baker, Kenneth and others. *Methodology for MX Movement Evaluation.* Arlington, VA: ANSER Analytic Services Inc., 1980. Unaccessioned, unclassified collections. BMO box B-28, AFHRA.
- Boeing Airplane Company. "Final Test Report, Mobile Minuteman Train Test Program, December 1960." Unaccessioned, declassified document. BMO document 02054115, file 13J-8-5, AFHRA.
- Boeing Company. "Minuteman Mobile D.E.I. (Boeing), December 8, 1960." Unaccessioned, unclassified collections. BMO box M-22, AFHRA.
- _____. "747 M-X Air Mobile System Concept, September 1973." Unaccessioned, unclassified collections. BMO box B-63, AFHRA.
- _____. "Boeing 747 Military Systems Applications Information Packet for B/G A. B. Martin, Deputy for Minuteman, SAMSO, February 7, 1973." Unaccessioned, unclassified collections. BMO box B-63, AFHRA.
- _____. "Buried Trench Weapon System Studies Summary Report, June 1977." Unaccessioned, unclassified collections. BMO box B-6, AFHRA.
- _____. "MX Loading Dock Concept Design Study, September 20, 1978." Unaccessioned, unclassified collections. BMO box 22, AFHRA.

- _____. "MX Vertical Shelter Ground System Definition, Configuration Description, and Operation and Support Concepts, March 14, 1979." Unaccessioned, unclassified collections. BMO box B-100, AFHRA.
- _____. "Early Multiple Aim Point Systems Deployment MM-III IOC 1980." Unaccessioned, unclassified collections. BMO box M-11, AFHRA.
- _____. "SAL Design Constraints and Potential Verification Methods, August 25, 1980." Unaccessioned, unclassified collections. BMO box B-28, AFHRA.
- Coates, William V. "MX Baseline Pool Based Weapon System Summary, January 1978." Unaccessioned, unclassified collections. BMO box B-106, AFHRA.
- Lockheed Missiles and Space Company. "The Greyhound Concept." Sunnyvale, CA: 1970. Unaccessioned, unclassified collections. BMO box B-62, AFHRA.
- Lockheed-Georgia Company. "Air Mobile/Ground Launch: A Survivable ICBM Operational Concept, November 1975." Unaccessioned, unclassified collections. BMO box B-62, AFHRA.
- _____. "Air Movable/Ground Launch: A New Minuteman Operational Concept, September 1976." Unaccessioned, unclassified collections. BMO box M-11, AFHRA.
- Martin Marietta. "Rail Installation Costs MX BTWS, Rail Installation Cost Validation Meeting, March 3, 1977." Unaccessioned, unclassified collections. BMO box 106, AFHRA.
- Ralph M. Parsons Company. "MX Buried Trench Construction and Test Project Concrete Test Program, March 29, 1978." Unaccessioned, unclassified collections. BMO box B-11, AFHRA.
- _____. "MX Buried Trench Construction and Test Project, February 10, 1978." Unaccessioned, unclassified collections. BMO box B-11, AFHRA.
- Space Technology Laboratories, Inc. "Accuracies of Air Force Ballistic Missiles (CEP Status Report.), February 1, 1960." Unaccessioned, unclassified collections. BMO box J-3, AFHRA.
- Space Technology Laboratories, Inc. "Mobile Weapon System Design Criteria, WS 133A-M (Minuteman), May 19, 1960." Unaccessioned, unclassified collections. BMO box M-1, AFHRA.
- TRW. "MX Air Mobile Activities, February 15, 1974." Unaccessioned, unclassified collections. BMO box B-61, AFHRA.

_____. "MX Buried Trench Weapon System Characterization Study: Transporter Launcher, Mobile Launch Control Center, Mobile Launch Control Center Transporter, September 15, 1975." Redondo Beach, CA: TRW Mechanical Systems Design Department, 1975. Unaccessioned, unclassified collections. BMO box B-5, AFHRA.

_____. "MX Ground Mobile System Shelter Based Option Summary Characterization, March 15, 1976." Unaccessioned, unclassified collections. BMO box 22, AFHRA.

_____. "Buried Trench Characterization Summary Report, April 1976." Redondo Beach, CA: 1976. Unaccessioned, unclassified collections. BMO box B-5, AFHRA.

_____. "Earth Pool Weapon System Characterization Pool Basing, 20 March 1978." Unaccessioned, unclassified collections. BMO box 106, AFHRA.

_____. "MX Basing Concept Update: Separate Transporter and Mobile Launcher, 12 May 1980." Unaccessioned, unclassified collections. BMO box B-3, AFHRA.

Letters Not Belonging to a Titled Collection

Allen, Jr., Lew to Representative Melvin Price, December 29, 1978. Unaccessioned, unclassified collections. BMO box B-1, AFHRA.

Blakemore Richard E. to Brigadier General Forrest McCartney. January 2, 1980. No subject. Unaccessioned, unclassified collections. BMO box D-33, file: Nevada Legislative Commission's Special Committee on MX, AFHRA.

Brown, Harold to Senator John C. Stennis, April 29, 1980. Unaccessioned, unclassified collections. BMO box B-1, AFHRA.

Casey, Aloysius G. "Reference Telecon Marv Atkins, December 13, 1978." Unaccessioned, unclassified collections. BMO box B-60, AFHRA.

Dunn Louis G. to O. J. Ritland, "Minuteman Acceleration, June 22, 1959." Unaccessioned, declassified document. BMO document ICBM-4-38, file 13J-4-4-13, AFHRA.

Hane, Betty I, Contracting Officer, to Mr. Robert Ingersoll, Boeing Aerospace Company. "Redirection of MX Basing Concepts, Contract F04704-78-C-0035, March 3, 1980." Unaccessioned, unclassified collections. BMO box B-22, AFHRA.

Horner, Richard E., Acting Assistant Secretary, Research and Development to the Assistant Secretary of Defense (Research and Development), March 21, 1956. Unaccessioned, unclassified collections. BMO box M-1, AFHRA.

Ingersoll, R. J. Contracts Manager, MX Program, to air force plant representative-Seattle. "Redirection of Basing concepts, Contract F04704-78-C-0035, May 8, 1980." Unaccessioned, unclassified collections. BMO box B-22, AFHRA.

Korner, W.G. to A. Dean, TRW Interoffice Correspondence, "MX Program-Trip Report to Goodyear Akron, June 4, 1974." Unaccessioned, unclassified collections. BMO box 106, AFHRA.

_____. TRW Interoffice Correspondence, "Simulated Bomb Bay Drop of a Missile from the C-5A Aircraft, August 4, 1975." Unaccessioned, unclassified collections. BMO box B-60, AFHRA.

Lahs, R. A. to W.R. Williams, TRW Interoffice Correspondence, "Preliminary Design Performance Analysis for a Proposed MX Towplane/glider System, July 11, 1974." Unaccessioned, unclassified collections. BMO box 106, AFHRA.

McCartney, Brigadier General Forrest S. to BMO, "Dr. Perry's Statement on MX of April 25, 1980, May 28, 1980." Unaccessioned, unclassified collections. BMO box B-22, AFHRA.

McKenzie, Greg. "Testimony Prepared for the Nevada Legislative Oversight Committee Hearing on February 2, 1980." Unaccessioned, unclassified collections, BMO box D-33, file: Nevada Legislative Commission's Special Committee on MX, AFHRA.

Price, Melvin to General Lew Allen, Jr., November 8, 1978. Unaccessioned, unclassified collections. BMO box B-1, AFHRA.

Schwarzbach, J. M. to I. J. Adleson. TRW Interoffice Correspondence, "Trip Report-NASA Ames (Feasibility Study of Modern Airships Phase II and WPAFB MX Airborne Missile Launch System Studies and Analyses Coordination, June 3, 1976." Unaccessioned, unclassified collections. BMO box 106, AFHRA.

Smart, General Jacob E. to Commander, Air Research and Development Command, March 5, 1957. Contained in "The Initial Operational Capability (IOC) and IOC Instructions Received by AFBMD, 1955-1957." Unaccessioned, unclassified collections. BMO box F-2, AFHRA.

Weinberger, Caspar to Secretary of the Air Force Verne Orr, December 31, 1981. Unaccessioned, unclassified collections. BMO box B-3, AFHRA.

Wetzel, Colonel Albert J. to General Osmond J. Ritland. "Titan Mobility, March 23, 1960." Unaccessioned, unclassified collections. BMO box L-2, AFHRA.

White, General Thomas D. to Commander, Air Research and Development Command, November 18, 1955. Contained in "The Initial Operational Capability (IOC) and IOC Instructions Received by AFBMD, 1955-1957, Unaccessioned, unclassified collections. BMO box F-2, AFHRA.

White, General Thomas D. to Commander, Air Research and Development Command, December 29, 1955. Contained in "The Initial Operational Capability (IOC) and IOC Instructions Received by AFBMD, 1955-1957, Unaccessioned, unclassified collections. BMO box F-2, AFHRA.

HQ AFSC message to BMO. "MX-Renewable Energy System Project, March 31, 1980, 2100Z." Unaccessioned, unclassified collections. BMO box B-22, AFHRA.

Books

Aerospace Corporation. *The Aerospace Corporation: Its Work, 1960-1980*. Los Angeles: Times Mirror Press, 1980.

Algozzini, Joe. *Lionel's Postwar Space and Missile Trains*. Toy Train Reference Series, no. 2. Waukesha, WI: Greenberg Books, 1996.

Ball, Desmond. *Politics and Force Levels: The Strategic Missile Program of the Kennedy Administration*. Berkeley: University of California Press, 1980.

Beard, Edmund. *Developing the ICBM: A Study in Bureaucratic Politics*. New York: Columbia University Press, 1976.

Boorstin, Daniel J. *The Republic of Technology: Reflections on Our Future Community*. New York: Harper and Row, Publishers, 1978.

Bottome, Edgar M. *The Missile Gap: A Study of the Formulation of Military and Political Policy*. Rutherford, NJ: Fairleigh Dickinson University Press, 1971.

Cochrane, Thomas B., William M. Arkin, and Milton M. Hoenig. *Nuclear Weapons Databook*. Vol. 1, *U.S. Nuclear Forces and Capabilities*. Cambridge, MA: Ballinger Publishing Company, 1984.

Cochrane, Thomas B., William M. Arkin, Robert S. Norris, and Jeffrey I. Sands. *Nuclear Weapons Databook*. Vol. 4, *Soviet Nuclear Weapons*. New York: Harper and Row, 1989.

- Cochrane, Thomas B., Robert S. Norris, and Oleg A. Bukharin. *Making the Russian Bomb: From Stalin to Yeltsin*. Boulder, CO: Westview Press, 1995.
- Daso, Dik Alan. *Hap Arnold and the Evolution of American Airpower*. Smithsonian History of Aviation Series, ed. Von Hardesty. Washington, D.C.: Smithsonian Institution Press, 2000.
- Divine, Robert A. *The Sputnik Challenge*. New York: Oxford University Press, 1993.
- Dornberger, Walter. *V-2*. Translated by James Cleugh and Geoffrey Halliday. New York: Viking Press, 1955.
- Edwards, John. *Superweapon: The Making of MX*. New York: W. W. Norton and Company, 1982.
- Emme, Eugene M., ed. *The History of Rocket Technology*. Detroit: Wayne State University Press, 1964.
- Enthoven, Alain C. and K. Wayne Smith. *How Much is Enough: Shaping the Defense Program, 1961-1969*. New York: Harper and Row, Publishers, 1971.
- Gaddis, John Lewis, Philip H. Gordon, Ernest R. May, and Jonathon Rosenberg, eds. *Cold War Statesmen confront the Bomb: Nuclear Diplomacy since 1945*. Oxford: Oxford University Press, 1999.
- Gantz, Kenneth F., ed. *The United States Air Force Report on Ballistic Missiles*. New York: Doubleday and Company, Inc., 1958.
- Gibson, James N. *Nuclear Weapons of the United States: An Illustrated History*. Atglen, PA: Schiffer Publishing Ltd., 1996.
- Gorn, Michael H. ed. *Prophecy Fulfilled: "Toward New Horizons" and Its Legacy*. Washington, D.C.: Air Force History and Museums Program, 1994.
- Gray, Colin S. *The MX ICBM and National Security*. New York: Praeger Publishers, 1981.
- _____. *Missiles Against War: The ICBM Debate Today*. Issues in National Security. Fairfax, VA: National Institute for Public Policy, 1985.
- Greenwood, Ted. *Making the MIRV: A Study of Defense Decision Making*. Cambridge, MA: Ballinger Publishing Company, 1975.
- Gunston, Bill. *The Illustrated Encyclopedia of the World's Rockets and Missiles*. New York: Crescent Books, 1979.

- Hanley, Timothy C. and Harry N. Waldron. *Historical Overview: Space and Missile Systems Center*. Los Angeles AFB, CA: SMC History Office, 1996.
- Harford, James. *Korolev: How One Man Masterminded the Soviet Drive to Beat America to the Moon*. New York: John Wiley and Sons, Inc., 1997.
- Holland, Lauren H. and Robert A. Hoover. *The MX Decision: A New Direction in U.S. Weapons Procurement Policy?* Boulder, CO: Westview Press, 1985.
- Holloway, David. *The Soviet Union and the Arms Race*. New Haven: Yale University Press, 1983.
- Hoover, Robert A. *The MX Controversy: A Guide to Issues and References*. Guides to Contemporary Issues, ed. Richard Dean Burns. Claremont, CA: Regina Books, 1982.
- Hopkins, J.C. and Sheldon A. Goldberg. *The Development of Strategic Air Command: 1946-1986*. Offutt Air Force Base, NE: Office of the Historian, Headquarters Strategic Air Command, 1986.
- Hughes, Thomas P. *Rescuing Prometheus*. New York: Pantheon Books, 1998.
- Huston, John W. ed. *American Airpower Comes of Age: General Henry H. "Hap" Arnold's World War II Diaries*. Vol. 2. Maxwell Air Force Base, AL: Air University Press, 2002.
- Johnson, Stephen B. *The United States Air Force and the Culture of Innovation: 1945-1965*. Washington, D.C.: Government Printing Office, 2002.
- Kaufmann, William W. *The McNamara Strategy*. New York: Harper and Row, 1964.
- Killian, James R. *Sputnik, Scientists, and Eisenhower: A Memoir of the First Special Assistant to the President for Science and Technology*. Cambridge, MA: MIT Press, 1977.
- Launius, Roger D. and Dennis R. Jenkins, eds. *To Reach the High Frontier: A History of U.S. Launch Vehicles*. Lexington, KY: University Press of Kentucky, 2002.
- Levi, Barbara G., Mark Sakitt, and Art Hobson, eds. *The Future of Land-Based Strategic Missiles*. New York: American Institute of Physics, 1989.
- MacKenzie, Donald. *Inventing Accuracy: A Historical Sociology of Nuclear Missile Guidance*. Cambridge, MA: The MIT Press, 1990.

- McCusker, John J. *How Much is That in Real Money: A Historical Price Index for Use as a Deflator of Money Values in the Economy of the United States*. 2d ed. Worcester, MA: American Antiquarian Society, 2001.
- McDougall, Walter A. *The Heavens and the Earth: A Political History of the Space Age*. Baltimore: Johns Hopkins University Press, 1985.
- Neal, Roy. *Ace in the Hole: The Story of the Minuteman Missile*. Garden City, NY: Doubleday and Company, Inc., 1962.
- Nease, R.F. and D.C. Hendrickson. *A Brief History of Minuteman Guidance and Control*. Rockwell Defense Electronics, Autonetics: 1995.
- Neufeld, Jacob. *Ballistic Missiles in the United States Air Force, 1945-1960*. Washington D.C.: U.S. Government Printing Office, 1989.
- _____. *Reflections on Research and Development in the United States Air Force: An Interview with General Bernard A. Schriever and Generals Samuel C. Phillips, Robert T. Marsh, and James H. Doolittle, and Dr. Ivan A. Getting*. Washington, D.C.: Center for Air Force History, 1993.
- Neufeld, Michael J. *The Rocket and the Reich: Peenemunde and the Coming of the Ballistic Missile Era*. New York: Free Press, 1995.
- Office of the Historian, Headquarters Strategic Air Command. *From Snark to Peacekeeper: A Pictorial History of Strategic Air Command Missiles*. Offutt Air Force Base, NE: 1990.
- _____. *Alert Operations of the Strategic Air Command, 1957-1991*. Offutt Air Force Base, NE: Office of the Historian, 1991.
- Podvig, Pavel, ed. *Russian Strategic Nuclear Forces*. Cambridge, MA: MIT Press, 2001.
- Pringle, Peter and William Arkin. *SIOP: The Secret U.S. Plan for Nuclear War*. New York: W. W. Norton and Company, 1983.
- Reagan, Ronald W. *An American Life: The Autobiography of Ronald Reagan*. New York: Simon and Schuster, 1990.
- Roherty, James M. *Decisions of Robert S. McNamara: A Study of the Role of the Secretary of Defense*. Coral Gables, FL: University of Miami Press, 1970.
- Sapolsky, Harvey M. *The Polaris System Development: Bureaucratic and Programmatic Success in Government*. Cambridge, MA: Harvard University Press, 1972.

- Schlesinger, Arthur Jr. *A Thousand Days: John F. Kennedy in the White House*. Boston: Houghton Mifflin Company, 1965.
- Schneider, Barry R., Colin S. Gray, and Keith Payne, eds. *Missiles for the Nineties: ICBMs and Strategic National Policy*. Boulder, CO: Westview Press, 1984.
- Schwiebert, Ernest G. *A History of the U.S. Air Force Ballistic Missiles*. New York: Frederick A. Praeger, 1965.
- Scott, Harriet Fast and William F. Scott, ed. *The Soviet Art of War: Doctrine, Strategy, and Tactics*. Boulder, CO: Westview Press, 1982.
- Scoville, Herbert, Jr. *MX: Prescription for Disaster*. Cambridge, MA: MIT Press, 1981.
- Skinner, Kiron K., Annelise Anderson, and Martin Anderson, eds. *Reagan: A Life in Letters*. New York: Free Press, 2003.
- Stebbins, Richard P., ed. *Documents on American Foreign Relations 1967*. New York: Simon and Schuster, 1968.
- Stebbins Richard P. and Elaine P. Adam, eds. *American Foreign Relations 1972: A Documentary Record*. New York: New York University Press, 1976.
- _____. *American Foreign Relations 1974: A Documentary Record*. New York: New York University Press, 1977.
- Stoll, Richard J. Stoll. *U.S. National Security Policy and the Soviet Union: Persistent Regularities and Extreme Contingencies*. Studies in International Relations, ed. Charles W. Kegley, Jr. and Donald J. Puchala. Columbia, SC: University of South Carolina Press, 1990.
- Talbott, Strobe. *Endgame: The Inside Story of SALT II*. New York: Harper and Row, Publishers, 1979.
- Terriff, Terry B. *The Nixon Administration and the Making of U.S. Nuclear Strategy*. Ithaca: Cornell University Press, 1995.
- Trewhitt, Henry L. *McNamara*. New York: Harper and Row, Publishers, 1971.
- Trimble, William F. *Attack from the Sea: A History of the U.S. Navy's Seaplane Striking Force*. Annapolis, MY: Naval Institute Press, 2005.
- Von Braun, Wernher and Frederick I. Ordway. *History of Rocketry and Space Travel*, 2d ed. New York: Thomas Y. Crowell Company, 1969.

Werrell, Kenneth P. *The Evolution of the Cruise Missile*. Maxwell Air Force Base, AL: Air University Press, 1985.

Zaloga, Steven J. *The Kremlin's Nuclear Sword: The Rise and Fall of Russia's Strategic Nuclear Forces, 1945-2000*. Washington, D.C.: Smithsonian Institution Press, 2002.

Secondary Studies

Ball, Desmond. *Targeting for Strategic Deterrence*. London: The International Institute for Strategic Studies, 1983. Adelphi Papers no. 185.

Berger, Carl. *History of the 1st Missile Division*. Vandenberg AFB: CA, 1960.

Byrd, David A. *Rail-Based Missiles from Atlas to Peacekeeper*. Los Angeles Air Force Station, CA: Ballistic Missile Organization Historian, 1991. Courtesy Air Force Space Command Historian's Office.

Kolega, Daniel J. and James E. Leger. "Airborne Minuteman." In *AIAA 5th Aerodynamic Deceleration Systems Conference, Albuquerque, New Mexico, November 17-19, 1975*, by the American Institute of Aeronautics and Astronautics. New York: AIAA, 1975.

Shaw, Frederick J. and Richard W. Sirmons. "On Steel Wheels: The Railroad Mobile Minuteman," *SAC Monograph No. 216*. Offutt Air Force Base, NE: Office of the Historian, Strategic Air Command, 1986. Declassified extract, accessioned collections. IRIS K416.01-216, AFHRA.

Dissertations

Reed, George A. "U.S. Defense Policy, U.S. Air Force Doctrine and Strategic Nuclear Weapon Systems, 1958-1964: The Case of the Minuteman ICBM." Ph. D. diss., Duke University, 1986.

Articles

Aviation Week and Space Technology abbreviated as *AWST*.

Allen, Lew Jr. "Window to the World." *AWST* 110 (February 26, 1979): 9.

Arnold, H. H. "Air Power for Peace." *National Geographic Magazine* 89 (February 1946): 137-193.

Baar, James. "Hard-based Minutemen vs. Mobility." *Missiles and Rockets* 7 (October 17, 1960): 23-24.

- Bassett, Edward W. "MX Missile, Vertical Shelters Urged by U.S. Defense Chief." *AWST* 109 (July 31, 1978): 15-16.
- Brownlow, Cecil. "Dollar Drain Saps U.S. Strategic Stance." *AWST* 88 (March 18, 1968): 71-75.
- _____. "USAF Weighs Delivery Modes for MX Advanced ICBM Use." *AWST* 99 (September 1973): 15-16.
- Carroll, Robert G. H. "Making the Mark with Missiles." *Air Force Magazine* 59 (June 1976): 50-54.
- Fink, Donald E. "Minuteman Experience Aiding MX." *AWST* 105 (July 19, 1976): 113-120.
- Frisbee, John L. "The SALT II Debate." *Air Force Magazine* 62 (May 1979): 6.
- Goen, Richard L. "Nuclear Survival." *AWST* 97 (November 6, 1972): 62.
- Gray, Colin S. "Nuclear Strategy: The Case for a Theory of Victory." *International Security* 4 (Summer 1979): 54-87.
- _____. "Strategic Stability Reconsidered." *Daedalus* 109 (Fall 1980): 135-154.
- Griffiths, David R. "MX Decision Spurs Pressure on Basing." *AWST* 110 (June 18, 1979): 27-28.
- _____. "MX Flexibility Allows Doubling Shelters." *AWST* 111 (September 17, 1979): 16-18.
- _____. "Renewable Energy Pushed for MX Net." *AWST* 113 (November 17, 1980): 45-46.
- _____. "MX Basing Problem Unresolved." *AWST* 115 (August 24, 1981): 16-18.
- Hotz, Robert. "Mr. McNamara's Legacy." *AWST* 88 (March 25, 1968): 11.
- Howard, William E. "Minuteman Rail Concept Pushed." *Missiles and Rockets* 5 (June 1, 1959): 18-20.
- Kolcum, Edward H. "Strategic Planning Centers on Missiles." *AWST* 86 (March 6, 1967): 69-74.
- Lenorovitz, Jeffrey M. "MX Basing Mode Concepts Analyzed." *AWST* 107 (November 21, 1977): 63-67.

- _____. "Air Force Eyes ICBM Basing Options." *AWST* 109 (August 28, 1978): 18-19.
- _____. "Air Force Restudying MX Basing Plan." *AWST* 110 (January 29, 1979): 21.
- Lodal, Jan M. "Deterrence and Nuclear Strategy." *Daedalus* 109 (Fall 1980): 155-175.
- McDougall, Walter A. "Technocracy and Statecraft in the Space Age--Toward the History of a Saltation." *The American Historical Review* 87 (October 1982): 1010-1040.
- Miller, Barry. "MX Guidance Elements in Development." *AWST* 105 (December 13, 1976): 69-77.
- Neufeld, Jacob. "General Bernard A. Schriever: Technological Visionary." *Air Power History* 51 (Spring 2004): 38-43.
- Pipes, Richard. "Why the Soviet Union Thinks It Could Fight and Win a Nuclear War." *Commentary* 64 (July 1977): 21-34.
- Ramo, Simon. "The Guided Missile as a Systems Engineering Problem." Reprint from the *Canadian Aeronautical Journal* 3 (January and February 1957): 3-43.
- Robinson, Clarence A. Jr. "U.S. to Test ABM System with MX." *AWST* 110 (March 19, 1979): 23-26.
- _____. "SALT 2 Approval Hinges on MX." *AWST* 110 (May 14, 1979): 14-16.
- _____. "Acceptable Basing Mode for MX Sought." *AWST* 110 (May 21, 1979): 14-16.
- _____. "MX Racetrack Questioned in Congress." *AWST* 111 (November 12, 1979): 17-19.
- _____. "Alternate MX Basing Concepts Weighed." *AWST* 113 (October, 27, 1980): 19-21.
- _____. "Reagan Details Defense Boost." *AWST* 113 (November 10, 1980): 14.
- _____. "Reagan Team Asks Capabilities, Priorities of Services." *AWST* 113 (December 8, 1980): 16-21.
- _____. "MX Missile Concealment Investigated." *AWST* 114 (April 13, 1981): 21-23.

- _____. "ICBM, Bomber Decisions Due in Late July." *AWST* 115 (July 13, 1981): 18-20.
- _____. "Weinberger Pushes Strategic Airmobile MX Concept." *AWST* 115 (August 3, 1981): 16-19.
- _____. "Decisions Reached on Nuclear Weapons." *AWST* 115 (October 12, 1981): 18-23.
- Slay, Alton D. "MX, A New Dimension in Strategic Deterrence." *Air Force Magazine* 59 (September 1976): 44-49.
- Smith, Bruce A. "Nevada, Utah Study Impact of MX." *AWST* 111 (November 26, 1979): 14-17.
- _____. "USAF Changes MX Missile Launch Mode." *AWST* 112 (March 17, 1980): 20-21.
- _____. "MX Missile Performance, Throw Weight Improved." *AWST* 112 (June 16, 1980): 122-131.
- _____. "MX Basing Impact Report Criticized." *AWST* 114 (April 6, 1981): 22.
- Steinbrunner, John D. "National Security and the Concept of Strategic Stability." *The Journal of Conflict Resolution* 22 (September 1978): 411-428.
- Stone, Irving. "ICBM Studies Focus on 156-in. Motors." *AWST* 11 (March 15, 1965): 141-145.
- Ulsamer, Edgar. "Strategic options and Total Force Concepts, Interview with AFSC's Commander." *Air Force Magazine* 55 (May 1972): 39-45.
- _____. "M-X: The Missile System for the Year 2000." *Air Force Magazine* (March 1973): 39-44.
- _____. "Our ICBM Force: The Vulnerability Myth." *Air Force Magazine* 57 (August 1974): 65-70.
- _____. "MX Still Zigzagging." *Air Force Magazine* 62 (February 1979): 14.
- _____. "Airmobile MX." *Air Force Magazine* 62 (April 1979): 16.
- _____. "More Gyration Over MX Decision." *Air Force Magazine* 62 (July 1979): 15.

- Winston, Donald C. "Nixon Delays Advanced ICBM Development." *AWST* 90 (May 12, 1969): 26-27.
- "Air Force Reverses Position, Backs Horizontal MX Basing." *AWST* 112 (March 10, 1980): 21-22.
- "Congress Reacts Against Airmobile Basing of MX." *AWST* 115 (August 17, 1981): 30.
- "Drop of Minuteman by C-5A Tests Air-Mobile ICBM Concept." *AWST* 101 (November 11, 1974): 20-21.
- "Environmentalist Action May Slow MX Basing." *AWST* 116 (February 9, 1981): 27.
- "Heavy-Lift Platform for ICBM Studied." *AWST* 102 (March 3, 1975): 12.
- "Industry Observer." *AWST* 86 (February 6, 1967): 19.
- "Industry Observer." *AWST* 86 (April 3, 1967): 23.
- "Industry Observer." *AWST* 87 (November 6, 1967): 13.
- "Industry Observer." *AWST* 87 (December 18, 1967): 13.
- "Judge Halts MX Engine Tests." *AWST* 116 (February 9, 1981): 26.
- "Minuteman Ready for Rail Mobility Tests." *AWST* 72 (May 9, 1960): 28-30.
- "Mobile Minutemen to Be Randomized." *Missiles and Rockets* 7 (September 19, 1960): 29-30.
- "MX Shelter Blast Survivability Evaluated." *AWST* 108 (January 9, 1978): 24.
- "MX Basing Approval Expected." *AWST* 111 (July 30, 1979): 12-13.
- "MX Basing Doubts Voiced in Utah, Nevada." *AWST* 112 (February 11, 1980): 15-16.
- "MX Transporter/Emplacer Being Tested." *AWST* 112 (February 18, 1980): 65-67.
- "MX Loading Dock Concept Chosen by Defense Dept." *AWST* 112 (May 5, 1980): 26-27.
- "MX Launch Technique Changed." *AWST* 112 (June 16, 1980): 28.
- "MX Missile Motor Fired Successfully." *AWST* 114 (February 2, 1981): 19.

- “SAC Shapes Missile Force for Survival, Fast Reaction.” *AWST* 72 (June 20, 1960): 104-109.
- “Shift to Strategic Force Emphasis tied to Nixon Domestic Priorities.” *AWST* 92 (February 23, 1970): 19.
- “Study Finds Joint MX/Trident Impractical.” *AWST* 103 (October 13, 1975): 17.
- “Targeting Flexibility Emphasized by SAC.” *AWST* 104 (May 10, 1976): 29-34.
- “Test Blast Yields MX Basing Data.” *AWST* 109 (July 10, 1978): 25.
- “The Ballistic Challenge . . . as seen by Major General Bernard A. Schriever, Chief, Western Development Division of ARDC.” *Missiles and Rockets* 2 (April 1957): 94-96.
- “USAF Hopes to Press Advanced ICBM.” *AWST* 100 (February 11, 1974): 60-61.
- “USAF Pushes Advanced ICBM Studies.” *AWST* 101 (July 15, 1974): 100-101.
- “USAF Plans Test of MX Trench Concept.” *AWST* 107 (October 17, 1977): 17-19.
- “USAF Tests MX Breakout From Trench.” *AWST* 109 (November 20, 1978): 23.
- “Washington Roundup.” *AWST* 110 (April 9, 1979): 13.

On-line Articles

- “Biographies: Lieutenant General Otto J. Glasser.”
<http://www.af.mil/bios/bio.asp?bioID=5554>. Accessed on January 26, 2005.
- “What is its Relative Value in US Dollars.” <http://www.eh.net/hmit/compare>. Accessed October 21, 2004.

APPENDICES

APPENDIX A

DESIGN ENGINEERING INSPECTION, DECEMBER 1960

PHOTOGRAPHS OF MOBILE MINUTEMAN MODELS¹

During December 1960, air force officials reviewed the Boeing Company's ideas for handling mobile Minuteman trains at the mobile unit support base. A selection of Boeing photographs follows.

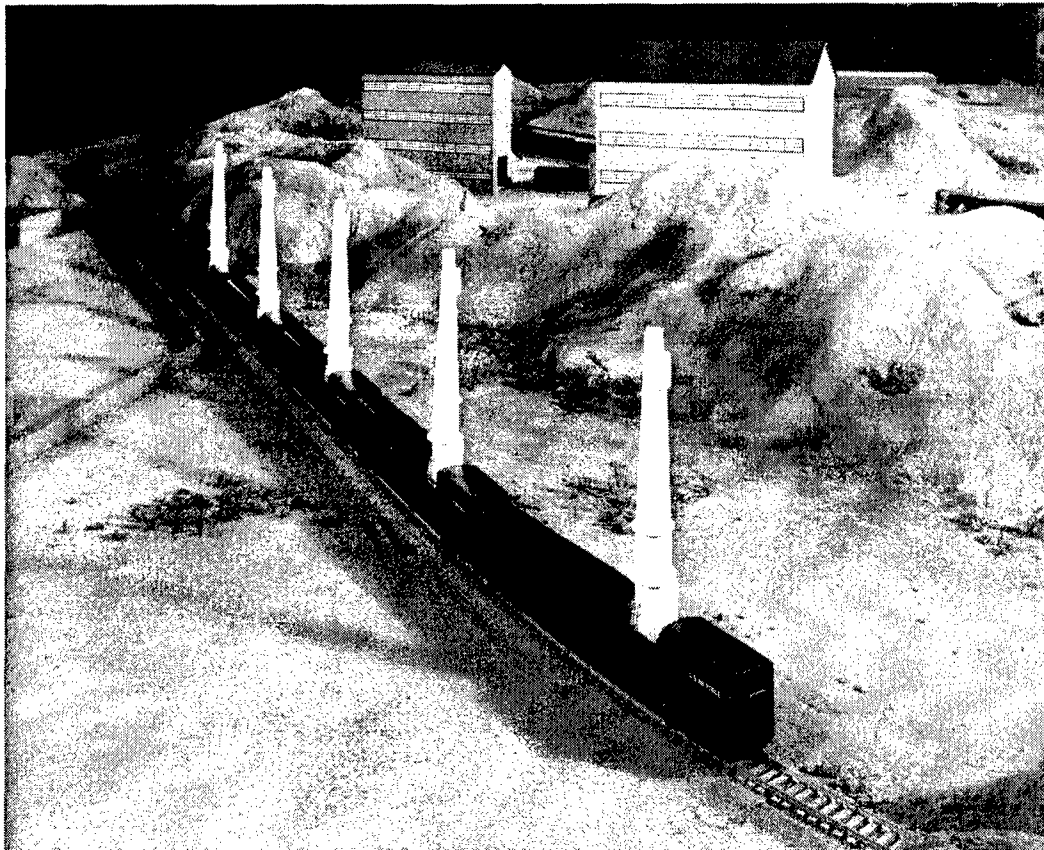

This photograph illustrates five missile cars with the missiles in a strategic alert condition. Based on air force desires, the number of missiles per train varied between three and six. The missiles are inside the vertical support structures. When launched, the vertical structure opened as a clamshell to permit missile flight.

¹Boeing Company, "Minuteman Mobile D.E.I. (Boeing), December 8, 1960," unaccessioned, unclassified collections. BMO box M-22, AFHRA.

MOBILE MINUTEMAN MODELS

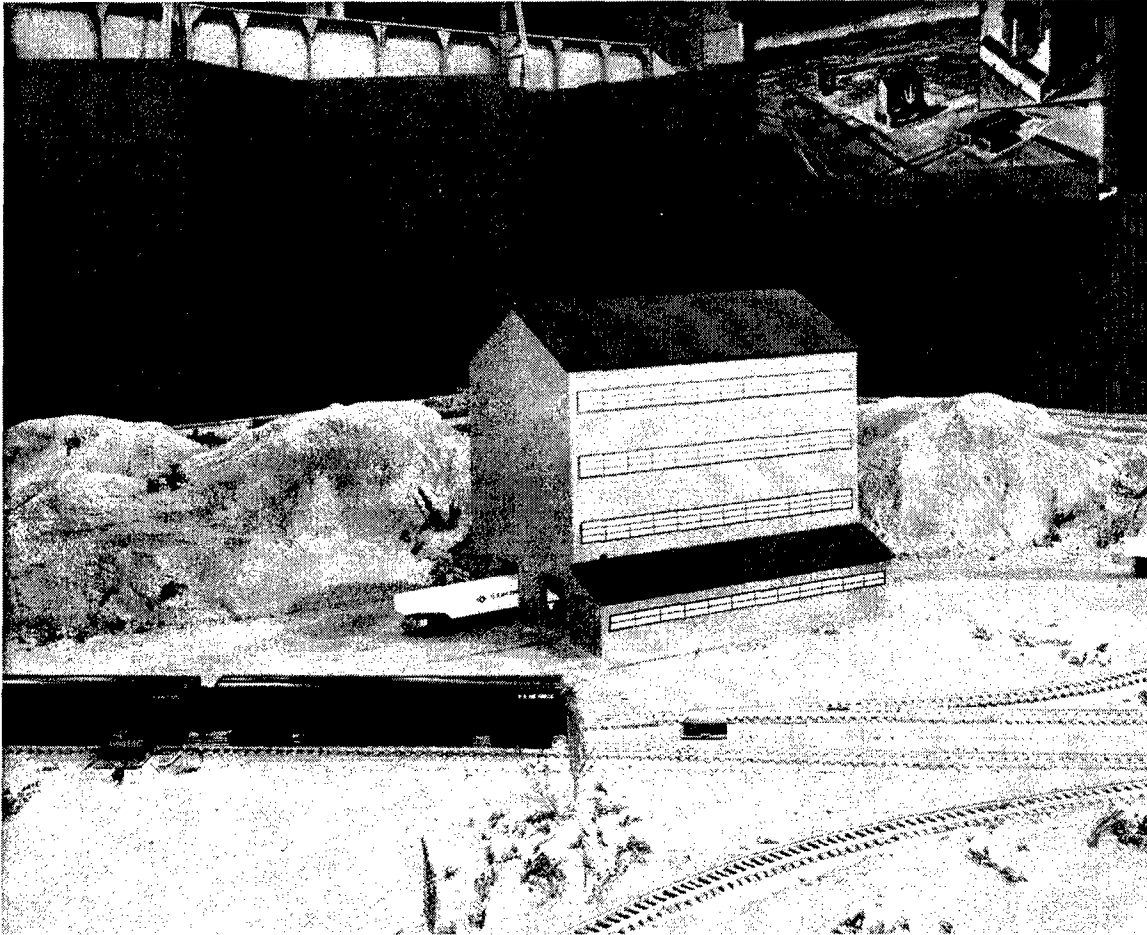

Parked near a missile transfer building, the missile cars provide a sense of scale to mobile Minuteman. The truck extending from the transfer building is a Minuteman transporter erector, a vehicle used for road transport of Minuteman missiles. At fixed-site deployments, the transporter erector elevated the missile (inside the trailer) to a vertical position and then lowered it into the underground launch facility.

MOBILE MINUTEMAN MODELS

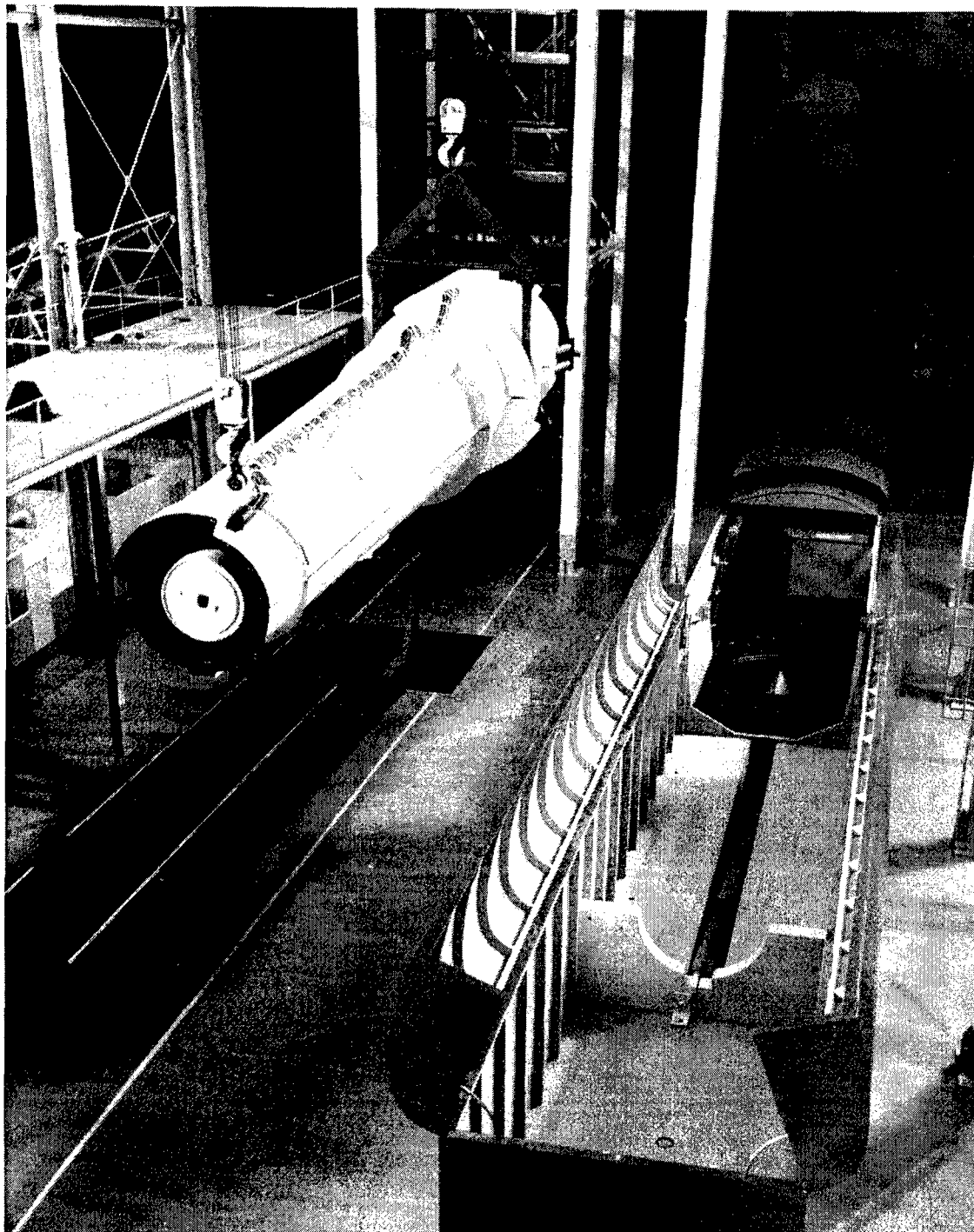

A transfer crane raised a Minuteman missile out of the missile car, but the warhead is not on the missile. Towards the rear of the missile car is the round, azimuth alignment table that rotated the missile to its heading. Down the car's middle is the hydraulic jack used to elevate the missile, and in the background, a man may be seen.

MOBILE MINUTEMAN MODELS

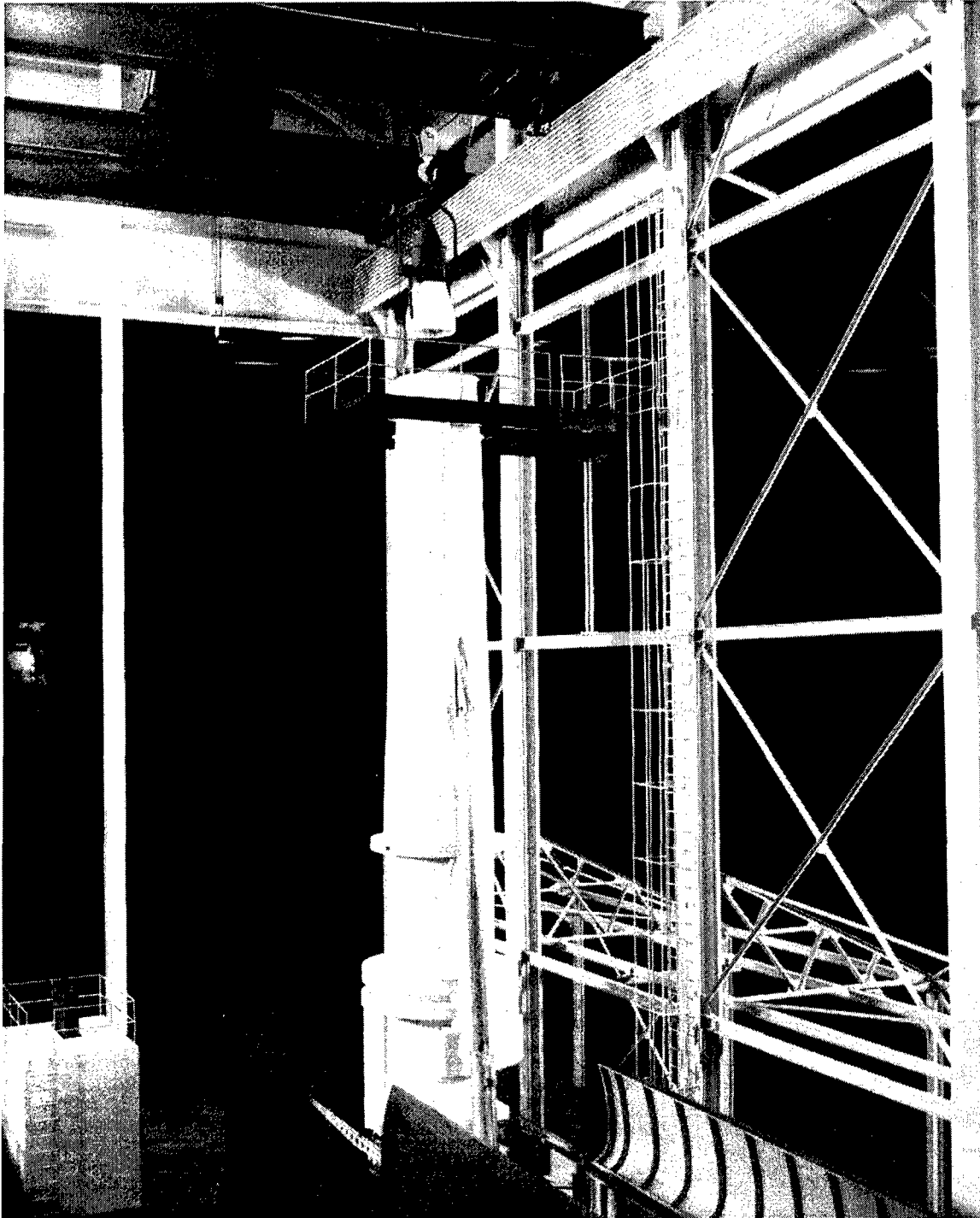

Removal of a missile's reentry vehicle. The photo provides details of the support structure of an elevated missile.

APPENDIX B

GOLDEN ARROW AND MULTIPLE POOL BASING ILLUSTRATIONS

This appendix contains declassified illustrations of the Golden Arrow triggered random mobile Minuteman, advanced basing concept, advanced airborne weapon system, and superhard basing modes, as well as illustrations of the Minuteman multiple pool basing mode.

Triggered Random-Mobile Minuteman

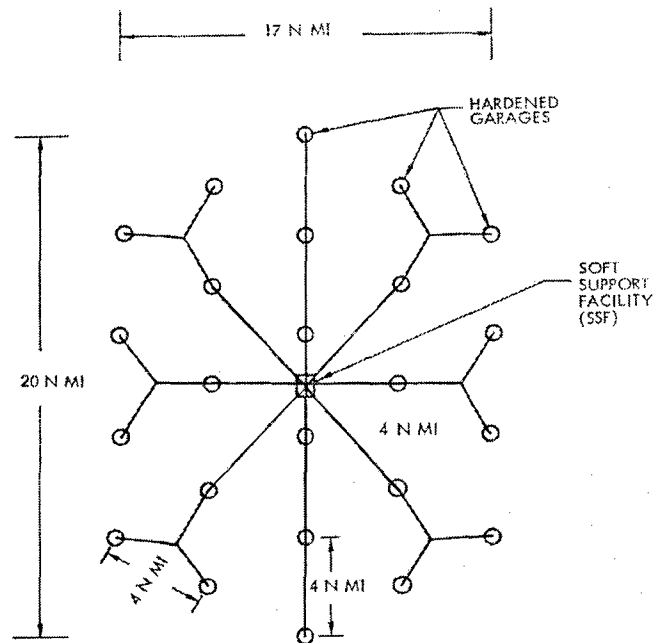

FIGURE 4.1
MINIMUM ROAD NETWORK FOR ONE SOFT SUPPORT
FACILITY AND 24 HARDENED GARAGES
(TWO N.MI. BETWEEN EACH GARAGE)

This drawing, a simple linear representation, shows the soft support facility as a square at the center. The circles are hardened garages, and the lines are government-owned roads. By providing more garages than transporter launchers, the concept provided a measure of deception.¹

¹Aerospace, "Triggered Random-Mobile Minuteman," 15.

GOLDEN ARROW AND MULTIPLE POOL BASING ILLUSTRATIONS

Advanced Basing Concept

- > DEPLOYED IN SHALLOW WATERS UNDER U.S. JURISDICTION
- > MISSILES CARRIED ON SLOW MOVING, MINIMALLY MANNED UNDERWATER LAUNCH PLATFORMS
- > SURVIVES BY MOBILITY AND CONCEALMENT
- > NO LIMITATION ON MISSILE SIZE, BUT COMMAND CONTROL AND GUIDANCE ACCURACY ARE MAJOR PROBLEM AREAS.

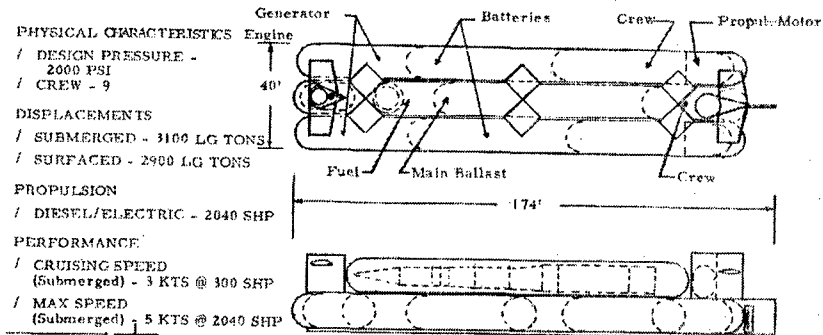
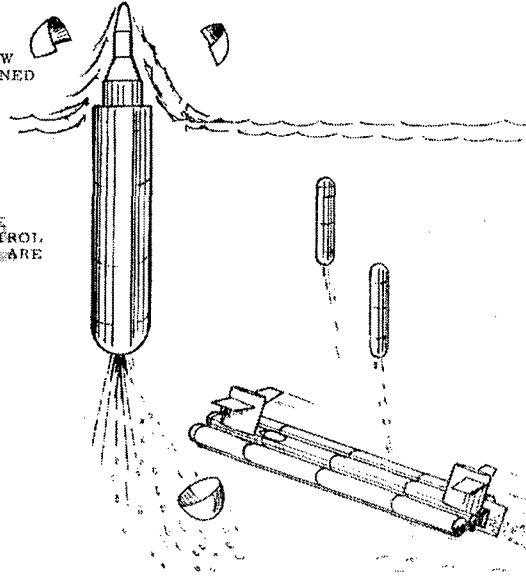

The top drawing illustrates the canisterized missile and a launch unit that has released two missiles; however, the report text states that a launch unit would carry only one missile. The bottom drawing shows details of the size and two views of the launch unit. The sketch clearly shows an ICBM similar in appearance to a Minuteman.²

²Aerospace, "Advanced Basing Concept," unnumbered page and 17.

GOLDEN ARROW AND MULTIPLE POOL BASING ILLUSTRATIONS

Advanced Airborne Weapon System Launch Routes

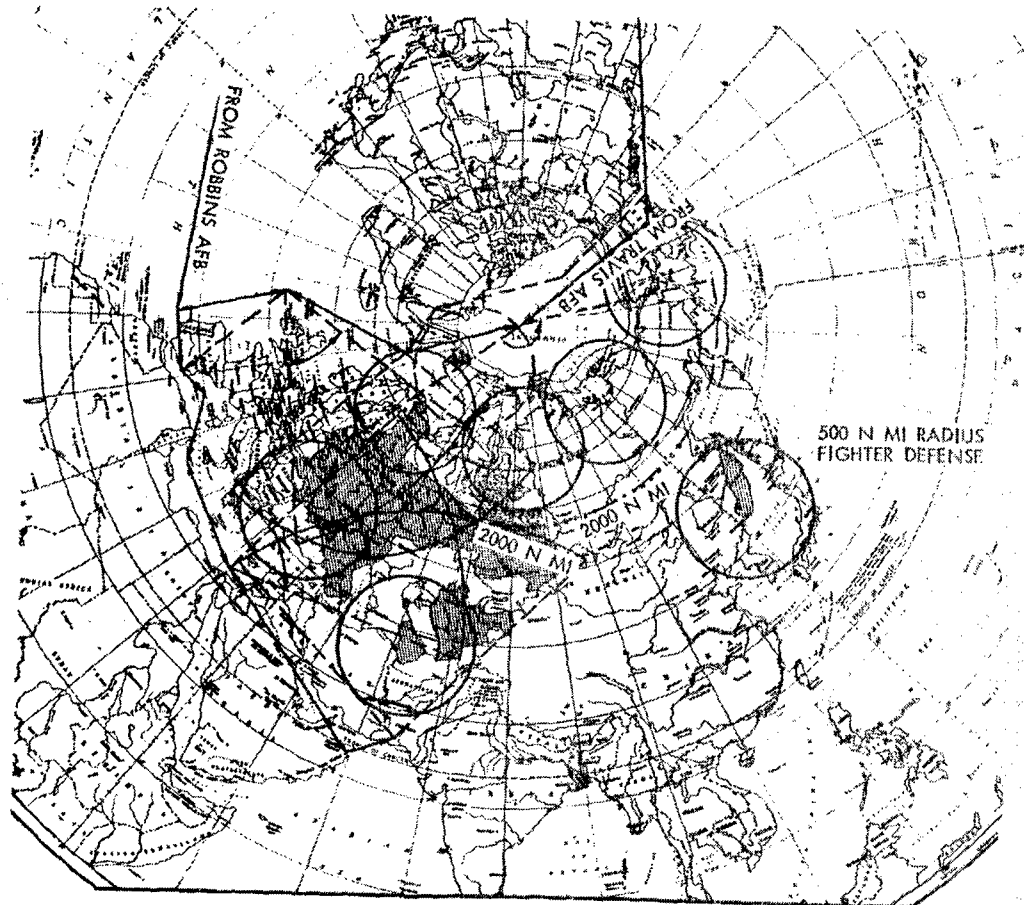

The map illustrates worldwide launch routes. Note the lines of attack from Robbins and Travis Air Force Bases. No drawings of the long endurance aircraft were available.³

³Aerospace, "Advanced Airborne Weapon System," 19.

GOLDEN ARROW AND MULTIPLE POOL BASING ILLUSTRATIONS

Superhard

SUPERHARD INSTALLATIONS

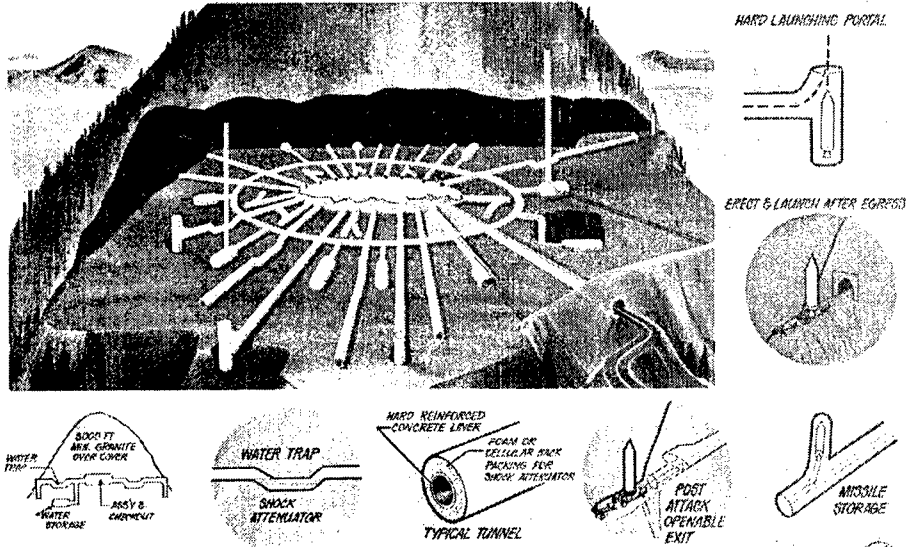

**NEARLY INVULNERABLE BASING CONCEPT
SUPERHARD**

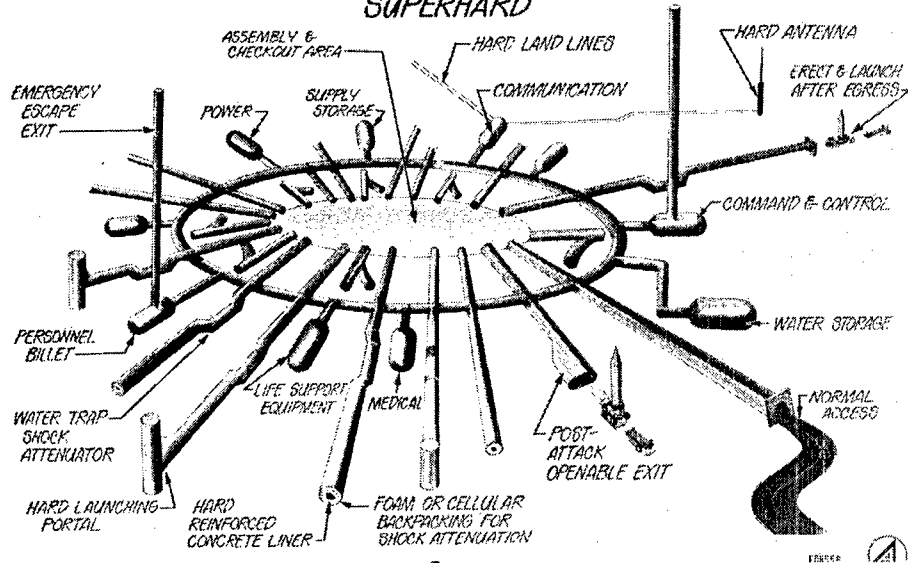

The top drawing illustrates a superhard base inside a mountain. Note the spider-web like pattern. The lower drawing, entitled "Nearly Invulnerable Basing Concept," demonstrated Aerospace's faith in the concept.⁴

⁴Aerospace, "Superhard," unnumbered pages.

GOLDEN ARROW AND MULTIPLE POOL BASING ILLUSTRATIONS

Minuteman Multiple Pool Basing Concept

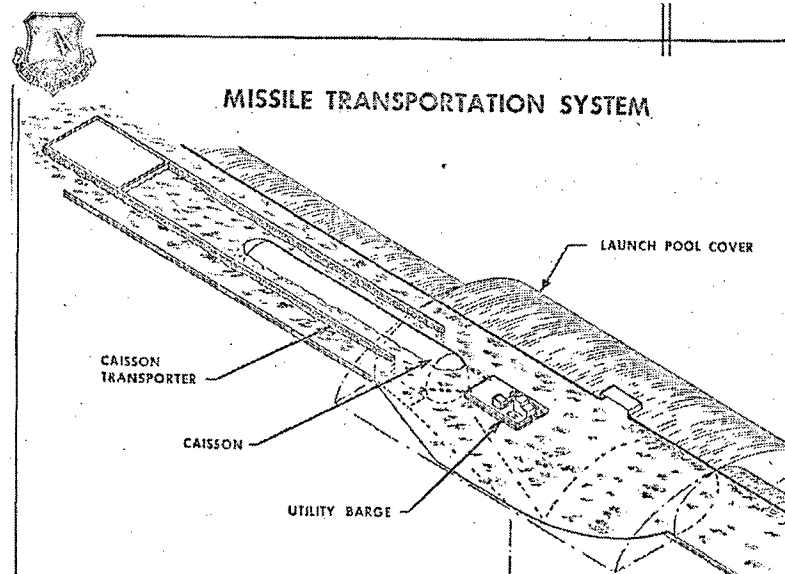
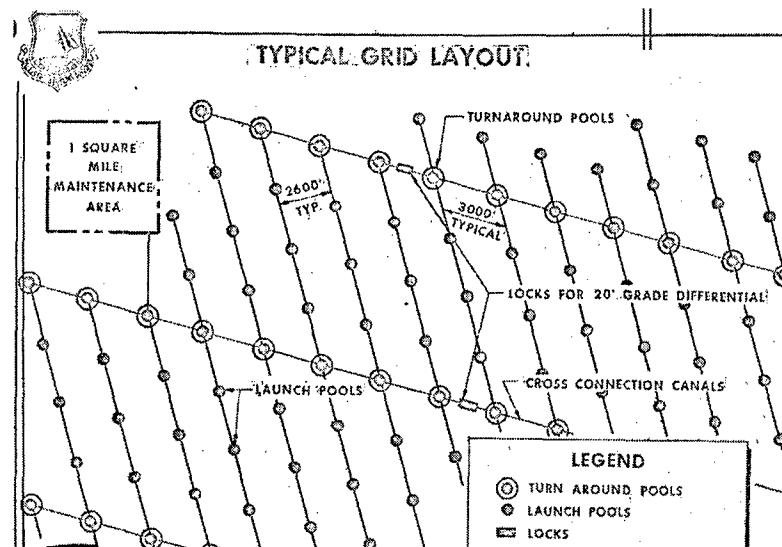

The turnaround pools, launch pools, and canals of Minuteman multiple pool basing restricted mobility to a specified area. By constructing 350 launch pools for fifty missiles, Minuteman multiple pool basing combined mobility, concealment, and deception to increase ICBM survivability. Covering the canals and launch pools hid the utility barges and missile caissons. In the 1970s and 1980s, planners applied similar concepts to the design of mobility schemes for the MX missile.⁵

⁵BSD, "Multiple Pool Basing," unnumbered slides.

GOLDEN ARROW AND MULTIPLE POOL BASING ILLUSTRATIONS

Minuteman Multiple Pool Basing

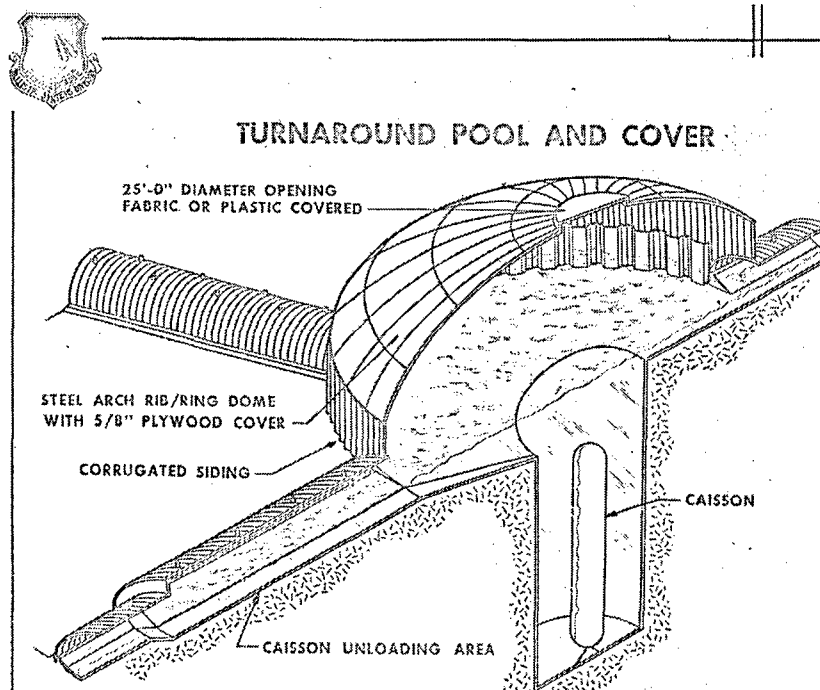
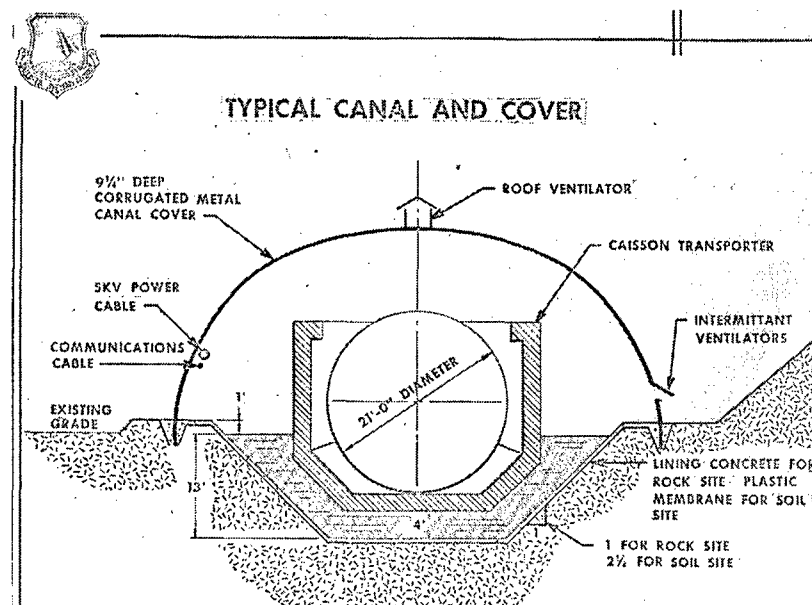

These two reproductions illustrate the construction of the connecting canals and turnaround pools. Launch pools were not as large as turnaround pools but had similar construction. During emplacement, the caisson tethered to the bottom of a launch pool.⁶

⁶Ibid.

GOLDEN ARROW AND MULTIPLE POOL BASING ILLUSTRATIONS

Minuteman Multiple Pool Basing

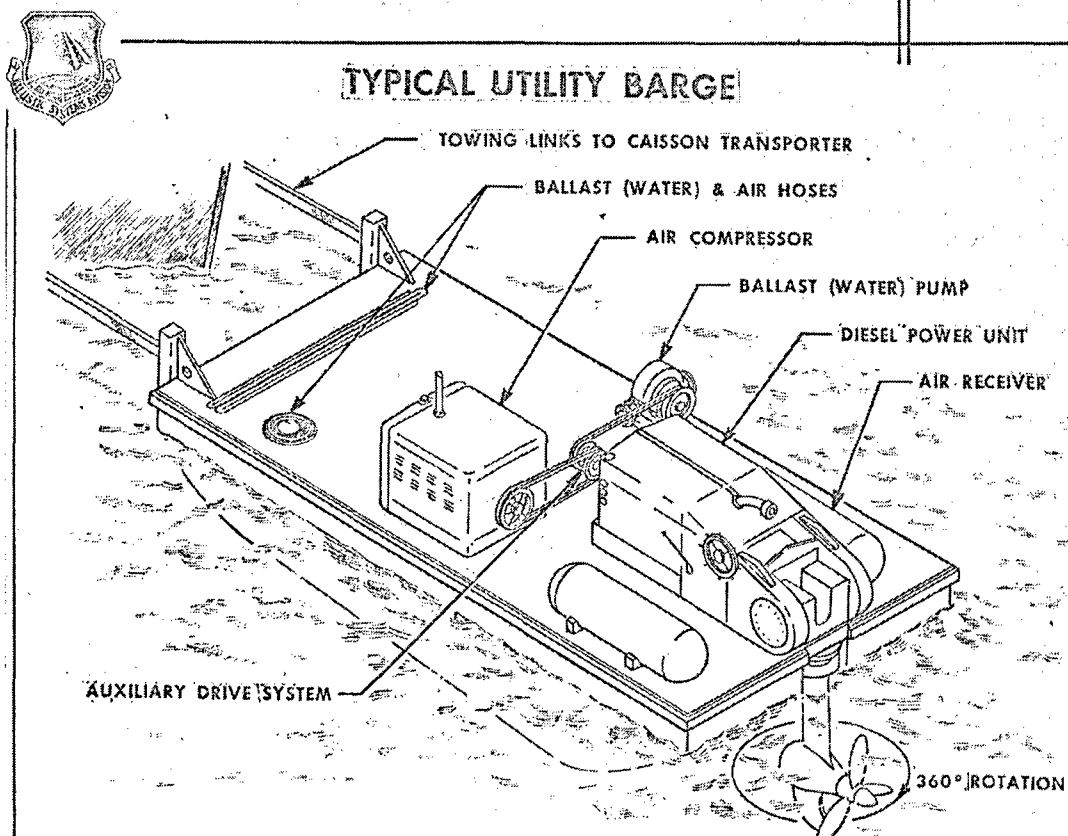

The utility barge was a diesel-powered flatboat that towed missile caissons through the canal system.⁷

⁷Ibid.

APPENDIX C

MX AIR MOBILE ILLUSTRATIONS

This appendix contains unclassified illustrations of MX air-mobile basing.

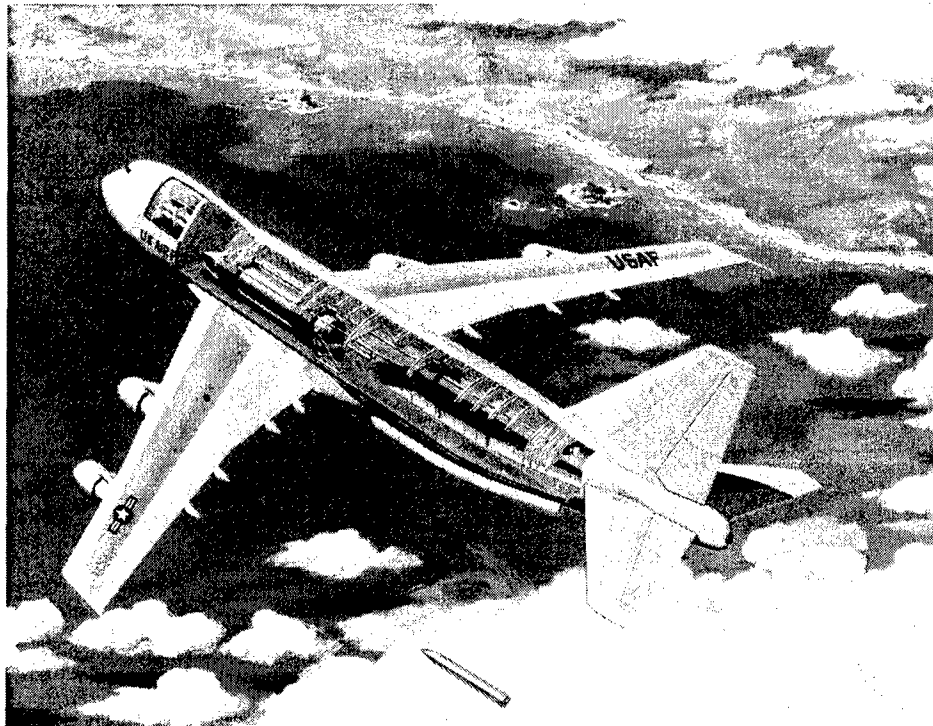

The Boeing MC-747 as conceived for air-mobile duty. The internally-mounted missiles moved on a rail to the bomb bay located aft of the wings. Boeing Vice President Ben T. Plymale pitched this aircraft as part of his 1974 presentation to the AIAA. Unlike the C-5 aerial drops of the Minuteman, this illustration does not show the missile descending via parachute.¹

¹Illustration inserted in Boeing, "Boeing 747 Military Systems Applications Information Packet for B/G A. B. Martin, Deputy for Minuteman, SAMSO, February 7, 1973," unnumbered, unaccessioned, unclassified collections. BMO box B-63, AFHRA.

MX AIR MOBILE ILLUSTRATIONS

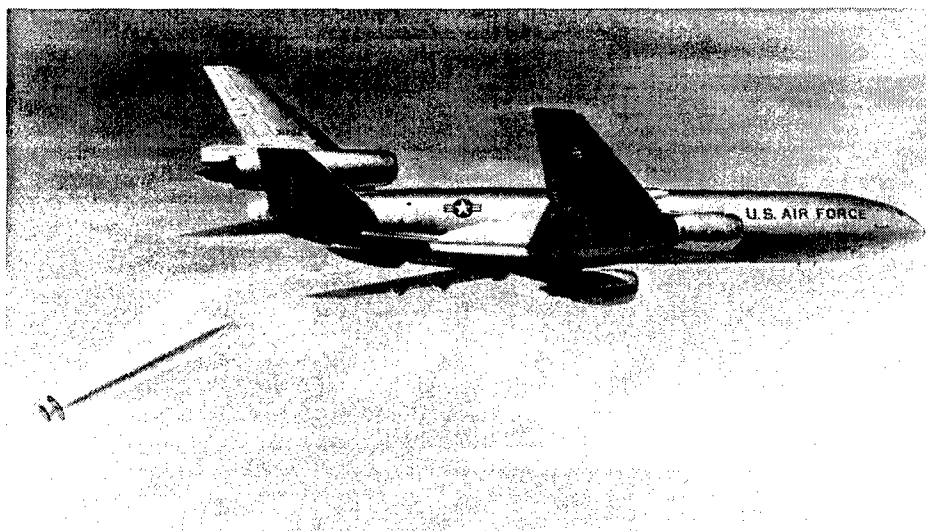
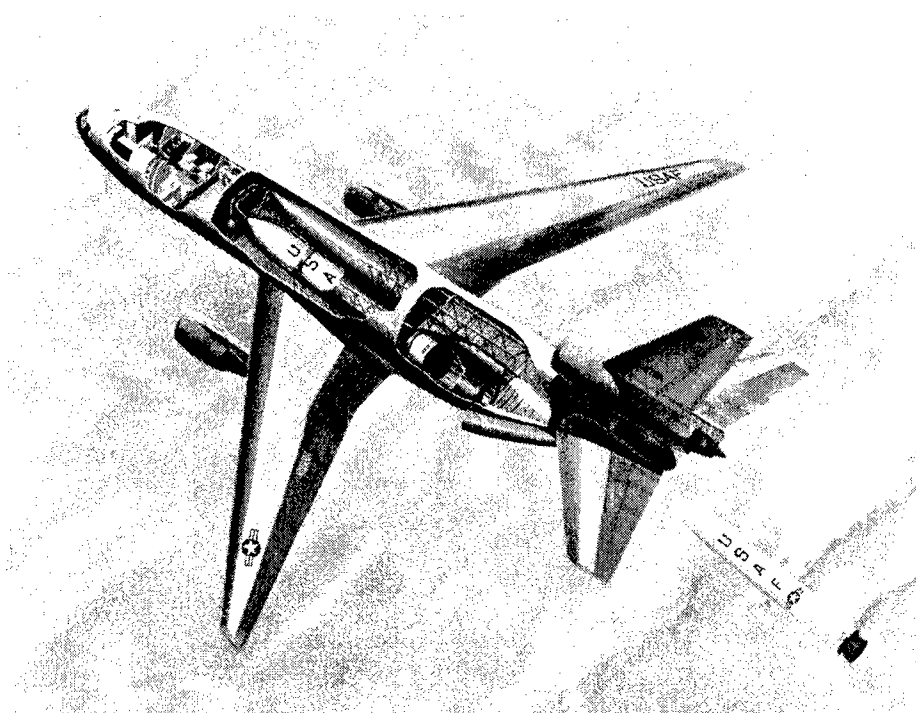

Unwilling to concede potential sales to Boeing, McDonnell Douglas illustrated their DC-10 aircraft carrying two MX missiles. Gravity pulled on the heavier first stage of the missile to ensure an upright position. Note the lack of parachute for the missile.²

²Illustrations inserted in BMO, "DC-10 Configuration Design Study for the Air Mobile Missile System, September 4, 1975," unnumbered, unaccessioned, unclassified collections. BMO box B-63, AFHRA.

MX AIR MOBILE ILLUSTRATIONS

SIZE COMPARISON OF MISSILE CARRIER AIRCRAFT

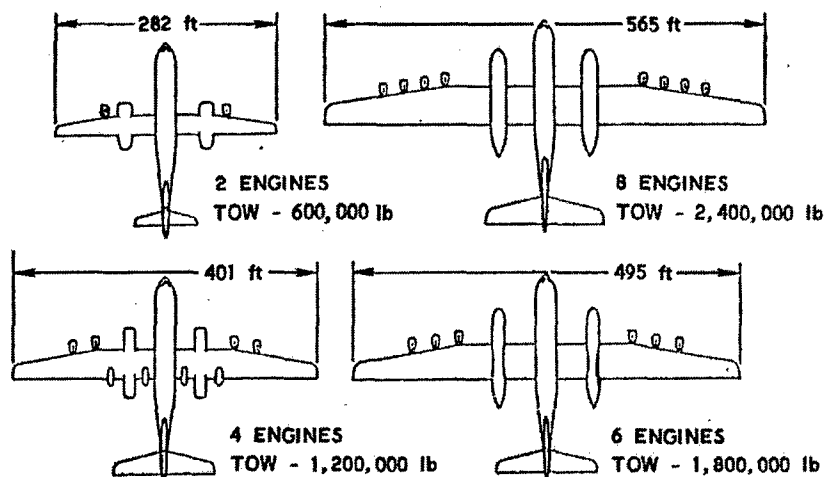

NO. ENGINES	2	4	6	8
T. O. GROSS WEIGHT, 10^6 lb	0.6	1.2	1.8	2.4
REFUELED GROSS WEIGHT, 10^6 lb	0.715	1.5	2.5	3.5
SPAN, ft	282	401	495	568
LENGTH, ft	254	257	262	275
WING AREA, ft^2	6020	12200	18540	24425
WING ASPECT RATIO	13.2	13.2	13.2	13.2

In 1973, the Aerospace Corporation studied a variety of carrier aircraft, including these four. The performance requirements included a payload capacity of four 100,000-pound ICBMs; aircraft velocity of 0.5 to 0.6 mach; minimum altitude of 20,000 feet; endurance of up to thirty days; and power via turbofan, turboprop, chemical, or nuclear fuel. These aircraft were to operate from "marginal airstrips or from water."³

³Aerospace Corporation, "M-X Program Aircraft Design Study," unnumbered slides.

MX AIR MOBILE ILLUSTRATIONS

Big Bird

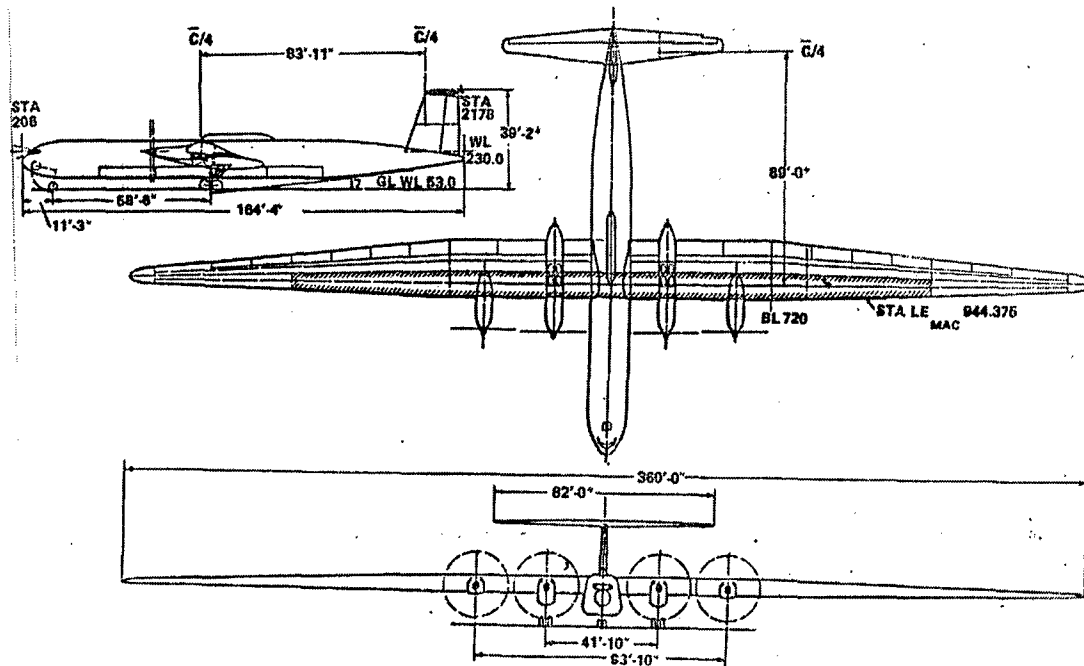

Secretary of Defense Caspar Weinberger favored big bird. In comparison to the Golden Arrow long-endurance aircraft, big bird's wingspan was thirty-five feet longer at 360 feet. The long-endurance aircraft had a longer fuselage, measuring 188 feet to big bird's 164 feet and was fifty-five feet tall to big bird's thirty-nine feet.⁴

⁴Big bird diagram from BMO, "Technical Assessment of Big Bird," unnumbered page. Long-endurance aircraft data from Aerospace, "The Airborne Alert Weapon System," 20. No diagram of the long-endurance aircraft was available.

APPENDIX D

MX POOL BASING AND TRENCH CONCEPTS

TRW studied pool-basing MX. The first illustration shows the transporter in the MX launch pool.

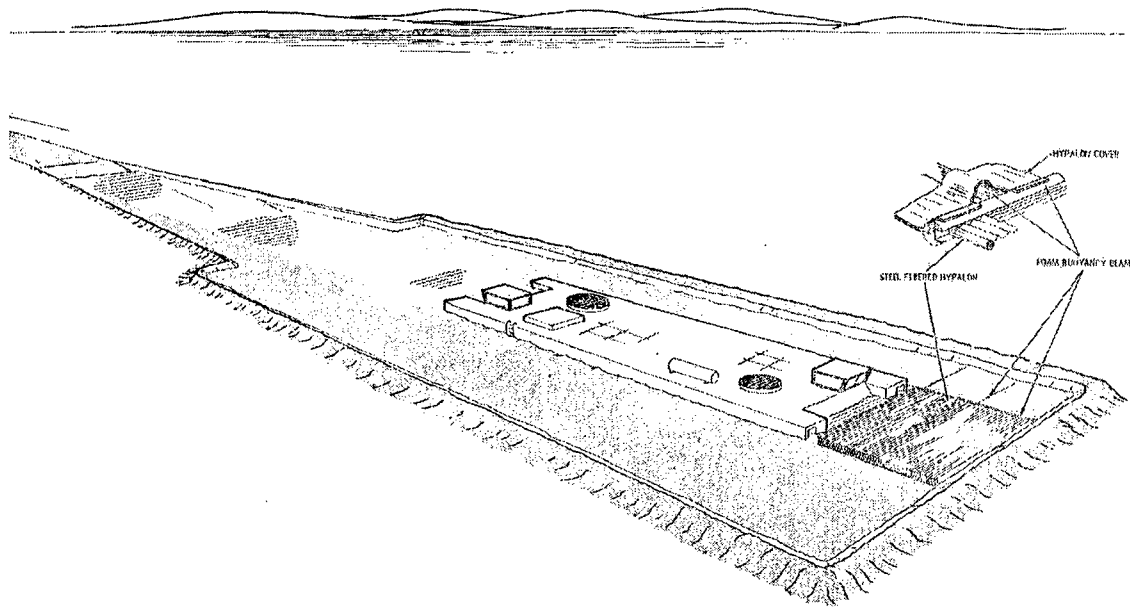

SLOPE SIDED EARTH POOL
POOL BASING

TRW
THE RANDOLPH CORP.
03 FEB 1978

The transporter has driven off the road and floats in the pool. In this position, it released the mobile launch platform and the MX canister, which descended to the pool's bottom. To maintain even buoyancy, the transport vehicle filled its ballast tanks with the displaced pool water.¹

¹TRW, "Earth Pool Weapon System Characterization," unnumbered slide.

MX POOL BASING

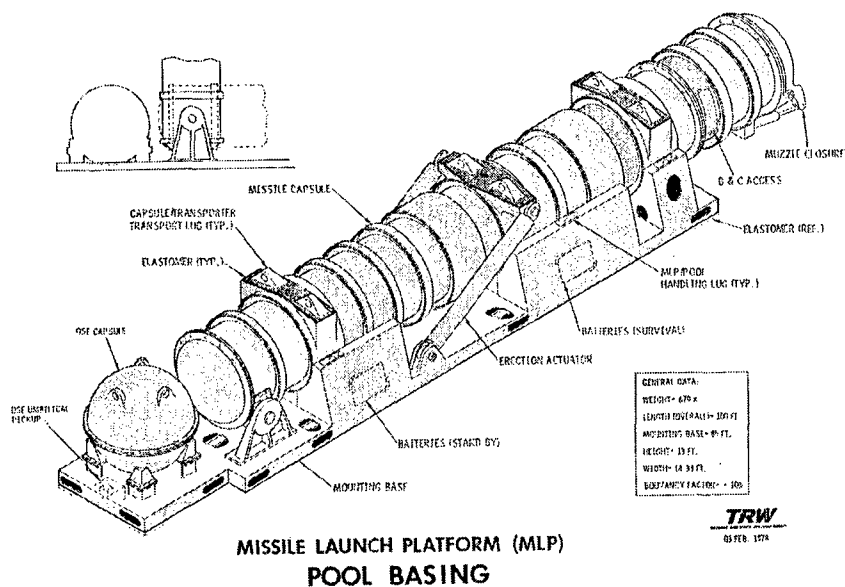

The platform held the canisterized MX missile and all of the necessary launch support equipment.

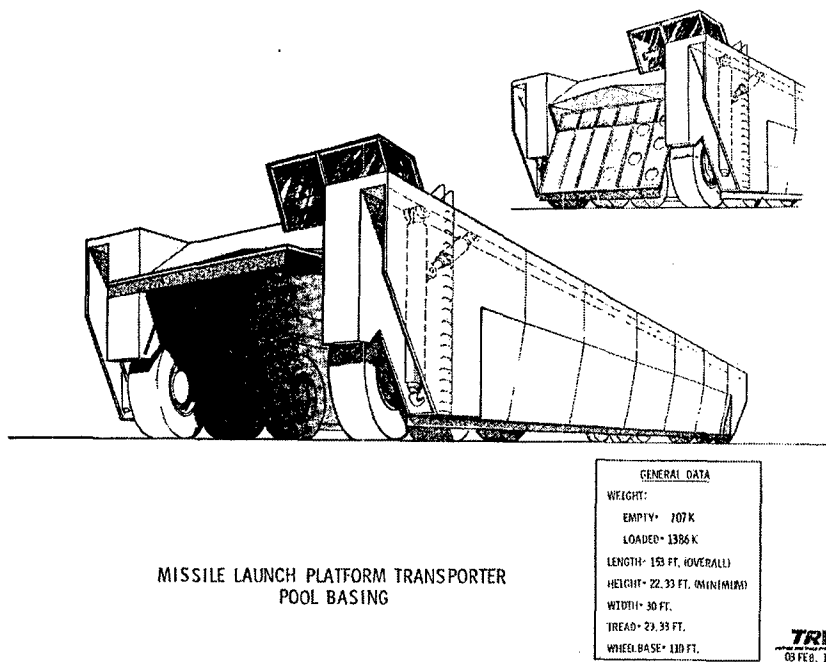

The transporter was a mammoth amphibian vehicle. Powered by four gas turbines of 5,000 horsepower each, its top speed would have been forty mph.²

²Ibid., both illustrations.

MX MPS BURIED TRENCH

The buried trench eliminated the problems of above-ground missiles roaming a large complex. The first illustration shows a buried trench deployment complex. Nine trenches are visible.

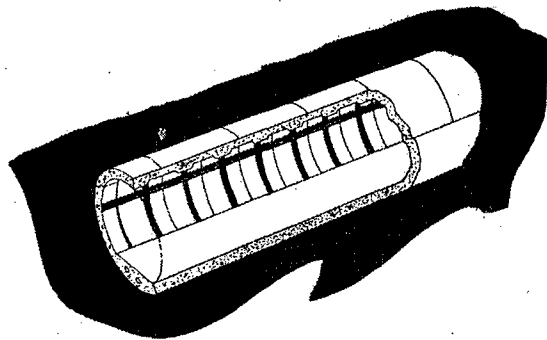
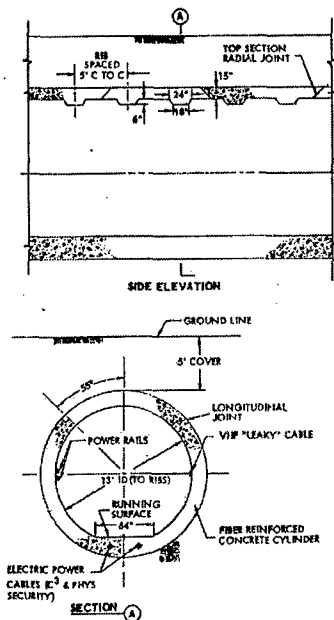
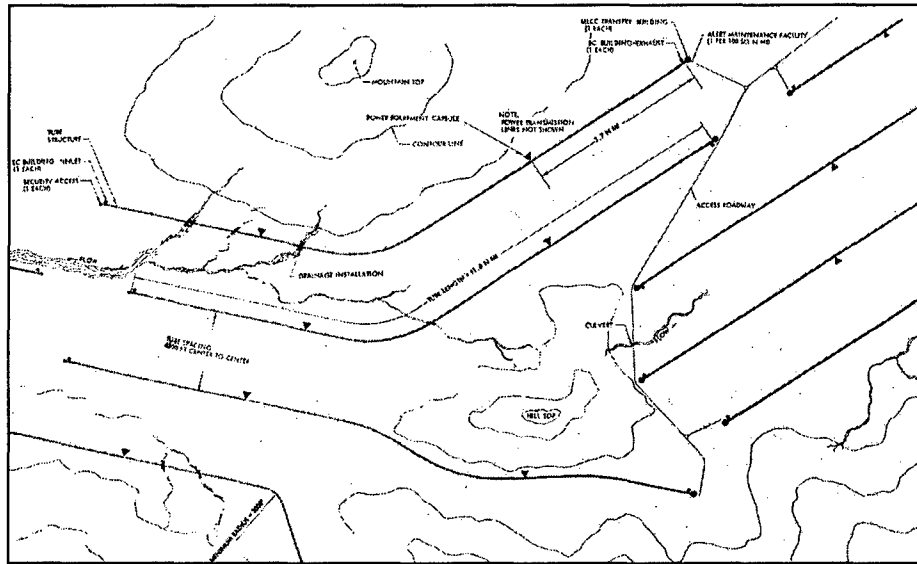

Shown in the second illustration are details of the tube construction. The ribs provided anchor points for the air blast deflector plugs.³

³TRW, "Buried Trench Characterization Summary Report," 20 (deployment area site plan) and 21 (tube structure).

MX MPS BURIED TRENCH

Boeing considered the air blast deflectors to be an engineering challenge. Trench trains had blast deflectors at each end.

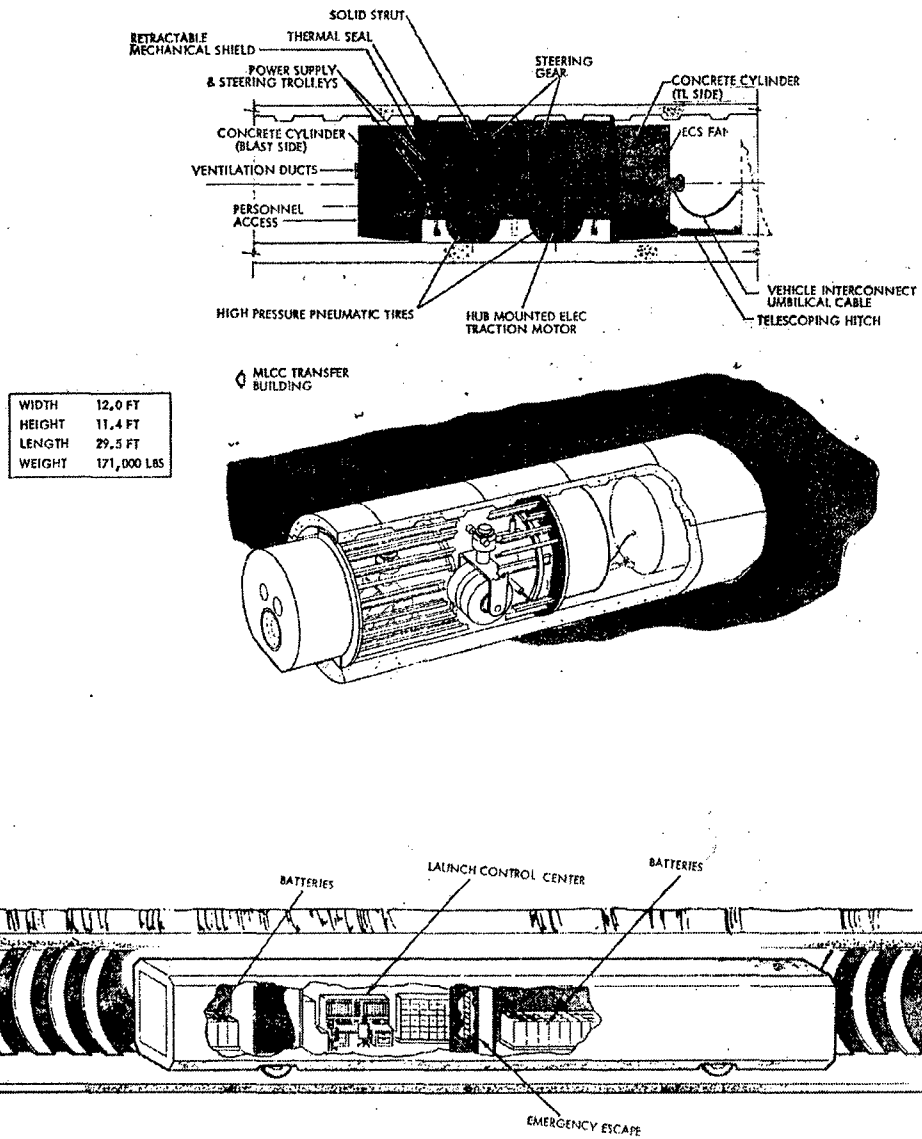

The mobile launch control center provided C3 and life support for a two-person crew. Note the emergency escape hatch.⁴

⁴Ibid., 11 (blast deflector) and 15 (mobile LCC).

MX MPS BURIED TRENCH

The transporter launcher contained the MX missile. The strong back protected the missile as it elevated through the tunnel and covering ground.

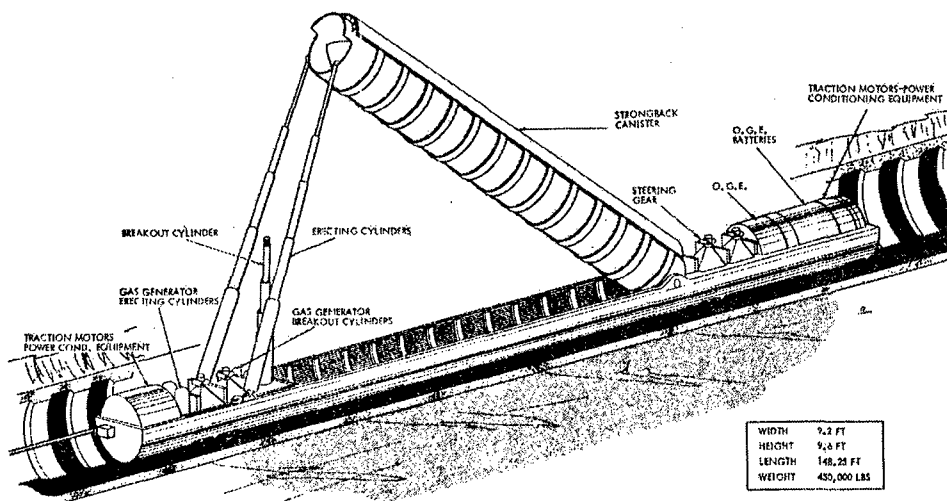

Compared to the size of the vehicle, the five-foot tunnel depth posed little challenge to the strong back assembly.⁵

⁵Top illustration, Ibid., 9. Bottom illustration, BMO, "Binder, Buried Trench Concept, Newspaper Articles," cover illustration, unaccessioned, unclassified collections. BMO box B-21, AFHRA.

APPENDIX E

MX MPS CONCEPTS

The MPS deployment scheme as announced by President Carter in September 1979. SALT verification ports are visible on the shelter and mobile shield vehicle.¹

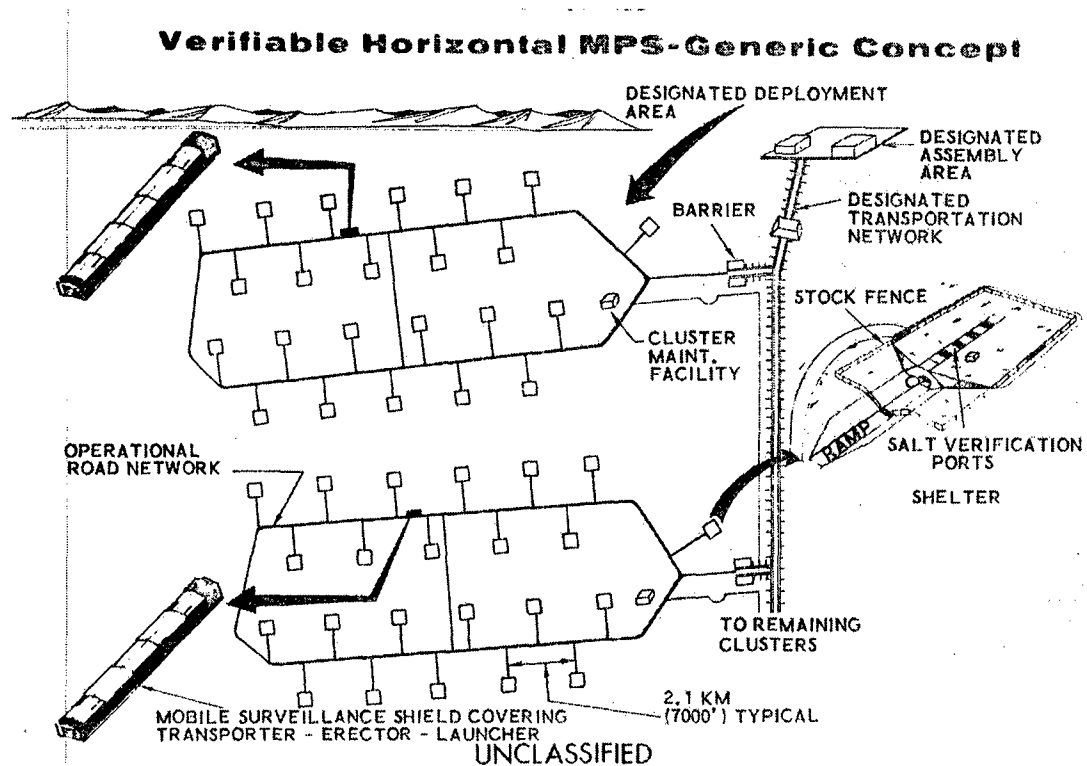

¹SAMSO, "MX Horizontal Shelter Kickoff Meeting, August 31, 1979," 6, unaccessioned, unclassified collections. BMO box B-59, AFHRA.

The launcher vehicle was massive, and to preserve location uncertainty, a surveillance shield (shown here in shadow outline) encased the vehicle.²

UNCLASSIFIED
Verifiable Horizontal Multiple Protective Structure

TRANSPORTER ERECTOR LAUNCHER AND MOBILE SURVEILLANCE SHIELD (MINIMUM COST ROADS)

- FEATURES**
- SHUFFLE & DASH USING TEL MOTIVE POWER
 - SHIELD USED DURING SHUFFLE ONLY
 - BREAKOUT
 - ONE FIXED DOOR
 - MINIMUM COST ROADS (CBR = 15)

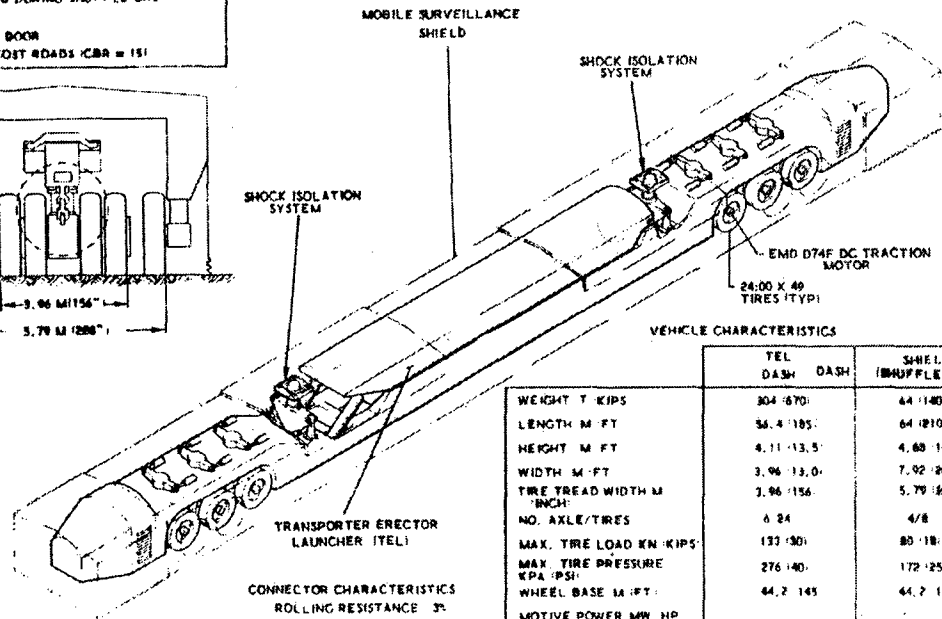
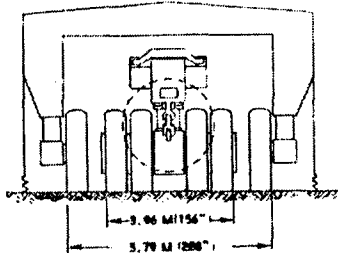

VEHICLE CHARACTERISTICS

	TEL DASH	DASH	SHIELD (SHUFFLE ONLY)
WEIGHT T KIPS	304-670		44-140
LENGTH M-FT	56.4-185		64-210
HEIGHT M-FT	4.11-13.5		4.68-16
WIDTH M-FT	3.96-13.0		7.92-26
TIRE TREAD WIDTH M-INCH	3.96-156		5.70-228
NO. AXLE/TIRES	6-24		4-8
MAX. TIRE LOAD KN-KIPS	133-50		80-18
MAX. TIRE PRESSURE KPA-PSI	276-40		172-25
WHEEL BASE M-FT	44.2-145		44.2-145
MOTIVE POWER MW-HP			
SHUFFLE	0.89-1200		1.19-1600*
DASH	2.42-3250		N/A

*INCLUDES POWER FOR TEL SHUFFLE

CONNECTOR CHARACTERISTICS
 ROLLING RESISTANCE 3%
 GRADE AVE. 2%
 MAX. 5%

UNCLASSIFIED

²Ibid., 12.

MPS LOADING DOCK

With the acceptance of the MPS loading dock, the shelter deployment pattern changed slightly. Connecting the squares between each set of six shelters forms a hexagon, but unlike the previous MPS scheme, there is no shelter contained within the hexagon. The launcher was no longer integral with the transporter vehicle, and the physically separate transporter off-loaded the launcher into a shelter.³

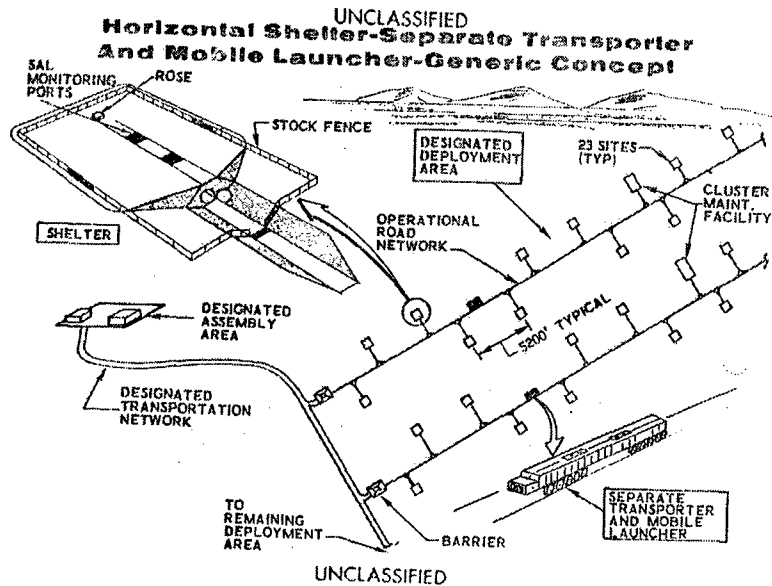

UNCLASSIFIED

Separate Transporter And Mobile Launcher

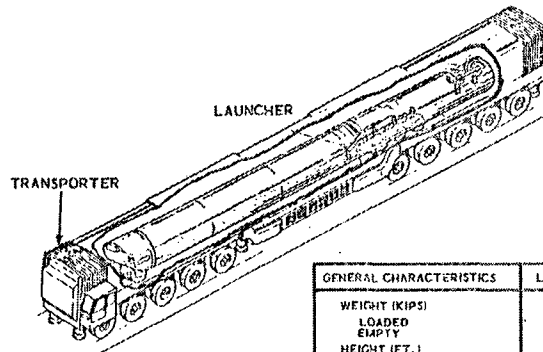

GENERAL CHARACTERISTICS	LAUNCHER	TRANSPORTER
WEIGHT (KIPS)		
LOADED	500	1250
EMPTY	-	750
HEIGHT (FT.)	9.7	26
WIDTH (FT.)	9.7	18
LENGTH (FT.)	155	180
TREAD WIDTH (FT.)	4.7	16
MOTIVE POWER (HP.)		
DASH FROM ROAD TO SHELTER		7000

UNCLASSIFIED

³TRW, "MX Basing Concept Update," 13 (grid) and 17 (separate transporter and mobile launcher).

MPS LOADING DOCK

The separate launcher fit inside the transporter vehicle. For entry into the shelter, it had its own set of rollers.

SEPARATE TRANSPORTER & LAUNCHER

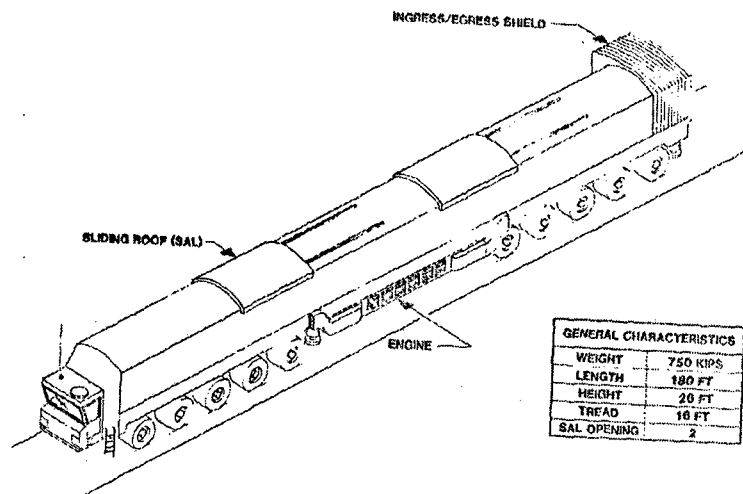
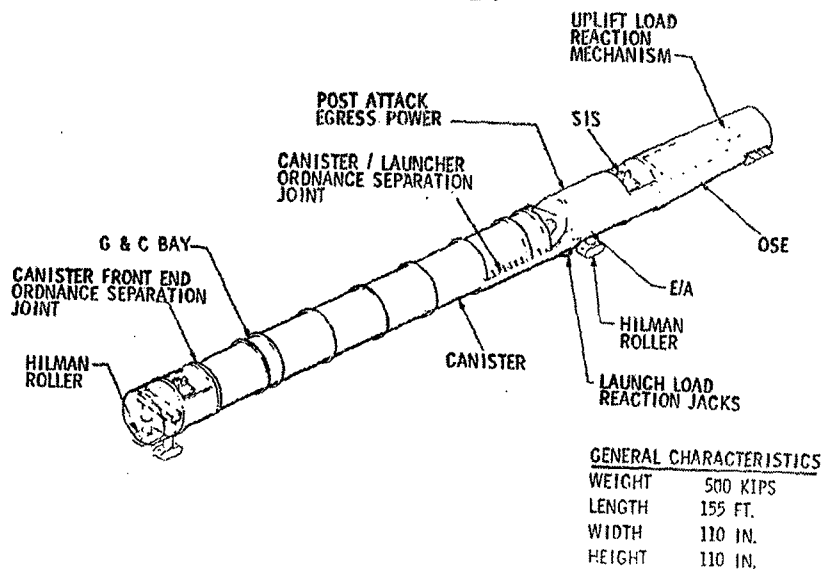

The loading dock transporter had two fewer SALT verification ports than the previous MPS launcher vehicle.⁴

⁴Ibid., unnumbered pages.

MPS LOADING DOCK

The loading dock shelters were smaller than those announced in 1979, and as with the separate transporter, they also had two fewer SALT monitoring ports.

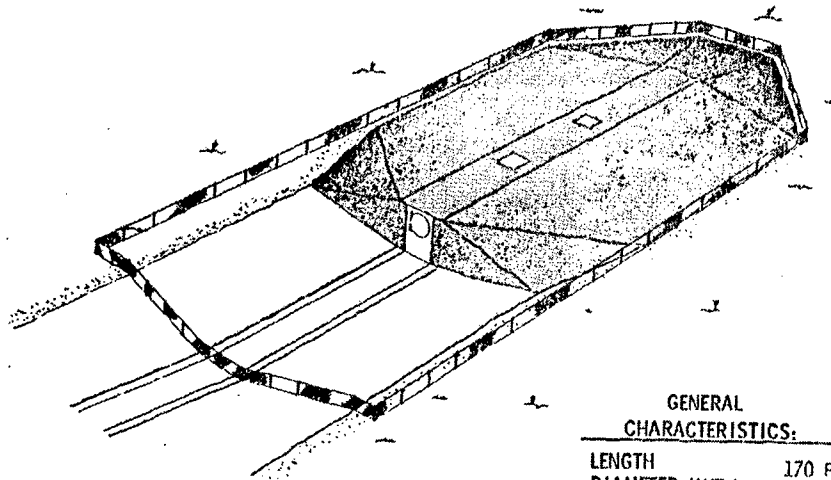

GENERAL CHARACTERISTICS:	
LENGTH	170 FT
DIAMETER (INT.)	174 IN
WALL THICKNESS	21 IN
DOCK HEIGHT	10 FT
SAL PORTS	2

SEPARATE TRANSPORTER & LAUNCHER HORIZONTAL EGRESS CANTILEVER LAUNCHER LAUNCH SEQUENCE

DOOR UNLATCHES AND
VEHICLE PUSHES DOOR OPEN

DEBRIS



LAUNCHER PARKS & STABILIZING
JACKS ARE ACTIVATED



FORWARD SECTION IS
JETTISONED AND CANISTER
IS ERECTED. MISSILE
IS LAUNCHED.

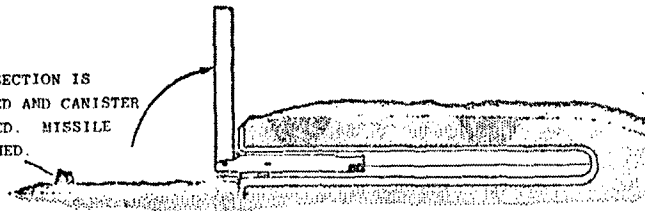

The launcher egressed and elevated the missile by use of a cantilever.⁵

⁵Ibid.