

ERDC TR-03-2

Engineer Research and Development  
Center

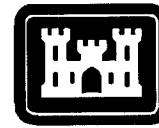

US Army Corps  
of Engineers®

*Strategic Environmental Research and Development Program*

## **Distribution and Fate of Energetics on DoD Test and Training Ranges: Interim Report 3**

Judith C. Pennington, Thomas F. Jenkins, Guy Ampleman,  
Sonia Thiboutot, James M. Brannon, Jeff Lewis, John E.  
DeLaney, Jay Clausen, Alan D. Hewitt, Michael A.  
Hollander, Charolett A. Hayes, Jeffrey A. Stark, André  
Marois, Sylvie Brochu, Hien Q. Dinh, Dennis Lambert,  
Annie Gagnon, Melanie Bouchard, Richard Martel, Patrick  
Brousseau, Nancy M. Perron, René Lefebvre, William  
Davis, Thomas A. Ranney, Catherine Gauthier, Susan  
Taylor, and Jean-Marc Ballard

September 2003

20031031 087

## **Distribution and Fate of Energetics on DoD Test and Training Ranges: Interim Report 3**

Judith C. Pennington, James M. Brannon

*Environmental Laboratory  
U.S. Army Engineer Research  
and Development Center  
3909 Halls Ferry Road  
Vicksburg, MS 39180-6199*

Thomas F. Jenkins, Alan D. Hewitt, Jeffrey A.  
Stark, Dennis Lambert, Nancy M. Perron,  
Susan Taylor

*Cold Regions Research and Engineering  
Laboratory  
U.S. Army Engineer Research  
and Development Center  
72 Lyme Road  
Hanover, NH 03755-1290*

Guy Ampleman, Sonia Thiboutot, Jeff Lewis,  
André Marois, Patrick Brousseau, Annie  
Gagnon, Melanie Bouchard

*Defence Research and Development  
Canada-Valcartier  
2459 Pie XI Blvd. North  
Val Bélair, Québec G3J 1X5*

Richard Martel, René Lefebvre,  
Jean-Marc Ballard, Catherine Gauthier  
*Institut National de la Recherche Scientifique  
880 Chemin Ste-Foy  
Bureau 840 CP 7500, St-Foy, ZC  
Ste-Foy, Quebec G1V 4C7*

Sylvie Brochu

*BCR Polysyntech, Inc.  
1524 des Impératrices  
Val-Bélair, Quebec G3J 1R7*

Jay Clausen

*AMEC Earth and Environmental  
110 Littleton Road, Suite 1B  
Westford, MA 01886*

John E. DeLaney, Michael A. Hollander,  
Hien Q. Dinh, William Davis

*U.S. Naval Explosives Ordnance Disposal  
Technical Division  
2008 Stump Neck Road  
Indian Head, MD 20640-5070*

Thomas A. Ranney

*Science and Technology Corporation  
Hanover, NH 03755*

Charolett A. Hayes

*DynTel  
3530 Manor Dr., Suite 4  
Vicksburg, MS 39180*

Interim report

Approved for public release; distribution is unlimited

**ABSTRACT:** Sustainment of training to maintain the readiness of our armed forces requires stewardship of human health and the environment. The objective of this project, initiated in FY00 and planned for completion in FY05, was to determine the potential for environmental contamination from residues of energetic materials on ranges. This report describes accomplishments for FY02. A U.S. and a Canadian site were characterized for explosives residues resulting from live-fire soldier training: Fort Bliss, New Mexico, and Canadian Forces Base (CFB), Shilo, Manitoba. Results are also reported on tests to determine residues associated with open detonations and low-order detonations and tests to define environmental fate and transport process descriptors.

Results of intensive sampling at Fort Bliss indicated that judgmental sampling targeting low-order residues and firing points is superior to grid sampling for identifying potential point sources of contamination over the typically large training range areas. Furthermore, composite sampling offers the best opportunity of capturing a realistic concentration under the conditions of extreme heterogeneity. Results of open detonations tests confirmed that the use of C4 generates significant explosives residuals. In low-order detonation tests, controlling the percent energy yield of artillery projectiles proved difficult. Adjustments in the variables from these results will improve control of future detonation tests. At CFB Shilo, energetic materials found in soils were associated with targets, and propellants were associated with firing points. The Shilo ranges exhibited relatively low levels of contamination not requiring immediate corrective action. Results of soil partitioning tests demonstrated that pentaerythritol tetranitrate (PETN) and tetryl are degraded in surface and aquifer soils. While adsorption is relatively limited and will not impede transport, degradation may be sufficient to reduce transport of these explosives. Results illustrate the importance of soil properties in determining the transport potential for explosives.

Study results provide data for estimation of firing range source terms, protocols for contaminant characterization, descriptions of residues from low-order detonations and from various unexploded ordnance (UXO) demolition procedures, and fate and transport process descriptors for energetic residues. These data support environmental compliance and training range sustainment.

**DISCLAIMER:** The contents of this report are not to be used for advertising, publication, or promotional purposes. Citation of trade names does not constitute an official endorsement or approval of the use of such commercial products. All product names and trademarks cited are the property of their respective owners. The findings of this report are not to be construed as an official Department of the Army position unless so designated by other authorized documents.

# Contents

---

Preface .....	xvi
Abbreviations .....	xx
Conversion Factors, Non-SI to SI Units of Measurement.....	xxiv
1—Introduction .....	1-1
Background.....	1-1
Regulatory Precedent.....	1-1
MMR Update .....	1-2
Related On-Going and Leveraged Studies.....	1-5
Range characterization .....	1-5
Fate and transport studies .....	1-8
Low-order detonations .....	1-9
Scope of Project CP1155 .....	1-9
Objectives .....	1-10
Summary of Previous Year (FY 01) Results .....	1-10
FY02 Execution .....	1-11
References.....	1-12
Bibliography for Camp Edwards .....	1-13
Bibliography of CP1155 Publications .....	1-19
Referred Journal Articles.....	1-19
Government Documents.....	1-19
Conference Presentations .....	1-20
2—Site Characterization Research at Dona Ana Range, Fort Bliss, New Mexico .....	2-1
Introduction.....	2-1
Background .....	2-1
Dona Ana Range, Fort Bliss, New Mexico .....	2-2
Objectives.....	2-3
Materials and Methods.....	2-4
Stratified random sampling .....	2-4
Judgmental sampling.....	2-5
Sample collection and processing .....	2-14
Onsite screening using EXPRAY kit .....	2-18
Results.....	2-18
Stratified random sampling .....	2-18
Judgmental sampling.....	2-21
Discussion and Conclusions .....	2-39

References.....	2-40
3—Evaluation of the Impacts of Live-Fire Training at Canadian Forces Base Shilo (Phase II) .....	3-1
Abstract.....	3-1
Executive Summary .....	3-1
Acknowledgements.....	3-2
Introduction.....	3-3
Range History/Description .....	3-5
Experimental.....	3-9
Contractors involved .....	3-9
Parameters monitored and analytical methods .....	3-10
Sample handling and treatment .....	3-11
Field investigation .....	3-12
QA/QC .....	3-14
Safety and emergency plan.....	3-15
Sampling strategy .....	3-15
Hydrogeological Survey .....	3-28
Safety proofing.....	3-28
Borehole drilling .....	3-28
Equipment decontamination.....	3-33
Monitoring wells installation.....	3-34
Testing of the monitoring wells.....	3-36
Land survey .....	3-38
Water level measurements and water table map.....	3-39
Hydraulic head map and groundwater direction and velocity .....	3-40
Recharge evaluation .....	3-41
Groundwater sampling .....	3-41
Surface water sampling .....	3-49
Water supply at CFB Shilo and aquifer modeling.....	3-50
Water Analyses, Results, and Discussion .....	3-50
Regional context.....	3-50
Hydraulic properties of the aquifer .....	3-52
Geochemical results .....	3-52
Soils and Biomass Analyses .....	3-71
Global results from Phase I .....	3-71
General approach for the results analysis.....	3-71
Energetic materials .....	3-95
Metals .....	3-106
Thorium.....	3-106
Results and Discussion .....	3-109
Rifle ranges .....	3-109
Hand grenade range.....	3-111
Anti-tank range.....	3-114
Battleruns .....	3-114
Aachen Battlerun .....	3-114
Berlin Battlerun.....	3-116
Cologne Battlerun .....	3-116
Deilinghofen Battlerun .....	3-119
Essen Battlerun .....	3-121
Klein Essen .....	3-123

Antenna Service Area .....	3-124
Conclusions and Recommendations .....	3-126
Conclusions .....	3-126
Recommendations .....	3-130
References.....	3-131
Appendix A: CFB/ASU Shilo Ammo Expenditure Record.....	3-134
Appendix B: Defence Construction Canada — Report of Activity.....	3-135
Introduction .....	3-135
Background .....	3-135
Work Program .....	3-135
DCC Field Team .....	3-136
Procedures .....	3-136
Results .....	3-137
Appendix C: INRS: Borehole and Grain Size Analyses Logs.....	3-142
Appendix D: ppb à Bq/l Conversion Calculations.....	3-214
4—Open Detonation of Military Munitions on Snow: An Investigation of Energetic Material Residues Produced .....	4-1
Abstract.....	4-1
Executive Summary .....	4-2
Acknowledgements.....	4-3
Introduction.....	4-3
Theory .....	4-4
Experimental.....	4-6
Samples .....	4-6
Site Setup.....	4-7
Detonation procedure and munitions preparation .....	4-9
Normal functioning configuration .....	4-9
Unexploded ordnance configuration .....	4-10
Sampling.....	4-11
Evaluation of explosive residue concentrations .....	4-12
Meteorology .....	4-14
Pressure Wave Measurement .....	4-14
Results and Discussion .....	4-15
Conclusion .....	4-22
References.....	4-23
Appendix A: Detonation Residue Quantities.....	4-25
Appendix B: Calculations .....	4-27
Step 1: Calculate area covered by soot.....	4-27
Step 2: Subtract amount found in blanks.....	4-28
Step 3: Calculate amount of explosive residue in a snow sample .....	4-28
Step 4: Calculate the concentration per meter squared of a sample ....	4-29
Step 5: Calculate total mg released per detonation .....	4-29
Step 6: Calculate explosive content of munitions .....	4-30
Step 7: Calculate percent explosive remaining after detonation .....	4-30
Appendix C: Meteorological Data .....	4-31
Appendix D: Selected Pressure Wave Graphs .....	4-33
5—Controlled Low-Order Detonations.....	5-1
Introduction.....	5-1
Background .....	5-1

Objectives.....	5-2
Materials and Methods.....	5-2
Physical test system.....	5-2
Explosives test system.....	5-3
Instrumentation.....	5-6
Detonations.....	5-7
Residue retrieval.....	5-7
Energy baseline .....	5-7
Yield calculations .....	5-8
Test protocols .....	5-8
Assumptions .....	5-9
Results and Discussion .....	5-10
81-mm mortars .....	5-10
155-mm projectiles.....	5-15
Achievement of intended yields .....	5-20
Residues .....	5-21
Conclusions.....	5-22
References.....	5-22
Appendix A: Diagrams of Table and Base .....	5-23
Appendix B: Ordnance Descriptions .....	5-25
Appendix C: Instrumentation Specifications .....	5-27
6—Fate and Transport Parameters .....	6-1
Introduction.....	6-1
Background .....	6-1
Objectives.....	6-2
Materials and Methods.....	6-2
Transformation kinetics of PETN and tetryl .....	6-2
Adsorption Partitioning of PETN and tetryl.....	6-3
Transformation kinetics of Yakima and Guernsey soils .....	6-3
Desorption partitioning of Yakima soils .....	6-3
Results and Discussion .....	6-4
Transformation kinetics and partitioning of PETN and tetryl.....	6-4
Transformation kinetics and partitioning .....	6-4
Summary and Conclusions .....	6-9
References.....	6-9
7—Summary and Conclusions .....	7-1
Site Characterizations .....	7-1
Open Detonations .....	7-2
Low-Order Detonations .....	7-3
Fate and Transport Parameters.....	7-3
Future Directions .....	7-3

SF 298

## List of Figures

---

Figure 1-1.	Development of red coloration in a fibrous particle of nitrocellulose when treated with a reagent that reacts with 2,4DNT.....	1-7
Figure 2-1.	Map of Dona Ana Range Complex, Fort Bliss, NM .....	2-3
Figure 2-2.	Diagram of CRREL, CHPPM, and AEC sampling strategies for stratified random sampling of minigrids at dona Ana Range, Fort Bliss, NM .....	2-5
Figure 2-3.	Diagram for samples collected near a heavily damaged tank target at Dona Ana Range, Fort Bliss, NM.....	2-7
Figure 2-4.	Diagram for samples collected for a 10- × 10-m area contaminated with pieces of TNT at dona Ana Range, Fort Bliss, NM.....	2-8
Figure 2-5.	Photograph of pieces of TNT found within 10- × 10-m area sampled at Dona Ana Range, Fort Bliss, NM.....	2-9
Figure 2-6.	Photograph of low-order 155-mm round with chunks of TNT visible .....	2-9
Figure 2-7.	Diagram for samples collected in a ravine down slope from a low-order 155-mm round at the artillery impact area at Dona Ana Range, Fort Bliss, NM.....	2-10
Figure 2-8.	Diagram for samples collected near the firing line at the LAW rocket range, Dona Ana Range, Fort Bliss, NM .....	2-12
Figure 2-9.	Diagram for samples collected near a low-order 90-mm recoilless rifle round at dona Ana Range, Fort Bliss, NM .....	2-13
Figure 2-10.	Photograph of low-order 2.75-in. rocket warhead, Dona Ana Range, Fort Bliss, NM.....	2-14
Figure 2-11.	Photograph of manual soil grinder and sieves tested at Fort Bliss, NM.....	2-18
Figure 2-12.	RDX concentrations in surface composite samples near a heavily damaged tank target at Dona Ana Range, Fort Bliss, NM .....	2-23
Figure 2-13.	Photo of two low-order recoilless rifle rounds at Dona Ana Range, Fort Bliss, NM.....	2-24
Figure 2-14.	TNT concentrations in soil for various sampling strategies at 10- × 10-m area contaminated with pieces of TNT at Dona Ana Range, Fort Bliss, NM.....	2-26



Figure 2-15.	TNT concentrations in soil for various sampling strategies at a second 10- × 10-m area contaminated with pieces of TNT at Dona Ana Range, Fort Bliss, NM .....	2-29
Figure 2-16.	NG concentrations for samples collected at the LAW rocket range, Dona Ana Range, Fort Bliss, NM.....	2-32
Figure 2-17.	TNT concentrations for surface soil samples collected in a ravine downslope from a low-order 155-mm round at the artillery impact area at Dona Ana Range, Fort Bliss, NM .....	2-36
Figure 2-18.	RDX concentrations for surface soil samples collected near a low-order 90-mm recoilless rifle round at Dona Ana Range, Fort Bliss, NM.....	2-37
Figure 3-1.	Epinette Creek River .....	3-8
Figure 3-2.	Assiniboine River.....	3-8
Figure 3-3.	Irrigation well in farmland near CFB Shilo.....	3-9
Figure 3-4.	Another irrigation well in farmland near CFB Shilo.....	3-9
Figure 3-5.	Preparation for proofing of well location.....	3-13
Figure 3-6.	Well location proofing using EM-61 .....	3-13
Figure 3-7.	Background soil samples on Road 5 .....	3-16
Figure 3-8.	Background soil sample in grazing area northeast of base.....	3-16
Figure 3-9.	Schematic view of the linear soil sampling pattern.....	3-17
Figure 3-10.	Typical CFB Shilo topography where linear sampling was applied.....	3-17
Figure 3-11.	Circular sampling around targets .....	3-18
Figure 3-12.	Sampling of soils in Essen target area using circular approach .....	3-18
Figure 3-13.	Milan missile debris in Essen.....	3-25
Figure 3-14.	Grenade Range sampling illustration .....	3-26
Figure 3-15.	Grenade Range Shilo.....	3-26
Figure 3-16.	Rifle Range sampling illustration.....	3-27
Figure 3-17.	Rifle Range Shilo .....	3-27
Figure 3-18.	Decontamination of drilling equipment .....	3-33
Figure 3-19.	Pumping of well equipped with flush-mount protective casing.....	3-34

Figure 3-20.	Development of wells using mechanical Waterra pump .....	3-35
Figure 3-21.	Device for injecting compressed air into well.....	3-36
Figure 3-22.	GPS location system for well land surveying .....	3-39
Figure 3-23.	Hydraulic head measurements using GEOFLO 40 .....	3-40
Figure 3-24.	Double-needle device for sampling VOC's .....	3-42
Figure 3-25.	Anti-tank Range Shilo.....	3-114
Figure 3-26.	Unexploded ordnance CFB Shilo.....	3-117
Figure 3-27.	UXO, CFB Shilo .....	3-117
Figure 3-28.	Another UXO, CFB Shilo .....	3-118
Figure 3-29.	Milan Missile Target in Essen, Shilo .....	3-122
Figure 4-1.	Warrant Officer Boucher weighing C4 .....	4-7
Figure 4-2.	Site setup .....	4-8
Figure 4-3.	Front-end loader clearing the range after a trial .....	4-9
Figure 4-4.	81-mm mortar round in UXO configuration .....	4-10
Figure 4-5.	Snow collection.....	4-11
Figure 4-6.	Bagged snow sample.....	4-12
Figure 4-7.	Soot plume of 60-mm mortar .....	4-13
Figure 4-8.	Measuring the plume.....	4-14
Figure 4-9.	Pressure sensor 10 m from detonation site.....	4-15
Figure 4-10.	PMA-2 landmine schematic .....	4-20
Figure 4-11.	Detonation wave propagation in surrogate vs. real PMA-2.....	4-21
Figure 5-1.	Setup of the system with witness plates, tarp, and pressure gauges .....	5-3
Figure 5-2.	Assembly drawing of the MCD tool with material callouts .....	5-4
Figure 5-3.	Diagram defining standoff distance as noted in Table 5-1 .....	5-4
Figure 5-4.	Test 1 .....	5-10
	a. Preshot setup for high-order detonation	
	b. Postdetonation observation – debris is charred wood	
Figure 5-5.	Test 2.....	5-11
	a. Predetonation setup against 81-mm mortar	
	b. Large piece of casing found after detonation	

Figure 5-6.	Test 3.....	5-11
	a. Predetonation setup against 81-mm mortar	
	b. Fuze found after detonation	
Figure 5-7.	Test 4.....	5-12
	a. Predetonation setup of 81-mm mortar and MCD tool	
	b. Image of high explosive found on table	
Figure 5-8.	Test 5.....	5-12
	a. Predetonation setup of 81-mm mortar and MCD tool	
	b. Large chunk of casing found after detonation with high explosive on tarp	
Figure 5-9.	Test 6.....	5-13
	a. Predetonation setup of 81-mm mortar with C4 in fuze well	
	b. Damage sustained to table from fragments	
Figure 5-10.	Test 7.....	5-13
	a. Predetonation setup of 81-mm mortar with MCD tool	
	b. Large amount of high explosive found in casing after detonation	
Figure 5-11.	Test 8.....	5-14
	a. Predetonation setup of 81-mm mortar with MCD tool	
	b. Large amount of high explosive found on table after detonation	
Figure 5-12.	Test 9.....	5-14
	a. Predetonation setup of 81-mm mortar with MCD tool	
	b. High explosive found in mortar casing after detonation	
Figure 5-13.	MCD tool by itself for calibration shots.....	5-15
Figure 5-14.	Test 12.....	5-16
	a. Predetonation setup of 155-mm projectile with MCD tool	
	b. High explosive found in projectile casing after detonation	
Figure 5-15.	Tests 13 and 14, 6-oz C4 sphere for calibration.....	5-16
Figure 5-16.	Test 15.....	5-17
	a. Predetonation setup of 155-mm projectile with MCD tool	
	b. High explosive found in projectile casing after detonation	
	c. Chunk of TNT found on tarp after detonation	
Figure 5-17.	Test 16.....	5-18
	a. Predetonation setup of 155-mm projectile with MCD tool	

	b. High explosive with crystalline pattern found in projectile casing after detonation	
Figure 5-18.	Test 17 .....	5-18
	a. Setup of the MCD tool against ½-in. piece of fragment against sandbag	
	b. Spalling noticed on backside of fragment	
Figure 5-19.	Test 18 .....	5-19
	a. Predetonation setup of 155-mm projectile with MCD tool	
	b. High explosive found in projectile casing after detonation	
Figure 5-20.	Test 19 .....	5-19
	a. Predetonation setup of 155-mm projectile with MCD tool	
	b. High explosive found in projectile casing after detonation	
Figure 5-21.	Test 20 .....	5-20
	a. Predetonation setup of 155-mm projectile with C4 in fuze well	
	b. Picture shows cracked weld at the shadow pole	
Figure 5-22.	Test 21 .....	5-20
	a. Predetonation setup of 155-mm projectile with MCD tool	
	b. High explosive jettisoned from base of casing	
Figure A-1.	Assembly drawing of base and table .....	5-23
Figure A-2.	Top and side view of table .....	5-23
Figure A-3.	Top and side view of base .....	5-24
Figure B-1.	Description of 81-mm mortar taken from ORDATA II database .....	5-25
Figure B-2.	Description of 155-mm projectile taken from ORDATA II database .....	5-26
Figure C-1.	NAC-500 camera and VCR.....	5-28
Figure 6-1.	Transformation kinetics of PETN and tetryl in Yokena Clay, Picatinny, Grange Hall, and LAAPD soils .....	6-5
Figure 6-2.	Transformation kinetics of TNT, RDX, and HMX in Yakima soil .....	6-7
Figure 6-3.	Transformation kinetics of TNT, RDX, and HMX in Gurnsey soil .....	6-8

## List of Tables

---

Table 1-1.	Summary of Analytical Samples Taken at Camp Edwards since Last Update .....	1-3
Table 1-2.	Organic Analytes other than Explosives .....	1-4
Table 2-1.	GC Retention Times for Target Analytes for the Primary and Secondary Columns.....	2-16
Table 2-2.	Explosives Detection Limits for Soil .....	2-16
Table 2-3.	RP-HPLC Retention Times of Target Analytes .....	2-17
Table 2-4.	Concentrations of Explosives in Soil Samples Obtained Using Stratified Random Sampling Approach, $\mu\text{g}/\text{kg}^{-1}$ .....	2-19
Table 2-5.	Concentrations of Explosives in Soils Near Tank Targets within the Artillery Impact Range at Dona Ana, $\mu\text{g}/\text{kg}^{-1}$ .....	2-21
Table 2-6.	Concentrations of Explosives in Soils Associated with Chunk TNT Observed on the Soil Surface at Location 1, $\mu\text{g}/\text{kg}^{-1}$ .....	2-25
Table 2-7.	Concentrations of Explosives in Soil Samples Collected in the Mini-Grid Pattern where Chunks of TNT Were Visible at Location 2, $\mu\text{g}/\text{kg}^{-1}$ .....	2-28
Table 2-8.	Concentrations of Explosives in Soils Beneath Chunks of TNT from Various Depths, $\mu\text{g}/\text{kg}^{-1}$ .....	2-30
Table 2-9.	Concentrations of NG in Soils Relative to the Firing Point on an Antitank Range, $\mu\text{g}/\text{kg}^{-1}$ .....	2-31
Table 2-10.	Concentrations of Explosives in Soils Near Low-Order Detonations, $\mu\text{g}/\text{kg}^{-1}$ .....	2-33
Table 2-11.	Concentrations of Explosives in Soils Downslope from a Low-Order 155-mm Artillery Round Found Within a Ravine, $\mu\text{g}/\text{kg}^{-1}$ .....	2-35
Table 2-12.	Explosives Concentrations in Samples Collected Near Low-Order Detonations, $\mu\text{g}/\text{kg}^{-1}$ .....	2-37
Table 2-13.	Concentrations of Explosives near Craters, $\mu\text{g}/\text{kg}^{-1}$ .....	2-38
Table 3-1.	GPS Locations of Soils and Biomass .....	3-20
Table 3-2.	Well Locations and Hydraulic Information.....	3-29
Table 3-3.	Summary of Slug Test Analysis at CFB Shilo .....	3-37

Table 3-4.	Location of Observation and Supply Wells and Springs Used for Groundwater Sampling and Sampling Schedule .....	3-43
Table 3-5.	Locations of Surface Water Sampling Points and Sampling Schedule .....	3-49
Table 3-6.	Physicochemical Parameters Measured in Groundwater with YSI and ORP Probes .....	3-53
Table 3-7.	Water Quality Threshold Criteria.....	3-56
Table 3-8.	Metals Concentrations Detected over CCME Guidelines for Drinking Water Quality in Groundwater Samples .....	3-57
Table 3-9.	Volatile Organic Compounds Detected in Groundwater Samples .....	3-62
Table 3-10.	Thorium Concentrations Measured in Groundwater.....	3-63
Table 3-11.	Metals Concentrations Detected Over CCME Guidelines in Surface Water.....	3-68
Table 3-12.	Thorium Concentrations Measured in Surface Water .....	3-70
Table 3-13a.	Metals Concentrations in Soils (Al to Co) .....	3-72
Table 3-13b.	Metals Concentrations in Soils (Cu to Ag) .....	3-76
Table 3-13c.	Metals Concentrations in Soils (Na to Zn).....	3-80
Table 3-13d.	Soils Characteristics .....	3-84
Table 3-14a.	Metals Concentrations in Biomass Samples (Al to Co) .....	3-84
Table 3-14b.	Metals concentrations in Biomass Samples (Cu to K) .....	3-86
Table 3-14c.	Metals concentrations in Biomass Samples (Se to Zn) .....	3-88
Table 3-15.	Parameters Exceeding the BGL or the AWQG for Shilo GW – Per Range or Area.....	3-90
Table 3-16.	Parameters Exceeding the BGL or the WQGL for Groundwater, the BGL or the SQGL for Soils, and the BGL for Biomass at Aachen Battlerun.....	3-91
Table 3-17.	Parameters Exceeding the BGL or the WQGL for Groundwater, the BGL or the SQGL for Soils, and the BGL for Biomass at Berlin Battlerun.....	3-91
Table 3-18.	Parameters Exceeding the BGL or the WQGL for Groundwater, the BGL or the SQGL for Soils, and the BGL for Biomass at cologne Battlerun .....	3-92
Table 3-19.	Parameters Exceeding the BGL or the WQGL for Groundwater, the BGL or the SQGL for Soils, and the BGL for Biomass at Deilinghofen Battlerun.....	3-93

Table 3-20.	Parameters Exceeding the BGL or the WQGL for Groundwater, the BGL or the SQGL for Soils, and the BGL for Biomass at Essen Battlerun.....	3-93
Table 3-21.	Parameters Exceeding the BGL or the WQGL for Groundwater, and the BGL or the SQGL for Soils for the Rifle Range.....	3-94
Table 3-22.	Parameters Exceeding the BGL or the WQGL for Groundwater, and the BGL or the SQGL for Soils for the Grenade Range .....	3-95
Table 3-23.	Energetic Material Concentrations in Soils.....	3-96
Table 3-24.	Thorium Concentrations in Soil Samples.....	3-107
Table 3-25.	Thorium Concentrations in Biomass Samples .....	3-108
Table 3-26.	Well Measurement Results at CFB Shilo – November, 2001 .....	3-139
Table 3-27.	Oxidation Reduction Potential Measurements at CFB Shilo – November, 2001.....	3-140
Table 3-28.	Dissolved Oxygen Readings at CFB Shilo – November 2001 .....	3-140
Table 3-29.	pH, Conductivity and Salinity Readings at CFB Shilo – November 2001 .....	3-141
Table 3-30.	Water Level Measurements Recorded at CFB Shilo – November 2001 .....	3-141
Table 4-1.	Estimated Explosive Residue Recovery Values.....	4-17
Table 4-2.	Calculated Residue Concentrations Found in UXO Versus Normally Detonated Trials.....	4-19
Table 5-1.	Summary of Test Setup and Yield Calculations.....	5-5
Table 5-2.	Summary of Recoveries .....	5-9
Table C-1.	PCB Piezotronics Model 137M25 Pressure Transducer .....	5-27
Table C-2.	5-Channel Radiometer.....	5-27
Table C-3.	IR Detector .....	5-27
Table C-4.	TLR Detector.....	5-27
Table C-5.	Data Acquisition System.....	5-27
Table C-6.	NAC-500 Camera and VCR Components.....	5-28
Table 6-1.	Properties of Soils Used in Adsorption and Desorption Testing.....	6-2

Table 6-2. Pseudo First-Order Transformation Rate Coefficients  
and Half-Lives of PETN and Tetryl..... 6-6

Table 6-3. Adsorption Coefficients for PETN and Tetryl in Soils ..... 6-6



# Preface

---

This report was prepared by the U.S. Army Engineer Research and Development Center (ERDC), Environmental Laboratory (EL), Vicksburg, MS, and Cold Regions Research and Engineering Laboratory (CRREL), Hanover, NH, in partnership with the Defence Research and Development Canada - Valcartier (DRDC-Val), Quebec, Canada, the U.S. Naval Explosives Ordnance Disposal Technology Division (NAVEOD), Indian Head, MD, and AMEC Earth and Environmental, Inc. (AMEC), Westford, MA. The research was sponsored by the Strategic Environmental Research and Development Program (SERDP), Arlington, VA, Mr. Bradley P. Smith, Executive Director, and Dr. Jeff Marqusee, Technical Director, under Compliance Project Number CP1155. The principal investigator was Dr. Judith C. Pennington, Research Biologist, Environmental Processes and Engineering Division (EPED), EL, ERDC. Co-principal investigators were Dr. Thomas F. Jenkins, Research Chemist, Environmental Sciences Branch (ESB), CRREL; Dr. James M. Brannon, Geochemist, EPED, EL, ERDC; Drs. Guy Ampleman and Sonia Thiboutot, DRDC-Val; Mr. Hien Dinh, NAVEO, and Mr. Jay Clausen, AMEC.

Chapter 1 was prepared by Drs. Pennington and Jenkins, and Mr. Clausen. Range soil characterization research reported in Chapter 2 was conducted by Dr. Jenkins, Mr. Alan D. Hewitt, Research Physical Scientist, ESB; Mr. Jeffrey A. Stark, Physical Sciences Technician, Civil Engineering Research Branch; Mr. Dennis Lambert, Mechanical Engineering Technician, Engineering Resources Branch; and Ms. Nancy Perron, Physical Sciences Technician, Snow and Ice Branch, ERDC, CRREL; Dr. Pennington and Mr. Thomas A. Ranney, Staff Scientist, Science and Technology Corporation, Lebanon, NH. Characterization of Canadian ranges reported in Chapter 3 was conducted by Drs. Ampleman and Thiboutot; Ms. Annie Gagnon and Melanie Bouchard, Mr. Jeff Lewis, Ph.D. diss. candidate at the Institut de Recherches Scientifiques (INRS), Ste-Foy, Quebec, Canada; Mr. André Marois, Technical Officer; Ms. Catherine Gauthier, M.S. thesis degree candidate at INRS, both also of DRDC-Val; Mr. Ranney, Drs. Jenkins and Pennington; Drs. Richard Martel and René Lefebvre, and Mr. Jean-Marc Ballard, hydrogeologists with INRS. Open detonation tests reported in Chapter 4 were conducted by Mr. Lewis, Drs. Thiboutot and Ampleman, and Mr. Patrick Brousseau, DRDC-Val; Dr. Sylvie Brochu, BCR Polysyntech, Val-Bélair, Quebec; Dr. Pennington and Mr. Ranney. Low-order detonation studies reported in Chapter 5 were conducted by Mr. John E. DeLaney, formerly NAVEO, and currently Benet Laboratories, Watervliet, NY; Messrs. Michael A. Hollander and Dinh, NAVEO; Mr. William Davis, Army Research Laboratory, Adelphi, MD; Dr. Pennington, Dr. Susan Taylor, Research Physical

Scientist, Environmental Sciences Branch, CRREL; and Ms. Charolett A. Hayes, Research Physical Scientist, DynTel, Vicksburg, MS. Research on soil partitioning and explosives dissolution reported in Chapter 6 was conducted by Dr. Brannon, Geochemist, ERDC, EL, and Ms. Hayes.

The authors of Chapter 2 are indebted to Mr. John Buck, U.S. Army Environmental Center (USAEC), and Mr. Barrett Borrey, U.S. Army Center for Health Protection and Preventive Medicine (USACHPPM) for allowing our team to participate in their site characterization study at the Dona Ana Range, Fort Bliss, New Mexico. Mr. Borrey provided contract support for the Explosives Ordnance Disposal (EOD) team, and logistical support at the range. Messrs. Keith Landreth and David Dodge, Fort Bliss, are also acknowledged for providing access to the range, arranging for receipt of supplies, and providing other logistical support at Fort Bliss. Mr. Ken Mioduski (USACHPPM), in particular, contributed by allowing the authors to accompany his sampling team as they traversed various areas of the range, providing opportunities to sample randomly selected grids and areas where anomalies such as low-order detonation debris was observed. The authors also acknowledge the EOD team, Mr. Russell Shattles and Mr. Chris Bausemer, Explosives Ordnance Technologies, Inc., Rumson, NJ, for keeping the team safe while sampling on the Dona Ana Range.

The authors of Chapter 3 are grateful to the Directors, Land Forces Services and SERDP, for their financial support and vision. The authors also wish to thank the Director General of the Environment for support during the first phase of this study. Range control Canadian Forces personnel of Canadian Forces Base (CFB) Shilo are especially thanked for their invaluable help, openness, and support in all these sampling events. More precisely, they would like to thank Mr. Rob Riez for his great help with administrative issues with the contractors and Mr. Garnett Shearer, Environmental Officer, who gave them all the support they needed to accomplish this task. They also wish to thank all personnel of range control at the CFB Shilo who helped them, and more particularly, Captain Rob Bower, Master Warrant Officer Chuck Roeder, and Captain Lonnie Goodfellow. They also want to thank Mr. Hans Mooj and Ms. Lauren Wiltzen from Defence Construction Canada (DCC) who manage the support staff and all the analytical supplies and analyses. They finally would also take the opportunity to thank Dr. Conrad Gregoire from Geological Survey of Canada for providing thorium analyses.

The authors of Chapter 4 acknowledge the efforts of Ms. Gagnon and Bouchard, DRDC-Val, for their tireless efforts in sample extraction and analysis. As well, the staff at the Munitions Experimentation and Testing Center (METC) in Val Belair, Quebec, must also be acknowledged for the execution of this experimental trial. In particular, the efforts of Chief Warrant Officer Christian Desrosiers, test safety director, were greatly appreciated. Likewise, Messrs. Pierre Veillette and Gilles Lefebvre, both of whom collected and prepared the meteorological and pressure wave data, are gratefully acknowledged.

The authors of Chapter 5 gratefully acknowledge the assistance of Messrs. Tom Douglas and Richard Gold, NAVEOD, for support of the low-order detonation effort. The instrumentation expertise contributed by Mr. Cornelius Reed, Applied Research Associates, Inc., Littleton, CO, is acknowledged. For assistance with recovery of residues from low-order detonations, appreciation

goes to Messrs. David Curran, Todd Burnham, Robert Wojewodzki, and John Flangan, Op-Tech, Edison, NJ.

Analytical chemistry support for research reported in Chapter 6 was provided by the Environmental Chemistry Branch, EPED, EL, Dr. Robert P. Jones, Chief.

This report was reviewed at ERDC, EL, by Drs. Mark Dortch and Jeff Davis. The study was conducted under the direct supervision of Dr. Richard E. Price, Chief, EPED, Dr. Edwin A. Theriot, Director, and Dr. Elizabeth Fleming, Acting Director.

Commander and Executive Director of ERDC was COL James R. Rowan, EN, and Director was Dr. James R. Houston.

This report may be cited as one document or by chapters.

### **Entire report:**

Pennington, J. C., Jenkins, T. F., Ampleman, G., Thiboutot, S., Brannon, J. M., Lewis, J., Delaney, J. E., Clausen, J., Hewitt, A. D., Hollander, M. A., Hayes, C. A., Stark, J. A., Marois, A., Brochu, S., Dinh, H. Q., Lambert, D., Gagnon, A., Bouchard, M., Martel, R., Brousseau, P., Perron, N. M., Lefebvre, R., Davis, W., Ranney, T. A., Gauthier, C., Taylor, S., and Ballard, J. M. (2003). "Distribution and fate of energetics on DoD test and training ranges: Report 3," ERDC TR-03-2, U.S. Army Engineer Research and Development Center, Environmental Laboratory, Vicksburg, MS.

### **Chapter 1:**

Pennington, J. C., Clausen, J., and Jenkins, T. F. (2003). "Introduction," Chapter 1, Distribution and fate of energetics on DoD test and training ranges: Interim Report 3, ERDC TR-03-2, U.S. Army Engineer Research and Development Center, Environmental Laboratory, Vicksburg, MS.

### **Chapter 2:**

Jenkins, T. F., Hewitt, A. D., Stark, J. A., Lambert, D., Perron, N. M., Ranney, T. A., and Pennington, J. C. (2003). "Site characterization research at the Dona Ana Range, Fort Bliss, New Mexico," Chapter 2, Distribution and fate of energetics on DoD test and training ranges: Report 3, ERDC TR-03-2, U.S. Army Engineer Research and Development Center, Environmental Laboratory, Vicksburg, MS.

### **Chapter 3:**

Ampleman, G., Thiboutot, S., Lewis, J., Marois, A., Gagnon, A., Bouchard, M., Martel, R., Lefebvre, R., Gauthier, C., Ballard, J. M., Ranney, T. A., Jenkins, T. F., and Pennington, J. C. (2003). "Evaluation of the impacts of live fire training at CFB Shilo (Phase II)," Chapter 3, Distribution and fate of energetics on DoD test and training ranges:

Report 3, ERDC TR-03-2, U.S. Army Engineer Research and Development Center, Environmental Laboratory, Vicksburg, MS.

**Chapter 4:**

Lewis, J., Thiboutot, S., Ampleman, G., Brochu, S., Brousseau, P., Pennington, J. C., Ranney, T. A. (2003). "Open detonation of military munitions on snow: An investigation of energetic material residues produced," Chapter 4, Distribution and fate of energetics on DoD test and training ranges: Report 3, ERDC TR-03-2, U.S. Army Engineer Research and Development Center, Environmental Laboratory, Vicksburg, MS.

**Chapter 5:**

DeLaney, J. E., Hollander, M., Dinh, H. Q., Davis, W., Pennington, J. C., Taylor, S., and Hayes, C. A. (2003). "Controlled low-order detonations," Chapter 5, Distribution and fate of energetics on DoD test and training ranges: Report 3, ERDC TR-03-2, U.S. Army Engineer Research and Development Center, Environmental Laboratory, Vicksburg, MS.

**Chapter 6:**

Brannon, J. M., and Hayes, C. A. (2003). "Fate and transport parameters," Chapter 6, Distribution and fate of energetics on DoD test and training ranges: Report 3, ERDC TR-03-2, U.S. Army Engineer Research and Development Center, Environmental Laboratory, Vicksburg, MS.

**Chapter 7:**

Pennington, J. C., Jenkins, T. F., Ampleman, G., Thiboutot, S., Brannon, J. M., Lewis, J., Delaney, J. E., Hollander, M., and Clausen, J. (2003). "Summary and Conclusions," Chapter 7, Distribution and fate of energetics on DoD test and training ranges: Report 3, ERDC TR-03-2, U.S. Army Engineer Research and Development Center, Environmental Laboratory, Vicksburg, MS.

# Abbreviations

---

AcN	Acetonitrile
ADNT	Aminodinitrotoluenes
2ADNT	2-amino-4,6-dinitrotoluene
4ADNT	4-amino-2,6-dinitrotoluene
AEC	Army Environmental Center
2A4NT	2-amino-4-nitrotoluene
4A2NT	4-amino-2-nitrotoluene
AQGL	Aquatic Quality Guideline
ASQG	Agricultural Soil Quality Guideline
ASTM	American Society for Testing and Materials
B	Biomass sample
BG	Background sample
BGL	Background Level
Bq	Becquerel
BTEX	Benzene, Toluene, Ethylbenzene, and Xylene
CCME	Canadian Council of Ministers of Environment
CF	Canadian Forces
CFB	Canadian Forces Base
CFTO	Canadian Forces Technical Order
COC	Contaminants of Concern
CG	Camp Guernsey, Wyoming
CHPPM	Center for Health Promotion and Preventive Medicine
CRREL	Cold Regions Research and Engineering Laboratory
DCC	Defence Construction Canada
DGE	Director General Environment, Canadian Department of National Defence

DLFS	Director Land Forces Services, Canadian Department of National Defence
3,5DNA	3,5-dinitroaniline
1,3DNB	1,3-dinitrobenzene
DND	Department of National Defence
DNT	Dinitrotoluene
2,4DNT	2,4-dinitrotoluene
2,6DNT	2,6-dinitrotoluene
DRDC-Val	Defence Research and Development Canada-Valcartier
EBW	Exploding bridgewire
EL	Environmental Laboratory
EOD	Explosive ordnance disposal
EPA	Environmental Protection Agency
ERDC	Engineer Research and Development Center
ETL	Enviro-Test Laboratory
FB	Fort Bliss, New Mexico
FR	Fort Richardson, Alaska
GATES	German Army Training Exchange Shilo
GC-ECD	Gas chromatography-electron capture detection
GPS	Global Positioning System
GW	Groundwater sample
HDPE	High Density Polyethylene
HE	High Explosive
HSV	High-speed video
HMX	Octahydro-1,3,5,7-tetranitro-1,3,5,7-tetrazocine, or High Melting Explosive
ICP/MS	Inductively Coupled Plasma /Mass spectrometer detector
INRS	Institut National de la Recherche Scientifique
IR	Infrared
ISQG	Industrial Soil Quality Guideline
LAW	Light Antitank Weapon
LS	Linear sampling in Battleruns
MAC	Maximum Acceptable Concentration
MCD	Main Charge Disruptor
mm	Millimeter

MMR	Massachusetts Military Reservation
m/y	Meter per year
3NA	3-Nitroaniline
NATO	North Atlantic Treaty Organization
NB	Nitrobenzene
NEW	Net explosive weight
NG	Nitroglycerin
NT	Nitrotoluene
NTU	Nephelometric Turbidity Unit
OB/OD	Open Burning/Open Detonation
OD	Open demolition
PEP	Propellants, explosives, and pyrotechnics
PETN	Pentaerythritol tetranitrate
ppb	Parts per billion
ppm	Parts per million
ppt	Parts per trillion
PVC	Poly Vinyl Chloride
QA/QC	Quality Assurance/ Quality Control
RDX	Hexahydro-1,3,5-trinitro-1,3,5-triazine, or Research Development Explosive
RP-HPLC	Reversed-phase high-performance liquid chromatography
RP-HPLC-UV	Reversed-phase high-performance liquid chromatography ultraviolet detection
RPD	Relative Percent Difference
RSD	Relative Standard Deviation
RSO	Range safety officer
S	Soil sample
SARM	Standard Analytical Reference Materials
SERDP	Strategic Environmental Research Development Program
SQGL	Soil Quality Guideline
SS	Subsurface Soil sample
SW	Surface Water sample
1,3,5TNB	1,3,5-trinitrobenzene
TNB	1,3,5-trinitrobenzene
TNT	2,4,6-trinitrotoluene

TRI	Toxic Release Inventory
TLR	Total light radiation
μS	Microsiemens
USACHPPM	U.S. Army Center for Health Protection and Preventative Medicine
USEPA	U.S. Environmental Protection Agency
UXO	Unexploded ordnance
VOCs	Volatile Organic Compounds
WES	Waterways Experiment Station
WQGL	Water Quality Guideline
YTC	Yakima Training Center, Washington



# Conversion Factors, Non-SI to SI Units of Measurement

---

Multiply	By	To Obtain
acres	4,046.873	square meters
feet	0.3048	meters
inches	2.54	centimeters
ounces (avdp)	28.4	grams
miles (U.S. statute)	1.609347	kilometers
pounds	0.454	kilograms
square miles	2.589998	square kilometers

# 1 Introduction

---

## Background

Testing and training ranges are essential to maintaining the readiness of the Armed Forces of the United States. However, concerns have arisen over potential environmental contamination from residues of energetic materials on impact ranges. The current state of knowledge concerning the nature, extent, and fate of contamination was inadequate to ensure sound management of ranges as sustainable resources. The potential for environmental impacts, including contamination of drinking water supplies, mandates that the Department of Defense (DoD) demonstrate responsible management of these facilities in order to continue testing and training activities.

## Regulatory Precedent

In April of 1997, the U.S. Environmental Protection Agency (USEPA) issued Administrative Order No. 2 to the National Guard Bureau and the Massachusetts National Guard requiring that certain training activities (artillery and mortar firing) cease, pending the completion of environmental investigations at the training ranges and Impact Area. In January 2000, the USEPA, Region I, issued an Administrative Order 3 for Response Action in the matter of "Training Range and Impact Area, Massachusetts Military Reservation" to the National Guard Bureau and the Massachusetts National Guard under authority of Section 1431(a) of the Safe Drinking Water Act, 42U.S.C. § 300i(a) (USEPA 2000). The purpose of the Order was to require the respondents to "undertake Rapid Response Actions and Feasibility Studies, Design and Remedial Actions to abate the threat to public health presented by the contamination from past and present activities and sources at and emanating from the Massachusetts Military Reservation (MMR) Training Range and Impact Area." This is an important precedent for suspension of military training because of environmental contamination of soils and groundwater.

The MMR is a 21,000-acre installation located on Cape Cod, Massachusetts. The Training Ranges and Central Impact Area is approximately 14,000 acres located on the Camp Edwards portion of the installation. The Central Impact Area, approximately 2,200 acres, has artillery and mortar targets and is surrounded by firing ranges, artillery and mortar positions, and training areas (AMEC 2001 (Bibliography for Camp Edwards)). The Cape Cod Aquifer, a sole

source aquifer for western Cape Cod, lies directly beneath the Training Ranges and Central Impact Area. Based on the findings of lead, explosives, explosives-related compounds, pesticides and other organic contaminants in soils, and RDX, TNT, HMX and some organics in groundwater, the USEPA ordered the respondents to conduct a remedial investigation and feasibility studies at several MMR areas including the Central Impact Area (USEPA 2000). The order also required rapid response actions for contaminated soils at several gun positions, target positions, and for contaminated sediments at a wetland site. Administrative Order No. 4 was issued on January 4, 2001, under the Resource Conservation and Recovery Act (RCRA) to the National Guard Bureau. This order requires that munitions found subsurface or in burial pits be properly stored and disposed of in a Contained Detonation Chamber (CDC), or by other means which prevent the release of explosives, metals, and other contaminants into the environment. As of October 2002, destruction of 2,802 items using the CDC with additional items awaiting disposal was reported (USEPA 2001).

## MMR Update

The fate and transport of propellants, explosives, and pyrotechnics (PEP) compounds is of considerable interest to the DoD as the result of findings at Camp Edwards, which suggests military training with high explosive (HE) artillery and mortar munitions have resulted in the introduction of PEP compounds to the environment. Given the current geopolitical climate, the DoD is in need of military ranges such as Camp Edwards to train soldiers. Therefore, a balance between military training requirements and impacts to the environment is crucial. As a consequence, determining whether military training activities are linked to the PEP contamination observed at Camp Edwards is necessary. Furthermore, the DoD has an interest in determining if the conditions observed at Camp Edwards are typical or atypical to other military ranges with similar training activities.

The Impact Area Groundwater Study Program (IAGWSP) at Camp Edwards has collected the following samples since the inception of the study in August 1997 through December 2002:

- 9,914 shallow surface soil samples representing 1,989 individual locations from 182 areas of investigation;
- 2,041 soil boring profile samples from 171 soil borings;
- 1,014 wipe samples from unexploded ordnance (UXO) and unexploded ordnance related material (UXORM);
- 69 sediment samples from 19 water bodies;
- 81 surface water samples from 19 water bodies;
- 6 storm water samples from the perimeter of the Impact Area;
- 3,495 groundwater profile samples from 256 borings; and
- 5,233 groundwater samples from 651 monitoring wells at 256 locations.

Since the last annual Strategic Environmental Research and Development Program (SERDP) Project update in 2001, additional samples have been collected at Camp Edwards (Table 1-1).

**Table 1-1  
Summary of Analytical Samples Taken at Camp Edwards since Last Update  
(September 2000)**

	Impact Area	Demo 1	J Ranges	KD Range	G&M Positions	Phase IIb	Total
Surface Soil (0-2')	782	199	544	0	192	754	1689
Deep Soil (>2')	53	0	94	0	0	1	95
Wipes/Brushings	0	0	6	0	0	0	6
GW	403	275	659	2	23	44	1003
Profile	209	148	174	0	0	19	341
Surface Water	0	0	38	0	0	0	38
Sediment	0	0	0	0	0	0	0
Storm Water	0	0	0	0	0	0	0
<b>Total</b>	<b>1447</b>	<b>622</b>	<b>1515</b>	<b>2</b>	<b>215</b>	<b>818</b>	<b>4619</b>

During the past year, various contractors have prepared 56 documents for the National Guard Bureau and U.S. Army Engineer District, New England (Bibliography for Camp Edwards, and <http://www.groundwaterprogram.org/docsreps.htm>). In addition, a number of presentations have been made on results from the Camp Edwards investigation.

The results from the past year's efforts have confirmed that three locations at Camp Edwards are sources of groundwater contamination. These include the Central Impact Area, Demolition Area 1 (Demo 1), and J Ranges. The contaminants of concern (COCs) identified for the Central Impact Area in groundwater are RDX, 2ADNT, and 4ADNT. Perchlorate could become a COC for groundwater at this site as well. RDX is the most mobile and extends away from the source area for 16,000 ft. A total of six explosive and propellant related compounds have been detected in groundwater sampled from monitoring wells at Demo 1, including perchlorate, RDX, HMX, 4ADNT, 2ADNT, TNT, and 2,4DNT. Perchlorate extends at least 9,000 ft, and RDX extends 4,000 ft from the Demo 1 kettle hole. Groundwater contaminants identified at the J Ranges include RDX, HMX, TNT, and perchlorate. Groundwater contaminants have not been observed from the remaining sites. The observations from Camp Edwards suggest that PEP compounds are of most concern at Camp Edwards and include perchlorate, RDX, HMX, 4ADNT, 2ADNT, TNT, and 2,4DNT.

Ongoing activities include the design of a hydraulic containments system at Demo 1, development of a Feasibility Study for the Central Impact Area, updating the regional groundwater model for Camp Edwards, evaluation of the connection between UXO, groundwater contamination, and further characterization at the J Ranges and Phase IIB sites.

In April of FY02 we compared existing data for MMR Central Impact Area with project data to date. Contaminant data for MMR are generally consistent with what we have observed at other sites. Exceptions include the detections of

perchlorates at MMR, which were not assayed at other sites, and higher HMX values at MMR than observed at other sites. The finding of perchlorate resulted in adding a list of organic contaminants other than explosives, including perchlorate, to selected composite samples from CP1155 ranges (Table 1-2). Results of analyses of six composite samples from Yakima Training Center yielded two perchlorate values, 42 and 49  $\mu\text{g}/\text{kg}^{-1}$ , which were slightly above the detection limit (40  $\mu\text{g}/\text{kg}^{-1}$ ), and two quantifiable values slightly below the detection limit ("J values"). In the seven soils from Camp Guernsey, no perchlorate values were above the detection limit and only one J value was reported. Of three samples from the hand grenade range at Fort Wainwright, one sample exhibited a J value for perchlorate. Detections of other organic analytes included *N*-nitroso diphenyl amine (3,690 and 2,920  $\mu\text{g}/\text{kg}^{-1}$  in two Yakima soil samples; detection limit 340  $\mu\text{g}/\text{kg}^{-1}$ ) and 1-methyl amino anthra quinone (5,930, 2,480, and 3,250  $\mu\text{g}/\text{kg}^{-1}$  in three Yakima soil samples; detection limit 340  $\mu\text{g}/\text{kg}^{-1}$ ). The first of these compounds is likely related to propellants and the second to smokes or obscurants (dyes). Both of these compounds have been detected at MMR.

<b>Table 1-2 Organic Analytes other than Explosives</b>	
<b>Chemical Name</b>	<b>Chemical Name</b>
Phenol	Dimethyl phthalate
2-Nitrophenol	Acenaphthene
2,4-Dichlorophenol	Diethyl phthalate
2-Chlorophenol	N-Nitrosodiphenyl amine
2,4-Dimethylphenol	Fluorene
4-Chloro-3-methylphenol	4-Chlorophenyl phenyl ether
2,4,6-trichlorophenol	4-Bromophenyl ether
4-Nitrophenol	Hexachlorobenzene
Pentachlorophenol	Anthracene
2,4-Dinitrophenol	Fluoranthene
2-Methyl-4,6-dinitrophenol	Phenanthrene
Benzoic acid	Dibutylphthalate
2-Methylphenol	Pyrene
2,4,5-Trichlorophenol	Butylbenzylphthalate
2-Fluorophenol (Surrogate (25-121) S)	Benzo(a)anthracene
4-Methylphenol	Di-N-octylphthalate
Benzyl alcohol	Chrysene
Phenol-D6(surrogate (14-113 S)	Bis(2-ethylhexy)phthalate
2,4,6-Tribromophenol (Surrogate (19-122 S)	Benzo(b)fluoranthene
N-Nitrosodimethylamine	Benzo(k)fluoranthene
N-Nitroso-di-N-propylamine	Indeno(1,2,3-C,D)pyrene
2-Chlorophenol-d4 (Surrogate (20-130 S))	Benzo(G,H,I)perylene
Bis(2-chloroisopropyl) ether	Benzo(a)pyrene
Nitrobenzene	Dibenzo(A,H)anthracene
Isophorone	Aniline
2,6-Dinitrotoluene	4-Chloroaniline
1,2-Diphenylhydrazine	2-Methylnaphthalene
Bis(2-chloroethoxy)methane	3-Nitroaniline
<i>(Continued)</i>	

Table 1-2 (Concluded)	
Chemical Name	Chemical Name
2,4-Dinitrotoluene	Dibenzofuran
3,3'Dichlorobenzidine	2-Nitroaniline
Bis(2-Chloroethyl)ether	4-Nitroaniline
1,4-Dichlorobenzene	Nitrobenzene-D5 (Surrogate (23-120 S) )
Hexachloroethane	p-Terphenyl-D13 (Surrogate (18-137 S) )
1,3-Dichlorobenzene	2-Chlorobenzaldehyde
1,2-Dichlorobenzene	2-Fluorobiphenyl (Surrogate (30-115 S) )
1,2,4-Trichlorobenzene	1,2-Dichlorobenzene-d4 (Surrogate (20-130 S) )
Naphthalene	1,3-Diethyl-1,3-diphenyl urea
Hexachlorocyclopentadiene	Carbozole
Acenaphthylene	1-Methylamino anthraquinone
Hexachlorobutadiene	2,3-Dimethyl Butane
2-Chloronaphthalene	7H-Benz(de)-anthracene-7-one

Recommendations for MMR were sampling for DNTs with depth at gun positions and sampling of standing water at the J-Range. Sampling in a concentric pattern consistent with data collection at MMR will be included at the next opportunity to better correlate project field data with specific MMR data.

## Related On-Going and Leveraged Studies

### Range characterization

**U.S. Army Alaska Public Works.** The U.S. Army Engineer Research and Development Center (ERDC) Cold Regions Research and Engineering Laboratory (CRREL) has an agreement with the U.S. Army Alaska Public Works to conduct site investigations at four firing ranges, Range Alpha and Stuart Creek at Fort Wainwright, and Washington and Delta Creek Ranges at Fort Greeley. These site investigations will be leveraged to provide additional data on concentrations of explosives residues in surface soils because of training range activities. In FY02 methods to collect representative samples at firing points were evaluated at the Fort Greeley ranges, including sampling at firing points. In addition, experiments were conducted to evaluate various laboratory processing protocols so that representativeness achieved in the field is not lost during subsampling in the laboratory.

**SERDP Compliance Project 1197.** Battelle, Columbus, Ohio, is conducting SERDP Compliance Project (CP) 1197 "A Field Program to Identify Toxic Release Inventory Chemicals and Determine Emission Factors from DoD Munitions Activities." The objective of the project is to demonstrate a methodology for measuring emissions of toxic release inventory (TRI) chemicals from DoD munitions activities and to apply the method to determine emission factors from munitions activities at DoD facilities. One focus of the project is to collecting air samples after the firing of various munitions in test chambers at Aberdeen Test Center (ATC), Maryland. Samples are collected both at the point of weapon discharge and at the point of munition impact. One of the weapons tested was the 105-mm howitzer, a munition for which we have conducted

sampling of surface soils at the firing points for Project CP 1155 at Fort Lewis, Washington, and at Fort Richardson, Alaska. Residues of the propellant 2,4DNT were detected in analytical results from Project CP 1155 at both sites, but not from Project CP 1197.<sup>1</sup> Results at Fort Lewis indicated 2,4DNT in surface soils where 105-mm howitzers had been fired over an intensive period in the summer of 2000 (Jenkins et al. 2001, Pennington et al. 2001). As many as 600 rounds were estimated to have been fired from each howitzer prior to sample collection. Concentrations as high as 237,000  $\mu\text{g kg}^{-1}$  were observed in soils from an area extending 30 m from the muzzle of the guns. The Fort Richardson tests were conducted in March 2002 by firing five rounds and sampling from both metal collection trays and surface snow at distances as far as 80 m from the muzzle. Results of chemical analyses of Fort Richardson samples supported the findings at Fort Lewis, in that 2,4DNT was detectable in all samples.

Microscopic analyses of material collected from the metal trays at Fort Richardson provide a possible explanation for the nondetections observed at ATC. Photographs taken through the optical microscope revealed several different types of particles including a large number of long fibers. When we added a colorimetric reagent that reacts with 2,4DNT to generate a reddish color, only the long fibers reacted, indicating the presence of 2,4DNT within these fibers (Figure 1-1). These fibers are most likely composed of nitrocellulose with 2,4DNT imbibed as the plasticizer, since the 105-mm howitzers utilize single-based propellant.

Our protocol for analysis of soils from firing points uses an overnight extraction with acetonitrile. This solvent is quite effective at recovering 2,4DNT from these fibers deposited on soils, hence our detection of 2,4DNT in soil and snow samples. On the other hand, the protocol used for the analysis of air samples in the ATC tests may not release the 2,4DNT from these nitrocellulose particles, and thus, they may not detect 2,4DNT. We are currently conducting comparisons of these procedures.

**SERDP Compliance Project 1226.** The Army Environmental Center (AEC) is conducting a SERDP-sponsored project, CP 1226 “UXO Corrosion – Potential Contamination Source” to identify the type, character, and rate of perforations in casings of UXO underlying soil at U.S. military installations. The goal of the corrosion project is to examine approximately 200 pieces of ordnance during the study. Soils collected in proximity to UXO will be analyzed at ERDC. Data will be leveraged with data amassed in CP 1155. The AEC is also conducting a “Range Sustainment Program” to proactively ensure sustained training on ranges and to protect drinking water sources on active ranges. Project CP 1155 has been coordinated with this project and will share site access with this project whenever possible to benefit both efforts.

---

<sup>1</sup> The apparent discrepancy between results of these two studies was the subject of a Science Advisory Board “Action Item” for Project CP 1155. The discussion of analytical differences is intended to address that action item.

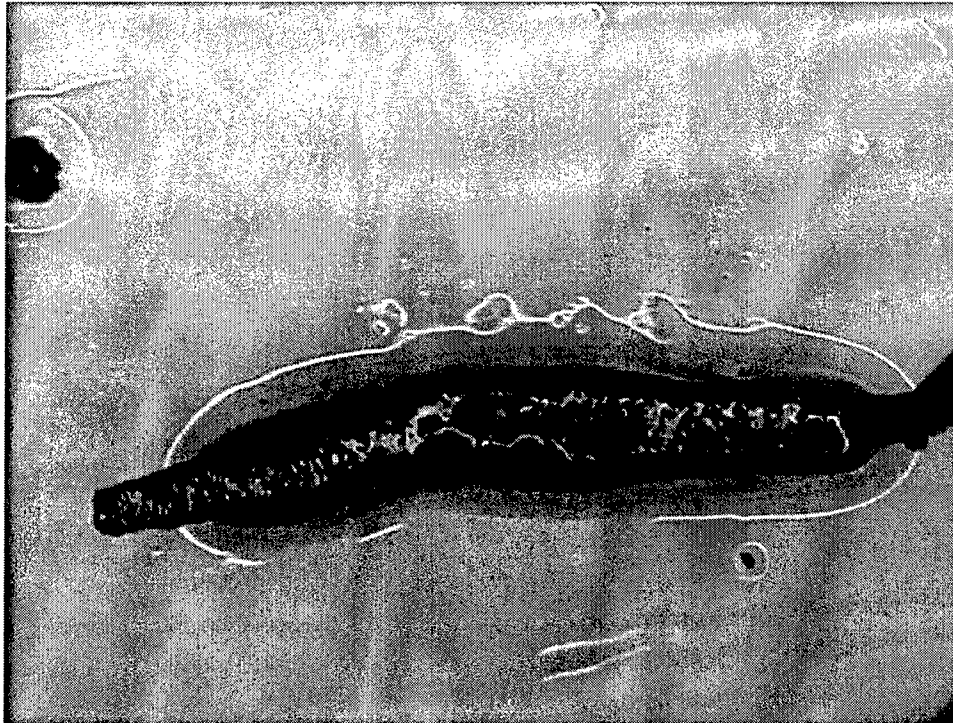

Figure 1-1. Development of red coloration in a fibrous particle of nitrocellulose when treated with a reagent that reacts with 2,4DNT. Particle was recovered near a firing point at Fort Richardson, Alaska

**Canadian Range Characterization Programme.** The Director Land Forces Service (DLFS) from the Canadian Head Quarters has tasked Defence Research and Development Canada (DRDC)-Valcartier (Val) scientists to perform research characterization of their main army training area, to assess the impacts of live fire training. Part of the work conducted within CP 1155 is strongly linked with this objective. CP1155 includes partial funding for Canadian Forces Base (CFB) Shilo and Gagetown for surface characterization, while the hydrogeological portion of these studies are supported by DLFS. Moreover, the DLFS mandate includes the analysis of other types of range contaminants such as heavy metals, petroleum products, and radioactive compounds when appropriate. All the data generated for these other analytes will be shared with CP 1155 project. The DLFS mandate included other training area such as the one located at CFB Valcartier and results obtained at this training area will be added to CP 1155 database. Future work at other Canadian training areas such as Petawawa or Suffield will still be supported partly by DLFS. On a yearly basis, approximately 30 percent of the fund is contributed by the SERDP project.

**Confined Burn Facilities (CBF) Projects.** Efforts have been made over the last several years to find alternative to incineration, or open burning and open detonation of unnecessary munitions and explosives. Unlike SERDP Project CP1155, which focuses on residues of munitions, these studies are focused primarily on air quality when disposing of unneeded munitions by burning or detonating. The Tooele Army Depot, Tooele, UT, has used various incineration technologies including a furnace capable of burning 140 to 180 kg of energetics material per hour, and the so-called "bang box" configurations for confined



burning to capture air emissions for further treatment. A 1,000-cu m “bang box” that can test 227 g of explosives or 2.27 kg of propellants has also been used at the Dugway Proving Ground, Utah. The box, formally known as the Propellant, Explosive, and Pyrotechnic Thermal Treatment Evaluation and Test Facility, is instrumented to measure emissions. The Naval Sea System (NAVSEA) Surface Warfare Center Division, Indian Head, MD, also has a CBF where they are conducting a project sponsored by the Environmental Security Technology Certification Program (ESTCP), “Confined Burn Facility Open Burning Ground Replacement Technology,” the goal of which is to develop an environmentally acceptable, economical, and proven alternative to open burning of munitions.

## **Fate and transport studies**

**Army Environmental Quality Technology Program.** Three studies are currently under execution at the ERDC-EL concerning fate and transport processes for explosives. The studies are funded under the Installation Restoration Research Program (IRRP) of the Army Environmental Quality Technology Program. One work unit, A835/301X/UX001, “Characterization and Mobilization of Unexploded Ordnance,” which concluded in FY02, quantified chemical signatures emanating from UXO under various environmental and geophysical conditions. The purpose of the study was to provide the technical basis for chemical sensor development, for discrimination between UXO and innocuous clutter, and for refinement in the classification of detected UXO. The second work unit, A835/309E/RE004, “Fate and Transport of Explosives Contaminants,” is developing screening level and comprehensive fate and transport models and process descriptors for UXO in soil, aquifer, and aquatic environments for evaluating the exposure component of risk assessments. The third work unit, AF25/309F/HF201, “Fate and Transport of Propellants, Smokes, and Illuminants,” is developing fate and transport process descriptors for propellants, smokes, and illuminants. These work units are concerned with explosives and other components from UXO rather than from the more diffuse and diverse explosives residues that exist at firing ranges. However, transport parameters developed under these work units will be used in the CP1155 study to ensure a comprehensive and unified database. Approximately 10 percent of the funds for defining fate and transport parameters are contributed by the SERDP project.

**UXO in marine environments.** The Naval Facilities Engineering Service Center, Port Huene, California, and the Space and Naval Warfare Systems Center, San Diego, CA, are conducting a study in conjunction with the ERDC-EL to determine toxicological and geochemical interactions of ordnance and explosives in marine environments. Geochemical studies will determine dissolution, adsorption, and transformation rates of explosives in marine environments. Process descriptors determined in freshwater will be compared with those determined in salt water to determine what descriptors are affected by salinity. The toxicology studies will focus on toxicity, bioaccumulation, trophic transfer, and tissue concentrations of explosives in marine organisms, and the toxic effects of mixtures of explosives.

## Low-order detonations

**Previous Main Charge Disruptor (MCD) testing.** Creation of low-order detonations has special application where disposal of munitions by blow-in-place demolition requires consideration of the safety of personnel or of the integrity of nearby property. A previous NAVEOD program, "Developmental Testing of the Main Charge Disruptor (MCD)," was designed to reduce the hazard of removing such munitions by developing methods to detonate the munitions without releasing maximum energy. Testing was performed with the MCD against pipe bombs and projectile munitions (Baker et al. 1997). Phase A involved testing of the MCD tool against Mk 80 series and penetrator bombs (Blankenbiller 1999). Additional testing (Phase B) was performed in November 1999 with the MCD tool against more Mk 80 series bombs (Gill 1999). In May 2000, three MCD candidates were tested against a variety of simulated UXO containing Tritonal, PBXN-109, Composition H-6, and Composition B (Baker et al. 2000). Included in the list of simulated UXO were the 155-mm, 105-mm, and 8-in. projectiles. The MCD tool, chosen from testing in May 2000, demonstrated the ability to achieve various yields based on placement and explosive loading of the tool. Application of the MCD tool for studying residues from low-order detonations of artillery projectiles for project CP 1155 was based on these previous tests.

## Scope of Project CP1155

This project is designed to develop techniques for assessing the potential for environmental contamination from energetic materials on testing and training ranges. Techniques are being developed to define the physical and chemical properties, concentration, and distribution of energetics and residues of energetics in soils, and the potential for transport of these materials to groundwater. Other issues, such as off-site transport in surface runoff, or as a component of airborne dust, are also important, but are beyond the scope of the project.

As installations are sampled, firing records from the past several years will be used to estimate the source term of munitions potentially introduced to the range. The estimates based on firing records will be compared with the field data from the site to determine the value of the records-based estimates. Surface soils associated with impact craters will be characterized for at least one U.S. and one Canadian site. Transport parameters (desorption kinetics, partitioning coefficients, and transformation and/or degradation rates) for TNT, RDX, and HMX will be determined using field soils from the site. These site-specific parameters will be related to soil properties and compared to values at other sites. Residues from high-order detonations will be determined by initiating blasts on snow and collecting the visible residue for chemical analysis. Residues from additional blasts will be collected on witness plates. These sampling approaches will permit characterization of spatial distribution of residues. 'Ground truthing' will consist of intensive soil sampling around impact craters on an active range. These data will contribute to refinements in the soil sampling strategies for live fire ranges.

Tests will be conducted to reliably generate low-order detonations with low-energy yields for two munitions. Residues from such blasts will be assayed to develop a source term for use in fate and transport and risk assessment models. The source term will detail the mass of explosive residue and, when appropriate, its distribution and surface area.

As additional sites are characterized, the database will be expanded to determine whether certain munitions consistently contribute more contamination than others. The database of climatic and geological data will also be related to contamination to determine whether these variables affect potential for contamination. Pertinent data from MMR will be reviewed and compared to the database to determine whether MMR residues are typical of other installations.

## Objectives

The primary objective of the study is to provide the DoD with techniques to assess the potential for groundwater contamination from residues of high explosives (TNT, PETN, RDX, and HMX) at testing and training ranges. Results of the project will facilitate informed management decision-making, minimize environmental impacts of testing and training, and contribute to continued operation of ranges.

Specific objectives include the following:

- a. Develop a protocol that can be used to determine the nature and extent of surface soil contamination around impact areas to include the sampling strategy and analytical methods best suited to this application.
- b. Provide source-term estimates for postblast residues based on the extent of surface soil contamination and the attributes of dissolution and release to fate and transport processes.
- c. Provide new data for the relevant environmental processes controlling the fate and transport of residues of high explosives on ranges.

## Summary of Previous Year (FY01) Results

In FY01, two U.S. installations, Yakima Training Center, Washington, and Camp Guernsey, Wyoming, and one Canadian installation, CFB Shilo, were characterized. Postblast residues from various heavy artillery munitions were characterized by sampling surface soils associated with firing positions and with craters from both high- and low-order detonations. At both U.S. installations, ground and surface water was also sampled. Vegetation was also characterized on the Canadian range. The study also included determination of transport parameters for RDX transformation products, MNX, DNX, and TNX, and for nitroglycerin. Dissolution rates and solubilities of TNT, RDX, and HMX were determined on the compound and on three explosives formulations, LX-14, Composition B, and octol.

Results of range characterization studies indicate that various types of military testing and training ranges differ in the contaminants present. Consistently high concentrations (percent levels) of explosives residues were found near ruptured ordnance. Artillery ranges are potentially very low nonpoint sources of explosives residues with higher point sources randomly scattered across the sites. A multi-increment composite sampling strategy is essential to adequately characterize the distribution of contaminants on artillery ranges. Contamination associated with demolition detonation of duded rounds using C4 is a potential concern. The use of C4 can result in incomplete detonations that scatter RDX across the soil. Since RDX is an undesirable groundwater contaminant, consideration should be given to improving the efficiency of blow-in-place disposal of duded rounds.

Dissolution rates of TNT, HMX, and RDX increased with surface area, temperature, and mixing rates. Since nitroglycerine degraded rapidly in all soils, it is not expected to persist. The RDX transformation products, MNX, DNX, and TNX, were generally stable in all soils tested. These compounds exhibit transport potential consistent with RDX. Transport parameters used to model potential groundwater contamination and to evaluate environmental or human health risk should reflect formulations of the explosives present and the dissolution rates as well as solubilities.

## **FY02 Execution**

During FY02, two U.S. and two Canadian sites were characterized for explosives residues resulting from live-fire soldier training: Fort Bliss, New Mexico, Scofield Barracks, Hawaii, Cold Lake Weapon Range, Alberta, and CFB Gagetown, New Brunswick. However, data acquisitions and interpretations presented in this report are limited to Fort Bliss and CFB Shilo, which were initiated in FY01 and for which data analyses were completed in FY02. Data for Scofield, Cold Lake, and Gagetown will be presented in the FY03 annual report. Results of low-order testing initiated in FY01 are reported here. Additional low-order tests were executed in FY02; however, data analyses are still in progress and results will appear in the FY03 annual report. All FY02 execution of fate and transport process descriptors is reported here.

Accomplishments to date of SERDP Project CP1155 include the following:

- a.* Data acquisition for estimating firing-range source terms for various munitions and range usages including high-order detonations, low-order detonations, and munitions firing points.
- b.* Protocol for characterizing soil contamination on various types of ranges having high spatial and concentration variability, e.g., heavy artillery, antitank, hand grenade, and air fighter training.
- c.* Definition of the residues generated by various UXO demolition procedures (blow-in-place).

- d. Process descriptors for range-specific energetic residues, including dissolution rates, partition coefficients, and transformation rates.

A bibliography of technical reports and presentations generated during execution of project CP1155 is included (Bibliography of CP 1155 Publications). Web sites where reports may be available include the following:

- ERDC EL (<http://www.wes.army.mil/el/t2info.html>)
- ERDC CRREL (<http://www.crrel.usace.army.mil/products/products.html>)
- R & D Défense Canada-Valcartier (<http://www.valcartier.drdc-rddc.gc.ca>)
- MMR Impact Area Groundwater Study (<http://www.groundwaterprogram.org/index.htm>)

## References

- AMEC. (2001). "Final IAGWSP Technical Team Memorandum 01-6 Central Impact Area Groundwater Report for the Camp Edwards Groundwater Quality Study Massachusetts Military Reservation Cape Cod, Massachusetts," MMR-3757. AMEC Earth and Environmental, Inc., Westford, MA.
- Baker, P., Randers-Pehrson, G., Benjamin, K., and Serrano, D. (1997). "Characterization, modeling, and testing of the Baldrick and Naval Surface Warfare Center (NSWC) explosively formed penetrators (EFPs) Main Charge Disruptor (MCD) candidates," ARL-TR-1363, Army Research Laboratory, Aberdeen Proving Ground, MD.
- Baker, P., Stegall, S., Canami, A., Slack, W., and Boyd, W.H. Jr. (2000). "The effect of case strength, path length, and main charge explosive type on the performance of three main charge disruptor candidates," ARL-TR-2193, Army Research Laboratory, Aberdeen Proving Ground, MD.
- Blankenbiller, D. C. (1999). "Final report for the Phase IIA Developmental Test Series (DT-IIA) of the Main Charge Disruptor (MCD)," ATC-8163, U.S. Army Aberdeen Test Center, Aberdeen Proving Ground, MD.
- Gill, D. (1999). "Developmental Testing (DT-IIB): Container, main charge disruptor (MCD) EX 788 Mod 0," NAVEODTECHDIV Technical Note TN-474, Naval Explosive Ordnance Disposal Technology Division, Indian Head, MD.
- Jenkins, T. F., Pennington, J. C., Ranney, T. A., Berry, T. E., Jr., Miyares, P. H., Walsh, M. E., Hewitt, A. D., Perron, N., Parker, L. V., Hayes, C. A., and Wahlgren, Maj. E. (2001). "Characterization of explosives contamination at military firing ranges," ERDC TR-01-05, U.S. Army Engineer Research and Development Center, Hanover, NH.

Pennington, J. C., Jenkins, T. F., Brannon, J. M., Lynch, J., Ranney, T. A., Berry, T. E., Jr., Hayes, C. A., Miyares, P. H., Walsh, M. E., Hewitt, A. D., Perron, N., and Delfino, J. J. (2001). "Distribution and fate of energetics on DoD Test and training ranges: Interim Report 1." ERDC TR-01-13, U.S. Army Engineer Research and Development Center, Vicksburg, MS.

U.S. Environmental Protection Agency. (1997). "Administrative order for response action EPA Docket Number SDWA-1-97-1030, USEPA Region 1 in the Matter of Training Range and Impact Area, Massachusetts Military Reservation," Boston, MA.

\_\_\_\_\_. (2000). "Administrative Order for Response Action EPA Docket Number SDWA-1-2000-0014, USEPA Region 1 in the Matter of Training Range and Impact Area, Massachusetts Military Reservation," Boston, MA.

\_\_\_\_\_. (2001). "Administrative Order for Response Action EPA Docket Number RCRA 1-2001-0014, USEPA Region 1 in the Matter of Training Range and Impact Area, Massachusetts Military Reservation," Boston, MA.

## **Bibliography for Camp Edwards**

AMEC. (2002a). "Innovative Technology Evaluation Groundwater Treatability Study Summary: Fluidized Bed Reactor Study #2. Camp Edwards, Massachusetts Military Reservation, Cape Cod, Massachusetts," MMR-6796 (Draft), AMEC Earth and Environmental, Inc. Westford, MA.

AMEC. (2002b). "Final Biota Field Sampling Work Plan, Demo 1 Soil Operable Unit for the Camp Edwards Impact Area Groundwater Quality Study, Massachusetts Military Reservation, Cape Cod, Massachusetts," MMR-6777, AMEC Earth and Environmental, Inc. Westford, MA.

AMEC. (2002c). "Final J-3 Wetland 2002 Annual Review for the Camp Edwards Impact Area Groundwater Quality Study, Massachusetts Military Reservation, Cape Cod, Massachusetts," MMR-6610, AMEC Earth and Environmental, Inc. Westford, MA.

AMEC. (2002d). "IAGWSP Site-Wide Perchlorate Characterization Workplan for the Camp Edwards Impact Area Groundwater Study, Program Massachusetts Military Reservation, Cape Cod, Massachusetts," MMR-6235 (Draft), AMEC Earth and Environmental, Inc. Westford, MA.

AMEC. (2002e). "Final summary report July 2000 UXO Detonations for the Camp Edwards Impact Area Groundwater Study Program, Massachusetts Military Reservation, Cape Cod, Massachusetts," MMR-6692, AMEC Earth and Environmental, Inc. Westford, MA.

AMEC. (2002f). "Final summary report August 2000 UXO Detonations for the Camp Edwards Impact Area Groundwater Study Program, Massachusetts Military Reservation, Cape Cod, Massachusetts," MMR-6696, AMEC Earth and Environmental, Inc. Westford, MA.

- AMEC. (2002g). "Final summary report September 2000 UXO Detonations for the Camp Edwards Impact Area Groundwater Study Program, Massachusetts Military Reservation, Cape Cod, Massachusetts," MMR-6698, AMEC Earth and Environmental, Inc. Westford, MA.
- AMEC. (2002h). "Final summary report October - December 2000 UXO Detonations for the Camp Edwards Impact Area Groundwater Study Program, Massachusetts Military Reservation, Cape Cod, Massachusetts," MMR-6712, AMEC Earth and Environmental, Inc. Westford, MA.
- AMEC. (2002i). "Final summary report January - March 2001 UXO Detonations for the Camp Edwards Impact Area Groundwater Study Program, Massachusetts Military Reservation, Cape Cod, Massachusetts," MMR-6734, AMEC Earth and Environmental, Inc. Westford, MA.
- AMEC. (2002j). "Final summary report April - June 2001 UXO Detonations for the Camp Edwards Impact Area Groundwater Study Program, Massachusetts Military Reservation, Cape Cod, Massachusetts," MMR-6737, AMEC Earth and Environmental, Inc. Westford, MA.
- AMEC. (2002k). "Final summary report July - September 2001 UXO Detonations for the Camp Edwards Impact Area Groundwater Study Program, Massachusetts Military Reservation, Cape Cod, Massachusetts," MMR-6767, AMEC Earth and Environmental, Inc. Westford, MA.
- AMEC. (2002l). "Final summary report October - December 2001 UXO Detonations for the Camp Edwards Impact Area Groundwater Study Program, Massachusetts Military Reservation, Cape Cod, Massachusetts," MMR-6789, AMEC Earth and Environmental, Inc. Westford, MA.
- AMEC. (2002m). "Method comparability study results for explosives in soil report for the Camp Edwards Impact Area Groundwater Study Program, Massachusetts Military Reservation, Cape Cod, Massachusetts," MMR-6739 (Draft TM 02-4), AMEC Earth and Environmental, Inc. Westford, MA.
- AMEC. (2002n). "Innovative technology evaluation groundwater treatability study summary: Fluidized bed reactor, Camp Edwards, Massachusetts Military Reservation, Cape Cod, Massachusetts," MMR-6589 (Draft), AMEC Earth and Environmental, Inc. Westford, MA.
- AMEC. (2002o). "Central impact area groundwater post-screening investigation report for the Camp Edwards Impact Area Groundwater Quality Study, Massachusetts Military Reservation, Cape Cod, Massachusetts," MMR-6646 (Draft TM 02-3), AMEC Earth and Environmental, Inc. Westford, MA.
- AMEC. (2002p). "Small arms ranges report for the Camp Edwards Impact Area Groundwater Quality Study, Massachusetts Military Reservation, Cape Cod, Massachusetts," MMR-6799 (Draft TM 02-3), AMEC Earth and Environmental, Inc. Westford, MA.

- AMEC. (2002q). "Former A, K and Demo 2 report for the Camp Edwards Impact Area Groundwater Quality Study, Massachusetts Military Reservation, Cape Cod, Massachusetts," MMR-6276 (TM 02-1), AMEC Earth and Environmental, Inc. Westford, MA.
- AMEC. (2002r). "Supplemental background investigation report for the Camp Edwards Impact Area Groundwater Study Program Massachusetts Military Reservation, Cape Cod, Massachusetts," MMR-3487 (Draft), AMEC Earth and Environmental, Inc. Westford, MA.
- AMEC. (2002s). "Final supplemental post-screening investigation (PSI) work plan, demo 1 soil operable unit (OU) for the Camp Edwards Impact Area Groundwater Quality Study, Massachusetts Military Reservation, Cape Cod, Massachusetts," MMR-6541, AMEC Earth and Environmental, Inc. Westford, MA.
- AMEC. (2002t). "Summary of toxicological information and basis of RfDs for benzanthrone, 1,4- diamino-2,3-dihydroanthranquinone, 1,4-di-p-toluidino-9,10-anthraquinone, and 1-(methylamino)-9,10-anthraquinone for the Camp Edwards Impact Area Groundwater Quality Study, Massachusetts Military Reservation, Cape Cod, Massachusetts," MMR-6179 (Draft), AMEC Earth and Environmental, Inc. Westford, MA.
- AMEC. (2002u). "Final completion of work report, Rapid Response Action (Round 2) and Release Abatement Measure Status Report MADEP Release Tracking Number 4-16163 (and 4-0037), Camp Edwards Impact Area Groundwater Quality Study, Massachusetts Military Reservation, Cape Cod, Massachusetts," AMEC Earth and Environmental, Inc. Westford, MA.
- AMEC. (2002v). "J-1, J-3, L ranges additional delineation report no. 1. volumes I and II. Camp Edwards Impact Area Groundwater Study Program Massachusetts Military Reservation, Cape Cod, Massachusetts," MMR-5834 (Draft), AMEC Earth and Environmental, Inc. Westford, MA.
- AMEC. (2002w). "Final gun and mortar firing positions additional characterization work plan for the Camp Edwards Impact Area Groundwater Quality Study, Massachusetts Military Reservation, Cape Cod, Massachusetts," MMR-5944, AMEC Earth and Environmental, Inc. Westford, MA.
- AMEC. (2002x). "Final post-screening investigation work plan demo 1 soil operable unit RTN: 4-15031 for the Camp Edwards Impact Area Groundwater Quality Study, Massachusetts Military Reservation, Cape Cod, Massachusetts," MMR-5842, AMEC Earth and Environmental, Inc. Westford, MA.
- AMEC. (2002y). "Final supplemental phase IIB work plan for the Camp Edwards Impact Area Groundwater Quality Study, Massachusetts Military Reservation, Cape Cod, Massachusetts," MMR-5990, AMEC Earth and Environmental, Inc. Westford, MA.



- AMEC. (2002z). "Environmental risk characterization demo 1 soil operable unit. RTN: 4-15031 for the Camp Edwards Impact Area Groundwater Quality Study, Massachusetts Military Reservation, Cape Cod, Massachusetts," MMR-5917 (Draft), AMEC Earth and Environmental, Inc. Westford, MA.
- AMEC. (2002aa). "Final central impact area perchlorate sampling plan for the Camp Edwards Impact Area Groundwater Study Program, Massachusetts Military Reservation, Cape Cod, Massachusetts," MMR-5988, AMEC Earth and Environmental, Inc. Westford, MA.
- AMEC. (2002bb). "Revised BIP field sampling and excavation plan for the Camp Edwards Impact Area Groundwater Study Program, Massachusetts Military Reservation, Cape Cod, Massachusetts," MMR-5939 (Draft), AMEC Earth and Environmental, Inc. Westford, MA.
- AMEC. (2002cc). "White phosphorus analysis recommendations. Impact Area Groundwater Study Program, Massachusetts Military Reservation, Cape Cod, Massachusetts," MMR-5859, Letter report from AMEC to USEPA, AMEC Earth and Environmental, Inc. Westford, MA.
- AMEC. (2002dd). "Final completion of work report, rapid response action [Round 1], Camp Edwards, Massachusetts Military Reservation, and Release Abatement Status Report," MMR-4652, MADEP Release Tracking Number 4-0037 (and 4-15032, 4-15033, 4-15034, 4-15035), AMEC Earth and Environmental, Inc. Westford, MA.
- AMEC. (2002ee). "Long term groundwater quality monitoring (LTGM) plan for 2002 preliminary assessment of data and revised Appendix B for the Camp Edwards Impact Area Groundwater Study, Massachusetts Military Reservation, Cape Cod, Massachusetts," MMR-5869, AMEC Earth and Environmental, Inc. Westford, MA.
- AMEC. (2002ff). "Final ecological risk assessment work plan, demo 1 soil operable unit, RTN: 4-15031 for the Camp Edwards Impact Area Groundwater Quality Study, Massachusetts Military Reservation, Cape Cod, Massachusetts," MMR-5821, AMEC Earth and Environmental, Inc. Westford, MA.
- AMEC. (2002gg). "Final J-2 range additional delineation workplan no. 2. for the Camp Edwards Impact Area Groundwater Quality Study for the Camp Edwards Impact Area Groundwater Study, Massachusetts Military Reservation, Cape Cod, Massachusetts," MMR-5781, AMEC Earth and Environmental, Inc. Westford, MA.
- AMEC. (2002hh). "Findings from the resampling and analysis for MCPA and MCPP for the Camp Edwards Impact Area Groundwater Study, Massachusetts Military Reservation, Cape Cod, Massachusetts," MMR-4893, AMEC Earth & Environmental, Inc. Westford, MA.

- AMEC. (2002ii). "Western Cape regional groundwater flow model draft summary report for the Camp Edwards Impact Area Groundwater Quality Study, Massachusetts Military Reservation, Cape Cod, Massachusetts," MMR-5782 (Draft), AMEC Earth and Environmental, Inc. Westford, MA.
- AMEC. (2002jj). "Final J-1, J-3, L ranges additional delineation workplan no. 2. for the Camp Edwards Impact Area Groundwater Quality Study, Massachusetts Military Reservation, Cape Cod, Massachusetts," MMR-5891, AMEC Earth and Environmental, Inc. Westford, MA.
- Clausen, J. L., Curry, D. M., Robb, J., and Gallagher, B. (2002a). "Environmental fate and transport modeling of explosives and propellants in the vadose zone," *18th Annual International Conference on Contaminated Soils, Sediments and Water*. October 21-24. Amherst, MA.
- Clausen, J. L., Curry, D. M., Robb, J., and Gallagher, W. B. (2002b). "A case for background levels of arsenic in groundwater at the Massachusetts Military Reservation." *Arsenic in New England: A Multi-Disciplinary Scientific Conference*. May 29-31, 2002. Dartmouth, NH.
- Clausen, J., Curry, D., Robb, J., and Gregson, B. (2002). "Comprehensive list of chemicals likely to be found at military ranges - A case study of Camp Edwards, Massachusetts," *SERDP and ESTCP Symposium*. December 3-5, 2002. Washington, DC.
- Curry D. M., Clausen, J. L., Robb, J., and Gregson, B. (2002). "Environmental implications of pyrotechnic training in an impact area - perchlorate contamination," *The 29th International Pyrotechnics Seminar*. July 14-19, 2002. Westminster, CO.
- Curry, D. M., Zaidel, J., Laase, A., Clausen, J. L., and Hill, D. (2002). "Environmental fate and transport modeling of explosives and propellants in the saturated zone," *18th Annual International Conference on Contaminated Soils, Sediments, and Water*. October 21-24. Amherst, MA.
- Tetra Tech EM, Inc. (2002a). "Final HUTA II report Massachusetts Military Reservation, Camp Edwards, MA," MMR-6756 (Draft), Franklin, TN.
- Tetra Tech EM, Inc. (2002b). "Munitions survey program phase 3 (MSP3) nuclear/biological/chemical (NBC) warfare training area investigation, final work plan Massachusetts Military Reservation Camp Edwards, MA," MMR-6243, Franklin, TN.
- Tetra Tech EM, Inc. (2002c). "Final report high use target area, transect 4, Massachusetts Military Reservation Camp Edwards, MA," MMR-6320 (Draft), Franklin, TN.
- Tetra Tech EM, Inc. (2002d). "MMR ordinance & explosives archives search report (ASR) integration & enhancement project interview summaries, Massachusetts Military Reservation Camp Edwards, MA," Franklin, TN.

- Tetra Tech EM, Inc. (2002e). "Gun & mortar witness interviews, second interview witness # 31, 49, 5, 52, 9, 53, 7 MMR ordinance & explosives archive search report (ASR) integration & enhancement project interview summaries, Massachusetts Military Reservation Camp Edwards, MA," MMR-6382, Franklin, TN.
- Tetra Tech EM, Inc. (2002f). "Munitions survey program phase 3 (MSP3) suspected former demolition area investigation, final work plan Massachusetts Military Reservation Camp Edwards, MA," MMR-6242, Franklin, TN.
- Tetra Tech EM, Inc. (2002g). "Final high use target area (HUTA) phase II investigation transect 2 report, Massachusetts Military Reservation Camp Edwards, MA," MMR-6275, Franklin, TN.
- Tetra Tech EM, Inc. (2002h). "Final high use target area (HUTA) phase II investigation transect 3 report, Massachusetts Military Reservation Camp Edwards, MA," MMR-6301, Franklin, TN.
- Tetra Tech EM, Inc. (2002i). "Final HUTA phase ii investigation transect 5 report, Massachusetts Military Reservation Camp Edwards, MA," MMR-6228, Franklin, TN.
- Tetra Tech EM, Inc. (2002j). "Munitions survey program phase 2 former A range, final letter report Massachusetts Military Reservation Camp Edwards, MA," MMR-6525, Franklin, TN.
- Tetra Tech EM, Inc. (2002k). "Munitions survey program phase 2 ammunition supply point draft final letter report Massachusetts Military Reservation Camp Edwards, MA," MMR-5992, Franklin, TN.
- Tetra Tech EM, Inc. (2002l). "Munitions survey program phase 2 demolition area 1, draft final letter report Massachusetts Military Reservation Camp Edwards, MA," MMR-6524, Franklin, TN.
- Tetra Tech EM, Inc. (2002m). "Munitions survey program phase 2 slit trench draft final letter report Massachusetts Military Reservation Camp Edwards, MA," MMR-6323, Franklin, TN.
- Tetra Tech EM, Inc. (2002n). "BA-1 report, Massachusetts Military Reservation Camp Edwards, MA," MMR-5965 (Draft), Franklin, TN.
- Tetra Tech EM, Inc. (2002o). "Final letter report ammunition supply point (ASP) geophysics investigation, Massachusetts Military Reservation Camp Edwards, MA, MMR-4866 (Draft), Franklin, TN.
- Tetra Tech EM, Inc. (2002p). "Final letter report demolition area 1 geophysical investigation, Massachusetts Military Reservation Camp Edwards, MA," MMR-4863 (Draft), Franklin, TN.

Tetra Tech EM, Inc. (2002q). "Final letter report former A range geophysics investigation, Massachusetts Military Reservation Camp Edwards, MA," MMR-4864 (Draft), Franklin, TN.

Tetra Tech EM, Inc. (2002r). "Final letter report former K range geophysics investigation, Massachusetts Military Reservation Camp Edwards, MA," MMR-4865 (Draft), Franklin, TN.

Tetra Tech EM, Inc. (2002s). "Summary of interviews – witness #25 through witness #33 and follow-up interviews conducted as part of the archives search report (ASR) September 25, 2001 – December 18, 2001, Massachusetts Military Reservation Camp Edwards, MA," MMR-4924 (Draft), Franklin, TN.

Tetra Tech EM, Inc. (2002t). "Photos from the corrosion study conducted by Tetra Tech," Franklin, TN.

## Bibliography of CP1155 Publications

### Referred Journal Articles

Jenkins, T. F., Walsh, M. E., Miyares, P. H., Hewitt, A. D., Collins, N. H., and Ranney, T. A. (2002). "Evaluation of the use of snow-covered ranges to estimate the explosives residues that result from high order detonations of army munitions," *Thermochimica Acta*, 384, 173-185.

Lynch, J. C., Brannon, J. M., and Delfino, J. J. (2002a). "Dissolution rates of three high explosive compounds: TNT, RDX, and HMX," *Chemosphere*, 47, 725-734.

Lynch, J. C., Brannon, J. M., and Delfino, J. J. (2002b). "Effects of component interactions on the aqueous solubilities and dissolution rates of the explosive formulations octol, composition B, and LX-14," *Journal of Chemical and Engineering Data*, 47, 542-549.

Lynch, J. C., Myers, K. F., Brannon, J. M., and Delfino, J. J. (2001). "Effects of pH and temperature on the aqueous solubility and dissolution rate of 2,4,6-trinitrotoluene (TNT), hexahydro-1,3,5-trinitro-1,3,5-triazine (RDX), and octahydro-1,3,5,7-tetranitro-1,3,5,7-tetrazocine (HMX)," *Journal of Chemical and Engineering Data*, 46, 1549-1555.

Pennington, J. C., and Brannon, J. M. (2002). "Environmental fate of explosives," *Thermochimica Acta*, 384, 163-172.

Walsh, M. E., Ramsey, C. A., and Jenkins, T. F. (2003). "The effect of particle size reduction on subsampling variance for explosives residues in soil," *Chemosphere*, 49, 1265-1271.

## Government Documents

- Ampleman, G., Thiboutot, S., Lewis, J., Marois, A., Gagnon, A., Bouchard, M., Martel, R., Lefebvre, R., Gauthier, C., Ballard, J.M., Jenkins, T., Ranney, T., and Pennington, J. (2003). "Evaluation of the impacts of live fire training at CFB Shilo (Phase II)," DRDC-Val TR 2003-XX, Defence Research and Development Canada - Valcartier, Val-Bélair, Quebec.
- Brannon, J. M., and Pennington, J. C. (2002). "Environmental fate and transport process descriptors for explosives," ERDC TR-02-10, U.S. Army Engineer Research and Development Center, Vicksburg, MS.
- Jenkins, T. F., Miyares, P. H., Walsh, M. E., Collins, N. H., and Ranney, T. A. (2000). "Evaluation of the use of snow covered ranges to estimate the explosives residues that result from detonation of army munitions," ERDC/CRREL Technical Report 00-15, U.S. Army Engineer Research and Development Center, Hanover, NH.
- Jenkins, T. F., Pennington, J. C., Ranney, T. A., Berry, T. E., Jr., Miyares, P. H., Walsh, M. E., Hewitt, A. D., Perron, N., Parker, L. V., Hayes, C. A., and Wahlgren, Maj. E. (2001). "Characterization of explosives contamination at military firing ranges," ERDC TR-01-05, U.S. Army Engineer Research and Development Center, Hanover, NH.
- Pennington, J. C., Jenkins, T. F., Brannon, J. M., Lynch, J., Ranney, T. A., Berry, T. E., Jr., Hayes, C. A., Miyares, P. H., Walsh, M. E., Hewitt, A. D., Perron, N., and Delfino, J. J. (2001). "Distribution and fate of energetics on DoD Test and training ranges: Interim Report 1." ERDC TR-01-13, U.S. Army Engineer Research and Development Center, Vicksburg, MS.
- Pennington, J. C., Jenkins, T. F., Ampleman, G., Thiboutot, S., Brannon, J. M., Lynch, J., Ranney, T. A., Stark, J. A., Walsh, M. E., Lewis, J., Hayes, C. A., Mirecki, J. E., Hewitt, A. D., Perron, N., Lambert, D., Clausen, J., and Delfino, J. J. (2002). "Distribution and fate of energetics on DoD test and training ranges: Interim Report 2." ERDC TR 02-8, U.S. Army Engineer Research and Development Center, Vicksburg, MS.
- Thiboutot, S., Ampleman, G., and Hewitt, A. (2002). "Guide for characterization of sites contaminated with energetic materials," ERDC-CRREL TR-02-01, U.S. Army Engineer Research and Development Center, Hanover, NH.

## Conference Presentations

- Ampleman, G., Thiboutot, S., Lewis, J., Marois, A., Martel, R., Lefebvre, R., Gauthier, C., Ballard, J. M., Jenkins, T., Ranney, T. A., and Pennington, J. C. (2003). "Evaluation of the environmental impact of live firing training at Canadian Force Base Shilo," Poster Session D: Risk Based Land Management (Soil and Groundwater). *FZK/TNO International Conference on Contaminated Land Management*. May 12-16, Kent, Belgium.

- Ampleman, G., Thiboutot, S., Lewis, J., Martel, R., Lefebvre, R., Gauthier, C., Ballard, J. M., Jenkins, T., Raney, T., Hewitt, A., and Pennington, J., (2002). "Evaluation of the impacts of live fire training in Canadian Ranges." *Partners in Environmental Technology Technical Symposium and Workshop*. December 3-5, Washington, DC.
- Jenkins, T. F., Hewitt, A. D., Walsh, M. E., Ranney, T. A., and Stutz, M. H. (2002). "Explosives contamination at DoD firing ranges." *UXO/Countermine Forum*. September 3-6, Orlando, FL.
- Jenkins, T. F., Hewitt, A. D., Walsh, M. E., Ranney, T. A., Pennington, J. C., Thiboutot, S., Ampleman, G., and Stutz, M. H. (2002). "Explosive contamination at DoD firing ranges." *UXO/Countermine Forum*. September 3-6, Orlando, FL.
- Jenkins, T. F., Ranney, T. A., Hewitt, A. D., Walsh, M. E., Stark, J., and Pennington, J. C. (2001). "Use of snow-covered ranges to determine the amount of explosives residues deposited from high-order detonations of Army munitions." *Geological Society of American National Meeting*. November 5-9, Boston, MA.
- Jenkins, T. F. (2001). "Characterization of sites potentially contaminated with explosives." *Partners in Environmental Technology Technical Symposium and Workshop*. November 26-29, Washington, DC.
- Jenkins, T. F. (2001). "Use of snow-covered ranges to determine the amount of explosives residues deposited from high-order detonations of Army munitions." Keynote presentation, *Partners in Environmental Technology Technical Symposium and Workshop*. November 28-30, Washington, DC.
- Jenkins, T. F., Pennington, J. C., Hewitt, A. D., Walsh, M. E., Thiboutot, S., Ampleman, G., Clausen, J., and Ranney, T. A. (2002). "Distribution and fate of energetics on DoD test and training ranges: Characterization of explosives contamination." *Partners in Environmental Technology Technical Symposium and Workshop*. December 3-5, Washington, DC.
- Pennington, J. C. (2001). "Environmental fate and transport of explosives." *17th International Conference on Contaminated Soils, Sediments, and Water*. October 24, 2001, Amherst, MA.
- Pennington, J. C., Jenkins, T. F., Brannon, J. M., Thiboutot, S., Delaney, J. E., Lynch, LTC J., and Clausen, J. L. (2001a). "Distribution and fate of energetics on DoD test and training ranges." *Geological Society of America Annual Meeting*. November 5, Boston, MA.
- Pennington, J. C., Jenkins, T. F., Brannon, J. M., Thiboutot, S., Delaney, J. E., Lynch, LTC J., and Delfino, J. J. (2001b). "Distribution and fate of energetics on DoD test and training ranges." *Partners in Environmental Technology Technical Symposium and Workshop*. November 27-29, Washington, DC.

- Pennington, J. C. (2002a). "Sustainable ranges: Characterization, fate, transport, and effects." Keynote presentation, *Partners in Environmental Technology Technical Symposium and Workshop*. December 3-5, 2002, Washington, DC.
- Pennington, J. C. (2002b). "Fate and transport of explosives in soil and ground water." *U.S. EPA Technical Support Project Semi-Annual Meeting*. November 19, Pensacola, FL.
- Thiboutot, S., Ampleman, G., Lewis, J., Martel, R., Paradis, D., Ballard, J.M., Lefebvre, R., and Gauthier, C. (2002). "Assessment of the environmental impact of the firing activity on active Canadian firing ranges." *Proceedings of the 33rd International ICT Conference*. Karlsruhe, Germany, June 2002, 55-1.

## **2 Site Characterization Research at Dona Ana Range, Fort Bliss, New Mexico**

---

### **Introduction**

#### **Background**

In the 2 years of this project, training ranges at Fort Lewis (FL), Washington, Yakima Training Center (YTC), Washington, and Camp Guernsey (CG), Wyoming, were sampled to assess the potential for contamination of groundwater with explosives-related contaminants (Jenkins et al. 2001, Pennington et al. 2001, 2002). At FL, surface soil samples were collected from three functional areas; a hand grenade range impact area, a firing point for 105-mm howitzers, and a portion of the artillery and mortar impact area. Groundwater was sampled from monitoring wells and seepage areas around the periphery of the artillery range. Historical firing records from an electronic database were reviewed to determine the kinds of munitions items that had been fired on the heavy artillery range over time.

At YTC, surface and shallow subsurface samples were collected from the artillery impact area, an antitank rocket range, and a number of munitions firing points. At CG, we collected soil samples from the artillery range impact area, a 155-mm firing point, and in areas impacted by low-order detonations, and blow-in-place operations. Surface soil samples were also collected from another hand grenade range at Fort Richardson (FR), Alaska.

All of these samples were analyzed for the presence of explosives and propellant residues using either GC-ECD SW846 Method 8095 (USEPA 1999), or reversed-phase high-performance liquid chromatography ultraviolet detection (RP-HPLC) -Method 8330 (USEPA 1994). Method 8095 provides detection limits from one to two orders of magnitude lower than Method 8330, but Method 8330 has proven more rugged in day-to-day operation.

The specific explosives and propellant residues found for a given type of range varied, depending on the energetic compounds present in the munition used



at that range. The distribution of explosives residues at these ranges was spatially very heterogeneous. Concentrations of explosives-related compounds in soils collected less than 1 m apart often differed by several orders of magnitude. To try to obtain representative samples in these areas, multi-increment composite samples were collected, and depending on the areas sampled, this improved the representativeness of samples to a greater or lesser degree. Concentrations of explosives residues in areas that were visibly free of craters, however, often had explosives concentrations as high as soils collected from the rims of craters formed from high-order detonations of various types of munitions. Much higher concentrations of residue, however, were found near low-order detonations and in some areas near blow-in-place operations.

### **Dona Ana Range, Fort Bliss, New Mexico**

The Dona Ana Range at Fort Bliss (FB) is located in the southwestern corner of New Mexico about 48 km (30 miles) north of El Paso, TX, and just south of the White Sands Missile Range (Figure 2-1). (Fort Bliss has a Texas address and the cantonment area is located at El Paso, TX; however, since the Dona Ana Range is located in the New Mexico portion of the installation, we have designated the area with the New Mexico location rather than the Texas location throughout.) Two impact areas are located within the Dona Ana Range Complex. One is located on the eastern slope of Rattlesnake Ridge, which is the southern most area of the Organ Mountains. The smaller range is directly north adjacent to the southeastern slope of Organ Peak. The two impact areas are 11,441 and 1,784 acres, respectively.

The climate at Fort Bliss is semiarid with the mean annual rainfall and temperature of 224 mm (8.8 in.) and 63.2 deg Fahrenheit. Historically, the two driest months of the year are April and May with mean rainfall of 5 and 6 mm (0.20 and 0.25 in.), respectively.

The Dona Ana Ranges are located in the northern Chihuaha biotic zone. Because the amounts of rainfall are different at different altitudes, the plants that inhabit various parts of the ranges differ. However, mesquite, sagebrush, sand yucca, dropseeds, saltbush, broom snakeweed, creosote bush, tarbush, and white-thorn are commonly found.

The soils at the Dona Ana Ranges are generally sandy loam, gravelly loam, fine sands, and silt. The soils are generally calcareous and alkaline, and are well drained.

The Dona Ana Ranges occupy most of the Organ Mountains and the alluvial fans on the east and south flanks. It extends well out into the basins to the east. The groundwater underlying the basin fill deposits is saline. The depth to groundwater in this area varies from about 30.5 m (100 ft) in the central part of the basin to 152 to 183 m (500 to 600 ft) near the heads of the alluvial fans. Most of the potable water in the area is located in the lenses of fresh water along the basin margins and the base of the mountains.

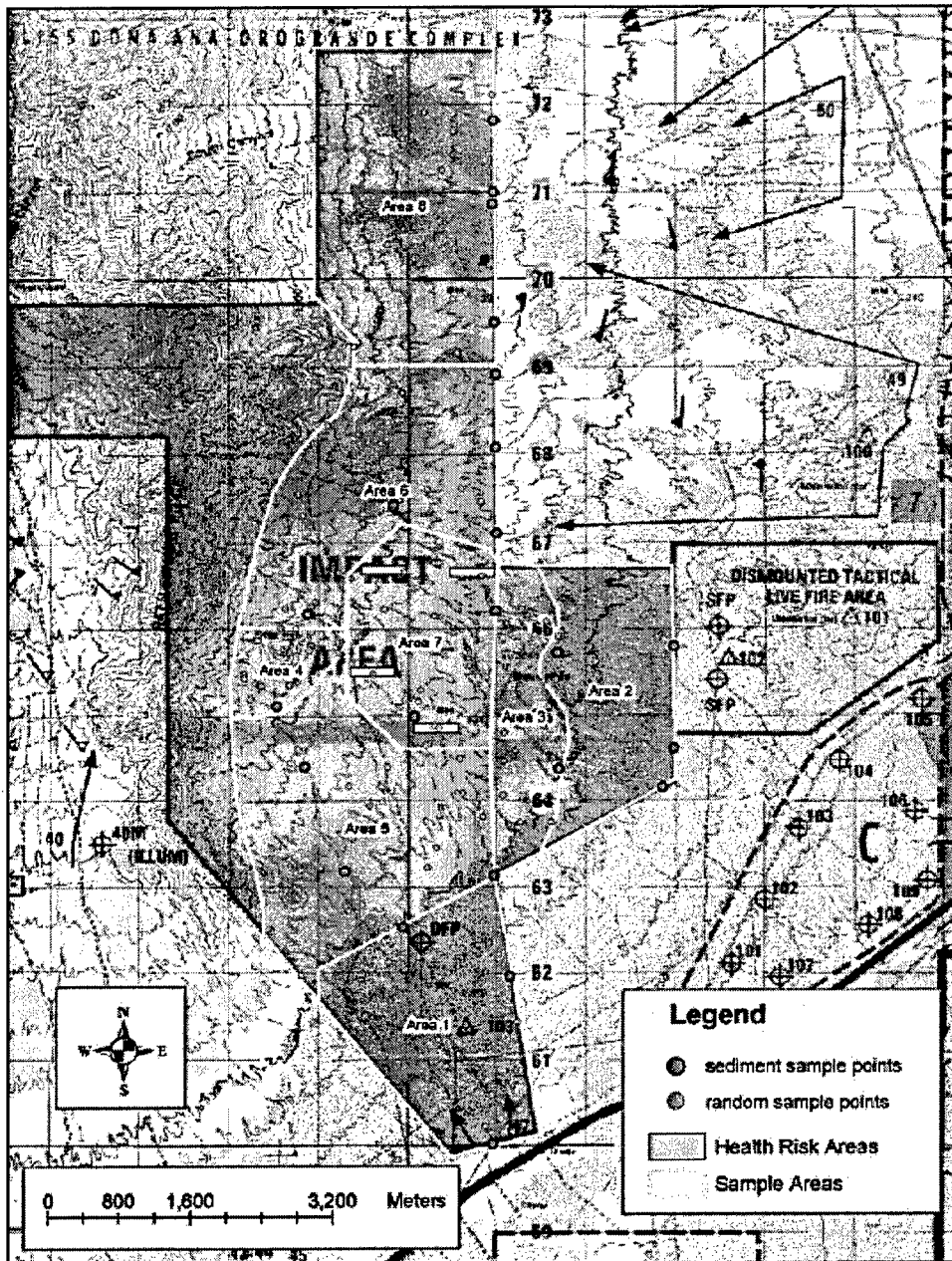

Figure 2-1. Map of Dona Ana Range Complex, Fort Bliss, New Mexico

## Objectives

The overall objective of the range characterization portion of this project was to determine the distribution of residues of explosives and propellants at military training ranges. Objectives for the FY 2002 study were to sample additional installations with various types of range activities and in areas with differing climates and soil types. This was to include both firing points and impact areas for artillery and mortars. A specific objective was to continue to test the use of composite sampling as a means of collecting representative samples in areas with various contamination sources. An additional objective was to determine whether surface intact and ruptured UXO items are localized contamination sources at the

various types of ranges. These sampling studies at firing points and impact ranges will also be used to determine if the conclusions obtained at the Fort Lewis, Yakima Training Center, and Camp Guernsey artillery ranges can be generalized to other sites.

The Dona Ana Range at Fort Bliss was selected for study because of the ability to access these ranges during the period that had been set aside for the U.S. Army Environmental Center (AEC) and the U.S. Army Center for Health Promotion and Preventive Medicine (CHPPM) to conduct a range characterization/screening level risk assessment. In addition, we had not sampled an artillery impact area that was located in the desert region of southwestern United States, and we were interested in the accumulation of residues that would occur in a very arid climate.

One specific objective of the research conducted at Fort Bliss was to assess the sample representativeness that can be achieved using 30-increment surface soil composites for grids that are 10 m × 10 m in size. Because the entire surface soil in this area to a depth of 2.5 cm is estimated to be about  $4.25 \times 10^3$  kg, it is not possible to sample and adequately subsample this entire area to estimate the “true” value for this grid. Our approach was to take duplicate 30-increment composite samples and determine to what degree the concentration estimates from these samples could be replicated.

## Materials and Methods

### Stratified random sampling

We collected several different types of soil samples at the Dona Ana Ranges Complex at Fort Bliss. In collaboration with field teams from CHPPM and AEC, we sampled a total of 19, 10-m × 10-m minigrids using duplicate 30-increment composite samples collected from the surface to a 2.5-cm depth (Figure 2-2). The protocol used to select these grids was developed as a part of the range characterization/risk screening effort being conducted by CHPPM/AEC. We collected soil samples in these grids using stainless steel hand shovels; the total mass of soil collected for these composite samples ranged from 1 to 2 kg.

Seven of these minigrids were located in an area used for firing 155-mm howitzers; the other 12 minigrids that were sampled were within the boundaries of the artillery impact area. These minigrids were selected from a set of randomly located minigrids established by personnel from CHPPM. The CHPPM personnel were conducting a range characterization at the same time that we were conducting our research study at Fort Bliss. These same 19 minigrids were sampled by CHPPM/AEC personnel. Samples collected by CHPPM/AEC were also composites collected at five predesignated locations within each minigrid as shown in Figure 2-2. The depth of sampling for the CHPPM/AEC samples was 0 to 7.5 cm.

Sampling Scheme for Stratified Random Sampling in 10-m by 10-m Minigrids  
 Conducted Jointly with CHPPM  
 Dona Ana Range Complex  
 Ft. Bliss, New Mexico

- ✕ Random Sampling Locations for 30-Point Composites
- Fixed Sampling Locations for 5-Point Composites (CHPPM)

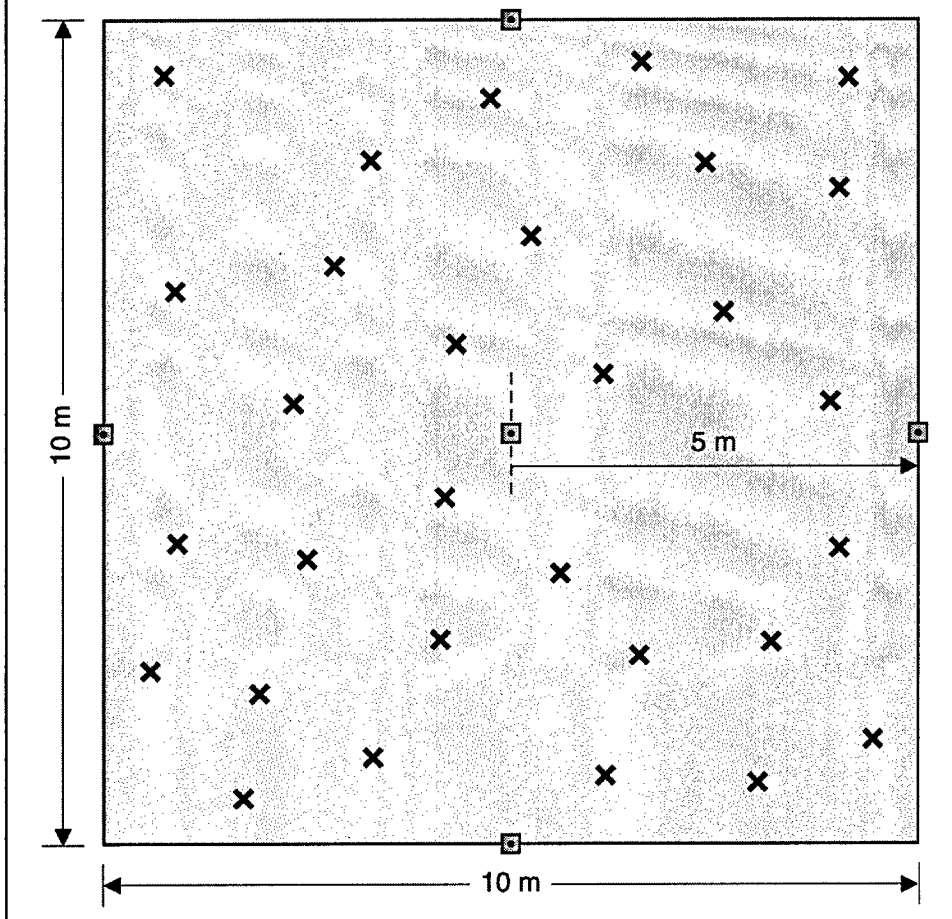

Figure 2-2. Diagram of CRREL, CHPPM, and AEC sampling strategies for stratified random sampling of minigrids at Dona Ana Range, Fort Bliss, New Mexico

### Judgmental sampling

In addition to samples collected from randomly selected grids, we also collected discrete and composite samples from other areas of the Dona Ana Range. These judgmental samples were collected where we observed various surface anomalies that we suspected might result in deposition or release of residues of energetic compounds. These included samples collected near artillery targets, in areas where chunks of explosives or propellants were observed on the surface, from the firing line at a LAW rocket range, from areas where low-order detonation debris was observed, from several craters including a demolition

crater, and from areas with unexploded ordnance (UXO). Composite samples were collected in an identical manner as described above for minigrid sampling. At several locations, we also collected five-point composite samples using the approach described above for samples collected by CHPPM/AEC personnel. Discrete surface and shallow subsurface soil samples were also collected in some of these same areas. Composite surface soil samples were collected at the firing point of a LAW rocket range at predetermined distances in front of and behind the firing line. A description of the areas sampled is provided below in Sample Collection and Processing.

All composite samples were placed in 305- × 381-mm (12- × 15-in.) polyethylene bags (KNF Clean Room Products, Inc., Ronkonkoma, NY). After collection, these bags were sealed using cable ties and were placed in Zip Lock bags and shipped to the laboratory in ice filled coolers by overnight carrier. Upon arrival at CRREL the samples were frozen at -30 °C until extracted and analyzed. Discrete soil samples were placed in Zip Lock bags and shipped to the laboratory and stored as described above.

**Artillery targets.** Composite samples were collected around the circumference of five artillery targets (old tanks). For tanks 1 and 5, duplicate samples were collected at a distance of 0 to 2 m and 5 m from the target (Figure 2-3). For tank targets 2 through 4, duplicate composites were collected only at the 0- to 2-m distance. Of the five targets sampled, target 5 was the most heavily impacted. Near tank target 1, there was a large open demolition (OD) crater that appeared to be used by explosive ordnance disposal (EOD) personnel for the destruction of unexploded ordnance (UXO). Targets 2 through 4 showed very little damage from training.

**Areas with visible chunk explosives.** Two areas were found where large numbers of pieces of explosive were visible on the surface. In each area, a 10- × 10-m minigrid was established, and the individual pieces of explosive were picked up and the number and mass recorded. In the first area, 34 pieces of explosive were found that weighed a total of 67 g. The largest piece weighed 44 g. The presence of these pieces of explosive appeared to be the result of two low-order 90-mm recoilless rifle rounds that were present adjacent to the 10- × 10-m area. Several different types of samples were collected in this area (Figure 2-4): seven 30-increment surface composites (0- to 2.5-cm depth), five 5-increment (0- to 7.5-cm) composites, and five discrete (0- to 2.5-cm) samples. In addition, discrete samples were collected directly under a chunk of explosive at 0 to 1 cm, 1 to 2 cm, and 2 to 3 cm.

In the second 10- × 10-m area littered with chunk explosives, we collected about 100 pieces (Figure 2-5). Sampling was conducted in a similar manner: seven 30-increment (0 to 2.5 cm) composites, five five-increment composites (0 to 7.5 cm), and five surface discrete samples (0 to 2.5 cm). In addition, four subsurface discrete samples at a 5- to 7-cm depth were collected below the first four surface discrete samples.

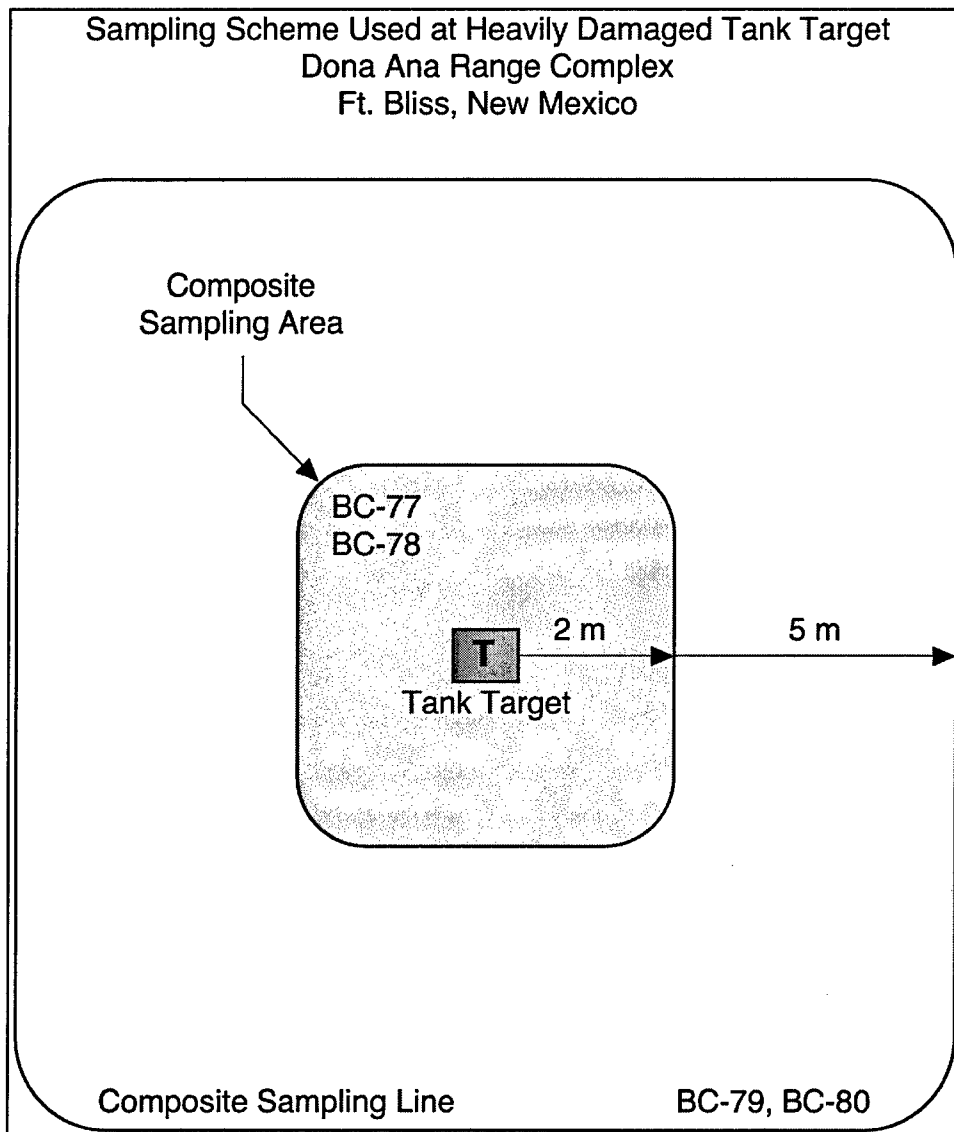

Figure 2-3. Diagram for samples collected near a heavily damaged tank target at Dona Ana Range, Fort Bliss, New Mexico

A third area where chunk explosive was observed on the surface was within a ravine (arroyo) where a 155-mm round had undergone a low-order detonation. Several pieces of explosive were observed in front of the open end of the round (Figure 2-6). Discrete surface soil samples were collected at distances of 20 cm, and 1, 2, 3, 4, 5, 12, 30, 50, and 100 m down the dry ravine from the location of the low-order 155-mm round (Figure 2-7).

Sampling Scheme for 10-m by 10-m Minigrids Contaminated with Chunk Explosives  
Dona Ana Range Complex  
Ft. Bliss, New Mexico

- ⊙ Discrete Sample Locations
- × Random Sampling Locations for 30-Point Composites
- Fixed Sampling Locations for 5-Point Composites (CHPPM)

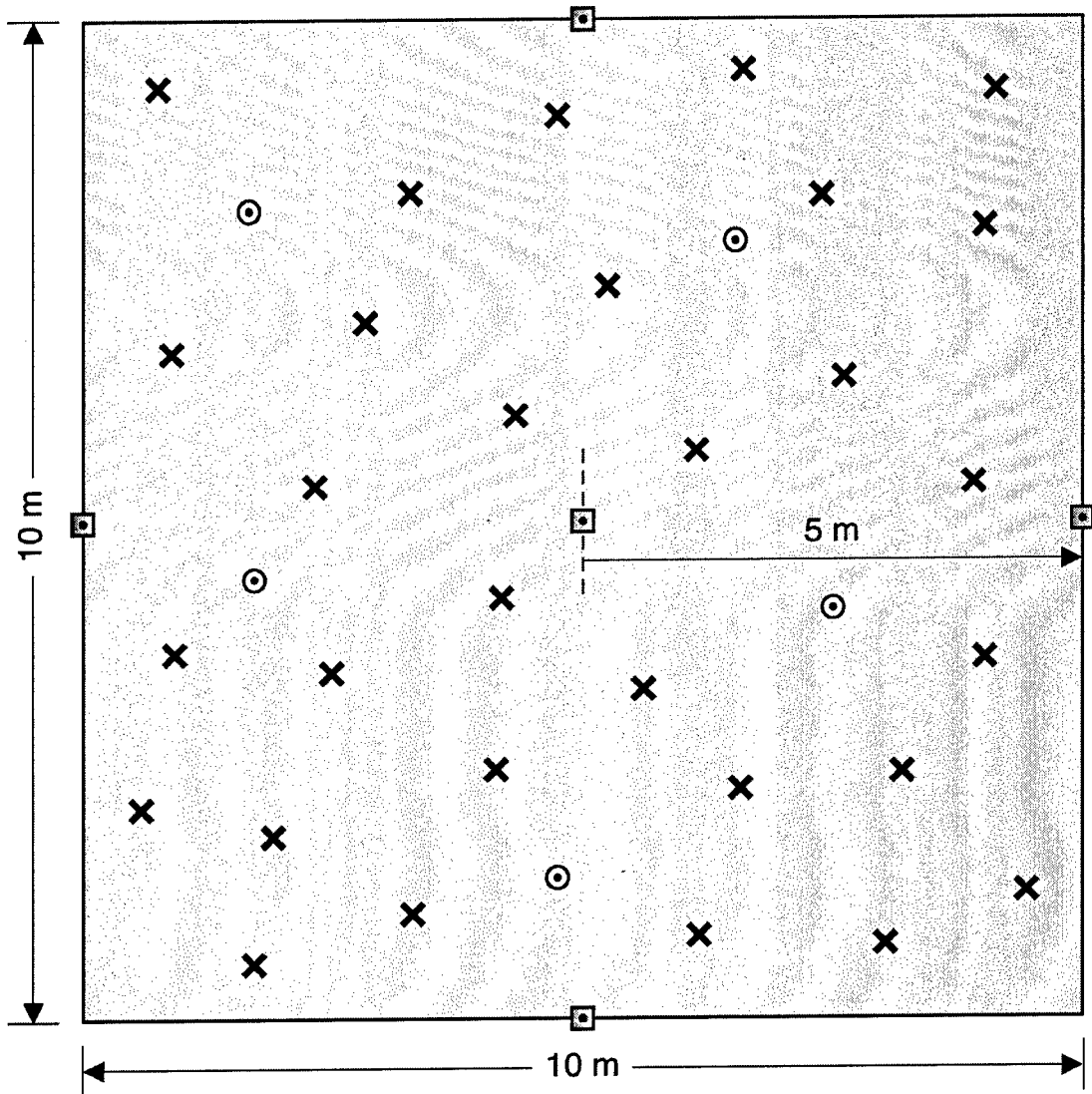

Figure 2-4. Diagram for samples collected for a 10- × 10-m area contaminated with pieces of TNT at Dona Ana Range, Fort Bliss, New Mexico

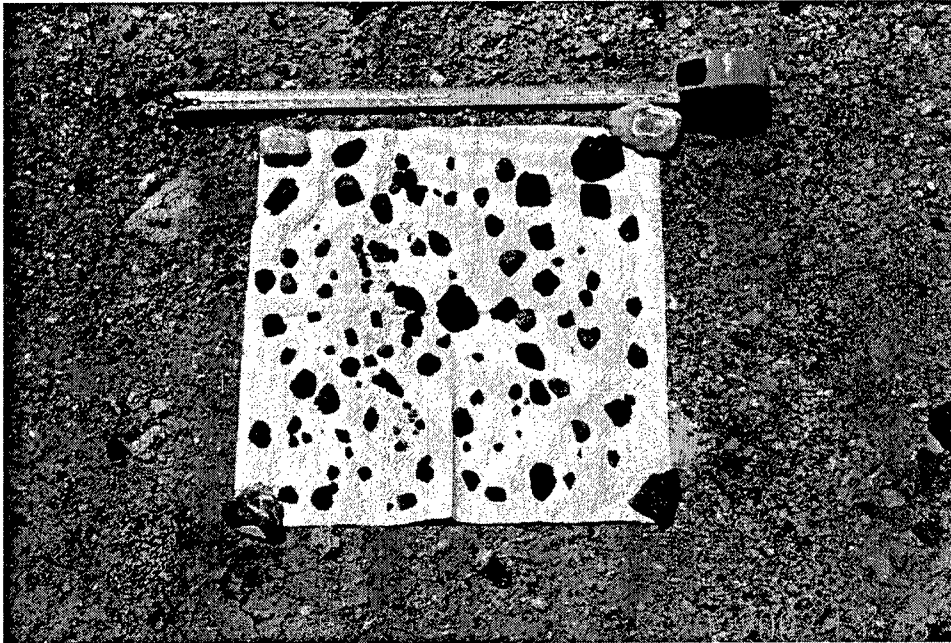

Figure 2-5. Photograph of pieces of TNT found within 10- x 10-m area sampled at Dona Ana Range, Fort Bliss, New Mexico



Figure 2-6. Photograph of low-order 155-mm round with chunks of TNT visible



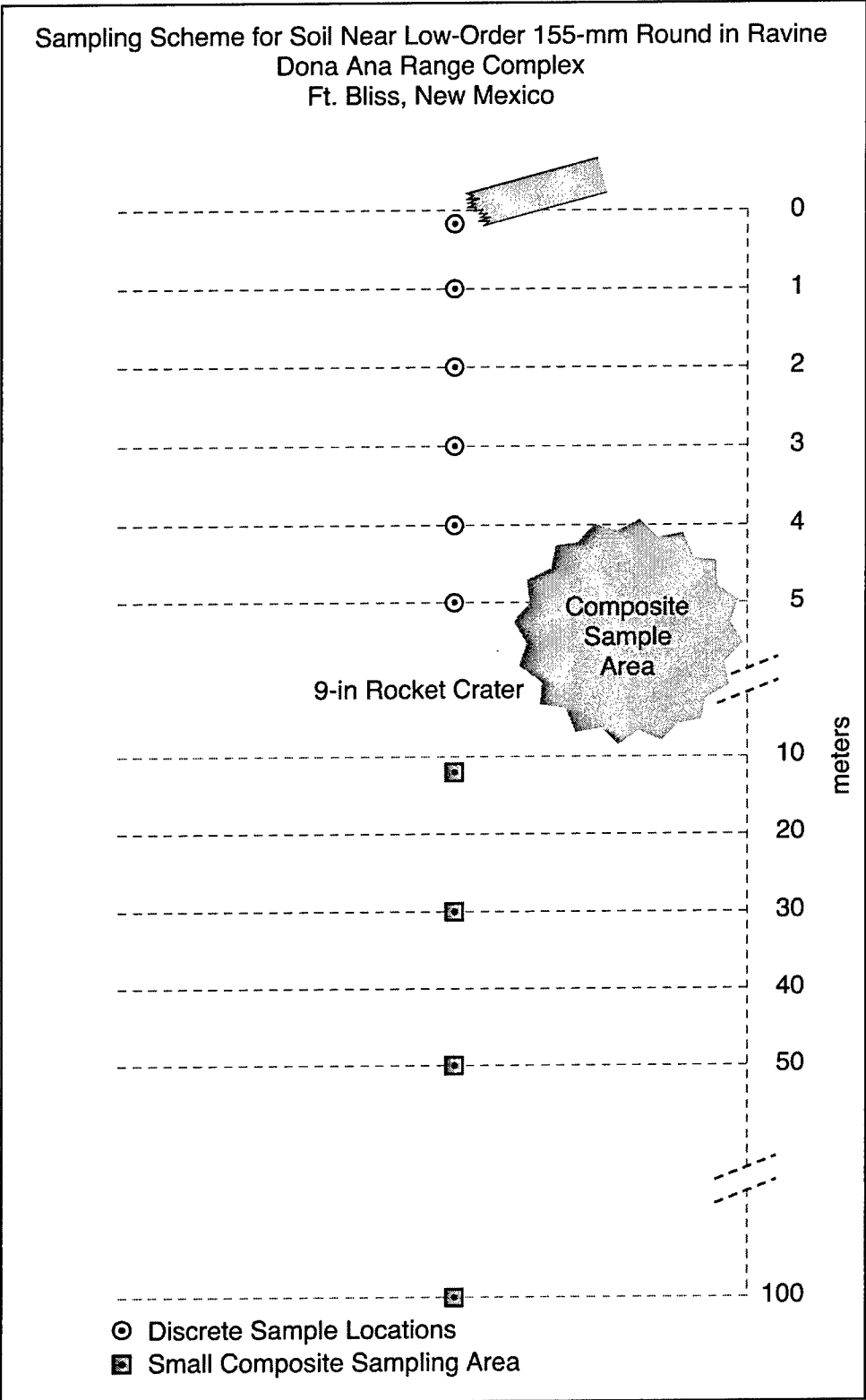

Figure 2-7. Diagram for samples collected in a ravine down slope from a low-order 155-mm round at the artillery impact area at Dona Ana Range, Fort Bliss, New Mexico

**Firing point at LAW rocket range.** Surface composite samples were collected in front of and behind the firing line at Range 53, a LAW rocket range (Figure 2-8). Duplicate 30-increment composites were collected along a 6-m strip parallel with and 5 m and 10 m behind the firing line. Duplicate 30-point composites were also collected at distances of 10, 20, and 30 m in front of the firing position along a 10-m strip parallel with the firing line.

**Low-order detonations.** A number of samples were collected next to munition items that had undergone low-order detonations. The first area sampled was next to a 155-mm howitzer round that had low ordered. Surface and subsurface discrete soil samples were collected next to the round at 0 to 2.5 cm and 2.5 to 7.5 cm, respectively.

Four soil samples were collected near a low-order 90-mm recoilless rifle round (Figure 2-9). A discrete sample was collected below the low-order round next to several pieces of chunk explosive. Discrete surface samples were also collected at 2 and 3.7 m downslope of the round. A composite surface soil sample was also collected in an arc 6 m downslope of the round. This sample and other composites were composed of 30 individual increments, unless otherwise stated.

A discrete sample was collected next to another 155-mm round that had undergone a low-order detonation. The soil sample was collected under several pieces of explosive that were moved. A composite surface sample was collected in front of the round at a distance of about 1 m. One discrete and one composite sample were collected 1.5 m downhill from the composite sample in an area expected to receive runoff from the round.

**Crater samples.** Several craters were sampled at various locations on the Dona Ana range. The first crater sampled was formed from the impact of a large 9.5-cm-diam rocket. A composite sample was collected from the crater walls and bottom. The EOD staff members were not familiar with this munition item. The next crater sampled may have been formed from a 90-mm recoilless rifle round because one was observed in the bottom of the crater. A surface composite was collected in a circular pattern at a distance of 1 m from the edge of the crater. Several samples were collected around a large open demolition crater located adjacent to tank target 1. Samples were collected from the bottom, the side-wall, and the rim of the detonation crater. Duplicate composite samples were also collected within the crater formed from the impact of a 5-in. rocket that had not detonated. Lastly, a surface composite sample was collected combining soil from the bottom and walls of a crater of unknown origin.

**Soil samples collected next to UXO items.** A number of samples were collected next to intact and ruptured UXO items. The first sample of this type was collected next to a small opening on the side of the nose of a 155-mm round. The outer surface of the metal next to the opening was wiped and screened using the EXPRAY kit and the result was positive for nitroaromatics (probably TNT).

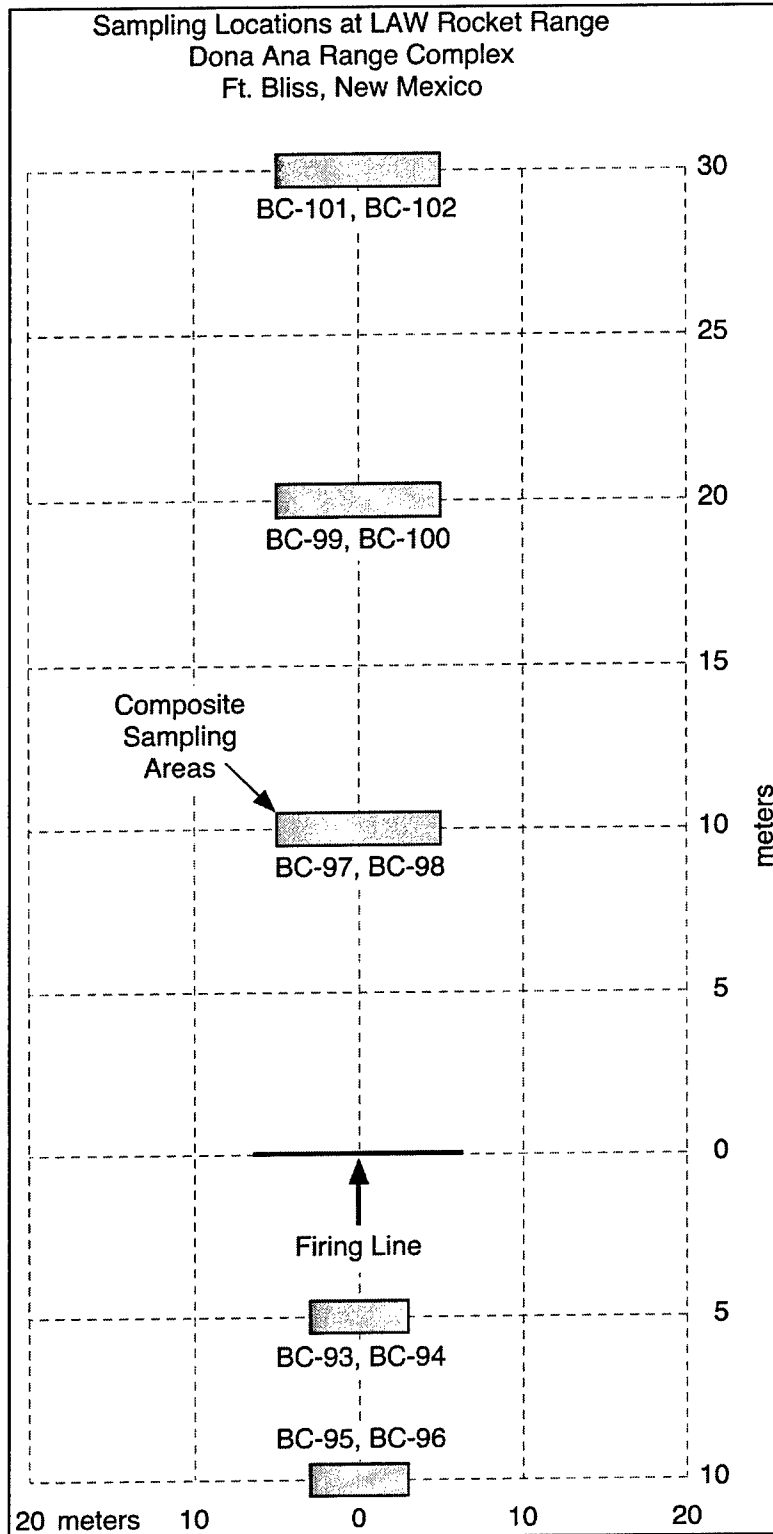

Figure 2-8. Diagram for samples collected near the firing line at the LAW rocket range, Dona Ana Range, Fort Bliss, New Mexico

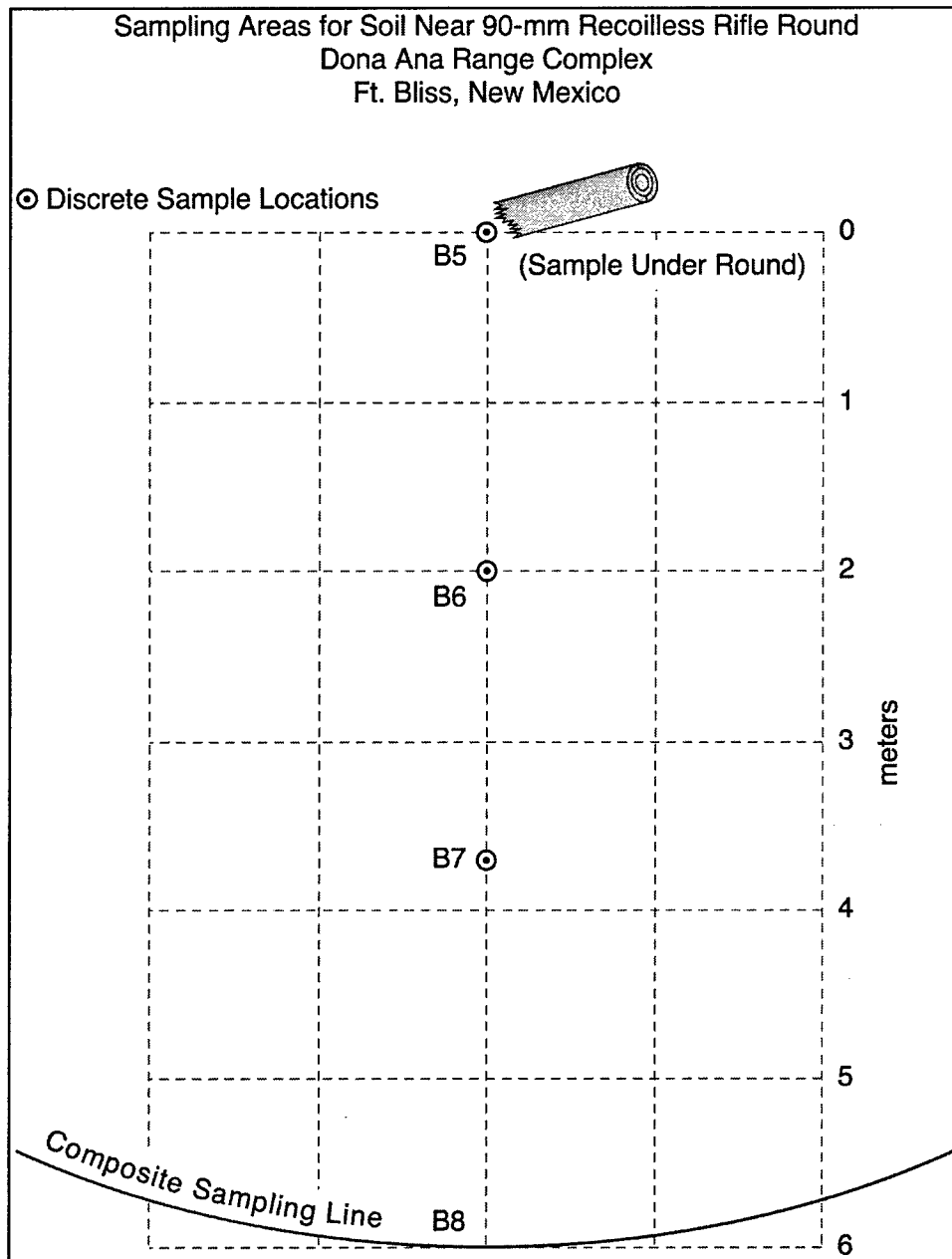

Figure 2-9. Diagram for samples collected near a low-order 90-mm recoilless rifle round at Dona Ana Range, Fort Bliss, New Mexico

Two discrete samples were collected around a 2.75-in. rocket warhead (Figure 2-10). The second sample was collected next to a hole in the propellant end of the rocket. A discrete soil sample was collected under the nose of a 155-mm round with the fuse missing and under a second 155-mm round with the fuse and booster missing. A surface discrete sample was also collected next to a 2.75-in. rocket from which the fuse and booster were missing.



Figure 2-10. Photograph of low-order 2.75-in. rocket warhead, Dona Ana Range, Fort Bliss, New Mexico

### Sample collection and processing

**Subsampling.** The samples from Fort Bliss were very dry and required no additional air-drying prior to processing. Composite soil samples were warmed to room temperature and passed through a 10-mesh sieve to remove small stones and pieces of metal. The material that passed the 10-mesh sieve was further separated by passing through a 30-mesh sieve. The material that passed the 30-mesh sieve (less than 0.6 mm) was placed in an aluminum pie pan and thoroughly mixed. A  $5.00 \pm 0.02$ -g subsample of soil was removed by collecting about 15 individual portions from random locations on the pie pan. Laboratory duplicates were obtained in an identical manner for about one-fifth of the composite samples. Discrete samples were passed through the 30-mesh sieve and the entire amount that passed the sieve was weighed and used for analysis.

The sieves were cleaned between samples by initially dislodging as much of the material as possible, then rinsing thoroughly with deionized water, and bottle spraying with acetone.

Selected soil samples were ground on a LabTechnics (Labtech Essa Pty. Ltd., Bassendean, WA, Australia) ring mill at CRREL. The grind time was 70 sec.

**Extraction.** Soil subsamples (5-g) were placed into 20-ml glass vials and a 10-ml aliquot of acetonitrile (AcN) was added to each. For subsamples less than 5 g, the proportion of soil (mass, g) to acetonitrile (volume, mL) was maintained at about 1 to 2. The vials were individually placed on a vortex mixer for 30 sec to suspend the soil particles, and the vials were placed in an ultrasonic bath for 18 hr. The temperature of the bath was maintained at less than 25 °C with cooling

water. The vials were removed from the bath and allowed to stand undisturbed for at least 30 min (USEPA 1994).

For samples analyzed by gas chromatography (GC), the extracts were filtered through a 25-mm Millex-FH (0.45- $\mu\text{m}$ ) disposable filter, discarding the first milliliter and collecting the remainder in a clean autosampler vial. For samples to be analyzed by reversed-phase high-performance liquid chromatography (RP-HPLC), a 1.0-ml portion of the filtered extract was mixed with 3.0 mL of reagent grade water. These processed extracts were refrigerated until analyzed.

Composite samples collected using the stratified random sampling method were analyzed using GC-ECD (electron capture detection) (USEPA 1999), as described below. Judgmental samples, collected near targets, firing points, low-order detonations, or chunks of explosives, were analyzed using either RP-HPLC or GC-ECD based on the level of contamination expected on the basis of our previous studies (Jenkins et al. 2001, Pennington et al. 2002). Those expected to have concentrations above 1,000  $\mu\text{g}/\text{kg}^{-1}$  were analyzed using RP-HPLC. Those expected to have concentrations below this value were analyzed using GC-ECD. In a number of cases, samples were analyzed using both methods, and when this occurred, values in excess of 1,000  $\mu\text{g}/\text{kg}^{-1}$  were taken from the RP-HPLC analyses.

**GC-ECD analysis.** Soil sample extracts were maintained at 4 °C until analyzed, generally within 14 days of extraction. The autosampler vials containing acetonitrile soil extracts were placed into GC autosampler trays that were continuously refrigerated by circulating 0 °C glycol/water through the trays.

The samples were injected onto a HP-6890 GC equipped with a microcell  $^{63}\text{Ni}$  electron capture detector. Results were obtained according to the general procedure outlined in EPA SW846 Method 8095 (USEPA 1999). Direct injection of 1  $\mu\text{L}$  of soil extract was made into a purged packed inlet port (250 °C) equipped with a deactivated Restek Uniliner. Primary analysis was conducted on a 7-  $\times$  0.53-mm ID fused-silica column, with a 0.5- $\mu\text{m}$  film thickness of 5 percent-(phenyl)-methylsiloxane (Rtx-5MS from Restek, Bellefonte, PA). The GC oven was temperature programmed as follows: 100 °C for 2 min, 10 °C/min ramp to 270 °C, 2-min hold. The carrier gas was hydrogen at 10 mL/min (linear velocity approximately 95 cm/sec). The ECD makeup gas was nitrogen flowing at 45 mL/min. The detector temperature was maintained at 300 °C. Retention times for target analytes are presented in Table 2-1. All extracts were also reanalyzed on a confirmation column, a 6-m  $\times$  0.53-mm ID having a 1.0- $\mu\text{m}$  film thickness of a proprietary phase (Rtx-TNT-2 from Restek). The GC oven was temperature programmed as follows: 130 °C for 1 min, 10 °C/min ramp to 160 °C, and then 30 °C/min to 270 °C, 2.3-min hold. The carrier gas was hydrogen at 15 mL/min (linear velocity approximately 150 cm/sec). The detector temperature was maintained at 300 °C. Retention times for target analytes using this separation are also presented in Table 2-1. Where analyte concentrations exceeded the highest standard, appropriate dilutions of the extracts were made and the diluted extracts analyzed. If analyte concentrations were within the linear range of the ECD, concentrations reported were taken from the determination on the primary column, unless co-elution with another compound appeared to occur. In such cases, reported concentrations were taken from the determination on the

confirmation column. Estimated detection limits for the GC-ECD analyses are given in Table 2-2. Multianalyte standards (Method 8095 (USEPA 1999)) were purchased from Restek and instrument calibration utilized five concentration levels.

Analyte	Retention Time, min	
	RTX-5	RTX-TNT-2
Nitrobenzene	0.57	0.51
o-Nitrotoluene	0.79	0.65
m-Nitrotoluene	0.93	0.81
p-Nitrotoluene	1.01	0.9
NG	2.33	2.46
1,3DNB	3.16	2.78
2,6DNT	3.32	2.58
2,4DNT	4.08	3.46
TNB	5.85	5.05
TNT	5.99	4.94
PETN	6.95	
RDX	7.56	5.8
4ADNT	8.1	5.53
3,5DNA	8.18	5.7
2ADNT	8.5	5.87
Tetryl	9.38	6.37
HMX	13.48	6.37

Analyte	Soil, µg/kg-1	
	RP-HPLC	GC-ECD
HMX	26	26
RDX	34	3
TNB	16	3
TNT	16	1
2,6DNT	19	0.8
2,4DNT	28	0.8
2ADNT	38	2.5
4ADNT	32	1.6
NG	20	2
DNA	Co-elutes with NB	2
DNB	100	0.7
TETRYL	600	20
PETN	500 (est.)	16

**RP-HPLC analysis.** High concentration extracts were analyzed by RP-HPLC according to the general outline provided in SW846 Method 8330 (USEPA 1994). When samples were analyzed by both GC-ECD and RP-HPLC, concentrations above 1,000  $\mu\text{g}/\text{kg}^{-1}$  were taken from the HPLC analysis, which had a higher range of linearity. Analysis was conducted on a modular system, from Thermo Finnigan (Thermo Separation Products Inc., San Jose, CA), composed of a SpectraSYSTEM Model P1000 isocratic pump, a SpectraSYSTEM UV2000 dual wavelength UV/VIS absorbance detector set at 210 and 254 nm (cell path 1 cm), and a SpectraSYSTEM AS3000 auto sampler. Instrument calibration, data capture, analysis, and reporting was performed using ChromQuest software. Nitroglycerin and PETN concentrations were taken at the 210-nm wavelength and the remaining analytes at 254 nm.

Separations were conducted on a 15-cm  $\times$  3.9-mm (4- $\mu\text{m}$ ) NovaPak C-8 column (Waters Chromatography Division, Milford, MA) eluted with 15:85 isopropanol/water (v/v) at 1.4 ml/min. Samples were introduced by overfilling a 100- $\mu\text{l}$  sampling loop. Concentrations were estimated against commercial multianalyte standards (Restek 8095 multianalyte standard) from peak heights. Estimated detection limits for the RP-HPLC method are presented in Table 2-2. Retention times of the analytes of interest are shown in Table 2-3.

**Table 2-3  
RP-HPLC Retention Times (min) of Target Analytes (Explosives, Propellants, Manufacturing Impurities, and Transformation Products)**

Compound	Retention Time <sup>1</sup>
HMX	1.40
TNB	2.29
RDX	2.61
DNB	4.37
TNT	4.99
Tetryl	5.65
NB + DNA	6.82
NG	7.51
2,4DNT	9.68
2,6DNT	11.82
2ADNT	12.63
4ADNT	14.38
PETN	15.63
p-NT	16.91
o-NT	17.34
m-NT	19.32

<sup>1</sup>HPLC column, 15-cm  $\times$  3.9-mm (4- $\mu\text{m}$ ) NovaPak C-8 column eluted with 15:85 isopropanol/water (v/v) at 1.4 ml/min.

**Onsite sample processing.** Several composite and discrete samples were subsampled onsite. Each field sample was air-dried, passed through a 10-mesh (2-mm) sieve; manually ground with a hand grinder mill, then returned to the plastic sample bag and thoroughly mixed (Figure 2-11). Seven subsamples were



taken from one composite sample and duplicates were taken from all of the others. Subsampling was performed after pouring the contents of the bag onto a fresh sheet of aluminum foil. The sample was slowly poured in a long rectangular pile, passing back and forth several times. After completion of the layered cake two large paint scrapers were used to remove sections (entire cross section) from the pile. Subsamples were wrapped in aluminum foil and returned to CRREL for analysis.



Figure 2-11. Photograph of manual soil grinder and sieves tested at Fort Bliss, New Mexico

### **Onsite screening using EXPRAY kit**

The Expray kit (Plexus Scientific, Silver Spring, Maryland) was used to help identify the composition of explosives residues associated with low-order rounds. Suspected pieces of high explosives and propellants were rubbed with test sheets, or a Q-tip when reaching into a cavity, then sprayed sequentially with two aerosol cans provided in the Expray kit. In addition, small pieces of suspected materials were also dissolved in acetone, then a drop of the solution was transferred to a test sheet and allowed to dry before spraying. This second approach was less susceptible to a false indication for the presence of nitramines when rubbing pieces of TNT.

## **Results**

### **Stratified random sampling**

The results for samples collected at minigrids selected, using CHPPM's stratified sampling protocol, are presented in Table 2-4.

**Table 2-4  
Concentrations of Explosives in Soil Samples Obtained Using Stratified Random  
Sampling Approach<sup>1</sup>, µg/kg<sup>-1</sup>**

CHPPM Sample Number	CRREL Sample Number	HMX	RDX	TNT	NG	2,4DNT	2,6DNT	2ADNT	4ADNT
FP-100-SL-01	BC-1	<26	<3	<1	<2	<0.8	<0.8	<2.5	<1.6
	BC-2	<26	<3	<1	<2	<0.8	<0.8	<2.5	<1.6
FP-100-SL-03	BC-3	<26	<3	<1	<2	<0.8	<0.8	<2.5	<1.6
	BC-4	<26	<3	<1	<2	<0.8	<0.8	<2.5	<1.6
FP-100-SL-04	BC-5	<26	<3	<1	<2	<0.8	<0.8	<2.5	<1.6
	BC-6	<26	<3	<1	<2	<0.8	<0.8	<2.5	<1.6
FP-100-SL-05	BC-7	<26	<3	<1	<2	<0.8	<0.8	<2.5	<1.6
	BC-8	<26	<3	<1	<2	<0.8	<0.8	<2.5	<1.6
FL-100-SL-06	BC-9	<26	<3	<1	<2	<0.8	<0.8	<2.5	<1.6
	BC-10	<27	9	<1	<2	<0.8	<0.8	<2.5	<1.6
FL-100-SL-07	BC-11A	<26	<3	<1	<2	<0.8	<0.8	<2.5	<1.6
	BC-11B	<26	<3	<1	26	<0.8	<0.8	<2.5	<1.6
	BC-12	<26	<3	<1	968	<0.8	<0.8	<2.5	<1.6
FP-100-SL-08	BC-13	<26	<3	<1	<2	<0.8	<0.8	<2.5	<1.6
	BC-14	<26	<3	<1	<2	<0.8	<0.8	<2.5	<1.6
ST7-SL-09	BC-15	<26	<3	<1	177	11	<0.9	<2.5	<1.6
	BC-16	<26	<3	<1	<2	<0.8	<0.8	<2.5	<1.6
ST7-SL-12	BC-17	<26	<3	<1	<2	<0.8	<0.8	<2.5	2
	BC-18	<26	<3	<1	<2	<0.8	<0.8	<2.5	<1.6
ST7-SL-11	BC-19	<26	9	49	<2	<0.8	<0.8	<2.5	<1.6
	BC-20	<26	<3	<1	<2	<0.8	<0.8	<2.5	<1.6
ST7-SL-07	BC-22	<26	<3	30	<2	<0.8	<0.8	<2.5	<1.6
	BC-23	<26	<3	<1	<2	<0.8	<0.8	<2.5	<1.6
ST7-SL-08	BC-24A	<26	<3	<1	<2	<0.8	<0.8	<2.5	<1.6
	BC-24B	<26	<3	<1	<2	<0.8	<0.8	<2.5	<1.6
	BC-25	<26	<3	<1	<2	<0.8	<0.8	<2.5	<1.6
ST4-SL-05	BC-30	<26	<3	<1	<2	<0.8	<0.8	<2.5	<1.6
	BC-31	<26	<3	15	171	<0.8	<0.8	<2.5	<1.6
ST7-SL-15	BC-43	<26	<3	<1	<2	<0.8	<0.8	<2.5	<1.6
	BC-44	<26	<3	<1	<2	<0.8	<0.8	<2.5	<1.6
ST4-SL-07	BC-52	<26	5	<1	<2	<0.8	<0.8	5	8
	BC-53	<26	8	<1	<2	<0.8	<0.8	8	11
ST4-SL-01	BC-54	<26	<3	<1	<2	<0.8	<0.8	<2.5	<1.6
	BC-55	<26	<3	<1	<2	<0.8	<0.8	<2.5	4
ST4-SL-2	BC-56A	<26	<3	<1	<2	<0.8	<0.8	<2.5	<1.6
	BC-56B	<26	<3	<1	<2	<0.8	<0.8	<2.5	<1.6
	BC-57A	<26	<3	<1	<2	<0.8	<0.8	<2.5	<1.6
	BC-57B	<26	<3	<1	<2	<0.8	<0.8	<2.5	<1.6
ST4-SL-08	BC-58A	26	<3	<1	634	3	<0.8	<2.5	<1.6
	BC-58B	<26	<3	<1	127	<0.8	<0.8	<2.5	<1.6
	BC-59A	<26	<3	<1	<2	<0.8	<0.8	<2.5	<1.6
	BC-59B	<26	<3	<1	<2	<0.8	<0.8	<2.5	<1.6
ST2-SL-14	BC-75A	66	<3	<1	355	<0.8	<0.8	12	<1.6
	BC-76A	<26	<3	11	81	<0.8	<0.8	8	<1.6

<sup>1</sup> These results were generated in the CRREL analytical laboratory. CHPPM also collected samples within this grid. Values above analytical detection limits are shaded. CRREL collected duplicate samples (e.g., BC-1 and BC-2) in each grid that we sampled with CHPPM.

The first seven minigrids, labeled FP-100, were collected at an area that has been used for firing 155-mm howitzers. Samples from only two of these 10-m × 10-m sampling areas had detectable levels of residues of energetic compounds. One replicate sample in grid FL100-SL-06 had a barely detectable level of RDX ( $9 \mu\text{g}/\text{kg}^{-1}$ ), but neither RDX nor any other target analyte was detected in its replicate sample. For grid FP100-SL-07, nitroglycerine (NG) was detected at  $968 \mu\text{g}/\text{kg}^{-1}$  in one field duplicate sample and at  $26 \mu\text{g}/\text{kg}^{-1}$  in one of two laboratory replicates of the other field duplicate. NG was not detected in the second laboratory replicate from this second field duplicate. NG is a component of double- and triple-based propellants and its presence in soils at firing points is not surprising. The source of RDX in the one firing point sample is unknown, but the concentration is just above analytical detection limits of  $3 \mu\text{g}/\text{kg}^{-1}$ . In general, though, very little residue of energetic materials was found in the surface soils in these seven randomly selected firing point minigrids.

The other 12 randomly selected minigrids were located within strata, defined by the CHPPM/AEC sampling plan, within the artillery range impact area. These samples are labeled ST7, ST4, and ST2 in Table 2-4.

Concentrations of explosives residues were detected sporadically and at low concentrations in the samples from the impact area. RDX was detected in 4 of the 24 samples collected in the impact areas at a maximum concentration of  $9 \mu\text{g}/\text{kg}^{-1}$ . TNT was detected in three samples at a maximum concentration of  $49 \mu\text{g}/\text{kg}^{-1}$ . HMX was detected in two samples with a maximum concentration of  $66 \mu\text{g}/\text{kg}^{-1}$ . The agreement of replicate field samples was poor for these low concentration samples except for sample ST4-SL-07, where the concentrations obtained for RDX and the two transformation products of TNT (2ADNT and 4ADNT) agreed very well.

Propellant residues (NG, 2,4DNT) were also detected in some of the impact area samples. NG was detected in 4 of the 12 samples with a maximum concentration of  $634 \mu\text{g}/\text{kg}^{-1}$ . Two samples revealed 2,4DNT, but the maximum concentration was only  $11 \mu\text{g}/\text{kg}^{-1}$ . The agreement of concentrations for replicate field samples was poor for propellant residues in these samples, also. Residues of energetic compounds in this artillery range impact area appear to be so heterogeneously distributed that even the collection of 30-point surface composite samples is inadequate in providing reproducible samples.

For these randomly collected samples, five sets of laboratory duplicates were analyzed. These duplicate subsamples were obtained after soil samples were sieved and thoroughly homogenized. Even so, the agreement between laboratory duplicates is poor for those samples where residues were detected (Table 2-4). In most cases, the concentrations were very low, near analytical detection limits. In sample BC58, though, the concentration of NG was above  $100 \mu\text{g}/\text{kg}^{-1}$  in both BC58A and BC58B,  $634$  and  $127 \mu\text{g}/\text{kg}^{-1}$ , respectively, a relative percent difference (RPD) of 133. Thus, even for subsamples from a given sample, the analyte distribution is heterogeneous, and the ability to replicate analytical results at low concentrations is poor.

These analytical results for samples collected using stratified random sampling demonstrate that residues of explosives and propellants are very low

over most of the Dona Ana Range at Fort Bliss. Except for NG, the concentrations of these residues were below the detection limits for SW846 Method 8330 (USEPA 1994), the most commonly used analytical method for explosives residues in soil. When SW846 Method 8095 (USEPA 1999) was used for analysis, some target analytes were detectable, but never above  $66 \mu\text{g}/\text{kg}^{-1}$ . For NG, concentrations up to  $634 \mu\text{g}/\text{kg}^{-1}$  were detected, but the half-life of NG in moist soil under aerobic conditions is very short (Jenkins et al. in preparation; Brannon et al. 2002). We believe that the NG in these samples is present within very small propellant particles and will rapidly decline when these desert soils are moistened and the NG dissolves into soil solution.

### Judgmental sampling

**Artillery targets.** Composite surface soil samples were collected around five tank targets in the artillery range impact area. At Tank Target 1, duplicate, 30-point composite samples were collected around the circumference of the tank at distances of 0 to 2 m and 5 m from the edge of the tank. The results are shown in Table 2-5. At the 0- to 2-m distance, one duplicate sample (BC37) had concentrations of HMX and RDX of 5,130, and 3,430  $\mu\text{g}/\text{kg}^{-1}$ , respectively, but no detectable levels of TNT. In the other replicate (BC38), the concentration of TNT was 1,380  $\mu\text{g}/\text{kg}^{-1}$  and the concentrations of HMX and RDX were 1,110 and 702  $\mu\text{g}/\text{kg}^{-1}$ , respectively. The relative percent differences for HMX and RDX were 128 and 132, respectively. These results confirm the difficulty in obtaining representative samples in impact areas. The relatively high HMX concentrations relative to RDX may indicate that this target had been used for training with antitank rockets as well as artillery. HMX is not a component of artillery or mortar rounds except as an impurity in RDX, but HMX is the major component of octol that is the explosive used in antitank rockets.

**Table 2-5**  
**Concentrations of Explosives in Soils Near Tank Targets within the Artillery Impact Range at Dona Ana,  $\mu\text{g}/\text{kg}^{-1}$**

CRREL Sample Number	Location <sup>1</sup> (m)	Target Number	HMX	RDX	TNT	NG	2,4DNT	4ADNT
BC 37	0-2	1	5,130	3,430	<16	<20	<28	76
BC 38	0-2	1	1,110	702	1,380	300	<0.8	124
BC 39A	5	1	<26	<34	1,360	270	<28	54
BC 39B	5	1	<26	14	1,120	250	<0.8	66
BC 40	5	1	50	13	23	352	<0.8	93
BC 45	0-2	2	<26	<3	<1	26	<0.8	<1.6
BC 50	0-2	3	<26	<3	<1	<20	<0.8	42
BC 51A	0-2	4	<26	13	18	<20	<0.8	18
BC 51B	0-2	4	47	13	17	<20	<0.8	20
BC 77	0-2	5	1,160	336	<16	482	<28	<32
BC 78	0-2	5	380	390	<1	800	<0.8	<1.6
BC 79	5	5	88	51	<1	47	<0.8	8
BC 80	5	5	<26	17	<1	1,370	<0.8	<1.6

<sup>1</sup>Distance (m) that samples were collected from target.

At the 5-m distance for Tank Target 1, the mean concentration for the two analytical duplicates in the first replicate sample (BC39A and BC39B) was  $1,240 \mu\text{g}/\text{kg}^{-1}$  for TNT,  $260 \mu\text{g}/\text{kg}^{-1}$  for NG, and  $60 \mu\text{g}/\text{kg}^{-1}$  for 4ADNT. The concentrations in the second field replicate were quite different for all of the target analytes that were detected, except NG. The concentration of TNT, for example, was only  $23 \mu\text{g}/\text{kg}^{-1}$  compared with  $1,240 \mu\text{g}/\text{kg}^{-1}$  for the first field replicate, a relative percent difference of 192 percent, while the concentration of NG were 260 and  $352 \mu\text{g}/\text{kg}^{-1}$ , respectively, a relative percent difference of only 33.9 percent. This appears to indicate that TNT and NG were deposited separately with a different degree of spatial heterogeneity. This is reasonable because TNT is an explosive, generally deposited from detonations, whereas NG is mainly used as a component of double- and triple-based propellants and is often found at firing points.

Analysis of soil samples collected at a distance of 0 to 2 m around the perimeter of Tank Targets 2, 3, and 4 are presented in Table 2-5. Concentrations of residues of explosives and propellants are less than  $50 \mu\text{g}/\text{kg}^{-1}$  in all cases. Only for Tank Target 4 were field duplicate samples collected. Results were quite reproducible except for HMX, which was detected at  $47 \mu\text{g}/\text{kg}^{-1}$  in one replicate and not detected in the other. Concentrations of RDX, TNT, 2ADNT, and 4ADNT were in excellent agreement for these two field replicates, even though the concentrations were  $20 \mu\text{g}/\text{kg}^{-1}$  or less. Visual inspection of these three tanks and areas in their proximity indicated that these targets had not been used to any great extent for training. Thus, the low concentrations found here were consistent with usage.

Tank Target 5 had been used extensively for firing activities as evidenced by extensive damage to the target and a large amount of cratering and munitions debris in the vicinity. Residue concentrations were similar to those found at Tank Target 1 (Table 2-5). For samples collected at 0 to 2 m, HMX, RDX, and NG concentrations ranged from 336 to  $1,160 \mu\text{g}/\text{kg}^{-1}$  (Figure 2-12). At 5 m, all concentrations were less than  $100 \mu\text{g}/\text{kg}^{-1}$ , with the exception of one field replicate where the NG concentration was  $1,370 \mu\text{g}/\text{kg}^{-1}$ . TNT was not detected in these samples although very low concentrations ( $8 \mu\text{g}/\text{kg}^{-1}$ ) of 2ADNT and 4ADNT were found in one field replicate sample at 5 m, indicating that TNT had been present at some point in the past.

The two field replicate samples collected at the 0- to 2-m distance were in fair agreement (relative percent differences of 14.9 for RDX, 49.6 for NG, and 101 for HMX). Concentrations in these samples were all in excess of  $100 \mu\text{g}/\text{kg}^{-1}$ . Concentrations for field replicate samples collected at the 5-m distance did not agree well. The relative percent differences for NG and RDX were 187 and 100, respectively. HMX was detectable in only one duplicate. The concentrations in these samples, however, were generally less than  $100 \mu\text{g}/\text{kg}^{-1}$ , and replicating samples in areas of lower concentration may be difficult. Two laboratory subsamples from BC39 were analyzed and the agreement was good, indicating that sample homogenization prior to subsampling was adequate for this sample. Mean concentrations for TNT and NG were 1,240 and  $260 \mu\text{g}/\text{kg}^{-1}$ , respectively, with RPDs of 19.4 percent and 7.7 percent. Similarly, mean concentrations for 2ADNT and 4ADNT were 48 and  $60 \mu\text{g}/\text{kg}^{-1}$ , with RPDs of 8.3 percent and 20.0 percent, respectively.

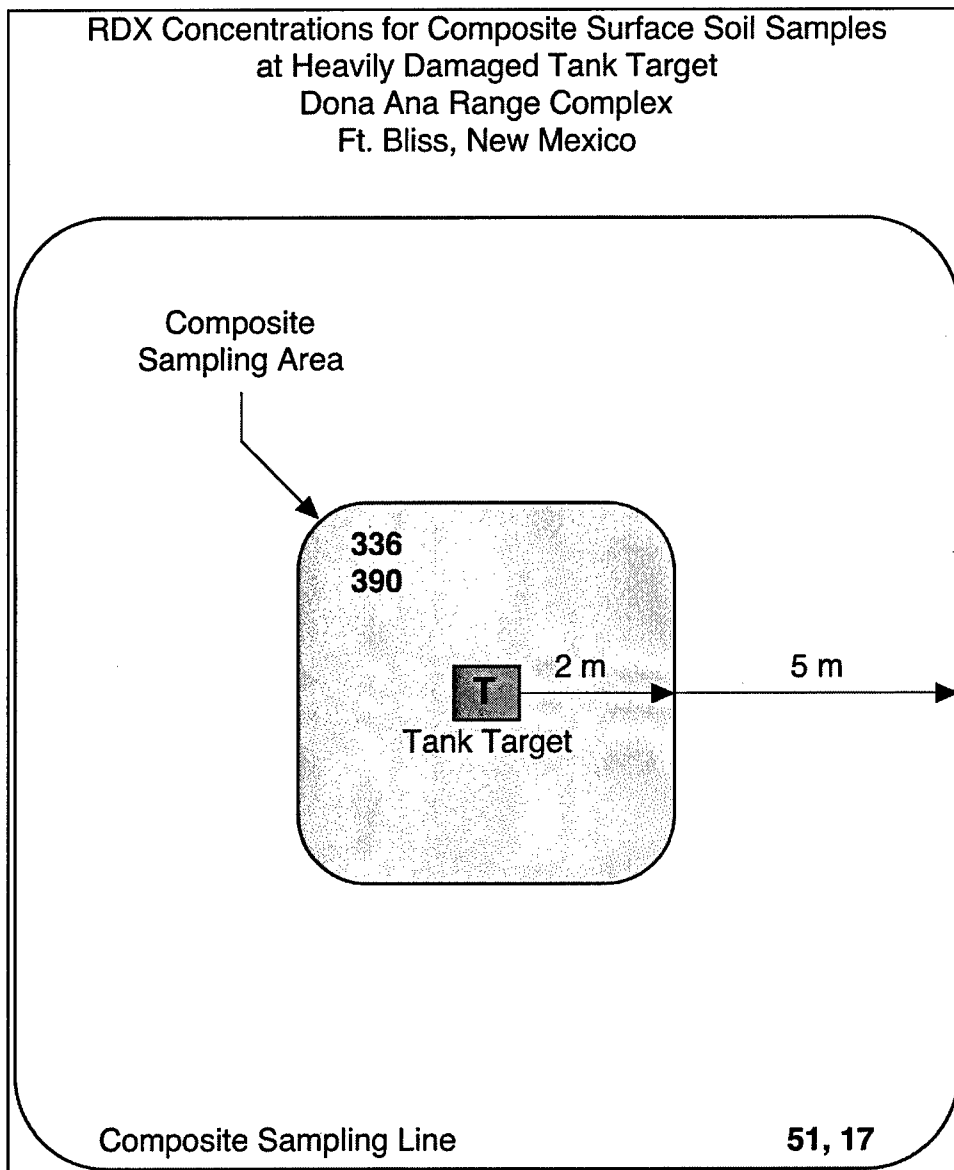

Figure 2-12. RDX concentrations ( $\mu\text{g}/\text{kg}$ ) in surface composite samples near a heavily damaged tank target at Dona Ana Range, Fort Bliss, New Mexico

**Areas with visible chunk explosives.** While traversing the artillery impact area, two areas were observed that had large numbers of pieces (0.2- to 5-cm diam) of explosive on the surface. These pieces of explosive were reddish brown on surfaces that were exposed to the light and were yellowish on surfaces not exposed to light. The density of these pieces was much lower than the density of small stones. Qualitative analysis of these pieces onsite using the EXPRAY Kit indicated that these chunks were TNT. The pieces of explosive present at the first site were probably from two low-order detonations of 90-mm recoilless rifle rounds (Figure 2-13) that were found nearby. At this site we marked off a 10-  $\times$  10-m grid in an area that contained the highest numbers of particles of TNT. Thirty-four pieces of TNT with a total mass of 73 g were collected within this grid. Three discrete soil samples were collected directly under one piece of

TNT at depths of 0 to 1 cm, 1 to 2 cm, and 2 to 3 cm (Table 2-6). At this discrete location, the concentrations of TNT in 0- to 1-cm depth was 2,100,000  $\mu\text{g}/\text{kg}^{-1}$ . Concentrations of TNT at the 1- to 2- and 2- to 3-cm depths were 194,000 and 103,000, respectively, indicating that TNT had migrated downward into the shallow soil. Likewise, concentrations of TNB, a photodegradation product of TNT, declined from 42,000  $\mu\text{g}/\text{kg}^{-1}$  in the 0- to 1-cm depth, to 20,900  $\mu\text{g}/\text{kg}^{-1}$  at 1 to 2 cm and 5,360  $\mu\text{g}/\text{kg}^{-1}$  at 2 to 3 cm.



Figure 2-13. Photo of two low-order recoilless rifle rounds at Dona Ana Range, Fort Bliss, New Mexico

Surface soil samples were collected within this 10- × 10-m grid after the visible pieces of TNT were removed. Three sampling strategies were used. Five replicate discrete samples were randomly collected within this area at the 0- to 1-cm depth. Five replicate 5-point composite samples were also collected at the 0- to 3-cm depth using the sample collection protocol that was used by CHPPM personnel conducting stratified random sampling at Fort Bliss. Seven 30-point composite samples were also collected from the 0- to 1-cm depth.

TNT was found at concentrations ranging from  $<16$  to 134  $\mu\text{g}/\text{kg}^{-1}$  for three of the five discrete samples with a median concentration of 48  $\mu\text{g}/\text{kg}^{-1}$  (Figure 2-14). The TNT concentrations in the other two discrete samples were below a detection limit of 16  $\mu\text{g}/\text{kg}^{-1}$  (Table 2-6). TNT concentrations in the five replicate five-point composites ranged from 6 to 78  $\mu\text{g}/\text{kg}^{-1}$ , with a median of 12  $\mu\text{g}/\text{kg}^{-1}$ . For the seven 30-point composites, TNT ranged from 19 to 3,120  $\mu\text{g}/\text{kg}^{-1}$ , with a median of 88  $\mu\text{g}/\text{kg}^{-1}$ . Three of the seven 30-point composites had TNT concentrations higher than any of the discrete or five-point composite samples. Since we know that this area had a substantial number of small pieces of TNT on the surface, many smaller pieces of TNT too small to be identified visually and removed prior to soil sampling, were certainly present. Collection of discrete samples resulted in the detection of TNT in only three of

the five samples, and even in the three samples where TNT was detected, the concentrations were always below 134  $\mu\text{g}/\text{kg}^{-1}$ . Thus, discrete samples do not give a very representative picture of the concentration of TNT in surface soils within this area.

<b>Table 2-6 Concentrations of Explosives in Soils Associated with Chunk TNT Observed on the Soil Surface at Location 1<sup>1</sup>, <math>\mu\text{g}/\text{kg}^{-1}</math></b>						
<b>USCHPPM Composite Samples<sup>2</sup></b>						
<b>CRREL Sample Number</b>	<b>HMX</b>	<b>TNB</b>	<b>RDX</b>	<b>TNT</b>	<b>2ADNT</b>	<b>4ADNT</b>
BC 65	<26	<3	<3	78	17	30
BC 66	<26	<3	<3	8	25	43
BC 67	<26	<3	<3	6	14	34
BC 68	<26	<3	<3	27	11	17
BC 69A	<26	<3	<3	12	19	30
BC 69B	<26	<3	<3	12	17	26
<b>CRREL Composite Samples<sup>3</sup></b>						
BC 70	<26	<3	<3	20	47	66
BC 71	<26	<3	<3	88	22	33
BC 72 A	<26	90	50	2,040	114	108
BC 72 B	<26	88	<34	2,010	90	84
BC 73	<26	<16	<34	382	62	76
BC 74	45	<16	126	83	51	76
BC 75	<26	154	<34	3,120	178	148
BC 76	<26	<16	<34	19	56	91
<b>Discrete Samples<sup>4</sup></b>						
B 49	<26	<16	<34	124	<38	<32
B 50	<26	<16	<34	48	<38	<32
B 51	<26	<16	<34	<16	<38	<32
B 52	<26	<16	<34	<16	<38	<32
B 53	<26	<16	<34	134	<38	<32
<b>Discrete Soil Samples Collected at Depth below a Chunk of TNT</b>						
B 32	<26,000 <sup>5</sup>	42,000	<34,000	2,100,000	<38,000	<32,000
B 33	<26	20,900	<34	194,000	5,310	3,460
B 34	156	5,360	<34	103,000	4,750	3,220
<sup>1</sup> Thirty-four chunks of explosive residue weighting 73 g were collected at Location 1. Values above analytical detection limits are shaded. HMX and 2,4-DNT were also detected in some of these samples. <sup>2</sup> Each composite was composed of five surface soil samples. <sup>3</sup> Each composite was composed of 30 surface soil samples. <sup>4</sup> Each discrete sample was composed of three scoops from the same spot, approximately 25 g of surface soil. <sup>5</sup> High detection limits are shown for some target analytes in several samples that had to be diluted by a factor of 1,000 to be in the range of linearity for determination of TNT concentrations.						



TNT Concentrations ( $\mu\text{g}/\text{kg}$ ) Using Various Sampling Strategies  
for Surface Soil in 10-m by 10-m Minigrids Contaminated with Chunk Explosives  
Dona Ana Range Complex  
Ft. Bliss, New Mexico

- ⊙ Discrete Sample Locations
- × Random Sampling Locations for 30-Point Composites
- ⊠ Fixed Sampling Locations for 5-Point Composites (CHPPM)

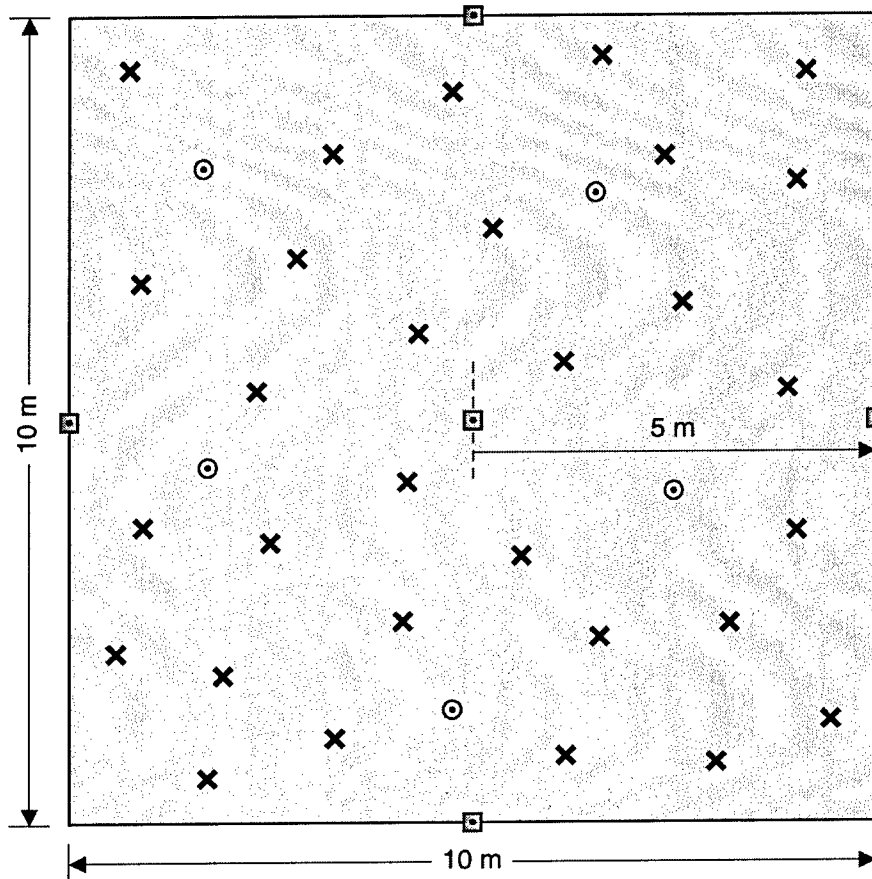

TNT Concentration ( $\mu\text{g}/\text{kg}$ )

	Max	Min	Median
Discrete	134	< 16	48
5-Point Composites	78	6	12
30-Point Composites	3,120	19	88

Figure 2-14 TNT concentrations ( $\mu\text{g}/\text{kg}^{-1}$ ) in soil for various sampling strategies at 10- × 10-m area contaminated with pieces of TNT at Dona Ana Range, Fort Bliss, New Mexico

Two sets of laboratory duplicates were analyzed within this group of samples (Samples B69 and B72), and the results are shown in Table 2-6. For these duplicates, TNT, 2ADNT, and 4ADNT were detected in both samples and TNB

in the second sample. The RPD for these samples ranged from 0 to 25 percent, which is excellent reproducibility, particularly for samples with some concentrations under  $20 \mu\text{g}/\text{kg}^{-1}$ . RDX was detected at  $50 \mu\text{g}/\text{kg}^{-1}$  in one laboratory duplicate of B72, but it was not detected in the other. The reason for this discrepancy is unknown, but it could indicate that a portion of the TNT was deposited from a different source than the RDX.

The second area that we observed to have multiple pieces of chunk TNT on the surface was also within the artillery range impact area, but the source of this contamination could not be identified. In a similar manner to the area discussed above, a  $10 \times 10$ -m grid was established in the area with largest number of visible chunks, and these were picked up. The identification of the chunks as TNT was obtained using the EXPRAY kit. A total of 100 chunks of TNT were recovered (Figure 2-5). We did not have the opportunity to weigh this material, but we estimate that the mass was between 100 and 200 g. Once the visible chunks of TNT were removed, we obtained surface soil samples from this area using a similar strategy to that described above. Some shallow subsurface samples were also collected.

TNT was present in all five surface discrete samples with concentrations ranging from 25 to  $22,400 \mu\text{g}/\text{kg}^{-1}$  (Table 2-7) with a median concentration of  $228 \mu\text{g}/\text{kg}^{-1}$  (Figure 2-15). RDX was present in only one discrete surface sample at  $1,400 \mu\text{g}/\text{kg}^{-1}$ , and HMX was present in two samples, with concentrations of 126 and  $198 \mu\text{g}/\text{kg}^{-1}$ . 2ADNT and 4ADNT were found in all but one of these discrete surface samples, with concentrations ranging from 48 to  $2,090 \mu\text{g}/\text{kg}^{-1}$  and 104 to  $2,570 \mu\text{g}/\text{kg}^{-1}$ , respectively. TNT concentrations for the four shallow discrete subsurface (5 to 7 cm) soils samples (Table 2-7) showed that concentrations were  $<16 \mu\text{g}/\text{kg}^{-1}$  in two samples, and 234 and  $1,210 \mu\text{g}/\text{kg}^{-1}$  in the other two. The amino transformation products of TNT were present in three of these discrete subsamples with maximum concentrations of  $545 \mu\text{g}/\text{kg}^{-1}$  for 2ADNT and  $553 \mu\text{g}/\text{kg}^{-1}$  for 4ADNT. RDX was not detected, and HMX was detected in only one sample at  $72 \mu\text{g}/\text{kg}^{-1}$ .

TNT was detected in all seven 30-increment composite samples and all five of the five-increment composite samples from this  $10 \times 10$ -m area (Table 2-7). Concentrations ranged from 110 to  $69,900 \mu\text{g}/\text{kg}^{-1}$  with a mean of  $16,300 \mu\text{g}/\text{kg}^{-1}$  for the 30-increment samples, and from 264 to  $3,710 \mu\text{g}/\text{kg}^{-1}$  with a mean of  $1,590 \mu\text{g}/\text{kg}^{-1}$  for the five-increment samples. 2ADNT and 4ADNT were also detected in all of these composites with concentrations ranging from 102 to 2,190 and 666 to 1,400, respectively. TNB was detected in three of the field replicates for each type of sampling composite with concentrations ranging from 42 to  $1,010 \mu\text{g}/\text{kg}^{-1}$ . HMX was not detected and RDX was detected in a single 30-increment replicate composite sample. In this case, the discrete samples and the two types of composite samples give a similar picture of the surface soil contamination in this area. The area was dominated by TNT and its environmental transformation products, which were present at concentrations in the soil that varied spatially over several orders of magnitude. The mean concentrations obtained for the surface discrete and composite samples, however, varied substantially. For the 30-increment composite samples collected from the 0- to 2.5-cm depth, the mean concentration was  $16,300 \mu\text{g}/\text{kg}^{-1}$ . The mean concentration for samples collected using the five-increment composite samples taken from

the 0- to 7.5-cm depth, was 1,850  $\mu\text{g}/\text{kg}^{-1}$ , indicating that the added depth collected for these samples tended to dilute the residues that were located mostly in the upper 2.5 cm of soil. This is confirmed from the surface (0- to 2-cm) discrete samples where the mean concentration was 4,750  $\mu\text{g}/\text{kg}^{-1}$ , whereas the mean concentration for the discrete samples collected at the 5- to 7-cm depth was 361  $\mu\text{g}/\text{kg}^{-1}$ .

**Table 2-7**  
**Concentrations of Explosives in Soil Samples Collected in the Mini-Grid Pattern where Chunks of TNT Were Visible at Location 2<sup>1</sup>,  $\mu\text{g}/\text{kg}^{-1}$**

USCHPPM Composite Samples <sup>2</sup> , 100-200 g									
CRREL Sample Number	Depth, cm	HMX	TNB	RDX	TNT	2,4DNT	NG	2ADNT	4ADNT
BC 88	Surface	<26	<16	<34	3,270	46	<20	1,570	1,120
BC 89	Surface	<26	578	<34	1,680	136	<20	2,050	1,300
BC 90	Surface	<26	354	52	3,710	72	<20	2,190	1,400
BC 91A	Surface	<26	<16	<34	312	<28	<20	1,260	788
BC 91B	Surface	<26	<16	<34	290	<28	<20	1,290	796
BC 92	Surface	<26	42	<34	264	<28	<20	996	666
CRREL Composite Samples <sup>3</sup>									
BC 81A	Surface	<26	<16	<34	670	<28	894	342	338
BC 81 B	Surface	<26	<16	<34	764	<28	<20	342	338
BC 82	Surface	<26	<16	<34	2,440	<28	<20	664	578
BC 83	Surface	<26	162	<34	69,900	50	<20	324	300
BC 84	Surface	<26	<16	<34	1,830	<28	<20	274	294
BC 85	Surface	<26	<16	<34	110	<28	<20	102	130
BC 86 A	Surface	<26	80	<34	5,620	<28	<20	290	294
BC 86 B	Surface	<26	48	<34	2,260	<28	<20	164	194
BC 87	Surface	<26	1,010	<34	35,300	64	1,030	858	624
Discrete Samples									
B 62	0-2	<26	<16	<34	138	<28	<20	86	162
B 63	5-7	<26	<16	<34	<16	<28	<20	72	98
B 64	0-2	<26	<16	<34	956	<28	<20	<38	<32
B 65	5-7	<26	<16	<34	<16	<28	<20	<38	<32
B 66	0-2	198	<16	1,400	228	<28	<20	1,470	1,670
B 67	5-7	72	<16	<34	1,210	<28	<20	545	553
B 68	0-2	<26	<16	<34	25	<28	<20	48	104
B 69	0-2	126	102	<34	22,400	<28	<20	2,090	2,570
B 70	5-7	<26	<16	<34	234	<28	<20	194	228

<sup>1</sup> A total of 100 chunks of explosive were collected at Location 2. Values above analytical detection limits are shaded.

<sup>2</sup> Each composite was composed of five surface soil samples.

<sup>3</sup> Each composite was composed of 30 surface soil samples.

<sup>4</sup> Each discrete sample was collected at a single spot from the appropriate depth, approximately 10 g of soil.

TNT Concentrations ( $\mu\text{g}/\text{kg}$ ) Using Various Sampling Strategies  
for Surface Soil in 10-m by 10-m Minigrids  
Dona Ana Range Complex  
Ft. Bliss, New Mexico

- ⊙ Discrete Sample Locations
- × Random Sampling Locations for 30-Point Composites
- Fixed Sampling Locations for 5-Point Composites (CHPPM)

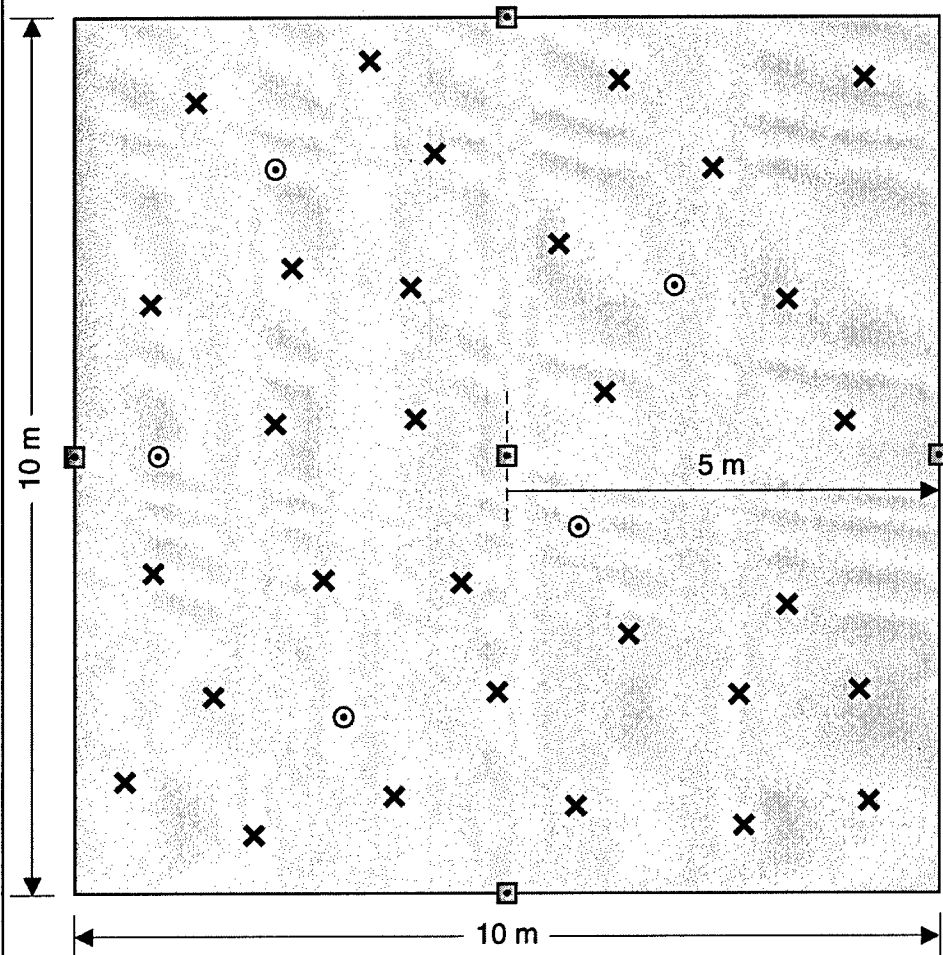

TNT Concentration ( $\mu\text{g}/\text{kg}$ )

	Max	Min	Median
Discrete	22,400	25	228
5-Point Composites	3,710	264	1,680
30-Point Composites	69,900	110	2,260

Figure 2-15. TNT concentrations ( $\mu\text{g}/\text{kg}^{-1}$ ) in soil for various sampling strategies at a second 10- × 10-m area contaminated with pieces of TNT at Dona Ana Range, Fort Bliss, New Mexico

For samples collected in this area, duplicate subsamples were collected for three samples (BC91, BC81 and BC86). The RPDs for TNT, 2ADNT, and 4ADNT were excellent (< 13.1 percent) for two of these duplicates and fair for the third (RPD < 85.3 percent). These results indicate that the sample homogenization and subsampling were adequate for these samples where the concentrations were generally above 100 µg/kg<sup>-1</sup>.

Surface and shallow subsurface soil samples were also collected below five pieces of TNT that were observed at various locations within the artillery impact area. Concentrations of TNT in the surface samples ranged from 102,000 to 6,760,000 µg/kg<sup>-1</sup> with a mean of 2,150,000 µg/kg<sup>-1</sup> (Table 2-8). Mean values for samples collected at depths of 1 to 2 cm, 2 to 3 cm, 3 to 4 cm, and 4 to 6 cm were 116,000, 42,600, 60,200, and 7,960, respectively. Likewise, mean concentrations of TNB at the surface, 1 to 2 cm, 2 to 3 cm, 3 to 4 cm, and 4 to 6 cm were 43,900, 11,300, 17,900, 20,000, and 9,580 µg/kg<sup>-1</sup>, respectively. The concentration of TNB at the 4- to 6-cm depth relative to the surface was 22 percent, whereas the concentration of TNT at 4 to 6 cm relative to the surface was 0.4 percent. Apparently once formed by photodegradation of TNT at the surface, downward transport of TNB is more facile than for TNT.

**Table 2-8**  
**Concentrations of Explosives<sup>1</sup> in Soils Beneath Chunks of TNT from Various Depths, µg/kg<sup>-1</sup>**

Sample Number	Depth cm	HMX	TNB	RDX	TNT	NG	2,4DNT	2,6DNT	2ADNT	4ADNT
B 26	0-1	<26	8,030	<34	396,000	<20	<16	<16	1,140	941
B 27	1-2	<26	1,700	<34	37,600	<20	<16	<16	1,740	1,700
B 28	2-3	<26	373	<34	9,360	<20	<16	<16	328	369
B 32	0-1	<26,000	42,000	<34,000	2,100,000	<20,000	<16,000	<16,000	<38,000	<32,000
B 33	1-2	<26	20,900	<34	194,000	<20	<16	<16	5,310	3,460
B 34	2-3	156	5,360	<34	103,000	<20	<16	<16	4,750	3,220
B 37	0-2	<26	2,260	<34	102,000	<20	<16	<16	2,190	1,980
B 38	2-3	423	6,360	<34	31,000	<20	584	<16	7,740	4,260
B 39	0-3	<26,000	85,200	<34,000	6,760,000	<20,000	<16,000	<16,000	<38,000	<32,000
B 40	3-4	<26	20,000	<34	60,200	<20	1,720	<16	4,100	1,950
B 41	4-6	134	16,200	<34	14,800	<20	645	<16	1,870	1,050
B 58	0-2	<26,000	82,000	<34,000	1,390,000	<20,000	<16,000	<16,000	<38,000	<32,000
B 59	2-3	<26	66,000	<34	27,000	<20	4,650	<16	3,360	1,410
B 60	5	<26	2,950	156	1,120	<20	740	<16	3,060	1,790

<sup>1</sup> High detection limits are shown for some target analytes in several samples that had to be diluted by a factor of 1,000 to be in the range of linearity for determination of TNT concentrations.

**Firing point at LAW rocket range.** The results for analysis of surface soil samples from the Dona Ana antitank rocket range at Fort Bliss are presented in Table 2-9 and Figure 2-16. NG was the only energetic material found in these samples with concentrations ranging from < 1 µg/kg<sup>-1</sup> to 1620 µg/kg<sup>-1</sup>. NG was detected in samples collected as far as 20 m in front of the firing line to as far as 10 m behind the firing line. NG is a major component of double-based propellant, the propellant used for 66-mm M72 LAW rockets. Thus, the presence of NG

is not surprising. The fact that NG was detected both in front and behind the firing line is reasonable because this weapon produces a back blast when the weapon is fired, and the rocket is propelled all the way to the target. Residues are thus deposited behind the firing line, as well as between the firing line and target area. We did not detect NG in samples collected 30 m in front of the firing line, but we did detect NG at 10 m behind the firing line which was the farthest point sampled behind the firing line.

**Table 2-9**  
**Concentrations of NG in Soils Relative to the Firing Point on an**  
**Antitank Range<sup>1</sup>,  $\mu\text{g}/\text{kg}^{-1}$**

Sample Number	Location, m	NG
<b>Behind Firing Point</b>		
BC 93A	5	796
BC 93B	5	956
BC 94	5	880
BC 95	10	888
BC 96	10	1,120
<b>In Front of Firing Point</b>		
BC 97	10	1,620
BC 98A	10	44
BC 98B	10	1,160
BC 99	20	<2
BC 100	20	39
BC 101	20	85
BC 102A	30	<2
BC 102B	30	<2

Three sets of laboratory duplicates were analyzed in this set of samples (Table 2-9). For BC93, the NG concentrations were 796 and 956  $\mu\text{g}/\text{kg}^{-1}$ , or an RPD of 18.2 percent. For sample BC98, however, the analytical duplicates for NG were 44 and 1,160  $\mu\text{g}/\text{kg}^{-1}$ , respectively, or an RPD of 185 percent. The results for BC102 were less than detectable for both samples. The poor agreement between analytical duplicates for BC98 may be the result of the nature of the residue deposition at the firing point. The deposition probably occurs as small propellant grains in which NG is contained within the nitrocellulose matrix. Since these particles are not uniformly distributed, it is difficult to reproduce samples from areas with this type of deposition.

**Low-order detonations.** While traversing the Dona Ana artillery impact area, we observed a large number of rounds that had detonated low order. This included a number of 155-mm howitzer rounds, 90-mm recoilless rifle rounds, a 2.75-in. rocket warhead, and 37-mm rounds. Members of the CHPPM sampling teams reported observing low-order mortar rounds as well. In some cases, as much as half of the high explosive remained in the ruptured rounds.

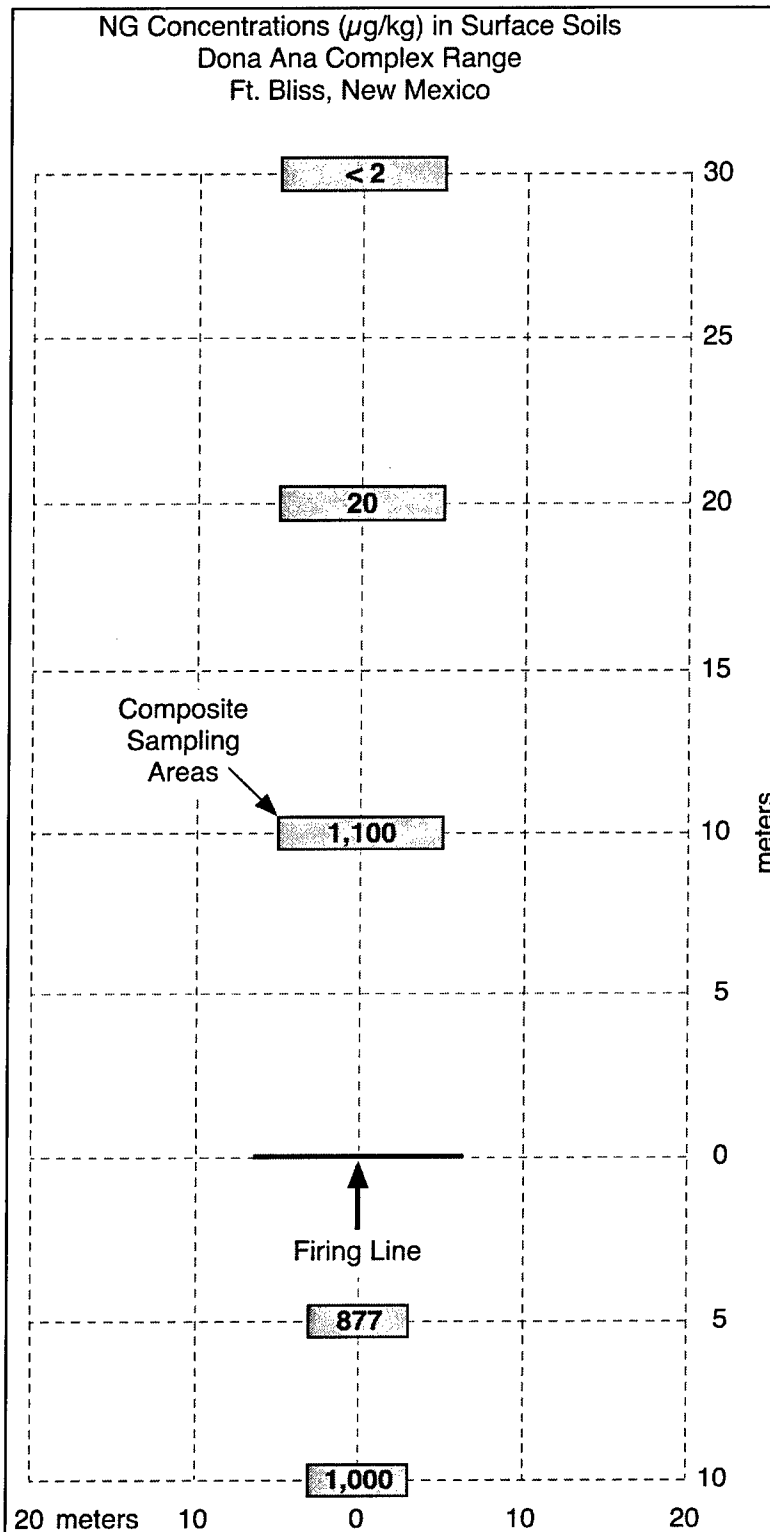

Figure 2-16. NG concentrations ( $\mu\text{g}/\text{kg}^{-1}$ ) for samples collected at the LAW rocket range, Dona Ana Range, Fort Bliss, New Mexico

Soil samples were collected near a number of these low-order detonations (Table 2-10). Two discrete samples were collected next to a low-order 155-mm round, one at the surface (0-2.5 cm) and one at 2.5 to 7.0 cm. The concentrations of TNT were 2,520,000 and 94,700  $\mu\text{g}/\text{kg}^{-1}$  at 0 to 2.5 cm and 2.5 to 7 cm, respectively. Likewise the concentrations of TNB were 148,000 and 128,000  $\mu\text{g}/\text{kg}^{-1}$  at these depth intervals. The ratio of the concentration of TNB at depth, relative to its surface concentration, is higher than for TNT. TNB is a phototransformation product of TNT and, hence, must be formed on the surface of particles of TNT. Hence, it is more available for dissolution and subsequent transport than is the bulk of the TNT present.

**Table 2-10**  
**Concentrations of Explosives<sup>1</sup> in Soils Near Low-Order Detonations,  $\mu\text{g}/\text{kg}^{-1}$**

CRREL Sample Number	Munition	Depth, cm	HMX	TNB	RDX	TNT	NG	2,4DNT	2,6DNT	2ADNT	4ADNT
B-1	155-mm 1	Surface	<26,000	148,000	<34,000	2,520,000	<20,000	<28,000	<19,000	<38,000	<32,000
B-2	155-mm 1	2.5-7	<26	128,000	<34	94,700	<20	5,710		830	56
B-5	90-mm 1	Surface	149,000	8,970	678,000	1,110,000	<20	1,330	536	17,800	11,900
B-9	37-mm 1	Surface	<26	<3	<3	<1	<2	<0.8	<0.8	<2.5	<1.6
B-10	155-mm 2	Surface	<26	<16	<34	2,840	<20	<28	<19	<38	<32
B-11	155-mm 3	Surface	<26,000	75,800	<34,000	8,590,000	<20,000	<28,000	<19,000	<38,000	<32,000
B-17	155-mm 4	Surface	410	54	1,360	1,060	1,060	134	<19	<38	78
B-18	155-mm 5	Surface	728	2,110	1,780	722,000	<20	1,870	48	7,830	5,850
B-36	37-mm 2	Surface	<26	60	<34	1,220	<20	<28	<19	576	866
B-42	2.75-in. Rocket Warhead	Surface	302,000	<16,000	1,130,000	13,500	<20,000	<28,000	<19,000	2,760	3,300
B-43	2.75-in. Rocket Warhead	3-4	17,300	<16	111,000	1,460	<20	<28	<19	1,910	1,200
B-56	2.75-in. Propellant	Surface	<26	<16	<34	<16	<20	<28	<19	<38	<32
B-57	2.75-in. Submunition	Surface	<26	140	<34	3,580	392	78	<19	<38	<32

<sup>1</sup> High detection limits are shown for some target analytes in several samples that had to be diluted by a factor of 1,000 to be in the range of linearity for determination of TNT concentrations.

The concentration of TNT in a discrete surface sample that was collected near a small opening on the side of a ruptured 155-mm round was 2,840  $\mu\text{g}/\text{kg}^{-1}$ . The concentrations of TNT and TNB in another sample collected next to a third low-order 155-mm round in an area with numerous small pieces of TNT on the surface were 8,590,000, and 75,800  $\mu\text{g}/\text{kg}^{-1}$ , respectively. The concentrations of TNT, RDX, HMX, NG, TNB, and 2,4DNT ranged from 54 to 1,360  $\mu\text{g}/\text{kg}^{-1}$  for a surface soil sample collected under the nose of a fourth 155-mm round with the fuse missing. Finally, a surface soil sample was collected in front of a 155-mm round in which the fuse and booster were missing. The TNT concentration in this sample was 722,000  $\mu\text{g}/\text{kg}^{-1}$ . TNB, RDX, HMX, and 2,4DNT were also detected in this sample at concentrations ranging from 728 to 2,110  $\mu\text{g}/\text{kg}^{-1}$ . 4ADNT and 2ADNT were also found at concentrations ranging from 5,850 and 7,830  $\mu\text{g}/\text{kg}^{-1}$ , respectively.



Concentrations of TNT, RDX, and HMX were 1,110,000, 678,000, and 149,000  $\mu\text{g}/\text{kg}^{-1}$ , respectively, in a discrete surface soil sample collected next to a low-order 90-mm round. The manufacturing impurities of TNT (2,4DNT and 2,6-DNT) and its environmental transformation products (TNB, 2ADNT and 4ADNT) were also found in this sample (Table 2-10).

A surface soil (0 to 2 cm) and a shallow-depth sample (3 to 4 cm) were also collected next to a low-order, 2.75-in. rocket warhead. RDX, HMX, and TNT concentrations in the surface sample were 1,130,000, 302,000, and 13,500  $\mu\text{g}/\text{kg}^{-1}$ , respectively. The RDX, HMX, and TNT concentrations for the shallow subsurface sample were 111,000, 17,300, and 1,460  $\mu\text{g}/\text{kg}^{-1}$ , respectively. The explosive in the warhead of the 2.75-in. rocket is composition B. RDX is the major component (60 percent) of Composition B, TNT is present at 39 percent, and HMX is an impurity in RDX at about 10 percent. The concentration of TNT in this sample is only about 1 percent of the RDX, however. An explanation for this would be a faster rate of dissolution of TNT in moisture from precipitation, compared with RDX. Once dissolved, the TNT can be transformed to its amino transformation products, and these products (2ADNT and 4ADNT) were present in these surface and subsurface samples in concentrations up to 3,300  $\mu\text{g}/\text{kg}^{-1}$  (Table 2-10).

Areas next to two low-order 37-mm rounds were also sampled at the Dona Ana impact area. These rounds appeared to have been on site for many years. No target analytes were detected in surface soils around the first of these rounds. TNT, TNB, 2ADNT, and 4ADNT were detected in the soils under the second round at concentrations of 1,220, 60, 576, and 866  $\mu\text{g}/\text{kg}^{-1}$ , respectively. Clearly TNT was still leaching from this round.

TNT, TNB, NG, and 2,4DNT were detected next to a 2.75-in. rocket submunition at concentrations of 3,580, 140, 392, and 78  $\mu\text{g}/\text{kg}^{-1}$ , respectively (Table 2-10). Neither 2ADNT nor 4ADNT was detected in this sample. Whether any of these compounds were leaking from this submunition item is uncertain, but concentrations were much higher than found in background areas of the range.

Small pieces of TNT, as confirmed with the EXPRAY kit, were present next to a 155-mm round that was found in a ravine. Samples were collected at distances ranging from 0.2 to 100 m down the ravine from this round (Table 2-11). The TNT concentrations in the soil sample collected 0.2 m from the round was 6,230,000  $\mu\text{g}/\text{kg}^{-1}$ , and concentrations declined as you moved away from the round (Figure 2-17). At a distance of 12 m downslope in the ravine, the concentration was 43  $\mu\text{g}/\text{kg}^{-1}$ . Samples were also collected farther downslope at 30, 50, and 100 m, and TNT was detected at 12 and 103  $\mu\text{g}/\text{kg}^{-1}$  in the 50- and 100-m sample, respectively, but other sources of TNT in the area could be responsible for these values.

**Table 2-11**  
**Concentrations of Explosives in Soils Downslope from a Low-Order 155-mm Artillery Round<sup>1</sup> Found Within a Ravine,  $\mu\text{g}/\text{kg}^{-1}$**

CRREL Sample Number	Distance from Round, m	HMX	TNB	RDX	TNT	2,4DNT	2,6DNT	2ADNT	4ADNT
B 24	0.2	<26	97,800	<34	6,230,000	<28	<19	<38	<32
B 23	1	<26	<16	<34	1,280	<28	<19	170	204
B 22	2	<26	<16	<34	37,800	<28	<19	70	78
B 21	3	<26	<3	46	15	<0.8	<0.8	<2.5	<1.6
B 20	4	<26	<3	102	31	<0.8	<0.8	<2.5	3
B 19	5	<26	<3	22	348	<0.8	<0.8	4	7
BC 48	12	41	<3	27	43	<0.8	<0.8	<2.5	<1.6
BC 49	30	<26	<3	<3	<1	<0.8	<0.8	<2.5	<1.6
BC 63	50	<26	<3	<3	12	<0.8	<0.8	<2.5	<1.6
BC 64	100	<26	<3	<3	103	<0.8	<0.8	4	5

<sup>1</sup> This artillery round was located in a ravine and contained undetonated TNT.

Similarly, we collected soil samples next to and downslope from two other low-order rounds. Concentrations of TNT, RDX, and HMX were 1,110,000, 678,000, and 149,000  $\mu\text{g}/\text{kg}^{-1}$ , respectively, for a soil samples collected next to a low-order 90-mm round (Table 2-12). These results suggest that the explosive fill for this round was Composition B. RDX concentrations at 2, 3.7, and 6 m from the round were 110,000, 38,700, and 674  $\mu\text{g}/\text{kg}^{-1}$ , respectively, suggesting some downslope movement of RDX. However, the reduction with distance was three orders of magnitude in only 6 m (Figure 2-18). The rate of decline in concentration for HMX was similar to that for RDX. The downslope decline in concentration was even faster for TNT. Concentrations of TNT declined from 1,110,000  $\mu\text{g}/\text{kg}^{-1}$  under the round to 384  $\mu\text{g}/\text{kg}^{-1}$  at 2 m, 210  $\mu\text{g}/\text{kg}^{-1}$  at 3.7 m, and <1  $\mu\text{g}/\text{kg}^{-1}$  at 6 m. Thus, TNT appears to be less mobile across the surface than RDX and HMX.

The concentrations of TNT decline from 8,600,000  $\mu\text{g}/\text{kg}^{-1}$  under another low-order 155-mm round to 22,400  $\mu\text{g}/\text{kg}^{-1}$  at 1.5 m downslope (Table 2-12). Since this was a TNT-containing round, RDX was not found under the round or 1.2 m away, but was found at 175,000  $\mu\text{g}/\text{kg}^{-1}$  in the 1.5-m sample, apparently from another source.

**Crater samples.** Near an artillery target tank, we observed a large crater that our EOD team identified from the debris present as a demolition crater. Both discrete and composite samples were collected in the crater and around the rim (Table 2-13).

The concentration of NG was 20,000  $\mu\text{g}/\text{kg}^{-1}$  in surface soil in the bottom of the crater. TNT, RDX, and HMX concentrations were 774, 630 and 60  $\mu\text{g}/\text{kg}^{-1}$  in this sample as well. The concentrations in the shallow subsurface in the crater were 3,350, 528, and 330  $\mu\text{g}/\text{kg}^{-1}$  for NG, TNT, and RDX, respectively.

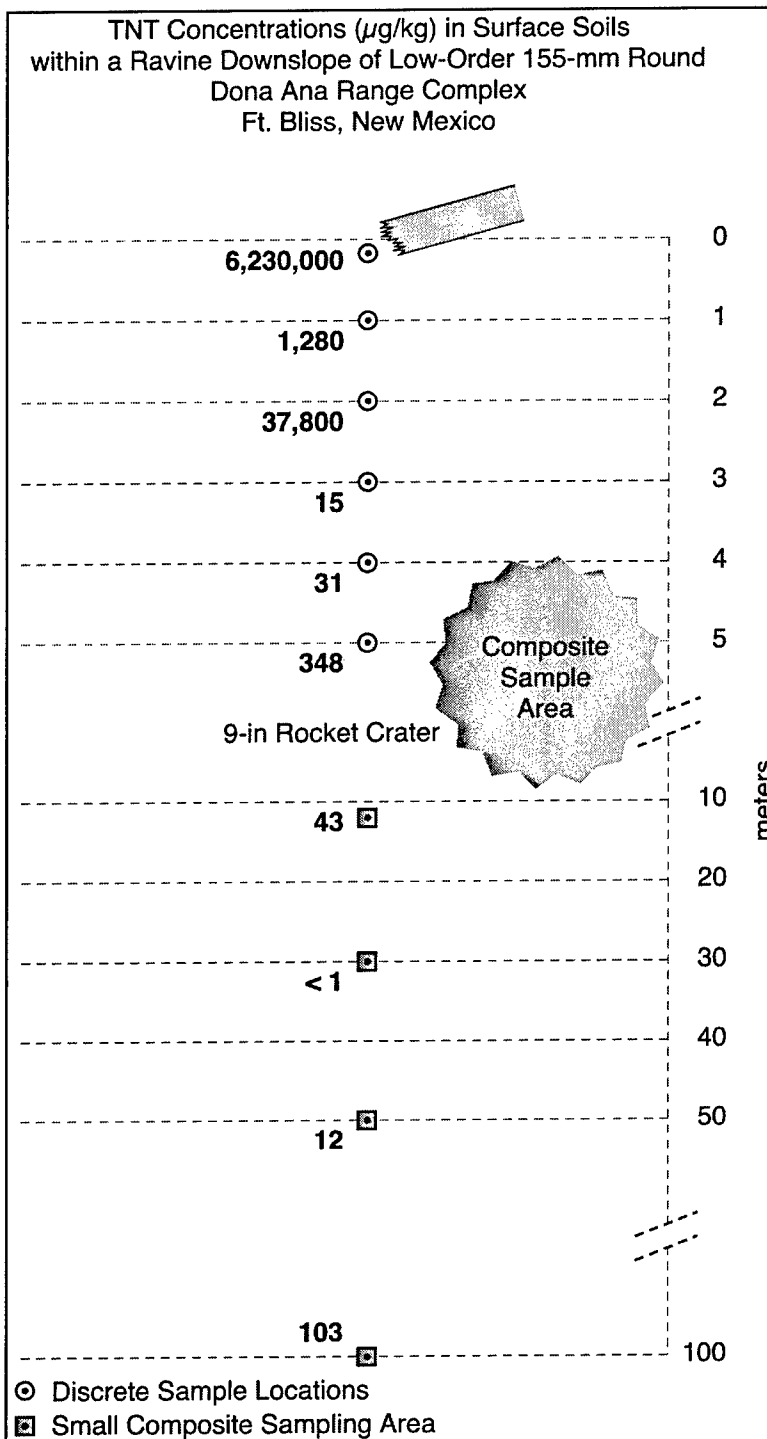

Figure 2-17. TNT concentrations ( $\mu\text{g}/\text{kg}^{-1}$ ) for surface soil samples collected in a ravine downslope from a low-order 155-mm round at the artillery impact area at Dona Ana Range, Fort Bliss, New Mexico

<b>Table 2-12 Explosives Concentrations in Samples Collected Near Low-Order Detonations, <math>\mu\text{g}/\text{kg}^{-1}</math></b>									
CRREL Sample Number	Distance from Round, m	HMX	TNB	RDX	TNT	2,4DNT	2,6DNT	2ADNT	4ADNT
<b>Near 90-mm Recoilless Rifle Low-order with Chunks of Explosive Present</b>									
B 5	Beneath	149,000	8,970	678,000	1,110,000	1,330	536	17,800	11,900
B 6	2	50,380	92	110,000	384	40	<19	100	154
B 7	3.7	40,700	<16	38,700	210	<28	<19	58	118
B 8	6	3,320	<16	674	<16	<28	<19	<38	<32
<b>Near 155-mm Low-order Round</b>									
B 11	Beneath	<26	75,800	<34	8,600,000	<28	<19	<38	<32
BC 28	1.2 in Arc	<26	6,760	<34	522,000	310	66	1,540	1,310
B 12	1.5 downslope	21,600	214		22,400	<28	<19	242	306

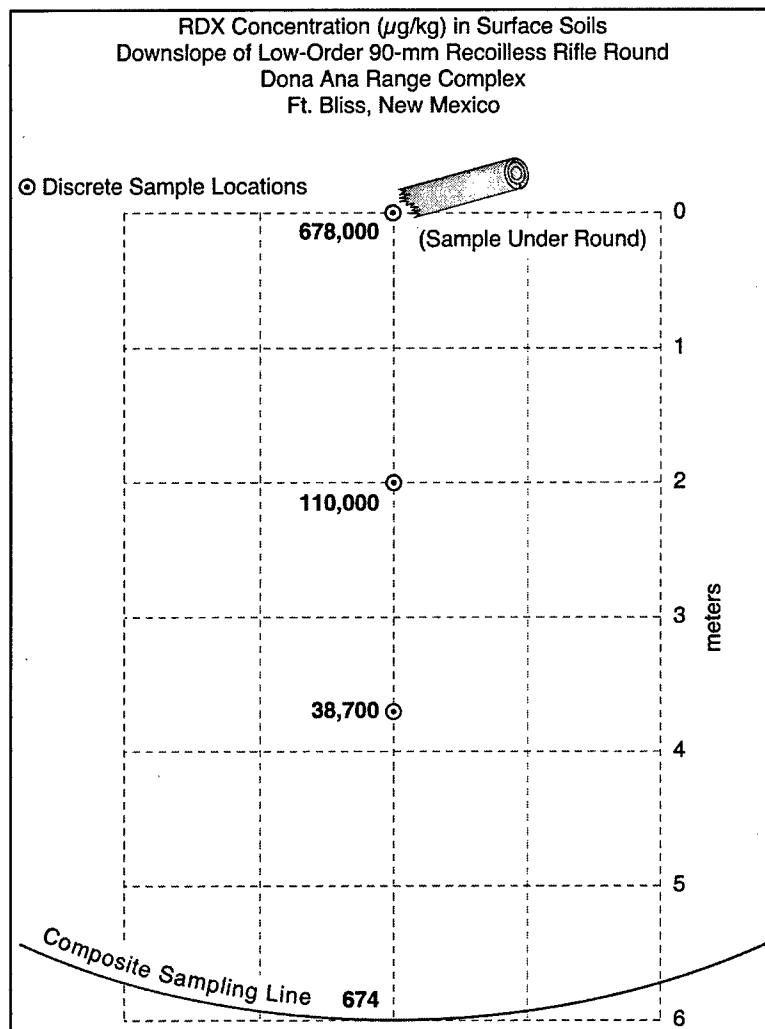

Figure 2-18. RDX concentrations ( $\mu\text{g}/\text{kg}$ ) for surface soil samples collected near a low-order 90-mm recoilless rifle round at Dona Ana Range, Fort Bliss, New Mexico

CRREL Sample Number	Crater	Location <sup>1</sup>	HMX	TNB	RDX	TNT	NG	2,4DNT	2ADNT	4ADNT
B 13	Demolition	Bottom, Surface	60	<16	630	774	20,000	<28	<38	<32
B 14	Demolition	Bottom, Subsurface	<26	<16	330	528	3,350	<28	<38	<32
BC 32	Demolition	Wall	<26	<3	17	40	2,060	<0.8	<2.5	<1.6
BC 33A	Demolition	Wall	<26	<3	<3	64	1,410	<0.8	13	15
BC 33B	Demolition	Wall	<26	<3	<3	38	2,020	<0.8	25	17
BC 35	Demolition	1 m Around Top Edge	<26	<3	99	37	358	<0.8	36	43
BC 36	Demolition	1 m Around Top Edge	<26	<16	<34	2,020	<2	<0.8	<38	<32
BC 41	5-in. Rocket	Bottom and Wall	<26	<3	<3	<1	<2	<0.8	3	5
BC 42	5-in. Rocket	Bottom and Wall	<26	<3	<3	<1	<2	<0.8	3	5
BC 46	Unknown Source	Bottom and Wall	<26	<3	<3	<1	<2	<0.8	<2.5	<1.6
BC 47	9-in. Rocket	Bottom and Wall	<26	<3	<3	<1	<2	<0.8	20	25
B 21	9-in. Rocket	Bottom and Wall	<26	<3	<3	15	<2	<0.8	4	9

<sup>1</sup> Relative to crater bottom, surface, wall, or edge.

The mean concentration of NG in the composite samples collected around the crater walls was  $1,890 \mu\text{g}/\text{kg}^{-1}$ . TNT was also detected at a mean concentration of  $46 \mu\text{g}/\text{kg}^{-1}$  as well as 2ADNT at  $10 \mu\text{g}/\text{kg}^{-1}$  and 4ADNT at  $9 \mu\text{g}/\text{kg}^{-1}$ . Concentrations of these same analytes were detected in composite samples collected 0 to 1 m around the rim of the crater as well. Clearly, the concentrations of energetic materials in and around this demolition crater were much greater than that over the major portion of the artillery range. This area would be another type of point source for contaminant migration under favorable hydrogeologic conditions.

One sample from the demolition crater was split and two laboratory duplicates were analyzed (BC-33A and B). For NG, where the mean concentration was  $1,410 \mu\text{g}/\text{kg}^{-1}$ , the RPD was 0.7 percent, but for TNT, where the mean concentrations was  $51 \mu\text{g}/\text{kg}^{-1}$ , the RPD was 51 percent (Table 2-13). It appears, here, as elsewhere, for concentrations less than  $100 \mu\text{g}/\text{kg}^{-1}$ , it is difficult to obtain reproducible subsamples without the use of a mechanical grinder (Walsh et al. 2003).

Two composite samples were collected from a crater formed from the impact of a 5-in. rocket. Only 2ADNT and 4ADNT were detected and at concentrations barely above analytical detection limits.

No target analytes were detected in a composite sample from the wall and bottom of a crater near a tank target. Judging from the debris present, craters in this area were formed from high-order detonations of 155-mm rounds. The lack

of detectable residues in this area agrees with work done on measuring the residue deposition from high-order detonations. This research demonstrated that over 99.99 percent of the explosives present were destroyed in high-order detonations (Jenkins et al. 2002).

A composite and a discrete soil sample were collected in the crater formed from the impact of a 9-in. rocket. TNT was detected in the discrete sample, and 2ADNT and 4ADNT were detected in both samples, but all concentrations were less than  $50 \mu\text{g}/\text{kg}^{-1}$ . These results corroborate previous results indicating that the concentration of explosives residues in impact craters or craters formed from high-order detonations are very low.

## Discussion and Conclusions

The surface soils at the Dona Ana Range at Fort Bliss were generally loams. A large amount of rock fragments was observed on surfaces subject to wind scour, and the surface is highly compacted. Rounds that impact this "armored" surface do not penetrate deeply into the soil. Thus, rounds that do not result in a high-order detonation remain at the surface as either UXO items or low-order detonation debris. Because of the sparse vegetation, these items are quite visible. The extremely arid conditions in southern New Mexico provide little moisture to dissolve and leach residues and hence small pieces of explosive that were distributed by low order detonations can remain at the surface for long periods. While we have observed these types of low-order detonations at other ranges (Jenkins et al. 2001, Pennington et al. 2002), the Dona Ana Range provided a unique opportunity to sample a larger number of these anomalies.

The concentrations of TNT and other energetic compounds are many orders of magnitude higher near low-order detonations than over most of the range, as represented by the soil samples collected using the stratified random sampling protocol. For example, TNT and RDX were found at concentrations greater than  $1,000,000 \mu\text{g}/\text{kg}^{-1}$  in surface soils below low-order detonations and where chunks of explosive were found on the surface but were generally below  $3 \mu\text{g}/\text{kg}^{-1}$  in randomly selected grids in the impact area. This agrees with the results found at Fort Lewis (Jenkins et al. 2001) and Yakima Training Center and Camp Guernsey (Pennington et al. 2002). Thus, these areas where low-order detonations take place may be potential point sources for groundwater contamination, depending on the climate, soil type and groundwater hydrology.

The types of low-order detonations observed at Fort Bliss are probably occurring at other training ranges as well, but observation of these residues is made difficult by dense vegetation. Similarly, the chunks of explosive found lying on the surface at many locations at the Dona Ana Range are probably present at other ranges, too, but the vegetation makes seeing these chunks difficult. Furthermore, wetter conditions would dissolve and leach this material much quicker than at Fort Bliss, and range fires could also affect the long-term presence of these surface chunks.

Under more moist conditions, at other installations, discrete chunks of explosive would dissolve much more rapidly producing concentrations near solubility limits directly below these chunks. The high concentrations would not diffuse laterally over the surface; thus, the surface contamination would be highly localized. However, in areas with sandy soils, these contaminants would leach deeper into the profile and could eventually intersect groundwater. The impact on groundwater of a number of these point sources could elevate the groundwater concentrations to levels of concern, while the finite source zones at the surface would be very difficult to locate. This could explain why the groundwater below the impact range at the Massachusetts Military Reservation (MMR) is contaminated with RDX and HMX, but the major sources at the surface have not been located. With the arid climate and depth to groundwater at Fort Bliss, though, leaching of explosives residues to groundwater is very unlikely.

The heterogeneous distribution of residues of explosives and propellants remains the most difficult obstacle in conducting site characterization at training ranges. Even the use of 30-point composite samples did not overcome this problem, particularly for areas with concentrations below  $100 \mu\text{g}/\text{kg}^{-1}$ . It was even difficult to obtain replicate subsamples from samples where the concentration was in this low range.

## References

- Brannon, J. A., Lynch, J., Hayes, C. A., and Delfino, J. J. (2002). "Transport parameters for firing range residues, Chapter 4, Distribution and fate of energetics on DoD test and training ranges: Interim Report 2," ERDC TR-02-8, U.S. Army Engineer Research and Development Center, Environmental Laboratory, Vicksburg, MS.
- Jenkins, T. F., Pennington, J. C., Ranney, T. A., Berry, T. E., Jr., Miyares, P. H., Walsh, M. E., Hewitt, A. D., Perron, N., Parker, L. V., Hayes, C. A., and Wahlgren, Maj. E. (2001). "Characterization of explosives contamination at military firing ranges," ERDC/CRREL Technical Report TR-01-05, U.S. Army Engineer Research and Development Center, Cold Regions Research and Engineering Laboratory, Hanover, NH.
- Jenkins, T. F., Walsh, M. E., Miyares, P. H., Hewitt, A. D., Collins, N. H., and Ranney, T. A. (2002). "Evaluation of the use of snow-covered ranges to estimate the explosives residues that result from high order detonations of Army munitions," *Thermochemica Acta* 384, 173-185.
- Jenkins, T. F., Mulherin, N., and Bartolini, C. "Estimation of half lives of several munitions-related chemicals in soil," ERDC/CRREL Technical Report (in preparation), U.S. Army Engineer Research and Development Center, Cold Regions Research and Engineering Laboratory, Hanover, NH.

Pennington, J. C., Jenkins, T. F., Brannon, J. M., Lynch, J., Ranney, T. A., Berry, T. E., Jr., Hayes, C. A., Miyares, P. H., Walsh, M. E., Hewitt, A. D., Perron, N., and Delfino, J. J. (2001). "Distribution and fate of energetics on DoD test and training ranges: Annual Report 1," Technical Report ERDC/EL TR-01-13, U.S. Army Engineer Research and Development Center, Environmental Laboratory, Vicksburg, MS.

Pennington, J. C., Jenkins, T. F., Ampleman, G., Thiboutot, S., Brannon, J. M., Lynch, J., Ranney, T. A., Stark, J. A., Walsh, M. E., Lewis, J., Hayes, C. A., Mirecki, J. E., Hewitt, A. D., Perron, N., Clausen, J., and Delfino, J. J. (2002). "Distribution and fate of energetics on DoD test and training ranges: Interim Report 2," Technical Report ERDC TR-02-8, U.S. Army Engineer Research and Development Center, Environmental Laboratory, Vicksburg, MS.

U.S. Environmental Protection Agency. (1994). "Nitro aromatics and nitramines by HPLC," Second Update, SW846, Method 8330, September 1994, Office of Solid Waste and Emergency Response, Washington, DC.

\_\_\_\_\_. (1999). "Nitroaromatics and nitramines by GC-ECD," Fourth Update, SW846, Method 8095, Office of Solid Waste and Emergency Response, Washington, DC.

Walsh, M.E., Ramsey, C.A., and Jenkins, T.F. (2003). "The effect of particle size reduction on subsampling variance for explosives residues in soil," *Chemosphere* 49, 1265-1271.



# 3 Evaluation of the Impacts of Live-Fire Training at Canadian Forces Base (CFB) Shilo (Phase II)

---

## Abstract

This work describes the evaluation of the impacts of the training activities in CFB Shilo training area and is the continuation of the first phase done in September 2000. During the first phase, three battleruns were sampled for energetic materials, metals, volatile organic compounds, and petroleum products to measure their impacts on soils and biomass, as well as on subsurface soils, surface water, and groundwater in the training areas. Such an assessment required an appropriate definition and understanding of the geological and hydrogeological context of the site. During the second phase, the two remaining battleruns, the rifle and the grenade ranges were sampled according to procedures described in this report. Since some trends were encountered in Phase I around target areas, more specific sampling, including biomass samples was conducted. Explosives, Thorium<sup>232</sup>, and heavy metals analyses revealed some localized problems related to environmental contamination and trends were observed that could be related to the firing activities. Some mitigation techniques are proposed for the identified problematic areas. Thorium analyses revealed a localized impact near the targets both in surface soils and in groundwater. The distribution of this chemical is not fully understood, and more analyses were done at the end of the summer 2002 to establish if the concentrations in groundwater are increasing or decreasing. Nevertheless, the concentrations in Thorium, being 10 times below the Canadian Council of Ministers of the Environment (CCME) criteria, do not represent a threat.

## Executive Summary

The international context of demilitarization, the closure of military bases and the more stringent aspects of environmental law, have led to the establishment of new areas for research and development. Many activities of the Canadian Forces, such as the firing of ammunition, demolitions, and the destruction of obsolete ammunition by open burning and open detonation, may lead to the

dispersion of energetic compounds and other munitions-related contaminants in the environment.

It is within this context that the Defence Research Development Canada-Valcartier (DRDC-Val) initiated a research program to study the environmental impact of energetic materials that are found in the Department of National Defence (DND) ammunition stockpile. The program on soil characterization positioned DND in a state of readiness and allowed the development of a unique expertise. The present study was done at Canadian Force Base Shilo, Manitoba, where German troops have trained intensively for the past 23 years. Prior to the German Army's withdrawal from Shilo, the Director General Environment (DGE) tasked DRDC-Val to conduct an environmental assessment to determine the impact of training activities on soils, as well as subsurface soils, surface water and groundwater in the training areas. The goal of the first phase was to assess the potential contamination by various residues and evaluate the total costs of future decontamination, if deemed necessary. Director Land Forces Services (DLFS) tasked DRDC-Val to complete the evaluation of the entire area, understand the problem, and propose mitigation techniques, if necessary, to sustain the activities. This generated the Phase II research activities worldwide. Our study represents one of the first extensive efforts to characterize live firing ranges in an entire practice area.

To understand the potential environmental impacts caused by live firing activities,<sup>1</sup> the characterization of battleruns and rifle and grenade ranges was conducted. Soils were sampled using a compositing technique. Biomass samples were also collected to ascertain their contamination. Subsurface soils were collected using a split-spoon sampler, and the boreholes were used to install observation wells. Groundwater samples were collected using newly installed and existing wells. Surface water samples were also collected in nearby rivers, streams, and lakes. Samples were analysed for explosive contamination by using a gas chromatography-electron capture detector (GC-ECD) method. Heavy metals concentrations and Thorium-232 were also assessed. Since Milan missiles were fired at CFB Shilo, efforts were made to evaluate the concentrations of radioactive thorium at targeted sites. This report explains the approach and strategy taken and presents the results obtained. The analyses for explosives, Thorium-232 and heavy metals revealed localized problems in specific areas. Some mitigation techniques were proposed.

## Acknowledgements

The authors wish to thank the Director Land Forces Services and the Strategic Environmental Research and Development Program (SERDP) for their financial support and vision. The authors also thank the Director General of the Environment for support during the first phase of this study. Range control CF personnel of CFB Shilo are especially thanked for their invaluable help,

---

<sup>1</sup>G. Ampleman, S.Thiboutot, J. Lewis, A. Marois, A. Gagnon, M. Bouchard, R. Martel, R. Lefebvre, C. Gauthier, J.M. Ballard, T.A. Ranney, T.F. Jenkins, and J.C. Pennington. (2002). "Evaluation of the Impacts of Live Fire Training Activities at CFB Shilo (Final)," DRDC-Val.TR 2003-006.

openness, and support in all these sampling events. More precisely, we thank Mr. Rob Riez for his great help with administrative issues with the contractors and Mr. Garnett Shearer, the Environmental Officer, who gave us all the support we needed to accomplish our task. We also thank all personnel of range control at the CFB Shilo who helped us, and specifically Capt. Rob Bower, Master Warrant Officer (MWO) Chuck Roeder, and Capt. Lonnie Goodfellow. We also want to thank Mr. Hans Mooj and Ms. Lauren Wiltzen, Defence Construction Canada (DCC), who managed the support staff, the analytical supply, and analyses. We would also take the opportunity to thank Dr. Conrad Gregoire, Geological Survey of Canada, for providing Thorium-232 analyses.

## Introduction

Energetic materials are the main components of gunpowder, explosive warheads, and solid rocket propellants and, therefore, can be found in war zones, training ranges, or on industrial production sites. During this decade, many needs have already emerged related to the identification, quantification, delimitation, and elimination of energetic contaminants dispersed by munitions, or present in explosives dumps, trials, or destruction fields, firing areas, and production sites [1-25].<sup>1</sup> The international context of the end of the Cold War resulted in the closing of many military bases and a growing awareness of environmental issues. Within this context, the Director, Research and Development Branch, through Defence Research Development Canada-Valcartan (DRDC-Val), has directed some of its resources to assess and develop expertise related to the environmental risks associated with explosive compounds.

Many Canadian Forces sites used as impact areas, training ranges, demolition, and open burning/open detonation (OB/OD) ranges, which were used to destroy out-of-specification materials, were highly suspected of being contaminated with energetic substances as described in the literature [1-14]. To evaluate the contamination of Department of National Defence (DND) sites, sampling and characterization of various ranges was performed over the last 10 years. A protocol describing the different methods of sampling and the analytical chemistry was developed [15]. This protocol was recently updated in collaboration with CRREL and is presently being reviewed under the auspices of the Technical Cooperation Program (TTCP) by the member nations in a key technical area (KTA 4-28) [16]. Research results to date have demonstrated that explosives are not common contaminants, since they exhibit limited aqueous solubility and are dispersed in a heterogeneous pattern of contamination. In the United States, major efforts have been made to develop analytical chemistry, to establish the best sampling procedure, and understand the complex fate of explosives in the environment [3, 4, 6-12, 17-25].

The selection of Canadian Forces Base (CFB) Shilo training area to conduct the first R&D efforts to assess the environmental aspects of live firing activities was based on the following factors. In the 1970s, Germany and Canada signed an agreement to allow German military troops to conduct training and perform

---

<sup>1</sup> Numbers in brackets indicate references listed following Chapter 3 text.

manoeuvres at CFB Shilo located in Manitoba. This exchange program was named GATES for German Army Training Exchange Shilo. For many years, German and Canadian soldiers trained in these battleruns using different German and Canadian weapons, tanks, and other armoured vehicles. In December 2000, Germany decided to stop training in Canada. The German and Canadian governments agreed to share unexploded ordnance (UXO) cleanup and remediation costs on this site. Another area of concern was the use of Milan missiles containing Thorium-232, which led to potential contamination by radioactive compounds. Accordingly, the Director General Environment (DGE) tasked DRDC-Val in the summer of 2000 to conduct an environmental assessment in the Shilo training area to determine the level of contamination, if any, in surface soils, as well as subsurface soils surface water and groundwater.

The ultimate goal of this sampling campaign was to assess global contamination related to explosives, heavy metals, and radioactive  $^{232}\text{Th}$  contamination. This information was used to determine Germany's share of any cleanup and remediation costs, when required. This assessment required an appropriate definition and understanding of the hydrogeological context of the site, with the Shilo base being located on a major aquifer that is heavily used for crop irrigation. Therefore, ensuring that no contamination migrated offsite was critical.

This assessment addressed four areas of concern. The contamination patterns of surface soils around targets and in the battleruns were evaluated. The unconfined aquifer underlying the training area (hydrostratigraphy, hydraulic conductivity, groundwater flow direction, etc.) and groundwater quality were characterized. The extent of biomass contamination in the worst-case scenario locations was assessed, and, finally, the surface water quality was evaluated. In previous DRDC-Val studies, both energetic materials and metals contaminated surface soils have been found in training ranges [1,2,13,14]. Characterizing the groundwater quality, especially on such large ranges, is critical because metals and energetic materials are mobile in sandy environments and may migrate in groundwater, presenting a threat to human health and the environment. Groundwater flow had to be carefully assessed by determining its velocity and direction. The quality of the groundwater has also to be evaluated. Groundwater is used as a drinking water source for the base, it sustains aquatic ecosystems, and it serves for irrigation. Consequently, any contamination could impact human health, irrigated crops, and aquatic ecosystems. In fact, groundwater flowing under CFB Shilo discharges as surface water in many springs southeast of the range, discharging into the Assiniboine River and into Marsh Creek to the north of the range. Both are highly sensitive areas for wildlife and humans receptors. Epinette Creek to the north is also used for irrigation. Biomass, such as prairie grass, has proven to bio-accumulate both metals and energetic materials [10]. Therefore, prairie grass could represent a high potential intake source of these compounds for wildlife. Finally, since wildlife has access to the surface water and it can also be used for irrigation, water quality had to be verified.

The 2000 initial study will be referred to in the present document as Phase I, which was completed by the publication of a DRDC-Val report [26]. The second phase of the study was initiated following a tasking from DLFS to assess the

impacts of live firing in major army training ranges in the general goal of sustaining the activities. CFB Shilo was selected as the first base to initiate this important program, since many efforts had been devoted to Phase I. Moreover, at the same period, a joint venture between Canada and the United States was initiated to evaluate the fate of explosives in live firing ranges under the auspices of the SERDP, a major funding program in the United States. Since the characterization of CFB Shilo had already begun with Phase I, Shilo was included as the first site for the collaborative work with the United States. Therefore, Canadian and U.S. scientists from the U.S. Army Engineer Research and Development Center (ERDC), including Cold Regions Research and Engineering Laboratory (CRREL), Hanover, NH, and the Environmental Laboratory (EL), Vicksburg, MS, accomplished Phase II with the support of both DLFS and SERDP.

This report describes the work carried out during Phase II at CFB Shilo between September and October 2001 and the results obtained from this sampling campaign. This study is the follow-up of the first phase conducted in September 2000, addressing the two remaining battleruns and the rifle and grenade ranges. The anti-tank range was the only range not sampled, since no level-one clearance had been conducted at that site, and the site was judged unsafe for sampling. Since specific problems were identified during the first phase, localized sampling of biomass and soils around targets was conducted. More background samples were also collected to compare and assess the natural and anthropogenic contribution. This study was performed under the work breakdown element 12ny01, "Characterization of DND Sites Contaminated with Energetic Materials," and was sponsored mainly by DLFS for the hydrogeological part, and by SERDP for the surface soil sampling. All work was done in collaboration with the Institut national de la recherche scientifique (INRS) and Defence Construction Canada (DCC). DRDC-Val and INRS have both developed expertise in the characterization and the environmental fate of energetic materials in Canadian Forces training ranges and open detonation ranges. DRDC-Val exchanged information and collaborated with the U.S. Army Scientists from CRREL and EL under the umbrella of Canada-United States Test and Evaluation Program (CANUSTEP) and funds from SERDP.

## **Range History/Description**

Military camp life in the Shilo area had its origin in 1910 with the acquisition of a training area sufficient in extent to provide for artillery practice and for maneuvers of all arms in a central location in what was then Military District No. 10. This came about when the continued influx of population into the west first directed the attention of the Militia Department to the importance of securing areas of the prairie provinces as military reservations.

The first camp, which opened on June 21, 1910, was called Sewell Camp, a brigade camp attended by 154 officers and 1,315 other ranks located on Canadian Pacific Railway (CPR) property some 5 miles north of Shilo's present location. In July 1915, the CPR changed the name of their railway station at Sewell to Camp Hughes. During World War I, as many as 30,000 troops were in training

and administration within its limits. After the war, Camp Hughes ceased to be a permanent camp and was used only for summer training of the Winnipeg Garrison of the Permanent Force and Western Canada militia units.

Late in 1931, the Engineers carried out the first survey in the area known today as CFB Shilo. This took place in what is now the Rifle Range Area. Further surveys were carried out in 1932, and these included most of what is the present Camp area. This survey not only covered the ground but also included the discovery and placement of a Camp water supply, a supply that is in use today, emanating from its vast aquifer, a legacy of the postglacial period.

Shilo had its first introduction to Army training in the summer of 1934 with mounted artillery and machine gun units taking part. In the following year, infantry units also trained here. From this day forward, Camp Shilo was in continuous use – first as a summer camp only, but after 1942, as a permanent year-round establishment. Not until 1940, and a new world war, did Shilo begin to assume the form we know today. With the reorganization of the Canadian Army after the war, Shilo became the permanent home of the Royal Canadian Artillery, except for the coast and anti-aircraft elements.

Artillery training has been carried out steadily since 1946, with increasing usage commencing in August 1950. In addition to this, Shilo has been the scene of the concentrated summer training of the artillery element and Militia units. During the period 1950 through 1954, Shilo was also the scene of the Royal Canadian Armoured Corps and Directorate of Armament Development cold weather trials. In February 1954, the Canadian Provost Corps School moved here from Camp Borden and was established in this centre. In 1960, the Royal Canadian School of Artillery was reorganized to include anti-aircraft, surface-to-surface missile, and apprentice soldier training. In 2000, an ammunition expenditure record was put together to evaluate the number of rounds that have been fired over the years. This document is presented in this chapter as Appendix A, pages 3-134 and 3-135, in the form of a tabulation entitled “CFB/ASU Shilo Ammo Expenditure Record” and represents a good overview of what was fired on the site. In terms of the present study, this information gives an idea of the amplitude of the UXO and contaminants that could have impacted the area over the years.

The Ranges, which today extend some 33 km south and east of the main campsite with an average width of 10 to 15 km, have an area of 38,000 hectares (96,000 acres). CFB Shilo is located 25 km southeast of Brandon, Manitoba (MB). The Government of Canada owns only 15 percent of that land. The Government of Manitoba has leased the remaining part to the Government of Canada until 2013. Topographically, the base lies on a relatively flat terrain with some dunes created after Glacial Lake Agassiz retreated from central Manitoba. Most of the area is treeless except for the forest in the northern parts (the Douglas Marsh and the Spruce Woods Provincial Park). Tree groves are also scattered throughout the area.

Boundaries of CFB Shilo consist mostly of rivers and parks. The southern part of the training area runs along the Assiniboine River. Spruce Woods Provincial Park defines the eastern limit of the training area. In addition, the

Spruce Woods Provincial Park constitutes the northern border. Finally, the Cornwallis Rural Municipality serves as the western limit. A few cities and rural municipalities can be found around CFB Shilo. Shilo and Brandon are the most populated ones.

CFB Shilo is divided into five regions (A, B, C, D, E) from north to south. The administrative buildings are located in the northwest portion of the area. The anti-tank, grenade, and rifle ranges are located in the northern part of the base. Five battleruns, Aachen, Berlin, Cologne, Deilinghofen, and Essen, were used primarily by the German troops. These battleruns are found, respectively, in regions B, C, D, and E. Each of the battleruns has its own area for petroleum refuelling, called "Parkplatz." Most of the targets found in the battleruns were pop-up targets instead of static targets. Consequently, different approaches than used on the other ranges had to be taken to sample the battleruns. This will be explained in more details in the next section.

CFB Shilo's climate can be described as a continental climate, with harsh winters where the average temperature of the coldest month is below 3 °C and the mean temperature of the warmest month exceeds 10 °C. The mean daily temperature ranges from a high of 18.7 °C in July to -18.4 °C in January. The annual mean temperature in CFB Shilo is 1.8 °C. CFB Shilo's weather is a land-controlled climate, which is influenced by tropical and polar air masses. Winter and summer temperatures are characterized as relatively severe. The annual mean precipitation is 453 mm (this number includes the equivalent amount of water resulting from snowfalls). Three quarters of all precipitation occurs between April and October. The remaining 25 percent represents snowfall. Wind is a constant factor at CFB Shilo. During winter, the winds in the area are predominantly from the west. In the spring, they can alternate from the west, northwest, and northeast. Wind speeds generally increase during these spring months. In summer, the wind speeds tend to decrease and come from the east to northeast. In the fall, wind speeds increase and direction becomes gradually northwest to west again. A more detailed description of Shilo climatology can be found in text entitled "Water Analyses, Results, and Discussion" in Chapter 3.

The bedrock essentially consists of Cretaceous shale with some traces of siltstone and sandstone. This could not be observed during drilling conducted under that study, since the wells installed were not deep enough to reach the bedrock. Deltaic sand deposits dating from the Quaternary period (i.e., 12,000 years ago) were found over the bedrock. These deposits originated from the meetings of the Assiniboine River and Glacial Lake Agassiz. Once the glacial lake subsided, aerial erosion shaped these deposits into a series of dunes. The thickness of this layer varies from 6 to 40 m. Two zones of different grain sizes occur. The Stockton sand covers almost all of the training area. Stockton is fine sand originating from the lacustrine deposits, which are highly susceptible to erosion. The Miniota sand found in the southern and western part of the training area is distinguished by a silt and clayey composition. This kind of sand is rarely affected by erosion.

The drainage system includes two watersheds, the Epinette Creek, and the Assiniboine River. The Epinette Creek passes through the military base, while the Assiniboine River is located along the southern border. Both rivers flow

toward the east (Figures 3-1 and 3-2). CFB Shilo occupies part of the Assiniboine Delta Aquifer. This unconfined aquifer covers an area of 3,900 km<sup>2</sup>. The sand thickness is the smallest near the Assiniboine River (approximately 6 m). Between Aachen and Essen battleruns (northern part of the training area), the thickness is the highest, approximately 30 m. The major uses of groundwater are for domestic purposes and for irrigation of farmlands that surround the base (Figures 3-3 and 3-4).



Figure 3-1. Epinette Creek River

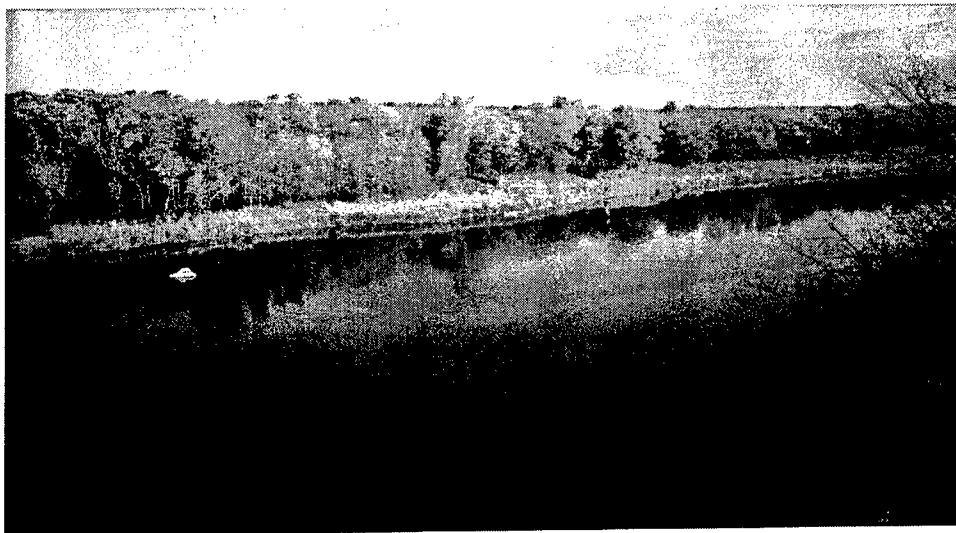

Figure 3-2. Assiniboine River



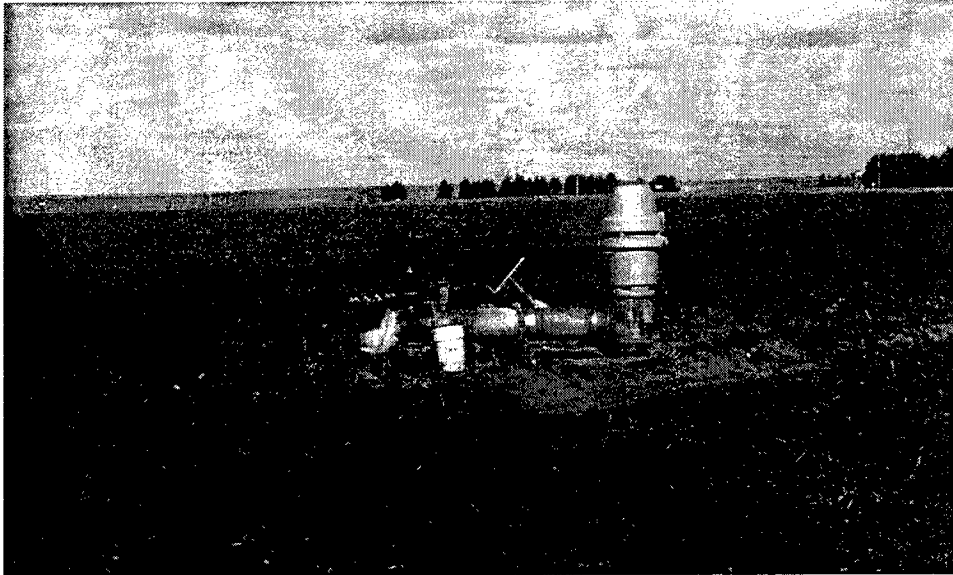

Figure 3-3. Irrigation well in farmland near CFB Shilo

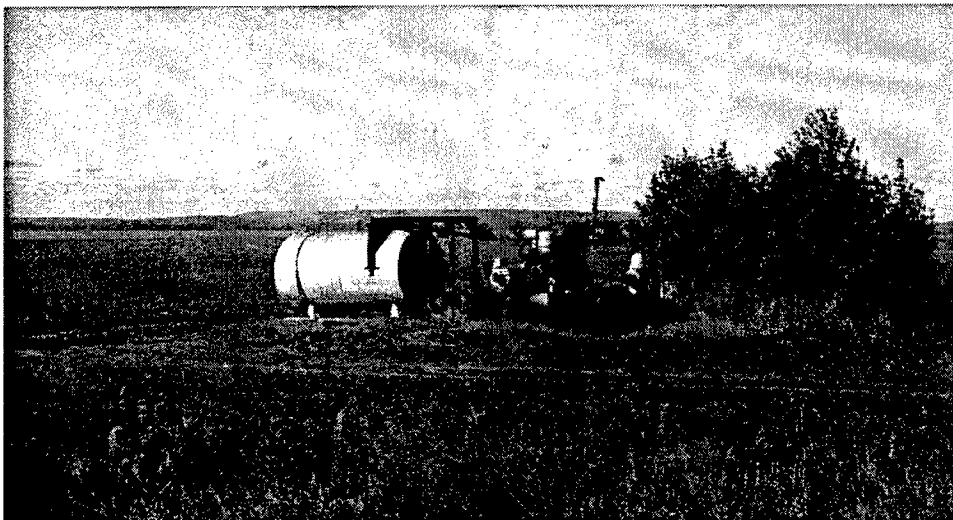

Figure 3-4. Another irrigation well in farmland near CFB Shilo

## Experimental

### Contractors involved

Mr. Rob Riesz, CFB Shilo, was responsible for hiring all of the contractors, including DCC, the analytical laboratory, the drillers and the proofing firm. DCC was responsible for supplying all of the analytical tools, solvents, etc., and the manpower to assist DRDC-Val and INRS for the sampling of soils, biomass, groundwater, and surface water. DCC partial report of activity can be found in this chapter, Appendix B, entitled "Defence Construction Canada – Report of Activity," pages 3-135 through 3-141. Subcontractors for UXO proofing (X-Tech), borehole drilling (Paddock Drilling Inc), and GPS survey (Lennon Surveys Brandon, MB) were hired for the hydrogeological needs of the study.

The analytical work for metals was subcontracted to Enviro-Test Laboratory (ETL), Winnipeg, Manitoba. Dr. Conrad Gregoire, Geological Survey of Canada (NRCan), was subcontracted by INRS for the  $^{232}\text{Th}$  analytical work. Dr. Michel Parent, NRCan, was also subcontracted by INRS for geological work (field work and map production) and was helped by M. Marc Cloutier and M. Pierre Gagnon, Cogéo Consultants, and Martin Ross, INRS-ETL.

### Parameters monitored and analytical methods

Soil and biomass samples were analysed for metals, energetic materials, and  $^{232}\text{Th}$ . Groundwater and surface water samples were analysed for metals, anions,  $^{232}\text{Th}$ , and energetic materials. Since no petroleum products including volatile organic compounds (VOCs) and benzene, toluene, ethyl xylene (BTEX) were found in Parkplatz during the first phase of this study, these parameters were analyzed only in a few groundwater and surface water samples. Metals were analyzed by Inductively Coupled Plasma Mass Spectrometry (ICP/MS) by an external laboratory (ETL), and all of the parameters available by this method were included in the study. The analytical results for individual samples as well as grain size analysis curves, hydraulic conductivity, and borehole logs can be obtained from the authors upon request. For groundwater samples, energetic materials were analysed at DRDC-Val by Gas Chromatography/Electron Capture Detector (GC/ECD), a method that can produce a 0.004-ppb detection limit. In our study, a quantification limit of 0.01 ppb for all analytes was obtained based on interferences peaks in the chromatograms. Analyses were performed with a GC HP6890 equipped with an ECD detector, an auto-injector HP7683 at an injection temperature of 250 °C. A capillary column based on phenylmethyl siloxane HP-5 (HP19095J-121) of 10.0 m  $\times$  0.53 mm was used under helium carrier gas. The temperature run used was as follows: 100 °C/ 2 min, ramp of 10 °C/ minute until 200 °C, ramp of 15 °C/minute until 280 °C, and a pause of 4 min at 280 °C. This method was based on recent work published in the U.S. [22-23].

Soil samples were dried in the dark, homogenized by adding acetone to form a slurry which was then evaporated. Soils were sieved through a 25-mesh sieve and extracted at DRDC-Val according to the following procedure: Soil (4 g) was mixed in acetonitrile (10 ml) and a vortex was applied for 1 min, followed by a sonication period of 18 hr and left to settle 30 min. The mixture was then filtered on a 45-micron filter, and these extracts were shipped to CRREL. The extracts were then analysed by CRREL with the following procedure:

Soil extracts were maintained at 4 °C until analyzed by the Gas Chromatograph coupled with an Electron Capture Detector (GC-ECD). The autosampler vials containing the acetonitrile soil extracts were placed into GC autosampler trays that were continuously refrigerated by circulating 0 °C glycol/water through the trays. The samples were injected into a HP-6890 GC equipped with a Ni63 cell micro-electron capture detector (GC- $\mu$ ECD). Results were obtained according to the general procedure outlined in EPA SW846 Method 8095 (Draft, [www.epa.gov](http://www.epa.gov)). Direct injection of 1  $\mu$ l of soil extract was made into a purged packed inlet port, maintained at 250 °C, that was equipped with a

deactivated Uniliner from Restek Corporation, Bellefonte, PA. Primary analysis was conducted on a 7-m × 0.53-mm ID fused-silica column, with a 0.5- $\mu$ m film thickness of 5 percent (phenyl)-methylsiloxane (Rtx-5MS from Restek). The GC oven was temperature programmed as follows: 100 °C for 2 min, 10 °C/min ramp to 270 °C, 2 min hold. The carrier gas was hydrogen at a constant flow of 10 ml/min (linear velocity approximately 95 cm/sec). The detector temperature was 300 °C. The ECD makeup gas was nitrogen flowing at 45 ml/min. If a peak was observed in the retention window for a specific signature compound, the extract was reanalyzed on a confirmation column, 6-m × 0.53-mm ID having a 1.0- $\mu$ m film thickness of a proprietary phase (Rtx-TNT2 from Restek). The GC oven was temperature programmed as follows: 130 °C for 1 min, 10 °C/min ramp to 160 °C, 30 °C/min ramp to 270 °C, 2 min hold. The carrier gas was hydrogen at a constant flow of 15 ml/min (linear velocity approximately 150 cm/sec). The detector temperature was 300 °C. The ECD makeup gas was nitrogen flowing at 45 ml/min. Concentrations were estimated against commercial multianalyte standards (from Restek) from peak heights. Where analyte concentrations exceeded the highest standard, appropriate dilutions of the extract were made and the diluted extract analyzed. If analyte concentrations were within the linear range of the ECD, concentrations reported were taken from the determination on the primary column, unless co-elution with another compound was evident. In such cases, reported concentrations were taken from the determination of the confirmation column.

The quantification limits obtained for energetic materials in the present study varied between 0.5 and 12.5 ppb for soils depending of the analyte. No biomass samples were analysed for energetic materials, since no explosives were detected in Phase I. INRS conducted the following onsite groundwater and surface water measurements: pH, electrical conductivity, temperature, salinity, dissolved oxygen, and Eh. Furthermore, water level measurements, *in situ* permeability tests, and groundwater flow direction and velocity measurements were also conducted in monitoring wells. Thorium-232 was analysed by the Geological Survey of Canada using ICP/MS with a detection limit of 10 ppt for aqueous samples and 0.1 ppm for soils.

### **Sample handling and treatment**

Explosives are not volatile compounds and, therefore, no specific precautions, such as the use of sealed containers, had to be taken during sampling of media containing explosives. Soil samples were composites based on a minimum of 20 random subsamples and stored in polyethylene bags. The bags were immediately stored in ice coolers in the dark to avoid photodegradation of light-sensitive compounds. The use of polyethylene bags decreased the space needed for storing samples and reduced shipping costs. The soil samples were shipped frozen to ETL, where the samples were split into two subsamples after a thorough hand homogenization. One set of frozen samples was sent to DRDC-Val for explosives analysis, and the other was digested and analyzed for metals by ETL. Water samples were collected and kept cold in 1-l amber glasses, stabilized with sodium bisulphate (1.5 g), and sent to DRDC-Val for explosive

analysis (see section entitled “Groundwater Sampling” for method of collection). Water samples for metals analyses were collected in standard 500-ml polyethylene bottles and acidified to a pH of 2. These water samples were not filtered onsite due to the lack of the right filter units. This represents the worst-case scenario, since the unfiltered particles present in water samples may contain adsorbed metals that are dissolved by the acidic conditions prior to the analyses. In September 2002, resampling of more groundwater samples was achieved in wells showing metal concentrations higher than Canadian Council of Ministers of the Environment (CCME) threshold criteria. These samples were field-filtered prior to acidification and then shipped to ETL for metal analyses. Moreover, several samples from the same locations were sent both filtered and acidified and nonfiltered and acidified to evaluate the contribution coming from dissolved metals or metals adsorbed on soil particles. During that last sampling, 30 groundwater samples (29 well locations and one QA/QC sample) were also collected and sent to ETL for perchlorate analysis (detection limit was 0.1 ppb, quantification limit 0.5 ppb) to evaluate the potential contamination by this compound that is used in many types of ammunition. These analyses will be performed under contract using ion-pair extraction with electro-spray with ionization mass spectrometry.

Soil and water samples for thorium analysis were shipped in 500-ml polyethylene jars to the Geological Survey of Canada. Water samples collected for nutrients and anions analysis were also collected in 500-ml polyethylene bottles and shipped cold to ETL. Biomass samples were collected in polyethylene bags, kept frozen in the dark, and sent to ETL. The samples were then cut in small pieces, homogenized, digested, and analyzed for metals by ETL.

### **Field investigation**

The field investigation included borehole drilling, monitoring well installation and development, monitoring wells testing for *in situ* hydraulic conductivity estimation, and *in situ* measurements of groundwater velocity and direction. Safety proofing of all the drilling sites was done with the help of an electromagnetic device (EM-61) and a Dillon magnetometer (Figures 3-5 and 3-6). All soil, biomass, and water sampling locations were surveyed by the Global Positioning System (GPS).



Figure 3-5. Preparation for proofing of well location



Figure 3-6. Well location proofing using EM-61

**Sample Nomenclature.** All samples were named according to the following five-part labelling system:

- First part: Sample type
  - S: Soils
  - SW: Surface Water
  - GW: Groundwater
  - B: Biomass (Prairie Grass and other species)
  - SS: Subsurface Soils collected during the drilling

- Second part: Location by range
  - A: Aachen
  - B: Berlin
  - C: Cologne
  - D: Deilinghofen
  - E: Essen
  - KE: Klein Essen
  - GRE: Hand Grenade Range
  - RIF: Rifle Range
  - ATR: Anti-tank Range
  - BG: Background Sample
- Third part: Identification of the sample source
  - Target number (1, 2, and 3) or
  - Well number (1 to 81) or
  - Range number ex: RIF 1 or
  - Background location (ex: Southwest of Berlin) or
  - Background location by GPS or
  - LS for linear sampling at XX percent of the range
  - where XX percent= percent of the overall range length or
  - HS for hot spots followed by the GPS locations or
  - Xm where X is the distance perpendicular to the bunker
- Fourth part: Identification of the sample
  - Linear sampling (A or B): A being the closest sample from the starting point near the road access
  - Systematic target sampling (0 to 1 m, 1 to 3 m, 3 to 5 m, 5 to 10 m, 10 to 20 m)
  - In rifle ranges: X-Y where X is the left target and Y the right target
  - In grenade ranges: A or B, A being on the right half of the range, B on the left part of the range
- Fifth part: Date of Collection or GPS locations

### **QA/QC**

Quality assurance and quality control programs were included in this study. Background soil and surface water samples were collected away from the ranges. Moreover, representative background samples were collected in each geological formation found in the area. Background wells were also installed up gradient and background groundwater samples were collected. Background biomass samples were also collected. Analyses were done twice for energetic materials (lab replicates), but were done only once for the other parameters. Ten (10) percent of field replicates were also sent for analysis. The contracted laboratory reported their QA-QC including surrogates and blanks, detection limits, and quantification limits. Trip blanks and field blanks were also included in the QA/QC plan.

## **Safety and emergency plan**

The sampling of a UXO contaminated area represents an increased level of risk for personnel. The Range Control Officers gave a safety briefing to people involved in the sampling program. This briefing explained the precautions to be taken to avoid contact with UXO on the ranges and also described the various types of UXO that may be found on ranges. A safety and emergency plan was also put in place for any incident that could occur while sampling water, soils, and biomass. This plan was under the responsibility of the Shilo Range Control unit. When onsite for sampling, personnel were always equipped with radios to contact range control in case of an emergency. Walkie-talkies were available to communicate between the teams.

## **Sampling strategy**

Soil and biomass sampling was conducted under DRDC-Val's supervision, while surface water and groundwater sampling was conducted under the guidance of INRS. A total number of 156 soil samples were collected in Phase II. These included 21 backgrounds and 12 field duplicates (8 percent). All samples were analysed for metals (156), while a limited number were analysed for thorium (61) and energetic materials (108 soils- 8 field duplicates). Biomass samples (64) were collected including 3 field duplicates and 17 background samples. Groundwater samples (92) and surface water samples (22) were collected in 2001 and were analysed for metals and energetic materials.

Background soil samples are critical for establishing the anthropogenic contribution versus the natural contribution for all parameters. One of the weaknesses of the Phase I was the limited number of representative soil and biomass background samples. This was the result of a limited time frame for Phase I. This situation was corrected in Phase II during which 21 soil and 17 biomass background samples were collected in all directions around the training area. As an example, soils and biomass background samples were collected nearby road No. 5, east of the training area (Figure 3-7), and in a grazing area northeast of the base (Figure 3-8). Moreover, background sampling locations were carefully chosen to represent the various geological formations that can be found in the area. Geological formations found at CFB Shilo vary from sand, swamp deposit to silt deposits. Therefore, background samples were collected for each of these formations. The background composite samples were collected in a random manner, in a circular pattern of approximately 20 m in different locations inside and outside the base. A minimum of 30 subsamples was collected to form each background sample. A statistical analysis was done with the results. This statistical analysis allows the identification of a background concentration and to define a limit for a value, which can be considered abnormal. Samples located at the extremity of the log normal curve were identified, the limits were chosen for a probability of 97.72 percent (2 times the standard deviation). The probability of finding a result with a value higher than this limit is 2.28 percent.

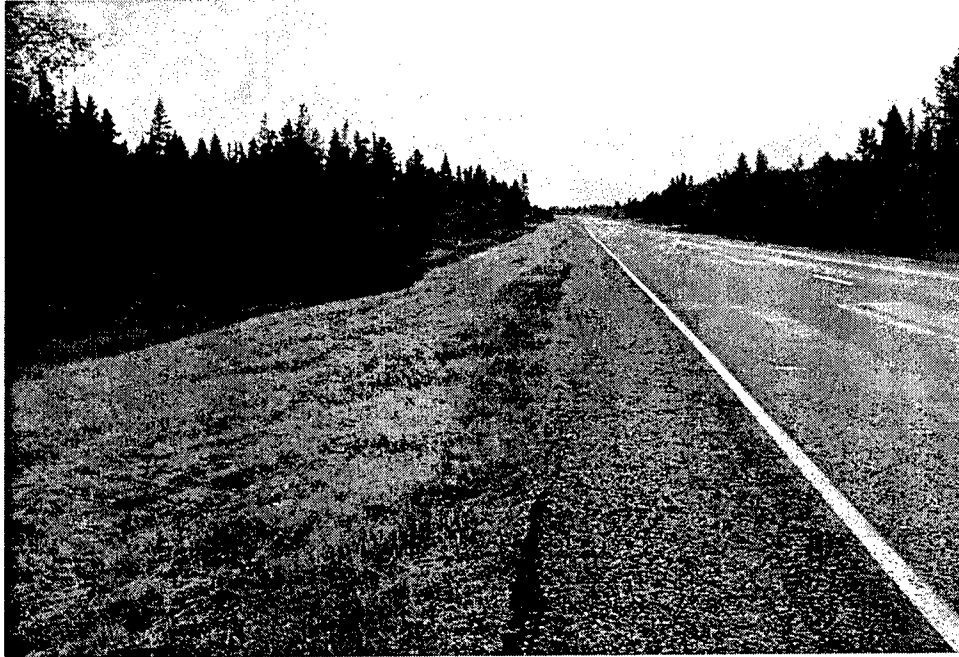

Figure 3-7. Background soil samples on Road 5

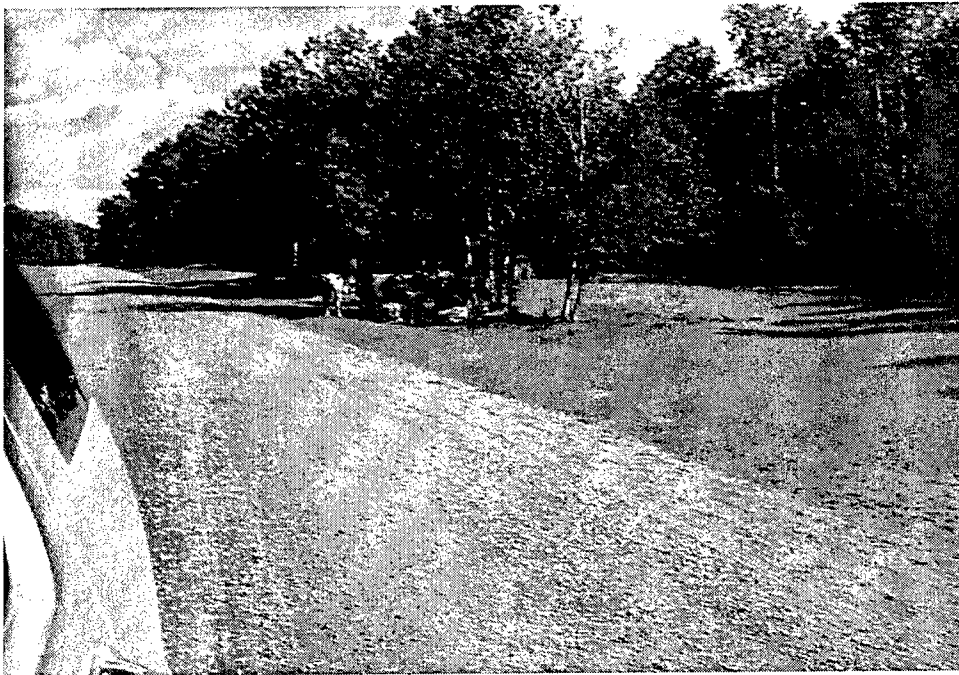

Figure 3-8. Background soil sample in grazing area northeast of base

Each of the five battleruns in Shilo is approximately 2 km wide. Three battleruns were sampled during Phase I (Berlin, Deilinghofen, and Essen), and the two remaining (Aachen and Cologne) were sampled during Phase II. A small part of Essen (Klein Essen) was also sampled. Deilinghofen and Essen battleruns were again visited during Phase II to resample a few targets to verify that the patterns obtained for soils in Phase I would be obtained in biomass. The



Parkplatzs in Cologne and Aachen were not sampled for VOCs or petroleum products during the Phase II, since nothing was found in Phase I in the three other battleruns. The same strategy used in the previous study was adopted for the Aachen and Cologne ranges, using both linear transects and circular pattern at selected targets (Figures 3-9 through 3-12). These strategies are described in more details on the next page. However, a smaller number of samples were collected using a different strategy in Klein Essen. This latter range was used mainly for small caliber and machine gun firing. Therefore, the strategy used in the other battleruns was not applicable there. Some samples were collected in the small caliber target areas, and these samples were screening for metals only. Energetic materials were not screened in Klein Essen, since small arms bullets contain no explosive filling.

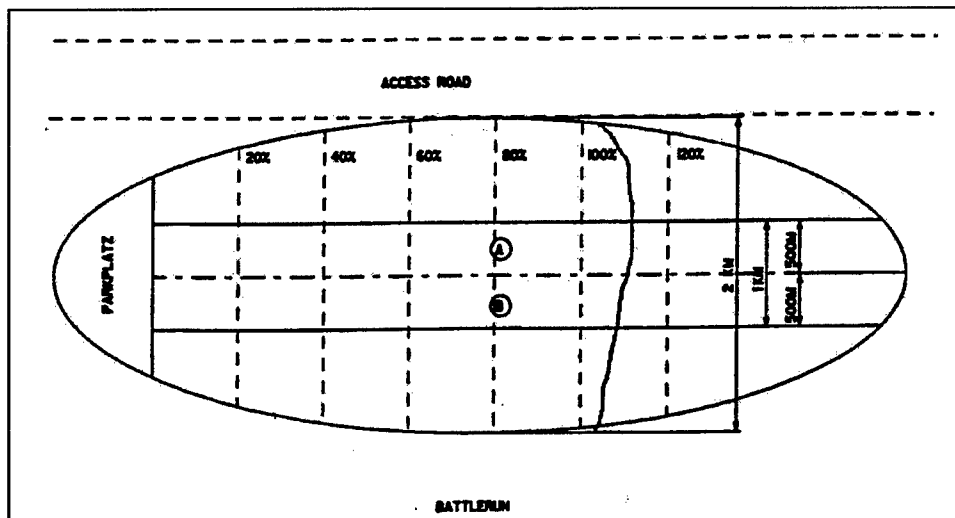

Figure 3-9. Schematic view of the linear soil sampling pattern



Figure 3-10. Typical CFB Shilo topography where linear sampling was applied

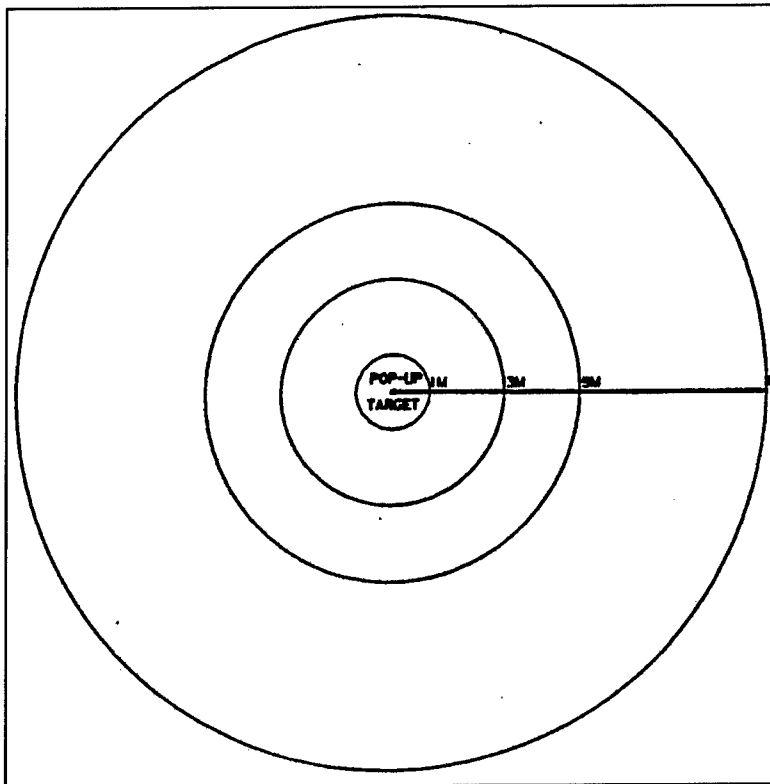

Figure 3-11. Circular sampling around targets



Figure 3-12. Sampling of soils in Essen target area using circular approach

The initial strategy planned for soil sampling was based on systematic sampling around a representative number of targets in battleruns and also hot spots (broken UXOs or debris, etc.). This strategy was used in previous studies on antitank ranges, which showed very distinct patterns of contamination around targets [2]. However, the nature and type of firing exercises conducted in the battleruns were different from those conducted in antitank ranges. In this type of firing exercises, the ammunition makes the target flip and pursues its flight until

it reaches the end of the battlerun. The sampling strategy was modified to account for this difference. We used two sampling approaches, both based on the collection of composite samples, in order to decrease the high level of heterogeneity usually observed with explosives residues in such scenarios [2].

The first sampling approach consisted of sampling targets by compositing samples taken in a circular pattern. A minimum of 20 surface subsamples were collected at a depth of 0 to 2 cm within a radius of 1 m, 1 to 3, 3 to 5, and 5 to 10 m immediately surrounding the target areas, as shown in Figure 3-11. A rope marked at the prescribed distances was fixed to a stick as close as possible to the target. Circles were defined by turning the rope around the stick at the defined distance. All targets were sampled in a 360-deg pattern around the targets. The GPS locations of all the sampled targets were recorded. These GPS locations are presented in Table 3-1. Since a pattern of contamination was observed around targets in Phase II, more biomass and soil samples were collected according to this approach.

The second sampling approach used a linear sampling pattern. This approach was used to evaluate whether the level of contamination by metal, thorium, or energetic materials was following a pattern with distance in the battleruns. If firing activities lead to the accumulation of contaminants in soils, higher levels would have been found at the end of battleruns, since most of the ammunitions fired were supposedly found there and the number of UXO items would be greater in these locations. Therefore, composite samples were collected at distances of 20, 40, 60, 100, and 120 percent of the length of each range, when accessible. For all battleruns, an access road was located along the range. The transects were fixed with the help of the Global Positioning System (GPS). The GPS locations are reported in Table 3-1. The linear samples corresponded to the point of the access road where the sampling team started walking perpendicularly to the range using a GPS to keep on a straight line. As explained earlier, the ranges are generally 2 km wide. The sampling team walked for 1.5 km in a straight direction and started sampling on their way back. The sample collected at the first 500-m distance was identified as Sample B, while the sample collected at the other 500-m distance was identified as Sample A with it being the nearest to the access road (Figure 3-9). A minimum of 20 surface subsamples taken at 0- to 2-cm depth were collected to build each composite Samples A and B corresponding to the two portions of 500 m along transects in the middle of battleruns at each 20-percent interval from the parkplatzs.

During the drilling of the boreholes, subsurface soil samples were also collected prior to the drilling of the last 2 m. Sampling was conducted with a 51-mm split spoon (60 cm long) at the depth of the middle of the screened interval of 1.52 m of the well. All of the soil samples were sent to INRS-ETL laboratory for grain size analysis and hydraulic conductivity estimation. Results are presented in the section of text entitled "Hydraulic Properties of the Aquifer," under subheading "Determination of the hydraulic conductivity."

**Table 3-1  
GPS Locations of Soils and Biomass**

Lab Number	Sample ID	Sampling Point		Date Sampled
		X	Y	
01-A75917	B-BG-52660E 22764N	52660	22764	1-Sep-10
01-A80978	B-BG-69940E 18340N	69940	18340	1-Sep-15
01-A80979	B-BG-80356E 06945N	80356	06945	1-Sep-15
01-A75919	B-BG-63783E 17228N	63783	17228	1-Sep-10
01-A75920	B-BG-62630E 17054N	62630	17054	1-Sep-10
01-A75921	B-BG-74864E 14968N	74864	14968	1-Sep-10
01-A75922	B-BG-79148E 13157N	79148	13157	1-Sep-10
01-A75923	B-BG-55265E 11847N	55265	11847	1-Sep-10
01-A75925	B-BG-55255E 09752N	55255	09752	1-Sep-10
01-A75926	B-BG-53656E 11283N	53656	11283	1-Sep-10
01-A75927	B-BG-80720E 05003N	80720	05003	1-Sep-10
01-A75928	B-BG-53670E 13403N	53670	13403	1-Sep-10
01-A75929	B-BG-67858E 98938N	67858	98938	1-Sep-10
01-A75930	B-BG-68067E 97960N	68067	97960	1-Sep-10
01-A75931	B-BG-69431E 98407N	69431	98407	1-Sep-10
01-A75932	B-BG-63565E 00626N	63565	00626	1-Sep-10
01-A75933	B-BG-62033E 01742N	62033	01742	1-Sep-10
01-A75937	S-BG-69940E 18340N	69940	18340	1-Sep-10
01-A75938	S-BG-52660E 22764N	52660	22764	1-Sep-10
01-A75939	S-BG-80356E 06945N	80356	06945	1-Sep-10
01-A75940	S-BG-57997E 20636N	57997	20636	1-Sep-10
01-A75941	S-BG-65629E 17392N	65629	17392	1-Sep-10
01-A75942	S-BG-63783E 17228N	63783	17228	1-Sep-10
01-A75943	S-BG-78159E 99759N	78159	99759	1-Sep-10
01-A75944	S-BG-62630E 17054N	62630	17054	1-Sep-10
01-A75945	S-BG-79182E 00111N	79182	00111	1-Sep-10
01-A75946	S-BG-74864E 14968N	74864	14968	1-Sep-10
01-A75947	S-BG-49148E 13157N	49148	13157	1-Sep-10
01-A75949	S-BG-55265E 11847N	55265	11847	1-Sep-10
01-A75951	S-BG-55255E 09752N	55255	09752	1-Sep-10
01-A75952	S-BG-53656E 11283N	53656	11283	1-Sep-10
01-A75953	S-BG-80720E 05003N	80720	05003	1-Sep-10
01-A75954	S-BG-53670E 13403N	53670	13403	1-Sep-10
01-A75955	S-BG-67858E 98938N	67858	98938	1-Sep-10
01-A75956	S-BG-68067E 97960N	68067	97960	1-Sep-10
01-A75957	S-BG-69431E 98407N	69431	98407	1-Sep-10
01-A75958	S-BG-63565E 00626N	63565	00626	1-Sep-10
01-A75959	S-BG-62033E 01742N	62033	01742	1-Sep-10
01-A77439	S-A-HS-60021E 12160N	60021	12160	1-Sep-10
01-A77440	S-A-HS-60042E 12060N	60042	12060	1-Sep-10
01-A77441	S-A-LS 20 percent-A	59000	12570	1-Sep-10
01-A77442	S-A-LS 20 percent-B	59000	13070	1-Sep-10
01-A77443	S-A-LS 40 percent A	60008	12000	1-Sep-10
01-A77444	S-A-LS 40 percent B	60008	12800	1-Sep-10

(Sheet 1 of 4)

**Table 3-1 (Continued)**

Lab Number	Sample ID	Sampling Point		Date Sampled
		X	Y	
01-A77446	S-A-LS 60 percent A	61000	11750	1-Sep-10
01-A77447	S-A-LS 60 percent B	61000	12250	1-Sep-10
01-A77448	S-A-LS 80 percent A	62000	11500	1-Sep-10
01-A77449	S-A-LS 80 percent B	62000	12300	1-Sep-10
01-A77451	S-A-LS 100 percent A	63000	12000	1-Sep-10
01-A77452	S-A-LS 120 percent A	64470	10900	1-Sep-10
01-A77453	S-A-LS 120 percent B	64470	11900	1-Sep-10
01-A77454	S-A-1-0-1	59975	11778	1-Sep-10
01-A77455	S-A-1-1-3	59975	11778	1-Sep-10
01-A77456	S-A-1-3-5	59975	11778	1-Sep-10
01-A77457	S-A-2-0-1	59038	12149	1-Sep-10
01-A77458	S-A-2-1-3	59038	12149	1-Sep-10
01-A77459	S-A-2-3-5	59038	12149	1-Sep-10
01-A80541	B-A-1-0-3	59975	11778	1-Sep-10
01-A80542	B-A-1-3-5	59975	11778	1-Sep-10
01-A80543	B-A-2-0-3	59038	12149	1-Sep-10
01-A80544	B-A-2-3-5	59038	12149	1-Sep-10
01-A77490	S-C-LS 40 percent A	64000	02950	1-Sep-12
01-A77489	S-C-LS 40 percent B	64000	02450	1-Sep-12
01-A77491	S-C-LS 60 percent A	65000	02750	1-Sep-12
01-A77492	S-C-LS 60 percent B	65000	02250	1-Sep-12
01-A77493	S-C-LS 80 percent A	66000	03200	1-Sep-12
01-A77494	S-C-LS 80 percent B	66000	02000	1-Sep-12
01-A77496	S-C-LS 100 percent A	67000	02250	1-Sep-12
01-A77497	S-C-LS 100 percent B	67000	02750	1-Sep-12
01-A77498	S-C-LS 120 percent A	68000	02750	1-Sep-12
01-A77499	S-C-LS 120 percent B	68000	02250	1-Sep-12
01-A77500	S-C-1-0-1	64000	02208	1-Sep-12
01-A77501	S-C-1-1-3	64000	02208	1-Sep-12
01-A77502	S-C-1-3-5	64000	02208	1-Sep-12
01-A77503	S-C-2-0-1	65230	02878	1-Sep-12
01-A77504	S-C-2-1-3	65230	02878	1-Sep-12
01-A77505	S-C-2-3-5	65230	02878	1-Sep-12
01-A77506	S-C-3-0-1	65980	02759	1-Sep-12
01-A77507	S-C-3-1-3	65980	02759	1-Sep-12
01-A77508	S-C-3-3-5	65980	02759	1-Sep-12
01-A77509	S-C-HS 65235E 02908N	65235	02908	1-Sep-12
01-A77510	S-C-HS 65266E 02930N	65266	02930	1-Sep-12
01-A77511	S-C-HS 66040E 02939N	66040	02939	1-Sep-12
01-A77512	S-C-HS 66017E 02566N	66017	02566	1-Sep-12
01-A77513	S-C-HS 65011E 02663N	65011	02663	1-Sep-12
01-A77514	S-C-HS 63025E 02811N	63025	02811	1-Sep-12
01-A77515	S-C-HS 68010 02205N	68010	02205	1-Sep-12
01-A77516	B-C-1-0-3	64000	02208	1-Sep-12
01-A77517	B-C-1-3-5	64000	02208	1-Sep-12

(Sheet 2 of 4)

<b>Table 3-1 (Continued)</b>				
<b>Lab Number</b>	<b>Sample ID</b>	<b>Sampling Point</b>		<b>Date Sampled</b>
		<b>X</b>	<b>Y</b>	
01-A77518	B-C-2-0-3	65230	02878	1-Sep-12
01-A77519	B-C-2-3-5	65230	02878	1-Sep-12
01-A77520	B-C-3-0-3	65980	02759	1-Sep-12
01-A77521	B-C-3-3-5	65980	02759	1-Sep-12
01-A77566	S-D-HS-74210E 01267N	74210	01267	1-Sep-14
01-A77567	S-D-HS-74326E 01195N	74326	01195	1-Sep-14
01-A77568	S-D-HS-74215E 01278N	74215	01278	1-Sep-14
01-A77569	S-D-HS-74215E 01278N (A)	74215	01278	1-Sep-14
01-A77570	S-D-1-0-1	74196	01287	1-Sep-14
01-A77571	S-D-1-1-3	74196	01287	1-Sep-14
01-A77572	S-D-1-3-5	74196	01287	1-Sep-14
01-A77573	S-D-2-0-1	74258	01273	1-Sep-14
01-A77574	S-D-2-1-3	74258	01273	1-Sep-14
01-A77575	S-D-2-3-5	74258	01273	1-Sep-14
01-A77576	B-D-1-0-3	74196	01287	1-Sep-14
01-A77577	B-D-1-3-5	74196	01287	1-Sep-14
01-A77578	B-D-2-0-3	74258	01273	1-Sep-14
01-A77579	B-D-2-3-5	74258	01273	1-Sep-14
01-A77580	S-E-HS-63240E 15109N	63240	15109	1-Sep-14
01-A77581	S-E-HS-63240E 15109N	63240	15109	1-Sep-14
01-A80965	B-E-HS-64435E 14486N	64435	14486	1-Sep-15
01-A77583	S-E-1-1-3	63175	15130	1-Sep-14
01-A77584	S-E-1-3-5	63175	15130	1-Sep-14
01-A77585	S-E-2-0-1	63175	11115	1-Sep-14
01-A77586	S-E-2-1-3	63175	11115	1-Sep-14
01-A77587	S-E-2-3-5	63175	11115	1-Sep-14
01-A77588	B-E-1-0-3	63175	15130	1-Sep-14
01-A77589	B-E-1-3-5	63175	15130	1-Sep-14
01-A77590	B-E-2-0-3	63175	11115	1-Sep-14
01-A77591	B-E-2-3-5	63175	11115	1-Sep-14
01-A80967	B-E-3-0-1 (RACINE)	64425	14508	1-Sep-15
01-A80968	B-E-3-0-3	64425	14508	1-Sep-15
01-A80969	B-E-3-3-5	64425	14508	1-Sep-15
01-A80970	B-E-4-0-3	64410	14504	1-Sep-15
01-A80971	B-E-4-3-5	64410	14504	1-Sep-15
01-A80972	S-E-3-0-1	64425	14508	1-Sep-15
01-A80973	S-E-3-1-3	64425	14508	1-Sep-15
01-A80974	S-E-3-3-5	64425	14508	1-Sep-15
01-A80975	S-E-4-0-1	64410	14504	1-Sep-15
01-A80976	S-E-4-1-3	64410	14504	1-Sep-15
01-A80977	S-E-4-3-5	64410	14504	1-Sep-15
01-A77558	S-KE-1-0-3	60506	16204	1-Sep-13
01-A77559	S-KE-BU-1	60470	16202	1-Sep-13
01-A77560	S-KE-BU-2	60470	16202	1-Sep-13
01-A77561	S-KE-BU-3	60470	16202	1-Sep-13

(Sheet 3 of 4)

**Table 3-1 (Concluded)**

Lab Number	Sample ID	Sampling Point		Date Sampled
		X	Y	
01-A77562	S-KE-BU-4	60470	16202	1-Sep-13
01-A77563	B-KE-1-0-3	60506	16204	1-Sep-13
01-A77564	B-KE-BU-1	60470	16202	1-Sep-13
01-A77565	B-KE-BU-2	60470	16202	1-Sep-13
01-A77540	S-RIF2-37-39	55900	18500	1-Sep-13
01-A77542	S-RIF2-40-42	55900	18500	1-Sep-13
01-A77543	S-RIF2-43-45	55900	18500	1-Sep-13
01-A77544	S-RIF2-46-48	55900	18500	1-Sep-13
01-A77546	S-RIF2-T28	55900	18500	1-Sep-13
01-A77547	S-RIF2-T34	55900	18500	1-Sep-13
01-A77548	S-RIF2-T40	55900	18500	1-Sep-13
01-A77549	S-RIF2-T46	55900	18500	1-Sep-13
01-A77550	S-RIF4-1-3	56600	18600	1-Sep-13
01-A77551	S-RIF4-4-6	56600	18600	1-Sep-13
01-A77552	S-RIF4-7-9	56600	18600	1-Sep-13
01-A77553	S-RIF4-10-12	56600	18600	1-Sep-13
01-A77554	S-RIF4-T4	56600	18600	1-Sep-13
01-A77555	S-RIF4-T9	56600	18600	1-Sep-13
01-A77556	B-RIF4-1-6	56600	18600	1-Sep-13
01-A77557	B-RIF4-7-12	56600	18600	1-Sep-13
01-A80951	S-ASA-HS-51508E 15705N	51508	15705	1-Sep-15
01-A80952	S-ASA-HS-51501E 15688N	51501	15688	1-Sep-15
01-A80953	S-ASA-HS-51488E 15697N	51488	15697	1-Sep-15
01-A80954	S-ASA-I-5	51397	15679	1-Sep-15
01-A80955	S-ASA-I-10	51397	15679	1-Sep-15
01-A80956	S-ASA-I-15	51397	15679	1-Sep-15
01-A80957	S-ASA-I-20	51397	15679	1-Sep-15
01-A80958	S-ASA-I-25	51397	15679	1-Sep-15
01-A80959	S-ASA-I-30	51397	15679	1-Sep-15
01-A80960	B-ASA-51508E 15705N	51508	15705	1-Sep-15
01-A80961	B-ASA-51501E 15688N	51501	15688	1-Sep-15
01-A80962	B-ASA-51488E 15697N	51488	15697	1-Sep-15
01-A80963	B-ASA-I-0-15M	51397	15679	1-Sep-15
01-A80964	B-ASA-I-15-30M	51397	15679	1-Sep-15

*(Sheet 4 of 4)*

The sediments encountered in the subsurface during drilling were visually described. Among the 41 boreholes, a total of 4 boreholes, namely SS-A-6, SS-B-6, SS-D-1, and SS-E-5, were sampled continuously every 60 cm with a 51-mm split-spoon sampler for soil classification and identification. The samples were composite samples at depth of 0 to 1, 1 to 2, 3 to 4, 5 to 6, 7 to 8, 9 to 10, 11 to 12, 13 to 14, 15 to 16, and 17 to 18 ft. Some duplicates were also collected. A total of 15 of these soil samples were sent to ETL for metal analysis. Detailed descriptions of the soil profiles were made by DCC and were recorded in boreholes logs. Additional soil samples were also obtained along the screened

interval directly from the auger to make the calibration-curve in the laboratory for the groundwater velocity measurements in the field with the Geoflo 40 flow meter.

Wherever biomass samples were collected, the method used consisted of building composite samples of indigenous living plants by cutting various types of plants randomly. A minimum of 20 to 30 subsamples of mixed biomass material was collected around targets. No biomass samples were collected along the transects in battleruns during Phase II because no trends in biomass had been observed in battleruns during Phase I. Only the upper part of the plants (without roots) was collected, since grazing animals rarely eat the roots of the prairie grass as verified by consulting an expert from Environment Canada.<sup>1</sup> Moreover, explosives (particularly RDX and HMX) are known to bio-accumulate in the upper part of the plant. Metals could bio-accumulate either in the upper plant system or in the roots, depending of the solubility of the metals. Only one sample of roots was collected in the Milan missile impact area to verify if the results obtained for thorium and other parameters would be higher in this sample. Background samples were collected mainly inside and outside the base at different locations corresponding to the different geological formations encountered in the studied area. A total of 64 biomass samples including 17 background samples were collected in, and around the training areas. Metals were evaluated by digesting the biomass samples using a standard procedure in nitric acid. In Phase II, plant leachates were not included, since results obtained in Phase I did not show any representative trends for the leachate results. So, only the total digestion of the plants was conducted. Moreover, the sampling was concentrated in a circular pattern around targets in the battleruns, since the results from Phase I did show some trends around targets for soils.

For <sup>232</sup>Th, the composite soil samples were also formed of a minimum of 20 subsamples. The target areas for the Milan missiles were identified, and the approach using the circular pattern was applied to collect soil samples (Figure 3-12). The areas were swept for radioactivity during Phase I. No radioactivity was detected, which was not surprising, since the half-life of <sup>232</sup>Th is very long and the radiation is emitted very slowly. In order to detect such low emission sources, a special detector should have been used and left in place for days. No radioactivity sweep was performed in Phase II. Nevertheless, soil samples were collected and sent for analysis in order to verify the results obtained in Phase I, and moreover, to assess whether the concentrations were decreasing with time. Biomass samples were also collected around Milan targets using the circular approach specific for targets. This was done to verify that bioaccumulation in plant tissues could be measured. A sample of plant roots was also collected in one occasion, since low solubility metals are known to bio-accumulate in plant roots instead of plant tissues. When the Essen impact area was visited, some Milan missile remains could still be found (Figure 3-13). These areas were sampled in a circular pattern as in Phase I. In the Essen target area, the sampling team wore protecting disposable masks, gloves, and Tivex suits to avoid any contact with the soil dust.

---

<sup>1</sup> Dr. Lucie Olivier, Project Manager, Environment Canada-Montréal, via teleconference.





Figure 3-13. Milan missile debris in Essen

Specific sampling strategies were used in grenade and rifle ranges. The grenade range was composed of a detonation area and a concrete bunker for the grenade thrower. Composite linear samples were collected in transects perpendicular to the grenade launching direction at distances of 5, 10, 15, 20, 30, and 35 m (Figures 3-14 and 3-15). Each transect measured 14 m long and was split into two portions of 7 m each, and named A and B samples. "A" was on the right-hand side of the grenade bunker when looking at the bunker from the detonation area. This sampling pattern was selected to verify whether a trend in the concentrations with the distance from the bunker could be observed. Moreover, a circular pattern would not have been helpful, since no targets were present on the range. Since there was only one crater in the detonation area, it was sampled as a potential hot spot (HS) by collecting 15 subsamples in the wall and at the bottom of the crater. The sampling pattern selected for the grenade range is illustrated in Figure 3-14. In this range, no biomass samples were collected, since the range was sandy and not vegetated.

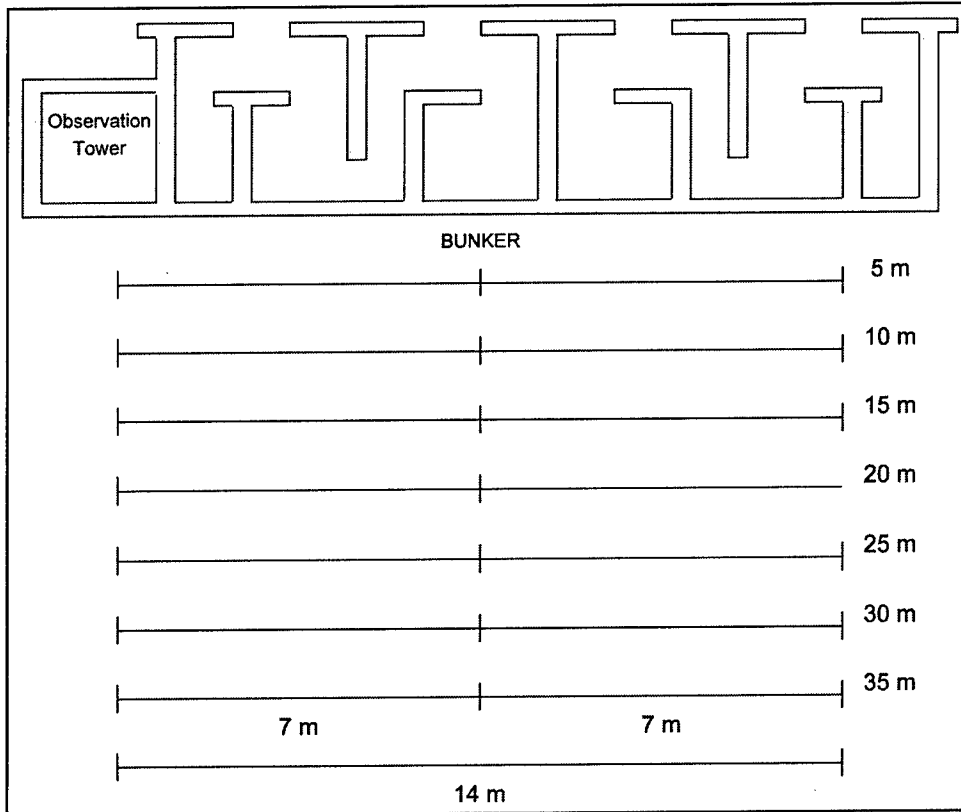

Figure 3-14. Grenade Range sampling illustration

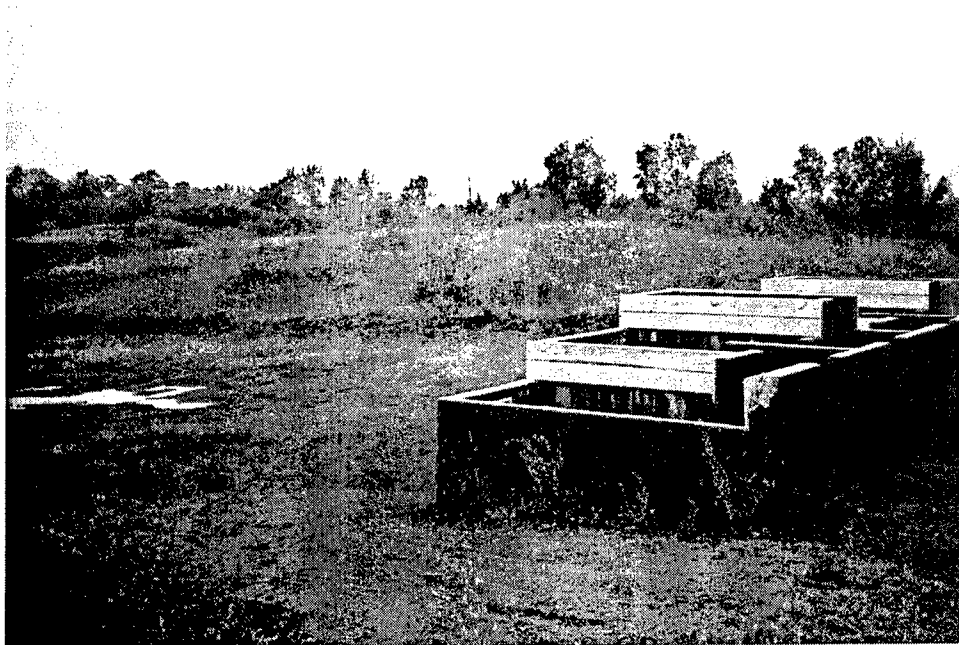

Figure 3-15. Grenade Range Shilo

The four rifle ranges in Shilo consisted of a series of numbered targets having sand butts (berms) in front of them. These butts are regularly sieved for metal debris. Surface soils, subsurface soils, and biomass samples were collected at three rifle ranges (1, 2, and 4). Rifle range Number 3 was not sampled based on its lower use by troops. Surface soils were collected from 0 to 10 cm deep, using stainless steel spoons. Subsurface soils were collected using a hand-operated auger. The soil was collected in the auger after drilling in the subsurface. All the auger content was collected. This represented a composite core sample of a depth between 5 and 50 cm. Eight composite surface soil samples were built of at least 20 subsamples and were collected in front of groups of three nearby targets (24 targets sampled) (Figures 3-16 and 3-17). Four subsurface soil samples were collected in each rifle range in front of four equally distance targets. Biomass samples were collected since all the rifle ranges were highly vegetated around the sand butts and many deer droppings were seen onsite. This means that many deer graze on this vegetation. The sampling pattern selected is illustrated in Figure 3-15. Four biomass composite samples were collected, each being built of at least 30 subsamples. Samples were collected in the area in front of a group of six close targets.

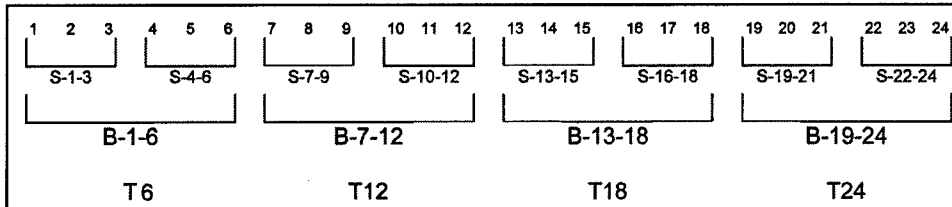

Figure 3-16. Rifle Range sampling illustration



Figure 3-17. Rifle Range Shilo

# Hydrogeological Survey

## Safety proofing

Safety proofing consisted of surveying the ground to detect surface laid and buried metallic objects, thus ensuring the absence of UXO at the location of the well. A level 2 clearance proofing (0 to 6 m deep) was conducted by XTECH Explosive Decontamination Inc. prior to drilling at all well locations to ensure the safety of drilling and technical personnel. XTECH, along with Range Control and INRS personnel, first used GPS to locate and identify future drilling sites. An electronic ordnance avoidance search was then performed at each of the 71 drilling sites located within the danger area boundaries (37 out of 42 in 2000, 34 out of 36 in 2001). The procedure included the proofing of a 2-m × 2-m square grid on drilling sites with a Geonix EM61 device, followed by a final search with a magnetometer (Forester Search Instrument in 2000 and with a Dillon magnetometer F1A4 Minelab in 2001) (Figures 3-5 and 3-6). The Geonix EM61 and the magnetometer can detect large ferrous objects at depth of 9 m. As an example, 155-mm shells can be detected at 3- to 5-m depths, which was considered safe to drill when no signals were observed. Cleared locations were identified with red ribbon and a stake indicating the date and drilling site number.

## Borehole drilling

Drilling and installation of groundwater monitoring wells was conducted in October 2000 (42 wells) and September 2001 (36 wells). All wells were drilled by Paddock Drilling Ltd (Brandon, MB) and were installed under INRS guidance by Cochrane Engineering Ltd (Winnipeg, MB) in 2000 and by Defence Construction Canada in 2001. The majority of boreholes were drilled with a Cattera rig, while a Nodwell-Brat 22 caterpillar was required for a few boreholes located in difficult access areas. Both rigs were equipped with a hollow-stem auger. For each site location, a probe hole was drilled with a 125-mm-stem auger to determine the depth of the water table and then backfilled with bentonite. This initial step was executed to ensure that all observation wells would be drilled to at least 2 m below the water table. Then, a 200-mm-diam borehole was drilled with the hollow-stem auger at least 1 m away from the probe hole. This borehole was drilled to a depth of 2 m below the depth of the water table.

Well locations were selected according to several criteria including site safety, ease of access, proximity to potential contamination sources, and adequate site coverage. Three wells were located outside of the base limits in order to obtain background values for all measured parameters. Further information on well localization and design can be found in Table 3-2. For borehole and grain size analyses logs, refer to this chapter, Appendix C, pages 3-142 through 3-213.

**Table 3-2  
Well Locations and Hydraulic Information**

Well ID	GPS-E <sup>1</sup>	GPS-N	Elevation, m	Shooting Point	GW elevation 2000, m	GW elevation 2001, m	Well Depth, m	Water Level, m	Length Slotted Pipe, m	Comments
<b>INRS 2001 Wells<sup>2</sup></b>										
GW-ANTENNE	450107	5513767	371.407	Top plastic cap	N/A <sup>(7)</sup>	361.89	14.66	9.51	10.0	Observation Well
GW-AMA-1	451371	5515945	369.579	Top plastic cap	N/A	365.42	6.13	4.15	5.0	Observation Well
GW-AMA-2	451359	5515701	370.957	Top plastic cap	N/A	365.21	8.50	5.74	5.0	Observation Well
GW-ATR-1	458557	5519084	374.101	Metal well cap	N/A	--	5.39	3.58	5.0	Observation Well
GW-A-9	469904	5509655	367.290	Metal well cap	N/A	365.70	3.03	1.51	5.0	Observation Well
GW-A-10	463406	5511067	374.153	Metal well cap	N/A	369.77	5.85	4.34	10.0	Observation Well
GW-BGR-3	474578	5515026	376.016	Metal well cap	N/A	371.77	9.73	4.20	10.0	Observation Well
GW-BGR-4	461084	5524505	383.199	Metal well cap	N/A	376.62	9.14	6.52	5.0	Observation Well
GW-C-8	463729	5501034	363.195	Metal well cap	N/A	353.48	11.76	9.64	5.0	Observation Well
GW-C-9	466929	5499917	359.571	Metal well cap	N/A	353.10	8.40	6.41	5.0	Observation Well
GW-D-9	474356	5504005	360.945	Metal well cap	N/A	355.75	7.24	5.12	5.0	Observation Well
GW-D-11	474379	5500610	358.457	Metal well cap	N/A	349.70	10.24	8.71	5.0	Observation Well
GW-D-12	477709	5500130	355.985	Metal well cap	N/A	337.99	22.00	17.95	10.0	Observation Well
GW-D-13	478113	5501166	350.225	Metal well cap	N/A	342.52	12.14	7.64	10.0	Observation Well
GW-E-7	464892	5515941	373.785	Metal well cap	N/A	370.01	5.27	3.72	5.0	Observation Well
GW-E-8	465994	5514995	374.013	Metal well cap	N/A	369.69	6.71	4.30	5.0	Observation Well
GW-E-9	465971	5514237	372.316	Metal well cap	N/A	369.98	3.68	2.31	5.0	Observation Well
GW-E-11	461977	5513661	373.880	Metal well cap	N/A	370.67	5.00	3.15	5.0	Observation Well
GW-GATE-S	453529	5516354	373.844	Top plastic cap	N/A	367.15	8.91	6.59	10.0	Observation Well
GW-GRE-1	457531	5517992	373.829	Metal well cap	N/A	370.00	6.20	3.71	5.0	Observation Well
GW-GRE-2	457486	5517962	373.056	Metal well cap	N/A	369.94	4.87	3.06	5.0	Observation Well
GW-RIF-1	455650	5518510	377.940	Metal well cap	N/A	--	10.63	8.50	5.0	Observation Well

(Sheet 1 of 5)

**Table 3-2 (Continued)**

Well ID	GPS-E <sup>1</sup>	GPS-N	Elevation, m	Shooting Point	GW elevation 2000, m	GW elevation 2001, m	Well Depth, m	Water Level, m	Length Slotted Pipe, m	Comments
GW-RIF-3	456510	5518326	375.141	Metal well cap	N/A	369.66	7.36	5.42	5.0	Observation Well
OBS-SUP-27	454292	5517105	379.905	Metal well cap	N/A	368.25	12.80	11.60	10.0	Observation Well
GW-TR	457112	5518359	372.527	Metal well cap	N/A	369.87	5.20	2.59	5.0	Observation Well
OBS-SUP-5	454440	5517050	379.000	N/A	N/A	--	14.28	11.64	10.0	Observation Well
OBS-SUP-16	454263	5517312	380.430	Metal well cap	N/A	368.32	13.84	12.07	5.0	Observation Well
GW-ZONE-4E	455282	5513887	370.809	Top plastic cap	N/A	366.37	8.61	4.43	10.0	Observation Well
GW-ZONE-4W	453722	5514810	373.220	Top plastic cap	N/A	366.02	7.9 n	7.41	5.0	Observation Well
GW-ZONE-5N	455251	5511039	369.150	Metal well cap	N/A	364.03	8.89	4.98	10.0	Observation Well
GW-ZONE-5S	455235	5508363	367.142	Metal well cap	N/A	361.21	9.26	5.80	10.0	Observation Well
GW-ZONE-7	468312	5497496	353.699	Metal well cap	N/A	347.70	9.20	5.95	10.0 <sup>(8)</sup>	Observation Well
GW-ZONE-7W	466672	5497613	354.741	Metal well cap	N/A	347.56	10.25	7.10	10.0	Observation Well
GW-ZONE-9N	459767	5519509	377.105	Metal well cap	N/A	370.75	9.06	6.30	5.0	Observation Well
GW-ZONE-9S	458562	5517394	372.072	Metal well cap	N/A	370.16	3.26	1.85	5.0	Observation Well
GW-ZONE-9W	459053	5518441	377.666	Metal well cap	N/A	370.52	8.61	7.10	5.0	Observation Well
<b>INRS 2000 Wells<sup>3</sup></b>										
GW-ATR	458709	5519393	373.443	Metal	370.543	370.47	4.82	2.91	5	Observation Well
GW-GRE	457433	5518019	374.106	Metal	369.936	369.87	6.41	4.15	10	Observation Well
GW-MARSH1	474028	5507383	366.708	Metal	362.003	362.04	7.40	4.60	5	Observation Well
GW-BGR	454213	5521773	372.092	Ground	370.282	370.04	5.93	2.90	5	Observation Well
GW-RIF	455526	5518382	374.586	Metal	369.196	369.22	7.36	5.29	10	Observation Well
GW-A-1	457314	5512967	372.141	Metal	366.996	366.20	7.31	5.85	5	Observation Well
GW-A-2	458680	5511651	373.619	Metal	366.844	366.93	8.53	6.57	5	Observation Well
GW-A-7	467437	5513209	371.282	PVC	367.042	--	Well Lost	n/a	5	Well not found in 2001. Observation well.
GW-A-3	459736	5511232	372.317	Metal	367.597	367.68	6.54	4.53	5	Observation Well
GW-A-4	460621	5510713	373.26	Metal	367.665	367.78	7.15	5.41	5	Observation Well
GW-A-5	461298	5510124	373.697	Metal	367.2845	367.38	7.46	6.26	5	Well not sampled in 2001: no ball valve in the well. Observation well.

(Sheet 2 of 5)

**Table 3-2 (Continued)**

Well ID	GPS-E <sup>1</sup>	GPS-N	Elevation, m	Shooting Point	GW elevation 2000, m	GW elevation 2001, m	Well Depth, m	Water Level, m	Length Slotted Pipe, m	Comments
GW-A-6	464317	5509933	373.343	Metal	368.293	--	Well Broken	n/a	5	2001: well broken and opened to atmosphere. Observation well
GW-A-8	456701	5511753	369.615	Metal	365.655	--	GPS Location unavailable during field work	n/a	5	Localization unavailable during fieldwork. Observation well.
GW-B-1	458732	5508595	370.323	Metal	363.653	363.79	9.14	6.47	5	Observation well
GW-B-2	464964	5508268	371.663	Metal	365.263	--	Well Lost	n/a	5	Observation well not developed/sampled in 2000/2001: localization unavailable during fieldwork.
GW-C-7	467947	5500061	360.465	Metal	352.725	352.80	9.50	7.61	5	Observation well.
GW-B-3	461998	5505288	367.15	Metal	360.08	360.10	8.71	6.96	5	Observation well
GW-B-4	464998	5505769	365.209	Metal	361.169	361.16	5.68	4.00	5	Observation well
GW-B-5	466445	5506186	363.941	Metal	361.776	361.81	3.89	2.02	5	Observation well
GW-B-6	467517	5506212	365.329	Metal	361.734	361.79	5.28	3.41	5	Observation well
GW-B-7	468635	5506220	363.892	Metal	361.522	361.63	4.25	2.18	5	Observation well
GW-C-1	461930	5503394	360.274	Metal	356.924	356.90	5.40	3.37	5	Observation well
GW-C-2	467340	5503345	361.761	Metal	358.231	358.33	5.48	3.37	5	Observation well
GW-C-3	468162	5503367	364.978	Metal	358.528	358.65	7.95	6.23	5	Observation well
GW-C-4	469277	5503351	363.07	Metal	358.62	358.73	6.13	4.29	5	Observation well
GW-C-5	465990	5502212	359.392	Metal	356.072	356.17	5.33	3.12	5	Observation well
GW-C-6	465259	5500077	363.003	Metal	352.153	352.18	13.05	10.74	5	Observation well
GW-D-1A	476754	5496861	355.025	Metal	341.655	--	17.72	Well DRY	5	Well dry in 2001. Observation well
GW-D-1B	476755	5496861	355.077	Metal	342.977	--	13.31	Well DRY	5	Well dry in 2001. Observation well
GW-D-2	474522	5499367	351.921	Metal	345.296	345.38	8.55	6.47	5	Observation well
GW-D-3	474257	5501746	362.745	Metal	351.455	351.57	13.05	11.09	5	Observation well
GW-D-4	474230	5502428	356.669	Metal	352.769	352.87	6.20	3.73	5	Well not developed in 2000: equipment failure. Observation well
GW-D-5	474024	5503012	362.747	Metal	353.822		Well Lost	LOST	5	Well not found in 2001. Observation well
GW-D-6	470700	5503172	361.253	Metal	357.743	357.85	5.07	3.35	5	Observation well
GW-D-7	472007	5498077	358.355	Metal	342.335	342.28	17.96	15.95	5	Observation well
GW-D-8	477687	5499763	354.713	Metal	332.498	332.55	24.50	22.10	5	Observation well
GW-E-1	462186	5517400	373.053	Metal	370.633	370.51	3.57	2.49	5	Observation well
GW-E-2	463266	5515336	376.004	Metal	372.754	372.61	5.32	3.25	5	Observation well
GW-E-3	464456	5514686	375.069	Metal	371.029	370.94	5.38	4.08	5	Observation well
GW-E-4	465506	5513781	378.275	Metal	370.75	370.67	9.25	7.53	5	Observation well
GW-E-5	460110	5515321	372.739	Metal	370.279	370.31	4.50	2.36	5	Observation well

(Sheet 3 of 5)

**Table 3-2 (Continued)**

Well ID	GPS-E	GPS-N	Elevation, m	Shooting Point	GW elevation 2000, m	GW elevation 2001, m	Well Depth, m	Water Level, m	Length Slotted Pipe, m	Comments
GW-E-6	465696	5515735	372.573	Metal	369.578	369.51	4.14	2.98	5	Observation well
<b>Private Wells<sup>4</sup></b>										
GW-PHILLIPS	453552	5518592	N/A	N/A	N/A	N/A	N/A	N/A	N/A	Supply Well
GW-PARC-1	478334	5500022	N/A	N/A	N/A	N/A	N/A	N/A	N/A	Supply Well
GW-PARC-2	480450	5501075	N/A	N/A	N/A	N/A	N/A	N/A	N/A	Supply Well
<b>Base Wells<sup>5</sup></b>										
GW-SUP-5	454380	5517000	N/A	N/A	N/A	N/A	N/A	N/A	N/A	Supply Well
GW-SUP-16	454200	5517250	N/A	N/A	N/A	N/A	N/A	N/A	N/A	Supply Well
GW-SUP-27	454180	5517020	N/A	N/A	N/A	N/A	N/A	N/A	N/A	Well not sampled in 2001: lack of time. Supply Well
OW-1	451819	5515634	N/A	N/A	365.602	365.49	11.77	5.81	N/A	Observation Well
OW-2	454369	5516746	N/A	N/A	367.988	367.97	16.41	12.27	N/A	Observation Well
OW-3	455669	5518600	N/A	N/A	N/A	N/A	12.2	7.97	N/A	Observation Well
OW-4	455850	5518500	N/A	N/A	N/A	N/A	7.34	6.97	N/A	Well dry. Observation Well
MW-101	457600	5517640	N/A	N/A	N/A	N/A	N/A	5.13	N/A	Observation Well
MW-104	455414	5517074	N/A	N/A	N/A	N/A	6.99	4.07	N/A	Observation Well
MW-105	456880	5517160	N/A	N/A	N/A	N/A	N/A	N/A	N/A	Well not found in 2001. Observation Well
MW-102	456050	5517950	N/A	N/A	N/A	N/A	N/A	4.71	N/A	Observation Well
MW-103	455930	5516940	N/A	N/A	N/A	N/A	5.44	2.94	N/A	Well not sampled in 2001: no more tubing available. Observation Well
MW-106	457130	5517220	N/A	N/A	N/A	N/A	N/A	N/A	N/A	Well not found in 2001. Observation Well
MW-107-A	455650	5517400	N/A	N/A	N/A	N/A	7.69	4.94	N/A	Observation Well
MW-107-B	455650	5517400	N/A	N/A	N/A	N/A	18.42	4.80	N/A	Observation Well
MW-108	455127	5517261	N/A	N/A	369.271	368.35	N/A	6.19	N/A	Observation Well
MW-109	455896	5517305	N/A	N/A	N/A	N/A	N/A	4.78	N/A	Observation Well
MW-110	457300	5517450	N/A	N/A	N/A	N/A	10.7	7.80	N/A	Observation Well
MW-111	457150	5517450	N/A	N/A	N/A	N/A	9.25	6.40	N/A	Observation Well
MW-112	456734	5517376	N/A	N/A	369.385	369.34	9.21	6.55	N/A	Observation Well
MW-113	455222	5517330	N/A	N/A	N/A	N/A	7.72	4.40	N/A	Observation Well
<b>Springs<sup>6</sup></b>										
GW-SPRING-1	478084	5499796	N/A	N/A	N/A	N/A	N/A	N/A	N/A	Spring Water
GW-SPRING-2	477612	5499216	N/A	N/A	N/A	N/A	N/A	N/A	N/A	Spring Water
GW-SPRING-3	470678	5498362	N/A	N/A	N/A	N/A	N/A	N/A	N/A	Spring Water

(Sheet 4 of 5)



**Table 3-2 (Concluded)**

Well ID	GPS-E <sup>1</sup>	GPS-N	Elevation, m	Shooting Point	GW elevation 2000, m	GW elevation 2001, m	Well Depth, m	Water Level, m	Length Slotted Pipe, m	Comments
<sup>1</sup> GPS Locations: Universal Transverse Mercator NAD 83, Zone 14 <sup>2</sup> INRS 2001 wells were drilled and installed by Paddock Drilling in September 2001. <sup>3</sup> INRS 2000 wells were drilled by Paddock Drilling Ltd and installed by Cochrane Engineering Ltd in October 2000. <sup>4</sup> Private wells are located on private lands <sup>5</sup> Base wells are located on the base and were drilled several years ago by different companies. <sup>6</sup> Sources are sampling points where artesian springs were flowing to the surface. <sup>7</sup> N/A: Nonapplicable <sup>8</sup> Contradictory data regarding the length of the slotted pipe. (5 or 10 ft?)										
<i>(Sheet 5 of 5)</i>										

### Equipment decontamination

To avoid cross-contamination between drilling sites, the drilling bit, augers, and soil sampling equipment (split-spoon) were decontaminated using the following procedure (Figure 3-18):



Figure 3-18. Decontamination of drilling equipment

- a. Washing with high-pressure water, followed by brushing with tap water and a phosphate-free detergent.
- b. Washing with a 10-percent hydrochloric acid solution.
- c. First rinse with distilled (purified) water.
- d. Cleaning with acetone.
- e. Final rinse with distilled water.

## Monitoring wells installation

Monitoring wells were installed according to ASTM-D5092-90 standards.<sup>1</sup> PVC tubing (51-mm) with a 1.5-m well screen (0.010-in. slots) was used for most of the wells. However, a 3.05-m well screen was used for a few wells such as GW-GRE and GW-RIF due to the absence of 1.5-m well screen. For 16 of the wells drilled in 2000, a silica sand pack was placed around the screened interval to block the entry of fine particles into the well. This sand pack extends from 0.6 to 1 m above the screened interval. For the remaining wells, the sand formation collapsed under the water table level, thus impeding the installation of a complete sand pack. In such cases, the *in situ* sand formation is either directly or partially in contact with the well screen. In year 2001, silica sand packs were placed in all of the 36 wells; however, sand blow-ups occurred in 23 wells, resulting in a partial collapse of the sand formation (0.3- to 1.5-m height) at the bottom of those wells prior to sand pack installation.

The annular space between the PVC tubing (51 mm) and the borehole wall (200 mm) was filled above the sand pack with bentonite grout up to 0.6 to 0.9 m below the soil surface in order to prevent preferential infiltration of water from the surface. A cement seal filling the rest of the annular space up to the surface was installed. Most wells were cased with a flush-mount protective metal casing and a locking cap as requested by Canadian Forces Base (CFB) Range personnel, since they were located in training areas where they could be in the way of army vehicles (Figure 3-19). A few wells located in areas prone to floods during springtime were equipped with a stickup of 1-m protective casing in order to facilitate their localization at all times (GW-A-7, GW-Antenna, GW-AMA-1, GW-AMA-2, GW-ZONE-4-E).



Figure 3-19. Pumping of well equipped with flush-mount protective casing

<sup>1</sup> ASTM-D5092-90 (1995) e1 ([www.astm.org](http://www.astm.org))

High-density polyethylene (HDPE) tubing (13-mm) going from the bottom to the top of the well and equipped with a D-32 foot valve was placed inside the PVC tubing for use in the process of well development and groundwater sampling with an electric Waterra pump (Hydrolift II) that uses an arm attached to the HDPE tubing that extends downward toward the screen interval of the well. (Figure 3-20). Well development involves removing fine particles in natural soil or in the sand pack around the screened interval by the movement of a surge block and by pumping water from each well (paragraph entitled "Groundwater Sampling"). The purpose of well development is to obtain a representative groundwater sample (one that contains no sediments). Well development took longer than expected, because the sand pack grain size was too large for the grain size of the sand formation and the *in situ* sand formation was sometimes in direct contact with the screen of the well. Well development was done shortly after well installation. A one-way foot valve and a surge block were attached to the end of the tubing. This allowed water and sediments to flow into the tubing during the down stroke into the well, then close as the arm moved upward, lifting the water column and fine sediments 150 mm per stroke. When the water being pumped from the well became clear and free of sediments, the tubing was lowered by 150 mm to begin developing the next section of the screen. This process continued until the entire length of the screen (top to bottom) had been developed below the water table. In 2000, the process of well development typically took 12 to 16 hr per well with some wells taking considerably longer. Well development took place at three wells simultaneously, with each well using one of the three available pumps. In 2000, wells were not fully developed because of time constraints. Each well was pumped for 3 to 5 hr until water was clear enough for sampling.



Figure 3-20. Development of wells using mechanical Waterra pump

Well development occurred shortly after the first wells were drilled, in Phase I from mid-October to early November in 2000, and for Phase II, during the first 2 weeks of September in 2001. In year 2000, training exercises interrupted well development for approximately 1 week. However, over this time frame, 35 of 41

wells were developed in the five training ranges, the rifle, grenade, and rocket ranges and the background well located off the base to the north. Seven wells remain undeveloped because of constraints of bad weather and equipment failure. Four of those were subsequently developed in 2001. The remaining three wells were dry (GW-D-1-A, GW-D-1-B) or could not be found (GW-B-2). In Phase II, all of the 36 wells drilled in 2001 were developed at least for 3 to 5 hr.

### Testing of the monitoring wells

Slug tests were made in all developed wells for an estimation of hydraulic conductivity of the sand formation. Slug tests were performed in one of two ways. The first way was by injecting compressed air into the well with a special device to drop the water table between 30 and 70 cm below its natural static level (Figure 3-21). After an instantaneous pressure release, the rise in water table was recorded with a Level Logger pressure gauge (from Solinst). Data interpretation was done with the Bower and Rice method to evaluate hydraulic conductivity [27]. The second slug test method was conducted by removing water from the well with a bailer to drop the water table 60 cm below static level instead of using pressurized air. This method was used where the water table was located below the top of the screened interval. Sixty-four (64) slug tests were performed in the year 2000. Eighty-eight (88) more were performed in year 2001 in order to obtain a more complete set of data and a more precise estimate of hydraulic conductivity. In total, 152 slug tests were performed in 71 wells in 2000 and 2001. One to three tests were performed in each well. Results from both years were similar and are presented in section entitled "Hydraulic properties of the aquifer," subparagraph "Determination of the hydraulic conductivity." Slug test results are presented in Table 3-3.



Figure 3-21. Device for injecting compressed air into well (slug tests)

**Table 3-3  
Summary of Slug Test Analysis at CFB Shilo**

Observation Well	Hydraulic Conductivity, m/sec			Average, m /sec	Date
	Test 1	Test 2	Test 3		
GW-RIF	2.73E-04	-	-	2.73E-04	2000
GW-GRE	8.49E-05	1.02E-04	-	9.31E-05	2000
GW-ATR	1.36E-04	-	-	1.36E-04	2000
GW-MARSH1	7.82E-05	8.31E-05	-	8.06E-05	2000
GW-BGR	2.54E-04	2.34E-04	-	2.44E-04	2000
GW-A-1	2.69E-04	2.73E-04	-	2.71E-04	2000
GW-A-2	1.20E-04	1.22E-04	1.29E-04	1.24E-04	2000
GW-A-3	1.84E-04	2.14E-04	-	1.98E-04	2000
GW-A-4	5.27E-05	4.95E-05	-	5.11E-05	2000
GW-A-5	8.41E-05	-	-	8.41E-05	2000
GW-A-6	2.57E-05	2.80E-05	-	2.68E-05	2000
GW-A-7	6.71E-05	6.37E-05	-	6.54E-05	2000
GW-A-8	2.79E-05	1.96E-04	-	7.39E-05	2000
GW-B-1	3.67E-04	4.10E-04	3.61E-04	3.79E-04	2001
GW-B-2	-	-	-	-	-
GW-B-3	1.34E-04	1.45E-04	-	1.39E-04	2000
GW-B-4	9.97E-05	1.27E-04	-	1.13E-04	2000
GW-B-5	7.20E-05	6.78E-05	-	6.99E-05	2000
GW-B-6	1.09E-04	1.34E-04	-	1.21E-04	2000
GW-B-7	1.18E-04	1.17E-04	-	1.17E-04	2000
GW-C-1	2.35E-04	-	-	2.35E-04	2000
GW-C-2	2.73E-04	2.41E-04	-	2.57E-04	2000
GW-C-3	1.41E-04	1.06E-04	-	1.22E-04	2000
GW-C-4	1.46E-04	1.26E-04	-	1.36E-04	2000
GW-C-5	2.73E-04	2.64E-04	-	2.68E-04	2000
GW-C-6	2.72E-04	2.31E-04	-	2.51E-04	2000
GW-C-7	-	-	-	-	-
GW-D-1A	-	-	-	-	-
GW-D-1B	-	-	-	-	-
GW-D-2	1.04E-05	2.54E-04	-	5.14E-05	2000
GW-D-3	8.39E-05	1.06E-04	-	9.43E-05	2000
GW-D-4	1.18E-04	1.51E-04	-	1.33E-04	2000
GW-D-5	9.33E-05	-	-	9.33E-05	2000
GW-D-6	1.16E-04	9.62E-05	-	1.06E-04	2000
GW-D-7	-	-	-	-	-
GW-D-8	-	-	-	-	-
GW-E-1	2.53E-05	2.60E-05	-	2.56E-05	2000
GW-E-2	5.46E-05	5.38E-05	5.84E-05	5.56E-05	2000
GW-E-3	7.41E-05	7.72E-05	-	7.56E-05	2000
GW-E-4	4.10E-05	-	-	4.10E-05	2000
GW-E-5	1.97E-04	1.90E-04	2.06E-04	1.97E-04	2001
GW-E-6	4.39E-05	3.23E-05	-	3.77E-05	2000
GW-ANTENNE	-	-	-	-	-
GW-AMA-1	2.90E-04	3.48E-04	-	3.19E-04	2001

(Continued)

Observation Well	Hydraulic Conductivity, m/sec			Average, m /sec	Date
	Test 1	Test 2	Test 3		
GW-AMA-2	7.35E-04	7.42E-04	-	7.38E-04	2001
GW-ATR-1	2.58E-04	2.81E-04	-	2.70E-04	2001
GW-A-9	6.28E-05	5.69E-05	4.89E-05	5.62E-05	2001
GW-A-10	3.03E-04	2.54E-04	-	2.79E-04	2001
GW-BGR-3	2.09E-04	1.85E-04	-	1.97E-04	2001
GW-BGR-4	2.97E-04	2.29E-04	-	2.63E-04	2001
GW-C-8	2.27E-04	2.05E-04	-	2.16E-04	2001
GW-C-9	2.13E-04	2.34E-04	2.28E-04	2.25E-04	2001
GW-D-9	1.53E-04	1.57E-04	1.83E-04	1.64E-04	2001
GW-D-11	4.75E-05	5.87E-05	5.90E-05	5.51E-05	2001
GW-D-12	5.73E-05	5.68E-05	5.73E-05	5.71E-05	2001
GW-D-13	1.89E-05	1.10E-05	2.08E-05	1.69E-05	2001
GW-E-7	1.30E-04	1.15E-04	-	1.23E-04	2001
GW-E-8	1.70E-04	1.15E-04	-	1.42E-04	2001
GW-E-9	1.14E-04	1.23E-04	-	1.18E-04	2001
GW-E-11	3.54E-05	4.19E-05	5.43E-05	4.39E-05	2001
GW-GATE-S	3.17E-04	3.39E-04	-	3.28E-04	2001
GW-GRE-1	1.93E-04	-	-	1.93E-04	2001
GW-GRE-2	1.44E-04	-	-	1.44E-04	2001
GW-RIF-1	3.10E-04	2.69E-04	-	2.90E-04	2001
GW-RIF-3	1.23E-04	1.33E-04	1.38E-04	1.31E-04	2001
GW-TR	2.33E-04	1.95E-04	-	2.14E-04	2001
OBS-SUP-5	1.40E-04	1.35E-04	-	1.37E-04	2001
OBS-SUP-16	3.20E-04	2.77E-04	3.88E-04	3.28E-04	2001
OBS-SUP-27	1.50E-04	1.49E-04	-	1.50E-04	2001
GW-ZONE-4E	1.02E-04	1.10E-04	9.85E-05	1.03E-04	2001
GW-ZONE-4W	4.00E-04	3.95E-04	3.97E-04	3.97E-04	2001
GW-ZONE-5N	2.69E-04	2.57E-04	3.31E-04	2.86E-04	2001
GW-ZONE-5S	4.35E-04	4.49E-04	4.18E-04	4.34E-04	2001
GW-ZONE-7	2.96E-04	-	-	2.96E-04	2001
GW-ZONE-7W	3.91E-04	-	-	3.91E-04	2001
GW-ZONE-9N	9.59E-05	1.12E-04	1.53E-04	1.20E-04	2001
GW-ZONE-9S	1.21E-04	9.49E-05	-	1.08E-04	2001
GW-ZONE-9W	4.06E-05	3.73E-04	-	2.07E-04	2001
	GEOMETRIC MEAN			0.00013618	
<b>Duplicate</b>					
GW-D-4	1.18E-04	1.51E-04	-	1.33E-04	2000
GW-D-4	2.04E-04	2.32E-04	-	2.18E-04	2001

### Land survey

Wardrop Engineering Inc. (Winnipeg, MB) provided GPS locations (northing and easting) of monitoring wells drilled in 2000 and elevations of the metal well cap (Figure 3-22). Adjustments were made to calculate the elevation of the PVC tubing used as the point of reference for water level measurements.

The error associated with GPS location is  $\pm 2$  m, whereas the precision on elevation was  $\pm 0.01$  m. The technique involved the use of two GPSs.



Figure 3-22. GPS location system for well land surveying

Wells drilled in 2001 were surveyed by Lennon Surveys (Brandon, MB). GPS locations and elevations of the metal well caps were provided for each well. Adjustments were made to calculate the elevation of the PVC tubing used as the point of reference for water level measurements. Well locations and elevations can be found in Table 3-2.

### **Water level measurements and water table map**

Water level measurements were made after well development was completed and enough time had elapsed to allow the water table to recover its original level. An electronic measuring tape with a precision of  $\pm 0.5$  cm was used to record the water depth in every well in relation to the top of the PVC tubing. Water level measurements were made in October 2000 and September 2001. Elevation of the water table in wells was calculated using values obtained by the survey of the wells. These values, along with the elevation of surface water estimated from topographic maps, were used to calculate the elevation of the water table. The water table contours were calculated using a Kriging technique in Surfer V. 7.0

software. This map shows that groundwater flows in a radial fashion in a general north to south direction. The aquifer underlying CFB Shilo is unconfined and is recharged directly by infiltration of precipitation. The unconfined aquifer discharges into the Assiniboine River. The horizontal hydraulic gradient is steeper near the Assiniboine River than in the rest of CFB Shilo.

### Hydraulic head map and groundwater direction and velocity

The horizontal component of groundwater velocity and direction was measured *in situ* with a flowmeter (Geoflo 40L) within the developed wells. The Geoflo 40L is a probe with eight thermistors placed around a heat source. This probe was introduced into the well and a reading was taken at two elevations within the screened interval (30 cm from the bottom of the well and 30 cm below the top of the screen) to see if groundwater velocity and direction varied with depth (Figure 3-23). Soil samples obtained along the screened interval during borehole drilling were used in the laboratory to make the calibration curve for the field measurement of groundwater velocities with the Geoflo 40L.

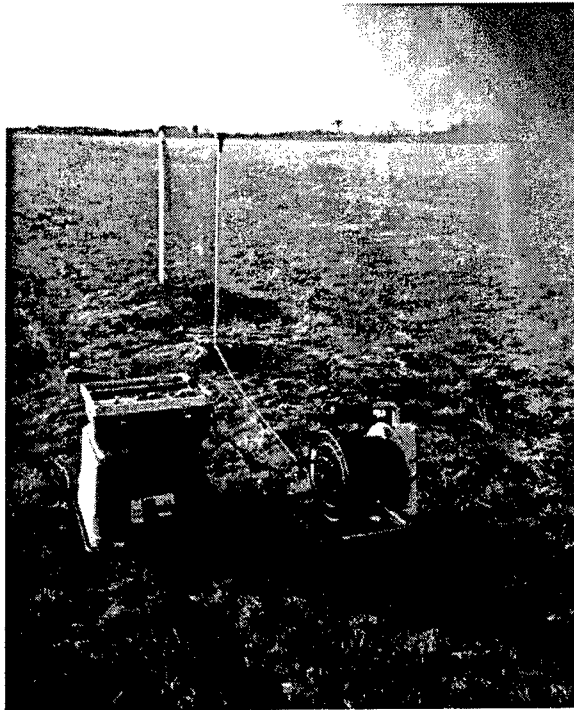

Figure 3-23. Hydraulic head measurements using GEOFLO 40L

The instrument measures the propagation and the deformation of a heat pulse in groundwater. In dynamic systems like an aquifer, the heat pulse propagates with an elliptical shape and the long-axis is oriented in the groundwater flow direction. The length and the orientation of this axis can be calculated with usual trigonometric formulas. The resultant vector is fitted on a calibration curve made in the laboratory using sand from the aquifer to get the groundwater velocity.



Results are presented in paragraph entitled "Determination of groundwater flow direction and velocity."

### **Recharge evaluation**

Groundwater recharge is the product of effective porosity and the change in water level observed during recharge events (snow melt and rain episodes). The estimation of the groundwater recharge was based on a water table hydrograph from a well (near GW-A-2) located in the centre of CFB Shilo. This well was selected because its water level was influenced by neither irrigation nor supply wells. Hydrologic data from this monitoring well are spread between January 1983 and January 2000; a total of 19 recharge events can be distinguished. Recharge was evaluated to vary between 0 and 142 mm/year. Mean recharge value is 50 mm/y over the 17-year period used for evaluation.

### **Groundwater sampling**

Physicochemical parameters were measured in the field with YSI 63 and YSI 95 probes. These parameters included temperature, pH, conductivity, salinity, dissolved oxygen, and redox potential. Groundwater was sampled for nutrients analysis, anions, metals, energetic material, and thorium. The groundwater sampling protocol of the Quebec Ministry of the Environment was followed. Prior to collection of the samples, at least three volumes of groundwater standing in the well and in the pore volume of the sand pack were purged from each well. A Waterra Hydrolift II pump coupled to a dedicated 31-mm HDPE tubing connected to a foot valve was used for the purging of most wells, although a few were purged by hand-pumping. In 2001, none of the groundwater samples could be filtered, since filters of proper dimensions were not supplied on time; however, samples for metal analysis were acidified in the field. Given the absence of filtration, the concentrations in metals may be overestimated since the metals adsorbed on particles will be released into the water sample under acidic conditions prior to the analyses. This does not represent the ideal situation, since a filtration of the sample must be done. The results for metals analysis in 2001, therefore, represent a worst-case scenario. Groundwater samples that were collected in most of the wells at the end of summer 2002 were filtered on site prior to shipping to the lab. In a few locations, duplicate water samples, one filtered and the other unfiltered, were collected; the resulting analysis should provide an insight into the potential contribution of particles larger than 0.45 µm to the metal load. Analytical results will be compared to the values obtained in the prior sampling event.

In 2000, 35 out of 42 wells were sampled, compared to 70 out of 78 in 2001. A few of those wells could not be sampled because of difficult access created by weather conditions, because they could not be developed, or because they could not be found. A number of observation wells that had been installed on the base several years ago for previous groundwater studies were also sampled as follows: four (4) in 2000 and sixteen (16) in 2001. Moreover, three private wells were sampled in 2001. Four (4) duplicates were taken for quality control in 2000 compared to 13 in 2001. Finally, groundwater flowing from three emerging sources located near the shores of the Assiniboine River was collected both in 2000 and 2001. The total is 42 sampling locations and 4 duplicates for 2000 and 92 sampling locations and 13 duplicates in 2001.

A number of wells located near potential sources of volatile organic compounds, namely Parkplatz zones (GW-A-1, GW-C-1, GW-E-1), or near inhabited or training areas (GW-OBS-SUP-5, GW-OBS-SUP-16, GW-OBS-SUP-27, GW-OW-1, GW-OW-2, MW-108) were sampled for VOCs. A special double-needle device was used for collecting groundwater samples for VOC analysis to minimize volatile losses (Figure 3-24). Nine wells were sampled for VOCs, three in 2000, and six in 2001. Locations of the observation wells, supply wells, and springs used for groundwater sampling are presented in Table 3-4.



Figure 3-24. Double-needle device for sampling VOC's

**Table 3-4  
Location of Observation and Supply Wells and Springs Used for Groundwater Sampling and Sampling Schedule**

Well ID	East Coordinate <sup>1</sup>	North Coordinate	Well Development		Physico-Chemical		Routine/Anions		Metals		Energetic Material		Thorium		VOCs		Comments
			2000	2001	2000	2001	2000	2001	2000	2001	2000	2001	2000	2001	2000	2001	
INRS 2001 well <sup>2</sup>																	
GW-ANTENNE	450107	5513767	N/A	1	N/A	1	N/A	1	N/A	1-p <sup>(3)</sup>	N/A	1-p	N/A	1	N/A	N/A	
GW-AMA-1	451371	5515945	N/A	1	N/A	1	N/A	1	N/A	1-p	N/A	1-p	N/A	1	N/A	N/A	
GW-AMA-2	451359	5515701	N/A	1	N/A	1	N/A	1	N/A	1-p	N/A	1-p	N/A	1	N/A	N/A	
GW-ATR-1	458557	5519084	N/A	1	N/A	1	N/A	1	N/A	1-p	N/A	1-p	N/A	1	N/A	N/A	
GW-A-9	469904	5509655	N/A	1	N/A	1	N/A	1	N/A	1-p	N/A	1-p	N/A	1	N/A	N/A	
GW-A-10	463406	5511067	N/A	1	N/A	1	N/A	1	N/A	1-p	N/A	1-p	N/A	1	N/A	N/A	
GW-BGR-3	474578	5515026	N/A	1	N/A	1	N/A	1	N/A	1-p	N/A	1-p	N/A	1	N/A	N/A	
GW-BGR-4	461084	5524505	N/A	1	N/A	1	N/A	1	N/A	1-p	N/A	1-p	N/A	1	N/A	N/A	
GW-C-8	463729	5501035	N/A	1	N/A	1	N/A	1	N/A	1-p	N/A	1-p	N/A	1	N/A	N/A	
GW-C-9	466929	5499917	N/A	1	N/A	1	N/A	1	N/A	1-p	N/A	1-p	N/A	1	N/A	N/A	
GW-D-9	474356	5504005	N/A	1	N/A	1	N/A	1	N/A	1-p	N/A	1-p	N/A	1	N/A	N/A	
GW-D-11	474379	5500610	N/A	1	N/A	1	N/A	1	N/A	1-p	N/A	1-p	N/A	1	N/A	N/A	
GW-D-12	477709	5500130	N/A	1	N/A	1	N/A	1	N/A	1-p	N/A	1-p	N/A	1	N/A	N/A	
GW-D-13	478113	5501166	N/A	1	N/A	1	N/A	1	N/A	1-p	N/A	1-p	N/A	1	N/A	N/A	
GW-E-7	464892	5515941	N/A	1	N/A	1	N/A	1	N/A	1-p	N/A	1-p	N/A	1	N/A	N/A	
GW-E-8	465994	5514995	N/A	1	N/A	1	N/A	1	N/A	1-p	N/A	1-p	N/A	1	N/A	N/A	
GW-E-9	465971	5514237	N/A	1	N/A	1	N/A	1	N/A	1-p	N/A	1-p	N/A	1	N/A	N/A	
GW-E-11	461977	5513661	N/A	1	N/A	1	N/A	1	N/A	1-p	N/A	1-p	N/A	1	N/A	N/A	
GW-GATE-S	453529	5516354	N/A	1	N/A	1	N/A	1	N/A	1-p	N/A	1-p	N/A	1	N/A	N/A	
GW-GRE-1	457531	5517992	N/A	1	N/A	1	N/A	1	N/A	1-p	N/A	1-p	N/A	1	N/A	N/A	
GW-GRE-2	457485	5517962	N/A	1	N/A	1	N/A	1	N/A	1-p	N/A	1-p	N/A	1	N/A	N/A	
GW-RIF-1	455650	5518510	N/A	1	N/A	1	N/A	1	N/A	1-p	N/A	1-p	N/A	1	N/A	N/A	
GW-RIF-3	456510	5518326	N/A	1	N/A	1	N/A	1	N/A	1-p	N/A	1-p	N/A	1	N/A	N/A	
GW-TR	457112	5518359	N/A	1	N/A	1	N/A	1	N/A	1-p	N/A	1-p	N/A	1	N/A	N/A	
OBS-SUP-5	454440	5517050	N/A	1	N/A	1	N/A	1	N/A	1-p	N/A	1-p	N/A	1	N/A	1	
OBS-SUP-16	454263	5517312	N/A	1	N/A	1	N/A	1	N/A	1-p	N/A	1-p	N/A	1	N/A	1	
OBS-SUP-27	454292	5517105	N/A	1	N/A	1	N/A	1	N/A	1-p	N/A	1-p	N/A	1	N/A	1	
GW-ZONE-4E	455282	5513887	N/A	1	N/A	1	N/A	1	N/A	1-p	N/A	1-p	N/A	1	N/A	N/A	

(Sheet 1 of 6)

**Table 3-4 (Continued)**

Well ID	East Coordinate <sup>1</sup>	North Coordinate	Well Development		Physico-Chemical		Routine/Anions		Metals		Energetic Material		Thorium		VOCs		Comments	
			2000	2001	2000	2001	2000	2001	2000	2001	2000	2001	2000	2001	2000	2001		
GW-ZONE-4W	453722	5514810	N/A	1	N/A	1	N/A	1	N/A	1-p	N/A	1-p	N/A	1	N/A	N/A	N/A	
GW-ZONE-5N	455251	5511039	N/A	1	N/A	1	N/A	1	N/A	1-p	N/A	1-p	N/A	1	N/A	N/A	N/A	
GW-ZONE-5S	455235	5508363	N/A	1	N/A	1	N/A	1	N/A	1-p	N/A	1-p	N/A	1	N/A	N/A	N/A	
GW-ZONE-7	468312	5497496	N/A	1	N/A	1	N/A	1	N/A	1-p	N/A	1-p	N/A	1	N/A	N/A	N/A	
GW-ZONE-7W	466672	5497613	N/A	1	N/A	1	N/A	1	N/A	1-p	N/A	1-p	N/A	1	N/A	N/A	N/A	
GW-ZONE-9N	459767	5519509	N/A	1	N/A	1	N/A	1	N/A	1-p	N/A	1-p	N/A	1	N/A	N/A	N/A	
GW-ZONE-9S	458562	5517394	N/A	1	N/A	1	N/A	1	N/A	1-p	N/A	1-p	N/A	1	N/A	N/A	N/A	
GW-ZONE-9W	459053	5518441	N/A	1	N/A	1	N/A	1	N/A	1-p	N/A	1-p	N/A	1	N/A	N/A	N/A	
<b>INRS 2000 Wells<sup>3</sup></b>																		
GW-ATR	458709	5519393	1	N/A	1	1	1	1	1	1-f-p (10)	1-p	1-p	1-p	N/A	1	N/A	N/A	
GW-GRE	457433	5518019	1	N/A	1	1	1	1	1	1-f-p	1-p	1-p	1-p	N/A	1	N/A	N/A	
GW-MARSH1	474028	5507383	1	N/A	1	1	1	1	1	1-f-p	1-p	1-p	1-p	N/A	1	N/A	N/A	
GW-BGR	454213	5521773	1	N/A	1	1	1	1	1	1-f-p	1-p	1-p	1-p	N/A	1	N/A	N/A	
GW-RIF	455526	5518382	1	N/A	1	1	1	1	1	1-f-p	1-p	1-p	1-p	N/A	1	N/A	N/A	
GW-A-1	457314	5512967	1	N/A	1	1	1	1	1	1-f-p	1-p	1-p	1-p	N/A	1	1-p	N/A	
GW-A-2	458680	5511651	1	N/A	1	1	1	1	1	1-f-p	1-p	1-p	1-p	N/A	1	N/A	N/A	
GW-A-3	459736	5511232	1	N/A	1	1	1	1	1	1-f-p	1-p	1-p	1-p	N/A	1	N/A	N/A	
GW-A-4	460621	5510713	1	N/A	1	1	1	1	1	1-f-p	1-p	1-p	1-p	N/A	1	N/A	N/A	
GW-A-5	461298	5510124	1	N/A	1	1	1	1	1	1-f-p	1-p	1-p	1-p	N/A	N/A	N/A	N/A	Well not sampled in 2001; no ball valve in well.
<b>INRS 2000 Wells<sup>3</sup></b>																		
GW-A-6	464317	5509933	1	N/A	1	1	1	1	1	1-f-p	1-p	1-p	1-p	N/A	N/A	N/A	N/A	Well not sampled in 2001; broken and opened to atmosphere.
GW-A-7	467437	5513209	1	N/A	1	1	1	1	1	1-f-p	1-p	1-p	1-p	N/A	N/A	N/A	N/A	Well not sampled in 2001; not found.
GW-A-8	456701	5511753	1	N/A	1	1	1	1	1	1-f-p	1-p	1-p	1-p	N/A	N/A	N/A	N/A	Well not sampled in 2001; well localization unavailable during fieldwork.

(Sheet 2 of 6)

**Table 3-4 (Continued)**

Well ID	East Coordinate <sup>1</sup>	North Coordinate	Well Development		Physico-Chemical		Routine/Anions		Metals		Energetic Material		Thorium		VOCs		Comments
			2000	2001	2000	2001	2000	2001	2000	2001	2000	2001	2000	2001	2000	2001	
GW-B-1	458732	5508595	1		1		1		1-p		1-p		1		N/A		Well not sampled in 2000: bad winter conditions.
GW-B-2	464964	5508268													N/A		Well not developed/sampled in 2000/2001: not found.
GW-B-3	461998	5505288	1	N/A	1		1	1-p	1-f-p	1-p	1-p	1-p	N/A	1	N/A		
GW-B-4	464998	5505769	1	N/A	1		1	1-p	1-f-p	1-p	1-p	1-p	N/A	1	N/A		
GW-B-5	466445	5506186	1	N/A	1		1	1-p	1-f-p	1-p	1-p	1-p	N/A	1	N/A		
GW-B-6	467516	5506212	1	N/A	1		1	1-p	1-f-p	1-p	1-p	1-p	N/A	1	N/A		
GW-B-7	468635	5506220	1	N/A	1		1	1-p	1-f-p	1-p	1-p	1-p	N/A	1	N/A		
GW-C-1	461930	5503394	1	N/A	1		1	1-p	1-f-p	1-p	1-p	1-p	N/A	1	N/A		
GW-C-2	467340	5503345	1	N/A	1		1	1-p	1-f-p	1-p	1-p	1-p	N/A	1	N/A		
GW-C-3	468162	5503367	1	N/A	1		1	1-p	1-f-p	1-p	1-p	1-p	N/A	1	N/A		
GW-C-4	469277	5503351	1	N/A	1		1	1-p	1-f-p	1-p	1-p	1-p	N/A	1	N/A		
GW-C-5	465990	5502212	1	N/A	1		1	1-p	1-f-p	1-p	1-p	1-p	N/A	1	N/A		
GW-C-6	465259	5500077	1	N/A	1		1	1-p	1-f-p	1-p	1-p	1-p	N/A	1	N/A		
GW-C-7	467947	5500061	1	N/A	1		1	1-p	1-f-p	1-p	1-p	1-p	N/A	1	N/A		
GW-D-1A	476754	5496861													N/A		Well not developed/sampled: equipment failure in 2000, dry in 2001.
GW-D-1B	476754	5496861													N/A		Well not developed/sampled: equipment failure in 2000, dry in 2001.
GW-D-2	474522	5499367	1	N/A	1		1	1-p	1-f-p	1-p	1-p	1-p	1	1	N/A	N/A	
GW-D-3	474257	5501746	1	N/A	1		1	1-p	1-f-p	1-p	1-p	1-p	1	1	N/A	N/A	
GW-D-4	474230	5502428	1		1		1	1-p				1-p	1	1	N/A	N/A	Well not developed in 2000: equipment failure. Some physicochemical data are invalid.
GW-D-5	474024	5503012	1	N/A	1		1	1-p	1-f-p	1-p	1-p	1-p	1	1	N/A	N/A	Well not sampled in 2001: not found.

(Sheet 3 of 6)

**Table 3-4 (Continued)**

Well ID	East Coordinate	North Coordinate	Well Development		Physico-Chemical		Routine/Anions		Metals		Energetic Material		Thorium		VOCs		Comments
			2000	2001	2000	2001	2000	2001	2000	2001	2000	2001	2000	2001	2000	2001	
<b>INRS 2000 Wells<sup>3</sup></b>																	
GW-D-6	470700	5503172	1	N/A	1	1	1	1	1-f-p	1-p	1-p	1-p	N/A	1	N/A	N/A	
GW-D-7	472007	5498077	1	N/A	1	1	1	1	1-f-p	1-p	1-p	1-p	N/A	1	N/A	N/A	
GW-D-8	477687	5499763		1			1			1-p			N/A	1	N/A	N/A	Well not developed/sampled in 2000; bad winter conditions.
GW-E-1	462186	5517400	1	N/A	1	1	1	1	1-f-p	1-p	1-p	1-p	N/A	1	1-p	N/A	
GW-E-2	463266	5515336	1	N/A	1	1	1	1	1-f-p	1-p	1-p	1-p	N/A	1	N/A	N/A	
GW-E-3	464456	5514686	1	N/A	1	1	1	1	1-f-p	1-p	1-p	1-p	N/A	1	N/A	N/A	
GW-E-4	465506	5513781	1	N/A	1	1	1	1	1-f-p	1-p	1-p	1-p	N/A	1	N/A	N/A	
GW-E-5	460110	5515321		1			1			1-p			N/A	1	N/A	N/A	Well not developed/sampled in 2000; bad winter conditions
GW-E-6	465695	5515735	1	N/A	1	1	1	1	1-f-p	1-p	1-p	1-p	N/A	1	N/A	N/A	
<b>Private Wells<sup>4</sup></b>																	
GW-PHILLIPS	453552	5518592	N/A	N/A	N/A	1	N/A	1	N/A	1-p	N/A	1-p	N/A	1	N/A	N/A	
GW-PARC-1	478334	5500022	N/A	N/A	N/A	1	N/A	1	N/A	1-p	N/A	1-p	N/A	1	N/A	N/A	
GW-PARC-2	480450	5501075	N/A	N/A	N/A	1	N/A	1	N/A	1-p	N/A	1-p	N/A	1	N/A	N/A	
<b>Base Wells<sup>5</sup></b>																	
GW-SUP-5	454380	5517000	N/A	N/A	N/A	1	N/A	1	N/A	1-p	N/A	1-p	N/A	1	N/A	N/A	
GW-SUP-16	454200	5517250	N/A	N/A	N/A	1	N/A	1	N/A	1-p	N/A	1-p	N/A	1	N/A	N/A	
GW-SUP-27	454180	5517020	N/A	N/A	N/A		N/A		N/A		N/A		N/A		N/A	N/A	Not sampled
OW-1	451819	5515634	N/A	N/A	1	1	1	1	1-f-p	1-p	1-p	1-p	N/A	1	N/A	1	
OW-2	454369	5516746	N/A	N/A	1	1	1	1	1-f-p	1-p	1-p	1-p	N/A	1	N/A	1	
OW-3	455669	5518600	N/A	N/A	N/A	1	N/A	1	N/A	1-p	N/A	1-p	N/A	1	N/A	N/A	
OW-4	455850	5518500	N/A	N/A	N/A		N/A		N/A		N/A		N/A		N/A	N/A	Well dry
MW-101	457600	5517640	N/A	N/A	N/A	1	N/A	1	N/A	1-p	N/A	1-p	N/A	1	N/A	N/A	
MW-102	456050	5517950	N/A	N/A	N/A	1	N/A	1	N/A	1-p	N/A	1-p	N/A	1	N/A	N/A	
MW-103	455930	5516940	N/A	N/A	N/A		N/A		N/A		N/A		N/A		N/A	N/A	No tubing available

(Sheet 4 of 6)

**Table 3-4 (Continued)**

Well ID	East Coordinate <sup>1</sup>	North Coordinate	Well Development		Physico-Chemical		Routine/Anions		Metals		Energetic Material		Thorium		VOCs		Comments
			2000	2001	2000	2001	2000	2001	2000	2001	2000	2001	2000	2001	2000	2001	
MW-104	455414	5517074	N/A	N/A	N/A	1	N/A	1	N/A	1-p	N/A	1-p	N/A	1	N/A	N/A	
MW-105	456880	5517160	N/A	N/A	N/A		N/A		N/A		N/A		N/A		N/A	N/A	Well not found
MW-106	457130	5517220	N/A	N/A	N/A		N/A		N/A		N/A		N/A		N/A	N/A	Well not found
MW-107-A	456650	5517400	N/A	N/A	N/A	1	N/A	1	N/A	1-p	N/A	1-p	N/A	1	N/A	N/A	
MW-107-B	456650	5517400	N/A	N/A	N/A	1	N/A	1	N/A	1-p	N/A	1-p	N/A	1	N/A	N/A	
MW-108	455127	5517261	N/A	N/A	N/A	1	1	1	1-f-p	1-p	1-p	1-p	N/A	1	N/A	1	
MW-109	455896	5517305	N/A	N/A	N/A	1		1		1-p	N/A	1-p	N/A	1	N/A	N/A	
MW-110	457300	5517450	N/A	N/A	N/A	1	N/A	1	N/A	1-p	N/A	1-p	N/A	1	N/A	N/A	
MW-111	457150	5517450	N/A	N/A	N/A	1	N/A	1	N/A	1-p	N/A	1-p	N/A	1	N/A	N/A	
MW-112	456734	5517376	N/A	N/A	N/A	1	1	1	1-f-p	1-p	1-p	1-p	N/A	1	N/A	N/A	
MW-113	455222	5517330	N/A	N/A	N/A	1	N/A	1	N/A	1-p	N/A	1-p	N/A	1	N/A	N/A	
<b>Springs<sup>6</sup></b>																	
GW-SPRING-1	478084	5499796	N/A	N/A	1	1	1	1	1-f-p	1-p	1-p	1-p	1	1	N/A	N/A	
GW-SPRING-2	477612	5499216	N/A	N/A	1	1	1	1	1-f-p	1-p	1-p	1-p	1	1	N/A	N/A	
GW-SPRING-3	470678	5498362	N/A	N/A	1	1	1	1	1-f-p	1-p	1-p	1-p	1	1	N/A	N/A	
GW-A-9	456701	5511753	1	N/A	1		1		1-f-p		1-p		N/A		N/A	N/A	DDuplicate GW-A-8
GW-C-8	467947	5500061	1	N/A	1		1		1-f-p	1-p	1-p	1-p	N/A	1	N/A	N/A	Duplicate GW-C-7
GW-D-9	472007	5498077	1	N/A	1		1		1-f-p	1-p	1-p	1-p	1	1	N/A	N/A	Duplicate GW-D-7
GW-E-7	463266	5515336	1	N/A	1		1		1-f-p	1-p	1-p	1-p	1	1	N/A	N/A	Duplicate GW-E-2
GW-SP-5	N/A	N/A	1	N/A	1		N/A	1	1-f-p	N/A	1-p	1-p	N/A	N/A	N/A	N/A	Trip blank
<b>Duplicates/Quality Control</b>																	
GW-SP-6	N/A	N/A	1	N/A	1		N/A	1	1-f-p	N/A	1-p	1-p	N/A	N/A	N/A	N/A	Field blank
RESERVOIR	N/A	N/A	1	N/A	1		N/A	1	1-f-p	N/A	1-p	1-p	N/A	N/A	N/A	N/A	Washing station reservoir
GW-BLANK-1	474578	5515026	N/A	1	N/A	1	N/A	1	N/A	1-p	N/A	1-p	N/A	1	N/A	N/A	Duplicate of BGR-3 (2001)
GW-BLANK-2	461084	5524505	N/A	1	N/A	1	N/A	1	N/A	1-p	N/A	1-p	N/A	1	N/A	N/A	Duplicate of BGR-4 (2001)
GW-BLANK-3	469904	5509655	N/A	1	N/A	1	N/A	1	N/A	1-p	N/A	1-p	N/A	1	N/A	N/A	Duplicate of A-9 (2001)
GW-BLANK-4	474578	5515026	N/A	1	N/A	1	N/A	1	N/A	1-p	N/A	1-p	N/A	1	N/A	N/A	Duplicate of BGR-3 (2001)

(Sheet 5 of 6)

Table 3-4 (Concluded)

Well ID	East Coordinate <sup>1</sup>	North Coordinate	Well Development		Physico-Chemical		Routine/Anions		Metals		Energetic Material		Thorium		VOCs		Comments
			2000	2001	2000	2001	2000	2001	2000	2001	2000	2001	2000	2001	2000	2001	
GW-BLANK-5	458732	5508595		1		1		1		1-p		1-p	1			N/A	Duplicate of B-1 (2001)
GW-BLANK-6	458680	5511651	1	N/A	1	1	1	1	1-f-p	1-p	1-p	1-p	N/A	1		N/A	Duplicate of A-2 (2001)
GW-BLANK-7	474257	5501746	1	N/A	1	1	1	1	1-f-p	1-p	1-p	1-p	1			N/A	Duplicate of D-3 (2001)
GW-BLANK-8	461998	5505288	1	N/A	1	1	1	1	1-f-p	1-p	1-p	1-p	N/A	1		N/A	Duplicate of B-3 (2001)
GW-BLANK-9	454369	5516746	N/A	N/A	1	1	1	1	1-f-p	1-p	1-p	1-p	1			N/A	Duplicate of OW-2 (2001)
GW-BLANK-10	451819	5515634	N/A	N/A	1	1	1	1	1-f-p	1-p	1-p	1-p	1			N/A	Duplicate of OW-1 (2001)
GW-BLANK-11	454369	5516746	N/A	N/A	1	1	1	1	1-f-p	1-p	1-p	1-p	1			N/A	Dup of OW-2 (VOC) (2001)
GW-D-9 (Dup)	474356	5504005	N/A	1		N/A	1	N/A	1	N/A	1-p	N/A	1			N/A	Duplicate of GW-D-9 (2001)
GW-ZONE-7W (Dup)	466672	5497613	N/A	1		N/A	1	N/A	1	N/A	1-p	N/A	1			N/A	Duplicate of ZONE-7W (2001)
GW-RIF-3 (Dup)	456510	5518326	N/A	1		N/A	1	N/A	1	N/A	1-p	N/A	1			N/A	Duplicate of RIF-3 (2001)
GW-RIN-1	N/A	N/A	N/A	1		N/A	1	N/A	1	N/A	1-p	N/A	1			N/A	Driller's final rinse water (2001)
GW-DRILLER-1	N/A	N/A	N/A	1		N/A	1	N/A	1	N/A	1-p	N/A	1			N/A	Brandon municipal water (2001)
GW-FIELD-1	N/A	N/A	N/A	1		N/A	1	N/A	1	N/A	1-p	N/A	1			N/A	Distilled water; bottle opened during field sampling (2001)
GW-ROAD-1	N/A	N/A	N/A	1		N/A	1	N/A	1	N/A	1-p	N/A	1			N/A	Distilled water; bottle opened during transportation (2001)

<sup>1</sup> GPS Locations: Universal Transverse Mercator NAD 83, Zone 14

<sup>2</sup> INRS 2001 wells were drilled and installed by Paddock Drilling in September 2001.

<sup>3</sup> INRS 2000 wells were drilled by Paddock Drilling Ltd and installed by Cochrane Engineering Ltd in October 2000.

<sup>4</sup> Private wells are located on private lands.

<sup>5</sup> Base wells are located on the base and were drilled several years ago by different companies.

<sup>6</sup> Sources are sampling points where artesian springs were flowing to the surface.

<sup>7</sup> N/A: Nonapplicable

1-f : 1 sample ; filtered

1-f-p : 1 sample ; filtered ; preservative added

(Sheet 6 of 6)



## Surface water sampling

Surface water samples were collected in Sewell Lake, Epinette Creek, and the Assiniboine River to assess the quality of surface waters. Nine sites were sampled in 2000 (SW-HLAKE, SW-MLAKE, SW-SA-1, SW-SA2, SW-SA3, SW-SE1, SW-SE2, SW-SE3, SW-ZONE6-LAKE). These same sites were resampled in 2001 except for SW-SA-3; however, two samples were taken in two new nearby locations. Eight more sampling sites were added in 2001 (SW-ANTEN-SPRING, SW-ADAMS-SPRING, SW-SS-1, SW-SWAIS-SPRING, SW-SA-2A, SW-SA-2C, SW-SA3-AMONT, SW-SA3-AVAL) to provide a more complete coverage of surface waters. A few samples were also taken from dugouts in the southern part of CFB Shilo (SW-DO-2, SW-DO-3, SW-DO4, SW-DO-5). One duplicate was taken for quality control each year, GW-SP-4 as duplicate of SW-ZONE6-LAKE in 2000, and SW-Horsel as duplicate of SW-Hlake in 2001. YSI and ORP probes were also used to measure physicochemical parameters of surface water. No filtering of the surface water samples was made in the field prior to sending them to the lab for chemical analysis, both in 2000 and 2001. A detailed schedule of surface water sampling is presented in Table 3-5.

**Table 3-5  
Locations of Surface Water Sampling Points and Sampling Schedule**

Sampling Point ID	East Coordinate	North Coordinate	Physico-chemical		Routine/Anions		Metals		Energetic Material		Thorium		Comments
			2000	2001	2000	2001	2000	2001	2000	2001	2000	2001	
SW-ANTEN-SPRING	448615	5512416		1		1		1-p		1-p		1	
SW-ADAMS SPRING	479182	5509975		1		1		1-p		1-p		1	
SW-DO-2	458344	5504630		1		1		1-p		1-p		1	
SW-DO-3	459289	5504044		1		1		1-p		1-p		1	
SW-DO-4	458854	5503823		1		1		1-p		1-p		1	
SW-DO-5	456453	5503253		1		1		1-p		1-p		1	
SW-HLAKE	468320	5496357	1	1	1	1	1-p <sup>2</sup>	1-p	1-p	1-p	1	1	
SW-MLAKE	480742	5502506	1	1	1	1	1-p	1-p	1-p	1-p	1	1	
SW-SA-1	447131	5514115	1	1	1	1	1-p	1-p	1-p	1-p		1	
SW-SA-2	456634	5501448	1	1	1	1	1-p	1-p	1-p	1-p		1	
SW-SA-2A	468139	5594924		1		1		1-p		1-p		1	
SW-SA-2C	480100	5598322		1		1		1-p		1-p		1	
S-A-3	480827	5500934	1		1		1-p		1-p				
SW-SA-3-AMONT	480793	5500961		1		1		1-p		1-p		1	
SW-SA-3-AVAL	480793	5500961		1		1		1-p		1-p		1	
SW-SE-1	457997	5520636	1	1	1	1	1-p	1-p	1-p	1-p		1	
SW-SE-2	465735	5517405	1	1	1	1	1-p	1-p	1-p	1-p		1	

(Continued)

**Table 3-5 (Concluded)**

Sampling Point ID	East Coordinate <sup>1</sup>	North Coordinate	Physico-chemical		Routine/Anions		Metals		Energetic Material		Thorium		Comments
			2000	2001	2000	2001	2000	2001	2000	2001	2000	2001	
SW-SE-3	476591	5509912	1	1	1	1	1-p	1-p	1-p	1-p		1	
SW-SS-1	458035	5498105		1		1		1-p		1-p		1	
SW-SWAIS-SPRING	451274	5511075		1		1		1-p		1-p		1	
SW-ZONE6-LAKE	461912	5500361	1	1	1	1	1-p	1-p	1-p	1-p	1	1	
Duplicates													
SW-SP-4	461912	5500361	1		1		1-p		1-p		1		Duplicate of SW-ZONE6-LAKE (2000)
SW-HORSEL	468320	5496357		1		1		1-p		1-p		1	Duplicate of Hlake (2001)

<sup>1</sup> GPS Locations: Universal Transverse Mercator NAD 83, Zone 14  
<sup>2</sup> p : Preservative added in the field

### Water supply at CFB Shilo and aquifer modeling

A conceptual model of the aquifer will be built to illustrate the hydrogeology and transport mechanisms and the observed behaviour of the potential contaminants in soil and groundwater. Based on measured physical properties such as hydraulic heads, hydraulic conductivity, recharge, etc., and based on the information on pumping rate of the supply wells at CFB-Shilo, or irrigation wells, a numerical model of the groundwater flow in the studied area will be built. The model will be produced in the master's thesis of Ms Catherine Gauthier, who is also co-author of the present report.

## Water Analyses, Results, and Discussion

### Regional context

**Geology.** The geologic study of CFB shilo was made using information collected during fieldwork in September 2001. Two deep boreholes were drilled to evaluate the sequence of sediment formations and the depth of the aquifer. Georadar measurements were also made to obtain further information of sediment structures. Surficial geologic mapping surveys showed that CFB Shilo is entirely underlain by thick sandy sediments of the Assiniboine delta, a large meltwater-fed delta that was deposited at an elevation of about 375 m above sea level (ASL) in Lake Agassiz during the last deglaciation [28-31]. The deltaic sand is medium- to coarse-grained with an observed thickness ranging from 15 m in natural sections on the banks of the Assiniboine River to as much as 36 m in the built-up area of the base. Because of the shallow depth of most boreholes

located within the training area, two deep boreholes were augered to determine the thickness of the deltaic sand and the depth of the aquifer. This stratigraphic information revealed that the deltaic sands are generally underlain by glaciolacustrine silts whose thickness ranges from a few centimeters to 25 m or more and are in turn underlain by dense, matrix-dominated grey till.

The Assiniboine delta grades distally into and interfingers with silt sands, which have been reported in at least one borehole northeast of the Douglas Marsh. Most of the surface of the deltaic sands has been reworked extensively by wind activity; these aeolian features range from reworked deltaic sand to composite parabolic dunes. These medium to fine-grained aeolian sands are hence commonly finer-grained than the underlying deltaic sands. Subsurface investigations (boreholes and Ground Penetrating Radar (GPR) surveys) showed that the aeolian sands also contain several discontinuous organic layers, which form paleosols or buried peats of Holocene age. The surface of the Assiniboine delta is overlain by organic sediments in the vicinity of the Douglas Marsh and Epinette River.

**Climatology.** CFB Shilo's climate can be described as a continental climate, with harsh winters where the average temperature of the coldest month is below 3 °C and the mean temperature of the warmest month exceeds 10 °C. The mean daily temperature ranges from a high of 18.7 °C in July to -18.4 °C in January. The annual mean temperature of CFB Shilo is 1.8 °C. CFB Shilo's weather is a land-controlled climate, which is influenced by tropical and polar air masses. Winter and summer temperatures are characterized as relatively severe. At CFB Shilo, the annual mean precipitation is 453 mm. The bulk of this precipitation falls as rain during April and October. Wind is a constant factor at CFB Shilo. During winter, the winds in the area are predominately from the west. In the spring, they can alternate from west, northwest and northeast. Wind speeds generally increase during the spring months. In summer, the wind speeds tend to decrease and come from the east to northeast. In the fall, wind speeds increase and direction becomes gradually northwest to west again.

**Hydrology and Hydrogeology.** The drainage system includes two watersheds, Epinette Creek and Assiniboine River. The first one passes through the military base, while the second one is located along the southern border (Figures 3-1 and 3-2). Both rivers flow toward the east. Dillon Consulting and Render estimated the value of aquifer recharge by precipitation at 5 percent of the precipitation (20 out of 400 mm and 24 out of 483 mm in 2000 and 2001, respectively). Groundwater recharge was also estimated from a water table hydrograph in a well located in the center of CFB Shilo. Individual events were evaluated to vary between 0 and 142 mm/y with a mean annual recharge of 50 mm/y for a 17-year period.

CFB Shilo is located on part of the Assiniboine Delta aquifer. This unconfined aquifer covers an area of 3,900 km<sup>2</sup>. The sand thickness is smallest near the Assiniboine River (approximately 6 m). Between Aachen and Essen battleruns (northern part of the training area), the thickness is at its maximum at approximately 30 m. Major uses of groundwater are for domestic purposes and irrigation of farmlands surrounding the base.

## Hydraulic properties of the aquifer

**Determination of the Hydraulic Conductivity.** During the drilling of the boreholes, subsurface soil samples were collected with a 51-mm split-spoon (60 cm long) at the depth of the middle of the screen interval and were sent to INRS laboratory for grain-size analysis. Grain-size analysis was performed by sieving for the coarse soil fraction and by laser analysis for the grains under 63  $\mu\text{m}$ . Two types of soils were analyzed in 2000, the deltaic sand formation and the glacio-lacustrine silt formation. The sand had a grain size that varied from 0.5  $\mu\text{m}$  to 1 mm with a mean of 350  $\mu\text{m}$ . The estimated hydraulic conductivity established with the Hazen formula based on the d10 of the grain-size curves varied between  $1.3 \times 10^{-3}$  m/s to  $4.0 \times 10^{-6}$  m/s with a geometric mean of  $1.8 \times 10^{-4}$  m/s. Analysis made in 2001 on sand using the same methodology resulted in an estimated hydraulic conductivity varying between  $1.05 \times 10^{-3}$  m/s and  $1.0 \times 10^{-4}$  m/s, with a geometric mean of  $2.1 \times 10^{-4}$  m/s. These results are in agreement with the slug test results of  $1 \times 10^{-4}$  m/s. This value was calculated using the results of 152 slug tests performed in 2000 and 2001 in a total of 71 wells. One to three tests were performed in each well.

According to the year 2000 analysis, the glacio-lacustrine silt formation had a grain size that varied from 0.5 to 400  $\mu\text{m}$  with a mean of 30  $\mu\text{m}$ . The estimated hydraulic conductivity by the Hazen formula varied between  $8.9 \times 10^{-8}$  m/s to  $3.2 \times 10^{-9}$  m/s with a geometric mean of  $8.7 \times 10^{-9}$  m/s.

### **Determination of Groundwater Flow Direction and Velocity.**

Groundwater flow directions measured by the Geoflo 40L are consistent with the piezometric map except for four wells (GW-A-6, GW-B-6, GW-B-3, and GW-GRE). Local groundwater flow may have been affected by the water table, or false readings of the instrument may be responsible for these differences. Groundwater velocities estimated from the Geoflo 40L data were consistent with the velocities calculated from other field data (70 to 700 m/y with an average velocity of 350 m/y). The calculated groundwater velocity is based on the average hydraulic conductivity estimated from slug tests ( $1 \times 10^{-4}$  m/s), the horizontal hydraulic gradient measured on the water table map (0.002 to 0.02 with a mean gradient of 0.01) and an estimated porosity of 0.3.

## Geochemical results

**Groundwater.** Groundwater at CFB Shilo is characterized by a neutral pH (mean, 7.56), a low alkalinity (170 to 240 mg/l), a low conductivity (340 to 450  $\mu\text{S}$  ( $\mu\text{ohms/cm}$ ) for lab data and 225 to 535  $\mu\text{S}$  for field data), a low total dissolved solids concentration (170 to 240 mg/l) and a very low concentration in anions (below detection limits)(bicarbonate, carbonate, chloride, sulphate). The redox potential averages 211 mV, indicating an oxidizing environment. The high level of dissolved oxygen in groundwater (69 percent) confirms that aerobic environment exists. Table 3-6 presents physicochemical parameters measured in the field.

**Table 3-6  
Physicochemical Parameters Measured in Groundwater with YSI and ORP Probes**

Well ID	T, °C	pH	Conductivity, µS	Salinity, ppt	DO, mg/l	DO, %	ORP in the field, mV
<b>2001 INRS Wells</b>							
GW-ANTENNE	11.9	7.60	280	0.2	2.50	21.0	278
GW-AMA-1	13.7	7.70	250	0.2	7.20	64.8	259
GW-AMA-2	10.7	7.60	271	0.2	7.45	67.0	272
GW-ATR-1	11.9	8.03	240	0.2	13.83	127.4	271
GW-A-9	13.4	6.50	258	0.2	1.10	9.5	296
GW-A-10	12.2	7.39	215	0.1	9.81	91.4	213
GW-BGR-3	9.7	7.55	311	0.2	7.17	62.9	151
GW-BGR-4	7.5	7.70	233	0.2	10.73	89.4	229
GW-C-8	7.5	7.96	204	0.1	14.02	116.5	284
GW-C-9	11.8	8.02	181	0.1	13.68	126.0	278 f
GW-D-9	10.0	8.05	428	0.2	9.74	85.1	279 f
GW-D-11	10.6	8.33	407	0.2	12.70	114.3	276 f
GW-D-12	11.8	7.86	220	0.2	9.86	101.7	282 f
GW-D-13	10.5	7.93	115	2.8	10.50	107.0	278 f
GW-E-7	13.5	7.59	120	0.1	12.13	117.3	283
GW-E-8	13.8	7.23	439	0.3	3.44	32.8	270
GW-E-9	12.7	7.66	300	0.2	0.30	2.9	296
GW-E-11	N/A	8.10	280	0.2	10.92	105.0	278 f
GW-GATE-S	9.5	7.36	1500	0.0	10.91	99.2	242
GW-GRE-1	10.7	8.40	160	0.1	4.51	41.2	232
GW-GRE-2	14.0	7.57	156	0.1	6.86	67.0	295
GW-RIF-1	12.0	7.95	273	0.1	11.52	108.2	230
GW-RIF-3	8.3	6.60	213	0.2	8.50	69.5	140
GW-TR	13.8 s/8.9 n	7.38 s/6.38 n	0 s/336 n	0.0 s/0.2 n	3.76 s/0.00 n	37.4 s/0.00 n	208
GW-OBS-SUP-5	8.9	5.56	334	0.2	11.48	98.4	110
GW-OBS-SUP-16	7.6	6.20	261	0.2	9.46	78.3	111
GW-OBS-SUP-27	10.0	6.10	312	0.2	10.37	91.5	111
GW-ZONE-4E	10.7	7.68	187	0.1	5.48	48.3	134
GW-ZONE-4W	9.3 s / 7.7 n	7.83	0 s / 368 n	0.0 s/0.2 n	12.00 s/12.06 n	106.7 s/101.6 n	233
GW-ZONE-5N	10.2 s/8.1 n	7.83 s/7.26 n	0 s/257 n	0.0 s/0.2 n	9.44 s/9.52 n	83.6 s/82.1 n	194
GW-ZONE-5S	9.2 / 6.2	7.74 s/7.33 n	0 s / 1100 n	0 s / 0.0 n	10.18 s/11.04 n	94.1 et 91.6 AUT	205
GW-ZONE-7	11.2	7.60	210	0.1	4.82	48.4	269
GW-ZONE-7W	10.7	7.51	103	0.1	4.58	42.3	275 f
GW-ZONE-9N	8.4	7.73	128	0.1	7.60	66.0	216
GW-ZONE-9S	13.8	7.76	397	0.2	12.17	117.7	284 f
GW-ZONE-9W	7.6 n	6.86 n	356	0.2 n	1.09 n	9.7 n	93 n
<b>2000 INRS Wells</b>							
GW-ATR	11.1 s/15.0 n	8.14 s/2.12 n	19	0.1 s/0.0 n	9.64 s / 6.91 n	99.5 s / 59.6 n	263 s/533 n
GW-GRE	12.5	7.93	1500	0.0	8.40	100.3	252
GW-MARSH	8.3	8.08	229	0.2	13.98	120.5	278
GW-BGR	7.2	7.32	538	0.4	0.22	1.2	26
GW-RIF	11.1	8.13	102	0.1	4.64	48.1	263
GW-A-1	8.9	7.70	267	0.2	8.38	74.4	262

(Sheet 1 of 3)

**Table 3-6 (Continued)**

Well ID	T, °C	pH	Conductivity, µS	Salinity, ppt	DO, mg/L	DO, %	ORP in the field, mV
GW-A-2	7.5	7.80	262	0.2	14.25	117.7	289
GW-A-3	10.3	7.95	271	0.2	8.05	71.0	239
GW-A-4	8.7	7.70	202	0.1	11.48	98.9	247
GW-A-5	7.7	7.75	247	0.2	14.60	122.2	187
GW-A-6	N/A	N/A	N/A	N/A	N/A	N/A	N/A
GW-A-7	N/A	N/A	N/A	N/A	N/A	N/A	N/A
GW-A-8	N/A	N/A	N/A	N/A	N/A	N/A	N/A
GW-B-1	8.5	6.30	249	0.2	9.09	77.8	114
GW-B-2	N/A	N/A	N/A	N/A	N/A	N/A	N/A
GW-B-3	7.9	7.79	275	0.2	12.35	104.1	202
GW-B-4	14.1	7.62	173	0.1	6.72	65.1	240 f
GW-B-5	14.9	7.48	323	0.2	4.65	44.5	242 f
GW-B-6	13.8	7.40	484	0.2	3.10	28.6	243 f
GW-B-7	13.7	7.40	402	0.2	4.36	41.8	241 f
GW-C-1	13.6	7.55	444	0.2	2.80	26.6	236 f
GW-C-2	11.6	5.90	266	0.2	3.67	33.7	194 f
GW-C-3	13.0	6.14	237	0.2	9.79	91.8	222 f
GW-C-4	11.8	6.16	284	0.2	6.65	60.9	165 f
GW-C-5	10.7	4.49	243	0.2	6.67	60.0	231 f
GW-C-6	12.3	7.70	276	0.2	12.69	121.5	234 f
GW-C-7	12.4	7.62	277	0.0	9.52	88.8	291
GW-D-1-A	N/A	N/A	N/A	N/A	N/A	N/A	N/A
GW-D-1-B	N/A	N/A	N/A	N/A	N/A	N/A	N/A
GW-D-2	8.2	7.00	219	0.2	1.32	12.3	320
GW-D-3	8.0	7.53	299	0.2	12.11	104.8	244
GW-D-4	N/A	N/A	N/A	N/A	N/A	N/A	224 f
GW-D-5	N/A	N/A	N/A	N/A	N/A	N/A	N/A
GW-D-6	11.7	6.00	300	0.2	5.69	52.0	250 f
GW-D-7	7.6	7.00	227	0.2	2.65	19.9	N/A
GW-D-8	8.1	8.42	271	0.2	0.51	4.7	214
GW-E-1	N/A	7.48	233	0.0	8.30	85.6	288
GW-E-2	N/A	7.54	224	0.0	7.69	76.5	285
GW-E-3	10.1	7.70	255	0.2	7.03	61.8	294
GW-E-4	14.5	7.41	242	0.1	8.50	83.5	243 f
GW-E-5	N/A	7.51	192	0.0	4.79	47.4	281
GW-E-6	15.4	7.50	322	0.2	2.48	23.8	249 f
<b>Private Wells</b>							
GW-PHILLIPS	12.1	7.53	307	0.2	48.20	71.9	N/A
GW-PARC-1	8.4	7.51	333	0.2	4.80	41.1	-68
GW-PARC-2	8.6	7.42	340	0.2	49.20	86.2	220
<b>Base Wells</b>							
GW-SUP-16	7.4 n	6.99 n	1700 n	0.0 n	0 n	0 n	-39 n
GW-SUP-27	N/A	N/A	N/A	N/A	N/A	N/A	N/A
GW-SUP-5	7.5 n	7.00 n	1500 n	0.0 n	1.76 n	14.8 n	-35 n
OW-1	9.4	7.94	186	0.0	6.96	61.7	282

(Sheet 2 of 3)

**Table 3-6 (Concluded)**

Well ID	T, °C	pH	Conductivity, µS	Salinity, ppt	DO, mg/l	DO, %	ORP in the field, mV
OW-2	8.2	7.95	363	0.3	8.10	68.8	228
OW-3	7.0	7.54	295	0.2	11.70	96.3	231
OW-4	N/A	N/A	N/A	N/A	N/A	N/A	N/A
MW-101	9.1	7.70	436	0.2	3.21	27.9	288
MW-102	10.6	7.95	267	0.1	6.53	57.6	283
MW-103	N/A	N/A	N/A	N/A	N/A	N/A	N/A
MW-104	12.2	7.70	201	0.1	9.24	86.6	268
MW-105	N/A	N/A	N/A	N/A	N/A	N/A	N/A
MW-106	N/A	N/A	N/A	N/A	N/A	N/A	N/A
MW-107-A	8.2	7.36	377	0.3	3.74	32.1	200
MW-107-B	7.6	7.33	295	0.2	0.17	1.4	-41
MW-108	7.9	7.86	253	0.2	11.78	99.3	250
MW-109	8.1	7.30	320	0.2	0.29	2.5	-5
MW-110	8.0	7.18	389	0.3	0.75	7.7	200
<b>Base Wells</b>							
MW-111	8.3	7.34	652	0.5	0.45	4.1	229
MW-112	7.3	7.68	256	0.2	10.80	90.4	188
MW-113	7.4	7.49	324	0.2	0.33	3.0	132
<b>Springs</b>							
SPRING-1	10.1	7.78	320	0.2	11.45	101.8	30
SPRING-2	7.8	7.68	315	0.2	6.20	52.1	-38
SPRING-3 <sup>1</sup>	7.8	7.91	139	0.1	11.02	92.3	-3
SPRING-3 <sup>2</sup>	10.2	8.08	294	0.2	10.77	95.8	130
SPRING-3 <sup>3</sup>	9.3	8.06	286	0.2	11.04	96.3	55

<sup>1</sup> West Branch of the Assiniboine River

<sup>2</sup> North Branch of the Assiniboine River

<sup>3</sup> Ten meters below the junction of the West and North Branches of the Assiniboine River

f : filtered

n Measured in November

s Measured in September

(Sheet 3 of 3)

Metals were analyzed in the 39 groundwater samples collected in 2000 and at 92 locations in 2001. Table 3-7 presents CCME guidelines for aquatic life, drinking water, livestock watering, and irrigation. The limit of detection of ETL analytical methods is also shown. Metal concentrations were compared to these criteria except those for aquatic life, since they only apply to surface water. Table 3-8 shows metals in groundwater that were higher than these criteria.

**Table 3-7  
Water Quality Threshold Criteria**

Parameter	Unit	CCME Guidelines for Canadian Drinking Water Quality	EPA Maximum Contaminant Level, for drinking water	WHO guidelines for drinking water	CCME Guidelines: Aquatic life, Freshwater	CCME Guidelines: Agriculture, Irrigation	CCME Guidelines: Agriculture, Livestock	ETL Detection limit
Alkalinity as CaCO <sub>3</sub>	mg/l							30
Alkalinity as Bicarbonate	mg/l							40
Alkalinity as Hydroxide	mg/l							10
pH	No Unit	6.5 - 8.5	6.5 - 8.5	Around neutrality	6.5-9.0			-
Conductivity	µohms/cm							20
Solids - Dissolved	mg/l	<ou égal 500	500	1000		500 - 3 500	3 000	5
Turbidity	NTU	1 et <ou égal 5	5	5				-
Chloride - Soluble	mg/l	<ou égal 250				100 - 700		10
Nitrate-Nitrite-N Soluble	mg/l N	10 (nitrate - nitrogen). 45 nitrate	10 (nitrate nitrite)	nitrate (as NO <sub>3</sub> <sup>-</sup> ) 50 acute. nitrite (as NO <sub>2</sub> <sup>-</sup> ) 3 acute. 0.2 chronic			nitrate-nitrite: 100	1
Sulphate - Soluble	mg/l SO <sub>4</sub>	<ou égal 500	250 b (sulfate)	250			1 000	10
Aluminium - Total	mg/l	0.1	0.05-0.2	0.2	0.005 - 0.1	5	5	0.02
Arsenic - Total	mg/l	0.025	0.01	0.01	0.005	0.1	0.025	0.0005
Antimony - Total	mg/l	0.006	0.006	0.005				0.001
Barium - Total	mg/l	1	2	0.7				0.0003
Beryllium - Total	mg/l		0.004	NAD		0.1	0.1	0.001
Boron - Total	mg/l	5	Under review	0.5		0.5 -6	5	0.03
Bismuth - Total	mg/l							0.0001
Cadmium - Total	mg/l	0.005	0.005	0.003	0.000017	0.0051	0.08	0.0002
Calcium - Total	mg/l	No criteria					1 000	0.1
Chromium - Total	mg/l	0.05	0.1	0.05				0.002
Cobalt - Total	mg/l					0.05	1	0.0002

(Continued)



**Table 3-7 (Concluded)**

Parameter	Unit	CCME Guidelines for Canadian Drinking Water Quality	EPA Maximum Contaminant Level, for drinking water	WHO guidelines for drinking water	CCME Guidelines: Aquatic life, Freshwater	CCME Guidelines: Agriculture, Irrigation	CCME Guidelines: Agriculture, Livestock	ETL Detection limit
Copper - Total	mg/l	<ou égal 1.0	1.3 et 1	2 et 1	0.002-0.004	0.2 - 1	0.5 - 5	0.001
Cesium - Total	mg/l	Cs 134 and Cs 137: 10 Bq/L						0.0001
Hardness as CaCO3	mg/l	No criteria		No criteria				0.07
Iron - Total	mg/l	<ou égal 0.3	0.3	0.3	0.3	5		0.05
Lead - Total	mg/l	0.010	0.015	0.01	0.001-0.007	0.2	0.1	0.0005
Lithium - Total	mg/l					2.5		0.002
Magnesium	mg/l	No criteria						0.01

NAD: No adequate data to permit recommendation on a health-based guideline value

**Table 3-8  
Metals Concentrations Detected over CCME Guidelines for Drinking Water Quality in Groundwater Samples**

ETL ID Number in 2000	ETL ID Number in 2001	Sample ID	> CCME Drinking Water Concentration detected in 2001, ppb	> CCME Drinking Water Concentration detected in 2000, ppb
<b>2001 INRS wells</b>				
N/A	01-A77028	GW-ANTENNE	Al (270), Fe (1660), Mn (1020)	
N/A	01-A77030	GW-AMA-1	Al (290), Fe (2510), Mn (114)	
N/A	01-A77032	GW-AMA-2	Al (300), Fe (1160), Mn (111)	
N/A	01-A78052	GW-ATR-1	Al (2380), Sb (33), Fe (10500), Mn (827)	
N/A	01-A78572	GW-A-9	Al (300), Fe (880), Mn (268)	
N/A	01-A77814	GW-A10	Al (510), Fe (1570), Mn (137)	
N/A	01-A78555	GW-BGR-3	Al (1000), Sb (26), Fe (1600), Mn (730)	
N/A	01-A78542	GW-BGR-4	Al (2040), Fe (6390), Mn (257)	
N/A	01-A78579	GW-C-8	Al (71100), As (302), Sb (36), Ba (3720), Cr (117), Fe (310000), Pb (158), Mn (19000)	
N/A	01-A77027	GW-C-9	Al (2380), Fe (6350), Mn (351)	
N/A	01-A77017	GW-D-9	Al (1560), Fe (4630), Mn (394)	
N/A	01-A77019	GW-D-11	Al (2560), Sb (11), Fe (6770), Mn (461)	
N/A	01-A77043	GW-D-12	Al (6850), Sb (14), Fe (9890), Mn (823)	
N/A	01-A77020	GW-D-13	Al (15500), Fe (23500), Pb (13.1), Mn (415), Se (15)	
N/A	01-A76577	GW-E-7	Al (1160), Cd (40.5), Fe (1980), Mn (87,2)	
N/A	01-A76578	GW-E-8	Al (960), Fe (6230), Mn (345)	
N/A	01-A76579	GW-E-9	Al (820), Fe (1280)	
N/A	01-A77817	GW-E-11	Al (3150), Sb (20), Fe (4660), Mn (164)	
N/A	01-A76604	GW-Gate-S	Al (460), Fe (1720), Mn (195)	

(Sheet 1 of 4)

**Table 3-8 (Continued)**

ETL ID Number in 2000	ETL ID Number in 2001	Sample ID	> CCME Drinking Water Concentration detected in 2001, ppb	> CCME Drinking Water Concentration detected in 2000, ppb
N/A	01-A77800	GW-GRE1	Al (1850), Fe(11900), Mn (127)	
N/A	01-A77801	GW-GRE2	Al (2050), Fe (3020)	
N/A	01-A77773	GW-RIF-1	Al (150), Fe (710)	
N/A	01-A78054	GW-RIF-3	Al (1000), Sb (22), Fe (2600), Mn (64)	
N/A	01-A77803	GW-TR	Al (2760), Fe (11000), Mn (717)	
N/A	01-A78619	OBS-SUP-5	Al (720), Sb (28), Fe (2350), Mn (237)	
N/A	01-A78625	OBS-SUP-16	Al (830), Sb (29), Fe (2670), Mn (169)	
N/A	01-A78620	OBS-SUP-27	Al (310), Sb (24), Fe (1390), Mn (76,6)	
N/A	01-A76603	GW-Zone-4-E	Al (2490), Fe (3190), Mn (238)	
N/A	01-A76602	GW-Zone-4-W	Al (500), Fe (2760), Mn (182)	
N/A	01-A76580	GW-Zone-5-N	Al (5690), Fe (12800), Pb (10.8), Mn (1770)	
N/A	01-A76581	GW-Zone-5-S	Al (1160), Fe (8150), Mn (184)	
N/A	01-A77818	GW-ZONE-7	Al (1030), Fe (8600), Mn (1080)	
N/A	01-A77771	GW-ZONE-7W	Fe (360), Mn (171)	
N/A	01-A76605	GW-Zone-9-N	Al (6320), Fe (11600), Mn (188)	
N/A	01-A77029	GW-Zone-9S	Al (800), Fe (7630), Mn (2830)	
N/A	01-A78056	GW-ZONE-9W	Al (1680), Sb (23), Fe (3130), Mn (254)	
<b>2000 Wells</b>				
00-A87898	01-A77823	GW-ATR	Al (1540), Fe (8590), Mn (368)	
00-A80083	01-A77822	GW-GRE	Al (5790), Fe (11100), Mn (455)	
N/A	01-A78629	GW-MARSH-1	Al (13000), Fe (17400), Pb (13.7), Mn (775)	
00-A87899	01-A78544	GW-BGR	Fe (1280), Mn (1760)	
00-A80082	01-A77774	GW-RIF	Al (2570), Sb (17), Fe (8020), Mn (699)	
00-A85950	01-A77040	GW-A-1	Al (4160), Fe (7230), Mn (641)	
00-A85948	01-A78581	GW-A2	Al (11900), Fe (36600), Pb (24.4), Mn (1480)	
00-A85949	01-A77042	GW-A-3	Al (1040), Fe (6700), Mn (457)	
00-A85951	01-A77041	GW-A-4	Al (15700), Fe (17300), Mn (422)	
N/A	01-A78571	GW-B-1	Al (270), Sb (14), Fe (1730), Mn (364)	
00-A83316	01-A78614	GW-B-3	Al (1420), Sb (37), Fe (8620), Mn (612)	
00-A83317	01-A78051	GW-B-4	Al (15500), Sb (26), Fe (22400), Pb (13.6), Mn (762)	
00-A83318	01-A78050	GW-B-5	Al (2960), Sb (37), Fe (6410), Mn (1160)	
00-A83319	01-A78073	GW-B-6	Al (333), Sb (29), Fe (2210), Mn (260)	
00-A83310	01-A78049	GW-B-7	Al (3290), Sb (36), Fe (7940), Mn (521)	
00-A83315	01-A78070	GW-C-1	Al (4770), Sb (30), Fe (24400), Pb (14.8), Mn (1360)	Mn (52)
00-A83312	01-A78545	GW-C-2	Al (3260), As (28.8), Fe (27500), Pb (14.5), Mn (4320)	
00-A83313	01-A78546	GW-C-3	Al (1880), Fe (26000), Pb (11.8), Mn (4530)	
00-A83314	01-A78617	GW-C-4	Al (1490), Fe (7860), Mn (603)	
00-A83311	01-A78547	GW-C-5	Al (2220), Fe (10400), Mn (1040)	
00-A80081	01-A78071	GW-C-6	Al (4750), Sb (30), Fe (10700), Pb (11.1), Mn (1800)	
00-A88118	01-A78072	GW-C-7	Al (4030), As (38.2), Sb (33), Fe (40300), Pb (32,7), Mn (3600), Se (15)	

(Sheet 2 of 4)

**Table 3-8 (Continued)**

ETL ID Number in 2000	ETL ID Number in 2001	Sample ID	> CCME Drinking Water Concentration detected in 2001, ppb	> CCME Drinking Water Concentration detected in 2000, ppb
00-A83322	01-A78630	GW-D-2	Al (120), Fe (1820), Mn (270)	Mn (279)
00-A83320	01-A78570	GW-D-3	Al (11400), As (47.1), Ba (1060), Fe (41600), Pb (25.7), Mn (5050)	
N/A	01-A78556	GW-D-4	Al (6850), As (40.7), Fe (37200), Pb (18.7), Mn (3790)	
00-A83323	01-A78618	GW-D-6	Al (1860), Fe (5700), Mn (380)	
00-A88120	01-A78053	GW-D-7	Al (2160), Fe (5000), Mn (512)	
N/A	01-A78615	GW-D-8	Al (46100), As (129), Sb (44), Ba (2270), Cr (93), Fe (169000), Pb (175), Mn (13100)	
00-A87900	01-A77819	GW-E-1	Al (2110), Fe (2840), Mn (197)	
N/A	01-A77802	GW-E-2	Al (7620), Fe (9590), Mn (456)	
00-A87904	01-A78543	GW-E-3	Al (160), Fe (500)	
00-A87903	01-A77816	GW-E-4	Al (10500), Sb (47), Fe (10400), Mn (424)	Al (180), Fe (320)
N/A	01-A77820	GW-E-5	Al (16200), Sb (7), Fe (36800), Pb (14.2), Mn (4560)	
00-A87902	01-A77815	GW-E-6	Al (22800), Sb (40), Fe (43700), Pb (16.8), Mn (1090)	Mn (948)
<b>Private Wells</b>				
N/A	01-A74111	GW-Philips	Fe (360)	
N/A	01-A74112	GW-PARC-1	Fe (13300), Mn (282)	
N/A	01-A75363	GW-PARC-2	Fe (670)	
<b>Base Wells</b>				
N/A	01-A75781	GW-SUP-5	Fe (1290), Mn (400)	
N/A	01-A75782	GW-SUP-16	Fe (1680), Mn (390)	
00-A88122	01-A78541	OW-1	Al (4450), Fe (7380), Mn (456)	
00-A88117	01-A78608	OW-2	Al (16200), Sb (28), Ba (1030), Fe (53600), Pb (26.3), Mn (3890)	
N/A	01-A78609	OW-3	Al (12400), Sb (31), Ba (1600), Fe (79000), Pb (115), Mn (7080)	
N/A	01-A78597	MW-101	Al (7310), Fe (15300), Pb (12.6), Mn (2400)	
N/A	01-A78596	MW-102	Al (2060), Fe (5900), Mn (399)	
N/A	01-A78554	MW-104	Al (2940), Sb (17), Fe (14200), Mn (772)	
N/A	01-A78604	MW-107-A	Al (11500), Sb (42), Ba (1540), Fe (32600), Pb (20.5), Mn (3180)	
N/A	01-A78605	MW-107-B	Al (770), Sb (22), Fe (4830), Mn (309)	
00-A88116	01-A78621	MW-108	Al (5050), Sb (20), Fe (12900), Mn (1190)	
N/A	01-A78628	MW-109	Al (420), Sb (18), Fe (2030), Mn (682)	
N/A	01-A78606	MW-110	Al (12000), Sb (20), Fe (27300), Pb (15.4), Mn (1330)	
N/A	01-A78607	MW-111	Al (20400), As (50.2), Sb (24), Ba (2600), Fe (163000), Pb (67.3), Mn (9870), Se (11)	
00-A88115	01-A78627	MW-112	Al (2270), Fe (10000), Mn (743)	
N/A	01-A78626	MW-113	Al (980), Fe (12600), Mn (1160)	
<b>Springs</b>				
00-A79822	01-A74113	GW-Spring-1	Fe (1900), Mn (249)	
00-A79823	01-A74114	GW-Spring-2	Fe (4310), Mn (295)	
00-A79824	01-A74115	GW-Spring-3	Fe (800), Mn (139)	

(Sheet 3 of 4)

Table 3-8 (Concluded)				
ETL ID Number in 2000	ETL ID Number in 2001	Sample ID	> CCME Drinking Water Concentration detected in 2001, ppb	> CCME Drinking Water Concentration detected in 2000, ppb
Duplicates/Quality Control				
00-A87905	N/A	GW-A-9		
00-A88119	N/A	GW-C-8		
00-A88121	N/A	GW-D-9		
00-A87906	N/A	GW-E-7		
00-A79829	N/A	GW-SP-5		
00-A79830	N/A	GW-SP-6		
00-A79831	N/A	RESERVOIR		Fe(5800), Pb (12), Mn (86)
N/A	01-A78599	GW-BLANK-1 (GW-BGR-3)	Al (720), Sb(29), Fe (1670), Mn (755)	
N/A	01-A78582	GW-BLANK-2 (GW-BGR-4)	Al (2310), Fe (6740), Mn (260)	
N/A	01-A78553	GW-BLANK-3 (GW-A-9)	Al (290), Fe (730), Mn (260)	
N/A	01-A78610	GW-BLANK-4 (GW-BGR-3)	Al (145000), As (31.6), Sb (20), Ba (4810), Cr (216), Fe (204000), Pb (113), Mn (11300)	
N/A	01-A78573	GW-BLANK-5 (GW-B-1)	Al (130), Fe (1290), Mn (307)	
N/A	01-A78580	GW-BLANK-6 (GW-A-2)	Al (11800), Fe (36300), Pb (23.3), Mn (1340)	
N/A	01-A78578	GW-BLANK-7 (GW-D-3)	Al (7500), As (33.4), Sb (18), Fe (30300) Pb (14.5), Mn (3130)	
N/A	01-A78611	GW-BLANK-8 (GW-B-3)	Al (1370), Sb (33), Fe (8070), Mn (555)	
N/A	01-A78612	GW-BLANK-9 (OW-2)	Al (11900), Ba (1040), Fe (53400), Pb (115), Mn (4210)	
N/A	01-A78598	GW-BLANK-10 (OW-1)	Al (3800), Sb (19), Fe (8620), Mn (557)	
N/A	01-A78613	GW-BLANK-11		
N/A	01-A77018	GW-D-9 (Dup)	Al (1320), Sb (9), Fe (4360), Mn (359)	
N/A	01-A77772	GW-ZONE-7W (Dup)	Fe (400), Mn (174)	
N/A	01-A78055	GW-RIF-3 (Dup)	Al (280), Sb (29), Fe (1020)	
N/A	01-A77821	GW-RIN-1	Al (270), Sb (21), Fe (19200), Mn (726)	
N/A	01-A75780	GW-DRILLER-1		
N/A	01-A78539	GW-FIELD-1		
N/A	01-A78540	GW-ROAD-1		
Dup: duplicate				(Sheet 4 of 4)

In 2000, the background sample (GW-BGR) was located north of CFB Shilo, upstream Epinette Creek, away from habitations and human activity. No parameter was found exceeding CCME guidelines for this location. Aluminium concentrations measured in both field and trip blanks were, respectively, 60 and 20 ppb. These values are higher than those observed in several groundwater samples, indicating either a lab contamination (lab water, bottles, or analytical instrument) or a sample contamination during transportation or field manipulation. Therefore, 60 ppb should be considered the quantification limit for aluminium; results lower than these are not relevant.

Apart for INRS-drilled wells, two other wells installed by the base prior to this study (OW-1 and OW-2) and two wells installed by other engineering firms (MW-108 and MW-112) were sampled (Table 3-8). These wells were installed to ascertain that no contamination was coming from the northern part of the training area. In particular, the anti-tank, grenade, and rifle ranges were suspected as possible contributors of contaminants. No problems were detected in any of those wells except for high aluminium concentrations (9 times the background, 4.5 times the field blank) in one well (MW-108). However, these concentrations were still below CCME guidelines.

Metal analysis from 2001 generally showed concentrations much higher than those of 2000. However, this is because samples were acidified in the field without filtration, thereby liberating metals adsorbed on sediments. Therefore, these values cannot be compared to those of 2000 and are not representative of real concentrations in groundwater. They are linked to the quantity of total dissolved solids in water samples, as indicated by the fact that the two wells showing the highest metal concentrations were also those with the highest concentrations of dissolved solids (GW-C-8, TDS 1,700 mg/l, and MW-111, TDS 1,100 mg/l). This can be seen as the potential maximum charge of metal that were brought to the groundwater level over the years, both in solution and in suspension. Comparing these values to drinking water guidelines can still be an interesting exercise; if metal concentrations for unfiltered and acidified samples do not exceed guidelines, therefore we have strong evidence that natural concentrations in groundwater are well below established criteria. Parameters exceeding guidelines are the following: aluminium (Al, 83 wells), arsenic (As, 7 wells), antimony (Sb, 34 wells), barium (Ba, 7 wells), chromium (Cr, 1 well), iron (Fe, 93 wells), lead (Pb, 22 wells), manganese (Mn, 87 wells) and selenium (Se, 3 wells). Aluminium, manganese and iron are naturally occurring in the environment; high concentrations are probably the results of desorption following acidification. The same phenomenon is probably responsible for the high concentrations of other metals. However, since these metals are sometimes linked to military activities, locations showing concentrations above guidelines were re-sampled in September 2002 to verify that these concentrations would not occur in filtered water samples. INRS borehole and grain size analyses logs are presented in Appendix C of this chapter on pages 3-142 through 3-213.

In 2000, energetic materials were not detected in the 39 groundwater samples. However, traces of TNT were seen on gas chromatograms below the quantification limit of the analytical instrument (30 ppb). The samples showing traces of TNT were GW-Spring-2, GW-B-7, GW-D-6, GW-A-7, GW-A-2, and GW-MARSH 1. The 101 groundwater samples were analyzed in 2001 to confirm these results. Once again, no energetic materials were detected over the quantification limit of 0.01 ppb meaning that earlier results for TNT were the result of background noise.

Volatile organic carbon and BTEX compounds were not detected in the three groundwater samples taken from parkplatz of Aachen, Cologne, and Essen in 2000. In 2001 in contrast, the following were detected in very low concentrations: xylenes in one well (OBS-SUP-5), and toluene in a second (OBS-SUP-16); methylene chloride in these same wells, and in two other wells (OBS-SUP-27 and MW-108). However, methylene chloride is a common laboratory

contaminant. Results for VOCs are presented in Table 3-9. These contaminants are likely related to spills of gasoline on the ground. The toluene concentration (28 ppb) slightly exceeded the CCME guideline of 24 ppb. A total of six wells were sampled in 2001; one of them was sampled twice. The four wells previously mentioned were located in building areas such as garages where conventional activities and opportunities for contamination of wells or sampling equipment by volatile compounds from solvents were numerous. Such sources could explain the very low concentrations observed. For example, well OBS-SUP-27 was installed just in front of a garage, slightly below ground level. During sampling, the space between the casing and the PVC tubing was found flooded with dirty water. Some infiltration of surface water could have occurred, and, considering the proximity of potential sources of contamination, may explain the low concentration of VOCs observed. Five of the six samples indicated very high concentrations of acetone (from 1,000 to 2,200,000 ppb). Contamination of the samples by a leaky acetone bottle used for decontamination purposes and carried previously in the same cooler was suspected; this was confirmed by the resampling of the well that had exhibited the highest acetone concentration. No traces of acetone were detected in the new samples.

<b>Table 3-9 Volatile Organic Compounds (VOCs) Detected in Groundwater Samples</b>				
<b>ETL ID number</b>	<b>Sample ID</b>	<b>Elements and Concentrations, ppb October 2000</b>	<b>Elements and Concentrations, ppb September 2001</b>	<b>Elements and Concentrations, ppb November 2001</b>
<b>2000 INRS Wells</b>				
00-A88114	GW-A-1		N/A <sup>1</sup>	N/A
00-A83315	GW-C-1		N/A	N/A
00-A88113	GW-E-1		N/A	N/A
<b>2001 INRS Wells</b>				
01-A78619	OBS-SUP-5	N/A	M + P XYLENES (7), METHYLENE CHLORIDE (7)	N/A
01-A78625	OBS-SUP-16	N/A	ACETONE <sup>2</sup> (2 200 000), TOLUENE (28)	METHYLENE CHLORIDE (1)
01-A78620	OBS-SUP-27	N/A	ACETONE (85000), METHYLENE CHLORIDE (12)	N/A
<b>Base Wells</b>				
01-A78541	OW-1	N/A	ACETONE (25000)	N/A
01-A78608	OW-2	N/A	ACETONE (1000)	N/A
01-A78621	MW-108	N/A	ACETONE (1000), METHYLENE CHLORIDE (8)	N/A
<b>Duplicates</b>				
01-A78613	GW-BLANK-11 <sup>3</sup>	N/A	ACETONE (100), METHYLENE CHLORIDE (2)	N/A
<sup>1</sup> Not Applicable <sup>2</sup> There are no CCME criteria for acetone in drinking water. Criteria for the other chemicals are methylene chloride (50 ppb), m + p xylenes (300 ppb) and toluene (24 ppb). Only one sample was found to slightly exceed one of CCME Guidelines for Drinking Water Quality, toluene in OBS-SUP-27 <sup>3</sup> Duplicate of OW-2				

The metal thorium (Th) was present in small quantities in certain types of Milan missiles fired at CFB Shilo. According to information provided by Shilo personnel, Milan missiles were fired in specific locations in Essen, Cologne, and

Deilinghofen battleruns. Based on this information, groundwater samples from ten (10) wells and three (3) springs located near these locations were collected and analyzed for thorium in 2000. A year later, groundwater sampling for thorium analysis was performed in 87 wells, 2 base supply wells, and 3 springs. Radioactivity threshold criteria for thorium obtained from CCME guidelines was transformed into a concentration criteria using calculations that can be retrieved in "ppb à Bq/l Conversion Calculations" presented in this chapter, Appendix D, page 3-214. Results are presented in parts per billion (ppb) and were converted from becquerels/liter (Bq/l). The limit of detection was 5 ppt in 2000 and 10 ppt in 2001.

The Canadian Guidelines for Drinking Water Quality established by the Canadian Council of Ministers of the Environment (CCME) ([www.ccme.ca](http://www.ccme.ca)) specifies Maximum Acceptable Concentrations (MAC) in drinking water for several radionuclides. Standards for Thorium-232 and Lead-210 are the most stringent and were established at 0.1 Bq/l, or 24.5 ppb. This standard was used to determine that no sample contained thorium concentrations above the CCME standard; in fact, the highest thorium concentration measured, 2.35 ppb found in GW-D-8 near the firing area, is one order of magnitude below the standard.

The second and third highest concentrations of thorium were 0.907 ppb and 0.217 ppb, measured, respectively, in Cologne (GW-C-2) and Essen battleruns (GW-E-6). Results for GW-D-3, where the highest concentration was measured during Phase I in 2000 (1.15 ppb), revealed a much lower concentration of 0.31 ppb in 2001. No thorium was found in the three springs and in the two supply wells of the base. Detailed thorium results for groundwater are presented in Table 3-10.

**Table 3-10  
Thorium Concentrations Measured in Groundwater**

Well ID	Thorium, ppb 2000	Thorium, ppb 2001	Thorium, Bq/l E-4 2000	Thorium, Bq/l E-4 2001	Comments
<b>2001 INRS Wells</b>					
GW-ANTENNE	N/A	0.03	N/A	1.22	
GW-AMA-1	N/A	0.03	N/A	1.22	
GW-AMA-2	N/A	0.03	N/A	1.22	
GW-ATR-1	N/A	0.11	N/A	4.49	
GW-A-9	N/A	0.01	N/A	0.41	
GW-A-10	N/A	0.03	N/A	1.22	
GW-BGR-3	N/A	0.04	N/A	1.63	
GW-BGR-4	N/A	0.25	N/A	10.20	
GW-C-8	N/A	< 0.01	N/A	< 0.41	
GW-C-9	N/A	0.18	N/A	7.35	
GW-D-9	N/A	0.20	N/A	8.16	
GW-D-11	N/A	0.30	N/A	12.25	
GW-D-12	N/A	0.24	N/A	9.80	

(Sheet 1 of 4)

**Table 3-10 (Continued)**

Well ID	Thorium, ppb 2000	Thorium, ppb 2001	Thorium, Bq/l E-4 2000	Thorium, Bq/l E-4 2001	Comments
GW-D-13	N/A	0.26	N/A	10.61	
GW-E-7	N/A	0.07	N/A	2.86	
GW-E-8	N/A	0.10	N/A	4.08	
GW-E-9	N/A	0.03	N/A	1.22	
GW-E-11	N/A	0.04	N/A	1.63	
GW-GATE-S	N/A	0.03	N/A	1.22	
GW-GRE-1	N/A	0.10	N/A	4.08	
GW-GRE-2	N/A	0.07	N/A	2.86	
GW-RIF-1	N/A	0.03	N/A	1.22	
GW-RIF-3	N/A	0.03	N/A	1.22	
GW-TR	N/A	0.14	N/A	5.71	
GW-OBS-SUP-5	N/A	0.06	N/A	2.45	
GW-OBS-SUP-16	N/A	0.05	N/A	2.04	
GW-OBS-SUP-27	N/A	0.03	N/A	1.22	
GW-ZONE-4E	N/A	0.11	N/A	4.49	
GW-ZONE-4W	N/A	0.07	N/A	2.86	
GW-ZONE-5N	N/A	0.49	N/A	20.00	
GW-ZONE-5S	N/A	0.15	N/A	6.12	
GW-ZONE-7	N/A	0.27	N/A	11.02	
GW-ZONE-7W	N/A	0.01	N/A	0.41	
GW-ZONE-9N	N/A	0.09	N/A	3.67	
GW-ZONE-9S	N/A	0.08	N/A	3.27	
GW-ZONE-9W	N/A	< 0.01	N/A	< 0.41	
<b>2000 INRS Well</b>					
GW-ATR	N/A	0.31	N/A	12.65	
GW-GRE	N/A	0.03	N/A	1.22	
GW-MARSH-1	N/A	0.15	N/A	6.12	
GW-BGR	N/A	< 0.01	N/A	< 0.41	
GW-RIF	N/A	0.16	N/A	6.53	
GW-A-1	N/A	0.33	N/A	13.47	
GW-A-2	N/A	0.40	N/A	16.33	
GW-A-3	N/A	0.46	N/A	18.78	
GW-A-4	N/A	0.43	N/A	17.55	
GW-A-5	N/A	N/A	N/A	N/A	
GW-A-6	N/A	N/A	N/A	N/A	
GW-A-8	N/A	N/A	N/A	N/A	
GW-B-1	N/A	< 0.01	N/A	< 0.41	
GW-B-2	N/A	0.01	N/A	0.41	
GW-B-3	N/A	0.08	N/A	3.27	
GW-B-4	N/A	0.16	N/A	6.53	
GW-B-5	N/A	0.08	N/A	3.27	
<b>2000 INRS Wells</b>					
GW-B-7	N/A	0.07	N/A	2.86	
GW-C-1	N/A	0.15	N/A	6.12	

(Sheet 2 of 4)



**Table 3-10 (Continued)**

Well ID	Thorium, ppb 2000	Thorium, ppb 2001	Thorium, Bq/l E-4 2000	Thorium, Bq/l E-4 2001	Comments
GW-C-2	0.907	0.10	37.02	4.08	
GW-C-3	N/A	0.18	N/A	7.35	
GW-C-4	N/A	0.10	N/A	4.08	
GW-C-5	0.062	0.07	2.53	2.86	
GW-C-6	0.093	0.11	3.80	4.49	
GW-C-7	N/A	0.38	N/A	15.51	
GW-D1-A	N/A	N/A	N/A	N/A	
GW-D1-B	N/A	N/A	N/A	N/A	
GW-D-2	0.010	N/A	0.41		
GW-D-3	1.145	0.31	46.74	12.65	
GW-D-4	N/A	0.01	N/A	0.41	
GW-D-5	0.041	N/A	1.67	0.00	
GW-D-6	N/A	0.10	N/A	4.08	
GW-D-7	N/A	0.10	N/A	4.08	
GW-D-8	N/A	2.35	N/A	95.93	
GW-E-1	N/A	0.08	N/A	3.27	
GW-E-2	0.021	0.13	0.86	5.31	
GW-E-3	0.033	0.02	1.35	0.82	
GW-E-4	0.082	0.04	3.35	1.63	
GW-E-5	N/A	0.27	N/A	11.02	
GW-E-6	0.217	0.23	8.86	9.39	
GW-E-7	0.054	N/A	2.20	N/A	
<b>Private Wells</b>					
GW-PHILIPS		< 0.01		< 0.41	
GW-PARC-1	N/A	< 0.01	N/A	< 0.41	
GW-PARC-2	N/A	< 0.01	N/A	< 0.41	
<b>Base Wells</b>					
GW-SUP-5		< 0.01		< 0.41	
GW-SUP-16	N/A	< 0.01	N/A	< 0.41	
GW-SUP-27	N/A	N/A	N/A	N/A	
OW-1	N/A	0.37	N/A	15.10	
OW-2	N/A	0.54	N/A	22.04	
OW-3	N/A	0.82	N/A	33.47	
MW-101	N/A	0.28	N/A	11.43	
MW-102	N/A	0.03	N/A	1.22	
MW-104	N/A	0.25	N/A	10.20	
MW-107-A	N/A	0.07	N/A	2.86	
MW-107-B	N/A	0.05	N/A	2.04	
MW-108	N/A	0.12	N/A	4.90	
MW-109	N/A	0.04	N/A	1.63	
MW-110	N/A	< 0.01	N/A	< 0.41	
MW-111	N/A	< 0.01	N/A	< 0.41	
MW-112	N/A	0.10	N/A	4.08	
MW-113	N/A	0.17	N/A	6.94	

(Sheet 3 of 4)

**Table 3-10 (Concluded)**

Well ID	Thorium, ppb 2000	Thorium, ppb 2001	Thorium, Bq/l E-4 2000	Thorium, Bq/l E-4 2001	Comments
<b>Springs</b>					
GW-SPRING-1	< 0.005	< 0.01	< 0.20	< 0.41	
GW-SPRING-2	< 0.005	< 0.01	< 0.20	< 0.41	
GW-SPRING-3	< 0.005	< 0.01	< 0.20	< 0.41	
<b>Duplicates</b>					
GW-BLANK-1	N/A	0.04	N/A	1.63	Duplicate of GW-BGR-3 (2001)
GW-BLANK-2	N/A	0.28	N/A	11.43	Duplicate of GW-BGR-4 (2001)
GW-BLANK-3	N/A	0.01	N/A	0.41	Duplicate of GW-A-9 (2001)
GW-BLANK-4	N/A	0.22	N/A	8.98	Duplicate of GW-BGR-3 (2001)
GW-BLANK-5	N/A	< 0.01	N/A	< 0.41	Duplicate of GW-B-1 (2001)
GW-BLANK-6	N/A	0.37	N/A	15.10	Duplicate of GW-A-2 (2001)
GW-BLANK-7	N/A	0.12	N/A	4.90	Duplicate of GW-D-3 (2001)
GW-BLANK-8	N/A	0.06	N/A	2.45	Duplicate of GW-B-3 (2001)
GW-BLANK-9	N/A	0.36	N/A	14.70	Duplicate of OW-2 (2001)
GW-BLANK-10	N/A	0.33	N/A	13.47	Duplicate of OW-1 (2001)
GW-D-9 (Dup)	N/A	0.25	N/A	10.20	Duplicate of GW-D-9 (2001)
GW-ZONE-7W (Dup)	N/A	0.01	N/A	0.41	Duplicate of GW-ZONE-7W (2001)
GW-RIF-3 (Dup)	N/A	< 0.01	N/A	< 0.41	Duplicate of GW-RIF-3 (2001)
GW-RIN-1	N/A	0.06	N/A	2.45	Driller's final rinse water (2001)
GW-DRILLER-1	N/A	< 0.01	N/A	< 0.41	Brandon municipal water (2001)
GW-FIELD-1	N/A	< 0.01	N/A	< 0.41	Distilled water; bottle opened during field sampling (2001)
GW-ROAD-1	N/A	< 0.01	N/A	< 0.41	Distilled water; bottle opened during transportation (2001)

(Sheet 4 of 4)

Thorium concentrations in groundwater varied by three orders of magnitude. They ranged from <0.005 ppb (below detection limit) to 2.35 ppb. While even the highest result was one order of magnitude below the CCME guideline, several considerations should be kept in mind. Measured concentrations decreased with distance from Milan firing ranges, several being below the detection limit. This is an indication of a measurable contribution of an anthropogenic source of Th in groundwater at CFB Shilo. Only three background samples were collected. The relatively high thorium concentration found in one of them (BGR-4, 0.25 ppb) may be an indication that these samples are not representative of background concentrations. The threshold value obtained from the mean background (BG) was 0.3 ppm. When compared to this background level (BGL), 12 samples located in the target areas presented concentrations over this limit.

The general pattern of thorium concentration in groundwater at CFB Shilo is one of decreasing concentrations with distance from targeted areas. However, this pattern is not consistent with the general direction of groundwater flow; high thorium concentrations were found up gradient from Milan target locations, while lower concentrations were recorded just down gradient from the same locations. This was especially obvious in Aachen and near the building areas,

which were not located along the flow lines coming from the Milan impact areas and still contain high thorium concentrations, including GW-OW-3 and GW-OW-2 at 0.82 and 0.54 ppb, respectively. These results indicated that groundwater flow is not the only factor controlling thorium concentrations in groundwater and that other phenomena are prevailing before thorium reaches the water table and may exert a strong influence on thorium distribution.

A possible explanation for the high thorium concentrations observed in groundwater outside the general flow path could be transport and deposition by wind prior to percolation to the water table. This transport could happen either during the firing exercises or by dust transport. The directions of prevailing winds in southern Manitoba (northwest and southeast) correlates relatively well with the observed pattern of thorium distribution around target areas. Thorium concentrations form ellipsoids around target areas, the elongated side of the ellipse being parallel to prevailing winds. However, since a high proportion of groundwater sampling locations are in line with prevailing wind directions, further thorium analyses outside the axis of these winds would be necessary to verify this hypothesis.

On the other hand, the short distance between sampling locations with high thorium concentrations, and others with values under detection limits suggests the possible presence of hotspots. These hotspots could be created by the deposition of missile debris following the explosion or wind transport. Such small hotspots would be difficult to locate and could provide a reasonable explanation for the great variations in thorium levels found in groundwater.

**Surface Water.** Several water quality parameters measured in the Assiniboine River in 2000 showed values higher than those measured in groundwater. These included alkalinity (280 mg/l), conductivity (920  $\mu\text{ohms/cm}$ ), and total dissolved solids concentration (590 mg/l). The presence of chloride (2 mg/l) and sulphate (205 mg/l) was also noted in the Assiniboine River. The same parameters showed an increase along the course of Epinette Creek as follows: alkalinity (180 to 335 mg/l), conductivity (340 to 610 mg/l), and total dissolved solids (180 to 340 mg/l). The following values for 2001 are similar: alkalinity (240 mg/l), conductivity (577  $\mu\text{ohms/cm}$ ), total dissolved solids concentration (376 mg/l). Again, the presence of chloride and sulphate was noted in the Assiniboine River as well as in one location in the southern part of Epinette Creek. The parameters also showed the same increase along the course of Epinette Creek. Physicochemical parameters measured in the field are presented in Table 3-6.

In 2000, metals were analysed in nine surface water samples. Table 3-11 shows metals in surface water that exceeded CCME threshold criteria. In the upstream part of Epinette Creek (SE-1 and SE-2), no concentrations of metals above CCME threshold guidelines were observed. In the downstream part, (SE-3), a higher level of copper and manganese was measured. Iron and manganese concentrations were associated with water drained from the marsh as observed in the background groundwater sample (GW-BGR). The presence of copper was also noted down gradient of CFB in the Assiniboine River (SA-3). Since no problem associated with copper in soils or groundwater was found down gradient of the range, copper contamination should not be related to the training activities.

**Table 3-11  
Metals Concentrations Detected Over CCME Guidelines in Surface Water**

Sample ID	Concentration detected > Drinking Water guidelines in 2001 ppb	Concentration detected > Aquatic Life Guidelines in 2001 ppb	Concentration detected > Drinking Water guidelines in 2000 ppb	Concentration detected > Aquatic Life Guidelines in 2000 ppb
SW-Adams-Spring	Fe (700) Mn (377)	Cu (7) Fe (700)		
SW-DO-2	Fe (1220) Mn (224)	As (5.7) Cu (8) Fe (1220)		
SW-DO-3	Al (340) Fe (6660) Mn (1340)	Al (340) As (13.3) Cu (25) Fe (6660)		
SW-DO-4	Al (1450) Fe (4450) Mn (253)	Al (1450) Cu (8) Fe (4450),		
SW-DO-5	Al (130), As (32) Fe (6100), Mn (1290)	Al (130), As (32), Cu (8), Fe (6100)		
SW-HLake	Mn (53.8)	Cu (11)	Al(290), Fe(690), Mn(143)	Al (290), Fe (690)
SW-MLake		Cu (8)	Al (230), Fe (690), Mn(90)	Al (230), Fe (690)
SW-SA-1	Al (190), Fe (580) Mn (52.1)	Al (190), As (7.2) Cu (10), Fe (580)		
SW-SA-2	Al (310), Sb (13) Fe (770), Mn (56.2)	Al (310), As (6.8) Cu (7), Fe (770)		
SW-SA-2A	Al (1110), Fe (1460), Mn (169)	Al (1110), As (7.5) Cu (12), Fe (1460)		
SW-SA-2C	Al (1340), Fe (1630), Mn (153)	Al (1340), As (6.6) Cu (16), Fe (1630)		
S-A-3				Cu (12)
SW-SA3-AMONT	Al (650), Fe (970) Mn (99.2)	Al (650), As (7.1) Cu (8), Fe (970)		
SW-SA-3-AVAL	Al (780), Fe (1090), Mn (152)	Al (780), As (6.4) Cu (14), Fe (1090)		
SW-SE-1	Fe (330)	As (7.3), Cu (13) Fe (330)		
SW-SE-2	Fe (4040), Mn (1700)	As (24.6), Cu (11) Fe (4040),		
SW-SE-3	Ba (1010), Fe (2490), Mn (241)	As (12.5), Cu (16) Fe (2490)	Mn (64.8)	Cu (13.6), Mn (64.8)
SW-SS-1	Al (1810), Fe (2050), Mn (258)	Al (1810), As (7.5) Cu (9), Fe (2050) Zn (40)		
SW-SWA1S-SPRING	Fe (580), Mn (95)	As (6.6), Cu (14) Fe (580), Zn (60)		
SW-Zone6	Fe (770), Mn (99.2)	Cu (11), Fe (770)	Al (230), Fe (690), Mn(90.2)	Al (230), Fe (690)
SW-SP-4 <sup>1</sup>			Al (240), Fe(720), Mn(91)	Al (24), Fe(720)
SW-Horse <sup>2</sup>				Se (2)

<sup>1</sup> Duplicate of SW-ZONE6-LAKE

<sup>2</sup> Duplicate of Hlake

Five samples indicated aluminium levels exceeding CCME aquatic life criteria, while three others exceeded CCME drinking water criteria. However,

measured aluminium concentrations in both field and trip blanks were higher than aluminium concentrations exceeding aquatic life criteria, indicating either that water provided by the lab was naturally rich in aluminium, or that a certain level of contamination of the samples occurred during transportation and field manipulations. Therefore, measured levels in field (20 ppb) and trip (60) blanks should be considered as the quantification limit for aluminium. Therefore, levels exceeding aquatic life criteria are not relevant. The only concern for aluminium in surface water was related to Horseshoe Lake (290 ppb) and Zone 6 Lake (230 ppb). However, because Horseshoe Lake (H LAKE) is intermittent, the aquatic life is not of concern. Zone 6 Lake is a groundwater outcrop that was named for sampling purposes. This lake is not listed in the record of the province and, therefore, is not considered to be a lake. Therefore, excess aluminium concentrations are not a concern for aquatic life. These high levels cannot be linked to anthropogenic contribution from Shilo training areas.

In 2001, metals were analyzed in 21 surface water samples. Very high concentrations of aluminium, iron and manganese exceeding both CCME drinking water and aquatic life criteria were measured in almost all samples. The measured concentrations were strongly related to the turbidity of the samples taken, which varied between 1.5 and 69 nephelometric turbidity units (NTU), with a mean value of 15 NTU. These metals are naturally occurring in soils and sediments and are not linked to training activities. The same explanation is also valid for the numerous water samples exceeding aquatic life criteria for copper and arsenic as well as for the few samples exceeding aquatic life criteria for zinc and drinking water criteria for arsenic, barium and antimony. Even if samples were acidified in the absence of filtration, no metals concentrations exceeded CCME aquatic life criteria. This is a strong indication that surface waters are not contaminated with metals by military training activities.

In 2000, energetic materials were not reported in the nine surface water samples collected at H LAKE and M LAKE. A total of 17 surface water samples, including H LAKE and M LAKE, were analyzed in 2001; no energetic materials were detected above the quantification limit of 0.01 ppb.

In 2000, thorium-232 was analyzed in three surface water samples. Concentrations varied between 0.006 and 0.018 ppb. Thorium concentrations found in the 21 surface water samples collected in 2001 were very low, ranging from below the detection limit (for 10 samples) to 0.08 ppb. In general, thorium concentrations in surface water were lower than those observed in groundwater. These results are an indication that Milan missile firing did not contribute to significant thorium concentrations in nearby lakes and rivers. Thorium results for surface water are presented in Table 3-12.

Sample ID	Thorium, ppb 2000	Thorium, ppb 2001	Thorium, Bq/l E <sup>-4</sup> 2000	Thorium, Bq/l E <sup>-4</sup> 2001
SW-ANTEN-SPRING	N/A	< 0.01	N/A	< 0.41
SW-ADAMS-SPRING	N/A	< 0.01	N/A	< 0.41
SW-DO-2	N/A	0.01	N/A	0.41
SW-DO-3	N/A	0.03	N/A	1.22
SW-DO-4	N/A	0.04	N/A	1.63
SW-DO-5	N/A	0.01	N/A	0.41
SW-HLAKE	0.018	< 0.01	0.73	< 0.41
SW-HORSEL	N/A	< 0.01	N/A	< 0.41
SW-MLAKE	0.014	< 0.01	0.57	< 0.41
SW-SA-1	N/A	0.02	N/A	0.82
SW-SA-2	N/A	0.02	N/A	0.82
SW-SA-2A	N/A	0.05	N/A	2.04
SW-SA-2C	N/A	0.06	N/A	2.45
SW-SA-3	N/A		N/A	
SW-SA3-AMONT	N/A	0.04	N/A	1.63
SW-SA-3-AVAL	N/A	0.04	N/A	1.63
SW-SE-1	N/A	< 0.01	N/A	< 0.41
SW-SE-2	N/A	< 0.01	N/A	< 0.41
SW-SE-3	N/A	< 0.01	N/A	< 0.41
SPRING-1	N/A		N/A	
SW-SS-1	N/A	0.08	N/A	3.27
SW-SWAIS-SPRING	N/A	< 0.01	N/A	< 0.41
SW-ZONE6	0.006	< 0.01	0.24	< 0.41
SW-HORSEL	N/A	< 0.01	N/A	< 0.41

**Quality Control of Water Samples.** Field and trip blanks were analyzed for metals in 2000. Aluminium concentrations measured in both samples were, respectively, 60 and 20 ppb, indicating that the higher value should be considered as the quantification limit for this metal. Duplicates indicated values similar to those from samples taken at the same location. Field and trip blanks analysis for 2001 (GW-FIELD-1 and GW-ROAD) resulted in values below or slightly above detection limits for all parameters, indicating the absence of contamination during field operations and transport of samples. Results of analyses of the 13 duplicates indicated values more or less similar to their corresponding sample. The difference in measured values is probably due to a difference in water turbidity, leading to a greater or lesser leaching of metals during acidification of the unfiltered samples.

## Soils and Biomass Analyses

### Global Results from Phase I

For Phase I, the analytical results obtained for the parameters tested in all types of samples showed no major environmental impacts related to the training activities. In soils, the accumulation of some heavy metals associated with ammunition was observed around pop-up targets but did not reach levels of concern. Neither surface nor subsurface soil samples showed levels of metals higher than agricultural CCME criteria. Phase I results clearly demonstrated no major problems associated with soil contamination. The fact that higher levels of contaminants were encountered around targets proved that the firing activity caused an accumulation of contaminants locally but not to levels of concern. However, one exception to this was accumulation of radioactive thorium near targets in both soils and groundwater. This represents a concern. Soil samples near targets presented statistically higher results for  $^{232}\text{Th}$ , while results for groundwater showed measurable levels of radioactive compound close to identified Milan missile impacted areas. This emphasized the fact that these missiles impact the environment. Levels were still very low, both in soils and groundwater, but considering the very long half-life of this particular contaminant, finding measurable traces of this element is a high concern.  $^{232}\text{Th}$  had accumulated around target impact areas, and in spite of a very low solubility, occurred at traces levels in the groundwater. The possibility of migration off range in a long-term scenario should be investigated. None of the analyses for explosives revealed contamination in soils, groundwater, or biomass.

Results for metals concentrations in plants (extracts) and the metals dust on the plants (leachates) from battleruns showed no levels of concerns when compared to the biomass background mean values. Only five detections were encountered in the Berlin battlerun where some metals showed concentrations higher than for the background samples. These concentrations were not considered critical. Higher levels of chromium and aluminium were found in the 80- and 120-percent transects where the highest concentrations of UXOs were expected. No detections were observed in the Essen or in the Deilinghofen battleruns.

Unfortunately, no biomass samples were collected around targets for which systematic soil sampling was carried out in order to keep the cost of the study as low as possible. However, trends in accumulation of metals were observed for soils. (Biomass samples were collected during Phase II.)

### General approach for the results analysis

In our evaluation of the results for Phase II, the mean values for background samples were the mean of all collected backgrounds for each parameter measured. When results were higher than the mean background, they were also compared to the backgrounds specific to the same geological formation. When results lower than detection limits were encountered for specific background samples, the detection limit was chosen as the result for the calculation of the

mean value. The results obtained in training areas were compared to the mean value of the background to which was added twice the standard deviation. This allowed the selection of results having values greater than the background means, while being statistically representative. When greater values (hits) were encountered, we compared these to the mean of background samples that were collected in the same geological setting close to the samples showing high hits. This was conducted in order to avoid a comparison that would be nonrepresentative of the particular sample location since the geology of the Shilo area presented various types of formations including sand, silt and swamp deposits. As an example, copper can be found in high concentrations in the marsh northeast of the Shilo training area where it is naturally occurring, while not detected in other geological formations. Results are presented for each parameter instead of per sample to facilitate the analysis of the results, since trends can be easily seen for each parameter. Backgrounds were always tabulated first with mean and standard deviation values. Then, results for samples collected in the training area were tabulated. For soils, results over the CCME threshold values for agricultural soils were highlighted in blue bold fonts,<sup>1</sup> while results over the mean value added to twice the standard deviation were highlighted in red bold fonts in Table 3-13. For biomass, results higher than the mean values added to twice the standard deviation were highlighted in red bold fonts in Table 3-14. Metals concentrations in groundwater samples exceeding either the Background Level (BGL) or the Agricultural Water Quality Guideline (AWQG) in all ranges were presented in Table 3-15. The following tables were then built by extracting all results exceeding either the CCME threshold values or the mean of the background values. Tables for groundwater, soils, and biomass in each range were built for Aachen (Table 3-16), Berlin (Table 3-17), Cologne (Table 3-18), Deilinghofen (Table 3-19), Essen (Table 3-20), Rifle (Table 3-21), and Grenade Range (Table 3-22).

<b>Table 3-13a Metals Concentrations in Soils (Al to Co)</b>										
Sample	Al	As	Ba	Be	B	Bi	Cd	Ca	Cr	Co
	ppm (mg/kg)									
S-BG-69940E 18340N	4680	3.07	203	0.34	6.4	0.11	0.29	9990	8.1	7.7
S-BG-52660E 22764N	4620	4.01	273	0.31	23.6	0.11	0.54	30500	10.3	6.57
S-BG-80356E 06945N	6290	6.69	272	0.41	6	0.12	0.76	11200	9.2	8.46
S-BG-57997E 20636N	3630	6.17	102	0.24	3.6	0.05	0.21	34900	23.8	6.52
S-BG-65629E 17392N	4130	7.93	404	0.23	16.1	0.11	0.61	41800	11.1	5.41
S-BG-63783E 17228N	2400	3.17	54.3	0.18	1.1	0.04	0.09	2080	4.8	3.38
S-BG-78159E 99759N	1800	4.91	65.1	0.17	1.6	0.02	0.13	17200	7.4	2.92
S-BG-62630E 18054N	3550	3.81	92	0.24	1.9	0.05	0.18	3210	6.1	4.03
S-BG-79182E 00111N	2300	6.37	65.2	0.19	2.8	0.04	0.16	23100	5.9	3.47
S-BG-74864E 14968N	2430	2.76	62.1	0.19	1.1	0.04	0.14	2160	5.1	3.67
S-BG-49148E 13157N	6330	9.24	234	0.46	7.9	0.11	0.46	33500	21.5	9.25
S-BG-49148E 13157N (Dup)	6950	11.4	212	0.56	6.4	0.12	0.51	12700	20.4	12

(Sheet 1 of 5)

<sup>1</sup> All references to color can be seen in the electronic version of this report; however, color is not shown in the limited number of hard copies printed.



**Table 3-13a (Continued)**

Sample	Al	As	Ba	Be	B	Bi	Cd	Ca	Cr	Co
	ppm (mg/kg)									
S-BG-55265E 11847N	4020	4.4	133	0.26	4	0.05	0.26	8760	11.2	5.02
S-BG-74864E 14968N (Dup)	2130	2.51	54.8	0.18	0.9	0.03	0.1	1890	5.2	3.35
S-BG-55255E 09752N	4620	5.49	131	0.29	5.7	0.07	0.26	14600	12.9	6.19
S-BG-53656E 11283N	6560	7.13	170	0.42	6.6	0.1	0.33	20100	18.3	8.82
S-BG-80720E 05003N	2090	4.85	72.4	0.16	3	0.03	0.14	35800	6.2	3.33
S-BG-53670E 13403N	5250	6.64	146	0.34	4.5	0.15	0.31	12000	27.3	8.04
S-BG-67858E 90938N	4520	5.85	126	0.3	5.1	0.09	0.39	6320	8.3	6.05
S-BG-68067E 97960N	7660	8.79	207	0.48	9.1	0.17	0.7	11600	13.7	9.84
S-BG-69431E 98407N	6820	9.82	207	0.54	7.8	0.16	0.66	9330	11.1	9.36
S-BG-63565E 00626N	6750	9.39	209	0.45	6.5	0.19	0.75	8700	11.7	8.61
S-BG-62033E 01742N	8370	10.1	238	0.54	7.4	0.21	0.76	9520	14.4	10.5
<b>Mean Value for background</b>	4691	6.28	162.3	0.33	6.0	0.09	0.38	15694	11.9	6.63
<b>Standard Deviation</b>	1631	2.12	73.4	0.11	3.2	0.05	0.20	9682	5.0	2.29
S-A-HS-60021E 12160N	3590	4.17	166	0.22	2.9	0.06	1.29	6440	20.3	5.58
S-A-HS-60042E 12060N	4820	4.34	118	0.27	4.3	0.07	0.66	19000	19.6	5.77
S-A-LS 20%-A	4060	4.5	132	0.24	3.6	0.09	0.54	7080	16.9	5.88
S-A-LS 20%-B	3440	4.46	86.2	0.22	2	0.05	0.38	4410	14.3	5.43
S-A-LS 40% A	4430	5.26	121	0.29	3.1	0.08	0.83	5860	17.3	6.65
S-A-LS 40% B	4370	4.96	116	0.26	2.5	0.07	0.56	5190	16	7.01
S-A-LS 40% B (Dup)	4290	4.97	130	0.29	2.6	0.07	0.44	9080	18.8	7.13
S-A-LS 60% A	4810	5.27	176	0.33	3.4	0.1	0.69	8570	16.5	6.76
S-A-LS 60% B	4440	4.49	161	0.25	3.1	0.1	0.56	6420	16.9	5.86
S-A-LS 80% A	3910	5.09	127	0.25	2.7	0.08	0.41	6890	15.4	6.55
S-A-LS 80% B	3590	4.87	139	0.26	3.1	0.09	0.91	6940	18.4	8.29
S-A-LS 80% A (Dup)	4580	4.71	141	0.26	2.8	0.09	0.45	5950	14.4	6.3
S-A-LS 100% A	3590	3.42	128	0.21	3.1	0.05	0.13	12300	16.6	4.34
S-A-LS 120% A	3190	3.68	89.4	0.17	1.6	0.05	0.27	5400	16.4	4.76
S-A-LS 120% B	3650	4.24	109	0.21	2.1	0.08	0.31	5190	18.6	5.05
S-A-1-0-1	2810	4.49	75.4	0.17	1.8	0.05	0.39	19700	18.5	5.62
S-A-1-1-3	3330	4.71	72.5	0.17	1.9	0.04	0.48	15900	18.6	6.64
S-A-1-3-5	4290	5.03	117	0.23	2.7	0.07	1.98	8020	18.8	12.1
S-A-2-0-1	2650	3.82	87.8	0.15	1.3	0.04	0.33	3750	15.7	4.94
S-A-2-1-3	2920	4.1	83.6	0.17	1.6	0.04	0.25	3520	17.4	4.89
S-A-2-3-5	3490	4.48	145	0.2	3.5	0.06	0.71	5790	20.1	6.05
S-GR-5M-A	4700	5.11	267	0.32	4.3	0.11	4.21	21900	28.2	7.17
S-GR-5M-B	5050	5.89	280	0.42	5.8	0.12	4.75	18600	29	8.1
S-GR-10M-A	4720	5.65	211	0.37	8.6	0.11	3	24200	33.6	7.68
S-GR-10M-B	5410	5.13	199	0.39	5.4	0.1	2.45	28600	29.1	6.81
S-GR-15M-A	5060	5.22	198	0.33	6	0.08	3.12	31900	30	6.67
S-GR-15M-B	5030	4.96	194	0.34	5.2	0.08	2.86	23900	28.4	6.18
S-GR-15M-B (Dup)	5180	5.37	201	0.29	5.9	0.08	2.81	30600	29.9	6.5
S-GR-20M-A	4230	4.5	158	0.29	4.5	0.07	1.84	24000	26.8	5.68
S-GR-20M-B	5060	5.44	193	0.32	5.5	0.08	2.26	28900	34.1	6.79
S-GR-25M-A	5720	5.04	194	0.38	6.1	0.1	2.21	26100	33.2	7.11

(Sheet 2 of 5)

**Table 3-13a (Continued)**

Sample	Al	As	Ba	Be	B	Bi	Cd	Ca	Cr	Co
	ppm (mg/kg)									
S-GR-25M-B	5380	4.77	166	0.35	5.1	0.09	1.94	22300	28.5	6.68
S-GR-25M-B (Dup)	4640	4.46	153	0.33	4.5	0.08	1.76	18400	28.2	5.91
S-GR-30M-A	5220	5.25	193	0.41	5.8	0.09	2.32	18900	32.3	7.37
S-GR-30M-B	5050	5.05	223	0.39	5.1	0.08	2.89	18200	28	6.78
S-GR-35M-A	5330	5.65	217	0.38	5.7	0.1	2.6	17900	29.4	7.18
S-GR-35M-B	3940	4.98	225	0.28	4	0.08	3.24	13700	22.5	6.12
S-GR-HS-57538E 18001N	3840	4.85	122	0.27	2.7	0.05	1.08	6830	15.2	5.49
S-C-LS 20% A	4800	6.81	131	0.27	2.2	0.09	0.51	9130	13.9	6.78
S-C-LS 20% B	7450	8.24	186	0.4	5.2	0.15	0.66	14600	12.4	8.53
S-C-LS 40% A	7820	9.63	208	0.4	4.7	0.16	0.72	11000	13.4	10.1
S-C-LS 40% B	8120	9.31	216	0.44	5.9	0.18	0.76	13300	13.7	10.2
S-C-LS 40% A (Dup)	7610	9.19	210	0.42	4.8	0.18	0.75	12000	14.1	10.3
S-C-LS 60% A	6940	8.47	186	0.4	3.2	0.15	0.87	8980	11.1	9.2
S-C-LS 60% B	8290	9.61	230	0.44	6.3	0.21	0.83	13600	13.3	10.9
S-C-LS 80% A	5520	7.59	151	0.32	2.5	0.12	0.69	7340	13.5	7.68
S-C-LS 80% B	5830	8.53	175	0.36	4.2	0.14	0.85	13200	11.4	9.21
S-C-LS 80% B (Dup)	6440	9.16	193	0.4	4.7	0.16	0.92	14500	12.7	9.85
S-C-LS 100% A	3860	5.09	102	0.21	0.6	0.08	0.45	5910	6.6	4.65
S-C-LS 100% B	7500	9.51	222	0.45	5	0.17	0.79	12300	13.9	12.2
S-C-LS 120% A	4640	4.63	129	0.26	1.4	0.11	0.41	6890	8.2	6.16
S-C-LS 120% B	5200	5.31	178	0.32	2.5	0.14	1.33	8140	9.2	6.67
S-C-1-0-1	5550	12.3	160	0.36	4.1	0.11	1.01	35900	17.2	11.8
S-C-1-1-3	5400	14.8	158	0.39	5.4	0.12	0.5	38900	16.1	12.5
S-C-1-3-5	6560	13.3	203	0.57	8.4	0.16	0.64	23000	14.6	13.3
S-C-2-0-1	3100	4.65	71.1	0.23	0.6	0.05	0.29	3250	7.2	4.08
S-C-2-1-3	4820	5.3	139	0.32	1.8	0.08	0.45	5630	8.5	5.66
S-C-2-3-5	5960	5.59	168	0.34	2.5	0.13	1.07	6000	10.4	6.34
S-C-3-0-1	5400	9.97	203	0.39	3.7	0.1	0.89	13600	18.6	8.94
S-C-3-1-3	5140	8.62	176	0.37	2.7	0.08	0.55	8800	13.2	7.36
S-C-3-3-5	5670	9.3	183	0.43	3.9	0.12	0.73	8010	12	8.65
S-C-HS 65235E 02908N	4590	6.37	179	0.41	3.3	0.14	0.97	6570	11.3	7.3
S-C-HS 65266E 02930N	6660	6.13	229	0.42	4.5	0.2	1.45	9240	12.7	7.84
S-C-HS 66040E 02939N	4320	6.77	171	0.37	3	0.16	5.86	6940	12.9	7.27
S-C-HS 66017E 02566N	5100	14.5	251	0.57	11.9	0.2	1.29	29500	18.2	15.9
S-C-HS 65011E 02663N	13100	9.83	197	0.52	3.8	0.31	0.86	3360	16.8	9.45
S-C-HS 63025E 02811N	3260	6.58	82.4	0.2	0.6	0.05	0.24	11200	21.9	4.75
S-C-HS 68010 02265N	5470	4.94	175	0.38	4.1	0.17	0.95	9000	9.4	6.87
S-RIF1-1-3	1870	3.46	56.2	0.13	1.6	0.02	0.08	7960	12.6	3.92
S-RIF1-4-6	2040	3.97	61	0.15	1.7	0.23	0.09	9840	13.5	4.35
S-RIF1-7-9	2110	4.11	67.5	0.15	1.8	0.06	0.11	12300	14.8	4.9
S-RIF1-10-12	1860	3.87	58.6	0.14	1.6	0.16	0.1	9730	12.2	4.14
S-RIF1-10-12 (Dup)	1800	3.74	59.3	0.15	1.5	0.08	0.1	11700	12.7	4.22
S-RIF1-13-15	1920	3.82	63.5	0.15	1.5	0.13	0.11	9180	12.8	4.37
S-RIF1-16-18	1900	3.9	59.9	0.16	1.4	0.16	0.1	9120	12.2	4.26

(Sheet 3 of 5)

**Table 3-13a (Continued)**

Sample	Al	As	Ba	Be	B	Bi	Cd	Ca	Cr	Co
	ppm (mg/kg)									
S-RIF1-19-21	2000	3.78	60.8	0.13	3.1	0.11	0.1	7540	11	4.13
S-RIF1-19-21 (Dup)	1890	3.66	59.3	0.15	1.6	0.16	0.09	14200	11.9	4.09
S-RIF1-22-24	2090	4.04	67.9	0.16	1.5	0.22	0.1	9910	12.7	4.56
S-RIF1-T24	2010	3.93	67	0.15	1.4	0.06	0.09	11900	12.6	4.37
S-RIF1-T16	2530	4.4	80.2	0.2	1.8	0.08	0.14	7960	12.7	5.36
S-RIF1-T12	3700	6.47	92.3	0.31	2.6	0.43	0.17	16700	11.5	6.14
S-RIF1-T6	2110	4.37	77	0.17	1.6	0.13	0.12	12400	13.3	4.7
S-RIF2-25-27	2370	13.9	67.2	0.23	2.3	3.27	0.26	7340	13.3	5.3
S-RIF2-28-30	2300	15.3	63.3	0.19	1.8	3.66	0.22	5000	10.2	5.18
S-RIF2-31-33	2700	14.5	74.2	0.24	2.2	2.95	0.23	6380	10.1	5.82
S-RIF2-34-36	3610	17.1	94.3	0.26	2.2	4.16	0.3	6780	13.9	6.44
S-RIF2-37-39	3580	13.9	98.7	0.29	2.6	2.89	0.28	7080	11.9	6.71
S-RIF2-37-39 (Dup)	3590	12.9	95.5	0.28	2.4	2.54	0.27	6990	11.8	6.47
S-RIF2-40-42	5230	8.29	129	0.36	3.1	0.85	0.34	6340	14.3	7.85
S-RIF2-43-45	5300	7.28	144	0.4	2.8	0.38	0.35	6280	14.4	8.48
S-RIF2-46-48	4260	6.62	96.3	0.31	2.4	0.67	0.2	9610	17.4	7.01
S-RIF2-46-48 (Dup)	4850	6.02	129	0.32	2.4	0.19	0.32	5690	11.7	7.64
S-RIF2-T28	2850	5.98	93.9	0.28	1	0.48	0.18	15300	9.2	6.33
S-RIF2-T34	2130	5.65	70.5	0.21	0.6	0.17	0.15	5900	10.1	6.63
S-RIF2-T40	2980	5.89	81.3	0.25	0.6	0.07	0.16	7060	8.6	6.61
S-RIF2-T46	7740	7.67	141	0.6	7.2	0.32	0.49	12900	15.8	9.2
S-RIF4-1-3	2460	10.7	73.1	0.17	0.8	2.74	0.23	5240	8.5	5.09
S-RIF4-4-6	2670	11.4	87	0.22	1.1	2.71	0.48	5520	8.8	5.44
S-RIF4-7-9	2450	11.4	80.5	0.22	0.8	2.92	0.29	5900	8.2	5.24
S-RIF4-10-12	2600	9.43	81.8	0.26	1	2.18	0.23	5680	8.8	5.28
S-RIF4-T4	2620	6.24	83.1	0.22	0.6	0.82	0.19	8980	9.8	6.87
S-RIF4-T9	2770	7.43	91.5	0.27	0.7	0.97	0.2	8300	14.1	7.67
S-KE-0-3	5080	5.63	101	0.35	2.8	0.51	0.24	8780	15.7	6.37
S-KE-BU-1	2440	4.16	71.7	0.19	1.2	0.11	0.16	8620	11.8	4.3
S-KE-BU-2	2260	3.81	92.5	0.15	0.6	0.04	0.13	5630	12.3	3.92
S-KE-BU-3	2130	3.8	68.9	0.17	0.6	0.04	0.11	8640	12.4	3.85
S-KE-BU-4	2080	3.44	65.7	0.16	0.6	0.05	0.13	6650	10.2	3.54
S-D-HS-74210E 01267N	5770	5.85	188	0.36	4.7	0.17	0.75	14000	13	9.76
S-D-HS-74326E 01195N	3620	5.19	113	0.23	3.4	0.07	0.36	11300	10.1	8.2
S-D-HS-74215E 01278N	4530	6.33	135	0.31	3.3	0.12	0.5	11100	15.2	11.6
S-D-1-0-1	2630	5.98	274	0.17	0.7	0.1	0.19	11500	15.2	140
S-D-1-1-3	2220	5.84	117	0.15	0.6	0.08	0.18	10600	12.3	72.8
S-D-1-3-5	2400	5.84	92.1	0.19	1.1	0.08	0.27	13100	16.3	62.5
S-D-2-0-1	2370	7.06	102	0.17	0.6	0.07	0.19	14500	18.3	112
S-D-2-1-3	3060	7.1	104	0.2	1.7	0.09	0.28	14900	18.9	47.8
S-D-2-3-5	2730	5.56	101	0.19	1.5	0.06	0.22	15900	11.9	23.3
S-E-HS-63240E 15109N	2640	4	123	0.14	0.8	0.08	0.13	5560	10.7	6.34
S-E-HS-63240E 15109N	4020	3.85	125	0.28	2	0.08	0.31	5220	7.2	8.37
S-E-1-0-1	2960	4.25	91.5	0.2	0.6	0.11	0.14	3880	7.8	6.14

(Sheet 4 of 5)

**Table 3-13a (Concluded)**

Sample	Al	As	Ba	Be	B	Bi	Cd	Ca	Cr	Co
	ppm (mg/kg)									
S-E-1-1-3	2540	3.21	56.6	0.17	0.8	0.04	0.11	2690	8.7	4.39
S-E-1-3-5	2850	4.4	114	0.19	0.8	0.1	0.19	4060	8.2	9.73
S-E-2-0-1	2790	4.38	69.7	0.15	0.6	0.1	0.14	6800	8.7	8.19
S-E-2-1-3	2630	4.56	61.4	0.19	0.6	0.1	0.14	6380	8.4	7.31
S-E-2-3-5	2760	4.04	63.6	0.16	0.6	0.05	0.12	3220	7.9	12.8
S-ASA-HS-51508E 15705N	6770	14	250	0.44	4.9	0.13	27	12800	26.6	10.7
S-ASA-HS-51501E 15688N	6470	9.43	190	0.38	4.4	0.1	8.72	18000	24.7	11.3
S-ASA-HS-51488E 15697N	5960	12	213	0.44	6	0.11	4.49	18300	26.2	12.4
S-ASA-I-5	6930	10.1	215	0.45	6.5	0.13	1.01	24600	26.8	12.5
S-ASA-I-10	9140	12.4	253	0.6	7.5	0.16	0.9	14000	28.2	14.9
S-ASA-I-15	7280	10.2	190	0.48	5.2	0.12	0.73	18000	26.4	12.6
S-ASA-I-20	10100	13.1	271	0.69	7.1	0.17	0.81	15600	32.1	17.1
S-ASA-I-25	8470	11.2	232	0.54	5.9	0.14	0.68	19400	29.3	14.6
S-ASA-I-30	7640	9.71	235	0.54	6	0.15	0.74	15900	23.4	13.1

Color shown only in electronic version of this report:

Values in red: Results over the mean value added to twice the standard deviation are highlighted in red bold fonts

Values in blue: Results over the CCME threshold value for agricultural soils are highlighted in blue bold fonts

(Sheet 5 of 5)

**Table 3-13b  
Metals Concentrations in Soils (CU TO AG)**

Sample	Cu	Fe	Pb	Mg	Mn	Mo	Ni	K	Se	Ag
	ppm (mg/kg)									
S-BG-69940E 18340N	11.1	10200	12.2	2490	1070	0.58	13.2	1110	0.7	1
S-BG-52660E 22764N	25.2	13000	18.4	5450	2090	1.16	17.6	1740	1.1	1
S-BG-80356E 06945N	16.8	13800	10.5	2750	1450	0.92	15.3	980	0.9	1
S-BG-57997E 20636N	44.7	25500	48.4	9990	1230	3.53	34	665	0.2	1
S-BG-65629E 17392N	146	13100	132	4320	3180	1.85	18.2	1230	0.6	1
S-BG-63783E 17228N	4.1	7680	4.38	1150	312	0.34	7.3	527	0.1	1
S-BG-78159E 99759N	10.5	10700	3.68	1540	352	0.97	9.9	295	0.1	1
S-BG-62630E 18054N	5.3	8870	6.28	1340	384	0.39	8	643	0.2	1
S-BG-79182E 00111N	5.9	9910	3.75	5810	435	0.53	8.2	428	0.2	1
S-BG-74864E 14968N	4.6	7700	6.67	1090	360	0.42	6.1	609	0.2	1
S-BG-49148E 13157N	131	21800	44.5	10100	1070	2.43	30.4	1510	0.5	1
S-BG-49148E 13157N (Dup)	37.3	24800	13	4380	1590	2.23	35.7	1710	0.7	1
S-BG-55265E 11847N	17.9	13800	7.62	2870	780	1.33	14.5	889	0.3	1
S-BG-74864E 14968N (Dup)	5.3	7400	5.06	947	305	0.4	6.3	488	0.1	1
S-BG-55255E 09752N	22.7	17000	9.81	5680	1050	1.52	20	824	0.4	1
S-BG-53656E 11283N	32.2	24100	11.7	8380	1570	2.09	28.1	1210	0.4	1
S-BG-80720E 05003N	7.1	10500	3.93	6830	368	0.65	9.1	307	0.2	1
S-BG-53670E 13403N	55	30000	12.2	4880	1210	3.92	38.8	941	0.4	1
S-BG-67858E 90938N	12	12000	10.3	2380	943	0.85	13.7	1140	0.4	1
S-BG-68067E 97960N	22.6	19200	21.1	4200	1720	1.35	24.1	1830	0.8	1
S-BG-69431E 98407N	16	17500	15.4	3450	1430	0.98	22.8	1640	0.7	1

(Sheet 1 of 5)

**Table 3-13b (Continued)**

Sample	Cu	Fe	Pb	Mg	Mn	Mo	Ni	K	Se	Ag
	ppm (mg/kg)									
S-BG-63565E 00626N	19.1	17000	15.8	2850	1500	1.27	20.7	1490	0.7	1
S-BG-62033E 01742N	23	19700	18.4	3350	1600	1.47	24.7	1660	0.8	1
Mean Value	29.4	15446	18.9	4184	1130	1.36	18.6	1038	0.5	1
Standard Deviation	23.5	5403	14.8	2087	534	0.71	8.2	422	0.2	0
S-A-HS-60021E 12160N	52.4	18500	49.3	1720	503	2.72	26.2	641	0.2	1
S-A-HS-60042E 12060N	55.5	19200	34.3	6880	644	2.39	54.4	987	0.3	1
S-A-LS 20%-A	48.4	16500	27.1	1660	661	2.2	24.8	834	0.4	1
S-A-LS 20%-B	32.7	15800	7.92	1420	527	1.89	20.9	546	0.2	1
S-A-LS 40% A	41	17200	11.9	1680	664	2.03	23.6	824	0.4	1
S-A-LS 40% B	41.1	17500	8.84	1700	678	1.91	22.3	719	0.4	1
S-A-LS 40% B (Dup)	48.2	19000	12.9	2120	636	2.43	26.1	704	0.3	1
S-A-LS 60% A	87.7	16300	13.6	2510	738	1.96	394	1120	0.4	1
S-A-LS 60% B	40.5	17200	12.3	1770	754	2.14	25.4	1050	0.3	1
S-A-LS 80% A	33.3	15300	10.3	2010	590	1.89	22.2	925	0.3	1
S-A-LS 80% B	41.2	14700	10.9	1780	493	2.26	26.2	933	0.4	1
S-A-LS 80% A (Dup)	37.3	15700	10.3	1700	699	1.61	20.5	948	0.3	1
S-A-LS 100% A	38.6	15100	17.5	2080	368	2.19	22.3	578	0.5	1
S-A-LS 120% A	42.9	16700	8.68	1580	498	2.2	57.2	656	0.2	1
S-A-LS 120% B	44.7	18200	9.42	1500	546	2.58	31.5	668	0.3	1
S-A-1-0-1	46.6	20100	9.49	2640	481	2.57	26.5	484	0.1	1
S-A-1-1-3	45.6	19400	6.85	2490	472	2.51	25.6	462	0.2	1
S-A-1-3-5	47.3	19200	9.55	1910	647	2.32	29.9	689	0.3	1
S-A-2-0-1	80.8	15500	10.7	1240	444	2.16	23.1	511	0.2	1
S-A-2-1-3	55.7	18400	9.66	1230	459	2.41	24.4	545	0.2	1
S-A-2-3-5	51.5	17400	15.7	1480	570	2.8	28.8	932	0.3	1
S-GR-5M-A	779	18700	404	10700	850	1.46	50.4	1270	0.3	1
S-GR-5M-B	318	17300	261	10800	741	1.37	48.1	1820	0.3	1
S-GR-10M-A	295	20400	191	11900	911	1.98	58.6	1650	0.3	1
S-GR-10M-B	182	20100	133	11700	937	1.17	52.6	1500	0.2	1
S-GR-15M-A	161	21300	114	11800	1140	1.2	53.1	1280	0.2	1
S-GR-15M-B	199	20200	84	9100	978	0.98	50.5	1220	0.2	1
S-GR-15M-B (Dup)	154	22100	83.3	11100	1060	1.12	51.9	1250	0.1	1
S-GR-20M-A	120	17000	68.3	9310	907	1	48.2	1060	0.1	1
S-GR-20M-B	167	20900	80.5	11600	917	1.25	59.4	1260	0.2	1
S-GR-25M-A	174	20900	78.3	10800	907	1.14	59.3	1580	0.2	1
S-GR-25M-B	194	18900	75.6	9280	750	0.99	49.2	1410	0.2	1
S-GR-25M-B (Dup)	176	18500	60.5	7740	701	1.15	48.1	1210	0.2	1
S-GR-30M-A	156	18300	106	8780	769	1.1	54.9	1600	0.2	1
S-GR-30M-B	153	17500	71.8	7810	778	0.86	49.9	1340	0.3	1
S-GR-35M-A	93.6	19300	72.8	7640	756	1.19	49.2	1670	0.2	1
S-GR-35M-B	93.3	19100	58.3	5590	602	1.34	39.1	932	0.1	1
S-GR-HS-57538E 18001N	105	15200	24.6	3160	604	1.02	24.5	729	0.1	1
S-C-LS 20% A	21.2	17500	9.65	2510	922	1.71	20.7	869	0.3	1
S-C-LS 20% B	16.5	17500	15.5	4630	1280	1.2	19.1	1510	0.6	1

(Sheet 2 of 5)

**Table 3-13b (Continued)**

Sample	Cu	Fe	Pb	Mg	Mn	Mo	Ni	K	Se	Ag
	ppm (mg/kg)									
S-C-LS 40% A	27	19700	18.1	3890	1470	1.35	21.8	1530	0.6	1
S-C-LS 40% B	19.3	18600	18.7	4280	1450	1.23	21.3	1760	0.7	1
S-C-LS 40% A (Dup)	22.6	18900	18.9	4120	1430	1.39	23.2	1620	0.7	1
S-C-LS 60% A	14.5	16100	15.1	3010	1260	1.07	18.9	1300	0.6	1
S-C-LS 60% B	20.7	19400	19.1	4250	1650	1.28	22.7	1970	0.8	1
S-C-LS 80% A	20.5	18400	11.9	2430	1080	1.53	20.7	1080	0.5	1
S-C-LS 80% B	16.6	17400	13.8	4440	1340	1.15	19.6	1440	0.5	1
S-C-LS 80% B (Dup)	22.9	18500	16.6	4690	1430	1.29	21.1	1490	0.6	1
S-C-LS 100% A	5.1	10300	8.2	1540	709	0.62	9.5	716	0.3	1
S-C-LS 100% B	17.8	19500	15.5	4060	1780	1.26	23.9	1360	0.7	1
S-C-LS 120% A	8	11500	9.72	1860	968	0.63	12.3	866	0.4	1
S-C-LS 120% B	11.1	12500	14.2	1940	1060	0.75	13.2	1190	0.4	1
S-C-1-0-1	28.8	23600	13.2	12000	1240	2.22	34.1	1180	0.5	1
S-C-1-1-3	26.4	22400	12.4	15100	1090	2.03	33.7	1100	0.5	1
S-C-1-3-5	41.1	20600	15.2	8540	1370	1.56	28.8	1550	0.7	1
S-C-2-0-1	5.4	10700	4.27	1380	479	0.69	9	451	0.2	1
S-C-2-1-3	7.3	12100	7.85	1680	827	0.81	10.6	880	0.4	1
S-C-2-3-5	10.9	13200	15.2	2030	897	0.87	12.1	1350	0.4	1
S-C-3-0-1	29.7	19500	13.3	4880	940	2.23	27.9	1050	0.5	1
S-C-3-1-3	19.7	16500	8.8	3250	817	1.44	19.5	888	0.5	1
S-C-3-3-5	13.5	14900	11.4	2780	1040	1.19	18.6	1170	0.6	1
S-C-HS 65235E 02908N	10.8	14500	16.8	2260	698	0.97	13.4	1540	0.5	1
S-C-HS 65266E 02930N	18.8	14200	22.8	2610	1090	1.25	15.8	1780	0.6	1
S-C-HS 66040E 02939N	21.3	11700	24	2420	747	1.33	17.4	1450	0.4	1
S-C-HS 66017E 02566N	31.2	17100	20.1	17100	1160	2.14	36.4	2320	0.8	1
S-C-HS 65011E 02663N	26.5	17500	181	3030	974	1.37	19.3	1740	0.7	1
S-C-HS 63025E 02811N	16.6	14700	16.5	2130	518	1.71	16.8	433	0.2	1
S-C-HS 68010 02265N	12.2	11800	17.8	2360	1050	0.74	13	1710	0.6	1
S-RIF1-1-3	30.2	13400	32.4	1340	286	1.67	19.2	366	0.1	1
S-RIF1-4-6	99	14500	1830	1840	322	1.86	23.8	393	0.1	1
S-RIF1-7-9	116	16800	288	2250	382	2.05	23.7	403	0.1	1
S-RIF1-10-12	184	13500	1920	1860	321	1.65	20.6	357	0.1	1
S-RIF1-10-12 (Dup)	94.2	13500	738	2090	349	1.74	19.8	344	0.1	1
S-RIF1-13-15	123	13700	1250	1720	333	1.75	20.3	360	0.1	1
S-RIF1-16-18	192	13400	1740	1670	323	1.66	18.7	352	0.1	1
S-RIF1-19-21	626	12400	954	1510	310	1.48	16.6	380	0.2	1
S-RIF1-19-21 (Dup)	256	13000	1700	5200	323	1.63	17.6	364	0.1	1
S-RIF1-22-24	127	14100	2940	2130	353	1.74	19.3	405	0.2	1
S-RIF1-T24	48.4	14000	1130	2010	377	1.77	19.5	377	0.1	1
S-RIF1-T16	69	14500	533	1870	407	1.68	24.9	542	0.1	1
S-RIF1-T12	472	13500	4610	4240	396	1.49	23.9	632	0.2	1
S-RIF1-T6	225	15900	1270	2420	417	1.84	21.8	402	0.1	1
S-RIF2-25-27	2730	14500	37500	2250	378	2.2	38.7	515	0.2	1
S-RIF2-28-30	4330	11800	44000	1710	380	2.06	28.5	462	0.3	1

(Sheet 3 of 5)

**Table 3-13b (Continued)**

Sample	Cu	Fe	Pb	Mg	Mn	Mo	Ni	K	Se	Ag
	ppm (mg/kg)									
S-RIF2-31-33	3190	12100	32300	2110	443	1.76	24.3	521	0.3	1
S-RIF2-34-36	4190	14800	45000	2540	502	2.27	32.7	834	0.4	1
S-RIF2-37-39	3110	14500	31300	2740	489	1.58	46	894	0.3	1
S-RIF2-37-39 (Dup)	3120	13900	30900	2530	508	1.51	43.4	801	0.4	1
S-RIF2-40-42	1320	15700	10400	2650	714	1.43	38.4	1110	0.4	1
S-RIF2-43-45	2530	15200	4050	2690	730	1.31	49.9	1190	0.5	1
S-RIF2-46-48	7260	16600	7380	3410	467	1.74	107	865	0.4	1
S-RIF2-46-48 (Dup)	2780	13900	2220	2480	665	0.98	55.4	1180	0.3	1
S-RIF2-T28	1550	12000	12400	3810	442	0.87	40.4	488	0.1	1
S-RIF2-T34	673	12700	2990	1980	440	1.2	32.2	357	0.2	1
S-RIF2-T40	232	12600	512	2330	449	0.86	21.4	376	0.2	1
S-RIF2-T46	213	16500	1430	4970	786	1.12	30.7	1710	0.7	1
S-RIF4-1-3	1860	11400	28300	1710	402	1.19	30.9	504	0.3	1
S-RIF4-4-6	2570	11800	28400	1800	425	1.4	22.8	573	0.3	1
S-RIF4-7-9	3820	11100	31000	1770	387	1.47	28	530	0.2	1
S-RIF4-10-12	3510	11600	25600	1830	405	1.3	21.1	565	0.2	1
S-RIF4-T4	3740	15100	25700	2310	407	1.28	159	470	0.3	1
S-RIF4-T9	7620	16700	13500	2350	470	1.98	183	445	0.4	1
S-KE-0-3	4200	16400	6840	3700	520	1.36	50.6	1000	0.3	1
S-KE-BU-1	1360	12800	1240	2190	361	1.24	24.4	416	0.1	1
S-KE-BU-2	747	13300	372	1120	349	1.52	20.2	354	0.1	1
S-KE-BU-3	1230	13600	283	1100	314	1.64	19.8	316	0.1	1
S-KE-BU-4	2660	11700	449	1370	322	1.27	17.1	348	0.1	1
S-D-HS-74210E 01267N	32	15400	27.7	3650	930	1.07	18.2	1260	0.4	1
S-D-HS-74326E 01195N	27.2	13300	19.4	1780	689	1.16	14.8	803	0.3	1
S-D-HS-74215E 01278N	39.3	16400	56.6	3380	771	1.7	22	820	0.4	1
S-D-1-0-1	137	15200	241	1510	531	2.25	19.3	395	0.2	1
S-D-1-1-3	101	11700	167	1240	468	1.29	13.5	314	0.2	1
S-D-1-3-5	99.1	17200	219	1300	542	2.38	22.8	436	0.2	1
S-D-2-0-1	95.4	19600	95.6	1250	516	2.81	24.3	302	0.2	1
S-D-2-1-3	95.2	17800	114	1620	559	2.9	25.6	446	0.2	1
S-D-2-3-5	63.9	14100	240	1420	535	1.51	16.4	426	0.1	1
S-E-HS-63240E 15109N	56.7	11100	268	1310	246	1.04	12.4	387	0.1	1
S-E-HS-63240E 15109N	13	9450	42.2	1470	477	.5	9.3	806	0.1	1
S-E-1-0-1	61.5	10200	308	1280	231	0.71	10.8	428	0.1	1
S-E-1-1-3	16.5	10800	24.4	1060	251	0.97	12.4	431	0.1	1
S-E-1-3-5	103	10400	302	1360	261	0.71	10.9	538	0.1	1
S-E-2-0-1	79.6	11500	476	1200	263	0.9	12.8	366	0.1	1
S-E-2-1-3	106	11000	471	1140	233	0.97	12.8	334	0.1	1
S-E-2-3-5	82.3	10500	103	1120	236	0.82	11.9	377	0.1	1
S-ASA-HS-51508E 15705N	55.9	21300	61	5260	1260	1.71	25.7	1420	0.4	1
S-ASA-HS-51501E 15688N	46.5	28200	24.2	8010	1550	2.51	35.1	1130	0.2	1
S-ASA-HS-51488E 15697N	45.8	24000	23	9230	1270	2.83	37.6	1420	0.4	1

(Sheet 4 of 5)

**Table 3-13b (Concluded)**

Sample	Cu	Fe	Pb	Mg	Mn	Mo	Ni	K	Se	Ag
	ppm (mg/kg)									
S-ASA-I-5	59.7	28700	75.1	12100	1730	3.02	41.1	1770	0.3	1
S-ASA-I-10	55.7	29700	47.9	7200	1820	2.38	41.9	1760	0.5	1
S-ASA-I-15	49.7	28500	32.8	7900	1480	2.61	38.1	1360	0.4	1
S-ASA-I-20	57.4	34500	45.8	8810	1980	2.84	48	1960	0.5	1
S-ASA-I-25	49.7	30800	26.6	10300	1760	2.79	43.2	1660	0.5	1
S-ASA-I-30	39.9	25900	25	8080	1650	2.76	34.8	1640	0.5	1

Color shown only in electronic version of this report:

Values in red: Results over the mean value added to twice the standard deviation are highlighted in red bold fonts

Values in blue: Results over the CCME threshold value for agricultural soils are highlighted in blue bold fonts

(Sheet 5 of 5)

**Table 3-13c  
Metals Concentrations in Soils (Na to Zn)**

Sample	Na	Sr	Ti	Sn	Tl	U	V	Zn
	ppm (mg/kg)							
S-BG-69940E 18340N	36	22.9	0.2	4	151	0.543	10.6	31
S-BG-52660E 22764N	198	60.4	0.2	4	115	0.521	10.7	59
S-BG-80356E 06945N	42	21	0.2	4	159	0.965	15.3	113
S-BG-57997E 20636N	151	36.2	0.2	4	169	0.611	15.4	27
S-BG-65629E 17392N	109	64.1	0.3	4	117	0.492	10.8	134
S-BG-63783E 17228N	22	6.65	0.2	4	108	0.418	9.38	15
S-BG-78159E 99759N	56	22	0.2	4	110	0.662	9.55	10
S-BG-62630E 18054N	33	9.98	0.2	4	130	0.457	11	29
S-BG-79182E 00111N	51	23.8	0.2	4	126	0.811	11.9	16
S-BG-74864E 14968N	33	6.02	0.2	4	132	0.422	9.39	22
S-BG-49148E 13157N	451	61.9	0.2	4	206	0.988	18.9	83
S-BG-49148E 13157N (Dup)	55	20.8	0.2	4	196	0.908	19.7	69
S-BG-55265E 11847N	106	16.5	0.2	4	155	0.571	12.3	41
S-BG-74864E 14968N (Dup)	27	5.82	0.2	4	119	0.361	8.73	15
S-BG-55255E 09752N	70	19.8	0.2	4	165	0.704	12.8	38
S-BG-53656E 11283N	102	26.6	0.2	4	221	0.811	17.2	44
S-BG-80720E 05003N	67	34.7	0.2	4	114	0.804	10.7	14
S-BG-53670E 13403N	78	18.2	0.2	4	181	0.689	15.5	48
S-BG-67858E 90938N	42	12.3	0.2	4	147	0.884	12.3	56
S-BG-68067E 97960N	52	19.5	0.2	4	182	0.903	17.8	87
S-BG-69431E 98407N	41	17.3	0.2	4	173	1.21	18.3	78
S-BG-63565E 00626N	38	19.5	0.2	4	167	1.2	17.5	102
S-BG-62033E 01742N	44	21.2	0.2	4	180	1.02	18.7	82
<b>Mean Value</b>	83	24.7	0.2	4	153	0.737	13.67	53
<b>Standard Deviation</b>	54	11.8	0.0	0	27	0.208	3.27	29
S-A-HS-60021E 12160N	54	14.3	0.2	4	149	0.489	11.5	55
S-A-HS-60042E 12060N	735	47.7	0.2	4	183	1.03	13.8	104
S-A-LS 20%-A	26	16.1	0.2	4	142	0.589	12	67
S-A-LS 20%-B	20	10.1	0.2	4	130	0.473	10.7	36

(Sheet 1 of 4)



**Table 3-13c (Continued)**

Sample	Na	Sr	Tl	Sn	Ti	U	V	Zn
	ppm (mg/Kg)							
S-A-LS 40% A	48	14.6	0.2	4	163	0.583	13.4	143
S-A-LS 40% B	53	12	0.2	4	160	0.516	12.8	66
S-A-LS 40% B (Dup)	66	16.6	0.2	4	164	0.576	13.6	54
S-A-LS 60% A	148	20.6	0.2	4	144	0.642	13.3	63
S-A-LS 60% B	56	17.3	0.2	4	145	0.529	12.5	66
S-A-LS 80% A	58	14.2	0.2	4	155	0.515	13.3	47
S-A-LS 80% B	60	15.5	0.2	4	170	0.57	13.5	48
S-A-LS 80% A (Dup)	50	13.9	0.2	4	151	0.528	12.6	55
S-A-LS 100% A	67	21.4	0.2	4	133	0.569	10.3	39
S-A-LS 120% A	68	13.9	0.2	4	119	0.464	10.4	36
S-A-LS 120% B	54	14.1	0.2	4	133	0.565	11.6	40
S-A-1-0-1	65	19.6	0.2	4	137	0.39	11.2	29
S-A-1-1-3	61	17.2	0.2	4	147	0.473	11.5	23
S-A-1-3-5	55	15.1	0.2	4	154	0.599	12.4	37
S-A-2-0-1	53	8.93	0.2	4	120	0.433	9.94	50
S-A-2-1-3	76	8.15	0.2	4	136	0.371	11.3	55
S-A-2-3-5	57	14.3	0.2	4	158	0.484	13.1	53
S-GR-5M-A	81	28.2	0.2	4	216	0.732	17.4	1590
S-GR-5M-B	96	38.6	0.2	4	233	0.867	21.6	1380
S-GR-10M-A	105	40.9	0.2	4	227	0.78	19.3	1840
S-GR-10M-B	84	44.8	0.2	4	209	0.738	18.1	2100
S-GR-15M-A	109	36.5	0.2	4	204	0.743	17.5	2190
S-GR-15M-B	97	33.7	0.2	4	188	0.638	16.7	2020
S-GR-15M-B (Dup)	96	39	0.2	4	227	0.786	17.1	2120
S-GR-20M-A	89	27.6	0.2	4	165	0.599	14.5	2050
S-GR-20M-B	111	35.1	0.2	4	212	0.734	17.2	2400
S-GR-25M-A	95	32.2	0.2	4	203	0.763	18.8	2220
S-GR-25M-B	86	26.9	0.2	4	183	0.679	17.1	1750
S-GR-25M-B (Dup)	87	24.3	0.2	4	161	0.618	15.5	1560
S-GR-30M-A	92	27.8	0.2	4	192	0.699	18.7	1890
S-GR-30M-B	89	24.4	0.2	4	204	0.659	17.3	1730
S-GR-35M-A	79	27	0.2	4	203	0.666	18.1	1770
S-GR-35M-B	69	17	0.2	4	210	0.585	14.4	1180
S-GR-HS-57538E 18001N	64	12.7	0.2	4	149	0.538	13.4	622
S-C-LS 20% A	48	16.5	0.2	4	153	0.82	14.8	47
S-C-LS 20% B	50	22.1	0.2	4	155	0.876	16.6	73
S-C-LS 40% A	37	18.9	0.2	4	174	1.03	18.4	82
S-C-LS 40% B	57	22.4	0.2	4	175	1.1	18.8	88
S-C-LS 40% A (Dup)	44	20.2	0.2	4	174	1.01	17.8	84
S-C-LS 60% A	32	19.1	0.2	4	164	1.01	16.1	70
S-C-LS 60% B	36	22.4	0.3	4	161	1.12	19.2	104
S-C-LS 80% A	29	15.1	0.2	4	150	0.88	14.7	55
S-C-LS 80% B	40	18.7	0.2	4	161	0.949	16	74
S-C-LS 80% B (Dup)	50	21.6	0.2	4	173	1.05	17.5	88

(Sheet 2 of 4)

**Table 3-13c (Continued)**

Sample	Na	Sr	Tl	Sn	Tl	U	V	Zn
	ppm (mg/kg)							
S-C-LS 100% A	22	13.3	0.2	4	123	0.787	11.2	43
S-C-LS 100% B	49	21.8	0.2	4	178	0.98	17.7	90
S-C-LS 120% A	30	13.3	0.2	4	142	0.749	12.1	49
S-C-LS 120% B	33	18.9	0.2	4	162	0.869	14.2	81
S-C-1-0-1	48	29.1	0.3	4	173	1.31	18.7	54
S-C-1-1-3	60	31.8	0.3	4	177	1.39	20.2	49
S-C-1-3-5	44	25.2	0.3	4	191	1.29	21.5	75
S-C-2-0-1	14	6.77	0.2	4	125	0.612	10.8	24
S-C-2-1-3	28	13.4	0.2	4	156	0.821	13.3	58
S-C-2-3-5	40	16.7	0.2	4	179	0.844	15.5	72
S-C-3-0-1	46	17.9	0.2	4	188	0.976	18.2	64
S-C-3-1-3	34	14.1	0.2	4	168	0.887	16	49
S-C-3-3-5	45	16.2	0.2	4	196	1.06	18	68
S-C-HS 65235E 02908N	45	19.4	0.2	4	200	0.998	17.1	88
S-C-HS 65266E 02930N	45	23.6	0.2	4	189	0.948	17.5	111
S-C-HS 66040E 02939N	43	20.8	0.2	4	186	0.858	16.6	132
S-C-HS 66017E 02566N	77	36.2	0.3	4	236	1.29	23.9	104
S-C-HS 65011E 02663N	35	7.98	0.3	4	204	1.18	21.7	4970
S-C-HS 63025E 02811N	33	15.5	0.2	4	137	0.737	12.1	467
S-C-HS 68010 02265N	27	18.4	0.2	4	169	0.79	13.9	139
S-RIF1-1-3	79	10.3	0.2	4	96.8	0.281	8.77	18
S-RIF1-4-6	84	12.1	0.2	4	101	0.318	9.46	27
S-RIF1-7-9	93	13.7	0.2	4	106	0.306	9.89	29
S-RIF1-10-12	75	11.9	0.2	4	89.7	0.281	8.36	35
S-RIF1-10-12 (Dup)	78	12.7	0.2	4	94.3	0.282	8.47	25
S-RIF1-13-15	77	11.5	0.2	4	101	0.309	8.95	30
S-RIF1-16-18	75	10.9	0.2	4	97.2	0.298	8.79	35
S-RIF1-19-21	78	10.2	0.2	4	93.4	0.358	8.58	82
S-RIF1-19-21 (Dup)	76	11.8	0.2	4	90.5	0.309	8.42	41
S-RIF1-22-24	78	11.7	0.2	4	98.1	0.314	8.97	33
S-RIF1-T24	82	13.1	0.2	4	103	0.324	8.95	22
S-RIF1-T16	76	11.7	0.2	4	117	0.409	10.4	31
S-RIF1-T12	75	57.6	0.2	4	121	0.515	12.4	80
S-RIF1-T6	75	18.2	0.2	4	102	0.362	9.6	41
S-RIF2-25-27	74	38.5	0.2	10	79.8	0.368	9.83	281
S-RIF2-28-30	72	88.2	0.2	11	76.4	0.352	9.28	477
S-RIF2-31-33	67	54.1	0.2	7	101	0.423	10.8	343
S-RIF2-34-36	47	53.6	0.3	5	120	0.567	13.6	436
S-RIF2-37-39	50	35.6	0.3	4	129	0.609	14.6	319
S-RIF2-37-39 (Dup)	54	31.4	0.3	4	121	0.552	13.4	324
S-RIF2-40-42	39	17	0.2	4	153	0.732	16.9	171
S-RIF2-43-45	41	16.7	0.2	4	167	0.743	17.8	262
S-RIF2-46-48	77	22.1	0.2	4	147	0.588	14.7	659
S-RIF2-46-48 (Dup)	19	13.7	0.2	4	149	0.653	16.4	285

(Sheet 3 of 4)

**Table 3-13c (Concluded)**

Sample	Na	Sr	Tl	Sn	Ti	U	V	Zn
	ppm (mg/kg)							
S-RIF2-T28	54	20.2	0.2	4	134	0.551	11.2	195
S-RIF2-T34	47	10	0.2	4	134	0.407	9.96	84
S-RIF2-T40	35	10.3	0.2	4	130	0.462	10.9	49
S-RIF2-T46	42	23.9	0.3	4	168	0.952	26.6	83
S-RIF4-1-3	45	26.3	0.2	11	112	0.425	9.74	198
S-RIF4-4-6	47	32.1	0.2	11	119	0.456	10.3	283
S-RIF4-7-9	49	33.3	0.2	14	99.3	0.406	9.54	400
S-RIF4-10-12	44	20.4	0.2	8	110	0.457	10.1	365
S-RIF4-T4	58	16.7	0.4	4	116	0.531	10.5	310
S-RIF4-T9	55	17.8	0.2	4	120	0.518	11.5	683
S-KE-0-3	103	21.5	0.2	4	158	0.654	15.4	425
S-KE-BU-1	42	11.9	0.2	4	116	0.424	10.2	164
S-KE-BU-2	36	9.89	0.2	4	110	0.391	9.4	93
S-KE-BU-3	33	11.6	0.2	4	110	0.426	9.39	137
S-KE-BU-4	37	10.6	0.2	4	107	0.36	8.6	281
S-D-HS-74210E 01267N	51	25.3	0.2	4	180	0.829	15.8	76
S-D-HS-74326E 01195N	54	19.5	0.2	4	136	0.665	11.5	46
S-D-HS-74215E 01278N	48	22.4	0.2	4	151	0.771	13.6	51
S-D-1-0-1	62	139	0.2	4	105	0.514	8.81	45
S-D-1-1-3	56	53.4	0.2	4	99.2	0.481	8.5	40
S-D-1-3-5	57	33.6	0.2	4	112	0.519	10.6	46
S-D-2-0-1	52	50.4	0.2	4	104	0.562	10.4	32
S-D-2-1-3	58	41.7	0.2	4	105	0.647	12.9	38
S-D-2-3-5	48	37.9	0.2	4	104	0.657	11.5	33
S-E-HS-63240E 15109N	56	28.2	0.2	4	96.7	0.431	10.5	44
S-E-HS-63240E 15109N	28	15.8	0.2	4	114	0.534	12.3	48
S-E-1-0-1	37	21.1	0.2	4	102	0.424	11.8	33
S-E-1-1-3	20	7.02	0.2	4	96.9	0.38	10.2	21
S-E-1-3-5	35	27.4	0.2	4	104	0.542	12.1	39
S-E-2-0-1	38	19.3	0.2	4	101	0.457	11.7	33
S-E-2-1-3	32	16.3	0.2	4	91.2	0.519	11.1	28
S-E-2-3-5	23	13.3	0.2	4	98.8	0.409	11.3	26
S-ASA-HS-51508E 15705N	95	31	0.2	4	188	0.87	21	495
S-ASA-HS-51501E 15688N	103	26.7	0.2	4	212	0.802	21.7	368
S-ASA-HS-51488E 15697N	92	27	0.2	4	210	0.877	23.4	243
S-ASA-I-5	89	56.8	0.2	4	235	0.956	23.7	118
S-ASA-I-10	89	36.2	0.3	4	215	1.06	28.9	152
S-ASA-I-15	85	31.6	0.2	4	191	0.875	23.4	115
S-ASA-I-20	95	32.4	0.3	4	236	1.16	32.4	179
S-ASA-I-25	81	27.9	0.2	4	230	1.02	28.3	160
S-ASA-I-30	80	27.8	0.2	4	207	1	25.2	164

Color shown only in electronic version of this report:  
 Values in red: Results over the mean value added to twice the standard deviation are highlighted in red bold fonts  
 Values in blue: Results over the CCME threshold value for agricultural soils are highlighted in blue bold fonts

(Sheet 4 of 4)

Sample	pH	Cation Exchange Capacity meq/100g	Carbon Organic %	Sand SSK	Total Inorganic Nitrogen	Silt SSK	Clay SSK
S-A-LS 20%-B	7	4.6	0.7	91	1.4	2	7
S-A-LS 40% A	7.2	7.1	1.7	88	2.2	6	7
S-A-LS 80% B	7.2	4.3	0.8	90	4.4	6	5
S-A-LS 100% A	7.3	7.1	1	90	3.2	4	6
S-A-1-0-1	8.1	2.9	0.4	92	2.8	3	5
S-A-2-1-3	7.4	6	1	88	2.8	5	7
S-C-LS 20% B	7.6	9.1	2	85	2	8	7
S-C-LS 40% A	7.6	11.4	1.6	80	1.6	12	9
S-C-LS 40% A (Dup)	7.5	10.5	1.1	54	1.6	35	11
S-C-LS 80% B	7.7	8	1.6	84	1.8	9	7
S-C-LS 80% B (Dup)	7.7	8.3	1.3	84	1.8	10	6
S-C-LS 100% A	7.3	4.6	0.7	92	1.2	3	5
S-C-1-0-1	8.1	5.4	0.8	90	1.6	3	8
S-C-2-1-3	6.8	6.6	1.3	88	1.8	6	6
S-C-3-3-5	7.4	8.6	1.3	86	1.6	8	6

Sample	Al	As	Sb	Ba	Be	Cd	Ca	Cr	Co
	ppm (mg/kg)								
B-BG-69940E 18340N	637	0.35	0.06	53.7	0.05	0.18	6090	16.7	0.66
B-BG-52660E 22764N	252	0.17	0.06	47.4	0.05	0.05	4520	15.2	0.31
B-BG-80356E 06945N	78	0.05	0.06	69.1	0.05	0.04	7460	9.6	0.12
B-BG-63783E 17228N	164	0.12	0.06	42.3	0.05	0.04	4870	11	0.19
B-BG-62630E 18054N	320	0.19	0.06	51.2	0.05	0.04	4550	12.7	0.3
B-BG-74864E 14968N	160	0.11	0.14	65.6	0.05	0.12	5080	6.9	0.17
B-BG-74864E 14968N (Dup)	46	0.05	0.06	33.4	0.05	0.13	4310	3	0.08
B-BG-79148E 13157N	152	0.11	0.06	39.9	0.05	0.07	6200	10.2	0.37
B-BG-55265E 11847N	162	0.11	0.06	18.1	0.05	0.16	5910	12	0.21
B-BG-55255E 09752N	519	0.27	0.06	33.9	0.05	0.05	5840	17	0.47
B-BG-53656E 11283N	131	0.05	0.06	29.1	0.05	0.03	5350	8.3	0.19
B-BG-80720E 05003N	5	0.11	0.06	29.1	0.05	0.02	3890	11.7	0.17
B-BG-53670E 13403N	13	0.32	0.06	34.5	0.05	0.06	4220	1.5	0.34

(Sheet 1 of 3)

**Table 3-14a (Continued)**

Sample	Al	As	Sb	Ba	Be	Cd	Ca	Cr	Co
	ppm (mg/kg)								
B-BG-67858E 98938N	86	0.05	0.06	25	0.05	0.09	6290	10.6	0.13
B-BG-68067E 97960N	104	0.13	0.06	24.4	0.05	0.05	6830	4.6	0.1
B-BG-69431E 98407N	251	0.17	0.06	27.3	0.05	0.40	5910	12.7	0.19
B-BG-63565E 00626N	3	0.07	0.06	20.2	0.05	0.03	3500	2.4	0.04
B-BG-62033E 01742N	3	0.07	0.12	26.1	0.05	0.03	7770	3	0.07
<b>Mean Value</b>	<b>171</b>	<b>0.14</b>	<b>0.07</b>	<b>37.2</b>	<b>0.05</b>	<b>0.09</b>	<b>5477</b>	<b>9.4</b>	<b>0.23</b>
<b>Standard Deviation</b>	<b>125</b>	<b>0.07</b>	<b>0.01</b>	<b>12.1</b>	<b>0.00</b>	<b>0.06</b>	<b>1001</b>	<b>4.0</b>	<b>0.12</b>
B-RIF1-1-6	309	0.34	7.26	36.5	0.05	0.08	7950	17	0.36
B-RIF1-7-12	466	0.57	17.3	37.9	0.05	0.05	7480	10.2	0.38
B-RIF1-13-18	174	0.22	7.95	43.4	0.05	0.08	8220	5.2	0.16
B-RIF1-19-24	162	0.18	7.38	43.5	0.05	0.05	7200	5.8	0.18
B-RIF2-25-30	124	0.21	10.8	29.9	0.05	0.02	7630	3.7	0.18
B-RIF2-31-36	246	0.38	17.9	31.7	0.05	0.04	5910	9.8	0.31
B-RIF2-37-42	252	0.4	19.6	34.7	0.05	0.04	5550	9	0.23
B-RIF2-43-48	166	0.15	0.95	29	0.05	0.03	5540	5.7	0.14
B-RIF2-37-42 (Dup)	222	0.28	9.82	37.2	0.05	0.05	7000	5.3	0.21
B-RIF4-1-6	73	0.11	2.56	36.7	0.05	0.05	7870	4.6	0.16
B-RIF4-7-12	56	0.06	1.23	31.6	0.05	0.02	4450	2.6	0.08
B-C-1-0-3	276	0.32	0.06	35.3	0.05	0.04	5440	12.9	0.33
B-C-1-3-5	256	0.2	0.06	32.7	0.05	0.07	5010	10.1	0.28
B-C-2-0-3	151	0.11	0.11	53.1	0.05	0.2	5630	10	0.25
B-C-2-3-5	108	0.07	0.06	51.2	0.05	0.15	5120	7.8	0.15
B-C-3-0-3	95	0.08	0.06	17.4	0.05	0.08	5590	5.4	0.1
B-C-3-3-5	245	0.13	0.06	32.7	0.05	0.09	5250	8.1	0.22
B-KE-1-0-3	144	0.08	0.06	43	0.05	0.27	8100	2.2	0.06
B-KE-BU-1	192	0.09	0.06	50.2	0.05	0.13	8570	18	0.25
B-KE-BU-2	123	0.14	0.26	48.5	0.05	0.08	6710	2	0.11
B-D-1-0-3	54	0.07	0.15	67.3	0.05	0.05	15500	9	4.63
B-D-1-3-5	132	0.07	0.1	19.3	0.05	0.1	9880	25.3	0.62
B-D-2-0-3	64	0.11	0.06	61.2	0.05	0.23	14600	7.1	3.56
B-D-2-3-5	71	0.05	0.06	18.5	0.05	0.08	13600	0.1	0.25
B-E-1-0-3	139	0.14	0.38	55.8	0.05	0.21	11700	6.8	0.38
B-E-1-3-5	152	0.12	0.23	83.9	0.05	0.23	9840	3.8	0.33
B-E-2-0-3	134	0.11	0.24	29.8	0.05	0.17	10500	6.1	0.45
B-E-2-3-5	164	0.17	0.39	39.6	0.05	0.09	6790	8.3	0.77
B-E-3-0-1 (RACINE)	2430	2.1	0.08	108	0.14	0.25	4860	46.8	2.55
B-E-3-0-3	126	0.05	0.27	112	0.05	0.09	9610	5.6	0.16
B-E-3-3-5	180	0.08	0.06	101	0.05	0.05	6440	10.2	0.36
B-E-4-0-3	172	0.08	0.06	66.9	0.05	0.06	7710	12.8	0.46
B-E-4-3-5	172	0.09	0.06	90.6	0.05	0.06	8020	20.1	0.57
B-E-HS-63240E 15109N	83	0.09	0.06	52.8	0.05	0.23	7740	3.2	0.19
B-E-HS-63240E 15109N	90	0.05	0.06	77.9	0.05	0.09	6670	5.3	0.26
B-E-HS-64435E 14486N	222	0.13	0.6	83.2	0.05	0.16	6780	12.8	0.31
B-E-HS-64435E 14486N (Dup)	125	0.09	0.06	124	0.05	0.05	8070	7.3	0.31

(Sheet 2 of 3)

**Table 3-14a (Concluded)**

Sample	Al	As	Sb	Ba	Be	Cd	Ca	Cr	Co
	ppm (mg/kg)								
B-A-1-0-3	156	0.08	0.25	26.8	0.05	0.2	4760	5	0.25
B-A-1-3-5	145	0.05	0.06	23.7	0.05	0.26	5080	6.2	0.31
B-A-2-0-3	122	0.05	0.06	38.6	0.05	0.22	6350	1.9	0.28
B-A-2-3-5	67	0.05	0.1	44.9	0.05	0.21	7390	6.9	0.23
B-ASA-51508E 15705N	164	0.18	0.06	45.8	0.05	1.74	6030	16.3	0.27
B-ASA-51501E 15688N	868	0.58	0.06	49.2	0.05	1.07	6970	41.7	0.79
B-ASA-51488E 15697N	337	0.47	0.06	33.8	0.05	0.78	5630	11.1	0.52
B-ASA-I-0-15M	330	0.26	0.06	39	0.05	0.08	5450	4.2	0.21
B-ASA-I-15-30M	670	0.5	0.06	43.3	0.05	0.09	6580	13	0.28

Color shown only in electronic version of this report  
 Values in red: Results higher than the mean values added to twice the standard deviation.

(Sheet 3 of 3)

**Table 3-14b  
Metals Concentrations in Biomass Samples (Cu to K)**

Sample	Cu	Fe	Pb	Mg	Mn	Mo	Ni	P	K
	ppm (mg/kg)								
B-BG-6994DE 18340N	2.4	1220	0.61	1920	110	3.06	8.6	2210	10900
B-BG-52660E 22764N	1.4	463	0.54	1910	46.8	0.44	7.4	1390	12300
B-BG-80356E 06945N	1.9	135	0.26	1530	59.8	0.66	3.8	1250	6380
B-BG-63783E 17228N	1.8	349	0.33	1070	57.9	3.05	4.3	1390	7370
B-BG-62630E 18054N	1.6	650	0.72	724	67.7	1.03	6.2	857	3180
B-BG-74864E 14968N	8.8	366	0.66	1500	116	1.28	12.4	1610	11500
B-BG-79148E 13157N	15.8	270	0.23	1400	70.9	1.78	29.7	2040	7690
B-BG-55265E 11847N	2.7	351	0.36	1940	121	3.96	6.1	1340	10100
B-BG-74864E 14968N (Dup)	1.3	49	0.17	1330	93.5	0.66	1.2	956	9550
B-BG-55255E 09752N	1.7	1180	0.64	1380	180	2.72	7.9	828	2680
B-BG-53656E 11283N	4.7	176	0.21	1030	44	2.16	4.8	1270	4520
B-BG-80720E 05003N	0.1	5	0.23	611	3.9	0.15	6.1	190	3590
B-BG-53670E 13403N	1.4	5	0.79	950	22	0.02	3.5	5	1540
B-BG-67858E 98938N	2	137	0.2	1110	44.8	1.31	4.5	1100	5820
B-BG-68067E 97960N	1.8	156	0.46	1010	53.3	0.67	1.6	751	5580
B-BG-69431E 98407N	2.9	255	0.74	1020	58.8	1.11	5.2	1100	7910
B-BG-63565E 00626N	0.1	5	0.47	652	9.9	0.07	0.8	109	5360
B-BG-62033E 01742N	0.1	5	0.24	1440	15.3	0.12	1.9	942	6620
<b>Mean Value</b>	2.9	321	0.44	1252	65.3	1.35	6.4	1074	6811
<b>Standard Deviation</b>	2.3	259	0.19	343	33.5	0.96	3.8	440	2537
B-RIF1-1-6	22.1	488	363	2270	83.2	4.38	8.6	1340	4820
B-RIF1-7-12	28.8	864	631	2160	74.6	3.46	5.9	1350	7570
B-RIF1-13-18	15.1	257	324	2110	58.2	3.57	3.4	1050	5580
B-RIF1-19-24	13.9	276	299	1690	68.5	3.14	3.4	861	3820
B-RIF2-25-30	18.2	221	325	2220	66.2	3.06	2.5	1540	4440
B-RIF2-31-36	33.2	443	595	1800	81.4	2.92	5.3	1020	3790
B-RIF2-37-42	47.6	437	611	1650	59.5	0.97	5	914	3190

(Continued)

**Table 3-14b (Concluded)**

Sample	Cu	Fe	Pb	Mg	Mn	Mo	Ni	P	K
	ppm (mg/kg)								
B-RIF2-43-48	4.3	243	<b>30.2</b>	1390	60.2	1.75	3	1300	3310
B-RIF2-37-42 (Dup)	<b>22.5</b>	343	<b>304</b>	1850	66.3	1.18	3.2	1250	4200
B-RIF4-1-6	5.6	121	<b>102</b>	1540	47.7	0.99	2	1310	5480
B-RIF4-7-12	6.1	101	<b>65</b>	931	45.1	0.83	1.4	926	2930
B-C-1-0-3	1.7	573	<b>1.18</b>	998	54.4	0.69	6.6	770	4360
B-C-1-3-5	1.7	476	<b>0.94</b>	763	51.8	1.18	5.1	743	3500
B-C-2-0-3	1.5	285	0.71	1150	66.2	0.7	4.9	1380	5630
B-C-2-3-5	1.7	85	<b>3.31</b>	1090	31.6	0.81	6.8	1340	6070
B-C-3-0-3	4.9	163	0.73	1220	35.5	0.72	2.9	1170	4840
B-C-3-3-5	1.9	439	<b>2.07</b>	872	55	1.15	4.1	1020	2960
B-KE-1-0-3	<b>8.9</b>	212	<b>1.05</b>	1510	55.9	0.54	1.4	<b>2120</b>	<b>15300</b>
B-KE-BU-1	6.4	364	<b>2.71</b>	1530	62.5	1.59	8	<b>2050</b>	11000
B-KE-BU-2	4	174	<b>12.9</b>	1400	44.9	0.87	1.4	1760	8710
B-D-1-0-3	5.5	113	<b>1.72</b>	<b>2930</b>	43.1	2.77	1.1	<b>2270</b>	<b>14400</b>
B-D-1-3-5	3.4	324	0.53	1700	54.3	1.02	10.5	1540	6540
B-D-2-0-3	7.2	130	0.51	<b>2290</b>	44.1	1.12	1.2	<b>3090</b>	<b>18600</b>
B-D-2-3-5	4.1	144	0.24	<b>2150</b>	48.2	0.74	1.4	1950	9270
B-E-1-0-3	<b>9.2</b>	364	<b>2.68</b>	1300	69.4	1.49	5.3	<b>1990</b>	9870
B-E-1-3-5	5.6	339	<b>1.85</b>	1650	45.5	0.81	3.5	1790	10100
B-E-2-0-3	7.4	317	<b>4.95</b>	<b>2080</b>	104	<b>4.88</b>	5.4	<b>1990</b>	5820
B-E-2-3-5	7	379	<b>3.11</b>	1100	69.1	1.61	6.1	1460	5860
B-E-3-0-1 (RACINE)	6	<b>4460</b>	<b>6.89</b>	1110	<b>259</b>	0.59	<b>28.3</b>	702	2250
B-E-3-0-3	3	212	0.4	1220	38.2	1.1	4.2	1280	8270
B-E-3-3-5	2.5	324	0.64	878	65.4	1.29	6.8	1180	4000
B-E-4-0-3	2.6	354	0.42	799	59.5	<b>3.32</b>	8.6	1470	6450
B-E-4-3-5	3.3	368	0.47	958	92.1	1.99	12.7	1540	6970
B-E-HS-63240E 15109N	5.1	183	0.23	1330	52.2	1.4	3.2	1820	10900
B-E-HS-63240E 15109N	3.3	233	0.37	1110	54.1	1.78	5	1530	7930
B-E-HS-64435E 14486N	2.3	439	0.76	966	52.7	<b>39.9</b>	7.7	1360	5060
B-E-HS-64435E 14486N (Dup)	2.4	216	0.46	891	53.8	<b>4.6</b>	5.3	1080	5460
B-A-1-0-3	2.7	267	<b>4.43</b>	635	38.7	1.25	4.2	785	2670
B-A-1-3-5	4.8	224	<b>1.08</b>	687	40.8	2.02	4.6	956	3400
B-A-2-0-3	4.9	194	0.47	1110	60.3	0.7	2.9	1740	8550
B-A-2-3-5	5.9	131	0.34	1210	45.5	1.24	2.9	1740	8300
B-ASA-51508E 15705N	1.8	303	0.44	1600	52.8	<b>6.14</b>	8.3	1630	7770
B-ASA-51501E 15688N	2.7	<b>1510</b>	<b>2.77</b>	1710	105	2.51	<b>19.5</b>	1490	4930
B-ASA-51488E 15697N	2.4	802	<b>1.77</b>	1220	124	2.63	7.2	829	2490
B-ASA-I-0-15M	2.7	616	<b>1.26</b>	1280	41.9	<b>4.03</b>	3.6	1200	4710
B-ASA-I-15-30M	3.3	<b>1440</b>	<b>1.82</b>	1840	92.3	2.36	7.5	1130	5540

Color shown only in electronic version of this report  
 Values in red: Results higher than the mean values added to twice the standard deviation are highlighted in red bold fonts.

**Table 3-14c  
Metals Concentrations in Biomass Samples (Se to Zn)**

Sample	Se	Na	Sr	Tl	Sn	Ti	V	Ag	Zn
	ppm (mg/kg)								
B-BG-6994DE 18340N	0.4	16	10.8	0.04	1	18.5	1.64	1	25.4
B-BG-52660E 22764N	0.1	31	9.85	0.04	1	5.61	0.23	1	23
B-BG-80356E 06945N	0.1	7	9.3	0.04	1	1.82	0.08	1	23.4
B-BG-63783E 17228N	0.1	7	7.49	0.04	1	5.98	0.24	1	25.6
B-BG-62630E 18054N	0.1	12	7.84	0.04	1	11.4	0.78	1	19.8
B-BG-79148E 13157N	0.2	17	8.28	0.04	1	3.48	0.36	1	31.7
B-BG-55265E 11847N	0.2	9	7.62	0.04	1	4.82	0.41	1	17.8
B-BG-74864E 14968N	0.1	13	8.33	0.04	1	3.77	0.35	1	30.9
B-BG-74864E 14968N (Dup)	0.1	6	7.02	0.04	1	2.71	0.14	1	24.8
B-BG-55255E 09752N	0.1	12	7.51	0.04	1	17.8	1.53	1	20.1
B-BG-53656E 11283N	0.1	12	8.99	0.04	1	2.58	0.18	1	32.2
B-BG-80720E 05003N	0.1	15	3.2	0.04	1	5.1	0.06	1	4.5
B-BG-53670E 13403N	0.2	13	6.36	0.04	1	16.9	0.06	1	29
B-BG-67858E 98938N	0.1	10	9.19	0.04	1	1.64	0.12	1	18.4
B-BG-68067E 97960N	0.2	10	7.83	0.04	1	2.57	0.23	1	21.5
B-BG-69431E 98407N	0.1	12	7.12	0.04	1	3.5	0.34	1	30.9
B-BG-63565E 00626N	0.1	14	3.88	0.04	1	1.9	0.06	1	2.5
B-BG-62033E 01742N	0.1	12	7.81	0.04	1	2.15	0.06	1	23.8
<b>Mean Value</b>	0.1	13	7.69	0.04	1	6.24	0.38	1	22.5
<b>Standard Deviation</b>	0.1	3	1.26	0.00	0	4.41	0.31	0	5.9
B-RIF1-1-6	0.3	13	18.9	0.04	1	8.4	0.64	1	46.2
B-RIF1-7-12	0.4	11	18.2	0.04	1	11	1.15	1	39.3
B-RIF1-13-18	0.2	8	24.9	0.04	1	4.03	0.36	1	65.3
B-RIF1-19-24	0.1	8	19.9	0.04	1	6.01	0.33	1	65.8
B-RIF2-25-30	0.2	17	22.6	0.04	1	3.1	0.27	1	37
B-RIF2-31-36	0.3	10	17.9	0.04	1	6.05	0.44	1	47.4
B-RIF2-37-42	0.2	10	13.8	0.04	1	6.83	0.56	1	57.8
B-RIF2-43-48	0.2	7	9.76	0.04	1	5.02	0.33	1	45.9
B-RIF2-37-42 (Dup)	0.2	18	14.6	0.04	1	5.79	0.52	1	55
B-RIF4-1-6	0.3	22	17.1	0.04	1	2.14	0.11	1	60.5
B-RIF4-7-12	0.2	7	10.8	0.04	1	1.46	0.11	1	46.5
B-C-1-0-3	0.1	13	6.51	0.04	1	9.1	0.59	1	21.8
B-C-1-3-5	0.1	12	5.96	0.04	1	8.95	0.53	1	17.3
B-C-2-0-3	0.1	12	10.9	0.04	1	4.52	0.21	1	28.2
B-C-2-3-5	0.1	13	10.4	0.04	1	3.47	0.14	1	31.3
B-C-3-0-3	0.1	13	6.31	0.04	1	2.81	0.11	1	16.3
B-C-3-3-5	0.2	13	7.32	0.04	1	8.03	0.52	1	21.1
B-KE-1-0-3	0.1	19	20.7	0.04	1	3.16	0.34	1	38.4

(Continued)



**Table 3-14c (Concluded)**

Sample	Se	Na	Sr	Tl	Sn	Ti	V	Ag	Zn
	ppm (mg/kg)								
B-KE-BU-1	0.1	18	22.1	0.04	1	2.68	0.3	1	30.7
B-KE-BU-2	0.1	11	13.2	0.04	1	4.48	0.28	1	26
B-D-1-0-3	0.1	23	197	0.04	1	1.43	0.06	1	27.6
B-D-1-3-5	0.1	25	13	0.04	1	4.97	0.06	1	29.7
B-D-2-0-3	0.1	33	184	0.04	1	2	0.06	1	40.9
B-D-2-3-5	0.1	22	17	0.04	1	2.33	0.16	1	25.3
B-E-1-0-3	0.1	19	45.6	0.04	1	5.16	0.25	1	29.8
B-E-1-3-5	0.1	20	28.6	0.04	1	5.99	0.29	1	34
B-E-2-0-3	0.1	27	26.4	0.04	1	4.91	0.34	1	42.9
B-E-2-3-5	0.2	24	16	0.04	1	7.66	0.31	1	27
B-E-3-0-1 (RACINE)	0.4	22	12.6	0.07	1	90.2	5.09	1	54.3
B-E-3-0-3	0.1	17	18.1	0.04	1	3.76	0.18	1	30.2
B-E-3-3-5	0.1	13	12.2	0.04	1	5.58	0.27	1	30.1
B-E-4-0-3	0.1	17	14.2	0.04	1	5	0.2	1	27.1
B-E-4-3-5	0.1	19	15.6	0.04	1	5.24	0.11	1	33.3
B-E-HS-63240E 15109N	0.1	16	16.5	0.04	1	2.28	0.16	1	30.4
B-E-HS-63240E 15109N	0.1	16	14.3	0.04	1	3.74	0.06	1	30.9
B-E-HS-64435E 14486N	0.1	17	12.4	0.04	1	8.53	0.34	1	28.4
B-E-HS-64435E 14486N (Dup)	0.1	17	17	0.04	1	3.85	0.14	1	28.9
B-A-1-0-3	0.1	15	7	0.04	1	5.59	0.25	1	17.7
B-A-1-3-5	0.1	12	7.84	0.04	1	3.36	0.24	1	20.5
B-A-2-0-3	0.1	18	10.7	0.04	1	4.41	0.27	1	32.9
B-A-2-3-5	0.1	16	14.2	0.04	1	2.49	0.06	1	34.5
B-ASA-51508E 15705N	0.2	13	14.3	0.04	1	3.6	0.17	1	43.8
B-ASA-51501E 15688N	0.2	24	12.3	0.04	1	33	1.42	1	274
B-ASA-51488E 15697N	0.2	19	7.88	0.04	1	14	0.66	1	124
B-ASA-I-0-15M	0.2	16	14.2	0.04	1	10.2	0.72	1	24.9
B-ASA-I-15-30M	0.3	18	12	0.04	1	22.6	1.36	1	31.8

Color shown only in electronic version of this report  
 Values in red: Results higher than the mean values added to twice the standard deviation are highlighted in red bold fonts.

**Table 3-15  
Parameters Exceeding the BGL or the AWQG for Shilo GW – Per Range or Area**

Range or area	# well	Parameters
Aachen	6	Al (2), As (3), Ba (2), Cr (3), Ce (3), Co (1), <b>Cu (5), Fe (4)</b> , Pb (4), Mg (1), Li (1), Mo (4), Ni (3) Ru (3), Sn (4), Ti (3), Tl (2), U (3), Va (1), Zn (2), Zr (3)
Berlin	6	Al (1), As (4), Sb (4), Al (1), Bi (1), Cd (2), Co (4), Cu (4), Cr (5), Ce (3), Fe (4), Ni (4), Pb (1), Ru (3), Sn (4), Ti (4), Tl (3), Zn (2), Zr (3), U (3), Va (3)
Cologne	9	Ag (1), Al (1), As (9), Al (1), Sb (2), Ba (3), Bi (4), Ca (1), Cr (8), Co (7), Ce (5), Cd (5), Cu (8), Fe (9), Li (1), Pb (9), Mo (1), Ni (7), Se (3), Ru (7), Sn (4), Sr (2), Ti (9), Tl (6), U (6), Va (4), Zn (3), Zr (8)
Deileighnhofen	10	Al (6), As (7), Sb (3), Ba (3), Bi (4), Cd (4), Cu (10), Cr (7), Co (4), Ce (5), Fe (7), Li (1), Pb (6), Mo (2), Ni (7), Ru (8), Se (3), Sn (4), Ti (6), Tl (5), Va (6), U (10), W (1), Zn (4), Zr (5)
Essen	9	Al (3), As (2), Ba (1), Bi (2), Co (3), Cu (5), Cd (1), Cr (5), Ce (5), Fe (5), Li (2), Ni (7), Pb (4), Ru (5), Sn (3), Ti (5), Zr (5)
Rifle range	2	As (1), Cr (1), Co (1), Cu (2), Pb (1), Fe (1), Mn (1), Ni (1), Ru (1), Sn (1), Ti (1), Zr (1)
Grenade range	3	Al (2), Ag (1), As (2), Bi (1), Cd (1), Co (1), Cu (1), Cr (2), Ce (1), Fe (2), Mn (1), Ni (1), Pb (1), Se (2), Ru (1), Se (1), Sn (2), Ti (2), Tl (2), Va (1), W (2), Zn (1), Zr (2)
OW	2	Ag (1), Al (2), Ba (3), Bi (2), Cr (2), Co (2), Ce (2), Fe (2), Pb (2), Mn (2), Na (1), Ni (2), Ru (2), Se (1), Sn (3), Ti (2), Tl (2), U (2), Va (2), W (2), Zn (2), Zr (2)
DW	1	As (1), Cr (1), Ce (1), Fe (1), Mo (1), Ni (1), U (1), V (1)
Marsh	1	Bi (1), Cr (1), Ce (1), Fe (1)
Phillips	1	Bi (1)
MW	10	Ag (2), Al (4), As (5), Ba (4), Ce (1), Bi (4), Cd (5), Ce (4), Co (6), Cu (9), Cr (10), Fe (9), Li (1), Mn (8), Mo (2), Na (1), Ni (8), Pb (8), Ru (7), Tl (4), Se (2), Sn (5), Ti (5), W (2), Zr (5) Sb (1), Va (6), U (3), Zn (4)
TR	1	Bi (1), Cr (1), Ce (1), Fe (1), Ni (1), Pb (1), Ru (1), Ti (1), Tl (1), U (1), Va (1)
ATR	2	As (2), Co (1), Cu (2), Ni (2), Pb (2), Sb (1), Fe (2), Ru (1), Ti (1), Tl (1), Va (1), Zr (1)
Zone	10	As (5), Co (1), Cu (4), Cr (4), Ce (2), Fe (4), Mn (6), Ni (4), Pb (2), Ru (3), Ti (2), Tl (2), Va (2), W (1), Zr (3)

**Bold fonts:** Results either higher than the AWQG or higher than twice the BGL

**Table 3-16**

**Parameters Exceeding the BGL or the WQGL for Groundwater, the BGL or the SQGL for Soils, and the BGL for biomass at Aachen Battlerun**

Matrix	Parameters exceeding either BGL or QGL		
GW	Al (2), As (3), Ba (2), Cr (3), Ce (3), Co (1), <b>Cu (5)</b> , Fe (4), Pb (4), Mg (1), Li (1), Mo (4), Ni (3), Ru (3), Sn (4), Ti (3), Tl (2), U (3), Va (1), Zn (2), Zr (3)		
Soil	<b>Cu</b>	S-A-LS 60% A and S-A-2-0-1	Over ASQG
	<b>Ni</b>	S-A-HS 60042E 12060 N S-A-LS 60% A S-A-LS 120% A	Over ASQG Over ASQG and 16 times BGL Over ASQG
	<b>Mo</b>	S-A-2-3-5	Slightly over BGL
	<b>Cd</b>	S-A-1-3-5	Over ASQG
	<b>Co</b>	S-A-1-3-5	Over BGL
Biomass	<b>Pb</b>	B-A-1-0-3 and 1-3-5	Highest hit at 5.5 times BGL
	<b>Cd</b>	B-A-1-3-5 and 2-0-3	Slightly higher
	<b>Sr</b>	B-A-2-0-3 and 2-3-5	Slightly higher
	<b>Zn</b>	B-A-2-3-5	Slightly higher
Color shown only in electronic version of this report In bold fonts: Results either higher than the AWQG or higher than twice the BGL In blue fonts: Parameters found both in the GW and in the surface soils or in the groundwater and the biomass In red highlight: Parameters found only in the groundwater			

**Table 3-17**

**Parameters Exceeding the BGL or the WQGL for Groundwater, the BGL or the SQGL for Soils, and the BGL for Biomass at Berlin Battlerun**

Matrix	Parameters exceeding either the QGL or the BGL
GW	<b>Al (1), As (4), Sb (4), Al (1), Bi (1), Cd (2), Co (4), Cu (4), Cr (5), Ce (3), Fe (4), Ni (4), Pb (1), Ru (3), Sn (4), Ti (4), Tl (3), Zn (2), Zr (3), U (3), Va (3)</b>
Soils	No soils were collected in 2001
Biomass	No biomass was collected in 2001
GW: Groundwater In bold fonts: Préciser	

**Table 3-18  
Parameters Exceeding the BGL or the WQGL for Groundwater, the  
BGL or the SQGL for Soils, and the BGL for Biomass at Cologne  
Battlerun**

<b>Matrix</b>	<b>Parameters exceeding either the QGL or the BGL</b>		
GW	Ag (1), Al (1), As (9), Sb (2), <b>Ba (3)</b> , Bi (4), Ca (1), <b>Cr (8)</b> , <b>Co (7)</b> , Ce (5), Cd (5), Cu (8), <b>Fe (9)</b> , Li (1), <b>Pb (9)</b> , <b>Mo (1)</b> , Ni (7), <b>Se (3)</b> , Ru (7), Sn (4), Sr (2), <b>Ti (9)</b> , Tl (6), <b>U (6)</b> , <b>Va (4)</b> , Zn (3), Zr (8)		
Soils	<b>Al</b>	S-C-LS 40% B, 60% B, HS 65011E02663N	Over BGL
	<b>As</b>	S-C-1-0-1, 1-1-3, 1-3-5, HS 66017E02566N	Over ASQG
	<b>Be</b>	S-C-1-3-5, S-C-HS 66017E02566N	Over BGL
	<b>Bi</b>	S-C-LS-60% A, HS 65266E02930N	Over BGL
		S-C-HS65011E02663N, 66017E02566N	
	<b>Cd</b>	S-C-HS 65266E02930N, 66040E 02939N	Over ASQG (4 times higher)
	<b>Cr</b>	S-C-HS 63025E 02811N	Over BGL
	<b>Co</b>	S-C-LS-100% A, S-C-1-0-1, 1-1-3, 1-3-5	Over BGL
	<b>Pb</b>	S-C-HS-65011E02663N	Over BGL
	<b>Mg</b>	S-C-1-0-1,1-1-3,1-3-5, HS66017E02566N	Over BGL
	<b>K</b>	S-C-LS 60% B, HS66017E02566N	Over BGL
	<b>Tl</b>	S-C-LS-60% B, S-C-1-0-1,1-1-3,1-3-5, S-C-HS 65266E02930N, 66040E 02939N	Over BGL
	<b>Ti</b>	S-C-HS 66017E02566N	Over BGL
	<b>U</b>	S-C-1-0-1, 1-1-3,1-3-5, HS66017E02566N	Over ASQG
<b>Zn</b>	S-C-HS-65011E02663N, 63025E 02811N	Over BGL	
Biomass	<b>As</b>	B-C-1-0-3	
	<b>Sb</b>	B-C-2-0-3	
	<b>Pb</b>	B-C-1-0-3, 1-3-5, 2-3-5, 3-3-5	
	<b>Sr</b>	B-C-2-0-3, 2-3-5	
<p><b>In bold fonts:</b> Results either higher than the AWQG or higher than twice the BGL. Color shown only in electronic version of this report. <b>In blue fonts:</b> Parameters found both in the GW and in the surface soils or in the groundwater and the biomass <b>In red:</b> Parameters found only in the groundwater</p>			

**Table 3-19**  
**Parameters Exceeding the BGL or the WQGL for Groundwater, the BGL or the SQGL for Soils, and the BGL for Biomass at Deilinghofen Battlerun**

Matrix	Parameters exceeding either the BGL or the QGL		
GW	Al (6), As (7), Sb (3), Ba (3), Bi (4), Cd (4), Cu (10), <b>Cr (7)</b> , <b>Co (4)</b> , <b>Ce (5)</b> , <b>Fe (7)</b> , <b>Li (1)</b> , <b>Pb (6)</b> , <b>Mo (2)</b> , Ni (7), Ru (8), Se (3), Sn (4), Ti (6), <b>Ti (5)</b> , <b>Va (6)</b> , U (10), W (1), Zn (4), Zr (5)		
Soils	Co	5 out of 6	Over BGL, highest 12.5 times
	Cu	All	Over ASQG, highest hit 3.4 times
	Pb	All	Over ASQG, highest hit 3.4 times
	Mo	Two samples	Over BGL at target # 2
	Sr	Three samples	Over BGL at target # 1 and 2 (highest hit 2.9 times)
Biomass	Sb	Two samples	Slightly exceed at target # 1
	Ba	One sample	Slightly exceed at target #2
	Cd	One sample	Slightly exceed at target #2
	Ca	All samples	Highest 2.1 times the BGL
	Cr	One sample target #1	1.46 time the BGL
	Co	Three samples	2.4 times the BGL
	Pb	One sample target #1	2.1 times the BGL
	Mg	Three samples	Highest 1.5 times the BGL
	P, K	Four samples	Highest 1.5 times the BGL
	Na	Four samples	Highest 4 times the BGL
	Sr	Four samples	Highest 19 times
	Zn	One sample target #2	Slightly exceed

**In bold fonts:** Results either higher than the AWQG or higher than twice the BGL

Color shown only in electronic version of this report

**In blue fonts:** Found both in the GW and in the surface soils or in the groundwater and the biomass

In red: Parameters found only in the groundwater

**Table 3-20**  
**Parameters Exceeding the BGL or the WQGL for Groundwater, the BGL or the SQGL for Soils, and the BGL for Biomass at Essen Battlerun**

Matrix	Parameters exceeding either the BGL or the QGL		
GW	Al (3), As (2), Ba (1), Bi (2), Co (3), Cu (5), <b>Cd (1)</b> , <b>Cr (5)</b> , <b>Ce (5)</b> , Fe (5), Li (2), Ni (7), Pb (4), Ru (5), Sn (3), Ti (5), Zr (5)		
Soils	Cu	4 samples	Over ASQG by approximately twice the ASQG
	Pb	6 samples	Over ASQG, highest hit 6.7 times
Biomass	Sb	6 samples	Highest hit 4.3 times the BGL
	Ba	9 samples	Highest hit 2 times the BGL
	Cd	1 samples	Slightly exceed
	Ca, Mg, Na	10 samples	Over for these samples near Milan debris
	C, Co	1 sample	Over for both samples at target #4
	Cu	1 sample	Slightly over at target #1
	Pb	4 samples	Slightly over at target # 1 and 2
	Mo	4 samples	Over t target # 2 and 4
Sr	All samples	Over (highest hit 3 times the BGL	

**In bold fonts:** Results either higher than the AWQG or higher than twice the BGL

Color shown only in electronic version of this report.

**In blue fonts:** Parameters found both in the GW and in the surface soils or in the groundwater and the biomass.

In red: Parameters found only in the groundwater

**Table 3-21**

**Parameters Exceeding the BGL or the WQGL for Groundwater, and the BGL or the SQGL for Soils for the Rifle Range**

<b>Matrix</b>	<b>Parameters exceeding either the BGL or the QGL</b>		
GW	As (1), Cr (1), Co (1), Cu (2), Pb (1), Fe (1), Mn (1), Ni (1), Ru (1), Sn (1), Ti (1), Zr (1)		
Soils	<b>As</b>	6 samples	Over ASQG, highest at 1.4 times higher
	<b>Bi</b>	21 samples including 6 sub-surface	Over BGL, highest 21 times higher
	<b>Cu</b>	32 samples	Over the BGL and ASQG
		17 samples	Results over 100 ppm. Both surface and subsurface soils were impacted with high levels of Cu. Maximum level at 84 times higher than the ASQG
	<b>Pb</b>	All samples	Presented high levels of lead. Results varied from 32 ppm to 44,000 ppm. In range #2, the results exceeded the ISQG by 73 times
	<b>Ni</b>	4 samples including surface and subsurface soils	Exceeded the ASQG. Maximum level at 3.6 times higher
	<b>Sr</b>	4 samples	Slightly exceeded the BGL in ranges 1 and 2
	<b>Tl</b>	5 samples	Slightly exceeded the BGL in ranges #2 and 4
	<b>Sn</b>	7 samples	Over BGL in ranges #2 and 4. Maximum level at 3 times higher
	<b>Zn</b>	14 samples	Exceeded the ASQG including surface and subsurface. Maximum level at 683 times higher
Biomass	<b>Al</b>	1 sample	Slightly exceeded the BGL for Al
	<b>As</b>	4 samples	Exceeded (maximum level at 2 times higher
	<b>Sb</b>	All samples	Maximum level at 218 times higher
	<b>Ca, Mg, Na</b>	10 samples	Over for either Ca, Mg or Na
	<b>Cu</b>	8 samples	Maximum level at 6.3 times
	<b>Fe</b>	1 sample	Slightly over
	<b>Pb</b>	All samples	Vary from 38 to 789 times the BGL
	<b>Mo</b>	3 samples	Slightly over
	<b>Se</b>	4 samples	Slightly over
	<b>Sr</b>	10 samples	Maximum level at 2.4 times higher
	<b>V</b>	1 sample	Slightly over
	<b>Zn</b>	All samples	Maximum level at 2 times higher

**In bold fonts:** Results either higher than the AWQG or higher than twice the BGL  
Color shown only in electronic version of this report.

**In blue fonts:** Parameters found both in the GW and in the surface soils or in the groundwater and the biomass.

**In red:** Parameters found only in the groundwater

<b>Table 3-22</b>			
<b>Parameters Exceeding the BGL or the WQGL for Groundwater, and the BGL or the SQGL for Soils for the Grenade Range</b>			
<b>Matrix</b>	<b>Parameters exceeding either the BGL or the QGL</b>		
GW	Al (2), Ag (1), As (2), Bi (1), Cd (1), Co (1), Cu (1), <b>Cr (2)</b> , Ce (1), Fe (2), Mn (1), Ni (1), Pb (1), Se (2), Ru (1), Sn (2), <b>Tl (2)</b> , Tl (2), Va (1), W (2), Zn (1), Zr (2)		
Soils	<b>Cd</b>	All samples	Over ASQG, highest at 4 times
	<b>Cr</b>	All samples	Over BGL, highest at 1.5 times
	<b>Cu</b>	All samples	Over ASQG, highest at 5 times
	<b>Pb</b>	13 samples	Over ASQG, highest at 5.7 times the ASQG, 20 times the BGL
	Mg	12 samples	Over BGL, highest at 1.5 times
	<b>Ni</b>	9 samples	Over ASQG, highest at 1.2 times
	<b>Ti</b>	7 samples	Over BGL, highest at 1.3 times
	<b>Zn</b>	All samples	Over ASQG, highest at 12 times
Biomass	No biomass samples were collected during first sampling in 2001		
<p><b>In bold fonts:</b> Results either higher than the AWQG or higher than twice the BGL. Color shown only in electronic version of this report.</p> <p><b>In blue fonts:</b> Parameters found both in the GW and in the surface soils or in the groundwater and the biomass.</p> <p>In red: Parameters found only in the groundwater</p>			

Surface soil samples were compared to the most stringent agricultural CCME threshold levels for metals that were included in the latest published CCME quality guideline ([www.ccme.ca](http://www.ccme.ca)). For metals that were not included in the CCME list, results were compared to the mean values of all soil backgrounds samples. The same approach used for the biomass was then selected and results exceeding the mean value added to twice the standard deviation were highlighted. Again here, results that exceeded the mean values were compared in a second run with the mean value of backgrounds found in the same geological formations.

### Energetic materials

All soils, groundwater, and surface water samples were analysed for energetic materials except soils samples collected in the rifle ranges, in Klein Essen battlerun, and at the Antenna Service Area (ASA) area where only metal contamination was suspected. Thirteen parameters were screened for explosives including the most common explosives RDX, HMX and TNT. In groundwater and surface water samples, no explosives were detected. Since no explosives were detected in biomass samples during Phase I, no biomass samples were analysed for explosives contamination during Phase II.

A total of 108 soil samples were analysed for energetic materials including 21 backgrounds. The samples collected for energetic material analysis in the training area were collected in the following areas: Aachen, Cologne, Essen, and Deilinghofen battleruns, and in the grenade range. No samples for energetic material analyses were collected in Klein Essen and rifle ranges, since only small arms were used in these ranges. Results for energetic materials are presented in Table 3-23. In battleruns, both linear transect patterns (between 20 and 120 percent of the range length at each 20-percent interval) and circular patterns

around targets (at 0 to 1 m, 1 to 3 m, and 3 to 5 m away from the center of the target) were done, as in Phase I. Moreover, "hot spot" samples (HS) were collected in battleruns where craters, munitions, or munition debris were encountered. These samples were named HS with the GPS locations where they were collected. All samples were composite samples built of at least 15 subsamples either in linear transects, circular around targets, or circles around the hot spots. When munitions were found, the samples were collected as near as possible to the UXO with subsamples around it. Out of the 87 samples collected in the firing ranges, 36 presented measurable traces of at least one explosive analyte. These results will be discussed range by range in the following section.

**Table 3-23  
Energetic Material Concentrations in Soils**

SAMPLE		Energetic material concentrations in soils ppb (µg/kg)												
Name	Number	NG	1,3-DNB	2,6-DNT	2,4-DNT	TNB	TNT	PETN	RDX	4-Am-DNT	3,5-DNA	2-Am-DNT	Tetryl	HMX
S-BG-69940E 18340N	a	N.D.	N.D.	N.D.	N.D.	N.D.	N.Q.	N.D.	N.D.	N.D.	N.D.	N.D.	N.D.	N.D.
	b	N.D.	N.D.	N.D.	N.D.	N.D.	N.Q.	N.D.	N.D.	N.D.	N.D.	N.D.	N.D.	N.D.
	Average													
S-BG-52660E 22764N	a	N.D.	N.D.	N.D.	N.D.	N.D.	N.D.	N.D.	N.D.	N.D.	N.D.	N.D.	N.D.	30.5
	b	N.D.	N.D.	N.D.	N.D.	N.D.	N.D.	N.D.	N.Q.	N.D.	N.D.	N.D.	N.D.	21.8
	Average													26
S-BG-80356E 06945N	a	N.D.	N.D.	N.D.	N.D.	N.D.	N.Q.	N.D.	N.Q.	N.D.	N.D.	N.D.	N.D.	N.D.
	b	N.D.	N.D.	N.D.	N.D.	N.D.	N.Q.	N.D.	N.D.	N.D.	N.D.	N.D.	N.D.	N.D.
	Average													
S-BG-57997E 20636N	a	N.D.	N.D.	N.D.	N.D.	N.D.	N.Q.	N.D.	N.Q.	N.D.	N.D.	N.D.	N.D.	N.D.
	b	N.D.	N.D.	N.D.	N.D.	N.D.	N.Q.	N.D.	N.Q.	N.D.	N.D.	N.D.	N.D.	N.D.
	Average													
S-BG-65629E 17392N	a	N.D.	N.D.	N.D.	N.D.	N.Q.	N.Q.	N.D.	N.D.	N.D.	N.D.	N.D.	N.D.	N.D.
	b	N.D.	N.D.	N.D.	N.D.	N.Q.	N.Q.	N.D.	N.Q.	N.D.	N.D.	N.D.	N.D.	N.D.
	Average													
S-BG-63783E 17228N	a	N.D.	N.D.	N.D.	N.D.	N.D.	N.Q.	N.D.	N.D.	N.D.	N.D.	N.D.	N.D.	N.D.
	b	N.D.	N.D.	N.D.	N.D.	N.D.	N.Q.	N.D.	N.D.	N.D.	N.D.	N.D.	N.D.	N.D.
	Average													
S-BG-78159E 99759N	a	N.D.	N.D.	N.D.	N.D.	N.D.	N.Q.	N.D.	N.Q.	N.D.	N.D.	N.D.	N.D.	N.D.
	b	N.D.	N.D.	N.D.	N.D.	N.D.	N.Q.	N.D.	N.Q.	N.D.	N.D.	N.D.	N.D.	N.D.
	Average													
S-BG-62630E 18054N	a	N.D.	N.D.	N.D.	N.D.	N.D.	N.Q.	N.D.	N.D.	N.D.	N.D.	N.D.	N.D.	N.D.
	b	N.D.	N.D.	N.D.	N.D.	N.D.	N.Q.	N.D.	N.D.	N.D.	N.D.	N.D.	N.D.	N.D.
	Average													
S-BG-79182E 00111N	a	N.D.	N.D.	N.D.	N.D.	N.D.	N.Q.	N.D.	N.D.	N.D.	N.D.	N.D.	N.D.	N.D.
	b	N.D.	N.D.	N.D.	N.D.	N.D.	N.Q.	N.D.	N.D.	N.D.	N.D.	N.D.	N.D.	N.D.
	Average													

(Sheet 1 of 9)



**Table 3-23 (Continued)**

SAMPLE		Energetic material concentrations in soils ppb (µg/kg)												
Name	Number	NG	1,3-DNB	2,6-DNT	2,4-DNT	TNB	TNT	PETN	RDX	4-Am-DNT	3,5-DNA	2-Am-DNT	Tetryl	HMX
S-BG-74864E 14968N	a	N.D.	N.D.	N.D.	N.D.	N.D.	N.Q.	N.D.	N.D.	N.D.	N.D.	N.D.	N.D.	N.D.
	b	N.D.	N.D.	N.D.	N.D.	N.D.	N.Q.	N.D.	N.D.	N.D.	N.D.	N.D.	N.D.	N.D.
	Average													
S-BG-49148E 13157N	a	N.D.	N.D.	N.D.	N.D.	N.Q.	N.Q.	N.D.	N.D.	N.D.	N.D.	N.D.	N.D.	N.D.
	b	N.D.	N.D.	N.D.	N.D.	N.Q.	N.Q.	N.D.	N.D.	N.D.	N.D.	N.D.	N.D.	N.D.
	Average													
S-BG-49148E 13157N (dup)	a	N.D.	N.D.	N.D.	N.D.	N.Q.	N.Q.	N.D.	N.D.	N.D.	N.D.	N.D.	N.D.	N.D.
	b	N.D.	N.D.	N.D.	N.D.	N.Q.	N.Q.	N.D.	N.D.	N.D.	N.D.	N.D.	N.D.	N.D.
	Average													
S-BG-55265E 11847N	a	N.D.	N.D.	N.D.	N.D.	N.Q.	N.Q.	N.D.	N.D.	N.D.	N.D.	N.D.	N.D.	N.D.
	b	N.D.	N.D.	N.D.	N.D.	N.Q.	N.Q.	N.D.	N.D.	N.D.	N.D.	N.D.	N.D.	N.D.
	Average													
S-BG-74864E 18968N (dup)	a	N.D.	N.D.	N.D.	N.D.	N.Q.	N.Q.	N.D.	N.D.	N.D.	N.Q.	N.D.	N.D.	N.D.
	b	N.D.	N.D.	N.D.	N.D.	N.Q.	N.Q.	N.D.	N.D.	N.D.	N.Q.	N.D.	N.D.	N.D.
	Average													
S-BG-55255E 09752N	a	N.D.	N.D.	N.D.	N.D.	N.Q.	N.Q.	N.D.	N.D.	N.D.	N.D.	N.D.	N.D.	N.D.
	b	N.D.	N.D.	N.D.	N.D.	N.Q.	N.Q.	N.D.	N.D.	N.D.	N.D.	N.D.	N.D.	N.D.
	Average													
S-BG-53656E 11283N	a	N.D.	N.D.	N.D.	N.D.	N.D.	N.D.	N.D.	N.D.	N.D.	N.D.	N.D.	N.D.	N.D.
	b	N.D.	N.D.	N.D.	N.D.	N.D.	N.D.	N.D.	N.D.	N.D.	N.D.	N.D.	N.D.	N.D.
	Average													
S-BG-80720E 05003N	a	N.D.	N.D.	N.D.	N.D.	N.Q.	N.Q.	N.D.	N.Q.	N.D.	N.Q.	N.D.	N.D.	N.D.
	b	N.D.	N.D.	N.D.	N.D.	N.D.	N.Q.	N.D.	N.D.	N.D.	N.Q.	N.D.	N.D.	N.D.
	Average													
S-BG-53670E 13403N	a	N.D.	N.D.	N.D.	N.Q.	N.D.	N.D.	N.D.	N.D.	N.D.	N.D.	N.D.	N.D.	N.D.
	b	N.D.	N.D.	N.D.	N.D.	N.D.	N.D.	N.D.	N.D.	N.D.	N.D.	N.D.	N.D.	N.D.
	Average													
S-BG-67858E 98938N	a	N.D.	N.D.	N.D.	N.D.	N.Q.	N.Q.	N.D.	N.D.	N.D.	N.D.	N.D.	N.D.	N.D.
	b	N.D.	N.D.	N.D.	N.D.	N.Q.	N.Q.	N.D.	N.D.	N.D.	N.D.	N.D.	N.D.	N.D.
	Average													
S-BG-68067E 97960N	a	N.D.	N.D.	N.D.	N.D.	N.D.	N.Q.	N.D.	N.D.	N.D.	N.D.	N.D.	N.D.	N.D.
	b	N.D.	N.D.	N.D.	N.D.	N.D.	N.D.	N.D.	N.D.	N.D.	N.D.	N.D.	N.D.	N.D.
	Average													
S-BG-69431E 98407N	a	N.D.	N.D.	N.D.	N.D.	N.D.	N.D.	N.D.	N.D.	N.D.	N.D.	N.D.	N.D.	N.D.
	b	N.D.	N.D.	N.D.	N.D.	N.D.	N.D.	N.D.	N.Q.	N.D.	N.D.	N.D.	N.D.	N.D.
	Average													
S-BG-63565E 60626N	a	N.D.	N.D.	N.D.	N.D.	N.Q.	N.Q.	N.D.	N.D.	N.D.	N.D.	N.D.	N.D.	N.D.
	b	N.D.	N.D.	N.D.	N.D.	N.Q.	N.D.	N.D.	N.D.	N.D.	N.D.	N.D.	N.D.	N.D.
	Average													

(Sheet 2 of 9)

**Table 3-23 (Continued)**

SAMPLE		Energetic material concentrations in soils ppb (µg/kg)												
Name	Number	NG	1,3-DNB	2,6-DNT	2,4-DNT	TNB	TNT	PETN	RDX	4-Am-DNT	3,5-DNA	2-Am-DNT	Tetryl	HMX
S-BG-62033E 01742N	a	N.D.	N.D.	N.D.	N.D.	N.Q.	11.3	N.D.	N.Q.	N.D.	N.D.	N.D.	N.D.	14.6
	b	N.D.	N.D.	N.D.	N.D.	N.Q.	17.5	N.D.	N.Q.	N.D.	N.D.	N.D.	N.D.	20.0
	Average						14							17
S-A-HS-60021E 12160N	a	N.D.	N.D.	N.D.	N.D.	N.Q.	N.Q.	N.D.	N.D.	N.D.	N.D.	N.D.	N.D.	N.D.
	b	N.D.	N.D.	N.D.	N.D.	N.Q.	N.D.	N.D.	N.D.	N.D.	N.D.	N.D.	N.D.	N.D.
	Average													
S-A-HS-60042E 12060N	a	N.D.	N.D.	N.D.	N.D.	N.D.	N.Q.	N.D.	N.D.	N.D.	N.D.	N.D.	N.D.	N.D.
	b	N.D.	N.D.	N.D.	N.D.	N.D.	N.Q.	N.D.	N.D.	N.D.	N.D.	N.D.	N.D.	N.D.
	Average													
S-A-LS 20%-A	a	11.3	N.D.	N.D.	5.8	N.D.	N.D.	N.D.	N.D.	N.D.	N.D.	N.D.	N.D.	N.D.
	b	18.1	N.D.	N.D.	5.9	N.D.	N.D.	N.D.	N.D.	N.D.	N.D.	N.D.	N.D.	N.D.
	Average	15			6									
S-A-LS20%-B	a	N.D.	N.D.	N.D.	N.D.	N.D.	29.5	N.D.	5.0	N.D.	N.D.	N.D.	N.D.	N.D.
	b	N.D.	N.D.	N.D.	N.D.	N.D.	25.5	N.D.	6.4	N.D.	N.D.	N.D.	N.D.	N.D.
	Average						28		6					
S-A-LS 40%-A	a	N.D.	N.D.	N.D.	N.D.	N.D.	N.D.	N.D.	N.D.	N.D.	N.D.	N.D.	N.D.	N.D.
	b	N.D.	N.D.	N.D.	N.D.	N.D.	N.D.	N.D.	N.D.	N.D.	N.D.	N.D.	N.D.	N.D.
	Average													
S-A-LS 40%-B	a	N.D.	N.D.	N.D.	N.D.	N.D.	N.Q.	N.D.	N.Q.	N.D.	N.D.	N.D.	N.D.	N.D.
	b	N.D.	N.D.	N.D.	N.D.	N.D.	N.Q.	N.D.	N.Q.	N.D.	N.D.	N.D.	N.D.	N.D.
	Average													
S-A-LS 40%-B(DUP)	a	N.D.	N.D.	N.D.	N.D.	N.D.	N.D.	N.D.	N.Q.	N.D.	N.D.	N.D.	N.D.	N.D.
	b	N.D.	N.D.	N.D.	N.D.	N.D.	N.D.	N.D.	N.Q.	N.D.	N.D.	N.D.	N.D.	N.D.
	Average													
S-GR-30M-A	a	N.D.	N.D.	113.2	2875.0	N.Q.	6.6	N.D.	16.1	18.5	N.D.	20.0	N.D.	N.D.
	b	N.D.	N.D.	128.0	3875.0	N.Q.	18.9	N.D.	12.7	18.1	N.D.	33.5	N.D.	N.D.
	Average			121	3375		13		14	18		27		
S-GR-30M-B	a	N.D.	N.D.	5.1	85.0	N.D.	N.Q.	N.D.	7.0	14.3	N.D.	10.8	N.D.	N.D.
	b	N.D.	N.D.	2.6	71.5	N.D.	N.Q.	N.D.	4.0	5.2	N.D.	6.0	N.D.	N.D.
	Average			4	78				6	10		8		
S-GR-35M-A	a	N.D.	N.D.	5.8	79.5	N.D.	16.8	N.D.	20.5	43.8	N.D.	31.2	34.2	19.7
	b	N.D.	N.D.	3.3	60.8	N.D.	9.6	N.D.	14.9	36.5	N.D.	27.0	18.1	12.6
	Average			5	70		13		18	40		29	26	16
S-GR-35M-B	a	N.D.	N.D.	3.2	7.2	N.D.	8.2	N.D.	N.Q.	26.2	N.D.	16.4	N.D.	N.D.
	b	N.D.	N.D.	1.4	6.7	N.D.	6.50	N.D.	N.Q.	20.0	N.D.	14.6	N.D.	N.D.
	Average			2	7		7			23		16		
S-GR-HS-57538E 18001N	a	N.D.	N.D.	N.Q.	5.8	N.Q.	695.0	N.D.	1775.0	47.0	N.D.	30.8	N.D.	219.2
	b	N.D.	N.D.	N.D.	17.1	N.D.	755.0	N.D.	2600.0	18.0	N.D.	22.1	N.D.	163.0
	Average				11		725		2188	33		26		191

(Sheet 3 of 9)

**Table 3-23 (Continued)**

SAMPLE		Energetic material concentrations in soils ppb (µg/kg)												
Name	Number	NG	1,3-DNB	2,6-DNT	2,4-DNT	TNB	TNT	PETN	RDX	4-Am-DNT	3,5-DNA	2-Am-DNT	Tetryl	HMX
S-GR-5M-A	a	N.D.	N.D.	4.4	6.5	N.D.	N.Q.	N.D.	3390.0	12.9	N.D.	37.8	N.D.	154.8
	b	N.D.	N.D.	0.5	2.5	N.D.	N.D.	N.D.	4725.0	N.D.	N.D.	30.8	N.D.	152.8
	Average			2	5				4058			34		154
S-GR-5M-B	a	9.1	N.D.	2.7	5.4	N.D.	8.5	N.D.	42.2	35.5	N.D.	36.5	65.0	N.D.
	b	16.5	N.D.	1.8	3.9	N.D.	6.1	N.D.	21.4	22.0	N.D.	16.2	37.5	N.D.
	Average	13		2	5		7		32	29		26	51	
S-GR-10M-A	a	N.D.	N.D.	3.9	17.4	N.D.	5.2	N.D.	1257.5	28.2	N.D.	36.5	N.D.	43.0
	b	N.D.	N.D.	1.9	22.1	N.D.	7.7	N.D.	2312.5	8.2	N.D.	50.0	N.D.	79.5
	Average			3	20		6		1785	18		43		61
S-GR-10M-B	a	N.D.	N.D.	2.2	4.1	N.D.	N.Q.	N.D.	117.0	18.0	N.D.	21.0	N.D.	N.D.
	b	N.D.	N.D.	0.9	2.7	N.D.	N.Q.	N.D.	60.2	4.7	N.D.	9.6	N.D.	N.D.
	Average			2	3				89	11		15		
S-GR-15M-A	a	N.D.	N.D.	2.4	6.2	N.D.	6.2	N.D.	71.0	13.5	10.2	28.0	N.D.	12.7
	b	N.D.	N.D.	1.2	8.9	N.D.	8.2	N.D.	71.0	7.5	6.5	18.8	N.D.	17.6
	Average			2	8		7		71	11	8	23		15
S-GR-15M-B	a	N.D.	N.D.	2.4	3.6	N.D.	N.Q.	N.D.	775.0	17.2	14.6	9.0	N.D.	29.5
	b	N.D.	N.D.	2.7	2.4	N.D.	N.Q.	N.D.	900.0	36.0	15.0	8.0	N.D.	47.5
	Average			3	3				838	27	15			39
S-GR-15M-B(DUP)	a	N.D.	N.D.	2.8	13.4	N.D.	5.4	N.D.	41.5	20.1	N.D.	15.0	N.D.	N.D.
	b	N.D.	N.D.	2.1	6.6	N.D.	5.4	N.D.	21.4	6.6	N.D.	8.6	N.D.	N.D.
	Average			2	10		5		31	13		12		
S-GR-20M-A	a	N.D.	N.D.	3.4	8.4	N.Q.	N.Q.	N.D.	63.2	11.7	N.D.	9.8	N.D.	14.8
	b	N.D.	N.D.	2.5	7.5	N.D.	N.Q.	N.D.	69.2	7.0	N.D.	7.5	N.D.	14.5
	Average			3	8				66	9		9		15
S-GR-20M-B	a	N.D.	N.D.	15.3	10.9	N.D.	N.Q.	N.D.	1537.5	21.3	N.D.	11.3	N.D.	83.5
	b	N.D.	N.D.	1.8	10.5	N.D.	N.Q.	N.D.	1322.5	5.7	N.D.	12.2	N.D.	98.2
	Average			9	11				1430	14		12		91
S-GR-25M-A	a	N.D.	N.D.	3.8	26.5	N.D.	N.Q.	N.D.	33.0	16.2	N.D.	12.0	N.D.	19.8
	b	N.D.	N.D.	2.1	23.1	N.D.	N.Q.	N.D.	19.2	5.4	N.D.	19.2	N.D.	18.6
	Average			3	25				26	11		16		19
S-GR-25M-B	a	N.D.	N.D.	2.9	14.8	N.D.	52.5	N.D.	36.0	21.7	N.D.	23.4	N.D.	16.0
	b	N.D.	N.D.	1.6	11.1	N.D.	26.0	N.D.	18.9	11.0	N.D.	10.2	N.D.	N.D.
	Average			2	13		39		27	16		17		
S-GR-25M-B(DUP)	a	N.D.	N.D.	11.0	40.2	N.D.	9.1	N.D.	147.0	27.2	N.D.	20.0	N.D.	25.8
	b	N.D.	N.D.	2.2	27.8	N.D.	7.9	N.D.	128.0	15.0	N.D.	11.8	N.D.	16.8
	Average			7	34		9		138	21		16		21
S-C-HS-65266E 02930N	a	N.D.	N.D.	N.D.	N.D.	N.D.	N.D.	N.D.	N.D.	N.D.	N.D.	N.D.	N.D.	N.D.
	b	N.D.	N.D.	N.D.	N.D.	N.D.	N.D.	N.D.	N.D.	N.D.	N.D.	N.D.	N.D.	N.D.
	Average													

(Sheet 4 of 9)

**Table 3-23 (Continued)**

SAMPLE		Energetic material concentrations in soils ppb (µg/kg)												
Name	Number	NG	1,3-DNB	2,6-DNT	2,4-DNT	TNB	TNT	PETN	RDX	4-Am-DNT	3,5-DNA	2-Am-DNT	Tetryl	HMX
S-C-HS-66040E 02939N	a	N.D.	N.D.	N.D.	N.D.	N.D.	N.Q.	N.D.	N.Q.	N.D.	N.D.	N.D.	N.D.	N.D.
	b	N.D.	N.D.	N.D.	N.D.	N.Q.	N.D.	N.D.	N.D.	N.D.	N.D.	N.D.	N.D.	N.D.
	Average													
S-C-HS-66017E 02566N	a	N.D.	N.D.	2.6	N.D.	N.D.	N.Q.	N.D.	N.D.	N.D.	N.D.	N.D.	N.D.	N.D.
	b	N.D.	N.D.	1.4	N.D.	N.D.	N.D.	N.D.	N.D.	N.D.	N.D.	N.D.	N.D.	N.D.
	Average			2										
S-C-HS-65011E 02663N	a	N.D.	N.D.	N.D.	N.D.	N.D.	N.D.	N.D.	N.D.	N.D.	N.D.	N.D.	N.D.	N.D.
	b	N.D.	N.D.	N.D.	N.D.	N.D.	N.D.	N.D.	N.D.	N.D.	N.D.	N.D.	N.D.	N.D.
	Average													
S-C-HS-63025E 02811N	a	N.D.	N.D.	N.D.	N.D.	N.D.	N.D.	N.D.	N.D.	N.D.	N.D.	N.D.	N.D.	N.D.
	b	N.D.	N.D.	N.D.	N.D.	N.D.	N.D.	N.D.	N.D.	N.D.	N.D.	N.D.	N.D.	N.D.
	Average													
S-C-HS-68010 02205N	a	N.D.	N.D.	N.D.	N.D.	N.D.	N.Q.	N.D.	N.Q.	N.D.	N.D.	N.D.	N.D.	N.D.
	b	N.D.	N.D.	N.D.	N.D.	N.D.	N.D.	N.D.	N.Q.	N.D.	N.D.	N.D.	N.D.	N.D.
	Average													
S-C-LS 120%-A	a	N.D.	N.D.	N.D.	N.D.	N.D.	14.2	N.D.	N.D.	N.D.	N.Q.	N.D.	N.D.	N.D.
	b	N.D.	N.D.	N.D.	N.D.	N.D.	6.5	N.D.	N.D.	N.D.	N.D.	N.D.	N.D.	N.D.
	Average						10							
S-C-LS 120%-B	a	N.D.	N.D.	N.D.	N.D.	N.D.	N.D.	N.D.	5.0	N.D.	N.D.	N.D.	N.D.	N.D.
	b	N.D.	N.D.	N.D.	N.D.	N.D.	N.D.	N.D.	5.3	N.D.	N.D.	N.D.	N.D.	N.D.
	Average								5					
S-C-1-0-1	a	N.D.	N.D.	N.D.	N.D.	N.D.	N.Q.	N.D.	N.D.	N.D.	N.D.	N.D.	N.D.	N.D.
	b	N.D.	N.D.	N.D.	N.D.	N.D.	N.D.	N.D.	N.D.	N.D.	N.D.	N.D.	N.D.	N.D.
	Average													
S-C-1-1-3	a	N.D.	N.D.	N.D.	N.D.	N.D.	N.D.	N.D.	N.Q.	N.D.	N.D.	N.D.	N.D.	N.D.
	b	N.D.	N.D.	N.D.	N.D.	N.D.	N.D.	N.D.	N.D.	N.D.	N.D.	N.D.	N.D.	N.D.
	Average													
S-C-1-3-5	a	N.D.	N.D.	N.D.	N.D.	N.Q.	N.Q.	N.D.	N.D.	N.D.	N.D.	N.D.	N.D.	N.D.
	b	N.D.	N.D.	N.D.	N.D.	N.D.	N.D.	N.D.	N.Q.	N.D.	N.D.	N.D.	N.D.	N.D.
	Average													
S-C-2-0-1	a	N.D.	N.D.	N.D.	N.D.	N.D.	N.D.	N.D.	N.D.	N.D.	N.D.	N.D.	N.D.	N.D.
	b	N.D.	N.D.	N.D.	N.D.	N.D.	N.D.	N.D.	N.D.	N.D.	N.D.	N.D.	N.D.	N.D.
	Average													
S-C-2-1-3	a	N.D.	N.D.	N.D.	N.D.	N.D.	N.D.	N.D.	23.2	N.D.	N.D.	N.D.	N.D.	N.D.
	b	N.D.	N.D.	N.D.	N.D.	N.Q.	N.Q.	N.D.	16.8	N.D.	N.D.	N.D.	N.D.	N.D.
	Average								20					
S-C-2-3-5	a	N.D.	N.D.	N.D.	N.D.	N.D.	N.D.	N.D.	N.D.	N.D.	N.D.	N.D.	N.D.	N.D.
	b	N.D.	N.D.	N.D.	N.D.	N.D.	N.D.	N.D.	N.D.	N.D.	N.D.	N.D.	N.D.	N.D.
	Average													
S-C-3-0-1	a	N.D.	N.D.	N.D.	N.D.	N.D.	N.D.	N.D.	N.D.	N.D.	N.D.	N.D.	N.D.	N.D.
	b	N.D.	N.D.	N.D.	N.D.	N.D.	N.D.	N.D.	N.D.	N.D.	N.D.	N.D.	N.D.	N.D.
	Average													

(Sheet 5 of 9)

**Table 3-23 (Continued)**

SAMPLE		Energetic material concentrations in soils ppb (µg/kg)												
Name	Number	NG	1,3-DNB	2,6-DNT	2,4-DNT	TNB	TNT	PETN	RDX	4-Am-DNT	3,5-DNA	2-Am-DNT	Tetryl	HMX
S-C-3-1-3	a	N.D.	N.D.	N.D.	N.D.	N.D.	N.D.	N.D.	N.D.	N.D.	N.D.	N.D.	N.D.	N.D.
	b	N.D.	N.D.	N.D.	N.D.	N.D.	N.D.	N.D.	N.D.	N.D.	N.D.	N.D.	N.D.	N.D.
	Average													
S-C-3-3-5	a	N.D.	N.D.	N.D.	N.D.	N.D.	N.D.	N.D.	N.D.	N.D.	N.D.	N.D.	N.D.	N.D.
	b	N.D.	N.D.	N.D.	N.D.	N.D.	N.D.	N.D.	N.D.	N.D.	N.D.	N.D.	N.D.	N.D.
	Average													
S-C-HS-65235E 02908N	a	N.D.	N.D.	N.D.	N.D.	N.D.	N.D.	N.D.	N.D.	N.D.	N.D.	N.D.	N.D.	N.D.
	b	N.D.	N.D.	N.D.	N.D.	N.D.	N.D.	N.D.	N.Q.	N.D.	N.D.	N.D.	N.D.	N.D.
	Average													
S-C-LS 20%-A	a	N.D.	N.D.	N.D.	N.D.	N.D.	N.D.	N.D.	N.D.	N.D.	N.D.	N.D.	N.D.	N.D.
	b	N.D.	N.D.	N.D.	N.D.	N.D.	N.D.	N.D.	N.D.	N.D.	N.D.	N.D.	N.D.	N.D.
	Average													
S-C-LS 20%-B	a	N.D.	N.D.	N.D.	N.Q.	N.D.	N.D.	N.D.	20.9	N.D.	N.D.	N.D.	N.D.	N.D.
	b	N.D.	N.D.	N.D.	N.D.	N.D.	N.D.	N.D.	22.8	N.D.	N.D.	N.D.	N.D.	N.D.
	Average								22					
S-C-LS 40%-A	a	N.D.	N.D.	N.D.	N.D.	N.D.	N.Q.	N.D.	N.D.	N.D.	N.D.	N.D.	N.D.	N.D.
	b	N.D.	N.D.	N.D.	N.D.	N.D.	N.Q.	N.D.	N.D.	N.D.	N.D.	N.D.	N.D.	N.D.
	Average													
S-C-LS 40%-B	a	N.D.	N.D.	N.D.	N.D.	N.D.	N.D.	N.D.	N.D.	N.D.	N.D.	N.D.	N.D.	N.D.
	b	N.D.	N.D.	N.D.	N.D.	N.D.	N.D.	N.D.	N.D.	N.D.	N.D.	N.D.	N.D.	N.D.
	Average													
S-C-LS 40%-A(DUP)	a	N.D.	N.D.	N.D.	N.D.	N.D.	N.Q.	N.D.	N.D.	N.D.	N.D.	N.D.	N.D.	N.D.
	b	N.D.	N.D.	N.D.	N.D.	N.D.	N.D.	N.D.	N.D.	N.D.	N.D.	N.D.	N.D.	N.D.
	Average													
S-C-LS 60%-A	a	N.D.	N.D.	N.D.	N.D.	N.D.	N.D.	N.D.	N.D.	N.D.	N.D.	N.D.	N.D.	N.D.
	b	N.D.	N.D.	N.D.	N.D.	N.D.	N.D.	N.D.	N.D.	N.D.	N.D.	N.D.	N.D.	N.D.
	Average													
S-C-LS 60%-B	a	N.D.	N.D.	N.D.	N.D.	N.D.	N.D.	N.D.	N.D.	N.D.	N.D.	N.D.	N.D.	N.D.
	b	N.D.	N.D.	N.D.	N.D.	N.D.	N.D.	N.D.	N.D.	N.D.	N.D.	N.D.	N.D.	N.D.
	Average													
S-C-LS 80%-A	a	N.D.	N.D.	N.D.	N.D.	N.D.	N.D.	N.D.	N.D.	N.D.	N.D.	N.D.	N.D.	N.D.
	b	N.D.	N.D.	N.D.	N.D.	N.D.	N.D.	N.D.	N.D.	N.D.	N.D.	N.D.	N.D.	N.D.
	Average													
S-C-LS 80%-B	a	11.5	N.D.	N.D.	8.3	N.D.	N.Q.	N.D.	N.Q.	N.D.	N.D.	N.D.	N.D.	N.D.
	b	12.5	N.D.	N.D.	4.9	N.D.	N.D.	N.D.	N.D.	N.D.	N.D.	N.D.	N.D.	N.D.
	Average	12			6.6									
S-C-LS 80%-B(DUP)	a	N.D.	N.D.	4.9	51.2	N.D.	N.D.	N.D.	N.D.	N.D.	N.D.	N.D.	N.D.	N.D.
	b	N.D.	N.D.	2.2	41.7	N.D.	N.D.	N.D.	N.D.	N.D.	N.D.	N.D.	N.D.	N.D.
	Average			4	46									

(Sheet 6 of 9)

**Table 3-23 (Continued)**

SAMPLE		Energetic material concentrations in soils ppb (µg/kg)												
Name	Number	NG	1,3-DNB	2,6-DNT	2,4-DNT	TNB	TNT	PETN	RDX	4-Am-DNT	3,5-DNA	2-Am-DNT	Tetryl	HMX
S-C-LS 100%-A	a	N.D.	N.D.	N.D.	N.D.	N.D.	N.D.	N.D.	N.Q.	N.D.	N.D.	N.D.	N.D.	N.D.
	b	N.D.	N.D.	N.D.	N.D.	N.D.	N.D.	N.D.	N.Q.	N.D.	N.D.	N.D.	N.D.	N.D.
	Average													
S-C-LS 100%-B	a	N.D.	N.D.	N.D.	N.D.	N.D.	N.D.	N.D.	N.Q.	N.D.	N.D.	N.D.	N.D.	N.D.
	b	N.D.	N.D.	N.D.	N.D.	N.D.	N.D.	N.D.	N.Q.	N.D.	N.D.	N.D.	N.D.	N.D.
	Average													
S-E-HS-63240E 15109N	a	N.D.	N.D.	N.D.	N.D.	N.D.	N.D.	N.D.	N.D.	N.D.	N.D.	N.D.	N.D.	N.D.
	b	N.D.	N.D.	N.D.	N.D.	N.D.	N.D.	N.D.	N.D.	N.D.	N.D.	N.D.	N.D.	N.D.
	Average													
S-E-HS-63240E 15109N	a	N.D.	N.D.	N.D.	N.D.	N.D.	N.Q.	N.D.	N.D.	N.D.	N.D.	N.D.	N.D.	N.D.
	b	N.D.	N.D.	N.D.	N.D.	N.D.	N.Q.	N.D.	N.Q.	N.D.	N.D.	N.D.	N.D.	N.D.
	Average													
S-E-1-0-1	a	18.5	N.D.	N.D.	N.D.	N.D.	N.D.	N.D.	N.D.	N.D.	N.D.	N.D.	N.D.	N.D.
	b	24.8	N.D.	N.D.	N.Q.	N.D.	N.D.	N.D.	N.D.	N.D.	N.D.	N.D.	N.D.	N.D.
	Average	22												
S-E-1-1-3	a	45.2	N.D.	N.D.	N.D.	N.D.	N.Q.	N.D.	N.D.	N.D.	N.D.	N.D.	N.D.	N.D.
	b	36.2	N.D.	N.D.	N.D.	N.D.	N.D.	N.D.	N.D.	N.D.	N.D.	N.D.	N.D.	N.D.
	Average	41												
S-E-1-3-5	a	408	N.D.	N.D.	N.D.	N.Q.	N.Q.	N.D.	N.Q.	N.D.	N.D.	N.D.	N.D.	N.D.
	b	313	N.D.	N.D.	N.D.	N.D.	N.Q.	N.D.	N.Q.	N.D.	N.D.	N.D.	N.D.	N.D.
	Average	360												
S-E-2-0-1	a	5.7	N.D.	N.D.	N.D.	N.D.	N.D.	N.D.	N.D.	N.D.	N.D.	N.D.	N.D.	N.D.
	b	4.9	N.D.	N.D.	N.D.	N.D.	N.Q.	N.D.	N.Q.	N.D.	N.D.	N.D.	N.D.	N.D.
	Average	5												
S-E-2-1-3	a	11.4	N.D.	N.D.	N.D.	N.D.	N.Q.	N.D.	N.D.	N.D.	N.D.	N.D.	N.D.	N.D.
	b	10.1	N.D.	N.D.	N.D.	N.D.	N.Q.	N.D.	N.D.	N.D.	N.D.	N.D.	N.D.	N.D.
	Average	11												
S-E-2-3-5	a	65.8	N.D.	N.D.	2.3	N.D.	N.Q.	N.D.	N.D.	N.D.	N.D.	N.D.	N.D.	N.D.
	b	46.0	N.D.	N.D.	2.0	N.Q.	N.Q.	N.D.	N.D.	N.D.	N.D.	N.D.	N.D.	N.D.
	Average	56			2									
S-D-HS-74210E 01267N	a	N.D.	N.D.	N.D.	N.D.	N.D.	N.Q.	N.D.	N.D.	N.D.	N.D.	N.D.	N.D.	N.D.
	b	N.D.	N.D.	N.D.	N.D.	N.Q.	N.Q.	N.D.	N.Q.	N.D.	N.D.	N.D.	N.D.	N.D.
	Average													
S-D-HS-74326E 01195N	a	N.D.	N.D.	N.D.	N.D.	N.D.	N.D.	N.D.	N.D.	N.D.	N.D.	N.D.	N.D.	N.D.
	b	N.D.	N.D.	N.D.	N.D.	N.D.	N.D.	N.D.	N.Q.	N.D.	N.D.	N.D.	N.D.	N.D.
	Average													
S-D-HS-74215E 01278N	a	N.D.	N.D.	N.D.	N.D.	N.Q.	55.2	N.D.	N.D.	39.2	N.D.	40.8	N.D.	N.D.
	b	N.D.	N.D.	N.D.	N.D.	N.Q.	37.0	N.D.	N.D.	12.4	N.D.	15.1	N.D.	N.D.
	Average						46			26		28		
S-D-1-0-1	a	N.D.	N.D.	N.D.	N.D.	N.D.	N.D.	N.D.	N.D.	N.D.	N.D.	N.D.	N.D.	N.D.
	b	N.D.	N.D.	N.D.	N.D.	N.D.	N.D.	N.D.	N.D.	N.D.	N.D.	N.D.	N.D.	N.D.
	Average													

(Sheet 7 of 9)

**Table 3-23 (Continued)**

SAMPLE		Energetic material concentrations in soils ppb (µg/kg)												
Name	Number	NG	1,3-DNB	2,6-DNT	2,4-DNT	TNB	TNT	PETN	RDX	4-Am-DNT	3,5-DNA	2-Am-DNT	Tetryl	HMX
S-D-1-1-3	a	N.D.	N.D.	N.D.	N.D.	N.D.	N.D.	N.D.	N.D.	N.D.	N.D.	N.D.	N.D.	N.D.
	b	N.D.	N.D.	N.D.	N.D.	N.D.	N.D.	N.D.	N.D.	N.D.	N.D.	N.D.	N.D.	N.D.
	Average													
S-D-1-3-5	a	6.1	N.D.	N.D.	N.D.	N.D.	N.D.	N.D.	N.Q.	N.D.	N.D.	N.D.	N.D.	N.D.
	b	6.0	N.D.	N.D.	N.D.	N.D.	N.D.	N.D.	N.D.	N.D.	N.D.	N.D.	N.D.	N.D.
	Average	6												
S-D-2-0-1	a	N.D.	N.D.	N.D.	N.D.	N.D.	N.D.	N.D.	N.D.	N.D.	N.D.	N.D.	N.D.	N.D.
	b	N.D.	N.D.	N.D.	N.D.	N.D.	N.D.	N.D.	N.D.	N.D.	N.D.	N.D.	N.D.	N.D.
	Average													
S-D-2-1-3	a	N.D.	N.D.	N.D.	N.D.	N.D.	N.D.	N.D.	N.D.	N.D.	N.D.	N.D.	N.D.	N.D.
	b	N.D.	N.D.	N.D.	N.D.	N.D.	N.D.	N.D.	N.D.	N.D.	N.D.	N.D.	N.D.	N.D.
	Average													
S-D-2-3-5	a	N.D.	N.D.	N.D.	N.D.	N.D.	N.D.	N.D.	N.D.	N.D.	N.D.	N.D.	N.D.	N.D.
	b	N.D.	N.D.	N.D.	N.D.	N.D.	N.D.	N.D.	N.D.	N.D.	N.D.	N.D.	N.D.	N.D.
	Average													
S-A-2-0-1	a	N.D.	N.D.	N.D.	N.D.	N.D.	N.D.	N.D.	N.D.	N.D.	N.D.	N.D.	N.D.	N.D.
	b	N.D.	N.D.	N.D.	N.D.	N.D.	N.D.	N.D.	N.D.	N.D.	N.D.	N.D.	N.D.	N.D.
	Average													
S-A-2-1-3	a	N.D.	N.D.	N.D.	N.D.	N.D.	N.Q.	N.D.	N.D.	N.D.	N.D.	N.D.	N.D.	N.D.
	b	N.D.	N.D.	N.D.	N.D.	N.D.	N.Q.	N.D.	N.Q.	N.D.	N.D.	N.D.	N.D.	N.D.
	Average													
S-A-2-3-5	a	N.D.	N.D.	N.D.	N.D.	N.D.	N.Q.	N.D.	N.D.	N.D.	N.D.	N.D.	N.D.	N.D.
	b	N.D.	N.D.	N.D.	N.D.	N.D.	N.Q.	N.D.	N.D.	N.D.	N.D.	N.D.	N.D.	N.D.
	Average													
S-A-LS 60%-A	a	N.D.	N.D.	N.D.	N.Q.	N.D.	N.D.	N.D.	N.D.	N.D.	N.D.	N.D.	N.D.	N.D.
	b	N.D.	N.D.	N.D.	N.Q.	N.D.	N.D.	N.D.	N.D.	N.D.	N.D.	N.D.	N.D.	N.D.
	Average													
S-A-LS 60%-B	a	N.D.	N.D.	N.D.	N.D.	N.D.	2068	N.D.	N.D.	N.D.	N.D.	N.D.	N.D.	N.D.
	b	N.D.	N.D.	N.D.	N.D.	N.D.	1034	N.D.	N.Q.	N.D.	N.D.	N.D.	N.D.	N.D.
	Average						1551							
S-A-LS 80%-A	a	N.D.	N.D.	N.D.	N.D.	N.D.	5.4	N.D.	N.D.	N.D.	N.D.	N.D.	N.D.	N.D.
	b	N.D.	N.D.	N.D.	N.D.	N.D.	4.1	N.D.	N.Q.	N.D.	N.D.	N.D.	N.D.	N.D.
	Average						5							
S-A-LS 80%-B	a	N.D.	N.D.	N.D.	N.D.	N.D.	N.D.	N.D.	N.D.	N.D.	N.D.	N.D.	N.D.	N.D.
	b	N.D.	N.D.	N.D.	N.D.	N.D.	N.D.	N.D.	N.D.	N.D.	N.D.	N.D.	N.D.	N.D.
	Average													
S-A-LS 80%-B(DUP)	a	N.D.	N.D.	N.D.	N.D.	N.D.	N.D.	N.D.	N.D.	N.D.	N.D.	N.D.	N.D.	N.D.
	b	N.D.	N.D.	N.D.	N.D.	N.D.	N.D.	N.D.	N.D.	N.D.	N.D.	N.D.	N.D.	N.D.
	Average													
S-A-LS 100%-A	a	N.D.	N.D.	N.D.	N.D.	N.D.	N.Q.	N.D.	N.Q.	N.D.	N.D.	N.D.	N.D.	N.D.
	b	N.D.	N.D.	N.D.	N.D.	N.D.	N.Q.	N.D.	N.D.	N.D.	N.D.	N.D.	N.D.	N.D.
	Average													

(Sheet 8 of 9)

Table 3-23 (Concluded)														
SAMPLE		Energetic material concentrations in soils ppb (µg/kg)												
Name	Number	NG	1,3-DNB	2,6-DNT	2,4-DNT	TNB	TNT	PETN	RDX	4-Am-DNT	3,5-DNA	2-Am-DNT	Tetryl	HMX
S-A-LS 120%-A	a	N.D.	N.D.	N.D.	N.D.	N.D.	N.D.	N.D.	N.D.	N.D.	N.D.	N.D.	N.D.	N.D.
	b	N.D.	N.D.	N.D.	N.D.	N.D.	N.Q.	N.D.	N.D.	N.D.	N.D.	N.D.	N.D.	N.D.
	Average													
S-A-LS 120%-B	a	N.D.	N.D.	N.D.	N.D.	N.D.	55.2	N.D.	N.Q.	N.D.	N.D.	N.D.	N.D.	N.D.
	b	N.D.	N.D.	N.D.	N.D.	N.D.	52.5	N.D.	N.D.	N.D.	N.D.	N.D.	N.D.	N.D.
	Average						54							
S-A-1-0-1	a	N.D.	N.D.	N.D.	N.D.	N.D.	N.Q.	N.D.	N.Q.	N.D.	N.D.	N.D.	N.D.	N.D.
	b	N.D.	N.D.	N.D.	N.D.	N.D.	N.Q.	N.D.	N.Q.	N.D.	N.D.	N.D.	N.D.	N.D.
	Average													
S-A-1-1-3	a	N.D.	N.D.	N.D.	N.D.	N.D.	N.D.	N.D.	N.D.	N.D.	N.D.	N.D.	N.D.	N.D.
	b	N.D.	N.D.	N.D.	N.D.	N.D.	N.Q.	N.D.	N.D.	N.D.	N.D.	N.D.	N.D.	N.D.
	Average													
S-A-1-3-5	a	N.D.	N.D.	N.D.	N.D.	N.D.	N.D.	N.D.	N.D.	N.D.	N.D.	N.D.	N.D.	N.D.
	b	N.D.	N.D.	N.D.	N.D.	N.D.	N.D.	N.D.	N.Q.	N.D.	N.D.	N.D.	N.D.	N.D.
	Average													
S-E-3-0-1	a	N.D.	N.D.	N.D.	N.D.	N.D.	N.D.	N.D.	N.Q.	N.D.	N.D.	N.D.	N.D.	N.D.
	b	N.D.	N.D.	N.D.	N.D.	N.D.	N.D.	N.D.	N.Q.	N.D.	N.D.	N.D.	N.D.	N.D.
	Average													
S-E-3-1-3	a	N.D.	N.D.	N.D.	N.D.	N.D.	N.D.	N.D.	N.Q.	N.D.	N.D.	N.D.	N.D.	N.D.
	b	N.D.	N.D.	N.D.	N.D.	N.D.	N.D.	N.D.	N.D.	N.D.	N.D.	N.D.	N.D.	N.D.
	Average													
S-E-3-3-5	a	8.6	N.D.	N.D.	N.D.	N.D.	N.Q.	N.D.	N.D.	N.D.	N.D.	N.D.	N.D.	N.D.
	b	16.1	N.D.	N.D.	N.D.	N.D.	N.Q.	N.D.	N.Q.	N.D.	N.D.	N.D.	N.D.	N.D.
	Average	12												
S-E-4-0-1	a	N.D.	N.D.	N.D.	2.3	N.D.	N.Q.	N.D.	N.Q.	N.D.	N.D.	N.D.	N.D.	N.D.
	b	N.D.	N.D.	N.D.	N.D.	N.D.	N.Q.	N.D.	N.Q.	N.D.	N.D.	N.D.	N.D.	N.D.
	Average													
S-E-4-1-3	a	N.D.	N.D.	N.D.	N.D.	N.D.	N.Q.	N.D.	N.Q.	N.D.	N.D.	N.D.	N.D.	N.D.
	b	N.D.	N.D.	N.D.	N.D.	N.D.	N.D.	N.D.	N.Q.	N.D.	N.D.	N.D.	N.D.	N.D.
	Average													
S-E-4-3-5	a	N.D.	N.D.	N.D.	N.D.	N.D.	N.D.	N.D.	N.Q.	N.D.	N.D.	N.D.	N.D.	N.D.
	b	N.D.	N.D.	N.D.	N.D.	N.D.	N.D.	N.D.	N.Q.	N.D.	N.D.	N.D.	N.D.	N.D.
	Average													
Estimated DL in extract		2.0	0.20	0.16	0.18	0.60	0.10	5.0	0.60	0.32	0.40	0.50	4.0	5.0
		Sample had numerous interference peaks												
a and b: lab duplicates		Sample analyzed only in diluted solution												
Quantification limits in soils (ppb)		5	0.5	0.4	2	10	0.25	12.5	1.5	0.8	5	1.3	10	12.5
Note = the quantification limits take into account the interference peak and background results. N.D. : not detected N.Q. : detected, but not quantified														

(Sheet 9 of 9)

Analysis by GC using the EPA-8095 method was done at CRREL. This method allows detection limits in fractions of ppb for explosive analytes.



However, the quantification limits for our soil samples were slightly higher based on interference peaks present in the soils extracts. The quantification limits obtained for the following analytes were, respectively (in ppb): NG (5), 1,3-DNB (0.5), 2,6-DNT (0.4), 2,4-DNT (2), TNB (10), TNT (0.25), PETN (12.5), RDX (1.5), 4-am-DNT (0.8), 2-am-DNT (1.3), 3,5-DNA (5), Teteryl (10) and HMX (12.5).

One background sample (BG) presented traces of HMX (S-BG-52660E 22764N) and another one presented traces of both HMX and TNT (S-BG-62033E 01742N). The first one was collected far away from the training area (approximately 2 km). The presence of HMX is quite unusual at that remote location. This location was re-sampled in Sept 2002 to verify this result that could be explained by laboratory cross-contamination. The second BG showing the presence of both TNT and HMX was collected southwest of the limit of the Cologne BR still within the limit of the training area. A field duplicate was also collected in Sept 2002 to confirm this result. Soil erosion and wind from Cologne BR could explain the presence of traces of both energetic analytes in this last sample.

All samples were thoroughly homogenised and analysed in duplicates (lab-duplicates) to verify the sample homogenization efficiency. Means and standard deviations were calculated for all sets of replicate measurements. Suspect individual measurements were flagged on the basis of extreme values of the relative standard deviation (RSD) and inconsistencies in the overall pattern for that sample or analyte. More than 80 percent of the laboratory replicates showed a RSD < 30 percent, which indicates that the approach taken for soil homogenization by adding acetone after the drying step was quite efficient. However, for some parameters, RSD as high as 155 percent were still observed.

A total of 12 field duplicates of the 87 soil samples collected across the training area were collected to assess the field reproducibility achieved by the composite sampling approach. The results obtained for field replicates varied from sample to sample as well as from analyte to analyte within the same sample. For sample S-GR-25M-B and S-GR-25M-B-dup, respectively, results showed good agreement between field duplicates. All analytes for sample S-GR-25M-B were detected in the same order of magnitude as in sample S-GR-25M-B-dup. In general, the percent RSD was higher for field replicates than for lab replicates in this study, and this has been often observed in past studies [5,17,18]. However, the levels measured in all field replicates did not vary more than one order of magnitude between replicates and the general pattern was the same for both samples. The main goal for analyzing field and lab duplicates within this study was not to perform a detailed statistical analysis of the data set, but to increase the level of confidence. Since, in general, the percent RSD for most lab replicates was relatively low, and the same trends were seen for field replicates, the acquired data were judged adequate and conclusions were drawn from them. This demonstrated again that explosives showed a pattern of high spatial heterogeneity as field contaminants, and that, even with careful compositing, the percent RSD between field replicates is often still high.

## Metals

For all soil samples, 29 parameters, including the most common metals, were analysed by inductively coupled plasma/mass spectrometry (ICP/MS) (Al, As, Ba, Be, B, Bi, Cd, Ca, Cr, Co, Cu, Fe, Pb, Mg, Mn, Mo, Ni, K, Se, Ag, Na, Sr, Tl, Sn, Ti, U, Th, V, and Zn). Thorium was analysed only for a limited number of samples, most of them being located in areas where Milan missiles had been fired. For biomass samples, 28 parameters, including the most common metals, were analysed (Al, As, Ba, Be, Cd, Ca, Cr, Co, Cu, Fe, Pb, Mg, Mn, Mo, Ni, P, K, Sb, Se, Ag, Na, Sr, Tl, Sn, Ti, Th, V, and Zn). Again, Thorium was analysed only in a limited number of samples. For aqueous samples, the following 48 parameters were analysed: alkalinity as CaCO<sub>3</sub>, alkalinity as bicarbonate, alkalinity as hydroxide, pH, electrical conductivity, total dissolved solids, turbidity, chloride, nitrite-nitrate, sulphate, hardness as CaCO<sub>3</sub>, and metals (Al, As, Sb, Ba, Be, B, Bi, Cd, Ca, Cr, Co, Cu, Ce, Fe, Pb, Li, Mg, Mn, Mo, Ni, P, K, Ru, Se, Ag, Na, Sr, Tl, Sn, Te, Ti, U, Th, V, W, Zr, and Zn). Since the results for metals are presented in many tables, and since many parameters exceeding the criteria, global analysis of all metals was not possible. We, therefore, analyzed them on a range by range basis that will be presented in the "Results and Discussion" section of this chapter.

## Thorium

In soils thorium concentrations varied from 1.19 to 6.35 ppm in Aachen battlerun (Table 3-24). The calculated mean value for the background samples was 2.73 ppm and the average measured concentrations of thorium in soils were around 3 ppm. The highest concentration of 6.35 ppm was found around Target 1 in Aachen battlerun. Since no Milan missiles were reported to have been fired in Aachen battlerun, only 25 percent of the samples collected were screened for thorium. So, only a few hits were found at levels above background in the target area of Aachen and Deleignhofen.

<b>Table 3-24 Thorium Concentrations in Soil Samples</b>			
<b>Sample</b>	<b>Concentration, ppm</b>	<b>Sample</b>	<b>Concentration, ppm</b>
S-BG-69940	3.89	S-E-HS-63450	2.46
S-BG-52660	3.26	S-E-1-0-1	2.94
S-BG-80356	2.59	S-E-1-1-3	3.26
S-BG-57997	3.04	S-E-1-3-5	3.46
S-BG-65629	1.19	S-E-2-0-1	2.10
S-BG-63783	2.74	S-E-2-1-3	2.98
S-BG-78159	1.41	S-E-2-3-5	3.17
S-BG-62630	2.70	S-D-HS-74210	3.68
S-BG-79182	3.52	S-D-HS-74215	5.55
S-BG-74864	3.64	S-D-HS-74215	1.79
S-BG-49148	1.76	S-D-1-0-1	2.37
S-BG-49148	2.97	S-D-1-1-3	4.14
S-BG-55265	3.90	S-D-1-3-5	2.31
S-BG-74864	2.41	S-D-2-0-1	1.31
S-BG-55255	2.19	S-D-2-1-3	1.40
S-BG-53656	3.54	S-D-2-3-5	2.33
S-BG-80720	1.54	S-D-2-1-3	1.95
S-BG-53670	2.83	S-A-LS-80% B	3.44
S-BG-67858	3.21	S-A-LS-100% A	2.85
S-BG-68067	2.17	S-A-1-0-1	6.35
S-BG 69431	2.86	S-A-3-0-1	3.14
S-BG-63565	2.19	S-A-3-1-3	4.50
S-BG-62033	3.19	S-E-3-3-5	2.24
<b>S-BG-MEAN</b>	<b>3 ± 1</b>	S-E-4-0-1	3.41
S-A-LS-20% B	2.81	S-E-4-1-3	3.52
S-A-LS-40% A	2.38	S-E-4-3-5	2.92
S-C-1-0-1	2.05	Internal standard 6.5	6.5
S-C-2-1-3	4.46	Internal standard 1.2	1.22
S-C-3-3-5	2.43	Blank-1	<0.1
S-C-LS-20% B	2.50	Blank-2	<0.1
S-C-LS-40% A	3.66		
S-C-LS-40% A DUP	2.17		
S-C-LS-80% B	3.03		
S-C-LS-80% B-DUP	3.27		
S-C-LS-100% A	2.39		
S-E-HS-63240	4.67		

Color shown only in electronic version of this report.  
In red: value higher than mean background level + twice standard deviation.

For surface water samples, most concentrations of thorium were detected at very low levels or were below the detection limits (Table 3-12). In groundwater samples, thorium concentrations generally decreased with distance from targeted areas (Table 3-10). The highest concentration measured in 2000 reached 1.145 ppb and was located in Deilinghofen firing area (GW-D-3). At this same location, in 2001, the concentration decreased to 0.31 ppb. This could indicate

that the concentration of thorium is decreasing (GW-D-3 location). The highest concentrations measured were 2.35 ppb again in Deilinghofen (GW-D-8, located downgradient of GW-D-3). Nevertheless, this concentration is lower than the CCME threshold criteria. No thorium was found in the three springs and in the two supply wells of the base.

In biomass samples, thorium exceeded the BGL for some Essen samples (Table 3-25). Only two background biomass samples were analysed for thorium concentration and this situation was corrected by collecting more biomass background samples during the Sept 2002 sampling campaign. The mean value calculated from the two background samples was 0.80 ppb. In Essen, seven biomass samples showed thorium concentrations higher than 0.80 ppb, nevertheless, all of the results were around 1 ppb, with the highest being at 1.38 ppb near missile debris. This value is very low; therefore, thorium concentrations in biomass should not be considered a threat. One sample included only the roots of the plants. In this sample a concentration of 15.69 ppb was observed. Plants are known to be capable of concentrating metals in their root system. As discussed earlier, grazing animals do not eat the root system; therefore, no threat should be considered against grazing animals. Moreover, this sample represented a localized source, since it was taken directly under Milan missile debris and did not represent the situation for the entire range. No action is required except removing the debris and disposing of it according to the existing radiological procedure. In Deilinghofen, no biomass samples showed thorium concentration higher than the background levels.

<b>Sample</b>	<b>Concentration (ppb)</b>
B-D-1-0-3	0.16
B-D-1-0-3	0.18
B-D1-3-5	0.54
B-D-12-0-3	0.25
B-D-2-3-5	0.43
B-E-1-0-3	0.97
B-E-1-3-5	0.85
B-E-2-0-3	0.77
B-E-2-3-5	0.99
B-E-HS-63240 15109	0.47
B-E-H-S-63240 15109 DUP	0.57
B-E-HS-64435 14486	1.38
B-E-HS-64435 14486	0.58
B-E-3-0-1 RACINE	15.69
B-E-3-0-3	0.68
B-E-3-3-5	1.03
B-E-4-0-3	0.93
B-E-4-3-5	0.83
BG-1	0.66
BG-2	0.75

## Results and Discussion

Since some particular contaminants were observed in specific areas, such as around targets in the battleruns, in grenade and rifle ranges, etc., the specific problem related to each type of ranges was evaluated. Concentrations of contaminants in soils, biomass, and groundwater were correlated. Attempts were made to correlate the firing activities with the resulting observed contamination patterns. Recommendations to propose solutions or mitigation techniques were made.

The results for metals in soils and biomass are presented at Tables 3-13 and 3-14. The results in red are higher than the mean background levels (BGL) added to twice the standard deviation. The results in blue are higher than the CCME agricultural soil quality guidelines (ASQG).<sup>1</sup> A total number of 46 biomass and 130 soil samples were collected during Phase II in 2001. The parameters analyzed in soils were as follows: Al, As, Ba, Be, B, Bi, Cd, Ca, Cr, Co, Cu, Fe, Pb, Mg, Mn, Mo, Ni, K, Se, Ag, Na, Sr, Tl, Sn, Ti, U, V, and Zn. The parameters analyzed in biomass were as follows: Al, As, Sb, Ba, Be, Cd, Ca, Cr, Co, Cu, Fe, Pb, Mg, Mn, Mo, Ni, P, K, Se, Ag, Na, Sr, Tl, Sn, Ti, V, Zn. Thus, a total number of 1,257 parameters were analyzed for biomass and 3,045 for soils. Out of these, 19 percent exceeded the BGL for biomass and 12 percent exceeded either the BGL or the ASQG for soils. The results for plants correspond to the total amount of metals both bio-accumulated and deposited on the plants, since the total digestion of the plants was accomplished. Analyzing leachates to discriminate between metals in and on plants was not judged necessary, since wildlife ingest the metals, in both cases by eating the entire plants.

Since groundwater results were obtained from unfiltered samples, these represent the worst case. However, comparing results with results from soils and biomass is still worthy and interesting. The results obtained are presented for rifle ranges, grenade range, for Aachen, Cologne, Deleighofen, Essen, and Klein Essen battleruns, and for the ASA.

### Rifle ranges

Three of the four Shilo rifle ranges were sampled as described in the section of this chapter entitled "Sampling Strategy" based on their extensive use by the troops. Both soil and biomass samples were collected in front of targets as shown in Figures 3-16 and 3-17. Samples collected in these ranges totaled 34 soil and 11 biomass. Subsurface soils were also collected using either stainless steel scoops or a manually operated core sampler. Subsurface soils were collected to verify whether contamination would be observed in the vertical soil profile. Many deer tracks and droppings were observed on these ranges.

**Soils.** The total of 126 parameters exceeded either the BGL or the ASQG out of the 952 parameters analysed for in the 34 soil samples (Table 3-21). These parameters were as follows:

---

<sup>1</sup> Color is shown only in the electronic version of the report and not in the limited number of printed copies.

- As: 6 surface soils samples that exceeded the ASQG (maximum level at 1.4 times higher or 16.3 ppm);
- Bi: 21 samples, including 6 subsurface samples that exceeded the BGL (maximum level at 21 times higher or 4.16 ppm);
- Cu: 32 samples that exceeded the BGL and ASQG (15 samples were lower than 100 ppm, while 17 samples presented results over 100 ppm). Both surface and subsurface soils were impacted with high levels of copper (maximum level at 84 times higher than the ASQG or 7620 ppm);
- Pb: All samples presented high levels of lead. Results varied from 32 ppm to 44,000 ppm. In range 2, the results exceeded the Industrial Soil Quality Guideline (ISQG) by 73 times or 44,000 ppm;
- Ni: 4 samples including surface and subsurface soils exceeded the ASQG (maximum level at 3.6 times higher or 183 ppm);
- Sr: 4 samples slightly exceeded the BGL in ranges 1 and 2;
- Tl: 5 samples slightly exceeded the BGL in ranges 2 and 4;
- Sn: 7 samples exceeded the BGL in ranges 2 and 4 (maximum level at 3 times higher or 14 ppm);
- Zn: A total of 14 samples exceeded the ASQG including surface and subsurface (maximum level at 683 times higher or 683 ppm).

The results obtained for metal concentrations in soils demonstrated a clear impact of the firing activities with small arms. Both surface and subsurface soils showed the same trends. The samples were carefully sieved to avoid the inclusion of metallic fragments in the digest. By doing this, we evaluated the potential contribution of metals attached to soil particles that can be inhaled or transported via sedimentation or dissolution through the groundwater. However, very fine metallic particles that were included contributed to the total amount of metals and may not represent necessarily the bioavailable metals. Large fragments are understood to be nonbioavailable, but will eventually contribute to groundwater contamination with time, since as they are slowly dissolved by atmospheric conditions. Therefore, removing metallic fragments from the ranges decreases the potential intake for groundwater contamination and represents a good practice that should be continued.

**Biomass.** A total of 75 of the 308 parameters exceeded the BGL in the 11 biomass samples. These were as follows:

- Al: 1 sample slightly exceeded the BGL for Al;
- As: 4 samples exceeded (maximum level at 2 times higher, or 466 ppm);
- Sb: All samples greatly exceeded the BGL (maximum level at 218 times higher, or 19.6 ppm);
- Ca, Mg, Na: 10 samples exceeded the BGL for either Ca, Mg, or Na with a maximum for Ca at 7,870 ppm;
- Cu: 8 samples exceeded the BGL. (maximum level at 6.3 times higher on rifle range 2, or 47 ppm);
- Fe: 1 sample slightly exceeded BGL.
- Pb: All samples greatly exceeded (vary from 38 to 789 times the BGL, or 631 ppm);
- Mo: 3 samples slightly exceeded BGL in rifle range 1;
- Se: 4 samples in the three ranges slightly exceeded BGL;

- Sr: 10 samples exceeded BGL (maximum level at 2.4 times higher or 24.9 ppm);
- V: 1 sample slightly exceeded BGL;
- Zn: All samples exceeded (maximum level at 2 times higher, or 65.3 ppm);

Results obtained for soils in rifle ranges correlated well with results obtained for the biomass samples. In particular, high levels of arsenic, copper, lead, strontium, and zinc were found both in soils and biomass (Table 3-21). Lead was found at the highest concentration compared to backgrounds and was as high as 789 times the BGL in plants. Antimony was also found at high levels in the biomass extracts. Unfortunately, Sb was not included in the soil analysis series. A peculiar difference between soils and biomass was observed. The larger amount of alkaline metals (Na-Mg-K) in plants was not found in soils. These analytes are known to be readily extracted by plants. The mixed contamination of plants by heavy metals and Ca-K-Mg-Na create a preferential intake of these contaminated plants by the wildlife. This was observed on the ranges where many deer tracks and droppings were seen. The salty taste of the Na-Mg-K attracts the deer to this heavy metal contaminated vegetation. This problem should be addressed in the future to avoid grazing animals on these areas. A measure as simple as a tall fence around the rifle ranges should correct this situation, at least for large animals like deer.

**Groundwater.** The following parameters that exceeded BGL or CCME Soil Quality Guidelines (SQGL) criteria for soils and biomass were also found exceeding groundwater BGL or water quality guidelines (WQGL) criteria: As, Pb, Cu, Fe, Ni and Sn. These metals were allowed to percolate through the groundwater, even at neutral pH, by moving of particles containing metals or dissolved metals. However metals concentrations found in the groundwater of the rifle ranges were not very high, indicating that the process of desorption is very slow, since the concentrations in soils were very high.

### **Hand grenade range**

**Soils.** A total of 17 soil samples were collected at the grenade range. Ninety (90) of the 364 metals exceeded either the BGL or the ASQG. These parameters were as follows:

- Cd: All samples exceeded the ASQG except the crater sample (maximum level at 4 times higher, or 3.24 ppm);
- Cr: All samples exceeded the BGL (maximum level at 1.5 times higher, or 29.4 ppm);
- Cu: All samples exceeded the ASQG (maximum level at 5 times higher, or 40.5 ppm);
- Pb: 13 samples exceeded the ASQG (maximum level at 5.7 times higher than the ASQG, 20 times the BGL, or 72.8 ppm);
- Mg: 12 samples exceeded the BGL (maximum level at 1.5 times higher, or 7,810 ppm);
- Ni: 9 samples exceeded the ASQG (maximum level at 1.2 times higher, or 46 ppm);

- Ti: 7 samples exceeded the BGL (maximum level at 1.3 times higher, or 210 ppm);
- Zn: All samples exceeded the ASQG (maximum level at 12 times higher, or 1,770 ppm).

Many metal concentrations were higher than the BGL or ASQG in the grenade range. Metals for which hits were encountered were found on the entire surface of the range, even at the farthest distance from the grenade launching point (35 m). No specific trends were seen in the linear sampling results, neither with length nor with width of the site (A and B samples at different distances, Figures 3-14 and 3-15). The metals found can be related to the Canadian grenade composition. Many parameters exceeded the ASQG.

**Biomass.** No biomass samples were collected at the first sampling event, since the range was not vegetated. However, vegetation was present around the perimeter of the range. If the biomass around the range shows problematic concentrations of some metals, a fence blocking the access of wildlife to the contaminated plants could be installed around the impacted area.

**Groundwater.** Results for many parameters were greater than the BGL or the WQGL in the two wells located down gradient of the grenade range. The parameters exceeding both soils and groundwater criteria were Cd, Cu, Cr, Ni, Pb, Ti, and Zn. Moreover, many other parameters, including W, Ag, As, and Bi, exceeded the BGL or the WQGL for groundwater. This might indicate an impact to the groundwater caused by the grenade range, which can be considered a point source.

Since the soils of the grenade range are impacted with various heavy metals, mitigation techniques should be put into place to reduce or eliminate the dissolution and transport of these to the vadose zone where they may reach the groundwater and move outside of the area. Groundwater was also contaminated with various heavy metals, with many parameters exceeded the BGL or WQGL. The results for soils at the Shilo grenade range are probably representative of all Canadian grenade ranges. The results are not surprising, since grenades are designed to fragment their metallic casing and to project these fragments into the surrounding environment.

A new design for grenade ranges should be put in place if sustained activities are desired. One can imagine that if the water percolating from the grenade range is controlled, the training activity can go on forever. To control the water, the equivalent of a house foundation with a central drain to collect and treat the water could be built. First, a concrete slab covering all the range could be constructed and filled with sand (5 ft thick). The slab should be surrounded by concrete walls and equipped with a central drain system to collect the water that would percolate through the sand. This contaminated water would have to be stored and treated, according to the state of the art, prior to disposal. This structure would prevent the metals from leaching to the groundwater, ensuring sustained range activity. A second option would consist of installing a semi-circular building (Hercules building) over the grenade range that would prevent the rain from impacting the range. A third option would be to install a pump and treat station in a well down gradient of the grenade range to collect the groundwater coming out of the range.



This latter option would be more costly in the long run and would be less efficient. These options are our first thoughts of solutions that could be put into place to control and prevent the contamination. These potential solutions should be discussed in more depth with the end users who would select the best and most practical solution.

**Energetic Materials.** The hand grenade range was sampled linearly as described earlier (see paragraph entitled "Sampling Strategy" and Figure 3-14). Fifteen surface samples were collected across the grenade range. Subsurface samples were not collected since the explosive ordnance disposal (EOD) military officer did not allow digging. However, the frequent detonation of hand grenades allows the mixing of the soil profile and, therefore, surface samples represent a mix of both surface and shallow subsurface soils. All samples presented at least measurable amounts of six explosive residues. Detailed results for the hand grenade range can be found in Table 3-23.

The explosive residues found in this range were 2,6-DNT; 2,4-DNT; TNT; RDX, 4-am-DNT; 2-am-DNT; 3,5-DNA; Teteryl; and HMX. Concentrations of these analytes varied from nondetected to as much as 4,058 ppb for RDX, at 5 m away from the bunker wall. The highest hit for TNT was 725 ppb and was measured in a crater freshly formed by recent grenade detonation. In the same sample, RDX and HMX were also detected at 2,188 and 191 ppb, respectively. The hand grenade range clearly presented a very distinctive contamination pattern when compared to battlerun patterns. The contamination was relatively uniform and present on the entire surface of the range, even at the limit of the range, as much as 35 m away from the bunker. Sample S-GR-30m-A and B presented higher levels of 2,6- and 2,4-DNTs compared to TNT, which is somewhat unusual.

Currently, the Canadian hand grenades are C7 fragmentation grenades, which contain Composition B (186 g), a melt-cast explosive (RDX (60 percent), TNT (39 percent) and HMX (about 10 percent as an impurity in military grade RDX)). Military grade TNT contains about 1 percent TNT isomers (other than the 2,4,6-isomer); 2,4-DNT; 2,6-DNT; 1,3-DNB; and 1,3,5-TNB. The detonator of the grenade also includes 1.3 g of RDX. The grenade primer and fuse systems, and casings contain various heavy metals as well. The ratio of RDX to HMX should be around 8, based on the main composition of the grenade explosive charge. The field ratios obtained of RDX to HMX were between 11 (in the fresh crater sample) and 2.2 for sample 35m-A. This is not surprising, since RDX leaches more rapidly in the soils since it is more water soluble than HMX, has a faster dissolution rate, and thereby results in a lower field RDX to HMX ratio for weathered residues.

In general, the pattern of contamination observed at the Shilo hand grenade range can be directly related to the C7 hand grenade used there. The ratio of various explosive analytes was not always the same as in the grenade composition, but differences can be easily explained by various biotic, abiotic transformation (degradation, photolysis, reaction with organic matter, etc.) and preferential dissolution. The levels of explosive analytes encountered in the hand grenade range are higher than in the battleruns. The contamination on the hand grenade range was present all across the range. However, the maximum level

measured was still under 5 ppm, which is not considered a high level of contamination. No explosives were detected in groundwater. Similar results for explosives in range soils were obtained in USA hand grenade ranges at Fort Lewis and Fort Richardson [7]. The levels of EM and metals in soils measured in these two ranges were somewhat higher than the one measured in the Shilo hand grenade range, potentially explained by a more intense use of their ranges.

Considering all of the results obtained at the grenade range, activity clearly impacts the range soils. The idea of building a slab and controlling the infiltration of metals and also the dissolution of explosives residues should be considered to definitely solve this problem.

### **Anti-tank range**

No soil and biomass samples were taken in the anti-tank range due to safety reasons. Since level-one clearance had not been done for sometime, the probability of walking on UXO was too high (Figure 3-25).



Figure 3-25. Anti-tank Range Shilo

**Groundwater.** Two wells were installed down gradient of the anti-tank range. Results showed that the following parameters exceeded the BGL or the WQGL: nitrate-nitrite, Al, As, Sn, Cr, Co, Cu, Fe, Pb, Mn, Ni, P, Ru, Tl, Ti, V, and Zr. The anti-tank range may represent a point source for many metals, but, unfortunately, these results cannot be compared with soils nor biomass analyses. Surprisingly, no explosives were detected in the two wells as seen in another study [2].

### **Battleruns**

#### **Aachen Battlerun**

**Soils.** A total of 21 soils samples were collected in Aachen battlerun. Linear sampling was conducted at 20, 40, 60, 80, 100, and 120 percent of the range

length. Sample 100 percent B was not collected due to the presence of large bushes and trees on that portion of the range. Two field duplicates were collected at 40- and 80-percent transects. At the 20-percent linear transect, a large quantity of debris from ammunition was observed. Two targets were sampled using the circular pattern both for soils and biomass. Two hot spots were found on the range. They were S-A-HS 60021E 12160N and S-A-HS-60042E 12060N. One looked like a hole where ammunition was dumped, and the other was a spot where a flare had burned.

Out of the 588 parameters analyzed in the 21 soil samples, 8 parameters exceeded either the BGL or the ASQG in Aachen. (Table 3-16). These were as follows:

- Cu: 2 samples exceeded ASQG;
- Ni: 3 samples exceeded ASQG and 16 times BGL, or 394 ppm;
- Mo: 1 sample slightly exceeded BGL;
- Cd: 1 sample exceeded ASQG;
- Co: 1 sample exceeded BGL.

The results demonstrated that the firing activity conducted in the Aachen battlerun did not lead to the accumulation of high levels of metals in soils. This confirms the results obtained in the other battleruns sampled during Phase I in 2000. However, five samples showed values higher than ASQG levels for Cu, Ni, Cd, and Co.

**Biomass.** Four biomass samples were collected around targets 1 and 2. They were collected in a circular pattern between 0 and 3 m and 3 and 5 m from the center of the target. Nine of the 108 parameters exceeded the BGL in the four biomass samples. These were as follows:

- Pb: 2 samples exceeded (highest hit at 5.5 times BGL, or 4.43 ppm);
- Cd: 2 samples slightly higher than BGL;
- Sr: 2 samples slightly higher than BGL;
- Zn: 1 sample slightly higher than BGL.

The results obtained for biomass in Aachen presented mainly higher hits for lead at target 1. By comparing the soils and biomass results, a parallel can be established for cadmium at target 2 where both soils and biomass showed higher levels than both the BGL and ASQG. The levels of lead in soils at target 1 did not present values higher than those found in the biomass.

**Groundwater.** Many parameters exceeded the BGL and the WQGL in Aachen wells presented in Table 3-16. More particularly, Co, Cu, Mo, Ni and Zn were found in soils, biomass, and groundwater. Moreover, 14 metal analytes in groundwater exceeded either BGL or WQGL, while not exceeding the BGL or SQGL in soils, or the BGL in biomass. Our surface soil sampling did not include the coverage of the entire surface of the battlerun and represented only a limited portion of the area. Therefore, results from groundwater analyses were more representative of the impact by the activity. Since the samples were not filtered, this represents the worst-case scenario.

**Energetic Materials.** For the energetic materials, the linear transect sampling was done, two targets were sampled with the help of the circular pattern, and two hot spots were sampled. One hot spot was near the remains of a flare (S-A-HS 62033E 10742N) and the other was in a crater where munition debris was seen (S-A-HS-60021E 12160N). Out of the 14 samples collected in Aachen, 5 presented measurable traces of explosives. They were, respectively, as follows:

- S-A-LS 20 percent A: NG and 2,4-DNT (15 and 6 ppb)
- S-A-LS 20 percent B: TNT and RDX (27 and 6 ppb)
- S-A-LS 60 percent B: TNT (1.2 ppb)
- S-A-LS 80 percent A: TNT (5 ppb)
- S-A-LS 120 percent B: TNT (52 ppb)

No explosive residues were detected in the two locations where debris of munition were present (HS samples) nor in the two circular samples near targets. Explosive residues were detected along the battlerun at 20, 60, 80, and 120 percent of the range length. At 20 percent sample A, traces of NG and 2,4-DNT were found that can be related to the compositions of gun propellants. TNT and RDX present in other transects were found in low concentrations with the highest result being around 1 ppm of TNT.

#### **Berlin Battlerun**

Neither soils nor biomass were collected in Phase II. However, groundwater samples were collected and metals analytes that exceeded the BGL or WQGL are presented in Table 3-17. Many parameters exceeded the threshold levels including Uranium.

#### **Cologne Battlerun**

**Soils.** A total of 30 soil samples were collected in 20-, 40-, 60-, 80-, 100-, and 120-percent linear transects. Three targets were sampled using the circular pattern and seven hot spots nearby various UXOs or UXO debris were collected as well (Figures 3-26, 3-27, and 3-28). Six biomass samples were collected around the three targets.



Figure 3-26. Unexploded ordnance (UXO) CFB Shilo

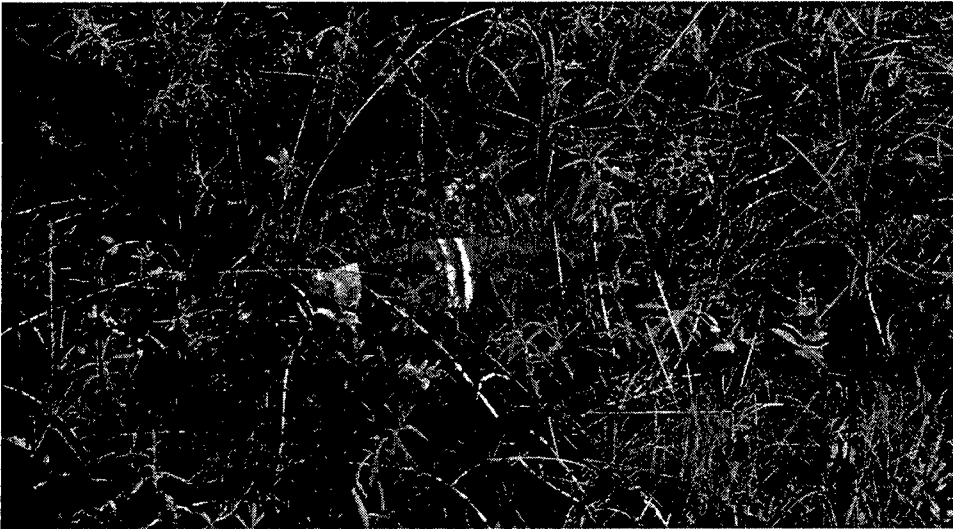

Figure 3-27. UXO, CFB Shilo



Figure 3-28. Another UXO, CFB Shilo

The seven hot spots sampled were 63025E 02811N (small caliber shells), 65011E 02663N (melted flare), 68010E 02205N (120 mm mortar), 65235E 02905N (155 mm), 65266E 02930N (155 mm), 66040E 02939N (155 mm live), and 66017E 02566N (155 mm, shell broken open).

A total of 42 parameters exceeded either the BGL or the ASQG out of the 840 parameters analysed for these 30 soils samples (Table 3-18). These were the following:

- Al, As, Be, Bi, Cd (over ASQG (4X), or 5.86 ppm);
- Cr, Co, Pb (over ASQG (5 X) or 181 ppm);
- Mg, K, Tl, Ti, U (over BGL, highest at 4 times BGL or 17,100 ppm);
- Zn (over ASQG (25X), or 4970).

For the melted flare sample, lead concentration was higher than the ASQG and was five times the BGL. The same sample presented higher levels of Al, Bi, Cd, and Zn. Target 1 concentrations were higher for uranium and arsenic, which were also found at two hot spots. This could indicate that ammunition-containing uranium might have been used in the past in the battlerun. The uranium and arsenic concentrations were 33 percent higher than the BGL, and the arsenic concentration was 40 percent higher than ASQG.

Nine samples presented concentrations higher than ASQG in Cologne battleruns, mainly at targets and hot spots. The results obtained for linear transects correlated well with what was observed during Phase I in the 2000 study in the sense that only a few hits were observed in the battleruns, but never exceeded the ASQG. This demonstrated that localized impacts around targets and hot spots can be observed and may exceed the ASQG in some localized spots in battleruns.

**Biomass.** A total of 8 parameters of the 162 parameters exceeded the BGL in the six biomass samples. These were As, Sb, Pb, and Sr. Out of these, only the results for lead showed values more than twice the BGL. The highest result was

found at target 2 where lead was measured at three times the BGL, or 3.31 ppm. This result was not correlated to the surface soil results where no higher trend for this analyte was observed. At target 1, both soils and biomass presented higher levels of arsenic.

**Groundwater.** Results for the groundwater collected in nine wells located in the Cologne battlerun are presented in Table 3-18. A total of 27 metal analytes were detected at levels higher than the BGL or the WQGL. Of these, 16 were also detected over the threshold values in soils or biomass. Uranium was again detected at levels higher than the ASQG in soils and over the BGL in groundwater. Arsenic and cadmium were also detected at levels higher than the ASQG in soils and over the BGL in groundwater. These results demonstrated that these compounds are coming from an anthropogenic source, and can be related to the firing conducted in this battlerun. Since uranium is not found in background samples, its presence can only be related to the use of weapons containing this element. To our knowledge, depleted uranium ammunition was not fired on this site according to the range control. Therefore, the presence of uranium may indicate that some of these weapons were sporadically fired in the past and that the firings were not recorded.

**Energetic Materials.** For the energetic materials, the linear transect sampling was used in this battlerun. Moreover, three targets were sampled in the circular pattern, and six hot spots were sampled close to various munition debris and near a broken 155-mm UXO (S-C-HS- 66017E 02566N). Out of the 30 samples collected, 6 presented measurable traces of explosives. They were the following, respectively:

- S-C-LS 20 percent B: RDX (21 ppb)
- S-C-LS 80 percent B: NG and 2,4-DNT (12 and 25 ppb)
- S-C-LS 120 percent A: TNT (10 ppb)
- S-C-LS 120 percent B: RDX (5 ppb)
- S-C-2-1-3: RDX (20 ppb)
- S-C-HS- 66017E 02566N: 2,6-DNT (2 ppb)

In this battlerun, six hot spot locations were identified within the range. Out of these six potential sources, only one showed traces of 2,6-DNT near a broken 155-mm UXO. At that location, neither TNT nor RDX was present. At target 2, only one sample showed traces of RDX. In the linear transects, we observed the same trends as in the Aachen battlerun, where traces of TNT, RDX, NG, or 2,4-DNT were detected at 20, 80 and 120 percent of the BR length. In general, traces of some of the explosive analytes were found in six samples, but always at concentrations lower than 0.05 ppm.

### **Deilinghofen Battlerun**

The Deilinghofen range was characterized in the 2000 study (Phase I). In Phase II, soils and biomass samples were collected at two additional targets and in hot spots. This range was searched to identify some localized potential problems and also to collect biomass samples around targets. Only three hot spots were found on the range and were live large caliber ammunitions (155 mm) lying on the surface. They were all complete unbroken shells.

**Soils.** A total of 22 parameters exceeded either the ASQG or the BGL out of the 252 parameters analyzed in these 9 soil samples (Table 3-19). These were as follows:

- Co: 5 out of 6 target samples largely exceeded the BGL (highest hit 12.5 times BGL, or 140 ppm);
- Cu: All the target samples largely exceeded the ASQG (highest hit 3.4 times ASQG, or 137 ppm);
- Pb: All target samples exceeded the ASQG (highest hit 3.4 times ASQG, or 241 ppm);
- Mo: 2 samples slightly exceeded the BGL at target 2;
- Sr: Three samples exceeded the BGL at targets 1 and 2.

Results obtained for the six soils samples around targets exceeded the ASQG both for copper and lead. These metals are usually found in small arms range and are characteristic of them. So, this indicated that these targets were used for small arms targets as well as larger caliber rounds as confirmed by range control. Tank manoeuvres often include the firing of small caliber ammunition with mounted machine guns.

**Biomass.** A total of 29 parameters exceeded the BGL out of the 112 parameters analyzed for the four biomass samples. These were as follows:

- Sb, Ba, Cd, Ca: All samples exceeded, highest 2.1 times the BGL, or 15,500 ppm;
- Cr: 1 sample exceeded at target 1, highest 1.46 times the BGL, or 25.3 ppm;
- Co: 3 samples exceeded, samples at 0-3 m from targets, 3.2 and 2.4 times the BGL or 4.63 ppm maximum;
- Pb: 1 sample exceeded at target 1, 2.1 times the BGL, or 1.72 ppm;
- Mg: 3 samples exceeded, highest hit 1.5 times the BGL, or 2,930 ppm;
- P and K: 4 samples exceeded, highest at 1.5 times the BGL, or 18,600 ppm;
- Na: all samples exceeded the BGL;
- Sr: all samples exceeded, 2 samples nearby targets greatly exceeded (19 times, or 197 ppm);
- Zn: 1 sample exceeded at 40.9 ppm.

The results obtained for the biomass samples in Deilinghofen demonstrated that higher levels of various metals were found in the vicinity of targets. The results correlated well with those of the soil samples where, in both cases, higher levels of cobalt, lead, and strontium were found. However, copper was not found in biomass samples, while it was found in high levels in soils. This might indicate that this metal was not phytoaccumulated in the biomass, while cobalt, lead, and strontium were. Some higher results were obtained in plants for calcium, magnesium, and sodium while not observed in soils. This can be explained by the solubility of these particular alkaline and earth-alkaline metals. They are rapidly dissolved by rain or snow melt, can be taken up by plants, or leached through the groundwater leaving the concentrations in soils very low. The presence of these analytes at higher levels might attract wildlife to the range since they are known as attractants because of their salty taste. Therefore, the wildlife present on the



Shilo range might ingest these plants that contain not only the alkaline and earth-alkaline metals but also the other metals phytoaccumulated in the biomass.

**Groundwater.** A total of 25 metal analytes were detected in exceedance of the BGL or the WQGL in samples collected in the 10 wells located in this battlerun. Out of these 25 metals, 9 were found over the threshold values (BGL or SQGL) in either soils or biomass. Chromium, Pb, Co, and U were of particular concern, since they were found in the majority of wells over at least twice the BGL or over the AWQG. Uranium was found in all of the wells in this part of the range. This can indicate that uranium is naturally occurring in this part of the range, that uranium-containing targets were used in this range, or that depleted uranium or thorium weapons were used there. Since Thorium-232 is not a decomposition product of natural uranium, nor of depleted uranium, the presence of Thorium-232 would suggest thorium weapon use.

**Energetic Materials.** Since they were conducted in Phase I, no linear transects were done in this battlerun. A total of nine samples were collected at two targets and three HS locations. Only two showed traces of explosive residues. They were as follows:

- S-D-HS-74215E 01278N: TNT, 4-am-DNT and 2-am-DNT (46, 26, and 28 ppb, respectively)
- S-D-1-3-5: NG (6 ppb)

In this particular battlerun, one sample collected near a UXO presented detectable traces of TNT and its two amino metabolites. Another sample presented low levels of NG at target 1. Here again, the levels encountered were low with a maximum of 0.05 ppm for TNT.

### **Essen Battlerun**

The Essen range was characterized in Phase I (2000). As with the Deilinghofen range, it was revisited in 2001 for the same reasons. A total of six soils and 13 biomass samples were collected; soils near two UXOs and biomass near four Milan missile debris sites. One plant root sample was collected in a spot where most of the Milan debris was observed. This was done to verify the hypothesis that roots bioaccumulate more contaminants than the stem and leaves of the plants. Moreover, analyses for thorium were repeated to verify that the thorium concentrations (Milan missile impact area in Essen range, (Figure 3-29) changed with time in both soils and groundwater.

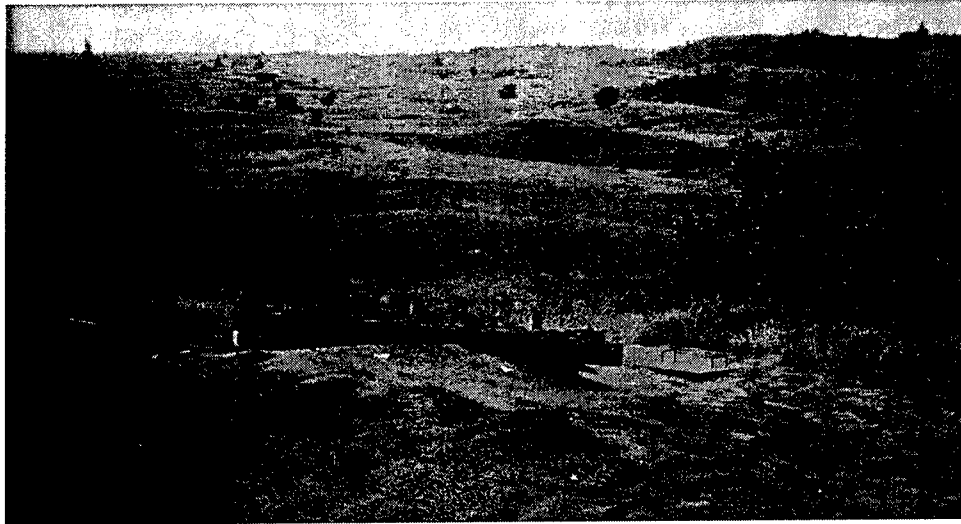

Figure 3-29. Milan Missile Target in Essen, Shilo

**Soils.** A total of 10 samples exceeded the ASQG for copper and lead out of the 224 parameters analysed for the eight soil samples (Table 3-20). These were the following:

- Cu, Pb: 6 samples exceeded the ASQG for lead (highest hit, 6.7 times the ASQG, or 476 ppm).

**Biomass.** A total of 73 parameters exceeded the BGL out of the 351 parameters analysed in the 13 biomass samples. These were as follows:

- Sb: 6 samples exceeded (highest hit 4.3 times the BGL, or 0.6 ppm);
- Ba: 9 samples exceeded (highest hit was 2 times the BGL, or 108 ppm);
- Cd, Ca, Mg, and Na: 10 samples exceeded either one of these analytes nearby Milan debris up to 12,000 ppm;
- Cr, Co, Cu, Pb, Mo, and Sr: all samples exceeded, (highest hit 3 times the BGL, or 45.6 ppm).

The root sample exceeded by far the BGL found for Al, Ba, Be, Cd, Cr, Co, Fe, Pb, Mn, Ni, Se, Na, Sr, Tl, Ti, V, and Zn. These results showed a very strong trend proving that roots bioaccumulate metals to a higher extent than the leaves and stems. These results could not be directly compared to the backgrounds, since no roots were collected in a background area. The impact would depend on whether the roots are eaten by various species of wildlife likely to graze on the site. For species that eat the roots, the conclusions about risk to wild life in the 2000 and 2001 study are highly underestimated. An expert<sup>1</sup> stated that normally the deer and other grazing animals eat preferentially the upper plant tissues and not the roots.

The results obtained for the plant tissues in Essen clearly showed an accumulation of various analytes of concern, including heavy metals, especially lead, molybdenum, and strontium. The presence of other analytes such as

---

<sup>1</sup> Dr. Lucie Olivier, Project Manager, Environment Canada, Montreal, via teleconference, March 2002.

sodium, calcium, and potassium may act as an attractant for the wildlife and enhance the grazing of these contaminated biomass samples relative to less contaminated areas of the base.

The results obtained in soils for copper and lead were correlated with those obtained for the biomass where these two analytes were found at higher levels in both media.

**Groundwater.** A total of 17 metal analytes exceeded either the BGL or the WQGL in the seven wells located in this battlerun. Out of these, five analytes (Co, Cu, Cd, Cr, and Pb) were also found at levels higher than the BGL or SQGL in soils and biomass. In particular, Cu and Pb levels were found at high levels in all types of samples.

**Energetic Materials.** The linear transect sampling was not conducted in this battlerun, since it was accomplished in Phase I. Fourteen samples were collected around four targets and at two HS locations. Six of these presented measurable concentrations of propellant residues. They were the following, respectively:

- S-E-1-0-1: NG (21 ppb)
- S-E-1-1-3: NG (41 ppb)
- S-E-1-3-5: NG (360 ppb)
- S-E-2-0-1: NG (3 ppb)
- S-E-2-1-3: NG (10 ppb)
- S-E-2-3-5: NG and 2,4-DNT (56 and 2 ppb)

In Essen targets, only NG and 2,4-DNT were found with no detectable traces of RDX and TNT. These two analytes are related to gunpowder and could be the result of the Milan missile firing that was conducted there. Milan missile propellant might have not completely burned when the missiles hit the targets. Again, the level of NG and 2,4-DNT were negligible, the highest concentration being less than 0.4 ppm. The two hot spots where ammunition debris was found were free of detectable explosive residues.

### **Klein Essen**

A limited number of samples were collected in Klein Essen. The activity conducted there consisted mainly of machine gun firing. Only five soil and four biomass samples were collected near targets and the bunker. No energetic materials analyses were done at this range, since energetic materials are not associated with small arms. Samples were collected near the bunker since a lot of small arms shells were seen on the ground. No wells were installed in this range.

**Soils.** A total of 15 parameters exceeded either the BGL or the ASQG out of the 140 parameters analysed for in the five soil samples. These were as follows:

- Cu: 6 samples higher than ISQG (highest at 46 times the ISQG, or 4,200 ppm);
- Pb: 4 samples higher than ISQG (highest at 10 times the ISQG, or 6,840 ppm);

- Ni: 4 samples exceeded BGL (highest at 2.7 times the BGL or 50.6 ppm, equal to ISQG);
- Zn: all samples exceeded BGL (highest at 8 times the BGL or 425 ppm, highest at 1.2 times ISQG).

All samples presented high levels of both copper and lead, higher than the ASQG, even higher than the industrial soil quality guidelines (ISQG). The highest hit for copper was at 46 times the ISQG. The results obtained for soils clearly showed the accumulation of high levels of copper and lead from the firing activity conducted in Klein Essen. Results higher than ISQG were encountered and are similar to the ones encountered in rifle ranges where small arms are also used.

**Biomass.** Three biomass samples were collected in Klein Essen, one at a target and two near the bunker (in front and behind).

A total of 16 parameters exceeded the BGL out of the 81 parameters analysed in the three biomass samples. These were as follows:

- Sb, Cd, Ca, Cr, Cu, Pb: 3 samples exceeded (highest result 15.7 times the BGL, or 12.0 ppm);
- P, K, Sr: 3 samples exceeded (highest at 3 times the BGL, or 22.1 ppm);
- Zn: 1 sample exceeded (91.5 times the BGL, or 38.4 ppm).

In general, many analytes of concern were accumulated in both the surface soils and the plants, with results obtained in both media correlating well.

#### **Antenna Service Area (ASA)**

The ASA area was sampled even though this was not a firing range. The ASA was sampled to complete all areas potentially impacted by metals. The ASA area was suspected of being contaminated by metals, since two activities were conducted there over the last few years. The first activity consisted of burning obsolete small arms in an incinerator without a gas scrubber, and the second consisted of accumulating metallic debris coming from the clearances of the ranges. A previous study conducted at CFAD Dundurn demonstrated that the burning of small arms in this type of incinerator led to the contamination of surrounding soils, buildings and biomass [32]. Soils at three hot spots were sampled around the pile of metallic debris, and six composite samples were collected linearly at distances of 5 to 30 m from the furnace at 5-m intervals. A total of nine composite soil samples were collected and five biomass samples. Three biomass samples were collected around the pile of metallic debris and two biomass samples were collected at distances of 0 to 15 and 15 to 30 m from the furnace in a downwind direction.

**Soils.** A total of 65 parameters exceeded either the BGL or the ASQG out of the 252 parameters analysed for the nine soil samples. These were as follows:

- Al, As, Be, Cd: all samples around metal debris pile exceeded the ASQG (highest was at 1.2 times, or 27 ppm);
- Cr and Co: all samples exceeded the BGL;

- Fe, Mo, Sr, Ti, Tl: most of the samples exceeded (two times the BGL);
- Pb: 1 sample exceeded ASQG (close to incinerator at 75.1 ppm);
- Zn: 3 samples exceeded ASQG (hotspots, highest at 495 ppm).

Many metals concentrations were higher than the BGL and the ASQG near these two sources at ASA. No trends related to the distance of the incinerator were observed. The identified problematic analytes were similar to the ones observed in the CFAD Dundurn study [32].

**Biomass.** A total of 32 parameters exceeded the BGL out of the 125 parameters analysed for the five biomass samples. These following analytes showed higher values than the related BG:

- Al: 2 samples exceeded (highest hit 868 ppm or 5 times BGL);
- As: 3 samples exceeded (highest hit 0.58 ppm or 4 times BGL);
- Cd: 3 samples exceeded (highest hit 1.74 ppm or 17 times BGL);
- Cr: 1 sample exceeded (41.7 ppm or 4.6 times BGL);
- Co: 2 samples exceeded (highest hit 0.79 ppm or 4 times BGL);
- Fe: 2 samples exceeded (highest hit 1510 ppm or 47 times BGL);
- Pb: 4 samples exceeded (highest hit 2.77 ppm or 6.9 times BGL);
- Mo: 2 samples exceeded (6.14 ppm or 4.4 times BGL);
- Ni: 1 sample exceeded (19.5 ppm or 3 times BGL);
- Se: 1 sample exceeded (0.3 ppm or 3 times BGL);
- Sr: 4 samples exceeded (highest hit 14.3 ppm or 2 times BGL);
- Ti: 2 samples exceeded (highest hit 33 ppm or 825 times BGL);
- V: 2 samples exceeded (highest hit 1.42 ppm or 3.5 times BGL);
- Zn: 3 samples exceeded (highest hit 43.8 ppm or 2 times BGL);

In general, these parameters exceeded between 2 times and 825 times for Titanium, which reveal a high impact for this latter element. The biomass collected near the ASA clearly showed the accumulation of various metals that were also observed in the soils. Some results in the biomass samples exceeded the BGL for Cd by as much as five times.

Many parallels can be established between the soil and biomass results. Both media were impacted by various analytes and trends were comparable. The results indicated that both activities led to the spreading of metals in the surrounding environment. This type of furnace was banned following the Dundurn study [32]. Therefore, the adverse impacts of this activity were stopped. As for the piling of metal debris, a mitigation measure could be put in place such as a concrete slab, equipped with a central drain, on which the debris would be piled instead of sitting directly on the surface soils. The management of the drainage system would be critical to hinder the metals from reaching the groundwater. Moreover, no wildlife can have access to the biomass presenting higher levels of metals since the area is fenced. The main potential threat at this site is the leaching of the contamination through the soil to reach the underlying groundwater.

**Groundwater.** Two wells were located southwest of the ASA area (AMA1, AMA2). In these wells, only copper and tin were found at levels slightly higher

than the BGL. No correlation can be established between the soil-biomass and groundwater results in this case. This might be explained by the remote position of the two wells compared to the two sources sampled at the ASA.

## Conclusions and Recommendations

### Conclusions

According to the hydrogeological evaluation, groundwater characteristics at CFB Shilo are as follows: a neutral pH (mean 7.56), a low alkalinity (170 to 240 mg/l), a low conductivity (340 to 450 mg/l for lab data and 225 to 535 mg/l for field data), a low total dissolved solids concentration (170-240 mg/l), and a very low concentration in anions (below detection limits). Groundwater velocity was estimated from the Geoflo 40L data and was consistent with the velocities calculated from other field data at 70 to 700 m/y with an average velocity of 350 m/y. Groundwater flow was generally from north to south.

Metal analysis in groundwater from 2001 sampling campaign generally showed concentrations much higher than those from samples collected in 2000. However, this is a result of the fact that the 2001 samples were acidified in the field without filtration, thereby liberating metals adsorbed on particles. The two wells showing the highest metal concentrations are also those with the highest concentrations of dissolved solids (GW-C-8 TDS 1,700 mg/l, and MW-111, TDS 1,100 mg/l). This can be seen as the potential maximum charge of metal that can be brought to the GW level over the years both in solution and in suspension. These values do not, however, represent the concentrations of dissolved metals that would be present in groundwater at any time. Parameters exceeding guidelines were the following: aluminium (Al 83 wells), arsenic (As 7 wells), antimony (Sb 34 wells), barium (Ba 7 wells), chromium (Cr 1 well), iron (Fe 93 wells), lead (Pb 22 wells), manganese (Mn 87 wells), and selenium (Se 3 wells). Aluminium, manganese, and iron are naturally occurring in the environment; high concentrations are probably the results of desorption/dissolution following acidification. The same phenomenon is probably responsible for the high concentrations of other metals. However, since these metals are sometimes linked to military activities, locations showing concentrations above guidelines were re-sampled in September 2002 to verify that these concentrations would not occur in filtered water samples. Generally, metals that exceeded criteria in groundwater also exceeded criteria in soils and biomass. However, metals exceeded the BGL or the aquatic quality guideline (AQGL) more often in groundwater than in soils. This is not surprising since all contaminants, at a certain moment, reach the groundwater and this situation corresponds to a bigger surface source compared to surface sampling, which is localized source. In other words, groundwater concentrations represent a composite from the whole surface source, while the soil concentrations represent small localized sources.

According to the state of the art in groundwater sampling, water samples should be filtered prior to acidification, but the fact that we did not do so allowed us to evaluate the total contaminant present in both the dissolved and suspended state. This represents the worst-case scenario as a potential threat to groundwater

quality. Since the pH of Shilo's groundwater is constant and neutral, the release of metals from the soils particles is very slow and does not present a threat for the time being. Our study demonstrated that metals are adsorbed onto particles that can be spread out by irrigation when unfiltered water is used. Along the southeastern boundary of the Shilo training area, farmers use the groundwater to irrigate crops. Therefore, the wells installed in the same area should be sampled on a yearly basis without filtration, as surveillance wells.

Thorium-232 concentrations in groundwater varied by three orders of magnitude. Concentrations ranged from <0.005 ppb (below detection limit) to 2.35 ppb. While even the highest result was one order of magnitude below the CCME guideline (24.5 ppb), several considerations should be kept in mind. Measured concentrations generally decreased with distance from Milan firing ranges, several being below the detection limit. This is an indication of a measurable contribution of an anthropogenic source of Th in groundwater at CFB Shilo. When compared to the thorium BGL, 12 groundwater samples located in the target areas presented concentrations over this limit. The highest thorium concentration was found in GW-D-8 near the firing area (2.35 ppb) and was one order of magnitude below the CCME standard of 24.5 ppb.

The second and third highest concentrations were 0.907 ppb and 0.217 ppb, measured respectively in Cologne (GW-C-2) and Essen battleruns (GW-E-6). Analytical results for location GW-D-3, where the highest concentration was measured during Phase I in year 2000 (1.15 ppb), revealed a lower concentration of 0.31 ppb in year 2001. This may suggest that the contamination of <sup>232</sup>Th is presently decreasing. No thorium was found either in the three springs or in the two supply wells of the base. The general pattern of thorium concentration in groundwater at CFB Shilo is one of decreasing concentrations with distance from targeted areas. For the soils, thorium is naturally occurring at 3 ppm at CFB Shilo and 99.99 percent of natural thorium is <sup>232</sup>Th. Some thorium hits were found close to targets at 6 ppm. This concentration suggests limited impacts and does not represent a major problem. In the biomass close to Milan debris, plants bioaccumulated thorium at the ppb levels, with the root system accumulating more than the leaves and stem.

In year 2000, energetic materials were not detected in the 39 groundwater samples at concentrations above 30 ppb. However, traces of TNT were seen in gas chromatograms below the quantification limit of the analytical instrument (30 ppb). The 101 groundwater samples were analyzed in 2001 to confirm these results. Once again, no energetic materials were detected over the quantification limit of 0.01 ppb, meaning that earlier results for TNT were the result of background noise of the analytical instrument. This was an important finding of this study.

VOCs and BTEX were either not detected or detected as traces below reporting limits in a few wells. Consequently, these compounds do not represent a problem in the training areas.

During Phase II, metals were analyzed in 21 surface water samples. Very high concentrations of aluminium, iron, and manganese exceeding both CCME drinking water and aquatic life criteria were measured in almost all samples. The

measured concentrations were strongly related to the turbidity of the samples. These metals are naturally occurring in soils and sediments and cannot be linked directly to training activities. However, aluminum is an important component of many munitions and could impact the environment. The same explanation is also valid for the numerous water samples exceeding aquatic life criteria for copper and arsenic, as well as for the few samples exceeding aquatic life criteria for zinc and drinking water criteria for arsenic, barium, and antimony. One exception is zinc presence, which could be related to the use of smoke munitions that contain important amounts of zinc. It would be unlikely that such munitions were fired over these lakes. The fact that no sample analyses showed excess in metals whose presence could be related to training activities (such as lead, mercury, etc.) is a strong indication that surface waters were not contaminated by military training activities. No energetic materials were found in surface water.

For biomass, Phase I demonstrated that no energetic materials (EM) were detected in any samples. For soils, some hits were found in battleruns and in the grenade range. In battleruns, the levels are generally low (below 1 ppm) with a tendency to accumulate around targets. Close to hot spots, explosives compounds and their derivatives were found probably due to leaching of EM out of the cracked shells, or due to deposition from low order detonations of EM-containing ordnance. EM from gun propellants were found in some localized spots that could be related to firing activities (missiles, rockets, etc.), or to the burning of surplus propellants on site.

In general, metals and EMs were related and were described by our characterization data range by range. The grenade range presented contamination by both metals and EMs. Traces of explosives were measured in samples from the entire area. Moreover, high levels of various metals were found everywhere as well. A new design for grenade ranges should be put in place if sustained activities are desired. One can imagine that if the water drainage coming from the grenade range is controlled, the activity can be sustained indefinitely. To control the water, the equivalent of a house foundation with a central drain to collect the water for treatment could be built. First, installation of a concrete slab covering all the range and filled with sand (5 ft thick) surrounded by concrete walls should be considered. This structure has to be equipped with a central drain system to collect the water that would percolate through the sand. This contaminated water would have to be stored and disposed according to the state of the art. This structure would prevent the metals and EM from leaching to the groundwater, ensuring sustained activity. A second option would consist in installing a semi-circular building (Hercules building) over the grenade range that would prevent the rain from dissolving metals and allowing the infiltration of metals to the groundwater. A third option would be to install a pump and treat station in a well down gradient of the grenade range to collect the groundwater coming out of the range. This latter option would be more costly in the long run and would be less efficient. These options are our first thoughts on solutions that could be put into place to control and prevent the contamination by both metals and EMs. These potential solutions should be discussed more in depth with the users to identify and implement the best, practical solution.

The situation encountered at rifle ranges demonstrated a clear impact of the firing activities with small arms. Both surface and subsurface soils showed the



same trends with high levels of heavy metals detected. The samples were carefully sieved to avoid the inclusion of large metallic fragments in the digests. By doing this, we hoped to evaluate the potential contribution of metals attached to soil particles that can be inhaled or that are simply capable of sedimentation or dissolution into the groundwater. However, very fine metallic particles that were included contributed to the total amount of metals and may not represent the bioavailable metals. It is understood that large fragments are not bioavailable but will eventually contribute to groundwater contamination with time, since they will be slowly dissolved. Therefore, removing metallic fragments from the range soils periodically decreases the potential intake for groundwater contamination and represents a good practice that should be continued.

Results obtained for soils in the rifle ranges correlated well with results obtained for the biomass samples. In particular, high levels of arsenic, copper, lead, strontium, and zinc were found both in soils and biomass. Lead was found at the highest concentration compared to backgrounds and was as high as 789 times the BGL in plants. Antimony was also found at high levels in the biomass extracts; unfortunately, it was not included in the soil analysis series. A peculiar difference between soils and biomass was observed. The larger amount of alkaline metals (Na-Mg-K) in plants was not found in soils. These analytes are known to be extracted by plants. The mixed contamination of plants by heavy metals and Ca-K-Mg creates a preferential intake of these contaminated plants by the wildlife. This was observed on the ranges where many deer tracks and droppings were seen. The salty taste of the Na-Mg-K attracts the deer to this heavy metal-contaminated vegetation. This should be addressed in the future to avoid grazing of the animals on these areas. A measure as simple as a fence around the rifle ranges should correct this situation.

As for the Shilo battleruns, the results obtained for the biomass samples demonstrated that higher levels of various metals were found in the vicinity of targets. The biomass results correlated well with the soil results where, in both cases, higher levels of various metals like cobalt, lead, and strontium were found. Some higher results were obtained in plants for calcium, magnesium, and sodium, while not observed in soils. This can be explained by the solubility of these particular alkaline and earth-alkaline metals. They are rapidly dissolved by rain or snow melt and can be taken up by plants or leach through to the groundwater leaving the concentrations in soils very low. The presence of these analytes at higher levels might attract wildlife because of the salty taste. Therefore, the wildlife present on the Shilo range might ingest preferentially these plants that contain not only the alkaline and earth-alkaline metals, but also the other metals phytoaccumulated as well in the biomass nearby targets. However, in general, the levels measured are quite low and no corrective actions have to be taken on battleruns related to either metals or EM.

For the ASA area, again, many parallels can be established between the soil and biomass results. Both media were impacted with various analytes and trends were comparable. The results indicated that both activities (burning of small arms and metal debris piling) led to the spreading of metals into the surrounding environment. This type of furnace was banned following the Dundurn study. Therefore, the adverse impacts of burning were stopped. As for the piling of metal debris, a mitigation measure could be put into place, such as the building of

a concrete slab, equipped with a central drain, on which the debris would be piled instead of sitting directly on the surface soils. The management of the drain system would be critical to hinder the metals from reaching the groundwater. Moreover, no wildlife has access to the biomass presenting higher levels of metals since the area is fenced. The main potential threat at this site is the leaching of the contamination across the soil into the underlying groundwater.

The study demonstrated that the sampling patterns that were designed for each type of ranges were adequate. They were efficient and led to useful data for each type of range. In particular, the combined approaches used in the battleruns (linear transects and circular patterns) were highly useful and resulted in two interesting conclusions. The rifle range pattern was also well-adapted for the rifle berms and gave a complete coverage of the area. In the grenade range, we learned that the pattern used was fine, but the surface coverage was too small. The next time we sample a grenade range, samples will be collected outside the range limits, since contamination was found everywhere, including at the limits of the range.

Another very interesting aspect of this work is the fact that CFB Shilo is now instrumented with more than 80 wells that can be sampled at a specific frequency and serve as monitoring wells for the future. This is an infrastructure that will remain useful for years and will serve to identify and survey any potential problem that can become critical before it reaches the boundary of the training area.

In general, the situation at CFB Shilo does not represent a high-risk situation that would justify recommending a halt to the training activities. Nevertheless, some points are still of concerns such as the high levels of metals in rifle ranges, the mixed contamination found in the grenade range, and the possibility of fauna grazing on contaminated biomass. A site risk assessment should be conducted based on this present study to address these specific topics.

Finally, the work conducted at CFB Shilo training area will serve as a template and a reference study for all other Army training ranges.

## **Recommendations**

The following recommendations can be drawn from this study:

- A meeting should be held between the Shilo environmental officer and the authors of the present report to decide which wells will be sampled, and at what frequency, to act as surveillance wells.
- A meeting should be held, involving the users, DLFS staff, DAPM staff, and the authors to discuss the potential alternatives available to mitigate the adverse impacts of grenade and small arms training and also the piling of munition debris such as in the ASA area (building of concrete installations to manage the metals buildup in groundwater, building of a tall fence around targets in rifle ranges, building of a concrete slab).

- Milan missiles (some remains of these missiles were still found in the training area, mainly in the Essen battlerun) should be collected and treated as radioactive wastes and disposed of according to the radiological procedure put in place.
- Finally, a site risk assessment should be done based on the findings of this report to assess the potential risk of the presence of heavy metals in small arms range both in soils and biomass, in the grenade range, and around targets in the battleruns. The risks should be addressing the human health and the environmental threat.

## References

1. Ampleman, G., Thiboutot, S., Gagnon, A., Marois, A., Martel, R, and Lefebvre, R. (1998). "Study of the impacts of OB/OD activity on soils and groundwater at the destruction area in CFAD Dundurn," DREV R-9827, Unclassified.
2. Thiboutot, S., Ampleman, G., Gagnon, A., Marois, A., Jenkins, T. F., Walsh, M. E., Thorne, P. G., and Ranney, T. A. (1998). "Characterization of antitank firing ranges at CFB Valcartier, WATC Wainwright and CFAD Dundurn," DREV R-9809, Unclassified.
3. U.S. Environmental Protection Agency. (1993). "Approaches for the remediation of Federal facility sites contaminated with explosives or radioactive wastes," EPA Handbook #EPA/625/R-93/013.
4. Checkai, R. T., Major, M. A., Nwanguma, R. O., Phillips, C. T., and Sadusky, M. C. (1993). "Transport and fate of nitroaromatic and nitramine explosives in soils from open burning/open detonation operations," ERDEC-TR-136, Edgewood Research Development & Engineering Center.
5. Thiboutot, S., Ampleman, G., Jenkins, T. F., Walsh, M. E., Thorne, P. G., Ranney, T. A., and Grant, G. L. (1997). "Assessment of sampling strategy for explosives-contaminated soils." *Proceedings of the 90th Annual Air and Waste Management Society Meeting*. Paper #94-WP 101.08, Toronto.
6. Jenkins, T. F., Walsh, M. E., Thorne, P. G., Thiboutot, S., Ampleman, G., Ranney, T. A., and Grant, C. L. (1997). "Assessment of sampling error associated with collection and analysis of soil samples at a firing range contaminated with HMX," CRREL Special Report #97-22.
7. Jenkins, T. F., Walsh, M. E., Thorne, P. G., Miyares, P. H., Ranney, T. A., Grant, C. L., and Esparza, J. R. (1998). "Site characterization for explosives contamination at a military firing range impact area," CRREL Special Report 98-9.
8. Jenkins, T. F., Thiboutot, S., Ampleman, G., Grant, C. L., Thorne, P. G., Walsh, M. E., Esparza, J. R., Ranney, T. A., and Stutz, M. H. (1998). "Sampling and analytical considerations for site characterization at military

firing ranges." *Proceedings of the 2nd Biennial International Conference on Chemical Measurement and Monitoring of the Environment*. Ottawa, Canada. EnviroAnalysis '98, eds. Ray Clement and Bob Burk, Ottawa, Ontario: Carleton University, 37-42.

9. Brannon, J. M., Jenkins, T. F., Parker, L. V., Deliman, P., Gerald, J. A., Ruiz, C., Porter, B., and Davis, W. M. (2000). "Procedures for determining integrity of UXO and explosives soil contamination at firing ranges," ERDC TR-00-4 (ERDC/CRREL MP-01-5604), U.S. Army Engineer Research and Development Center, Vicksburg, MS.
10. Walsh, M. E., Collins, C. M., Racine, C. H., Jenkins, T. F., Gelvin, A. B., and Ranney, T. A. (2001). "Sampling for explosives residues at Fort Greely, Alaska," ERDC/CRREL TR-01-15.
11. Pennington, J. C., Jenkins, T. F., Brannon, J. M., Lynch, J., Ranney, T. A., Berry, T. E. Jr., Hayes, C. A., Miyares, P. H., Walsh, M. E., Hewitt, A. D., Perron, N., and Delfino, J. J. (2001). "Distributional and fate of energetics on DoD test and training ranges: Interim report 1," Technical Report ERDC TR-01-13, U.S. Army Engineer Research and Development Center, Vicksburg, MS.
12. Jenkins, T. F., Walsh, M. E., Thorne, P. G., Thiboutot, S., Ampleman, G., Ranney, T. A., and Grant, C. L. (1997). "Assessment of sampling error associated with collection and analysis of soil samples at a firing range contaminated with HMX," CRREL Special Report 97-22.
13. Ampleman, G., Thiboutot, S., Désilets, S., Gagnon, A., and Marois, A. (2000). "Evaluation of the soils contamination by explosives at CFB Chilliwack and CFAD Rocky Point," DREV Report TR-2000-103.
14. Thiboutot, S., Ampleman, G., Gagnon, A., and Marois, A. (2000). "Characterization of an unexploded ordnance contaminated range (Tracadie Range) for potential contamination by energetic materials," DREV Report TR-2000-102.
15. Thiboutot, S., Ampleman, G., Dubé, P., Jenkins, T. F., Walsh, M. E., Hawari, J., Spencer, B., and Paquet, L. (1998). "Protocol for the characterization of explosives contaminated sites," DREV R-9721, Unclassified.
16. Thiboutot, S., Ampleman, G., and Hewitt, A. D. (2002). "Guide for characterization of sites contaminated with energetic materials," ERDC/CRREL TR-02-1.
17. Jenkins, T. F., and Walsh, M. E. (1987). "Development of an analytical method for explosive residues in soil," CRREL Report 87-7, U.S.A.T.H.M.A., Report #AMXTH-TE-FR-86102.
18. Cragin, J. H., Legget, D. C., Foley, B. T., and Schumacher, P. W. (1985). "TNT, RDX and HMX explosives in soils and sediments, analysis techniques and drying losses," U.S.A.T.H.M.A. Report #AMX-TH-TE-FR-85038.

19. Selim, H. M., and Iskandar, I. K. (1994). "Sorption-desorption and transport of TNT and RDX in soils," CRREL Report AD-A-285-570.
20. Fellows, R. S., Harvey, S. D., and Cataldo, D. A. (1992). "An evaluation of the environmental fate and behaviour of munitions material (TNT metabolites) in soil and plant system," Contract DE-AC06-76RLO 1830.
21. Walsh, M. E., and Ranney, T. A. (1998). "Determination of nitroaromatic, nitramine, and nitrate ester explosives in water using SPE and GC-ECD: Comparison with HPLC," CRREL Report 98-2.
22. Walsh, M. E., and Ranney, T. (1998). "Determination of nitroaromatic, nitramine, and nitrate ester explosives in water using solid-phase extraction and gas chromatography-electron capture detection: Comparison with high-performance liquid chromatography," *J. Chromatogr. Sc.* 36(8), 406-416.
23. Walsh, M. E. (2001). "Determination of nitroaromatic, nitramine, and nitrate ester explosives in soil by gas chromatography and an electron capture detector," *Talanta*, 54: 427-438, ERDC/CRREL MP-02-5774.
24. Jenkins, T. F., Grant, C. L., Brar, G. S., Thorne, P. G., Schumacher, P. W., and Ranney, T. A. (1997). "Sampling error associated with collection and analysis of soil samples at TNT-contaminated sites," *Field Analytical Chemistry and Technology* 1(3), 151-163.
25. Walsh, M. E., and Ranney, T. A. (1999). "Determination of nitroaromatic, nitramine, and nitrate ester explosives in soils using GC-ECD," CRREL Report 99-12.
26. Thiboutot, S., Ampleman, G., Martel, R., Lefebvre, R., and Paradis, D. (2001). "Environmental characterization of Canadian Forces Base Shilo training area (battleruns) following gates closure," DREV TR-2001-126.
27. Bower, H., and Rice, R. C. (1976). "A slug test for determining hydraulic conductivity of unconfined aquifers with partially penetrating wells," *Water Resources* 12, 423.
28. Elson, J. A. (1960). "Surficial geology, Brandon, Manitoba," *Geological Survey of Canada*, Map 1067A, 1, 253-440.
29. Elson, J. A. (1967). "Geology of Glacial Lake Agassiz." *Life Land and Water*, W. J. Mayer-Oakes, ed., Winnipeg, University of Manitoba Press, 37-95.
30. Klassen, R. W. (1983). "Assiniboine delta and the Assiniboine-Qu'Appelle valley system-implications concerning the history of the glacial lake Agassiz in southwestern Manitoba. in Glacial Lake Agassiz," J. T. Teller and L. Clayton, ed., Geological Association of Canada, Special paper 26, 212-229.
31. Klassen, R. W. (1989). "Quaternary geology of the southern Canadian Interior Plains," *Quaternary Geology of Canada and Greenland*. Chapter 2,

R. J. Fulton, ed., *Geological Survey of Canada, Geology of Canada*, Vol 1, 138-174.

32. Thiboutot, S., Ampleman, G., Lewis, J., and Brochu, S. (2001). "Evaluation of heavy metals contamination at CFAD Dundurn resulting from small-arms ammunition incineration," DREV TR 2001-127.

## Appendix A — CFB/ASU Shilo Ammo Expenditure Record

Canada Year	Ammo Type	Rounds Fired	Duds Reported	Duds Destroyed	Remarks
1971	ALL	10,000	NOT AVAL	NOT AVAL	ESTIMATE
1972	ALL	10,800	NOT AVAL	NOT AVAL	
1973	ALL	11,000	NOT AVAL	NOT AVAL	
1974	ALL	12,000	NOT AVAL	NOT AVAL	
1989	66-mm HEAT	331	1	2	ROCKET RANGE
	84-mm HEAT	784	137	132	ROCKET RANGE
	105-mm	11,457	26	36	ALL NATURES
	155-mm	3,695	0	13	
	81-mm	4,142	4	42	
	60-mm	81	0	2	
	YEAR TOTAL (LESS ROCKET RANGE)	19,375	30 (0.2%)	93 (0.5%)	
1991	66- AND 84-mm HEAT	984	NOT AVAL	41	ROCKET RANGE
	105-mm	9,396	NOT AVAL	5	ALL NATURES
	155-mm	2,878	NOT AVAL	13	
	81-mm	3,006	NOT AVAL	11	
	YEAR TOTAL (LESS ROCKET RANGE)	15, 280	NOT AVAL	70 (0.5%)	
1994	66-mm HEAT	240	NOT AVAL	39 (16%)	FIELD FIRING
1997	105-mm	4,289	6	NOT AVAL	4,010 RDS AREA B
	155-mm	751	NOT AVAL		
	81-mm	2,644	1	NOT AVAL	2,392 AREAS C,D,E
	60-mm	291	0	NOT AVAL	ALL AREA B
	YEAR TOTAL	7, 975	7 (0.01%)	NOT AVAL	53% AREA B
1998	105-mm	3,815	3	NOT AVAL	2,944 RDS AREA B
	105-mm TK	644	0	NOT AVAL	ALL AREA B
	155-mm	1,077	2	NOT AVAL	827 RDS AREA B

Canada Year	Ammo Type	Rounds Fired	Duds Reported	Duds Destroyed	Remarks
	81-mm	1,123	0	NOT AVAL	705 RDS AREA B
	60-mm	59	0	NOT AVAL	ALL AREA B
	ERYX	24	0	0	ALL AREA B
YEAR TOTAL		6,742	5 (0.001%)	NOT AVAL	68% AREA B
1999	66-mm HEAT	81	NOT AVAL	NOT AVAL	
	84-mm TP RAP	137	NOT AVAL	NOT AVAL	
	84-mm HEAT	50	NOT AVAL	NOT AVAL	
	105-mm	5,049	NOT AVAL	NOT AVAL	
	105-mm SH PRAC TK	85	NOT AVAL	NOY AVAL	
	105-mm TPFSDST TK	282	NOT AVAL	NOT AVAL	
	155-mm	4,204	NOT AVAL	NOT AVAL	
	81-mm	1,471	NOT AVAL	NOT AVAL	
	60-mm	223	NOT AVAL	NOT AVAL	
	TOW/ERYX	12	0	0	
YEAR TOTAL (LESS 66 AND 84-mm)		11,326	NOT AVAL	NOT AVAL	

## Appendix B — Defence Construction Canada – Report of Activity

### Introduction

This is a summary report on the follow-up fieldwork conducted as part of the DREV/INRS Shilo II project initiated in September, 2001. The DREV/INRS<sup>1</sup> team was supported by DCC for the installation of groundwater observation wells and the conduct of both water sampling and biomass sampling, on the CFB Shilo Range, during the period of September 6 through September 22.

### Background

After completion of the initial field program in September, the decision was made by DREV/INRS that some additional fieldwork was required to fill data gaps. Arrangements were made by INRS with DCC to undertake a short program of additional work on the Range to conduct further field measurements primarily on the newly installed groundwater observation wells. In addition, the DCC team was requested to take various water quality measurements in the field (water levels, ORP, YSI 95 and YSI 63 readings), as well as to collect surface water samples and select well samples for VOC analyses.

<sup>1</sup> A list of abbreviations is presented in the preliminary pages.

## Work Program

The additional fieldwork was conducted during the period of November 26 through 30, 2001. The work program, as per instructions from INRS, included the following:

- Various linear distance measurements relative to the construction of the water wells;
- Collection of groundwater samples for VOC lab analyses at three wells;
- Various *in situ* ground and surface water quality parameter measurements using INRS provided field monitoring probes; and,
- Groundwater elevation measurements at three groundwater wells installed during Shilo I in 2000.

## DCC Field Team

The fieldwork was undertaken by a two-person DCC environmental services team from the DCC Western Region. It was decided by DCC that the work to be undertaken would not require the mobilization of the full DCC environmental team, as was the case in September. It was also recommended to INRS that DCC environmental services staff that were originally involved in Shilo II also conduct the follow-up work. Because of DCC staff familiarity with well locations, and Shilo Range protocol and field conditions, this resulted in the work being completed as expeditiously as possible.

Funding for the DCC team was provided by way of an extension to the original contract to DCC from DREV. The contract was managed out of DCC's Shilo Office, and the local DND OPI continued to be the CFB Shilo Eng.O.

## Procedures

**Equipment and Supplies.** INRS provided DCC with a water level recorder, an ORP probe, a YSI Model 95 and YSI Model 63 probe, as well as pH 4,7 and 10 solutions for Model 63 calibration. Along with the probes and measuring equipment, INRS provided a VOC sampling device and pre-labeled VOC sample bottles.

DCC supplied: the tools required to access the wellheads; the distilled (deionized) water for probe decontamination washing between testing; the measuring equipment; and, protective items such as gloves.

**Laboratory Analyses.** EnviroTest Laboratories' Manitoba Technology Center (ETL) was requested to undertake sample analyses for the work, as an extension of their contract for the entire Shilo I and II projects. Samples collected by DCC were kept in iced conditions, stored in a sample cooler with frozen ice pack, and delivered by DCC to ETL at the completion of the work on November 30. A chain-of-custody form was completed by DCC and signed by ETL.

ETL had been requested by INRS to manage and split the samples, after receipt, and to send whatever samples necessary to the DREV laboratories in Valcartier, Quebec, for their further analyses.



**Groundwater Well Measurement, Testing, and Sampling.** For those wells requiring measurement work, a program of field access was developed and discussed with Sergeant-Major Roeder, OC Range Control, CFB Shilo. Access was coordinated with Range activities, including live fire exercises and field training in each of the Range Areas. The program was altered to fit daily restrictions, and coordination was undertaken with Range Control at the outset of each day's planned activities. During the day, Range Control was kept advised of DCC movements from one Area to another.

The DCC proposed field program for accessing wells was as follows:

- Area E - Deilinghofen Battle Run (GW-D-9, 11, 12 and 13)
- Area 7 - Training Area (GW-Zone-7 and 7W)
- Area D - Cologne Battle Run (GW-C-8 and 9)
- Area B - Aachen and Essen Battle Runs (GW-A-9 and 10, GW-E-7,8,9 and 11)
- Area 5 - Training Area (GW-Zone-5S and 5N)
- Area 4 - Training Area (GW-Zone-4E and 4W)
- Zone 9 - Training Area (GW-Zone-9S, 9N and 9W)
- Area A - Danger Area (GW-RIF-1 and 3, GW-TR, GW-GRE, GRE-1 and 2, GW-ATR-1 and 2)
- Ammo Area (GW-AMA-1 and 2)
- Antenna Area (GW-Antenna)
- Background (Carberry Area - GW-BGR-3)
- Camp Hughes (GW-BGR-4)
- Base Area (GW-SUP-5, 16 and 27, GW-OBS-SUP-16 and 27, GW-Gate-S)

The access sequence was altered daily in order to not enter off-limits areas for the day. This resulted in a lengthier program both temporally and in terms of total distance traveled. The background wells were located off-Base at Camp Hughes and at the Brandon Junction Tower, south of the town of Carberry on Highway 5 (extreme northeast corner of Range Zone 10), some 30 and 60 km from Base Shilo, respectively.

The total distance traveled during the field measurement phase of the program was approximately 650 km over anti-tank roads, Range trails and cut lines, tank trails and tracked routes, and main and secondary Highways.

**Surface Water Testing and Sampling.** In addition, the field program required the collection of two surface water samples (SW-SE-1 and 2) from both Sewell Lake (dock location) and Epinette Creek (railway embankment location). The latter was inaccessible as a result of winter weather and ground cover conditions. A Lake sample was taken from a hole chipped through the ice at the dock.

**Groundwater Elevation Recording.** Three monitoring wells were listed in INRS instructions as requiring the measurement of water levels, as recorded from the top of the PVC well, with cap removed. These were monitoring wells (MW)

MW-101, 102, and 108, installed in 2000 during Shilo I. MW-109, a fourth in the MW series of installations, was required to be tested only for ORP.

## Results

**Climatic Conditions.** During the period of November 26 through 30, 2001, the weather at CFB Shilo consisted of light to heavy snow fall throughout the days, with continual cloud cover and periods of high winds, causing temporary visual “white-outs” on roadways and snow drifting on the Range. The daily temperatures were approximately -12 °C to -19 °C, not including the wind chill factor.

The depth of snow on the ground throughout the Range varied from about 10 cm to 25 cm. The soils were frozen wherever mixed with snow, such as on the tracked routes and trails.

Hours of daylight were between approximately 07:30 hr and 16:30 hr, although work in and around the Base and Range could be continued until around 17:00 hr daily. Thereafter, work continued under lighted conditions as necessary.

**Groundwater Well Measurements.** At each well location, where GPS coordinates and elevations were determined by Lennon Surveys in September, a series of measurements were required in order to correct water level data for lengths of well stick-up or depths of wellhead below the ground level. At flush-mounted wells, the measurements required were: “A” - the distance between the top of the protective casing and the ground; and, “B” - the distance between the protective casing cap and the top of the PVC pipe constituting the screened well. For some wells, the casing extended just above the ground level, and at others the casing and well had sunk to below the ground level, although originally installed essentially flush with the ground. The two measurements will allow for a correction of water level data to a true groundwater elevation relative to the surveyed elevations of September.

What is not known is whether the elevations tied-in by Lennon Surveys earlier were taken when the installation was still essentially flush with the ground or after differential settlement had taken place. Given the relatively thick strata of nearly homogeneous sandy soils, and the nature of the land-use in and around the wells, a certain amount of shifting of the well installation may have been anticipated at the outset of Shilo II.

The data from the current measurements (Table 3-26) indicate that 16 of 34 wellheads had settled into the ground to depths varying from 0.9 cm to 18.30 cm below ground level, leaving depressions of various depths.

Of the “3 ft stick-up” wells installed, fitted with protective steel covers, the distances of stick-up above ground varied from 88.1 cm to 98.8 cm to the top of the PVC tube.

The measurement data are being used by DCC to prepare groundwater borehole logs indicating well installation information.

<b>Table 3-26 Well Measurement Results at CFB Shilo - November, 2001</b>				
<b>GW Well Location</b>	<b>Distance "A"<sup>1</sup></b>		<b>Distance "B"<sup>3</sup> (cm)</b>	<b>Stick-Up Distance (cm)<sup>4</sup></b>
	<b>(cm above ground)</b>	<b>(cm below ground)<sup>2</sup></b>		
OBS-SUP-16	1.20		4.30	
OBS-SUP-27		5.10	5.10	
GW-Antenna				90.60
GW-Ammo-1				95.70
GW-Ammo-2				89.00
GW-Zone-4E				88.10
GW-Zone-9S		3.40	6.40	
GW-Zone-9W		6.90	5.10	
GW-Zone-7W	1.10		7.90	
GW-Zone-7	0.80		4.80	
GW-D-9	2.70		7.50	
GW-C-8	2.10		7.10	
GW-D-11	1.90		4.70	
GW-D-12	0.90		4.30	
GW-D-13	1.20		6.20	
GW-C-9		18.30	5.80	
GW-A-10		1.90	4.60	
GW-A-9		3.10	7.80	
GW-E-9		8.30	3.10	
GW-E-8	1.60		2.80	
GW-E-7		3.30	5.30	
GW-E-11	0.10		6.10	
GW-Zone-9N		2.60	5.70	
GW-BGR-3	2.60		4.20	
GW-BGR-4	1.60		5.80	
GW-RIF-3		12.10	5.70	
GW-RIF-1	not located			
GW-SUP-5	base supply well installation			
GW-SUP-16	base supply well installation			
GW-TR		9.50	6.30	
GW-GRE	0.00		8.10	
GW-GRE-2		0.90	5.80	
GW-GRE-1		6.10	11.80	
GW-Gate-S		8.80	10.30	
GW-Zone-4W				98.80
GW-Zone-5N		3.00	13.80	
GW-Zone-5S		8.70	12.80	

<sup>1</sup> Distance "A" (above ground): between the top of the protective metal cap (above ground) and the soil surface  
<sup>2</sup> Distance "A" (below ground): between the soil surface and the top of the protective metal cap (below ground)  
<sup>3</sup> Distance "B": between the top of the protective metal cap and the top of the PVC well  
<sup>4</sup> Stick-up distance: between top of PVC well and soil surface

**Water Testing Results – ORP.** The results of the testing program (which was conducted as a second priority after all groundwater well measurements were obtained) are listed in Table 3-27. Testing was done with 3 probes provided by INRS. The ORP (oxidation reduction potential) probe required no calibration, and measured the redox potential of the groundwater, which tend to decrease as the water migrates along the path of a regional flow system.

<b>Table 3-27 Oxidation Reduction Potential Measurements at CFB Shilo - November, 2001</b>	
<b>Groundwater Well Location</b>	<b>ORP Reading (millivolts)</b>
MW 109	- 094
GW-SUP-5	- 034
GW-SUP-16	- 039
GW-9W	093

The results indicate that three of four readings were slightly negative in value. These values will be used with all other measurements taken during Shilo II to present a regional depiction of flow system behavior.

The ORP of the Lake Sewell sample was 047 mV, at a water temperature of 3.5 °C.

**Water Testing Results - Dissolved O<sub>2</sub>.** DO levels were measured with the YSI Model 95 probe, a handheld dissolved oxygen and temperature system. The results of this follow-up work are presented in Table 3-28.

<b>Table 3-28 Dissolved Oxygen Readings at CFB Shilo – November 2001</b>			
<b>Groundwater Well Location</b>	<b>DO Readings</b>		<b>Temperature °C</b>
	<b>mg/l</b>	<b>percent</b>	
GW-SUP-5	1.76	14.8	8.0
GW-SUP-16	0	0	7.7
GW-TR	0	0	8.9
GW-9W	1.09	9.7	7.6
GW-Gate-S	7.46	63.7	8.6
GW-Zone-4W	12.06	101.6	7.7
GW-Zone-5N	9.52	82.1	8.7
GW-Zone-5S	11.04	91.6	7.0

The DO level of the lake sample (SW-SE-1) was recorded as 14.09 mg/l (97.4 percent) at a water temperature of 0.3 °C.

**Water Testing Results - pH, Conductivity, and Salinity.** These parameters were measured downhole with the YSI Model 63 probe, calibrated daily, at the groundwater well locations listed in Table 3-29. In addition, readings for pH, conductivity and salinity were also taken in Lake Sewell, by lowering the probe (along with the YSI Model 95 probe) through the open hole in the ice cover. For each reading, the indicated YSI 63 temperature was also recorded.

<b>Table 3-29 pH, Conductivity and Salinity Readings at CFB Shilo - November, 2001</b>				
<b>GW Well Location</b>	<b>Temperature °C</b>	<b>pH</b>	<b>Salinity (ppt)</b>	<b>Conductivity (mS or uS)</b>
GW-SUP-5	7.0	7.00	0.0	1.5 mS
GW-SUP-16	7.1	6.99	0.0	1.7 mS
GW-TR	8.9	6.38	0.2	336.4 uS
GW-9W	7.6	6.86	0.2	355.6 uS
GW-Gate-S	8.0	7.35	0.3	359.7 uS
GW-Zone-4W	8.2	7.41	0.2	367.8 uS
GW-Zone-5N	7.5	7.26	0.2	257.1 uS
GW-Zone-5S	5.3	7.33	0.0	1.1 mS

Three of the readings for conductivity were recorded as millisiemens/cm while the rest were in microsiemens/cm.

The readings for the above parameters on the lake water, just below the ice cap, were as follows: pH - 6.79; salinity - 0.2 ppt; and, conductivity - 193.8 uS. The temperature at the depth and time of reading with the YSI 63 probe was recorded at 3.5 °C.

**Groundwater Elevation Readings.** The level of standing water in the observation wells was measured using the water level probe provided by INRS. The wells requiring measurement were identified as MW 101, MW 102, and MW 108. In addition, water level was measured in GW-A-5, a 2000 Shilo I installation. Although the latter well required sampling for analyses, the waterra tubing could not be extracted, and probes (other than the water level probe) could not be lowered into the 5-cm-diam well.

The readings are summarized in Table 3-30.

<b>Table 3-30 Water Level Measurements Recorded at CFB Shilo - November 2001</b>		
<b>Monitoring Well Location</b>	<b>Water Level Reading (m from top of well)</b>	<b>Top of Well Stick-up Distance (cm above ground level)</b>
MW 101	5.133	70.5
MW 102	4.705	36.4
MW 108	6.080	87.7
MW 109	Not taken	62.0
GW-A-5	6.310	- Protective cap 0.8 cm above grade - 2.42 cm between cap and well top

## Appendix C — Borehole (pp 3-142 thru 3-177) and Grain Size Analyses (pp 3-178 thru 3-213) Logs

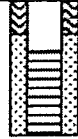
DRILL HOLE LOG: ESI									
 Defence Construction Canada Construction de Défense Canada				Project:			Borehole No.:		
				Shilo II			GW-A-9		
Client:  DREV, DND, Valcartier, Quebec				Location:			Project No.:		
				CFB Shilo, Manitoba			SL 12910		
				Driller:			Date Drilled:		
				Paddock Drilling Ltd., Brandon			September 17, 2001		
Depth (m)	Elevation (m)	Blows	Sample			Description of Materials	Installation		HC Vapour conc. (ppm)
			Number	Type	Container		Schematic	Details	
- - - -2.0 - - -4.0 - -6.0 - -8.0 - -10 - -12 - -14 - -16	▽		SS-GW-A-9-6ft (1.83m)	Split Spoon	Bag	SAND, fine grained, moist, well graded  water level @ 1.22m from ground level  note: water level taken during drilling		bentonite to 0.91m  screen @ 1.22 m  silica sand to 3.05m  TD @ 3.05m	
Coordinates: 469903E, 5509655N			Drill Type: Hollow Stem			Vertical Scale: 1:125 (approx.)			
Drawn By: Wesley Nash			Approved By:			Plate: 1 of 1			

## DRILL HOLE LOG: ESI

<b>Client:</b>  DREV, DND, Valcartier, Quebec	Project:	Borehole No.:
	Shilo II	GW-A-10
	Location:	Project No.:
	CFB Shilo, Manitoba	SL 12910
	Driller:	Date Drilled:
Paddock Drilling Ltd., Brandon	September 16, 2001	

Depth (m)	Elevation (m)	Blows	Sample			Description of Materials	Installation		HC Vapour conc. (ppm)
			Number	Type	Container		Schematic	Details	
-2.0			SS-GW-A-10-15ft (4.57m)	Split Spoon	Bag	SAND, fine grained, dry, loose		grout to 1m	
-4.0	▽					SAND, medium grained, moist, well graded		bentonite to 3.35m	
-6.0						water level @ 4.42m from ground level		screen @ 3.05m	
-8.0								silica sand to 5.29m	
-10.0								TD @ 5.79m	
-12.0									
-14.0									
-16.0									
								0.5m of blow-up	
								Approx. 0.5m blow-up	

Coordinates: 463406E, 5511067N	Drill Type: Hollow Stem	Vertical Scale: 1:125 (approx.)
Drawn By: Wesley Nash	Approved By:	Plate: 1 of 1





## DRILL HOLE LOG: ESI

 <p style="font-size: small;">Defence Construction Canada Construction de Défense Canada</p> <hr/> <p><b>Client:</b> DREV, DND, Valcartier, Quebec</p>	Project:	Borehole No.:
	Shilo II	GW-AMA-1
	Location:	Project No.:
	CFB Shilo, Manitoba	SL 12910
	Driller:	Date Drilled:
Paddock Drilling Ltd., Brandon	September 12, 2001	

Depth (m)	Elevation (m)	Blows	Sample			Description of Materials	Installation		HC Vapour conc. (ppm)
			Number	Type	Container		Schematic	Details	
-2.0						<p>SAND, fine-medium grained, dry, light brown</p> <p>water level @ 3.35m from ground level</p> <p>note: water level taken during drilling</p>	 <p>0.6m of blow-up</p>	<p>note: 3ft riser above ground</p> <p>bentonite to 2.13m</p> <p>screen @ 3.68m</p> <p>silica sand to 4.58m</p> <p>TD @ 5.18m</p>	
-4.0	▽		SS-AMA-1-11ft (3.35m)	Split Spoon	Bag				
-6.0									
-8.0									
-10									
-12									
-14									
-16									

Coordinates: 451371E, 5515945N	Drill Type: Hollow Stem	Vertical Scale: 1:125 (approx.)
Drawn By: Wesley Nash	Approved By:	Plate: 1 of 1

## DRILL HOLE LOG: ESI

 <p style="font-size: small;">Defence Construction Canada Construction de Défense Canada</p> <hr/> <p><b>Client:</b> DREV, DND, Valcartier, Quebec</p>	Project:	Borehole No.:
	Shilo II	GW-AMA-2
	Location:	Project No.:
	CFB Shilo, Manitoba	SL 12910
Driller:	Date Drilled:	
Paddock Drilling Ltd., Brandon	September 10/11, 2001	

Depth (m)	Elevation (m)	Blows	Sample			Description of Materials	Installation		HC Vapour conc. (ppm)
			Number	Type	Container		Schematic	Details	
-2.0			SS-AMA-2-22.5ft (6.86m)	Split Spoon	Bag	SAND, fine grained, dry		note: 3ft riser above ground	
-4.0		SAND, medium grained, damp, light brown				bentonite to 4.88m			
-6.0	▽	water level @ 5.18m from ground level				screen @ 5.79m			
-8.0		note: water level taken during drilling				silica sand to 6.71m			
-10.0						TD @ 7.32m			
-12.0									
-14.0									
-16.0									

Coordinates: 451358E, 5515701N	Drill Type: Hollow Stem	Vertical Scale: 1:125 (approx.)
Drawn By: Wesley Nash	Approved By:	Plate: 1 of 1

## DRILL HOLE LOG: ESI



Defence Construction Canada  
Construction de Défense Canada

**Client:**

DREV, DND, Valcartier, Quebec

<b>Project:</b>	<b>Borehole No.:</b>
Shilo II	GW-ATR-1
<b>Location:</b>	<b>Project No.:</b>
CFB Shilo, Manitoba	SL 12910
<b>Driller:</b>	<b>Date Drilled:</b>
Paddock Drilling Ltd., Brandon	September 17, 2001

Depth (m)	Elevation (m)	Blows	Sample			Description of Materials	Installation		HC Vapour conc. (ppm)
			Number	Type	Container		Schematic	Details	
0									
-2.0	▽								
-4.0									
-6.0									
-8.0									
-10									
-12									
-14									
-16									
Coordinates: 458556E, 5519083N			Drill Type: Hollow Stem			Vertical Scale: 1:125 (approx.)			
Drawn By: Wesley Nash			Approved By:			Plate: 1 of 1			

## DRILL HOLE LOG: ESI

Defence Construction Canada Construction de Défense Canada	Project:	Borehole No.:
	Shilo II	GW-BGR-3
	Location:	Project No.:
	CFB Shilo, Manitoba	SL 12910
Client:	Driller:	Date Drilled:
DREV, DND, Valcartier, Quebec	Paddock Drilling Ltd., Brandon	September 19, 2001

Depth (m)	Elevation (m)	Blows	Sample			Description of Materials	Installation		HC Vapour conc. (ppm)			
			Number	Type	Container		Schematic	Details				
-2.0			SS-GW-BGR-3-22ft (6.71m)	Split Spoon	Bag	SAND, fine grained, dry, light brown		grout to 1m				
-4.0						SAND, coarse grained, wet, greyish brown		bentonite to 5.18m				
-6.0	▽					water level @ 5.79m from ground level		screen @ 6.71 m				
-8.0						SILT, loose, wet, dark grey		silica sand to 9.46m				
-10.0						note: water level taken during drilling		TD @ 9.76m				
-12.0								0.30m blow-up				
-14.0												
-16.0												
Coordinates: 474577E, 5515025N						Drill Type: Hollow Stem			Vertical Scale: 1:125 (approx.)			
Drawn By: Wesley Nash						Approved By:			Plate: 1 of 1			

## DRILL HOLE LOG: ESI



Defence Construction Canada  
Construction de Défense Canada

**Client:**

DREV, DND, Valcartier, Quebec

**Project:**

Shilo II

**Location:**

CFB Shilo, Manitoba

**Driller:**

Paddock Drilling Ltd.,  
Brandon

**Borehole No.:**

GW-BGR-4

**Project No.:**

SL 12910

**Date Drilled:**

September 17, 2001

Depth (m)	Elevation (m)	Blows	Sample			Description of Materials	Installation		HC Vapour conc. (ppm)			
			Number	Type	Container		Schematic	Details				
-2.0			SS-GW-BGR-4-24ft (7.32m)	Split Spoon	Bag	SAND, trace organics, fine grained, dry		bentonite to 6.71m				
-4.0						SAND, medium grained, moist						
-6.0						organic layer @ 5.8m						
-8.0						water level @ 7.01m from ground level						
-10.0						note: water level taken during drilling						
-12.0												
-14.0												
-16.0												
Coordinates: 461083E, 5524504N						Drill Type: Hollow Stem			Vertical Scale: 1:125 (approx.)			
Drawn By: Wesley Nash						Approved By:			Plate: 1 of 1			

## DRILL HOLE LOG: ESI

 <p style="font-size: small;">Defence Construction Canada Construction de Défense Canada</p> <hr/> <p><b>Client:</b> DREV, DND, Valcartier, Quebec</p>	<b>Project:</b>	<b>Borehole No.:</b>
	Shilo II	GW-C-8
	<b>Location:</b>	<b>Project No.:</b>
	CFB Shilo, Manitoba	SL 12910
	<b>Driller:</b>	<b>Date Drilled:</b>
Paddock Drilling Ltd., Brandon	September 15, 2001	

Depth (m)	Elevation (m)	Blows	Sample			Description of Materials	Installation		HC Vapour conc. (ppm)
			Number	Type	Container		Schematic	Details	
0.0						Organics, light brown			
-2.0						SAND, trace gravel, medium grained, well graded iron staining		bentonite to 9.1m	
-4.0									
-6.0									
-8.0						SAND, clay lens, moist, poorly graded		screen @ 10.1m	
-10.0	▽		SS-C-8-34ft (10.37m)	Split Spoon	Bag			silica sand to 11.6m	
-12.0						water level @ 9.70m from ground level		TD @ 11.6m	
-14.0									
-16.0									
Coordinates: 463728E, 5501034N			Drill Type:			Vertical Scale: 1:125 (aprox.)			
Drawn By: Wesley Nash			Approved By:			Plate: 1 of			

## DRILL HOLE LOG: ESI



Defence Construction Canada  
Construction de Défense Canada

**Client:**

DREV, DND, Valcartier, Québec

**Project:**

Shilo II

**Location:**

CFB Shilo, Manitoba

**Driller:**

Paddock Drilling Ltd.,  
Brandon

**Borehole No.:**

GW-C-9

**Project No.:**

SL 12910

**Date Drilled:**

September 15, 2001

Depth (m)	Elevation (m)	Blows	Sample			Description of Materials	Installation		HC Vapour conc. (ppm)
			Number	Type	Container		Schematic	Details	
-2.0							Bentonite to 6.10m		
-4.0					SAND, medium grained, well graded, light brown				
-6.0	▽		SS-C-9-22ft (6.71m)	Split Spoon	water level @ 7.08m from ground level		screen @ 7.03m		
-8.0				Bag			silica sand to 8.53m		
-10.0							TD @ 8.53m		
-12.0									
-14.0									
-16.0									
Coordinates: 466928E, 5499917N			Drill Type:			Vertical Scale: 1:125 (approx.)			
Drawn By: Wesley Nash			Approved By:			Plate: 1 of			

## DRILL HOLE LOG: ESI

 <p style="font-size: small;">Defence Construction Canada Construction de Défense Canada</p> <hr/> <p><b>Client:</b> DREV, DND, Valcartier, Quebec</p>	<b>Project:</b>	<b>Borehole No.:</b>
	Shilo II	GW-D-11
	<b>Location:</b>	<b>Project No.:</b>
	CFB Shilo, Manitoba	SL 12910
	<b>Driller:</b>	<b>Date Drilled:</b>
	Paddock Drilling Ltd., Brandon	September 15, 2001

Depth (m)	Elevation (m)	Blows	Sample			Description of Materials	Installation		HC Vapour conc. (ppm)
			Number	Type	Container		Schematic	Details	
-2.0						SAND, fine grained, moist, fine grained, light brown	Bentonite to 7.62m		
-4.0									
-6.0						SAND, course grained, poorly graded, trace pebbles, light brown	screen @ 8.53m		
-8.0	▽		SS-D-11@29ft (8.34m)	Split Spoon					silica sand to 10.06m
-10.0						water level @ 8.76m from ground level	TD @ 10.06m		
-12.0									
-14.0									
-16.0									
Coordinates: 474378E, 5500610N			Drill Type: Hollow Stem			Vertical Scale: 1:125 (approx.)			
Drawn By: Wesley Nash			Approved By:			Plate: 1 of 1			



## DRILL HOLE LOG: ESI



Defence Construction Canada  
Construction de Défense Canada

**Client:**

DREV, DND, Valcartier, Quebec

**Project:**

Shilo II

**Borehole No.:**

GW-D-12

**Location:**

CFB Shilo, Manitoba

**Project No.:**

SL 12910

**Driller:**

Paddock Drilling Ltd.,  
Brandon

**Date Drilled:**

September 15/16, 2001

Depth (m)	Elevation (m)	Blows	Sample			Description of Materials	Installation		HC Vapour conc. (ppm)
			Number	Type	Container		Schematic	Details	
-4.0			SS-GW-D-12-70ft (21.95m)	Split Spoon	Bag	SAND, medium grained, dry, light brown		grout to 1m	
-8.0						SAND, medium grained, damp, dark red/brown		bentonite to 18.29m	
-12						SAND, medium- course grained, greyish brown			
-16						water level @ 18.35m from ground level		screen @ 19.21m	
-20	▽							silica sand to 21.96m	
-24								TD @ 22.26m	
-28									
-32									

Coordinates: 477708E, 5500130N

Drill Type: Hollow Stem

Vertical Scale: 1:250(approx.)

Drawn By: Wesley Nash

Approved By:

Plate: 1 of 1

## DRILL HOLE LOG: ESI



Defence Construction Canada  
Construction de Défense Canada

**Client:**

DREV, DND, Valcartier, Quebec

**Project:**

Shilo II

**Borehole No.:**

GW-D-13

**Location:**

CFB Shilo, Manitoba

**Project No.:**

SL 12910

**Driller:**

Paddock Drilling Ltd.,  
Brandon

**Date Drilled:**

September 16, 2001

Depth (m)	Elevation (m)	Blows	Sample			Description of Materials	Installation		HC Vapour conc. (ppm)
			Number	Type	Container		Schematic	Details	
-2.0			SS-GW-D-13-27ft (8.23m)	Split Spoon	Bag	SAND, course grained, dry, light brown		grout to 1m	
-4.0						SAND, medium grained, damp, reddish brown		bentonite to 8.23m	
-6.0						SAND, silty, wet, greyish brown			
-8.0	K					water level @ 7.71m from ground level		screen @ 9.15m	
-10.0								silica sand to 11.59m	
-12.0								TD @ 12.20m	
-14.0								0.61m of blow-up	
-16.0									

Coordinates: 478112E, 5501165N

Drill Type: Hollow Stem

Vertical Scale: 1:125 (approx.)

Drawn By: Wesley Nash

Approved By:

Plate: 1 of 1

## DRILL HOLE LOG: ESI



Defence Construction Canada  
Construction de Défense Canada

**Client:**

DREV, DND, Valcartier, Quebec

<b>Project:</b>	Shilo II	<b>Borehole No.:</b>	GW-D-9
<b>Location:</b>	CFB Shilo, Manitoba	<b>Project No.:</b>	SL 12910
<b>Driller:</b>	Paddock Drilling Ltd., Brandon	<b>Date Drilled:</b>	September 15, 2001

Depth (m)	Elevation (m)	Blows	Sample			Description of Materials	Installation		HC Vapour conc. (ppm)
			Number	Type	Container		Schematic	Details	
0									
-2.0						SAND, medium grained, dry, light brown		grout to 0.61m	
-4.0					SAND, medium grained, damp, reddish brown	bentonite to 4.27m			
-6.0	▽				water level @ 5.26m from ground level	screen @ 5.18m		silica sand to 7.01m	
-8.0			SS-GW-D-9-17ft (5.18m)	Split Spoon	Bag			TD @ 7.01m	
-10									
-12									
-14									
-16									

Coordinates: 474356E, 5504004N	Drill Type: Hollow Stem	Vertical Scale: 1:125 (approx.)
Drawn By: Wesley Nash	Approved By:	Plate: 1 of 1

## DRILL HOLE LOG: ESI

 <p style="font-size: small;">Defence Construction Canada Construction de Défense Canada</p> <hr/> <p><b>Client:</b> DREV, DND, Valcartier, Quebec</p>	<b>Project:</b> Shilo II	<b>Borehole No.:</b> GW-E-11
	<b>Location:</b> CFB Shilo, Manitoba	<b>Project No.:</b> SL 12910
	<b>Driller:</b> Paddock Drilling Ltd., Brandon	<b>Date Drilled:</b> September 14, 2001

Depth (m)	Elevation (m)	Blows	Sample			Description of Materials	Installation		HC Vapour conc. (ppm)
			Number	Type	Container		Schematic	Details	
							SS-E-11-12.5ft (3.81m)	Split Spoon	
-2.0	▽				SAND, coarse grained, dry, light brown  water level @ 3.35m from ground level  note: taken at time of drilling				
-4.0									
-6.0									
-8.0									
-10									
-12									
-14									
-16									

Coordinates: 461976E, 5513661N	Drill Type: Hollow Stem	Vertical Scale: 1:125 (approx.)
Drawn By: Wesley Nash	Approved By:	Plate: 1 of 1

## DRILL HOLE LOG: ESI

 <p>Defence Construction Canada Construction de Défense Canada</p> <hr/> <p><b>Client:</b> DREV, DND, Valcartier, Quebec</p>	Project:	Borehole No.:
	Shilo II	GW-E-7
	Location:	Project No.:
	CFB Shilo, Manitoba	SL 12910
Driller:	Date Drilled:	
Paddock Drilling Ltd., Brandon	September 14, 2001	

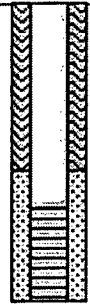
Depth (m)	Elevation (m)	Blows	Sample			Description of Materials	Installation		HC Vapour conc. (ppm)		
			Number	Type	Container		Schematic	Details			
-2.0						<p>SAND, medium grained, damp, brown</p> <p>water level @ 3.82m from ground level</p>		<p>bentonite to 2.74m</p> <p>screen @ 3.66m</p> <p>silica sand to 5.18m</p> <p>TD @ 5.18m</p>			
-4.0	▽										
-6.0											
-8.0											
-10.0											
-12.0											
-14.0											
-16.0											
			SS-E-7-14ft (4.27m)	Split Spoon	Bag						

Coordinates: 464891E, 5515940N	Drill Type: Hollow Stem	Vertical Scale: 1:125 (approx.)
Drawn By: Wesley Nash	Approved By:	Plate: 1 of 1

## DRILL HOLE LOG: ESI

 <p style="font-size: small;">Defence Construction Canada Construction de Défense Canada</p> <hr/> <p><b>Client:</b> DREV, DND, Valcartier, Quebec</p>	Project:	Borehole No.:
	Shilo II	GW-E-8
	Location:	Project No.:
	CFB Shilo, Manitoba	SL 12910
Driller:	Date Drilled:	
Paddock Drilling Ltd., Brandon	September 14, 2001	

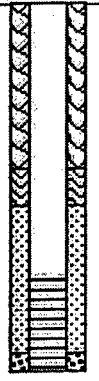
Depth (m)	Elevation (m)	Blows	Sample			Description of Materials	Installation		HC Vapour conc. (ppm)
			Number	Type	Container		Schematic	Details	
-2.0			SS-E-8-17ft (5.18m)	Split Spoon	Bag	SAND, medium grained, dry, light brown		grout to 3.05m  bentonite to 3.66m  screen @ 5.18m  silica sand to 6.40m  TD @ 6.71m	
-4.0	▽					SAND, medium grained, damp, redish brown			0.30m of blow-up
-6.0						water level @ 5.18m from ground level			
-8.0						note: taken at time of drilling			
-10.0									
-12.0									
-14.0									
-16.0									

Coordinates: 465993E, 5514995N	Drill Type: Hollow Stem	Vertical Scale: 1:125 (approx.)
Drawn By: Wesley Nash	Approved By:	Plate: 1 of 1

## DRILL HOLE LOG: ESI

 <p><b>Defence Construction Canada</b> Construction de Défense Canada</p> <hr/> <p><b>Client:</b> DREV, DND, Valcartier, Quebec</p>	Project:	Borehole No.:
	Shilo II	GW-E-9
	Location:	Project No.:
	CFB Shilo, Manitoba	SL 12910
Driller:	Date Drilled:	
Paddock Drilling Ltd., Brandon	September 15, 2001	

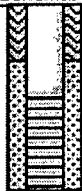
Depth (m)	Elevation (m)	Blows	Sample			Description of Materials	Installation		HC Vapour conc. (ppm)
			Number	Type	Container		Schematic	Details	
-2.0	▽		SS-E-9-9ft (2.74m)	Split Spoon	Bag	<p>SAND, silty, fine, organics present, brown</p> <p>water level @ 2.43m from ground level</p>		<p>bentonite to 1.22m</p> <p>screen @ 2.13m</p> <p>silica sand to 3.66m</p> <p>TD @ 3.66m</p>	
-4.0									
-6.0									
-8.0									
-10									
-12									
-14									
-16									

Coordinates: 465970E, 5514236N	Drill Type: Hollow Stem	Vertical Scale: 1:125 (approx.)
Drawn By: Wesley Nash	Approved By:	Plate: 1 of 1

## DRILL HOLE LOG: ESI

 <p>Defence Construction Canada Construction de Défense Canada</p>	Project:	Borehole No.:
	Shilo II	GW-Gate-S
	Location:	Project No.:
	CFB Shilo, Manitoba	SL 12910
Client:	Driller:	Date Drilled:
DREV, DND, Valcartier, Quebec	Paddock Drilling Ltd., Brandon	September 10, 2001

Depth (m)	Elevation (m)	Blows	Sample			Description of Materials	Installation		HC Vapour conc. (ppm)
			Number	Type	Container		Schematic	Details	
-2.0						SAND, medium grained, damp, brown			
-4.0						SAND, medium grained, moist, poorly graded, brown	bentonite to 6.71 m		
-6.0	▽		SS-Gate-S-26ft (7.93m)	Split Spoon	Bag	water level @ 6.86m from ground level	screen @ 6.16m		
-8.0						note: water level taken during drilling	silica sand to 9.15m		
-10							TD @ 9.15m		
-12									
-14									
-16									
Coordinates: 453529E, 5516354N			Drill Type: Hollow Stem			Vertical Scale: 1:125 (approx.)			
Drawn By: Wesley Nash			Approved By:			Plate: 1 of 1			



## DRILL HOLE LOG: ESI

 <p style="font-size: small;">Defence Construction Canada Construction de Défense Canada</p> <hr/> <p><b>Client:</b> DREV, DND, Valcartier, Quebec</p>	Project:	Borehole No.:
	Shilo II	GW-GRE-1
	Location:	Project No.:
	CFB Shilo, Manitoba	SL 12910
	Driller:	Date Drilled:
Paddock Drilling Ltd., Brandon	September 13, 2001	

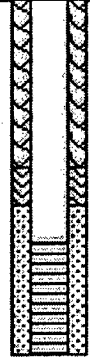
Depth (m)	Elevation (m)	Blows	Sample			Description of Materials	Installation		HC Vapour conc. (ppm)
			Number	Type	Container		Schematic	Details	
-2.0			SS-GRE-1-15ft	Split Spoon	Bag	SAND, fine grained, damp, redish brown		grout to 2.74m	
-4.0	▽					SAND, medium grained, damp, light brown		bentonite to 3.35m	
-6.0						water level @ 3.83m from ground level		screen @ 4.88m	
-8.0								silica sand to 6.40m	
-10.0				TD @ 6.40m					
-12.0									
-14.0									
-16.0									

Coordinates: 457530E, 5517992N	Drill Type: Hollow Stem	Vertical Scale: 1:125 (approx.)
Drawn By: Wesley Nash	Approved By:	Plate: 1 of 1

## DRILL HOLE LOG: ESI

 <p style="font-size: small;">Defence Construction Canada Construction de Défense Canada</p> <hr/> <p><b>Client:</b> DREV, DND, Valcartier, Quebec</p>	Project:	Borehole No.:
	Shilo II	GW-GRE-2
	Location:	Project No.:
	CFB Shilo, Manitoba	SL 12910
Driller:	Date Drilled:	
Paddock Drilling Ltd., Brandon	September 14, 2001	

Depth (m)	Elevation (m)	Blows	Sample			Description of Materials	Installation		HC Vapour conc. (ppm)
			Number	Type	Container		Schematic	Details	
-2.0			SS-GRE-2-13ft (3.96m)	Split Spoon	Bag	SAND, medium grained, well graded, damp, greyish brown  SAND, medium grained, moist, reddish brown  water level @ 3.77m from ground level		bentonite to 2.44m  screen @ 3.35m  silica sand to 4.88m  TD @ 4.88m	
-4.0	▽								
-6.0									
-8.0									
-10									
-12									
-14									
-16									

Coordinates: 457485E, 5517961N	Drill Type: Hollow Stem	Vertical Scale: 1:125 (approx.)
Drawn By: Wesley Nash	Approved By:	Plate: 1 of 1

## DRILL HOLE LOG: ESI



Defence Construction Canada  
Construction de Défense Canada

**Client:**

DREV, DND, Valcartier, Quebec

<b>Project:</b>	Borehole No.:
Shilo II	OBS-SUP-16
<b>Location:</b>	Project No.:
CFB Shilo, Manitoba	SL 12910
<b>Driller:</b>	Date Drilled:
Paddock Drilling Ltd., Brandon	September 18, 2001

Depth (m)	Elevation (m)	Blows	Sample			Description of Materials	Installation		HC Vapour conc. (ppm)
			Number	Type	Container		Schematic	Details	
-2.0			SS-OBS-SUP-16-40ft (12.20m)	Split Spoon	Bag	SAND, medium grained, dry, loose, light brown  SAND, coarse grained, damp, red cobbles, greyish brown  SAND, coarse grained, greyish brown, organic streaks  water level @ 12.70m from ground level		grout @ 3.05m  bentonite to 10.06m  Screen @ 11.58m  silica sand to 13.11m  TD @ 13.11m	
-4.0									
-6.0									
-8.0									
-10.0									
-12.0	▽								
-14.0									
-16.0									
Coordinates: 454263E, 5517312N			Drill Type: Hollow Stem			Vertical Scale: 1:125 (approx.)			
Drawn By: Wesley Nash			Approved By:			Plate: 1 of 1			

## DRILL HOLE LOG: ESI



Defence Construction Canada  
Construction de Défense Canada

Client:

DREV, DND, Valcartier, Quebec

Project:	Borehole No.:
Shilo II	OBS-SUP-27
Location:	Project No.:
CFB Shilo, Manitoba	SL 12910
Driller:	Date Drilled:
Paddock Drilling Ltd., Brandon	September 18, 2001

Depth (m)	Elevation (m)	Blows	Sample			Description of Materials	Installation		HC Vapour conc. (ppm)
			Number	Type	Container		Schematic	Details	
0						Asphalt surface			
-2.0						SAND, medium grained, dry, loose, light brown		bentonite to 10.06m	
-4.0						SAND, course grained, damp organic layer 0.3m thick @ 7.01m		Screen @ 9.45m	
-6.0								silica sand to 12.5m	
-8.0								TD @ 12.5m	
-10.0									
-12.0						water level @ 11.51m from ground level			
-14.0									
-16.0									
Coordinates: 454292E, 5517105N			Drill Type: Hollow Stem			Vertical Scale: 1:125 (approx.)			
Drawn By: Wesley Nash			Approved By:			Plate: 1 of 1			

## DRILL HOLE LOG: ESI



Defence Construction Canada  
Construction de Défense Canada

**Client:**

DREV, DND, Valcartier, Quebec

**Project:**

Shilo II

**Location:**

CFB Shilo, Manitoba

**Driller:**

Paddock Drilling Ltd.,  
Brandon

**Borehole No.:**

OBS-SUP-5

**Project No.:**

SL 12910

**Date Drilled:**

September 18, 2001

Depth (m)	Elevation (m)	Blows	Sample			Description of Materials	Installation		HC Vapour conc. (ppm)					
			Number	Type	Container		Schematic	Details						
-2.0			SS-OBS-SUP-5-45ft (13.72m)	Split Spoon	Bag	water level @ 11.70m from ground level		bentonite to 11.89m  screen @ 11.28m  silica sand to 14.33m  TD @ 14.33m						
-4.0														
-6.0														
-8.0														
-10.0														
-12.0	▽													
-14.0														
-16.0														
Coordinates: 454440E, 5517050N									Drill Type: Hollow Stem			Vertical Scale: 1:125 (approx.)		
Drawn By: Wesley Nash									Approved By:			Plate: 1 of 1		

## DRILL HOLE LOG: ESI



Defence Construction Canada  
Construction de Défense Canada

**Client:**

DREV, DND, Valcartier, Quebec

**Project:**

Shilo II

**Location:**

CFB Shilo, Manitoba

**Driller:**

Paddock Drilling Ltd.,  
Brandon

**Borehole No.:**

GW-Rif-1

**Project No.:**

SL 12910

**Date Drilled:**

September 12, 2001

Depth (m)	Elevation (m)	Blows	Sample			Description of Materials	Installation		HC Vapour conc. (ppm)					
			Number	Type	Container		Schematic	Details						
-2.0			SS-Zone-Rif-1-30ft (9.15m)	Split Spoon	Bag	<p>SAND, medium, dry, well graded, light brown</p> <p>water level @ 8.84m from ground level</p> <p>note: water level taken during drilling</p>		<p>bentonite to 8.23m</p> <p>screen @ 9.15m</p> <p>silica sand to 9.75m</p> <p>TD @ 10.67m</p> <p>0.92m blow-up</p>						
-4.0														
-6.0														
-8.0	▽													
-10														
-12														
-14														
-16														
Coordinates: 455650E, 5518509N									Drill Type: Hollow Stem			Vertical Scale: 1:125 (approx.)		
Drawn By: Wesley Nash									Approved By:			Plate: 1 of 1		

## DRILL HOLE LOG: ESI

 <p style="font-size: small;">Defence Construction Canada Construction de Défense Canada</p> <hr/> <p><u>Client:</u> DREV, DND, Valcartier, Quebec</p>	Project:	Borehole No.:
	Shilo II	GW-Rif-3
	Location:	Project No.:
	CFB Shilo, Manitoba	SL 12910
	Driller:	Date Drilled:
Paddock Drilling Ltd., Brandon	September 13, 2001	

Depth (m)	Elevation (m)	Blows	Sample			Description of Materials	Installation		HC Vapour conc. (ppm)	
			Number	Type	Container		Schematic	Details		
-2.0						<p>SAND, medium, dry, loose, well graded, light brown</p>           <p>water level @ 5.60m from ground level</p>		<p>bentonite to 4.88m</p>  <p>screen @ 5.79m</p> <p>silica sand to 7.32m</p> <p>TD @ 7.32m</p>		
-4.0										
-6.0	▽									
-8.0										
-10										
-12										
-14										
-16										

Coordinates: 456510E, 5518325N	Drill Type: Hollow Stem	Vertical Scale: 1:125 (approx.)
Drawn By: Wesley Nash	Approved By:	Plate: 1 of 1

## DRILL HOLE LOG: ESI



Defence Construction Canada  
Construction de Défense Canada

**Client:**

DREV, DND, Valcartier, Quebec

**Project:**

Shilo II

**Location:**

CFB Shilo, Manitoba

**Driller:**

Paddock Drilling Ltd.,  
Brandon

**Borehole No.:**

GW-TR

**Project No.:**

SL 12910

**Date Drilled:**

September 13, 2001

Depth (m)	Elevation (m)	Blows	Sample			Description of Materials	Installation		HC Vapour conc. (ppm)						
			Number	Type	Container		Schematic	Details							
-2.0	▽		GW-TR-12ft (3.66)	Split spoon	Bag	<p>SAND, fine grained, damp, reddish brown</p> <p>SAND, medium grained, damp, light brown</p> <p>water level @ 2.79m from ground level</p> <p>note: found under TR-1 in field notes. Field sample erroneously named GW-TR-1@12ft.</p>		<p>grout to 2.13m</p> <p>bentonite to 2.74m</p> <p>screen @ 3.66m</p> <p>silica sand to 5.18m</p> <p>TD @ 5.18m</p>							
-4.0															
-6.0															
-8.0															
-10.0															
-12.0															
-14.0															
-16.0															
Coordinates: 457111E, 5518359N									Drill Type: Hollow Stem			Vertical Scale: 1:125 (approx.)			
Drawn By: Wesley Nash									Approved By:			Plate: 1 of 1			



## DRILL HOLE LOG: ESI



Defence Construction Canada  
Construction de Défense Canada

**Client:**

DREV, DND, Valcartier, Quebec

Project:	Borehole No.:
Shilo II	GW-Zone-4E
Location:	Project No.:
CFB Shilo, Manitoba	SL 12910
Driller:	Date Drilled:
Paddock Drilling Ltd., Brandon	September 12, 2001

Depth (m)	Elevation (m)	Blows	Sample			Description of Materials	Installation		HC Vapour conc. (ppm)
			Number	Type	Container		Schematic	Details	
-2.0	▽		SS-Zone-4E-12ft	Split Spoon	Bag	SAND, fine grained, dry		note: 3ft riser above ground	
-4.0						SAND, medium grained, damp, light brown		grout to 2.44m	
-6.0						water level @ 3.35m from ground level		bentonite to 3.67m	
-8.0						note: taken during drilling		screen @ 4.57m	
-10.0								silica sand to 7.62m	
-12.0								TD @ 7.62m	
-14.0									
-16.0									

Coordinates: 455282E, 5513886N	Drill Type: Hollow Stem	Vertical Scale: 1:125 (approx.)
Drawn By: Wesley Nash	Approved By:	Plate: 1 of 1

## DRILL HOLE LOG: ESI

 <p style="font-size: small;">Defence Construction Canada Construction de Défense Canada</p> <hr/> <p><b>Client:</b> DREV, DND, Valcartier, Quebec</p>	Project:	Borehole No.:
	Shilo II	GW-Zone-4W
	Location:	Project No.:
	CFB Shilo, Manitoba	SL 12910
Driller:	Date Drilled:	
Paddock Drilling Ltd., Brandon	September 11, 2001	

Depth (m)	Elevation (m)	Blows	Sample			Description of Materials	Installation		HC Vapour conc. (ppm)
			Number	Type	Container		Schematic	Details	
. . . -2.0 . . . -4.0 . . . -6.0 ▽ . . . -8.0 . . . -10 . . . -12 . . . -14 . . . -16			SS-Zone-4W-22ft (6.72m)	Split Spoon	Bag	<p>SAND, fine, black</p> <p>SAND, medium-course grained, moist, light brown</p> <p>water level @ 6.10m from ground level</p> <p>note: water level taken during drilling</p>		<p>note: 3ft riser above ground</p> <p>bentonite to 5.79m</p> <p>screen @ 6.72m</p> <p>silica sand to 8.23m</p> <p>TD @ 8.23m</p>	

Coordinates: 453722E, 5514810N	Drill Type: Hollow Stem	Vertical Scale: 1:125 (approx.)
Drawn By: Wesley Nash	Approved By:	Plate: 1 of 1

## DRILL HOLE LOG: ESI



Defence Construction Canada  
Construction de Défense Canada

**Client:**

DREV, DND, Valcartier, Quebec

Project:	Borehole No.:
Shilo II	GW-Zone-5N
Location:	Project No.:
CFB Shilo, Manitoba	SL 12910
Driller:	Date Drilled:
Paddock Drilling Ltd., Brandon	September 12, 2001

Depth (m)	Elevation (m)	Blows	Sample			Description of Materials	Installation		HC Vapour conc. (ppm)
			Number	Type	Container		Schematic	Details	
-2.0			SS-Zone-5N-19.5ft (5.95m)	Split Spoon	Bag	SAND, medium grained, well graded, damp, light brown		bentonite to 4.57m	
-4.0						SAND, medium grained, well graded, moist, light brown		screen @ 5.79m	
-6.0	▽					water level @ 5.49m from ground level		silica sand to 8.84m	
-8.0						note: water level taken during drilling		TD @ 8.84m	
-10									
-12									
-14									
-16									
Coordinates: 455251E, 5511038N			Drill Type: Hollow Stem			Vertical Scale: 1:125 (approx.)			
Drawn By: Wesley Nash			Approved By:			Plate: 1 of 1			

## DRILL HOLE LOG: ESI

 <p style="font-size: small;">Defence Construction Canada Construction de Défense Canada</p> <hr/> <p><b>Client:</b> DREV, DND, Valcartier, Quebec</p>	Project:	Borehole No.:
	Shilo II	GW-Zone-5S
	Location:	Project No.:
	CFB Shilo, Manitoba	SL 12910
	Driller:	Date Drilled:
Paddock Drilling Ltd., Brandon	September 12, 2001	

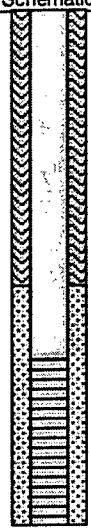
Depth (m)	Elevation (m)	Blows	Sample			Description of Materials	Installation		HC Vapour conc. (ppm)
			Number	Type	Container		Schematic	Details	
-2.0			SS-Zone-5S-20ft (6.10m)	Split Spoon	Bag	SAND, fine, organics present, black		bentonite to 4.88m  screen @ 6.10m silica sand to 9.15m  TD @ 9.15m	
-4.0						SAND, medium, moist, light brown			
-6.0	▽					water level @ 5.79m from ground level			
-8.0						note: water level taken during drilling			
-10.0									
-12.0									
-14.0									
-16.0									

Coordinates: 455235E, 5508362N	Drill Type: Hollow Stem	Vertical Scale: 1:125 (approx.)
Drawn By: Wesley Nash	Approved By:	Plate: 1 of 1

## DRILL HOLE LOG: ESI



Defence Construction Canada  
Construction de Défense Canada

**Client:**

DREV, DND, Valcartier, Quebec

**Project:**

Shilo II

**Location:**

CFB Shilo, Manitoba

**Driller:**

Paddock Drilling Ltd.,  
Brandon

**Borehole No.:**

GW-Zone-7

**Project No.:**

SL 12910

**Date Drilled:**

September 16, 2001

Depth (m)	Elevation (m)	Blows	Sample			Description of Materials	Installation		HC Vapour conc. (ppm)
			Number	Type	Container		Schematic	Details	
-2.0						SAND, fine grained, dry, loose, brown		grout to 3.05m	
-4.0					SAND, course grained, moist, well graded				bentonite to 5.18m
-6.0	▽					water level @ 6.02m from ground level	screen @ 7.32m	silica sand to 8.85m	
-8.0			SS-Zone-7-22ft (6.71m)	Split Spoon	Bag				TD @ 9.15m
-10									
-12									
-14									
-16									

Coordinates: 468311E, 5497495N	Drill Type: Hollow Stem	Vertical Scale: 1:125 (approx.)
Drawn By: Wesley Nash	Approved By:	Plate: 1 of 1

## DRILL HOLE LOG: ESI



Defence Construction Canada  
Construction de Défense Canada

**Client:**

DREV, DND, Valcartier, Quebec

Project:	Borehole No.:
Shilo II	GW-Zone-7W
Location:	Project No.:
CFB Shilo, Manitoba	SL 12910
Driller:	Date Drilled:
Paddock Drilling Ltd., Brandon	September 16, 2001

Depth (m)	Elevation (m)	Blows	Sample			Description of Materials	Installation		HC Vapour conc. (ppm)
			Number	Type	Container		Schematic	Details	
0						SAND, fine grained, dry, loose, brown			
-2.0						SAND, course grained, moist, well graded, trace pebbles, light brown,		bentonite to 6.40m	
-4.0						water level @ 7.01m from ground level		screen @ 7.32m	
-6.0						note: water level taken during drilling		silica sand to 1m	
-8.0								TD @ 10.37m	
-10									
-12									
-14									
-16									
			SS-Zone-7W-25ft (7.62m)	Split Spoon	Bag				

Coordinates: 466672E, 5497612N  
Drawn By: Wesley Nash

Drill Type: Hollow Stem  
Approved By:

Vertical Scale: 1:125 (approx.)  
Plate: 1 of 1

## DRILL HOLE LOG: ESI



Defence Construction Canada  
Construction de Défense Canada

**Client:**

DREV, DND, Valcartier, Quebec

**Project:**

Shilo II

**Location:**

CFB Shilo, Manitoba

**Driller:**

Paddock Drilling Ltd.,  
Brandon

**Borehole No.:**





GW-Zone-9N

**Project No.:**

SL 12910

**Date Drilled:**

September 13, 2001

Depth (m)	Elevation (m)	Blows	Sample			Description of Materials	Installation		HC Vapour conc. (ppm)
			Number	Type	Container		Schematic	Details	
-2.0						SAND, medium grained, dry, light brown		grout to 2.90m	
-4.0						SAND, medium grained, damp, light brown		bentonite to 6.40m	
-6.0	▽					water level @ 7.32m from ground level		screen @ 7.62m	
-8.0			SS-Zone 9N-25ft	Split Spoon	Bag	note: water level taken during drilling		silica sand to 8.84m	
-10.0							0.30m of blow-up	TD @ 9.14m	
-12.0									
-14.0									
-16.0									
Coordinates: 459766E, 5519509N			Drill Type: Hollow Stem			Vertical Scale: 1:125 (approx.)			
Drawn By: Wesley Nash			Approved By:			Plate: 1 of 1			

## DRILL HOLE LOG: ESI

 <p style="font-size: small;">Defence Construction Canada Construction de Défense Canada</p> <hr/> <p><b>Client:</b> DREV, DND, Valcartier, Quebec</p>	Project:	Borehole No.:
	Shilo II	GW-Zone-9S
	Location:	Project No.:
	CFB Shilo, Manitoba	SL 12910
Driller:	Date Drilled:	
Paddock Drilling Ltd., Brandon	September 13, 2001	

Depth (m)	Elevation (m)	Blows	Sample			Description of Materials	Installation		HC Vapour conc. (ppm)
			Number	Type	Container		Schematic	Details	
							SS-Zone 9S-6ftft (1.83m)	Split Spoon	
-2.0	▽				SAND, medium grained, damp, light brown  water level @ 1.95m from ground level	0.61m of blow-up			
-4.0									
-6.0									
-8.0									
-10									
-12									
-14									
-16									

Coordinates: 458561E, 5517394N	Drill Type: Hollow Stem	Vertical Scale: 1:125 (approx.)
Drawn By: Wesley Nash	Approved By:	Plate: 1 of 1



## DRILL HOLE LOG: ESI

 <p style="font-size: small;">Defence Construction Canada Construction de Défense Canada</p> <hr/> <p><b>Client:</b> DREV, DND, Valcartier, Quebec</p>	Project:	Borehole No.:
	Shilo II	GW-Zone-9W
	Location:	Project No.:
	CFB Shilo, Manitoba	SL 12910
	Driller:	Date Drilled:
Paddock Drilling Ltd., Brandon	September 14, 2001	

Depth (m)	Elevation (m)	Blows	Sample			Description of Materials	Installation		HC Vapour conc. (ppm)
			Number	Type	Container		Schematic	Details	
-2.0						SAND, medium grained, dry, brown	grout to 3.05m		
-4.0						SAND, medium grained, damp, light brown	bentonite to 6.10m		
-6.0						water level @ 7.22m from ground level	screen @ 7.01m		
-8.0	▽		SS-Zone-9W-23ft	Split Spoon	Bag		silica sand to 8.54m		
-10.0							TD @ 8.54m		
-12.0									
-14.0									
-16.0									

Coordinates: 459052E, 5518440N	Drill Type: Hollow Stem	Vertical Scale: 1:125 (approx.)
Drawn By: Wesley Nash	Approved By:	Plate: 1 of 1

# C.F.B. Shilo - ID SS-GW-A-10@15'

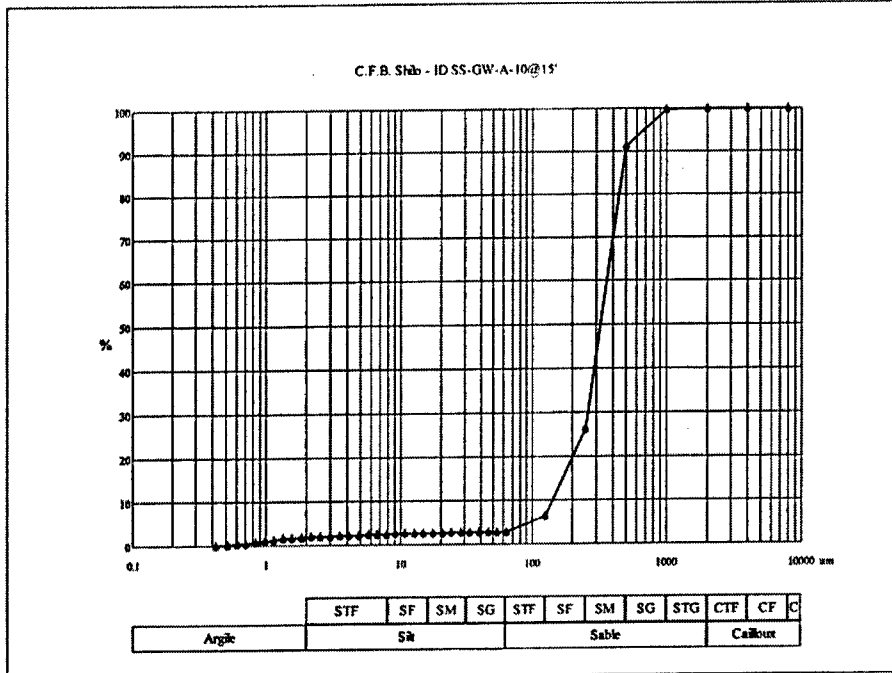

Tamis	Qte	Qte%	Cumul%
0.42	0.13	0.13	0.00
0.51	0.13	0.13	0.13
0.60	0.14	0.14	0.26
0.71	0.23	0.23	0.40
0.83	0.30	0.30	0.63
0.98	0.27	0.27	0.93
1.15	0.22	0.22	1.20
1.35	0.18	0.18	1.42
1.58	0.14	0.14	1.60
1.86	0.11	0.11	1.74
2.18	0.09	0.09	1.85
2.56	0.08	0.08	1.94
3.00	0.07	0.07	2.02
3.53	0.07	0.07	2.09
4.14	0.06	0.06	2.16
4.86	0.06	0.06	2.22
5.71	0.06	0.06	2.29
6.70	0.05	0.05	2.35
7.87	0.05	0.05	2.40
9.23	0.04	0.04	2.45
10.84	0.04	0.04	2.49
12.73	0.04	0.04	2.53
14.94	0.03	0.03	2.57
17.54	0.03	0.03	2.60
20.60	0.02	0.02	2.63
24.18	0.02	0.02	2.65
28.39	0.01	0.01	2.67
33.33	0.01	0.01	2.68
39.13	0.01	0.01	2.69
45.94	0.01	0.01	2.70
53.93	0.01	0.01	2.71
63.00	3.66	3.67	2.72
125.00	19.91	19.95	6.38
250.00	64.75	64.89	26.34
500.00	8.37	8.39	91.23
1000.00	0.36	0.36	99.62
2000.00	0.02	0.02	99.98
4000.00	0.00	0.00	100.00
8000.00	0.00	0.00	100.00

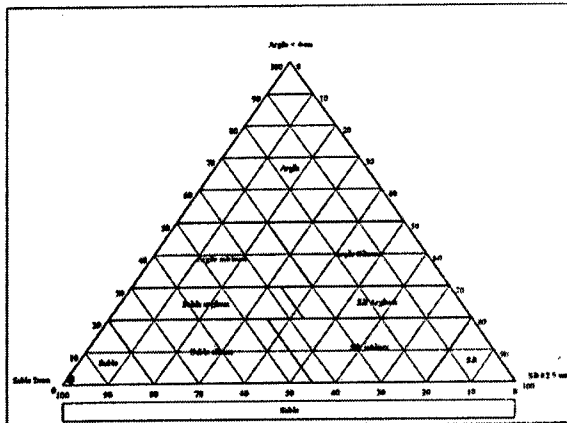

### INFO

Projet: C.F.B. Shilo II  
 Well A-10 Sample Depth: 15'  
 Graph prepared by: Catherine Gauthier  
 Software: Gran V.1.01 CGC/CGQ Eric Boisvert 1998  
 Date: February 6, 2002

Parametre	Valeur
Moyenne	1.7577
Médiane	1.6830
Ecart Type G.	0.6128
Ecart Type G. Inc.	0.6885
Skewness	0.2333
Kurtose	1.4655
Coef Hazen	2.0087E-002
Argile <2um	1.80
Silt[2-62.5um]	0.92
Sable[62.5um-2mm]	97.26
Argile <4um	2.15
Silt[4-62.5um]	0.57

# C.F.B. Shilo - ID SS-GW-A-9@6'

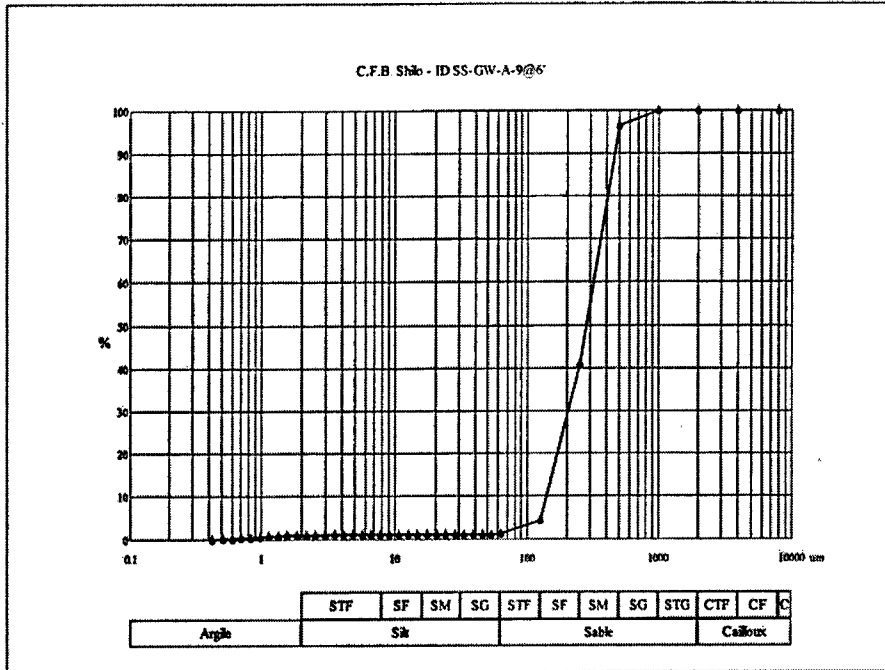

Tamis	Qte	Qte%	Cumul%
0.42	0.08	0.08	0.00
0.51	0.08	0.08	0.08
0.60	0.08	0.08	0.16
0.71	0.12	0.12	0.24
0.83	0.15	0.15	0.36
0.98	0.13	0.13	0.51
1.15	0.11	0.11	0.64
1.35	0.08	0.08	0.75
1.58	0.06	0.06	0.83
1.86	0.05	0.05	0.89
2.18	0.04	0.04	0.94
2.56	0.03	0.03	0.98
3.00	0.02	0.02	1.01
3.53	0.02	0.02	1.03
4.14	0.02	0.02	1.05
4.86	0.02	0.02	1.07
5.71	0.02	0.02	1.09
6.70	0.01	0.01	1.11
7.87	0.01	0.01	1.12
9.23	0.01	0.01	1.13
10.84	0.01	0.01	1.14
12.73	0.01	0.01	1.15
14.94	0.01	0.01	1.16
17.54	0.01	0.01	1.17
20.60	0.01	0.01	1.18
24.18	0.01	0.01	1.19
28.39	0.01	0.01	1.20
33.33	0.00	0.00	1.21
39.13	0.00	0.00	1.21
45.94	0.00	0.00	1.21
53.93	0.01	0.01	1.21
63.00	3.13	3.14	1.22
125.00	36.44	36.52	4.36
250.00	55.37	55.49	40.88
500.00	3.48	3.49	96.36
1000.00	0.15	0.15	99.85
2000.00	0.00	0.00	100.00
4000.00	0.00	0.00	100.00
8000.00	0.00	0.00	100.00

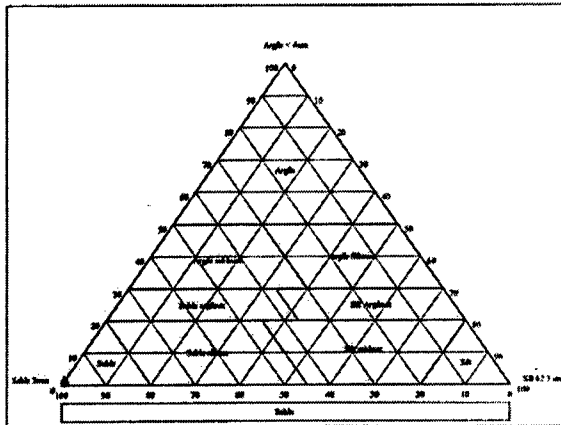

### INFO

Projet: C.F.B. Shilo II  
 Well A-9 Sample Depth: 6'  
 Graph prepared by: Catherine Gauthier  
 Software: Gran V.1.01 CGC/CGQ Eric Boisvert 1998  
 Date: February 6, 2002

Parametre	Valeur
Moyenne	1.9322
Médiane	1.8860
Ecart Type G.	0.5606
Ecart Type G. Inc.	0.5657
Skewness	0.1302
Kurtose	1.0352
Coef Hazen	1.9356E-002

Argile <2µm	0.92
Silt[2-62.5µm]	0.31
Sable[62.5µm-2mm]	98.78

Argile <4µm	1.05
Silt[4-62.5µm]	0.17

# C.F.B. Shilo - ID SS-AMA-1@11'

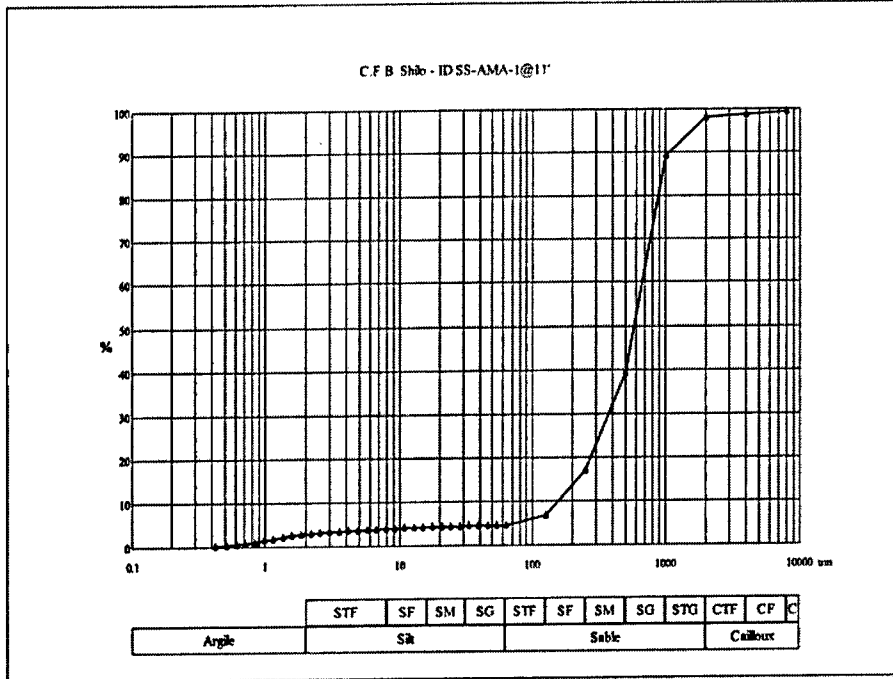

Tamais	Qte	Qte%	Cumul%
0.42	0.21	0.21	0.00
0.51	0.21	0.21	0.21
0.60	0.22	0.22	0.42
0.71	0.34	0.34	0.64
0.83	0.44	0.44	0.98
0.98	0.40	0.40	1.43
1.15	0.35	0.35	1.83
1.35	0.30	0.30	2.18
1.58	0.25	0.25	2.48
1.86	0.20	0.20	2.73
2.18	0.18	0.18	2.93
2.56	0.15	0.15	3.11
3.00	0.13	0.13	3.26
3.53	0.12	0.12	3.39
4.14	0.11	0.11	3.51
4.86	0.10	0.10	3.62
5.71	0.10	0.10	3.72
6.70	0.09	0.09	3.82
7.87	0.09	0.09	3.91
9.23	0.08	0.08	4.00
10.84	0.08	0.08	4.09
12.73	0.07	0.07	4.17
14.94	0.07	0.07	4.24
17.54	0.06	0.06	4.31
20.60	0.05	0.05	4.37
24.18	0.04	0.04	4.42
28.39	0.03	0.03	4.46
33.33	0.03	0.03	4.49
39.13	0.03	0.03	4.52
45.94	0.02	0.02	4.55
53.93	0.02	0.02	4.57
63.00	2.25	2.26	4.59
125.00	10.20	10.24	6.85
250.00	22.23	22.31	17.08
500.00	49.56	49.74	39.40
1000.00	8.82	8.85	89.14
2000.00	0.73	0.73	97.99
4000.00	0.65	0.65	98.73
8000.00	0.62	0.62	99.38

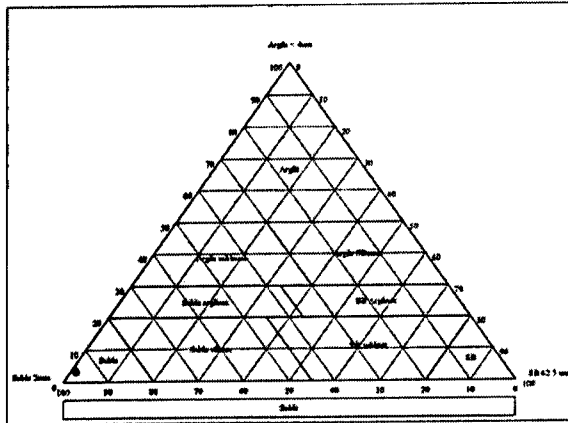

### INFO

Projet: C.F.B. Shilo II  
 Well AMA-1 Sample Depth: 11'  
 Graph prepared by: Catherine Gauthier  
 Software: Gran V.1.01 CGC/CGQ Eric Boisvert 1998  
 Date: February 7, 2002

### Parametre

Parametre	Valeur
Moyenne	1.0202
Médiane	0.8211
Ecart Type G.	0.9598
Ecart Type G. Inc.	1.1298
Skewness	0.3472
Kurtose	1.4422
Coef Hazen	2.3952E-002
Argile <2µm	2.82
Silt[2-62.5µm]	1.76
Sable[62.5µm-2mm]	93.41
Argile <4µm	3.49
Silt[4-62.5µm]	1.10

# C.F.B. Shilo - ID SS-AMA-2@22.5'

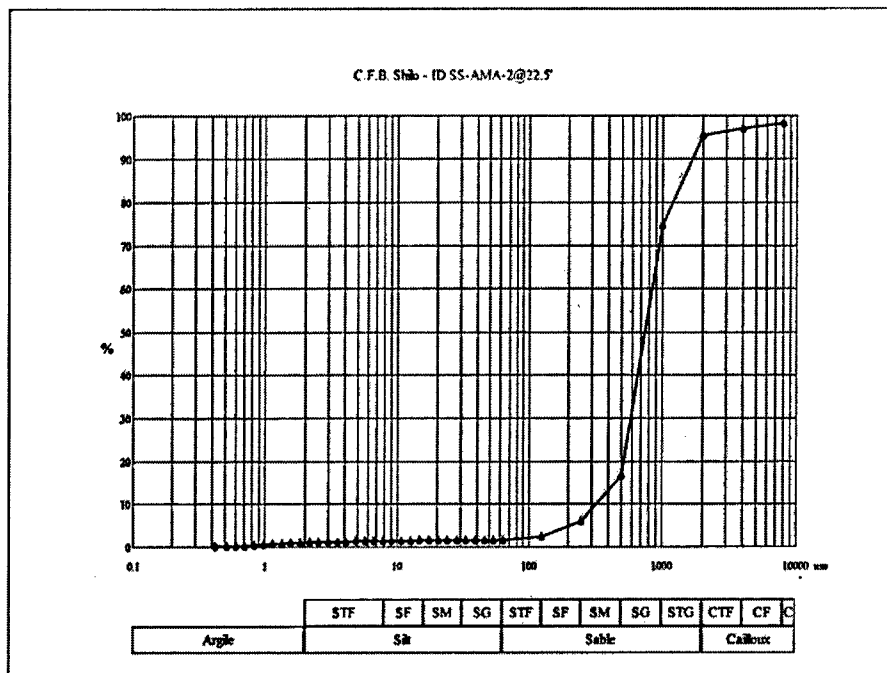

Tamis	Qte	Qte%	Cumul%
0.42	0.06	0.06	0.00
0.51	0.06	0.06	0.06
0.60	0.07	0.07	0.12
0.71	0.12	0.12	0.19
0.83	0.16	0.16	0.31
0.98	0.15	0.15	0.47
1.15	0.13	0.13	0.62
1.35	0.11	0.11	0.75
1.58	0.09	0.09	0.86
1.86	0.07	0.07	0.95
2.18	0.06	0.06	1.02
2.56	0.05	0.05	1.08
3.00	0.04	0.04	1.13
3.53	0.03	0.03	1.17
4.14	0.03	0.03	1.20
4.86	0.03	0.03	1.23
5.71	0.03	0.03	1.26
6.70	0.03	0.03	1.29
7.87	0.03	0.03	1.32
9.23	0.03	0.03	1.35
10.84	0.02	0.02	1.38
12.73	0.02	0.02	1.40
14.94	0.02	0.02	1.42
17.54	0.02	0.02	1.44
20.60	0.01	0.01	1.46
24.18	0.01	0.01	1.47
28.39	0.01	0.01	1.48
33.33	0.01	0.01	1.49
39.13	0.01	0.01	1.50
45.94	0.01	0.01	1.51
53.93	0.01	0.01	1.52
63.00	0.73	0.73	1.53
125.00	3.68	3.69	2.27
250.00	10.83	10.85	5.95
500.00	57.74	57.87	16.81
1000.00	20.72	20.77	74.68
2000.00	1.52	1.52	95.45
4000.00	1.31	1.31	96.97
8000.00	1.71	1.71	98.29

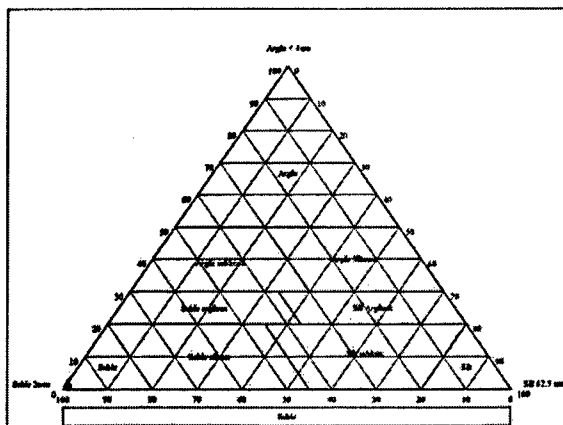

## INFO

Projet: C.F.B. Shilo II  
 Well AMA-2 Sample Depth: 22.5'  
 Graph prepared by: Catherine Gauthier  
 Software: Gran V.1.01 CGC/CGQ Eric Boisvert 1998  
 Date: February 7, 2002

Parametre	Valeur
Moyenne	0.3795
Médiane	0.4079
Ecart Type G.	0.6879
Ecart Type G. Inc.	0.8216
Skewness	0.0361
Kurtose	1.5524
Coef Hazen	1.0479E-001
Argile <2µm	0.98
Silt[2-62.5µm]	0.55
Sable[62.5µm-2mm]	93.92
Argile <4µm	1.20
Silt[4-62.5µm]	0.34

# C.F.B. Shilo - ID SS-ANTENNE-1@35'

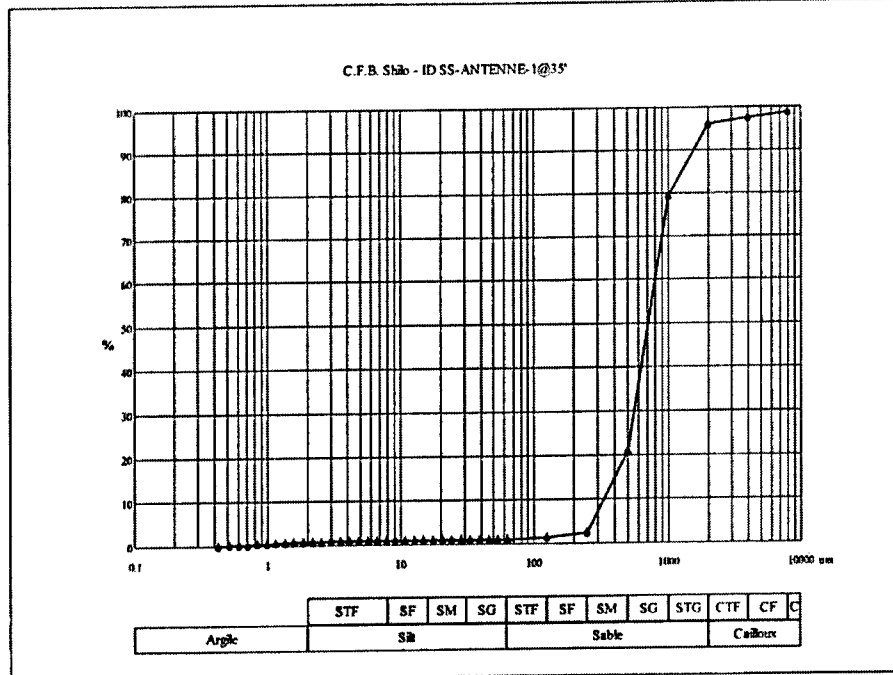

Tamais	Qte	Qte%	Cumul%
0.42	0.05	0.05	0.00
0.51	0.05	0.05	0.05
0.60	0.05	0.05	0.10
0.71	0.10	0.10	0.15
0.83	0.13	0.13	0.25
0.98	0.12	0.12	0.38
1.15	0.09	0.09	0.50
1.35	0.07	0.07	0.59
1.58	0.06	0.06	0.66
1.86	0.04	0.04	0.72
2.18	0.03	0.03	0.76
2.56	0.03	0.03	0.79
3.00	0.02	0.02	0.82
3.53	0.02	0.02	0.84
4.14	0.01	0.01	0.86
4.86	0.01	0.01	0.87
5.71	0.01	0.01	0.88
6.70	0.01	0.01	0.89
7.87	0.01	0.01	0.90
9.23	0.01	0.01	0.91
10.84	0.01	0.01	0.92
12.73	0.01	0.01	0.93
14.94	0.01	0.01	0.94
17.54	0.01	0.01	0.95
20.60	0.01	0.01	0.96
24.18	0.00	0.00	0.97
28.39	0.00	0.00	0.97
33.33	0.00	0.00	0.97
39.13	0.00	0.00	0.97
45.94	0.00	0.00	0.97
53.93	0.01	0.01	0.97
63.00	0.32	0.32	0.98
125.00	1.11	1.11	1.30
250.00	18.46	18.49	2.41
500.00	58.40	58.50	20.91
1000.00	16.64	16.67	79.40
2000.00	1.46	1.46	96.07
4000.00	1.15	1.15	97.54
8000.00	1.31	1.31	98.69

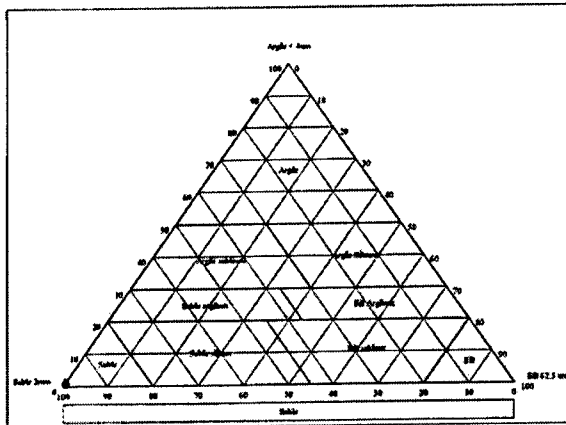

### INFO

Projet C.F.B. Shilo II  
 Well ANTENNE-1 Sample Depth: 35'  
 Graph prepared by: Catherine Gauthier  
 Software: Gran V.1.01 CGC/CGQ Eric Boisvert 1998  
 Date: February 6, 2002

Parametre	Valeur
Moyenne	0.4924
Médiane	0.5034
Ecart Type G.	0.6714
Ecart Type G. Inc.	0.7290
Skewness	-0.0448
Kurtose	1.2880
Coef Hazen	1.1037E-001
Argile <2µm	0.74
Silt[2-62.5µm]	0.24
Sable[62.5µm-2mm]	95.09
Argile <4µm	0.86
Silt[4-62.5µm]	0.12

# C.F.B. Shilo - ID SS-ATR-1@12'

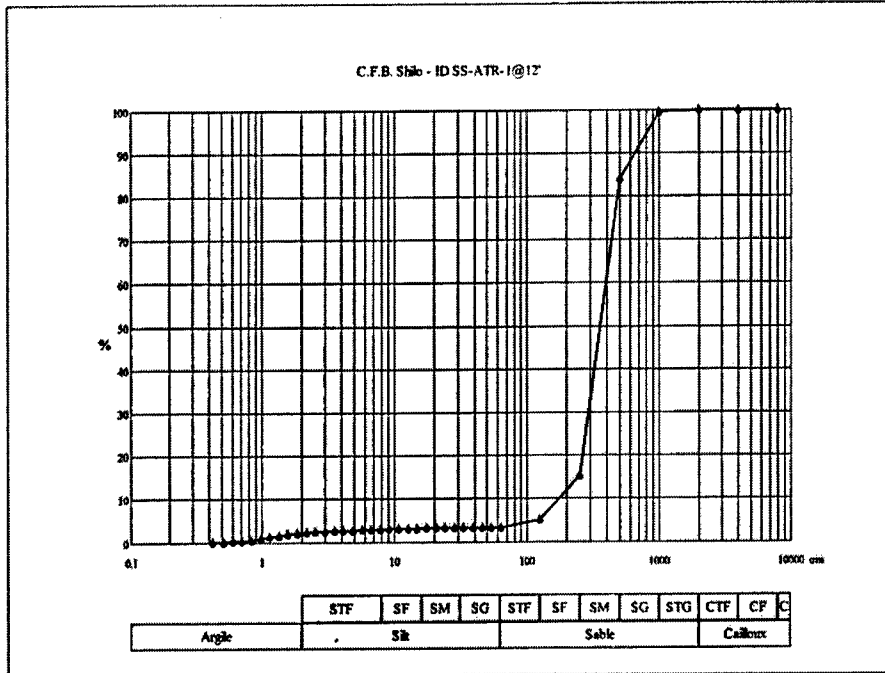

Tamis	Qte	Qte%	Cumul%
0.42	0.11	0.11	0.00
0.51	0.11	0.11	0.11
0.60	0.12	0.12	0.22
0.71	0.24	0.24	0.34
0.83	0.34	0.34	0.58
0.98	0.35	0.35	0.92
1.15	0.32	0.32	1.28
1.35	0.28	0.28	1.60
1.58	0.23	0.23	1.88
1.86	0.18	0.18	2.11
2.18	0.15	0.15	2.29
2.56	0.12	0.12	2.44
3.00	0.10	0.10	2.56
3.53	0.09	0.09	2.66
4.14	0.08	0.08	2.75
4.86	0.07	0.07	2.83
5.71	0.07	0.07	2.90
6.70	0.06	0.06	2.97
7.87	0.05	0.05	3.03
9.23	0.05	0.05	3.08
10.84	0.04	0.04	3.13
12.73	0.04	0.04	3.17
14.94	0.04	0.04	3.21
17.54	0.03	0.03	3.25
20.60	0.03	0.03	3.28
24.18	0.02	0.02	3.31
28.39	0.02	0.02	3.33
33.33	0.02	0.02	3.35
39.13	0.02	0.02	3.37
45.94	0.02	0.02	3.39
53.93	0.03	0.03	3.41
63.00	1.75	1.76	3.44
125.00	10.11	10.15	5.20
250.00	68.33	68.61	15.35
500.00	15.49	15.55	83.96
1000.00	0.32	0.32	99.52
2000.00	0.06	0.06	99.84
4000.00	0.10	0.10	99.90
8000.00	0.00	0.00	100.00

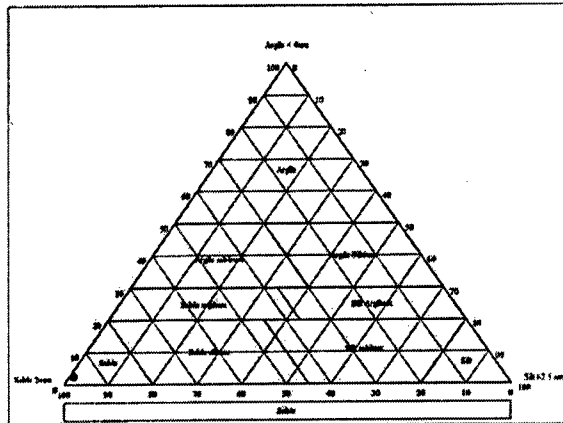

### INFO

Projet: C.F.B. Shilo II  
 Well ATR-1 Sample Depth: 12'  
 Graph prepared by: Catherine Gauthier  
 Software: Gran V.1.01 CGC/CGQ Eric Boisvert 1998  
 Date: February 7, 2002

Parametre	Valeur
Moyenne	1.4927
Médiane	1.4928
Ecart Type G.	0.4936
Ecart Type G. Inc.	0.6271
Skewness	0.1407
Kurtose	1.5389
Coef Hazen	3.0089E-002

Argile <2µm                    2.19  
 Silt[2-62.5µm]                1.25  
 Sable[62.5µm-2mm]         96.40

Argile <4µm                    2.73  
 Silt[4-62.5µm]                0.71

# C.F.B. Shilo - ID SS-BGR-3@22'

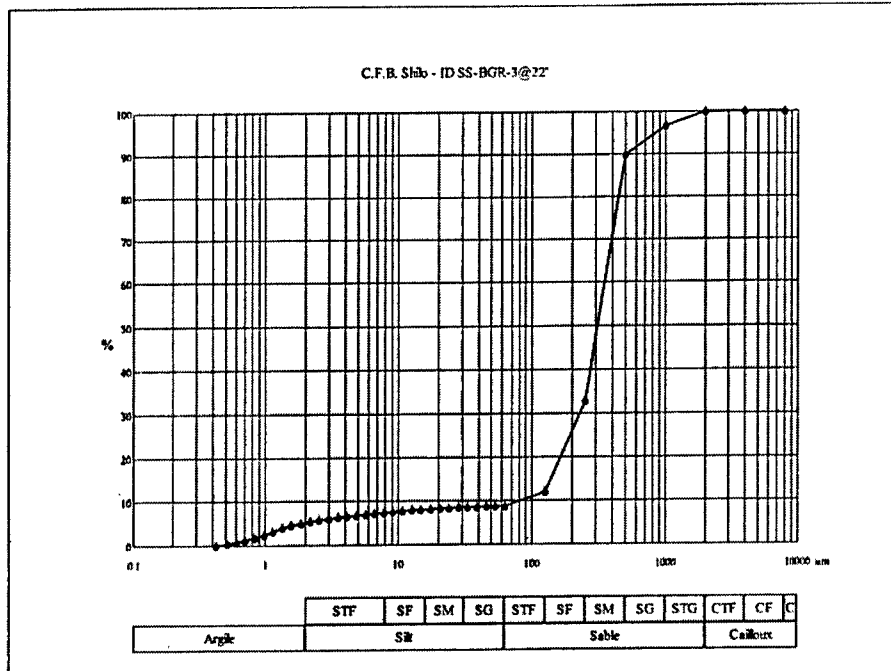

Tamis	Qte	Qte%	Cumul%
0.42	0.34	0.34	0.00
0.51	0.34	0.34	0.34
0.60	0.35	0.35	0.68
0.71	0.59	0.59	1.04
0.83	0.78	0.78	1.63
0.98	0.77	0.77	2.41
1.15	0.70	0.70	3.19
1.35	0.62	0.62	3.89
1.58	0.53	0.53	4.51
1.86	0.42	0.42	5.05
2.18	0.34	0.34	5.47
2.56	0.28	0.28	5.81
3.00	0.24	0.24	6.09
3.53	0.22	0.22	6.33
4.14	0.21	0.21	6.55
4.86	0.21	0.21	6.77
5.71	0.21	0.21	6.98
6.70	0.20	0.20	7.19
7.87	0.19	0.19	7.39
9.23	0.19	0.19	7.58
10.84	0.18	0.18	7.77
12.73	0.16	0.16	7.95
14.94	0.15	0.15	8.11
17.54	0.13	0.13	8.26
20.60	0.11	0.11	8.39
24.18	0.08	0.08	8.50
28.39	0.07	0.07	8.58
33.33	0.06	0.06	8.66
39.13	0.05	0.05	8.72
45.94	0.05	0.05	8.77
53.93	0.04	0.04	8.82
63.00	3.28	3.30	8.86
125.00	20.50	20.61	12.15
250.00	56.96	57.26	32.76
500.00	6.63	6.66	90.02
1000.00	3.30	3.32	96.68
2000.00	0.00	0.00	100.00
4000.00	0.00	0.00	100.00
8000.00	0.00	0.00	100.00

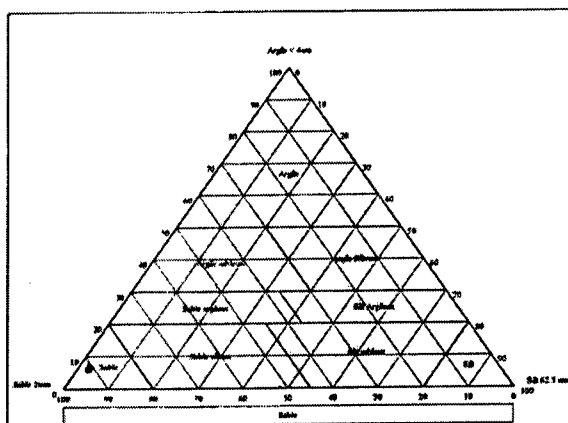

## INFO

Projet: C.F.B. Shilo II  
 Well BGR-3 Sample Depth: 22'  
 Graph prepared by: Catherine Gauthier  
 Software: Gran V.1.01 CGC/CGQ Eric Boisvert 1998  
 Date: February 7, 2002

Parametre	Valeur
Moyenne	1.8892
Médiane	1.7417
Ecart Type G.	0.7961
Ecart Type G. inc.	1.7237
Skewness	0.4792
Kurtose	3.7282
Coef Hazen	6.3851E-003
Argile <2um	5.24
Silt[2-62.5um]	3.61
Sable[62.5um-2mm]	91.15
Argile <4um	6.51
Silt[4-62.5um]	2.35



# C.F.B. Shilo - ID SS-GW-BGR-4@24'

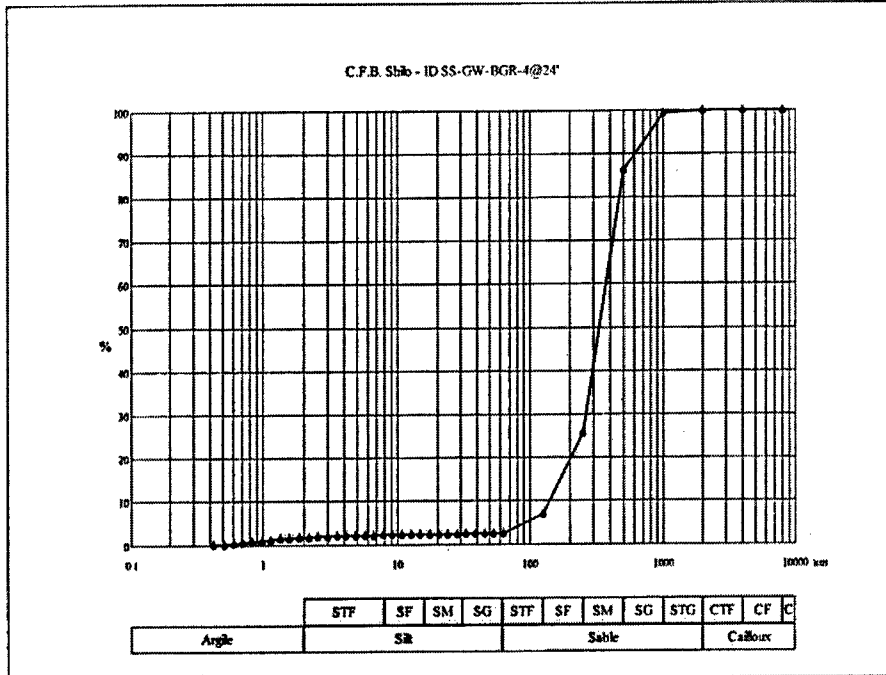

Tamis	Qte	Qte%	Cumul%
0.42	0.14	0.14	0.00
0.51	0.14	0.14	0.14
0.60	0.15	0.15	0.28
0.71	0.23	0.23	0.43
0.83	0.29	0.29	0.66
0.98	0.26	0.26	0.95
1.15	0.21	0.21	1.21
1.35	0.17	0.17	1.42
1.58	0.13	0.13	1.59
1.86	0.10	0.10	1.72
2.18	0.08	0.08	1.82
2.56	0.07	0.07	1.90
3.00	0.06	0.06	1.97
3.53	0.05	0.05	2.04
4.14	0.04	0.04	2.09
4.86	0.04	0.04	2.13
5.71	0.04	0.04	2.17
6.70	0.04	0.04	2.21
7.87	0.03	0.03	2.25
9.23	0.03	0.03	2.28
10.84	0.03	0.03	2.31
12.73	0.03	0.03	2.34
14.94	0.02	0.02	2.37
17.54	0.02	0.02	2.39
20.60	0.02	0.02	2.41
24.18	0.01	0.01	2.43
28.39	0.01	0.01	2.44
33.33	0.01	0.01	2.45
39.13	0.01	0.01	2.46
45.94	0.01	0.01	2.47
53.93	0.01	0.01	2.48
63.00	4.60	4.61	2.49
125.00	18.58	18.63	7.10
250.00	60.36	60.51	25.72
500.00	13.06	13.09	86.24
1000.00	0.58	0.58	99.33
2000.00	0.06	0.06	99.91
4000.00	0.03	0.03	99.97
8000.00	0.00	0.00	100.00

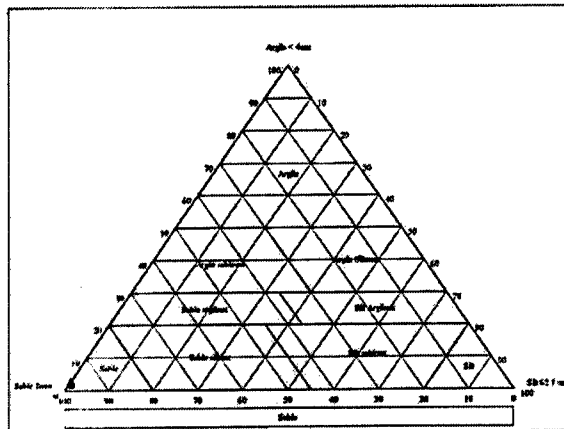

## INFO

Projet: C.F.B. Shilo II  
 Well BGR-4 Sample Depth: 24'  
 Graph prepared by: Catherine Gauthier  
 Software: Gran V.1.01 CGC/CGQ Éric Boisvert 1998  
 Date: February 7, 2002

Parametre	Valeur
Moyenne	1.7009
Médiane	1.6268
Ecart Type G.	0.6825
Ecart Type G. Inc.	0.7587
Skewness	0.2082
Kurtose	1.4310
Coef Hazen	1.9392E-002
Argile <2µm	1.77
Silt[2-62.5µm]	0.71
Sable[62.5µm-2mm]	97.42
Argile <4µm	2.07
Silt[4-62.5µm]	0.41

# C.F.B. Shilo - ID SS-C-8@34'

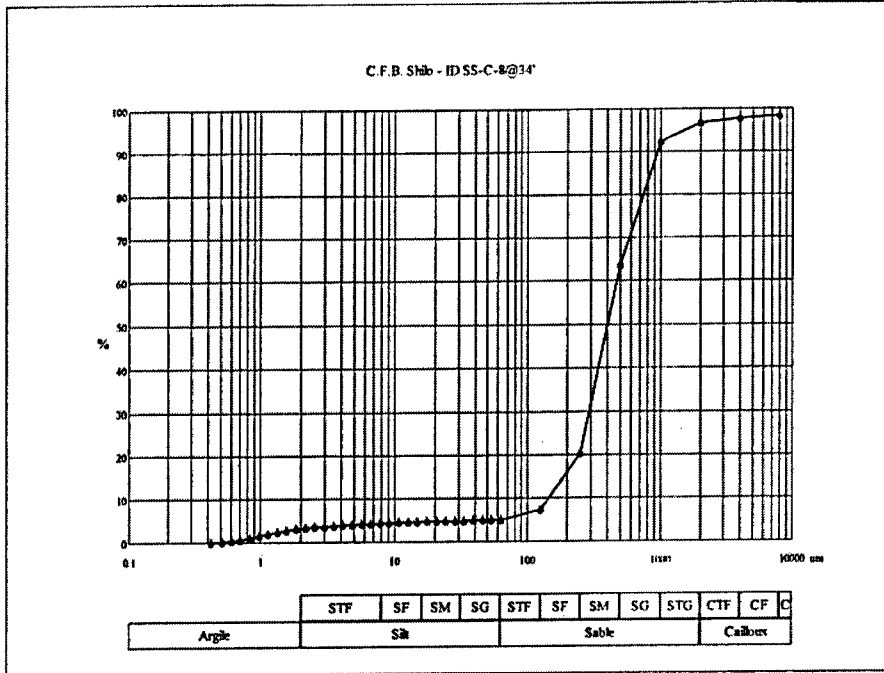

Tamis	Qte	Qte%	Cumul%
0.42	0.18	0.18	0.00
0.51	0.18	0.18	0.18
0.60	0.19	0.19	0.36
0.71	0.38	0.38	0.55
0.83	0.52	0.52	0.93
0.98	0.50	0.50	1.45
1.15	0.44	0.44	1.96
1.35	0.37	0.37	2.40
1.58	0.30	0.30	2.77
1.86	0.23	0.23	3.07
2.18	0.19	0.19	3.30
2.56	0.16	0.16	3.49
3.00	0.14	0.14	3.65
3.53	0.13	0.13	3.79
4.14	0.12	0.12	3.92
4.86	0.11	0.11	4.04
5.71	0.10	0.10	4.15
6.70	0.10	0.10	4.25
7.87	0.09	0.09	4.35
9.23	0.08	0.08	4.44
10.84	0.07	0.07	4.52
12.73	0.07	0.07	4.59
14.94	0.06	0.06	4.66
17.54	0.05	0.05	4.72
20.60	0.04	0.04	4.77
24.18	0.03	0.03	4.81
28.39	0.03	0.03	4.84
33.33	0.03	0.03	4.87
39.13	0.03	0.03	4.90
45.94	0.02	0.02	4.93
53.93	0.04	0.04	4.95
63.00	2.36	2.37	4.99
125.00	12.98	13.02	7.36
250.00	43.17	43.30	20.38
500.00	28.67	28.76	63.68
1000.00	4.16	4.17	92.44
2000.00	0.98	0.98	96.61
4000.00	0.69	0.69	97.59
8000.00	1.71	1.72	98.28

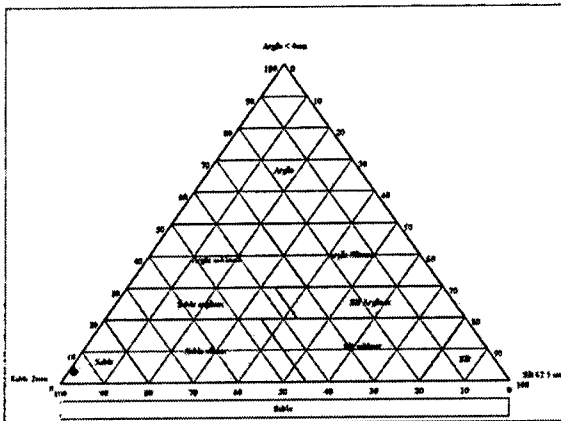

## INFO

Projet: C.F.B. Shilo II  
 Well C-8 Sample Depth: 34'  
 Graph prepared by: Catherine Gauthier  
 Software: Gran V.1.01 CGC/CGQ Eric Boisvert 1998  
 Date: February 7, 2002

Parametre	Valeur
Moyenne	1.3235
Médiane	1.2971
Ecart Type G.	0.9298
Ecart Type G. Inc.	1.1503
Skewness	0.1157
Kurtose	1.5901
Coef Hazen	2.0692E-002

Argile <2um                    3.18  
 Silt[2-62.5um]                1.82  
 Sable[62.5um-2mm]         91.62

Argile <4um                    3.89  
 Silt[4-62.5um]                1.10

# C.F.B. Shilo - ID SS-C-9@22'

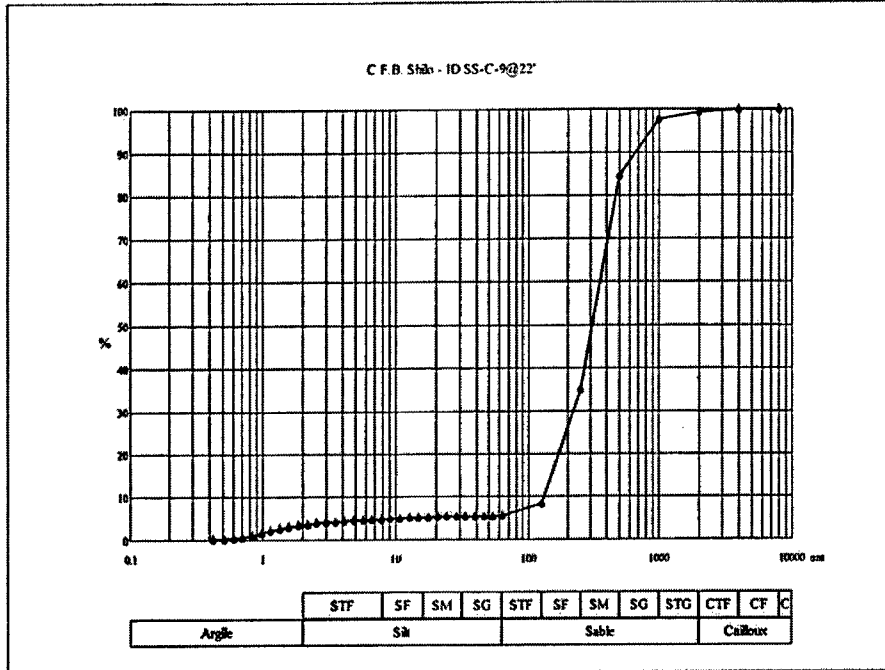

Tamis	Qte	Qte%	Cumul%
0.42	0.18	0.18	0.00
0.51	0.19	0.19	0.18
0.60	0.20	0.20	0.37
0.71	0.39	0.39	0.57
0.83	0.54	0.54	0.96
0.98	0.54	0.54	1.51
1.15	0.49	0.49	2.05
1.35	0.43	0.43	2.54
1.58	0.36	0.36	2.97
1.86	0.29	0.29	3.34
2.18	0.24	0.24	3.63
2.56	0.20	0.20	3.87
3.00	0.17	0.17	4.07
3.53	0.15	0.15	4.24
4.14	0.13	0.13	4.39
4.86	0.12	0.12	4.52
5.71	0.11	0.11	4.64
6.70	0.10	0.10	4.75
7.87	0.09	0.09	4.85
9.23	0.09	0.09	4.94
10.84	0.08	0.08	5.03
12.73	0.07	0.07	5.11
14.94	0.06	0.06	5.18
17.54	0.05	0.05	5.24
20.60	0.04	0.04	5.29
24.18	0.03	0.03	5.34
28.39	0.03	0.03	5.37
33.33	0.03	0.03	5.40
39.13	0.03	0.03	5.43
45.94	0.03	0.03	5.46
53.93	0.04	0.04	5.49
63.00	2.85	2.86	5.53
125.00	26.64	26.77	8.39
250.00	49.18	49.41	35.16
500.00	13.01	13.07	84.57
1000.00	1.73	1.74	97.64
2000.00	0.49	0.49	99.38
4000.00	0.13	0.13	99.87
8000.00	0.00	0.00	100.00

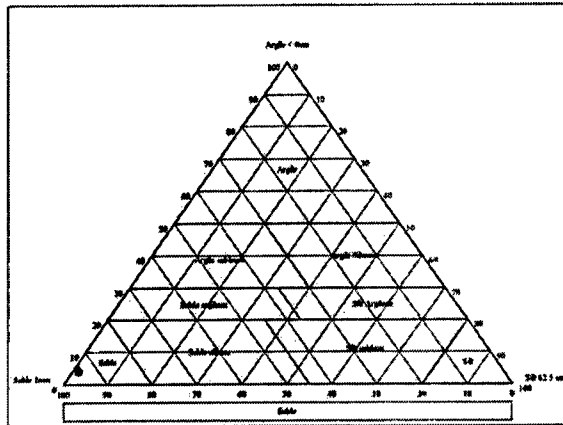

### INFO

Projet: C.F.B. Shilo II  
 Well C-9 Sample Depth: 22'  
 Graph prepared by: Catherine Gauthier  
 Software: Gran V.1.01 CGC/CGQ Eric Boisvert 1998  
 Date: February 6, 2002

Parametre	Valeur
Moyenne	1.7863
Médiane	1.7276
Ecart Type G.	0.7983
Ecart Type G. Inc.	1.3481
Skewness	0.3352
Kurtose	2.4538
Coef Hazen	1.6984E-002

Argile <2µm	3.47
Silt[2-62.5µm]	2.05
Sable[62.5µm-2mm]	93.85

Argile <4µm	4.36
Silt[4-62.5µm]	1.17

# C.F.B. Shilo - ID SS-D-11@29'

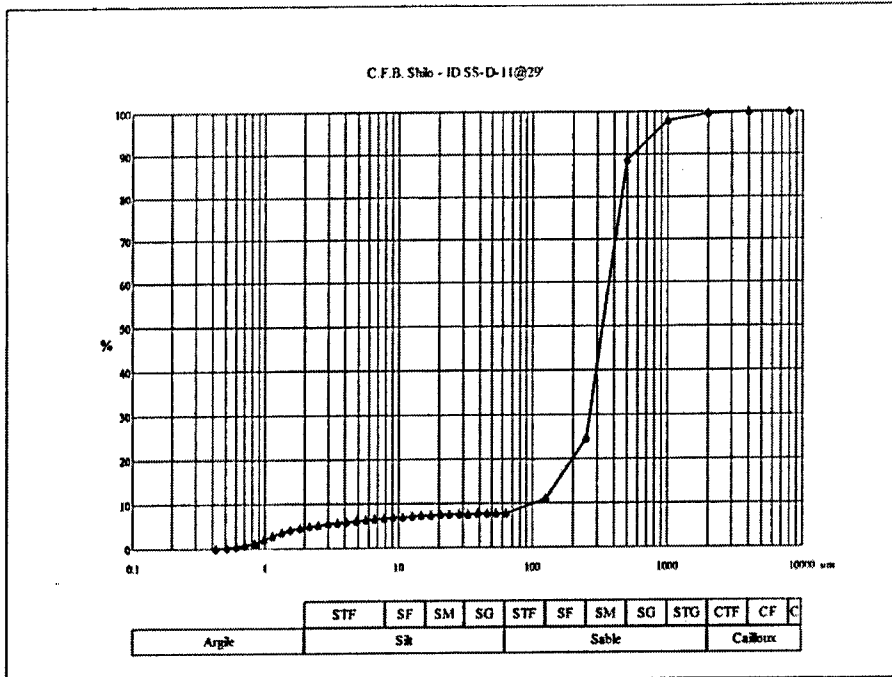

Tamais	Qte	Qte%	Cumul%
0.42	0.19	0.19	0.00
0.51	0.20	0.20	0.19
0.60	0.22	0.22	0.39
0.71	0.55	0.55	0.61
0.83	0.81	0.81	1.16
0.98	0.80	0.80	1.98
1.15	0.70	0.70	2.78
1.35	0.59	0.59	3.48
1.58	0.48	0.48	4.08
1.86	0.38	0.38	4.56
2.18	0.32	0.32	4.94
2.56	0.28	0.28	5.26
3.00	0.25	0.25	5.54
3.53	0.23	0.23	5.79
4.14	0.21	0.21	6.02
4.86	0.20	0.20	6.23
5.71	0.19	0.19	6.44
6.70	0.17	0.17	6.63
7.87	0.16	0.16	6.80
9.23	0.14	0.14	6.96
10.84	0.13	0.13	7.10
12.73	0.12	0.12	7.23
14.94	0.10	0.10	7.35
17.54	0.09	0.09	7.45
20.60	0.07	0.07	7.54
24.18	0.06	0.06	7.61
28.39	0.05	0.05	7.67
33.33	0.05	0.05	7.72
39.13	0.05	0.05	7.77
45.94	0.04	0.04	7.82
53.93	0.06	0.06	7.86
63.00	3.14	3.15	7.92
125.00	13.64	13.69	11.07
250.00	63.63	63.88	24.77
500.00	9.19	9.23	88.65
1000.00	1.61	1.62	97.87
2000.00	0.45	0.45	99.49
4000.00	0.06	0.06	99.94
8000.00	0.00	0.00	100.00

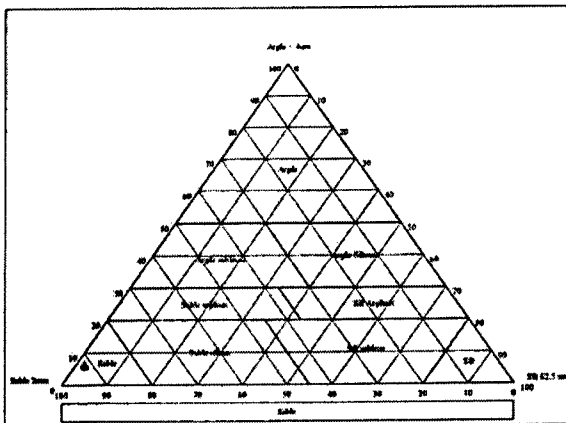

### INFO

Projet: C.F.B. Shilo II  
 Well D-11 Sample Depth: 29'  
 Graph prepared by: Catherine Gauthier  
 Software: Gran V.1.01 CGC/CGQ Eric Boisvert 1998  
 Date: February 7, 2002

Parametre	Valeur
Moyenne	1.7768
Médiane	1.6394
Ecart Type G.	0.7324
Ecart Type G. Inc.	1.6285
Skewness	0.4999
Kurtose	4.7888
Coef Hazen	9.7996E-003
Argile <2um	4.73
Silt[2-62.5um]	3.18
Sable[62.5um-2mm]	91.57
Argile <4um	5.97
Silt[4-62.5um]	1.94

# C.F.B. Shilo - ID SS-D-12@70'

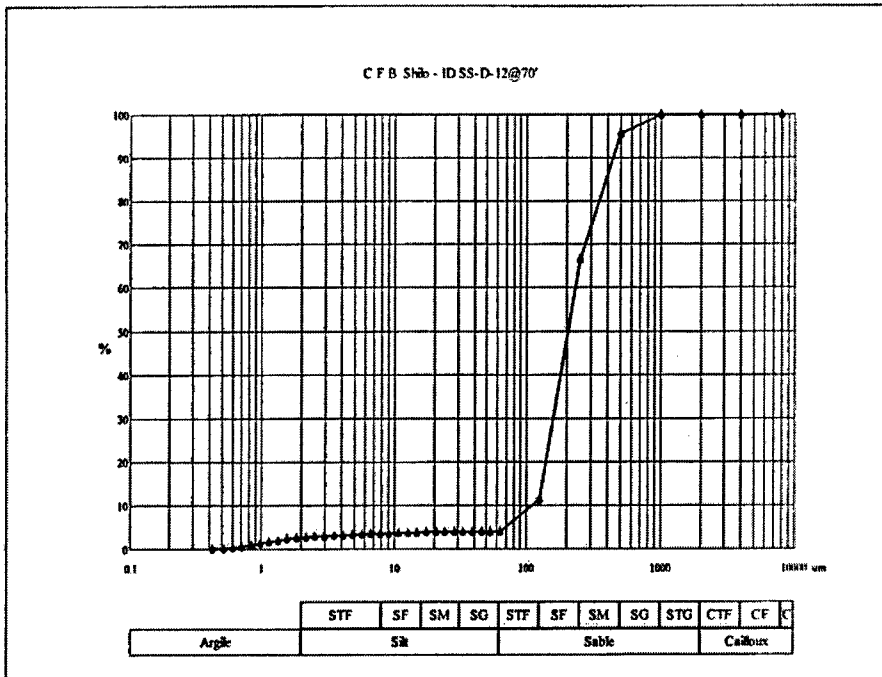

Tamis	Qte	Qte%	Cumul%
0.42	0.17	0.17	0.00
0.51	0.17	0.17	0.17
0.60	0.18	0.18	0.34
0.71	0.32	0.32	0.52
0.83	0.43	0.43	0.84
0.98	0.40	0.40	1.27
1.15	0.34	0.34	1.68
1.35	0.29	0.29	2.02
1.58	0.23	0.23	2.31
1.86	0.18	0.18	2.54
2.18	0.15	0.15	2.72
2.56	0.13	0.13	2.87
3.00	0.11	0.11	3.00
3.53	0.10	0.10	3.11
4.14	0.09	0.09	3.21
4.86	0.09	0.09	3.30
5.71	0.08	0.08	3.39
6.70	0.08	0.08	3.47
7.87	0.07	0.07	3.55
9.23	0.07	0.07	3.62
10.84	0.06	0.06	3.69
12.73	0.06	0.06	3.75
14.94	0.05	0.05	3.81
17.54	0.04	0.04	3.86
20.60	0.03	0.03	3.90
24.18	0.03	0.03	3.93
28.39	0.02	0.02	3.96
33.33	0.02	0.02	3.98
39.13	0.02	0.02	4.00
45.94	0.02	0.02	4.02
53.93	0.02	0.02	4.04
63.00	7.48	7.50	4.06
125.00	54.89	55.07	11.57
250.00	28.86	28.95	66.63
500.00	4.22	4.23	95.59
1000.00	0.13	0.13	99.82
2000.00	0.02	0.02	99.95
4000.00	0.03	0.03	99.97
8000.00	0.00	0.00	100.00

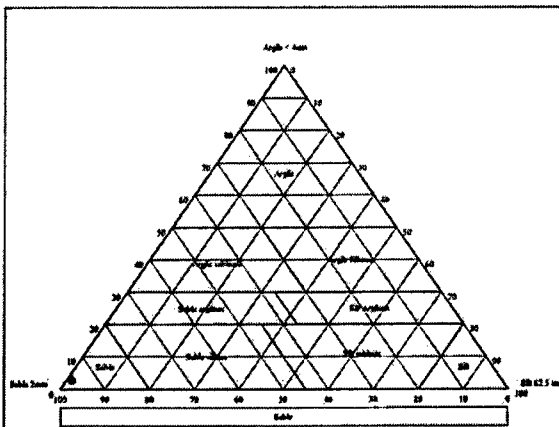

### INFO

Projet: C.F.B. Shilo II  
 Well D-12 Sample Depth: 70'  
 Graph prepared by: Catherine Gauthier  
 Software: Gran V.1.01 CGC/CGQ Eric Boisvert 1998  
 Date: February 6, 2002

Parametre	Valeur
Moyenne	2.2324
Médiane	2.2644
Ecart Type G.	0.6592
Ecart Type G. Inc.	0.7486
Skewness	0.0229
Kurtose	1.3036
Coef Hazen	1.1737E-002
Argile <2µm	2.62
Silt[2-62.5µm]	1.44
Sable[62.5µm-2mm]	95.89
Argile <4µm	3.19
Silt[4-62.5µm]	0.87

# C.F.B. Shilo - ID SS-D-13@27'

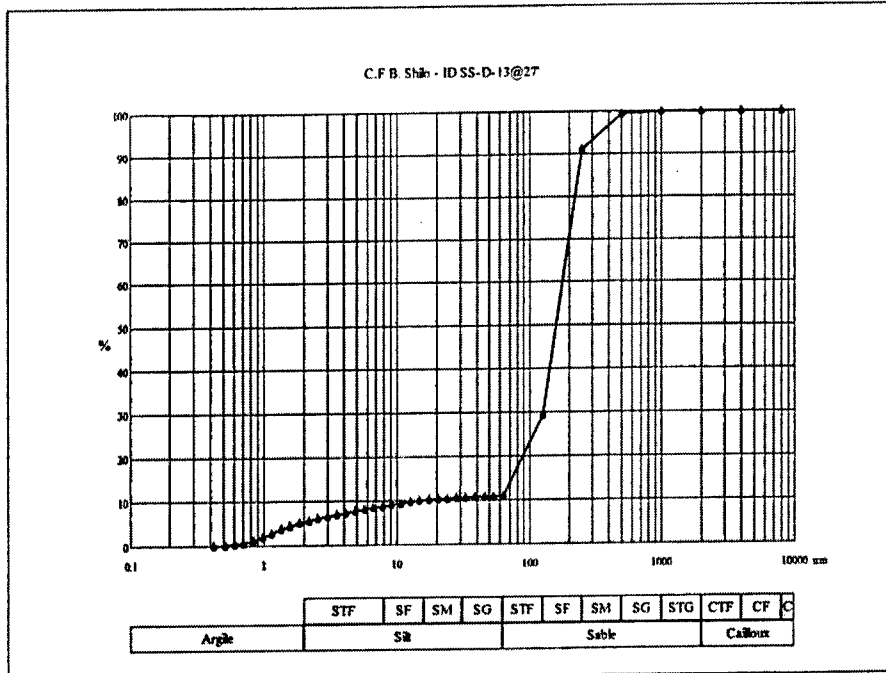

Tamais	Qte	Qte%	Cumul%
0.42	0.16	0.16	0.00
0.51	0.16	0.16	0.16
0.60	0.19	0.19	0.32
0.71	0.55	0.55	0.51
0.83	0.83	0.83	1.07
0.98	0.91	0.91	1.90
1.15	0.85	0.85	2.81
1.35	0.77	0.77	3.67
1.58	0.67	0.67	4.44
1.86	0.57	0.57	5.12
2.18	0.50	0.50	5.69
2.56	0.44	0.44	6.19
3.00	0.41	0.41	6.63
3.53	0.39	0.39	7.04
4.14	0.37	0.37	7.44
4.86	0.37	0.37	7.81
5.71	0.36	0.36	8.18
6.70	0.35	0.35	8.54
7.87	0.32	0.32	8.89
9.23	0.30	0.30	9.22
10.84	0.27	0.27	9.52
12.73	0.24	0.24	9.79
14.94	0.21	0.21	10.03
17.54	0.18	0.18	10.24
20.60	0.14	0.14	10.42
24.18	0.10	0.10	10.56
28.39	0.08	0.08	10.66
33.33	0.07	0.07	10.74
39.13	0.06	0.06	10.81
45.94	0.06	0.06	10.87
53.93	0.05	0.05	10.93
63.00	18.31	18.40	10.98
125.00	61.43	61.73	29.38
250.00	8.12	8.16	91.12
500.00	0.68	0.68	99.28
1000.00	0.04	0.04	99.96
2000.00	0.00	0.00	100.00
4000.00	0.00	0.00	100.00
8000.00	0.00	0.00	100.00

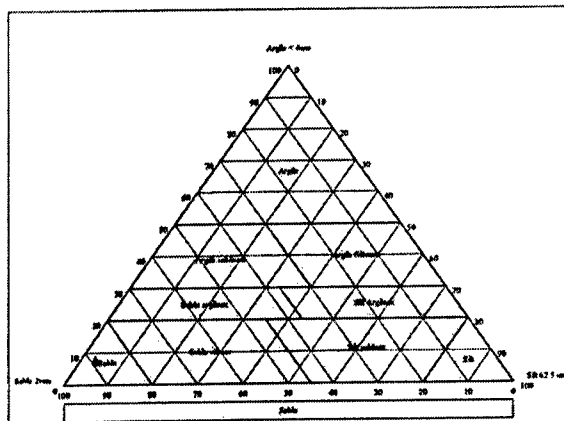

### INFO

Projet: C.F.B. Shilo II  
 Well D-13 Sample Depth: 27'  
 Graph prepared by: Catherine Gauthier  
 Software: Gran V.1.01 CGC/CGQ Eric Boisvert 1998  
 Date: February 7, 2002

Parametre	Valeur
Moyenne	2.8514
Médiane	2.7140
Ecart Type G.	0.7324
Ecart Type G. Inc.	1.4849
Skewness	0.5074
Kurtose	3.6301
Coef Hazen	2.1481E-004
Argile <2um	5.38
Silt[2-62.5um]	5.60
Sable[62.5um-2mm]	89.02
Argile <4um	7.35
Silt[4-62.5um]	3.63

# C.F.B. Shilo - ID SS-GW-D-9@17

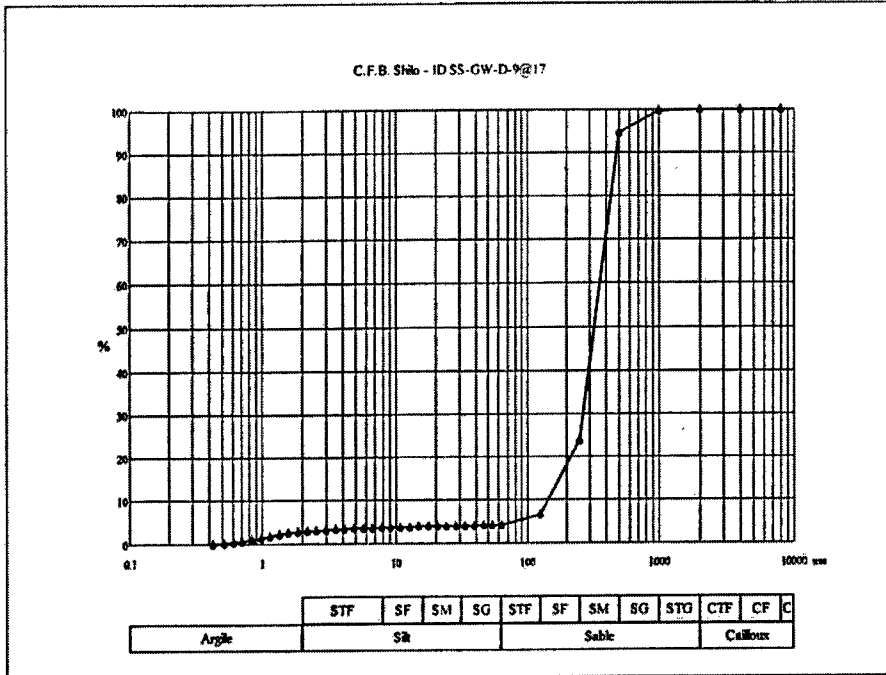

Tamis	Qte	Qte%	Cumul%
0.42	0.19	0.19	0.00
0.51	0.19	0.19	0.19
0.60	0.20	0.20	0.38
0.71	0.35	0.35	0.58
0.83	0.47	0.47	0.93
0.98	0.42	0.42	1.41
1.15	0.36	0.36	1.83
1.35	0.29	0.29	2.19
1.58	0.23	0.23	2.48
1.86	0.18	0.18	2.71
2.18	0.15	0.15	2.89
2.56	0.13	0.13	3.04
3.00	0.11	0.11	3.17
3.53	0.10	0.10	3.28
4.14	0.09	0.09	3.38
4.86	0.08	0.08	3.47
5.71	0.07	0.07	3.56
6.70	0.06	0.06	3.63
7.87	0.06	0.06	3.69
9.23	0.05	0.05	3.75
10.84	0.05	0.05	3.80
12.73	0.04	0.04	3.85
14.94	0.04	0.04	3.89
17.54	0.03	0.03	3.93
20.60	0.03	0.03	3.96
24.18	0.02	0.02	3.99
28.39	0.02	0.02	4.01
33.33	0.02	0.02	4.03
39.13	0.02	0.02	4.05
45.94	0.02	0.02	4.07
53.93	0.03	0.03	4.09
63.00	2.41	2.42	4.12
125.00	17.27	17.34	6.54
250.00	70.41	70.71	23.88
500.00	5.09	5.11	94.60
1000.00	0.27	0.27	99.71
2000.00	0.02	0.02	99.98
4000.00	0.00	0.00	100.00
8000.00	0.00	0.00	100.00

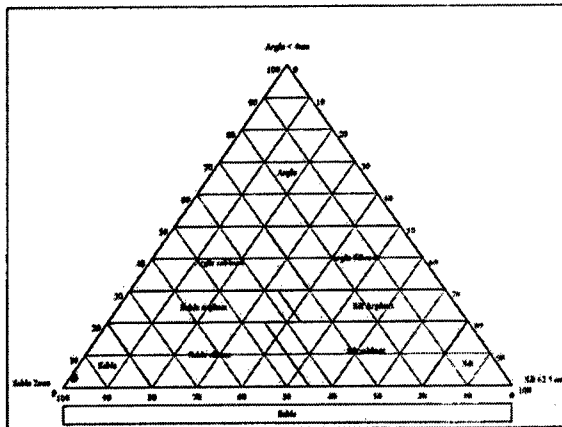

### INFO

Projet: C.F.B. Shilo II  
 Well D-9 Sample Depth: 17'  
 Graph prepared by: Catherine Gauthier  
 Software: Gran V.1.01 CGC/CGQ Eric Boisvert 1998  
 Date: February 6, 2002

Parametre	Valeur
Moyenne	1.7709
Médiane	1.6935
Ecart Type G.	0.5453
Ecart Type G. Inc.	0.6699
Skewness	0.3289
Kurtose	1.8483
Coef Hazen	2.0606E-002
Argile <2µm	2.80
Silt[2-62.5µm]	1.32
Sable[62.5µm-2mm]	95.86
Argile <4µm	3.36
Silt[4-62.5µm]	0.75

# C.F.B. Shilo - ID SS-E-11@12.5'

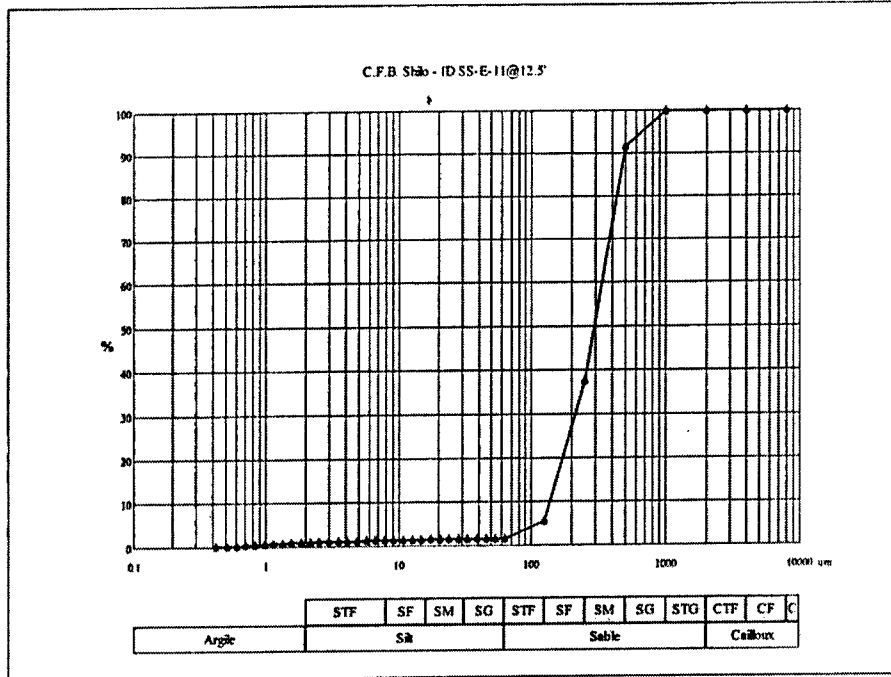

Tamais	Qte	Qte%	Cumul%
0.42	0.07	0.07	0.00
0.51	0.07	0.07	0.07
0.60	0.07	0.07	0.14
0.71	0.12	0.12	0.21
0.83	0.16	0.16	0.33
0.98	0.14	0.14	0.49
1.15	0.12	0.12	0.63
1.35	0.09	0.09	0.75
1.58	0.08	0.08	0.84
1.86	0.06	0.06	0.92
2.18	0.05	0.05	0.98
2.56	0.05	0.05	1.03
3.00	0.04	0.04	1.08
3.53	0.04	0.04	1.12
4.14	0.04	0.04	1.16
4.86	0.04	0.04	1.20
5.71	0.03	0.03	1.24
6.70	0.03	0.03	1.27
7.87	0.03	0.03	1.30
9.23	0.03	0.03	1.33
10.84	0.02	0.02	1.36
12.73	0.02	0.02	1.38
14.94	0.02	0.02	1.40
17.54	0.02	0.02	1.42
20.60	0.01	0.01	1.44
24.18	0.01	0.01	1.45
28.39	0.01	0.01	1.46
33.33	0.01	0.01	1.47
39.13	0.01	0.01	1.48
45.94	0.01	0.01	1.49
53.93	0.01	0.01	1.50
63.00	3.97	3.98	1.51
125.00	31.85	31.93	5.49
250.00	54.03	54.17	37.42
500.00	8.19	8.21	91.59
1000.00	0.20	0.20	99.80
2000.00	0.00	0.00	100.00
4000.00	0.00	0.00	100.00
8000.00	0.00	0.00	100.00

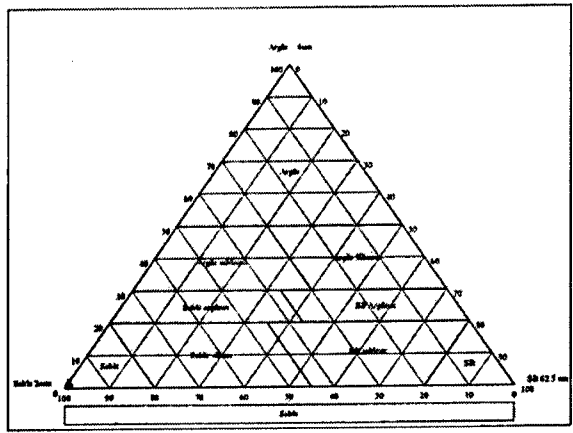

## INFO

Projet: C.F.B. Shilo II  
 Well E-11 Sample Depth: 12.5'  
 Graph prepared by: Catherine Gauthier  
 Software: Gran V.1.01 CGC/CGQ Eric Boisvert 1998  
 Date: February 6, 2002

Parametre	Valeur
Moyenne	1.8549
Médiane	1.8112
Ecart Type G.	0.6506
Ecart Type G. Inc.	0.6680
Skewness	0.1130
Kurtose	1.0763
Coef Hazen	1.9002E-002
Argile <2um	0.95
Silt[2-62.5um]	0.56
Sable[62.5um-2mm]	98.49
Argile <4um	1.15
Silt[4-62.5um]	0.36



# C.F.B. Shilo - ID SS-E-7@14'

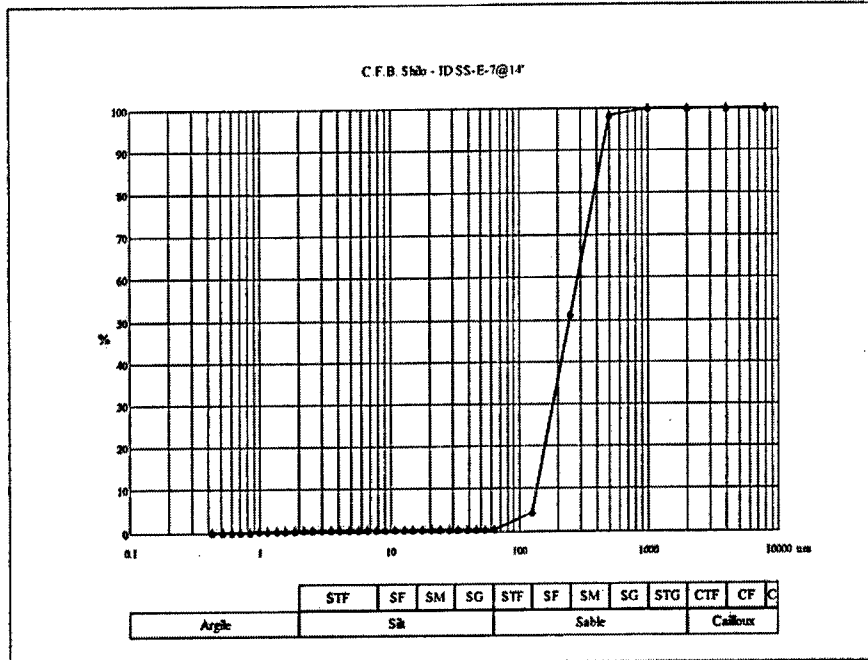

Tamis	Qte	Qte%	Cumul%
0.42	0.04	0.04	0.00
0.51	0.04	0.04	0.04
0.60	0.04	0.04	0.08
0.71	0.05	0.05	0.12
0.83	0.07	0.07	0.17
0.98	0.06	0.06	0.24
1.15	0.04	0.04	0.30
1.35	0.03	0.03	0.34
1.58	0.02	0.02	0.37
1.86	0.02	0.02	0.39
2.18	0.01	0.01	0.41
2.56	0.01	0.01	0.42
3.00	0.01	0.01	0.43
3.53	0.01	0.01	0.44
4.14	0.01	0.01	0.45
4.86	0.01	0.01	0.46
5.71	0.01	0.01	0.47
6.70	0.01	0.01	0.48
7.87	0.01	0.01	0.49
9.23	0.01	0.01	0.50
10.84	0.01	0.01	0.51
12.73	0.01	0.01	0.52
14.94	0.01	0.01	0.53
17.54	0.00	0.00	0.54
20.60	0.00	0.00	0.54
24.18	0.00	0.00	0.54
28.39	0.00	0.00	0.54
33.33	0.00	0.00	0.54
39.13	0.00	0.00	0.54
45.94	0.00	0.00	0.54
53.93	0.00	0.00	0.54
63.00	3.87	3.88	0.54
125.00	46.78	46.90	4.42
250.00	46.82	46.94	51.32
500.00	1.73	1.73	98.26
1000.00	0.01	0.01	99.99
2000.00	0.00	0.00	100.00
4000.00	0.00	0.00	100.00
8000.00	0.00	0.00	100.00

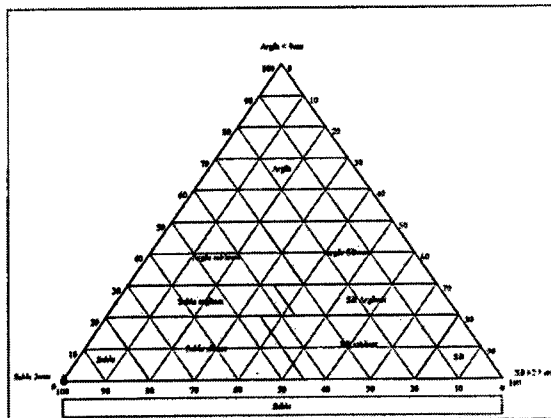

### INFO

Projet: C.F.B. Shilo II  
 Well E-7 Sample Depth: 14'  
 Graph prepared by: Catherine Gauthier  
 Software: Gran V.1.01 CGC/CGQ Eric Boisvert 1998  
 Date: February 7, 2002

Parametre	Valeur
Moyenne	2.0493
Médiane	2.0191
Ecart Type G.	0.5272
Ecart Type G. Inc.	0.5278
Skewness	0.0867
Kurtose	0.9993
Coef Hazen	1.8426E-002
Argile <math><2\mu\text{m}</math>	0.40
Silt[2-62.5 $\mu\text{m}$ ]	0.14
Sable[62.5 $\mu\text{m}$ -2mm]	99.46
Argile <math><4\mu\text{m}</math>	0.45
Silt[4-62.5 $\mu\text{m}$ ]	0.09

# C.F.B. Shilo - ID SS-E-8@17'

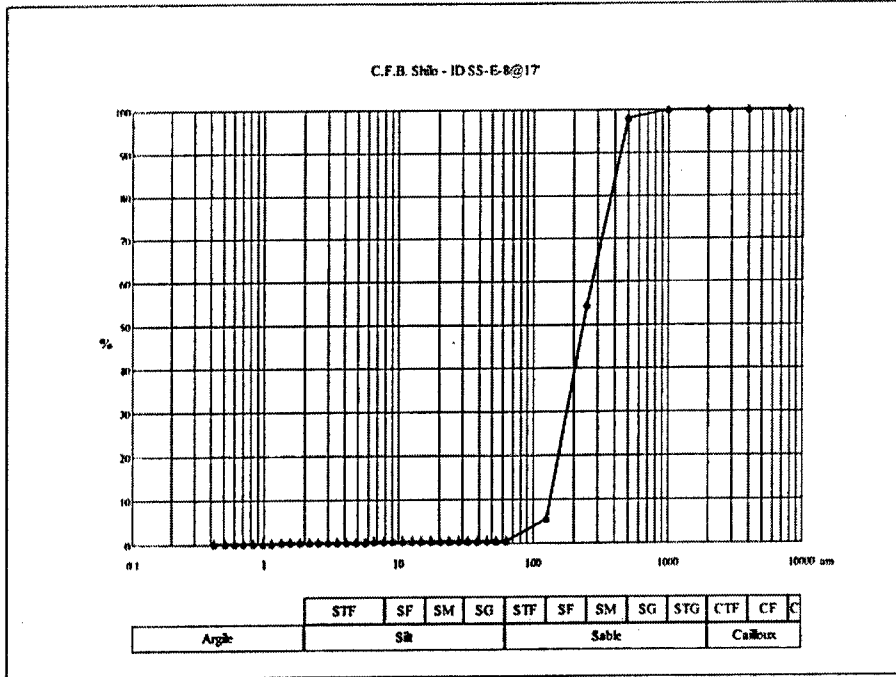

Tamais	Qte	Qte%	Cumul%
0.42	0.02	0.02	0.00
0.51	0.02	0.02	0.02
0.60	0.02	0.02	0.04
0.71	0.04	0.04	0.06
0.83	0.05	0.05	0.10
0.98	0.05	0.05	0.15
1.15	0.04	0.04	0.20
1.35	0.03	0.03	0.24
1.58	0.03	0.03	0.27
1.86	0.02	0.02	0.30
2.18	0.02	0.02	0.32
2.56	0.02	0.02	0.34
3.00	0.01	0.01	0.36
3.53	0.01	0.01	0.37
4.14	0.01	0.01	0.38
4.86	0.01	0.01	0.39
5.71	0.01	0.01	0.40
6.70	0.01	0.01	0.41
7.87	0.01	0.01	0.42
9.23	0.01	0.01	0.43
10.84	0.01	0.01	0.44
12.73	0.01	0.01	0.45
14.94	0.01	0.01	0.46
17.54	0.00	0.00	0.47
20.60	0.00	0.00	0.47
24.18	0.00	0.00	0.47
28.39	0.00	0.00	0.47
33.33	0.00	0.00	0.47
39.13	0.00	0.00	0.47
45.94	0.00	0.00	0.47
53.93	0.00	0.00	0.47
63.00	5.04	5.05	0.47
125.00	49.04	49.13	5.52
250.00	43.26	43.34	54.65
500.00	2.00	2.00	97.99
1000.00	0.01	0.01	99.99
2000.00	0.00	0.00	100.00
4000.00	0.00	0.00	100.00
8000.00	0.00	0.00	100.00

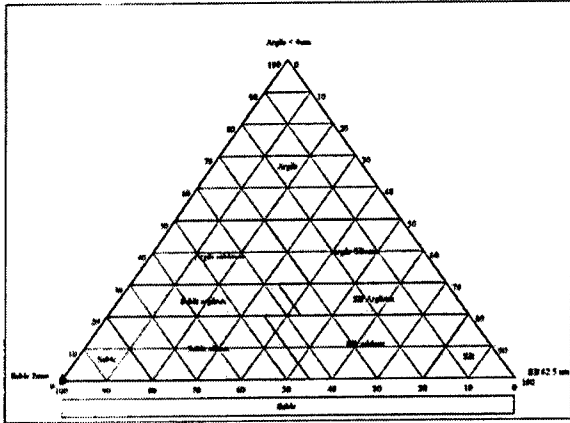

### INFO

Projet: C.F.B. Shilo II  
 Well E-8 Sample Depth: 17'  
 Graph prepared by: Catherine Gauthier  
 Software: Gran V.1.01 CGC/CGQ Eric Boisvert 1998  
 Date: February 6, 2002

Parametre	Valeur
Moyenne	2.0880
Médiane	2.0682
Ecart Type G.	0.5510
Ecart Type G. Inc.	0.5542
Skewness	0.0604
Kurtose	1.0067
Coef Hazen	1.7731E-002
Argile <2um	0.31
Silt[2-62.5um]	0.16
Sable[62.5um-2mm]	99.53
Argile <4um	0.38
Silt[4-62.5um]	0.09

# C.F.B. Shilo - ID SS-E-9@9'

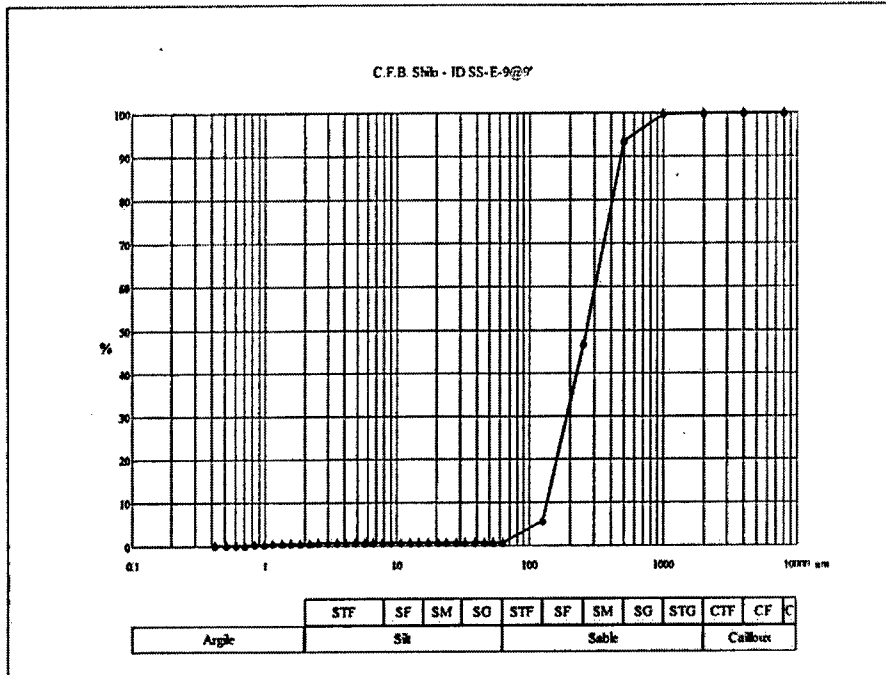

Tamis	Qte	Qte%	Cumul%
0.42	0.05	0.05	0.00
0.51	0.05	0.05	0.05
0.60	0.05	0.05	0.10
0.71	0.08	0.08	0.15
0.83	0.10	0.10	0.23
0.98	0.08	0.08	0.33
1.15	0.07	0.07	0.41
1.35	0.05	0.05	0.48
1.58	0.04	0.04	0.53
1.86	0.03	0.03	0.57
2.18	0.02	0.02	0.60
2.56	0.02	0.02	0.62
3.00	0.02	0.02	0.64
3.53	0.01	0.01	0.66
4.14	0.01	0.01	0.67
4.86	0.01	0.01	0.68
5.71	0.01	0.01	0.69
6.70	0.01	0.01	0.70
7.87	0.01	0.01	0.71
9.23	0.01	0.01	0.72
10.84	0.01	0.01	0.73
12.73	0.01	0.01	0.74
14.94	0.01	0.01	0.75
17.54	0.01	0.01	0.76
20.60	0.01	0.01	0.77
24.18	0.00	0.00	0.78
28.39	0.00	0.00	0.78
33.33	0.00	0.00	0.78
39.13	0.00	0.00	0.78
45.94	0.00	0.00	0.78
53.93	0.00	0.00	0.78
63.00	5.02	5.03	0.78
125.00	40.91	41.02	5.82
250.00	46.60	46.72	46.83
500.00	6.14	6.16	93.55
1000.00	0.28	0.28	99.71
2000.00	0.01	0.01	99.99
4000.00	0.00	0.00	100.00
8000.00	0.00	0.00	100.00

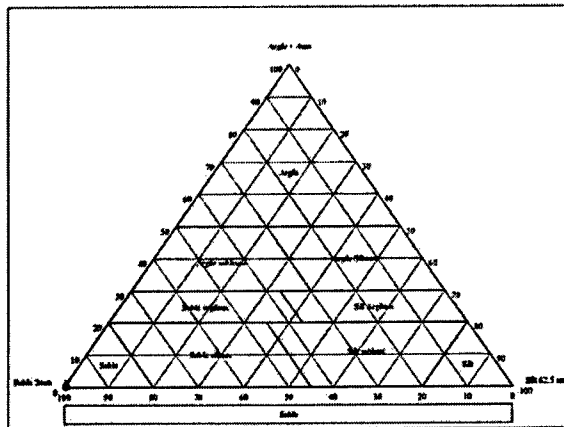

## INFO

Projet: C.F.B. Shilo II  
 Well E-9 Sample Depth: 9'  
 Graph prepared by: Catherine Gauthier  
 Software: Gran V.1.01 CGC/CGQ Eric Boisvert 1998  
 Date: February 7, 2002

Parametre	Valeur
Moyenne	1.9638
Médiane	1.9502
Ecart Type G.	0.6426
Ecart Type G. Inc.	0.6531
Skewness	0.0352
Kurtose	1.0325
Coéf Hazen	1.7999E-002
Argile <2µm	0.59
Silt[2-62.5µm]	0.20
Sable[62.5µm-2mm]	99.21
Argile <4µm	0.67
Silt[4-62.5µm]	0.11

# C.F.B. Shilo - ID SS-GATE-S@26'

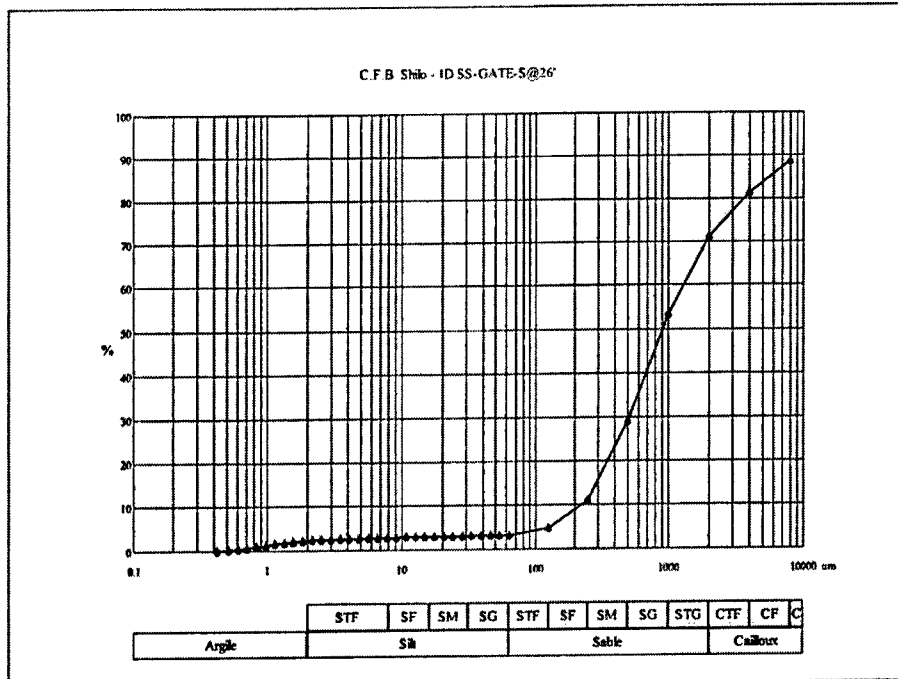

Tamis	Qte	Qte%	Cumul%
0.42	0.17	0.17	0.00
0.51	0.17	0.17	0.17
0.60	0.18	0.18	0.34
0.71	0.29	0.29	0.52
0.83	0.38	0.38	0.81
0.98	0.32	0.32	1.20
1.15	0.26	0.26	1.52
1.35	0.20	0.20	1.78
1.58	0.15	0.15	1.98
1.86	0.12	0.12	2.13
2.18	0.10	0.10	2.25
2.56	0.08	0.08	2.35
3.00	0.07	0.07	2.43
3.53	0.07	0.07	2.50
4.14	0.06	0.06	2.57
4.86	0.06	0.06	2.63
5.71	0.05	0.05	2.69
6.70	0.05	0.05	2.74
7.87	0.04	0.04	2.79
9.23	0.04	0.04	2.83
10.84	0.04	0.04	2.87
12.73	0.03	0.03	2.91
14.94	0.03	0.03	2.94
17.54	0.03	0.03	2.97
20.60	0.02	0.02	3.00
24.18	0.02	0.02	3.02
28.39	0.01	0.01	3.04
33.33	0.01	0.01	3.05
39.13	0.01	0.01	3.06
45.94	0.01	0.01	3.07
53.93	0.01	0.01	3.08
63.00	1.66	1.67	3.09
125.00	6.20	6.23	4.76
250.00	18.13	18.21	10.99
500.00	24.10	24.21	29.20
1000.00	17.82	17.90	53.42
2000.00	10.00	10.05	71.32
4000.00	7.28	7.31	81.36
8000.00	11.27	11.32	88.68

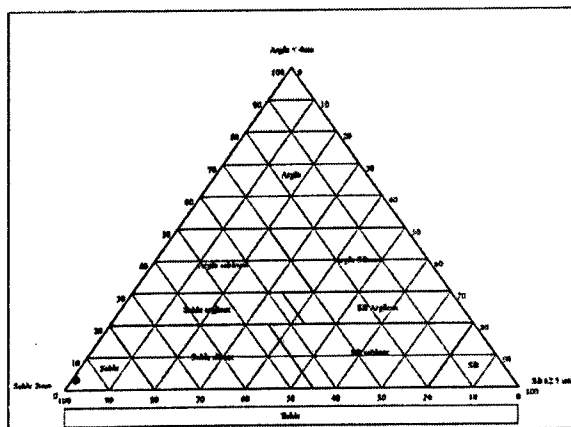

### INFO

Projet: C.F.B. Shilo II  
 Well GATE-S Sample Depth: 26'  
 Graph prepared by: Catherine Gauthier  
 Software: Gran V.1.01 CGC/CGQ Eric Boisvert 1998  
 Date: February 6, 2002

Parametre	Valeur
Moyenne	-0.1766
Médiane	0.1359
Ecart Type G.	1.9907
Ecart Type G. Inc.	2.1043
Skewness	-0.2336
Kurtose	1.1856
Coef Hazen	5.0134E-002
Argile <2µm	2.19
Silt[2-62.5µm]	0.91
Sable[62.5µm-2mm]	68.22
Argile <4µm	2.56
Silt[4-62.5µm]	0.54

# C.F.B. Shilo - ID SS-GRE-1@15'

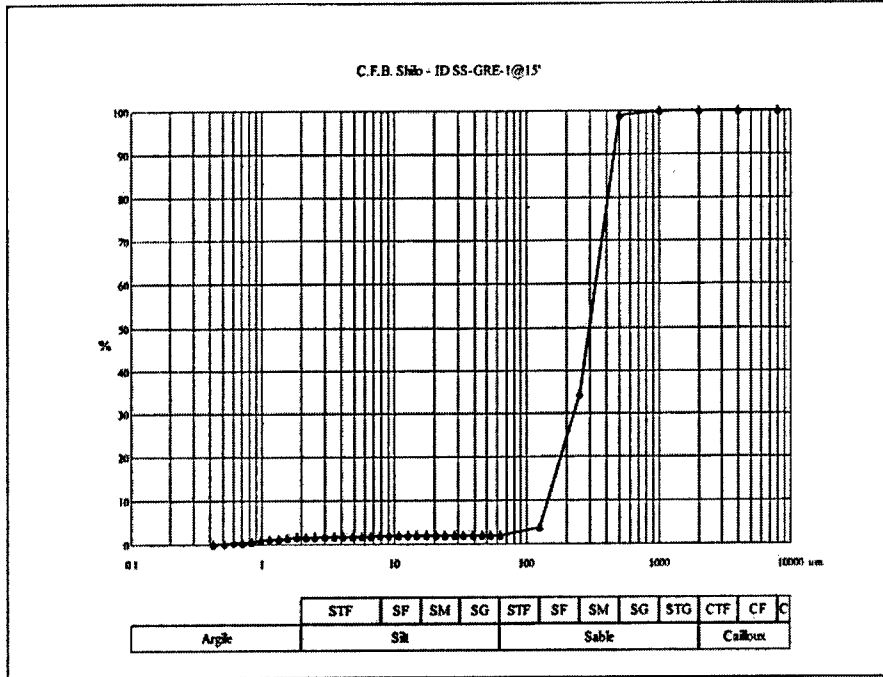

Tamis	Qte	Qte%	Cumul%
0.42	0.12	0.12	0.00
0.51	0.12	0.12	0.12
0.60	0.13	0.13	0.24
0.71	0.19	0.19	0.37
0.83	0.25	0.25	0.56
0.98	0.21	0.21	0.81
1.15	0.18	0.18	1.02
1.35	0.14	0.14	1.20
1.58	0.11	0.11	1.35
1.86	0.08	0.08	1.46
2.18	0.06	0.06	1.54
2.56	0.05	0.05	1.60
3.00	0.04	0.04	1.65
3.53	0.04	0.04	1.69
4.14	0.03	0.03	1.73
4.86	0.03	0.03	1.76
5.71	0.03	0.03	1.79
6.70	0.03	0.03	1.82
7.87	0.02	0.02	1.85
9.23	0.02	0.02	1.87
10.84	0.02	0.02	1.89
12.73	0.02	0.02	1.91
14.94	0.02	0.02	1.93
17.54	0.01	0.01	1.95
20.60	0.01	0.01	1.96
24.18	0.01	0.01	1.97
28.39	0.01	0.01	1.98
33.33	0.01	0.01	1.99
39.13	0.01	0.01	2.00
45.94	0.01	0.01	2.01
53.93	0.01	0.01	2.02
63.00	1.80	1.81	2.03
125.00	30.55	30.67	3.83
250.00	64.12	64.37	34.50
500.00	0.93	0.93	98.88
1000.00	0.09	0.09	99.81
2000.00	0.10	0.10	99.90
4000.00	0.00	0.00	100.00
8000.00	0.00	0.00	100.00

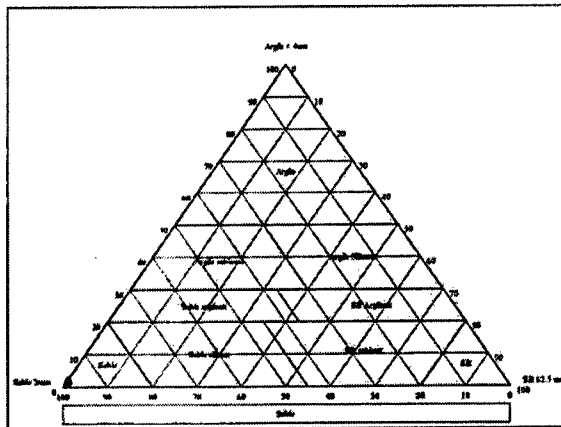

### INFO

Projet: C.F.B. Shilo II  
 Well: GRE-1 Sample Depth: 15'  
 Graph prepared by: Catherine Gauthier  
 Software: Gran V.1.01 CGC/CGQ Eric Boisvert 1998  
 Date: February 6, 2002

Parametre	Valeur
Moyenne	1.9219
Médiane	1.8513
Ecart Type G.	0.4769
Ecart Type G. Inc.	0.4918
Skewness	0.2437
Kurtose	1.1417
Coef Hazen	2.0646E-002

Argile <2µm                    1.49  
 Silt[2-62.5µm]                0.53  
 Sable[62.5µm-2mm]        97.87

Argile <4µm                    1.72  
 Silt[4-62.5µm]                0.31

# C.F.B. Shilo - ID SS-GRE-2@13'

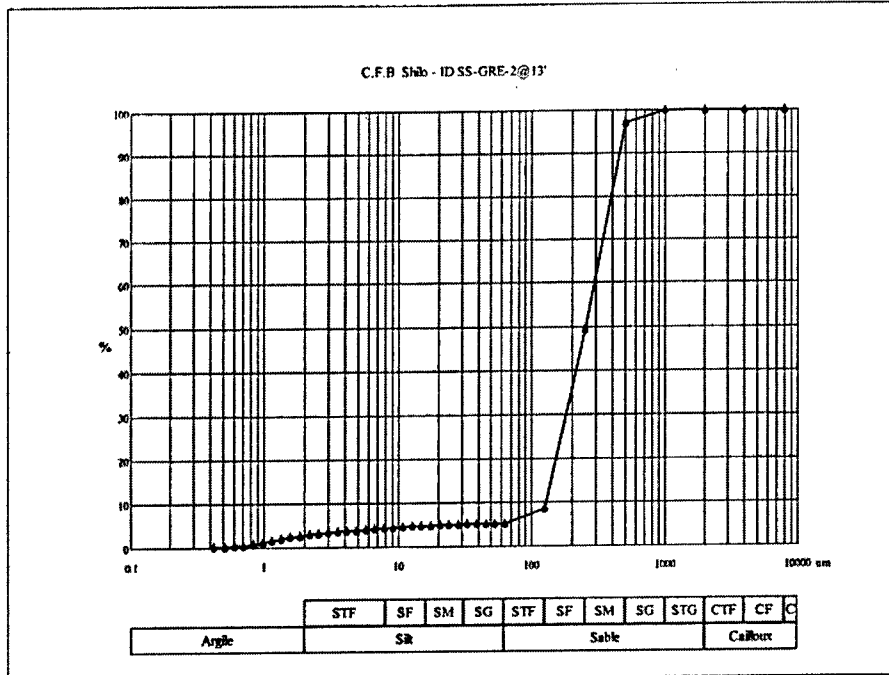

Tamis	Qte	Qte%	Cumul%
0.42	0.11	0.11	0.00
0.51	0.11	0.11	0.11
0.60	0.12	0.12	0.22
0.71	0.30	0.30	0.34
0.83	0.43	0.43	0.64
0.98	0.45	0.45	1.07
1.15	0.41	0.41	1.53
1.35	0.36	0.36	1.94
1.58	0.31	0.31	2.30
1.86	0.26	0.26	2.61
2.18	0.23	0.23	2.87
2.56	0.20	0.20	3.10
3.00	0.19	0.19	3.30
3.53	0.18	0.18	3.49
4.14	0.17	0.17	3.67
4.86	0.16	0.16	3.84
5.71	0.16	0.16	4.00
6.70	0.15	0.15	4.16
7.87	0.13	0.13	4.31
9.23	0.12	0.12	4.45
10.84	0.11	0.11	4.57
12.73	0.10	0.10	4.68
14.94	0.09	0.09	4.78
17.54	0.07	0.07	4.87
20.60	0.06	0.06	4.94
24.18	0.05	0.05	5.00
28.39	0.04	0.04	5.05
33.33	0.03	0.03	5.09
39.13	0.03	0.03	5.12
45.94	0.03	0.03	5.15
53.93	0.03	0.03	5.18
63.00	3.45	3.46	5.21
125.00	40.56	40.70	8.67
250.00	47.61	47.77	49.37
500.00	2.75	2.76	97.14
1000.00	0.09	0.09	99.90
2000.00	0.01	0.01	99.99
4000.00	0.00	0.00	100.00
8000.00	0.00	0.00	100.00

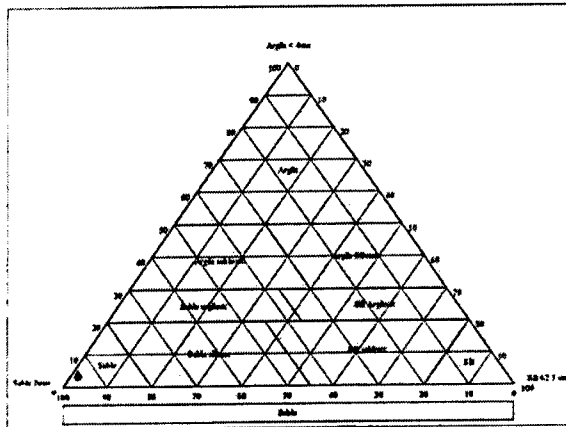

### INFO

Projet: C.F.B. Shilo II  
 Well GRE-2 Sample Depth: 13'  
 Graph prepared by: Catherine Gauthier  
 Software: Gran V.1.01 CGC/CGQ Eric Boisvert 1998  
 Date: February 7, 2002

Parametre	Valeur
Moyenne	2.0638
Médiane	1.9917
Ecart Type G.	0.6269
Ecart Type G. Inc.	0.9533
Skewness	0.3828
Kurtose	2.0412
Coef Hazen	1.6349E-002
Argile <2um	2.73
Silt[2-62.5um]	2.48
Sable[62.5um-2mm]	94.78
Argile <4um	3.63
Silt[4-62.5um]	1.57

# C.F.B. Shilo - ID SS-OBS-SUP-16@40'

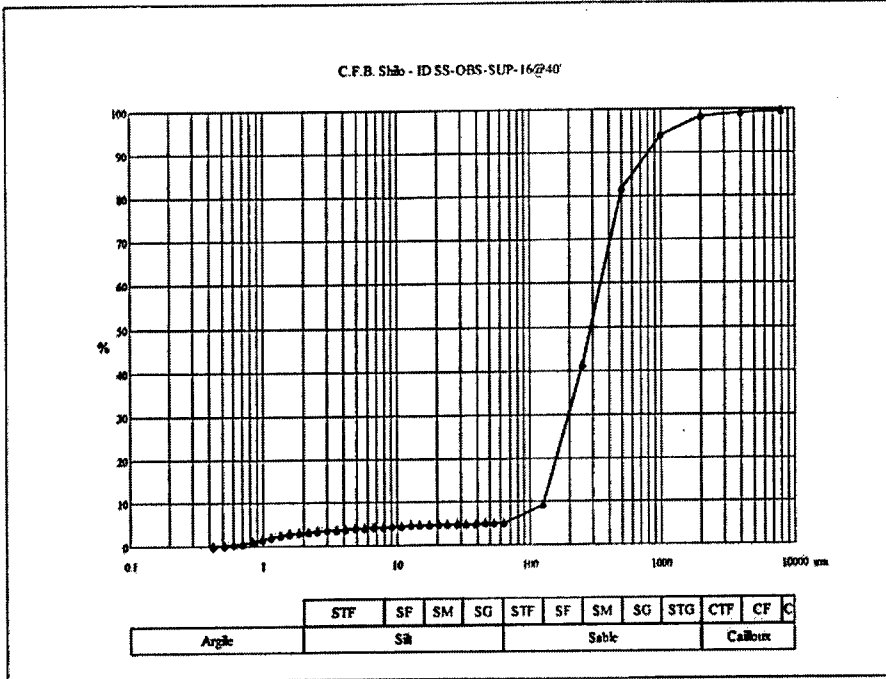

Tamis	Qte	Qte%	Cumul%
0.42	0.19	0.19	0.00
0.51	0.19	0.19	0.19
0.60	0.20	0.20	0.38
0.71	0.38	0.38	0.58
0.83	0.52	0.52	0.96
0.98	0.48	0.48	1.49
1.15	0.41	0.41	1.97
1.35	0.33	0.33	2.38
1.58	0.27	0.27	2.71
1.86	0.21	0.21	2.98
2.18	0.18	0.18	3.19
2.56	0.15	0.15	3.37
3.00	0.13	0.13	3.53
3.53	0.12	0.12	3.66
4.14	0.12	0.12	3.78
4.86	0.11	0.11	3.90
5.71	0.11	0.11	4.01
6.70	0.10	0.10	4.12
7.87	0.10	0.10	4.22
9.23	0.09	0.09	4.32
10.84	0.08	0.08	4.41
12.73	0.08	0.08	4.49
14.94	0.07	0.07	4.57
17.54	0.06	0.06	4.64
20.60	0.05	0.05	4.70
24.18	0.04	0.04	4.75
28.39	0.03	0.03	4.79
33.33	0.03	0.03	4.82
39.13	0.03	0.03	4.85
45.94	0.02	0.02	4.88
53.93	0.02	0.02	4.90
63.00	4.37	4.39	4.92
125.00	31.87	32.01	9.31
250.00	40.05	40.23	41.32
500.00	12.47	12.53	81.55
1000.00	4.23	4.25	94.07
2000.00	0.80	0.80	98.32
4000.00	0.28	0.28	99.13
8000.00	0.59	0.59	99.41

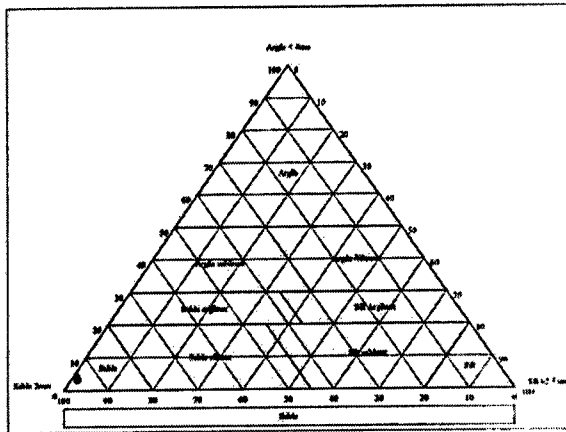

## INFO

Projet: C.F.B. Shilo II  
 Well OBS-SUP-16 Sample Depth: 40'  
 Graph prepared by: Catherine Gauthier  
 Software: Gran V.1.01 CGC/CGQ Eric Boisvert 1998  
 Date: February 6, 2002

## Parametre

Parametre	Valeur
Moyenne	1.7871
Médiane	1.8038
Ecart Type G.	0.9239
Ecart Type G. Inc.	1.0854
Skewness	0.0119
Kurtose	1.3929
Coef Hazen	1.6098E-002
Argile <2µm	3.08
Silt[2-62.5µm]	1.84
Sable[62.5µm-2mm]	93.40
Argile <4µm	3.75
Silt[4-62.5µm]	1.17

# C.F.B. Shilo - ID SS-OBS-SUP-27@41'

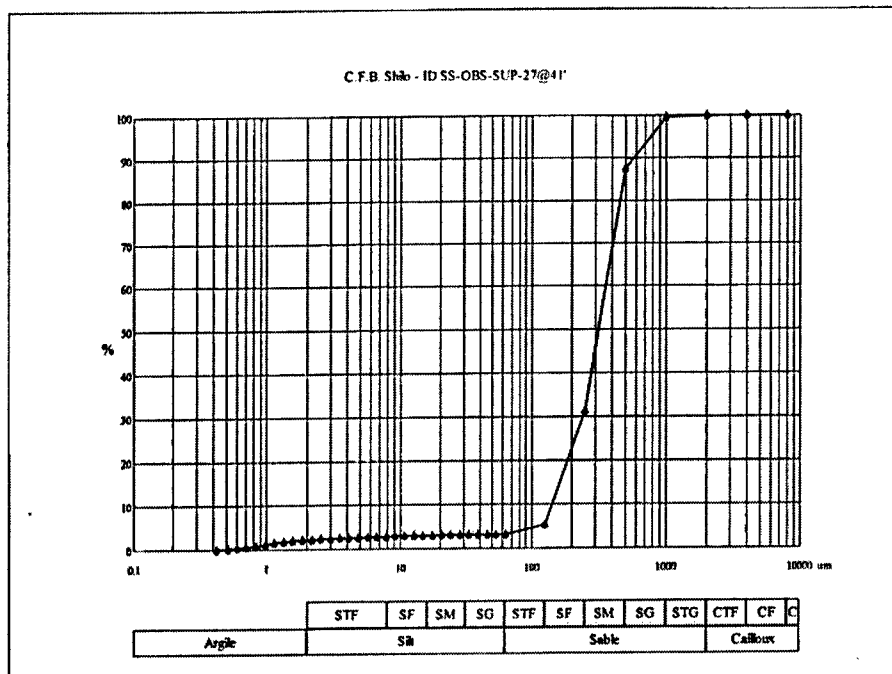

Tamis	Qte	Qte%	Cumul%
0.42	0.17	0.17	0.00
0.51	0.17	0.17	0.17
0.60	0.17	0.17	0.34
0.71	0.28	0.28	0.51
0.83	0.36	0.36	0.79
0.98	0.31	0.31	1.15
1.15	0.26	0.26	1.46
1.35	0.21	0.21	1.73
1.58	0.16	0.16	1.94
1.86	0.13	0.13	2.10
2.18	0.10	0.10	2.23
2.56	0.09	0.09	2.33
3.00	0.08	0.08	2.42
3.53	0.07	0.07	2.50
4.14	0.07	0.07	2.57
4.86	0.06	0.06	2.64
5.71	0.06	0.06	2.70
6.70	0.05	0.05	2.76
7.87	0.05	0.05	2.81
9.23	0.05	0.05	2.86
10.84	0.04	0.04	2.91
12.73	0.04	0.04	2.95
14.94	0.04	0.04	2.99
17.54	0.03	0.03	3.03
20.60	0.03	0.03	3.06
24.18	0.02	0.02	3.09
28.39	0.02	0.02	3.11
33.33	0.02	0.02	3.13
39.13	0.02	0.02	3.15
45.94	0.02	0.02	3.17
53.93	0.02	0.02	3.19
63.00	2.26	2.27	3.21
125.00	25.66	25.73	5.48
250.00	56.20	56.36	31.21
500.00	11.86	11.89	87.57
1000.00	0.36	0.36	99.47
2000.00	0.06	0.06	99.83
4000.00	0.11	0.11	99.89
8000.00	0.00	0.00	100.00

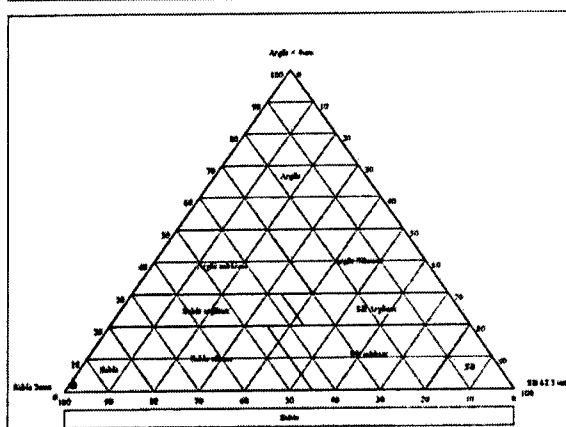

## INFO

Projet: C.F.B. Shilo II  
 Well: OBS-SUP-27 Sample Depth: 41'  
 Graph prepared by: Catherine Gauthier  
 Software: Gran V. 1.01 CGC/CGQ Eric Boisvert 1998  
 Date: February 6, 2002

## Parametre

Parametre	Valeur
Moyenne	1.7515
Médiane	1.7022
Ecart Type G.	0.6785
Ecart Type G. Inc.	0.7230
Skewness	0.1390
Kurtose	1.1895
Coef Hazen	1.9937E-002
Argile <2um	2.16
Silt[2-62.5um]	1.05
Sable[62.5um-2mm]	96.62
Argile <4um	2.55
Silt[4-62.5um]	0.66



# C.F.B. Shilo - ID SS-OBS-SUP-5@45'

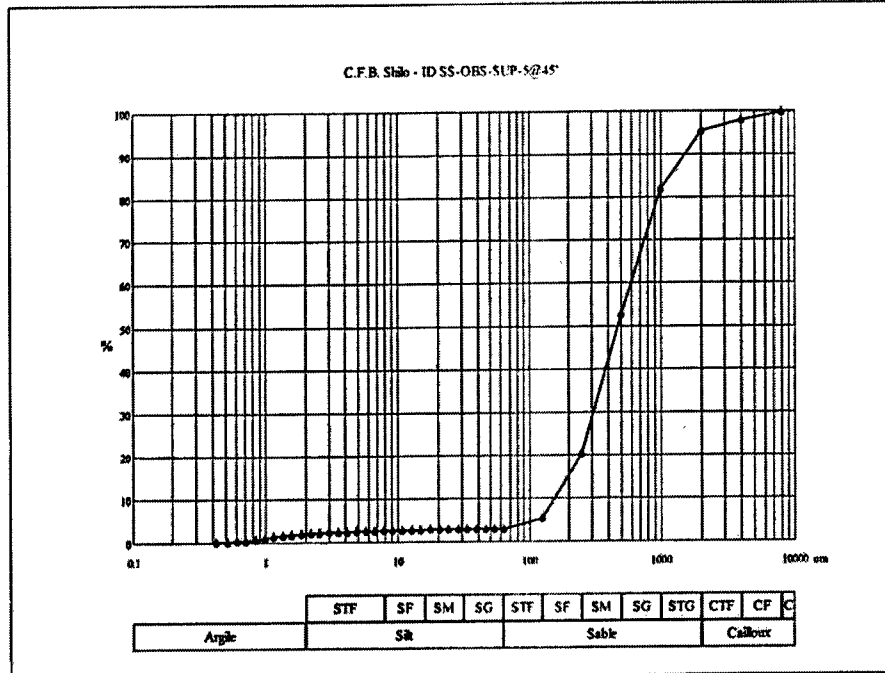

Tamis	Qte	Qte%	Cumul%
0.42	0.12	0.12	0.00
0.51	0.12	0.12	0.12
0.60	0.13	0.13	0.24
0.71	0.25	0.25	0.37
0.83	0.35	0.35	0.62
0.98	0.32	0.32	0.97
1.15	0.26	0.26	1.29
1.35	0.21	0.21	1.56
1.58	0.16	0.16	1.77
1.86	0.13	0.13	1.93
2.18	0.11	0.11	2.06
2.56	0.09	0.09	2.17
3.00	0.08	0.08	2.26
3.53	0.07	0.07	2.34
4.14	0.07	0.07	2.41
4.86	0.06	0.06	2.48
5.71	0.06	0.06	2.54
6.70	0.05	0.05	2.60
7.87	0.05	0.05	2.65
9.23	0.04	0.04	2.70
10.84	0.04	0.04	2.74
12.73	0.04	0.04	2.78
14.94	0.03	0.03	2.82
17.54	0.03	0.03	2.85
20.60	0.02	0.02	2.88
24.18	0.02	0.02	2.90
28.39	0.01	0.01	2.92
33.33	0.01	0.01	2.93
39.13	0.01	0.01	2.94
45.94	0.01	0.01	2.95
53.93	0.02	0.02	2.96
63.00	2.35	2.36	2.98
125.00	14.98	15.04	5.34
250.00	32.34	32.46	20.38
500.00	29.02	29.13	52.84
1000.00	13.47	13.52	81.97

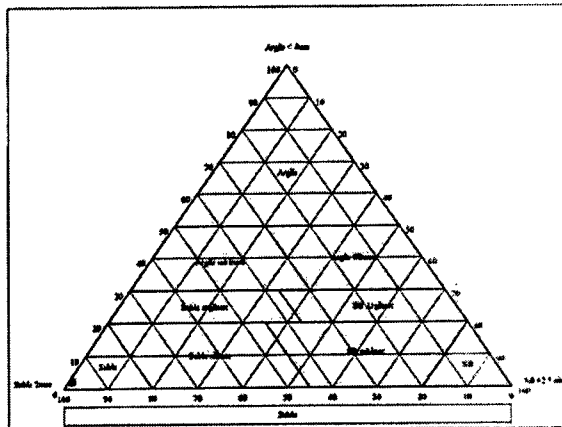

## INFO

Projet: C.F.B. Shilo II  
 Well OBS-SUP-5 Sample Depth: 45'  
 Graph prepared by: Catherine Gauthier  
 Software: Gran V.1.01 CGC/CGQ Eric Boisvert 1998  
 Date: February 6, 2002

Parametre	Valeur
Moyenne	1.0627
Médiane	1.0793
Ecart Type G.	1.1568
Ecart Type G. Inc.	1.1935
Skewness	-0.0076
Kurtose	1.0794
Coef Hazen	2.4010E-002
Argile <2µm	1.99
Silt[2-62.5µm]	0.99
Sable[62.5µm-2mm]	92.51
Argile <4µm	2.39
Silt[4-62.5µm]	0.59

# C.F.B. Shilo - ID SS-RIF-1@30'

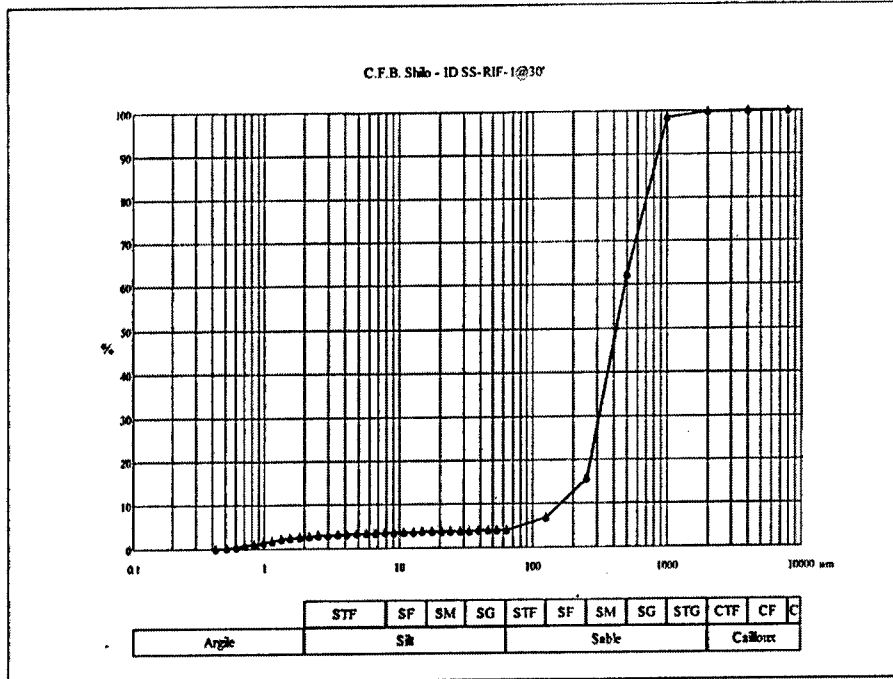

Tamis	Qte	Qte%	Cumul%
0.42	0.20	0.20	0.00
0.51	0.20	0.20	0.20
0.60	0.21	0.21	0.40
0.71	0.35	0.35	0.61
0.83	0.45	0.45	0.96
0.98	0.40	0.40	1.42
1.15	0.33	0.33	1.82
1.35	0.26	0.26	2.15
1.58	0.20	0.20	2.41
1.86	0.16	0.16	2.61
2.18	0.13	0.13	2.77
2.56	0.11	0.11	2.90
3.00	0.10	0.10	3.01
3.53	0.09	0.09	3.11
4.14	0.08	0.08	3.20
4.86	0.08	0.08	3.28
5.71	0.07	0.07	3.36
6.70	0.06	0.06	3.43
7.87	0.06	0.06	3.50
9.23	0.05	0.05	3.56
10.84	0.05	0.05	3.61
12.73	0.05	0.05	3.66
14.94	0.04	0.04	3.71
17.54	0.04	0.04	3.75
20.60	0.03	0.03	3.79
24.18	0.02	0.02	3.82
28.39	0.02	0.02	3.84
33.33	0.02	0.02	3.86
39.13	0.02	0.02	3.88
45.94	0.02	0.02	3.90
53.93	0.03	0.03	3.92
63.00	2.91	2.92	3.95
125.00	8.94	8.98	6.87
250.00	46.31	46.51	15.85
500.00	36.02	36.18	62.36
1000.00	1.17	1.18	98.53
2000.00	0.24	0.24	99.71
4000.00	0.05	0.05	99.95
8000.00	0.00	0.00	100.00

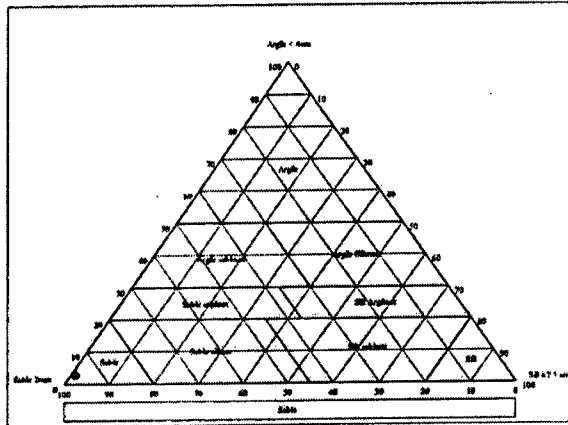

### INFO

Projet: C.F.B. Shilo II  
 Well RIF-1 Sample Depth: 30'  
 Graph prepared by: Catherine Gauthier  
 Software: Gran V.1.01 CGC/CGQ Eric Boisvert 1998  
 Date: February 7, 2002

Parametre	Valeur
Moyenne	1.2902
Médiane	1.2395
Ecart Type G.	0.6799
Ecart Type G. Inc.	0.8394
Skewness	0.2668
Kurtose	1.4317
Coef Hazen	2.5336E-002
Argile <2µm	2.69
Silt[2-62.5µm]	1.26
Sable[62.5µm-2mm]	95.76
Argile <4µm	3.18
Silt[4-62.5µm]	0.76

# C.F.B. Shilo - ID SS-RIF-3@20'

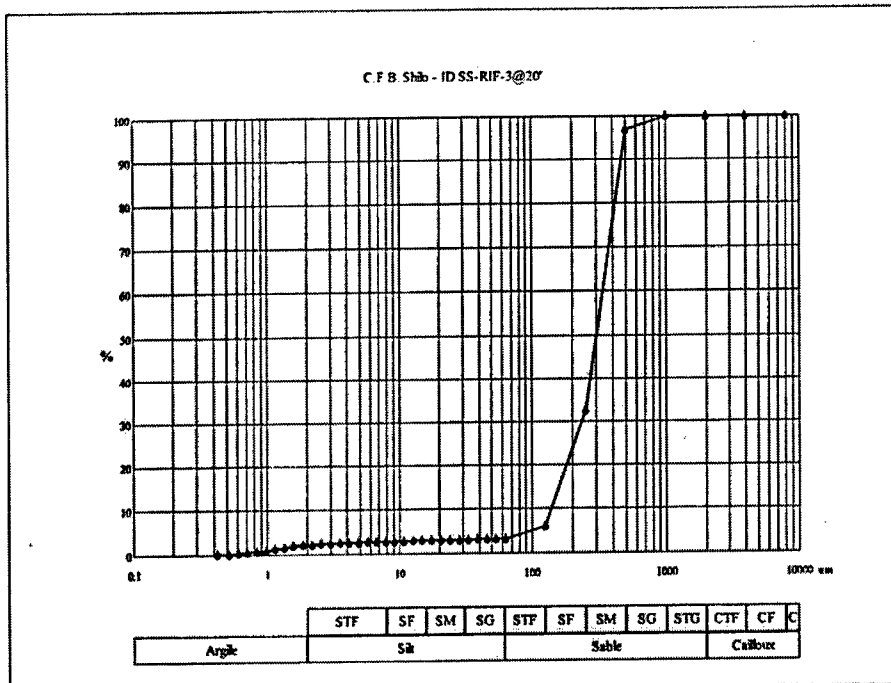

Tamis	Qte	Qte%	Cumu% <sup>1</sup>
0.42	0.14	0.14	0.00
0.51	0.14	0.14	0.14
0.60	0.15	0.15	0.28
0.71	0.25	0.25	0.43
0.83	0.33	0.33	0.68
0.98	0.31	0.31	1.01
1.15	0.28	0.28	1.33
1.35	0.24	0.24	1.61
1.58	0.19	0.19	1.85
1.86	0.15	0.15	2.04
2.18	0.12	0.12	2.19
2.56	0.09	0.09	2.31
3.00	0.08	0.08	2.40
3.53	0.07	0.07	2.48
4.14	0.06	0.06	2.55
4.86	0.05	0.05	2.61
5.71	0.05	0.05	2.66
6.70	0.05	0.05	2.71
7.87	0.04	0.04	2.76
9.23	0.04	0.04	2.80
10.84	0.04	0.04	2.84
12.73	0.03	0.03	2.88
14.94	0.03	0.03	2.91
17.54	0.03	0.03	2.94
20.60	0.02	0.02	2.97
24.18	0.02	0.02	2.99
28.39	0.02	0.02	3.01
33.33	0.02	0.02	3.03
39.13	0.01	0.01	3.05
45.94	0.01	0.01	3.06
53.93	0.02	0.02	3.07
63.00	2.81	2.82	3.09
125.00	26.62	26.73	5.92
250.00	63.91	64.19	32.65
500.00	3.08	3.09	96.84
1000.00	0.06	0.06	99.93
2000.00	0.01	0.01	99.99
4000.00	0.00	0.00	100.00
8000.00	0.00	0.00	100.00

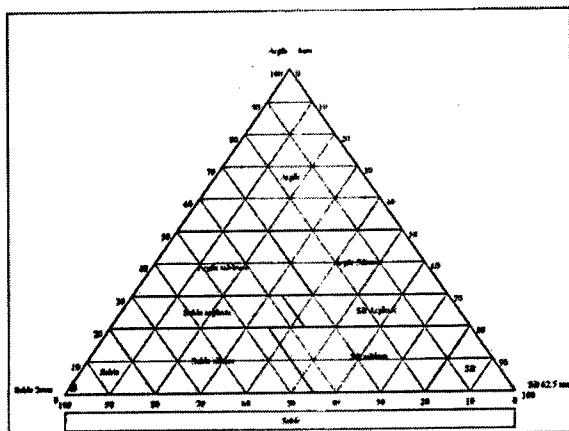

### INFO

Projet: C.F.B. Shilo IID  
 Well RIF-3 Sample Depth: 20'  
 Graph prepared by: Catherine Gauthier  
 Software: Gran V.1.01 CGC/CGQ Eric Boisvert 1998  
 Date: February 7, 2002

### Parametre

Parametre	Valeur
Moyenne	1.8895
Médiane	1.8051
Ecart Type G.	0.5575
Ecart Type G. Inc.	0.6087
Skewness	0.2861
Kurtose	1.2984
Coef Hazen	1.9311E-002

Argile <2µm	2.11
Sil[2-62.5µm]	0.98
Sable[62.5µm-2mm]	96.90

Argile <4µm	2.54
Sil[4-62.5µm]	0.56

# C.F.B. Shilo - ID GW-TR@12'

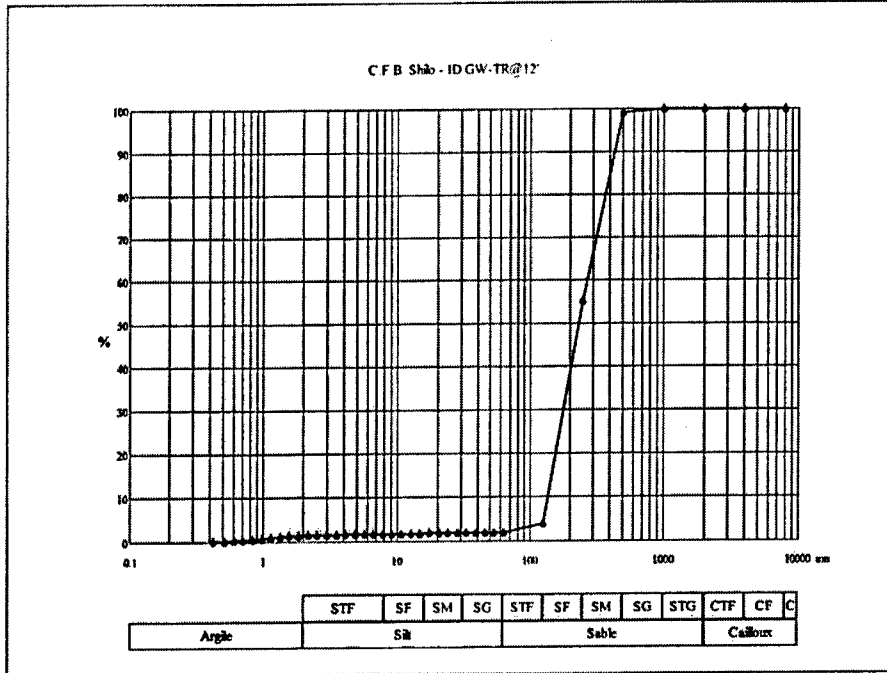

Tamis	Qte	Qte%	Cumul%
0.42	0.12	0.12	0.00
0.51	0.12	0.12	0.12
0.60	0.12	0.12	0.24
0.71	0.19	0.19	0.36
0.83	0.23	0.23	0.55
0.98	0.20	0.20	0.78
1.15	0.17	0.17	0.98
1.35	0.13	0.13	1.15
1.58	0.10	0.10	1.28
1.86	0.08	0.08	1.38
2.18	0.06	0.06	1.46
2.56	0.05	0.05	1.52
3.00	0.04	0.04	1.57
3.53	0.03	0.03	1.61
4.14	0.03	0.03	1.64
4.86	0.03	0.03	1.68
5.71	0.02	0.02	1.71
6.70	0.02	0.02	1.73
7.87	0.02	0.02	1.75
9.23	0.02	0.02	1.77
10.84	0.02	0.02	1.79
12.73	0.02	0.02	1.81
14.94	0.02	0.02	1.83
17.54	0.01	0.01	1.85
20.60	0.01	0.01	1.86
24.18	0.01	0.01	1.87
28.39	0.01	0.01	1.88
33.33	0.01	0.01	1.89
39.13	0.01	0.01	1.90
45.94	0.01	0.01	1.91
53.93	0.01	0.01	1.92
63.00	1.99	2.00	1.93
125.00	51.20	51.35	3.92
250.00	43.60	43.73	55.28
500.00	0.96	0.96	99.01
1000.00	0.02	0.02	99.97
2000.00	0.01	0.01	99.99
4000.00	0.00	0.00	100.00
8000.00	0.00	0.00	100.00

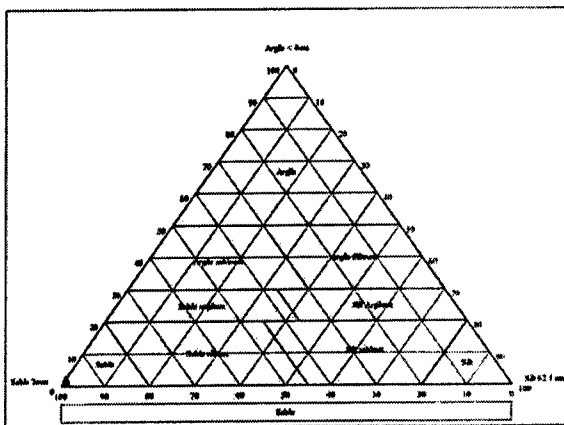

### INFO

Projet: C.F.B. Shilo II  
 Well TR Sample Depth: 12'  
 Graph prepared by: Catherine Gauthier  
 Software: Gran V.1.01 CGC/CGQ Eric Boisvert 1998  
 Date: February 6, 2002

Parametre	Valeur
Moyenne	2.0910
Médiane	2.0701
Ecart Type G.	0.4937
Ecart Type G. inc.	0.4936
Skewness	0.0657
Kurtose	0.9933
Coef Hazen	1.8411E-002
Argile <2µm	1.42
Silt[2-62.5µm]	0.50
Sable[62.5µm-2mm]	98.06
Argile <4µm	1.64
Silt[4-62.5µm]	0.29

# C.F.B. Shilo - ID GW-ZONE-4E@22'

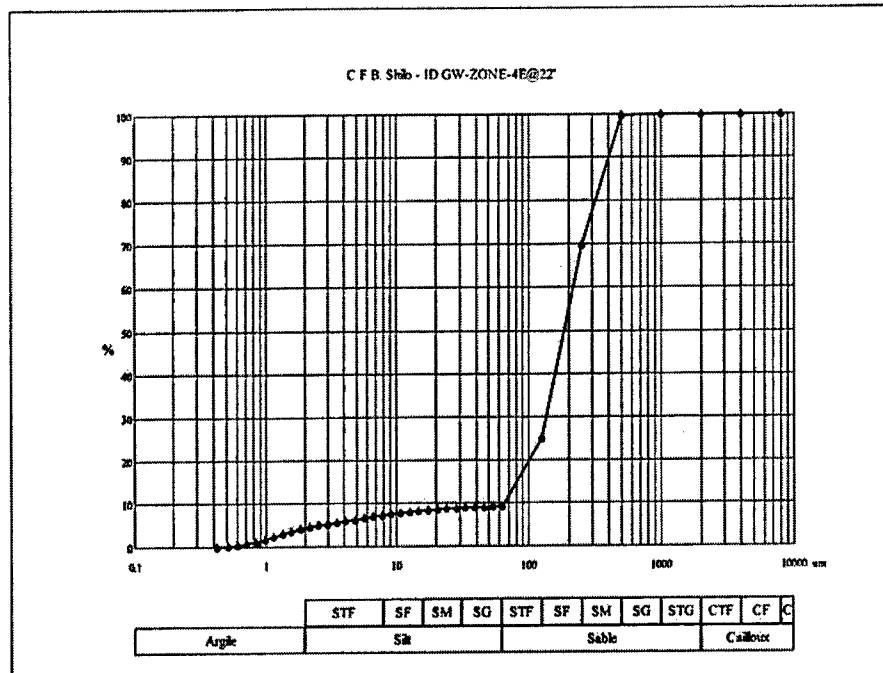

Tamis	Qte	Qte%	Cumul%
0.42	0.20	0.20	0.00
0.51	0.20	0.20	0.20
0.60	0.21	0.21	0.40
0.71	0.45	0.45	0.61
0.83	0.64	0.64	1.07
0.98	0.67	0.67	1.71
1.15	0.63	0.63	2.38
1.35	0.57	0.57	3.02
1.58	0.50	0.50	3.59
1.86	0.42	0.42	4.09
2.18	0.38	0.38	4.52
2.56	0.34	0.34	4.90
3.00	0.32	0.32	5.24
3.53	0.33	0.33	5.56
4.14	0.33	0.33	5.89
4.86	0.34	0.34	6.23
5.71	0.34	0.34	6.57
6.70	0.33	0.33	6.91
7.87	0.31	0.31	7.24
9.23	0.28	0.28	7.55
10.84	0.25	0.25	7.84
12.73	0.23	0.23	8.09
14.94	0.20	0.20	8.32
17.54	0.17	0.17	8.52
20.60	0.13	0.13	8.69
24.18	0.10	0.10	8.82
28.39	0.08	0.08	8.92
33.33	0.07	0.07	9.00
39.13	0.06	0.06	9.07
45.94	0.05	0.05	9.13
53.93	0.05	0.05	9.18
63.00	15.70	15.79	9.23
125.00	44.62	44.88	25.03
250.00	29.62	29.80	69.91
500.00	0.25	0.25	99.71
1000.00	0.02	0.02	99.96
2000.00	0.02	0.02	99.98
4000.00	0.00	0.00	100.00
8000.00	0.00	0.00	100.00

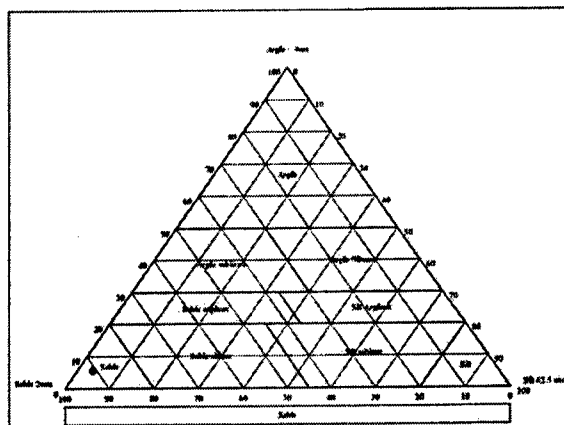

### INFO

Projet: C.F.B. Shilo II  
 Well: ZONE-4-E Sample Depth: 22'  
 Graph prepared by: Catherine Gauthier  
 Software: Gran V.1.01 CGC/CGQ Eric Boisvert 1998  
 Date: February 7, 2002

Parametre	Valeur
Moyenne	2.5704
Médiane	2.4365
Ecart Type G.	0.8486
Ecart Type G. Inc.	1.4915
Skewness	0.4852
Kurtose	2.6995
Coef Hazen	4.2416E-003
Argile <2µm	4.29
Silt[2-62.5µm]	4.94
Sable[62.5µm-2mm]	90.75
Argile <4µm	5.82
Silt[4-62.5µm]	3.41

# C.F.B. Shilo - ID S-ZONE-4W@22'

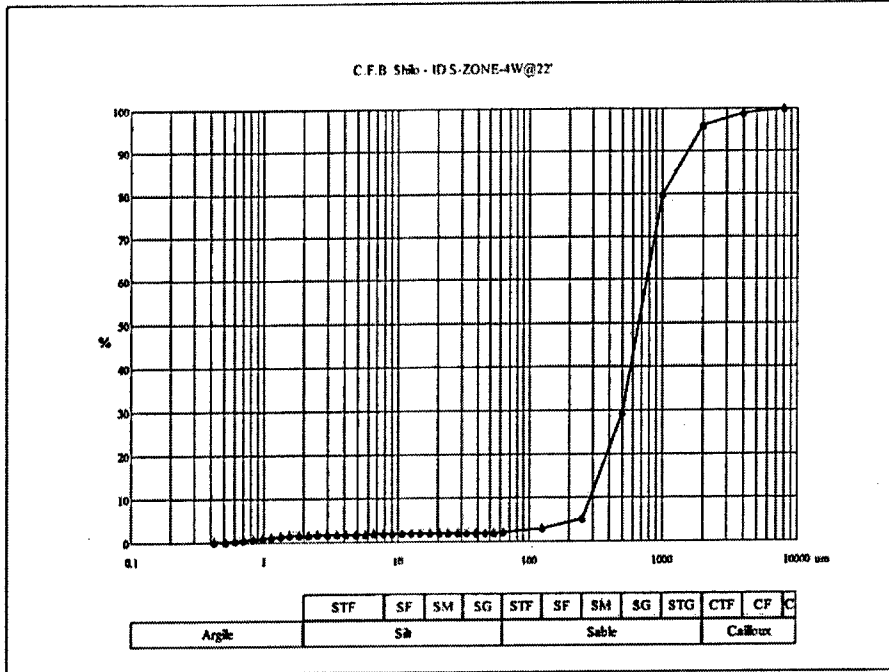

Tamis	Qte	Qte%	Cumul%
0.42	0.16	0.16	0.00
0.51	0.16	0.16	0.16
0.60	0.16	0.16	0.32
0.71	0.22	0.22	0.48
0.83	0.26	0.26	0.70
0.98	0.21	0.21	0.96
1.15	0.16	0.16	1.17
1.35	0.12	0.12	1.33
1.58	0.09	0.09	1.45
1.86	0.06	0.06	1.54
2.18	0.05	0.05	1.60
2.56	0.04	0.04	1.65
3.00	0.03	0.03	1.69
3.53	0.03	0.03	1.72
4.14	0.03	0.03	1.75
4.86	0.03	0.03	1.78
5.71	0.02	0.02	1.81
6.70	0.02	0.02	1.83
7.87	0.02	0.02	1.85
9.23	0.02	0.02	1.87
10.84	0.02	0.02	1.89
12.73	0.02	0.02	1.91
14.94	0.02	0.02	1.93
17.54	0.01	0.01	1.95
20.60	0.01	0.01	1.96
24.18	0.01	0.01	1.97
28.39	0.01	0.01	1.98
33.33	0.01	0.01	1.99
39.13	0.01	0.01	2.00
45.94	0.01	0.01	2.01
53.93	0.01	0.01	2.02
63.00	1.01	1.01	2.03
125.00	2.13	2.13	3.05
250.00	24.17	24.22	5.18
500.00	50.31	50.42	29.40
1000.00	16.11	16.15	79.83
2000.00	3.00	3.01	95.97
4000.00	0.91	0.91	98.98
8000.00	0.11	0.11	99.89

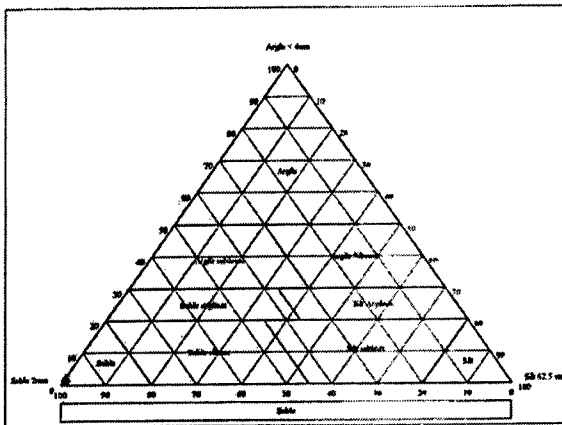

### INFO

Projet: C.F.B. Shilo II  
 Well ZONE-4-W Sample Depth: 22'  
 Graph prepared by: Catherine Gauthier  
 Software: Gran V.1.01 CGC/CGQ Eric Boisvert 1998  
 Date: February 7, 2002

Parametre	Valeur
Moyenne	0.6172
Médiane	0.6076
Ecart Type G.	0.7955
Ecart Type G. Inc.	0.8462
Skewness	0.0038
Kurtose	1.2077
Coef Hazen	8.2346E-002

Argile <2µm	1.57
Silt[2-62.5µm]	0.46
Sable[62.5µm-2mm]	93.94

Argile <4µm	1.75
Silt[4-62.5µm]	0.29

# C.F.B. Shilo - ID SS-ZONE-5N@19.5'

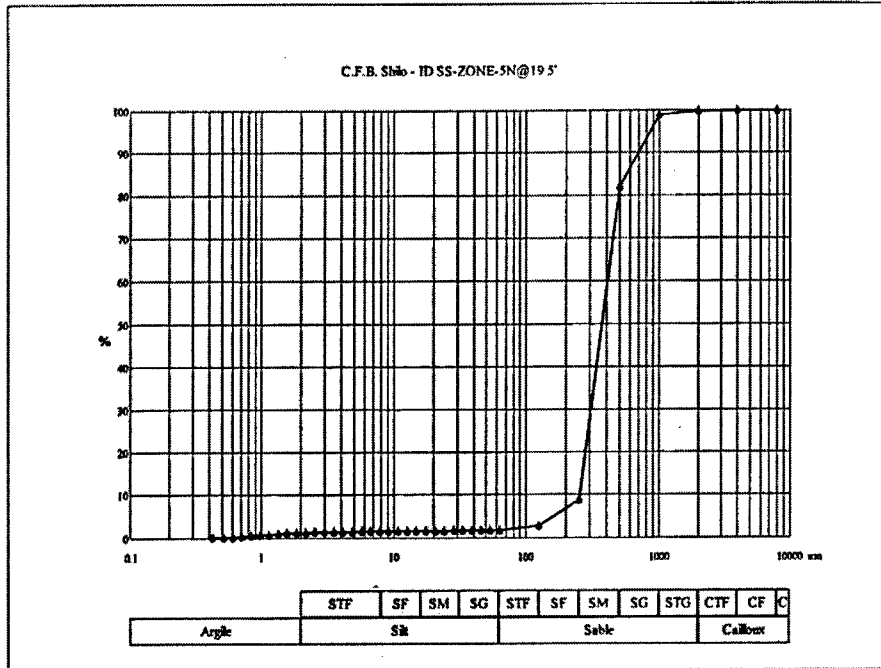

Tamis	Qte	Qte%	Cumul%
0.42	0.09	0.09	0.00
0.51	0.09	0.09	0.09
0.60	0.09	0.09	0.18
0.71	0.15	0.15	0.27
0.83	0.20	0.20	0.42
0.98	0.17	0.17	0.62
1.15	0.14	0.14	0.79
1.35	0.11	0.11	0.93
1.58	0.09	0.09	1.04
1.86	0.07	0.07	1.13
2.18	0.05	0.05	1.20
2.56	0.05	0.05	1.25
3.00	0.04	0.04	1.30
3.53	0.04	0.04	1.34
4.14	0.03	0.03	1.38
4.86	0.03	0.03	1.41
5.71	0.03	0.03	1.44
6.70	0.03	0.03	1.47
7.87	0.02	0.02	1.50
9.23	0.02	0.02	1.52
10.84	0.02	0.02	1.54
12.73	0.02	0.02	1.56
14.94	0.02	0.02	1.58
17.54	0.01	0.01	1.60
20.60	0.01	0.01	1.61
24.18	0.01	0.01	1.62
28.39	0.01	0.01	1.63
33.33	0.01	0.01	1.64
39.13	0.01	0.01	1.65
45.94	0.01	0.01	1.66
53.93	0.01	0.01	1.67
63.00	1.03	1.03	1.68
125.00	6.11	6.12	2.72
250.00	72.98	73.13	8.84
500.00	16.79	16.83	81.97
1000.00	0.84	0.84	98.80
2000.00	0.22	0.22	99.64
4000.00	0.14	0.14	99.86
8000.00	0.00	0.00	100.00

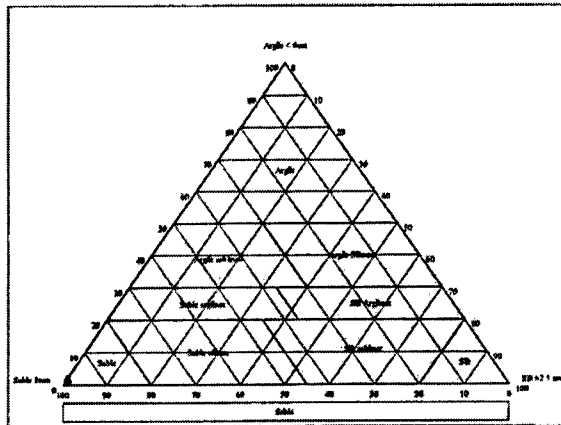

## INFO

Projet: C.F.B. Shilo II  
 Well ZONE-5-N Sample Depth: 19.5'  
 Graph prepared by: Catherine Gauthier  
 Software: Gran V.1.01 CGC/CGQ Eric Boisvert 1998  
 Date: February 6, 2002

Parametre	Valeur
Moyenne	1.3955
Médiane	1.4035
Ecart Type G.	0.4508
Ecart Type G. Inc.	0.5373
Skewness	0.0258
Kurtose	1.4195
Coef Hazen	6.3891E-002

Argile <2µm 1.16  
 Silt[2-62.5µm] 0.52  
 Sable[62.5µm-2mm] 97.96

Argile <4µm 1.37  
 Silt[4-62.5µm] 0.31

# C.F.B. Shilo - I.D SS-GW-ZONE-5S@20'

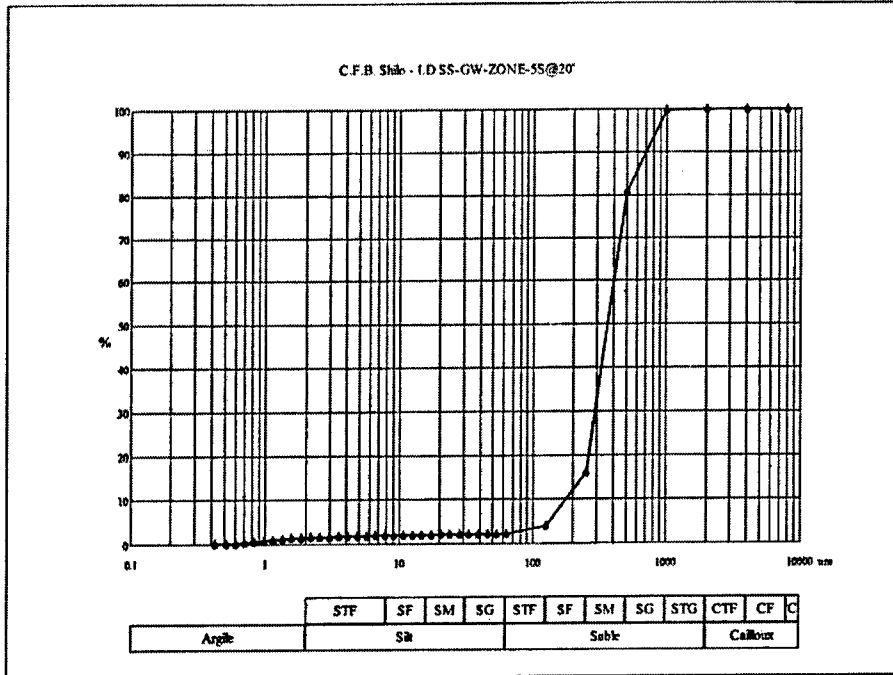

Tamais	Qte	Qte%	Cumul%
0.42	0.08	0.08	0.00
0.51	0.08	0.08	0.08
0.60	0.09	0.09	0.16
0.71	0.17	0.17	0.25
0.83	0.23	0.23	0.42
0.98	0.22	0.22	0.65
1.15	0.19	0.19	0.87
1.35	0.16	0.16	1.06
1.58	0.12	0.12	1.22
1.86	0.10	0.10	1.34
2.18	0.08	0.08	1.44
2.56	0.07	0.07	1.53
3.00	0.06	0.06	1.60
3.53	0.05	0.05	1.66
4.14	0.05	0.05	1.71
4.86	0.04	0.04	1.76
5.71	0.04	0.04	1.80
6.70	0.04	0.04	1.84
7.87	0.03	0.03	1.88
9.23	0.03	0.03	1.91
10.84	0.03	0.03	1.94
12.73	0.03	0.03	1.97
14.94	0.02	0.02	2.00
17.54	0.02	0.02	2.02
20.60	0.02	0.02	2.04
24.18	0.01	0.01	2.06
28.39	0.01	0.01	2.07
33.33	0.01	0.01	2.08
39.13	0.01	0.01	2.09
45.94	0.01	0.01	2.10
53.93	0.02	0.02	2.11
63.00	1.92	1.93	2.13
125.00	12.06	12.10	4.05
250.00	64.47	64.68	16.15
500.00	18.86	18.92	80.84
1000.00	0.17	0.17	99.76
2000.00	0.07	0.07	99.93
4000.00	0.00	0.00	100.00
8000.00	0.00	0.00	100.00

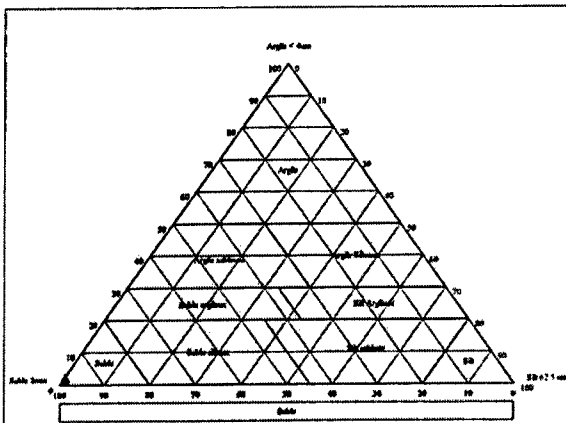

### INFO

Projet: C.F.B. Shilo II  
 Well ZONE-5-S Sample Depth: 20'  
 Graph prepared by: Catherine Gauthier  
 Software: Gran V.1.01 CGC/CGQ Eric Boisvert 1998  
 Date: February 6, 2002

Parametre	Valeur
Moyenne	1.4715
Médiane	1.4689
Ecart Type G.	0.5352
Ecart Type G. Inc.	0.6107
Skewness	0.1217
Kurtose	1.2823
Coef Hazen	3.0882E-002
Argile <2um	1.39
Silt[2-62.5um]	0.73
Sable[62.5um-2mm]	97.80
Argile <4um	1.69
Silt[4-62.5um]	0.43



# C.F.B. Shilo - ID SS-ZONE-7@22'

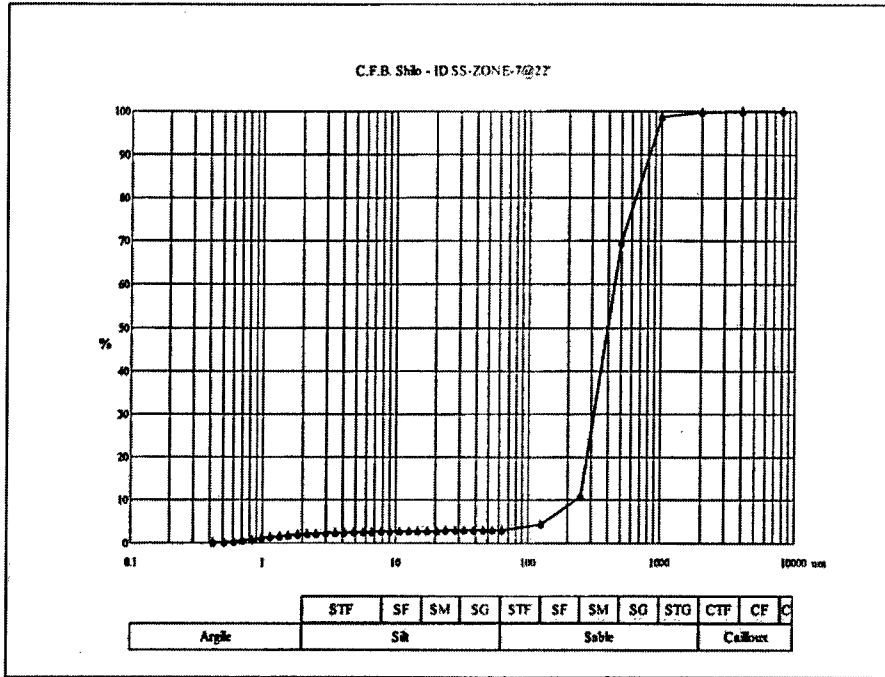

Tamis	Qte	Qte%	Cumul%
0.42	0.14	0.14	0.00
0.51	0.14	0.14	0.14
0.60	0.15	0.15	0.28
0.71	0.26	0.26	0.43
0.83	0.34	0.34	0.69
0.98	0.30	0.30	1.03
1.15	0.25	0.25	1.34
1.35	0.20	0.20	1.59
1.58	0.16	0.16	1.79
1.86	0.13	0.13	1.95
2.18	0.11	0.11	2.08
2.56	0.09	0.09	2.19
3.00	0.08	0.08	2.28
3.53	0.07	0.07	2.36
4.14	0.06	0.06	2.43
4.86	0.06	0.06	2.49
5.71	0.05	0.05	2.55
6.70	0.05	0.05	2.60
7.87	0.04	0.04	2.65
9.23	0.04	0.04	2.69
10.84	0.03	0.03	2.73
12.73	0.03	0.03	2.76
14.94	0.03	0.03	2.79
17.54	0.02	0.02	2.82
20.60	0.02	0.02	2.84
24.18	0.02	0.02	2.86
28.39	0.02	0.02	2.88
33.33	0.01	0.01	2.90
39.13	0.01	0.01	2.91
45.94	0.01	0.01	2.92
53.93	0.03	0.03	2.93
63.00	1.34	1.35	2.96
125.00	6.59	6.62	4.31
250.00	58.53	58.78	10.93
500.00	28.78	28.90	69.70
1000.00	1.14	1.14	98.60
2000.00	0.21	0.21	99.75
4000.00	0.04	0.04	99.96
8000.00	0.00	0.00	100.00

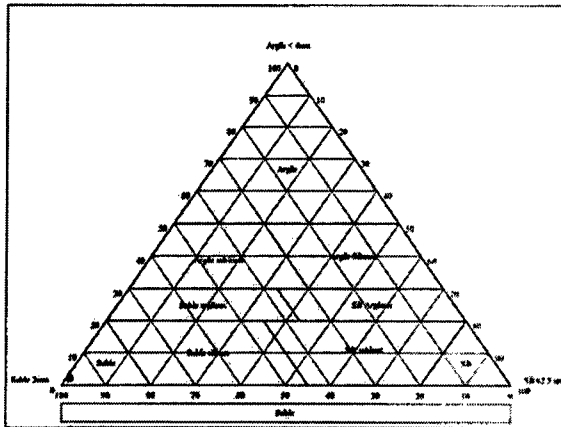

## INFO

Projet: C.F.B. Shilo II  
 Well ZONE-7 Sample Depth: 22'  
 Graph prepared by: Catherine Gauthier  
 Software: Gran V.1.01 CGC/CGQ Eric Boisvert 1998  
 Date: February 6, 2002

Paramètre	Valeur
Moyenne	1.2915
Médiane	1.2949
Ecart Type G.	0.5746
Ecart Type G. Inc.	0.6702
Skewness	0.1127
Kurtose	1.3371
Coef Hazen	5.1481E-002

Argile <2µm                    2.01  
 Silt[2-62.5µm]                0.95  
 Sable[62.5µm-2mm]        96.79

Argile <4µm                    2.42  
 Silt[4-62.5µm]                0.55

# C.F.B. Shilo - ID SS-ZONE-7W@25'

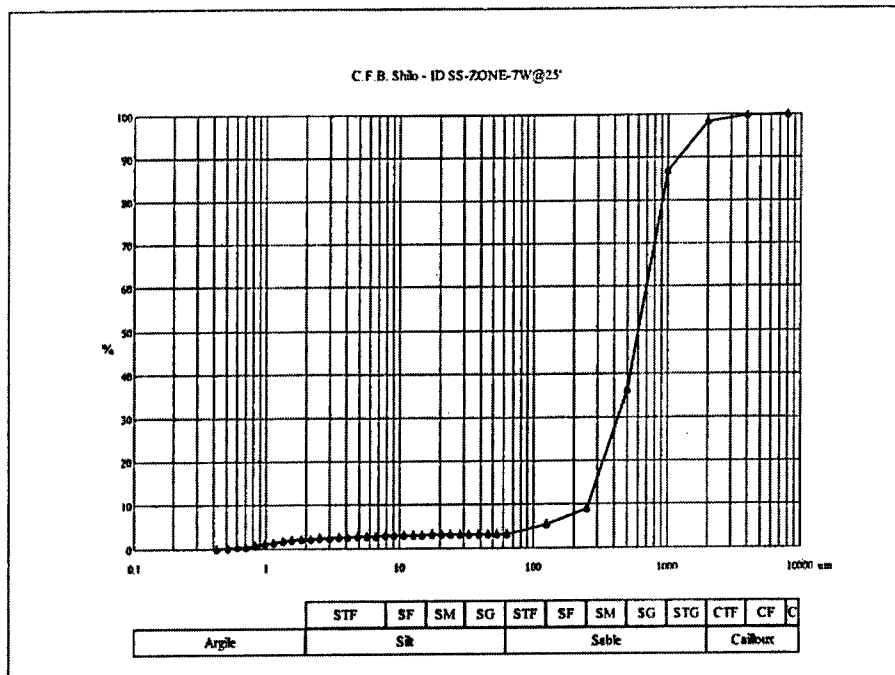

Tamis	Qte	Qte%	Cumul%
0.42	0.13	0.13	0.00
0.51	0.13	0.13	0.13
0.60	0.14	0.14	0.26
0.71	0.26	0.26	0.40
0.83	0.36	0.36	0.66
0.98	0.33	0.33	1.02
1.15	0.28	0.28	1.35
1.35	0.23	0.23	1.64
1.58	0.19	0.19	1.87
1.86	0.15	0.15	2.06
2.18	0.12	0.12	2.21
2.56	0.10	0.10	2.33
3.00	0.09	0.09	2.43
3.53	0.08	0.08	2.52
4.14	0.07	0.07	2.60
4.86	0.07	0.07	2.67
5.71	0.06	0.06	2.74
6.70	0.06	0.06	2.80
7.87	0.05	0.05	2.86
9.23	0.05	0.05	2.91
10.84	0.04	0.04	2.96
12.73	0.04	0.04	3.00
14.94	0.04	0.04	3.04
17.54	0.03	0.03	3.08
20.60	0.02	0.02	3.11
24.18	0.02	0.02	3.13
28.39	0.02	0.02	3.15
33.33	0.01	0.01	3.17
39.13	0.01	0.01	3.18
45.94	0.01	0.01	3.19
53.93	0.02	0.02	3.20
63.00	2.07	2.08	3.22
125.00	3.69	3.70	5.30
250.00	27.19	27.29	9.00
500.00	50.52	50.70	36.29
1000.00	11.24	11.28	86.98
2000.00	1.39	1.39	98.26
4000.00	0.34	0.34	99.66
8000.00	0.00	0.00	100.00

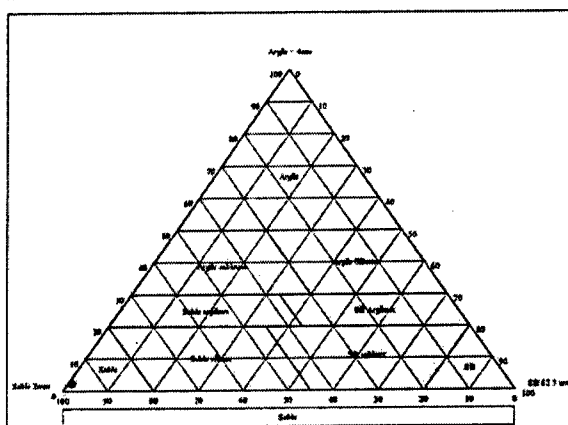

## INFO

Projet: C.F.B. Shilo II  
 Well ZONE-7-W Sample Depth: 25'  
 Graph prepared by: Catherine Gauthier  
 Software: Gran V.1.01 CGC/CGQ Eric Boisvert 1998  
 Date: February 7, 2002

Parametre	Valeur
Moyenne	0.8337
Médiane	0.7624
Ecart Type G.	0.7800
Ecart Type G. Inc.	0.9432
Skewness	0.2154
Kurtose	1.4687
Coef Hazen	6.5752E-002
Argile <2µm	2.13
Silt[2-62.5µm]	1.09
Sable[62.5µm-2mm]	95.04
Argile <4µm	2.58
Silt[4-62.5µm]	0.64

# C.F.B. Shilo - ID SS-ZONE-9N@25'

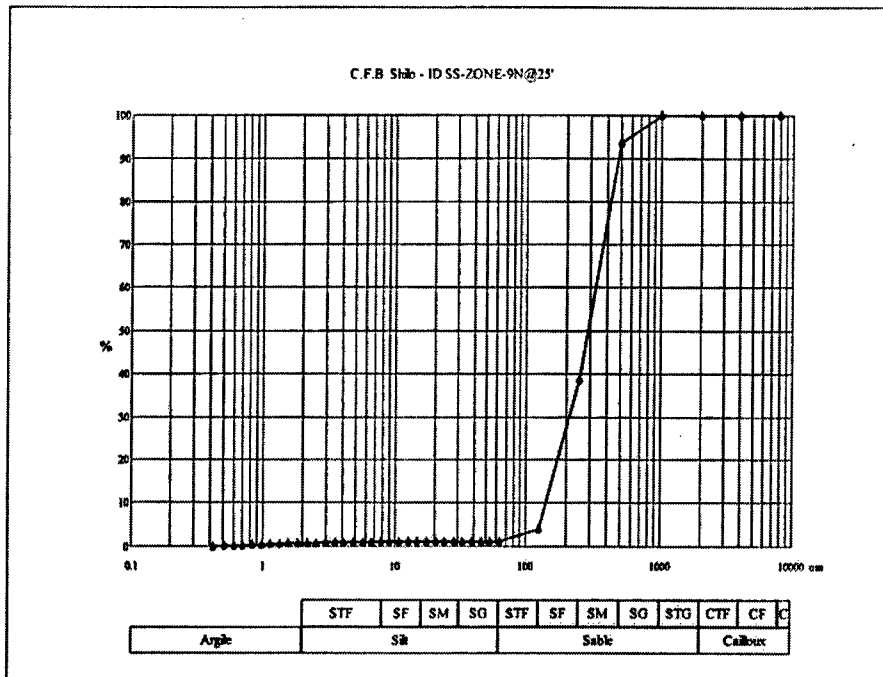

Tamis	Qte	Qte%	Cumul%
0.42	0.04	0.04	0.00
0.51	0.04	0.04	0.04
0.60	0.04	0.04	0.08
0.71	0.09	0.09	0.12
0.83	0.12	0.12	0.21
0.98	0.12	0.12	0.33
1.15	0.10	0.10	0.45
1.35	0.08	0.08	0.55
1.58	0.07	0.07	0.63
1.86	0.06	0.06	0.70
2.18	0.05	0.05	0.76
2.56	0.04	0.04	0.81
3.00	0.04	0.04	0.85
3.53	0.03	0.03	0.89
4.14	0.03	0.03	0.92
4.86	0.03	0.03	0.95
5.71	0.02	0.02	0.98
6.70	0.02	0.02	1.00
7.87	0.02	0.02	1.02
9.23	0.02	0.02	1.04
10.84	0.02	0.02	1.06
12.73	0.02	0.02	1.08
14.94	0.01	0.01	1.10
17.54	0.01	0.01	1.11
20.60	0.01	0.01	1.12
24.18	0.01	0.01	1.13
28.39	0.01	0.01	1.14
33.33	0.01	0.01	1.15
39.13	0.01	0.01	1.16
45.94	0.01	0.01	1.17
53.93	0.01	0.01	1.18
63.00	2.77	2.77	1.19
125.00	34.79	34.85	3.97
250.00	54.59	54.68	38.82
500.00	6.48	6.49	93.50
1000.00	0.01	0.01	99.99
2000.00	0.00	0.00	100.00
4000.00	0.00	0.00	100.00
8000.00	0.00	0.00	100.00

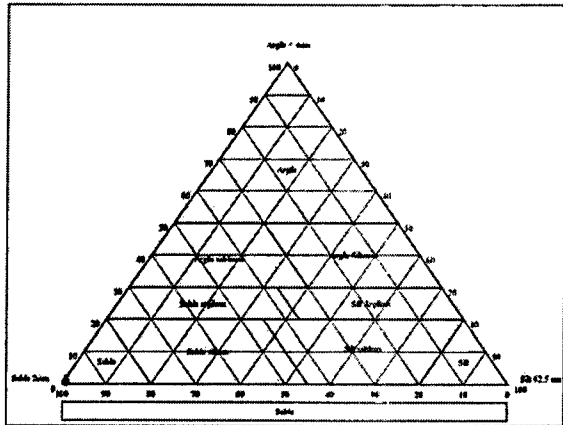

## INFO

Projet: C.F.B. Shilo II  
 Well ZONE-9N Sample Depth: 25'  
 Graph prepared by: Catherine Gauthier  
 Software: Gran V.1.01 CGC/CGQ Eric Boisvert 1998  
 Date: February 6, 2002

## Parametre

Parametre	Valeur
Moyenne	1.8712
Médiane	1.8420
Ecart Type G.	0.5968
Ecart Type G. Inc.	0.5991
Skewness	0.0827
Kurtose	1.0206
Coef Hazen	1.9863E-002
Argile <2um	0.73
Silt[2-62.5um]	0.46
Sable[62.5um-2mm]	98.81
Argile <4um	0.92
Silt[4-62.5um]	0.28

# C.F.B. Shilo - ID SS-ZONE-9S@6'

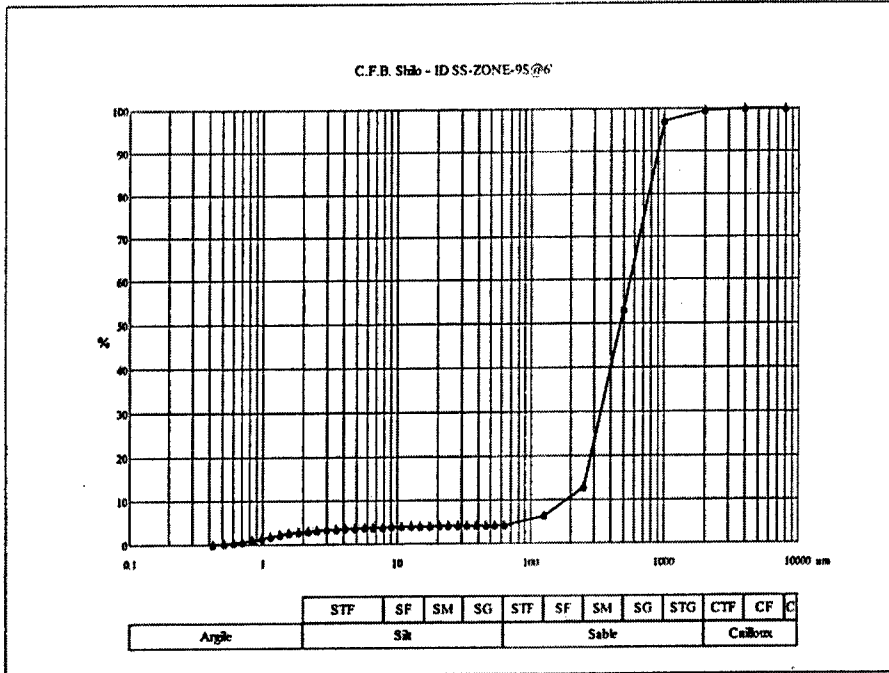

Tamis	Qte	Qte%	Cumul%
0.42	0.15	0.15	0.00
0.51	0.16	0.16	0.15
0.60	0.17	0.17	0.31
0.71	0.35	0.35	0.48
0.83	0.50	0.50	0.83
0.98	0.46	0.46	1.33
1.15	0.39	0.39	1.79
1.35	0.32	0.32	2.19
1.58	0.26	0.26	2.51
1.86	0.20	0.20	2.77
2.18	0.17	0.17	2.97
2.56	0.14	0.14	3.14
3.00	0.12	0.12	3.28
3.53	0.10	0.10	3.40
4.14	0.09	0.09	3.50
4.86	0.08	0.08	3.59
5.71	0.07	0.07	3.67
6.70	0.07	0.07	3.74
7.87	0.06	0.06	3.81
9.23	0.05	0.05	3.87
10.84	0.05	0.05	3.92
12.73	0.04	0.04	3.97
14.94	0.04	0.04	4.01
17.54	0.03	0.03	4.05
20.60	0.03	0.03	4.08
24.18	0.02	0.02	4.11
28.39	0.02	0.02	4.13
33.33	0.02	0.02	4.15
39.13	0.02	0.02	4.17
45.94	0.02	0.02	4.19
53.93	0.03	0.03	4.21
63.00	2.12	2.13	4.24
125.00	8.46	6.48	6.37
250.00	40.17	40.27	12.84
500.00	43.87	43.98	53.11
1000.00	2.44	2.45	97.08
2000.00	0.35	0.35	99.53
4000.00	0.12	0.12	99.88
8000.00	0.00	0.00	100.00

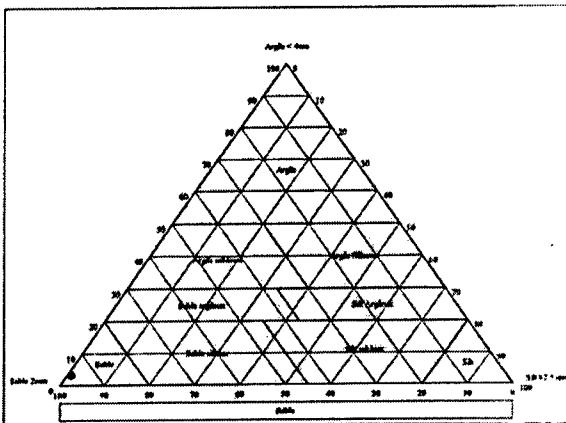

### INFO

Projet: C.F.B. Shilo II  
 Well ZONE-9S Sample Depth: 6'  
 Graph prepared by: Catherine Gauthier  
 Software: Gran V.1.01 CGC/CGQ Eric Boisvert 1998  
 Date: February 7, 2002

Parametre	Valeur
Moyenne	1.1478
Médiane	1.0643
Ecart Type G.	0.6946
Ecart Type G. Inc.	0.8722
Skewness	0.3221
Kurtose	1.4981
Coef Hazen	3.4022E-002
Argile <math><2\mu</math>	2.86
Silt[2-62.5 $\mu</math>]$	1.38
Sable[62.5 $\mu</math>-2mm]$	95.29
Argile <math><4\mu</math>	3.48
Silt[4-62.5 $\mu</math>]$	0.76

# C.F.B. Shilo - ID SS-ZONE-9W@23'

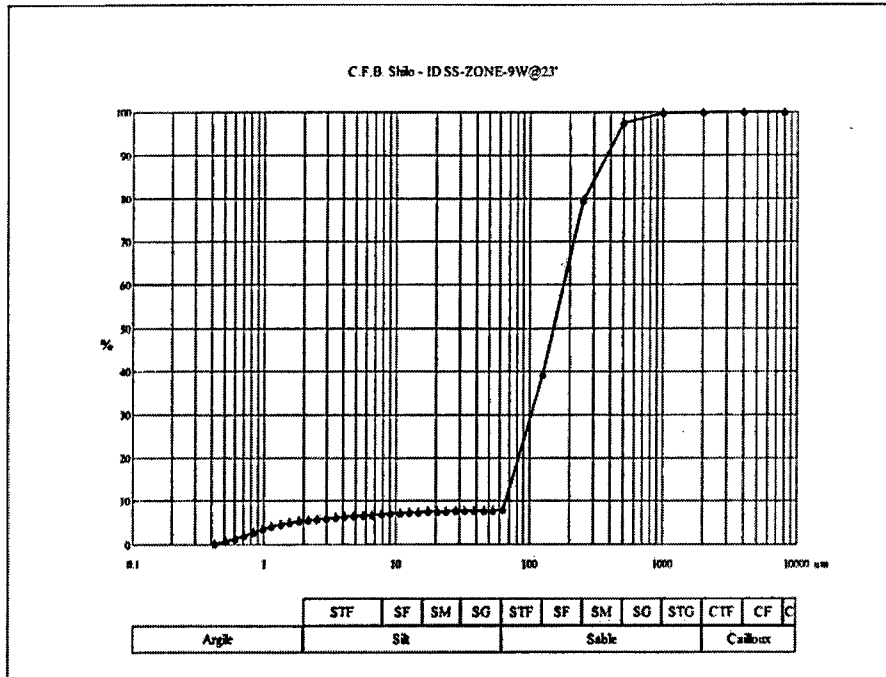

Tamis	Qte	Qte%	Cumul%
0.42	0.63	0.63	0.00
0.51	0.63	0.63	0.63
0.60	0.63	0.63	1.27
0.71	0.75	0.75	1.90
0.83	0.84	0.85	2.66
0.98	0.64	0.64	3.50
1.15	0.49	0.49	4.15
1.35	0.38	0.38	4.64
1.58	0.30	0.30	5.02
1.86	0.25	0.25	5.33
2.18	0.22	0.22	5.58
2.56	0.20	0.20	5.80
3.00	0.19	0.19	6.00
3.53	0.18	0.18	6.19
4.14	0.17	0.17	6.37
4.86	0.16	0.16	6.54
5.71	0.15	0.15	6.70
6.70	0.14	0.14	6.86
7.87	0.13	0.13	7.00
9.23	0.12	0.12	7.13
10.84	0.11	0.11	7.25
12.73	0.11	0.11	7.36
14.94	0.09	0.09	7.47
17.54	0.08	0.08	7.56
20.60	0.07	0.07	7.64
24.18	0.05	0.05	7.71
28.39	0.04	0.04	7.76
33.33	0.04	0.04	7.80
39.13	0.04	0.04	7.84
45.94	0.04	0.04	7.88
53.93	0.04	0.04	7.92
63.00	31.15	31.36	7.96
125.00	39.94	40.21	39.32
250.00	17.77	17.89	79.52
500.00	2.34	2.36	97.41
1000.00	0.20	0.20	99.77
2000.00	0.03	0.03	99.97
4000.00	0.00	0.00	100.00
8000.00	0.00	0.00	100.00

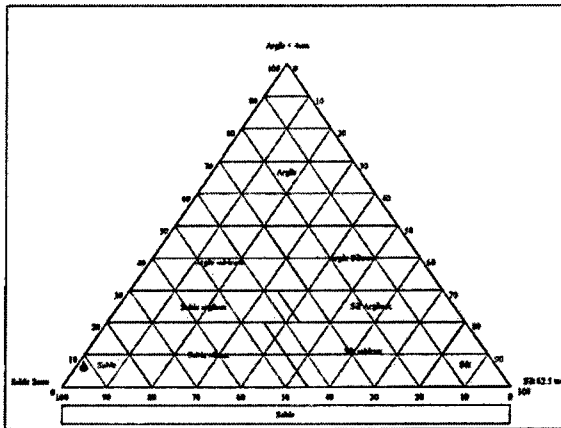

## INFO

Projet: C.F.B. Shilo II  
 Well ZONE-9W Sample Depth: 23'  
 Graph prepared by: Catherine Gauthier  
 Software: Gran V.1.01 CGC/CGQ Eric Boisvert 1998  
 Date: February 6, 2002

Parametre	Valeur
Moyenne	2.7437
Médiane	2.7527
Ecart Type G.	0.8899
Ecart Type G. Inc.	1.6647
Skewness	0.3080
Kurtose	2.7236
Coef Hazen	4.3386E-003

Argile <2µm                    5.44  
 Silt[2-62.5µm]                2.52  
 Sable[62.5µm-2mm]        92.01

Argile <4µm                    6.33  
 Silt[4-62.5µm]                1.63

## Appendix D — ppb à Bq/l Conversion Calculations

definition: 1 Bq = 1 radioactive disintegration per second

$$dN/dt = -k \cdot N$$

where:  $k$  = disintegration constant (1/seconds)  
 $N$  = number of thorium atoms  
 $t$  = time (seconds)

Find  $k$

$$k = \ln(2) / t_{1/2}$$

where  $t_{1/2}$  = half life of thorium  
= 1.4 x 10<sup>10</sup> years  
= 4.4 x 10<sup>17</sup> seconds

therefore,  $k = \ln(2) / 4.4 \times 10^{17} \text{ sec}$   
 $k = 1.57 \times 10^{-18} \text{ 1/sec}$

Find  $N$

definition: 1 ppb = 1 mg/1000 kg = 1 µg/kg

Recall that 1 kg water = 1 litre

à 1 µg/kg = 1 µg/l

1 mol Th = 232.04 g

à 1 µg Th = 4.31 x 10<sup>-9</sup> mol

# mols x Avogadro's constant gives the number of individual atoms.

Avogadro's Constant = 6.033 x 10<sup>23</sup>

à 4.31 x 10<sup>-9</sup> mol x 6.033 x 10<sup>23</sup> = 2.6 x 10<sup>15</sup> atoms thorium =  $N$

Find  $dN/dt$

$$\begin{aligned} k \times N &= (1.57 \times 10^{-18} \text{ 1/sec}) \times (2.6 \times 10^{15} \text{ atoms thorium}) \\ &= 0.00408 \text{ atoms/second} \\ \text{à } 1 \text{ ppb} &= 0.00408 \text{ Bq / l} \end{aligned}$$

CCME threshold criteria = 0.1 Bq/l

so, 0.1 / 0.00408 = 24.5 ppb

# 4 Open Detonation of Military Munitions on Snow: An Investigation of Energetic Material Residues Produced

---

## Abstract

The environmental impacts of detonation events have not been extensively studied in the past. Live-fire training and open detonation of either Unexploded Ordnance (UXO) in training ranges or obsolete ammunition stockpiles potentially impact the environment. In order to better assess the optimal conditions in which the detonations will not lead to adverse environmental impacts, a systematic study has been undertaken to document various detonation events to better understand the relationship between detonics and their environmental impacts. In the present study, four types of munitions currently used by the Canadian Forces, the 60- and 81-mm mortars, 105-mm high-explosive artillery projectile, and the M67 hand grenade, as well as one type of anti-personnel mine surrogate, the PMA-2, were detonated on snow. These munitions were detonated to imitate either proper functioning or UXO disposal. Fresh snow was used for each trial. Following each detonation, two or three snow samples were collected, each being 1 or 2 sq m in area. A template was set on the surface and a thin layer of snow, containing residues and soot, was collected using a shovel. Common explosives and their breakdown products were analysed, and this information was used to estimate the total amount of explosive residue produced by the detonation of a given munition.

This study demonstrated that measurable amounts of explosives were detected in the plume area after open detonation. The munitions used in this study had their fuzes removed for reasons of safety, which appears to have had an unexpected impact on the quantity of residues released, increasing them by several orders of magnitude when compared to live-fired munitions.

Generally, we predict that an average of 0.24 percent of the initial explosive charge is sprayed during a detonation. This value is subject to at least 1 order of

magnitude of error. Traces of RDX from the C4 booster charges were also measured in all cases.

This trial was co-sponsored by the Director General Environment (DGE) from Canada and the Strategic Research and Development Program (SERDP) from the United States of America.

## Executive Summary

This study was undertaken in the context of sustaining operational military activities. By better understanding the impacts of open detonation, we will be able to support the Canadian Forces' mission while minimizing potential adverse environmental impacts. Live firing activities, detonation of unexploded ordnance (UXO) and detonation of surplus ammunitions are critical activities that have to be pursued to ensure the readiness of our troops. One of the biggest impacts of operational activities is the accumulation of UXOs in training areas, one of the most important problems encountered. The presence of UXOs results in a safety issue, which with time, corrosion, and ultimate perforation of the casing will lead to explosives leaching into the groundwater.

UXOs are usually dealt with by open detonation, but little is known of the potential for spraying explosives into the environment due to the occasional low-order detonation caused by unconfined demolition charges, such as C4 placed on the outside of the shell. This scenario may disperse explosives into the surrounding area, leading to environmental contamination. By carrying out systematic detonations and measuring the dispersion of explosives afterward, we will better understand the dynamics of detonation processes, and we will be able to give advice on how to reduce the potential adverse impacts. This will also give us critical information to assess how live firing impacts our training ranges.

The purpose of this study was to determine what types and quantities of residues are created when detonating live munitions and to estimate how much residue is produced when a given munition explodes. Live munitions are used routinely by military personnel when training, but their effect on the environment is poorly understood. Snow is an ideal medium to study explosive residues, as snow can be easily changed between trials to avoid cross contamination.

Thirty-one separate trials were conducted, each consisting of the detonation of a single round. Five different types of munitions were used during these trials including the 61-mm mortar, the 81-mm mortar, 105-mm artillery round, the M67 hand grenade, and the PMA-2 landmine surrogate. Each munition was detonated on a layer of fresh snow, and two to five residue samples were collected for each trial. These samples were then analyzed for explosives and their breakdown products.

The amounts of explosives detected were quite high, several orders of magnitude higher than the ones found in an earlier study (Jenkins et al. 2000b). The reason for this appears to be related to the fact that the fuzes were removed during the current study for reasons of safety. The lack of a fuze could be argued to create a "breached" shell casing, and this would decrease detonation pressures



and temperatures. This would likely increase the amount of detonation residues produced, as was observed.

However, these findings also emphasize the heterogeneous nature of explosive residue quantities, and suggest that estimates based on limited sampling is subject to considerable error. Even with the large uncertainty associated with this type of study, very interesting and pertinent information was obtained that will help us in drafting future recommendations to minimize the adverse impacts of the detonation of munitions in training exercises or clearance operations.

## **Acknowledgements**

The authors acknowledge the efforts of Mses. Annie Gagnon and Melanie Bouchard, DRDC-Valcartier, for their tireless efforts in sample extraction and analysis. As well, the staff at the Munitions Experimentation and Testing Center (METC), Val Belair, Quebec, must also be acknowledged for the execution of this experimental trial. In particular, the efforts of Chief Warrant Officer (CWO) Christian Desrosiers, test safety director, were greatly appreciated. Likewise, Messrs. Pierre Veillette and Gilles Lefebvre, both of whom collected and prepared the meteorological and pressure wave data, are gratefully acknowledged.

## **Introduction**

Millions of kilograms of high explosives have been detonated on military training ranges over the past century. Intensive training took place during the two world wars when record-keeping concerning high-explosives use in the field was virtually nonexistent. Estimates have been produced at bases such as Canadian Forces Base (CFB) Shilo concerning the number of rounds fired in the first half of the century on its training ranges (Ampleman et al. 2002), but outside of the general consensus that the numbers are very high, little else can be determined precisely.

Many high-explosive chemicals such as TNT and RDX are ring-shaped organic molecules. TNT is structurally similar to known cancer-causing agents such as toluene and benzene. Both of these explosives are commonly used in military munitions. Several environmental authorities in the United States have identified some high explosives as potential carcinogens (Agency for Toxic Substances and Disease Registry 1996). Scientific interest in studying the problem of explosive chemicals used on military training ranges has only developed in the past several years, although vast amounts of these chemicals have been used on Canadian military training ranges.

A common belief among end users of munitions (Army personnel) has been that, upon detonation, high explosives simply disappear. At the very least, explosives are believed to transform completely into gases that dissipate in the atmosphere. However, measurable quantities of explosives and their residues

have been demonstrated (Yinon and Zitrin 1993; Jenkins et al. 2000a,b) to remain at the site of an explosion after detonation. Although the quantities are small, with millions of rounds having exploded in impact areas over the past century, the cumulative effect may be significant.

Interest in this subject has been heightened by the on-going investigation at the Massachusetts Military Reservation (MMR) in the United States, which has found that the underlying groundwater aquifer was contaminated with low concentrations of RDX.<sup>1</sup> The source of this RDX is unknown, and possible candidate sources include buried, leaking unexploded ordnance (UXO), residues from past munitions disposal, and accumulated high-order detonation residues from the detonation of hundreds of thousands of rounds over the past 50 years, and low-order residues, that is residues from cracked open rounds. The aquifer contamination has led to the complete shutdown of this training area and expensive remediation. Hopefully, this kind of shutdown will be prevented from happening in Canada or elsewhere in the United States with proactive research.

A key aspect in furthering the understanding of the problem is learning about the environmental fate and products of explosives, once they have been detonated. The major chemical products of complete detonations are CO<sub>2</sub>, CO, H<sub>2</sub>O, N<sub>2</sub>, and soot. However, forensic science has demonstrated that measurable quantities of intact explosive chemicals such as RDX and NG may be found following detonation (Yinon and Zitrin 1993). This study was designed to provide solid information on the residues left by live munitions commonly used in the Canadian Forces, specifically the 61- and 81-mm mortars, the M67 hand grenade, and the 105-mm artillery round (Canadian Forces Technical Orders 2000, 1996). Although banned for use by the Canadian Forces, antipersonnel mines are used heavily in many areas around the globe. For this reason, surrogates of the PMA-2 land mine, containing the same quantity of TNT as the actual mine, were manufactured and tested as well. The PMA-2 is manufactured by several former eastern-block nations and has been found in many conflict zones around the globe (Armament Research Development and Engineering Center (ARDEC) 1996 (see [www.pica.army.mil/Public/about/historm.htm](http://www.pica.army.mil/Public/about/historm.htm))).

Some unique challenges are involved in testing residues left by live munitions. Testing is restricted to heavily used ranges, which are, as a consequence, also heavily contaminated with explosive residues from previous activities. Therefore, finding a way of avoiding sample contamination from the surroundings is necessary. Snow is uniquely suited to this, as it falls frequently and abundantly in northern regions, and is free of explosive residues (Chapter 4, Appendix A). In addition, the soot pattern formed from a detonating round is clearly visible on the white surface, giving strong visual evidence of where contamination is heaviest (Jenkins et al. 2000a,b).

## Theory

Live-fire training involves the extensive use of various types of ammunition on training ranges. Each firing leads to the complete or incomplete detonation of

---

<sup>1</sup> Mr. Jay Clausen, AMEC Earth and Environment, Westford, MA, Feb 2002.

the explosive charge and, therefore, may lead to the spreading of explosives in the environment. Moreover, a certain dud rate is always associated with each exercise, which is usually in the range of 3 to 5 percent, leaving live UXOs in training areas. In fact, some antitank munitions have had dud rates as high as 50 percent. UXOs present a short-term safety concern, since they are armed munitions ready to detonate. When they are found, they are open detonated by military explosive ordnance disposal (EOD) units by applying a charge of C4 on the munitions shell. This also may lead to the spreading of explosive from the C4 into the environment. The two scenarios, detonation of the munitions in firing events and open detonation of the UXOs with C4, may lead to the spreading of explosives in the surrounding soils and ultimately to the groundwater.

The literature regarding the environmental impacts of the detonation processes are limited, and very few studies have been dedicated to that subject (Jenkins et al. 2000a,b). A thorough study done at Canadian Forces Ammunition Depot (CFAD), Dundurn, (Ampleman et al. 1998) demonstrated that the open detonation of a very large amount of obsolete munitions did not lead to the accumulation of high levels of explosives in the environment. However, the destruction of obsolete ammunition involves the detonation of very large quantities of explosives and leads to high pressure and temperature, which is not representative of detonation events involving only one munition either in training or in the destruction of UXOs.

Therefore, a better understanding of the relationship between detonics and its environmental impacts is needed. Many parameters are involved in a detonation process. These parameters include the type of munition, its calibre, casing, and initiating train, as well as the way the detonation proceeds. These parameters all have a strong influence on the efficiency of the detonation. When munitions function normally in firing, they explode from the inside to the outside, and the detonation is considered confined. This should lead to a high-order event and result in a high-detonation pressure and temperature. Some parallel studies in the United States have been conducted where munitions were fired and the impact area sampled for traces of explosives (Jenkins et al. 2000a,b). We should expect then that the explosives would be almost all transformed to gaseous nontoxic products. On the other hand, we should also expect that a low-order detonation produced by either a malfunction of the munition in firing or from the destruction of a UXO using an insufficient boosting charge would lead to the spreading of high levels of explosives.

The atmospheric conditions in which a detonation occurs also play an important role in the outputs of the detonation. The temperature and barometric pressure both have an influence on the detonation phenomena and should be recorded at each event to compare different trials achieved in variable atmospheric conditions. A decision was made to systematically study detonation events by varying some of the important parameters such as: the munition calibre, the quantity of C4 boosting charge, its orientation at detonation, the geometry, application of the C4, and an explanation of the relationship between these parameters and the variation measured in the spreading of explosives.

Ideally, the temperature of the detonation should be recorded, since temperature is highly related with the complete or incomplete transformation of the explosives into gaseous products. However, temperature is one of the most difficult detonation parameters to measure accurately. Confined charges, such as munitions where peak temperatures generally occur prior to the rupture of the

casing, make measurement exceptionally difficult. We did, however, record the air-blast peak pressure, a parameter much easier to measure accurately by installing pressure gages at two distances from the detonation location. Five types of munitions of different shapes and size were detonated, either on steel plates or directly on the surface soil to study the influence of the surface on a detonation. Moreover, we varied the way the C4 charges were applied on the munitions to mimic either live firing events or the open detonation of UXOs. By placing a small amount of C4 booster in the fuse well, we simulated normal detonations, while placing a larger C4 charge on the outer surface of the munition simulated UXO destruction.

Some duplicate trials were also conducted to assess the reproducibility of the results. This was important considering the large error associated with the fact that we were not able to collect the entire detonation plume and, consequently, had to make projections concerning the total amount of residue produced.

The information gained in the present study will help acquire a better knowledge of the critical parameters influencing a detonation event and could help minimize some adverse impacts.

## Experimental

This trial involved five different munitions that were detonated in various settings to assess the effects of the munitions themselves and the effects of the initiating charges as well. Variation is expected in the explosive dispersion pattern as a function of the type of charge detonated as well as the method of detonation.

### Samples

The infantries of many North Atlantic Treaty Organization (NATO) countries use the 60-mm mortar. The high-explosive round used in this mortar is 37.7 cm long and has a main charge of 0.3 kg TNT. This differs from the U.S. version of this munition, which uses Composition B as its main charge. The propellant charge and the fuse were both removed from the round prior to testing. The propellant was completely used during launch so would not be present in either UXOs or normally detonating rounds. The fuse was removed as a routine safety measure. The fuse could contain RDX, HMX, lead azide, and various other primers.

The 81-mm mortar round is very similar to the 60-mm mortar; however, the main charge is 857 g Composition B. This is composed of 59.5 percent RDX, 39.5 percent TNT, and 1 percent wax. The mortar is 52.93 cm long. For the same reasons as for the 60-mm mortar tests, both the propellant and the fuse were removed prior to testing. The RDX typically includes 10 to 15 percent HMX as an impurity (Urbanski 1967). This results from the commercial production process of RDX in North America.

The M67 is the standard issue hand grenade of the Canadian Forces. The grenade is quite small, measuring 6.8 cm in diameter and is roughly spherical in shape. The main charge is 185 g Composition B, and the detonator of lead azide,

lead styphnate, and RDX. These grenades are normally only used on grenade ranges, which can see heavy use and are quite small.

The 105-mm high-explosive artillery round was the largest round tested during these trials. The round is one of only two calibres of artillery used by the Canadian Forces, the other being 155-mm. The high-explosive (HE) round can have a main charge of 2.1 kg of Composition B or 1.98 kg of TNT. The round used in this trial was filled with Composition B.

The PMA-2 antipersonnel mine has a charge of 100 g TNT. The mine is mass-produced by several countries, including the Czech Republic and China. The mine is very simple in design and is designed to detonate when pressure is applied to its top surface. It is 68 mm in diameter and 61 mm tall, with a case of plastic.

The booster charge used for all munitions was C4, a plastic explosive composed of 91 percent RDX (Canadian Forces Technical Order 2000). The quantity used depended on the munitions tested and varied between 5 and 150 g. Figure 4-1 shows Warrant Officer Boucher, the ammunition technician for the trials, precisely weighing the C4 prior to applying it to the munition to be tested.

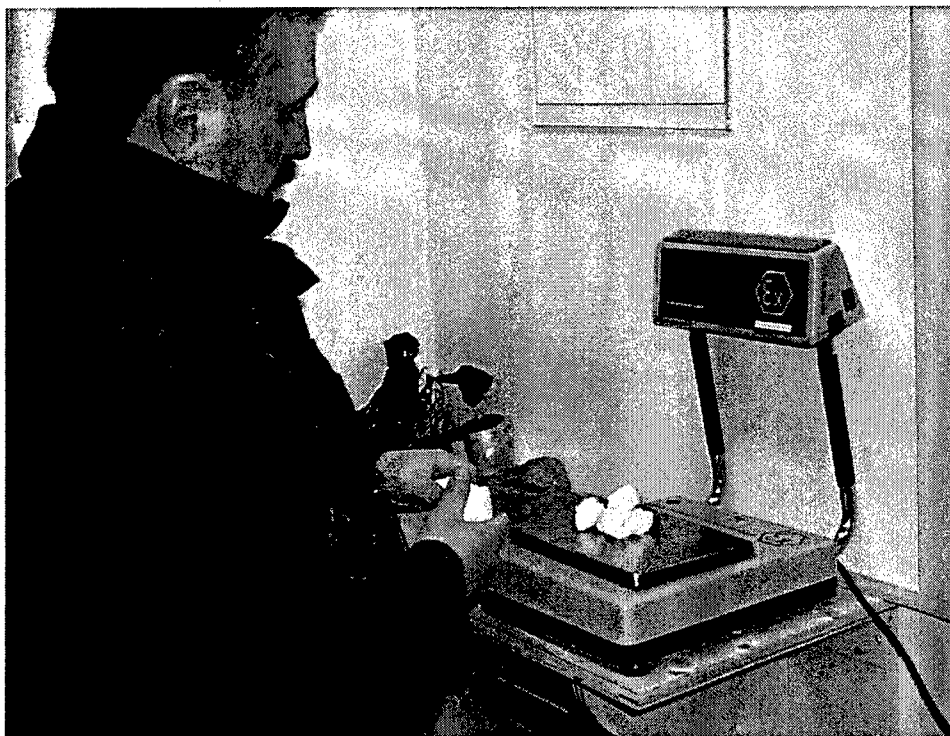

Figure 4-1. Warrant Officer Boucher weighing C4

### Site setup

All trials were conducted at the Defence Research and Development Canada-Valcartier (DRDC-Val) experimental range on Area Support Unit Valcartier. All tests were performed in February 2002 over a 2-week period.

The most critical requirement for the site was sufficient snow. Each trial used an enormous amount of new snow, so the site had to provide easy access to a large quantity of snow. Proximity to the clean snow was absolutely necessary to minimize the amount of time required by the snowplough to replace the contaminated snow with clean snow. However, having the clean snow supply far enough away from the detonation site to minimize cross contamination from detonation products being carried by the wind was also desirable. These two conflicting requirements were difficult to meet. As will be detailed later in this report, explosive residues were still found in the “fresh” snow supply, meaning that future trials should involve the use of an even more remote fresh snow supply.

The snow was sampled approximately 10 min after each detonation to allow time for a visual inspection of the detonation area by the EOD technician to ensure the safety of the sampling team. A short time (2 min) following detonation (to allow time for any “cook-offs” of explosive debris), the EOD technician inspected the area, then called the sampling team by radio when the area was judged safe to sample.

A diagram of the test area can be seen in Figure 4-2.

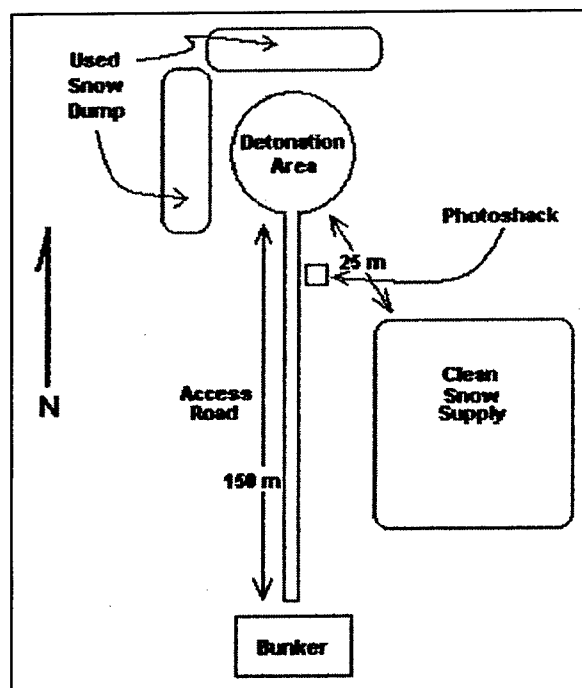

Figure 4-2. Site setup

The test site offered a bunker designed specifically for explosives testing. The bunker allowed personnel to stay quite close to the test site during a detonation, minimizing time spent in transit to and from the detonation area. The weather sensors (wind speed and direction, temperature, precipitation) were all located at the bunker, as was a high-speed camera. A second high-speed camera was located to the southeast of the detonation area, beside the access road in a steel protective chamber called the photoshack.

Range preparation was required for every trial. A front-end loader was used to first scrape away and dump the dirty snow from the previous trial and then to spread a new layer of fresh snow to a depth of approximately 40 cm. A different bucket was used on the front-end loader for the waste removal and the fresh snow supply to avoid cross contamination. For the larger munitions, a heavy steel detonation plate was placed in the middle of the fresh snow. The round to be tested was then placed on the steel plate prior to detonation to avoid underlying earth being blown into the residue cloud. Figure 4-3 shows the heavy equipment used for preparing the range.

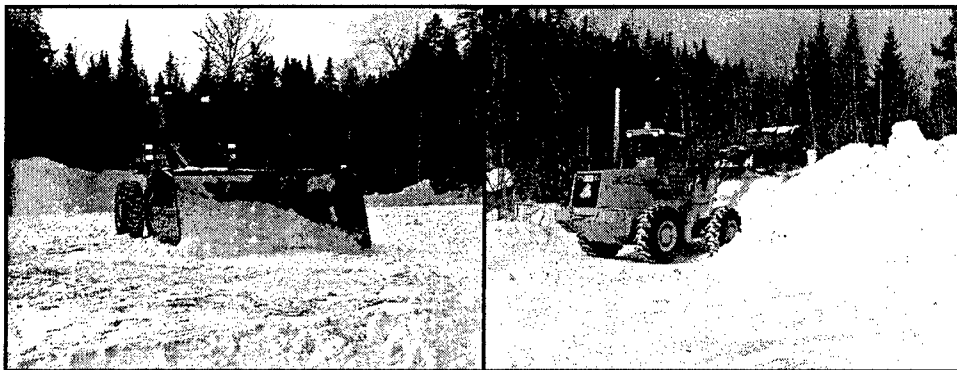

Figure 4-3. Front-end loader clearing the range after a trial

### **Detonation procedure and munitions preparation**

During this study, 31 munitions in total were detonated. A high standard of safety was required in testing these types of munitions, which meant that they had to be tested without their fuzes. Canadian Forces ammunition technicians were engaged to ensure all trials were conducted safely and according to standard procedures. They were responsible for construction of the detonation train, preparation of the rounds, and initiation of the explosives. The munitions were prepared in one of two ways to imitate two different circumstances. These two configurations are described below.

#### **Normal functioning configuration**

These tests were conducted to see how normally functioning rounds release residues into the environment. They were detonated in a manner imitating as closely as possible how they would function when used by military personnel in training and assuming they function as designed. This involved detonating them by placing a quantity of C4 in their fuze wells and initiating them with a blasting cap. Much smaller quantities of C4 were used to detonate these rounds than would normally be used to detonate blow-in-place UXO, as only enough C4 to fill the fuze well was used.

In the case of the PMA surrogate mines, a very small quantity of C4 (5 g) was first molded onto the top surface of the TNT. A #12 detonator was placed lengthwise (horizontally) on the C4 and pushed gently to embed the sides and

end of the detonator in the C4. C4 was then manually molded over the sides of the detonator.

The rounds were oriented whenever possible to the geometry that they would be in if they fell onto a target. For mortar rounds and artillery rounds, this meant nose-down. Practical and safety considerations often made this impossible, since the nose-down configuration would cause kinks in the electrical detonation wires.

The hand grenades were detonated by placing a blasting cap directly in the fuze well.

It must be emphasized that the fuzes were removed from all munitions for safety reasons. This fact, which initially appeared minor, appears to have had a significant effect on the results.

### **Unexploded ordnance configuration**

In these trials, we investigated how nonfunctioning, or dud rounds, release residues when they are detonated as unexploded ordnance. These rounds were detonated by applying a block of C4 explosive to their outer surface, as is done when such rounds are found in the field. These munitions were laid flat on the surface, as that is how they are usually found. Figure 4-4 shows a typical UXO charge for an 81-mm mortar round.



Figure 4-4. 81-mm mortar round in UXO configuration



## Sampling

Sampling was done using a square wooden template of either 1 or 2 m<sup>2</sup>. These were laid on the snow surface after detonation in the areas displaying the greatest concentration of residues. Residue concentration was established subjectively by observing the soot pattern on the ground and choosing areas that appeared to have more soot. Therefore, sampling was biased toward detection, and this naturally meant that most sampling was conducted near the center of the detonation. Figure 4-5 shows snow samples being collected from a 2-m<sup>2</sup> wooden trace laid on the snow surface. The front-end loader used for clearing the snow between trials is shown in the background.

Once the traces were laid down, the snow was sampled inside the trace boundary by scraping a thin layer off the surface of the snow with an unpainted aluminium shovel. The depth of snow sampled was kept to a minimum to minimize the volume of snowmelt produced. The depth sampled depended on the condition of the snow but averaged about 2 cm. The samples were collected from the outer edge of the soot plume toward the middle to avoid walking on areas that were to be sampled. Snow was shoveled into thick polyethylene bags that were then sealed with duct tape. Snow samples were accumulated in a large freezer at DRDC-Val and kept at -20 °C until they were retrieved for melting and processing. Normally three or four samples were taken in each trial, representing a total area of three to six m<sup>2</sup>.



Figure 4-5. Snow collection

## Evaluation of explosive residue concentrations

Samples were placed in large, covered plastic buckets, still in their plastic bags (Figure 4-6), and left to melt overnight. The total volume of the snowmelt was measured. The soot was then removed from the snowmelt by passing it through a filter paper covered with celite.

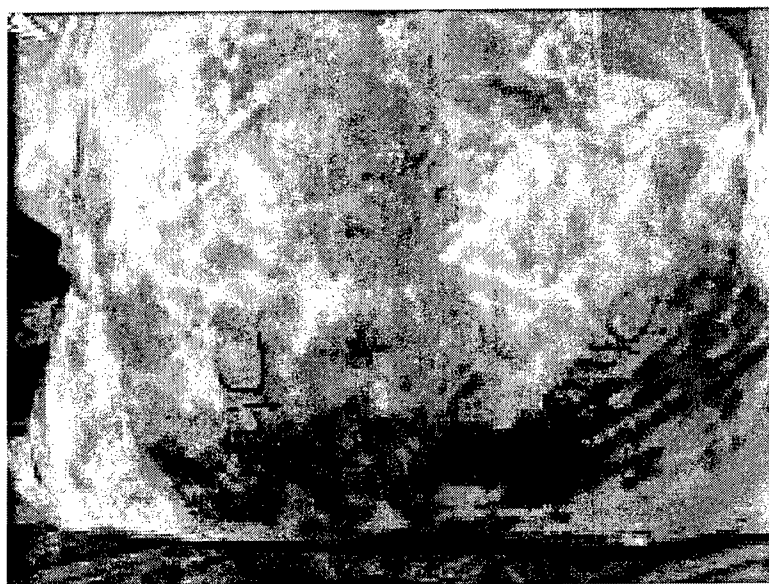

Figure 4-6. Bagged snow sample

A subsample of 500 ml of the filtered snowmelt was then passed through a Sep-Pak™ cartridge filter to absorb any explosive residues that may be present. Acetonitrile, 5 ml, was then passed through the Sep-Pak™ cartridges to extract the explosives residues. The extracts were treated according to EPA Method 8330 (USEPA 1994), and the acetonitrile solution was analyzed at Cold Regions Research and Engineering Laboratory (CRREL) using reversed-phased HPLC for explosives and their by-products.

The total mass of the explosive residues was calculated (Chapter 4, Appendix B, entitled “Calculations”) from the information obtained in the laboratory analysis combined with the size of the soot ‘footprint’ as measured after each detonation. The footprint can be clearly seen in Figure 4-7. The quantity of explosive residue detected by the HPLC represented the amount found in 500 ml of snowmelt. This was then multiplied to determine the amount of explosive found in the complete sample – normally 2,000 to 8,000 ml. This represented the total explosive residue in the 1- or 2-m square trace, which was used to collect the snow sample. Multiplying again by the total area of the soot footprint gave a theoretical total residue mass.

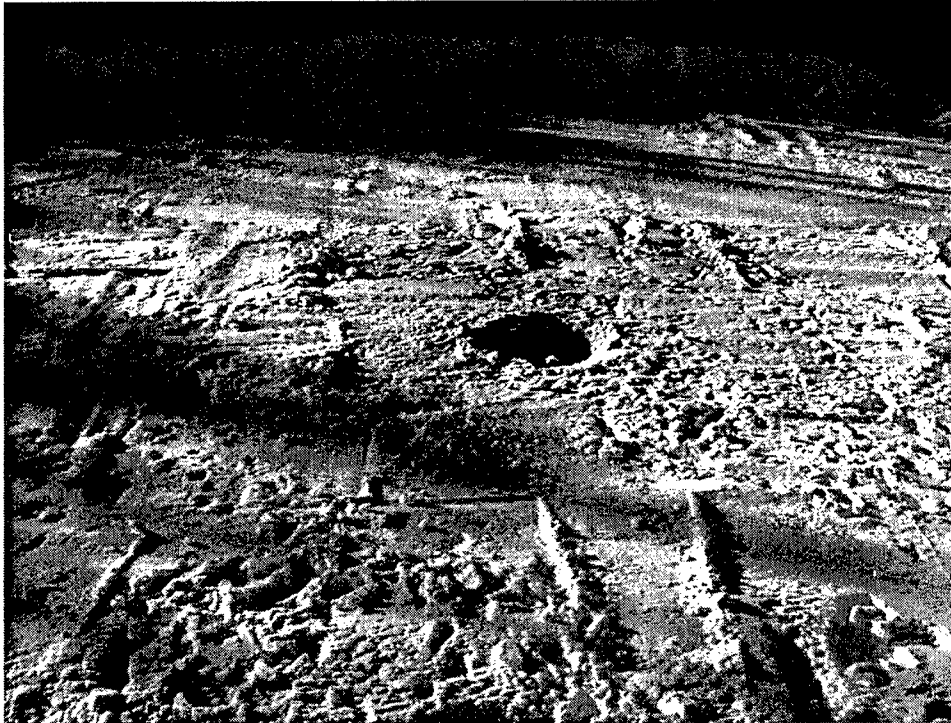

Figure 4-7. Soot plume of 60-mm mortar (crater is 1.5 m in diameter for scale)

The area covered by the soot footprint was found using a measuring tape for width and length (Figure 4-8). The plume was also sketched to give an idea of its approximate shape, and any significant irregularities, such as a significant finger of soot reaching out far beyond the general radius of the soot pattern. These data were used to calculate areas by using an ellipse as a model. If the shape of the footprint was too irregular to apply the ellipse calculation, multiple ellipses were placed over the footprint to obtain a reasonable total. This information was used to calculate the percent recovery of the explosives as expressed by the total mass of explosive residues present after a detonation divided by the amount of explosives present prior to detonation. This included the C4 booster used in each trial.



Figure 4-8. Measuring the plume

The soot extracted from the snowmelt almost certainly has a significant amount of explosives adsorbed onto its surface. The method for extracting these residues from the soot was being developed concurrently with this study, and therefore the results are not yet available. However, a certain amount of explosive residue will be adsorbed onto the soot, making our results somewhat conservative. This aspect of this trial will be published when the results are available. Based on the data published earlier (Jenkins et al. 2000a,b) we can expect that the snowmelt data without the carbon data could slightly underestimate TNT and RDX, and highly underestimate for HMX, which is less soluble than the other two explosives.

### **Meteorology**

Since weather has a significant impact on detonation trials, a full spectrum of meteorological data (Chapter 4, Appendix C) was collected for each trial. For each detonation, the temperature, barometric pressure, wind speed and direction, as well as the minimum and maximum wind gusts over a 5-min period were recorded. These data are especially important when comparing two sets of trials conducted in different meteorological conditions.

### **Pressure wave measurement**

The pressure wave created in the atmosphere by each detonation was recorded using PCB 113B51 sensors. Two sensors were used for each trial, and these were installed at 5- and 10-m distances for the smaller munitions, or 10-

and 15-m distances for the larger munitions. These sensors were powered using ports 1 and 2 of a PCB Model 481 current source, and output monitored through ports 1 and 2 of a Nicolet Model 440 oscilloscope. The acquisition frequency of the oscilloscope was maintained at 500 kHz for all trials. The pressure sensor setup is shown at 10 m in Figure 4-9.



Figure 4-9. Pressure sensor 10 m from detonation site (in background)

## Results and Discussion

Table 4-1 shows the quantity of residues recovered following detonation for the 31 trials conducted. No data are available for trials 17, 21, and 26 due to the loss of the corresponding snow samples. These data are expressed both as a percent of the explosive mass present prior to detonation and as an absolute value. The quantity of residues is an estimate and is, therefore, subject to error. The estimate was derived by multiplying the known amount of residue in a unit sampled area by the total area where residue was visible (generally 35 to 150 sq m). Several possible sources of error are evident. The first is the measurement of the total area of contaminated snow. The outer boundary of soot contamination is never well defined, and measurement of the soot footprint requires a certain amount of judgment on the part of the investigator. Secondly, multiplying the amount of residue in a measured area by the total area assumes that the soot footprint is homogeneous. This is certainly not the case. Contaminant concentrations decline the further one moves from the detonation. Moreover, explosives residues are likely to be distributed quite heterogeneously. If a chunk of unexploded TNT is sampled because it happens to be lying in the trace outline and is subsequently analyzed with the rest of the sample, the results will be inflated. A sample taken immediately beside this tainted sample, and not

containing the chunk of TNT, will of course produce much lower readings. We acknowledge the high uncertainty in the estimates presented in Table 4-1. However, the same approach was taken for each of the detonation trials, which means that the same assumptions were taken systematically. Therefore, comparing the sets of results can still lead to identification of general trends and provide a good idea of the order of magnitude of contamination. None of the results take into account explosives that are adsorbed onto the soot itself. The soot is extracted prior to processing the water for explosive residues, so any explosives present in the soot are not accounted for. A method for extracting explosives from soot was developed concurrently with this study, and the results are not yet available. Many trials with spiked soot showed a high sorption of TNT and TNT by-products on the soot itself. A method involving two-solvent extraction shows promise and should allow the extraction of all TNT sorbed to the soot samples. Based on a previous study (Ampleman et al. 1998), we can estimate that the results presented in Table 4-1 are underestimates by 6 to 20 percent for RDX and 80 percent for HMX. The magnitude of underestimation for the TNT is difficult to evaluate due to sorption processes. HMX is certainly the most highly underestimated due to its low water solubility. Depending on its sorption of soot, the TNT results might also be much higher than shown in Table 4-1. Again here, the underestimates hold for all trials and the resulting trends can still be observed.

The percent residue recovery shows how much explosive residue was recovered as a percent of what was available initially in the munition. The amount of explosive in the C4 booster was taken into consideration in all cases. In addition, the residual HMX that results from the synthesis of RDX using the Bachmann process was calculated and taken into account in the calculations. The Bachmann process does not typically produce pure RDX; HMX is present, generally between 10 and 15 percent of the total yield. Therefore, for the purpose of the calculation, a value of 12 percent was used. No Canadian Forces Technical Order exists governing the percentage of HMX acceptable in the RDX of its munitions or C4.

The percent residue recovery in Table 4-1 shows that RDX and TNT have a mean recovery of 0.34 percent. In contrast, very little HMX is recovered, and very often none at all is detected, although this might change when the soot data become available. The TNT percentage shows the sum total of TNT and its breakdown products, 2ADNT; 4ADNT; 2,4DNT; 2,6DNT; 1,3DNB; and 1,3,5TNB. Differences in molar masses between the breakdown products were not taken into account for the purposes of this calculation.

These results would seem to suggest that HMX is generally consumed in a detonation, while much larger amounts of RDX and TNT are not. In general, the percent residue recovery we obtained in all trials is three orders of magnitude higher than a previous study conducted on 60-mm mortar rounds at Fort Drum (Jenkins et al. 2000b). These results are surprising and show the high variability that can be obtained for such trials. Many factors could explain this, including slight differences in placement of the detonator or booster charge and the atmospheric conditions in which the trials were conducted.

**Table 4-1  
Estimated Explosives Residue Recovery Values**

Trial	Munitions	Configuration	Detonated on Plate?	MASS C4 Booster,	Initial quantities of Explosives used in trial (before detonation)				Forecast Residue Recovery				Percent Residue Recovery			
					Mass RDX in C4, g	Mass HMX in C4, g	Mass, g, TNT in munition	Mass, g, RDX in munition	Mass, g, HMX in munition	RDX mg	HMX mg	Total TNT & products, mg	RDX %	HMX %	TNT %	
1	60-mm	UXO	Yes	150	120.12	16.38	300	0	0	0	22	0.0	52	0.0185	0.0000	0.0174
2	60-mm	UXO	Yes	150	120.12	16.38	300	0	0	0	28	0.0	8.7	0.0236	0.0000	0.0029
3	60-mm	Normal	Yes	50	40.04	5.46	300	0	0	0	81	0.02	6.9	0.2035	0.0004	0.0023
4	60-mm	Normal	Yes	50	40.04	5.46	300	0	0	0	18	0.0	0.45	0.0441	0.0000	0.0001
5	60-mm	UXO	No	150	120.12	16.38	300	0	0	0	20	0.0	0.96	0.0168	0.0000	0.0003
6	60-mm	UXO	No	150	120.12	16.38	300	0	0	0	9.0	0.0	1.1	0.0073	0.0000	0.0004
7	60-mm	Normal	No	50	40.04	5.46	300	0	0	0	96	0.14	3.2	0.2396	0.0025	0.0011
8	60-mm	Normal	No	50	40.04	5.46	300	0	0	0	75	0.0	6.3	0.1874	0.0000	0.0021
9	M67 Grenade	Normal	No	0	0	0	74	89.8656	12.2544	0.35	0.0004	0.0000	0.0000	0.0000	0.0000	0.0038
10	M67 Grenade	Normal	No	0	0	0	74	89.8656	12.2544	0.20	0.0002	0.0000	0.0000	0.0000	0.0000	0.0000
11	M67 Grenade	UXO	No	100	80.08	10.92	74	89.8656	12.2544	1.6E2	0.056	1.3	0.0962	0.0002	0.0018	
12	M67 Grenade	UXO	Yes	100	80.08	10.92	74	89.8656	12.2544	2.6E3	0.21	7.3	1.5080	0.0009	0.0099	
13	M67 Grenade	UXO	Yes	100	80.08	10.92	74	89.8656	12.2544	1.3E2	0.12	5.9	0.0792	0.0005	0.0079	
14	M67 Grenade	Normal	Yes	0	0	0	74	89.8656	12.2544	1.4	0.11	0.0	0.0015	0.0009	0.0000	
15	M67 Grenade	Normal	Yes	0	0	0	74	89.8656	12.2544	0.54	0.078	3.5	0.0006	0.0006	0.0048	
16	M67 Grenade	UXO	No	100	80.08	10.92	74	89.8656	12.2544	2.1E2	0.39	0.0	0.1251	0.0017	0.0000	
18	PMA-2 A/P Mine	UXO	No	20	16.016	2.184	100	0	0	0	9.9E2	0.0	4.0E4	6.2079	0.0000	39.7788
19	PMA-2 A/P Mine	Normal	No	5	4.004	0.546	100	0	0	0	1.2E2	0.0	1.7E3	2.8769	0.0000	1.6800
20	PMA-2 A/P Mine	UXO	No	20	16.016	2.184	100	0	0	0	33	0.0	3.7E3	0.2042	0.0000	3.6553
22	PMA-2 A/P Mine	UXO	Yes	20	16.016	2.184	100	0	0	0	19	0.0	3.7E3	0.1208	0.0000	3.7122
25	PMA-2 A/P Mine	UXO	Yes	20	16.016	2.184	100	0	0	0	15	0.0	32	0.0963	0.0000	0.0321
27	105 mm HE artillery	UXO	Yes	100	80.08	10.92	840	1020.096	139.104	24	0.0	2.5E3	0.0022	0.0000	0.3007	
23	81-mm	UXO	Yes	150	120.12	16.38	342.8	416.29632	56.76768	13	0.0	6.2E3	0.0023	0.0000	1.7977	
24	81-mm	UXO	Yes	150	120.12	16.38	342.8	416.29632	56.76768	6.9	0.0	1.6E2	0.0013	0.0000	0.0478	
28	81-mm	UXO	Yes	60	48.048	6.552	342.8	416.29632	56.76768	5.2	0.0	18	0.0011	0.0000	0.0053	
29	81-mm	Normal	No	40	32.032	4.368	342.8	416.29632	56.76768	15	0.034	27	0.0034	0.0001	0.0079	
30	81-mm	Normal	No	40	32.032	4.368	342.8	416.29632	56.76768	8.8	0.0	1.5E2	0.0020	0.0000	0.0429	
31	81-mm	Normal	No	40	32.032	4.368	342.8	416.29632	56.76768	39	6.0	33	0.0087	0.0098	0.0097	

<sup>1</sup> Highlighted selections refer to those samples lost due to refrigeration failure. They melted under uncontrolled circumstances and thus were not analyzed

The mean percentage recovery of all three explosives from all 31 trials was 0.24 percent, when the aberrant 39.78 percent calculated for TNT in trial 18 was removed. When including the 39.78 percent, the mean jumps to 0.67 percent. While this value is meaningless scientifically, it gives the reader an idea of the magnitude of the residues remaining after an average detonation according to our data and assumptions.

Our trial involved 12 sets of replicate trials to assess the reproducibility of the data obtained. The following sets of trials were conducted twice: 1-2, 3-4, 5-6, 7-8, 9-10, 12-13, 14-15, 11-16, 18-20, 22-25, 23-24, 29-30-31. In general, the relative standard derivation (RSD) between these sets vary between 25 and 150 percent, which is acceptable considering the general uncertainty of the estimations. One exception is for set 12-13 where 1.51 percent of RDX is dispersed in trial 12 compared with 0.08 percent for trial 13. This very large difference between the two trials cannot be explained and more replicates would be needed in order to perform a statistical analysis of the data sets.

Table 4-2 shows the measured values of explosive concentrations. Each value represents the concentration of explosive in a single discrete sample. Due to data limitations (only one data point for some configurations) and high variability, no statistical differences were observed between residues from munitions detonated as UXOs and those detonated normally. Since none of the munitions we used had fuses, the detonation may not represent a normal firing.

The value chosen for analysis in Table 4-2 was  $\text{mg}/\text{m}^2$  of snow. This value was chosen because it takes the important physical parameters of the sample into account and avoids the error implicit in the percentage residue recovery. The latter value relies on multiplying the  $\text{mg}/\text{m}^2$  by the area of the soot plume. The  $\text{mg}/\text{m}^2$  is, in short, the value with the least error that is still representative. Interestingly, the percent residue recovery values were also compared in the same manner as in Table 4-2, and the results were virtually identical despite the additional error. The 105-mm round was not included in Table 4-2 as only one was fired, and, therefore, no comparison could be done. As well, the shortage of samples for the PMA-2 makes the results from this mine less reliable than the results from the 60- and 81-mm mortars, and the M67 grenade.

For the UXO configuration, a Canadian Forces ammunition technician applied the C4 exactly as it would be applied in the field. This meant applying the block directly to the casing. In this configuration, the C4 is unconfined and could lead to higher levels of RDX spreading. This will be covered in another study that will soon be published on the detonation of various charges of C4 in different shapes.



**Table 4-2  
Calculated Residue Concentrations (mg/m<sup>2</sup>) Found in UXO Versus Normally Detonated Trials**

RDX								
60 mm UXO	Normal	Grenade UXO	Normal	PMA-2 UXO	Normal	81 mm UXO	Normal	
0,00	2,15	0,89	0,00	22,09	23,04	0,12	0,06	
0,07	0,02	2,36	0,00	1,35		0,28	0,16	
0,52	0,03	0,23	0,00	3,01		0,12	0,07	
0,21	0,75	6,58	0,02	0,64		0,08	0,01	
0,00	0,04	75,85	0,00	0,22		0,00	0,04	
0,09	0,21	1,04	0,00	0,50		0,03	0,39	
1,14	8,01	1,67	0,01			0,18	0,43	
0,19	0,08	1,07	0,01			0,44	0,08	
0,07	1,33	0,77	0,06			0,04		
0,86	3,22	3,00	0,00					
0,60	0,37	0,23	0,00					
0,09		4,32	0,01					
0,00		11,34	0,01					
0,20								
0,39								
<b>Average</b>	<b>0,30</b>	<b>1,47</b>	<b>8,41</b>	<b>0,01</b>	<b>4,64</b>	<b>23,04</b>	<b>0,14</b>	<b>0,16</b>
TNT								
60 mm UXO	Normal	Grenade UXO	Normal	PMA-2 UXO	Normal	81 mm UXO	Normal	
0,00	0,13	0,08	0,00E+00	883,97	335,99	0,04	0,00	
0,00	0,05	0,00	0,00E+00	172,78		0,37	0,15	
1,73	0,00	0,00	0,00E+00	314,59		0,54	0,36	
0,17	0,02	0,00	1,23E-02	123,74		0,27	0,31	
0,03	0,00	0,22	1,63E-01	223,99		22,39	0,55	
0,00	0,17	0,00	0,00E+00	128,15		0,00	0,00	
0,41	0,10	0,00	0,00E+00			44,80	0,01	
0,00	0,25	0,00	0,00E+00			0,16	0,75	
0,02	0,00	0,15	0,00E+00			0,13		
0,04	0,17	0,00	0,00E+00					
0,02	0,01	0,00	0,00E+00					
0,00		0,00	0,00E+00					
0,00		0,00	1,67E-01					
0,07								
0,00								
<b>Average</b>	<b>0,17</b>	<b>0,08</b>	<b>0,03</b>	<b>0,03</b>	<b>307,87</b>	<b>335,99</b>	<b>7,63</b>	<b>0,27</b>
HMX								
60 mm UXO	Normal	Grenade UXO	Normal	PMA-2 UXO	Normal	81 mm UXO	Normal	
0,00	0,00	0,00	0,00	0,00	0,00	0,00	0,00	
0,00	0,00	0,00	0,00	0,00	0,00	0,00	0,00	
0,00	0,00	0,00	0,00	0,00	0,00	0,00	0,00	
0,00	0,00	0,00	0,00	0,00	0,00	0,00	0,00	
0,00	0,00	0,00	0,00	0,00	0,00	0,00	0,00	
0,00	0,00	0,00	0,00	0,00	0,00	0,00	0,00	
0,00	0,00	0,00	0,00	0,00	0,00	0,00	0,07	
0,00	0,01	0,00	0,00			0,00	0,04	
0,00	0,00	0,00	0,00			0,00	0,02	
0,00	0,00	0,00	0,00			0,00		
0,00	0,00	0,00	0,00					
0,00	0,00	0,00	0,00					
0,00	0,00	0,00	0,00					
0,00	0,00	0,00	0,00					
0,00	0,00	0,00	0,00					
0,00	0,00	0,01	0,00					
0,00		0,03	0,00					
<b>Average</b>	<b>0,0000</b>	<b>0,0011</b>	<b>0,0036</b>	<b>0,0007</b>	<b>0,0000</b>	<b>0,0000</b>	<b>0,0000</b>	<b>0,0174</b>

Note: Commas indicate decimal points in this table.

Detonation waves do not turn corners effectively, and this results in some regions of a munition detonating incompletely (Lee et al. 1998). This phenomenon could explain the high readings obtained for the PMA-2 mine surrogates. The PMA-2 mine surrogates were initiated with 5 to 20 g of C4 on the top surface of the TNT main charge. A schematic may be seen in Figure 4-10. The quantities of explosives and residues measured for the PMA-2 landmine surrogates during this experiment were several orders of magnitude higher than those found in a similar study using actual PMA-2 landmine. In the study performed by CRREL, average explosive residue values recovered from a 2.3-m<sup>2</sup> area of snow were fractions of micrograms (Jenkins et al. 2000a). The highest value obtained for TNT was 47.74 µg in the CRREL study. The results we obtained were substantially higher than this for TNT. Over a 1-m<sup>2</sup> area, we obtained several hits higher than 100 mg, and our highest was 353.6 mg. This result is five orders of magnitude larger than the highest hit obtained in the CRREL study.

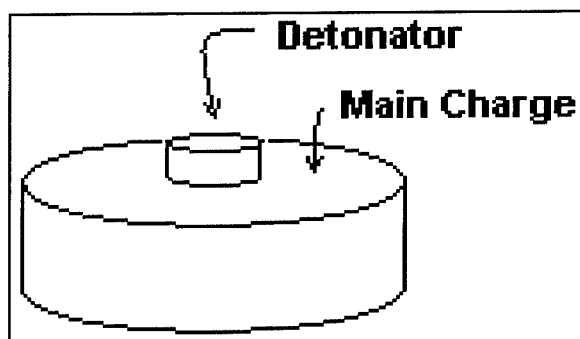

Figure 4-10. PMA-2 landmine schematic

The most likely reason for the discrepancy is the physical construction of the PMA-2 mines. As real PMA-2 mines were not available to us, we used surrogates. These had the same dimensions as the actual mines and included the same amount of TNT (100 g) but were not manufactured with a fuse well. This required the booster to be placed on the top of the mine, a setup shown in Figure 4-10. In contrast, real PMA-2 mines do have a fuse well. The booster is, therefore, in the center of the main charge and the detonation wave moves smoothly from the booster to the main charge, without having to turn a corner at the booster-main charge interface. As mentioned above, detonation waves do not turn corners well, and this likely explains the difference in the results obtained in this test as opposed to those obtained at CRREL. This is illustrated in Figure 4-11, where the shaded block represents the detonating booster, and the heavy dotted lines represent the propagating detonation waves.

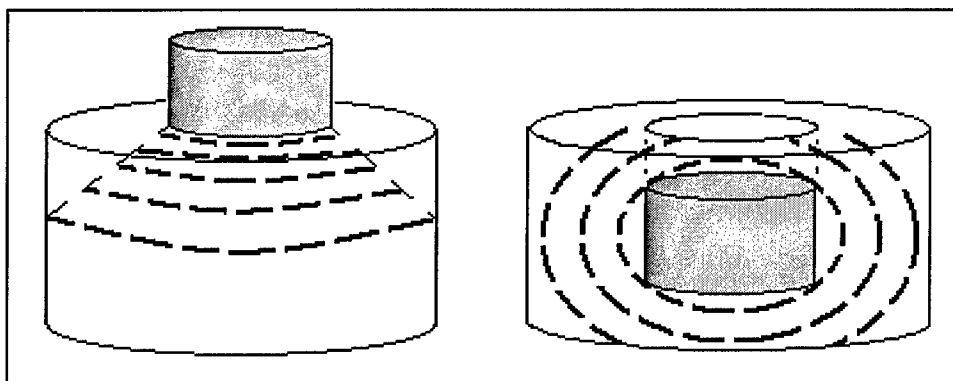

Figure 4-11. Detonation wave propagation in surrogate (left) vs. real (right) PMA-2

Therefore, as shown in Figure 4-11, the upper corners of the surrogate PMA-2 mine would not detonate, and this material would be sprayed over the surrounding area, creating the high levels of residue detected.

However, with the booster placed in the fuse well as is the case with the real mine, the entire main charge of TNT would be expected to detonate.

Twenty-six (26) data points are missing – these are highlighted in Appendix A and in all other relevant tables. These omissions were caused by samples that melted under uncontrolled conditions when the refrigeration unit where they were being stored malfunctioned.

Normally, two to six samples were taken per trial, so if one or two were missing, calculations could still be made with the remaining data. However, in the cases of trials 17, 21, and 26 (highlighted in Table 4-1), all samples were lost, and, therefore, no data could be obtained.

Trace amounts of RDX and TNT residues were found in all six blank samples taken. The average concentrations were  $0.06 \text{ mg/l}^{-1}$  for RDX and  $0.30 \text{ mg/l}^{-1}$  for the TNT. One blank also showed  $0.056 \text{ mg/l}^{-1}$  of HMX. This result is not entirely surprising, since the source of fresh snow used for each trial was exposed to fallout. However, the dirtiest blanks showed concentrations five orders of magnitude below the cleanest test samples. Blanks were collected prior to some of the detonations. The reasonably constant, very low background level of explosive residues in the blanks was averaged for each type of explosive, and this average was subtracted from the results. This low-level contamination of the fresh snow collected 25 to 75 m away from the detonation point is still highly interesting. This observation is a good confirmation that explosive residues may be sprayed at large distances from the point of detonation, outside of the visible plume sampled in our studies.

During the trials, two detonations, trials 17 and 19, were confirmed as incomplete, and one, trial 25, was suspected of being an incomplete detonation. All were tests of the PMA-2 landmine. The incomplete detonations were confirmed with the pressure wave data: trials 17 and 19 only reached 2 to 3 kPa at 5-m distance, and trial 25 reached 4 kPa. All other PMA-2 trials reached

pressures of around 10 kPa at 5 m. The 4- or 5-g of C4 charge used to initiate the mines in trials 17 and 19 were insufficient, which is why 20 g of C4 were used in all subsequent PMA-2 trials. Unfortunately, the data from trial 17 was lost when the samples melted unexpectedly. Trial 19 shows levels of residues comparable to or lower than those of other PMA-2 trials, a somewhat unexpected result. However, trial 25 showed the second-highest total amounts of residues from all trials. Selected pressure-time graphs are shown in Chapter 4, Appendix D, which demonstrate the difference in peak pressures between low-order and high-order detonations of the PMA-2 mines. This highlights the fact that low-order detonation leads to a higher percentage of residue sprayed into the surroundings and also that other parameters might exert a strong influence on the percentage of explosives sprayed. Trials were also compared based on the use or not of a steel plate as a platform for detonating charges. No clear trends were seen and the impact of the presence of the steel plate could not be clearly assessed.

Another interesting result is the quantity of RDX detected in the PMA-2 and 60-mm mortar results. This was initially a source of considerable concern, as both these munitions use 100 percent TNT as their charge; no RDX is used whatsoever. However, the source of RDX was soon realized to be the C4 used to initiate the mines. Only 20 g of C4 was used in the mines, and in two cases, only 5 g. Despite this, more RDX was found in the PMA samples than in many of the 81-mm mortar samples, which contain Composition B as its primary charge, 55.2 percent of which is RDX. This would suggest that smaller explosive charges do not detonate as completely as larger charges, a conclusion that is consistent with detonation theory (Zukas and Walters 1997). The “diameter effect” is a result of two-dimensional (2-D) losses during detonation of a thin explosive column. As the physical size of an explosive decreases, the shock wave propagation due to the 2-D losses becomes less efficient and the detonation becomes less complete. This may provide an explanation for why considerable amounts of RDX were found in the PMA-2 trials. Moreover, C4 charges are unconfined which also has a strong influence on the detonics process, since confined charges achieve higher detonation pressures and temperatures.

## Conclusion

These data obtained in this study suggest that approximately 0.24 percent of the total explosive present prior to detonation remains as residues following a detonation of standard military munitions. This value, however, is subject to an error of at least an order of magnitude due to sampling and calculation (Appendix B) variability and error. These results are approximately three orders of magnitude higher than previously published results on the estimation of explosives residues that resulted from detonation of army munitions, even with the underestimation due to the lack of the soot data. The most likely explanation for this is that the removal of the fuzes had a significant and unexpected impact on the detonation residues produced. Quite simply, the configuration we chose to represent a normally detonated round was not representative of the normal functioning of the munitions and was more representative of blow-in-place detonations.

Expressed as a percentage of the initial amount of explosive, much less HMX remains following a detonation when compared to TNT and RDX. This result will be reexamined when the data from the soot extractions become available.

The results from the PMA-2 mines differed by up to five orders of magnitude with previously published results, which adds to the conflicting results obtained in previous studies concerning explosive residues released by munitions. As detailed in the discussion section, the fact that we used mine surrogates with a different configuration from the real mines might explain these results. This stresses the importance of munition configuration on the effective or ineffective detonation of a charge.

Using C4 to initiate test rounds can add to the amounts of residues collected by introducing RDX into the detonation products.

In general, our study showed that quite a large proportion of explosives could be sprayed into the surrounding environment in clearance operations in training areas. Military EOD personnel use C4 to detonate UXOs on a regular basis in all training areas. Two other trials were recently conducted. One was dedicated to the detonation of C4 charges by themselves with various shapes and sizes. The second was dedicated to comparative UXO detonation with C4 and other boosters including commercially available shape charges. Both studies should add very interesting data that will help us better understand the relationship between the type of booster, its shape, and its environmental impacts. As soon as sufficient data are obtained, results will be discussed with the military users to try to mitigate the adverse impacts of the open detonation of UXO in all training ranges.

Given the error involved in extrapolating the total amount of residues produced from a small area sampled, we suggest that future trials focus on finding the absolute total residue by collecting all snow inside and just outside the soot plume. Such a trial on snow could consist of laying a grid over the soot plume observed on the snow surface, and sampling each grid element. This would provide hard data on the amount of residue left by a given munition and would also provide valuable data on how the residue is distributed. This ideal scenario is, however, very difficult to achieve for larger calibre munitions, and different approaches may be required for future trials.

## References

- Agency for Toxic Substances and Disease Registry. (1996). CAS#121-82-4.
- Ampleman, G., Thiboutot, S., Gagnon, A., Marois, A., Martel, R., and Lefebvre, R. (1998). "Study of the impacts of OB/OD activity on soils and groundwater at the destruction area in CFAD Dundurn," DREV-R-9827.
- Ampleman, G., Thiboutot, S., Lewis, J., Marois, A., Gagnon, A., Bouchard, M., Martel, R., Lefebvre, R., Gauthier, C., Ballard, J. M., Jenkins, T., Ranney, T., and Pennington, J. (2003). "Evaluation of the impacts of live fire training at CFB Shilo (Final)," DRDC-Val TR 2003-006, Val-Belair, Quebec.

- Canadian Forces Technical Order (CFTO). (2000). 60-mm mortar, C-74-310-DA0/TA-000; 81-mm mortar, C-74-315-D00/TA-000; M67 hand grenade, C-74-330-AA0/TA; 105-mm HE artillery round, C-74-315-HBA/TA-000; and plastic demolition charges, C-74-375-AA0/TA-000.
- Jenkins, T. F., Ranney, T. A., Miyares, P. H., Collins, N. H., and Hewitt, A. D. (2000a). "Use of surface snow sampling to estimate the quantity of explosives residues resulting from land mine detonations," CRREL Report 00-12, Hanover, NH.
- Jenkins, T. F., Ranney, T. A., Walsh, M. E., Miyares, P. H., Hewitt, A. D., and Collins, N. H. (2000b). "Evaluating the use of snow-covered ranges to estimate the explosives residues that result from detonation of Army munitions." CRREL Report 00-15, Hanover, NH.
- Lee, K. Y., Kennedy, J. E., Hill, L. G., Spontarelli, T., Stine, J. R., and Kerley, G. I. (1998). "Synthesis, detonation spreading and reaction rate modeling of fine TATB." *Proc., Eleventh Symp. (Intl.) on Detonation Office of Naval Research* ONR 33300-5.
- Lewis, J., Thiboutot, S., Ampleman, G., Brochu, S., Ranney, T., and Taylor, S. (2002). "Open detonation of military munitions on snow: An investigation of the quantities of energetic material residues produced." RDDC-DRDC Valcartier.
- Urbanski, T. (1967). *Chemistry and technology of explosives, Volume 3*, Pergamon Press.
- U.S. Armament Research, Development and Engineering Center. (1996). *Handbook of Ammunition used in former Yugoslavia*, Picatinny Arsenal, New Jersey. ([www.pica.army.mil/public/about/history.htm](http://www.pica.army.mil/public/about/history.htm))
- U.S. Environmental Protection Agency. (1994). "Nitro aromatics and nitramines by HPLC," 2nd update, SW 846, Method 8330, Office of Solid Waste and Emergency Response, Washington, DC.
- Yinon, J., and Zitrin, S. (1993). *Modern methods and applications in analysis of explosives*. Wiley, New York.
- Zukas, A. J., and Walters, W. P. (1997). *Explosive effects and applications*. Springer-Verlag, New York.

## Appendix A — Detonation Residue Quantities, mg

Munitions	Sample	Tetryl	2ADNT	4ADNT	RDX	TNT	2,4DNT	2,6DNT	1,3DNB	HMX	1,3,5TNB
60 mm UXO	1a	0	0	0	0.003	0	0	0	0	0	0
	1b	0	0	0	0.1442	0.0012	0	0	0	0	0
	1c	0	0	0	1.053	3.4668	0.023	0	0	0	0.00324
	1d	0	0	0	0.2138	0.1793	0	0	0	0	0.00042
60 mm UXO	2a	0	0	0	0.0057	0.0356	3E-04	0	0	0	0.00059
	2b	0	0	0	0.1856	0.0006	0.001	0.0017	0	0	0
	2c	0	0	0	2.2752	0.8453	0	0	0	0	0
	2d	0	0	0	0.1925	0.009	4E-04	0	0	0	0.00043
60 mm	3b	0	0	0	4.3008	0.288	0.002	0	0	0.0016	0.02438
	3c	0	0	0	0.0518	0.1091	0	0	0	0	0
	4a	0	0	0	0.0719	0.0057	6E-04	0	0	0	0
60 mm	4b	0	0	0	1.4945	0.0598	0	0	0	0	0
	4c	0	0	0	0.075	0	0	0	0	0	0.00342
	5a	0	0.008	0.016	0.1448	0.0541	0	0	0.0048	0	0.00131
60 mm	5b	0	7E-04	0.011	1.518	0.0847	0.007	0	0	0	0
	5c	0	0	0	1.1968	0.055	0	0	0	0	0
	5d	0	0.003	0.028	0.1815	0.0134	0	0	0	0	0
	6a	0	0	0	0.0051	0.0002	0	0	0	0	0
60 mm	6b	0	0	0	0.4049	0.154	0	0	0	0	0
	6c	0	0	0	0.774	0.0152	4E-04	0.0011	0	0	0
	7a	0	0	0	0.2184	0.1829	0	0	0	0	0
60 mm	7c	0	0	0	16.019	0.2324	0	0	0	0.02407	0
	8a	0	0	0	0.086	0.256	0	0	0	0	0
60 mm	8b	0	0	0	3.021	0.008	0	0	0	0	0
	8c	0	0	0	3.2232	0.1836	0	0	0	0	0
	8d	0	0	0	0.7426	0.032	0	0	0	0	0
	9a	0	0	0	0.0017	0.0077	0	0	0	0	0
Grenade	9b	0	0	0	0.0018	0.0004	0	0	0	0	0
	9c	0	0	0	0.0042	0.0012	0	0	0	0	0
	9d	0	0	0	0.0167	0.0202	0	0	0	0	0
	9e	0	0	0	0.0105	0.3061	0	0	0	0	0
	10a	0	0	0	0.0056	0.0019	0	0	0	0	0
Grenade	10c	0	0	0	0.0123	0.0011	0	0	0	0	0
	11a	0	0	0	0.896	0.0909	0	0	0	0.00378	0
Grenade	11b	0	0	0	2.3598	0.0018	0	0	0	0	0
	11c	0	0	0	0.2317	0.001	0	0	0	0	0
	11d	0	0	0	14.94	0.0025	0	0	0	0	0
	12a	0.01	0	0	151.7	0.4625	0	0	0	0.00992	0
Grenade	12c	0.01	0	0	2.079	0.002	0	0	0	0.00401	0

(Sheet 1 of 3)

Munitions	Sample	Tetryl	2ADNT	4ADNT	RDX	TNT	2,4DNT	2,6DNT	1,3DNB	HMX	1,3,5TNB
Grenade	13a	0	0	0	3.3511	0	0	0	0	0	0
	13b	0	0	0	2.1408	0.0025	0	0	0	0.00595	0
	13c	0.01	0	0	1.5399	0.3245	0	0	0	0.00112	0
	blanc #3	0	0	0	0	0.0275	0	0	0	0	0
Grenade	14a	0.01	0	0	0.0207	0.002	0	0	0	0.00401	0
	14b	0.01	0	0	0.1165	0.0027	0	0	0	0.0071	0
Grenade	15a	0	0	0	0.0109	0.0022	0	0	0	0.00778	0
	15b	0	0	0	0.0068	0.0005	0	0	0	0.00017	0
	15c	0	0	0	0.0154	0.0014	0	0	0	0	0
	15d	0	0	0	0.0118	0.1727	0	0	0	0	0
Grenade	16a	0	0	0	3.0008	0.0014	0	0	0	0	0
	16b	0	0	0	0.2305	0.003	0	0	0	0	0
	16c	0.01	0	0	4.326	0.0029	0	0	0	0.00617	0
	16d	0.01	0	0	20.034	0.0036	0	0	0	0.05082	0
PMA-2											
PMA-2											
	18c	0	0.263	0.22	8.84	353.6	2.122	0.34	0.1142	0	0.476
PMA-2	19	0	4.48	0.095	23.04	336	10.75	1.3344	0.1725	0	5.216
PMA-2	20a	0	0.16	0.158	1.3468	172.79	1.465	0.2276	0.0729	0	0.2923
	20b	0	0.265	0.237	3.016	314.6	2.168	0.3172	0.1128	0	0
PMA-2											
PMA-2											
	22b	0	0.061	0.028	0.6468	123.75	0.974	0.1634	0	0	0
	blanc avant 23	0	0	0	0.0047	0.0284	0	0	0	0	0
81 mm	23a	0	2E-04	0.001	0.1178	0.0414	0.001	0	0	0	0
	23b	0	0.014	0.022	0.5568	0.7584	0.01	0	0	0	0
	23c	0	0.006	0.009	0.2399	1.098	0.007	0	0	0	0
	23d	0	0	0	0.1542	0.564	0.003	0	0	0	0
81 mm	24a	0	0	0.004	0	22.4	0.48	0	0.021	0	0
	24b1	0	0	0	0.0532	0.0115	0	0	0	0	0
	24b2	0	0.104	0.091	0.3696	89.6	1.142	0.2299	0.0602	0	0.09436
	24d	0	0	0	0.8736	0.3311	0	0	0	0	0
PMA-2	25a	0	0.162	0.197	0.222	224	2.24	0.398	0	0	0
	25b	0	0.086	0.113	0.4992	128.16	1.67	0.2928	0	0	0
PMA-2											

(Sheet 2 of 3)



Munitions	Sample	Tetryl	2ADNT	4ADNT	RDX	TNT	2,4DNT	2,6DNT	1,3DNB	HMX	1,3,5TNB
105 mm	27a	0.02	0.004	0.011	0.0264	0.961	0.026	0.0076	0	0	0
	27b	0	0	0	0.0039	0.3057	0.005	0.002	0	0	0
	27e	0.01	0.009	0.002	0.0637	0.8454	0.037	0.0131	0	0	0
81 mm	28a	0	0	0	0.04	0.1444	0	0	0	0	0
	29a	0	0	0	0.0608	0.0107	0	0	0	0	0
81 mm	29c	0	0.005	0.011	0.4978	0.4826	0.008	0	0	0.00236	0
	29d	0	0.001	0.002	0.0758	0.3729	0	0	0	0	0.00084
	30a	0	0	0	0.0184	0.3309	0	0	0	0	0.00064
81 mm	30d	0	0	0	0.0396	0.5652	0	0	0	0	0
	31a	0	0	0	0.3935	0.029	0	0	0	0.07412	0
	31b	0	0	0	0.44	0.0445	0	0	0	0.04361	0
	31d	0	0	0	0.0849	0.7688	0	0	0	0.02356	0

*Shaded selections refer to those samples lost due to refrigeration failure. They melted under uncontrolled circumstances and thus were not analyzed.*

(Sheet 3 of 3)

## Appendix B — Calculations

### Step 1: Calculate area covered by soot

The area of soot is a measurement of the soot footprint. Given the width and length of the soot footprint, the area of an ellipse was calculated, and this value used for the total area covered by soot and explosive residues. The area of an ellipse is given by

$$\text{Area} = (\pi)(A)(B)$$

where A and B are the semi-major and semi-minor axis of the ellipse (the short and long radii). If the outline was irregular, several ellipses were used to create a close approximation of the area covered. Note that the outline is quite undefined, so measurement includes a considerable amount of error.

For example, for trial 5, a 60-mm mortar detonated as a UXO, A = 7 m and B = 2.25 m

$$\text{Area} = (\pi)(7\text{m})(2.25\text{m}) = 49.455 \text{ m}^2$$

which, given the error involved, we round to **50 m<sup>2</sup>**.

### **Step 2: Subtract amount found in blanks**

The value we use to begin this step is (mg explosive)/(l acetonitrile), where acetonitrile is the solvent. This value is as measured by the reversed-phase HPLC. A separate value was measured for each explosive residue species: i.e., RDX, TNT, etc. We will use a typical value, the one measured for RDX in sample 5d.

$$6.05 \text{ mg/l}^{-1}$$

A small amount of residue was found in the blank samples. These were averaged for each species, and subtracted from the results. For the case of RDX, the average value found in the blanks was 0.0635 mg/l<sup>-1</sup>. Therefore, the value used for these calculations will be:

$$(6.05 \text{ mg/l}^{-1}) - (0.0635 \text{ mg/l}^{-1}) = 5.9865 \text{ mg/l}^{-1}$$

which we round to three significant figures: **5.99 mg/l<sup>-1</sup>**

These were the values used in **Table 4-2**, as they are reasonably free of error.

### **Step 3: Calculate amount of explosive residue in a snow sample**

The acetonitrile solvent is 5 ml in volume. Therefore, to find the actual mass of residue in the sample, we must divide the above concentration by 200 (200 × 5 ml = 1 l).

$$(5.99 \text{ mg} \cdot \text{l}^{-1})/200 = 0.02995 \text{ mg} \cdot 5\text{ml}^{-1}$$

which we round to three significant figures : **0.030 mg • 5 ml<sup>-1</sup>**

Now we must consider that for each snow sample, only 500 ml was extracted. Therefore, the 0.03025 mg/5 ml must be multiplied by the ratio of (actual melted snow volume / 0.5 l). For sample 5d, the melted snow volume was 3.0 l. Therefore;

$$(0.0300 \text{ mg} \cdot 5\text{ml}^{-1}) \times (3.0 \text{ l} \cdot 0.5\text{l}^{-1}) = 0.1797 \text{ mg} \cdot 5\text{ml}^{-1}$$

which we round to three significant figures: **0.180 mg • 5 ml<sup>-1</sup>**

Since the 5 ml of acetonitrile contains the same amount of residue as the snow sample, we can write:

$$0.180 \text{ mg} \cdot \text{snow sample}^{-1}$$

This value, whose error is reasonably low, is what is listed in **Appendix A, Chapter 4**. It represents the amount of explosive residue found in the snow samples taken.

#### **Step 4: Calculate the concentration per meter squared of a sample**

The above result does not take into account the different sizes of snow samples taken. Some were 1 m<sup>2</sup>, some were 2 m<sup>2</sup>, and those taken around craters were of several different areas. This step takes the above value and divides it by the area of snow sampled to get a value in mg/m<sup>2</sup>. Since sample 5d was 2 m<sup>2</sup>, we divide by 2 to get:

$$(0.180 \text{ mg} \cdot \text{snow sample}^{-1}) / (2 \text{ m}^2 \cdot \text{snow sample}^{-1}) = 0.090 \text{ mg/m}^2$$

#### **Step 5: Calculate total mg released per detonation**

We now have a value for residue per square meter snow (Step 4), and a measurement of the area of snow affected (Step 1). Multiplying the two will give a value for the total amount of residue released.

$$(0.090 \text{ mg} \cdot \text{m}^{-2}) \times (50 \text{ m}^2) = 4.5 \text{ mg}$$

However, generally 3 to 5 of these measurements were obtained per detonation, because 3 to 5 snow samples were taken. Therefore, to get a truer representation, we take the average of the totals calculated above for each trial, and round to two significant figures (due to the error incurred in Step 1). For trial 5, the other total calculated mg released are:

- 5a: 3.5 mg
- 5b: 43 mg
- 5c: 30 mg

Therefore, the average will be:

$$(3.5 \text{ mg} + 43 \text{ mg} + 30 \text{ mg} + 4.5 \text{ mg}) / 4 = 20.25 \text{ mg}$$

which we round to **20 mg**.

This value is used in **Table 4-1** as “Estimated Explosives Residue Recovery Values.”

## Step 6: Calculate explosive content of munitions

Total explosive weights for Canadian Forces munitions were obtained from the relevant Canadian Forces Technical Order (CFTO). For the PMA-2 landmine these data were obtained from the Handbook of Ammunition used in Former Yugoslavia.

The 60-mm mortar and PMA-2 did not require further calculations, as they are both pure TNT.

The C4 demolition block is composed of 91 percent RDX and 9 percent polyisobutylene.

The 81-mm mortar, 105-mm HE round, and M67 grenade were filled with Composition B. Composition B is composed of 55.2 percent RDX, and 40 percent TNT with the remaining several percent wax.

A complication is that RDX, when produced using the Bachmann process, as in North America, contains between 10 to 15 percent HMX. No CFTO governs the amount of HMX allowable in RDX (if anything, the presence of HMX increases the explosive effectiveness), so for the purposes of calculation an average of 12 percent was used.

### For 150 g C4:

- $((150 \text{ g}) \times 0.91) \times 0.12 = 16.38 \text{ g HMX}$
- $((150 \text{ g}) \times 0.91) \times 0.88 = 120.12 \text{ g RDX}$

### For 81-mm Mortar (857 g Composition B)

- $857 \text{ g} \times 0.4 = 342.8 \text{ g TNT}$
- $(857 \text{ g} \times 0.552) \times 0.12 = 56.77 \text{ g HMX}$
- $(857 \text{ g} \times 0.552) \times 0.88 = 416.3 \text{ g RDX}$

These are the values used in **Table 4-1** as “Initial quantities of explosives used in trial.”

For Trial 5, using a 60-mm mortar, the total explosive charge was 300 g TNT plus 150 g C4, which breaks down into its component RDX and HMX as listed above.

## Step 7: Calculate percent explosive remaining after detonation

For the purposes of this calculation, all of the totals for the TNT breakdown products (2ADNT; 4ADNT; 2,4DNT; 2,6DNT; 1,3DNB; 1,3,5TNB; and TNT) calculated in **Step 4** were added together.

The percent remaining is simply this amount from Step 5 divided by the amount calculated in Step 6.

For trial 5, we have 20 mg RDX from Step 5 and 120.12 g RDX in Step 6 from the C4. The munition itself contains no RDX, as it is pure TNT. First, to obtain equivalent units, we divide the mg by 1,000:

$$20 \text{ mg} / 1,000 \text{ mg/g} = 0.02 \text{ g RDX}$$

This value is divided by the value found in Step 6:

$$0.02 \text{ g} / 120.12 \text{ g} = 0.000168$$

Multiplying by 100 to obtain a percentage, we get: **0.0168 percent**, the value in **Table 4-1** as "Percent Residue Recovery."

## Appendix C — Meteorological Data

Meteorological Readings								
Trial	Date	Time	Temperature °C	Barometric Pressure Mb	Wind Direction degrees	Wind Speed Km/hr	Wind minimum Km/hr	Wind maximum Km/hr
# 1	2002-02-12	10:05:24	-13.7	981.6	28	7.7	2	16
		10:10:25	-13.8	981.6	31	6.4	2	11
# 2	2002-02-12	11:20:35	-12.4	979.9	35	6.3	2	14
		11:25:35	-12.5	979.6	27	6.9	3	13
# 3	2002-02-12	13:10:49	-10.4	976.0	48	2.9	0	10
		13:15:50	-10.2	976.0	53	3.2	0	8
# 4	2002-02-12	14:05:56	-9.8	975.2	25	5.1	0	11
		14:10:57	-9.7	975.1	35	4.0	0	8
# 5	2002-02-12	15:01:04	-9.2	974.7	30	4.9	2	10
		15:06:04	-9.2	974.7	34	4.2	2	6
# 6	2002-02-13	09:39:01	-13.7	998.5	305	10.0	3	21
		09:44:01	-14.0	998.5	299	11.1	5	19
# 7	2002-02-13	10:44:09	-13.5	999.5	312	12.0	3	26
		10:49:10	-13.3	999.5	330	9.6	2	18
# 8	2002-02-13	11:44:18	-11.5	999.9	307	8.3	3	21
		11:49:18	-11.7	999.9	316	12.0	5	21
# 9	2002-02-13	13:14:29	-11.7	1000.8	290	12.1	5	26
		13:19:30	-11.7	1000.9	287	11.7	3	24
# 10	2002-02-13	14:14:38	-11.6	1001.4	296	8.4	3	19
		14:19:38	-11.9	1001.5	301	11.6	0	26
# 11	2002-02-13	15:14:46	-12.1	1002.1	321	12.6	3	26
		15:19:47	-12.3	1002.1	316	8.7	3	18
# 12	2002-02-14	09:29:56	-17.3	1005.4	11	3.8	2	6
		09:34:57	-16.7	1005.3	10	2.2	0	3
# 13	2002-02-14	10:30:04	-13.8	1004.6	86	1.3	0	5
		10:35:04	-13.7	1004.5	59	0.9	0	3
# 14	2002-02-14	11:25:11	-12.9	1003.7	23	2.9	0	8
		11:30:12	-12.3	1003.5	22	0.2	0	2

(Continued)

### Meteorological Readings (Concluded)

Trial	Date	Time	Temperature °C	Barometric Pressure Mb	Wind Direction degrees	Wind Speed Km/hr	Wind minimum Km/hr	Wind maximum Km/hr
# 15	2002-02-14	13:05:25	-10.1	1002.5	0	0.0	0	2
		13:10:26	-9.7	1002.4	0	0.5	0	3
# 16	2002-02-14	13:55:32	-9.9	1001.9	46	0.4	0	3
		14:00:32	-9.8	1001.9	46	0.2	0	2
# 17	2002-02-18	09:35:20	-8.3	1012.9	3	0.4	0	2
		09:40:21	-7.4	1012.8	3	0.6	0	2
# 18	2002-02-18	10:30:27	-5.9	1012.9	108	2.1	0	6
		10:35:28	-5.4	1012.8	144	2.8	0	6
# 19	2002-02-18	11:20:34	-5.8	1012.4	77	3.4	0	6
		11:25:35	-5.1	1012.3	154	2.1	0	10
# 20	2002-02-18	12:50:47	-3.5	1011.6	220	8.0	3	16
		12:55:47	-3.2	1011.6	223	6.7	0	14
# 21	2002-02-18	13:45:54	-3.3	1011.3	225	6.0	2	13
		13:50:54	-3.3	1011.4	217	7.6	2	16
# 22	2002-02-18	14:36:01	-3.1	1011.2	310	4.4	0	10
		14:41:01	-3.0	1011.2	263	6.8	2	11
# 23	2002-02-19	09:40:12	-7.6	1008.5	91	1.6	0	5
		09:45:12	-7.3	1008.4	43	1.4	0	3
# 24	2002-02-19	11:05:23	-3.8	1007.5	212	8.2	3	11
		11:10:24	-3.6	1007.4	201	7.3	3	14
# 25	2002-02-19	13:00:39	-0.6	1006.9	230	5.0	0	8
		13:05:40	-0.6	1006.8	219	8.1	3	14
# 26	2002-02-19	13:50:46	-0.8	1006.9	229	8.1	2	14
		13:55:47	-0.9	1006.9	234	10.8	5	19
# 27	2002-02-20	13:50:22	0.6	1002.8	87	0.6	0	3
		13:55:22	0.7	1002.7	85	0.1	0	2
# 28	2002-02-21	09:25:12	1.7	992.6	44	0.0	0	0
		09:30:13	1.5	992.6	44	1.0	0	3
# 29	2002-02-21	10:40:22	1.6	992.2	44	0.4	0	3
		10:45:23	1.8	992.2	48	0.7	0	3
# 30	2002-02-21	12:40:38	2.2	992.0	48	0.0	0	0
		12:45:39	2.1	991.9	48	0.0	0	0
# 31	2002-02-21	13:40:46	2.1	991.5	84	0.5	0	3
		13:45:47	2.1	991.4	86	0.0	0	0

## Appendix D — Selected Pressure Wave Graphs

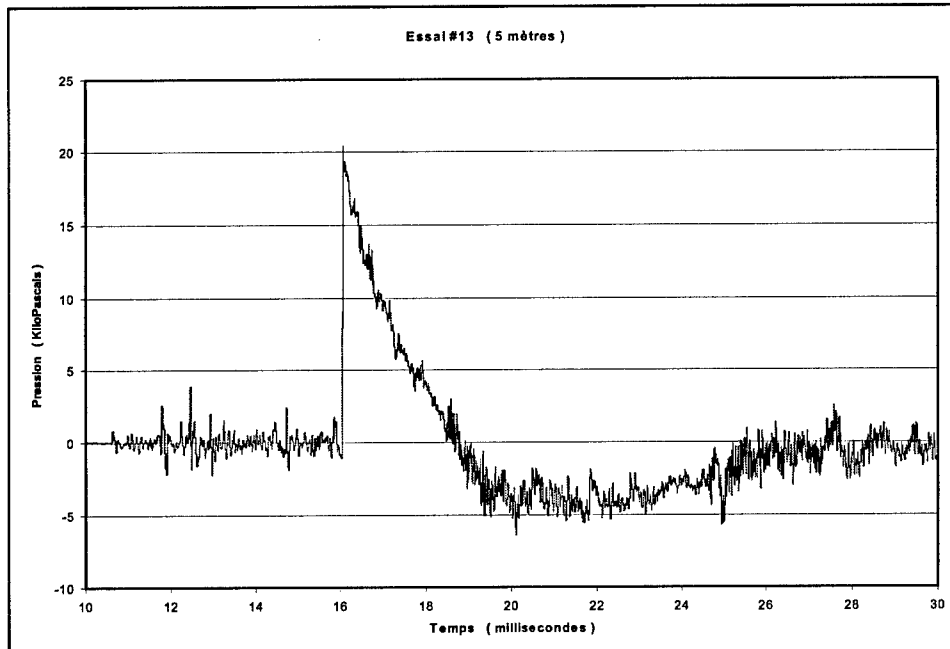

Trial 13, Pressure (kPa) vs. Time (ms) at 5 m, M67 Grenade + 100 g C4

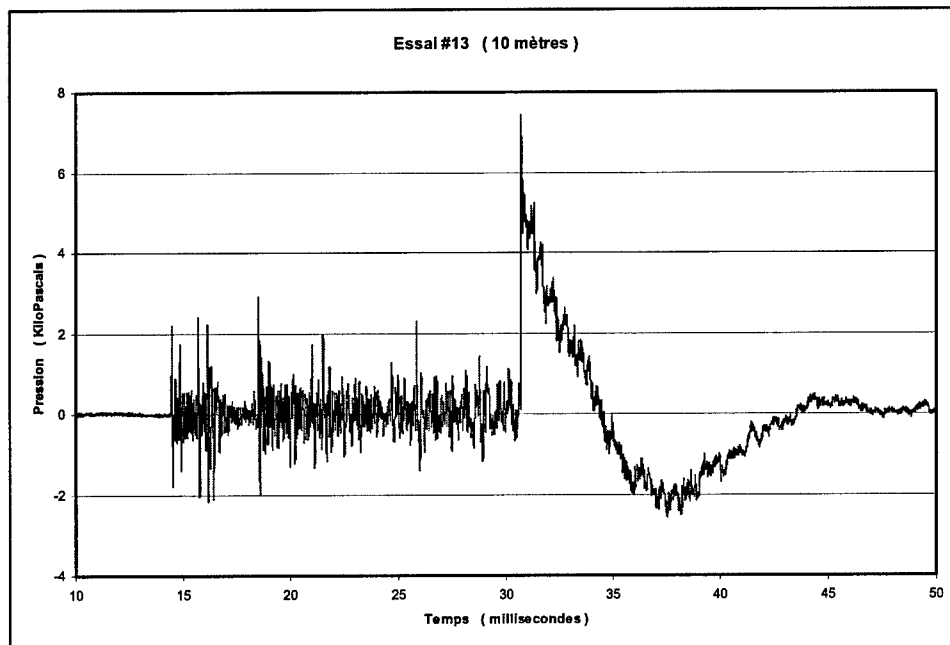

Trial 13, Pressure (kPa) vs. Time (ms) at 10 m, M67 Grenade + 100 g C4

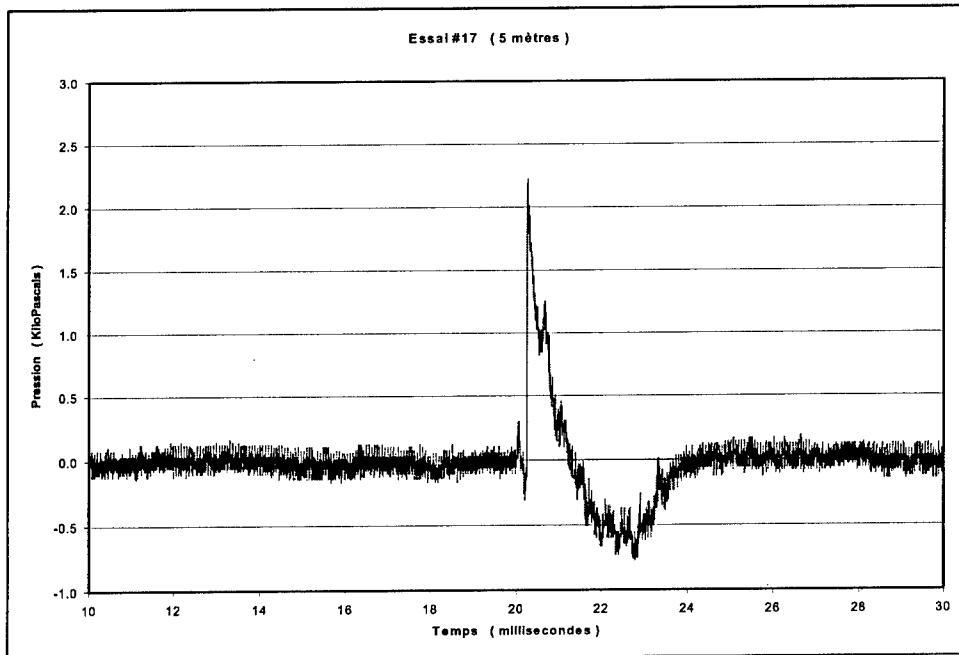

Trial 17, Pressure (kPa) vs. Time (ms) at 5 m, PMA-2 landmine + 4 g C4 (Low-Order detonation)

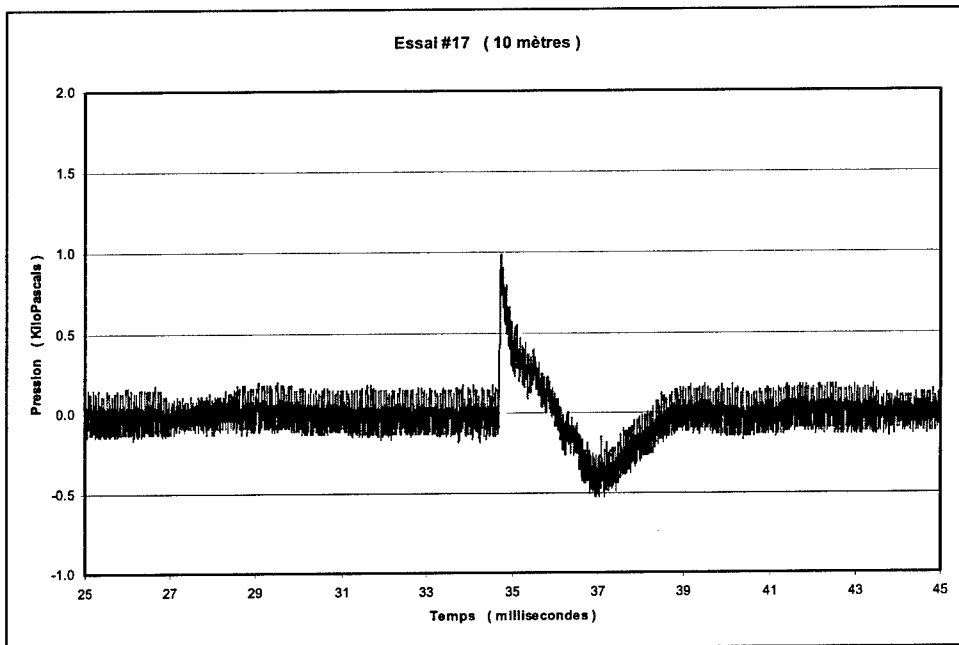

Trial 17, Pressure (kPa) vs. Time (ms) at 10 m, PMA-2 landmine + 4 g C4 (Low-Order detonation)



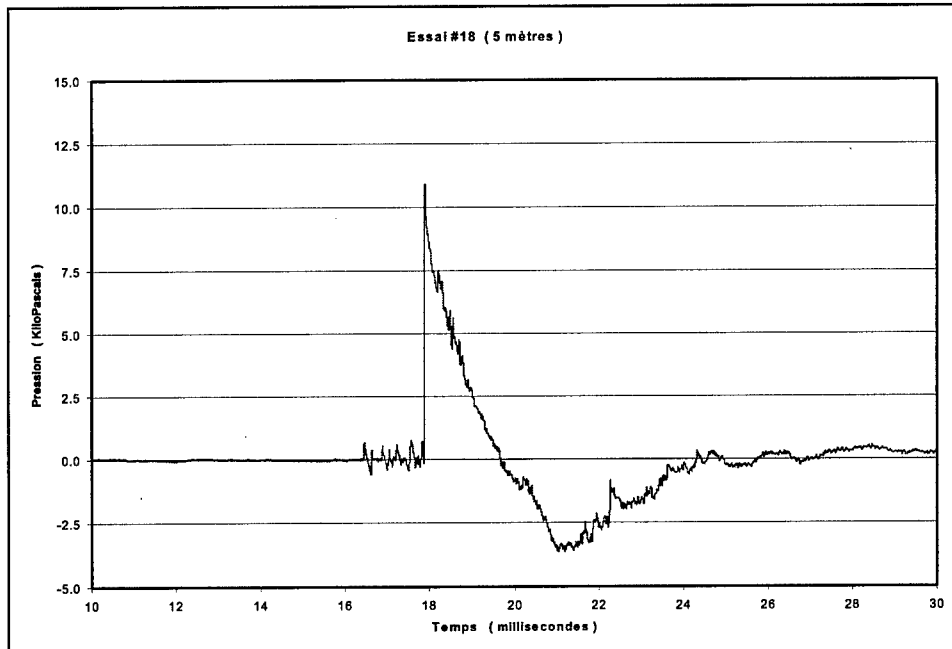

Trial 18, Pressure (kPa) vs. Time (ms) at 5 m, PMA-2 landmine + 20 g C4 (High-Order detonation)

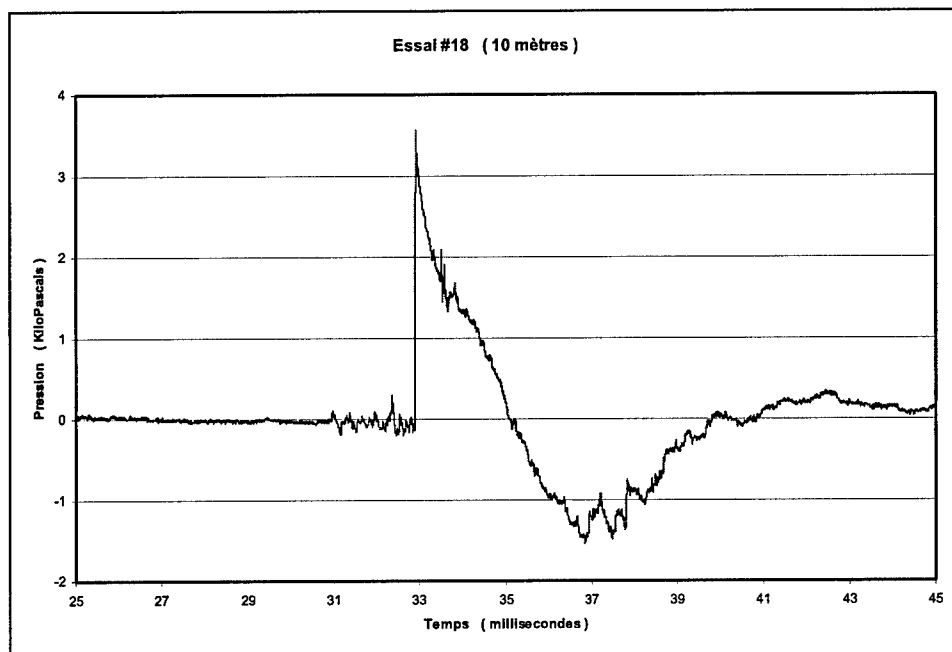

Trial 18, Pressure (kPa) vs. Time (ms) at 10 m, PMA-2 landmine + 20 g C4 (High-Order detonation)

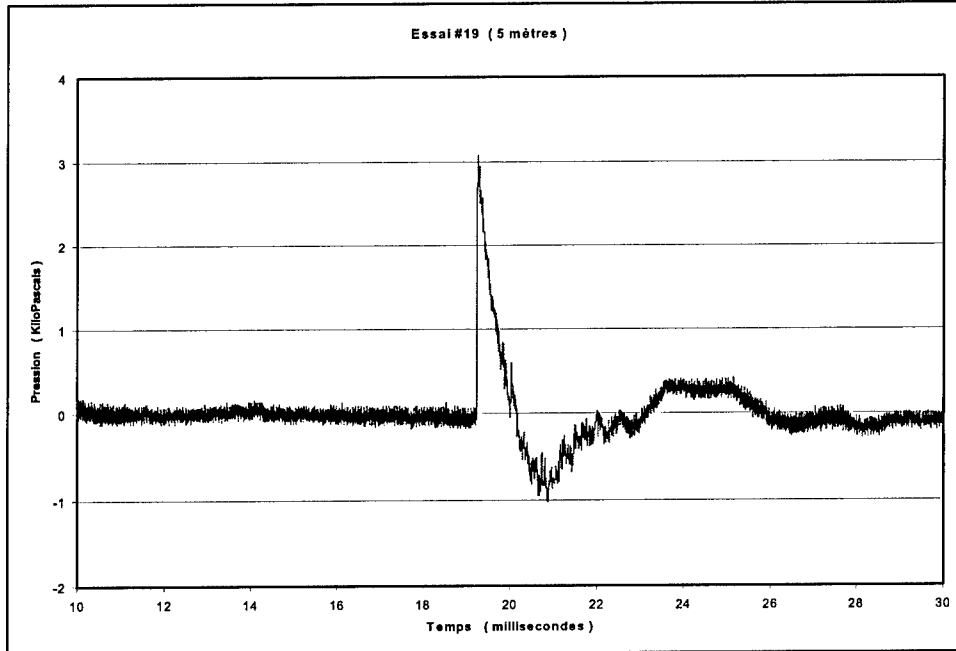

Trial 19, Pressure (kPa) vs. Time (ms) at 5 m, PMA-2 landmine + 5 g C4 (Low-Order detonation)

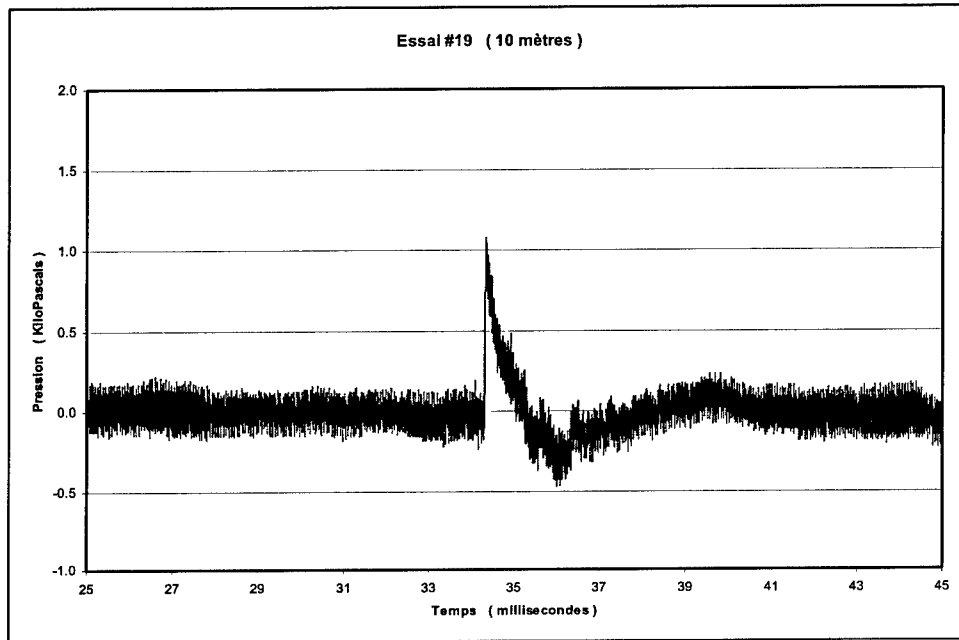

Trial 19, Pressure (kPa) vs. Time (ms) at 10 m, PMA-2 landmine + 5 g C4 (Low-Order detonation)

# 5 Controlled Low-Order Detonations

---

## Introduction

### Background

Creation of low-order detonations has special application where disposal of munitions by blow-in-place demolition requires consideration of the safety of personnel or of the integrity of nearby property. A previous Naval Explosives Ordnance Disposal Technical Division (NAVEOD TECHDIV) program, Developmental Testing of the Main Charge Disruptor (MCD), was designed to reduce the hazard of removing such munitions by developed methods to detonate the munitions without releasing maximum energy. Testing was performed with the MCD against pipe bombs and projectile munitions in June 1997 (Baker et al. 1997). Phase A involved testing of the MCD tool against Mk 80 series and penetrator bombs (Blankenbiller 1999). Additional testing was performed in November 1999 with the MCD tool against more Mk 80 series bombs (Gill 1999).

In May 2000, three MCD candidates were tested against a variety of simulated unexploded ordnance (UXO) containing Tritonal, PBXN-109, Composition H-6, and Composition B (Baker et al. 2000). Included in the list of simulated UXO were the 155-mm, 105-mm, and 8-in. projectile. The MCD tool, chosen from testing in May 2000, demonstrated the ability to achieve various yields based on placement and explosive loading of the tool. Hence, the MCD tool was chosen as the candidate for this project (CP 1155) testing to provide controlled yields for low-order detonations.

For CP 1155 studies of explosives residues from low-order detonations, the techniques developed by NAVOED were applied to two specific munitions, 81-mm mortars and 155-mm artillery projectiles, to produce residues consistent with those found in the field when these munitions have failed to function as designed. Evidence of low-order detonations, such as broken casings, has been reported elsewhere in this report and in our previous reports (Pennington et al. 2001, 2002).

Low-order detonations from fired ordnance generally occur as a result of a malfunction in the fuze train, booster, or main charge. Additionally, low-order

reactions of UXO on ranges can occur due to impacts by high-order fragments, which in turn cause sympathetic low-order detonations. In a low-order detonation, consumption of the explosive filler is less than 100 percent. Aside from physical inspection for unreacted explosive, a low-order detonation can be characterized by increased burn time, light intensity, and over pressure. Any unreacted explosive is generally jettisoned to the surrounding environment as the containment vessel breaks apart from explosive forces. A low-order reaction may also cause part of the explosive to melt or to be consumed through combustion rather than through detonation. Unreacted explosive is released if it is not consumed in the fireball. The amount of unreacted explosive is likely to be a function of the energy yield of the detonation, the overall size of the detonation, and the intensity and burn time of the fireball. The purpose of the low-order detonation tests described in this study was to establish a relationship between burn time, light intensity, and over-pressure measurements and the quantity and characteristics of explosives residues.

## Objectives

Specific objectives of this study were the following:

- Produce 25-, 50-, and 75-percent yields from 81-mm mortars, and 155-mm projectiles using the MCD tool.
- Collect the following data using instrumentation:
  - Impulse pressure
  - Light and temperature using a five-channel radiometer
  - Light using a Total Light Radiation (TLR) unit
  - Peak pressure
- Collect explosive residue samples from the tarp, witness plates, and steel table to determine total quantity, particle size distribution, and chemical composition.

## Materials and Methods

### Physical test system

The physical test system consisted of a 3.81-cm (1.5-in.) -thick steel table raised to a height of 68.58 cm (27 in.) on a platform of 15.24- × 15.24-cm (6- × 6-in.) timbers (Figure 5-1 and Appendix A, Chapter 5). Four cylindrical solid steel columns, blast shadow poles, 15.24 cm (6 in.) in diameter, were spaced 90 deg apart on the table. The blast shadow poles served to protect instrumentation from the fragments being thrown off from the detonations. The test system also included a white 15.24- × 15.24-m (50- × 50-ft) vinyl flame resistant tarp, 40 aluminum witness plates to collect samples of explosive residue, and an earth-covered bunker for protection of instruments and personnel (Figure 5-1).

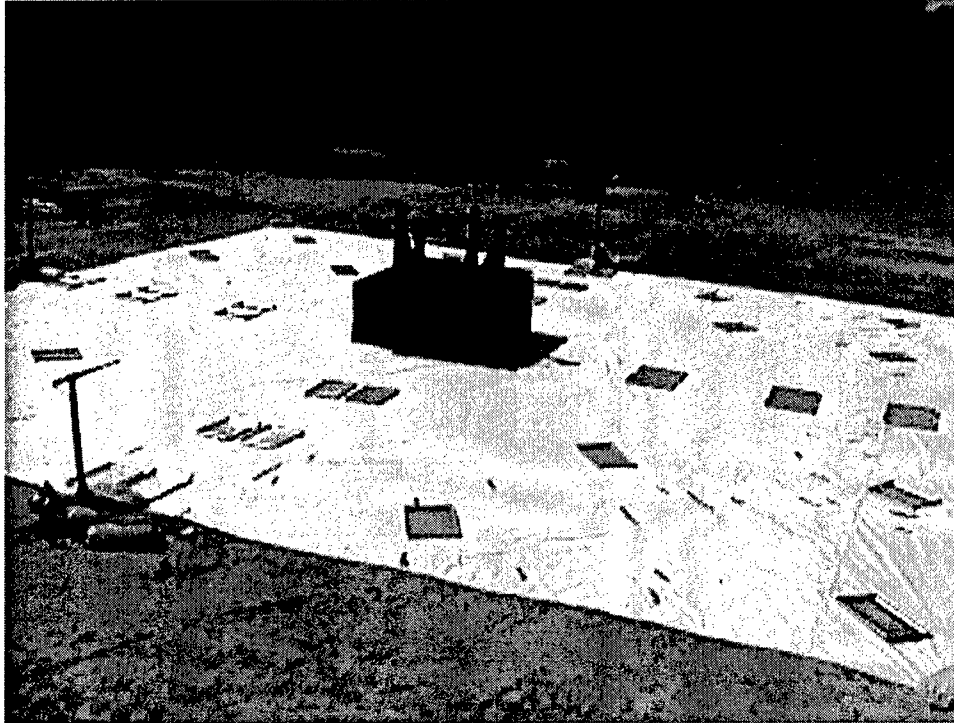

Figure 5-1. Setup of the system with witness plates, tarp, and pressure gauges

### Explosives test system

**MCD tool.** The tripod-mounted MCD tool consisted of an aluminum cylinder, 4.62 cm in diameter, containing a copper liner with a nylon attenuator in one end (Figure 5-2). Additional plastic attenuators were added to slow the velocity of the penetrator, thus reducing the energy being imparted into the ordnance item. To change the energy of the penetrator, C4 in various quantities (56.7 to 226.8 g) was hand packed into the aluminum cylinder. An exploding bridgewire (EBW) was inserted into the C4 to initiate the detonation of the MCD tool (Figure 5-2). To hold the EBW in place at the appropriate standoff distance (Figure 5-3 and Table 5-1), a foam insert with a hole in the center for the EBW was inserted into the aluminum cylinder. High-speed video indicates that the aluminum cylinder (143 g) fragments upon initiation, potentially add mass to the residue collected from the ordnance item.

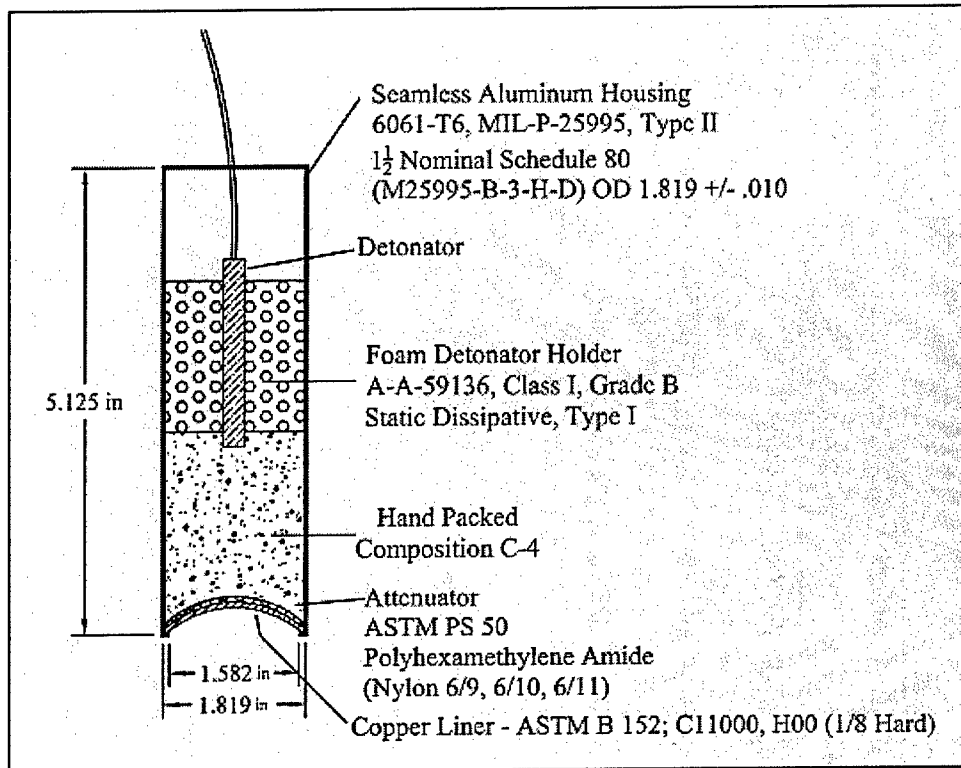

Figure 5-2. Assembly drawing of the MCD tool with material callouts  
(www.astm.org)

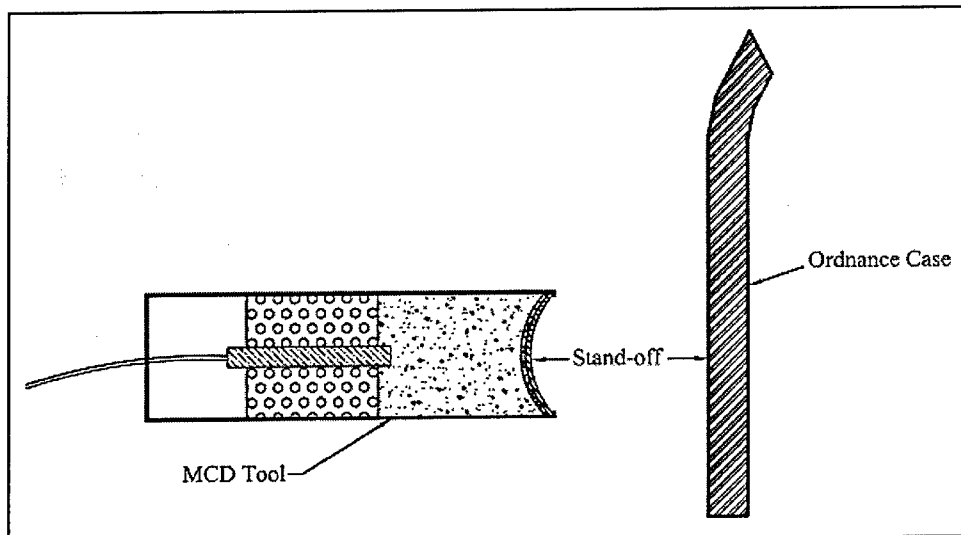

Figure 5-3. Diagram defining standoff distance as noted in Table 5-1

**Table 5-1  
Summary of Test Setup and Yield Calculations**

Test Number	Ordnance	Number of Attenuators	Stand-off Distance, in.	Stand-off Distance, cm	Angle from Horizontal, deg	Distance from Base of Fuze, in.	C4 Used in MCD <sup>1</sup> , oz	C4 Used in MCD, g	Intended Yield, %	Calculated Yield, %
1	81-mm <sup>2</sup>	1	0.5	1.27	0	3	4	113.4	100	118
2	81-mm	1	1.0	2.54	Unrecorded <sup>3</sup>	3	6	170.1	75	19.5
3	81-mm	1	1.0	2.54	45	3	6	170.1	75	56.7
4	81-mm	1	0.5	1.27	45	3	6	170.1	75	24.9
5	81-mm	1	0.5	1.27	60	3	6	170.1	75	32.4
6	81-mm	No MCD	C4 in fuse well				2	56.7	100	100.0
7	81-mm	3	0.3125	0.79	40	3	2	56.7	25	4.9
8	81-mm	3	0.3125	0.79	40	3	2	56.7	25	23.0
9	81-mm	2	0.3125	0.79	40	3	2	56.7	25	17.3
10	MCD	None	None	NA <sup>4</sup>	None	None	6	170.1	100	NA
11	MCD	None	None	NA	None	None	2	56.7	100	NA
12 <sup>5</sup>	155-mm <sup>6</sup>	0	6.0	15.24	Unrecorded	8.5	8	226.8	25	NA
13	C4 Sphere	None	None	NA	None	None	6	170.1	100	NA
14	C4 Sphere	None	None	NA	None	None	6	170.1	100	NA
15	155-mm	0	6.0	15.24	50	8.5	8	226.8	25	27.1
16	155-mm	0	0.75	1.91	Unrecorded	8.5	8	226.8	75	35.3
17	Fragment <sup>7</sup>	0	0.5	1.27	Unrecorded	NA	8	226.8	NA	NA
18	155-mm	0	0.625	1.59	Unrecorded	8.5	8	226.8	75	46.7
19	155-mm	0	0.5	1.27	Unrecorded	8.5	8	226.8	75	23.0
20	155-mm	No MCD	C4 in fuse well				6	170.1	100	100.0
21	155-mm	0	0.625	1.59	Unrecorded	8.5	8	226.8	75	36.6

<sup>1</sup> Main Charge Disruptor (MCD) used to break the case of the ordnance and initiate a reaction.

<sup>2</sup> The 81-mm is the M821 mortar.

<sup>3</sup> Data were not recorded during test.

<sup>4</sup> Not applicable.

<sup>5</sup> Premature detonation precluded data acquisition.

<sup>6</sup> The 155-mm is the M107 artillery projectile.

<sup>7</sup> A metal casing fragment with 0.5-in. wall thickness was used in this test.

Variable numbers of attenuators were used to influence the formation and velocity of the penetrator. The attenuators were manufactured from nylon plastic and were shaped to cover the top surface of the liner. Attenuators were bonded to the liner surface using contact cement to eliminate air gaps from the system. Each attenuator weighed approximately 2 g.

The liner was comprised of a copper disk (99 percent copper) and a nylon pad, which was bonded to the top of the copper disk with contact cement. The purpose of the nylon pad was to more evenly distribute shock loads over the surface area of the copper liner, to aid in consistent penetrator formation. The mass contributed from the liner and pad was 22.1 g. The amount of C4 used for any given experiment varied with the desired yield.

**Munitions.** The two types of munitions tested were 81-mm mortars (M821 with 726.00 g of Composition B filler), and 155-mm artillery projectiles (M107 with 6.6 kg of TNT filler) (Appendix B, Chapter 5, Figures B1 and B2, respectively). The 81-mm mortar used an empty fuze to fill the fuze well, and the 155-mm projectile used a lifting lug to act as an inert fuze in its fuze well. The 81-mm mortar had a tetryl booster against the main Composition B charge. The mass of the tetryl booster in the M821 mortar is believed to be 22 g. However, the mass was taken from information on 81-mm mortars other than the ones tested. No specifications directly correlated to the M821, and the content of tetryl were available. The tetryl booster was present in all tests against the M821, 81-mm mortar. The 155-mm projectiles contained only TNT. No booster was present in the detonation of the 155-mm projectiles.

## Instrumentation

The instrumentation consisted of the following (See Appendix C, Chapter 5, for specifications):

- Four pressure transducers, model 137M25 pressure gauges (PCB Piezotronics, Inc., Depew, New York) spaced 90 deg apart in line with the steel columns on the table to protect the gauges from fragmentation damage;
- Five-channel radiometer (Applied Research Associates (ARA), Littleton, CO) to collect light and temperature data;
- Total Light Radiation (TLR) unit;
- Infrared (IR) unit (ARA) and;
- HSV-500C<sup>3</sup> digital high-speed color video system (NAC Image Technology, Simi Valley, CA) operating at 500 ft per sec.
- 16-channel analog to digital converter set to acquire data at 0.5 mega-samples per second for capturing the pressure and light data for each event.



## Detonations

All instrumentation for data acquisition, as well as instrumentation triggers and the firing system were checked for performance prior to positioning and configuring each munition test item. New fiber-optic cables were installed on the range before each set of tests to act as the trigger for velocity data acquisition. The Range Safety Officer (RSO) set up each test. Test parameters were documented, and photos were taken prior to each detonation. The 81-mm mortars were retrieved from storage by the RSO who prepared the mortar by inserting an inert fuze into the fuze well for the low-order detonation, or, by placing 113.4 g of C4 in the fuze well to produce a high-order detonation. The mortar was strapped to a wooden support to maintain vertical orientation on the mortar base. The MCD tool, which was mounted on a plastic tripod, consisted of an aluminum cylinder, hand packed with various amounts of C4 (Table 5-1). Preparation of the 155-mm projectiles was similar to procedures for the 81-mm mortars except that a lifting lug was screwed into the fuze well instead of an inert fuze during low-order testing. For the high-order detonations, the fuze well was packed with 170 g of C4 to initiate the TNT charge. The MCD tool contained 226.8 g of C4.

Prior to placing the EBW into the MCD tool, all personnel, except for the RSO, moved into the bunker. Once the RSO had connected the wiring into the firing system, turned on the high-speed video camera, and all personnel were accounted for in the bunker, charging of the firing system was initiated. Once it was fully charged, countdown and detonation were executed. After detonation, the RSO checked the detonation site for safety. Once the "all clear" was given, range personnel proceeded to collect explosive residues.

## Residue retrieval

The 40 aluminum pans were removed, particulates were brushed into 4-oz amber glass jars and the pans were wiped with cotton balls moistened with acetone to remove fine residues. All samples from the pans were taken to the laboratory for microscopic analyses. Large chunks of explosives were picked up from the tarp and placed into plastic bags. The tarp and table were vacuumed to collect any remaining residue. All residues were weighed. When sampling was complete, holes in the tarp created by fragments of the munition detonation were taped with duct tape to exclude soil from subsequent tests. Any damaged instrumentation and wiring was also replaced or repaired.

## Energy baseline

Before detonation of tests, a bare charge (C4 sphere) was detonated to establish a pressure-time baseline for the instrumentation. The MCD tool used C4 and a liner. Impulse for the bare charge and the MCD tool were calculated by integrating the pressure with respect to time. The ratio between the sphere and MCD tool is known as the casing effect. This ratio allowed for impulse calculations for the various amounts of C4 used in the MCD tool during subsequent tests. The net explosive weight (NEW) TNT equivalent was calculated from the impulse due to the MCD tool and the ordnance item. The

NEW for the MCD tool was calculated by using the case effect data and weight of C4 in the tool. Subtracting the NEW calculated by the measured impulse from the NEW contributed by the MCD tool yielded the NEW due to the ordnance item. Packing 4 oz of C4 into the fuze well and initiating the detonation with EBW achieved a high-order detonation of an 81-mm mortar. The resulting impulse determined from the pressure-time curve represented yield with the casing effect taken into account. A similar detonation with a 155-mm projectile, but using 170 g of C4 and the EBW, gave the yield with casing effect for this projectile. The ratio between the measured impulse and the calculated impulse gave the casing effect for each ordnance item.

## Yield calculations

$I = \text{Impulse}$

$CE = \text{Case Effect}$

$W = \text{Weight of C4 used in MCD tool (Oz)}$

$R_e \text{ for C4} = 1.34 \text{ (TNT Equivalence factor)}$

$$I_{MCD} = \int_0^{700\mu s} p(t)_{MCD} \cdot dt$$

$$I_{Sphere} = \int_0^{700\mu s} p(t)_{sphere} \cdot dt$$

$$CE_{MCD} = \frac{I_{MCD}}{I_{Sphere}}$$

$NEW_{MCD} = W_{baseline}(1 - CE_{MCD})$  (Weight of C4 required to overcome ultimate strength of MCD)

$NEW'_{MCD} = (W - NEW_{MCD})(R_e)$  (TNT equivalent weight)

$$I = \int_0^{700\mu s} p(t)_{MCD+Ord} \cdot dt$$

$$CE_{Ord} = \frac{I_{Ord}}{I_{CONWEP}}$$

$$81mm \text{ } NEW_{TNT} = 0.188479 - 0.983893I + 2.449323I^2 - 0.917770I^3 + 0.192433I^4$$

$$155mm \text{ } NEW_{TNT} = 0.091181 - 0.50624I + 1.554967I^2 - 0.226836I^3 + 0.018263I^4$$

$$NEW'_{81mm} = \frac{81mm \text{ } NEW_{TNT} - NEW'_{MCD}}{CE_{81mm}}$$

$$NEW'_{155mm} = \frac{155mm \text{ } NEW_{TNT} - NEW'_{MCD}}{CE_{155mm}}$$

$$\% \text{ Yield}_{81mm} = \frac{NEW'_{81mm}}{NEW_{81mm}}; \quad \% \text{ Yield}_{155mm} = \frac{NEW'_{155mm}}{NEW_{155mm}}$$

## Test protocols

A total of 21 tests were executed; 14 with 81-mm mortars, and 7 with 155-mm projectiles. The protocols for achieving various percentage yields included varying the following parameters: number of attenuators, standoff distance of the tool to the munition item, angle of the tool from the horizontal, distance of the tool from the base of the fuze, and the amount of C4 used in the tool (Table 5-2).

Adjustments in these parameters were determined after comparing the intended and actual (calculated) yields of each detonation.

Test Number	Calculated Yield, %	Number of Trays	Quadrant	Residue Recovered In Quadrant, g	Residue Recovered on Tarp Outside of Trays, g	Residue Recovered off Tarp, g
12	NA	40	NE	261	9,350	941
15	27.1	40	NW	1,725		65
16	35.3	41	SE	234	233	
18	46.7	42	SE	99		735
19	23.0	42	SE	646		217
			SW	290		
20	100.0	40	S	223		
21	36.6	40	SE	71		2,603

### Assumptions

The following assumptions are inherent in the test system:

- The MCD tool will contribute to the overall yield when detonated.
- The pressure wave from the MCD tool and the ordnance item is directional.
- Explosive yield calculations will account for casing effects from the 81-mm mortars and the 155-mm projectiles. For example, 14.6 lb of bare TNT will produce a greater pressure than 14.6 lb of encased TNT, because energy is required to overcome the ultimate strength of the casing material.
- The pressure wave will flow around the cylindrical columns on the table. Placement of the pressure transducers within  $10 \times D_{\text{shadow pole}}$  (the diameter of the columns) will result in lower pressure readings.
- Light data can be collected using the five-channel radiometer. The ratio between channels will yield the temperature. The average of all ratios will yield an accurate temperature-time history for each event.
- The explosive yield can be calculated using pressure data and then correlated with the calculated temperatures to rapidly assess yield based on temperature. The result will generate a curve correlating temperature with net explosive weight consumed for a given type of ordnance.

## Results and Discussion

### 81-mm mortars

**Test 1.** Test 1 was a calibration detonation for the 81-mm mortar series of tests (Figure 5-4). Therefore, the intended energy yield was 100 percent. Postdetonation observations found no traces of unburned high explosive or large fragments from the case, which suggested that a high-order detonation had been achieved. Only charred wood fragments from the stand supporting the 81-mm mortar were found (Figure 5-4b). Postanalysis of the data indicated that the yield was 118 percent. The extra 18 percent can be attributed to the C4 in the MCD tool.



a. Preshot setup for high-order detonation

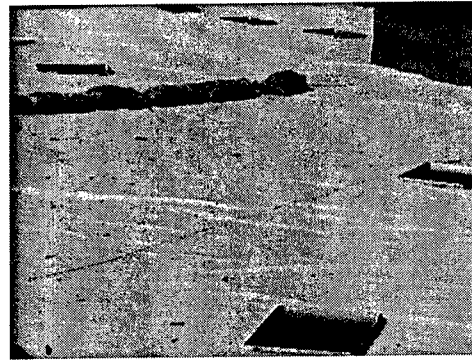

b. Postdetonation observation – Debris is charred wood

Figure 5-4. Test 1

**Test 2.** Test 2 was set up to produce a 75-percent energy yield using the MCD tool (Figure 5-5). Postdetonation observations indicated that the 81-mm mortar had a low-order detonation, based on the size of the casing remnant and the amount of explosive chunks found (Figure 5-5b). Most of the high explosive residue was found on the southern side of the tarp. Chunks were found on and off the tarp (i.e., farther than 24 ft from the blast). Postdetonation analysis showed a 19.5-percent yield.



a. Predetonation setup against 81-mm mortar



b. Large piece of casing found after detonation

Figure 5-5. Test 2

**Test 3.** Test 3 was set up to produce a 75-percent yield using the MCD tool (Figure 5-6). Postdetonation observations indicated that the 81-mm mortar had a low-order detonation, based on finding a large chunk of the fuze assembly remaining intact. However, few large chunks of high explosive were found, indicating a higher-order detonation than achieved in Test 2. A large chunk of high explosive and the fuze assembly were found on the northwest side of the tarp. Postdetonation analysis showed a 56.7-percent yield.

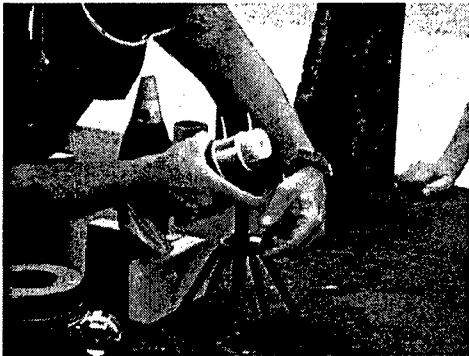

a. Predetonation setup against 81-mm mortar



b. Fuze found after detonation

Figure 5-6. Test 3

**Test 4.** Test 4 was set up to produce a 75-percent yield using the MCD tool (Figure 5-7). Postdetonation observations indicated that the 81-mm mortar had a low-order detonation, based on observation of a 4-in., intact piece of the base. However, no large chunks of high explosive were found. Small, sooty particles were found on the tarp along with a deposit of unburned high explosive on the table. Postdetonation analysis showed a 24.9-percent yield.

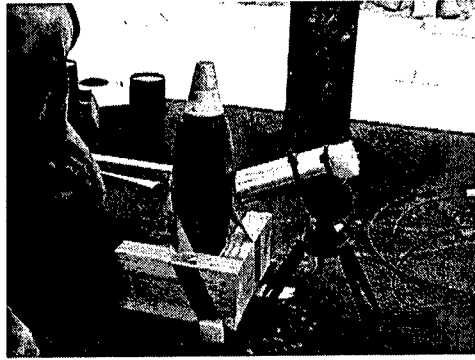

a. Predetonation setup of 81-mm mortar and MCD tool

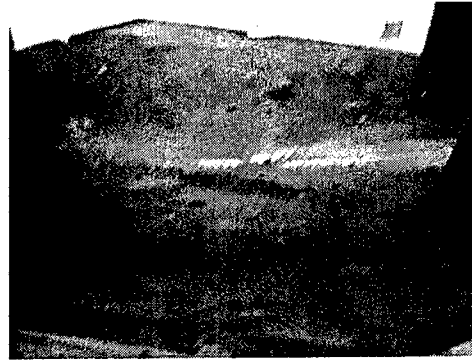

b. Image of high explosive found on table

Figure 5-7. Test 4

**Test 5.** Test 5 was set up to produce a 75-percent yield using the MCD tool (Figure 5-8). Postdetonation observations indicated that the 81-mm mortar had a low-order detonation, based on finding the bottom of the mortar intact. Additionally, large chunks of high explosive were found in the southwest quadrant with smaller chunks elsewhere on the tarp. Postdetonation analysis showed a 32.4-percent yield.



a. Predetonation setup of 81-mm mortar and MCD tool



b. Large chunk of casing found after detonation with high explosive on tarp

Figure 5-8. Test 5

**Test 6.** Test 6 was set up to produce a 100-percent yield using 2 oz of C4 in the fuze well without the MCD tool (Figure 5-9). The 81-mm mortar detonated high order, damaging and moving the steel table slightly. Some small debris was found. Most of the debris was concentrated in the northwest and southeast quadrants of the tarp. Postdetonation analysis showed a 100-percent yield.

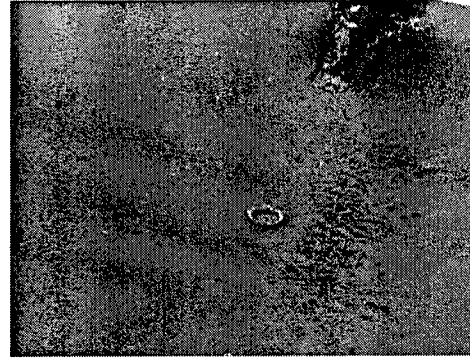
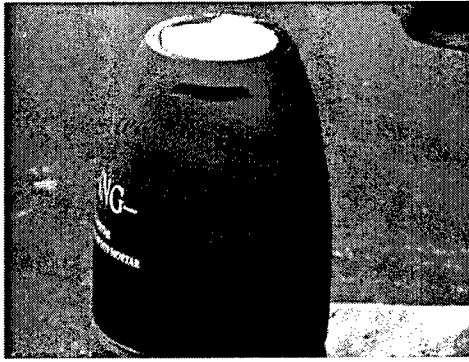

a. Predetonation setup of 81-mm mortar with C4 in fuze well

b. Damage sustained to table from fragments

Figure 5-9. Test 6

**Test 7.** Test 7 was set up to produce a 25-percent yield using the MCD tool (Figure 5-10). Postdetonation observations indicated that the 81-mm mortar had detonated low order, based on finding most of the case intact. Large chunks of high explosive were also found in the northwest quadrant with most of the explosive remaining inside the mortar case. Smaller, sooty particles of explosive were stuck to the witness plates suggesting a slow burn. Postdetonation analysis showed a 4.9-percent yield.

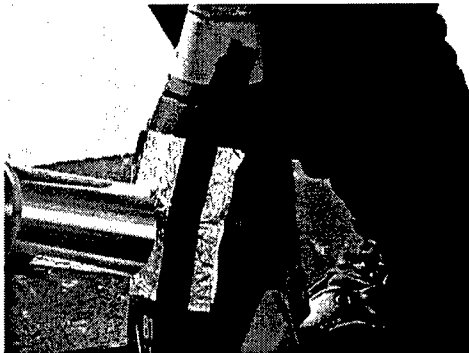

a. Predetonation setup of 81-mm mortar with MCD tool

b. Large amount of high explosive found in casing after detonation

Figure 5-10. Test 7

**Test 8.** Test 8 was set up to produce a 25-percent yield using the MCD tool (Figure 5-11). Postdetonation observations indicated that the 81-mm mortar had detonated low order, based on finding a large chunk of the lower section. No large chunks of high explosive were found on the tarp; although, high explosive was deposited on the table. Postdetonation analysis showed a 23-percent yield.



a. Predetonation setup of 81-mm mortar with MCD tool

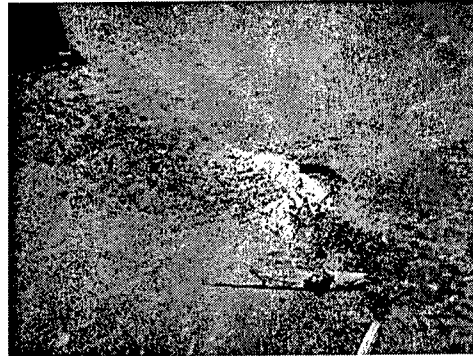

b. Large amount of high explosive found on table after detonation

Figure 5-11. Test 8

**Test 9.** Test 9 was set up to produce a 25-percent yield using the MCD tool (Figure 5-12). Postdetonation observations indicated that the 81-mm mortar had detonated low order, based on finding a chunk of the lower section of the case with explosive still inside. No large chunks of explosive were found on the tarp; although, explosive was deposited on the table. Explosive was also found outside the perimeter of the tarp. Postdetonation analysis showed a 17-percent yield.

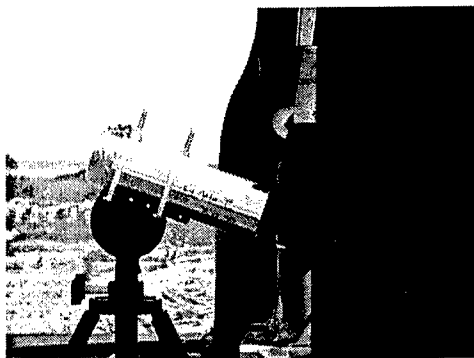

a. Predetonation setup of 81-mm mortar with MCD tool



b. High explosive found in mortar casing after detonation

Figure 5-12. Test 9

**Test 10.** Test 10 was set up to determine the contribution of the MCD to the total impulse from the mortar and MCD (Figure 5-13). To calibrate, the MCD was fired by itself with a 6-oz load of C4 and a copper liner. Pressure data were collected by the instrumentation and used to determine the contribution in terms of NEW using a TNT equivalence factor.



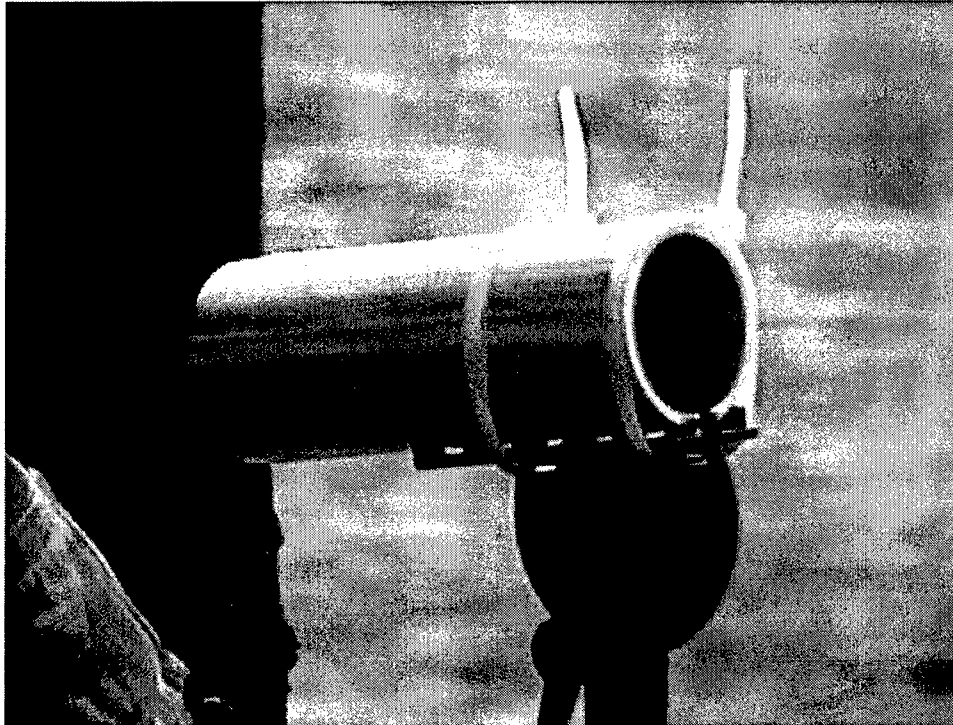
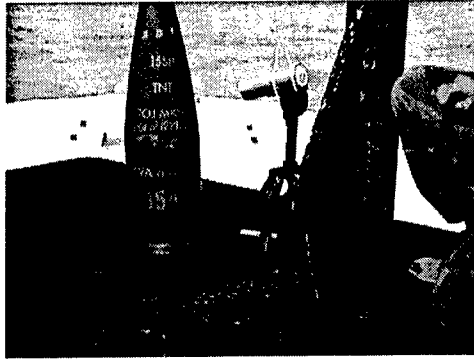

Figure 5-13. MCD tool by itself for calibration shots

**Test 11.** Test 11 was set up to determine the contribution of the MCD to the total impulse from the mortar and MCD (Figure 5-13). To calibrate, the MCD was fired by itself with a 2-oz load of C4 and a copper liner. Pressure data were collected by the instrumentation and used to determine the contribution in terms of NEW using a TNT equivalence factor.

### 155-mm Projectiles

**Test 12.** Test 12 was set up to produce a 25-percent yield using the MCD tool against the 155-mm projectile (Figure 5-14). The firing system initiated the firing train prematurely when charged. Hence, no yield data were collected. Large chunks of explosive were observed north of the detonation point and scattered outside the perimeter of the tarp. Sooty particles were found on the tarp, and the table had a glazing from burned explosive.



a. Predetonation setup of 155-mm projectile with MCD tool



b. High explosive found in projectile casing after detonation

Figure 5-14. Test 12

**Test 13.** Test 13 was another calibration test with a 6-oz C4 sphere (Figure 5-15). The test was set up to define the casing effect for the MCD tool. For example, a sphere of C4 will produce a larger impulse than the same amount of C4 in a case. The reason for the lower impulse is that some of the energy from the detonation goes into breaking the casing. The casing effect has an impact on the final outcome of calculated NEW contributing to the impulse from the ordnance item and MCD tool. For this test, no data were collected due to a premature initiation during charge-up of the firing system.



Figure 5-15. Tests 13 and 14, 6-oz C4 sphere for calibration

**Test 14.** Test 14 was another calibration test with a 6-oz C4 sphere (Figure 5-15). Test 14 was a repeat of Test 13, because no pressure data were collected from Test 13.

**Test 15.** Test 15 was set up to produce a 75-percent yield using the MCD tool against the 155-mm projectile (Figure 5-16). Postdetonation observations indicated that the 155-mm projectile detonated low order, based on finding a chunk of the base with TNT still inside. Large chunks of TNT were found on the tarp, and unburned TNT was found deposited on the northwest corner of the table. Post-Detonation analysis showed a 17.1-percent yield.

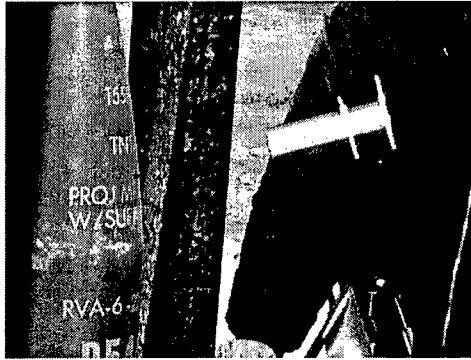

a. Predetonation setup of 155-mm projectile with MCD tool

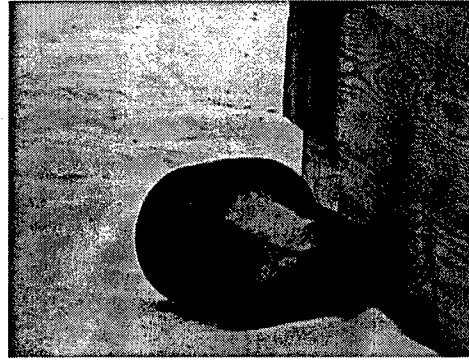

b. High explosive found in projectile casing after detonation



c. Chunk of TNT found on tarp after detonation

Figure 5-16. Test 15

**Test 16.** Test 16 was set up to produce a 75-percent yield using the MCD tool against the 155-mm projectile (Figure 5-17). Postdetonation observations indicated that the projectile detonated low order, based on finding of a chunk of the base with TNT still inside. Inspection of the TNT in the base revealed a pattern of long crystals radiating from the center of the round. Such crystallization suggested slow cooling of the explosive filler when it was poured into the casing. The debris on the tarp was very brittle. Postdetonation analysis showed a 35-percent explosive yield.

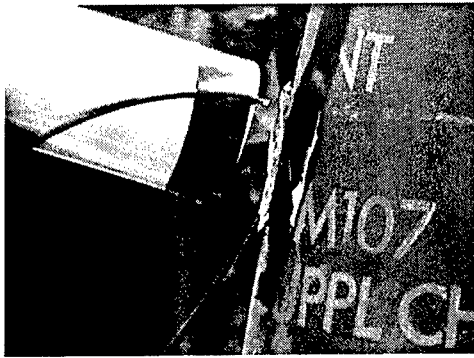

a. Predetonation setup of 155-mm projectile with MCD tool

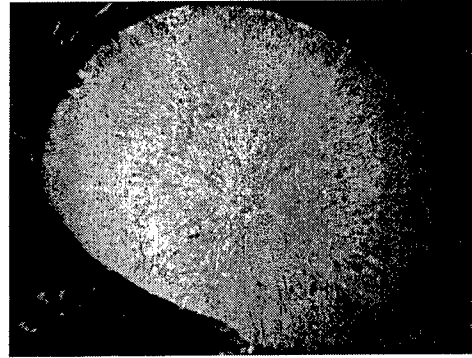

b. High explosive with crystalline pattern found in projectile casing after detonation

Figure 5-17. Test 16

**Test 17.** Test 17 was set up to see what effect the penetrator from the MCD tool had on the ordnance case and yield (Figure 5-18). A fragment from a low-order 155-mm projectile was placed against a sand bag to provide simulated tamping on the back. The MCD tool was set up with a standoff and explosive load similar to that seen in actual testing. After firing, spalling of the metal on the back of the case was observed. No conclusions were drawn with respect to the effect of the spalling on the yield.

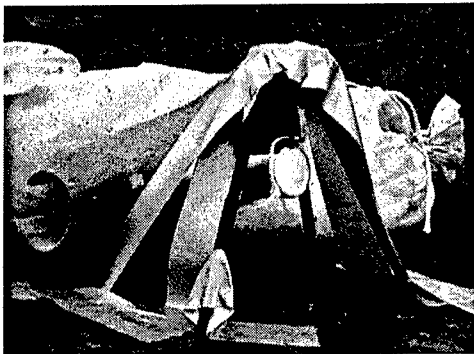

a. Setup of the MCD tool against 1/2-in. piece of fragment against sandbag

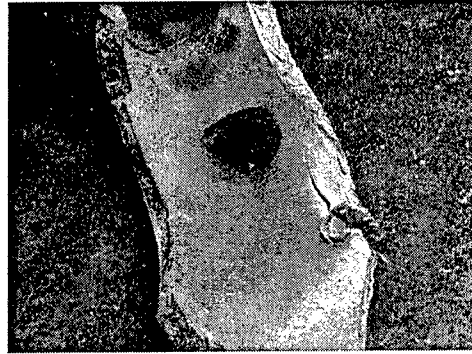

b. Spalling noticed on backside of fragment

Figure 5-18. Test 17

**Test 18.** Test 18 was set up to produce a 75-percent yield using the MCD tool against the 155-mm projectile (Figure 5-19). Postdetonation observations indicated that the projectile had detonated low order, based on finding of a chunk of the casing with TNT still inside. Large chunks of high explosive were found just outside the perimeter of the tarp south/southeast of the table. Most of the explosive debris was located in the southeast quadrant and was finely ground. Inspection of the casing gave no indication of how the projectile had been penetrated (i.e., whether spalling occurred). Characteristics of the penetration may provide insights into initiation of the explosive by shock and heat or just heat. Postdetonation analysis showed a 48-percent yield.



a. Predetonation setup of 155-mm projectile with MCD tool



b. High explosive found in projectile casing after detonation

Figure 5-19. Test 18

**Test 19.** Test 19 was set up to produce a 75-percent yield using the MCD tool against the 155-mm projectile (Figure 5-20). Postdetonation observations indicated that the projectile detonated low order, based on finding a chunk of the casing with TNT still inside. A large amount of finely ground explosive was found on the tarp. This material and the residue remaining in the base of the projectile were similar in crystalline structure to the explosive found from Test 16. Small pieces of high explosive were also found outside the perimeter of the tarp. Postdetonation analysis showed a 23-percent yield.

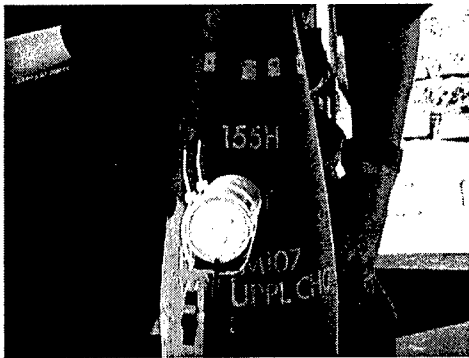

a. Predetonation setup of 155-mm projectile with MCD tool



b. High explosive found in projectile casing after detonation

Figure 5-20. Test 19

**Test 20.** Test 20 was set up to produce a 100-percent yield (high-order detonation) with 6-oz of C4 packed into the fuze well (Figure 5-21). Postdetonation observations indicated that the 155-mm projectile had detonated high order, based on finding no large fragments or unburned explosive residue but finding cracked table welds.

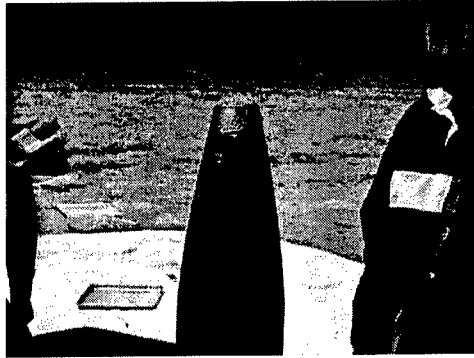

a. Predetonation setup of 155-mm projectile with C4 in fuze well

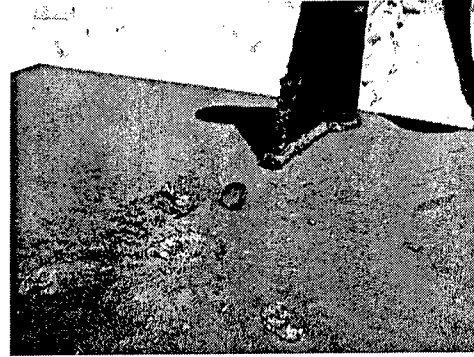

b. Picture shows cracked weld at the shadow pole

Figure 5-21. Test 20

**Test 21.** Test 21 was set up to produce a 75-percent yield using the MCD tool against the 155-mm projectile (Figure 5-22). Postdetonation observations indicated that the 155-mm projectile had detonated low order, based on finding a chunk of the casing. High-speed video showed large amounts of explosive being jettisoned from the case during the blast. Most of the explosive residues were collected from the southeast quadrant. Postdetonation analysis showed a 37-percent yield.

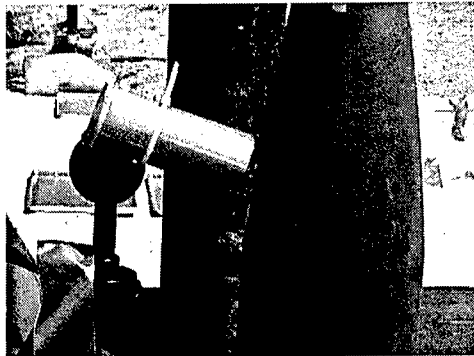

a. Predetonation setup of 155-mm projectile with MCD tool

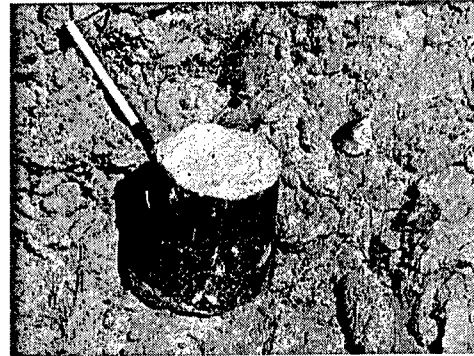

b. High explosive jettisoned from base of casing

Figure 5-22. Test 21

### Achievement of intended yields

Yields from low-order detonations were consistently lower than intended. In fact, calculated yields averaged  $28.95 \pm 13.78$  percent (mean  $\pm$  standard deviation,  $n = 12$ ), regardless of the type of round or the intended yield. These results suggest that the procedures consistently produced low-order detonations, but in an unpredictable lower range. The highest yield achieved for the 81-mm mortars was 56.7 percent; for the 155-mm projectiles the highest yield was 46.7. Apparently, yields between roughly 30 percent and high order are difficult to achieve. Yields intended to attain 25 percent were closer to the goal than yields intended to attain 75 percent. The mean calculated yield for the detonations

intended to generate 25 percent yields was  $18.1 \pm 9.7$  percent ( $n = 4$ ); the mean calculated yield for the detonations intended to generate 75 percent yields was only  $34.4 \pm 12.5$  percent ( $n = 8$ ).

Reexamination of the controllable variables, i.e., those presented in Table 5-2, resulted in the following recommendations for improving intended yields in future tests.

- Move the pressure transducers closer to the detonation center to improve the resolution of the instrumentation at the low measured pressures.
- Optimize the standoff distance of the MCD tool to capture the appropriate formation time of the penetrator. The liner, a copper cone in the front of the MCD tool, which functions by impacting the case of the munition to cause detonation, is predicted to invaginate and thrust into the munition case at approximately 2 times the diameter of the liner. Since the liner measures 3.81 cm (1.5 in.) in diameter, full formation can be expected to take place at approximately 7.62 cm (3 in.). In most of the shots, the MCD tool was either too close to the munition (0.762 to 1.27 cm (0.3 to 0.5 in.)) or too far away (15.24 cm (6 in.)).
- Use smaller-shaped charges against smaller ordnance items (e.g., the 81-mm mortars) to reduce the contribution of the tool to the detonation of the main charge. The yield is more likely influenced by the way the case is penetrated (i.e., the size of the vent hole created along with the velocity of the jet/penetrator) than by the quantity of explosive contributed by the tool. Therefore, factoring out the contribution of a relatively smaller tool will optimize interpretation of the yield from the munition.
- Use a larger tarp to increase the recovery of explosive residues.

## Residues

Obtaining accurate weights of explosives residues recovered from the pans and the tarp was encumbered by the presence of debris from the wooden brace used to support the munition in an upright position and debris from the plastic tripod used to support the tool. Fragments of the aluminum tool and of the casing material from the munition item were also common. Furthermore, soil was thrown onto the pans and tarp from fragments of the munitions or from tears in the tarp. Loss of significant explosive mass beyond the confines of the tarp was apparent. Large chunks were retrieved by hand, but smaller fragments and "dusty" residues of fine material off the tarp were lost. Therefore, cumulative weights of residues were not readily correlated with calculated yields (Table 5-2).

## Conclusions

Controlling the percent energy yield of low-order detonations of 81-mm mortars and 155-mm artillery projectiles proved difficult. However, adjustments in specific variables based on results of these tests should improve control for future detonations. Recovery of explosive residues was also problematic. Residues were thrown beyond the tarp indicating a need for expanded coverage, i.e., a larger tarp. Direction of residue propagation proved too unpredictable to justify relying on witness plates (aluminum pans) to produce representative samples. Therefore, future tests will rely on recovery of all residues on the tarp and retrieval by hand of larger chunks that fall beyond the larger tarp. A focus of future tests will be achieving detonation in the 75-percent yield level and improving recoveries of explosive residue.

## References

- Baker, P., Randers-Pehrson, G., Benjamin, K., and Serrano, D. (1997). "Characterization, modeling, and testing of the Baldrick and Naval Surface Warfare Center (NSWC) explosively formed penetrators (EFPs) Main Charge Disruptor (MCD) candidates," ARL-TR-1363, Army Research Laboratory, Aberdeen Proving Ground, MD.
- Baker, P., Stegall, S., Canami, A., Slack, W., and Boyd, W.H. Jr. (2000). "The effect of case strength, path length, and main charge explosive type on the performance of three main charge disruptor candidates," ARL-TR-2193, Army Research Laboratory, Aberdeen Proving Ground, MD.
- Blankenbiller, D. C. (1999). "Final report for the Phase IIA Developmental Test Series (DT-IIA) of the Main Charge Disruptor (MCD)," ATC-8163, U.S. Army Aberdeen Test Center, Aberdeen Proving Ground, MD.
- Gill, D. (1999). "Developmental Testing (DT-IIB): Container, Main Charge Disruptor (MCD) EX 788 Mod 0," NAVIODTECHDIV Technical Note TN-474, Naval Explosive Ordnance Disposal Technology Division, Indian Head, MD.
- Pennington, J. C., Jenkins, T. F., Brannon, J. M., Lynch, J., Ranney, T. A., Berry, T. E., Jr., Hayes, C. A., Miyares, P. H., Walsh, M. E., Hewitt, A. D., Perron, N., and Delfino, J. J. (2001). "Distribution and fate of energetics on DoD test and training ranges: Interim Report 1," ERDC TR-01-13, U. S. Army Engineer Research and Development Center, Environmental Laboratory, Vicksburg, MS.
- Pennington, J. C., Jenkins, T., Ampleman, G., Thiboutot, S., Brannon, J. M., Lynch, J., Ranney, T. A., Stark, J. A., Walsh, M. E., Lewis, J., Hayes, C. A., Mirecki, J. E., Hewitt, A. D., Perron, N., Lambert, D., Clausen, J., and Delfino, J. J. (2002). "Distribution and fate of energetics on DoD test and training ranges: Interim Report 2," ERDC/EL TR-02-8, U. S. Army Engineer Research and Development Center, Environmental Laboratory, Vicksburg, MS.



## Appendix A — Diagrams of Table and Base

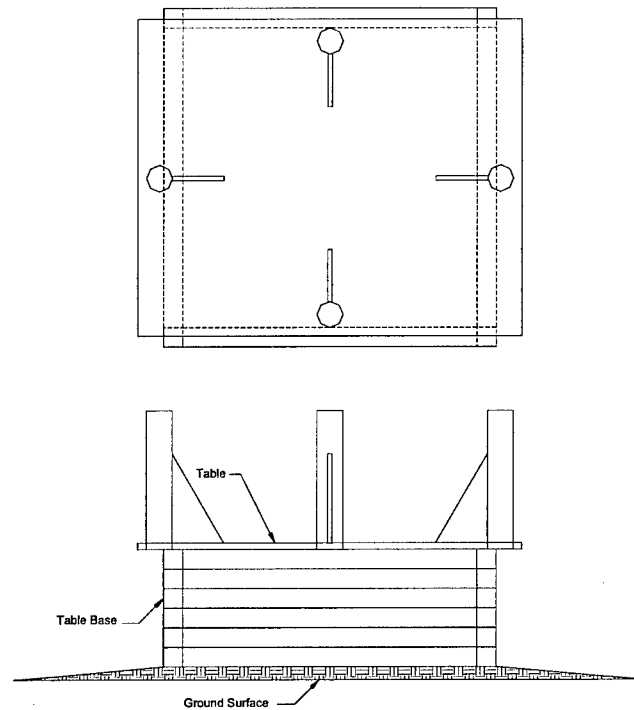

Figure A-1. Assembly drawing of base and table

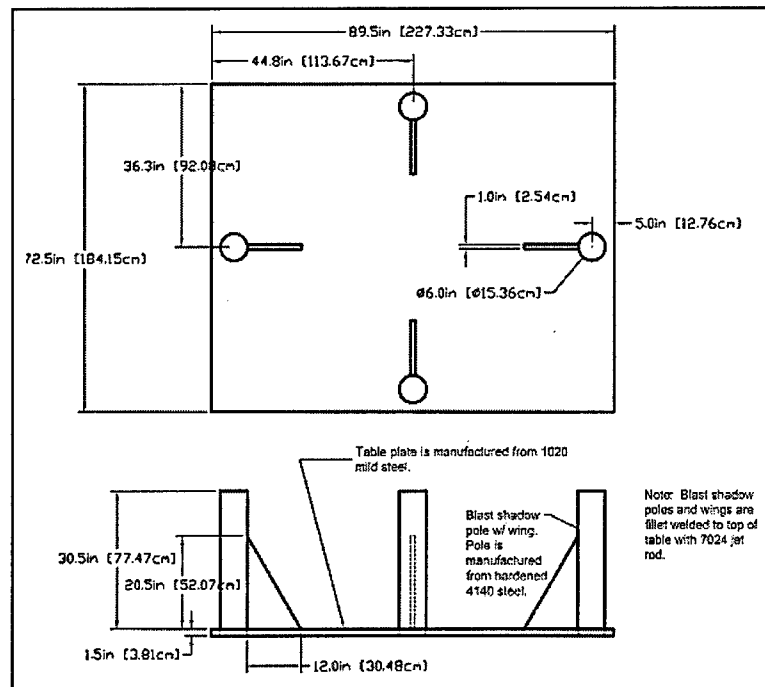

Figure A-2. Top and side view of table

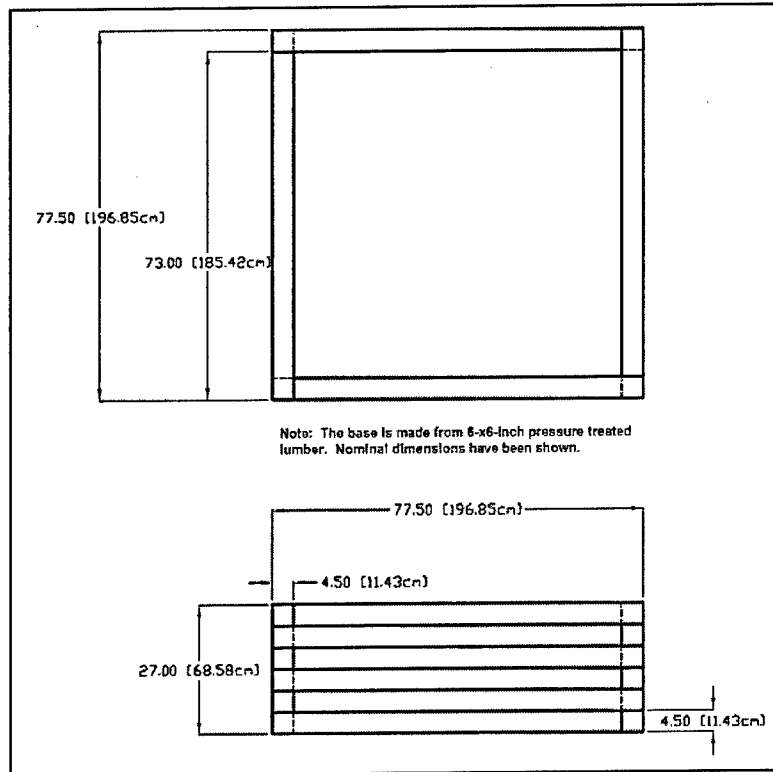
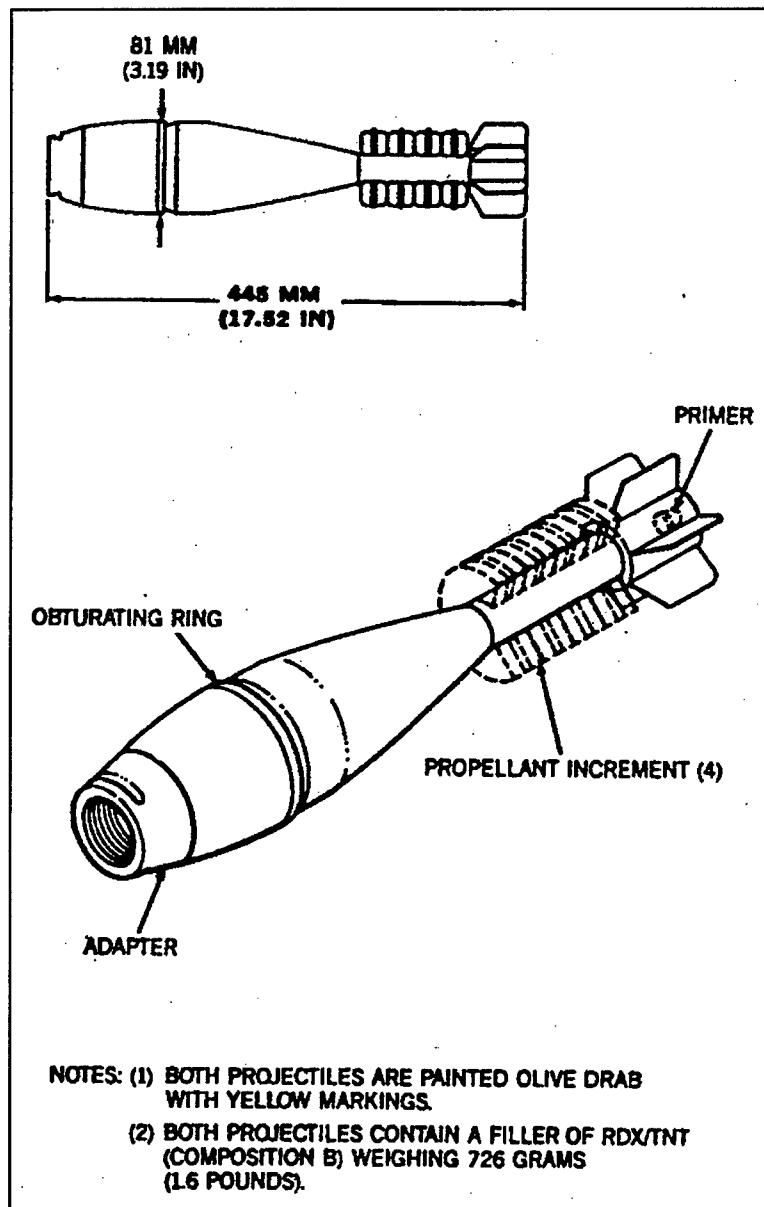

Figure A-3. Top and side view of base

## Appendix B — Ordnance Descriptions



Diameter	81.00 mm
Length	445.00 mm
Weight	42.91 kg
Explosive Type	Composition B
Net Explosive Weight	726.00 g

Figure B-1. Description of 81-mm mortar taken from ORDATA II database

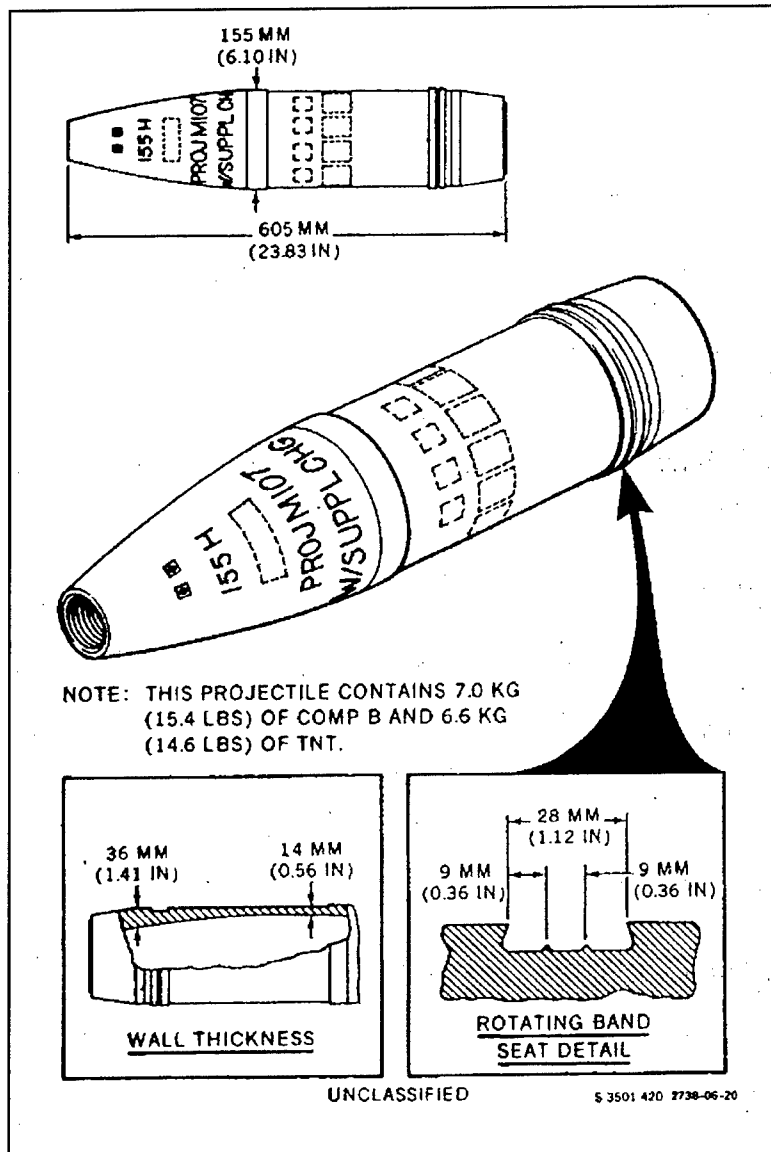

Diameter	155.00 mm
Length	605.00 mm
Weight	42.91 kg
Explosive Type	TNT
Net Explosive Weight	6.62 kg

Figure B-2. Description of 155-mm projectile taken from ORDATA II database

## Appendix C — Instrumentation Specifications

<b>Table C1 PCB Piezotronics Model 137M25 Pressure Transducer</b>		
	<b>Units</b>	<b>Value</b>
Dynamic Range (+/- 5V)	Psi [kPa]	250 [1,724]
Useful Overrange	Psi [kPa]	500 [3,448]
Resolution	Psi [kPa]	0.005 [0.034]
Linearity	percent FS	< 2.0
Rise Time (reflected)	$\mu$ sec	4
Sensitivity (+/- 10 percent)	mV/psi [mV/kPa]	20 [2.90]

<b>Table C2 5-Channel Radiometer</b>	
Wavelengths of Measured Light (nm)	550, 656, 855, 1055, 1550
Frequency Response Time	5 $\mu$ s
Bandwidth	10 nm

<b>Table C3 IR Detector</b>	
Wavelengths Measured	0.001 to 1000 microns
Response Time	100 $\mu$ s
Sensitivity vs. Wavelength Curve	Flat from .3 to 60 microns

<b>Table C4 TLR Detector</b>	
Sensitive Spectrum	400 to 1100 nm
Response Time	1 $\mu$ s

<b>Table C5 Data Acquisition System</b>	
Channels	16 Analog to Digital
Sample Rates	Up to 5 Mega-samples per second
Max number of samples per channel	512k
Sampling rate used	0.5 Mega-samples persecond

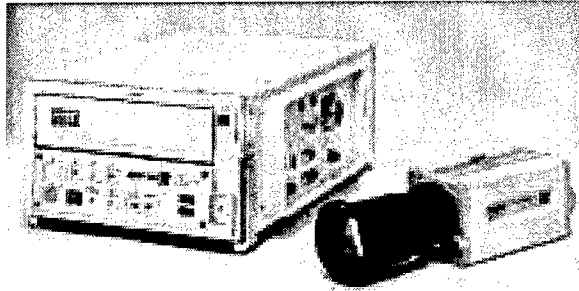

Figure C-1. NAC-500 camera and VCR

<b>Table C6 NAC-500 Camera and VCR Components</b>	
<b>C<sup>3</sup> High Speed Color Camera</b>	
Sensitivity	2500 lux @ 250 fps, F4
Shutter	Electronic: 1/500 – 1/10,000
Dimensions	76w × 77h × 142d mm
Cable Length	5,10,25, and 50 meters to VCR processor
<b>C<sup>3</sup> Lens</b>	
View Angle	(HxV); 47.1 × 36.2 – 5 × 3.7 degree
Work Distance	Minimum 1 m
<b>HSV-500 C<sup>3</sup> High Speed VCR</b>	
Recording Method	Tape (Super VHS)
Recording Time	43 minutes (ST-180 tape)
Video Output	NTSC and PAL Composite, Y/C Signal
Dimensions	246w × 137h × 343d mm
Display Indicators	Counter, Replay, Speed
<b>Power Requirements</b>	
Input Voltage	12-32 VDC
Power Consumption	70 Watts (including camera)

# 6 Fate and Transport Parameters

---

## Introduction

### Background

The main factors affecting fate and transport of explosives residues after they dissolve from the solid phase are adsorption, transformation and irreversible soil binding (Brannon and Myers (1997)). Anticipating the movement of explosives residues through soils and into groundwater requires the following fate and transport process descriptors: adsorption coefficients and transformation rate coefficients. Process descriptors mathematically depict the impacts of interactions between soil and water on explosives concentrations in both media. The *adsorption coefficient* is a mathematical expression that describes the distribution of a chemical compound between soil and water when the distribution is at equilibrium. When transformation or irreversible sorption is significant, equilibrium is not attained and the transformation rate coefficient is used to describe the fate and transport of an explosive contaminant. The *transformation rate coefficient* is a kinetic parameter that describes the removal of a compound from solution by biotic/abiotic transformation. The transformation rate coefficients generally follow first-order kinetics (Brannon and Myers 1997). The amount of available data on fate and transport process descriptors for explosives residues varies greatly. Most studies have been directed toward TNT and its transformation products, RDX, and to a lesser extent, HMX.

This chapter reports development of environmental fate and transport parameters for selected energetic residuals for pentaerythritol tetranitrate (PETN) and n-methyl-n, 2,4,6-tetranitroaniline (tetryl). Transport process descriptors had not been defined for these compounds. Fate and transport parameters are used to evaluate the migration of explosives residues from the solid phase into solution during rainfall events (dissolution kinetics) and the interactions of explosives residues in solution with firing range soils that then occur. This chapter presents new process data obtained in project CP1155 leveraged with data obtained in the Army Installation Restoration Research Program (IRRP) work unit titled "Fate and Transport of Explosives Contaminants" (Project Number A835/309E/RE004), which provided 90 percent of the funding for this effort.

## Objectives

The primary objective of this study was to determine process descriptors for selected explosives residues for which data are lacking. Fate and transport process parameters were determined for Tetryl and PETN. A secondary object was to determine site-specific process descriptors for TNT, RDX, and HMX in soils from Yakima Training Center, Washington, and Camp Guernsey, Wyoming, two sites where soils on live-fire training ranges were characterized earlier in this study.

## Materials and Methods

### Transformation kinetics of PETN and tetryl

An aquifer soil, LAAP D, and three surface soils with different physical characteristics, Yokena Clay, Grange Hall, and Picatinny, were used to measure transformation kinetics (Table 6-1). The tests were conducted under nitrogen in a glove box to simulate anaerobic aquifer conditions. Sufficient soil (4 g) and distilled, deionized, deoxygenated water (16 mls) were added to 25-ml glass centrifuge tubes to make a soil-to-water ratio of 1:4. For PETN testing, the distilled water added to the soil contained 3 mg/l<sup>-1</sup> PETN for LAAP D, Yokena Clay, and Picatinny, and 3.29 mg/l<sup>-1</sup> PETN for Grange Hall. Tetryl was spiked by adding 16 mls of a solution containing 2.86 mg/l<sup>-1</sup> tetryl for LAAP D, Yokena Clay, and Picatinny, and 2.25 mg/l<sup>-1</sup> PETN for Grange Hall. Samples were placed on a reciprocating shaker at 180 excursions per minute. At predetermined sampling times (1, 6, 24, 48, 72, 96, and 120 hr) triplicate replicates were centrifuged at 8,288 RCF for 30 min. Two (2) ml of acetonitrile were added to a two-ml aliquot of the aqueous phase, the sample was mixed and analyzed by high performance liquid chromatography (HPLC) using U.S. Environmental Protection Agency (USEPA) SW846 Method 8330 (USEPA 1994).

Soil	TOC, % <sup>1</sup>	CEC <sup>2</sup> , meq 100 g <sup>-1</sup>	pH	Clay, %	Sand, %	Silt, %
LAAP D	0.02	5.5	5.5	7.5	85	7.5
Yokena Clay	2.4	38.9	6.4	48.75	13.75	37.5
Picatinny	0.634	9.8	6.1	5	62.5	32.5
Grange Hall	0.29	16.7	8.2	10	39	51
Yakima	1.06	23.6	6.8	15	40	45
Guernsey	1.6	30.3	7.7	25	26	49

<sup>1</sup> Total organic carbon, percent.  
<sup>2</sup> Cation exchange capacity, milliequivalents per 100 g soil.



### **Adsorption Partitioning of PETN and tetryl**

Adsorption partitioning was conducted with LAAP D, Yokena Clay, and Grange Hall soils in a 1:4 ratio of soil to water in 25-ml glass centrifuge tubes. PETN samples were spiked at 0.5, 0.8, 1.1, 1.32, and 1.6 mg/l<sup>-1</sup> for LAAP D and Yokena Clay, and 0.7, 1.4, 2.1, 2.8, and 3.3 mg/l<sup>-1</sup> for Grange Hall soil. The tetryl treatments were spiked at 0.8, 2, 4, 6, and 8 mg/l<sup>-1</sup> for LAAP D and Grange Hall soils. Adsorption partitioning determinations were not made for Yokena Clay soils because steady-state conditions were not attained during adsorption kinetics tests. Triplicate treatments for PETN testing were shaken for 24 hr. Triplicate tetryl treatments were shaken for 24 hr for LAAP D soils and 48 hr for Grange Hall soils. All tests were shaken on a reciprocating shaker at 180 excursions per minute, centrifuged at 8,288 relative centrifugal force (RCF) for 60 min, and the aqueous phase removed and analyzed for PETN and tetryl as previously described for the kinetics tests.

### **Transformation kinetics of Yakima and Guernsey soils**

The original intention was to determine transformation kinetics on soils already contaminated by training activities on the range. However, due to the extreme heterogeneity in the distribution of explosives in the field (Pennington et al. 2001), no explosives were detected in soils set aside for these tests. Therefore, uncontaminated site soils were spiked with explosives. Contaminant loading of Yakima soil was accomplished by spraying 4 mls of acetone containing 460 mg/l<sup>-1</sup> of TNT, 606 mg/l<sup>-1</sup> RDX, and 600 mg/l<sup>-1</sup> HMX, respectively onto 100 g of dispersed soil in a stainless steel pan. Contaminant loading of Guernsey soil was accomplished by spraying 4 mls of acetone containing 355 mg/l<sup>-1</sup> of TNT, 298.5 mg/l<sup>-1</sup> RDX, and 413 mg/l<sup>-1</sup> HMX, respectively onto 100 g of dispersed soil in a stainless steel pan. For each soil, the acetone was allowed to evaporate for 4 hr under a hood, with occasional stirring to ensure that all of the soil was exposed to the air. The soil was then tumbled for 3 days to ensure that the explosives were evenly distributed. Tests were prepared by loading 4 gms soil into 25 ml centrifuge tubes and adding 16 mls of water. Samples were placed on a reciprocating shaker at 180 excursions per minute. At sampling times (0.5, 1, 6, 24, and 48 hr), duplicate tubes were removed and centrifuged at 8,288 RCF for 30 min. Two mls of the aqueous sample was treated with 2 ml acetonitrile, and analyzed by HPLC for TNT, RDX, and HMX using EPA SW846 Method 8330 (USEPA 1994).

### **Desorption partitioning of Yakima soils**

Soil from Yakima, spiked as described in the preceding paragraph with RDX and HMX (4 g) at concentrations of 6.06 mg/l<sup>-1</sup>, and 4.6 mg/l<sup>-1</sup>, respectively, was loaded into 25-ml centrifuge tubes in two replicates. A total of 16 mls of water was added, tubes were shaken on a reciprocating box shaker at 180 excursions per minute for 1 hr, and centrifuged at 8,288 RCF for 30 min. A 2-ml aqueous aliquot was removed, 2 mls of acetonitrile were added, and the samples were analyzed for RDX and HMX as previously described. Excess water was replaced

and the shaking and analytical procedures repeated through three sequential cycles. Desorption partitioning was not conducted on Guernsey soils, because steady-state conditions were not attained during kinetics testing. Partitioning coefficients are based on the assumption of steady-state or equilibrium conditions between the solid and aqueous phases. In the absence of such conditions, partitioning coefficients are not valid and kinetic formulations such as the transformation rate coefficient must be used to determine fate and transport of the subject compound.

## Results and Discussion

### Transformation kinetics and partitioning of PETN and tetryl

Solution PETN and tetryl concentrations decreased over time in all tested soils (Figure 6-1). Half-lives for PETN were 398, 13.8, 65.4, and 20.6 hr for LAAP D, Yokena Clay, Picatinny, and Grange Hall soils, respectively (Table 6-2). Results suggest that PETN will be rapidly degraded in surface soils and degraded at a slightly slower rate in aquifer soils. Half-lives for tetryl were 111, 0.81, 23, and 415 hr for LAAP D, Yokena Clay, Picatinny, and Grange Hall soils, respectively. Results suggest that tetryl will also be degraded in both surface and aquifer soils. Degradation was especially rapid in the Yokena Clay surface soil.

Adsorption coefficients for PETN and tetryl were determined on LAAP D and Grange Hall soils only, because of lack of steady-state conditions during kinetics testing in Yokena Clay and Picatinny soils (Table 6-3). Adsorption coefficients for PETN were higher than those for tetryl, but both were relatively low. The highest  $K_d$  measured for PETN was  $15.6 \text{ l/kg}^{-1}$  in Grange Hall soil. The  $K_d$ s ranged from 0.77 to  $1.3 \text{ l/kg}^{-1}$ , a relatively narrow range. These results suggest that sorption of PETN and tetryl will not be a major impediment to transport of these compounds through soils to groundwater.

### Transformation kinetics and partitioning

Both RDX and HMX were rapidly desorbed and reached steady-state distribution between the solution phase and Yakima soil in 1 hr (Figure 6-2). TNT did not reach steady state, but was rapidly transformed, exhibiting a half-life of only 9.4 hr. TNT could not be detected in the solution phase after 48 hr. The decrease in solution phase TNT concentrations was accompanied by a slight increase then decline in concentrations of the mono amino transformation products, 2-amino-4,6-dinitrotoluene (2A-DNT) and 4-amino-2,6-dinitrotoluene (4A-DNT). These results indicate that following initial contact with water, TNT is desorbed from the soil and transformed to 2A-DNT and 4A-DNT. TNT found in the field will likely be in the solid compound state because it does not long persist following introduction into soil solution. These results indicate that only small amounts of TNT will be present in the soil or the groundwater. No decrease in solution phase concentrations of RDX and HMX was observed

following establishment of steady-state concentrations, which means that they are much more stable and mobile than TNT in this soil.

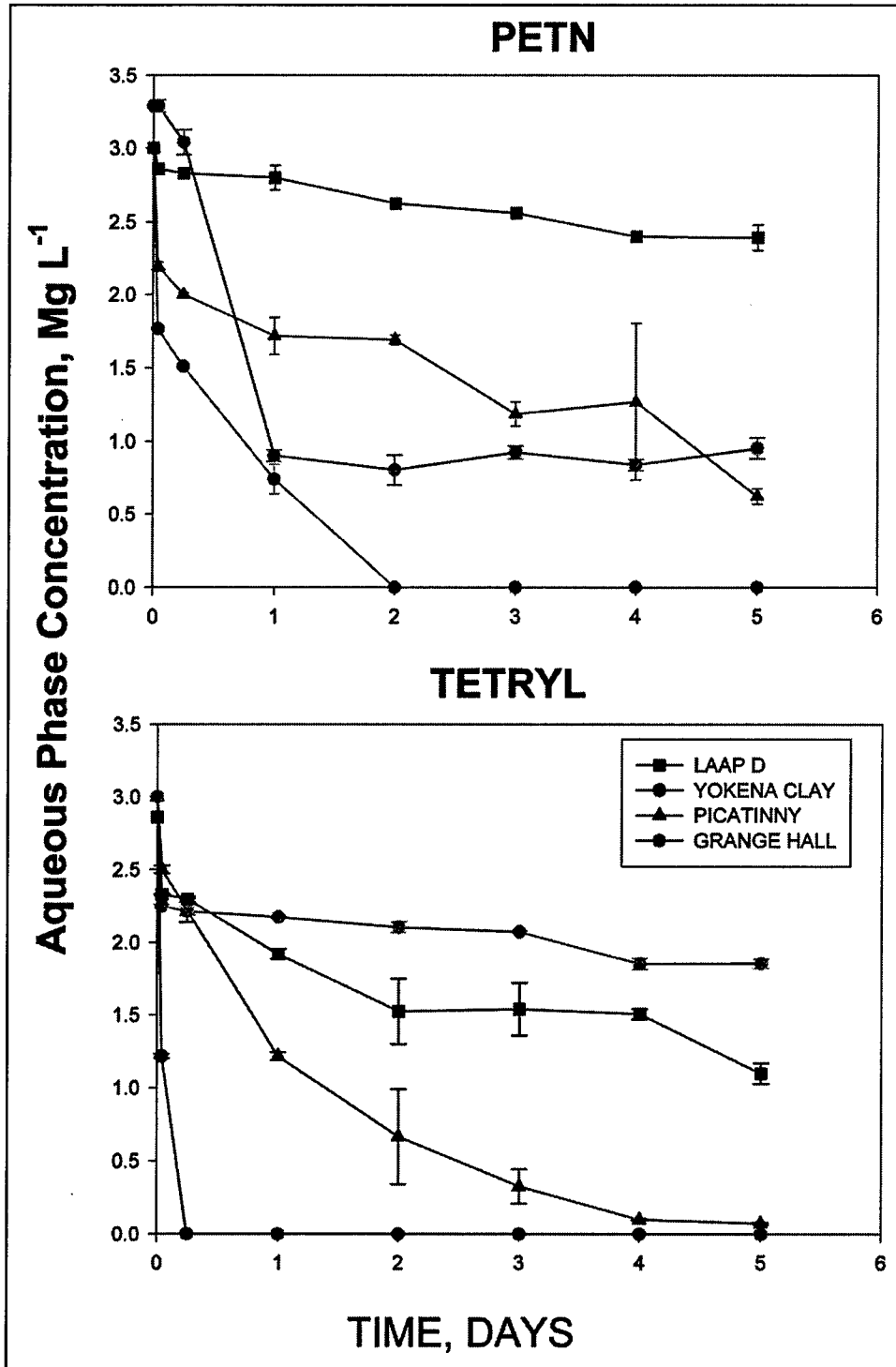

Figure 6-1. Transformation kinetics of PETN and tetryl in Yokena Clay, Picatinny, Grange Hall, and LAAPD soils

**Table 6-2**  
**Pseudo First-Order Transformation Rate Coefficients (k, hr<sup>-1</sup>) and Half-Lives (hr) of PETN and Tetryl**

Soil	PETN		Tetryl	
	k	Half-Life	k	Half-Life
LAAP D	0.0017	398	0.0062	111
Yokena Clay	0.05	13.8	0.852	0.81
Picatinny	0.011	65.4	0.031	23
Grange Hall	0.034	20.6	0.0017	415

**Table 6-3**  
**Adsorption Coefficients (K<sub>d</sub>, l/kg<sup>-1</sup>) for PETN and Tetryl in Soils**

Soil	PETN		Tetryl	
	K <sub>d</sub>	r <sup>2</sup>	K <sub>d</sub>	r <sup>2</sup>
LAAP D	1.32	0.89	1.1	0.74
Yokena Clay	Not determined		Not determined	
Picatinny	Not determined		Not determined	
Grange Hall	15.6	0.86	0.77	0.70

Both RDX and HMX reached steady-state distribution between the solution phase and Guernsey soil in 1 hr and remained stable for 48 hr (Figure 6-3). After 48 hr, concentrations rapidly decreased and transformation products for TNT (2A-DNT and 4A-DNT), RDX (MNX and TNX), and HMX (MN-HMX) began to appear. This behavior differed from that observed in Yakima soils and in other tests previously conducted with a wide variety of soils (Brannon and Pennington 2002). TNT did not reach steady state and could not be detected after 48 hr. Since the decreases in TNT, RDX, and HMX concentrations were accompanied by increases in concentrations of their respective transformation products, transformation occurred relatively quickly. Half-lives of TNT, RDX, and HMX in Guernsey soil were short, ranging from 4.7 hr for TNT to 52 hr for HMX. These results indicate that transformation of TNT, RDX, and HMX in Guernsey soil is rapid following the introduction of water to the soil. However, the potential for leaching of RDX and HMX is also present.

Partitioning coefficients were determined for RDX and HMX only in Yakima soils because of the lack of steady-state TNT concentrations in Yakima soils and the lack of steady-state TNT, RDX, and HMX concentrations in Guernsey soil. Partitioning coefficients in Yakima soil, developed from desorption isotherms (Brannon, Myers, and Tardy 1994), were  $1.5 \pm 0.064$  and  $2.5 \pm 0.04$  l/kg<sup>-1</sup> for RDX and HMX, respectively. These results indicate that RDX will be more readily transported than HMX in this soil.

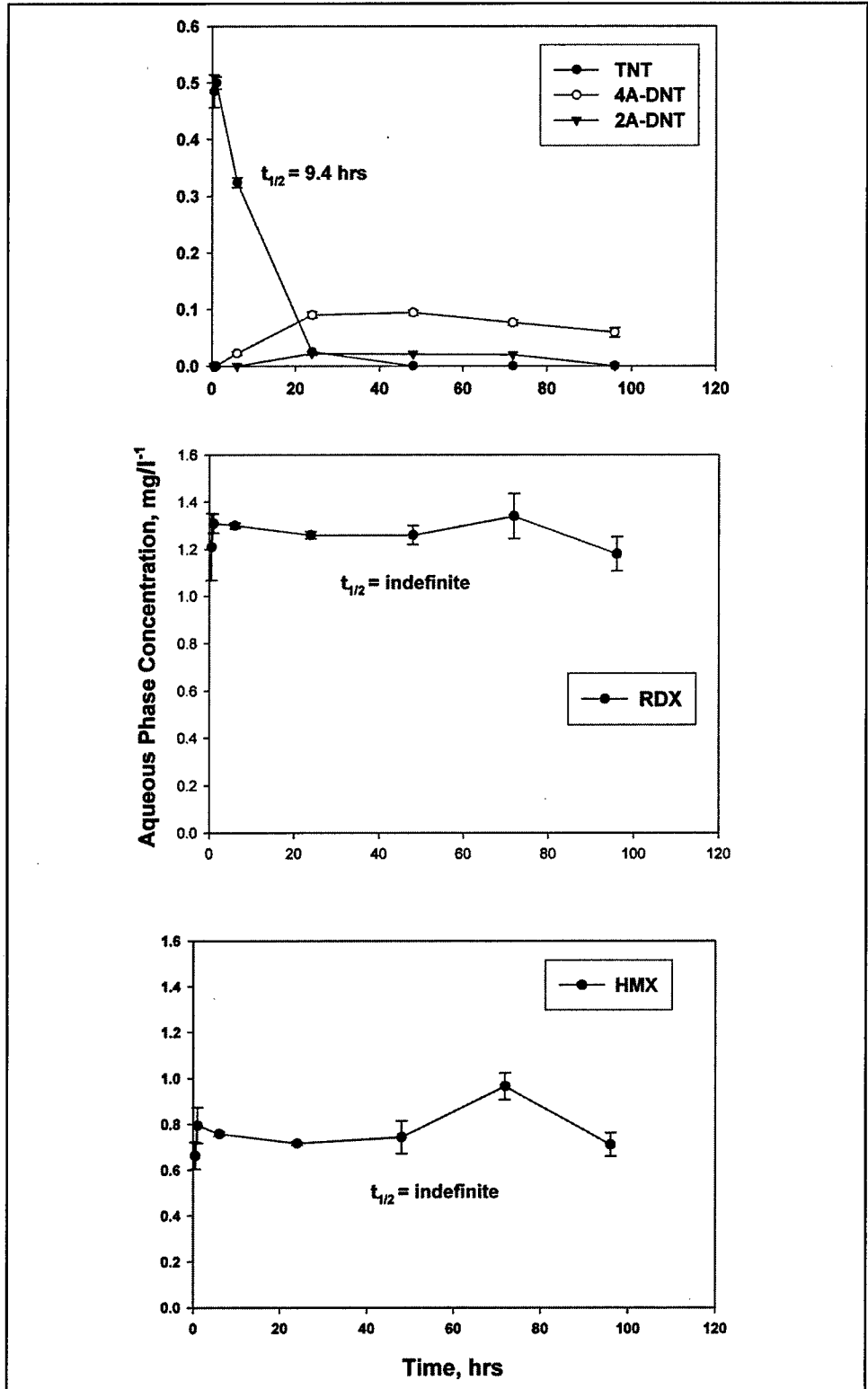

Figure 6-2. Transformation kinetics of TNT, RDX, and HMX in Yakima soil. Transformation products of RDX (MNX and TNX) and HMX (MN-HMX) were not detected

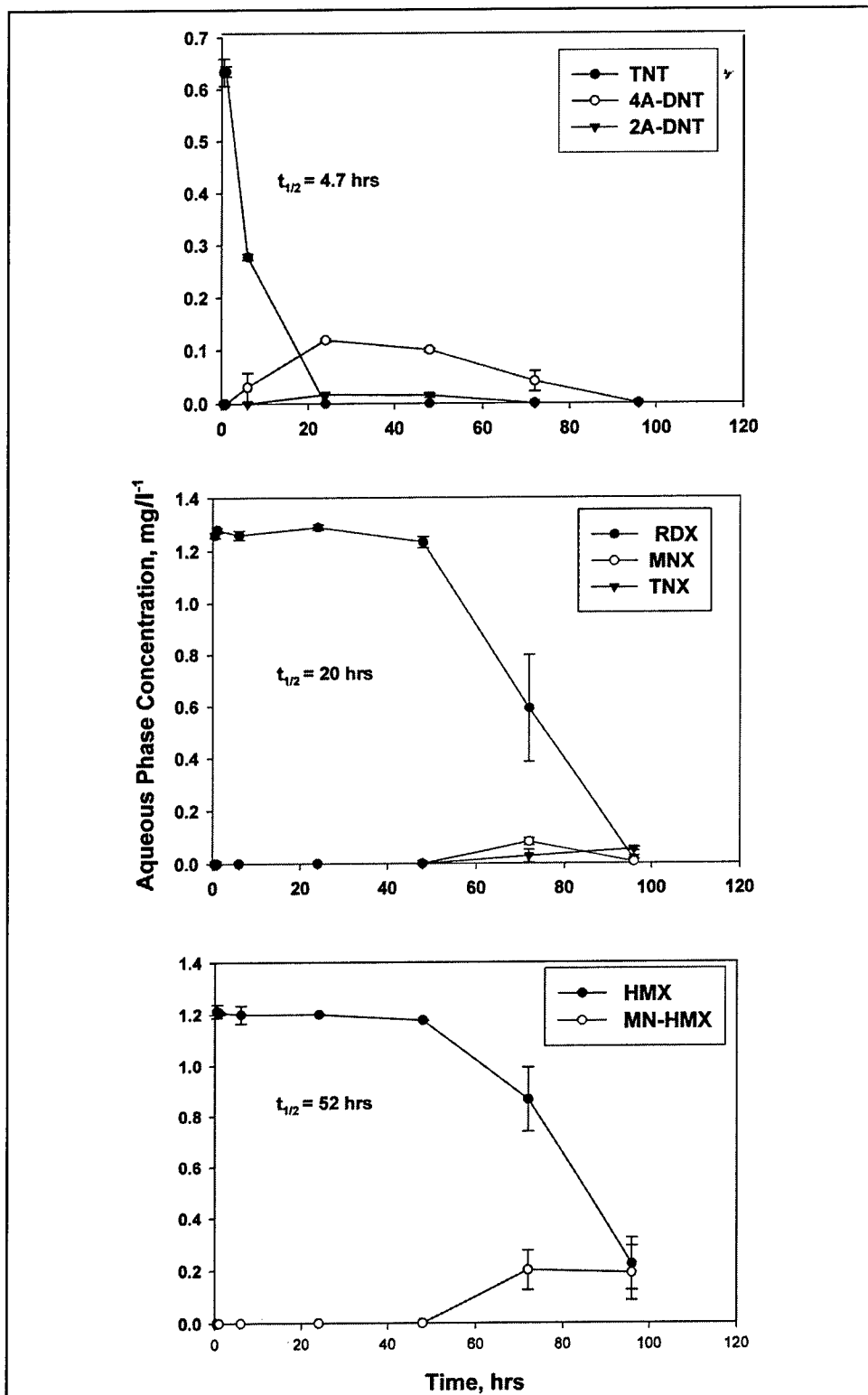

Figure 6-3. Transformation kinetics of TNT, RDX, and HMX in Gurnsey soil

## Summary and Conclusions

Transformation kinetics and partitioning studies showed that PETN and tetryl are degraded in both surface and aquifer soils. Degradation rates were especially rapid in the Yokena Clay surface soil. Adsorption of PETN and tetryl was relatively low for most soils, with only Grange Hall soil having a  $K_d$  that could effectively limit transport. These results suggest that sorption of PETN and tetryl will not generally be a major impediment to transport of these compounds to groundwater. However, degradation in surface and aquifer soils may effectively inhibit transport of these compounds.

The higher TOC and CEC in Guernsey soil suggest greater capacity for interactions with the explosives than exhibited by the Yakima soil, which is higher in sand and lower in TOC and CEC. RDX and HMX were stable in Yakima soils and sorbed to a limited extent, indicating that they are potentially mobile in this soil. Conversely, RDX and HMX were unstable in Guernsey soil, indicating that these compounds are potentially less mobile in the Guernsey soil than in the Yakima soil. Soils from both Yakima and Guernsey rapidly transformed TNT when water contacted the soil. TNT found in the field in these soils will likely be in the undissolved, solid state because TNT does not long persist following introduction into soil solution. Except for residual solid chunks on the surface, limited amounts of TNT would be expected to be present in either soil or groundwater at these sites. Results of these studies emphasize the importance of soil properties in determining the transport potential for these explosives and the differences in transport behavior among the explosives.

## References

- Brannon, J. M., and Myers, T. E. (1997). "Review of fate and transport processes of explosives," Technical Report IRRP-97-2, U.S. Army Engineer Waterways Experiment Station, Vicksburg, MS.
- Brannon, J. M., Myers, T. E., and Tardy, B. A. (1994). "Leachate testing and evaluation for freshwater sediments," Miscellaneous Paper D-94-1, U.S. Army Engineer Waterways Experiment Station, Vicksburg, MS.
- Brannon, J. M., and Pennington, J. C. (2002). "Environmental fate and transport process descriptors for explosives," Technical Report ERDC/EL TR-02-10, U.S. Army Engineer Research and Development Center, Vicksburg, MS.
- Pennington, J. C., Jenkins, T. F., Brannon, J. M., Lynch, J., Ranney, T. A., Berry, T. E., Jr., Hayes, C. A., Miyares, P. H., Walsh, M. E., Hewitt, A. D., Perron, N., and Delfino, J. J. (2001). "Distribution and fate of energetics on DoD test and training ranges: Interim Report 1," ERDC TR-01-13, U.S. Army Engineer Research and Development Center, Environmental Laboratory, Vicksburg, MS.
- U.S. Environmental Protection Agency. (1994). *Test Methods for Evaluating Solid Waste*, Physical/Chemical Methods SW-846, 3rd ed., Update II, Washington, DC.

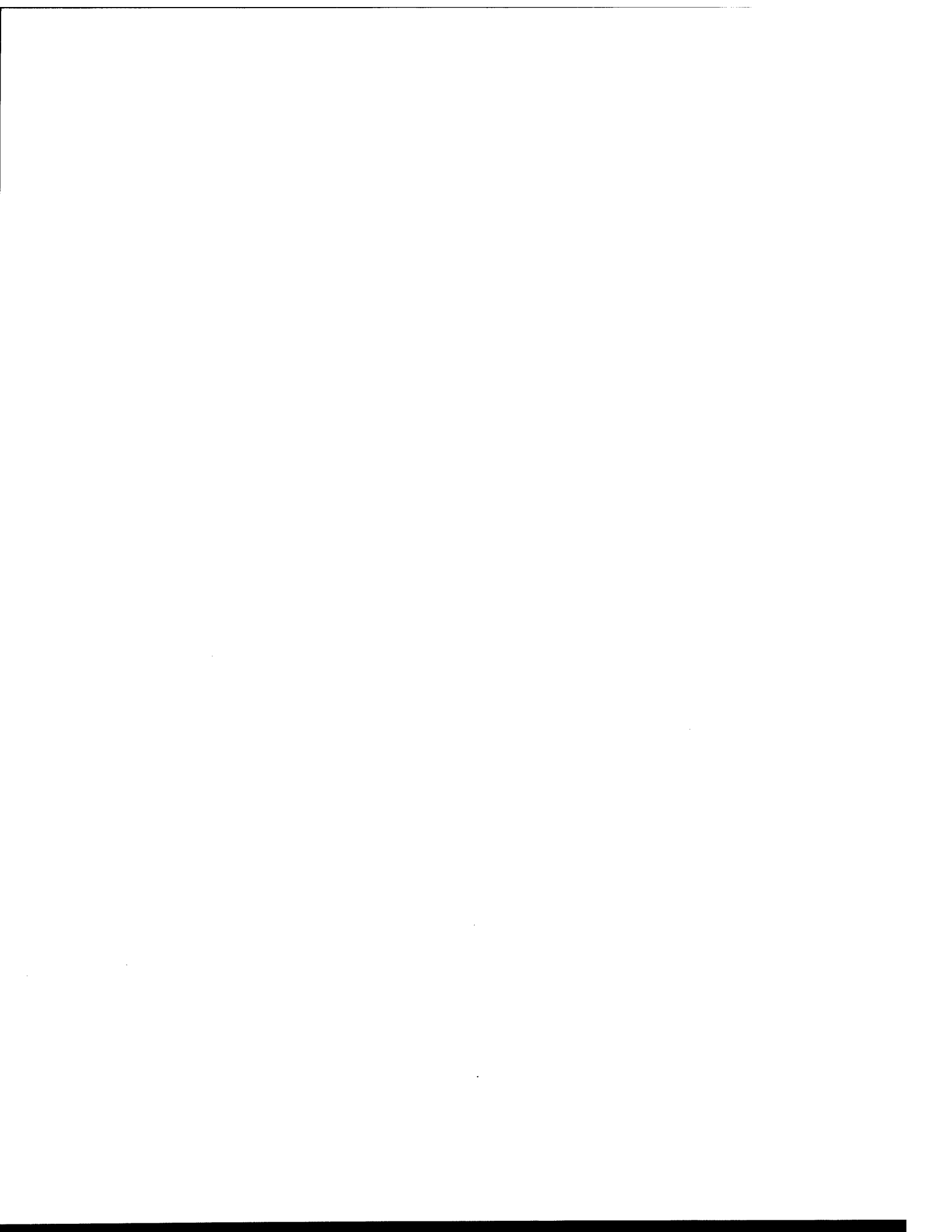



# 7 Summary and Conclusions

---

## Site Characterizations

**Fort Bliss, New Mexico.** The Dona Ana Range at Fort Bliss provided the opportunity to study the character and distribution of low-order detonation debris over a sparsely vegetated surface under extremely arid conditions that preserved the residues from dissolution and transport. Chunks of explosives in the vicinity of low-order detonations were abundant and more visible than at ranges previously examined. Analyses of surface soil samples associated with low-order detonations confirmed the data from previously sampled ranges, which demonstrated that the concentration of energetic compounds are many orders of magnitude higher near low-order detonations than over the remainder of the range. Data from the Dona Ana range also confirmed previous findings that the character of residuals are associated with the specific munitions and that residues from high-order detonations of heavy artillery projectiles are of very low concentrations. The heterogeneous distribution of residues of explosives and propellants remains the most difficult challenge in characterizing range contamination from live-fire training. Judgmental sampling targeting low-order residues and firing points is superior to grid sampling for identifying potential point sources of contamination over the typically large training range areas. Furthermore, composite sampling offers the best opportunity of capturing a realistic concentration under the conditions of extreme heterogeneity. However, even the use of 30-point composite samples did not completely overcome site heterogeneity, especially in areas with explosives concentrations below  $100 \mu\text{g kg}^{-1}$ . Additional research to improve agreement among replicate samples in this context is required.

**CFB Shilo.** Data collection at CFB Shilo encompassed not only residual energetic materials in soils, but also in groundwater and vegetation. Furthermore, analyses were not restricted to energetic materials, but also included thorium-232 associated with a Milan missile range, metals, volatile organic compounds (VOCs), and Benzene, Toluene, Ethylbenzene, and Xylene (BTEX). Results indicated that the Shilo ranges generally exhibit relatively low levels of contamination not requiring immediate corrective action. However, several issues of potential concern were identified.

- Metals in groundwater were associated with dissolved and suspended solids; therefore, annual monitoring of groundwater was recommended to

ensure that levels of concern are recognized should they develop in the future. Energetic compounds were not found in groundwater.

- Thorium-232 was observed to decrease in groundwater between the Phase I and II sampling events. The highest level, found near a target, was insufficient to create concern, but some bioaccumulation at the ppb level was observed in vegetation.
- The grenade range presented contamination by both metals and energetic materials at trace or greater concentrations over the entire area and often beyond. Control of leachates from grenade ranges was recommended.
- Small arms firing at rifle ranges exerted a clear impact on contaminant levels of heavy metals in soils and vegetation. The accumulation of the alkaline metals (Na-Mg-K) in plants makes them attractive to foraging deer; therefore, constraining grazing in rifle ranges is recommended.
- Burning of small arms and metal debris piling led to the spreading of metals into the surrounding environment; however, since burning has halted, and deer are restricted from the area by fences, confining the leachate from the metal piles was the only recommended action.

Neither VOCs nor BTEX were detected, except in a few trace quantities, in groundwater. Surface water contained metal, but most were naturally occurring background levels unlikely to be associated with military activities. No energetic materials were found in surface waters. Vegetation associated with battleruns exhibited low levels of metals, but concentrations were insufficient to create immediate concern. Energetic materials found in soils were generally associated with targets and propellants with firing points. These data were consistent with similar data reported in other chapters of this study. In general, conditions at Canadian Forces Base (CFB) Shilo do not justify a halt to training activity, but attention to several issues of potential concern is warranted.

## Open Detonations

The purpose of this study was to determine the character and quantity of residues created when detonating munitions. Tests consisted of 31 individual detonations on snow. Munitions included 60-mm mortars, 81-mm mortars, 105-mm artillery projectiles, the M67 hand grenade, and the PMA-2 landmine surrogate. Results demonstrated that 0.0001 to 1.5 percent of the total explosive mass was residual to the high-order detonations. These values are approximately three orders of magnitude higher than previous results obtained on snow, perhaps due to the great variability in creating such detonations and to differences in the sampling approach. Variables include the configuration of the munition and the C4 initiator, and atmospheric conditions. Snow samples were also collected to a greater depth than in previous studies. As reported in previous studies, C4 contributed significantly to explosives residuals.

## Low-Order Detonations

Controlling the percent energy yield of low-order detonations of artillery projectiles proved difficult. Achieving targeted yield levels less than 50 percent were more successful than achieving levels greater than 50 percent. Adjustments in the documented variables from these results will improve control of future detonations. Recovery of explosive residues was also challenging, since explosives were thrown beyond the tarp intended for their capture. Subsequent tests (data under analysis for presentation in FY03) used a larger tarp and a more efficient retrieval approach.

## Fate and Transport Parameters

In FY02 the environmental persistence of two energetic compounds, PETN and tetryl, were determined. Adsorption kinetics and partitioning studies demonstrated that both are degraded in surface and aquifer soils. While adsorption is relatively limited and will not generally impede transport to groundwater, degradation may be sufficient to reduce transport. In FY02 the transport properties of soils from two previously characterized sites, Yakima, Washington, and Camp Guernsey, Wyoming, were determined. TNT was rapidly transformed by both soils once in solution phase. RDX and HMX were stable in Yakima soils, adsorbing to a limited extent, but still potentially mobile. However, both were unstable in Guernsey soil, suggesting that both are potentially less mobile there. Results of these and previous studies (FY00 and FY01) emphasize the importance of soil properties in determining the transport potential for explosives and the differences in transport behavior among explosives compounds.

## Future Directions

Future directions for this project include the following:

- Characterization of Air Force and Naval ranges. One Air Force range in Canada, Cold Lake Weapons Range, was characterized late in FY02. Data will be reported in FY03. No Naval ranges have yet been identified for characterization.
- Continued characterization of residues at firing points. Firing points at two additional ranges, Scofield and Gageton, were characterized late in FY02. Results will be reported in FY03.
- Refinements in the estimates of residues from controlled low-order detonations. Additional low-order tests were conducted late in FY02. Results will be reported in FY03. Additional tests are scheduled for February 2003.
- Expansion of the range characterization database. Additional ranges will be sought for expanding the existing database.

- Modeling of the distribution of residues associated with various range uses. This effort will be heavily leveraged with a new “Distributed Source” task area under development within ERDC.
- Development of process descriptors for propellants, smokes, and obscurants. This task is heavily leveraged with the Army Environmental Quality Technology Program work unit already underway.
- Determination of the significance of non-HE organics on ranges. Several soil samples from each of three sites have been subjected to analyses for an extensive list of analytes including organic contaminants other than explosives, dyes, waxes and binders, and metals. This database will continue development with samples from the other sites already characterized and from any new sites sampled.

# REPORT DOCUMENTATION PAGE

Form Approved  
OMB No. 0704-0188

Public reporting burden for this collection of information is estimated to average 1 hour per response, including the time for reviewing instructions, searching existing data sources, gathering and maintaining the data needed, and completing and reviewing this collection of information. Send comments regarding this burden estimate or any other aspect of this collection of information, including suggestions for reducing this burden to Department of Defense, Washington Headquarters Services, Directorate for Information Operations and Reports (0704-0188), 1215 Jefferson Davis Highway, Suite 1204, Arlington, VA 22202-4302. Respondents should be aware that notwithstanding any other provision of law, no person shall be subject to any penalty for failing to comply with a collection of information if it does not display a currently valid OMB control number. PLEASE DO NOT RETURN YOUR FORM TO THE ABOVE ADDRESS.

<b>1. REPORT DATE (DD-MM-YYYY)</b> September 2003		<b>2. REPORT TYPE</b> Interim report		<b>3. DATES COVERED (From - To)</b>	
<b>4. TITLE AND SUBTITLE</b>  Distribution and Fate of Energetics on DoD Test and Training Ranges: Interim Report 3				<b>5a. CONTRACT NUMBER</b>	
				<b>5b. GRANT NUMBER</b>	
				<b>5c. PROGRAM ELEMENT NUMBER</b>	
<b>6. AUTHOR(S)</b> Judith C. Pennington, Thomas F. Jenkins, Guy Ampleman, Sonia Thiboutot, James M. Brannon, Jeff Lewis, John E. DeLaney, Jay Clausen, Alan D. Hewitt, Michael A. Hollander, Charolett A. Hayes, Jeffrey A. Stark, André Marois, Sylvie Brochu, Hien Q. Dinh, Dennis Lambert, Annie Gagnon, Melanie Bouchard, Richard Martel, Patrick Brousseau, Nancy M. Perron, René Lefebvre, William Davis, Thomas A. Ranney, Catherine Gauthier, Susan Taylor, Jean-Marc Ballard				<b>5d. PROJECT NUMBER</b>	
				<b>5e. TASK NUMBER</b>	
				<b>5f. WORK UNIT NUMBER</b>	
<b>7. PERFORMING ORGANIZATION NAME(S) AND ADDRESS(ES)</b>  (See reverse)				<b>8. PERFORMING ORGANIZATION REPORT NUMBER</b>  ERDC TR-03-2	
<b>9. SPONSORING / MONITORING AGENCY NAME(S) AND ADDRESS(ES)</b> U.S. Army Corps of Engineers Washington, DC 20314-1000				<b>10. SPONSOR/MONITOR'S ACRONYM(S)</b>	
				<b>11. SPONSOR/MONITOR'S REPORT NUMBER(S)</b>	
<b>12. DISTRIBUTION / AVAILABILITY STATEMENT</b>  Approved for public release; distribution is unlimited.					
<b>13. SUPPLEMENTARY NOTES</b>					
<b>14. ABSTRACT</b> Sustainment of training to maintain the readiness of our armed forces requires stewardship of human health and the environment. The objective of this project, initiated in FY00 and planned for completion in FY05, was to determine the potential for environmental contamination from residues of energetic materials on ranges. This report describes accomplishments for FY02. A U.S. and a Canadian site were characterized for explosives residues resulting from live-fire soldier training: Fort Bliss, Texas, and Canadian Forces Base (CFB), Shilo, Manitoba. Results are also reported on tests to determine residues associated with open detonations and low-order detonations and tests to define environmental fate and transport process descriptors. Results of intensive sampling at Fort Bliss indicated that judgmental sampling targeting low-order residues and firing points is superior to grid sampling for identifying potential point sources of contamination over the typically large training range areas. Furthermore, composite sampling offers the best opportunity of capturing a realistic concentration under the conditions of extreme heterogeneity. Results of open detonations tests confirmed that the use of C4 generates significant explosives residuals. In low-order detonation tests, controlling the percent energy yield of artillery projectiles proved difficult. Adjustments in the variables from these results will improve control of future detonation tests. At CFB Shilo, energetic materials found in soils were associated with targets, <i>(Continued)</i>					
<b>15. SUBJECT TERMS</b>		Explosives	Propellants	TNT	
Detonation residues		HMX	RDX	Training ranges	
Dinitrotoluene		Partition coefficients	Test ranges	Transformation rates	
<b>16. SECURITY CLASSIFICATION OF:</b>			<b>17. LIMITATION OF ABSTRACT</b>	<b>18. NUMBER OF PAGES</b>	<b>19a. NAME OF RESPONSIBLE PERSON</b>
<b>a. REPORT</b>	<b>b. ABSTRACT</b>	<b>c. THIS PAGE</b>			<b>19b. TELEPHONE NUMBER (include area code)</b>
UNCLASSIFIED	UNCLASSIFIED	UNCLASSIFIED		380	

#### 7. PERFORMING ORGANIZATION NAME(S) AND ADDRESS(ES)

U.S. Army Engineer Research and Development Center, Environmental Laboratory, 3909 Halls Ferry Road, Vicksburg, MS 39180-6199; U.S. Army Engineer Research and Development Center, Cold Regions Research and Engineering Laboratory, 72 Lyme Road, Hanover, NH 03755-1290; Defence Research and Development, Canada-Valcartier, 2459 Pie XI Blvd. North, Val Bélaire, Québec G3J 1X5; Institut National de la Recherche Scientifique, 880 Chemin Ste-Foy, Bueau 840 CP 7500, St-Foy, ZC, Ste-Foy, Quebec G1V 4C7; BCR Polysyntech, Inc., 1524 des Impératrices, Val-Bélaire, Quebec G3J 1R7; AMEC Earth and Environmental, 110 Littleton Road, Suite 1B, Westford, MA 01886; U.S. Naval Explosives Ordnance Disposal, Technical Division, 2008 Stump Neck Road, Indian Head, MD 20640-5070; Science and Technology Corporation, Hanover, NH 03755; DynTel, 3530 Manor Dr., Suite 4, Vicksburg, MS 39180

#### 14. ABSTRACT (Continued)

and propellants were associated with firing points. The Shilo ranges exhibited relatively low levels of contamination not requiring immediate corrective action. Results of soil partitioning tests demonstrated that pentaerythritol tetranitrate (PETN) and tetryl are degraded in surface and aquifer soils. While adsorption is relatively limited and will not impede transport, degradation may be sufficient to reduce transport of these explosives. Results illustrate the importance of soil properties in determining the transport potential for explosives.

Study results provide data for estimation of firing range source terms, protocols for contaminant characterization, descriptions of residues from low-order detonations and from various UXO demolition procedures, and fate and transport process descriptors for energetic residues. These data support environmental compliance and training range sustainment.