

# Woods Hole Oceanographic Institution

---

## Long-Term Evolution of the Coupled Boundary Layers (STRATUS)

Mooring Recovery and Deployment Cruise Report  
NOAA Research Vessel *R H Brown* • Cruise RB-01-08  
9 October - 25 October 2001

by

<sup>1</sup>Charlotte Vallée  
<sup>1</sup>Robert A. Weller  
<sup>1</sup>Paul R. Bouchard  
<sup>1</sup>William M. Ostrom  
<sup>1</sup>Jeff Lord  
<sup>1</sup>Jason Gobat  
<sup>1</sup>Mark Pritchard  
<sup>2</sup>Toby Westberry  
<sup>3</sup>Jeff Hare  
<sup>3</sup>Taneil Uttal  
<sup>4</sup>Sandra Yuter  
<sup>5</sup>David Rivas,  
<sup>5</sup>Darrel Baumgardner  
<sup>3</sup>Brandi McCarty  
<sup>6</sup>Jonathan Shannahoff  
<sup>1</sup>M.A. Walsh  
<sup>1</sup>Frank Bahr

<sup>1</sup>Woods Hole Oceanographic Institution (WHOI), <sup>2</sup>the University of California, Santa Barbara (UCSB)  
<sup>3</sup>NOAA Environmental Technology Laboratory (ETL), <sup>4</sup>the University of Washington (UW),  
<sup>5</sup>the University Nacional Autonoma de Mexico (UNAM), <sup>6</sup>the R/V R H Brown

February 2002

## Technical Report

Funding was provided by the National Oceanic and Atmospheric Administration under  
Grant Numbers NA96GPO429 and NA17RJ1223.

Approved for public release; distribution unlimited.



Upper Ocean Processes Group  
Woods Hole Oceanographic Institution  
Woods Hole, MA 02543  
UOP Technical Report 2002-01

20021126 099

WHOI-2002-02

UOP-2002-01

**Long-Term Evolution of the Coupled Boundary Layers (STRATUS)**

Mooring Recovery and Deployment Cruise Report  
NOAA Research Vessel *R H Brown* • Cruise RB-01-08  
9 October - 25 October 2001

by

<sup>1</sup>Charlotte Vallée  
<sup>1</sup>Robert A. Weller  
<sup>1</sup>Paul R. Bouchard  
<sup>1</sup>William M. Ostrom  
<sup>1</sup>Jeff Lord  
<sup>1</sup>Jason Gobat  
<sup>1</sup>Mark Pritchard  
<sup>2</sup>Toby Westberry  
<sup>3</sup>Jeff Hare  
<sup>3</sup>Taneil Uttal  
<sup>4</sup>Sandra Yuter  
<sup>5</sup>David Rivas  
<sup>5</sup>Darrel Baumgardner  
<sup>3</sup>Brandi McCarty  
<sup>6</sup>Jonathan Shannahoff  
<sup>1</sup>M.A. Walsh  
<sup>1</sup>Frank Bahr

<sup>1</sup>Woods Hole Oceanographic Institution (WHOI)  
<sup>2</sup>the University of California, Santa Barbara (UCSB),  
<sup>3</sup>NOAA Environmental Technology Laboratory (ETL)  
<sup>4</sup>the University of Washington (UW)  
<sup>5</sup>the University Nacional Autonoma de Mexico (UNAM)  
<sup>6</sup>the R/V *R H Brown*

February 2002


**Technical Report**

Funding was provided by the National Oceanic and Atmospheric Administration under Grant Numbers NA96GPO429 and NA17RJ1223.

Reproduction in whole or in part is permitted for any purpose of the United States Government. This report should be cited as Woods Hole Oceanog. Inst. Tech. Rept., WHOI-2002-02.

Approved for public release; distribution unlimited.

**Approved for Distribution:**

  
\_\_\_\_\_  
Terrence M. Joyce, Chair

Department of Physical Oceanography

**Long-Term Evolution of the Coupled Boundary Layers (STRATUS)**

Mooring Recovery and Deployment Cruise Report

NOAA Research Vessel *R H Brown*

Cruise RB-01-08

9 October - 25 October 2001

by

Charlotte Vallée \*  
Robert A. Weller \*  
Paul R. Bouchard \*  
William M. Ostrom \*  
Jeff Lord \*  
Jason Gobat \*  
Mark Pritchard \*  
Toby Westberry +  
Jeff Hare #  
Taneil Uttal #  
Sandra Yuter ^  
David Rivas Ω  
Darrel Baumgardner Ω  
Brandi McCarty #  
Jonathan Shannahoff β  
M.A. Walsh \*  
Frank Bahr \*

\* Woods Hole Oceanographic Institution (WHOI), + the University of California, Santa Barbara (UCSB),  
# NOAA Environmental Technology Laboratory (ETL), ^ the University of Washington (UW), Ω the  
University Nacional Autonoma de Mexico (UNAM), β the R/V *R H Brown*.



Upper Ocean Processes Group  
Woods Hole Oceanographic Institution  
Woods Hole, Massachusetts 02543

UOP Technical Report 02-01



## **Abstract**

This report documents the work done on cruise RB-01-08 of the NOAA R/V *Ron Brown*. This was Leg 2 of R/V *Ron Brown*'s participation in Eastern Pacific Investigation of Climate (EPIC) 2001, a study of air-sea interaction, the atmosphere, and the upper ocean in the eastern tropical Pacific. The science party included groups from the Woods Hole Oceanographic Institution (WHOI), NOAA Environmental Technology Laboratory (ETL), the University of Washington (UW), the University of California, Santa Barbara (UCSB), and the University Nacional Autonoma de Mexico (UNAM). The work done by these groups is summarized in this report. In addition, the routine underway data collected while aboard R/V *Ron Brown* is also summarized here.



## Table of Contents:

Abstract.....	3
Table of contents.....	5
List of Figures.....	7
List of Tables.....	10
SECTION 1: Introduction.....	11
SECTION 2: Cruise chronology.....	17
SECTION 3: UCSB Optical/CTD Profiles.....	21
SECTION 4: ETL Flux system.....	27
SECTION 5: C-Band Radar.....	43
SECTION 6: Cloud radar and microwave radiometer.....	49
SECTION 7: Lidar.....	57
SECTION 8: Aerosols.....	59
SECTION 9: The WHOI IMET surface moorings.....	61
A. The WHOI surface moorings – Overview.....	64
1. Meteorological Instrumentation.....	64
a. Improved METeological System.....	65
b. Stand-alone Relative Humidity/Temperature Instrument.....	65
c. Onset StowAway Tidbit Temperature Loggers (only for the Stratus 1 mooring).....	66
2. Oceanographic Instrumentation.....	66
a. Floating SST Sensor.....	66
b. Sub-surface Argos Transmitter.....	66
c. SEACAT Conductivity and Temperature Recorders.....	66
d. MicroCAT Conductivity and Temperature Recorder.....	67
e. Branker Temperature Recorders.....	67
f. SBE-39 Temperature Recorder.....	67
g. Onset StowAway Tidbit Temperature Loggers.....	67
h. Vector Measuring Current Meters.....	67
i. Falmouth Scientific Instruments Currents Meter (only for the Stratus 1 mooring).....	68
j. RDI Acoustic Doppler Current Profiler.....	68
k. Chlorophyll Absorption Meter (only for the Stratus 1 mooring).....	68
l. Acoustic Rain Gauge.....	69
m. Acoustic Release.....	69
B. Stratus 1 mooring – recovery.....	71
C. Stratus 2 mooring – deployment.....	75
D. Intercomparison of buoy and ship IMET sensors.....	82
E. CTD stations.....	88
SECTION 10: Argo floats.....	93
SECTION 11: Ancillary shipboard meteorological and oceanographic instrument.....	95
1. Introduction.....	95
2. Doppler radar system and Seabeam.....	95
a. Multibeam echo sounding system.....	95
b. Hydrographic/Sub-Bottom profiler.....	96
c. Depth recorder/indicator system.....	96
d. Acoustic Doppler Current Profiler.....	96
e. Doppler speed log.....	96
f. Conductivity, Temperature, Depth (CTD) system.....	96
g. Global Positioning System (GPS).....	96
3. Data collected during the Leg 2 cruise on the R/V R H Brown.....	98
Acknowledgments.....	110
References.....	110
APPENDIX 1: WHOI instrumentation recovered during Stratus 1.....	111
APPENDIX 2: Moored station log of Stratus 1.....	113
APPENDIX 3: WHOI instrumentation deployed during Stratus 2.....	122
APPENDIX 4: Moored station log of Stratus 2.....	124
APPENDIX 5: Stratus mooring deployment procedures.....	132

<b>APPENDIX 6: Stratus antifouling paint study.....</b>	<b>144</b>
<b>APPENDIX 7: Stratus 2 cruise logistics.....</b>	<b>152</b>
<b>APPENDIX 8: Cruise participants.....</b>	<b>157</b>
<b>APPENDIX 9: Plan of the days onboard R H Brown – Leg 2.....</b>	<b>158</b>
Plan 1: Plan of the October 10.....	158
Plan 2: Plan of the October 11.....	159
Plan 3: Plan of the October 12.....	160
Plan 4: Plan of the October 13.....	161
Plan 5: Plan of the October 14.....	162
Plan 6: Plan of the October 15.....	163
Plan 7: Plan of the October 16.....	164
Plan 8: Plan of the October 17.....	165
Plan 9: Plan of the October 18.....	166
Plan 10: Plan of the October 20.....	167
Plan 11: Plan of the October 21.....	168
Plan 12: Plan of the October 22.....	169
Plan 13: Plan of the October 23.....	170
Plan 14: Plan of the October 24.....	171



## List of Figures:

Figure 1	Stratus mooring cruise schedule.....	12
Figure 2	NOAA research vessel <i>Ron H. Brown</i> .....	13
Figure 3	Cruise track and mooring location.....	15
Figure 4	Contour plot of the bottom topography mapped during the survey prior to the deployment of Stratus 2.....	18
Figure 5	Target track path (black line) and ship's track (green) recorded by GPS during the mooring deployment, the acoustic survey of the anchor position, and the subsequent occupation of a position 1/4 mile downwind of the surface buoy.....	19
Figure 6	Figure showing the intersection of three horizontal range arcs based on slant ranges obtained at three survey points. The small blue circle is the position at which the anchor was deployed and the X marks a best estimate of the position on the bottom of the anchor.....	19
Figure 7	Chlorophyll along the 95 W transect. Values are taken at 0.5° intervals and 20m depths.....	22
Figure 8	Chlorophyll profiles in the upper 200m at the stations from 1°to 8°S.....	23
Figure 9	Time series of near - surface ocean temperature and 15m air Temperature.....	30
Figure 10	Time series of 18m wind speed.....	31
Figure 11	Time series of downward solar flux.....	32
Figure 12	Time series of downward infrared radiative flux.....	33
Figure 13	Time series of surface net heat flux components in meteorological coordinates. Sensible, latent, net infrared (downwelling minus upwelling), and rain.....	34
Figure 14	Time series of ocean temperature. Blue line is 5-meter depth ship thermosalinograph intake, green dots are the ETL seasnake (approximately 5 cm depth).....	35
Figure 15	Time series of sea surface temperature (from ETL seasnake) and 18m air temperature (ETL) for the Epic 2001 Leg 2 time period.....	36
Figure 16	Time series of wind speed (upper panel), northerly wind component (middle panel), and easterly wind component (lower panel).....	37
Figure 17	Time series of 24-hour rain accumulation for Leg 2.....	38
Figure 18	Time series of daily-averaged flux components: solar radiative Flux (dashed blue), net infrared radiative flux (cyan x), sensible heat flux (green solid), and latent heat flux (red dots).....	39
Figure 19	Time series of daily-averaged net heat flux into the ocean.....	40
Figure 20	: Diurnal average of rainfall for the Epic 2001 Leg 2 period.....	41
Figure 21	Diurnal average of temperatures (red - 5m SCS; green - 5cm; blue - 15m air temperature) for the Epic 2001 Leg 2 period (days 283-297).....	42
Figure 22	Horizontal cross-section of C-band radar data from 11 UTC October 21 (Day 294).....	45

Figure 23	Upper-air sounding launched at 11 UTC October 21 (Day 294). No quality control has been applied. Dew point is curve to left and temperature is curve to left.....	46
Figure 24	Relative humidity time-height plot from upper-air soundings every three hours throughout Leg 2.....	47
Figure 25	Cloud photo looking eastward at about 11:15 UTC on October 21 (Day 294).....	47
Figure 26	Photo of the MMCR Package showing the radar antenna (roof) and MWR reflector (right side).....	49
Figure 27	Example of radar reflectivity (upper panel), Doppler velocity (middle panel) and the spectral width (bottom panel) of the Doppler spectrum for a 24 hour period.....	52
Figure 28	Comparison of net heat flux (blue) with deep echo (red).....	53
Figure 29	Example of the radar reflectivity superimposed with the data on cloud base heights from the ceilometer.....	54
Figure 30	Raw brightness temperatures from the three channels of the Microwave radiometer.....	54
Figure 31	Stratus 1 mooring diagram –recovery.....	62
Figure 32	Stratus 2 mooring diagram deployment.....	63
Figure 33	Some of the instrumentation recovered on the deck.....	72
Figure 34	TPOD instrument at 250 m depth.....	72
Figure 35	MICROCAT instrument at 85 m depth.....	73
Figure 36	VMCM instrument at 20 m depth.....	73
Figure 37	SEACAT instrument at 3.71 m depth.....	74
Figure 38	Stratus buoy IMET towertop.....	76
Figure 39	Buoy spin orientation for pre-deployment test at WHOI.....	79
Figure 40	Pre-deployment buoy spin at WHOI.....	79
Figure 41	Buoy orientation for the spin done in Seattle, WA.....	81
Figure 42	Spin data plot for Seattle, WA.....	81
Figure 43	Comparison of Stratus 1 and 2 buoys IMET data on Barometric Pressure (mb).....	83
Figure 44	: Comparison of Stratus 1 and 2 buoys IMET data on Relative Humidity (%).....	83
Figure 45	Comparison of Stratus 1 and 2 buoys IMET data, ship and ETL data on Sea Surface Temperature (°C).....	84
Figure 46	Comparison of Stratus 1 and 2 buoys IMET data, ship and ETL data on Air Temperature (°C).....	84
Figure 47	Comparison of Stratus 1 and 2 buoys and ship IMET data on Wind Speed (m/s).....	85
Figure 48	Comparison of Stratus 1 and 2 buoys and ship IMET data on Wind Direction (m/s).....	85
Figure 49	Comparison of Stratus 1 and 2 buoys IMET and ETL data on Incoming Shortwave (W/m <sup>2</sup> ).....	86
Figure 50	Comparison of Stratus 1 and 2 buoys IMET and ETL data on Incoming Longwave (W/m <sup>2</sup> ).....	86
Figure 51	Comparison of Stratus 1 and 2 buoys IMET and ETL data on Specific Humidity (g/kg).....	87
Figure 52	Comparison of Stratus 2 buoy IMET and ship TSG data on Sea Surface Salinity (psu).....	89
Figure 53	CTD Station 20, cast # 64.....	90
Figure 54	CTD Station 21, cast # 65.....	91

Figure 55	CTD Station 23, cast # 67.....	91
Figure 56	CTD Station 24, cast # 68.....	92
Figure 57	SOLO deployments on the <i>New Horizon</i> and <i>Ron Brown</i> Cruises in EPIC 2001.....	94
Figure 58	Ship Course, Speed and Bathymetry.....	98
Figure 59	Air Temperature, relative Humidity, Short wave and Barometric pressure from Shipboard IMET sensors.....	99
Figure 60	Precipitation, Sea Surface Temperature, Wind direction and Wind speed.....	100
Figure 61	Sea Surface Temperature, Sea Surface Conductivity, Sea Surface Salinity and Fluoro-Value.....	101
Figure 62	NOAA image dated from the 9 October 2001.....	102
Figure 63	NOAA image dated from the 11 October 2001.....	103
Figure 64	Zonal and Meridional Currents velocity for the shipboard ADCP.....	105
Figure 65	ADCP vectors for vertical layers of 21m to 75m.....	106
Figure 66	ADCP vectors for vertical layers of 75m to 175m.....	107
Figure 67	ADCP vectors for vertical layers of 175m to 275m.....	108
Figure 68	ADCP vectors for vertical layers of 275m to 375m.....	109
Figure 69	Basic deck equipment and deck layout.....	133
Figure 70	Three slip lines rigged on the discuss to maintain constant swing control during the lift.....	135
Figure 71	Block hung from the A-Frame.....	137
Figure 72	H-Bit winding for releasing the final 2000m of line.....	139
Figure 73	Position of the line handler and assistant.....	140
Figure 74	Deployment of glass balls.....	141
Figure 75	Diagram describing insertion of RDI ADCP into cage.....	143
Figure 76	Bottom view of buoy.....	146
Figure 77	Discus buoy after recovery.....	149
Figure 78	TPOD 3763 at 13m.....	150
Figure 79	TPOD 3263 at 100m.....	150
Figure 80	Diagram of the discus buoy and painting scheme.....	151

## List of Tables:

Table 1	CTD depths, locations and times.....	24
Table 2	SPMR locations and times.....	25
Table 3	Upper - air soundings observations.....	44
Table 4	Instrument Package Characteristics for cloud radar and radiometers.....	50
Table 5	Stratus mooring recovery information.....	61
Table 6	Stratus mooring deployment information.....	61
Table 7	IMET sensor specifications.....	69
Table 8	Meteorological sensor serial numbers Stratus 1 WHOI discus buoy.....	71
Table 9	Meteorological sensor serial numbers Stratus 2 WHOI discus buoy.....	77
Table 10	Pre-deployment Stratus 2: buoy spin done at WHOI.....	78
Table 11	Buoy spin done on the dock in Seattle, WA. IMET 1 and 2 compass/vane listings.....	80
Table 12	Argo floats locations and times.....	93
Table 13	Instruments and measurements for air-sea interaction, cloud, and precipitation studies in EPIC 2001.....	97
Table 14	Instrumentation mounted on 3 meter discus buoy of Stratus 1.....	111
Table 15	Instrumentation mounted on the mooring line of the 3 meter discus buoy of Stratus 1.....	112
Table 16	Instrumentation mounted on 3 meter discus buoy of Stratus 2.....	122
Table 17	Instrumentation mounted on the mooring line of the 3 meter discus buoy of Stratus 2.....	123
Table 18	The corresponding tachometer reading for a given ship's speed.....	138
Table 19	A list of exposed instrumentation and equipment and respective antifouling treatments.....	147
Table 20	Degree of fouling expressed as the number of organisms per square foot.....	148

## SECTION 1: Introduction

The purpose of this cruise was to conduct air-sea interaction, atmospheric and oceanographic research in the eastern tropical Pacific. As part of the Eastern Pacific Investigation of Climate processes in the Coupled Ocean-Atmosphere System (EPIC), several different science groups were on board the R/V *R H Brown* (Figure 1) to carry out studies in the air, in the ocean, and at the air-sea interface. EPIC is a CLIVAR study with the goal of investigating links between sea surface temperature variability in the eastern tropical Pacific and climate over the American continents. Important to that goal is an understanding of the role of clouds in the eastern Pacific in modulating atmosphere-ocean coupling.

EPIC is a long-running program with process studies embedded within it. As part of the enhanced monitoring component of EPIC, the Upper Ocean Processes (UOP) Group of the Woods Hole Oceanographic Institution (WHOI) had deployed in October 2001 a surface mooring under the stratocumulus deck in order to collect accurate time series of surface forcing and upper ocean variability. The mooring is located near 20°S 85°W, at the western edge of the stratocumulus cloud deck found west of Peru and Chile, and is being maintained at that site for 3 years with cruises in October 2000, October 2001, October 2002 and October 2003.

The buoy was equipped with meteorological instrumentation, including two Improved METeorological (IMET) systems. The mooring also carried Vector Measuring Current Meters, single-point temperature recorders, and conductivity and temperature recorders located in the upper meters of the mooring line. In addition to the instrumentation noted above, a variety of other instruments, including an acoustic current meter, an acoustic doppler current profiler, a bio-optical instrument package, and an acoustic rain gauge, were deployed.

The science objectives of the WHOI UOP effort are, over several annual cycles, to observe the surface forcing, to observe the temporal evolution of the vertical structure of the upper 500 m of the ocean, and to document and quantify the local coupling of the atmosphere and ocean in this region. The approach taken to meet these objectives is to establish and maintain a well-instrumented surface mooring for three years under the stratus deck and to seek cooperative participation by other investigators to make additional oceanographic and meteorological observations at the site and to use the in-situ data sets to investigate how well oceanic, atmospheric, and coupled models perform in this region.

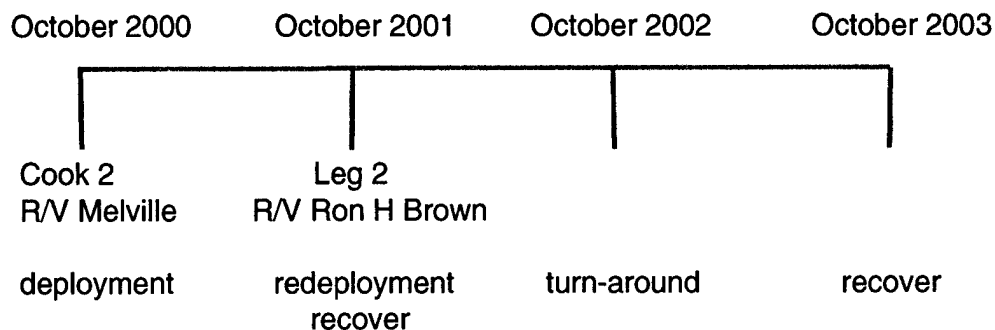
In the fall of 2001, September-October, the EPIC 2001 process study was conducted (see <http://www.pmel.noaa.gov/epic> for more information on EPIC 2001). In September, two research vessels, *R H Brown* and *New Horizon*, worked together with research aircraft along 95°W north of the Ecuador. They spent 10 days in the ITCZ at around 10°N. While *New Horizon* returned to San Diego, *Ron Brown* sailed to the Galapagos to exchange the science party and continue south of the equator.

The second leg of the R/V *Ron H Brown's* fall 2001 expedition, departed Puerto Ayora, Isla Santa Cruz, Galapagos, on October 9, 2001, at ~ 10:15 AM hours local time (16:15 UTC, October 9, 2001) with a science party (Appendix 1) from Woods Hole Oceanographic Institution (WHOI), Servicio Hidrográfico y Oceanográfico de la Armada de Chile (SHOA), University of California at Santa Barbara (UCSB), National Oceanic and Atmospheric Administration (NOAA), University of Washington (UW), University Nacional Autonoma de Mexico (UNAM), NOAA Environmental Technology Laboratory, Boulder (ETL), Instituto Oceanográfico de la Armada de Ecuador (INOCAR) and the Center for Ocean Land Atmosphere Studies, George Mason University (COLA).

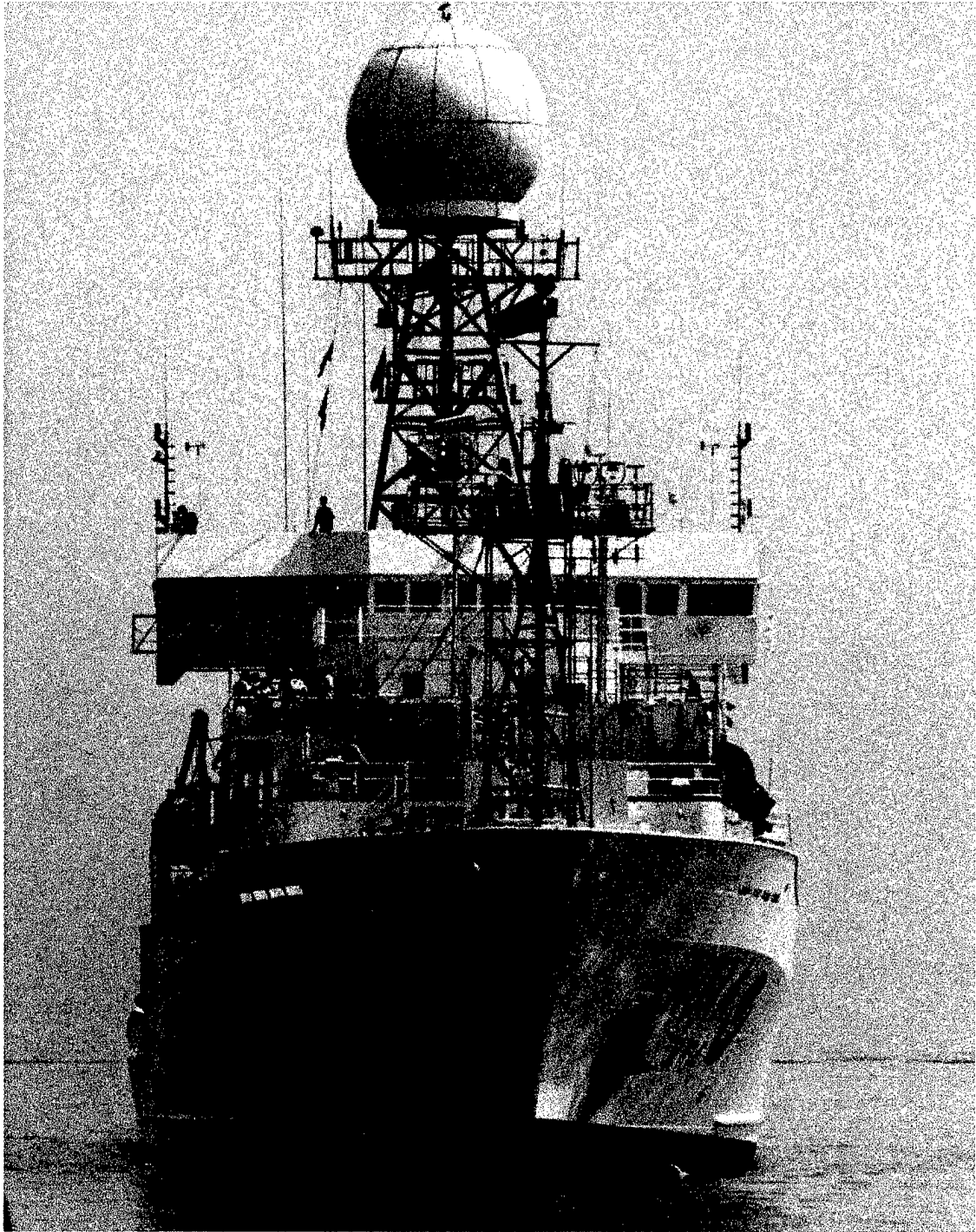
Participants from INOCAR and SHOA were on board as national observers from Ecuador and Chile, respectively. The support of these countries allowed sampling to be carried out in their national waters. Also on board were a NOAA Teacher-at-sea, Jane Temoshok (<http://www.ogp.noaa.gov/epic>) and photographer, John Kermond, from NOAA.

One of the goals of the cruise was to recover and re-deploy the surface mooring (continuing a 3-year occupation of that site, Figure 2).

The others goals of the cruise were to: 1) repair TAO buoys at 2°S, 95°W and 8°, 95°W; 2) measure air-sea fluxes along the cruise track, south along 95°W, at the WHOI mooring, and eastward under the stratus clouds off northern Chile; 3) investigate with radar and LIDAR, and balloon soundings, the structure of the atmosphere and its clouds; 4) investigate the absorption of light in the upper ocean, its spatial variability, and the variability of the biology of the upper ocean associated with changes in light absorption; 5) sample aerosols, and 6) collect routine shipboard meteorological and oceanographic observations in this data sparse region of the eastern tropical Pacific.



**Figure 1: Stratus mooring cruise schedule.**

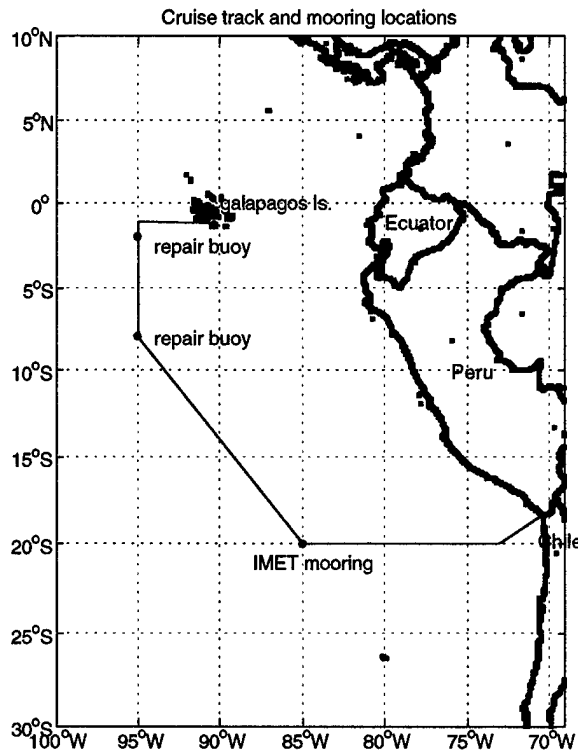


**Figure 2: NOAA research vessel *Ronald H. Brown*.**

1



The cruise track (Figure 3) started at Puerto Ayora at the Galapagos Islands. The first station was at 1°S 95°W. Work continued south along 95°W until 8°S. From there, R/V *Ron Brown* steamed to the WHOI IMET mooring site, where six days of work was done. Then R/V *Brown* steamed east along 20°S before leaving that latitude at 73 °W to enter Arica, Chile. The next section provides a more detailed cruise chronology as an overview before the work of each of the groups on board and the ship's routine underway data is described.



**Figure 3 : Cruise track and mooring location.**



## SECTION 2: Cruise chronology

On October 6, 2001, the R/V *R H Brown* arrived at Puerto Ayora, Santa Cruz Island, Galapagos. The ship departed Galapagos on October 9 at ~ 10:15 hours local at 0°44'59.3"S 90°18'09.5"W. The science party on board leg 2 included the UCSB ocean radiant heating group, the UNAM air aerosol/chemistry group, an University of Washington group working with the C-band radar and radiosondes, the ETL cloud radar group, the ETL lidar group, the ETL flux group, the WHOI surface mooring group and SHOA and INOCAR personnel participating as national observers from Chile and Ecuador.

Because of the difficulty of shipping equipment to the Galapagos, all science groups on leg 2 had loaded their equipment earlier.

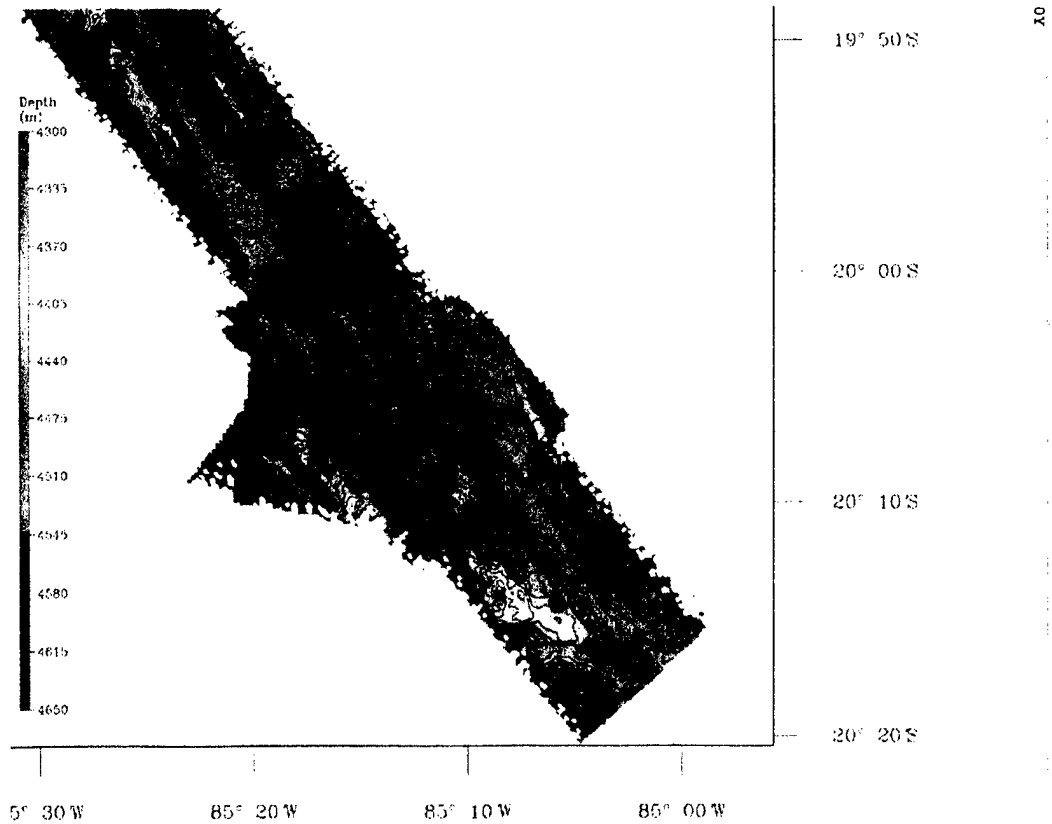
From Galapagos, the ship steamed to 1°S 95°W to begin a series of combined CTD (conductivity, temperature, depth) profiles to 500m with water sampling along with SPMR (solar radiative flux) profiles every 0.5° southward along 95°W until 8°S (see Section 3). At 2°S and again at 8°S repairs were made to TAO buoys. CTD and SPMR profiles were made at local noon while the ship was at 20°S 85°W.

During the cruise, one Argo float was deployed along 95°W, followed by three Argo floats along the transect toward the mooring site at 20° S, then two more floats were deployed between the IMET buoy and Arica, Chile. (see details Section 10)

On October 13, the WHOI group tested 2 acoustic releases down to 1000 m on the traction winch.

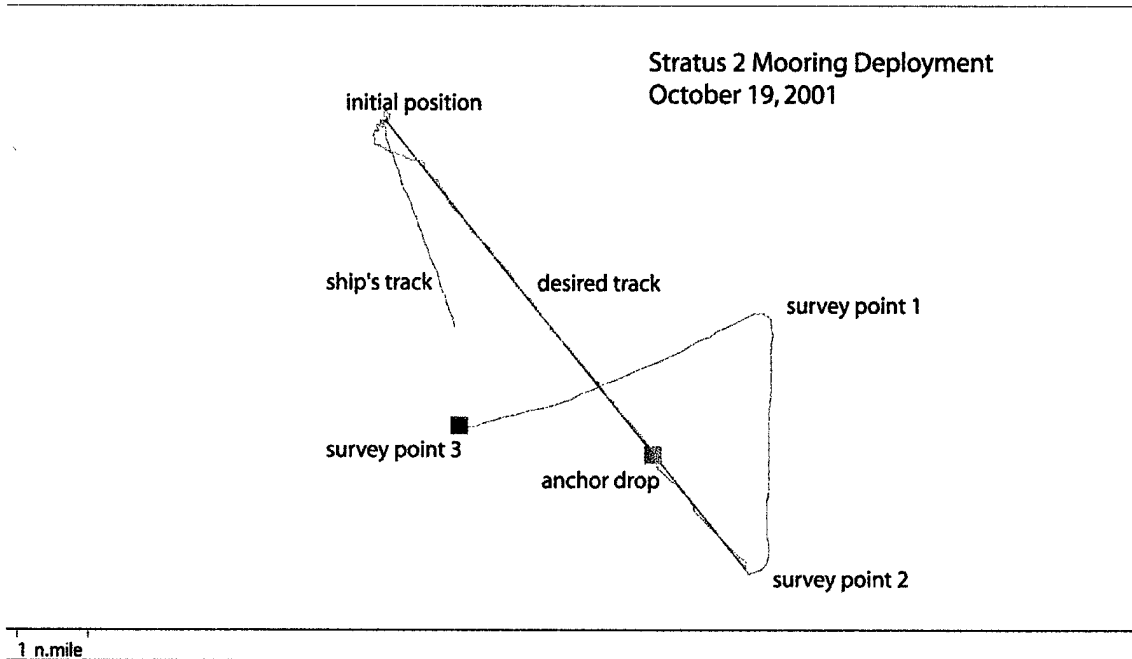
Arriving at the site for the mooring (85°W, 20°S) at ~1800 local on October 15, R/V *R H Brown* approached the WHOI IMET mooring. A visual inspection was done, using the rescue boat and showed the mooring to be in good condition. Then, R/V *Brown* parted downwind of the buoy to begin a ship-buoy comparison, collecting data telemetered from the buoy by its Argos transmitters. This comparison was interrupted only to move further away to make two 4,000 m CTD profiles. On October 17, the mooring deployed one year earlier was recovered without problem. The recovery began at 06:00 hours local on deck and the first instrument was out of water at 08:30.

On October 18, the new mooring was wound onto the TSE winch and final preparations made to the instrumentation, including application of antifouling paint, and grease to the ADCP transducer heads. Also on October 18, a bottom survey was carried out (Figure 4) using the ship's Sea Beam. A large, flat region was located that allowed the ship to steam into the wind (toward 140°), and this site was adopted as the target for the second deployment. Atmospheric sampling continued at the site on October 18.

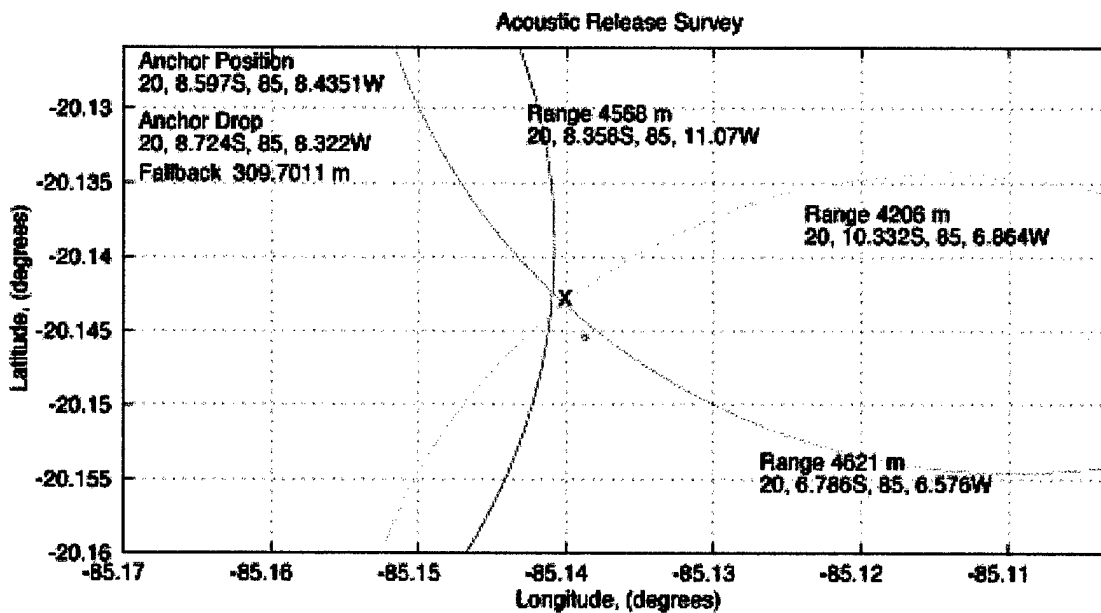


**Figure 4: Contour plot of the bottom topography mapped during the survey prior to the deployment of Stratus 2.**

On October 19, the new surface mooring was deployed. The deployment began with staging the instrumentation on deck at 06:00 hours local on October 19. The attaching of instruments to the buoy and lowering them over the side began at 07:45. The anchor was dropped at 14:46 hours local (19:46 UTC) on October 19, 2001 at 20° 08'45.1"S, 85° 08'18.0" W. Following the anchor drop, an acoustic survey of the anchor position was carried out. Figure 5 shows the track during the mooring deployment relative to the target track line as well as the ship's maneuvering during the acoustic survey and the subsequent day spent next to the surface buoy. Following the acoustic survey the release was disabled. The anchor location was identified as 20°08.597'S, 85°08.4351'W, approximately 310 m of the water depth away from the anchor drop site. Alongside the buoy, Sea Beam gave a water depth of 4454 meters (Figure 6).



**Figure 5: Target track path (black line) and ship's track (green) recorded by GPS during the mooring deployment, the acoustic survey of the anchor position, and the subsequent occupation of a position 1/4 mile downwind of the surface buoy.**



**Figure 6: Figure showing the intersection of three horizontal range arcs based on slant ranges obtained at three survey points. The small blue circle is the position at which the anchor was deployed and the X marks a best estimate of the position on the bottom of the anchor.**

After the anchor survey, the ship was positioned roughly a quarter of a mile downwind for a 24-hour comparison of ship and buoy meteorological sensors. Meteorological data from the buoy being telemetered were collected without problem onboard *R/V R H Brown*.

Atmospheric sampling continued and buoy–ship comparisons were restarted; two 4,000 m deep CTD's were taken on October 20. Tradewinds have been steady in direction with some variation in strength.

At 04:00 hours local on October 22, *R/V R H Brown* departed the mooring site, sailing eastward transit along 20°S. The RHB arrived Arica, Chile on October 25 at ~ 06:00 hours local.

After leaving the mooring site, it was learned that the Argos transmitter on IMET system #2 had failed. To provide a backup for obtaining buoy position, a transmitter was taken off Stratus 1 and placed with batteries in a waterproof box. During the subsequent leg, this box was lashed to the deck of the Stratus 2 buoy by the crew of *R/V Brown*.

The Plans of the Day (POD) aboard the *R/V R H Brown* ship during Leg 2 are shown in Appendix 7.

## SECTION 3: UCSB optical / CTD profiles

### 1. Introduction

The subject of the University of California, Santa Barbara group (UCSB group) is the study of the time and space variability of the underwater light field and the light absorbing components of the upper ocean. The heat budget of the mixed layer is a direct function of these light absorbing components through their modulation of the quality and quantity of light available, and light that passes through the mixed layer. Quantifying the role of this radiation penetration was their primary goal in the EPIC program. This is achieved through the measurement of surface irradiance, in-water solar fluxes, CTD profiles, and discrete samples taken for chlorophyll *a* and nutrient (NO<sub>3</sub>, PO<sub>4</sub>) analyses. Additionally, acquisition of high resolution (~1 km) SeaWiFS ocean color data complements the shipboard measurements with spatial variability of the observed variables.

### 2. Selected samples

The UCSB sampling during this cruise consisted of continuous 0.5° resolution along 95°W south of the equator and temporal sampling at the IMET buoy site. Data collected along the 95°W meridian gave a good understanding of chlorophyll and nutrient distributions across the cold tongue region and allowed to examine their role on upper ocean radiant heating rates in this dynamic region.

A total of 27 CTD stations (Table 1) taken on Leg 2 resulted in ~200 chlorophyll *a* samples and ~300 nutrient samples. Chlorophyll concentrations were highest near the equator (Figure 7 and 8). Water samples were filtered to measure chlorophyll concentration aboard the R/V *R H Brown*, and water samples were frozen and stored for nutrient analysis in the lab back at UCSB. In addition, 33 SPMR profiles shown in table 2 were collected and ~19 SeaWiFS overpasses were recorded.

The Satlantic Inc. SPMR (SeaWiFS Profiling Multichannel Radiometer) is a long (~ 120 cm), slender (~ 9 cm diameter) hand-deployed instrument that measures downwelling irradiance and upwelling radiance in 11 spectral bands (340 to 685 nm). The measured quantities are transmitted through a data cable and recorded on a computer set up in the ship's lab. An SPMR profile to 100 m was made every hour during daylight while at each of the long-term stations. A similar single profile (100m) was performed at each CTD station made during daylight hours.

An SPMR profile involves hand-lowering the instrument into the water with the ship moving slowly (~ 1 knot) forward so that ship-SPMR separation occurs. Once the instrument is ~ 30 m from the ship the SPMR is allowed to free-fall to 100 m. The instrument is kept away from the ship to avoid ship motion and shadowing effects. Once 100 m is reached the SPMR is pulled in by hand with the help of a small manual winch/spool.

Figure 7 is a vertical section of the chlorophyll data along the 95W transect. The cold tongue region is easily seen as an area of elevated chlorophyll values due to nutrient input from vigorous upwelling near the equator, while values fall off relatively quickly away from the equator. This is in contrast to the profiles collected at the IMET site which shows much lower, uniform values throughout the mixed layer (Figure 8). These differences will invariably be important to the structure of the underwater light field.

The optical data requires further processing in order to compute heat fluxes. Once done, these estimates can be combined with the observed chlorophyll and nutrient measurements to examine their role on the solar flux divergence. The SeaWiFS data can be used in much the same way, and also requires further processing.

Figure 1. Chlorophyll along the 95W transect. Values are taken at 0.5 degree intervals and 20 m depths.

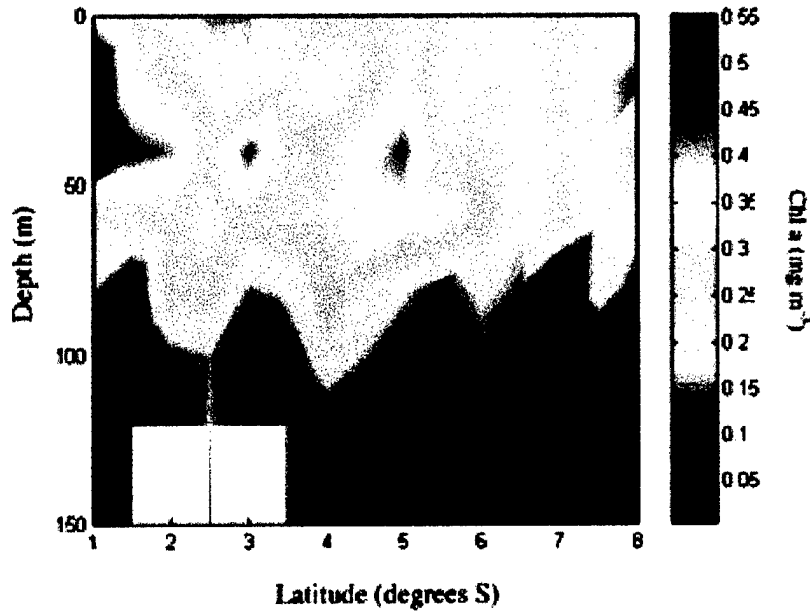
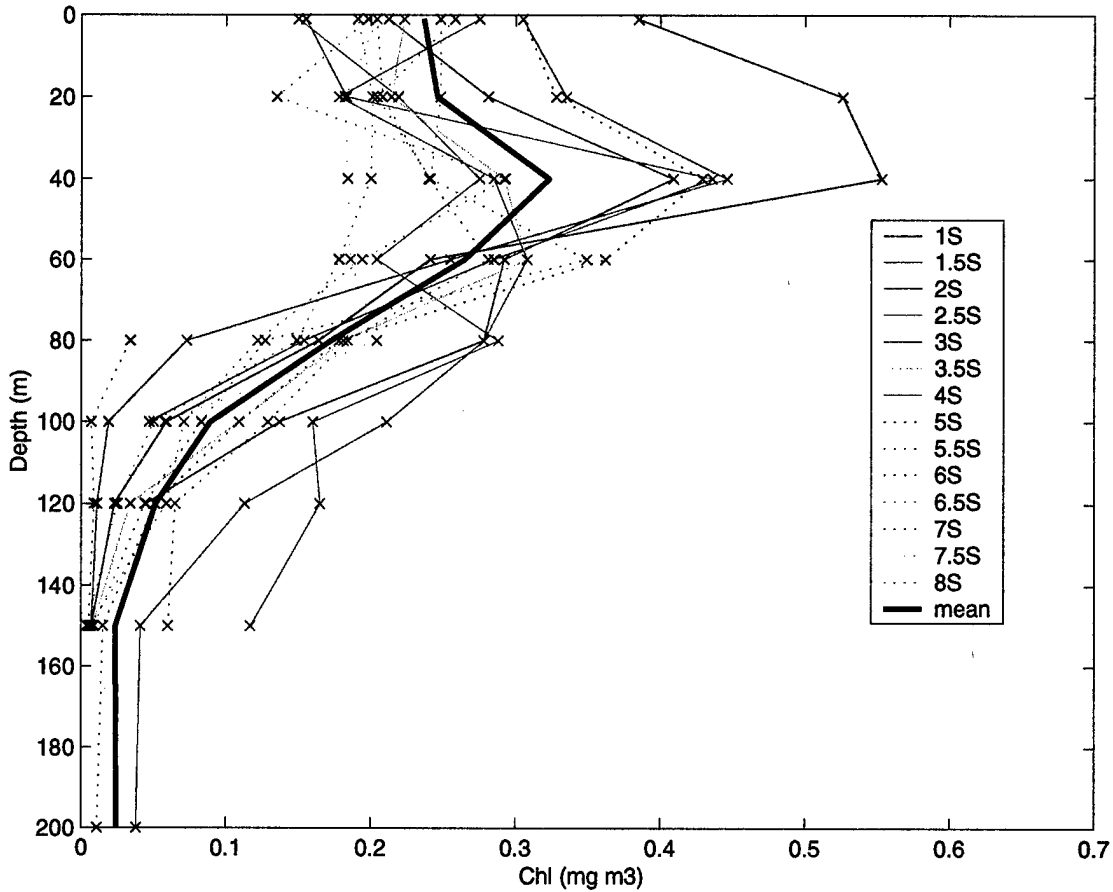


Figure 7 : Chlorophyll along the 95°W transect. Values are taken at 0.5° intervals and 20m depths.





**Figure 8: Chlorophyll profiles in the upper 200 m at the stations from 1° to 8° S.**

Chlorophyll concentrations (mg/m<sup>3</sup>) represented above for the stations taken at 0.5 degrees intervals from 1°S to 8°S along the 95°W in the upper 200 m, were highest near the equator and have more elevated values near the surface reaching 0.55 mg/m<sup>3</sup> at 1°S. Chlorophyll values decrease quickly past 40 m due to the reduced nutrient and the lack of oxygen. There is no more trace of chlorophyll from the lower 150 m except for the stations at 4°S and 5°S.

**Table 1: CTD depths, locations and times.**

CTD	CTD Cast #	Date	Start time (UTC)	Start latitude	Start longitude	Bottom Depths	CTD depths
Stations		2001	(UTC)	(ddmm.mm')	(ddmm.mm')	(m)	(m)
1	45	10-Oct	13:46	1°00.12	95°00.02	3330	500
2	46	10-Oct	16:48	1°30.027	95°10.054	3327	500
3	47	10-Oct	22:23	1°54.936	95°19.103	3398	500
4	48	11-Oct	2:29	2°30.074	95°08.463	3441	500
5	49	11-Oct	5:55	3°00.057	95°00.046	3550	500
6	50	11-Oct	9:20	3°29.934	95°00.010	3080	500
7	51	11-Oct	12:39	4°00.09	95°00.07	3654	500
8	52	11-Oct	16:05	4°30.010	95°00.00	3857	500
9	53	11-Oct	19:25	5°00.00	94°59.97	3984	500
10	54	11-Oct	22:54	5°29.892	95°00.035	3848	500
11	55	12-Oct	2:09	5°59.923	95°00.090	3838	500
12	56	12-Oct	5:23	6°30.022	94°59.939	3894	500
13	57	12-Oct	8:46	6°59.920	95°00.022	3985	500
14	58	12-Oct	12:01	7°29.98	95°03.18	3960	500
15	59	12-Oct	17:47	7°59.93	95°09.64	3939	500
16	60	13-Oct	18:13	11°53.20	91°55.59	2878	500
17	61	14-Oct	17:45	15°23.22	89°05.62	4142	500
18	62	15-Oct	17:44	19°23.66	85°47.01	4335	500
19	63	16-Oct	1:47	20°09.349	85°10.925	4434	100
20	64	16-Oct	14:57	20°06.335	85°20.402	4398	4000
21	65	16-Oct	18:03	20°06.15	85°20.76	4426	4000
22	66	18-Oct	17:08	20°08.43	85°11.26	4514	500
23	67	20-Oct	14:06	20°02.424	85°19.152	4528	4000
24	68	20-Oct	16:01	20°02.504	85°18.838	4550	4000
25	69	21-Oct	17:50	20°07.13	85°10.31	4514	500
26	70	22-Oct	16:49	20°07.53	83°16.16	4495	500
27	71	23-Oct	16:35	20°07.69	77°54.66	4700	500

**Table 2: SPMR locations and times**

SPMR Numbers	Date 2001	Start times (UTC)	Start latitude (ddmm.mm')	Start longitude (ddmm.mm')	Bottom Depths (m)
1	10-Oct	13:12	1°00.10	94°59.81	3325
2	10-Oct	17:30	1°29.97	95°10.40	
3	10-Oct	22:03	1°54.45	95°18.56	3425
4	11-Oct	15:51	4°30.02	95°00.17	3854
5	11-Oct	19:13	4°59.98	94°59.95	3981
6	11-Oct	22:37	5°29.99	95°00.08	3865
7	12-Oct	16:04	7°59.88	95°09.63	3937
8	13-Oct	18:01	11°53.15	91°55.61	2987
9	14-Oct	17:34	15°23.23	89°05.65	4138
10	15-Oct	17:32	19°23.70	85°47.06	4330
11	16-Oct	13:30	20°09.09	85°10.90	4431
12	16-Oct	17:44	20°06.27	85°20.53	4415
13	16-Oct	20:39	20°06.15	85°20.74	4426
14	18-Oct	13:24	20°09.28	85°10.27	
15	18-Oct	14:32	20°09.15	85°10.42	
16	18-Oct	15:52	20°08.91	85°09.98	
17	18-Oct	16:55	20°08.41	85°11.31	
18	18-Oct	19:08	19°59.96	85°18.63	4510
19	18-Oct	20:21	20°00.44	85°18.16	4497
20	20-Oct	15:24	20°02.43	85°18.46	4571
21	20-Oct	18:48	20°02.50	85°18.80	4554
22	20-Oct	20:36	20°07.46	85°10.33	4504
23	20-Oct	21:55	20°07.43	85°10.20	4510
24	20-Oct	23:00	20°07.42	85°10.28	4512
25	21-Oct	13:18	20°07.10	85°07.18	4402
26	21-Oct	14:45	20°07.09	85°09.95	4469
27	21-Oct	15:59	20°07.20	85°10.00	4480
28	21-Oct	17:33	20°07.14	85°10.35	4522
29	21-Oct	18:55	20°07.27	85°10.10	
30	21-Oct	20:20	20°07.41	85°10.04	4501
31	21-Oct	22:00	20°07.32	85°09.99	4512
32	22-Oct	16:37	20°07.44	83°16.18	4500
33	23-Oct	16:20	20°07.62	77°54.84	4706



## SECTION 4: ETL Flux system

### 1. Background on Measurement Systems

The ETL air-sea flux group conducted measurements of fluxes and near-surface bulk meteorology during Leg 2 of the EPIC2001 field program. The ETL flux system was installed initially in San Diego in October 2000 and brought back into full operation in Seattle in mid-August, 2001. It consists of five components: (1) a fast turbulence system with ship motion corrections mounted on the jackstaff. The jackstaff sensors are: Gill-Solent Sonic anemometer/thermometer, Ophir IR-2000 Infrared hygrometer, LiCor LI-7500 fast CO<sub>2</sub>/H<sub>2</sub>O gas analyzer, and a 3-axis Systron-Donner accelerometer/rotation rate sensor package; (2) a mean T/RH sensor (Vaisala) in an aspirator on top of the bow tower; (3) solar and infrared radiometers (Eppley pyranometer/pyrgeometer) mounted on the tower; (4) a near surface sea surface temperature sensor consisting of a floating thermistor deployed off port side with outrigger ("seasnake"); (5) a set of four optical rain gauges mounted on the bow tower. The mean meteorological data (Tair, RH, solar, IR, rain, Tsea) are digitized on Campbell 23x datalogger and transmitted via RS-232 as 1-minute averages. A central data acquisition computer logs all sources of data via RS-232 digital transmission:

1. Sonic anemometer/thermometer
2. Licor CO<sub>2</sub>/H<sub>2</sub>O
3. Slow means (Campbell 23x)
4. Unused
5. Ophir hygrometer
6. Systron-Donner Motion-Pak
7. Ship's SCS
8. GPS

At sea, we run a set of programs each day for preliminary data analysis and quality control. As part of this process, we produce a quick-look ascii file that is a summary of fluxes and means. The data in this file comes from three sources: The ETL sonic anemometer (acquired at 20.83 Hz), the ship's SCS system (acquired at 2 sec intervals), and the ETL mean measurement systems (sampled at 10 sec and averaged to 1 min). The sonic is 5 channels of data; the SCS file is 17 channels, and the ETL mean system is 39 channels. A series of programs are run that read these data files, decode them, and write daily text files at 1 min time resolution. A second set of programs reads the daily 1-min text files, time matches the three data sources, averages them to 5 or 30 minutes, computes fluxes, and writes new daily flux files. A set of time series graphs is also stored each day. The 30-min daily flux files have been combined and rewritten as a single file to form the file 'flux30\_sum.txt'. The daily graphs and the 5-min daily ascii file are stored in the individual dayDDD directories (DDD=yearday where 000 GMT January 1, 2001 =1.00). File structure is described in epic\_flux\_readme.txt.

ETL also operated two auxiliary remote sensors: a Vaisala CT-25K cloud base ceilometer and an ETL 915 MHz wind profiler. The ceilometer is a vertically pointing lidar that determines the height of cloud base from time-of-flight of the backscatter return from the cloud. The time and spatial resolutions are 15 second and 30 meters, respectively. The raw backscatter profile is stored in one file and cloud base height information deduced from the instrument's internal algorithm is stored in another. The ceilometer file structure is described in ceilo\_readme.txt. The 915 MHz wind profiler uses 5 beams (one vertical and four tilted at 15 degrees from zenith oriented N-S and E-W) to measure profiles of the wind vector from about 200 to 5000 m, depending on the scattering conditions. Raw data are processed to 1-hr consensus

files. Preliminary images of daily time-height wind vector diagrams are presently available. Considerable reprocessing is needed to remove velocity effects of precipitation and eliminate outliers caused by ship maneuvers.

## 2. Selected Samples

### *a. Flux Data*

Preliminary flux data is shown for yearday=293 (October 20, 2001). The time series of ocean and air temperature is given in Figure 9. The water temperature is about 18.5°C and the air temperature is about 17.5°C until it rises at mid-day to about 18.0°C. A perusal of the Leg 2 temperature plots shows the ubiquitous nature of the Leg 2 stratus environment, where the dynamics are suppressed and convective activity is at a minimum. The wind speed during that period is shown in Figure 10, with an initial value of about 9 m/s, dropping to around 7.5 m/s by the end of the Julian day. The solar flux time series (Figure 11) which show maximum mid-day values around 1100 Wm<sup>-2</sup>, with significant modulation of the incoming solar due to the stratus cloud ceiling. The effect of clouds on the downward IR radiative flux is illustrated in Figure 12, where the daytime flux is relatively high (390W m<sup>-2</sup>), as the low-level water clouds are strong emitters of IR radiation and their presence causes the warming. Nighttime scattered clearing appears to show modulation of the flux. Figure 13 shows the time series of the four of the five primary components of the surface heat balance of the ocean (solar flux has been omitted for clarity). The largest term is the latent heat (evaporation) flux, followed by the net IR flux (downward minus upward), the sensible heat flux, and the flux carried by precipitation (zero). Typical values in the Pacific warm pools (Leg 2 is conducted within the upwelling regime) for the first three are about 100 Wm<sup>-2</sup> for latent, -50 Wm<sup>-2</sup> for net IR, and 10 Wm<sup>-2</sup> for sensible heat. We are using the meteorological sign convention for the turbulent fluxes so all three fluxes actually cool the interface in this case. The time series of net heat flux to the ocean includes the contribution due to net solar radiative flux. The sum of the components in Figure 13 is about -160 Wm<sup>-2</sup>, which can be seen in the night time values; the large positive peak during the day is due to the solar flux. The integral over the entire day gives an average flux of 61 Wm<sup>-2</sup>, indicating warming of the ocean mixed layer. The sea surface temperature is seen in Figure 14.

### *b. Ceilometer and Wind Profiler Data*

A sample ceilometer 12-hr time-height cross section for October 20 (12 - 24 GMT). The upper panel shows cloud base heights as white dots and obscured conditions as purple dots. The lower panel is color-coded backscatter intensity. The vertical scale must be multiplied by 2 (i.e., maximum range is 8 km). This day had 86% cloud cover and a steady cloud base of about 900 meters. As was typical for the Leg 2 regime, no rain fell during this day.

A sample radar wind profiler 24-hr time-height vector diagram for October 20. Note that time is plotted backwards in this graph. The arrows indicate wind direction and the colors wind speed. This day has low level easterlies and south easterlies of about  $5 \text{ ms}^{-1}$  which change to  $10 \text{ ms}^{-1}$  easterly above 1 km.

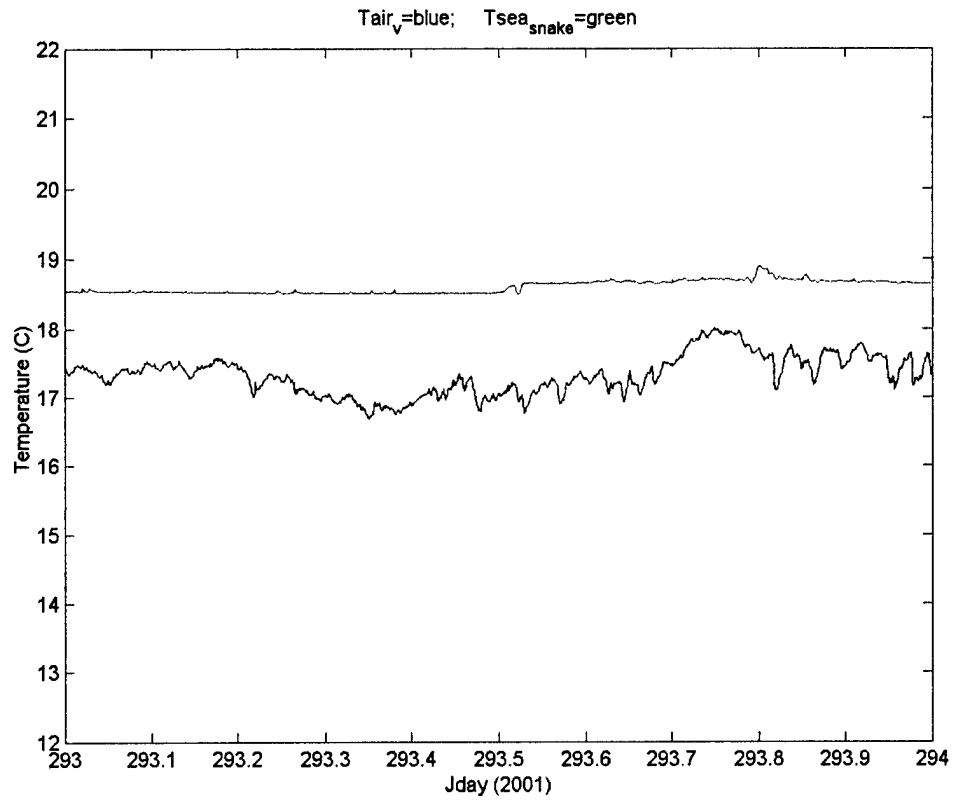
## **3. Cruise Summary Results**

### *a. Basic Time Series*

The 30-minute time resolution time series for sea/air temperature are shown in Figure 15 and for wind speed and N/E components in Figure 16. Time series for flux quantities are shown as daily averages. Figure 17 gives the 24hr rainfall accumulation, Figure 18 the flux components, Figure 19 the net heat flux to the ocean. The ubiquitous nature of the dry stratus regime is clearly evident in these time series.

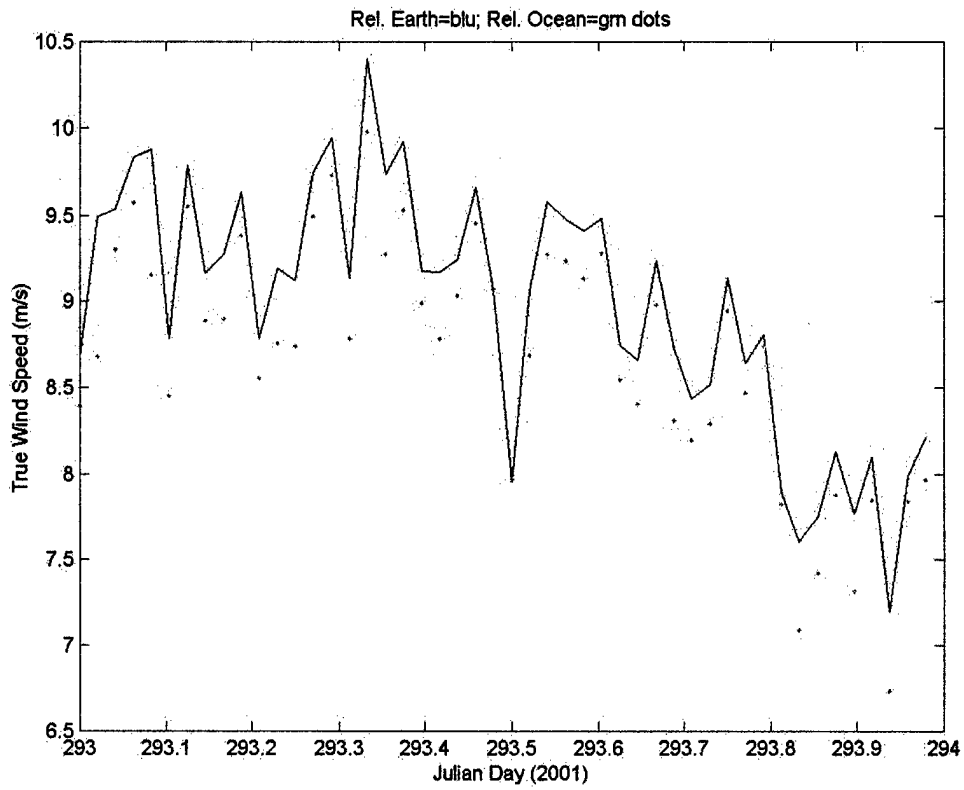
### *b. Diurnal Cycles*

We have computed mean diurnal cycles (in local time) for selected variables. The time period for the averages is days 283 - 296, which encompasses the Leg 2 cruise. In Figure 20, we show the composite rainfall; Figure 21 shows sea/air temperatures. Very little rain fell at the ship during the Leg 2 cruise, and the total rainfall (uncorrected) for the entire experiment was approximately 7 mm. The net heat flux shows the typical night time cooling is around  $100 \text{ Wm}^{-2}$ , while the average net heat flux for the entire experiment was about  $+90 \text{ Wm}^{-2}$ . This is a stark contrast to the Leg 1 data, as net cooling of about  $20 \text{ Wm}^{-2}$  occurred north of the Equator. For comparison, typical values in the tropical west Pacific warm pool are around  $+35 \text{ Wm}^{-2}$ . The diurnal cycle of air temperature is smaller than that for SST, which is typical of this area and is, again, a stark contrast to the Leg 1 observations.

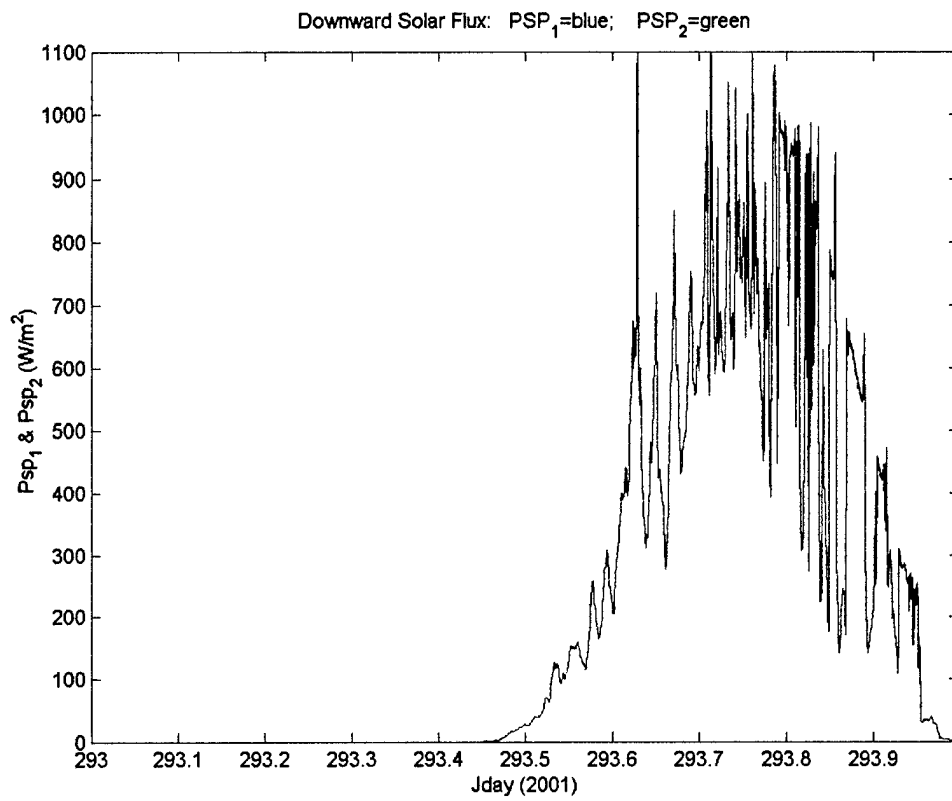


**Figure 9: Time series of near – surface ocean temperature and 15 m air temperature.**

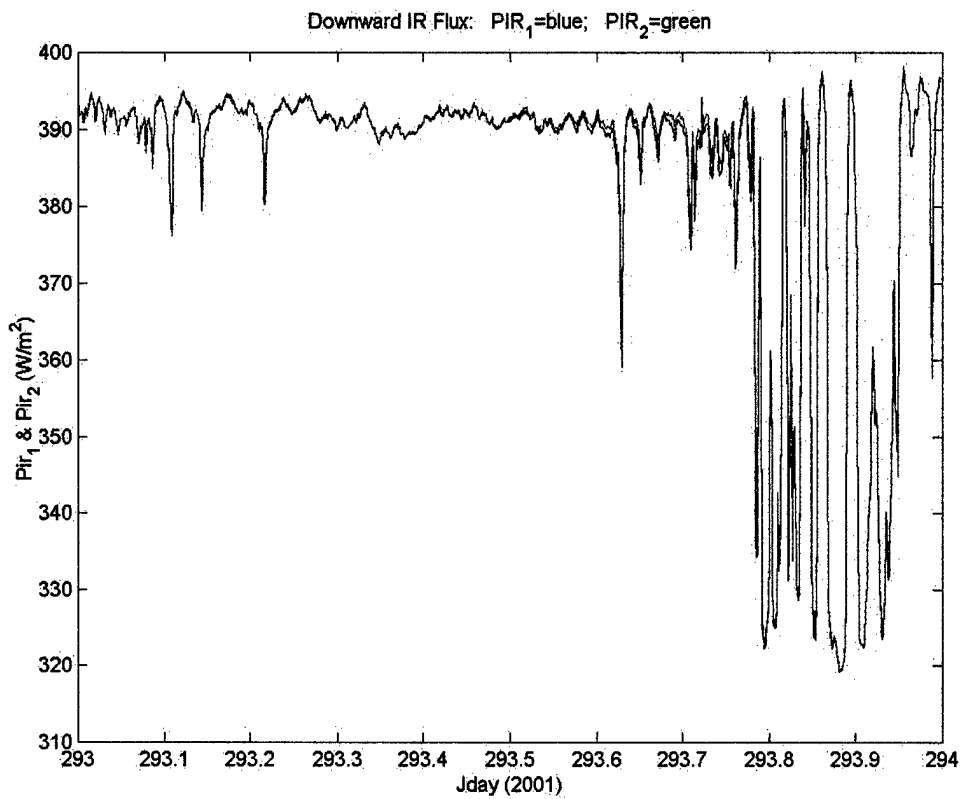




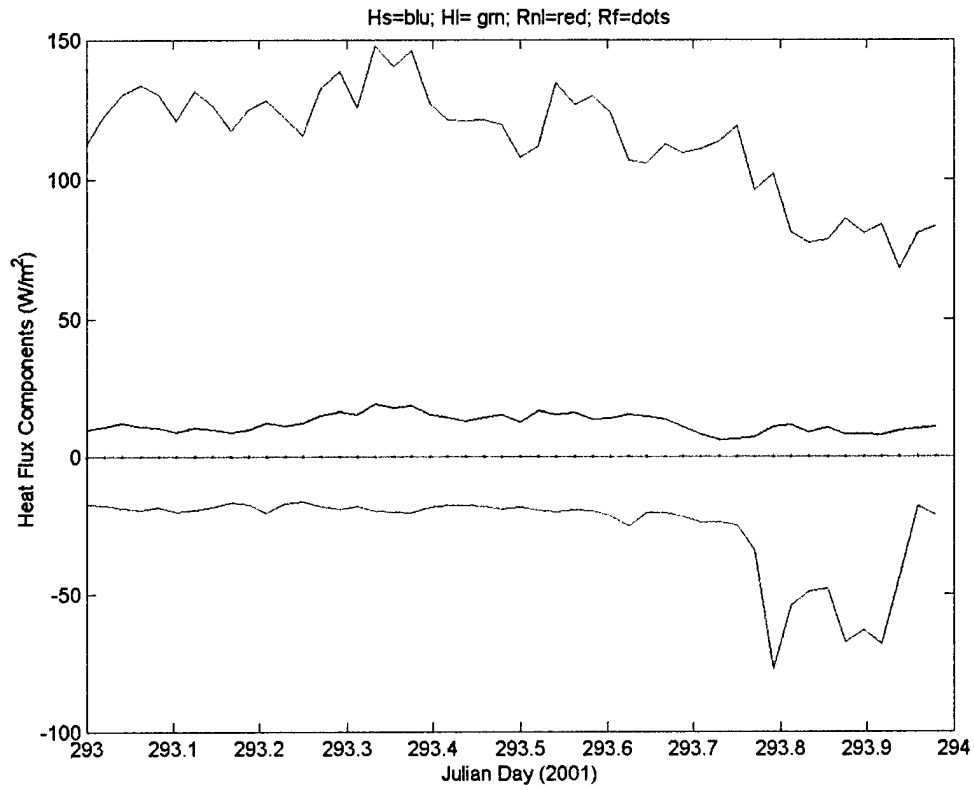
**Figure 10: Time series of 18 m wind speed.**



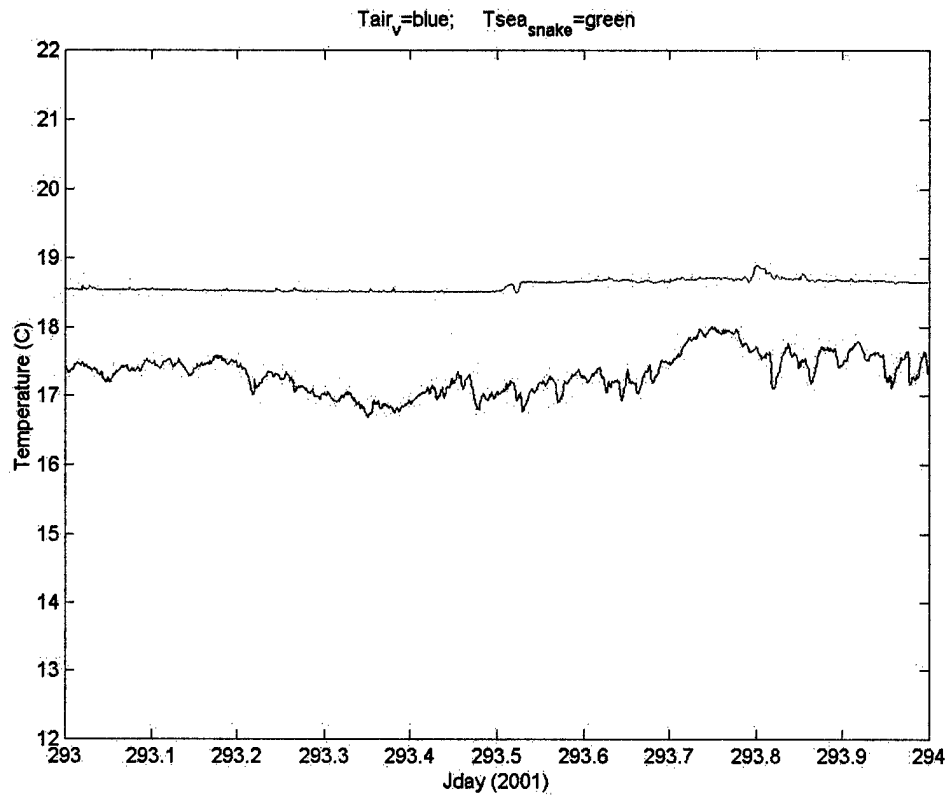
**Figure 11: Time series of downward solar flux.**



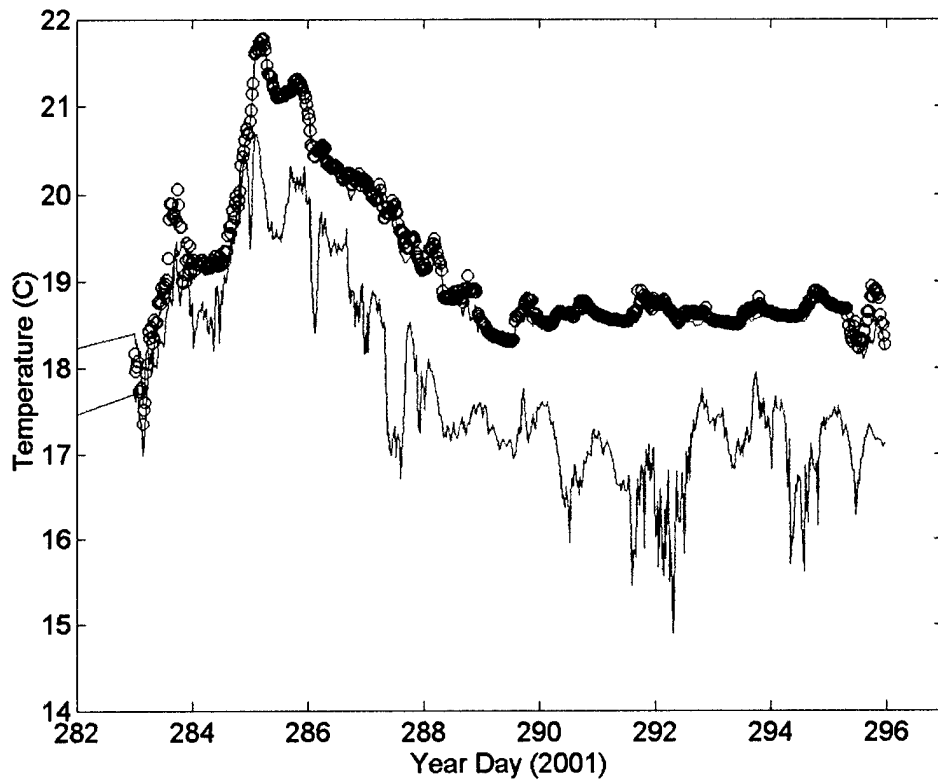
**Figure 12: Time series of downward infrared radiative flux.**



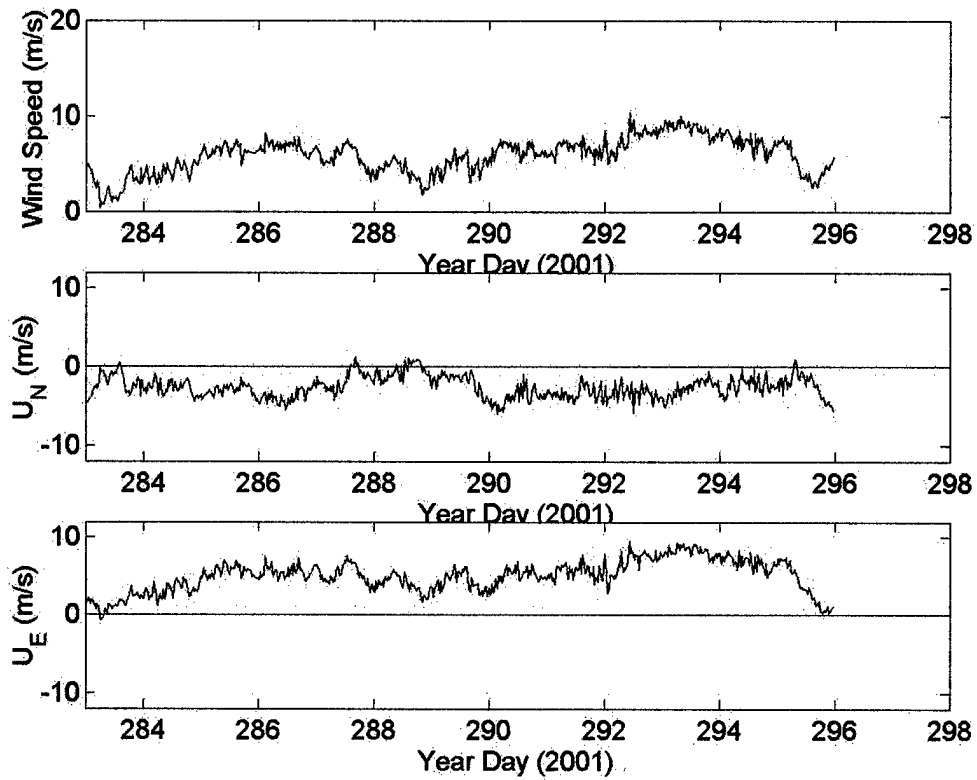
**Figure 13: Time series of surface net heat flux components in meteorological coordinates. Sensible, latent, net infrared (downwelling minus upwelling), and rain.**



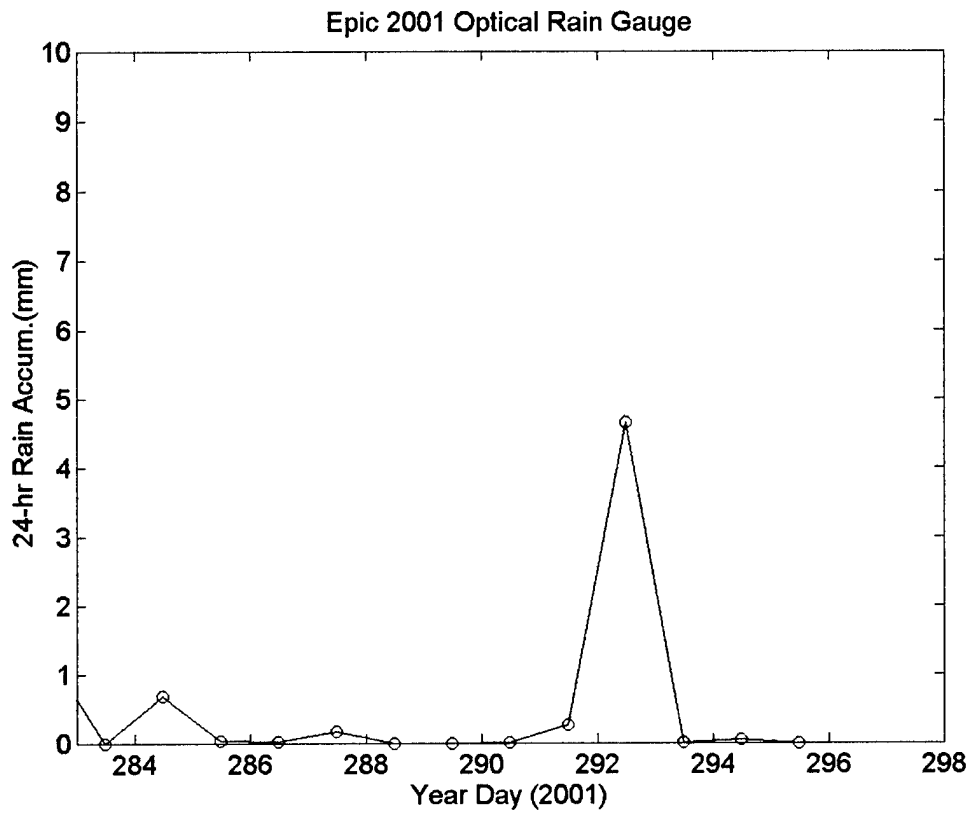
**Figure 14: Time series of ocean temperature. Blue line is 5 – meter depth ship thermosalinograph intake, green dots are the ETL seasnake (approximately 5 – cm depth).**



**Figure 15: Time series of sea surface temperature (from ETL seasnake) and 18 m air temperature (ETL) for the Epic 2001 Leg 2 time period.**

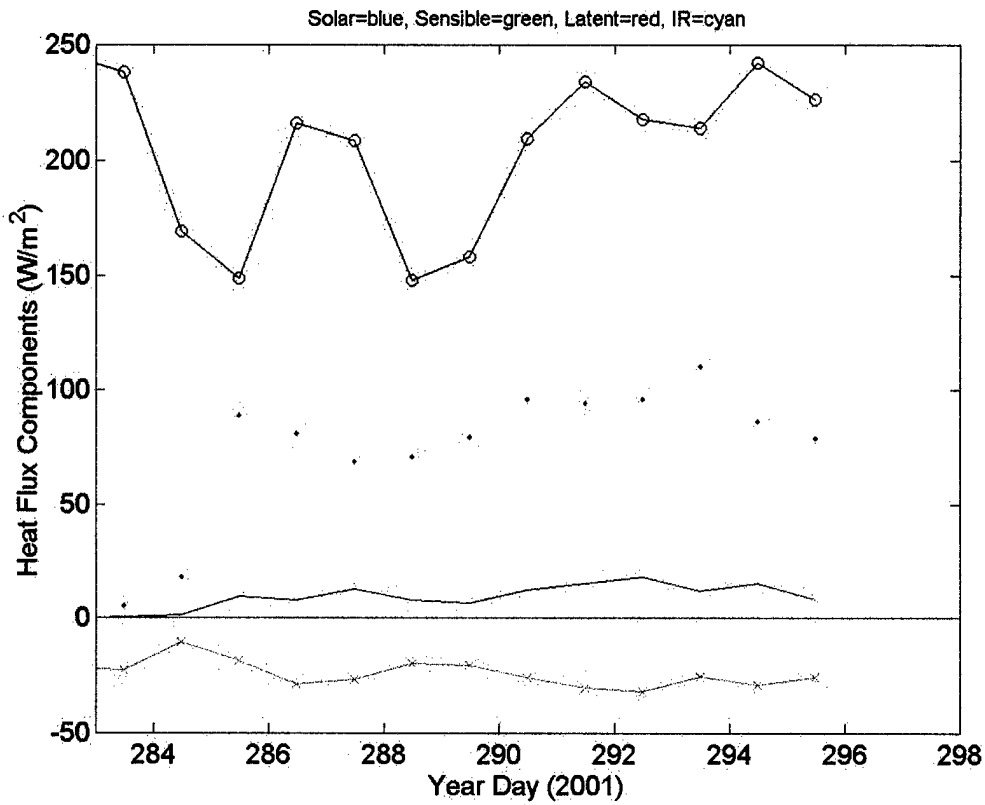


**Figure 16: Time series of wind speed (upper panel), northerly wind component (middle panel), and easterly wind component (lower panel).**

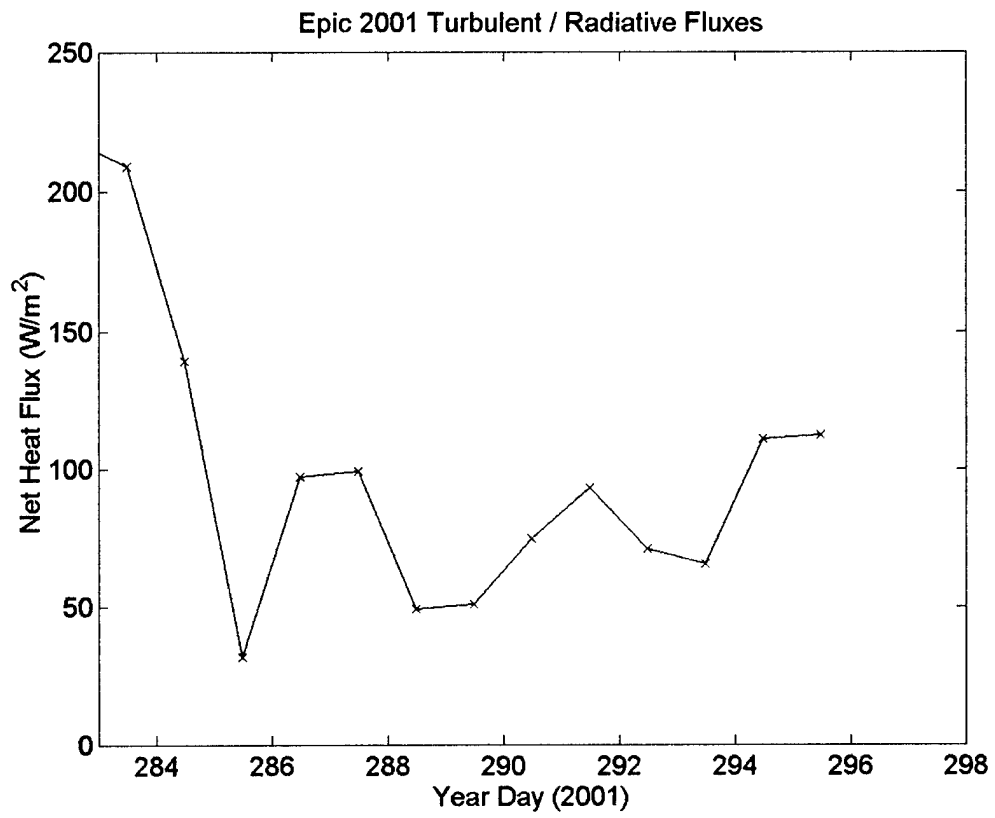


**Figure 17: Time series of 24 – hour rain accumulation for Leg 2.**

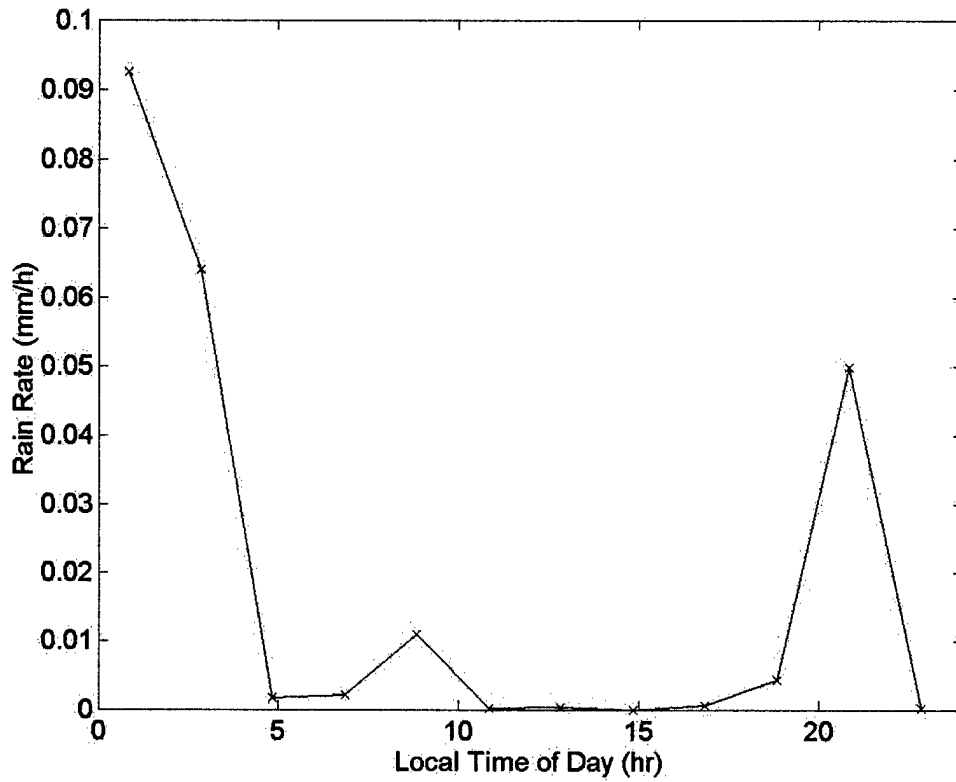




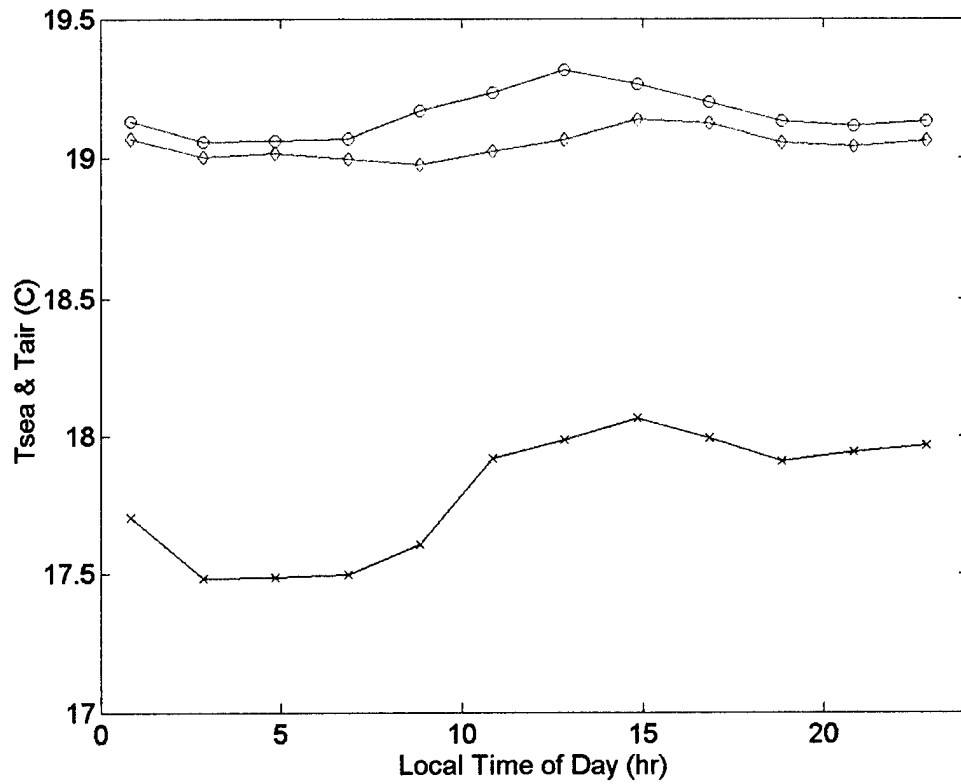
**Figure 18: Time series of daily – averaged flux components: solar radiative flux (dashed blue), net infrared radiative flux (cyan x), sensible heat flux (green solid), and latent heat flux (red dots).**



**Figure 19: Time series of daily – averaged net heat flux into the ocean.**



**Figure 20: Diurnal average of rainfall for the Epic 2001 Leg 2 period.**



**Figure 21: Diurnal average of temperatures (red – 5m SCS; green – 5cm; blue – 15m air temperature) for the Epic 2001 Leg 2 period (days 283-297).**

## SECTION 5: C-Band-Radar and upper-air soundings

The main goal of the University of Washington (UW) observations was to assess the degree to which the depletion of cloud water by precipitation processes, such as drizzle, regulates the southeast Pacific subtropical stratocumulus cloud cover and liquid water path. To accomplish this goal, the UW team employed several types of observations, including radar, upper air soundings, WMO weather observations, cloud photography, and drizzle drop collection.

Scanning C-band radar observations yield information on the three-dimensional structure, distribution, and evolution of drizzle-bearing clouds. Azimuthal scans were performed at 11 different elevation angles every five minutes for most of the cruise. A full set of azimuthal scans is called a volume scan. Sets of vertical scans were also performed 10 times per hour. The vertical scans were obtained in four directions (north, south, east and west) from 0.5 to 20 degrees elevation. Surveillance scans (azimuthal scans at coarser resolution and greater range than the volume scans) were performed every thirty minutes.

At approximately 5 a.m. local time (11 UTC) on October 21 (Day 294) the radar data in Figure 22 were obtained. The figure shows an interpolated horizontal cross-section at 0.95 km altitude of the radar volume data. The range rings mark 3 km range intervals from the ship, which is located in the center of the image. The radar reflectivity scale, in dBZ, is shown on the right. This figure illustrates the cellular nature of the drizzle that was seen throughout the cruise. Drizzle cells with radar reflectivity  $> \sim 15$  dBZ are present with some particularly strong cells to the NNW of the ship position. Most models and theories represent the cloud and drizzle characteristics of the stratocumulus region as varying diurnally but assume horizontal homogeneity at a given time. The data collected in Leg 2 of the EPIC cruise illustrate the inhomogeneity of the instantaneous drizzle structure across the area sampled by the ship radar.

GPS upper-air soundings documented the vertical profile of temperature, moisture and wind within and above the boundary layer. The upper air soundings or "weather balloons," directly measure temperature, pressure, and relative humidity. Through communication with at least three GPS satellites, environmental wind speed and wind direction can also be determined. Upper air soundings were launched every three hours for the duration of the cruise starting at 17 UTC October 10 (Day 283) and ending at 02 UTC on October 25 (Day 298).

The upper-air sounding that corresponds to the radar data in Figure 22 is shown in Figure 23. A sharp temperature inversion (temperature increase with increasing height) occurs at cloud top at  $\sim 1.2$  km altitude associated with a rapid decrease in the dew point temperature (moisture). The inversion height was fairly consistent throughout Leg 2 of the cruise. Cloud base is approximately the point below the inversion where the dew point temperature and air temperature first become equal.

Because the boundary layer was only about one kilometer thick, a sounding reaching five kilometers would include all of the data necessary to analyze the boundary layer, including above-inversion conditions. Data collected between 5 and 15 km shows additional large-scale features, such as subsidence, discussed below. Table 3 gives a summary of the heights reached by the upper air soundings.

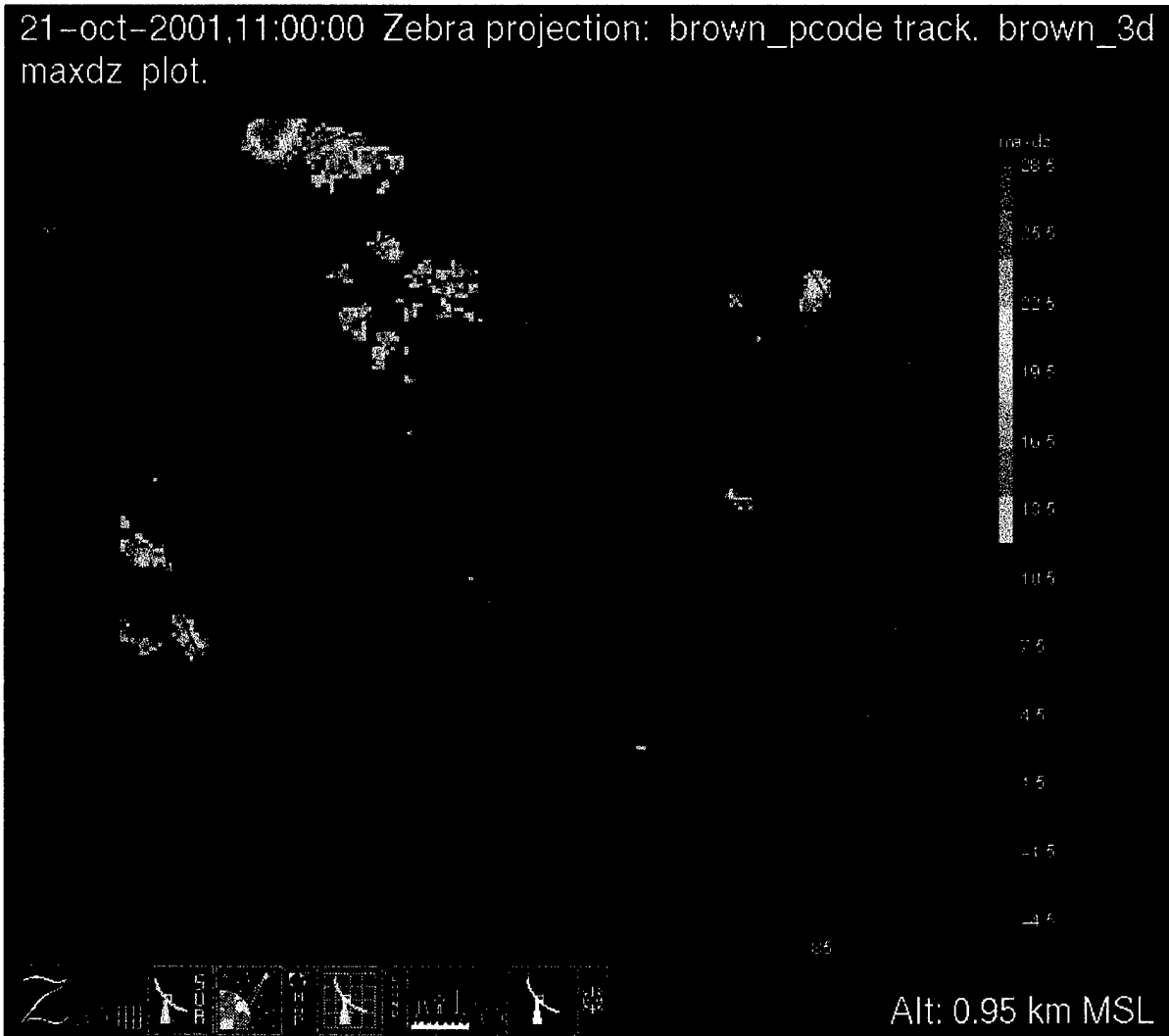
**Table 3: Upper-air Sounding information**

Total number of soundings	116
Number reaching 5 km	106
Number reaching 15 km	69

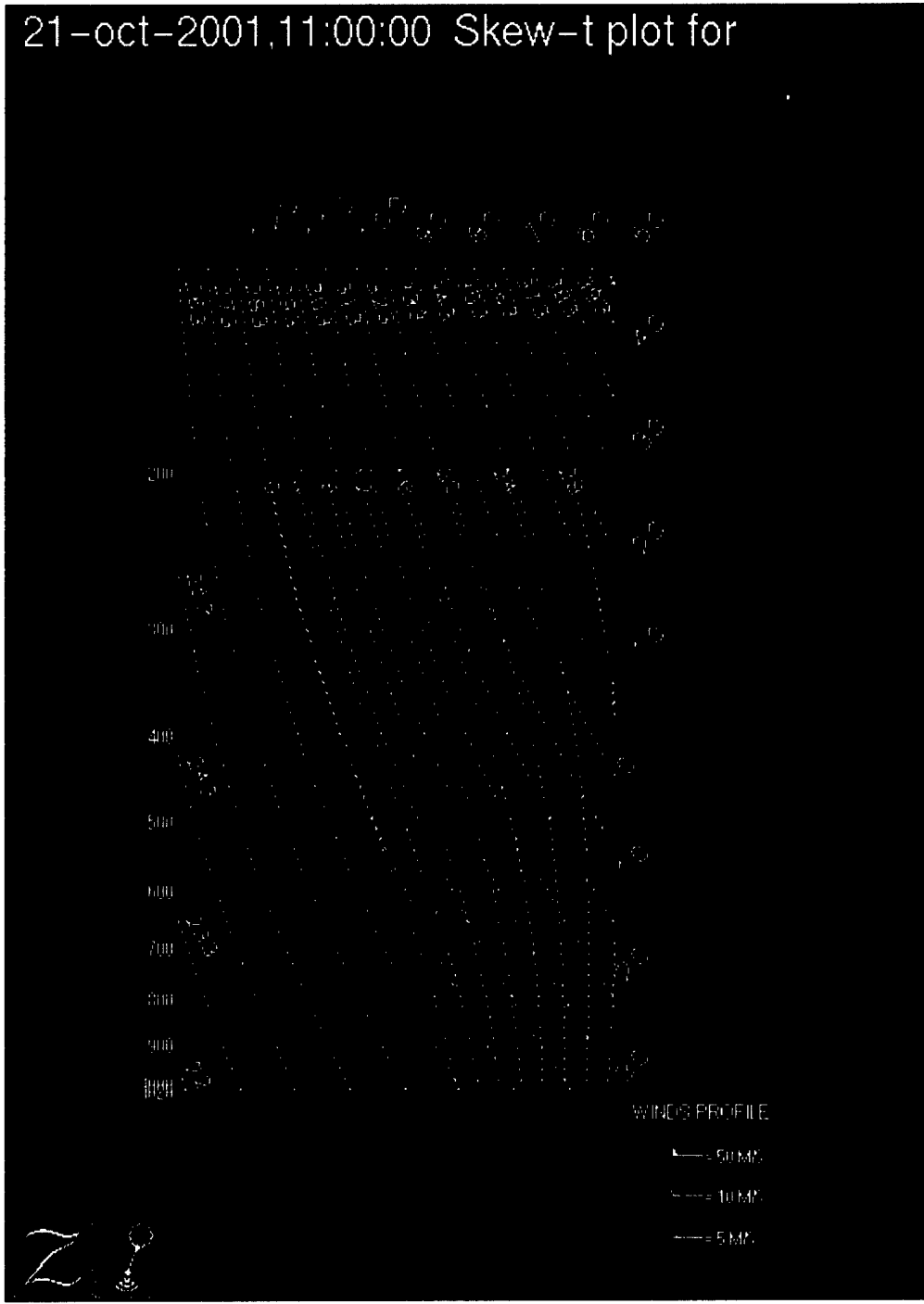
Figure 24 shows a time plot of relative humidity, created by using all of the upper air sounding data from the cruise. The data shown are the raw data without quality control. The inversion can be identified by the rapid vertical transition from saturated (stratocumulus clouds) to dry conditions. Evidence of large-scale subsidence, which causes the inversion to be particularly strong in this region, is shown by features (e.g. dry and moist layers) that slope downward with time. The cruise started at the Galapagos Islands (vicinity of Day 284), which are not in the stratocumulus region, and are characterized by different, moister conditions. The upper-level moisture visible toward the end of the cruise (Days 295-298) is probably due to "blow-off" from the Andes Mountains. In some cases, 100% relative humidity conditions extend to the surface, indicating drizzle. At other times, the air just below the inversion is not completely saturated, indicating a break in the clouds.

Weather observations, performed hourly, were important in keeping a written record of the observed changes in environmental conditions. Cloud photography provided a visual context for interpreting the radar and upper-air sounding data. During daylight hours, cloud photos were taken with a digital camera at 12 stations around the ship to obtain a 360-degree view. The photo in Figure 25 shows the eastward view at 11:15 UTC October 21 2001. This time approximately corresponds to the radar data in Figure 22 and the sounding in Figure 23. The cloud deck is somewhat broken, and a significant patch of drizzle is apparent in the center on the horizon. This photo is a typical example of the non-uniform drizzle conditions that were frequently observed.

To better quantify the size and rate of the drizzle, paper coated with water-sensitive dye (methylene blue) was exposed briefly during several drizzle events. Thirty-three samples were collected during 23 separate drizzle episodes on seven days during Leg 2. The drops on each sample sheet will be counted and categorized into different drop-size bins. The analysis will give approximate rain rate information, and it will provide information on the drizzle drop-size distribution at the surface. Several drizzle samples were collected during the day, which was unexpected. In theory, the clouds should thin during the day and thicken again after sunset, causing drizzle to occur at night and during the pre-dawn hours. Radar data also corroborate this new finding with several instances of drizzle cells appearing during the daytime.

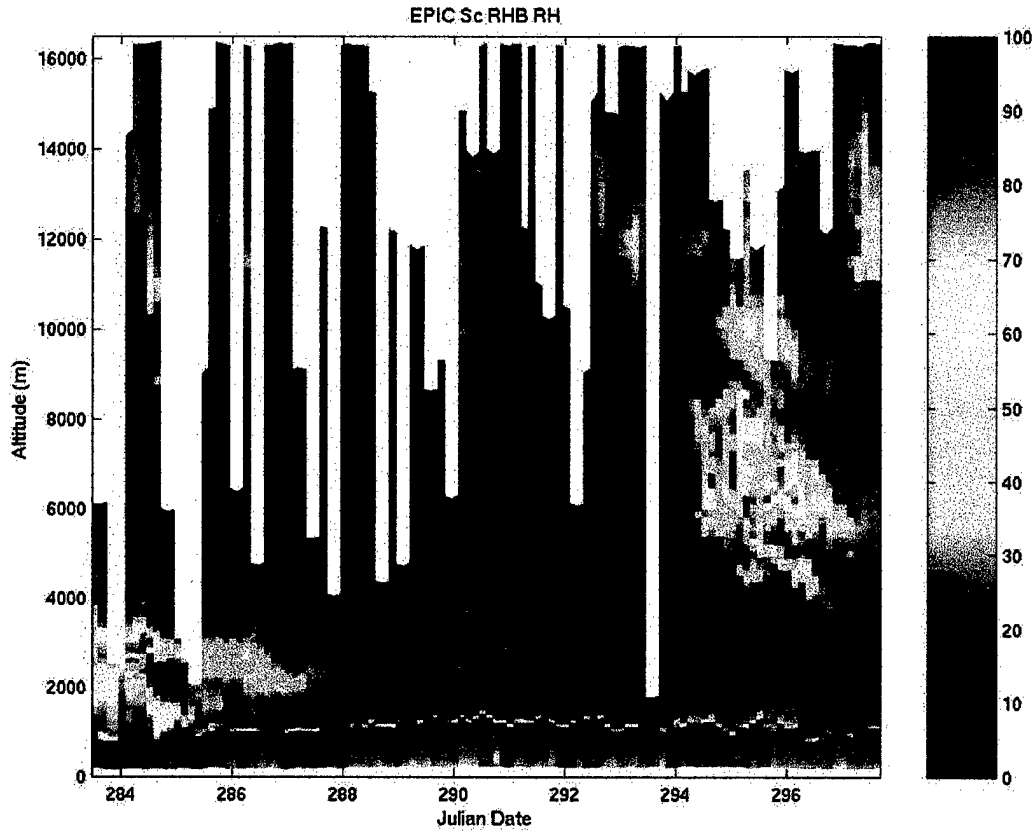


**Figure 22: Horizontal cross-section of C-band radar data from 11 UTC October 21 (Day 294).**

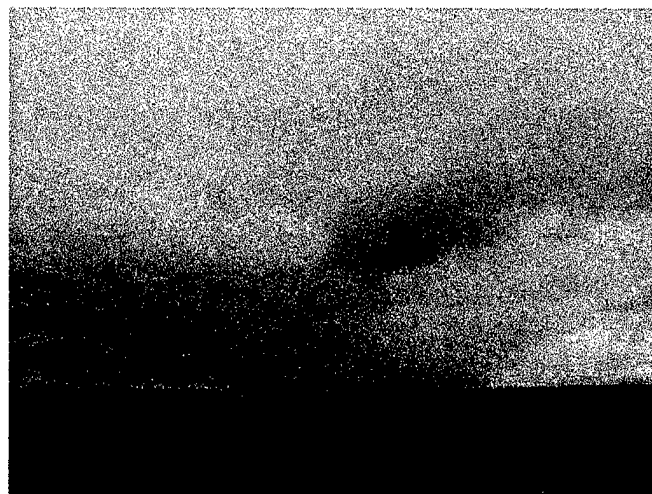


**Figure 23: Upper-air sounding launched at 11 UTC October 21 (Day 294). No quality control has been applied. Dew point is curve to left and temperature is curve to left.**





**Figure 24: Relative humidity time-height plot from upper-air soundings every three hours throughout Leg 2.**



**Figure 25: Cloud photo looking eastward at about 11:15 UTC on October 21 (Day 294).**

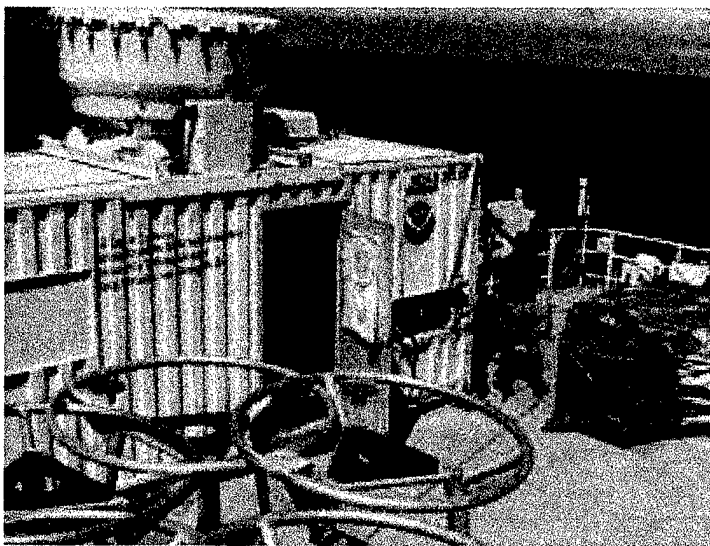


## SECTION 6: Cloud radar and microwave radiometers

### 1. Introduction

Clouds play vitally important roles in climate and water resources by virtue of their ability to transform radiant energy and water phase in the atmosphere. Research on climate change in the 1990s was a major motivation for accelerated development of remote sensing technologies to observe cloud properties from land, sea, air and space. NOAA/ETL has been a major contributor to these advances in the areas of millimeter-wave “cloud” radar and the use of microwave and infrared radiometers for ground-based cloud observations.

NOAA/ETL began designing and operating dual-frequency microwave radiometers and  $K_a$ -band cloud radars around 1980. More recently, it also designed the unattended cloud-profiling  $K_a$ -band radars, known as the Millimeter-wave Cloud Radar (MMCR), for the U.S Department of Energy’s Cloud and Radiation Test-bed sites. These radars are intended to operate for at least a decade at remote locations. A nearly identical radar is also operated by NOAA/ETL for field experiments of shorter duration on land and ships. This radar is joined in the same sea container by a dual-channel microwave radiometer (MWR) and a narrow-band infrared radiometer (IRR).



**Figure 26: Photo of the MMCR Package showing the radar antenna (roof) and MWR reflector (right side).**

## 2. Instrument background

The NOAA/ETL Millimeter cloud radar package, used aboard the R/V *R H Brown*, is composed of a  $K_a$ - radar with Doppler capabilities, a narrow band infrared radiometer, and a multi-channel microwave radiometer. Simultaneous data from these instruments provide the input for retrieving microphysical features of the overlying tropospheric clouds. These include estimates of the profiles of cloud particle median size, total concentration, and mass content for ice clouds and liquid water clouds. Combining the instruments in a single container (Figure 26) provides a powerful, self contained cloud research system. The following Table summarizes the operating specifications of the instruments in this package.

**Table 4: Instrument Package Characteristics for cloud radar and radiometers.**

### ----- Combined System -----

*Major Capabilities:* Multi-wavelength remote sensing, unattended operations, transportable.

*Primary Uses:* Monitoring cloud layer heights and thickness, water vapor and liquid water path, cloud base temperature, and retrievals of profiles of hydrometeor median size,

total concentration, and mass content.

*Platform:* 6.1-m sea container.

### ----- Cloud Radar (MMCR) -----

*Major Capabilities:* Ultra-high sensitivity, Doppler.

*Primary Uses:* vertical profiles of clouds, drizzle, snowfall and very light rain.

*Frequency:* 34.86 GHz (= 8.6 mm)

*Transmit Power:* 100 W peak, with up to 25 W avg.

*Transmitter:* Traveling Wave Tube (>20,000 h life)

*Antenna:* 1.8-m diameter; tilted flat radome.

*Beam Width:* 0.3 deg., circular.

*Height Coverage/ Resolutions:* ~20 km / 45 & 90 m;(255 and 495-m resolutions also available).

*Polarization:* transmit and receive H.

*Sensitivity:* approx. -40 dBZ at height of 10 km.

*Doppler Processing:* FFT.

*Data System:* wind profiler POP with 2 computers.

### ----- Microwave Radiometer (MWR) -----

*Primary Uses:* Monitoring vertical water vapor path and liquid water path.

*Frequencies:* 20.6, 31.65, and 90.0 (optional) GHz.

*Beam Width:* 5 deg.

### ----- IR Radiometer (IRR) -----

*Primary Uses:* Sensing presence of cloud overhead, estimating base temp. of optically thick clouds.

*Wavelength:* 9.9-11.4  $\mu\text{m}$  or 10.6-11.3  $\mu\text{m}$ .

*Field of View:* 2 deg.

(Table taken from "NOAA/ETL'S VERTICAL-PROFILING CLOUD RADAR AND RADIOMETER PACKAGE" Brooks E. Martner, Duane A. Hazen, Kenneth P. Moran, Taneil Uttal, M.J. Post, and Wendi B. Madsen NOAA Environmental Technology Laboratory, Boulder, Colorado, USA)

Collectively, the instruments are called the "MMCR Package". The system is a vertical profiler.

### **MMCR**

The MMCR is the heart of the system. Many of the radar operating characteristics are computer-selectable. Although it transmits only 100W of peak power, the radar can detect extremely weak tropospheric clouds overhead, including multiple layer and optically thick cloud situations that optical sensors usually cannot penetrate. It achieves its excellent sensitivity (-40 dBZ at 10 km) through the use of a high duty cycle, large antenna (for this wavelength), long sample times (~ 1s), and pulse compression techniques. The radar normally cycles through four operating modes that have different sensitivities, height resolutions and coverages, and susceptibilities to various artifacts, such as range side lobe clutter, 2<sup>nd</sup> -trip echoes, and folded velocities. Data from the four modes are merged in post-processing using algorithms developed at Penn State University. The resolutions of the merged data are 45 m and 10s. Full Doppler spectra can be recorded at each gate, but generally only the Doppler moments (reflectivity, mean velocity, and spectral width) computed from the spectra are recorded to reduce data rates. The radar data are recorded in netCDF format on optical disks.

### **MWR**

The dual-frequency MWR design is a Real-time conversion of the measured down-welling brightness temperatures to water vapor path (precipitable water vapor) and liquid water path is made using algorithms that incorporate site-specific climatological radiosonde data. The radiometer's view periodically switches between the sky and a reference calibration source. An external reflector plate spins continuously to centrifuge rainwater, condensation and slush away. Either of two commercial IRRs (Barnes or Heitronics) is available with the Package. The measured IRR brightness temperature approximates the physical temperature of cloud base for optically dense clouds. Temporal resolutions of 30-60s are typical for data from the radiometers, as used in the MMCR package.

## **3. Data samples**

Figure 27 shows an example of radar reflectivity (upper panel), Doppler velocity (middle panel) and the spectral width (bottom panel) of the Doppler spectrum for a 24 hour period with a height scale of 0-5 km ASL (note: Data was collected from 0-20 km ASL). Radar reflectivity is a strong function of cloud droplet size with a secondary dependence on concentration, Doppler velocities indicate total droplet fall speed (air motion + droplet terminal velocity). Comparison of net heat flux (blue) with deep echo (red) is shown in figure 28. Net heat flux includes sensible and latent turbulent heat fluxes and upwelling and downwelling solar and infrared radiant flux. Deep echo represents the number of hours per day (times 10) with radar echo depth (cloud + precip) exceeding 10 km.

Figure 29 shows an example of the radar reflectivity superimposed with the data on cloud base heights from the ceilometer. The radar echo beneath the ceilometer base is indicative of virga, and drizzle below cloud base, which for the radar is indistinguishable from cloud. Annotations from surface observations indicate periods when clouds visually appeared to create overcast, partially overcast conditions, visible virga etc.

Figure 30 shows raw brightness temperatures from the three channels of the microwave radiometer. These brightness temperatures will be recalibrated in post processing using "tip-curve" data which is collected when the atmosphere is as cloud free as possible, and then processed with retrieval techniques which will result in integrated values of total atmospheric column liquid water and water vapor.

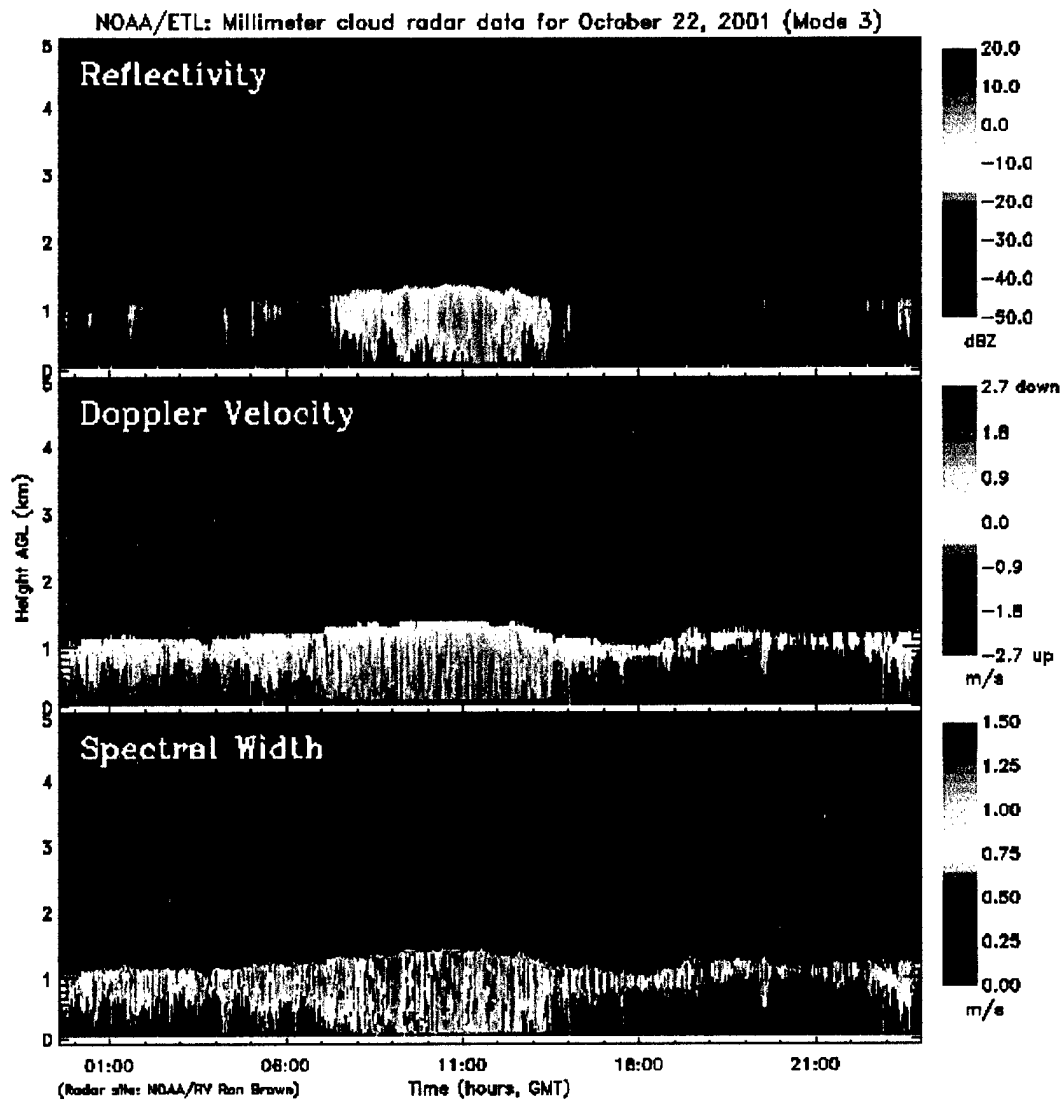


Figure 27: Example of radar reflectivity (upper panel), Doppler velocity (middle panel) and the spectral width (bottom panel) of the Doppler spectrum for a 24 hour period.

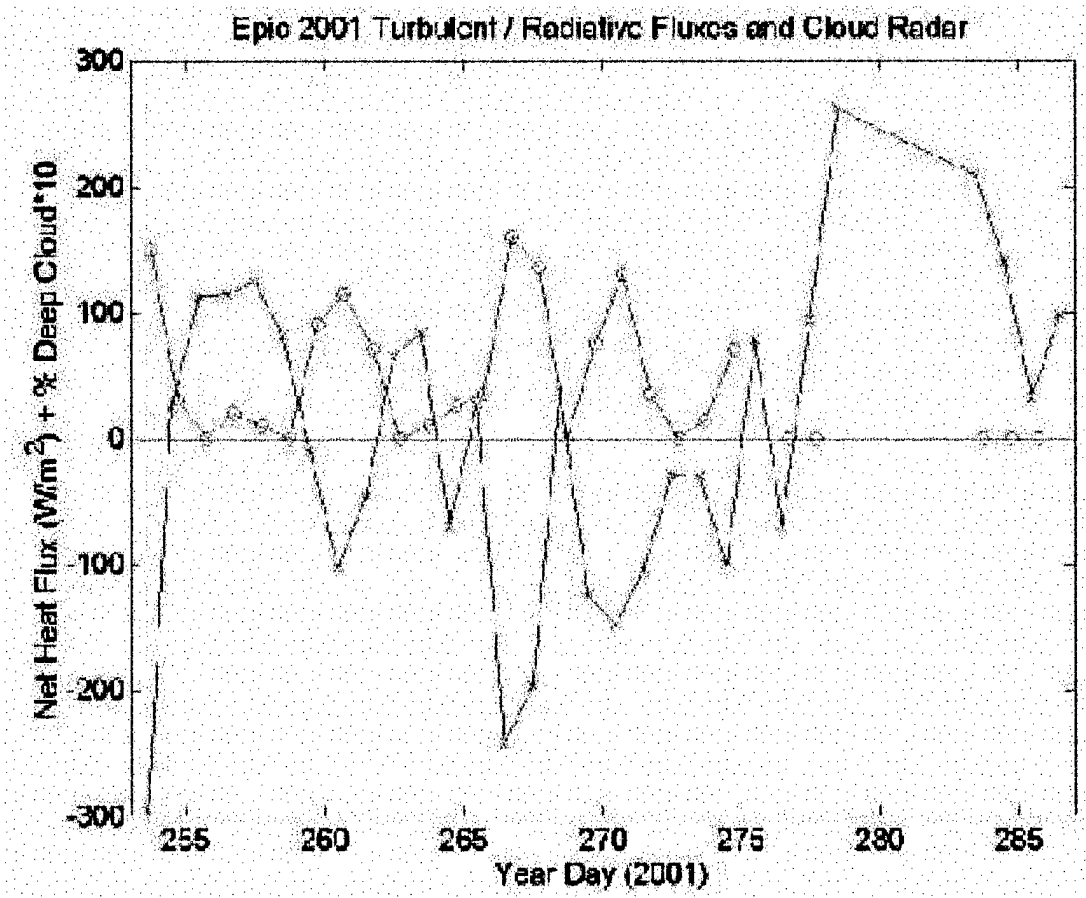


Figure 28: Comparison of net heat flux (blue) with deep echo (red).

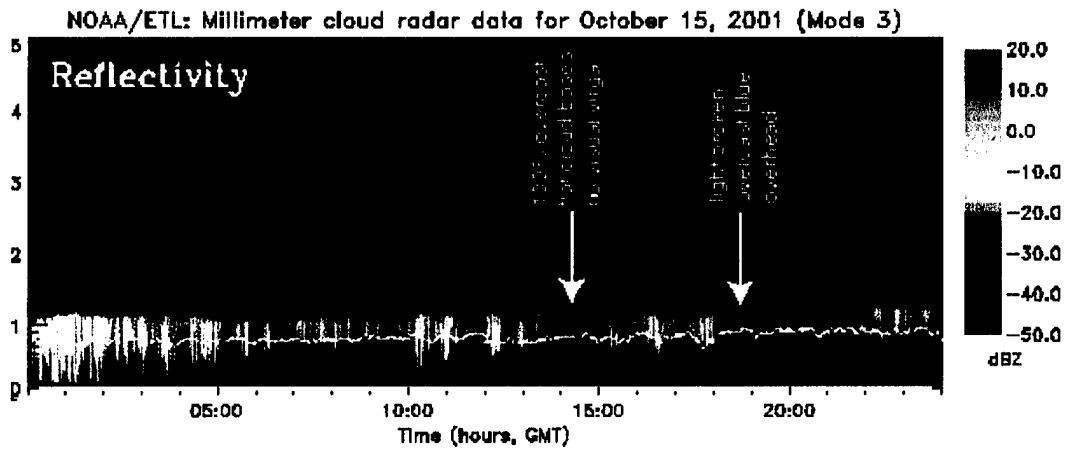


Figure 29: Example of the radar reflectivity superimposed with the data on cloud base heights from the ceilometer.

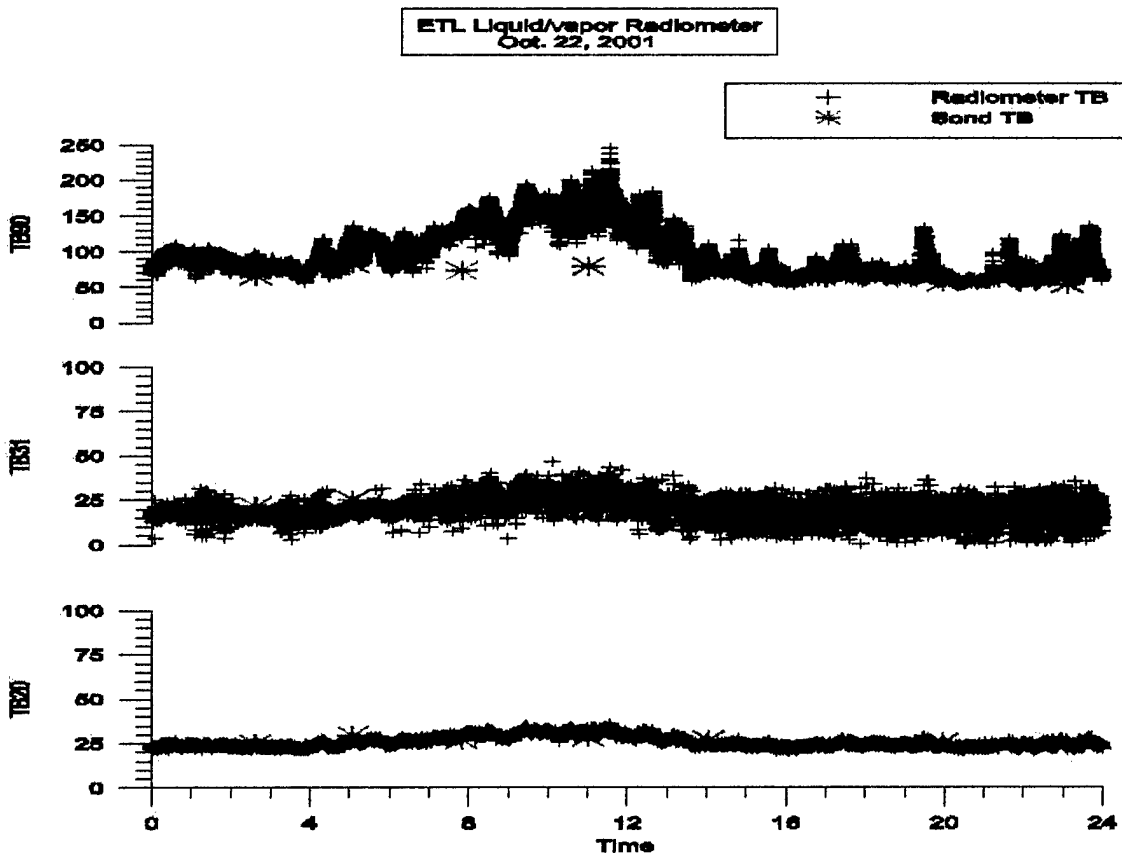


Figure 30: Raw brightness temperatures from the three channels of the microwave radiometer.



In contrast to the first leg of EPIC that was characterized by deep, precipitating ITCZ clouds, the clouds during Leg 2 were persistent, low-level boundary clouds with tops typically around 1 to 1.3 km ASL. There were no upper level clouds observed during the period, and the weaker, thinner clouds between 16:00 and 24:00 were typical of the diurnal cycle that was observed. The radiometers indicated that integrated vapor values decreased steadily as the R/V *Ron Brown* moved south from the Equator, with values at 10°south being about half the value of those at 0°.



## SECTION 7: Lidar

The ETL mini-MOPA is a CO<sub>2</sub> Doppler lidar, integrated with a stabilized scanning system that can measure a variety of sub-cloud layer turbulence properties including stress and turbulent kinetic energy profiles. This Doppler lidar can obtain detailed information on the vertical and horizontal structure of the boundary layer wind fields.

During the EPIC experiment, the mini-MOPA was operated to probe the atmosphere to acquire measurements that, with processing, provide data on cloud boundaries, sub-cloud wind direction and velocity, and water vapor profiles. The system provides data with a 150 meter range resolution at 200–300 Hertz pulse repetition frequency. Time averaging varies depending on the desired results. Cloud boundary and wind data are averaged less, and the water vapor measurements require more averaging to obtain profiles. The instrument has scanning capabilities, and thus can provide information on these variables, not only horizontally and vertically but hemispherically.

### EPIC LEG 2 mini-MOPA OPERATING TIMES (All times are in UTC)

October 9:	20:00 – 03:30
October 10:	19:00 – 05:30
October 11:	15:00 – 23:00
October 12:	02:00 – 03:30, 11:30 – 23:00
October 13:	00:00 – 01:00, 10:54 – 22:20
October 14	Down for amplifier Repairs
October 15	Down for amplifier Repairs
October 16	20:00 – 03:39
October 17	13:00 – 00:45
October 18	14:15 – 01:15
October 19	09:50 – 21:15
October 20	10:30 – 21:40
October 21	14:40 – 01:30
October 22	14:00 – 00:30

In order to obtain data reflecting the different types of atmospheric regimes, we operated at various times of the day. We operated during periods of transition, (dusk and dawn), in order to capture a potential change due to, or lack of, solar radiation on wind structure, turbulence, and velocity, and water vapor content. We took data before and after those periods as well, in order to document the characteristics of this Eastern Pacific region during the day and night.

On October 19 at 00:04, and on October 22 at 00:16, we operated for two satellite overpasses of the ship. We acquired measurements by taking shallow ppi scans (slices of the atmosphere constant in elevation) and shallow rhi scans (slices of the atmosphere constant in azimuth).

Explicit information on the mini-MOPA instrument itself, as well as, data examples can be viewed at <http://www2.etl.noaa.gov/mini-mopa.html>.



## **SECTION 8: Aerosols**

### **1. Introduction**

The Aerosol Physics Group of the Universidad Nacional Autonoma de Mexico (UNAM) was participating in the EPIC project to study the interaction of clouds and aerosols. Cloud formation and evolution is dependent upon the concentration, composition and size distribution of cloud condensation nuclei (CCN) that are subset of the atmospheric aerosols. The properties of CCN can be modified after they have been processed by clouds, i.e. after the particles have been in cloud water droplets or ice crystals. Sea salt and sulfate particles coming directly or indirectly from the ocean are expected to be the primary sources of CCN for clouds in the EPIC research area. Thus, measurements are needed of aerosols and precursor gases near the ocean surface, aerosols near cloud boundaries, and particles within the clouds. The UNAM research group was measuring source gases and aerosols on R/V *Ron Brown*; in addition, the group analyzed the evolution of these gases and aerosols into the cloud particles on the aircraft (the NSF C-130 aircraft) during Leg 1 and complementary gas, aerosol, cloud and meteorological measurements being made on the ship.

### **2. DMS**

Biological production of the volatile compound dimethylsulfide in the ocean is the main natural source of tropospheric sulfur on a global scale, with important consequences for the radiative balance of the Earth. Recent advances have shown that volatile sulfur is a result of ecological interactions and transformation processes through planktonic food webs. It is not only phytoplankton biomass, taxonomy or activity, but also food-web structure and dynamics that drive the oceanic production of atmospheric sulfur.

### **3. Samples**

During the second leg, the UNAM group measured DMSP and DMS which were produced by the phytoplankton, SO<sub>2</sub> gas concentration was continuously measured in the air that is a product of the DMS, sulfate concentration of particles that are formed by gas to particle conversion, total particle concentration, and the size distribution of particles in the diameter range from 0.1 to 3 micrometer.

DMS and DMSP were analyzed from water samples using gas chromatography. SO<sub>2</sub> was measured by UV fluorescence. Sulfate concentration on particles less than 1 micrometer was analyzed by ion chromatography on aerosol samples taken on quartz filters in a PM1.0 impactor. A TSI 3010 condensation nuclei counter measured total particle concentration of particles larger than approximately 0.005  $\mu\text{m}$ , and the size distribution of particles from 0.1 to 3  $\mu\text{m}$  was measured by an optical particle counter.

On the aircraft, the group measured total aerosol concentration with a condensation nuclei counter, the size distribution of aerosols from 0.1 to 20 micrometers with a PMS Passive Cavity Aerosol Spectrometer Probe and Forward Scattering Spectrometer Probe. They measured cloud condensation nuclei in the supersaturation range from 0.2 to 1%, in 0.2% steps, and cloud droplet, drizzle and precipitation size distribution with a variety of optical particle counters.

The CN measurements measured by the ship at approximately 10m above the sea surface with CN and CCN measurements made from the aircraft at 30 m were compared.

## SECTION 9: The WHOI IMET surface moorings

The surface mooring was first deployed at 20°9.4'S, 85°9.0'W during cruise Cook 2 of the *R/V Melville* on October 7, 2000 (*ref.* Table 5 and Figure 31 of Stratus 1). During Leg 2 of RHB's EPIC cruise, the mooring deployed last October was recovered on the 17 October 2001, and another mooring with almost identical instrumentation was deployed on the 19 October 2001 in its place at 20°8.6'S, 85°8.4'W (Table 6 and Figure 32 of Stratus 2) (see below meteorological and oceanographic instrumentation). The recovery, clean up, preparation and deployment required six days of intensive work at and around the mooring site. The Appendices 1 and 2 show the moored Station logs (serial numbers 1052 and 1080) which give a complete chronology and account of both the Stratus 1 recovery and Stratus 2 deployment respectively.

**Table 5 : Stratus mooring recovery information**

Mooring	Deployment Date and Time	Recovery Date and Time	Anchor Position
	Anchor over		
WHOI Stratus 1 Discus Buoy (WHOI Moor. Reference No. 1052)	7 October 2000 @ 20:43:00 UTC	17 October 2001 @ 12:39:00 UTC	20° 07.409'S 085° 08.432'W Water Depth: 4440m

**Table 6: Stratus mooring deployment information**

Mooring	Deployment Date and Time	Recovery Date and Time	Anchor Position
	Anchor over		
WHOI Stratus 2 Discus Buoy (WHOI Moor. Reference No. 1080)	19 October 2001 @ 19:46:00 UTC		20° 08.597'S 085° 08.4351'W Water Depth: 4454m

The buoy, meteorological and oceanographic equipment, mooring hardware, and related gear were shipped to the port of Seattle, WA USA in August 2001. Prior to this, the oceanographic and meteorological instrumentation had been tested and calibrated at WHOI. Further, the IMET meteorological instrumentation had been mounted to the buoy and that buoy included in an intercomparison on the *R/V R H Brown* with similar meteorological instrumentation from NOAA PMEL. In conjunction with that intercomparison the entire buoy had been rotated through 360°, stopping every 90° to record measured heading against true heading in order to quantify the uncertainty in measured wind direction due to the anemometers' compasses.

Final preparations were done on the boat in Puerto Ayora, Galapagos Islands. This work was done in the first week of October 2001. The buoy meteorological instrumentation and telemetry of the meteorological data were checked out, and all VMCMs, Brancker temperature recorders (TPODS), SEACATs, microCATS, SBE39s, and other instruments were prepared.

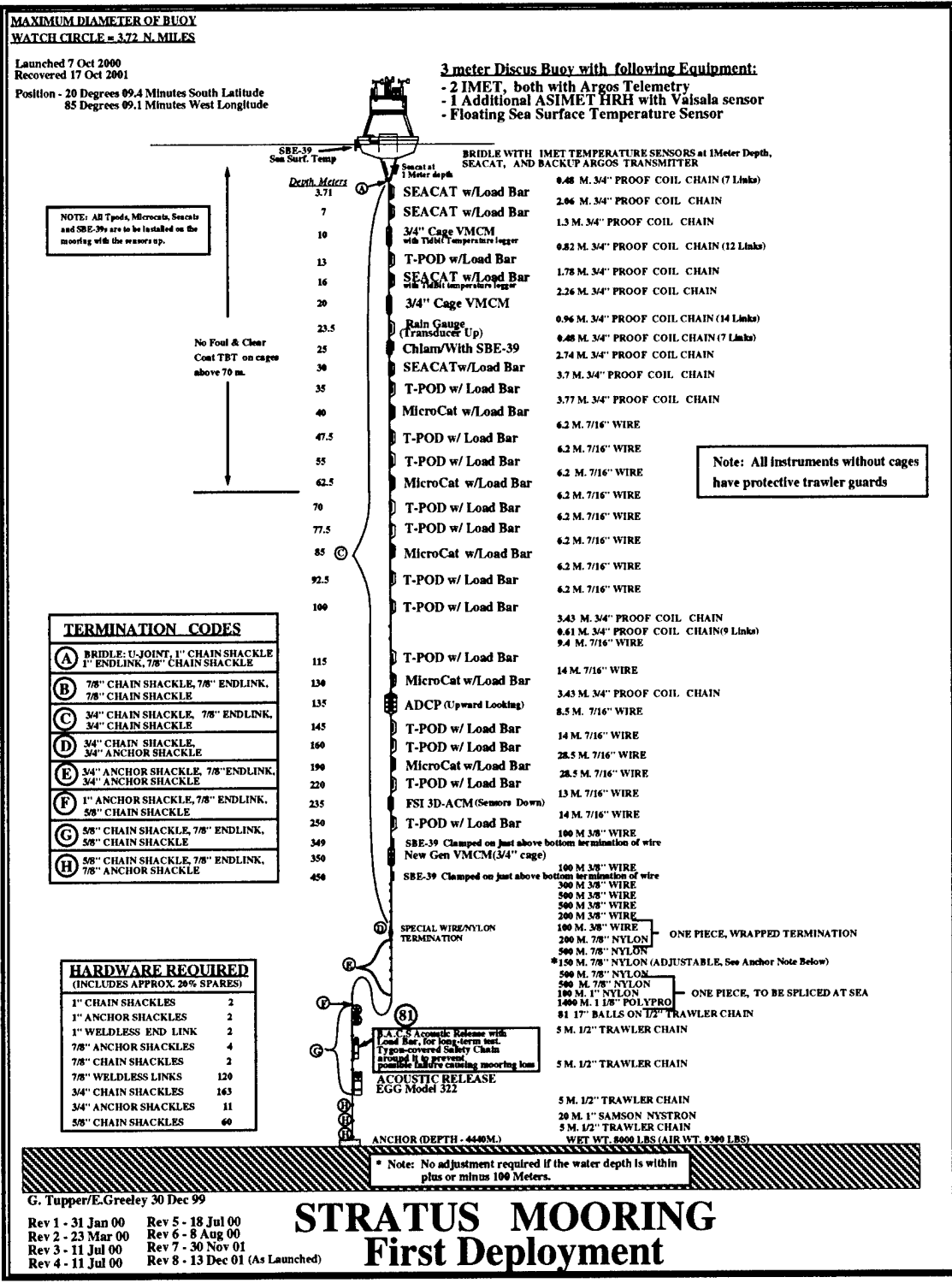
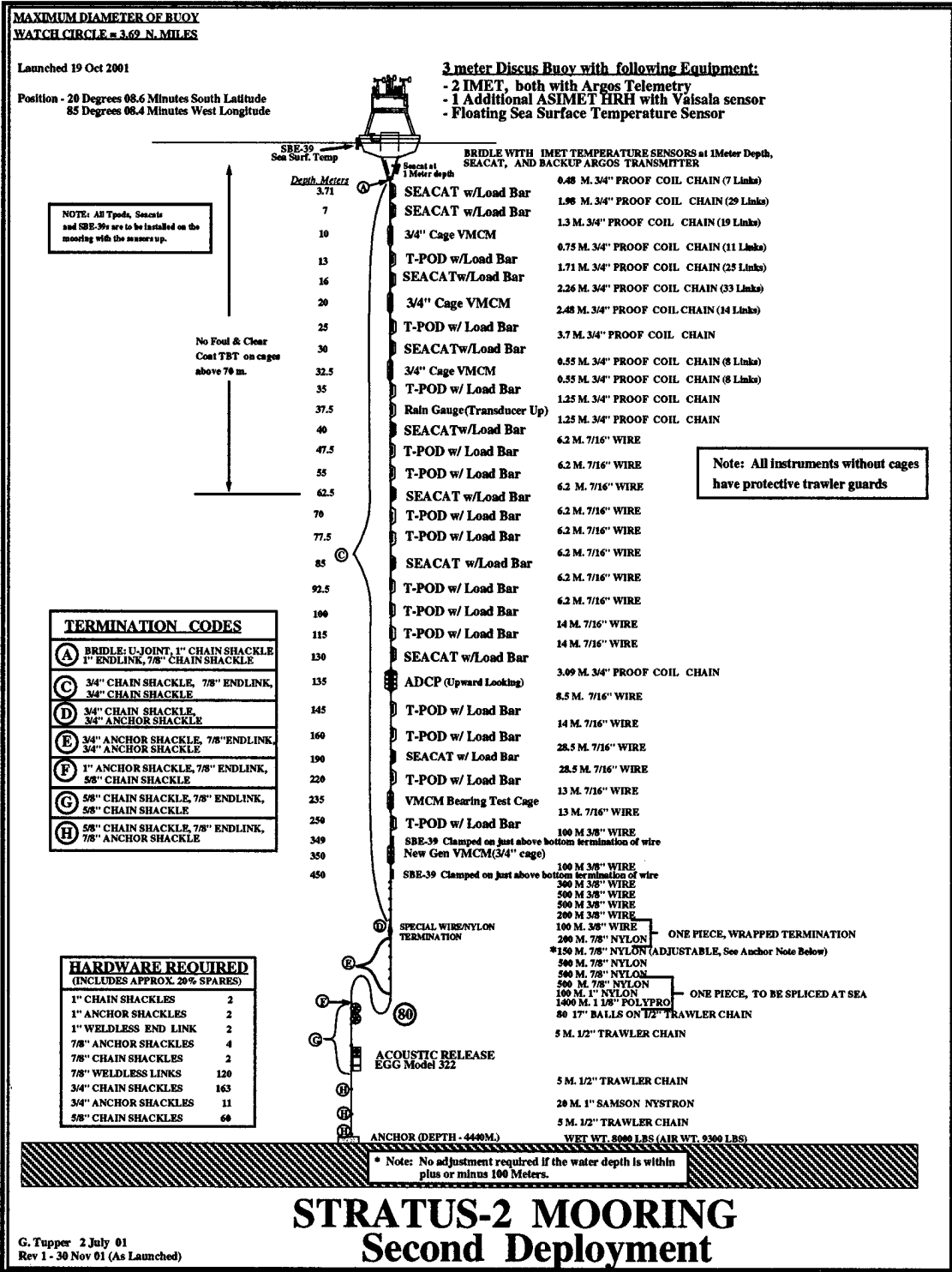


Figure 31 : Stratus 1 mooring diagram – recovery.





# STRATUS-2 MOORING Second Deployment

G. Tupper 2 July 01  
Rev 1 - 30 Nov 01 (As Launched)

Figure 32 : Stratus 2 mooring diagram - deployment

## **A. The WHOI Surface Moorings - Overview**

The three meter discus buoys were equipped with meteorological instrumentation, including two Improved METeorological (IMET) recorders, and a stand-alone humidity and temperature recorder. The two WHOI moorings also carried vector measuring current meters; and conductivity and temperature recorders located in the upper 450 meters of the mooring line, as well as an Acoustic Doppler current profiler and an acoustic rain gauge. The Stratus 1 mooring carried a Falmouth Scientific Instruments (FSI) current meter, 4 Onset Tidbit temperature loggers and a Chlorophyll absorption meter. The following Figures 31 and 32 schematically show the moorings diagram and the location of the sub-surface instrumentation.

All of the instrumentation used on the WHOI moorings had some type of pre-deployment time marks applied. The pre-deployment time marks for Stratus 1 and Stratus 2 are included in the Appendices 1 and 3 respectively (Tables 14, 15 and Tables 16, 17). The post-deployment time marks are also shown in Appendix 1.

The two Improved METeorological (IMET) recorders had their short-wave radiation sensors black bagged for two record cycles. The VMCMs had their rotors spun. All of the temperature recorders were put in an ice bath for their time intervals. The time marks will be used to verify the accuracy of the instrument's clock in data processing. The Appendices 1 and 3 have a complete listing of all instrumentation recovered and deployed respectively onboard R/V *R H Brown*. For each instrument type, the listings show the instrument type, sampling interval, instrument serial number and the corresponding depth. All the instrumentation can also be found in the Stratus 1 and 2 moored Station logs in the Appendices 2 and 4, respectively.

These WHOI moorings are an inverse catenary design utilizing wire rope, chain, nylon and polypropylene line and a scope of 1.25 (Scope = slack length/water depth). The surface buoys are a three-meter diameter discus buoy with a two-part aluminum tower and rigid bridle.

The design of these surface moorings took into consideration the predicted currents, winds, and sea-state conditions expected during the deployment duration. Further, they were constructed using hardware and designs that had been proven in the recent PACS deployment.

The instrument systems recovered on the Stratus 1 mooring and deployed on the Stratus 2 mooring are described in detail below.

### **1. Meteorological Instrumentation**

The discus buoy for both Stratus 1 and Stratus 2 was outfitted with two separate and redundant meteorological packages. The meteorological data recording system, IMET, logged data from eight meteorological sensors at one minute intervals; this data was averaged into one hour intervals and telemetered via Service Argos. A separate relative humidity and air temperature instrument made an independent measurement and recorded the data internally. Figure 36 shows the mounting locations and orientations of the instruments as they were deployed on the Stratus 2 mooring.

Figure 38 shows a top view of the meteorological instrumentation mounted on the WHOI discus buoys; Table 8 and Table 9 give the serial numbers of the sensors and modules of the meteorological instruments for Stratus 1 and Stratus 2 respectively. Two buoy spins of the Stratus 2 buoy were performed. The first was done as part of the pre-deployment procedure at WHOI and the second at the dock in Seattle to confirm that the compasses of each IMET were in proper working order. The data from the pre-deployment buoy spins are as follows: Table 10 IMET system 1, 2; Figure 39 buoy spin orientation; Figure 40 plots of buoy spin data. The Seattle spin data is listed in Table 11, Figure 41 and Figure 42.

#### **a. Improved METeorological System**

The IMET systems for the Stratus 1 and 2 discus buoys consisted of eight IMET sensor modules and one Argos transmitter module to telemeter data via satellite back to WHOI through Service Argos. Table 7 details IMET sensor specifications. The modules measure the following parameters:

1. relative humidity with temperature
2. barometric pressure
3. air temperature (R. M. Young passive shield)
4. sea surface temperature
5. precipitation
6. wind speed and direction
7. short-wave radiation
8. long-wave radiation

All IMET modules for the Stratus experiment were modified for lower power consumption so that a non-rechargeable alkaline battery pack could be used.

The data logger for the system was based on an Onset Computer Corp. model 7 Tattletale computer with hard drive, also configured and programmed with power conservation in mind. An associated interface board ties the model 7 via individual power and RS-485 communications lines to each of the nine IMET modules, including the PTT module.

#### **b. Stand-alone Relative Humidity/Temperature Instrument**

A self-contained relative humidity and air temperature instrument was mounted on the tower of the WHOI discus buoys. This instrument, developed and built by members of the UOP Group, takes a single point measurement of both relative humidity and temperature at a desired record interval. The sensor used was a Rotronics MP-101A. The relative humidity and temperature measurements are made inside a protective Gortex shield. The logger is an Onset Computer, Corp., model 4A Tattletale, with expanded memory to 512K. The unit is powered by its own internal battery pack. The instrument interval was set to 1 minute for the Stratus 1 Experiment.

#### **c. Onset StowAway TidbiT Temperature Loggers (only for the Stratus 1 mooring)**

The Tidbit temperature logger is a completely sealed, small (~3 cm diameter) medallion like temperature logger. It is depth rated to approximately 300 m (1,000 ft.) and has an operating temperature range of -20° to +50°C. The tidbit uses optical communication via an Optical Base Station that plugs into a standard PC serial port. One Tidbit was placed on the IMET system #2 air temperature module, co-located with the sensor. The sampling rate was set to once every 30 minutes.

## **2. Oceanographic Instrumentation**

The measured water line for the Stratus 1 and 2 buoys was 0.43 meters below the buoy deck. Figures 29 and 30 illustrate the location of the sub-surface sensors attached to the discus bridle of the Stratus 1 and 2 buoys. The depths of the instruments, parameters sampled, and sampling rates of Stratus 1 and 2 are summarized in Tables 15 and 17 respectively. Whenever possible, instruments were protected from being fouled by fishing lines by "trawl-guards" designed and fabricated at WHOI. These guards are meant to keep lines from hanging up on the in-line instruments.

### **a. Floating SST Sensor**

A Sea-Bird SBE-39 was placed in a floating holder (a buoyant block of synthetic foam sliding up and down along 3 stainless steel guide rods) in order to sample the sea temperature as close as possible to the sea surface. Visual check of this sensor after deployment indicated a depth of ~2 cm. The Sea-Bird model SBE-39 is a small, light weight, durable and reliable temperature logger that was set to record the sea surface temperature every 5 minutes.

### **b. Sub-surface Argos Transmitter**

An NACLS, Inc. Sub-surface Mooring Monitor (SMM) was mounted upside down on the bridle of the discus buoy. This was a backup recovery aid in the event that the mooring parted and the buoy flipped upside down.

### **c. SEACAT Conductivity and Temperature Recorders**

There were five, Sea-Bird, Inc., SEACAT conductivity and temperature recorders deployed on the WHOI surface mooring. The model SBE 16 SEACAT was designed to measure and record temperature and conductivity at high levels of accuracy while deployed in either a fixed or moored application. Powered by internal batteries, a SEACAT is capable of recording data for periods of a year or more. Data are acquired at intervals set by the user. An internal back-up battery supports memory and the real-time clock in the event of failure or exhaustion of the main battery supply. Communication with the SEACAT is over a three-wire RS-232 link. The SEACAT is capable of storing a total of 260,821 samples. A sample rate of 225 seconds was used on the Stratus 1 SEACATs. The shallowest SEACAT was mounted directly to the bridle the discus buoy. The others were mounted on in-line tension bars and deployed at various depths throughout the moorings. The conductivity cell is protected from bio-fouling by the placement of anti-foulant cylinders at each end of the conductivity cell tube.

### **d. MicroCAT Conductivity and Temperature Recorder**

The MicroCAT, model SBE37, is a high-accuracy conductivity and temperature recorder with internal battery and memory. It is designed for long-term mooring deployments and includes a standard serial interface to communicate with a PC. Its recorded data are stored in non-volatile FLASH memory. The temperature range is -5° to +35°C, and the conductivity range is 0 to 6 Siemens/meter. The pressure housing is made of titanium and is rated for 7,000 meters. The MicroCAT is capable of storing 419,430 samples of temperature, conductivity and time. The sampling interval of the Stratus 1 MicroCATs was 225 seconds (3.75 minutes). These instruments were mounted on in-line tension bars and deployed at

various depths throughout the moorings. The conductivity cell is protected from bio-fouling by the placement of anti-foulant cylinders at each end of the conductivity cell tube.

**e. Brancker Temperature Recorders**

The Brancker temperature recorders are self-recording, single-point temperature loggers. The operating temperature range for this instrument is 2° to 34°C. It has internal battery and logging, with the capability of storing 24,000 samples in one deployment. A PC is used to communicate with the Brancker via serial cable for instrument set-up and data download. The Stratus 1 and 2 Branckers were set to record data every 30 minutes. A total of 13 Brancker temperature loggers were deployed on the discus mooring.

**f. SBE-39 Temperature Recorder**

The Sea-bird model SBE-39 is a small, light weight, durable and reliable temperature logger that was set to record temperature every 5 minutes.

**g. Onset StowAway TidbiT Temperature Loggers**

The Tidbit temperature logger is a completely sealed, small (~3 cm diameter) medallion like temperature logger. It is depth rated to approximately 300 m (1,000 ft.) and has an operating temperature range of -20° to +50°C. The Tidbit uses optical communication via an Optical Base Station that plugs into a standard PC serial port. A total of three Tidbit temperature loggers were placed on the Stratus 1 and 2 mooring line. In order to make a reliable comparison of performance, all of the Tidbits were co-located with other temperature recording devices: one on the (IMET system #1) 1 m Sea Surface temperature module, one on the 10 m VMCM temperature sensor, and one on the 16 m SEACAT loadbar. The sampling rate was set to once every 30 minutes.

**h. Vector Measuring Current Meters**

The VMCM had two orthogonal cosine response propeller sensors that measured the components of horizontal current velocity parallel to the axles of the two-propeller sensors. The orientation of the instrument relative to magnetic north was determined by a flux gate compass. East and north components of velocity were computed continuously, averaged and then stored on cassette magnetic tape. Temperature was also recorded using a thermistor mounted in a fast response pod, which was mounted on the top end cap of the VMCM. The VMCMs were set to record every 7.50 minutes.

A new generation VMCM was deployed at the 350m depth on the Stratus 1 and 2 discus buoys. It has all of the same external components as the previous original VMCM but has a new circuit board and flash card memory module. It can store up to 40 Mb of data on the flash card therefore the sampling rate was set to once per minute.

A total of 3 VMCMs were deployed on the surface moorings. All of the VMCMs had a compass spin performed at the dock in Arica and Seattle to verify that the instrument was not damaged in transport.

**i. Falmouth Scientific Instruments Current Meter ( only for the Stratus 1 mooring )**

The 3D ACM, s/n 1325a, is an acoustic current meter on trial deployment from Falmouth Scientific Instruments, Inc. (FSI). The FSI current meter uses four perpendicularly oriented transducers to extract a single-point measurement. In addition to current values of north, east and up, the instrument also

records temperature, tilt, direction and time. The instrument was set to record once every 30 minutes with an averaging interval of 450 seconds.

#### **j. RDI Acoustic Doppler Current Profiler**

An RD Instruments (RDI) Workhorse Acoustic Doppler Current Profiler (ADCP, Model WHS300-1, Serial number TSN-1218) was mounted at 135 m looking upwards on the mooring line. The RDI ADCP measures a profile of horizontal current velocities. The data sampling rates and parameters are user-definable, and were set as follows: 12 velocity bins of 10 m each, starting 11.98 m from the transducers and ending at 131.98 m; 30 pings per ensemble with one ping per second; and a 30-minute interval between the start of ensembles. These settings provided an approximately 400-day deployment lifetime on the internal battery. These particular settings are only available using the Windows version of the RDI deployment software (the DOS version limits you to 8 m bins). The time between pings must be set manually in the text-based deployment file before it is sent to the instrument.

#### **k. Chlorophyll Absorption Meter (only for the stratus 1 mooring )**

A WETLabs Chlorophyll Absorption Meter (CHLAM), model number 9510005, serial number ACH0126, was placed on the Stratus 1 discus mooring at a depth of 25 meters. The CHLAM was mounted on a frame that fits inside a standard VMCM cage. A Sea-Bird pump drew water through a mesh filter and the CHLAM, and past two brominating canisters arranged end-to-end. Between samples, the bromide diffused through the system to reduce bio-fouling. Data were stored in a WET Labs MPAK data logger, serial number PK-023. The CHLAM/MPAK recorded a reference and signal from three optical wavelengths (650, 676 and 712 nanometers) and an internal temperature. The sample interval rate is 2 hours. At each sample, the pump is turned on for 10 seconds to flush the system. Ten seconds of sampling follow, with the 10-second average of signal and reference stored in the MPAK. The complete system was powered by two, 10 D-cell alkaline battery packs and should last for approximately 400 days.

#### **l. Acoustic Rain Gauge**

An Acoustic Rain Gauge from Jeff Nystuen at the Applied Physics Laboratory at the University of Washington was deployed at a depth of 37.5 meters on the Stratus 2 mooring; One was deployed the last year on the Stratus 1 mooring at a depth of 23.5 m. This instrument uses a hydrophone and listens to ambient noise. Rain falling on the sea surface produces noise at certain frequencies, and these frequencies are sampled by this instrument. Data from the IMET rain gauges on the surface buoy as well as from the acoustic rain gauge can be compared.

#### **m. Acoustic Release**

On the Stratus mooring there are 2 different acoustic releases. A primary release used for recovery of the mooring, and a secondary release used for test purposes. The primary release is an EG&G model 322 acoustic release. The Interrogate Frequency is 11.0 kHz. The Reply Frequency is 10.0 kHz. The codes are as follows: Enable=42, Disable=41, and Release=43. The test release is a Burn-wire Acoustic Release Transponder modified to be motor driven with a WHOI fabricated load bar. The Interrogate Frequency is 11.0 kHz. The Reply Frequency is 12.0 kHz. The codes are as follows: Enable=302632, Disable=302657, and Release=323616.

The test release has a titanium strength bar which was designed at WHOI. It was cut using a computer driven water jet. The strength member is rated for 60,000 lbs. This is being tested for the first time because the release mechanism on the BACS release can not handle the load it sees during the launch of the mooring and anchor drop. There is a piece of 1/2" trawler chain inside 2" tygon tubing in

parallel with the release. If the release fails or the strength member fails, the mooring will be held by the trawler chain. Then the recovery will be done with the primary release.

**Table 7: IMET sensor specifications**

Parameter	Sensor	Nominal Accuracy
Air temperature	Platinum Resistance Thermometer	+/- .25°C
Sea temperature	Platinum Resistance Thermometer	+/- .005°C
Relative humidity	Rotronic MP-100F	+/- 3%
Barometric pressure (Stratus 1 buoy)	Quartz crystal; AIR S2B	+/- .5 mbar
Barometric pressure (Stratus 2 buoy)	AIR SB- 2A	+/- .2 mbar
Wind speed and wind direction	R.M. Young model 5103 Wind Monitor	-3% (speed); +/- 1.5° (dir)
Short-wave radiation	Temperature Compensated Thermopile; Eppley PSP	+/- 3%
Long-wave radiation	Pyrometer; Eppley PIR	+/- 10%
Precipitation	R.M. Young Model 50201 Self-siphoning rain gauge	+/- 10%

The logger polls all IMET modules at one-minute intervals (takes several seconds) and then goes to low-power sleep mode for the rest of the minute. Data are written to disk once per hour. The logger also monitors main battery and aspirated temperature battery voltage.

The air temperature, sea surface temperature, barometric pressure, relative humidity, long-wave radiation and precipitation modules take a sample once per minute and then go to low-power sleep mode for the rest of the minute.

The vane on the wind module is sampled at one-second intervals and averaged over 15 seconds. The compass is sampled every 15 seconds and the wind speed is averaged every 15 seconds. East and north current components are computed every 15 seconds.

Once a minute, the logger stores east and north components that are an average of the most recent four 15-second averages. In addition average speed from four 15 second averages is stored, along with the maximum and minimum speed during the previous minute, average vane computed from four 15-second averages, and the most recent compass reading.

In addition, an IMET Argos PTT module is set for three IDs and transmits via satellite the most recent six hours of one-hour averages from the IMET modules. At the start of each hour, the previous hour's data are averaged and sent to the PTT, bumping the oldest hour's data out of the data buffer.



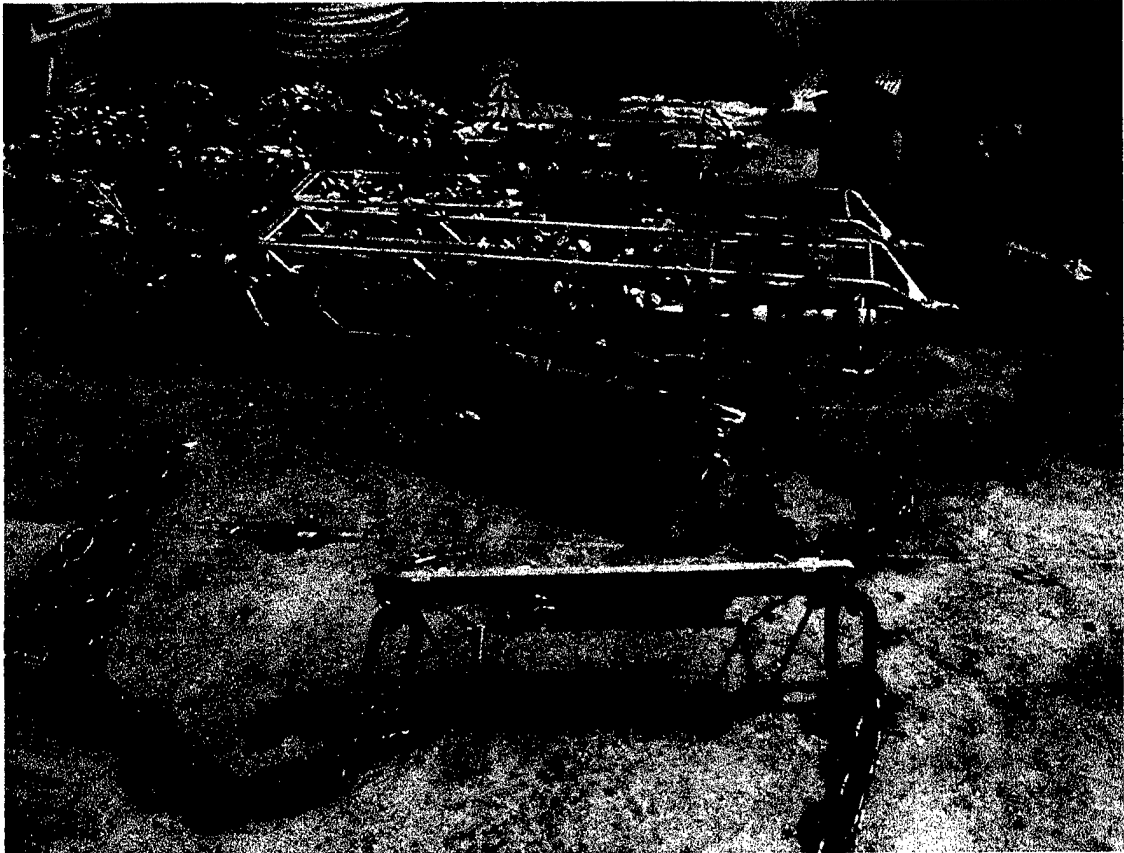
## B. Stratus 1 mooring – recovery

A total of 41 recording instruments with 72 sensors deployed the last year were recovered on the surface mooring (Figure 31). There are two meteorological systems, one stand-alone relative humidity/air temperature recorder (SAHTR), one floating sea surface temperature recorder, three current meter, sixteen temperature data loggers, ten conductivity/temperature-recording instruments, one chlorophyll absorption meter (CHLAM), one acoustic rain gauge, and one acoustic current meter. The moored station log which gives a complete chronology and account of Stratus 1 recovery is shown in Appendix 1.

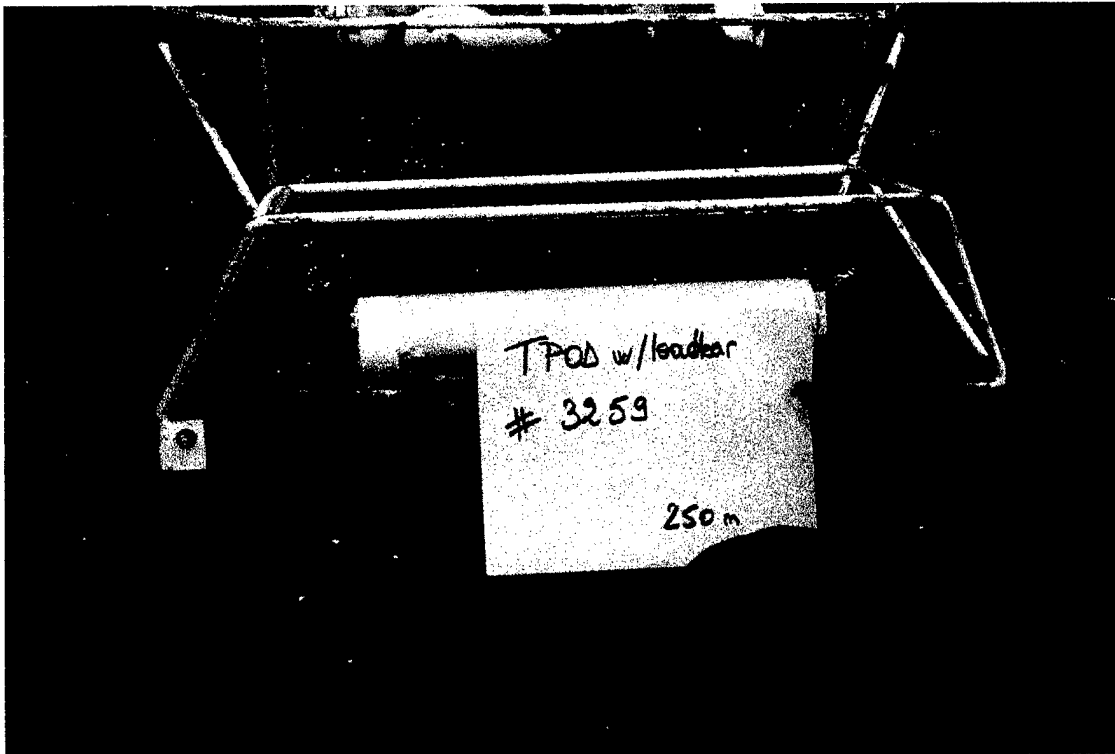
**Table 8: Meteorological sensor serial numbers Stratus 1 WHOI discus buoy.**

IMET 1		IMET 2	
WND	104	WND	105
SWR	111	SWR	109
LWR	101	LWR	006
HRH	108	HRH	110
BPR	107	BPR	106
SST	003	SST	104
TMP AT	102	TMP AT	104
PRC	102	PRC	101
LOGGER	117	LOGGER	226
PTT		PTT	
ARGOS I.D. #1	27916	ARGOS I.D. #1	27919
ARGOS I.D. #2	27917	ARGOS I.D. #2	27920
ARGOS I.D. #3	27918	ARGOS I.D. #3	27921
<b>STAND-ALONE</b>			
HRH	204		

All instruments recovered on October 17 were first collected on the deck in order to check their condition and see if all of the instrumentation deployed the last year was recovered (Figure 33). Figures 34, 35, 36 and 37 show examples of instruments recovered from different depths. The instrumentation and hardware of the Stratus 1 buoy were in good shape, with some bio-fouling seen in the upper 30 m by gooseneck barnacles and no fouling on instruments below 100 m. The CHLAM instrument of Stratus 1 failed due to water getting into the battery housings (2 each). This was caused by having the wrong size o-rings installed into the pressure case. The APL Rain Gauge failed as well as the FSI.



**Figure 33: Some of the Instrumentation recovered on the deck.**



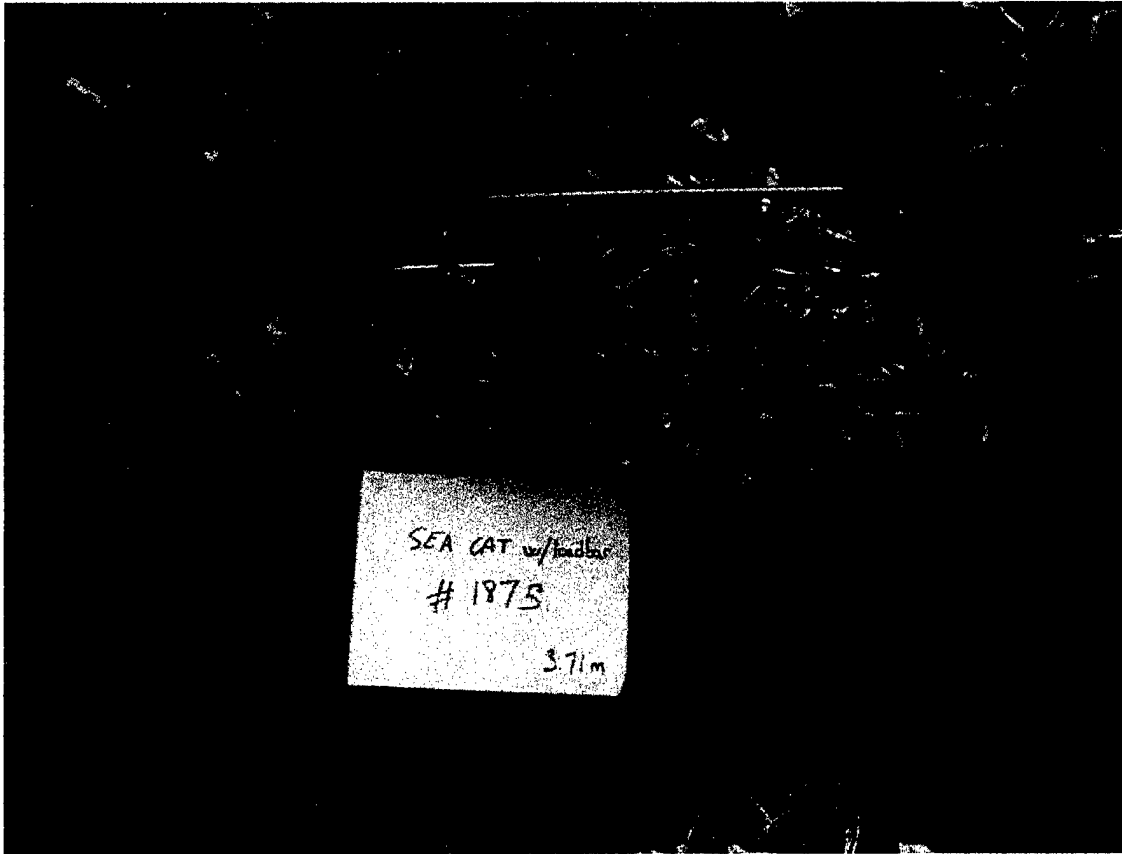
**Figure 34: TPOD instrument at 250 m depth.**



Figure 35: MICROCAT instrument at 85 m depth.



Figure 36: VMCM instrument at 20 m depth.



**Figure 37: SEACAT instrument at 3.71 m depth.**

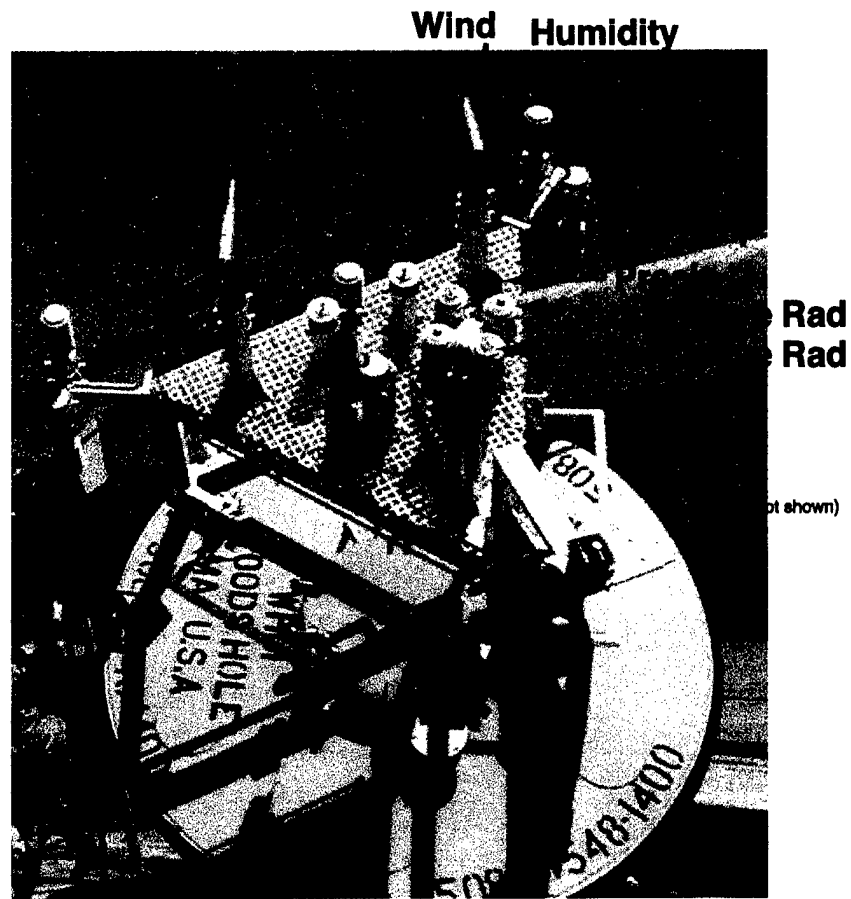
## C. Stratus 2 mooring - deployment

The buoy, meteorological and oceanographic equipment, mooring hardware, and related gear were shipped to Seattle, WA, on August 17 2001. Prior to this, the oceanographic and meteorological instrumentation had been tested and calibrated at WHOI. Further, the IMET meteorological instrumentation had been mounted to the buoy and that buoy included in an intercomparison on the R/V *Ron H Brown* with similar meteorological instrumentation from NOAA PMEL. In conjunction with that intercomparison the entire buoy had been rotated through 360°, stopping every 90° to record measured heading against true heading in order to quantify the uncertainty in measured wind direction due to the anemometers' compasses. See following for detailed results of the pre-deployment buoy spin.

Final preparations were done on the boat in Puerta Ayora, Galapagos Islands. This work was done in the first week of October 2001. The buoy meteorological instrumentation and telemetry of the meteorological data were checked out. VMCMs, Brancker temperature recorders (TPODS), SEACATS, microCATS, SBE39s and other instruments were prepared.

The surface mooring deployed has sixteen meteorological sensors mounted on the top half of the buoy tower (Figure 38) and are described in this section. Four near-surface oceanographic sensors are attached to the bridle and buoy hull. In addition to the buoy-mounted instruments, the Stratus 2 mooring supports an additional 34 recording packages, some of which have multiple sensors.

The Stratus 2 surface mooring has a total of 39 recording instruments with 66 sensors. There are two meteorological systems (loggers 1 and 2), one stand-alone relative humidity/air temperature recorder (SAHTR), and one stand-alone wind module, one floating sea surface temperature recorder, three current meters, sixteen temperature data loggers, ten conductivity/temperature-recording instruments, one acoustic rain gauge, and one acoustic current meter. The moored Station log which gives a complete chronology and account of Stratus 2 is shown in Appendix 4.



**Figure 38: Stratus Buoy IMET Towertop.**

**Table 9: Meteorological sensor serial numbers Stratus 2 WHOI discus buoy.**

**IMET 1**

WND	207
SWR	102
LWR	104
HRH	223
BPR	106
SST	1834
PRC	004
LOGGER	STR2_01
PTT	
ARGOS I.D. #1	09805
ARGOS I.D. #2	09807
ARGOS I.D. #3	09811

**IMET 2**

WND	212
SWR	002
LWR	103
HRH	217
BPR	110
SST	1837
PRC	109
LOGGER	STR2_02
PTT	
ARGOS I.D. #1	09819
ARGOS I.D. #2	09833
ARGOS I.D. #3	25078

**STAND-ALONE**

WND	213
HRH	218

**Table 10: Pre-deployment Stratus 2 Buoy spin done at WHOI. IMET 1, 2 compass / vane listings.**

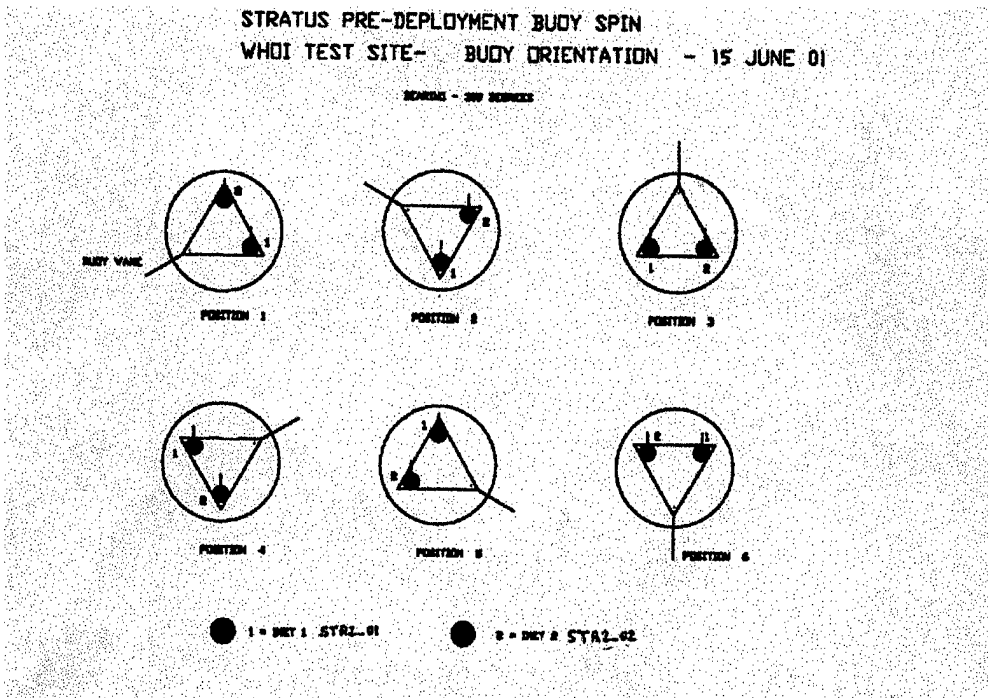
**STRATUS PRE-DEPLOYMENT BUOY SPIN TEST  
WHOI - 309 degrees**

**15 -Jun-01**

POSITION #		DIRECTION	VANE	COMPASS
1	IMET - 1	309.8	240.2	69.6
1	IMET - 2	314.1	240.5	73.6
2	IMET - 1	307.3	177.4	129.9
2	IMET - 2	311.2	181.8	129.4
3	IMET - 1	309.9	116.9	193.0
3	IMET - 2	313.9	119.6	194.3
4	IMET - 1	312.4	60.6	251.8
4	IMET - 2	311.2	59.6	251.6
5	IMET - 1	313.3	1.0	317.3
5	IMET - 2	309.0	359.2	309.8
6	IMET - 1	304.3	289.9	14.4
6	IMET - 2	309.1	302.3	6.8

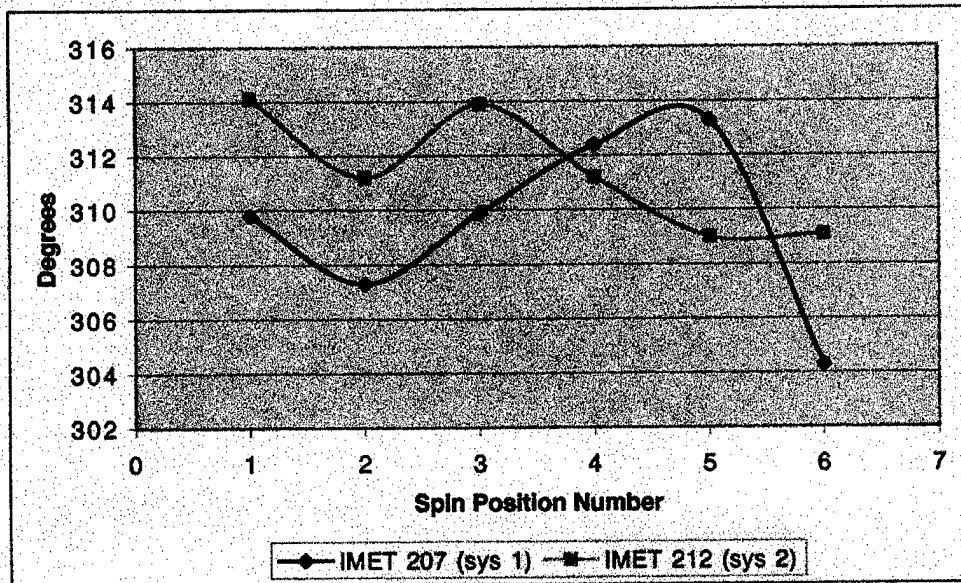
IMET 1 =DATA LOGGER S/N STR2\_01 IMET 1 = WND207  
 IMET 2 =DATA LOGGER S/N STR2\_02 IMET 2 = WND212





**Figure 39: Buoy spin orientation for pre-deployment test at WHOI.**

**Stratus 2 — Pre Buoy Spin — WHOI 15 June 01**



**Figure 40 : Pre-deployment Buoy spin at WHOI.**

**Table 11: Buoy Spin done on the dock in Seattle, WA. IMET 1 and 2 compass/vane listings.**

**STRATUS 2 PRE-DEPLOYMENT BUOY SPIN TEST**

Seattle, WA - 126.5 ° AT LIGHT POLE ON DOCK

17 Aug 01

POSITION #		DIRECTION	VANE	COMPASS
1	IMET - 1	125.7	239.1	246.6
1	IMET - 2	122	238.8	243.2
2	IMET - 1	130.9	182.0	308.9
2	IMET - 2	124.1	190.1	294.0
3	IMET - 1	128.2	119.0	9.2
3	IMET - 2	122.9	128.3	354.6
4	IMET - 1	128.3	342.0	146.3
4	IMET - 2	122.0	319.7	162.3
5	IMET - 1	126.2	356.1	129.7
5	IMET - 2	126.0	0.6	125.4
6	IMET - 1	126.8	299.1	187.7
6	IMET - 2	126.0	302.4	183.6

IMET 1 = WIND S/N WND 207

IMET 2 = WIND S/N WND 212

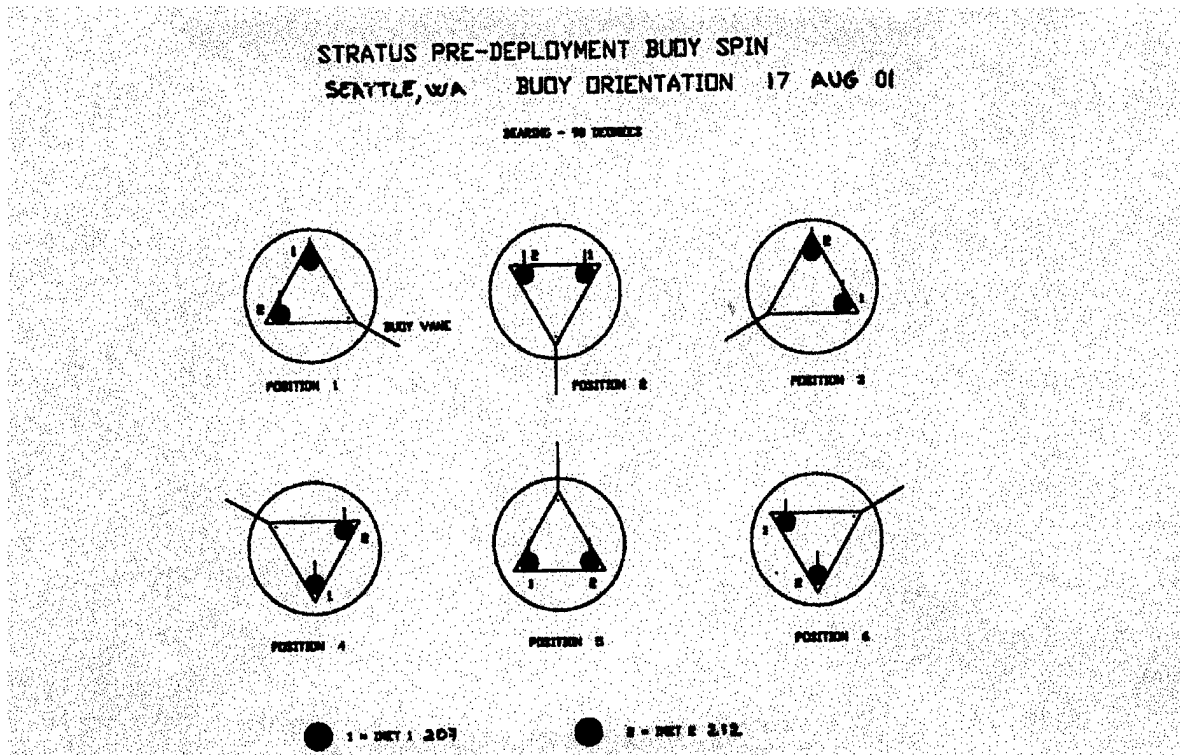


Figure 41: Buoy orientation for the spin done in Seattle, WA

**Stratus 2 — Pre Buoy Spin — Seattle, WA, 17 Aug 01**

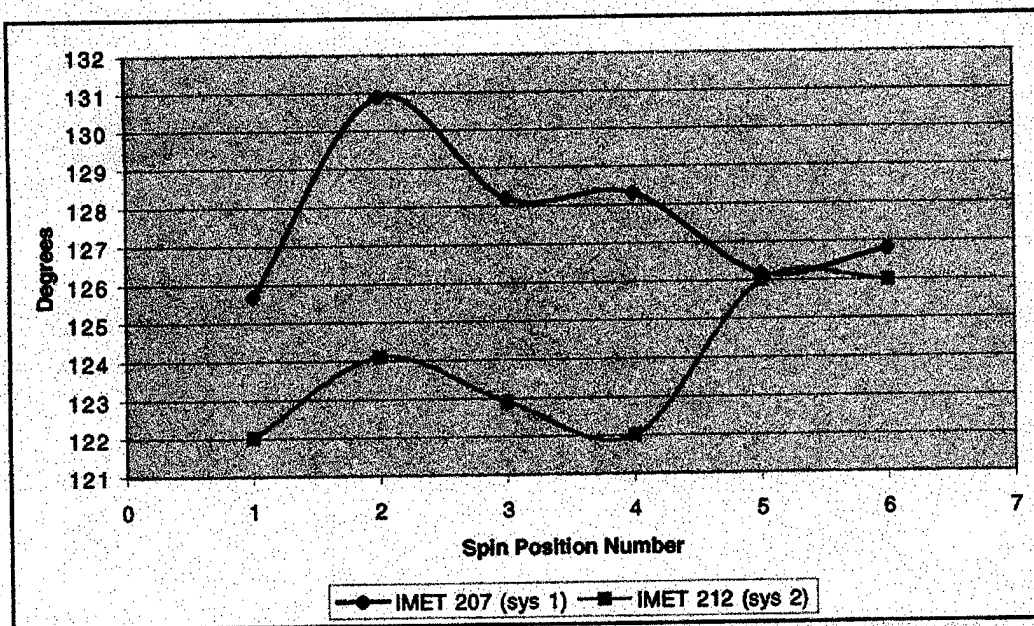


Figure 42: Spin data plot for Seattle, WA.

## **D. Intercomparison of buoy and ship IMET sensors**

After comparing the data from the buoys, ETL and ship IMET, we are confident that the ship IMET sensors were reasonably well calibrated and that the electronic logging was functioning correctly. The Figures listed below were plotted using data from when the ship was at the WHOI mooring site (20°S, 85°W) where it remained for 6 days, 15-22 October. No data from the buoys was used from 18 and 19 October as the Stratus 1 and 2 buoys were on deck.

Figures 43 and 44 show overplots of barometric pressure and relative humidity data for the Stratus 1 and 2 buoy two IMET systems, respectively, which agree well.

Figures 45 and 46 represent overplots of surface temperature and air temperature data for the ship, Stratus 1 and 2 buoys IMET and ETL. Sea surface temperature (Figure 45) shows a correspondence between ETL, ship and buoy readings. ETL readings were slightly higher (by about 0.1°C) than the ship's IMET sensor.

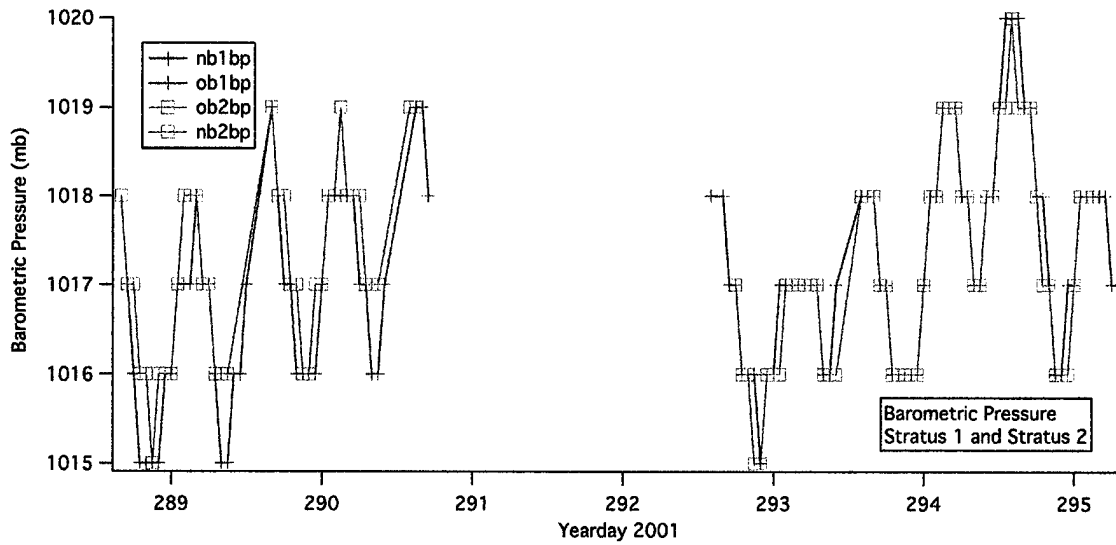
Comparison of air temperature (Figure 46) suggests the Stratus 1 buoy temperatures. The buoy temperatures are slightly higher than the ETL data (by about 0.2°C). SST is shown for reference.

During the ship's stay at the mooring site, the wind speed and wind direction shown in Figures 47 and 48 showed generally a good agreement between the buoy and ship data; except for the wind direction of system # 1 of the Stratus 1 buoy (Figure 48), which was later found to have a stiff bearing in the direction encoder.

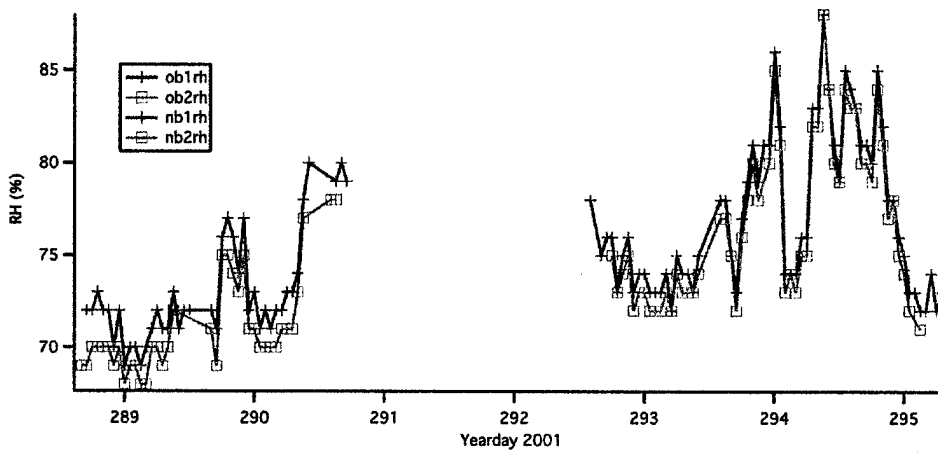
Figures 49, 50 and 51 illustrate the buoy and ETL readings of incoming short-wave and long-wave and specific humidity, respectively. The incoming short-wave readings (Figure 49) were similar to readings from the buoys and ETL data. The data from one system on Stratus 1 incoming long-wave (Figure 50) were lower than the ETL sensor (by about  $4\text{Wm}^{-2}$ ). Data from systems 1 and 2 for the Stratus 2 buoy were lower than the ETL sensor by almost  $20\text{W m}^{-2}$ , and they will be checked in post-calibration.

The buoys' readings on specific humidity (Figure 51) were slightly higher than the ETL readings, but no height correction has been made.

Figure 52 shows an overplot of Stratus 2 buoy and ship TSG data on Sea surface salinity. The buoy data are higher by about 0.1 psu than the ship sensor, but problems with the TSG pump were experienced.

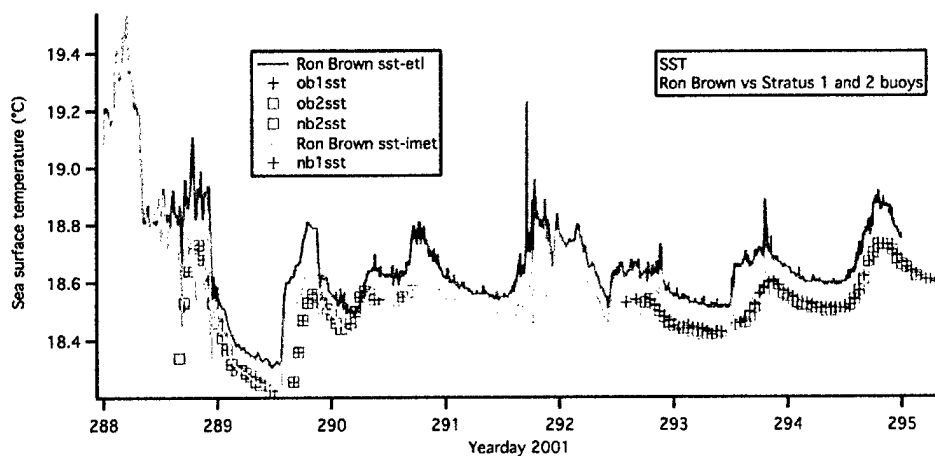


**Figure 43: Comparison of barometric pressure (mb) data from the two IMET systems on the Stratus 1 (left) and 2 (right) buoys.**

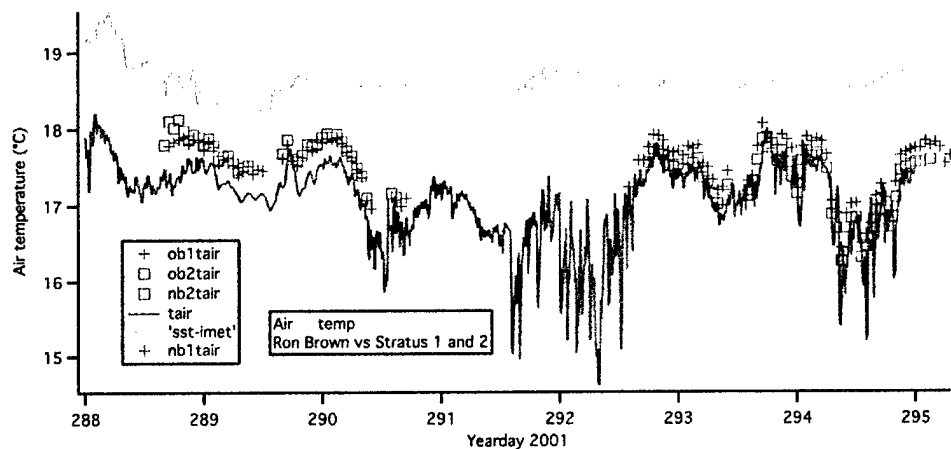


**Figure 44: Comparison of relative humidities (%) from the two IMET systems on the Stratus 1 (left) and 2 (right) buoys.**

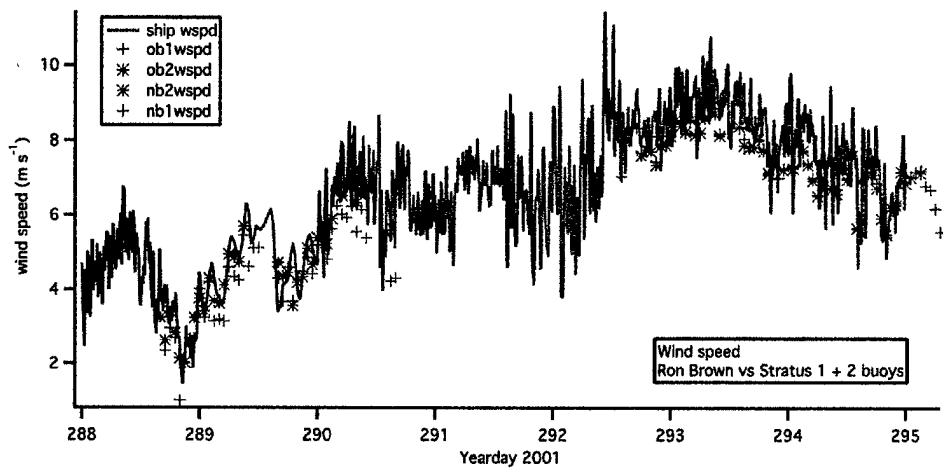
Note that data points from Stratus 1 are labelled ob1 and ob2, while data from Stratus 2 are labelled nb1 and nb2.



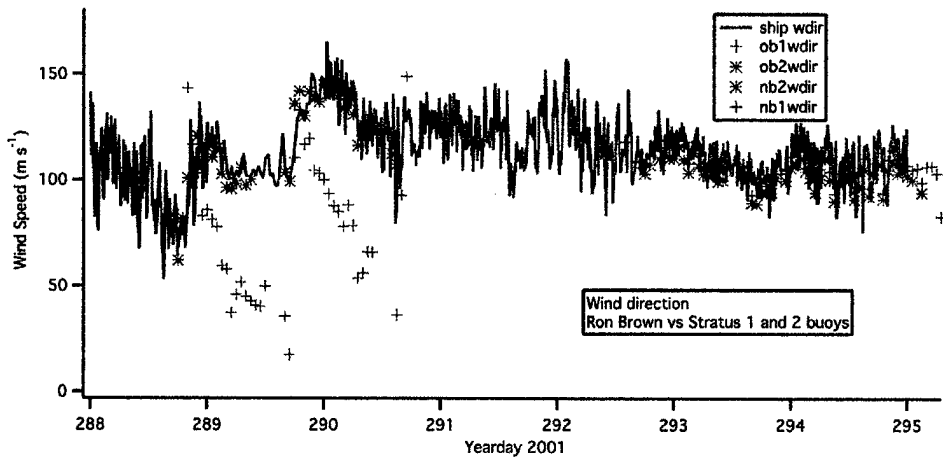
**Figure 45: Comparison of buoy Sea Surface Temperature (°C) from Stratus 1 (left) and 2 (right) buoys with ship and ETL data.**



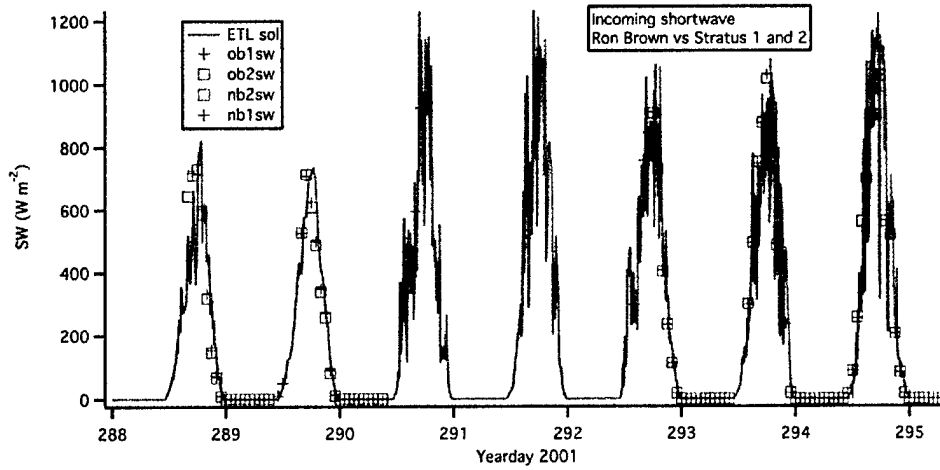
**Figure 46: Comparison of buoy air temperatures (°C) from Stratus 1 (left) and 2 (right) buoys with ship and ETL data. For reference, IMET SST, which is ~1° warmer is shown.**



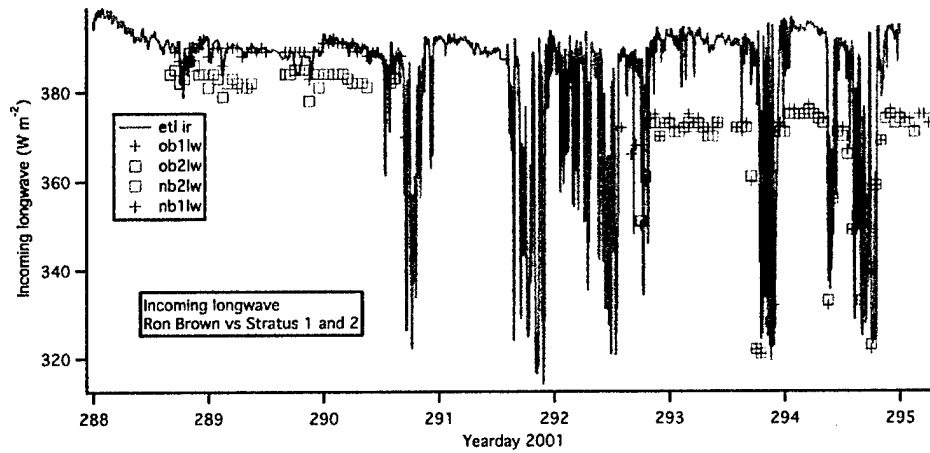
**Figure 47: Comparison of wind speeds (m/s) from the two systems on the Stratus 1 (left) and 2 (right) buoys with the ship IMET data.**



**Figure 48: Comparison of wind directions (m/s) from the two systems on the Stratus 1 (left) and 2 (right) buoys with ship IMET data.**

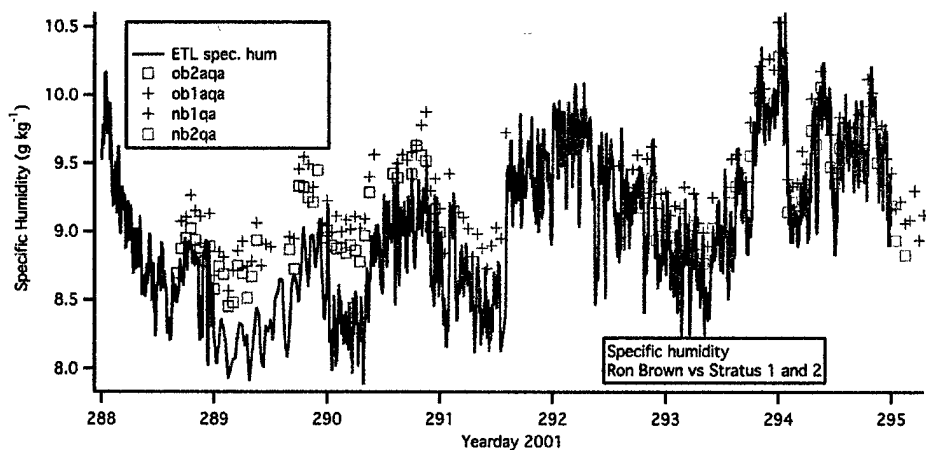


**Figure 49: Comparison of incoming short-wave ( $W/m^2$ ) from the two IMET systems on the Stratus 1 (left) and 2 (right) buoys with ETL data.**

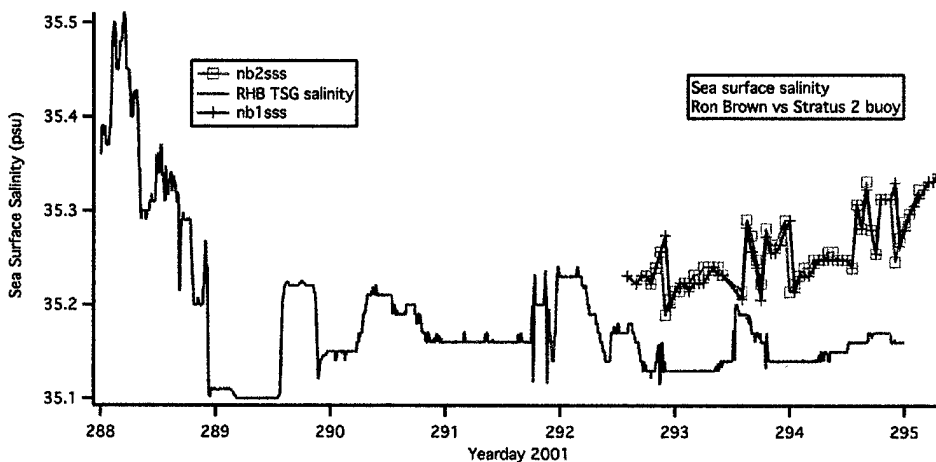


**Figure 50: Comparison of incoming long-wave ( $W/m^2$ ) from the two IMET systems on the Stratus 1 (left) and 2 (right) buoys with ETL data.**





**Figure 51: Comparison of specific humidity (g/kg) from the two IMET systems on the Stratus 1 (left) and 2 (right) buoys with ETL data.**



**Figure 52: Comparison of Sea Surface Salinity (psu) from the two IMET systems on the Stratus 2 buoy with ship TSG data.**

## E. CTD stations

A total of 27 CTD stations were taken from R/V *R H Brown* during EPIC 2001. The ship's CTD/Rosette system with 12 bottles was used for all stations. Water samples were collected in conjunction with the casts.

Most of the CTD stations (18 CTDs) were made every 0.5° of latitude to 500-meter depth along the transect 95°W South toward the WHOI mooring (see Table 1: CTD depth, locations and times in Section 3).

At the location of the WHOI mooring, personnel from UCSB and WHOI effected 7 CTD stations with 4 deep stations down to 4,000 meters. 2 deep CTDs were made one day before the recovery of Stratus 1 buoy, on 16 October 2001 and 2 others were made one day after the deployment of Stratus 2 buoy, on 20 October 2001. More details on the CTD's schedules are in Appendix 9 which is the Plan of the days onboard R/V *R H Brown* –Leg 2.

After completing the mooring work during 6 days, the CTDs were continued, with the 2 last CTDs made along the transit toward Arica, Chile.

Figures 53 through 56 are profiles of temperature, salinity and density from the CTD data at 4,000-meter depth collected during the Epic 2001 cruise.

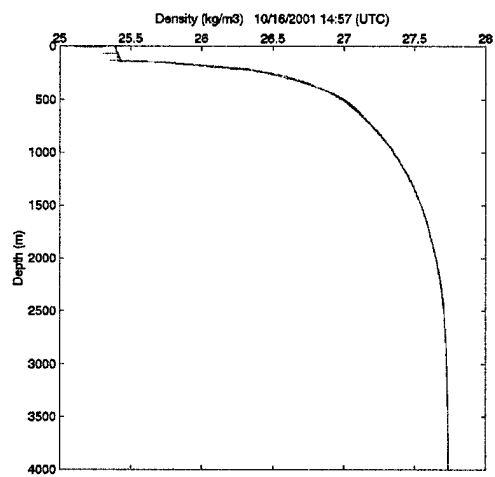
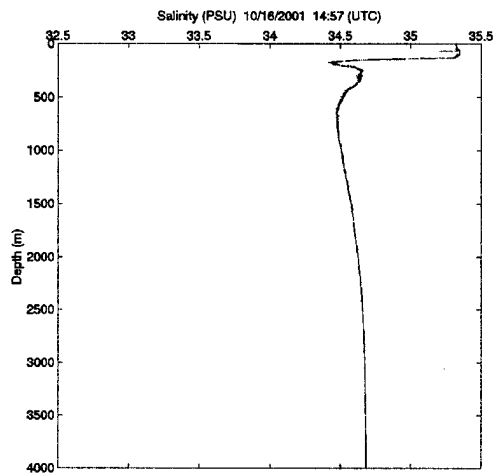
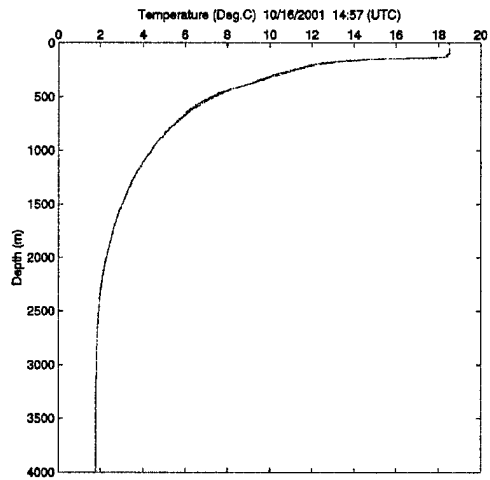


Figure 53: CTD Station 20, cast #64.

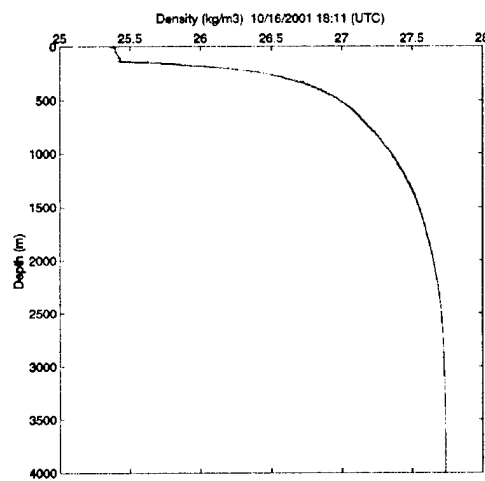
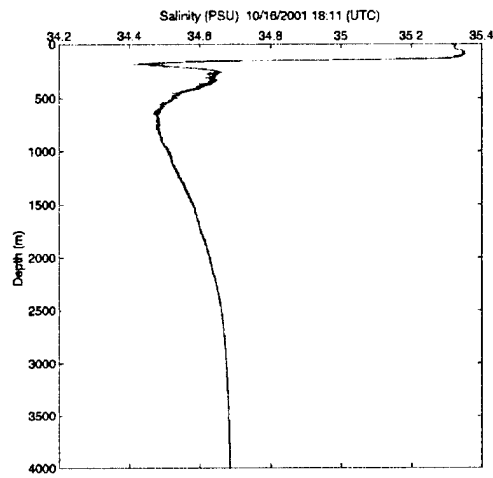
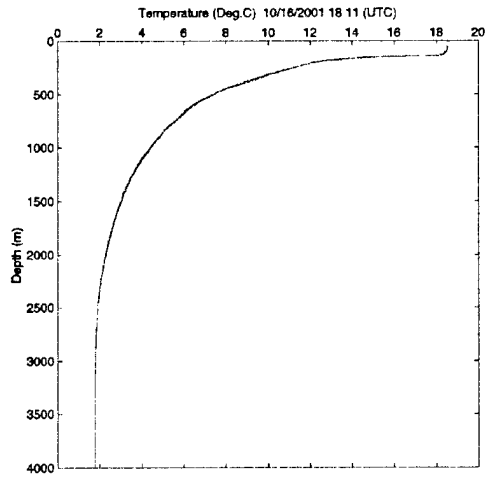


Figure 54: CTD Station 21, cast # 65.

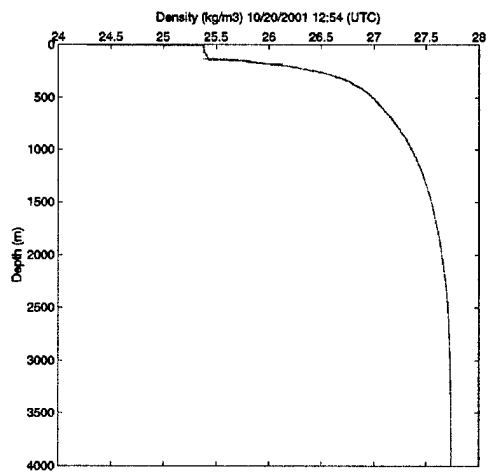
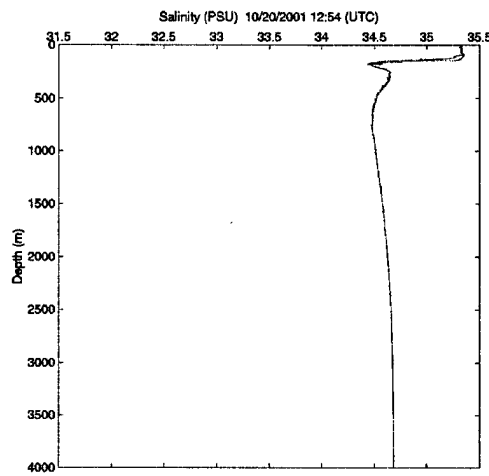


Figure 55: CTD Station 21, cast # 67.

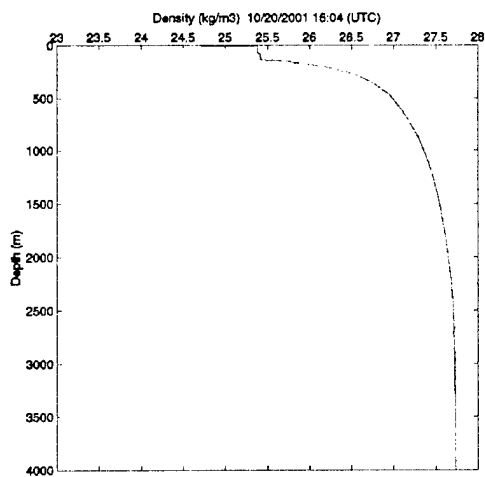
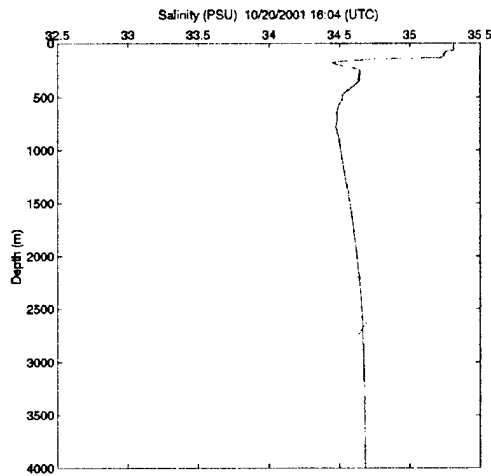
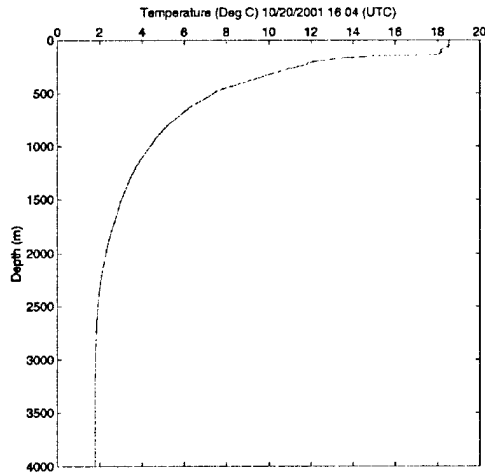


Figure 56: CTD Station 24, cast # 68.

## SECTION 10: Argo floats

### 1. SOLO Deployments

Profiling floats from Russ Davis (Scripps Institution of Oceanography) were deployed on Leg 2 (see deployment SOLO track in Figure 57). This was done in scientific support of the Argo project of global profiling float coverage by the Consortium on the Ocean's Role in Climate's program to observe the eastern tropical Pacific, and the EPIC program itself. The floats allow to report profiles of temperature and salinity from 900 meters to the surface approximately every 10 days. It also measures velocity over those 10 days, alternately drifting at 200 m and 900 m. Figure 57 shows the Argos locations requested during Leg 1 and Leg 2.

There are already a number of floats in the area and the requested deployment locations are intended to fill holes in the array and to extend it to the South East. The requested deployment locations were approximate and a departure of 0.5° in latitude or over 1° of longitude was acceptable.

During Leg 2, six Argo floats were deployed (see details in Table 12).

**Table 12: Argo floats locations and times.**

# ID	latitude	longitude	Time (UTC)	Date
2098	1°54'26"S	95°18'31" W	21:40	10 Oct 01
1145	9°55'36" S	93°33'48" W	6:12	13 Oct 01
1155	13°59'84" S	90°13'08" W	9:01	14 Oct 01
2097	18°00'11" S	86°56'30" W	9:23	15 Oct 01
2057	20°07'58" S	83°15'97" W	17:20	22 Oct 01
2091	20°07'53" S	77°15'63" W	20:15	23 Oct 01

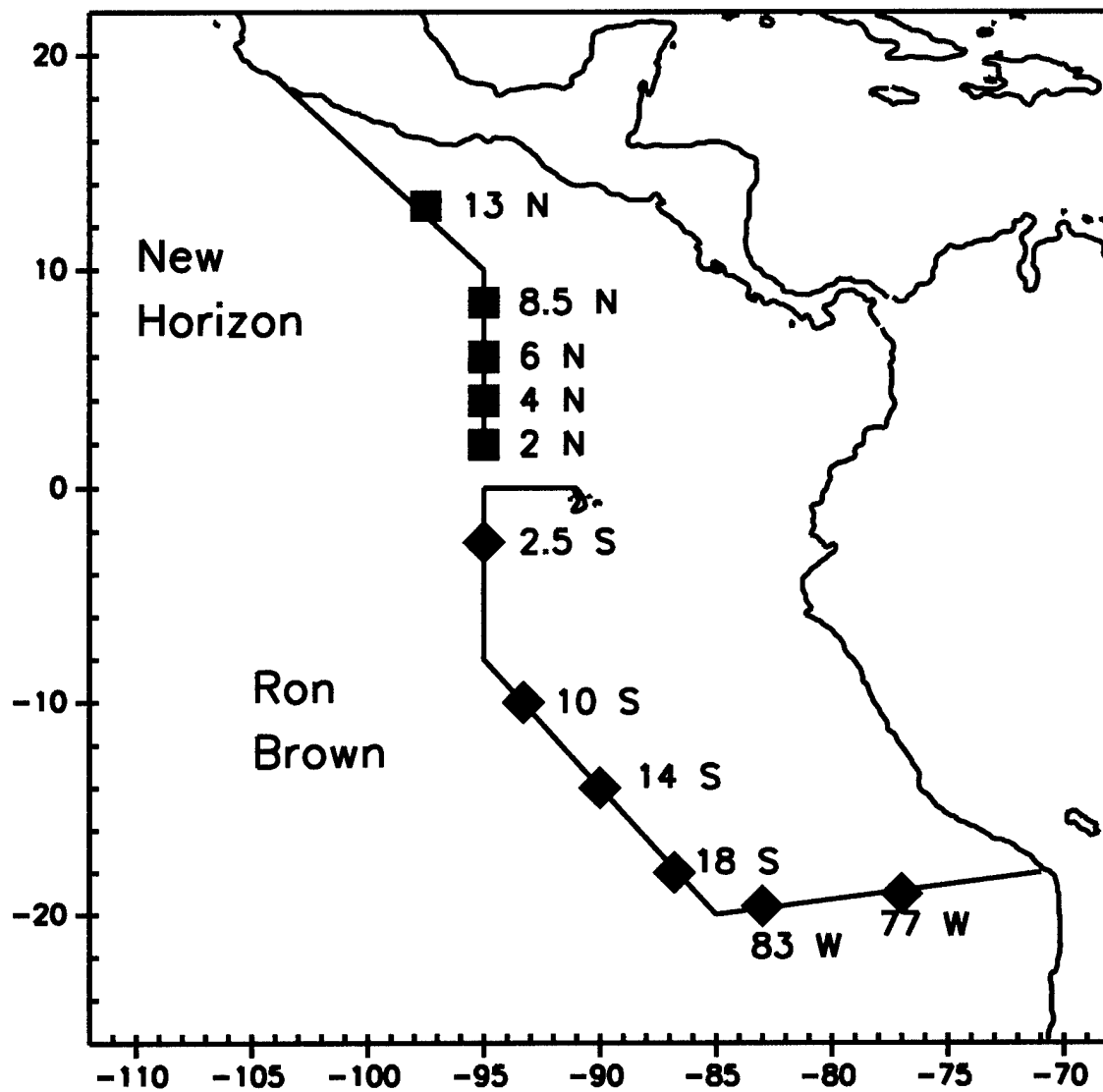


Figure 57: SOLO deployments on the New Horizon and Ron Brown cruises in EPIC 2001.



## **SECTION 11. Ancillary Shipboard Meteorological and Oceanographic Instrumentation**

### **1. Introduction**

Launched in May 1996 at the Halter Marine Group shipyard in Moss Point, Mississippi, and sponsored by Mrs. Alma Brown, NOAA research vessel *Ronald H. Brown* (RHB) participated in the Eastern Pacific Investigation of Climate Processes in the Coupled Ocean-Atmosphere System (EPIC) to study several aspects of the Inter-Tropical Convergence Zone (ITCZ) the Atmospheric Boundary Layer (ABL)/Cold Tongue and the Stratocumulus region during the EPIC 2001 field program.

The RHB is a multi-purpose vessel equipped with a balanced mix of oceanographic and atmospheric observation capabilities. With its sophisticated state-of-art sampling equipment and shipboard scientific computer system (SCS), R/V *Ronald H. Brown* can collect data that enable scientists to make critical near-term forecasts of global climate variability and predictions of climate changes on decadal-to-centennial time scales. The emphasis is on observations of precipitating systems, clouds, and atmospheric boundary layer structure and their coupling to oceanic mixed layer structure through the sea surface temperature field. Table 17 summarizes the underway instrumentation.

### **2. Doppler radar system and Seabeam**

A Doppler radar system, characterized by a 12-foot diameter dome that sits atop the aftermast, provides NOAA its first opportunity to understand precipitation and storm dynamics over the ocean. A Seabeam sonar system provides support for exploration of undersea volcanic events and bathymetric mapping of the ocean floor. Typical missions of the R/V *Ronald H. Brown* include oceanographic sampling of surface, midwater and ocean floor parameters; collection of meteorological data; towing scientific packages and remotely operated vehicles; shipboard data processing and sample analysis, and station keeping to support deep ocean mooring arrays.

**a. Multibeam echo sounding system**, SeaBeam 2112, is a 12 KHz swath sonar system capable of bathymetric mapping and seafloor feature studies in water depths ranging from 50m to 11,000m with up to 151 sonar beams. Swath coverage varies as a function of depth from 150 degrees at 1000m, 120 degrees at 5000m, and 90 degrees at 11,000m.

**b. Hydrographic/Sub-bottom profiler**, Ocean Data Equipment Corporation (ODEC) Bathy 2000, is a flexible dual-frequency (3.5/12 KHz) system providing survey capability from shallow inland waterways to full ocean depth. The 12 KHz deep/shallow bottom profiler provides single beam depth data to 10,000m for bottom profiling or for tracking acoustic pingers in the water column. The 3.5 KHz sub-bottom profiler uses an array of TR-109 transducers to provide shallow sub-bottom penetration with a 35 degree beam in water depths to 10,000m.

**c. Depth recorder/indicator system**, Raytheon Model RD-500, is an 80 KHz chart recording fathometer that measures depths to 500 m. One unit is located in the Pilot House, and one is located in the Computer Lab.

**d. Acoustic Doppler Current Profiler**, RD Instruments Model VM-150-18HP, is a 153.6 KHz system providing vertical profiles of ocean current speed and direction at depths up to 380m.

**e. Doppler Speed Log**, ODEC Model DSN-450, is a 200 KHz dual-axis, four beam system that provides accurate indications of ship's speed, distance traveled, and water depth. Ship's speed is referenced to the sea bottom in shallow water and to the surrounding water mass at deeper depths. This system provides speed input to numerous shipboard electronic systems including navigational radars, SeaBeam, Bathy 2000, Dynamic Positioning System, and MK-39 Attitude and Heading Reference System.

**f. Conductivity, Temperature, Depth (CTD) system**, Sea-Bird Model 911 plus, provides profiles of conductivity and temperature versus depth from the surface to 6800m. The system is equipped with a 12- bottle rosette with Sea-Bird RS-232 tripping mechanism that allows for the collection of discrete water samples at various depths.

**g. Global Positioning System (GPS)**, is a worldwide satellite-based radio navigation system that can provide navigational, geodetic position, and velocity data in three dimensions. The multiple onboard systems have P-code or differential (DGPS) capabilities and are interfaced to the Dynamic Positioning System, the electronic chart display in the Pilot House, and the ship's Scientific Computer System.

**Table 13: Instruments and measurements for air-sea interaction, cloud, and precipitation studies in EPIC 2001.**

<b>Item</b>	<b>System</b>	<b>Measurements</b>
1	Air-sea flux system	Motion corrected turbulent fluxes
2	Pyranometer & Pyrgeometer	Downward solar radiative, IR flux
3	Bulk meteorology	SST, Tair, RH, wind speed
4	Ceilometer	Cloud-base height
5	0.92 Ghz Doppler radar profiler	Wind & precipitation Profiles
6	Raingauges	Rainrate
7	35 Ghz Doppler cloud radar	Cloud microphysical properties
8	20.31 GHz microwave radiometer	Integrated cloud liquid water, total vapor
9	Upward pointed IR thermometer	Cloud-base radiative temperature
10	Mini-MOPA Doppler Lidar	Sub-cloud air motions
11	DIAL Lidar (also Mini-MOPA)	Water vapor profiles
12	BNL Portable Radiative Flux Pack	Direct/diffuse solar, IR fluxes
13	Atmospheric Particle Samplers	Aerosols
14	Modular Microstructure Profiler (MMP)	T, Sal., velocity fluctuations
15	Ocean Profiling Radiometer (SPMR)	Optical properties
16	Rawinsonde	Wind, temperature, humidity prof.
17	Scanning C-band Doppler radar	Precipitation 3-D structure
18	CTD	Ocean T, S profiles
19	ADCP	Ocean current profiles
20	Terrascan Satellite receiving system	NOAA AVHRR, GMS, GOES, SeaWIFs
21	IMET	Meteorology
22	Scientific Computer System (SCS)	All ship's sensors
23	Thermosalinograph	Near-surface T, S
24	AOML underway CO2 system	Water-air CO2 concentrations + O2
25	AOML Turner Designs Fluorometer	Chlorophyll concentration

### 3. Data collected during the Leg 2 Cruise on the R/V R H Brown.

#### NOAA data

##### Ship navigation data

The navigation data are recorded to the R/V R H Brown 's main computer log files in 1-minute intervals. Each record includes the GPS (PCODE) time and location, ship speed and heading. The underway file is in ASCII format. It has a file name that is PCODE. The files are in space separated, formatted, ASCII format. The column headers are: Pcode\_Time (hhmmss), where 'hh' is the two digit hour, 'mm' is the two digit minute, 'ss' is the two digit second, Pcode\_Lat (Degmin), Pcode\_Lon (Degmin), Pcode\_Cog which is ship course (Degrees), Pcode\_Sog which is ship speed (Knots). An other file name was used to sample the bathymetry which is nodc, and with a column header named Bathy-Depth (Meters). The navigation data during the Epic Leg 2 are shown in Figure 58. The full multi-beam SeaBeam mapping data are contained in the directories in .mb41. Software to read and produce the Seabeam maps can be viewed at: <http://www.scecdc.scec.org/larse/LMapp5.html>.

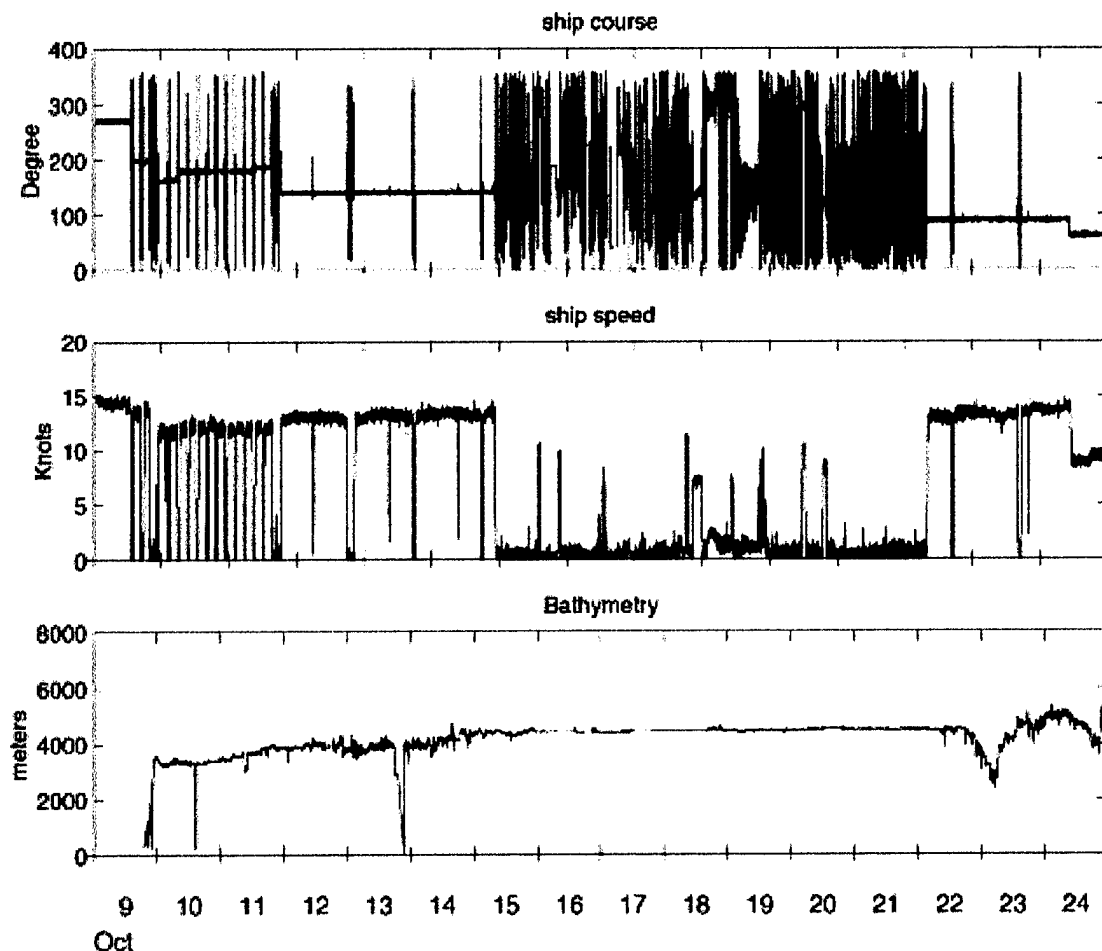
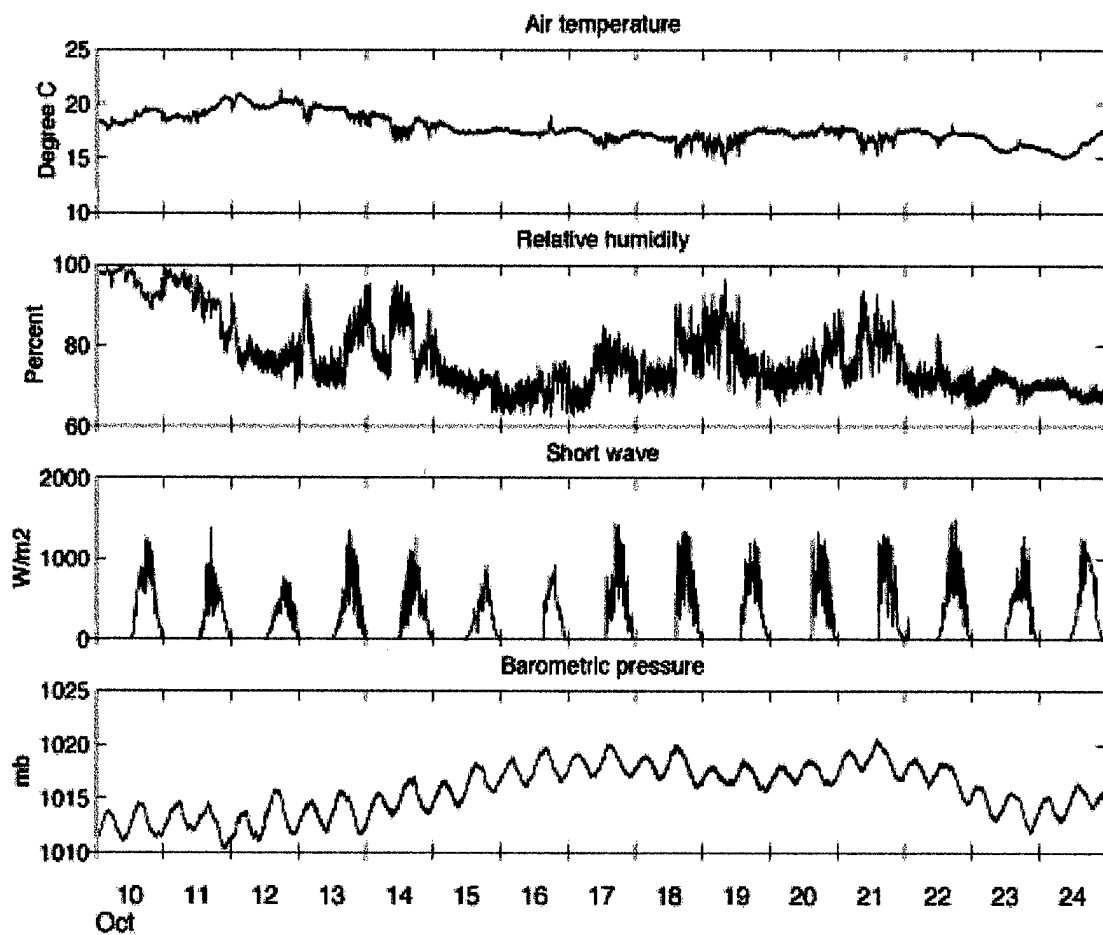


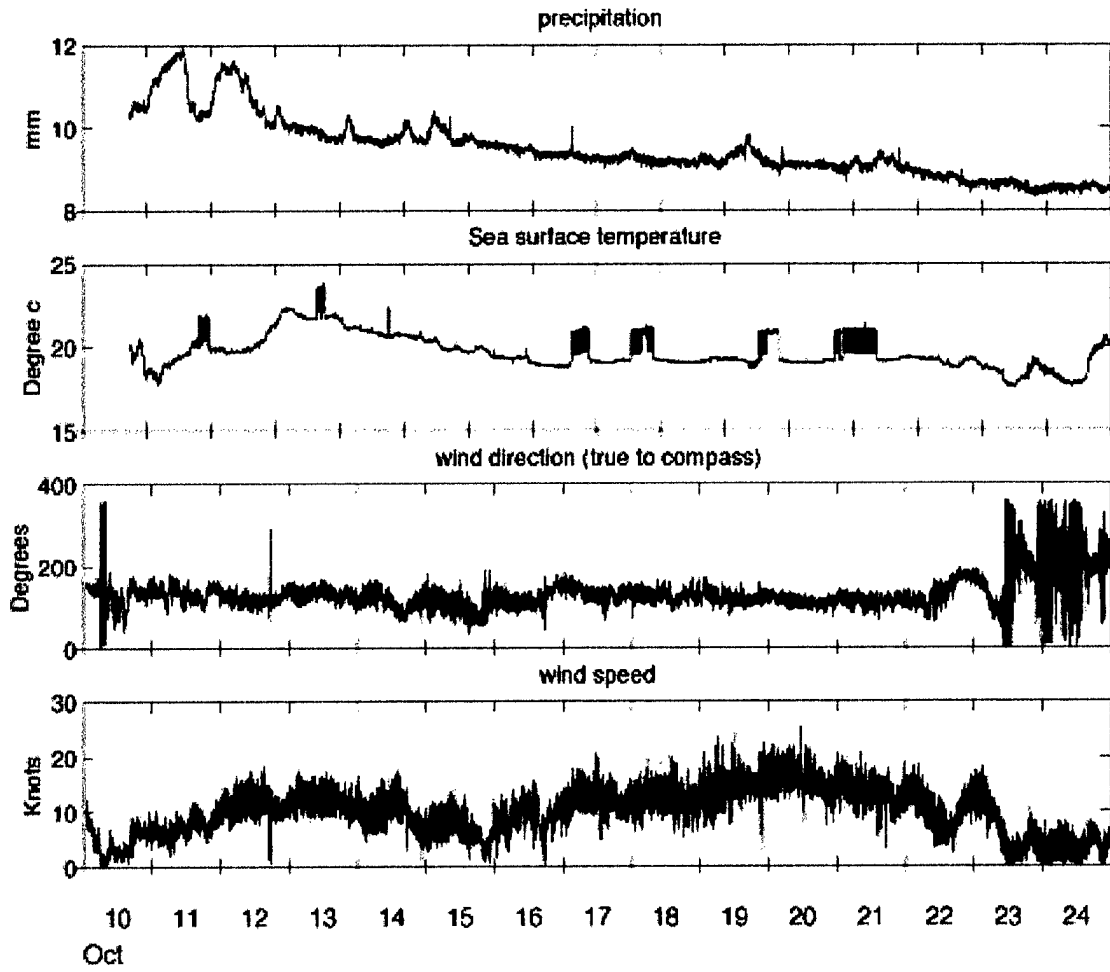
Figure 58: Ship course, Speed and Bathymetry.

## Shipboard IMET and Thermo-Salinograph sensors.

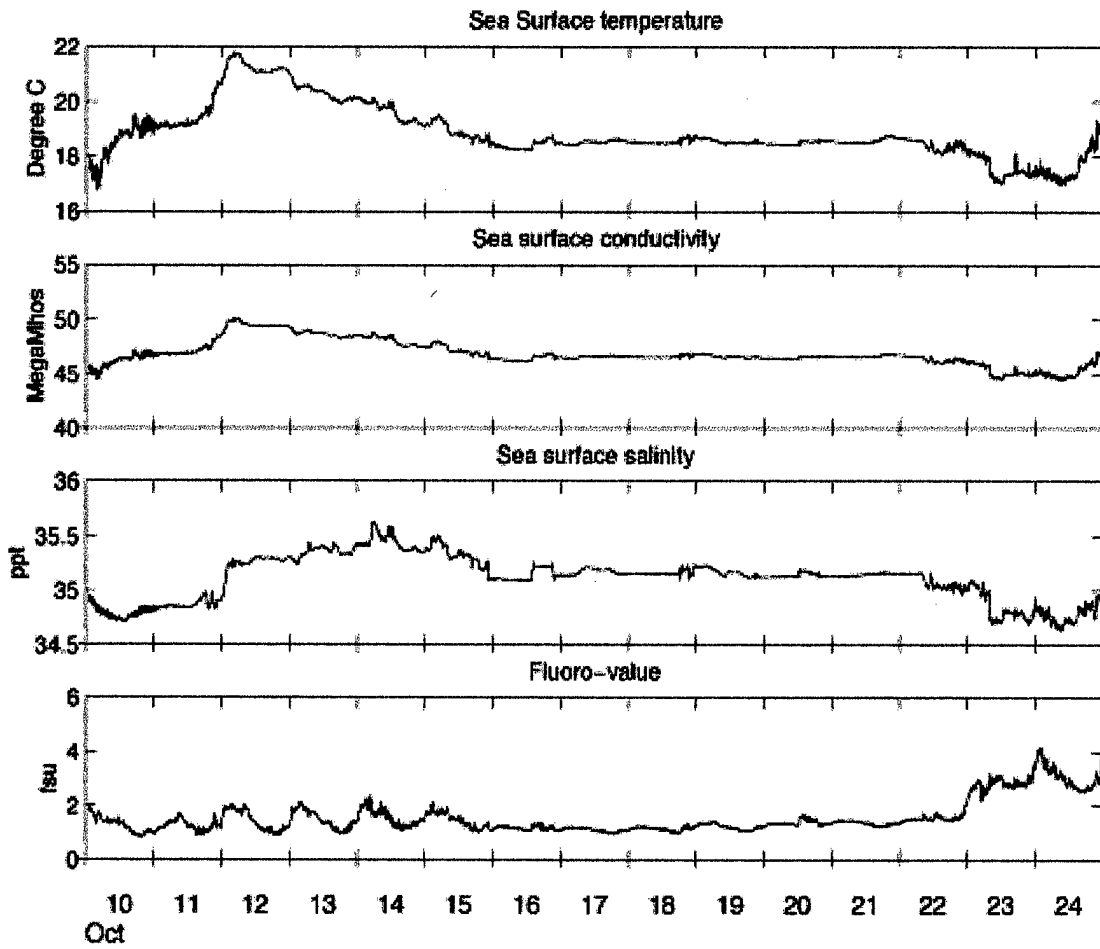
The meteorological and oceanographic data sampled by the IMET and Thermo-Salinograph instruments are recorded to the R/V R H Brown's main computer log files in 1-minute intervals. Each record includes the IMET data with short radiation and wind, Thermo-Salinograph data, GPS (PCODE) time and location, and ship speed and heading. These files are kept in the IMET/directory and are in ASCII format. The file names are OBS and WIND, OCEAN and BNL. The column headers are: Imet-Temp (Deg), Imet-Rel-Hum (Percent), Imet-Shortwave (watts/m2), Baro-CorrectedSeaLevel (mb), Imet-Rwind2-dir (degrees), Imet-Rwind2-spd-knts (Knots), Imet-rain (mm), TSG-Unit-Temp (Deg.C), TSG-Conductivity (Mega\_Mhos), TSG-Salinity (PPT) and Fluoro-Value (FSU). IMET and Thermo-Salinograph data are shown in Figure 59 through Figure 61.



**Figure 59: Air Temperature, Relative Humidity, Short-wave and Barometric pressure from Shipboard IMET sensors.**



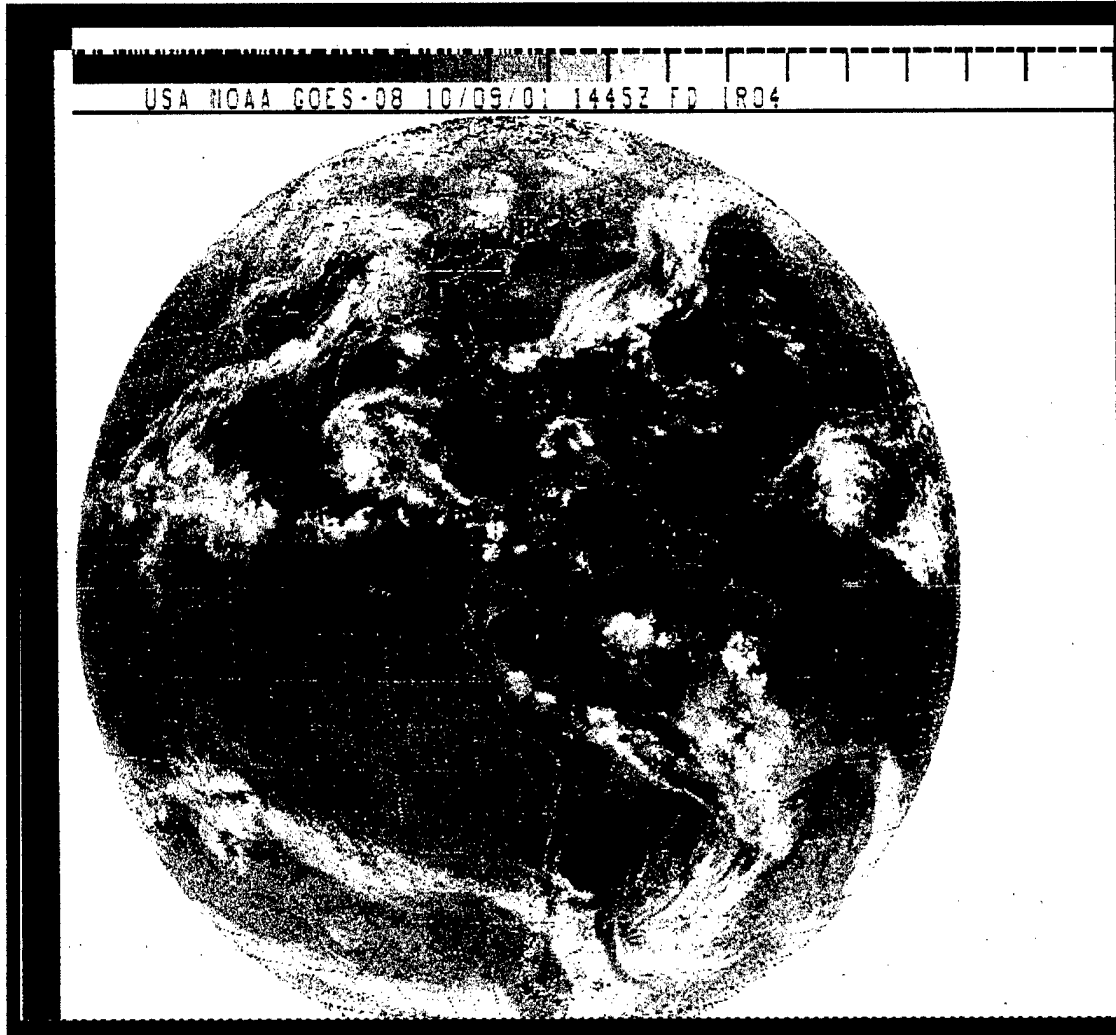
**Figure 60: Precipitation, Sea Surface Temperature, Wind direction and Wind speed.**



**Figure 61: Sea Surface Temperature, sea Surface Conductivity, Sea Surface salinity and Fluoro-Value.**

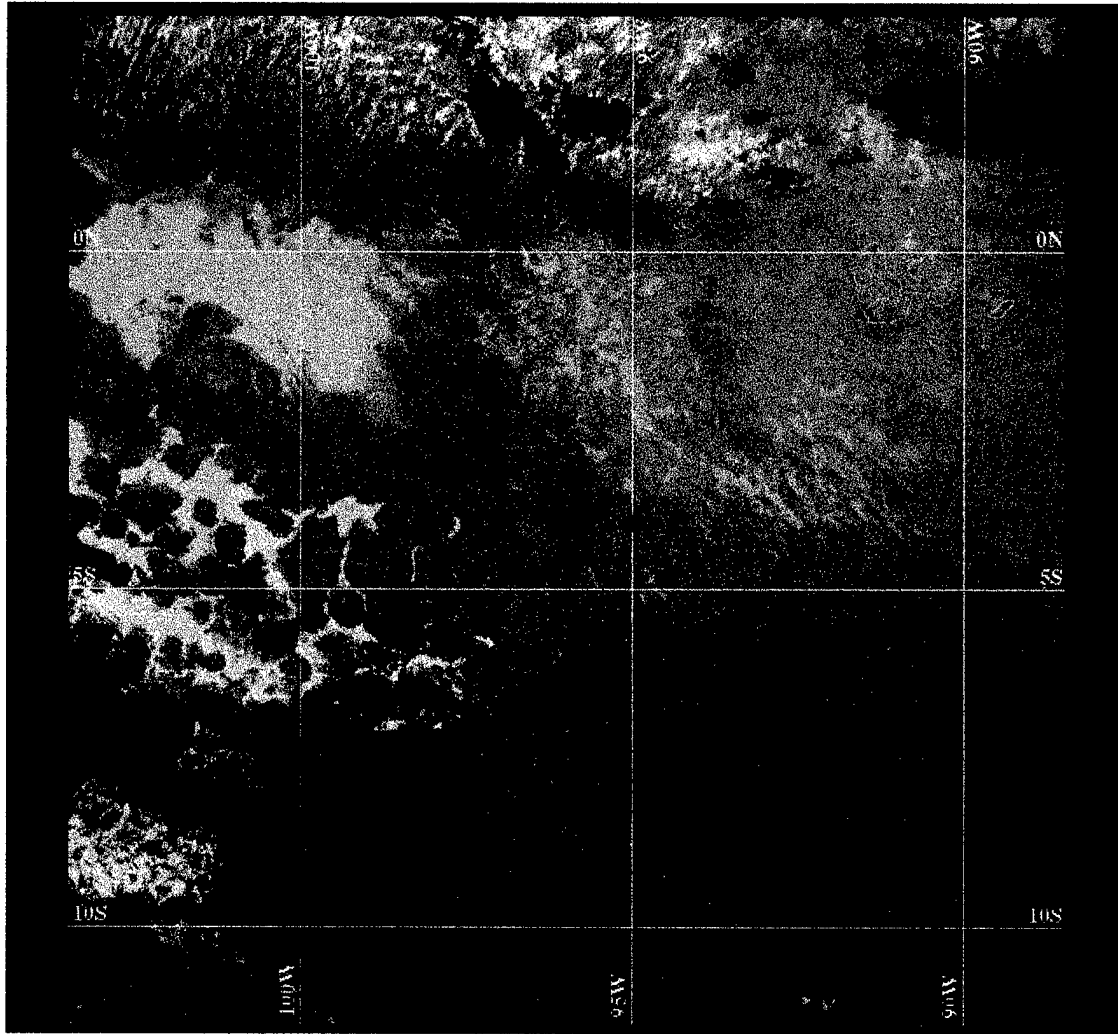
## Terascan : Ship s satellite images

Figures 62 and 63 represent two images taken a board the R/V *R H Brown* by satellite.



**Figure 62: NOAA image dated from the 9 October 2001.**





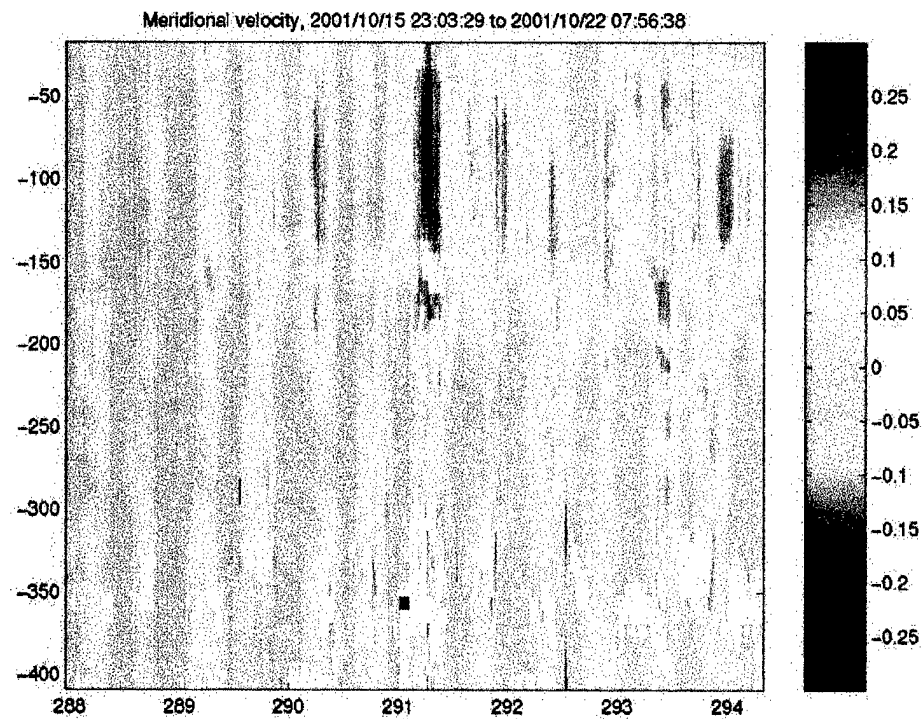
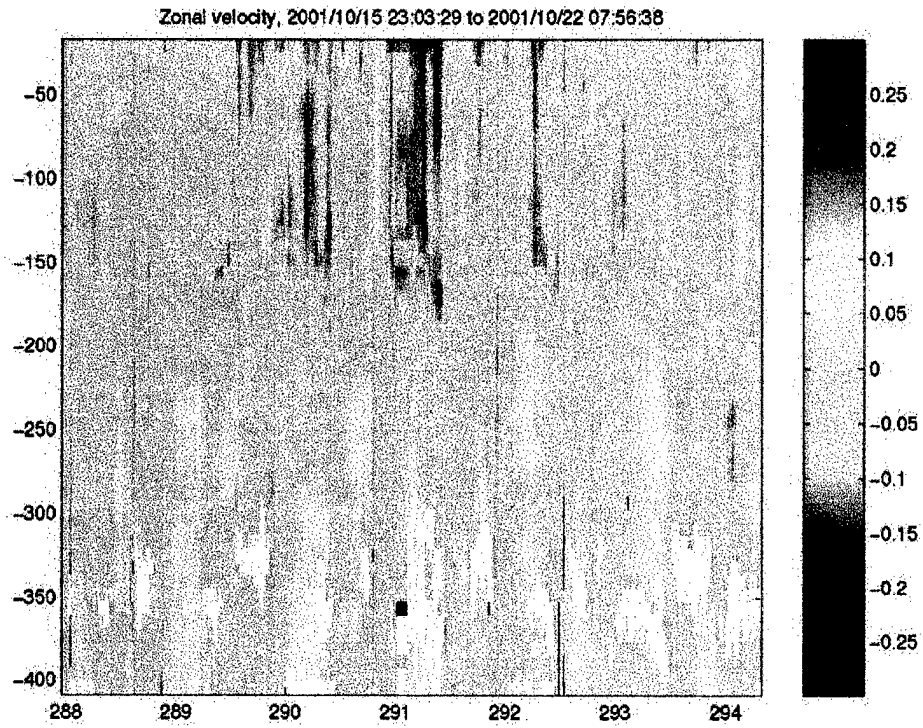
**Figure 63: NOAA image dated from the 11 October 2001.**

## Shipboard ADCP data

The RD Instruments vessel mounted Acoustic Doppler Current Profiler (ADCP) recorded the zonal (U – East) and Meridional (V – North) vector current velocities when the ship spent 6 days on station during the Leg 2 cruise. The raw data were stored in the standard RDI ADCP binary format pingdata.###. Processing was done with the free CODAS software package developed at the University of Hawaii (information can be found at

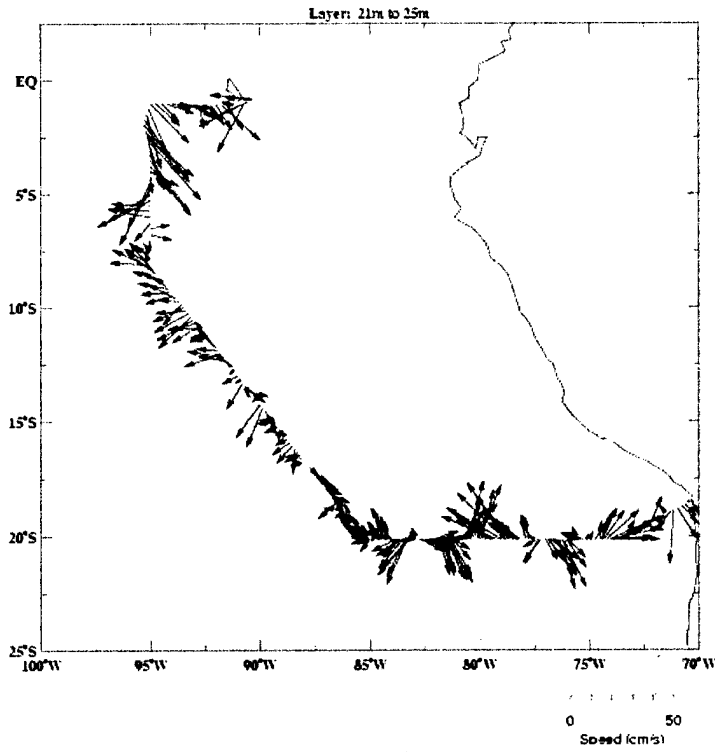
[http://www.ncdc.noaa.gov/coare/catalog/data/ocean\\_large\\_scale/adcp\\_coare.html](http://www.ncdc.noaa.gov/coare/catalog/data/ocean_large_scale/adcp_coare.html)).

The converted pingdata and the corresponding current velocities are shown in Figure 64. Average ADCP vectors within a 1/4 degree by 1/4 degree longitude/latitude grid for a series of standard vertical averages are shown in Figure 65 through Figure 68.

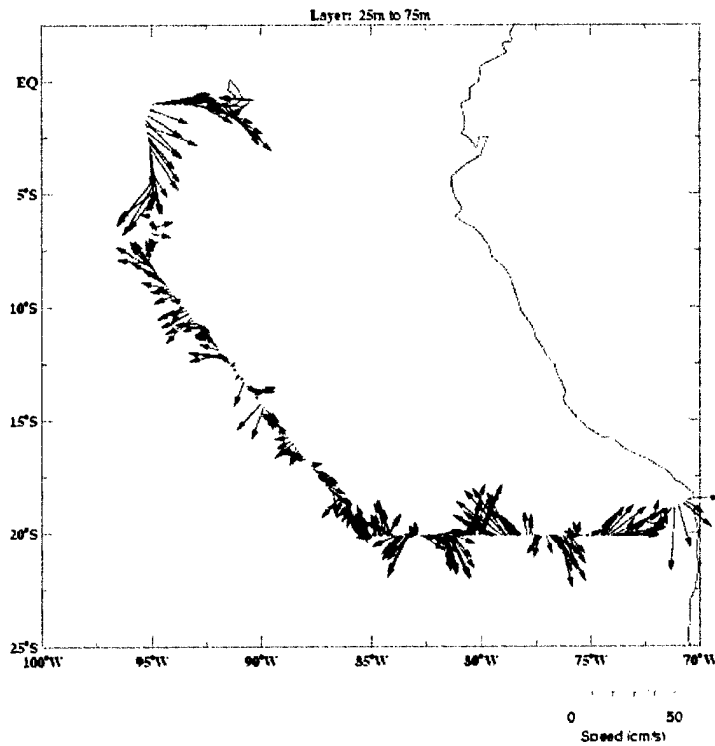


**Figure 64: Zonal and Meridional Currents velocity for the shipboard ADCP.**

**ADCP RB0108**  
October 9 to 25, 2001



**ADCP RB0108**  
October 9 to 25, 2001

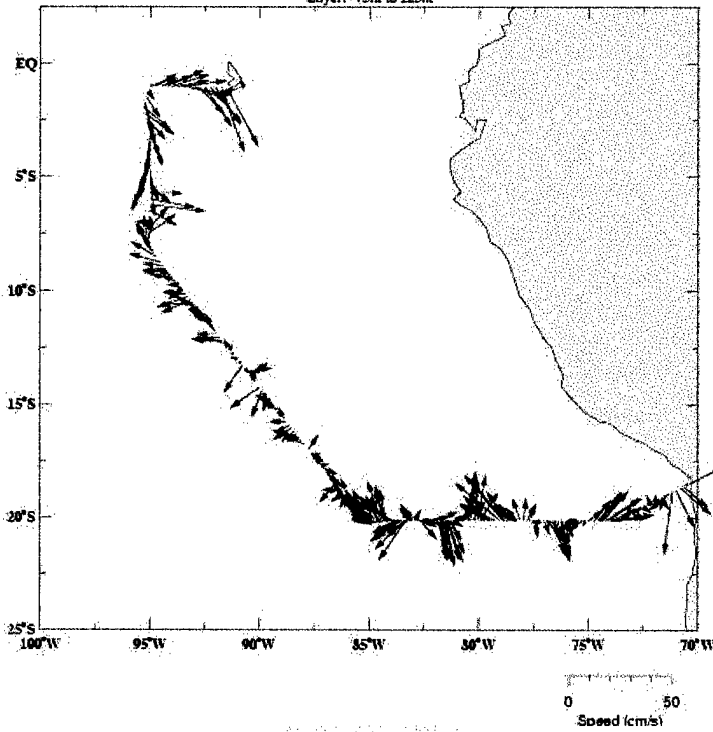


**Figure 65: ADCP vectors for vertical layers of 21m to 75m.**

**ADCP RB0108**

October 9 to 25, 2001

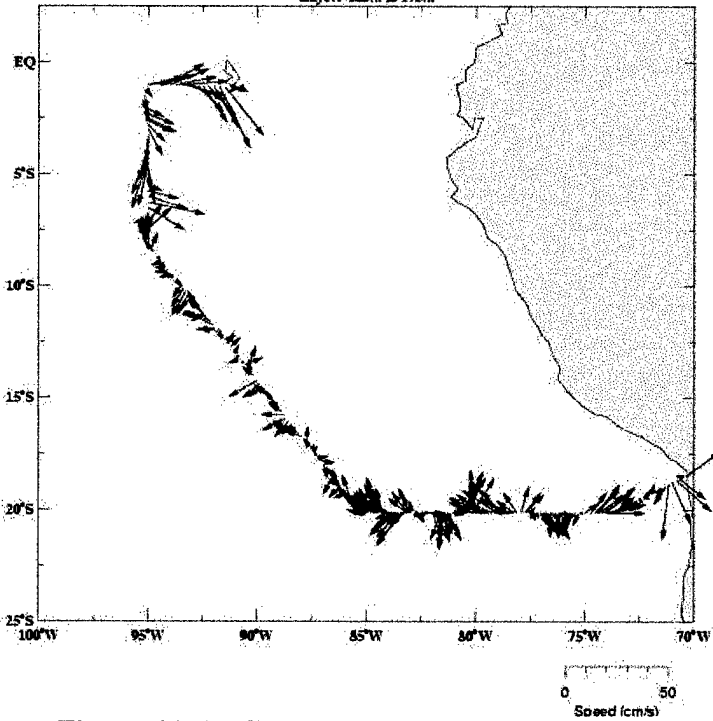
Layer: 75m to 125m



**ADCP RB0108**

October 9 to 25, 2001

Layer: 125m to 175m

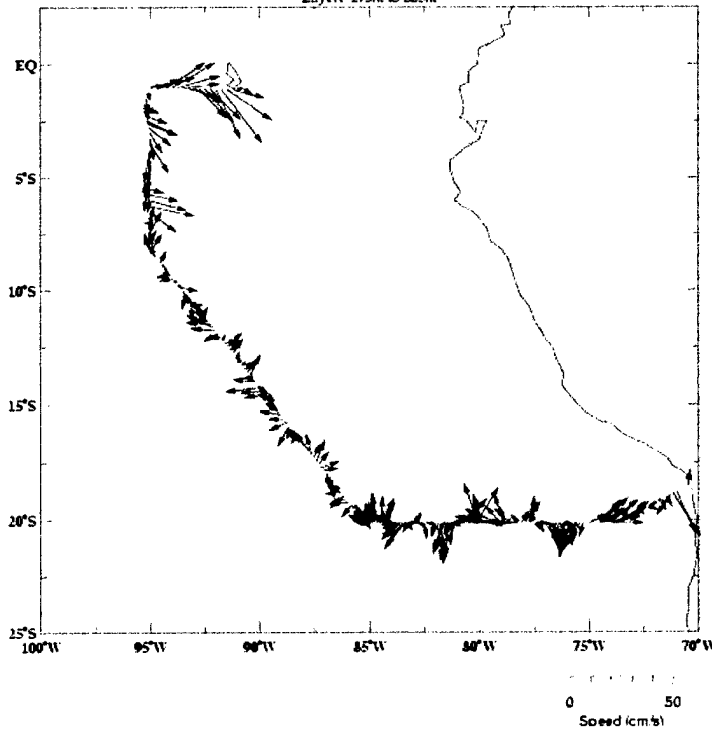


**Figure 66: ADCP vectors for vertical layers of 75m to 175m.**

**ADCP RB0108**

October 9 to 25, 2001

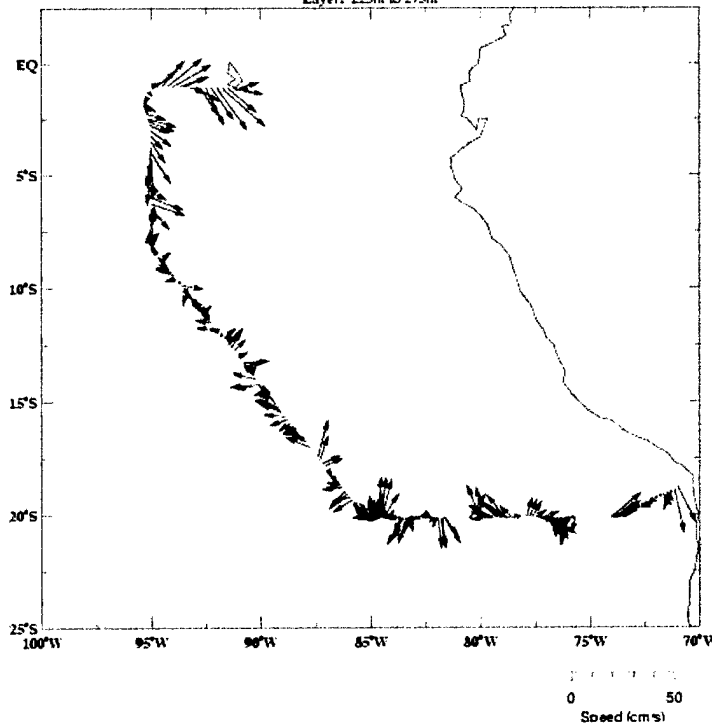
Layer: 175m to 225m



**ADCP RB0108**

October 9 to 25, 2001

Layer: 225m to 275m

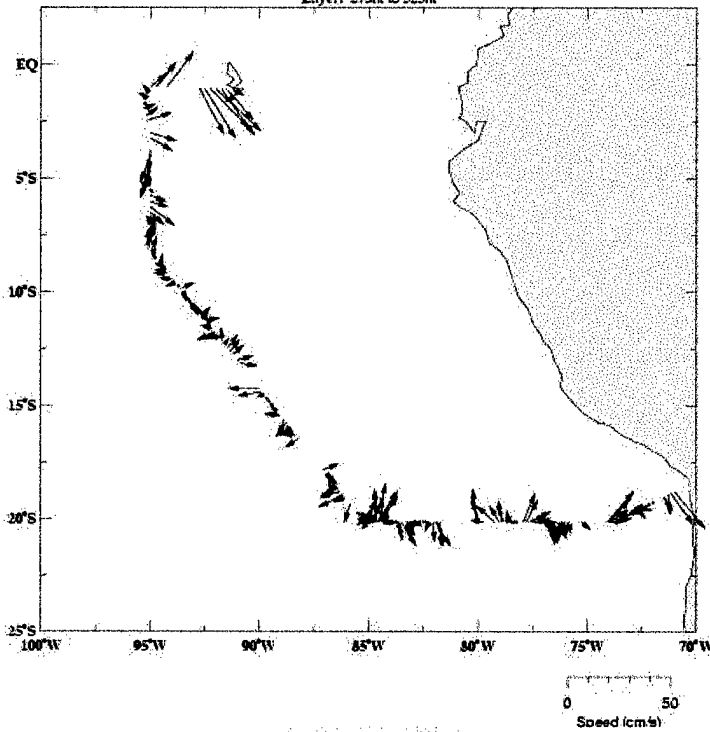


**Figure 67: ADCP vectors for vertical layers of 175m to 275m.**

**ADCP RB0108**

October 9 to 25, 2001

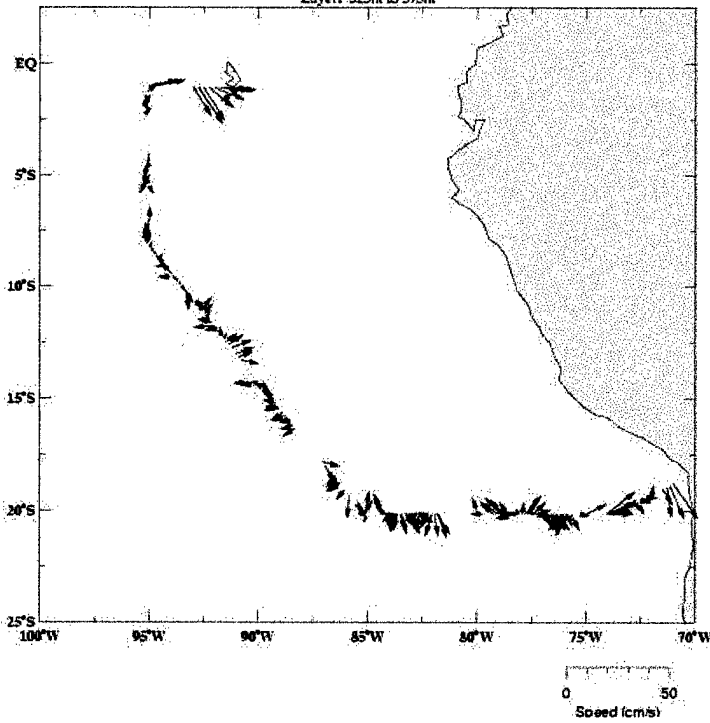
Layer: 275m to 325m



**ADCP RB0108**

October 9 to 25, 2001

Layer: 325m to 375m



**Figure 68: ADCP vectors for vertical layers of 275m to 375m.**

## Acknowledgments

The captain, Don Dreves, the Executive officer, George White, the field operations officer, Robert Kamphaus, the junior officer, the junior officer, Cathy Martin, the survey technician, Jonathan Shannahoff and crew of the R/V *R H Brown*, deserve special thanks for their hard work and dedication in making Leg 2 a total success.

This work was supported by the National Oceanic and Atmospheric Administration Grant No. NA96GP0429 and NA17RJ1223.

## References

- Lisanne E. Lucas, Bryan S. Way, Robert A. Weller, Paul R. Bouchard, William M. Ostrom, Term Evolution of the Coupled Boundary Layers (Stratus 1), Mooring Deployment Cruise Report, R/V *Melville* Cruise Number Cook 2, 2 October – 14 October 2000. Upper Ocean Processes Group, UOP Technical Report 00-01, Woods Hole Oceanographic Institution Technical Report WHOI-00-01, 94 pages.
- Trask, Richard P., Bryan S. Way, William M. Ostrom, Geoffrey P. Allsup, and Robert A. Weller, 1995. Arabian Sea Mixed Layer Dynamics Experiment, Mooring Deployment Cruise Report, R/V *Thomas Thompson* Cruise Number 40, 11 October-25 October 1994. Upper Ocean Processes Group, UOP Technical Report 95-1, Woods Hole Oceanographic Institution Technical Report WHOI-95-01, 64 pages
- Heinmiller, Robert H., 1976. Mooring Operations Techniques of the Buoy Project at the Woods Hole Oceanographic Institution. Woods Hole Oceanographic Institution Technical Report, WHOI-76-69, 94 pp.
- Trask, Richard P., and Robert A. Weller, 1995. Cyclic Fatigue Testing of Surface Mooring Hardware for the Arabian Sea Mixed Layer Dynamics Experiment. Upper Ocean Processes Group, UOP Technical Report 95-15, Woods Hole Oceanographic Institution Technical Report, WHOI-95-16, 66 pp.



## APPENDIX 1 : WHOI Instrumentation recovered during RB-01-08

**Table 14: Instrumentation mounted on 3 meter discus buoy of Stratus 1.**

Parameter	Sensor ID	Elevation relative to buoy deck (meters)	Elevation relative to water line (meters)	Measurement location
IMET system 1	Logger 117			
Wind speed	WND 104	2.96	3.39	Prop axis
Wind direction	WND 104	2.96	3.39	Prop axis
Air Temperature	TMP 102	1.61	2.04	End of probe
Relative Humidity	HRH 108	2.31	2.74	Tip of sensor
Barometric Pressure	BPR 107	2.36	2.79	Center of port
Precipitation	PRC 102	2.71	3.14	Top of funnel
Long-wave Radiation	LWR 101	3.15	3.48	Base of dome
Short-wave Radiation	SWR 111	3.14	3.47	Base of dome
Sea Temperature	SST 003	-1.00	-0.57	End of probe
IMET system 2	Logger 226			
Wind speed	WND 105	2.89	3.32	Prop axis
Wind direction	WND 105	2.89	3.32	Prop axis
Air Temperature	TMP 104	1.59	2.02	End of probe
Relative Humidity	HRH 110	2.34	2.77	Tip of sensor
Barometric Pressure	BPR 106	2.40	2.83	Center of port
Precipitation	PRC 101	2.74	3.17	Top of funnel
Long-wave Radiation	LWR 006	3.15	3.58	Base of dome
Short-wave Radiation	SWR 109	3.14	3.57	Base of dome
Sea Temperature	SST 104	-1.00	-0.57	End of probe
Stand-alone Relative Humidity	HRH 204	2.32	2.75	Tip of sensor
Tid-bit Air Temp	358910	1.77	2.20	Tied to TMP 104
SBE-39 Floating SST	0072	surface	0	
Tid-bit Sea Temp	358909	-1.00	-0.57	Near SST 003
SeaCat Conductivity/ Temperature	1878	-1.00	-0.57	Center of cell

**Table 15: Instrumentation mounted on the mooring line of the 3 meter discus buoy of Stratus 1.**

Instrument	Serial Number	Depth from Mooring Diagram (meters)	Sampling Rate/Record Rate	Time Deployed (7 Oct.2000) (UTC)	Time Spike (UTC) Start - Finish	Time recovered (17 Oct. 2001) (UTC)	Parameter(s) Measured
SeaCat	1875	3.71	3.75 Min.	13:27:30	20:29 - 20:38 28 Sept. 2000	20:45:20	Temperature
	1873	7		13:26:50		20:46:20	
	2325	16		13:38:17		20:51:20	Salinity
	1880	30		13:21:20		20:58:40	
Brancker T-Pod	3763	13	30 Min.	13:30:22	19:59 - 21:01 28 Sept 2000	20:50:00	Temperature
	4491	35		13:18:20		21:00:00	
	3301	47.5		13:59:30		19:47:35	
	3831	55		14:02:40		19:45:46	
	3830	70		14:07:50		19:41:30	
	3764	77.5		14:09:30		19:39:18	
	3258	92.5		14:12:35		19:33:45	
	3263	100		14:17:55		19:31:45	
	4495	115		14:21:10		19:28:20	
	4485	145		14:30:28		19:20:35	
	4228	160		14:34:45		19:16:15	
	3836	220		14:40:02		19:07:04	
	3259	250		14:46:10		18:59:50	
	VMCM	VM038		10		7.5 Min.	
VM037		20	13:19:01	⊙ 17:35:00 ⊙ 20:04:00	20:53:10		
New Gen VMCM	VM01	350		14:54:10	⊙ 17:32:00 ⊙ 20:05:00	18:51:54	
				7 Oct 2000 (Bands Off)			
MicroCat	1328	40	3.75 Min.	13:18:20	20:15 - 20:28 28 Sept 2000	19:49:10	Temperature Conductivity
	1326	62.5		14:04:25		19:43:40	
	1305	85		14:11:50		19:35:15	
	1330	130		14:24:55		19:25:00	
	1306	190		14:38:45		19:11:20	
SBE-39	0050	25 (on Chlam)	5 Min.	13:21:40	22:01 - 22:11 28 Sept 2000	20:57:20	Temperature
	0048	349		14:49:25		18:51:50	
	0049	450		15:10:45		18:45:35	
Chlam	ACH0126	25	2 Hours	13:21:40		20:57:20	
ADCP	TSN-1218	135	30 Min	14:29:20		19:23:22	East and North Currents
FSI	1325A	235	30 Min	14:44:25		19:02:35	East and North Currents
Tidbit	358909	(on bridle)	30 Mins		19:23-20:14 29 Sept. 2000	1 (on bridle)	
	358907	10 (on VMCM)		13:30:45		20:47:30	
	358908	16 (on SeaCat)		13:38:17		20:51:20	
Acoustic Rain Gauge	F9	23.5		13:21:40		20:50:40	Precipitation

APPENDIX 2: Moored Station Log of Stratus 1

Moored Station Log

(fill out log with black ball point pen only)

ARRAY NAME AND NO. Stratus I MOORED STATION NO. 1052

Launch (anchor over)

Date 7 October 2000 Time 20:43:00 UTC
day-mon-year
Latitude 20°09.508 N or (S) Longitude 85°08.278 E or (W)
deg-min deg-min
Position Source: GPS, LORAN, SAT. NAV., OTHER GPS
Deployed by: Ostion, Bouchard, Dunn, Rydeff Recorder/Observer: Sandy Lucas
Ship and Cruise No Helville, Cook 02 Intended duration: 365 days
Depth Recorder Reading 4440 m Correction Source: Sea beam
Depth Correction 0 m
Corrected Water Depth 4440 m Magnetic Variation: 8.3 (E) or (W)
Anchor Position: Lat. 20°9.4174 N or (S) Long. 85°9.0729 E or (W)
Argos Platform ID No. See Next page Additional Argos Info may be found on pages 2 and 3.

Acoustic Release Information

Enable 42 Disable 41
Release No. 339 Tested to 1000 meters
Receiver No. 4 Release Command 43
Interrogate Freq. 11 kHz Reply Freq. 10 kHz

Recovery (release fired)

Date 17 October 2001 Time 12:39:00 UTC
day-mon-year
Latitude 20°07.409 N or (S) Longitude 85°08.432 E or W
deg-min deg-min
Position Source: GPS, LORAN, SAT. NAV., OTHER GPS
Recovered by: Ostion, Bouchard, Lind, Gobat Recorder/Observer: Charlotte Valle
Ship and Cruise No. R.H. Brown 0801 Actual duration: 1 days
Distance from actual waterline to buoy deck 58 meters

Surface Components

Buoy Type 3m. Discus Hull Color(s) Hull Blue & White w/ Gray Stripe Tower White  
 Buoy Markings \_\_\_\_\_

Surface Instrumentation			
Item	ID	Height *	Comments
Data logger	117	—	located in well / system # 1
Relative humidity	HRH 108	231 cm	(tip of sensor) Relative to buoy deck
Wind module	WND 104	296 cm	( Prop. axis)
Air temp.	TNP 102	161 cm	(End of probe)
Barom. Pressure	BPR 107	236 cm	(center of Port)
Short wave Rad.	SWR 111	314 cm	( base of dome)
Long wave Rad.	LWR 101	315 cm	( " " " )
Precipitation	PRC 102	271 cm	( Top of funnel)
Argos Trans	PTT 27916		PTT 101
	27917		
	27918		
Data logger	226		located in well / system # 2
Relative humidity	HRH 110	234 cm	(tip of sensor)
Wind module	WND 105	289 cm	(prop. axis)
Air temp	TNP 104	159 cm	(end of probe)
Barom. Pressure	BPR 106	240 cm	(center of Port)
Short wave Rad.	SWR 108	314 cm	( base of dome)
Long wave Rad.	LWR 106	315 cm	( " " " )
Precipitation	PRC 101	274 cm	( Top of Funnel)
ARGOS TRANS PTT	27919		PTT 104
	27920		
	27921		
Relative humidity	HRH 204	232 cm	(tip of sensor) Stand Alone
Tidbit Air temp	358910	177 cm	Tied to TNP 104 ( sys #2 Air temp)
Flashing light	24412	279 cm	Solar Power (mid Height)
Radar Reflector	none	211 cm	(mid height)

\* Height above buoy deck

## Sub-Surface Instrumentation on Buoy and Bridle

Item	ID	Depth †	Comments
INET/SST	SST 003	1m	System # 1
INET/SST	SST 104	1m	System # 2
Seacat	1878	1m	
Tidbit	358 909	1m	located on bridle next to SST #1
Argos Trau <sup>PTT</sup>	11427		clamped to bridle
SBE 39	0072	0m	Floating SST
Bridle	-	-	No tension logged
			Termination of bridle to 0.42 m. 3/4" Proof
			coil chain is: U-joint → 1" chain shackle
			→ 1" endlink → 7/8" chain shackle.
† Depth below buoy deck			

## Sub-Surface Components

	Type	Size(s)	Manufacturer		
Chain					
Wire Rope					
Synthetics					
Hardware					
Flotation	Type (G.B.s, Spheres, etc)	Size	Quantity	Color	
	G.B.s w/ Hard Hats *	17"	81	yellow	
	* lost at least 1 after deployment	(see page 10)			
No. of Flotation Clusters		1			
Anchor Dry Weight		9300 lbs			

MOORED STATION NUMBER 1052

depth from datum

Item No.	Lgth [m]	Item	Inst No.	Time Over	Notes	Data No.	Calc Dpth	Time Back	Notes
	0.48	3/4" Proof Coil Chain							
3.71		Seacat w/ loadbar	1873	13:27:30	Inst. hanging upside, did not			20:45	
	2.06	3/4" P.C.C.							
7		Seacat w/ loadbar	1873	13:26:50				20:46	
	1.3	3/4" P.C.C.							
10		3/4" cage vncn	VN038	13:21:50	bands off 11:0 13:30:45			20:47:30	
	-	Tidbit on @ vncn cage	358907	13:30:45				20:47:30	
	0.82	3/4" P.C.C.							
13		TPCB w/ loadbar	3763	13:30:22				20:50:00	
	1.78	3/4" P.C.C.							
16		Seacat w/ loadbar	2325	13:38:17				20:51	
	-	Tidbit on @ seacat loadbar	358908	13:38:17				20:51:20	
	2.26	3/4" P.C.C.							
20		3/4" vncn cage	VN037	13:19:01	Bands off			20:53:10	
	0.96	3/4" P.C.C.							
23.5		Keen Gauge Trans up	F9	13:21:55				20:50:40	
	0.48	3/4" P.C.C.							
25		ETHAN	AETH0126	13:21:40				20:57	
25	-	80E-39 located on crane	0050	13:21:40				20:57	
	2.74	3/4" P.C.C.							
Date/Time		Comments							
line 7		⊕ Tidbit collocated with the vncn Temp. sensor (see photo)							
line 12		⊕ Tidbit located on seacat loadbar near temp sensor							
line 19		⊕ 80E-39 located on ETHAN (see photo)							
line 1 → bridle		⊕ shed to bridle w/ a U-joint → 1" chainshack → 7/8" end link → 7/8" chainshack							
all lines 1-75 to each other		⊕ 3/4" chain shackle, 7/8" end link, 3/4" chain shackle							

MOORED STATION NUMBER 1052

depth from drawing

	Item No.	Lgth [m]	Item	Inst No.	Time Over	Notes	Data No.	Calc Dpth	Time Back	Notes
30	21		Sea cat w/ loadbar	1880	13:21				20:59:40	Blocked Top
	22	3.7	3/4" P.C.C.							
35	23		TPOD w/ loadbar	4491	13:18				21:00:00	
	24	3.77	3/4" P.C.C.							
40	25		Mini cat w/ loadbar	1328	13:18				19:49:10	high extreme end - faulted
	26	6.2	7/16" wire						19:47:35	
47.5	27		TPOD w/ loadbar	3301	13:59:30				19:47:35	
	28	6.2	7/16" wire						19:45:46	
55	29		TPOD w/ loadbar	3831	14:02:40				19:45:46	#?
	30	6.2	7/16" wire						19:43:40	
62.5	31		Mini cat w/ loadbar	1326	14:04:25				19:43:40	barnacles & molluscs
	32	6.2	7/16" wire						19:41:30	
70	33		TPOD w/ loadbar	3830	14:07:50				19:41:30	barnacles
	34	6.2	7/16" wire						19:39:18	
77.5	35		TPOD w/ loadbar	3764	14:09:30				19:39:18	barnacles
	36	6.2	7/16" wire							
85	37		Mini cat w/ loadbar	1305	14:11:50				19:35:15	barnacles
	38	6.2	7/16" wire							
92.5	39		TPOD w/ loadbar	3258	14:12:35				19:33:45	barnacles
	40	6.2	7/16" wire							
Date/Time		Change from original design Comments 3.71m - 62.5m								
line 31		Switched Mini cat w/ sea cat due to lack of Anti foul Rings for mini cats								

MOORED STATION NUMBER 1052

*depth from drawing*

	Item No.	Lgth [m]	Item	Inst No.	Time Over	Notes	Data No.	Calc Dpth	Time Back	Notes
100	41		TPOB w/ loadbar	3263	14:17:55				19:31:45	
	42	3.43	3/4" P.C.C							Foul
	43	0.61	3/4" P.C.C			9 links				Foul
	44	9.4	7/16" wire						19:28:20	
115	45		TPOB w/ loadbar	4495	14:21:10	end cap says Sw: 4492			19:28:20	
	46	14.0	7/16" wire							
130	47		Nico cat w/loadbar	1330	14:24:55				19:25:00	#?
	48	3.43	3/4" P.C.C							
135	49		ADCP upward facing		14:29:20				19:23:22	Jelly Barnacle
	50	8.5	7/16" wire							
145	51		TPOB w/ loadbar	4485	14:30:29				19:20:35	
	52	14.0	7/16" wire							
160	53		TPOB w/ loadbar	4228	14:34:45				19:16:15	few barnacle
	54	28.5	7/16" wire							
190	55		Pinocat w/loadbar	1306	14:39:45				19:11:20	#?
	56	28.5	7/16" wire							
220	57		TPOB w/ loadbar	3936	14:40:02				19:07:04	
	58	13.0	7/16" wire							
235	59		FSI-3D Acn sensors down	1325A	14:44:25				19:02:35	1 amode completely destroyed
	60	14.0	7/16" wire							
Date/Time		Comments								
		Change from original drawing: Switched 16m moored w/ 130m - sensor due to lack of Anti-Foul plate								



MOORED STATION NUMBER 1052

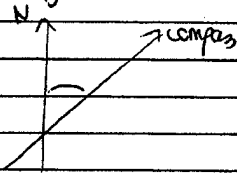
depth from  
drawing

Item No.	Lgth [m]	Item	Inst No.	Time Over	Notes	Data No.	Calc Dpth	Time Back	Notes
250	61	TP00 w/ anchor	3259	14:46:10				18:59:50	
	62	3/8" wire							
349	63	SBE-39 clamped to wire	0048	14:49:25				18:51:50	
350	64	New Gen V11 3/4" cage	VN 01	14:49:25	bands 066 H.O: 14:54:10			18:51:54	when robot stopped (time)
	65	3/8" wire							
450	66	SBE-39 clamped just above wire end	0049	15:10:45				18:45:35	
	67	3/8" wire						18:39:00	
	68	3/8" wire						18:29:00	
	69	3/8" wire						18:17:17	
	70	3/8" wire		15:56:20				18:13:30	
	71	3/8" wire		16:10:00	* wire repair see note			18:10:40	
	72	7/8" Nylon			Special seam in between			18:04:40	
	73	7/8" Nylon						17:51:30	
	74	7/8" Nylon		16:38	Adjusted from 350 due to H.O depth			16:56:21	Manually stop off Recover mooring at 17:3
	75	7/8" Nylon						16:50:50	
	76	7/8" Nylon						16:38:40	
	77	1" Nylon							
	78	1 1/8" Polypro							
	79	(81) 17" Glass balls		19:48				14:15:00	4 G. B breaks
	80	5 1/2" Transducer							

Date/Time	Comments
line 63	SBE-39 is clamped to wire just above termination
line 66	SBE-39 is clamped to wire just above termination / lower bolt stripped rolled w/ blk tape (see photo)
lines 71 & 72	wire + nylon are on piece w/a wrapped termination
line 74	reduced to 150 m from 350 m due to anchor depth of 4430 m
line 71	wire rubbed on deck edge (approx 12 m above wire/nylon jet) repair was made w/ nylon & black tape

MOORED STATION NUMBER 1052

Item No.	Lgth [m]	Item	Inst No.	Time Over	Notes	Data No.	Calc Dpth	Time Back	Notes
81		back acoustic release w/ button	25290						
82	5.0	1/2" Trawl chain							
83		Acoustic release E.G.F. Model 322	339	20:24:20	Pulled string disabled at 22:38			14:30	
84	5.0	1/2" Trawl chain							
85	20.0	1" Sampson Nylon line							
86	5.0	1/2" Trawl chain							
87		Anchor (2000 lbs in 1/2)		20:43:00	20°09 508.5 25°08.87W				
88									
89									
90									
91									
92									
93									
94									
95									
96									
97									
98									
99									
100									
Date/Time		Comments							
line 81		Base Release: Integrate Freq 11 kHz Reply 12 kHz Release 323 616 enable 302 632							
line 83		Acoustic Release Receiver # 4							
		11 Reels of Poly on ar32							

Date/Time	Comments
Oct 8 2000	Standing by buoy - Fished out part of hard hat ( Imploded ball)
Oct 17 2001	1224 trying to enable test release
"	enable new UTC primary release
"	Testu. from top to 100 m: blocked by biofilm After 100 m → barrels + goose-neck brackets (pollwiper) ↳ coquillages
"	11 seals of poly on AR 32
Oct 18 2001	Magnetic declination variation of $8^\circ$ 

### APPENDIX 3: WHOI Instrumentation deployed during RB-01-08.

**Table 16: Instrumentation mounted on 3 meter discus buoy of Stratus 2.**

Parameter	Sensor ID	Elevation relative to buoy deck (meters)	Elevation relative to water line (meters)	Measurement location
IMET system 1	STR2_01			
Wind speed	WND 207	2.97	3.4	Prop axis
Wind direction	WND 207	2.97	3.4	Prop axis
Relative Humidity	HRH 223	2.5	2.93	Tip of sensor
Barometric Pressure	BPR 106	2.385	2.815	Center of port
Precipitation	PRC 004	2.735	3.165	Top of funnel
Longwave Radiation	LWR 104	3.15	3.58	Base of dome
Shortwave Radiation	SWR 102	3.15	3.58	Base of dome
Sea Temperature	SB 37- 1834	-1.00	-0.57	End of probe
IMET system 2	STR2_02			
Wind speed	WND 212	2.97	3.4	Prop axis
Wind direction	WND 212	2.97	3.4	Prop axis
Relative Humidity	HRH 217	2.73	3.16	Tip of sensor
Barometric Pressure	BPR 110	2.395	2.825	Center of port
Precipitation	PRC 109	2.735	3.165	Top of funnel
Longwave Radiation	LWR 103	3.15	3.58	Base of dome
Shortwave Radiation	SWR 002	3.15	3.58	Base of dome
Sea Temperature	SB 37- 1837	-1.00	-0.57	End of probe
Stand-alone wind module	WND 213	2.57	3	Tip of sensor
Stand-alone Relative humidity	HRH 218	2.735	3.165	Tip of sensor
SBE-39 Floating SST	0477	surface	0	
SeaCat Conductivity/ Temperature	1882	-1.1	-0.67	Center of cell

**Table 17: Instrumentation mounted on the mooring line of the 3 meter discus buoy of Stratus 2.**

Instrument	Serial Number	Depth from Mooring Diagram (meters)	Sampling Rate/Record Rate	Time Deployed (19Oct.2001) (UTC)	Time Spike (UTC) Start - Finish	Time recovered () (UTC)	Parameter(s) Measured
SeaCat SBE-16	994	3.71					Temperature
	2324	7		13:05:30	17:49 - 19:01		
	2322	16		13:00:00	18 Oct. 2001		Salinity
	2323	30		12:54:00			Conductivity
	144	40		12:45:00			
	927	62.5		13:41:25			
	928	85		13:47:40			
		993	130		13:59:50		
	146	190		14:16:41			
Brancker T-Pod	3305	13		13:01:30			Temperature
	3761	25		12:55:50	17:35 - 18:52		
	4489	35		12:48:20	18 Oct 2001		
	3283	47.5		13:36:19			
	3833	55		13:39:28			
	4488	70		13:43:53			
	3667	77.5		13:46:07			
	4481	92.5					
	3309	100		13:54:15			
	3701	115		13:57:44			
	3704	145		14:07:20			
	4483	160		14:12:35			
	4493	220		14:20:43			
3703	250		14:27:49				
VMCM	VM031	10		13:01:30	⊙ 17:33:00 ⊙ 20:03:00		East and North Currents
	VM023	20		12:56:30	⊙ 17:35:00 ⊙ 20:04:00		
New Gen VMCM	VM-027	32.5		12:50:20	⊙ 17:32:00 ⊙ 20:05:00		
	VM-na	235		14:22:40	3 Oct 2000 (Rotor Spin)		
	VM-001	350		14:35:40			
SBE-39	0282	349		14:38:32	22:01 - 22:11		Temperature
	0276	450		14:50:47	28 Sept 2000		
ADCP	TSN-1220	135		14:03:49			East and North Currents
Acoustic Rain Gauge	IBIS	37.5		12:47:20			Precipitation

APPENDIX 4: Moored Station Log of Stratus 2

Moored Station Log

PAGE 1

(fill out log with black ball point pen only)

ARRAY NAME AND NO. STRATUS II MOORED STATION NO. 1080

Launch (anchor over)

Date 19 October 2001 Time 19:46:00 UTC
Latitude 20° 08' 45.1" N or (S) Longitude 85° 08' 18.0" E or (W)
Position Source: GPS, LORAN, SAT. NAV., OTHER GPS
Deployed by: Octon, Bouchard, Ford, Walker Recorder/Observer: Charlotte Walker
Ship and Cruise No Brown = RB-01-08 Intended duration: 365 days
Depth Recorder Reading 4459 m Correction Source:
Depth Correction -4 m
Corrected Water Depth 4454 m Magnetic Variation: E or W
Anchor Position: Lat. 20° 8.597 N or (S) Long. 85° 8.4351 E or (W)
Argos Platform ID No. See next page Additional Argos Info may be found on pages 2 and 3.

Acoustic Release Information

Release No. Tested to meters
Receiver No. Release Command
Interrogate Freq. Reply Freq.

Recovery (release fired)

Date Time UTC
Latitude N or S Longitude E or W
Position Source: GPS, LORAN, SAT. NAV., OTHER
Recovered by: Recorder/Observer:
Ship and Cruise No. Actual duration: days
Distance from actual waterline to buoy deck meters

**Surface Components**

Buoy Type 3m Discum buoy

Color(s) Hull

deck yellow  
blue in water

Tower white

Buoy Markings \_\_\_\_\_

Surface Instrumentation			
Item	ID	Height *	Comments
Data logger	STR 2-01		In well logger #1
Relative Humidity	HRH 223	250cm	(tip of sensor) relative to buoy deck
wind module	WND 207	297cm	(prop. axis)
Barom. pressure	BPR 106	238.5 cm	(center of port)
Short wave Rad.	SWR 102	315 cm	(base of dome)
long wave Rad.	LWR 104	315 cm	(base of dome)
Precipitation	PRE 004	273.5 cm	(top of Funnel)
ARGOS trans	PT 09805		
	09807		
	09811		
Data logger	STR 2-02		In well logger #2
Rel. Humidity	HRH 217	273 cm	(tip of sensor)
wind module	WND 212	297 cm	(prop. axis)
Barom. pressure	BPR 110	239.5 cm	(center of port)
Short wave Rad.	SWR 002	315 cm	(base of dome)
long wave Rad.	LWR 103	315 cm	(base of dome)
Precipitation	PRE 109	273.5 cm	(top of Funnel)
ARGOS trans	PT 09819		
	09833		
	25 078		
wind module	213	257 cm	stand alone
Rel. humidity	HRH 212	273.5 cm	stand alone
<b>* Height above buoy deck</b>			

Depth from deck

Sub-Surface Instrumentation on Buoy and Bridle			
Item	ID	Depth†	Comments
INET SB 37	1834	1 m	System # 1
INET SB 37	1837	1 m	System # 2
SEACAT	1882	1.1 m	
AREOS xmtr	24 576	1.5 m	clamped to bridle (to the center)
SBE 39	0477	∅	Floating SST
Bridle	-	-	No tension logged Termination of bridle to... 0.48 m 3/4" prof coil chain is: U joint - 1" chain shackle - 1" end link - 7/8
† Depth below buoy deck			

Sub-Surface Components

	Type	Size(s)	Manufacturer		
Chain					
Wire Rope					
Synthetics					
Hardware					
Flotation	Type (G.B.s, Spheres, etc)	Size	Quantity	Color	
	GB's w/ hard hats	17"	80	yellow	
No. of Flotation Clusters _____					
Anchor Dry Weight <u>9300</u> lbs					



MOORED STATION NUMBER 1080

depth from  
surface

Item No.	Lgth [m]	Item	Inst No.	Time Over	Notes	Data No.	Calc Dpth	Time Back	Notes
1	0.48	3/4" Proof coil chain							
3.71m		seawat	994						
	1.98	3/4" P.C.C.							
7		seawat	2324	13:05:30					
	1.3	3/4" P.C.C.							
10		VNEN	031	13:01:30	when action started				
	0.75	3/4" P.C.C.							
13		TPOD	3305	13:01:30					
	1.71	3/4" P.C.C.							
16		seawat	2322	13:00:00					
	2.26	3/4" P.C.C.							
20		VNEN	023	12:56:30	Time when action started				
	2.48	3/4" P.C.C.							
25		TPOD	3761	12:55:50					
	3.7	3/4" P.C.C.							
30		seawat	2323	12:54:00					
	0.55	3/4" P.C.C.							
32.5		VNEN	VN-027	12:50:20	when action started				
	0.55	3/4" P.C.C.							
35		TPOD	4489	12:48					
Date/Time		Comments							
		P.C.C. = Proof Coil Chain							
		All TPOD's are brankers							
		All seawat's are 30E 1621							

MOORED STATION NUMBER 1080

depth from  
showing

Item No.	Lgth [m]	Item	Inst No.	Time Over	Notes	Data No.	Calc Dpth	Time Back	Notes
21	1.25	3/4" P.C.C							
37.5		Acoustic Rain Gauge	IBIS	12:47					
23	1.25	3/4" P.C.C							
40		seawat	0144	12:45:00					
25	6.2	7/16" wire							
47.5		TPOD	3283	13:36:19					
27	6.2	7/16" wire							
55		TPOD	3233	13:39:28					
29	6.2	7/16" wire							
62.5		seawat	0927	13:41:25					
31	6.2	7/16" wire							
70		TPOD	4488	13:43:55					
33	6.2	7/16" wire							
77.5		TPOD	3667	13:46:07					
35	6.2	7/16" wire							
85		seawat	0928	13:47:40					
37	6.2	7/16" wire							
92.5		TPOD	4481						
39	6.2	7/16" wire							
100		TPOD	3309	13:54:15					
Date/Time			Comments						

MOORED STATION NUMBER 1080

Item No.	Lgth [m]	Item	Inst No.	Time Over	Notes	Data No.	Calc Dpth	Time Back	Notes
	41	7/16" wire							
115	42	TPOD	3701	13:57:44					
	43	7/16" wire							
130	44	Seacat	0993	13:59:50					
	45	3/4" p.c.c							
135	46	ADCP	TSN 1220	14:03:49	upward looking				
	47	7/16" wire							
145	48	TPOD	3704	14:07:20					
	49	7/16" wire							
160	50	TPOD	4483	14:12:35					
	51	7/16" wire							
190	52	Seacat	0146	14:16:41					
	53	7/16" wire							
220	54	TPOD	4493	14:20:43					
	55	7/16" wire							
235	56	VNCP	NA	14:22:40	beatty test age 14:24:26 in water				
	57	7/16" wire							
250	58	TPOD	3703	14:27:49					
	59	3/8" wire							
349	60	SBE 39	0282	14:38:32	clamped on wire				
Date/Time		Comments							

MOORED STATION NUMBER 1080

depth from  
shooting beam

350

450

Item No.	Lgth [m]	Item	Inst No.	Time Over	Notes	Data No.	Calc Dpth	Time Back	Notes
61		VNEN	VN-001 203	14:35:40	New Gen when retracted				
62	100	3/8" wire							
63		SBE 39	0276	14:50:47	clamped on wire				
64	300	3/8" wire		14:51:00					
65	500	3/8" wire		15:02:25					
66	500	3/8" wire		15:22:13					
67	200	3/8" wire		15:37:27					
68	100	3/8" wire		15:44:42	one piece unwrapped turn				
69	200	7/8" Nylon		15:48:42					
70	150	7/8" Nylon		15:56:05					
71	500	7/8" Nylon		17:33:02					
72	500	7/8" Nylon		18:00:22					
73	500	7/8" Nylon		18:13:00					
74	100	7" Nylon		18:15:35	one piece to be spliced at sea				
75	1400	1 1/8" Polypa		18:36:35					
76	80	17" glass balls		19:05:00 19:22:00	start & end time				
77	5	1/2" Trawl chain		19:23					
78		Acoustic release Egg model 322	701740	19:39:50					
79	5	1/2" Trawl chain		19:40					
80	20	1" Sampson Nylon		19:44:40					

Date/Time	Comments
line 76	Pin removed (cordon détaché de l'Acoustic. R) 19:27:00
line 80	Anchor drop position: 20°08'45.1" S // 85°08'18.0" W

MOORED STATION NUMBER 1080

Date/Time	Comments
Oct 19 2001	Time deployment for each instruments → took at the beginning in water
" " "	Start deployment time : 12:45:30 UTC
	End deployment time : 19:46:00 UTC
	↳ ≈ 7 hours

## APPENDIX 5: Stratus mooring deployment procedures

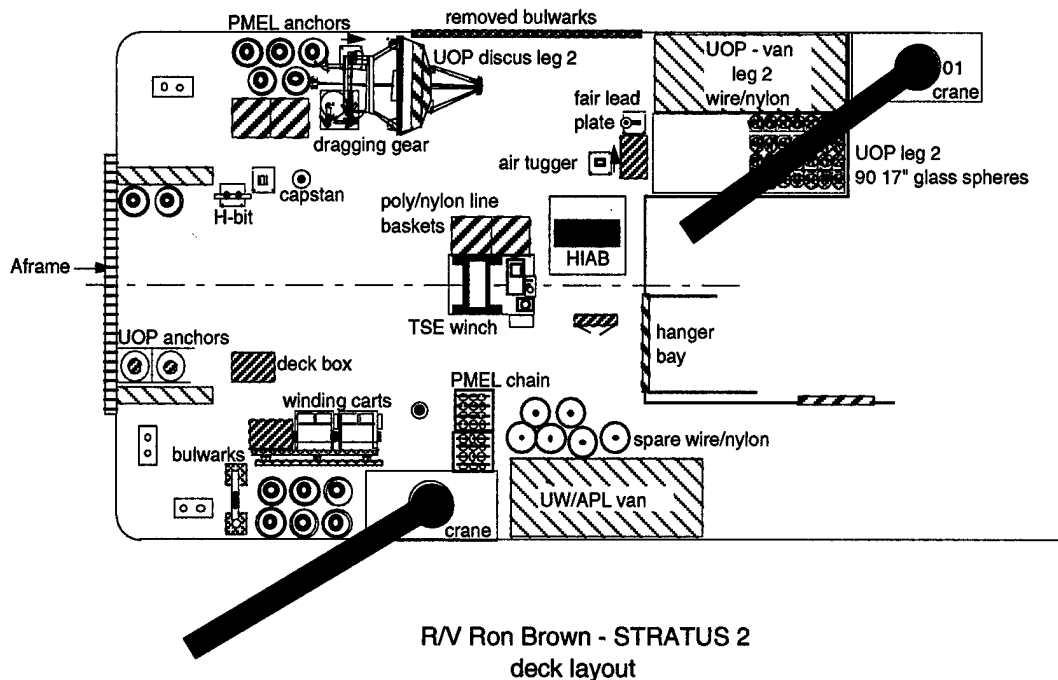
The Stratus surface mooring deployed from the R/V *Ronald H. Brown* was set using the UOP two phase mooring technique. Phase 1 involved the lowering of approximately 40 meters of instrumentation over the port side of the ship. Phase 2 was the deployment of the buoy into the sea. The benefits of lowering the first 40 meters of instrumentation are three fold in that: (1) it allows for the controlled lowering of the upper instrumentation; (2) the suspended instrumentation, attached to the buoy's bridle, acts as a sea anchor to stabilize the buoy during the deployment; and (3) the 90 meter length of paid out mooring wire and instrumentation provides adequate scope for the buoy to clear the stern without capsizing or hitting the ship. The remainder of the mooring is deployed over the stern. The following narrative is the actual step-by-step procedure used for the Stratus 2 mooring, deployed from the R/V *Ronald H. Brown*. The basic deck equipment and deck layout is illustrated in figure 69. The mooring gear used in the deployment of the surface mooring included: the TSE winch, port and starboard side pedestal cranes, HIAB jib crane, A-frame, and the standard complement of blocks, chain grabs, stopper and slip lines.

The TSE winch drum was pre-wound with the following mooring components, listed from deep to shallow:

- 150 m 7/8" nylon
- 200 m 7/8" nylon vinyl tarp barrier interface
- 100 m 3/8" wire
- 200 m 3/8" wire
- 500 m 3/8" wire
- 500 m 3/8" wire
- 300 m 3/8" wire
- 100 m 3/8" wire
- 100 m 3/8" wire

A vinyl tarp was placed between the nylon and wire rope to prevent the wire from burying into the nylon line under tension. A tension cart was used to pretension the nylon and wire during the winding process.

The personnel used during the first phase of the operation were: a deck supervisor, winch operator, 4 mooring wire handlers, air tugger operator, and jib crane operator.



**Figure 69: Basic deck equipment and deck layout**

Prior to the deployment of the mooring, the top 100-meter length of 3/8" diameter wire rope was paid out from the TSE winch. Its bitter end was passed through the center of the A-frame and around the aft port quarter and up forward along the port rail to the instrument lowering area.

The four hauling wire handlers were positioned for deployment. Their positions were in front of the TSE winch, the center of the A-frame, aft port quarter, and approximately 5 meters forward along the port rail. The wire handler's job was to keep the hauling wire from fouling in the ship's propellers and pass the wire around the stern to the closest line handlers on the port rail.

Prior to the starting the mooring deployment, the ship hove to with the ship's bow positioned so that the wind was slightly on the port bow. The jib crane was extended out so that there was approximately four meters of free whip hanging over the instrument lowering area. An air tugger (small pneumatic winch) was rigged as a stopper line, approximately eight feet inboard of the instrument lowering area. All sub-surface instruments were staged, in order of deployment, on the port side main deck. Instrumentation from 40 meters to the surface had a pre-connected shot of chain shackled to the top of the instrument. Instrumentation below 40 meters had chain or wire shots secured to the bottom of the instrument.

The first instrument segment to be lowered was the 6.2-meter length of 7/16" wire rope, 40-meter depth SEACAT, and 1.25-meter length of 3/4" chain. The instrument lowering commenced by shackling the bitter end of the hauling wire to the free end of the 6.2 meter length of 7/16" wire rope shot. The crane whip hook suspended over the instrument lowering area was lowered to approximately 1 meter from the deck. A 4 foot "Lift All" sling barrel hitched through a 3/4" chain grab was attached to the crane hook. The chain grab was hooked onto the 1.25-meter chain approximately .5 meters from the free end. The crane whip was raised so the chain and instruments were lifted off the deck approximately 0.5 meters. The crane was instructed to lower its whip and the attached mooring components down into the water.

The TSE winch simultaneously paid out the hauling wire. The wire handlers positioned around the stern eased the hauling wire over the port side, allowing only enough wire over the side to keep the deepest mooring segment vertical in the water. The 1.25 meter 3/4" chain was stopped off .5 meter above the ship's deck, using a 3/4" chain grab attached to an Ingersol Rand 1000 lb. line pull air tugger line. The crane was then directed to its 3/4" chain grab to the deck. The air tugger's line hauled in enough to take the load from the crane. The crane's hook was removed.

The next segment in the mooring to be lowered was the 32.5 meter Acoustic Rain Gauge, and 1.25 m length of chain. The instrument and chain were brought into the instrument lowering area with the instrument bottom end pointing outboard so it could be shackled to the top of the stopped off chain shot. The loose end of the chain, fitted with a 3/4" chain shackle and 7/8" end link, was again hooked onto the chain grab on the crane whip. The crane whip was raised, bringing the chain and instrument into a vertical position, 0.5 m off the deck. Once the crane's whip had the load of the mooring components hanging over the side, the stopper line was slacked and removed. The TSE winch paid out the hauling wire as the crane whip was lowered to the deck.

The operation of lowering the upper mooring components in conjunction with the pay out of the hauling wire was repeated up to the 2-meter shot of 3/4" chain shackled to the 7 meter depth SEACAT. The air tugger line was hooked into the shot of chain above the SEACAT and drawn tight as the crane whip lowered the chain to the deck edge. The crane whip and chain grab were removed. The bottom of the 3.71 meter depth SEACAT was attached to the chain segment at the top of the instrument array previously lowered into the water. The free end of 0.48 meter 3/4" chain was then shackled to the 1" end link attached to discus bridle universal joint. At this point the chain segment attached to the top of the SEACAT was stopped off to the deck by inserting a 1/2" screw pin shackle and 5/8" pear ring into the middle of the 0.48 meter length of 3/4" chain. A slip line was passed through the pear link and made fast to a deck cleat. The air tugger line was slacked and removed.

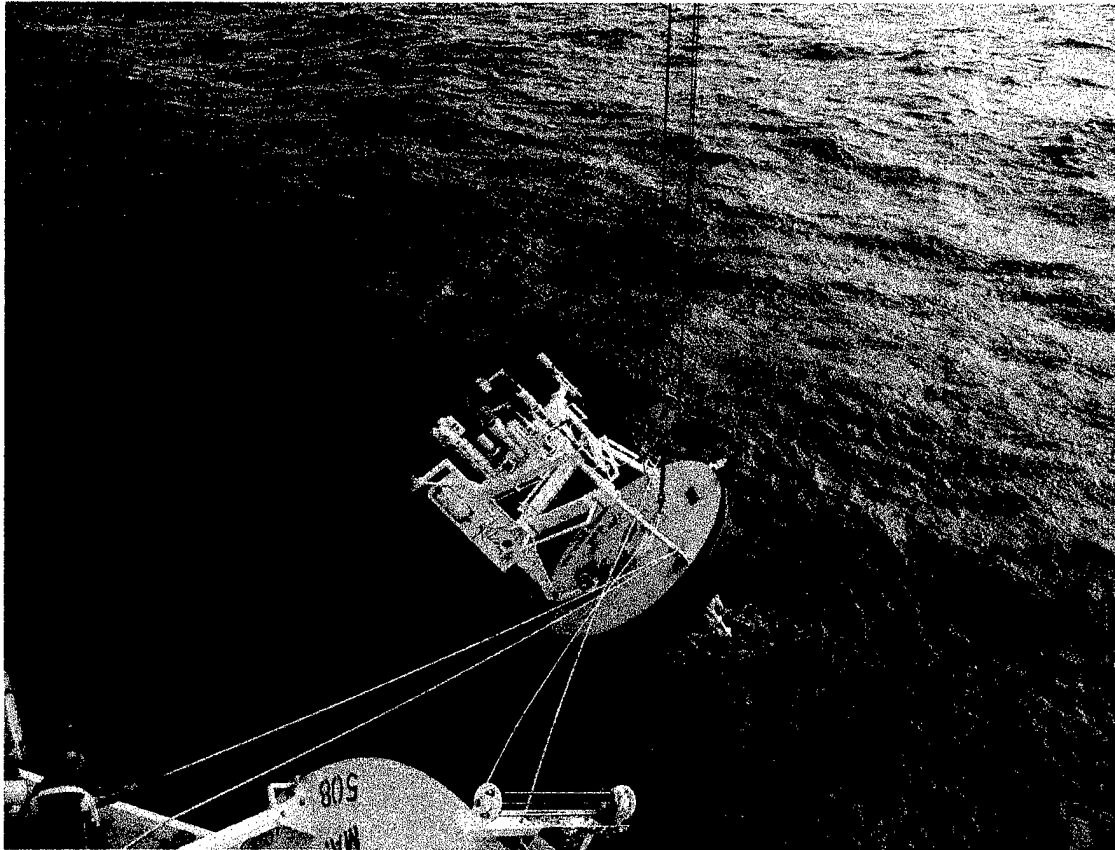
The second phase of the operation was the launching of the discus buoy. There were three slip lines rigged on the discus to maintain constant swing control during the lift. Lines were positioned on the bridle bail, a buoy deck bail, and on the instrument tower (Figure 70). The 30 ft. bridle slip line was used to stabilize the bridle and allow the hull to pivot on the bridle's apex at the start of the lift. The 60 ft. tower slip line was rigged to check the tower swing as the hull swings outboard. A 75 ft. buoy deck bail slip line was the most important slip line. This line prevents the buoy from spinning as it settles out in the water. It is important that the quick release hook, hanging from the crane's whip, can be released without fouling against the discus tower. The buoy deck bail slip line was removed just following the release of the discus into the sea. One additional line called the whip tag line was used in this operation. This tag line was tied to the crane whip headache ball to help pull the whip away from the tower's meteorological sensors once the quick release hook was released and the discus cast adrift.

The personnel used for this phase of the operation included a deck supervisor, TSE winch operator, three hauling wire handlers, three slip line handlers, a crane operator, a crane whip tag line handler and quick release hook handler.

With all three slip lines in place, the crane was directed to swing over the discus buoy. The extension of the crane's boom was approximately 50 ft. The crane's whip was lowered to the discus and the quick release hook, on a 2 foot sling, was attached to the main lifting bail. Slight tension was taken up on the whip to hold the buoy. The chain lashings, binding the discus to the deck, were removed. The slip line holding the suspended 40 meters of mooring string up the apex of the discus bridle was eased off to allow the discus to take the hanging tension. The buoy was then raised up and swung outboard as the slip lines kept the hull in check. The bridle slip line was removed first, followed by the tower bail slip line. Once the discus had settled into the water (approximately 25 ft. from the side of the ship), and the release



hook had gone slack, the quick release hook handler pulled the trip line and cleared the whip away from the buoy (forward) with the help of the whip tag line handler. The slip line to the buoy deck bail was cleared just before quick release hook was tripped. If the discus were released prior to the buoy settling out in the water, the tower could swing into the whip and cause potential damage to the tower sensors. The ship then maneuvered slowly ahead to allow the discus to pass around to the stern of the ship.



**Figure 70: Three slip lines rigged on the discus to maintain constant swing control during the lift.**

The TSE winch pulled in the hauling wire once the discus had drifted behind the ship. Ship's speed was increased to 1 knot through the water in order to maintain a safe distance between the discus and the ship. Once this occurred, the bottom end of the 6.2 meter shot of 7/16" wire rope shackled to the hauling wire was hauled in and stopped off at the transom using a 20 meter stopper composed of 3/4" Samson 2 and 1 nylon and a 2 ton snap hook. This line was fair leaded from an 8" snatch block shackled to the front of the winch and back to a deck cleat.

The next instrument, a 47.5 meter depth Brancker temperature recorder with pre-attached 6.2 meter wire shot, was brought out and shackled to the bitter end of the stopped off wire rope. The free end of 6.2 meter wire rope shackled to the bottom of the Brancker's load bar was then shackled to the free end of hauling wire. The wire was hauled with the TSE winch to take up the slack. A canvas cover was wrapped around the shackles and termination before being wound up on the winch drum. The purpose of the canvas wrap is to prevent damage from point loading the lower layers of wire rope and nylon already on the drum.

Prior to lowering instruments over the stern, a line from an air tugger was reeved through a block on the A-frame. A quick release hook was attached to the free end of the line in preparation for assisting instruments over the transom with damaging them.

The TSE winch slowly took the mooring tension away from the stopper line hooked onto the 6.2 meter wire rope. The stopper, line was removed. As the TSE winch paid out, the Branker was raised of the deck with the air tugger/quick release set-up. Once the instrument was clear of the stern, the tugger line was slacked and the hook released from the instrument. As the bottom end of 6.2 meter wire shot came off the winch, the canvas wrap was removed. A stopper line was hooked onto the 7/8" end link, which was shackled between the hauling wire and 6.2 meter wire shot. The winch paid out the mooring wire slowly and pulled the stopper line aft to approximately 2 meters from the transom edge. The stopper line was secured to the deck cleat. The TSE winch transferred the mooring tension to the deck cleat. The hauling wire was unshackled, and the next instrument and wire shot were brought out to the stopped off wire. The process of instrument insertion was repeated for the remaining instruments.

To elevate the mooring wire and prevent chafing during pay out of the remaining wire and nylon, a block was hung from the A-Frame. A line was passed from a heavy-duty air tugger, through a block on the frame, and into a "hanging" block. The block was hooked around the mooring wire, forward of termination hardware (Figure 71). The tugger line was hauled in, lifting the mooring wire off the transom edge. The ship's speed during this phase of the mooring operations was approximately 1 knot. Once the remaining wire had been deployed, the small hanging snatch block was removed. A large throated trawl block, capable of passing nylon and polypropylene line, terminations, shackles and rings through it, was hung in its place.



**Figure 71: Bock hung from the A-Frame.**

The long lengths of wire and nylon were paid out approximately 10% slower than the ship's speed through the water. This was accomplished by using a digital tachometer, Ametek model #1726, to calculate the mooring pay out speed versus the ship's speed through the water. The selected readout from the tachometer was in Revolutions per Second. Table 18 shows for a given ship's speed the corresponding tachometer reading.

**Table 18: The corresponding Tachometer readings for a given ship's speed**

Pay out speed (knots)	readings (rev/sec)
0.25	3.221
0.5	6.441
0.75	9.662
1	12.883
1.25	16.103
1.5	19.324
1.75	22.545
2	25.766
2.25	28.986
2.5	32.207
3	38.648
3.5	45.09
4	51.531
4.5	57.973
5	64.414

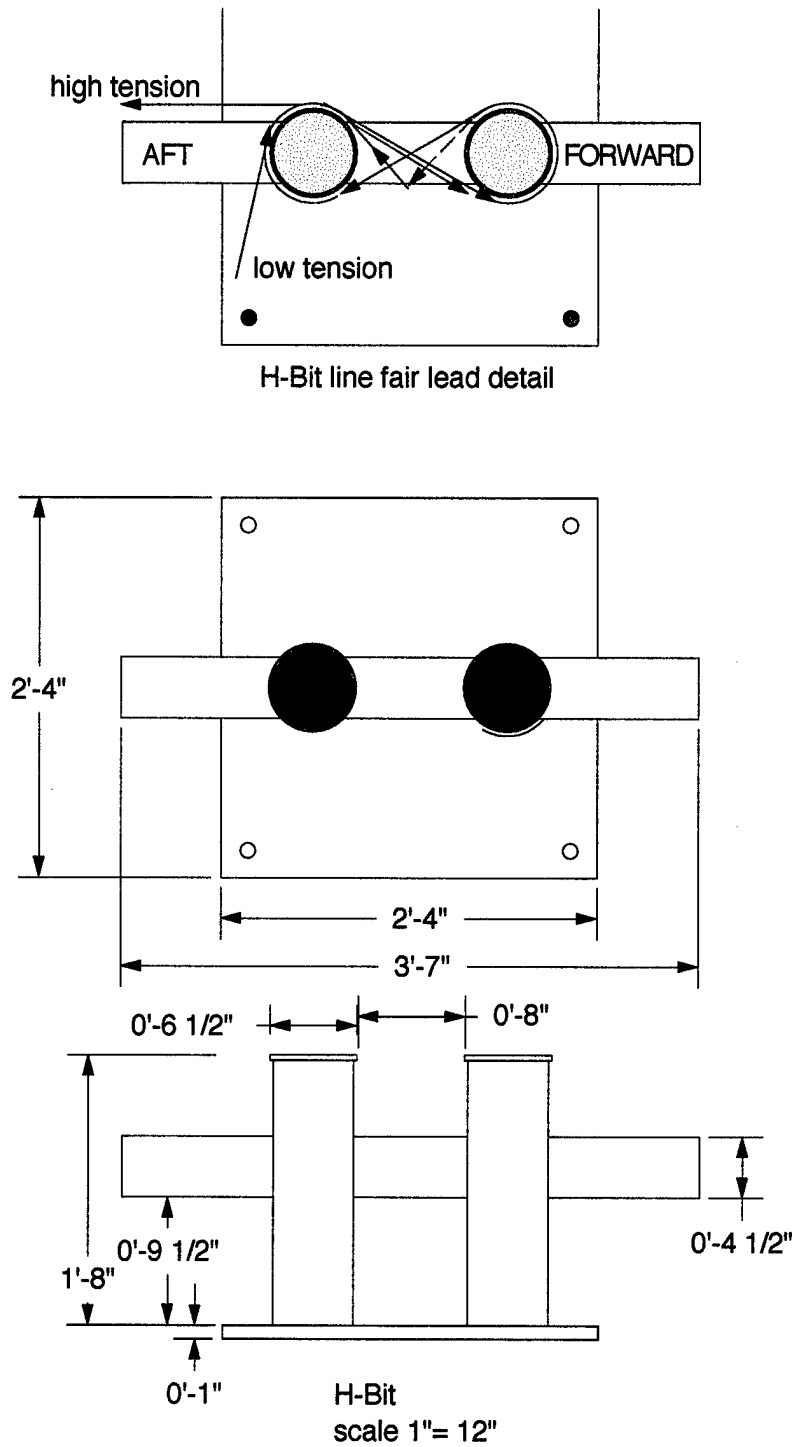
All the mooring wire and nylon on the TSE winch drum was paid out. The end of the nylon was stopped off to a deck cleat. The mooring was set up for towing in the following manner. A 5-meter length of 1/2" trawler chain was secured to the stopped off nylon end. A second stopper line was hooked onto the chain. Both stoppers were eased out so that 1 to 2 meters of the chain shot was past the stern and secured to deck cleats. The speed of the ship was around 1 knot. A Reel-O-Matic tension cart was positioned along side the TSE winch. A 500 meter reel of 7/8" nylon was mounted to the cart. The nylon was fairleaded to the TSE winch and wound up onto the drum. A second 500 meter reel of 7/8" nylon was wound on the winch in the same manner. Approximately one hour was required for this operation.

While the nylon / polypropylene line was being paid out, the port crane was used to lift 80 glass balls out of the rag top container. The balls were staged fore and aft on the port rail. The eighty glass balls were bolted on 1/2" trawler chain in 4 ball/4 meter increments. Four segments were shackled together to form 16 meter strings in preparation for deployment.

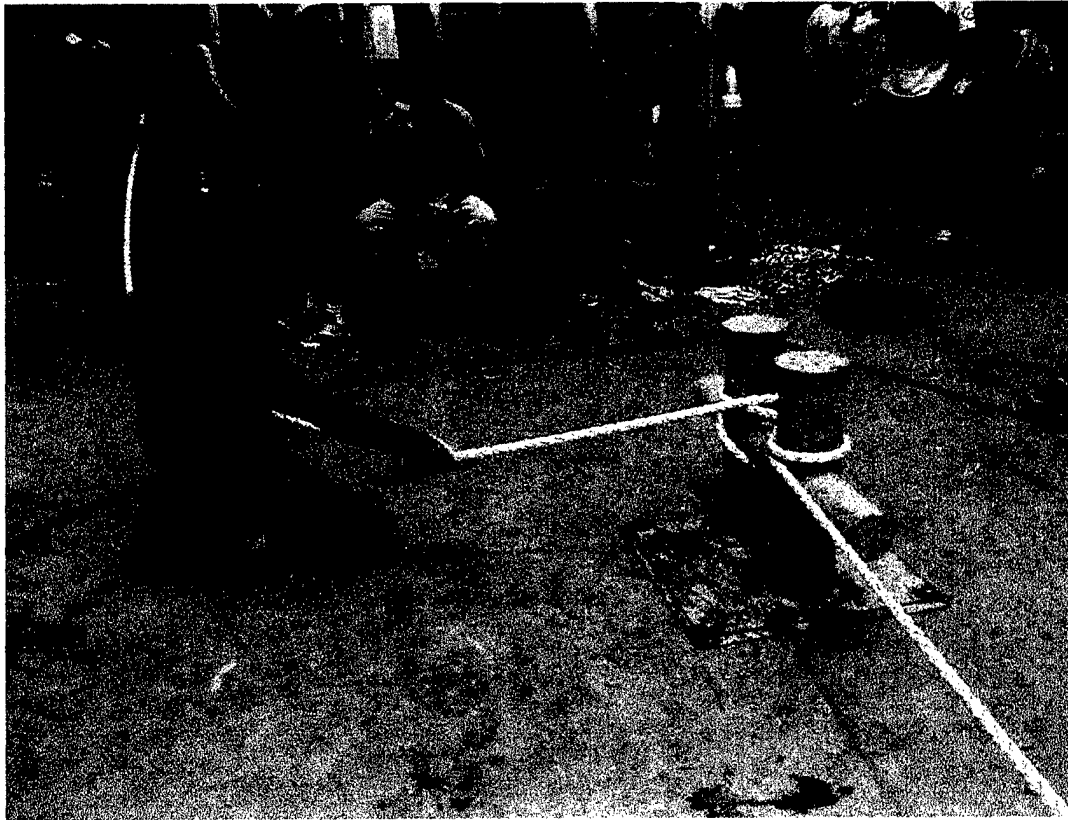
The free end of the nylon on the winch was shackled to the stopped off 1/2" chain and hauled in, pulling the deployed nylon termination back onto the deck. This termination was stopped off and the towing chain was removed. The nylon terminations were shackled together and pay out continued. The mooring was stopped off 1 meter from the transom using a stopper line.

A 2000 meter shot of line, made up of 500 meters 7/8" nylon, spliced into 100 meters 1" nylon, spliced into 1400 meters 1-1/8" polypropylene line, was the next component to be deployed. This line was staged in two wire baskets on the port side of the TSE winch. An H-bit cleat was positioned in front of the winch and secured to the deck. The free end of the shot of nylon/polypropylene was bent around the H-bit and passed on to the stopped off mooring line. Figure 72 and details how this line was reeved around the H-bit. The shackle connection between the two nylon shots was made. The line handler at the H-bit pulled all the residual slack in the line and held the line tight against the H-bit. The stopper line was then eased off and removed. It was very important that the H-bit line handler keep the mooring line

parallel to the H-bit, with constant back tension, while the mooring tension was on the H-bit. The position of the line handler is detailed in photograph Figure 73. While one person hauled line out of the wire.



**Figure 72: H-Bit winding for releasing the final 2000 m of line.**

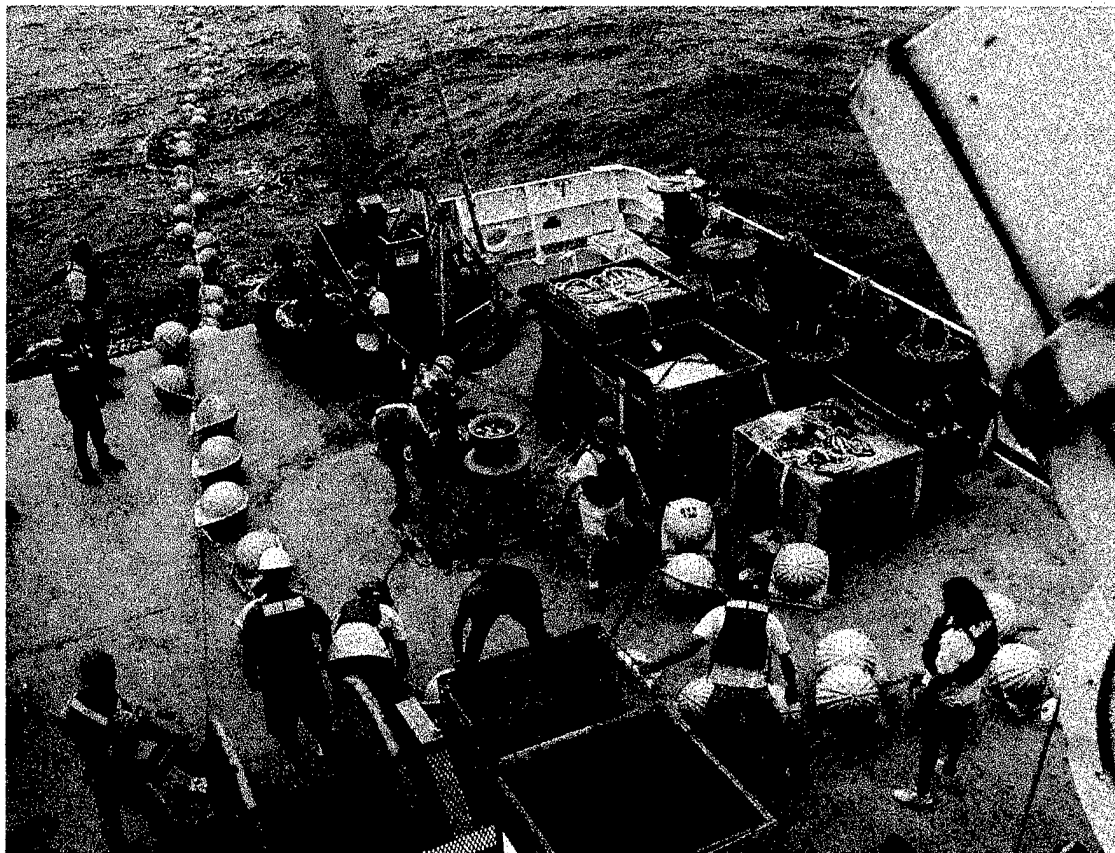


**Figure 73: Position of the line handler and assistant.**

basket, the H-bit line handler eased line out at an appropriate speed, relative to the ship's speed through the water.

Once the end of the polypropylene line was reached, pay out was stopped. A Yale grip was installed on the high tension side of the line. A stopper line was connected to the Yale grip and secured to a deck cleat. The mooring line was eased around the H-bit, and the TSE winch tag line was shackled to the end of the polypropylene line. The winch line and mooring line were wound up taking the mooring tension away from the stopper line. The stopper line was removed. The TSE winch paid out the mooring line so that its thimble was approximately 1 meter from the ship's transom.

The deployment of eighty 17" glass balls was accomplished by using two 20 meter long 3/4" Sampson stopper lines fitted with 2 ton snap hooks and chain grabs (Figure 74 ). Each line was led through an 8" snatch block secured to the front of the TSE winch. This configuration of the deck stopper fair lead allowed for the maximum available distance between the TSE winch and the transom while keeping the mooring components centered in the front of the winch. The first string of glass balls was dragged aft up to the stopped off polypropylene line. The string was stretched forward, to the winch. A stopper line was used to stop off the ball string close to the winch. The winch paid out to transfer the load to the stopper line.



**Figure 74: Deployment of glass balls**

The stopper was paid out slowly and several deck personnel assisted in dragging the remaining glass balls aft. The stopper line was paid out so that the adjacent glass ball out board of the stopper's hook remained on deck with a segment of 1/2" trawler chain bent over the deck edge. The stopper line was secured to the deck. Another string of 16 glass balls was shackled to the free end of the string attached to the mooring. The free stopper line was hooked into the chain close to the TSE winch. Tension was pulled up, and the line cleated, then the aft stopper line was eased off and removed. The next 16 glass ball segment was pulled aft and shackled onto the end of the stopped off glass balls. The swapping stopper lines technique repeated until the 5 meter length of 1/2" trawler chain shackled to the last ball string was stopped off 1 meter from the transom.

The acoustic release and attached 1/2" trawler chain segments were deployed using an air tugger hauling line reeved through a block hung in the A-frame and the heavy-duty air tugger. Shackled to the end of tugger line was a 1/2" chain grab. The 20 meter 1" Samson anchor pennant was previously shackled to the TSE winch tag line and pre-wound onto the winch drum. The acoustic release was positioned on the fantail 1 meter from the transom. The stopped off 5 meter length of 1/2" trawler chain was shackled to the top of the release. A 5 meter length of 1/2" chain was shackled to the bottom of release, and the loose end of the chain secured to the anchor pennant.

The A-frame was positioned so the hanging air tugger line and chain grab was over the top end of the release. The tugger line was lowered and hooked onto the 1/2" chain approximately 1 meter from the bottom end of the release. The anchor pennant was drawn up so that all available slack in the line was taken up on the winch drum. The tugger line was hauled in lifting the release 1.5 meters off the deck. The

A-Frame was shifted out board with the TSE winch slowly paying out its line. The tugger line hauled in and paid out during this shift out board in order to keep the release off the deck as the instrument passed over the transom. Once the release had cleared the deck, the TSE winch pay out was stopped and the tugger line was removed. The 5 meter 1/2" chain was then stopped off with a stopper line and the anchor pennant was removed.

As the ship approached the target site, the anchor pennant was paid out and shackled to the 5 meter shot of chain. Tension was taken on the mooring, and the two stopper lines were removed. The anchor pennant was paid out, and personnel held chafing gear around the line, where it bent over the transom. The 5 meter, 1/2" chain shackled to the anchor was lead out over the stern and back onto the deck. The bottom end of the anchor pennant was paid out parallel to the end of the 1/2" trawler chain. The free end of the 1/2" chain was then shackled to the stopped off end link. A 1/2" screw pin shackle and a 5/8" pear ring were also secured to the end link. A deck cleat was bolted to the deck, positioned fore and aft, 1 meter forward of the stopped off anchor pennant. This deck cleat was bolted down with a 1" eyebolt positioned on its aft end. A 20 meter length of 3/4" Samson line was bent through the 5/8" pear ring and one of its free ends tied in a bowline on to the cleat's eye bolt. The free end of the line was pull tight and secured onto the horns of the cleat. The TSE winch tag line was eased off and removed.

The starboard crane was shifted so that the crane whip hung over, and slightly aft of the anchor. The whip was lowered and the whip hook secured to the tip plate chain bridle. A slight strain was applied to the bridle. The chain lashings were removed from the anchor, and tip plate bolts removed from the deck. The Samson line was slipped off transferring the mooring tension to the 1/2" chain and anchor. The line was pulled clear and the crane whip raised 0.5 meters, lifting the forward side of the tip plate and causing the anchor to slide over board. NOTE: In order to use the WHOI tip plate on the stern of the R/V *RH Brown*, a 12" steel extension was bolted to the aft section of the tip plate.



## INSTRUCTIONS FOR LOADING THE RDI WORKHORSE ADCP IN TO CAGE

The fit of the instrument into its titanium cage is very tight, and the following insertion procedure (Figure 75) works successfully.

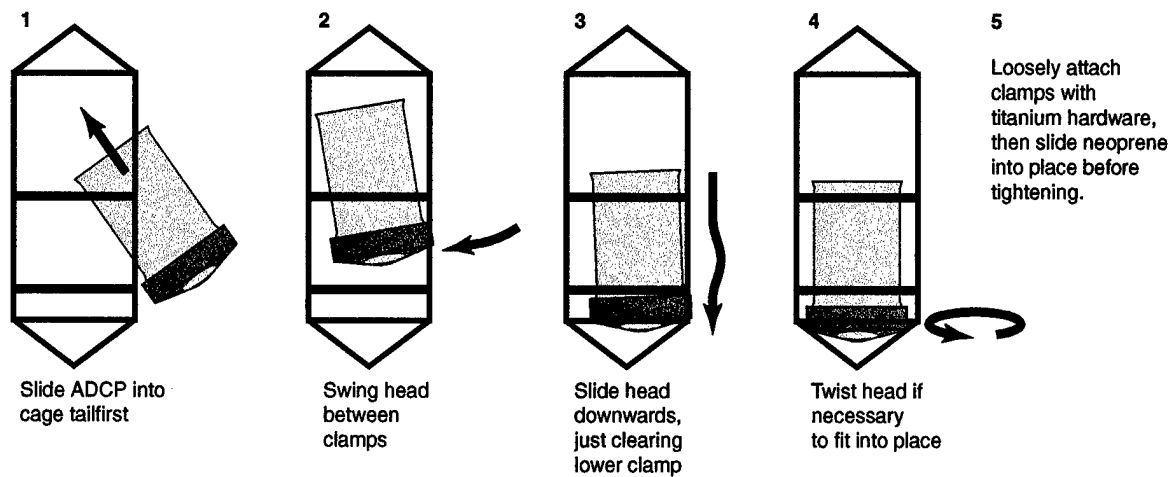


Figure 75: Diagram describing insertion of RDI ADCP into cage.

## **APPENDIX 6: Stratus antifouling paint study**

(Provided by W.Ostrom, WHOI and M.A Walsh, E-Paint Company,Inc.)

The Stratus 1 discus hull was used as a platform to evaluate two antifouling coatings in an on going study to identify coatings suitable for controlling marine biofouling on moored aluminum buoy hulls and subsurface instrumentation.

### **Background**

The purpose of this research is two-fold, 1) to identify environmentally compliant alternatives to organotin-based antifoulants, and 2) to develop test methodology useful for evaluating antifouling coatings suitable for use on moored aluminum buoy hulls, oceanographic instrumentation and the like.

The Upper Ocean Processes group has traditionally relied on organotin-based antifouling paints such as Amercoat #635 (Ameron International Protective Coatings Group) and Micron 33 (International Paint) to protect buoy hulls and instrumentation from the colonization of fouling organisms. However, this class of antifouling paint has been banned by the International Maritime Organization (IMO), with use of these products phased out by 2003. Fears of an imminent ban of organotin antifouling paints as well as environmental and toxicological concerns with their use prompted members of the Upper Ocean Processes group to identify alternatives. Work began in the early 90's to identify an environmentally compliant replacement. Years of foul-resistance testing using discus and guard buoys as platforms moored throughout the world have identified an effective replacement for organotin antifouling paints, E Paint Company's SN-1.

Instead of the age-old method of leaching toxic heavy metals, the patented E Paint approach takes visible light and oxygen in water to create peroxides that inhibit the settling larvae of fouling organisms. Photogeneration of peroxides and the addition of an organic co-biocide, which rapidly degrades in water to benign by-products, make E Paint Company's SN-1 an effective alternative to organotin antifouling paints. This paint has been repetitively tested in the field and has shown good bonding and anti-fouling characteristics as well as a service life up to 8 months (UOP technical report 98-02 pg. 98-101.)

This research effort investigates the erosion characteristics of two No Foul SN-1 formulations in an attempt to correlate erosion rates with service life. Two SN-1 formulations were evaluated for this study, SN-1 and SN-1+.SN-1+ is a self-polishing version of the SN-1 reported to erode at a more uniform rate to provide a longer service life. Prolonged service life of No Foul SN-1, 2-3 years or equal to organotin-based antifoulants, has not been demonstrated scientifically.

Developing methodologies to rapidly screen environmentally compliant antifouling coatings like E Paint's SN-1 is crucial to identifying alternatives to organotin antifoulants. Traditional methods of evaluating antifouling coatings involve static panel tests in estuarine environments or patch tests on oceangoing ships. Both methodologies have their shortcomings. The major drawback to panel testing is that the coatings tested are not subjected to "real world" conditions that would be experienced by a ship at sea. The drawback to patch testing on vessels in service is that most studies are conducted on the bottom of the ship totally ignoring fouling conditions in the photic zone. It is difficult to monitor the effects of water temperature and other environmental conditions on fouling rates. And, use of unprotected controls is often not feasible. Using moored oceanographic environmental sensing stations as platforms for

antifouling paint testing has proved useful to rapidly identifying effective environmentally compliant systems.

The benefits of using moored oceanographic environmental sensing stations as platforms for antifouling paint testing cannot be overstated. Patch testing on the mooring hull exposes prospective coatings to all conditions experienced by a vessel at sea. Currents, wind and wave action, simulate movement. Direct exposure to the sun simulates exposure typical to the sides of a ship. Treatment of equipment, support frames and/or treated panels below the buoy allow for exposures at different depths. Perhaps most important is the wealth of environmental data available for evaluating coating systems. Wind speed, wave height, water temperature, and chemical properties of the water are recorded and may be used to extrapolate how these conditions affected coating performance. The increased number of moored sensing stations allows for the testing of prospective coatings throughout the world. This latest deployment and recovery is part of an ongoing effort to establish methodologies for testing antifouling coatings on moored oceanographic environmental sensing stations as platforms.

This effort was successful in accomplishing the following research goals:

- ✓ Foul-resistance of E Paint Company's SN-1 was established and compared favorably to the organotin antifouling coating used as a control.
- ✓ Foul-resistance of E Paint Company's SN-1 was established on oceanographic equipment and support frames.
- ✓ Erosion rates of the antifouling coatings tested were determined and theoretical service life per coating thickness estimated.
- ✓ Methodology to test antifouling coatings on moored oceanographic environmental sensing stations as platforms was established.

## MATERIALS AND METHODS

### **Application of Test Coatings to the Discus Buoy:**

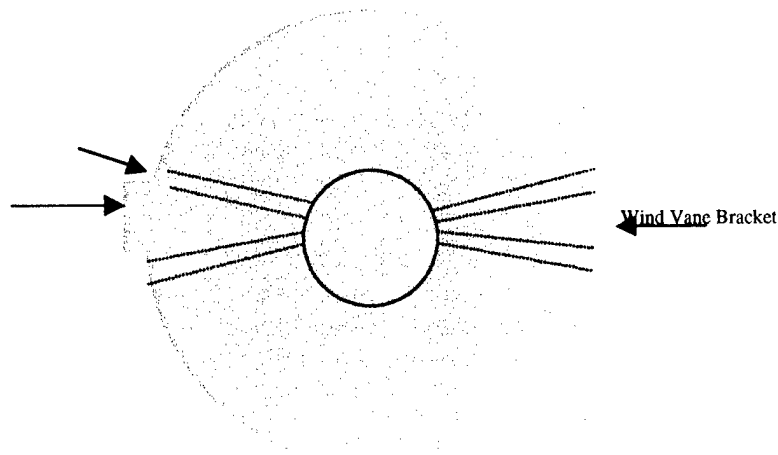
The discus buoy was previously coated with many layers of old antifouling paint. The hull was pressure washed to remove loose or flaking paint and primed with an epoxy barrier coat, Devco Bar-Rust 235. This primer served as a tie-coat between the underlying layers of old paint and the new antifouling paint. The product was pigmented gray.

The primed hull of the buoy was section off by masking areas designated for test formulations and controls. A diagram of the buoy is presented below in Figure 76:

## SECTION B

Unpainted Control

Ocean Surface  
Temperature Bracket



## SECTION A

Diagram not drawn to scale.

**Figure 76: Bottom view of buoy.**

While the epoxy tie-coat was tack-free but soft to finger pressure, as recommended by the manufacturer, the first coats of No Foul SN-1 were applied. Two different formulations of No Foul SN-1 were applied. Both were pigmented white. To section A, the standard SN-1 was applied. To section B, an experimental version of SN-1, with additives to improve resistance to UV light exposure, was applied. All paints were applied using a roller. Both coatings dried overnight prior to application of the second coat. The weights of products applied were measured and weights applied per area determined. Weights of product applied were recorded.

The procedure for application of the first coat was repeated for the second coat. The product applied as the second coat was tinted gray for contrast and latter determination of coating erosion rates.

Application of the third coats of paint was to be similar to that of the second. An attempt was made to apply a blue version of the experimental SN-1+ over the gray on section B. Unfortunately this was not completed due to application difficulties with the formulation. Instead, blue No Foul SN-1 was applied to both sections. Two coats were applied to both sections of the buoy.

An organo-tin based product was applied as a comparative control in two areas, one near the surface ocean temperature sensor mount and the other near the mount for the wind vane. The product, Micron 33 manufactured by International Paint (Union, NJ), is comprised of the following active ingredients: TBT methacrylate, TBTO and cuprous thiocyanate. This product is considered one of the most effective antifoulants currently available in the United States. However this and all organo-tin based coatings have been banned by the United States and the IMO (International Maritime Organization).

Upon recovery the conditions of the coatings applied to the disc hull were assessed and foul-resistance determined. All the test coatings were photographed and samples taken to determine residual paint film thickness. The type and degree of fouling present on disc hull was documented.

Table 19 below details the preventive measures taken in protecting the subsurface instrumentation from marine biofouling.

**Table 19: A List of Exposed Instrumentation and Equipment and Respective Antifouling Treatments.**

Instrument	Paint	Color	Coat/mils.	Applied	Date Applied
VMCM cage	SN-1	white	2 / 6 mils.	spray	Aug-00
VMCM sting	SN-1	white	1 / 3 mils.	spray	Aug-00
VMCM fans	SN-1	white	1 / 3 mils.	spray	Aug-00
VMCM assembled	Tempo TBT	clear	1 / 3 mils.	spray	Oct-00
MicroCat trawl guard	SN-1	white	1 / 3 mils.	spray	Oct-00
MicroCat trawl guard	Tempo TBT	clear	1 / 3 mils.	spray	Oct-00
SEACAT trawl guard	SN-1	white	1 / 3 mils.	spray	Oct-00
SEACAT trawl guard	Tempo TBT	clear	1 / 3 mils.	spray	Oct-00
SEACAT sensor shield	SN-1	white	1 / 3 mils.	spray	Oct-00
Brancker thermister	SN-1	white	3 / 3 mils.	brush	Oct-00
Brancker trawl guard	SN-1	white	1 / 3 mils.	spray	Oct-00
Brancker trawl guard	Tempo TBT	clear	1 / 3 mils.	spray	Oct-00
Chlam cage	SN-1	white	2 / 6 mils.	spray	Aug-00
Rain gauge	Tempo TBT	clear	1 / 3 mils.	spray	Oct-00
FSST frame	SN-1	white	2 / 6 mils.	brush	Oct-00
FSST frame assembled	Tempo TBT	clear	1 / 3 mils.	spray	Oct-00
discus bridle legs	SN-1	white	3 / 9 mils.	brush	Oct-00
discus bridle legs	SN-1	blue	1 / 3 mils.	brush	Oct-00
discus hull	SN-1	white	1 / 5 mils.	roll	Aug-00
discus hull	SN-1	gray	1 / 5 mils.	roll	Aug-00
discus hull	SN-1	blue	2 / 5 mils.	roll	Aug-00
discus hull	SN-1	white	1 / 5 mils.	roll	Oct-00
discus hull	SN-1+	white	1 / 5 mils.	roll	Aug-00

discus hull	SN-1+	gray	1 / 5 mils.	roll	Aug-00
discus hull	SN-1	blue	2 / 5 mils.	roll	Aug-00

**RESULTS**

**Discus Buoy Hull Evaluation**

Roughly 25% of the discus buoy hull was fouled with gooseneck barnacle. Though barnacles were the predominate fouling organism reported in this study, a bacterial/algal slime is also visible in photographs of recovered equipment. Gooseneck barnacles fouled close to 100% of unprotected control regions of the hull. The average length and width of these organisms attached to unprotected regions was 6-9 inches (15-23cm) and 0.25-0.375 inches (0.6-1.0cm) respectively. Gooseneck barnacles fouled treated surfaces to a lesser degree. The extent of fouling is reported in Table 20 as the number of organisms, and their length, per square foot.

**Table 20: Degree of fouling expressed as the number of organisms per square foot.**

<b>Coating</b>	<b># Barnacles</b>	<b>Maximum Barnacle Length (inches)</b>
E Paint SN-1	15	3"
Micron 33	15	9"
Control	Completely Fouled	6 to 9"

This research effort investigates the erosion characteristics of two No Foul SN-1 formulations in an attempt to correlate erosion rates with service life.

-based comparative control exhibited comparable foul-resistance. The smaller barnacle size fouling the SN-1 treated regions of the hull suggest that the coating resisted fouling longer than the Micron 33. Fouling to treated regions of the hull was reported to occur in small clusters of three to four organisms. Fouling occurred in large clusters in unprotected regions where the paint chipped or flaked away.

Figure 77 below shows the discus hull after recovery:

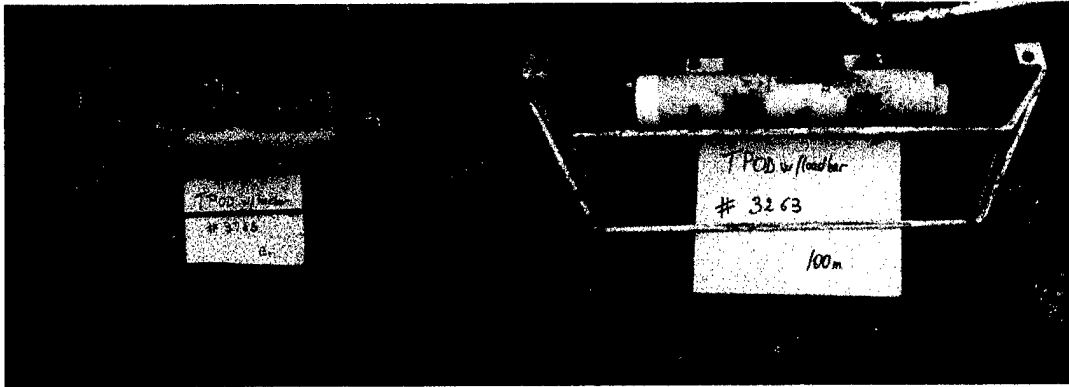


**Figure 77: Disc Buoy after Recovery.**

The image above shows a discoloration of surfaces treated with SN-1. A yellow/gray film believed to be algae is visible coating the treated surface. This film more heavily coated the hull near and above the waterline. On both sides A and B, the blue SN-1 has faded and an underlying layer of deeper blue paint is visible. At the waterline the topcoat had completely eroded as had 50% of the second coat of blue. Gray and white underlying coats of paint are visible near the waterline.

**Fouling on Instrumentation:**

Prolific gooseneck barnacle fouling was observed on unprotected instrumentation and support frames to 30m below the surface. Fouling rates decreased at greater depths. VMCM instrument cases exposed at 100m were fouled 50% with the barnacles where cage rods, VMCM stings and fans treated with SN-1 were <2% fouled. The TBTO clear coat also effectively controlled fouling on instrumentation. Figures 78 and 79 show the effect of depth on fouling rates.



**Figures 78 and 79: TPOD 3763 at 13m and TPOD 3263 at 100m**

The ability to evaluate the efficacy of antifouling coatings at different depths (up to 300m) is unique to this testing methodology.

## **DISCUSSION**

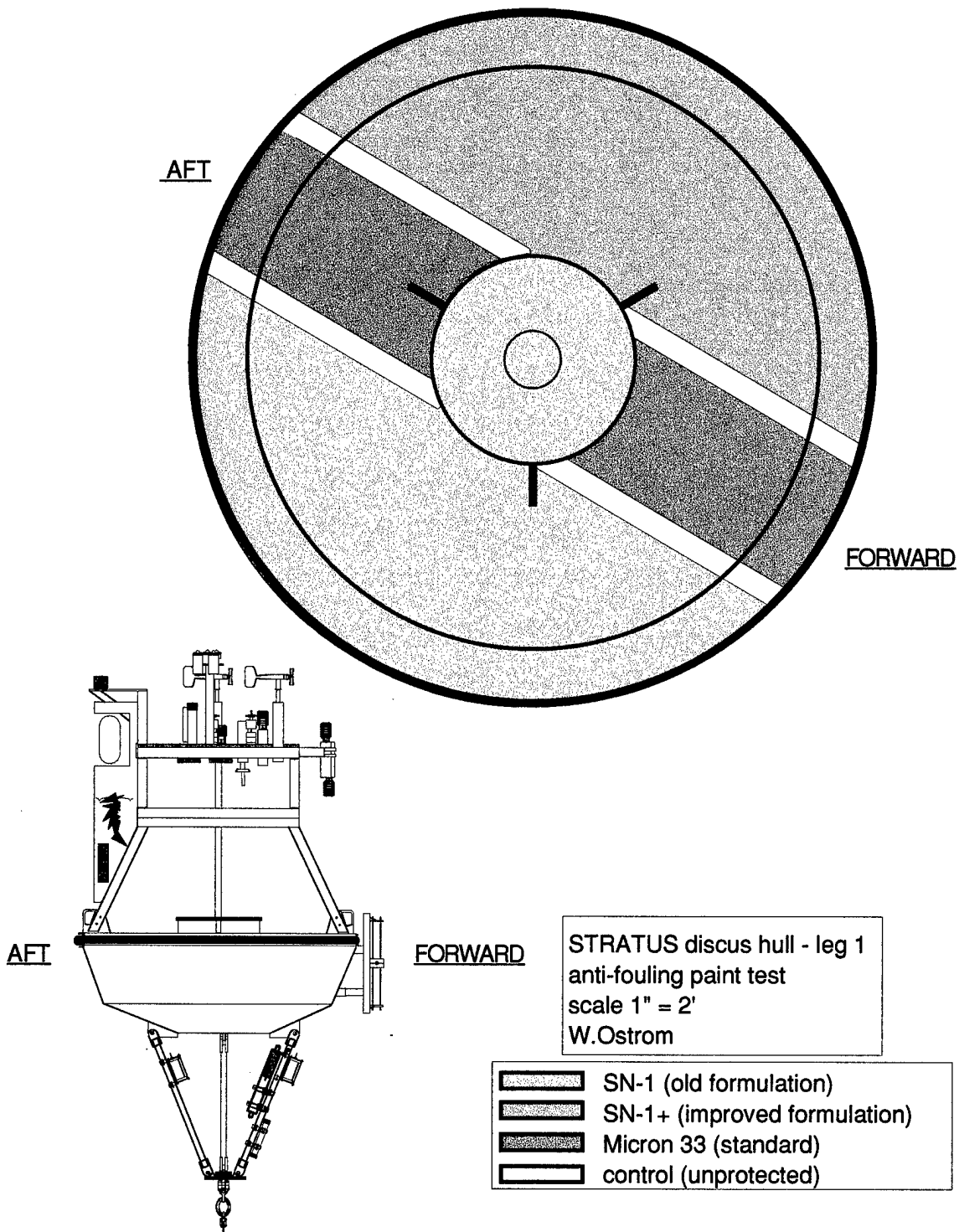
Methods to utilize moored oceanographic environmental sensing stations as platforms to demonstrate the efficacy of new environmentally compliant antifouling coatings were established. This effort demonstrated the viability of E Paint Company's SN-1 as a replacement to organotin antifouling paints. Foul-resistance of SN-1 was comparable to that of Micron 33 after 12 months exposure. Judging by the amount of paint remaining on the hull, service life of the 4 coats of SN-1 would have exceeded 18 months at this test site. Closer examination of the coatings after the buoy returns to WHOI should confirm this claim. Further coating longevity studies with SN-1 are warranted.

## **FUTURE WORK**

Coatings applied to the discus buoy hull will be more closely evaluated upon the return of the test platform to Woods Hole, Massachusetts. The film thickness of each coating will be measured in several locations from the waterline to the bottom of the hull. The effect of photo-degradation on coating erosion will be determined. In addition, the adhesion and physical integrity of test coatings will be determined following ASTM protocols.

Further testing involving longer exposure periods is warranted. Studies to determine the effect of coating thickness on foul-resistance as a function of time in different geographical locations would be of interest.





**Figure 80: Diagram of the Discus Buoy and Painting Scheme.**

## APPENDIX 7: Stratus 2 cruise logistics

Logistics for the Stratus 2 buoy turn around included shipping all cruise gear to Seattle, WA for transit to the Galapagos. This avoided the complications and expense of trying to ship gear to the Galapagos Islands. In addition, buoy build up and check out was done in Seattle and allowed for an extended burn in during transit. This also meant less time was required in the Galapagos to prepare for the cruise.

At the end of EPIC Leg 2, Stratus gear would remain on the R/V *Brown* until it arrived in Port at Charleston, SC.

To finalize logistics and cruise planning, it was necessary to visit the R/V *Ronald H. Brown*, and the NOAA Marine Operations Center, Pacific. During 24-27 June, Robert Weller and Jeff Lord traveled to Victoria, B.C., and Seattle, WA, to make these arrangements.

The *RH Brown* had a three-day port call in Victoria, BC, Canada. Scientists from ETL, UW and WHOI agreed to meet with ship's crew to discuss plans for science activities, deck load, and lab use. Although the crew was busy preparing for its upcoming cruise, we were able to cover a lot of ground in a very short period of time.

Cruise reports describing similar buoy operations, pictures and a videotape of the Stratus 1 buoy deployment were distributed to the crew. Deployment and recovery procedures as well as deck space requirements were discussed with the boson, Captain, and Field Operations Officer.

EPIC cruise participants discussed lab space needs and agreed on the amount of space available to WHOI prior to Leg 2 of the EPIC cruise. Tentative plans for loading in Seattle were made as well.

Following the meeting on the R/V *Brown*, Lord and Weller traveled to Seattle to meet with Bill Brandenburg at the NOAA Marine Operations Center. Arrangements were made to stage gear and set up the Stratus buoy at the NOAA facility prior to loading the R/V *Brown* for the cruise.

Mr. Brandenburg offered use of a garage for staging, forklifts as required, and outside storage for the rest of the cruise gear. We notified him about the size of our shipment, the duration of our stay, and our need for crane service. Again, this meeting was brief, but very valuable. We left Seattle confident that staging for the cruise would be trouble free.

During the last week of July, burn in of the ASIMET systems and data logger were concluded. The buoy was disassembled, and all support gear was packed and inventoried for shipping to Seattle.

On August 7-8 all Stratus gear was loaded on trucks bound for Seattle. A lowboy flatbed, a 48-foot flatbed, and a 54-foot enclosed trailer were required for the gear. On August 7, the 48-foot flatbed was loaded with two 20' seaintainers containing all mooring components and deck gear. Also on August 7<sup>th</sup>, the lowboy flatbed was loaded with the buoy hull, 2 anchors, and 2 winches (one for UW). On August 8, the 54 foot enclosed trailer was loaded with the remaining cargo. This included lab supplies, primary and spare tower tops, instruments, tools and personal gear.

A total of 70,000 pounds of mooring components and support gear were shipped to Seattle for the Stratus 2 mooring turn around.

On 14 August, 5 people flew to Seattle to prepare the buoy and load equipment onto the R/V *RH Brown*. The three trucks arrived in Seattle before 11:00 am on 15 August. A shore crane, provided by Ness Crane Service, removed the two 20' containers from the truck, and loaded them directly onto the ship. The crane also put the winch and two anchors on the ship, and positioned the buoy hull in our staging area.

The 54 foot enclosed trailer was unloaded and gear was separated into two groups. Gear to load on the ship, and gear required for buoy assembly and check out.

During the afternoon of 15 August, the buoy was assembled and some gear was loaded onto the ship. For the rest of the week, buoy assembly and check out continued, the lab was set up as much as possible, and some instruments were checked out.

On 20 August, the remaining gear, except the buoy, was loaded on board. The University of Washington's container arrived and was loaded. From August 20-24 remaining science gear from organizations participating in the EPIC program, and PMEL's TAO buoy maintenance gear arrived and was loaded on board. WHOI personnel assisted with this loading as well as the loading of ship's stores for the voyage. The WHOI discus buoy was loaded on board after everything else was loaded on deck.

A last-minute air shipment, consisting of a spare wind instrument and a few odds and ends, arrived in San Diego by September 5 for the R/V *RH Brown*'s final departure from the United States.

Six WHOI personnel participated in the EPIC cruise, Leg 2, from Puerto Ayorro, Galapagos, to Arica, Chile. Travel included a flight from Boston to Miami, Miami to Quito, Ecuador, and a government controlled flight from Quito to Baltra. Since reservations could not be guaranteed on the flight to Baltra, we decided to leave a few days early in the event of any difficulties or delays in catching the flight to Baltra.

On 2 October, personnel arrived in Quito and spent the night. A 9:30 am flight to Baltra on 3 October had us checking in at the airport at 7:00 am. The check in process, and the flight to Baltra, was uneventful. We crossed the island and checked into the Angermeyer Hotel where we would stay for the next five days.

The R/V *RH Brown* arrived in the Galapagos at 8:00 am on October 6. After a brief visit to the ship by Lord and Weller to discuss logistics for set up and departure, it was clear that WHOI work could not commence until the morning of 7 October. And so it did.

Cruise details are discussed elsewhere in this report.

The R/V *Ronald H. Brown* arrived back in Charleston, SC on 13 December. The File Operations Officer scheduled offloading with each organization so it was very efficient. WHOI was the last group to unload.

Paul Bouchard and Jeff Lord traveled to Charleston on 16 December. On 17 December the buoy, anchor, winch, and 2-20' containers were removed from the ship and loaded onto trucks. On 18 December, all other loose gear from the deck, and all the gear stowed in the lab was offloaded from the ship, and loaded onto a 48' box truck. On 19 December, Bouchard and Lord returned to Woods Hole.

**STRATUS 2 LOGISTICS CONTACTS**

*RONALD H. BROWN*

Home Port – Charleston, SC	
	<b>E-MAIL CONTACTS</b>
<b>INMARSAT B:</b>	Personnel on board: First.Last@noaa.gov
011-874-336-899 620 Voice	Field Operations Officer: foo.ronald.brown@noaa.gov
011-874-336 899 621 Fax	Commanding Officer: Co.Ronald.brown@noaa.gov
<b>INMARSAT A: - only if B is down</b>	
011-874-154-2463 Voice	
011-874-154-2644 Fax	
<b>INMARSAT Mini M:</b>	
011-874-761 831 360Voice	
Cellular: 757-635-0678 (Ship) 206-910-3584 (OOD) 206-910-8152 (CO) 206-910-0184 (CME)	

**SEATTLE**

NOAA Marine Operations Center  
1801 Fairview Ave., East  
Seattle, WA 98102

Mr. Bill Brandenburg  
Phone: (206) 553-4597  
Email: Bill.Brandenburg@noaa.gov

Ness Crane Service  
PO Box 70545  
Seattle, WA 98107-0545

(206) 784-1054

Silver Cloud Inn      Phone 206.447.9500  
1150 Fairview Ave.      Fax 206.812.4900  
Seattle, WA 98109

## **ECUADOR**

### **Quito**

Used Maxviajes Ecuador Tours SA (ECUADOR TOURS ONLINE.com) in Quito to meet us in the airport, get us in to the hotel, and get us checked in to the airport for the flight to Galapagos. \$ 90 for 7 people and bus service.

Samuel Fritz # 275 y 6 de Diciembre  
PO Box 17-11-4781  
Quito, Ecuador

Phone 593 2 241-1174-240-3433  
Or (02) 409-675-403-433  
FAX 593 2 240-3434  
[www.EcuadorToursOnline.com](http://www.EcuadorToursOnline.com)  
infotours@EcuadorToursOnline.com

Four Points by Sheraton Quito( \$ 115)  
Avienda Naciones Unidas y Republica de el Salvador  
Quito, Ecuador  
011 (593) 2 297-0002 Voice  
011(593) 2 243-3906 Fax

### **Galapagos**

Hotel Angermeyer  
Ave. Charles Darwin  
Puerto Ayora, Isla Santa Cruz  
011-593-5-526-066 Voice  
011-593-2-269-626  
Email: [galexur@ayora.ecua.net.ec](mailto:galexur@ayora.ecua.net.ec)

Other options would be Hotel Galapagos and The Red Mangrove Inn

Agent – Guayaquil  
Transportes Maritimos & Fluviales S.A.  
593-4-2208082 / 81  
593-4-2207909 / 10  
Christian Merizalde

## **ARICA, CHILE**

Arica Hotel  
Av. Commandante San Martin 599

Arica, Chile  
(011) 56-58 254 540 Voice  
(011) 56-58 231 133  
email: [resarica@panamaricanhotels.cl](mailto:resarica@panamaricanhotels.cl)

#### Agents

Naviera Portuaria Arica S.A.  
Maximo Lira, Street N/N  
Explanada Muelle Norte  
Arica, Chile

Edmundo Avila  
Humerto Vildoso

Phone: (011) 056-58-231715  
Fax: (011) 056-58-231949

[edmundovila@navieraporturia-arica.cl](mailto:edmundovila@navieraporturia-arica.cl)  
[naviport@hotmail.com](mailto:naviport@hotmail.com)  
[edmundovila@naviport.cl](mailto:edmundovila@naviport.cl)

or

Inchape Shipping Services  
Operations Department  
Phone : + 56-32-217681  
Fax : + 56-32-239632  
Mobile: + 56-9-3314169

## **APPENDIX 8: Cruise Participants**

### WHOI

Robert Weller, Chief Scientist  
Paul R. Bouchard  
Jeffrey Lord  
Jason Gobat  
Mark Pritchard  
Charlotte Vallée  
William M. Ostrom

### Environmental Technology Laboratory (ETL)

Jeffrey Hare  
Taneil Uttal  
Scott Abbott  
Duane Hazen  
Scott Sandberg  
Brandi McCarty

### Ecuadorian Navy Oceanography Institute (INOCAR)

Edgar Rivas

### Chilean Navy Hydrographic and Oceanographic Service (SHOA)

Claudia Valenzuela

### University of Washington (UW)

Sandra Yuter  
Kimberly Comstock  
Sungsu Park  
Robert Schaaf  
Joe Adelbrook

### CICESE

David Rivas Camargo

### UCSB

Olga Polyakov  
Toby Westberry

### National Oceanic and Atmospheric Administration (NOAA)

John Kermond

### Center for Ocean land Atmosphere studies (COLA)

Robert Burgman

Teacher-at-sea : Jane Temoshok

## APPENDIX 9: Plan of the days onboard R/V *R H Brown* – LEG 2

RB-01-08: EPIC I  
Plan of the Day:  
**Wednesday, 10 October 2001**  
(DOY: 283)

**SUNRISE: 0601**                      **LAN: 1207**              **SUNSET: 1811**  
(Local Apparent Noon)

### Weather Forecast:

It doesn't get much nicer than this out here! Enjoy the mostly sunny skies and calm winds. Expect light SE trade winds as we head south along the 95 W line. Seas: 0-1 ft. Swell: SE 2-3 ft.

Temps: High: 24 C (76 F), Low: 19 C (66 F)

## CTD TRANSECT ALONG 95° W

0715 - 0815                      SPMR and 500 m CTD at 1 S

1030 - 1130                      SPMR and 500 m CTD at 1.5 S

1140              SEAWIFS Satellite pass (9 min duration)  
(W-NW heading to receive complete pass)

1330 – 1530                      2 S Buoy repair (fishing opportunity)

1545 – 1645                      SPMR and 500 m CTD 1 nm S of buoy

1945 – 2030                      500 m CTD at 2.5 S

2300 – 2345                      500 m CTD at 3 S

0215 - 0300                      500 m CTD at 3.5 S

0515 - 0600                      500 m CTD at 4 S

**Plan 1: Plan of October 10.**



RB-01-08: EPIC I  
Plan of the Day:  
**Thursday, 11 October 2001**  
(DOY: 284)

**SUNRISE: 0601**                      **LAN: 1207**      **SUNSET: 1813**  
(Local Apparent Noon)

Weather Forecast:

We'll have mostly cloudy skies today, otherwise nice weather. Expect SE trade winds as we continue south along 95 W. Winds: SE 7-10 kts. Seas: 1-2 ft. Swell: SE 3-4 ft.

Temps: High: 22 C (72 F), Low: 18 C (64 F)

**CTD TRANSECT ALONG 95° W**

0945 - 1045                      SPMR and 500 m CTD at 4.5 S

1222      SEAWIFS Satellite pass (10 min duration)  
(S heading should work OK to receive complete pass)

1330 - 1430                      SPMR and 500 m CTD at 5 S  
(Note: The buoy drifted away)

1715 - 1815                      SPMR and 500 m CTD at 5.5 S

2100 - 2145                      500 m CTD at 6 S

0015 - 0100                      500 m CTD at 6.5 S

0345 - 0430                      500 m CTD at 7 S

0715 - 0815                      SPMR and 500 m CTD at 7.5 S

**Plan 2: Plan of October 11.**

RB-01-08: EPIC I  
Plan of the Day:  
**Friday, 12 October 2001**  
(DOY: 285)

**SUNRISE: 0559**                      **LAN: 1206**              **SUNSET: 1812**  
(Local Apparent Noon)

Weather Forecast:

SE trade winds and low clouds will continue. We'll have overcast skies most of the day. SE trade winds.  
08 - 12 kts. Seas: 2-4 ft. Swell: SE 3-5 ft.

Temps: High: 22 C (72 F), Low: 18 C (64 F)

**FINISH FIRST CTD TRANSECT; TRANSIT TO 20 S**

0915 - 1030                      Attempt to locate buoy at 8 S

- if located, inspect buoy (fishing opp)
- if not located, go to SPMR and CTD

1030 - 1130                      SPMR and 500m CTD 1nm S of buoy

1128              SEAWIFS Satellite pass (8 min duration)  
(W-NW heading should work OK to receive complete pass)

Once complete, begin 3 day transit to IMET buoy location

(20 S, 85 W) stopping daily around local noon for SPMR, CTD, and SeaWiFS satellite pass. ETA to IMET: late night 15 Oct.

Deploy Drifters when crossing: 10 S, 14 S, and 18 S

**Plan 3: Plan of October 12.**

RB-01-08: EPIC I  
Plan of the Day:  
**Saturday, 13 October 2001**  
(DOY: 286)

**SUNRISE: 0548**            **LAN: 1154**    **SUNSET: 1801**  
(Local Apparent Noon)

Weather Forecast:

SE trade winds and low clouds will continue. Overcast skies may break up a bit, but it will be mostly cloudy. SE trade winds strengthen a bit, 10 - 15 kts. Seas: 3-5 ft. Swell: SE 3-5 ft.

Temps: High: 23 C (73 F), Low: 19 C (66 F)

**TRANSIT TO 20 S**

1200 -1300 Daily stop for SPMR, 500 m CTD, and  
SeaWiFS satellite pass

1209 SEAWIFS Satellite pass (10 min duration)  
(SE heading to receive complete pass)

1300 - 1400    Test of WHOI acoustic releases  
(down to 1000m on traction winch)

ETA to IMET buoy: evening of 15 Oct.

Deploy Drifters when crossing 14 S and 18 S

**Plan 4: Plan of October 13.**

RB-01-08: EPIC I  
Plan of the Day:  
**Sunday, 14 October 2001**  
(DOY: 287)

**SUNRISE: 0533**                      **LAN: 1142**              **SUNSET: 1753**  
(Local Apparent Noon)

**Weather Forecast:**

SE trade winds and low clouds will continue. We'll have a few breaks in the overcast skies, but don't expect to see too much sun. Occasional showers are possible, but will be brief.

Winds: SE10 - 15 kts. Seas: 3-5 ft. Swell: SE 3-5 ft.

Temps: High: 23 C (73 F), Low: 19 C (66 F)

**TRANSIT TO 20 S**

1116 SEAWIFS Satellite pass (9 min duration)  
(NW heading to receive complete pass)

1130 -1230 Daily stop for SPMR, 500 m CTD, and  
SeaWiFS satellite pass

1256 SEAWIFS Satellite pass (5 min duration)  
(SE heading will receive complete pass)

Deploy Drifter when crossing 18 S (ETA 0400 L)

ETA to IMET buoy: evening of 15 Oct.

**Plan 5: Plan of October 14.**

RB-01-08: EPIC I

Plan of the Day.

**Monday, 15 October 2001**

(DOY: 288)

**SUNRISE: 0618**

**LAN: 1229**

**SUNSET: 1843**

(Local Apparent Noon)

Weather Forecast:

Same as yesterday, only a bit cooler. SE trade winds and low clouds continue. Occasional showers are possible.

Winds: SE 8 - 12 kts. Seas: 3-4 ft. Swell: SE 3-5 ft.

Temps: High: 21C (70 F), Low: 17 C (63 F)

### **Arrive at IMET Station, begin buoy comparison**

1230 -1330 Daily stop for SPMR and 500 m CTD

1259 SEAWIFS Satellite pass (10 min duration)

(SE heading will receive complete pass)

ETA to IMET buoy: 1800.

### **LOOKING AHEAD**

6 Days on station at IMET buoy

Tuesday -	buoy comparison, 2 deep (4000 m) CTD's
Wednesday -	buoy recovery
Thursday -	clean and stow all recovered gear
Friday -	deploy new IMET buoy in same location
Saturday -	buoy comparison, 2 deep (4000 m) CTD's

**Plan 6: Plan of October 15.**

RB-01-08: EPIC I  
Plan of the Day:  
**Tuesday, 16 October 2001**  
(DOY: 289)

**SUNRISE: 0609**                      **LAN: 1227**              **SUNSET: 1844**  
(Local Apparent Noon)

Weather Forecast:

Expect little change. SE trade winds and low clouds continue. Occasional showers are possible.

Winds: E-SE 8 - 12 kts. Seas: 2-3 ft. Swell: SE 3-5 ft.

Temps: High: 21C (70 F), Low: 17 C (63 F)

**IMET Station -- Day 1 -- buoy comparison**

0800- 0830 Small boat operations to inspect IMET buoy

0930 – 1200      Deep CTD #1 – 10 nm downwind of IMET buoy

1201 SEAWIFS Satellite pass (15 min duration)

(W-NW heading will receive complete pass)

1215 – 1230      SPMR

1230 – 1500      Deep CTD # 2 – 10 nm downwind of IMET buoy

1500 – Transit back to 0.25 nm from IMET buoy;

continue comparison

\*\* Additional SPMR casts as other operations permit.

**Plan 7: Plan of October 16.**

RB-01-08: EPIC I  
Plan of the Day:  
**Wednesday, 17 October 2001**  
(DOY: 290)

**SUNRISE: 0609**                      **LAN: 1226**                      **SUNSET: 1844**  
(Local Apparent Noon)

Weather Forecast:

A weather front to our SW will begin to influence our weather. SE trade winds will freshen and low clouds continue. Showers are possible. As the front approaches we should see broken clouds and winds shifting around to the N-NW and increase.

Winds: E-SE 10 - 15 kts, until late tonight.

Seas: 2-4 ft. Swell: SE 3-5 ft and W as the front approaches.

Temps: High: 20 C (68 F), Low: 17 C (63 F)

**IMET Station -- Day 2 -- buoy recovery**

0740            Buoy released

0830- 1700 IMET buoy recovery

- small boat ops to hook into glass balls

- small boat ops to hook into buoy

1246 SEAWIFS Satellite pass (10 min duration)

(E-SE heading will receive complete pass)

\*\* SPMR casts as other operations permit.

**Plan 8: Plan of October 17.**

RB-01-08: EPIC I  
Plan of the Day:  
**Thursday, 18 October 2001**  
(DOY: 291)

**SUNRISE: 0609**                      **LAN: 1226**      **SUNSET: 1844**  
(Local Apparent Noon)

**Weather Forecast:**

A weather front to our SW will continue to influence our weather. Fresh SE trade winds and low clouds continue. Brief drizzle is possible. Winds: E-SE 10 - 15 kts, until late tonight.

Seas: 3-5 ft. Swell: SE 3-5 ft and W as the front approaches.

Temps: High: 20 C (68 F), Low: 17 C (63 F)

**IMET Station -- Day 3 -- clean instruments**

SPMRs roughly every hour throughout daylight hours  
(as other operations permit)

1151 SEAWIFS Satellite pass (9 min duration)  
(W-NW heading will receive complete pass)

1200 – 1230      Daily 500m CTD cast

1300 – 1500      Buoy deployment set and drift test (bridge only)  
and SEABEAM

1500 – 1800      Complete SEABEAM survey

**Plan 9: Plan of October 18.**



RB-01-08: EPIC I  
Plan of the Day:  
**Saturday, 20 October 2001**  
(DOY: 293)

**SUNRISE: 0607**                      **LAN: 1226**              **SUNSET: 1845**  
(Local Apparent Noon)

Weather Forecast:

We're starting to see the front approach from the SW. Fresh SE trade winds and low clouds continue. Brief rain and periods of broken clouds are likely. Winds: E-SE 15 - 20 kts.

Seas: 5-6 ft. Swell: SE 4-6 ft.

Temps: High: 20 C (68 F), Low: 16 C (61 F)

**IMET Station -- Day 5 -- New buoy comparison**

0745 – 1015      Deep (4000 m) CTD cast # 1

1030 – 1045      SPMR

1115 – 1400      Deep (4000 m) CTD cast #2  
(lube cable on way up ~1230).

1138 SEAWIFS Satellite pass (8 min duration)  
IF POSSIBLE (W-NW heading will receive complete pass)

1315 SEAWIFS Satellite pass (8 min duration)  
(E-SE heading will receive complete pass)

1400 – 1415      SPMR

1430 – 1530      Transit back to IMET buoy

\*\* Additional SPMRs as operations permit

**Plan 10: Plan of October 20.**

RB-01-08: EPIC I  
Plan of the Day:  
**Sunday, 21 October 2001**  
(DOY: 294)

**SUNRISE: 0607**                      **LAN: 1226**      **SUNSET: 1845**  
(Local Apparent Noon)

**Weather Forecast:**

The front has stayed to our south, but will continue to influence our weather. Fresh SE trade winds and low clouds continue. Brief rain and periods of broken clouds are likely.

Winds: E-SE 12 - 16 kts. Seas: 3-5 ft. Swell: SE 4-5 ft.

Temps: High: 20 C (68 F), Low: 16 C (61 F)

**IMET Station -- Day 6 -- Continue buoy comparison**

SPMRs roughly every hour throughout daylight hours

1219 SEAWIFS Satellite pass (10 min duration)

(W-NW heading will receive complete pass)

1245 – 1315      Daily 500m CTD cast

2200 (+5)      TIME CHANGE. Move clocks ahead 1 hour to observe +4 time zone (1 more time change before arrival)

**Looking Ahead**

Monday - 22 October

0400 (+4) Depart station. Enroute to Arica, daily CTDs

**Plan 11: Plan of October 21.**

RB-01-08: EPIC I  
Plan of the Day:  
**Monday, 22 October 2001**  
(DOY: 295)

**SUNRISE: 0702**                      **LAN: 1317**      **SUNSET: 1933**  
(Local Apparent Noon)

Weather Forecast:

SE trade winds have lightened a bit and we're back under the stratocumulus layer of low clouds. Expect a few brief periods of rain and hopefully a few periods of broken clouds.

Winds: E-SE 8 - 12 kts. Seas: 2-4 ft. Swell: SE 3-5 ft.

Temps: High: 20 C (68 F), Low: 16 C (61 F)

**Transit to Arica, Chile; Daily CTD station**

1225 SEAWIFS Satellite pass (6 min duration)

(W-NW heading will receive complete pass)

1245 - 1330      Daily SPMR + 500m CTD cast

(83 W Drifter upon departure)

1401 SEAWIFS Satellite pass (9 min duration)

(E heading should receive complete pass OK)

**Looking Ahead**

ETA to Arica: 0800 on Thursday, 25 October

**Plan 12: Plan of October 22.**

RB-01-08: EPIC I  
Plan of the Day:  
**Tuesday, 23 October 2001**  
(DOY: 296)

**SUNRISE: 0640**                      **LAN: 1255**        **SUNSET: 1911**  
(Local Apparent Noon)

**Weather Forecast:**

Should be a nice day, if you like clouds and cooler weather. The winds have lightened and the cloud layer has thinned out.

We should see some sun breaks in the afternoon.

Winds: E 5 - 10 kts. Seas: 1-3 ft. Swell: SE 3-4 ft.

Temps: High: 20 C (68 F), Low: 15 C (59 F)

**Transit to Arica, Chile; Daily CTD station**

1215 – 1300        Daily SPMR + 500m CTD cast

1305 SEAWIFS Satellite pass (10 min duration)  
(E-SE heading will receive complete pass)

1315 LIVE Internet broadcast

~1700        Drifter deployment 77 W

1930 SCIENCE NIGHT – Project summary in Library

**24 October**

0200 (+4)        TIME CHANGE – Advance clocks one hour to 0300 (+3)

**Looking Ahead**

ETA to Arica: 0800 on Thursday, 25 October

**Plan 13: Plan of October 23.**

RB-01-08: EPIC I  
Plan of the Day:  
**Wednesday, 24 October 2001**  
(DOY: 297)

**SUNRISE: 0719**                      **LAN: 1335**      **SUNSET: 1951**  
(Local Apparent Noon)

Weather Forecast:

Another calm day. Clouds and cooler weather.

We should see some sun breaks in the afternoon.

Winds: Light and variable, becoming light from the south

Seas: 0-1 ft. Swell: S 2-3 ft.

Temps: High: 19 C (66 F), Low: 15 C (59 F)

**Transit to Arica, Chile**

No operations planned today

**Thursday, 25 October 2001**

**SUNRISE: 0707**    **SUNSET: 1946**

ETA to Arica pilot station: 0800

ETA alongside pier 0830

**Plan 14: Plan of October 24.**



## DOCUMENT LIBRARY

*Distribution List for Technical Report Exchange - July 1998*

University of California, San Diego  
SIO Library 0175C  
9500 Gilman Drive  
La Jolla, CA 92093-0175

Hancock Library of Biology & Oceanography  
Alan Hancock Laboratory  
University of Southern California  
University Park  
Los Angeles, CA 90089-0371

Gifts & Exchanges  
Library  
Bedford Institute of Oceanography  
P.O. Box 1006  
Dartmouth, NS, B2Y 4A2, CANADA

NOAA/EDIS Miami Library Center  
4301 Rickenbacker Causeway  
Miami, FL 33149

Research Library  
U.S. Army Corps of Engineers  
Waterways Experiment Station  
3909 Halls Ferry Road  
Vicksburg, MS 39180-6199

Marine Resources Information Center  
Building E38-320  
MIT  
Cambridge, MA 02139

Library  
Lamont-Doherty Geological Observatory  
Columbia University  
Palisades, NY 10964

Library  
Serials Department  
Oregon State University  
Corvallis, OR 97331

Pell Marine Science Library  
University of Rhode Island  
Narragansett Bay Campus  
Narragansett, RI 02882

Working Collection  
Texas A&M University  
Dept. of Oceanography  
College Station, TX 77843

Fisheries-Oceanography Library  
151 Oceanography Teaching Bldg.  
University of Washington  
Seattle, WA 98195

Library  
R.S.M.A.S.  
University of Miami  
4600 Rickenbacker Causeway  
Miami, FL 33149

Maury Oceanographic Library  
Naval Oceanographic Office  
Building 1003 South  
1002 Balch Blvd.  
Stennis Space Center, MS, 39522-5001

Library  
Institute of Ocean Sciences  
P.O. Box 6000  
Sidney, B.C. V8L 4B2  
CANADA

National Oceanographic Library  
Southampton Oceanography Centre  
European Way  
Southampton SO14 3ZH  
UK

The Librarian  
CSIRO Marine Laboratories  
G.P.O. Box 1538  
Hobart, Tasmania  
AUSTRALIA 7001

Library  
Proudman Oceanographic Laboratory  
Bidston Observatory  
Birkenhead  
Merseyside L43 7 RA  
UNITED KINGDOM

IFREMER  
Centre de Brest  
Service Documentation - Publications  
BP 70 29280 PLOUZANE  
FRANCE

REPORT DOCUMENTATION PAGE	1. REPORT NO. WHOI-2002-02	2. UOP-2002-01	3. Recipient's Accession No.
4. Title and Subtitle Long-Term Evolution of the Coupled Boundary Layers (STRATUS) Mooring Recovery and Deployment Cruise Report NOAA Research Vessel <i>R H Brown</i>			5. Report Date February
7. Author(s) <sup>1</sup> Charlotte Vallée, <sup>1</sup> Robert A. Weller, <sup>1</sup> Paul R. Bouchard, <sup>1</sup> William M. Ostrom, <sup>1</sup> Jeff Lord, <sup>1</sup> Jason Gobat, <sup>1</sup> Mark Pritchard, <sup>2</sup> Toby Westberry, <sup>3</sup> Jeff Hare, <sup>3</sup> Taneil Uttal, <sup>4</sup> Sandra Yuter, <sup>5</sup> David Rivas, <sup>5</sup> Darrel Baumgardner, <sup>5</sup> Brandi McCarty, <sup>6</sup> Jonathan Shannahoff, <sup>1</sup> M.A. Walsh, <sup>1</sup> Frank Bahr *			6. 8. Performing Organization Rept. No. WHOI-2002-02
9. Performing Organization Name and Address  Woods Hole Oceanographic Institution Woods Hole, Massachusetts 02543			10. Project/Task/Work Unit No.  11. Contract(C) or Grant(G) No. (C) NA96GPO429 (G) NA17RJ1223
12. Sponsoring Organization Name and Address  NOAA			13. Type of Report & Period Covered Technical Report  14.
15. Supplementary Notes This report should be cited as: Woods Hole Oceanog. Inst. Tech. Rept., WHOI-2002-02.			
16. Abstract (Limit: 200 words) This report documents the work done on cruise RB-01-08 of the NOAA R/V <i>Ron Brown</i> . This was Leg 2 of R/V <i>Ron Brown</i> 's participation in Eastern Pacific Investigation of Climate (EPIC) 2001, a study of air-sea interaction, the atmosphere, and the upper ocean in the eastern tropical Pacific. The science party included groups from the Woods Hole Oceanographic Institution (WHOI), NOAA Environmental Technology Laboratory (ETL), the University of Washington (UW), the University of California, Santa Barbara (UCSB), and the University Nacional Autonoma de Mexico (UNAM). The work done by these groups is summarized in this report. In addition, the routine underway data collected while aboard R/V <i>Ron Brown</i> is also summarized here.			
17. Document Analysis a. Descriptors stratus boundary layers cruise report  b. Identifiers/Open-Ended Terms    c. COSATI Field/Group			
18. Availability Statement  Approved for public release; distribution unlimited.		19. Security Class (This Report) UNCLASSIFIED	21. No. of Pages 176
		20. Security Class (This Page)	22. Price