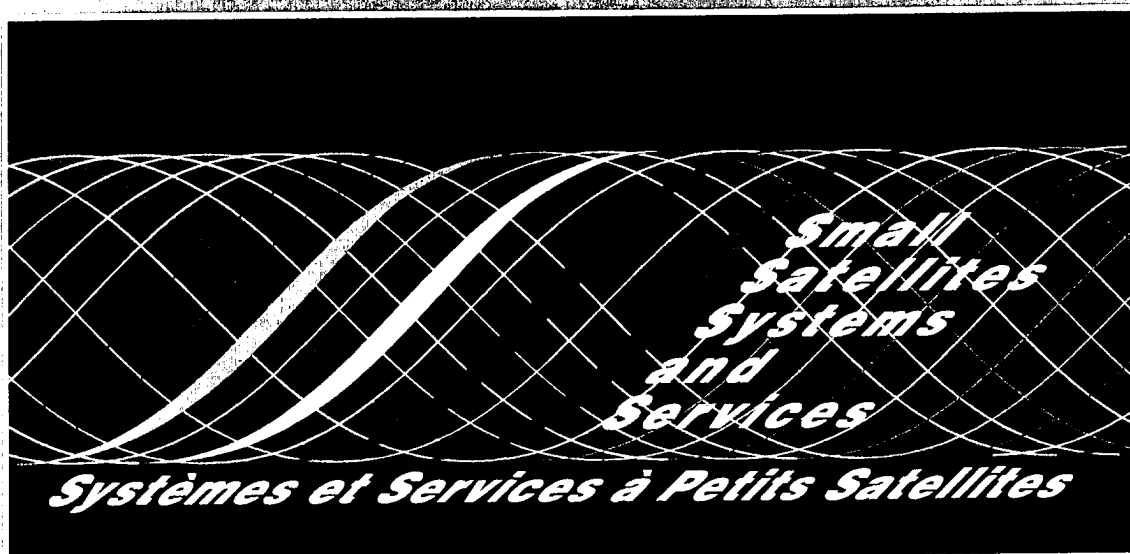


REQUEIL DES ACTES  
PROCEEDINGS



5<sup>e</sup> Symposium International  
19 - 23 juin 2000

5<sup>th</sup> International Symposium  
19-23 June 2000

La Baule - France

cnrs

CENTRE NATIONAL D'ETUDES SPATIALES

# REPORT DOCUMENTATION PAGE

Form Approved OMB No. 0704-0188

Public reporting burden for this collection of information is estimated to average 1 hour per response, including the time for reviewing instructions, searching existing data sources, gathering and maintaining the data needed, and completing and reviewing the collection of information. Send comments regarding this burden estimate or any other aspect of this collection of information, including suggestions for reducing this burden to Washington Headquarters Services, Directorate for Information Operations and Reports, 1215 Jefferson Davis Highway, Suite 1204, Arlington, VA 22202-4302, and to the Office of Management and Budget, Paperwork Reduction Project (0704-0188), Washington, DC 20503.

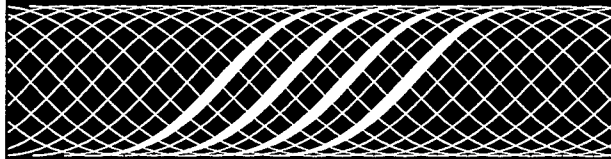
1. AGENCY USE ONLY (Leave blank)		2. REPORT DATE 2001	3. REPORT TYPE AND DATES COVERED Conference Proceedings	
4. TITLE AND SUBTITLE 5th International Symposium 'Small Satellites Systems and Services'			5. FUNDING NUMBERS F61775-00-WF075	
6. AUTHOR(S) Conference Committee				
7. PERFORMING ORGANIZATION NAME(S) AND ADDRESS(ES) Colloquium 12 rue de la Croiz-Faubin F-75557 Paris cedex 11 Paris France			8. PERFORMING ORGANIZATION REPORT NUMBER N/A	
9. SPONSORING/MONITORING AGENCY NAME(S) AND ADDRESS(ES) EOARD PSC 802 BOX 14 FPO 09499-0200			10. SPONSORING/MONITORING AGENCY REPORT NUMBER CSP 00-5075	
11. SUPPLEMENTARY NOTES				
12a. DISTRIBUTION/AVAILABILITY STATEMENT Distribution is at the public domain.			12b. DISTRIBUTION CODE A	
13. ABSTRACT (Maximum 200 words)  The Final Proceedings for 5th International Symposium 'Small Satellites Systems and Services', 19 June 2000 - 23 June 2000  Result and feedback from experiment; Launch services; Satellite architecture; Methods and tools; Technologies for Small Satellites including rocket propulsion ; Missions under development; Future missions				
14. SUBJECT TERMS EOARD, Space Technology, Small Satellites			15. NUMBER OF PAGES 1266	16. PRICE CODE N/A
17. SECURITY CLASSIFICATION OF REPORT UNCLASSIFIED	18. SECURITY CLASSIFICATION OF THIS PAGE UNCLASSIFIED	19. SECURITY CLASSIFICATION OF ABSTRACT UNCLASSIFIED	20. LIMITATION OF ABSTRACT UL	

NSN 7540-01-280-5500

Standard Form 298 (Rev. 2-89)  
Prescribed by ANSI Std. Z39-18  
298-102



**5<sup>e</sup> Symposium International  
5<sup>th</sup> International Symposium**



***Small  
Satellites  
Systems and  
Services***

***Systèmes et Services  
à Petits Satellites***

**Juin/June 19-23, 2000  
La Baule - France**

**20010806 092**



CENTRE NATIONAL D'ETUDES SPATIALES

*AQ FOI-11-2200*

## **SESSION 1 :**

### **Résultats et retours d'expériences**

#### ***Results and feedbacks from experiments***

*Présidents / Chairpersons: Michel AVIGNON, Otavio BOGOSSIAN*

- (S1.1) **A Power System Design for the Petite Amateur Navy Satellite - PANSAT**  
Phelps R.L. Naval Postgraduate School, Monterey, Etats-Unis
- (S1.2) **DLR - TUBSAT: A Microsatellite for Interactive Earth Observation**  
Schulz S., Renner U. Technical University of Berlin, Berlin, Allemagne
- (S1.3) **MINISAT-01: Three years of scientific operations**  
Talavera A., Garcia J., Quintana C. Lab. de Astrofisica Espacial y Fisica Fundamental, Madrid, Espagne
- (S1.4) **SUNSAT1 - Orbital results and upgrades for 4m multi-band imaging in SUNSAT-2**  
Mostert S., Milne G.W., du Plessis J.J., Schoonwinkel A.  
University of Stellenbosch, Stellenbosch, Afrique du Sud
- (S1.5) **The development of low cost missions at Surrey**  
Allery M. Surrey Satellite Technology Ltd, Guilford, Royaume-Uni

## **SESSION 2 :**

### **Services de lancement de petits satellites**

#### ***Launch services for small satellites***

*Présidents / Chairpersons: Udo RENNEN, Jean-Pierre REDON*

- (S2.1) **EELV Secondary Payload Adapter (ESPA)**  
Haskett S.A., Weis S.C., Doggrell L.J., Fosness E.R., Sciulli D., Meink T. et al  
US Air Force Space Test Program, Kirtland AFB, NM, Etats-Unis
- (S2.2) **DNEPR Space Launch System for Small Satellites**  
Andreev V.A., Drobakhin O.I., Konyukhov S.N., Milkhallov V.S., Us S.I., Solovey V.A.  
International Space Company Kosmotras, Moscou, Russie
- (S2.3) **Rocket's Commercial Launch Service Debut**  
Viertel Y., Kinnersley M., Freeborn P., Eurokot Launch Services GmbH, Bremen, Allemagne
- (S2.5) **Piggyback Satellite Launch by H-IIA Launch Vehicle**  
Ujino T., Shimizu R., Onoe I., Namura E., Terashima K., Matsunaga H.  
National Space Development Agency of Japan (NASDA), Tokyo, Japon
- (S2.6) **First Leolink Launch from Alcantara**  
Oiknine C. Leolink, France
- (S2.7) **STARSEM offer to launch small satellites on SOYUZ**  
Francis R., Schlosser Ph. STARSEM, Paris, France

## **SESSION 3 :**

### **Architecture et systèmes / Architecture and systems**

*Présidents / Chairpersons: Antonio MARTINEZ DE ARAGON, Michel BOUSQUET*

- (S3.1) **A Three-Axis Stabilized Microsatellite**  
Lew A.L., Schwartz P.D., Le B.Q., Radford W.E., Ling S. X., Magee T.C., Mosher L.E., Charles H.K., Wienhold P.D. John  
Hopkins University, Laurel, Etats-Unis
- (S3.2) **The MITA Satellite: An Italian Bus for Small Missions**  
Sabatini P., Lupi T., Viola F., Falvella M.C., Carlo Gavazzi Space SpA, Milan, Italie
- (S3.3) **MARS Micromission Spacecraft - A Flexible, Low-Cost bus for Near-Sun Investigations**  
Deining W.D., Andreozzi L., Demara R., Epstein K.W., Overturf N., Reinert R.P.,  
Ball Aerospace & Technologies Corp., Boulder, Etats-Unis
- (S3.4) **CNES microsatellite product line, an approach for innovation**  
Bouzat C., CNES, Toulouse, France
- (S3.5) **Proteus: European Standard for Small Satellites**  
Grivel C., Douillet F., Huiban T., Sainct H. et al, Alcatel Space Industries, Cannes-La-Bocca, France

## **SESSION 4 :**

### **Outils et méthodes / *Methods and tools***

*Présidents / Chairpersons: Michel BOUSQUET, Antonio MARTINEZ DE ARAGON*

- (S4.2) **Station Multi-Mission de Natal - Brésil, Concept et Architecture d'une station TT&C bande S faible coût / *Concept and architecture of a low cost TT&C ground station located in Natal - Brazil***  
Dubut J.P., de Carvalho M.J.M., Pereira R.A. Jr., Mattiello Francisco M.F. INPE/CRN, Natal, Brésil
- (S4.3) **Software Subsystem for a Small Earth Observation Satellite**  
Garrido B., Alfaro N., de Miguel J., Garcia A. Instituto Nacional de Tecnica Aeroespacial (INTA), Madrid, Espagne
- (S4.4) **L'atelier d'ingénierie simultanée  $\mu$ CE pour la filière  $\mu$ -satellites du CNES/  
*The Concurrent Engineering Workshop for the  $\mu$ -Satellite Productline at CNES***  
Delatte B., Rossiquet C. CNES, Toulouse, France
- (S4.5) **Mars Proximity Link Operations**  
Kazz G.J., Greenberg E., MacMedan M.L. NASA/JPL, Pasadena, Etats-Unis
- (S4.6) **Prototyping the Space Internet with STRV**  
Blott R. The Defense Evaluation and Research Agency, Farnborough, Royaume-Uni
- (S4.7) **La maîtrise des risques lors des SAP (Sessions d'Avant Projet) sur la filière microsatellite du CNES/ *Risk Management during "SAP" (Sessions d'Avant Projet) on Microsatellite Program***  
Douchin F., Lassalle-Balier G., CNES, Toulouse, France
- (S4.8) **A complexity-based risk assessment of low-cost planetary missions: when is a mission too fast and too cheap ?**  
Bearden D.A. The Aerospace Corporation, El Segundo, CA, Etats-Unis

## **SESSION 5a :**

### **Technologies Petits Satellites : Propulsion *Small Satellites Technologies: Propulsion***

*Présidents / Chairpersons: Jerry SELLERS, Michel BOURDEIL*

- (S5a.1) **An Alternative Geometry Hybrid Rocket for Orbit Transfer.**  
Haag G.S., Sweeting M., Richardson G. Surrey Space Centre, Guildford, Royaume-Uni
- (S5a.2) **Nitrous Oxide as a Rocket Propellant for Small Satellites**  
Zakirov V., Lawrence T., Sellers J., Sweeting M. Surrey Space Center, Surrey, Royaume-Uni
- (S5a.3) **Combined Ammonia Propulsion System**  
Smith P. Polyflex Aerospace Ltd, Cheltenham, Royaume-Uni
- (S5a.4) **Orbit Control of MITA-Class Satellites with FEEP Electric Propulsion System**  
Bianco P., De Rocco L., Omer O.M.M. Carlo Gavazzi Space SpA, Milan, Italie
- (S5a.5) **Aerobraking Design and Study Applied to CNES Microsatellite Product Line**  
Brezun E. CS SI, Toulouse, France, Bondivenne G., Keller P. CNES, Toulouse, France
- (S5a.6) **A Cold Gas Propulsion Module for Small Satellites**  
Cardin J.M., Acosta J. VACCO Aerospace Products, South El Monte, CA, Etats-Unis

## **SESSION 5b :**

### **Technologies Petits Satellites : Autres technologies *Small Satellites Technologies: Other technologies***

*Présidents / Chairpersons: Virendra JHA, Simona DI PIPPO*

- (S5b.8) **Micro-Satellite Based, On-orbit Servicing Work at the Air Force Research Laboratory**  
Madison R.W., Davis M.J. Air Force Research Laboratory, Kirtland AFB, MN, Etats-Unis
- (S5b.9) **Digital Reaction Wheel Assembly RSI 01-5 for Small and Low-Cost Spacecraft**  
Landes A., Boettcher-Arff S. Teldix GmbH, Heidelberg, Allemagne
- (S5b.10) **Lightweight Lithium ION Batteries for Microsat Applications**  
Lagattu B., SAFT Defense and Space Division, Poitiers, Gave G. CNES, Toulouse, France
- (S5b.11) **"THE BITSYtm" Spacecraft Kernel: Reducing Mission Cost with Modular Architecture and Miniature Technology".**  
Chabert N., London Satellite Exchange Ltd, London, Royaume Uni, McDermott S.A., Goldstein D.J., AeroAstro Inc., Etats-Unis
- (S5b.12) **Experimentation de contrôle d'orbite autonome sur le microsatellite Demeter / *An autonomous orbit control experiment for the DEMETER microsatellite***  
Charmeau M.C., Lamy A., Laurichesse D., Grondin M., CNES, Toulouse, France

**(S5b.13) The Nanosol Biaxial Sun Sensor**

Doctor A, Glaberson J., BFGoodrich Aerospace, Barnes Engineering, Shelton, Etats-Unis

**(S5b.15) Active Permanent Magnetic Attitude Control for Small Satellites**

Fullmer R., Florin D. Space Dynamics Laboratory, Utah State University, Logan, UT, Etats-Unis

**(S5b.16) High Speed, Miniature Momentum/Reaction Wheels**

Kestleman V.N., Brothers L.J., Valley Forge Composite Technologies, Inc., Carlisle, PA, Etats-Unis

**(S5b.17) The PRIMA Electrical Power System**

Croci L., Beltrame G., Officine Galileo B.U. Spazio, Milan, Italie

**SESSION 6 :**

**Missions en cours de développement**

**Missions under development**

*Présidents / Chairpersons: Bob HUM, Philippe WALDTEUFEL*

**(S6.1) CESAR mission.**

Caruso D., Yelos J., Comision Nacional de Actividades Espaciales, Buenos Aires, Argentine, Acedo L., Urech A, Instituto Nacional de Tecnica Aeroespacial, Madrid, Espagne.

**(S6.2) ESA's new Earth Observation Programme : Starting with Small Satellite Missions**

Tobias A., Fuchs J., Aguirre M., Silvestrin P., ESA / ESTEC, Noordwijk, Pays Bas

**(S6.3) PROBA (Project for On-Board Autonomy)**

Bernaerts D., Teston F., Bermyn J., Verhaert Design and Development nv, Kruibeke, Belgique

**(S6.4) The Scientific Multi-Experiment Mission DAVID of the Italian Space Agency**

Ruggieri M., Bonifazi C., Paraboni A., Capobianco F., Capsoni C., de Fina S., Pratesi M. Universita' di Roma "Tor Vergata", Rome, Italie

**(S6.5) SMART-1 Technology Experiments in Preparation to Future ESA Planetary Missions**

Marini A., Racca G., Foing B., ESA/ESTEC, Noordwijk, Pays Bas

**(S6.6) Small Satellites as Complex Systems: Management Tools and Techniques in the FedSat Project**

Moody J. Australia-Asia School of Management, Australian National University, Canberra, Australie

**(S6.7) PICARD microsatellite program**

Damé L., Meissonnier M. CNRS, Verrières-le-Buisson, France, Tatry B., CNES, Toulouse, France

**(S6.9) Les missions microsatellites DEMETER, PARASOL et MICROSCOPE. / DEMETER, PARASOL and MICROSCOPE Microsatellites Missions**

Tatry B. CNES, Toulouse, Parrot M. CNRS/LPCE, Orléans, Tanre D., CNRS/LOA, Touboul P., ONERA, France

**(S6.10) Les missions PROTEUS / CNES Minisatellite missions**

Rougeron M. CNES, Toulouse, France

**SESSION 7 :**

**Missions futures / Future missions**

*Présidents / Chairpersons: Daniel CARUSO, Michel ROUGERON*

**(S7.1) IRIS : First steps of the service**

Sansone F., Larock V, Rehorst H., SAIT, Bruxelles, Belgique

**(S7.2) SMART-2, A Small satellite system to change the way scientific satellites are flown**

Garcia C., Whitcomb G. ESA-ESTEC, Noordwijk, Pays-Bas

**(S7.3) Mars Micromissions: Providing Low Cost Access to Mars**

Willis J., Leschly K., Lehman D. Jet Propulsion Laboratory, Pasadena, Etats-Unis

**(S7.4) The concept of the function demonstration satellite of advanced micro satellite (MICROSAT)**

Kogure S., Satori S., Nakasuka S., Okamoto H. NASDA, Ibaraki, Japon

**(S7.5) Earth Observation Program at the Khrunichev State Research and Production Space Center**

Glazkova I. Khrunichev State Research and Production Space Center, Moscou, Russie

**(S7.6) AMS - an Advanced free flying Mailbox Satellite : some choices and solutions**

Galligan K.P. ESA/ESTEC, Noordwijk, Pays-Bas

## **SESSION 8 :**

### **Projets en liaison avec les universités *Projects linked with Universities***

*Présidents / Chairpersons: Bénédicte ESCUDIER, Franco ONGARO*

- (S8.1) FalconSAT 1: Small Satellites as a Tool for Teaching Astronautics**  
Reeves E., Chesley B., Sellers J., Humble R. U.S. Air Force Academy, Colorado, Etats-Unis
- (S8.2) Naval Postgraduate School Graduate Education in Space Systems through Space Flight Experience**  
Sakoda D.J., Naval Postgraduate School, Monterey, Etats-Unis
- (S8.3) The Aries Project**  
Chavez Alcaraz E., Navarrete Parades E., ITESM CEM, Atizapan de Zaragoza, Mexique
- (S8.4) UNISAT Solar Array Integration and Testing**  
Agneni A., Santoni F., Ferrante M., Romoli A., Università degli studi di Roma "la Sapienza", Rome, Ferrazza F., Eurosolare SpA, Rome, Italie
- (S8.5) IONOSPHERIC Observation Nanosatellite Formation (ION-F)**  
Campbell M., Univ. of Washington, Seattle WA, Fullmer R., Swenson C., Utah State University, Logan UT, Hall C., Virginia Polytechnic Institute, Blacksburg VA, Etats Unis
- (S8.6) The Emerald Nanosatellites: two student-built small satellites to explore robust distributed space systems**  
Townsend J. Stanford Space Systems Development Lab. (SSDL), Stanford, Etats-Unis
- (S8.7) The  $\mu$ SAT-EDU project**  
Murgio L.A., Rossa M.B., Gallino M., Instituto Universitario Aeronautica, Córdoba, Argentine

## POSTERS

- (P.1) **RESUME project**  
Roggero E., Cerocchi M., CONAE, Saray J., Baldelli D., UTN-FRH, Buenos Aires, Argentine
- (P.2) **Satellite Tracking from the Top of the World;**  
Operation of a Multi Purpose Ground Station at 80°N\*  
Skatteboe R. Norwegian Space Centre, Oslo, Norvège
- (P.3) **NOVEL Range Measurement System**  
Carayon J.L., Chatain C, CNES, Toulouse, France
- (P.4) **The Agile Mission**  
Musso C., Augelli M., Crisconio M., Falvella M.C., Giommi P., Pellizzoni A., Valentini G., Bignami G.F. Agenzia Spaziale Italiana, Rome, Italie
- (P.6) **Suivi de chargements sensibles ou dangereux par système satellite et solution proposée**  
Dubut J.P., de Carvalho M.J.M., dos Santos M.A.F. INPE/CRN, Natal, Brésil
- (P.8) **Xenon Feed Systems for Electric Propulsion**  
Smith P. Polyflex Aerospace Ltd, Cheltenham, Royaume-Uni
- (P.9) **The Design and Implementation of an Autonomous Ground Station for PANSAT**  
Horning J.A. Space Systems Academic Group, Monterey, Etats-Unis
- (P.10) **Near Equatorial Orbit (NEqO) Satellite Constellation for Remote Sensing and Digital Communications**  
Othman M., Arshad A. S., United Nations Office for Outer Space Affairs, Vienne, Autriche
- (P.11) **Space Systems Using GEO and LEO Satellites. Mission: Long Distance Activities Support**  
de Miguel J., Alfaro N., Garrido B. Instituto Nacional de Técnica Aeroespacial (INTA), Madrid, Espagne
- (P.12) **JAVA à l'épreuve des petits satellites / JAVA face to small satellites**  
Aprville L., Sénac P., Richard F., Diaz M. Alcatel Space Industries, Toulouse, France
- (P.13) **A Gamma Ray Observatory on the MITA Platform Agile a Forerunner for ASI Small Satellite Scientific Programme**  
Crocco L. Carlo Gavazzi Space, Milan, Italie
- (P.14) **Open Source to Small Satellites Ground Station**  
de Carvalho M.J.M., Alves Pereira R. Jr, Mattiello Francisco M.de F., Dubut J.P.  
Instituto Nacional de Pesquisas Espaciais, Natal, Brésil
- (P.15) **Fifteen Years of Small Satellite Communications: A Lesson Learned**  
Pavesi B., Rondinelli G. Telespazio spa, Rome, Italie
- (P.17) **MINISAT-01: Tools for scheduling, data analysis and payload monitoring**  
Talavera A., Garcia J., Quintana C. Lab. de Astrofísica Espacial y Física Fundamental, Madrid, Espagne
- (P.18) **A Method for Predicting on Board Computers Single-Event Effects Induced Failure Rates, Based on Markov Chains**  
Ferreya P.A., Marques C.A., Gaspar J.P. Facultad de Matemática Astronomía y Física, Córdoba, Argentine
- (P.20) **Cryogenic Transition-Edge Microbolometers and Calorimeters with on-chip coolers for X-ray and Far-Infrared Detection**  
Kinnunen K, University of Jyväskylä, Jyväskylä, Finlande
- (P.21) **Design and development of on-board data handling (OBDH) software for a university micro-satellite**  
Ponte S. Department of Aerospace Engineering, Aversa, Italie
- (P.22) **Design of the Smart Microsatellite Electrical Power Subsystem**  
D'Errico M., Pastena M. Dipartimento di Ingegneria Aerospaziale, Aversa, Italie
- (P.23) **SMART Microsatellite structure, Mechanisms and Thermal Design.**  
Fraglioni M. Aerospace Engineering Department, Aversa, Italie
- (P.24) **The European Spacecraft Platform Database**  
Lionnet P., Toussaint M., Debruyne E. Eurospace, Paris, France
- (P.25) **Smallsats: from infancy to adulthood?**  
Lionnet P., Toussaint M., Debruyne E. Eurospace, Paris, France
- (P.26) **Space School for Teenagers**  
Sausen M.T., Avila J. Ministerio da Ciencia e Tecnologia, Sao Jose dos Campos, SP, Brésil
- (P.27) **Station Faible Coût pour Micro-Satellites**  
Lemagner F., Thomas C., CNES, Toulouse, France
- (P.28) **Swedish Small Satellites**  
Lundahl K., Swedish Space Corporation, Solna, Suede
- (P.29) **Let it run Automation of Ground Mission Operations and Satellite Testing Activities**  
Aked R., Ilzkovitz M., Vlyminckx F., Lobbrecht I., Space Applications Services (SAS), Zaventem, Belgique
- (P.30) **Dial-A-Sat: Access Links for Small Satellites via Commercial MSS**  
Colzi E., De Caunes H., Ribes A., Winton A., ESA/ESTEC, Noordwijk, Pays Bas

## **SESSION 1 :**

### **Résultats et retours d'expériences**

#### ***Results and feedbacks from experiments***

*Présidents / Chairpersons: Michel AVIGNON, Otavio BOGOSSIAN*

- (S1.1) A Power System Design for the Petite Amateur Navy Satellite - PANSAT**  
Phelps R.L. Naval Postgraduate School, Monterey, Etats-Unis
- (S1.2) DLR - TUBSAT: A Microsatellite for Interactive Earth Observation**  
Schulz S., Renner U. Technical University of Berlin, Berlin, Allemagne
- (S1.3) MINISAT-01: Three years of scientific operations**  
Talavera A., Garcia J., Quintana C. Lab. de Astrofisica Espacial y Fisica Fundamental, Madrid, Espagne
- (S1.4) SUNSAT1 - Orbital results and upgrades for 4m multi-band imaging in SUNSAT-2**  
Mostert S., Milne G.W., du Plessis J.J., Schoonwinkel A.  
University of Stellenbosch, Stellenbosch, Afrique du Sud
- (S1.5) The development of low cost missions at Surrey**  
Allery M. Surrey Satellite Technology Ltd, Guilford, Royaume-Uni



**A POWER SYSTEM DESIGN FOR THE  
PETITE AMATEUR NAVY SATELLITE – PANSAT**

**Mr. Ronald L. PHELPS**

*US Naval Postgraduate School  
Space Systems Academic Group  
777 Dyer Road, Bldg. 233, Rm. 125  
Monterey, CA 93943*

**ABSTRACT:** The Petite Amateur Navy Satellite was launched aboard the Space Shuttle Discovery on Oct 28 1998 into a circular 550km low-earth orbit. Since its inception, 50 officer students have performed thesis work that made PANSAT's launch and operation possible. This paper describes an Electrical Power System (EPS) designed for the Petite Amateur Navy Satellite.

A Shuttle launch places strict safety requirements on a secondary power supply thus, it was necessary to adhere to NASA manned flight safety requirements when designing the battery and its housing. Described in this paper is the PANSAT battery design, which mitigates potential hazards, such as short circuits, electrolyte leakage and gas generation and thus meets manned flight safety requirements.

In this paper, a picture of the on-orbit environment and battery performance is deduced from the onboard sensors. This is possible since PANSAT is instrumented with 64 temperature and 11 current sensors. Of the eleven current sensors eight are assigned to solar panel currents, two monitor battery currents and one measures the 12V bus current. In addition, individual cell temperatures and voltages of each battery are measured. The remaining temperature sensors are distributed throughout the electronic modules of the spacecraft and on each of the solar panels. Discussed in this paper is an experiment to use the eight solar panel current measurements and the temperature measurements of all 18 solar panels to deduced PANSAT's relative motion with respect to the sun.

## **1. MISSION DESCRIPTION**

From its inception, the Space Systems Academic Group has had as it's primary mission the education of officer students of the Naval Postgraduate School. The PANSAT satellite project realized this goal by providing hands on design work for officer student thesis projects and continues to provide opportunities in the areas of on-orbit operations and ground station support. PANSAT will provide to the amateur community a spread spectrum digital store and forward bulletin board via a half-duplex link.

With an orbit life expectancy of at least 10 years — due to its 550km orbit — battery life will be the principal factor determining mission life. A goal is to extend the mission life to four years using a modified battery charging and monitoring algorithm. Some modifications to the battery charge algorithm are in place and being evaluated presently. Ejection of PANSAT from the Shuttle Orbiter imparted a spin about PANSAT's axis of symmetry. Over the length of the mission this spin and other movements of the satellite have been observed using the temperature and solar panel current sensor readings.

## 2. PANSAT DESIGN OVERVIEW

A conservative design approach was adopted at the projects inception and the use of space qualified components was considered the best design philosophy. However, component costs and availability made changes in design approach necessary. The more practical method was to use commercial off-the-shelf components (COTS) for the major portion of the project and design redundancy into the satellite at the subsystem level, then identify those areas requiring the use of radiation hardened/space qualified components. One area of the design was identified that required space qualified components – the Error Detection and Correction subsystem or EDAC. The EDAC detects single-bit errors caused by single event upsets in the System Controller RAM and corrects them.

In keeping with the redundant design philosophy, PANSAT has two System Controllers SCA/SCB, two Temperature Multiplexers TMUXA/TMUXB, two 4-megabyte Mass Memory modules MASS/MASSB, two 12V NiCd batteries, and multiple transmit and receive paths in the communications system. The only subsystem electronics with no redundancy is the Electrical Power System. In fact, the Electrical Power System has several single points of failure, some as a result of safety requirements from NASA.

Eighteen of PANSAT's twenty-six faces are covered with solar arrays that on average generate 16.33 W of power after subtracting for losses in charging and discharging the batteries and losses in the solar panel isolation diodes. Seventeen panels are 253.4 cm<sup>2</sup> [39.28 in<sup>2</sup>] and have 32 mounted single junction silicon solar cells. Each silicon solar panel contains a single string which generates approximately 5.5W at its maximum power point of approximately 16.25V. The remaining panel, mounted on the launch interface, is gallium arsenide and was added to generate power in the event the launch interface pointed towards the sun. When illuminated the panel can generate approximately 1.5W. With 22 (2cm x 2cm) cells and a maximum power point of 19V it was integrated into the spacecraft power bus using a DC/DC converter.

PANSAT structural components are machined from 6061-T6 aluminum. There are two internal equipment plates, 18 body mounted solar panels, and eight triangle panels. Four of the triangle panels are mount supports for the omnidirectional antenna system. The structure also includes a HitchHiker ejection launch interface, internal support cylinder and 11.34kg [25 Lbs.] of ballast to increase the ballistic coefficient. See Fig. 1, PANSAT expanded view.

## 3. ELECTRICAL POWER SYSTEM ELECTRONICS

The Electrical Power System, a hybrid analog/digital design, was built with COTS integrated circuit components. The EPS has no microcontroller or processor, so it relies on a System Controller to command power switching and gather the EPS telemetry. In the EPS, eight selected panel outputs are measured with individual current sensors and then combined with the remaining solar panel outputs into the solar panel power bus. Four MOSFET switches are used to charge, discharge, trickle charge, or place each battery on the spacecraft power bus. As with the subsystem switches, all battery switch settings are commanded by the active System Controller.

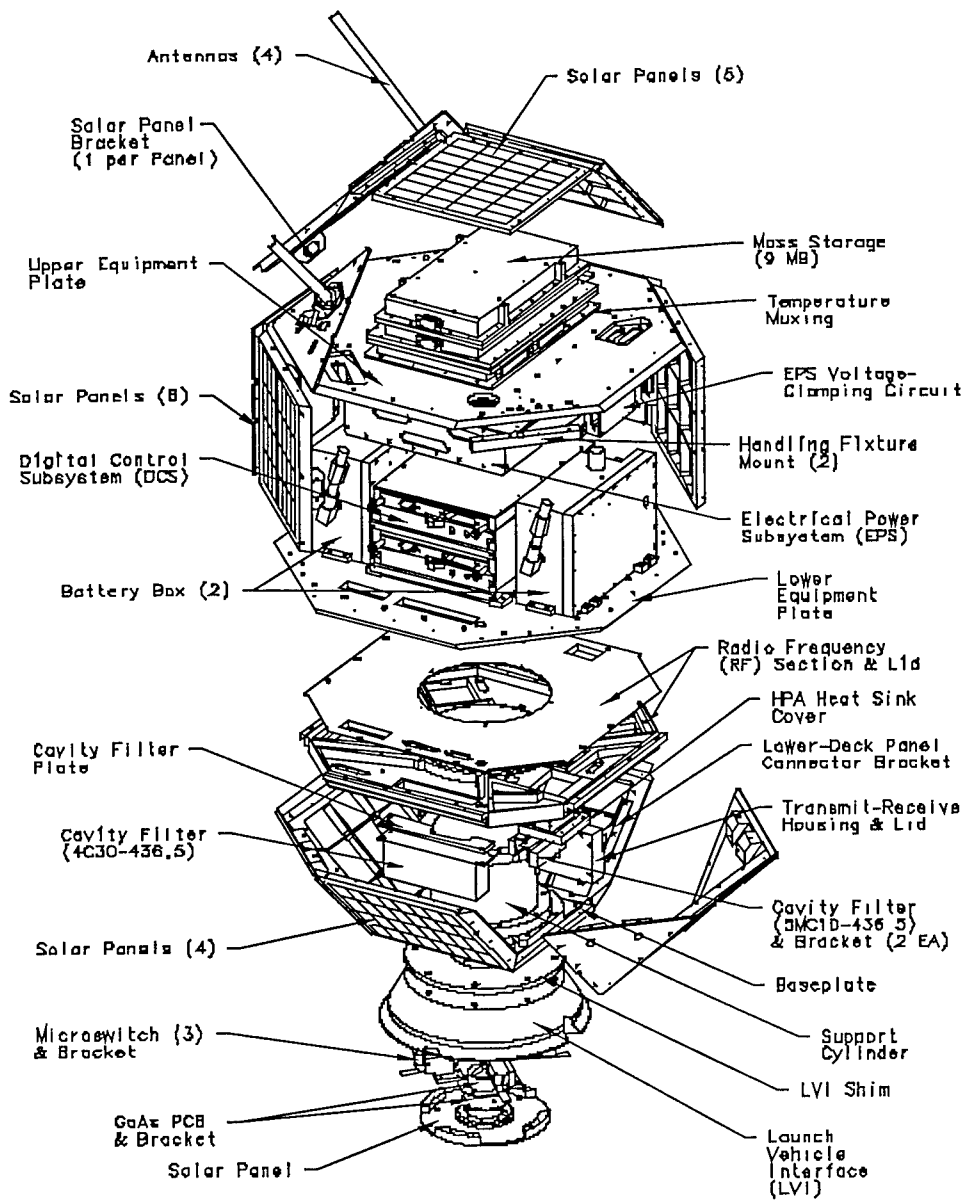


Fig 1: PANSAT Expanded View.

NASA payload safety personnel identified areas in PANSAT's design which had potential to cause catastrophic failures. These are conditions that could occur any time after launch up to the point PANSAT exits from the orbiter payload bay. According to NASA safety regulations [NASA 89], two potentially hazardous conditions were; inadvertent transmissions by the PANSAT communications subsystem while the satellite was in the cargo bay, either before or just after ejection, and the potential explosion hazard caused if hydrogen and oxygen gas are generated by the batteries. NASA required 3 independent inhibits for each potential catastrophic failure to meet safety requirements.

The following details were designed into the satellite to mitigate these hazards. Three microswitches acting as independent inhibits were placed in the solar panel power bus to prohibit power from reaching the RF subsystem when PANSAT is stowed in the Hitchhiker canister. One microswitch was placed in the ground leg and two in the power leg of the solar panel power bus. Additionally both batteries were discharged prior to flight so that no gases could be generated if the batteries were rapidly discharged by a short circuit. These same three switches also make it unlikely that the batteries would be inadvertently overcharged which could lead to the generation of explosive gases from the batteries electrolyte.

Two inhibits were needed to restrain PANSAT from transmitting as it exited the orbiter payload bay following ejection. NASA safety agreed that the RF subsystem as controlled by the satellite's software could be considered as one inhibit. To create an additional inhibit a hardware timer circuit was added to the RF subsystem so that once PANSAT was ejected from the canister the transmit circuit was disabled for 15 seconds. This ensured that the satellite would be far enough away from the orbiter that should a transmission occur at full rated power it would not impinge upon the shuttle payload bay above acceptable levels.

When PANSAT is ejected from the HitchHiker canister the three microswitches close and power up the satellite. The peripheral control bus (PCB) is powered up and the SC can begin controlling the satellite. In the EPS a watchdog timer circuit switches power to the primary System Controller A – SCA. If for any reason the primary System Controller doesn't function correctly and does not reset the watchdog timer within 2 minutes, then the timer will switch off the primary System Controller and power up the secondary System Controller – SCB. From this point on PANSAT will bring both batteries up to full charge and listen for contacts from the NPS ground station. First contact was achieved on Nov. 6, 1998 ten days after launch.

The PANSAT spacecraft power bus is battery dominated so when a battery is being charged the bus voltage tracks the battery voltage plus one diode drop. When the satellite is in eclipse the spacecraft power bus follows the battery voltage minus one diode drop. When no battery is being charged and the satellite is in the sunlit portion of the orbit, a voltage clamp limits the spacecraft voltage to 16V which is the upper input limit of the electronic subsystems DC/DC converters. All voltage conversion and regulation is done at the subsystem level.

Terrestrial nickel cadmium batteries are PANSAT's secondary power source. Individual cells from a lot size of 150 cells were tested so those with comparable charge/discharge profiles could be grouped into matched batteries. This method of matching the individual cell charge/discharge profiles will increase battery cycle life. Six batteries in total were made. Two prototypes were used for testing and four for flight. The prototype batteries were used to develop and test PANSAT's battery monitoring algorithm. These matched terrestrial cells, Sanyo Cadnica 4400D's, have 4.4 A-hr capacity and are equivalent in size to commercial D size batteries. Taps in each battery allow individual cell voltages to be multiplexed within the EPS and output to the operational System Controller where they are measured, stored and downlinked to the ground for analysis.

Initial design requirements called for redundant batteries in the unlikely event one battery failed. However, as the satellite design matured it became apparent that two batteries working in parallel were necessary to reduce the number of battery charge cycles and thus extend battery life to the two years specified in the mission requirements. Charge cycles are reduced by charging one battery to full capacity from a 40% Depth of Discharge (DOD) – over approximately 4 orbits – and placing it on line so that it may supply power in eclipse and buffer transmits until its capacity is reduced to 60%. While one battery is being discharged the other battery is being charged to full capacity from 60%. In this manner each battery alternates supplying power to the satellite and being recharged, incurring a total of two cycles per battery per day. If it were not for this capability the PANSAT mission would last approximately 6 months as a one battery system would near its cycle life limit.

During the design phase a suggestion was made to experimentally determine attitude information for the satellite using current measurements on a selected number of solar panels. Typical space flight quality current sensors available at that time were large and expensive. However, a highly accurate COTS current sensing IC became available in an 8-pin dual in-line package which made it possible to place 11 sensors in a  $64.5\text{cm}^2$  [ $10\text{in}^2$ ] area of the printed circuit board. In addition to measuring currents on individual panels this same sensor was used to measure battery charge and discharge currents and the current on the spacecraft power bus. A more detailed discussion of the attitude determination experiment results appears later in this paper.

Single-points-of-failure were unavoidable in PANSAT's design and several exist in the EPS subsystem. One is the Peripheral Control Bus, the parallel communications bus used by all PANSAT subsystems. When the spacecraft power bus is energized, a DC/DC converter located in the EPS generates a regulated 5V which is distributed to all the subsystems from the EPS. If this converter ever fails the entire spacecraft would fail to function as all commanding, message traffic and telemetry measurements require a functioning PCB. Additionally, the three microswitches providing safety inhibits, as described earlier, are also single-points-of-failure since if any of the three failed to close, no power from the solar panels would reach the EPS.

## 5. BATTERY HOUSING

The design approach for PANSAT relied on redundancy as a means of limiting subsystem failures resulting from less reliable commercial components. For this reason it was initially thought two batteries should be designed into PANSAT so a single battery failure would not threaten the mission. However, as described earlier in the paper, two batteries working in parallel were needed to extend the mission life to the required two years.

Each battery is comprised of nine commercial off-the-shelf Sanyo Cadnica NiCd cells of 4.4 A-hr capacity. To increase battery life 54 cells were selected from a larger lot of 150 cells by matching charge/discharge profiles. Selection criteria was for cells with similar profiles to be grouped into batteries. A total of four flight and two prototype 47.5 W-hr flight batteries were built from these matched cells.

The Sanyo Cadnica cells (KR-4400D) have a pressure relief valve and as such were not considered sealed by NASA safety standards, [NASA 85]. For that reason and for reliability reasons a housing with a pressure relief valve was designed to contain any electrolyte leakage or generated gas. A big advantage of the Sanyo cells is they are dry cells, having only two drops of electrolyte each, and thus minimize any potential effects caused by leakage.

The cylindrically shaped cells are held in place in ½ inch deep milled pockets sized to fit the diameter of the cell. An insulating disk made of polycarbonate is placed underneath each cell to isolate it from the metal housing complete with channel to allow room for connecting wires to the negative electrode of each cell. The housing interior was coated with Teflon ® which adds to the electrical insulation and was required to reduce the chance of gas generation should any cell leak electrolyte onto the metal housing. Each cell was potted into its pocket with thermally conductive elastomer. The Teflon ® coating and conductive elastomer each have high thermal conduction properties and minimize any temperature gradients across the battery pack. This is important as the battery charge monitor – the algorithm to monitor and control the charge state of the batteries – will function more reliably when all cells are at the same temperature. Measured gradients across the battery average less than 2 degrees C. An expanded view of the battery housing design is depicted in Fig 2.

A polycarbonate plate milled with pockets to accept the top of the cells is bolted onto the housing and holds the cells in place. Five bolts pass through hollow polycarbonate standoffs – called dielectric spacers in Fig 2 – into the metal housing and firmly clamp the cells into their pockets. Each standoff has two milled pockets for thermistors which are linked thermally to individual cells by use of the same thermally conductive elastomer used to pot each cell into its pocket. A battery has ten thermistors. Five thermistors are multiplexed by TMUXA and five are multiplexed by TMUXB the outputs of which are read by the analog-to-digital converter in the operating SC.

Another NASA requirement of was the addition of a thermal cutout switch in the battery ground leg. If for any reason a battery was shorted and began to overheat this switch would take the battery out of the circuit. It was important to set the cutout temperature low enough to prevent this hazard however not so low as to cause the batteries to be cutoff as they heat up during a recharge. The temperature cutout was set to 55 degrees C. As it turned out on orbit temperatures during a recharge have never exceed 30 degrees C and are generally in a range from 0 to 20 degrees.

A 1 atmosphere pressure relief valve and 10 micron filter placed on the housing are used to contain any electrolyte leaking from a cell that bursts its relief valve. This has the secondary effect of improving the reliability of the battery pack by acting as a second containment barrier. More electrolyte will be contained in a cell with a burst valve if the housing is sealed or vented through a pressure relief valve than would be contained in a cell whose housing is not sealed or pressurized. A photo of a partially assembled battery is shown in Fig 3.

Item	Description	Manufac	Part/Draw No.	QTY
21	PLUS 1/4-Inch Straight w/ D-RING	CAJON	33-4-1P9T	1
20	Kepton low-voltage heater strip	DMCA	KHLY-304/2	1
19	8-32 X 2 SS Socket Head Cap Screw	N/A	UNCB-32X2	8
18	CONTOILED Variability Heat Sink Compound	Mull Tech.	CV-2545	N/A
17	Positionable Male Elbow, 1/4 in.	Swagelok	-40D-2-45T	1
16	Check valve	Swagelok	SS-4C-10	1
15	Pressure Relief Valve, 32 psf	Circle Seal	520T-4D-32	1
14	Sub-micron Filter, 10 Mic abs	Norman Ultrapore	422XT-1DB	1
13	Dielectric Spacer	NPS	B-PAN1109E	8
12	4 SS Split Washer	n/a	n/a	24
11	4-4Q SS Socket Head Cap Screw	n/a	UNCB-4QX3/8	28
10	Teflon encapsulated Viton O-ring	Lutz	Q-070CSX Q-851-ID	1
9	Polycarbonate Cell Cap 'B'	NPS	B-PAN11117	1
8	Polycarbonate Cell Cap 'A'	NPS	B-PAN1111B	8
7	Polycarbonate Cell Fixture 'A'	NPS	B-PAN1108B	1
6	Aluminum Housing, Part 'A'	NPS	B-PAN11083	1
5	Aluminum Housing, Part 'B'	NPS	B-PAN11084	1
4	Size 'D' Ni-Cd Cell, 1.2V, 4.4Ah	Sanyo	DR-4400D	9
3	Thermostat	ELWOOD SENSORS	35D0T120- B2D8	2
2	M527470 Ser 1 #11 Connector	HSC	H88428012 -1B-38P	1
1	M527470 Ser 1 #15 Connector	HSC	H88428012 -15B-38P	1
	Description	Manufac	Part/Draw No.	QTY

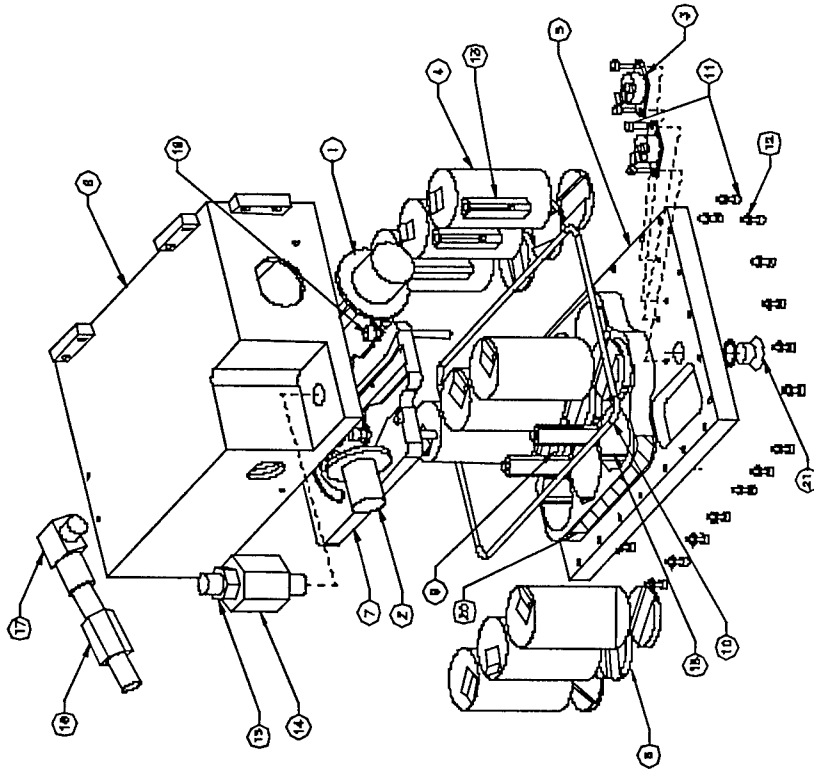


Fig 2: PANSAT Battery Housing Expanded View



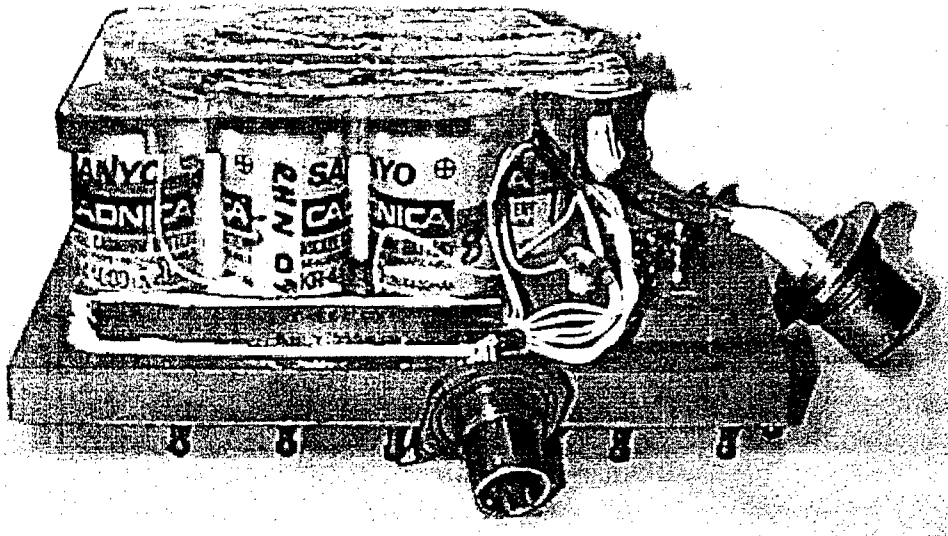


Fig 3: PANSAT Battery During Assembly

## 6. TELEMETRY

PANSAT's Status and health is evaluated every two seconds following a sweep of all telemetry data points. Every two minutes a single set of telemetry measurements is written to a MASS storage system which is later downlinked to the ground station at NPS. The capability also exists to record measurements taken 5 seconds apart for intervals of up to 1 hour which can then be used to evaluate telemetry with finer resolution of time.

### 6.1 PANSAT Attitude Dynamics

PANSAT has no attitude stabilization system, thus, its orbital dynamics are a result of the spin imparted by the HitchHiker ejection system, its inertial moments and the orbital environment. An experiment was conceived which would allow PANSAT's dynamics to be deduced using temperatures from all eighteen solar panels and current measurements from eight strategically selected solar panels; the panels numbered 4,5,7,9,11,13,14 and 16 in Fig. 4.

A video of PANSAT being ejected from the HitchHiker canister was evaluated frame by frame as described in [GRAS 99], to establish the rotation about PANSAT's axis of symmetry caused by the ejection mechanism. It was estimated that the satellite's rotation rate as it was exiting the orbiter cargo bay was approximately 1 rpm. One and a 1/2 years later it has been confirmed from solar panel current telemetry that the rotation rate is 1.25rpm.

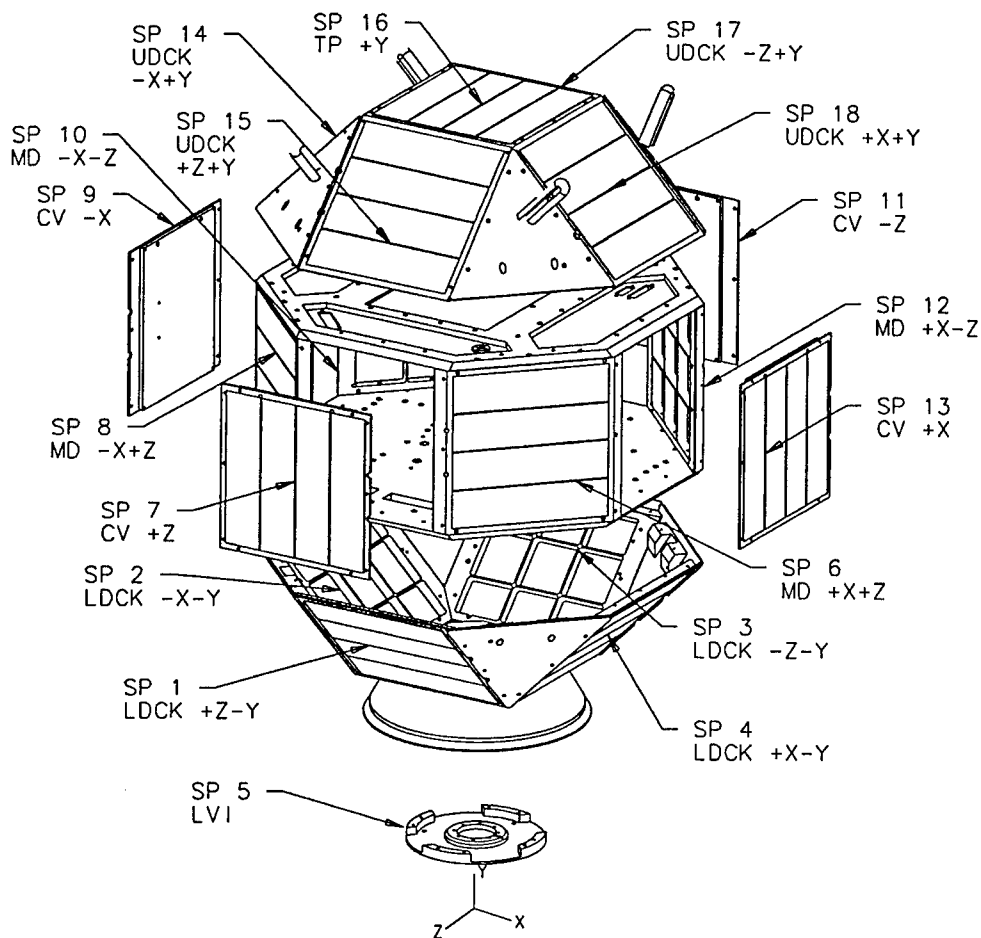


Fig 4: Solar Panel Identification.

From temperature measurements alone it is possible to deduce longer term trends in PANSAT's attitude. When solar panel temperatures are color coded as upper, middle and lower deck temperatures and then plotted, they form bands that clearly show the portions of the satellite which is being illuminated the most. Observations have shown that over the course of the mission PANSAT has oscillated from having its top panels pointing towards the sun to the mid-deck panels facing the sun to the lower deck panels facing the sun and then back again to the mid and then top panels. This oscillation period is difficult to predict and movement from one phase to another can be a few days or weeks.

## 6.2 Batteries

Battery cell voltages, temperatures and charge/discharge currents have been used to monitor battery health and prompt adjustments in the battery charge monitor algorithm for the purpose of extending battery life. As of the end of April 2000, each battery has been cycled nearly 1100 times, and from the Sanyo engineering handbook for NiCd batteries, [SANY 97], the expected life cycle of a NiCd

battery at a 40% Depth of Discharge is in the range of 2100 to 3700 cycles.<sup>1</sup> Battery discharge rates on PANSAT average 500ma with current spikes of approximately 2A during RF transmissions. These discharge rates are light in comparison to rated discharge capabilities and as a result we can expect more rather than fewer cycles from the batteries.

Standard charge rates for PANSAT's NiCd batteries is .1C to .2C, where C is 4.4A, the standard rated capacity, [GATE 92]. However, because the satellite has no electronics to limit the charge rate there are portions of each charge cycle where currents are greater than .2C. This higher charge rate has the potential to lower cycle life which could result in fewer cycles from the batteries.

With an understanding of the causes affecting cycle life in NiCd cells we were able to adjust the battery charge algorithm in a way to reduce the life shortening effects of the higher charge rates. The reasoning is as follows. Under optimum conditions charging generates only oxygen, no hydrogen, and all oxygen produced is recombined so pressure does not buildup and leak from the vent. At higher charge rates enough oxygen can be generated to where the electrolyte's capability to be recombined is exceeded and the cell will vent. As more oxygen is vented the cell's electrolyte will dry out causing the internal resistance to increase and shorten the cell's useful life. At lower temperatures the capability for the electrolyte to recombine the generated oxygen is lessened further still. The solution was to pulse charge the batteries so during the time between charge pulses the oxygen can recombine lessening the pressure.

As described earlier in this paper, the battery cells were matched according to their charge/discharge curves. As the mission has progressed the spread of cell voltages has increased giving indication that the cell are beginning to age. Battery discharge profiles measured prior to launch, show cell voltages at rest spread over 25mV for battery A and 150mV for battery B. As the mission has progressed the spread between cells voltages has widened and now is 65mV for Battery A and 250mV for Battery B. This spread could be a result of cells weakening due to carbonate build up from the organic materials in the cells oxidizing. A process that can be hastened when excess amounts of oxygen are present in the cell.

## 6.2 EDAC Errors

The Error Detection and Correction circuitry completes a System Controller memory wash every two minutes clearing single bit flips caused by radiation induced single event upsets. Each single bit flip that is detected and corrected is logged with a time stamp. Once the telemetry is downloaded the EDAC error times can be plotted over a Mercator projection of the globe. The two figures, Figures 5 and 6 are plots of the EDAC errors for the months of February and April of 2000. It is no surprise that the majority of the errors occur over what is commonly called the South Atlantic Anomaly.

## SUMMARY

The Electrical Power System despite its single points of failure, and simplistic design survived launch and has to date been very effective at providing for PANSAT the means to control and distribute power to all subsystems and the communications bus. It has also provided the sensor and multiplexing capability to perform analysis of PANSAT's orbital dynamics, as well as, providing measurements of battery cell voltages.

---

<sup>1</sup> At a discharge rate equal to a cells standard rated capacity (1C).



Fig. 5 EDAC Errors , April 2000



Fig 6. EDAC Errors, Feb 2000

**REFERENCES:**

- [NASA 89] National Aeronautics and Space Administration : *Safety Policy and Requirements for Payloads Using the Space Transportation System*, NSTS 1700.7B, January 1989.
- [NASA 85] National Aeronautics and Space Administration : *Manned Space Vehicle Battery Safety Handbook*, Johnson Space Center, September 1985.
- [GRAS 99] M. Graswald : Contributions to Attitude Dynamics of the Petite Amateur Navy Satellite (PANSAT), Technical Report NPS-SP-99-001, Naval Postgraduate School, Monterey California, February 1999
- [SANY 97] SANYO Electric Co., Ltd. : *Cadnica® Sealed Type Nickel-Cadmium Batteries Engineering Handbook*, Nov. 1997.
- [GATE 92] Gates Technical Marketing Staff of Gates Energy Products, Inc. : *Rechargeable Batteries Application Handbook*, Butterworth-Heinemann, 1992.

## **DLR-TUBSAT: A MICROSATELLITE FOR INTERACTIVE EARTH OBSERVATION**

**Stefan SCHULZ, Udo RENNER**

*Technical University of Berlin, Institute of Aerospace  
Marchstr. 12, D-10587 Berlin  
Tel.: +49 30 31421305, Fax.: +49 30 31421306  
E-Mail: stefan.schulz@tu-berlin.de, udo.renner@tu-berlin.de*

***ABSTRACT** - DLR-TUBSAT is a joint project of the Institute of Aerospace at the Technical University of Berlin (TUB) and the German Aerospace Center (DLR). The microsatellite was launched on 26 May 1999 with the Indian Polar Spacecraft Launch Vehicle (PSLV) together with KITSAT-3 and the primary payload IRS-P4. The test satellite was designed for interactive earth observation where the target is not clearly identified in advance, a search action is involved or a target has to be visually followed for a while. This paper will describe the mission objective, the final configuration of the satellite, the ground segment and the operations. Finally the achievements of the first year in orbit and the lessons learned will be presented.*

### **1 – INTRODUCTION**

Satellite remote sensing is very useful in areas such as forestry, agriculture, geology, hydrology and mapping in any way. Since 1970 a lot of remote sensing systems have been launched for imaging the earth, e.g. projects like LANDSAT, SPOT and IRS. Due to the size and costs of these projects remote sensing was limited to governmental organizations which were interested in weather services, military observations and mapping. The attitude of these satellites has to be nadir pointing in order to scan the earth face with linear CCD sensors and the repeat cycle is from 3 to 26 days. They need a high volume of data storage and data transmission. Remote sensing with a resolution in the range of 30 m is good for monitoring environmental processes that change within a period of more than 5 days.

Earth observation is going to be a commercial market more and more. With the launch of IKONOS a new era in the field of earth observation began. IKONOS provides panchromatic imaging data with a resolution of 1 m and multispectral of 4 m. These images are radiometrically and geometrically corrected, map projected and will be offered via internet. The satellite has a repeat cycle of one to three days and is capable of delivering more up to date information.

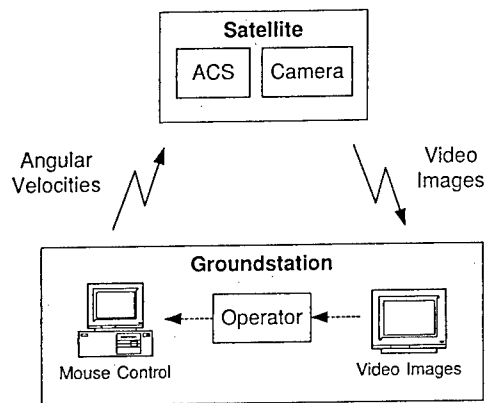


What role do microsattellites have in this business ?

1. Provide a cheap platform that can be configured and launched for a very specific mission within a short time.
2. Take advantage in their mobility of monitoring processes which change fast (within one day), for search actions or for following a target.

Microsattellites have a high mobility due to their compactness and small mass which is essential for observing the following category of events: weather phenomena like hurricanes, lightning or polar lights, spectacular fires, volcano eruptions, floods, earth quakes, ship, plane or railway accidents or any other events of this type which e.g. a news agency would like to present in the news. This interesting area is typically only a few square kilometers large and the resolution requirement is of course as high as possible.

In this case interactive earth observation means that the user in the ground station receives video images from the satellite and is able to steer the pointing direction of the camera platform interactively via mouse control to the interesting event on the ground (see figure 1). This is appreciated in applications where the target has not been identified clearly in advance, a search action is involved or a target has to be visually followed for a while.



**Figure 1:** Interactive earth observation

The test satellite DLR-TUBSAT has been designed especially for this purpose and was launched on 26 May 1999 with the Indian rocket PSLV (Polar Spacecraft Launch Vehicle) from the launch site Sriharikota together with KITSAT-3 and the primary payload IRS-P4 (OCEANSAT). The satellite was attached with a ball-lock type separation system to the vehicle equipment bay (VEB) of the upper stage and was separated about 19 min after launch with one meter per second. The final orbit parameters are listed in table 1.

Type	sun synchronous
Altitude	726 km
Descending node	12:00 am
Eccentricity	0.0017
Inclination	98.3811 °
Period	99.344 min

**Table 1:** Orbital characteristics

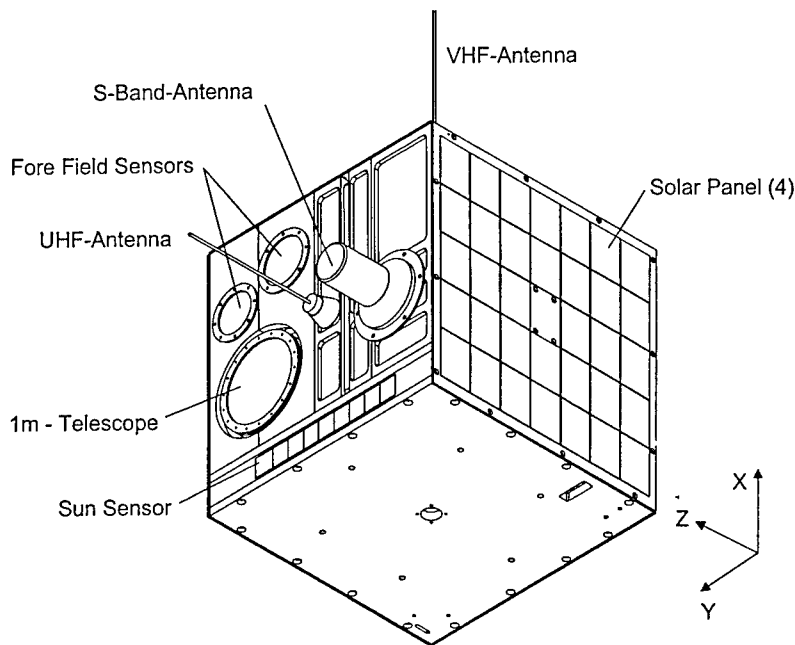


Figure 2: Microsatellite DLR-TUBSAT

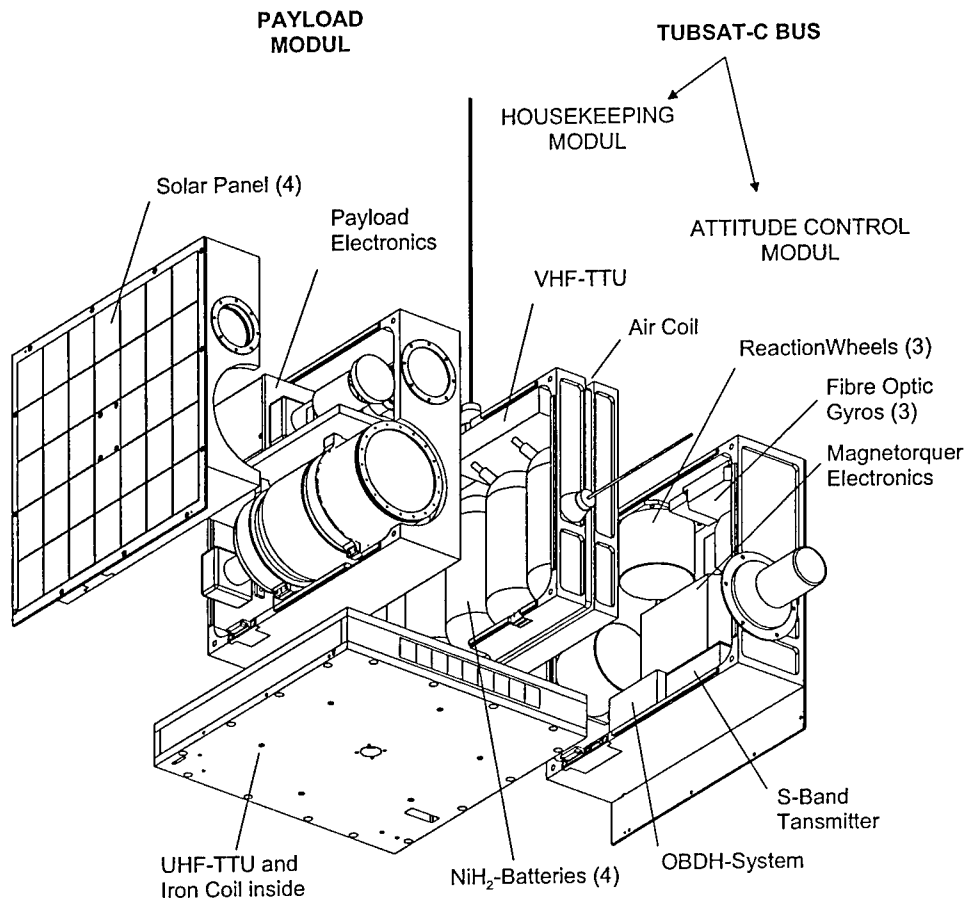
## 2 – SYSTEM DESCRIPTION

DLR-TUBSAT was jointly developed by the Technical University of Berlin (TUB) and the German Aerospace Center (DLR); TUB was responsible for the satellite bus and DLR for the payload. In the frame of operation the TUB has a cooperation with the German Remote Sensing Data Center (DFD) of DLR in Neustrelitz and a radio amateur ground station in Kiel. The TUB Satellite Control Centre is responsible for the health monitoring and the ground stations at Kiel and Neustrelitz for receiving the wide band video signals.

### 2.1 – Space Segment

The final configuration of the space segment is shown in figure 2 and 3. The cube shaped satellite measures  $32 \times 32 \times 32 \text{ cm}^3$  and weighs 44.81 kg. DLR-TUBSAT is subdivided into a Payload, a Housekeeping and a Attitude Control Module. The last two modules represent the TUBSAT-C bus. The lower compartment is mainly the interface for the separation system.

The Payload Module contains two fore field cameras with low and medium resolution and a high resolution telescope with a focal length of 1 m, a pixel size of  $8.3 \mu\text{m}$  and a ground pixel resolution of 6 m. Each CCD-chip contains  $752 \times 582$  pixels, and each camera can transmit video images in CCIR-standard and single digital pictures. The focal length of the fore field cameras is 16 mm and 50 mm respectively. The S-band antenna is physically located on the Attitude Control Module in order not to obstruct the field of view of the payload sensors, and the S-band transmitter is located close to the antenna. Analog video transmission is performed within a bandwidth of 8 MHz, the transmission of single pictures occurs at 125 kbaud. The beam width of the antenna is  $70^\circ$ .



**Figure 3:** Exploded view of the microsatellite DLR-TUBSAT

The House Keeping Module contains the batteries, the Power Control Unit (PCU), the air coil and the two Telemetry Telecommand Units (TTU) in VHF and UHF band, as well as the two antennae. Four duplex NiH<sub>2</sub> battery cells from Eagle-Picher each with a capacity of 12 Ah support an unregulated 10 V bus which is charged by four identical solar panels, each containing a single string of 34 silicon cells. The short circuit current of each panel is 960 mA. The PCU contains the DC/DC-converter and the power distribution device. It is capable of switching different loads simultaneously, while constantly monitoring current levels and providing protection against short circuit. The UHF/VHF-TTU receives and transmits data via FFSK modulation at a rate of 1200 baud. Both transceivers nominally operate parallel in a listening mode. As long as no telecommand is received from the ground, the satellite is silent.

The Attitude Control Module contains three reaction wheels, three fibre optic gyros, the magnetorquer electronics, the On Board Data Handling System (OBDS), the S-band transmitter as well as the S-band antenna.

The lower compartment contains the UHF-TTU and the iron coil, which is mounted in the direction of the z-axis of the satellite. A single string of solar cells is attached at the surface in the +z-axis and is used for the sun acquisition maneuver.

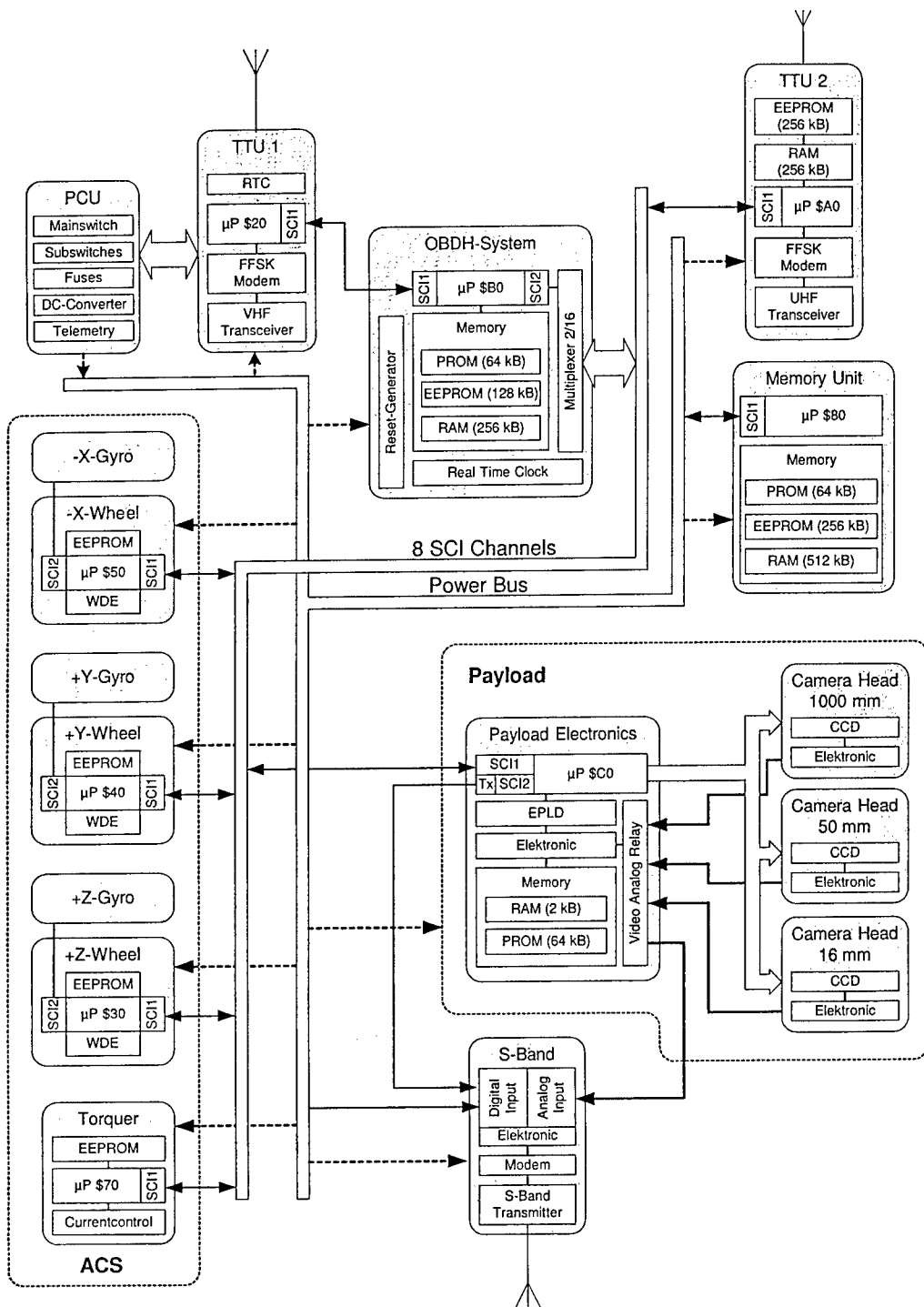


Figure 4: System architecture of DLR-TUBSAT

**System Architecture** The communication and power system is a radial network, where PCU and OBDH-System are the main devices (see figure 4). The PCU is responsible for power conditioning and distribution and the OBDH-system for controlling the communications. Each device is connected to the PCU via power bus, which consist of +5 V, +15 V and the unregulated battery voltage, and to the OBDH-System via SCI, excluding the TTU1 (VHF-band). The TTU1 is the primary unit which is connected to the first serial interface of the OBDH-System and to the PCU for controlling the switching tasks. The other devices are connected to the second serial interface via multiplexer. The S-band transmitter is connected to the payload, provides the transmission of the video images and the digital pictures with 125 kbaud (bi phase level coded). A summary of the main technical data is shown in table 3.

**Attitude Control System** The attitude control system is shown in the ACS-group in figure 4. The magnetorquers are used for the reduction of the angular momentum of the satellite. The reaction wheels RW202, developed by the TUB, have an integrated wheel drive electronic (WDE) with a micro controller to provide operation modes such as current control, wheel speed control and torque control. Furthermore one fibre optic gyro  $\mu$ FORS - 6, built by Lites, is connected to the WDE of one reaction wheel via serial communication interface and both are mounted in one body axis of the satellite. The micro controller of the WDE receives the angular velocity from the gyro four times per second and calculates an accumulated angle. This wheel/gyro-unit ACS202 (see figure 5) provides operation modes which control the angular velocity or the angle in one axis of the satellite. With three of them in each body axis of the satellite the spacecraft is three axis stabilized. The highly integrated wheel/gyro-unit was designed especially for microsattellites with requirements in the field of low power consumption (wheel: 1 W steady state, gyro: 2 W), low mass (wheel: <1 kg, gyro: 0.15 kg), small volume (wheel:  $80 \times 80 \times 70 \text{ mm}^3$ , gyro:  $100 \times 65 \times 20 \text{ mm}^3$ ) and simple interfaces (electrical: 5 V & 12 V, data: 8 N 1). The operation modes and the main data of the performance are shown in table 2.

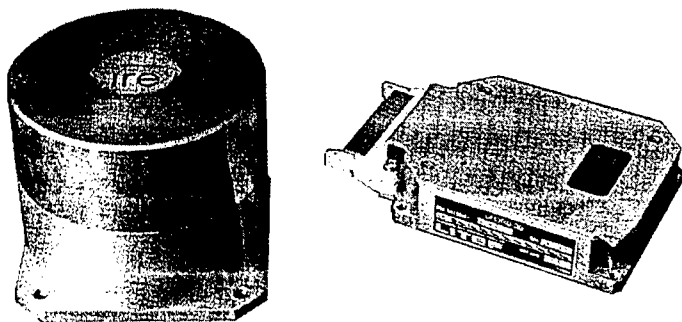


Figure 5: Wheel/Gyro-Unit ACS202

Operation modes
Current control
Speed control
Torque control
Angular velocity control
Angle control
Performance
$M = 0.02 \text{ Nm (max.)}$
$H = 0.24 \text{ Nms (max.)}$
Bias drift ( $1 \sigma$ ): $< 6^\circ / \sqrt{h}$
Noise ( $1 \sigma$ ): $< 0.6^\circ / \sqrt{h}$

Table 2: Wheel/Gyro-Unit ACS202

Mass	44.81 kg
Volume	32×32×32 cm <sup>3</sup>
Structure	4 compartments made of aluminium
Thermal control	passive
Power	4 NiH <sub>2</sub> battery cells (Eagle-Picher), 12 Ah, 10 V nominell
	4 solar panels with a single string of 34 silicon cells
Communication	VHF/ UHF-band, 1200 baud, 3.5-5 W
	S-band, 125 kbaud BPL coded or video transmission, 3.5 W
Attitude control	3 Wheel/Gyro-Units ACS 202 (TUB), magnetorquer
Payload	f= 16 mm (D= 1/0.95): Pixel resolution = 375 m
	f= 50 mm (D= 1/1.80): Pixel resolution = 120 m
	f= 1000 mm (D= 1/11.0): Pixel resolution = 6 m

**Table 3:** DLR-TUBSAT design summary

## 2.2 – Ground Segment

The ground segment of the DLR-TUBSAT Project consists of three parts and is shown in figure 6. The satellite control center (SCC) at the TUB is the main ground station which is responsible for mission control and health monitoring of DLR-TUBSAT. This is done by the transceiver unit in the VHF/UHF-band and a cross yagi-antenna. The digital pictures of the payload are received with the 1.2 m-antenna, which also not big enough to receive the analog images with a higher bandwidth of 8 MHz.

Due to this problem the cooperation with the German Remote Sensing Data Center (DFD) of DLR was necessary. The ground station is located in Neustrelitz (Germany), which is 150 km northward of Berlin, and receives the video images with a 4.3 m-antenna. A computer with a frame grabber unit digitizes the images and transmits them to a real-server. The computer in the SCC at the TUB with the real player connects the real server at Neustrelitz via internet. The digital pictures are displayed and the size is 320×240 pixels. The transfer rate depends on the utilization of the internet and local area network of the TUB and ranges from one picture per second down to zero. This causes a big problem, because the operator in the ground station needs continuous information about the pointing direction of the cameras to control the satellite via mouse.

Due to the unsteady transfer rate via internet a second cooperation with a ground station near Kiel (Germany) was initiated. This ground station receives the video images with a 6 m-antenna and is digitized with a frame grabber. The size of the digital pictures measures 384×288 pixels and the compression rate is higher. The computer in the SCC at the TUB connects the web-cam-server at Kiel via ISDN (multi link connection). The video images are displayed with a ordinary web-browser with constant transfer rate of one picture per second. The quality is good enough to identify lakes, rivers and coastlines, which is necessary for the orientation and navigation of the operator in the ground station.

## 3 – SYSTEM OPERATION

Between the events the satellite DLR-TUBSAT is in a hibernation mode with low power consumption. The attitude control system is switched off and the satellite is completely passiv and self contained. At the beginning of each pass the three reaction wheels and the three fibre optic gyros are switched on. Out of the tumbling mode, DLR-TUBSAT will

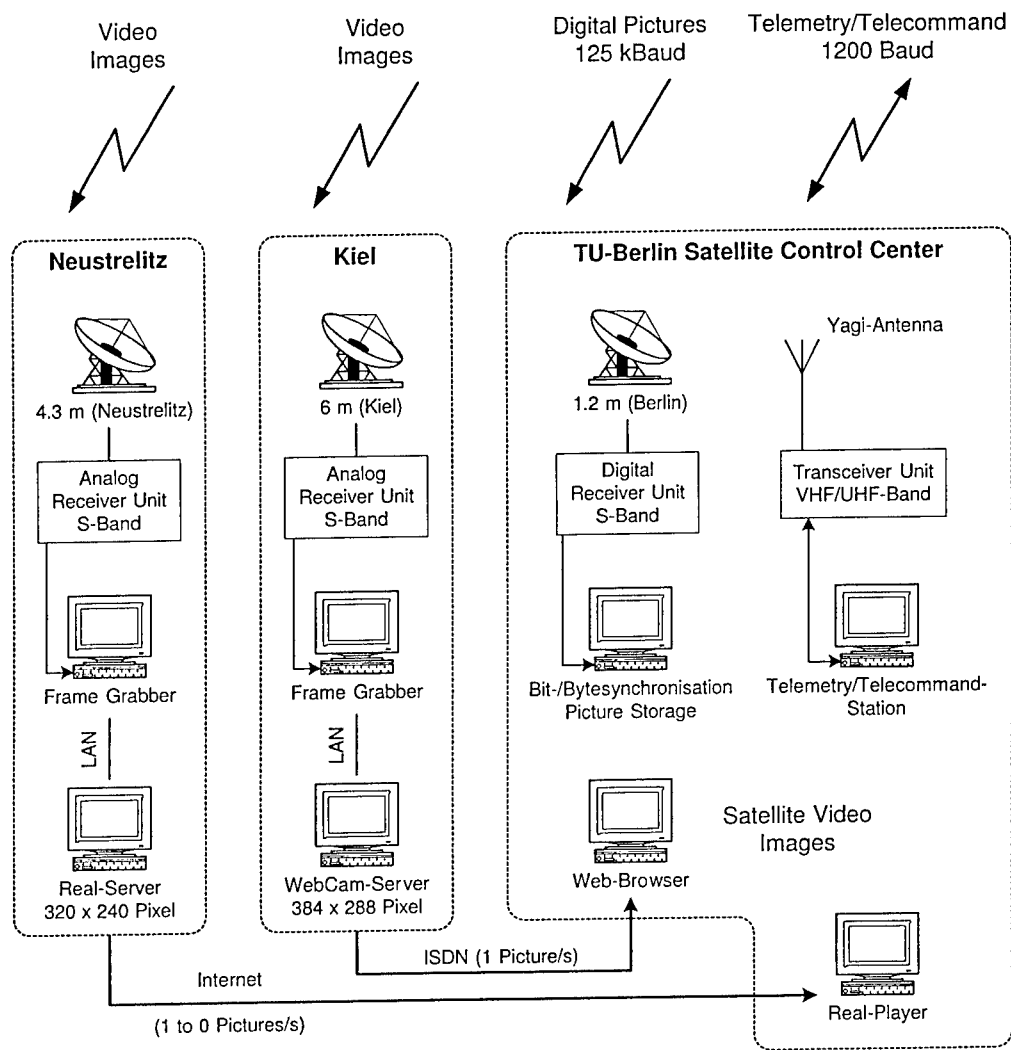


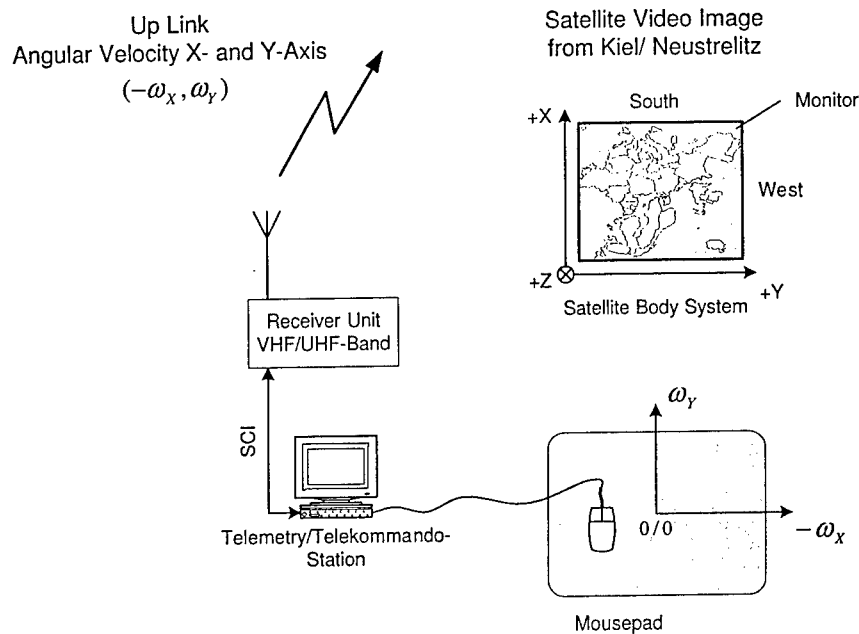
Figure 6: Ground station architecture

be stabilized by a rate reduction telecommand from the SCC at the TUB within less than 20 seconds. The next step is to point the S-band antenna to the ground station to provide the transmission of the video images for the operator. This is done by one of the two different sun acquisition maneuvers by using the information of the solar panels. Both maneuvers will be controlled on board by a program within 60 seconds. Before starting the acquisition maneuvers the camera system and the S-band transmitter for the video transmission have to be switched on.

1. -z-axis to the sun
2. +x-axis to the sun and a rotation rate  $\omega_x$  of 1 rpm

The first acquisition maneuver is used for the observation of the Mediterranean and Adriatic regions, e.g. Corsica, Sicily and Sardinia, in summer time when the sun has a high latitude.





**Figure 7:** Mouse Control Station at TUB

Due to this orbit with the descending node of 12.00 am we receive the video images automatically at the beginning of the second part of the pass, i.e. after the maximum of elevation, and the pointing direction of the cameras is nadir. This attitude is very useful for the operator, because he is able to determine the area where the satellite crosses the coastline or other areas of interest.

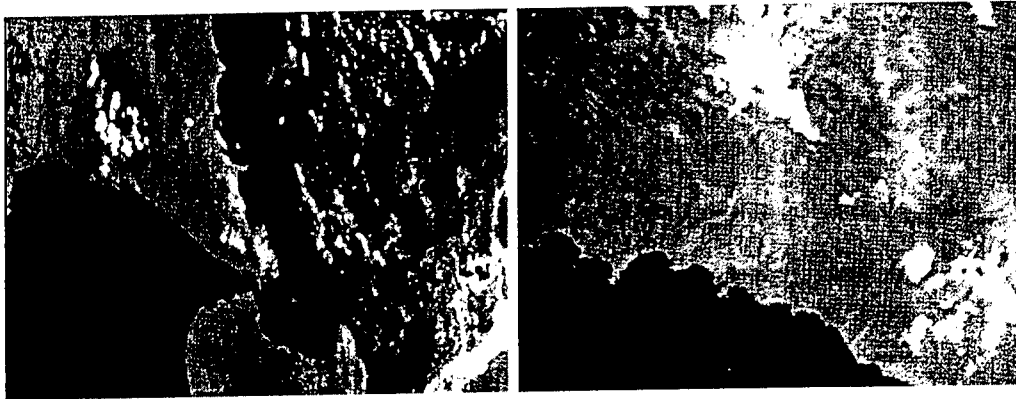
The second acquisition maneuver orientates the +x-axis to the sun. Because the camera system is not in the same axis, the satellite rotates with 1 rpm around the x-axis. When the S-band ground station is in the access area, the operator receives video images from east to west horizon of the earth every minute. Now he needs to stop the rotation of the satellite in the right moment. The final pointing direction of the camera system depends on the operator and has low accuracy.

At the time the operator in the SCC at the TUB receives the video images from Kiel he starts the mouse control mode. The orientation of the video images after the maneuver is shown in figure 7 where the top of the monitor is the southern direction. If not the operator needs to correct the attitude with an angle maneuver in the z-axis before starting the mouse control mode. The computer in figure 7 commands angular velocities for the x- and y-axis in subject to the position of the mouse every second. The axes of the mouse pad refer to the body axis of the satellite, i.e. moving the mouse to the top of the pad results in a rotation of the satellite to the south. The ground operator starts with the fore field sensor with medium resolution to find the target area. To follow and track the target he can switch to the high resolution camera every time. At the end of the pass the attitude control system and other subsystems will be switched off and the satellite returns into its hibernation mode, a passive tumbling mode with low power consumption, to recharge the batteries and to wait for the next event. This microsatellite has a very low duty cycle and is waiting most of his life but has to be operable very quickly.

#### 4 – FLIGHT RESULTS AND LESSONS LEARNED

The biggest problem we have is the weather condition in Germany. We have a lot pictures and video streams of the southern part of Europe, but only a very few of the northern part. Normally we do our sun acquisition maneuver and get an S-band down link, but see only clouds on the monitor. In this case we stabilize the satellite and wait until it comes to the Mediterranean or Adriatic region. Most of the time we have no clouds here and the coastline is suitable to determine the pointing direction of the camera system (see figure 9). One of our main tasks was to follow the coastline with the fore field sensor with medium resolution to Italy to make a maneuver to the island Corsica or Sardinia. Afterwards we switched to the high resolution sensor to observe harbours and so on.

After reaching the target area we took a lot of digital pictures with medium resolution (50 mm-camera). We stored the pictures on board or transmitted them immediately via S-band link to the SCC (Satellite Control Center) at the TUB. Two of them are shown in figure 8 and 9. Both were taken after a +z-axis sun acquisition maneuver, where the orientation of the picture is random. The left one shows southern Italy und Sicily with the volcano Etna (top left part) and the other one the coastline of southern France. Due to the fix aperture and the minimum exposure time of only 0.1 ms the bright clouds produce vertical white stripes in the pictures.



**Figure 8:** Southern Italy, Sicily and Vulcan Etna (50 mm-camera) **Figure 9:** Coastline of southern France (50 mm-camera)

**General performance** DLR-TUBSAT is functioning well. The temperatures are very stable between -8 and +4 ° C. The NiH<sub>2</sub>-battery cells are in good condition, although we do not use a charge regulator. The VHF/UHF-link for telemetry and telecommand is working well except in the southern regions of Europe, specially southern Italy and Spain. The down link in the S-band for transmitting the digital pictures is functioning very well. Due to the fact that the main part of the operation software of each device is stored in the ROM we have not had single event upsets.

**Attitude control system** The three wheel/gyro-units are functioning well after one year of operation time. Next time we would additionally use a star sensor for the acquisition maneuver to make it faster and more exact. Due to the higher bias drift of the fibre optic gyros the star sensor would be useful in situations in which the satellite needs to be stabilized

for a longer period of time e.g. if the operator has no orientation because of bad weather conditions.

## 5 – CONCLUSION

The microsatellite DLR-TUBSAT is a test satellite for interactive earth observation and is functioning well. We have had a lot of impressive passes, because it is very special to control a satellite in this way. From our point of view it is a very interesting mission and differs from all other existing earth observation projects.

The next satellite will have a star sensor in addition to the information from the solar panels, such as in the project MAROC-TUBSAT, a cooperation between TUB and the Royal Remote Sensing Centre in Rabat. This microsatellite has a star sensor orthogonal to the camera, which has a ground resolution of 320 m. At the moment the satellite is in Moscow and it will be launched with a Russian rocket Zenith at the end of September.

Furthermore the payload of the next satellite consists of only two color cameras, one with a focal length in the range of 50 mm and the other with a range of 1000 mm. A camera with lower resolution is not necessary because the acquisition maneuver has a higher accuracy. Both telescopes will have a bigger aperture in the range of 1/11 due to the very bright clouds. Because of the problems which occurred in the VHF/UHF-band the system for telemetry and telecommand and the video transmission of the next satellite will work in the S-band.

## References

- [1] Indian Space Research Organisation Headquarters. *PSLV-C2*. Brochure, 1999.
- [2] Mostert, Sias; Cronje, Thys; du Plessis, Francois. *The SUNSAT Micro Satellite Program*. 4th International Symposium, 1998.
- [3] Renner, Udo. *Earth Observation with TUBSAT-C*. 4th International Symposium, 1998.
- [4] Butz, Pius. *TUBSAT-C, A Microsat-Bus for Earth Observation Payloads*. 3th International Symposium, 1996.
- [5] N.N. *IKONOS*. <http://www.spaceimaging.com/carterra/geo/overview.htm>, 11.4.2000.

## MINISAT-01: THREE YEARS OF SCIENTIFIC OPERATIONS

**Antonio TALAVERA and Jesús GARCÍA**

*Laboratorio de Astrofísica Espacial y Física Fundamental  
INTA, P.O. Box 50727, E-28080 Madrid, Spain  
(ati@laeff.esa.es and jess@laeff.esa.es)*

**Carlos QUINTANA**

*División de Ciencias del Espacio  
INTA, Ctra. Ajalvir km 4, E-28850, Torrejón de Ardoz, Spain  
(quintana@laeff.esa.es)*

*ABSTRACT - Minisat-01 was launched on April 21, 1997. This satellite carries two astronomical instruments, EURD, a spectrograph for the study of far ultraviolet diffuse radiation and LEGRI, a gamma ray imager in the 20-100 Kev range. A micro-gravity experiment, CPLM to measure the behaviour of liquid bridges completes the payload.*

*We present a summary of the satellite lifetime centred in the payload instruments: operational characteristics, operation mode, constraints, commanding and telemetry,... We describe briefly the principal tasks carried out at the Science Operations Centre. We give statistics on the usage of the satellite during its three years in orbit. The scientific highlights produced with the data obtained with the principal instruments, EURD and LEGRI, are also presented.*

### 1 - INTRODUCTION

The aim of the Spanish MINISAT programme was to develop a multipurpose space platform in the so-called mini-satellites range (100-500 Kg). This programme was managed by the Instituto Nacional de Técnica Aeroespacial (INTA) with the participation of the Spanish space industry and under the auspices of the National Committee for Science and Technology (CICYT). It was envisaged to develop and build satellites for scientific applications, earth observation and communications. The first one of these satellites, Minisat-01, was launched on April 21, 1997, for a minimum expected life of two years. It carried a scientific payload which is still being operated with success after three years in orbit. A functional description of the system can be found in [Cerezo, 1998] and [Cerezo, 2000]. We shall describe in the following sections the main characteristics of the mission from an operational point of view. We shall summarise the operations of the payload and explain the different tasks involved in the daily life of Minisat-01. We shall present some statistics and highlight the scientific results obtained with the on-board instruments.

### 2 - MINISAT-01 PAYLOAD

As in most scientific satellites, in Minisat-01 we can distinguish between the service module and the payload. The former provides support to the later in terms of power, attitude control, command and data handling, etc. In this paper we shall restrict ourselves to the description of the payload and mainly to the operation of its instruments.

The Minisat-01 payload is formed by two main astronomical instruments, EURD, a spectrograph for the study of extreme ultraviolet diffuse radiation and LEGRI, a gamma ray imager in the 20-100 Kev range. A micro-gravity experiment, CPLM to measure the behaviour of liquid bridges completes the payload.

EURD was developed and built by a consortium composed by astronomers and engineers from the University of California at Berkeley and from INTA in Spain. The instrument is described in detail in [Bowyer et al, 1997]. It consists basically of two spectrographs, the long wavelength one (L) and the short wavelength one (S). They cover together the spectral range between 350 and 1100 Å, with 5 Å spectral resolution. Their apertures look in the anti-Sun direction and cover an area of 8 x 25 square degrees in the sky. The whole ecliptic plane is observed along the year and in this way the diffuse emission from the interstellar medium can be mapped. EURD pointing at a given time is fixed, however the orientation of its apertures can be changed by rotating the whole spacecraft around the Z-axis. This is one of the main operational constraints of Minisat-01.

LEGRI is a small telescope which uses the coded mask technology to produce gamma ray images. Its purpose was mainly technological, since it aimed at testing solid state detectors for high energy astrophysics, in particular mercury iodide (HgI<sub>2</sub>) and cadmium-zinc telluride (CdZnTe) crystals. Its optical axis is perpendicular to that of EURD (satellite -X-axis) and it can be pointed by rotating the satellite around its Z-axis. At a given time LEGRI is able to point in a major circle perpendicular to the ecliptic. The whole sky is therefore accessible in six months. LEGRI includes a Star Sensor pointing in the same direction of the gamma ray telescope. Its purpose is to improve the attitude reconstruction provided by the control system through identification of stars in the line of sight. For a detailed description of the instrument see [Reglero et al, 1997] and [Robert et al, 1997]. LEGRI is a collaboration between the University of Valencia, CIEMAT and INTA in Madrid and several British groups belonging to the Universities of Birmingham and Southampton and Rutherford Appleton Lab.

CPLM was built by the School of Aeronautics Engineering in Madrid. Its purpose was to study the shape of a pressurised deployable liquid column under the effect of accelerations produced by the spinning of the satellite. See [Sanz-Andrés et al, 2000] for a detailed description.

The three instruments are integrated in a common platform developed by INTA which provides all interfaces with the service module of the satellite.

These groups, which participated in the development of the different instruments forming the payload of Minisat-01, constitute the scientific teams which after launch receive and exploit the data produced by the mission.

### 3 - OPERATING MINISAT-01

The Ground Segment of the Minisat-01 mission (see Fig. 1) is composed of:

- the tracking station (ROT) which is located in Maspalomas, Canary Islands (Spain)
- the Mission Control Centre (MCC), located at the INTA premises near Madrid
- the Science Operations Centre (COC), located at INTA's Laboratory for Space Astrophysics (LAEFF) also near Madrid
- the end users, or Scientific Teams outlined before

The satellite has a low earth orbit with 151 degrees of inclination (retrograde orbit). This imposes one of the main operational restrictions, since the only tracking station has visibility of the

spacecraft only during a few consecutive orbits every day. Only such orbits with an elevation greater than 20 degrees can be used and therefore there are only five useful passes per day, with a duration of about ten minutes each. Real time operations are limited to monitoring satellite status of health, downlinking stored data (both scientific and engineering), and sending time tagged commands for next period of time. Some spacecraft configuration commands are executed occasionally in real time during the passes. Payload operations are pre-planned and the corresponding commanding sequences are sent to the on board computer where they are stored, normally two days in advance.

Daily standard uplink-downlink operations are executed in the first four passes and the last one is left for contingency. The payload instruments do not work during passes due mainly to power restrictions and also to the need for manoeuvring the spacecraft so that its antennas have a suitable aspect angle with respect to the ground station.

The operations of Minisat-01 can be classified in the following areas:

- planning and command preparation
- operation of the instruments
- uplink commands and collect telemetry data
- data processing and distribution
- instrument monitoring

The whole operation is illustrated in Fig. 1, and the operational characteristics of the satellite are summarised in Table 1.

Table 1. Operational Characteristics of Minisat-01

Satellite in LEO	Altitude = 590 km Inclination = 151 deg Period = 96 min
Pointing	Z-axis towards anti-Sun Manoeuvres around Z axis (yaw)
Ground contacts	5 passes/day (elevation $\geq$ 20 deg)
Telemetry	High speed = 1 Mbit/sec Low speed = 8 kbit/sec
Payload	EURD (pointing +Z) LEGRI (pointing -X) CPLM (rotation in yaw)

Standard operations and commands for configuring and running the instruments are defined by the Scientific Teams of EURD, LEGRI and CPLM. They receive the data produced daily by their respective instruments as well as some satellite engineering data (temperatures, power data, attitude) necessary for the correct interpretation of science data and for instrument monitoring

The MCC (heart of the Ground Segment) generates orbital predictions valid for a given period of time. From this information the COC makes the operation plan by allocating operation windows for the instruments, normally on a weekly basis. This schedule is delivered to the MCC together with command uplink procedures and properly formatted command files. The MCC prepares the SAWS

and SADS ---Spacecraft Activities Weekly and Daily Schedules--- taking into consideration any operation required by the Service Module. The MCC prepares also the procedures for pass operations and commands uplink which are sent to the ROT. Finally the ROT will send a command sequence to the in-flight spacecraft.

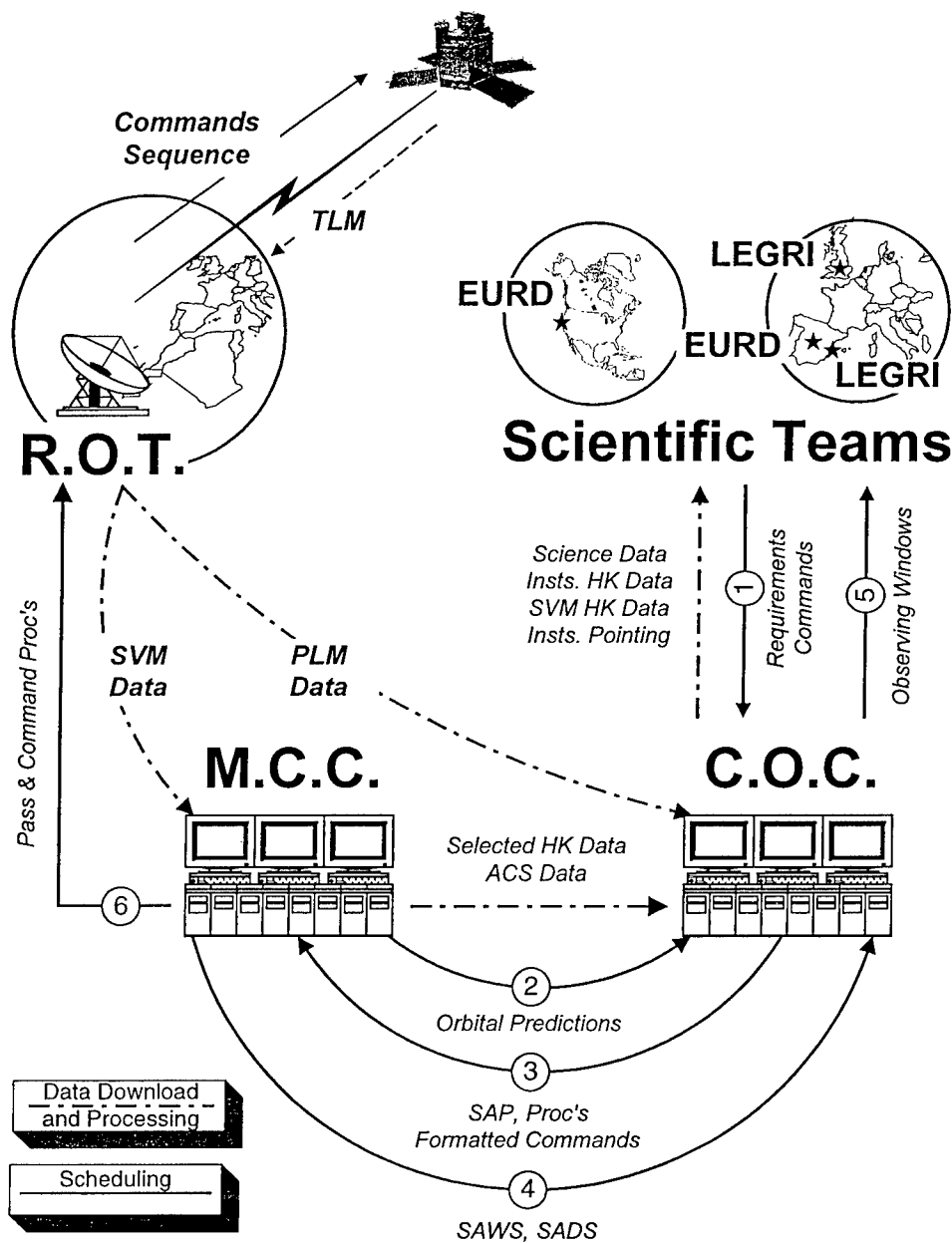


Fig. 1: Operational description of the Minisat-01 Mission.

The spacecraft telemetry is collected daily by the ROT. Data in the on board mass memory storage (about 22 Mbytes) is packed into frames which are sent to the ground station several times to provide redundancy and error recovery. Telemetry is composed by the Service Module data, which are sent to the MCC, and Payload Module data which are delivered directly to the COC. The COC receives selected housekeeping data from the MCC as well as attitude reconstruction. The COC processes all these data, checks consistency and status of the instruments and finally distributes the relevant data to each of the Scientific Teams.

### 3.1- Orbital constraints

In addition to the ground contacts, the operation of the payload instruments of Minisat-01 is constrained mainly by two orbital events:

- the orbital night, or shadow period
- the South Atlantic Anomaly (SAA)

The orbital events are illustrated in Fig. 2. The first event, also known as eclipse period, determines when the instruments are operated. EURD must operate only during the eclipse to avoid reflected UV light from the earth entering its detectors. The observation with EURD will therefore start when the satellite enters the penumbra and it will finish when it exits penumbra. In practice EURD is operated from a few minutes prior to the start of the eclipse till a few minutes after it. In this way the instrument can collect data with a larger aspect angle and thus a longer atmospheric column to study emission from earth airglow at high altitude. LEGRI can be operated in any part of the orbit, but normally it will only observe during the illuminated portion or orbital day. Due to limitations in the attitude control system, CPLM is used only in the day part of the orbit.

The South Atlantic Anomaly limits also the operation of the instruments when the satellite is going through this region in which electrically charged particles are trapped by the earth magnetic field. These particles can damage the sensitive instrument detectors and because of this the payload is put in standby mode during passage through the SAA.

Orbit housekeeping allows the MCC to predict the occurrence of these events quite accurately. These orbital predictions are the basis for the efficient planning of the operations. Shadow periods and ground contacts depend only on the orbit. Predicting the passage through the SAA requires a previous knowledge of its extent and intensity at the altitude of the orbit. For Minisat-01 we have taken a pentagon shape with corners located at geographic [longitud-latitude] (in degrees): [-90, -30], [-90, -15], [-60,0], [-15,0] and [40, -30]. This is based in measurements taken by the German satellite ROSAT [Snowden, 1997]. The restricted area is shown in Fig 2, where we can see how some orbits may be affected by the SAA.

Precession of the orbit will produce in some occasions an overlap of the described orbital events. The operation windows for each of the instruments are therefore defined as:

**EURD window:** no-contact + shadow + no-SAA  
**LEGRI window:** no-contact + no-shadow + no-SAA  
**CPLM window:** no-contact + no-shadow + no-SAA

Scheduling software developed at the COC will handle the orbital predictions and compute these windows for each instruments. LEGRI windows are constrained as well by the presence of the earth in the line of sight of the instrument (-X-axis). This is also taken into account by the scheduling software.



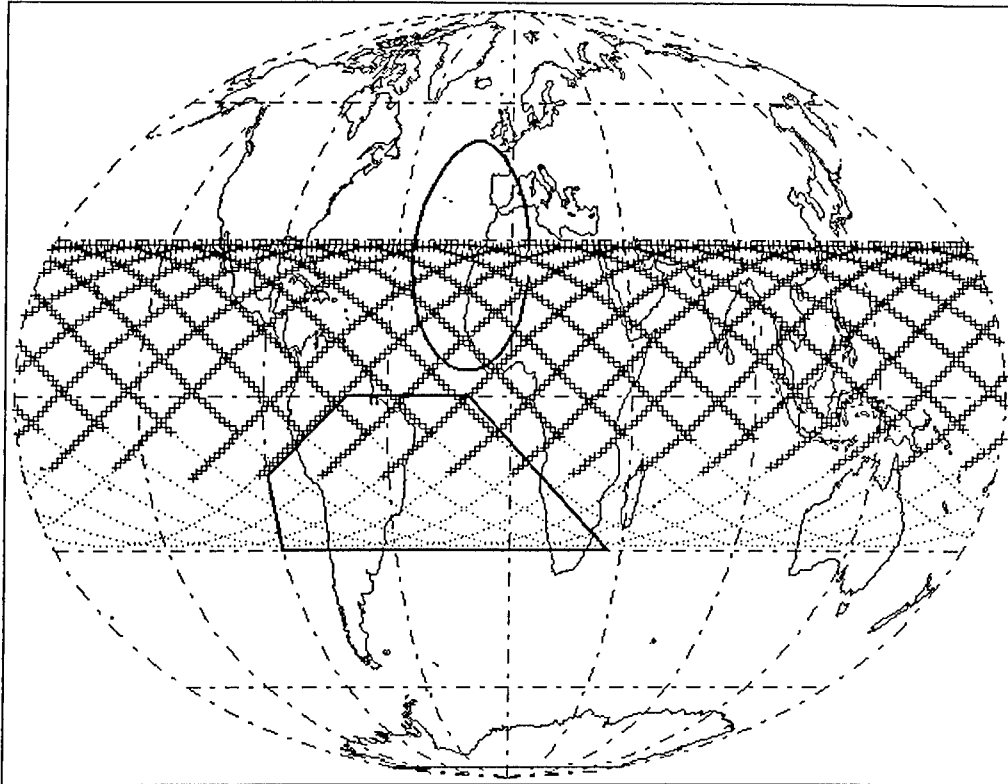


Fig. 2: The orbit of Minisat-01. The orbit path for a typical day is presented. In each orbit, the orbital day is represented with crosses and the shadow period with dots. The pentagon shape delimits the South Atlantic Anomaly avoidance region used in mission planning. The coverage area of the ground station, located in the Canary Islands is represented with a circle.

#### 4 - OPERATIONAL STATISTICS

The first months of the mission were devoted, after all spacecraft subsystems were checked out, to adjust the operational configuration of the instruments and to perform the first calibrations. Their sensitivity to the SAA was also determined and its final extent was adjusted by varying the time elapsed after entering the predefined avoidance region or prior to exiting this region. Nominal operations started on September 1 and September 2, 1997, for LEGRI and EURD respectively. Table 2 gives a summary of the observing time used by both instruments during their nominal life till March 31, 2000.

Observing mode is reached by LEGRI and EURD almost immediately after receiving the corresponding command. Only EURD needs some overhead time to transfer housekeeping data to the on board computer mass memory storage. There is in addition some more overhead time due to the fact that short operation windows are not used for observing. Thus, we define in Table 3 an average orbit usage. The so-called useless time includes the mentioned overheads, the averaged pass over the SAA and the portion of LEGRI windows which cannot be used due to the occultation of the target by the earth. Contact time is obtained by averaging the effective contact time in the five passes per day and the configuration time needed before and after the pass. We do not consider CPLM instrument, since the only operation carried out with it during the nominal life of the main

instruments is a weekly supervision of its internal pressure and temperature which only takes a few seconds.

Table 2. Nominal operations of LEGRI and EURD (31 months)

Total observing time at 31/March/2000		
LEGRI		4721.1 hours
EURD (L)		5331.1
EURD (S)		5317.8
Number of observing windows		Mean duration
LEGRI	10284	27.5 min
EURD	11300	28.3

From Table 3 we derive an orbital efficiency, the time which can be used for operation of the scientific instruments, of 58 %, averaged over their nominal life. We should point out that the efficiency along all the operational time has been maintained around this value.

During the life of Minisat-01 there have been different events which have produced a loss of operation time. The main cause of time loss has been the occurrence of on board computer resets due probably to electrostatic phenomena and possibly cosmic ray impacts. These resets became very frequent after two years in orbit and therefore it was decided to switch off the primary computer CPU and pass control to the secondary unit. This one proved to be very efficient, since only one reset has been experienced in the last 10 months. Other sources of time loss have been operational problems related to ground hardware failures and also operation errors.

The instruments themselves have experienced also occasional failures. Although it cannot be considered as a failure, some time has been lost by both EURD and LEGRI due to filling of the allocated storage memory. This occurred in EURD when hot bright stars fell into the instrument field of view. Memory overrun in LEGRI occurs when the SAA observing restriction is overridden to study the detector background radiation decay, and the instrument is left in observing mode over the SAA during several consecutive orbits.

Table 3. Minisat-01 average orbit usage

Orbital Period	96 min
LEGRI window	27.5
EURD window	31.3
Contact with ground station	14.0
Useless time	23.2

The operation of Minisat-01, from 1 September 1997 till 31 March 2000, has provided 14130 orbits. Different incidents occurred in the satellite and ground system, as we mentioned before, have produced the loss of 2016 orbits. Considering the defined orbital efficiency, we have had a total of 11266 hours of effective useful time for operation. The total observing time of EURD and LEGRI has been 10052.2 hours. Thus, we find that the overall efficiency in the use of Minisat-01 has been nearly 90 %.

## 5 - SCIENTIFIC RESULTS

In this section we shall describe briefly the results obtained by the two main instruments on board Minisat-01. The reader is referred to the relevant bibliography for a detailed description.

### 5.1 - EURD

The main scientific objective of EURD was to study the diffuse radiation produced by the local interstellar medium in the extreme ultraviolet. Current models predict the existence of some kind of Local Bubble filled with very hot and diffuse gas ( $T=10^6$  K y  $n=0.01$  cm<sup>-3</sup>). It would emit lines whose intensity depends of the physical parameters of the model, in particular the temperature. Observations with EURD, one of the most sensitive instruments in this range, with sufficient signal to noise ratio could disentangle between the different proposed models. Data collected till now indicate that the standard high temperature model is not applicable. In addition they impose severe restrictions for the development of new models. See [Edelstein et al, 2000].

Another by-side result obtained is related to the neutrinos. A model developed by Prof. Sciama [Sciama, 1998, and references therein] predicts an emission line in the range covered by EURD, produced by the radiative disintegration of massive neutrinos. The detection sensitivity reached by EURD after two years of operation ruled out the theory, since the line was not observed [Bowyer et al, 1999].

As we have already pointed out, hot stars within the field of view of EURD are detected, and their spectrum in the far UV can therefore be obtained. This is very interesting since there are very few instruments capable of observing in this wavelength range. EURD has obtained the spectra of 13 stars, some of them never observed before. Observations of stars performed with the Voyager spacecraft have confirmed the flux calibration of EURD. [Morales et al, 2000a] and [Morales et al, 2000b].

Last but not least, using EURD before and after the shadow period has permitted to register the emission produced in the high earth atmosphere above Minisat-01 orbit, due to sun illumination. The airglow spectrum obtained in the EURD range (350-1100 Å) is of unprecedented quality due to the high sensitivity and resolution of this instrument, 100 and 1000 times better respectively than with previous experiments [López-Moreno et al, 1998].

### 5.2 - LEGRI

As pointed out in Section 2, the purpose of LEGRI was twofold: to test the behaviour of solid state detectors (MgI<sub>2</sub> and CdZnTe) and to exercise the technique of coded mask imaging in gamma ray astronomy. Both objectives are highly interesting because of their application in future space astronomy missions in that domain. Moreover, the LEGRI Scientific Team is involved in such missions as INTEGRAL.

The data obtained up to now with this instrument have shown that mercury iodide (MgI<sub>2</sub>) detectors are very unstable and present a high intrinsic noise level: they are not suitable for astronomy from space. On the contrary, cadmium-zinc telluride present characteristics which make them very interesting for their use in space missions. The background noise produced by the isotopes formation and decay, produced by interaction of cosmic rays with the materials forming the satellite itself, has been studied in detail. Current models predict a different behaviour in different time scales. The large amount of data collected with LEGRI, confirms these predictions in noise level and, what is

more important, shows a great stability at medium and long term. These results are important for missions as INTEGRAL which will use this type of detectors. The behaviour of CdZnTe crystals has been studied also under high background conditions, as those present in the South Atlantic Anomaly. The results obtained in this case do not correspond with model predictions.

On the scientific aspect, the results are scarce. The failure of MgI2 detectors left LEGRI with only three useful columns on the detector plane (originally 10x10 crystals), and this fact makes almost impossible the utilisation of the coded mask technique, since de-convolution algorithms are very sensitive to noise. In other words, instrument sensitivity is very low. However, strong gamma ray sources as the Crab Nebula and other sources in the Galactic Centre have been detected.

More information about LEGRI results can be found in [Sánchez et al, 1999], [Porras et al, 2000], [Blai et al, 2000], [Suso et al, 2000].

## 6 - CONCLUSIONS AND FUTURE

Minisat-01 was designed to have a minimum nominal life of two years. This was one of the requirements of the EURD instrument to achieve a reasonable signal to noise level in the detection of the emission from the interstellar medium. Minisat-01 has entered its fourth year of successful operation. We have described some of the very interesting results obtained with its instruments. The satellite continues gathering very useful data, in particular for EURD. Also from an operational and engineering point of view, not discussed here, the project has provided the different teams involved in it a magnificent tool for learning and developing skills in the field of spacecraft operations.

In the next months we shall continue working with Minisat-01. We will try to reach new, challenging objectives. We have worked till now in a standard way, well within the restrictions of the system. Now we shall attempt to go to the real limits or even beyond them. For instance, there are regions in the local interstellar medium and hot stars which are up to 30 degrees out of the ecliptic. Observing them with EURD would be extremely interesting, but this requires to override the principal constraint of the attitude control system, Z-axis in the ecliptic plane. Deviations of as much as 10 degrees, included in the original specifications, have been tested. But this is not enough, and we shall try to go farther .....

## REFERENCES

- [Blai et al, 2000] P. Blai et al., "LEGRI Science Operations Centre. Architecture and operations", *Proc. Science with Minisat-01*, Madrid, 1999, Astrophysics and Space Science, in press, (2000)
- [Bowyer et al, 1997] S. Bowyer, J. Edelman, M. Lampton, "Very High Sensitive Extreme Ultraviolet Spectrometer for Diffuse Radiation", *Ap.J.*, 485, 523 (1997)
- [Bowyer et al, 1999] S. Bowyer, E. Korpela, J. Edelman, M. Lampton, C. Morales, J. Pérez-Mercader, J. Gómez, J. Trapero, "Evidence Against the Sciamia Model of Radiative Decay of Massive Neutrinos", *Ap.J.* 526,10 (1999)
- [Cerezo, 1998] F. Cerezo, "Minisat-01 (One Year After)", *Proc. 4<sup>th</sup> Symposium on Small Satellites, Systems and Services*, Antibes (France) 1998, Ed. CNES (1998)
- [Cerezo, 2000] F. Cerezo, "Performances of Minisat-01 platform subsystems", *Proc. Science with Minisat-01*, Madrid, 1999, Astrophysics and Space Science, in press, (2000)
- [Edelman et al, 2000] J. Edelman, S. Bowyer, E. Korpela, M. Lampton, J. Trapero, J.F. Gómez, C. Morales, V. Orozco, "EURD: Observations of Interstellar

- Radiation”, *Science with MINISAT-01*, Madrid, 1999, Astrophysics and Space Science, in press (2000)
- [Morales et al, 2000a] C. Morales, J. Trapero, J.F. Gómez, A. Giménez, V. Orozco, S. Bowyer, J. Edelstein, E. Korpela, M Lampton, J. Cobb, “Far Ultraviolet Absolute Flux of  $\alpha$ Virginis”, *Ap.J.* 530, 403 (2000)
- [Morales et al, 2000b] C. Morales, J. Trapero, J.F. Gómez, V. Orozco, A. Giménez, S. Bowyer, J. Edelstein, E. Korpela, M Lampton, J. Cobb, “EURD: The Experiment and the Stellar Absolute Fluxes”, *Science with MINISAT-01*, Madrid, 1999, Astrophysics and Space Science, in press (2000)
- [López-Moreno et al, 1998] J.J. López-Moreno, C. Morales, J.F. Gómez, J. Trapero, S. Bowyer, J. Edelstein, M. Lampton, E. Korpela, “EURD observations of EUV nighttime airglow lines”, *Geophysical Research Letters*, 25, 2937-2940 (1998)
- [Porras et al, 2000] E. Porras et al., 2000, “Comparison between theoretical predictions and LEGRI background experimental measurements”, *Proc. Science with Minisat-01*, Madrid, 1999, Astrophysics and Space Science, in press (2000)
- [Reglero et al, 1997] V. Reglero et al, “Low Energy Gamma Ray Imager on Minisat-01”, *Second INTEGRAL Workshop, The Transparent Universe*, St. Malo (France), ESA-SP382, p. 343 (1996)
- [Robert et al, 1997] A. Robert et al, “LEGRI Science Operation Centre and Scientific Program”, *Second INTEGRAL Workshop, The Transparent Universe*, St. Malo (France), ESA-SP382, p. 349 (1996)
- [Sánchez et al, 1999] F. Sánchez et al., “Background in low Earth orbits measured by LEGRI telescope - short and long term variability”, *NIM-B*, 155, 160 (1999)
- [Sanz-Andrés et al, 2000] A. Sanz-Andrés, P. Rodríguez de Francisco, J. Santiago Prowald, “The Experiment CPLM On Board Minisat-01”, *Proc. Science with Minisat-01*, Astrophysics and Space Science, in press, (2000)
- [Sciama, 1998] D. Sciama, “Updated parameters for the decaying neutrino theory and EURD observations of the diffuse UV background”, *Astr. & Astrophys.* 335, 12 (1998)
- [Snowden, 1997] S. Snowden, [http://legacy.gsfc.nasa.gov/Images/rosat/misc\\_saad.html](http://legacy.gsfc.nasa.gov/Images/rosat/misc_saad.html) (1997)
- [Suso et al, 2000] J. Suso et al., 2000, “LEGRI instrument health. A historical review”, *Proc. Science with Minisat-01*, Astrophysics and Space Science, Madrid, 1999, in press, (2000)

New 1.4

## SUNSAT 1 — ORBITAL RESULTS AND UPGRADES FOR 4M MULTI-BAND IMAGING IN SUNSAT-2

Sias Mostert, Garth W. Milne, JJ du Plessis, A Schoonwinkel.

Sun Space & Information Systems Pty Ltd and  
Department of Electrical and Electronic Engineering,  
University of Stellenbosch,

Private Bag X1, 7602 Matieland, South Africa.  
Phone: +27 21 8084936, Fax: +27 21 8084981

Sunsat project website: [sunsat.ee.sun.ac.za](http://sunsat.ee.sun.ac.za)

[mostert@ing.sun.ac.za](mailto:mostert@ing.sun.ac.za), [milne@ing.sun.ac.za](mailto:milne@ing.sun.ac.za) <http://sunsat.ee.sun.ac.za>

**ABSTRACT** - SUNSAT, SO-35, from the University of Stellenbosch in South Africa, has been operating in orbit since February 1999. Experimental payloads of a NASA GPS receiver for occultation research, laser reflectors, magnetometers, star cameras, an Amateur Radio communication suite, and a 15-m resolution, 3456 pixel, 3-band, stereo-capable push broom imager are working satisfactorily. Most research objectives have been met. Proposals and status of Sunsat-2 developments are given.

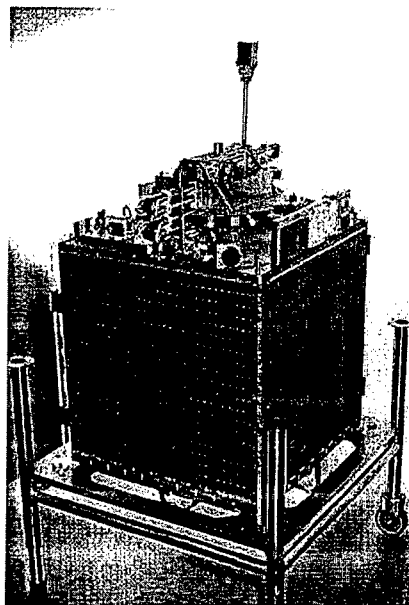
### 1 INTRODUCTION

The SUNSAT programme was started at the University of Stellenbosch in South Africa to provide a focus for creative energy in the Electric and Electronic Engineering Department, and with the expectation that a self-funding satellite activity would grow at the southern tip of Africa.

#### 1.1 - Sunsat 1

The first project, SUNSAT-1, was a micro-satellite project that fitted in with the authors' university goals of:

- Adding a multi-disciplinary engineering research opportunity to the graduate portfolio.
- Stimulating significant international interaction through a challenging research initiative.
- Helping stimulate interest of the youth in science and technology through media exposure schools programs, and Amateur Radio cooperation.



Sunsat 1 was a significant project for a single group (Computer & Control) in the EE Department to undertake. Major South African political changes, and absence of a space-specific funding agency, resulted in a low cost satellite programme, utilising commercial components. All funding had to be obtained by the group during the development process. Probably the most significant achievement is that Sunsatsat was completed, involving over 100 graduate students, and producing over 70 degrees.

The satellite, which is arguably the most complex and high-performance student-developed professional satellite to-date, is thus a test-bed for a complete set of indigenous designs, from software kernels to imagers and microwave communications. Educational aspects of the programme are covered in previous papers.<sup>1,2</sup>

In operation since February 23 1999, Sunsatsat has completed its major technology demonstration goals of

- Amateur communication (SO-35)
- NASA GPS and laser tracking experiments
- Multi-spectral 15m GSD imaging
- Live PAL video (figure 6)

### 1.2 - Other involvements

The continual activity since 1992 has established the ESL (Electronic Systems Laboratory) at the University of Stellenbosch, which the authors lead, as the focal point of South Africa's micro-satellite activity. Since the technologies in Sunsatsat were indigenously developed they could be applied by the ESL on other satellites, such as:

- Kitsat 3 – MEIS 15m resolution imager<sup>3</sup>
- SAFIR – Magnetometer
- FEDSAT – Boom and star camera

The need to support the long term growth in research and development of satellite engineering and applications, and the number of graduated students that wished to remain active in satellites, led to formation of Sun Space & Information Systems Pty Ltd in March 2000. The authors, university, and other key players are share-holders in this venture to commercialise the technology from the Sunsatsat project.

### 1.3 - Previous papers

Previous papers have given the background of the project<sup>4, 5, 6</sup> and photographs of the development. This paper will summarise in-orbit operation since launch, and then indicate the path planned for Sunsatsat-2, with information on one potential payload, a 4-m resolution imager.

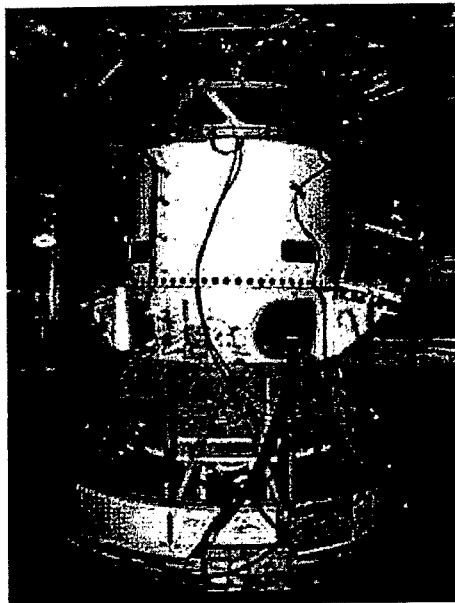


Figure 2 S band transmitted PAL TV frame of the Western Cape

## 2 SUNSAT-1 CONFIGURATION

Sunsat, while in the non-deployed configuration shown in figure 1, was mounted opposite Oersted on the Delta II as shown in figure 2. After separation, the tip mass was deployed in orbit to obtain the gravity gradient stabilised configuration in figure 3.

The satellite comprises a number of trays that are stacked on top of each other to provide a rigid structure that supports the fixed solar panels. A spin about the boom axis is induced by activation of torque coils for temperature equalisation.

The lower tray is 12cm high to contain the imager, which fits diagonally across it, and views the earth below via a 45-degree mirror. The imager mechanics can be seen in the top view of the bottom tray of the satellite (figure 4). The diagonal tube contains the optics and CCD-related electronics, and can be rotated left/right for cross-track or stereo viewing. Reaction wheels and battery packs also had to fit in the bottom tray. This situation made for very dense packaging, but was required to fit such a large imager into the 45 cm satellite dimension.

The other electronics in SUNSAT were packaged in trays for power control, telemetry, tele-command, VHF communications, UHF communications, OBC1, OBC2, RAM disk, ADCS, and top plate. The top plate visible in figure 1 carries horizon, sun, and star sensors, and also holds the deployable boom.

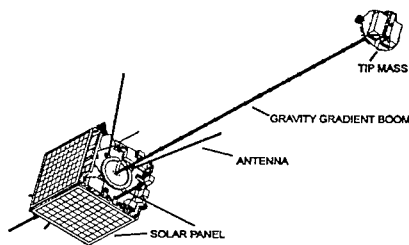


Figure 3 SUNSAT in-orbit configuration

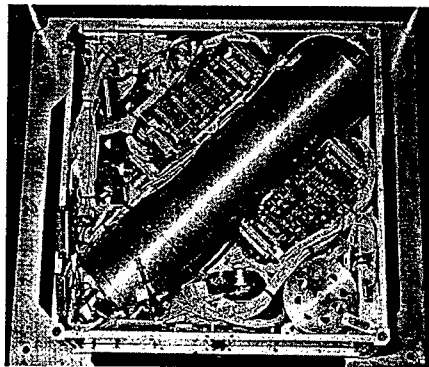


Figure 4 Imager tray

## 3 IN-ORBIT RESULTS FROM SUNSAT 1

Sunsat was launched on 23 February 1999 on the USAF Delta II ARGOS mission from Vandenberg Air Force Base. The sponsored launch was provided by NASA in exchange for carrying a Turbo-Rogue GPS receiver identical to that on the Oersted satellite which was the initial secondary payload. Oersted's requirements led to Sunsat being in a 655km x 857km, 96.4 degree orbit that drifts an hour earlier every seventy days from its initial 15:30 local time.

Sunsat's design assumed an 11:00 sun-synchronous orbit. The design was not changed for the new orbit since the goal was to evaluate Sunsat in a sun-synchronous remote sensing role. The orbital drift into the dusk-dawn position would make imaging inoperable and raise mean satellite temperature to a point that would have negative effects on NiCd life.

Since launch, Sunsat has drifted through the 12h00 condition where power became critical, and is now approaching the 100% sun condition where we have experienced 20 degree C increases in mean temperature as expected.

### 3.1 - Initial communications

Full duplex digital communication with Sunsat directly after launch was intermittent, since some satellite antennas had not then been deployed, and only Yagi ground station antennas were being used for TT&C. After boom deployment, communication became more reliable, and a slow but orderly check-out process was executed to verify that all mission critical systems were functional.



### 3.2 - Attitude establishment

Initial post-launch magnetometer and sun-sensor telemetry indicated an unexpected spin, and it appeared unlikely that the Y-Thompson state would be rapidly established. The gravity boom was deployed while the satellite was still in a moderate spin, which then abated and was damped with the magnetic controller. Figure 5 shows magnetometer trace during boom deployment.

While resetting and disabling controller modes, unwanted torquer currents were flowing, and when magnetic stabilisation was re-enabled, inverted gravity gradient lockups occurred. After mixed success at a number of attempts to invert the satellite with magnetic means, the pitch reaction wheel was used in an open-loop maneuver. This has proven to be a simple remedy for inverted lockups since the satellite erects during a single pass. Satellite inversions are now a non-event!

### 3.3 - Software commissioning and upgrading

Kernel and communications software on Sunsat had reached stability during satellite integration. The on-board process software was updated continually for nine months after launch, to a point where on Sunsat's first birthday in space, the computer up-time had reached 80 days before we reset OBC1 to upload additional software.

### 3.4 - TT&C links

UHF downlinks to Stellenbosch are hindered at times by terrestrial interference in the amateur UHF band. In spite of 10W EIRP transmitters, downlink margins were inadequate when the satellite was tumbling and Yagi antennas were used in the ground station. A 70cm helical feed with a low noise-figure pre-amplifier was added around the S-band feed on our 4.5m tracking dish, and provided greatly improved downlink reliability. During most passes excellent UHF communications from horizon to horizon is achieved.

### 3.5 - Microwave downlink

Sunsat has a 5 W S-band transmitter for television and 40Mb/s data down linking. The TV modulator and power amplifier work well. Figure 6 shows an image grabbed from this video stream. Note the tape antennas on SUNSAT protruding into the picture.

A great disappointment has been that the 40Mb/s QPSK data modem has not operated correctly in orbit, and no carrier is obtained when this is connected to the same S-band power amplifier as is used for the live TV. High-resolution image data presented later in the paper has been down-loaded at 9600 baud, a process that inspired development in image compression and narrow band bandwidth improvements.

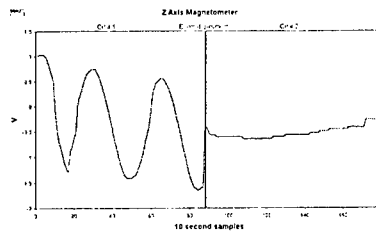


Figure 5 Magnetometer trace over boom deployment



Figure 6 Live S band transmission from PAL TV on Sunsat

### 3.6 - Pushbroom imager

The push-broom imager is operating as expected, and in early July 1999 was storing 3456 pixel by 3500 pixel images on the 64 Mbyte RAMDisk. The RAMDisk is partitioned by software to contain a

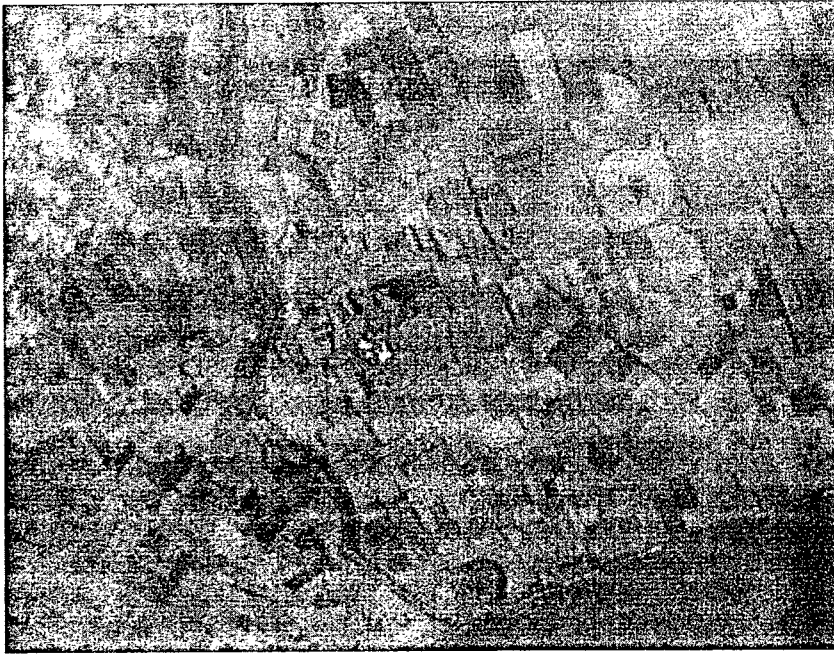


Figure 7 800 x 600 pixels from a SUNSAT image of 3456 pixel width

file system and also to store raw image data.

Figure 7 is an 800 x 600-pixel excerpt from a 3456 x 3456 pixel image taken near Hinds in New Zealand. The full color versions of these images are in the electronic version of this paper and on the web site <http://sunsat.ec.sun.ac.za>.

## 4 - HUMAN RESOURCE DEVELOPMENT

More than 100 engineers and scientists at Masters and Doctoral level participated in the SUNSAT development programme. To address the dire need for telecommunications engineers in South Africa, a special satellite communications course, combined with the engineering development of a satellite hardware and software emulation system, was initiated. In 1999 nearly 40 students received post-graduate engineering diplomas in Satellite Communications. In 2000 this programme was expanded to more than 50 trainees, and included students studying for a Master of Engineering Science degree.

### 4.1 - Facilities

The success of the SUNSAT 1 programme has led to the continued usage of the integration and environmental testing facilities established 45 minutes away from Stellenbosch at Houwteq. These facilities ensure that a logical upgrade path from micro satellite through to 500kg small satellites can be followed as part of the development programme in South Africa.

The environmental testing facilities include:

- Clean room floor-space of 2,200m<sup>2</sup> for satellite integration and test activities.
- Mechanical vibration and shock facilities supporting a static load of up to 1,363kg with a force of 160kN for random vibration over a spectrum of 320kN for shock testing.
- A Metrology facility with 3-D Measurement in a volume of 3m x 2.5m x 2.4m with a resolution of 0,005mm calibrated to NCS S2TD (RSA), WECC (Western European Calibration Community)
- A climatic testing chamber with dimensions of 1m x 1m x 1m over a temperature range of -70°C to ±150°C ±1°C at a rate of 10°C/min with a humidity control of 10% RH - 95% RH for temperature range 10°C to 90°C.
- An Electro-magnetic compatibility/interference anechoic chamber with dimensions of 11.5m x 7.5 m x 8.5 m rated to test over a frequency range of 20Hz to 18GHz for emission and 14kHz to 18GHz for susceptibility. The field strength varies from 20 - 40 V/m (14kHz - 18GHz) dependent on test object volume - 200 V/m (2GHz - 18GHz).
- Mass properties including balancing, centre of gravity and moment of inertia determination with the following properties: **Balancing:** with the smallest measurable imbalance of 14kg.mm at 30 rpm - 68 rpm and 1,4kg.mm 62 rpm - 150 rpm. **Centre of gravity:** with a minimum achievable C.O.G. Error of 0,25mm for (objects from 8kg to 2000kg) and an instrument error of 0,05%. **Moment of inertia:** with an accuracy of less than 1% (between 10kg and 4000kg)
- An acoustic vibration chamber with dimensions of 7,35m x 6,45m x 8,96m or 1,5m x 1,7m x 2,2m over a frequency range of 20Hz to 10kHz at a sound pressure level of 150dB.
- A thermal vacuum chamber with working dimensions of 3,4m diameter and 3,8m length, or a medium size chamber with a diameter of 0.7m and length of 0,9m A separately controlled thermal plate has a range of -145°C to +120°C at a rate of (Up or down) 1,5°C/min in a vacuum of 10-6mbar @ 120°C.

## 5 SUNSAT 2

After the success of SUNSAT 1, an upgrade to a 100kg enhanced micro satellite is being pursued. Research work is also in progress on improved imagers, ADCS and data handling systems.

In the last five years, our group has demonstrated its ability to participate successfully in international missions. These include carrying piggyback instruments for NASA, supplying instruments for other satellites such as Safir-2, and consultation to various organisations around the world. We expect to continue, and expand such interactions in the future.

### 5.1 - Mission studies

Following Sunsat's success and motivations from the Sunsat team, a feasibility study of funding for a second South African satellite is being co-ordinated by the National Research Foundation. The effort will focus on defining a mission goal satisfying a particular science community in South Africa, and on forming a multi-institute programme team.

## 5.2 - Satellite Engineering technology development

The satellite engineering group at Stellenbosch has base-lined the following parameters as key to the SUNSAT 2 mission. A 100kg to 120kg small remote sensing satellite, 3-axis stabilised while imaging, and compatible with ASAP 5 launch requirements. It should include an imager with less than 10m GSD (ground spacing distance), on-board processing, VHF/UHF telecommand and telemetry links, X-band transmitter for the image data, and a constellation management thruster experiment.

### 5.3 - SUNSAT-2 imager

Sunsat was densely packed to contain its many functions, and include a 15m GSD, 3-band, stereo-capable imager. The volume increase to the ASAP-5 dimensions permits significantly more imaging capability. The additional size permits larger optical apertures which provide better SNR's and MTF's, and can handle the larger sensor formats now available. Several linear CCD's are available with over 8000 pixels, and 14000 element, tri-colour sensors are available. The challenge is no longer with pixel count – it is now data rates and clocking rates.

### 5.4 - Data rate requirements

The following table gives data rates for a single spectral band from a 600km circular orbit, for various GSD's and pixels per line ( $=6908/\text{GSD} \times \text{Pixels} \times \text{bits/pixel}$ ). The table shows that for example, a 5000 pixel, 4m GSD, 3-band image requires a data rate of 258Mb/s (10 bit/pixel).

Bit rate in Mb/s for 600km orbit and 10 bits/pixel for given GSD and pixels/line									
GSD(m)	Pixels/line (thousands)								
	1	2	3	4	5	6	8	10	12
1	69	138	207	276	345	414	553	691	829
2	35	69	104	138	173	207	276	345	414
4	17	35	52	69	86	104	138	173	207
5	14	28	41	55	69	83	111	138	166
10	7	14	21	28	35	41	55	69	83
15	5	9	14	18	23	28	37	46	55

### 5.5 - Clock rate demands

Dividing the figures in the above table by 10 gives the CCD clock rate in MHz. The shaded areas in the table mark clock rates exceeding 10MHz, which typically implies that a multi-output CCD must be used. This is acceptable for monochrome imagers, but implies many amplifiers if many spectral channels are required.

### 5.6 - Downlink or memory requirements

Down-linking at the above data rates requires a very wide bandwidth, so image data may have to be stored, possibly compressed, and then downlinked over a period longer than a single LEO pass. The next table gives the storage required per kilometre of path for various GSD's and CCD pixels/line. The memory requirements can be met with modern RAM.

Mbytes/km for 10 bits/pixel for given GSD and pixels/line									
GSD(m)	Pixels/line (thousands)								
	1	2	3	4	5	6	8	10	12
1	1.3	2.5	3.8	5.0	6.3	7.5	10.0	12.5	15.0
2	0.6	1.3	1.9	2.5	3.1	3.8	5.0	6.3	7.5
4	0.3	0.6	0.9	1.3	1.6	1.9	2.5	3.1	3.8
5	0.3	0.5	0.8	1.0	1.3	1.5	2.0	2.5	3.0
10	0.1	0.3	0.4	0.5	0.6	0.8	1.0	1.3	1.5
15	0.1	0.2	0.3	0.3	0.4	0.5	0.7	0.8	1.0

The swath (GSD \* Pixels) is also a factor influencing scale factor choice, and many environmental applications cannot afford the loss in coverage caused by the smaller GSD's.

#### 5.7 - Baseline for Sunsat-2 imager

The imager specifications for SUNSAT-2 will depend on finalised mission goals. Present indications are that a small GSD and SNR of 100 for a 30% reflectivity is desired. With this guideline, one candidate imager configuration would have the following characteristics:

Spectral channels	3 x 100nm wide
GSD	4 m
Swath	35 km
Sensor	KLI8811 (8800 pixels)
SNR	>100 for 30% reflectivity (equatorial)
Optical aperture	260 mm
Focal length	1050 mm
Quantization	10 bit
Bit rate per colour	150 Mb/s
Stored image length / Gbyte	386 km
Total mass	< 45 kg

#### 5.8 Focal plane options

Four multi-band imaging options exist for configuring the CCD's in the image plane. The option used in Sunsat 1 was to split the spectral channels using a prism block and interference filters. This has the advantage of inherent co-registration of pixels of different spectral bands, so co-registration is not affected by satellite motion. For this reason Sunsat was able to produce 3456 pixel-wide, colour registered images, even while in a slow spin.

A simpler optical solution is to provide multiple CCD's parallel to each other in the focal plane. This option is attractive since additional spectral bands are easily added to the focal plane. However, ground data of a point emerges from the different sensors at different times, and has to be aligned in later processing. Extreme ADCS accuracy and precision telemetry is required if spectral registration is to be accomplished without using scene information.

Reduced demands on ADCS performance are made if tri-linear CCD's are used. The close proximity of sensor lines (often only 12 lines or 0.1 mm apart) reduces ADCS stability needs by about 200 com-

pared to the parallel CCD approach. The difficulty is to implement remote sensing type spectral filters on the chip. Standard tri-linear CCD's use organic filters matched to photo-scanning needs, which are seldom compatible with remote sensing preferences.

Custom-manufactured sensors permit multiple spectral bands, adjustable inter-line spacing (to meet filter feasibility needs), and special arrangements for clocking, output amplifiers, and particular engineering requirements. The disadvantage is naturally the cost and development risk of special sensors.

### **5.9 - Optical design**

Investigations to-date indicate that the Sunsat-2 imager will use a catadioptric design, with a 45 degree prism at the secondary reflector to bring the focal plane outside the optical barrel. This configuration obviates the need for external baffles, allows all focal plane options, and still uses on-axis optics. The catadioptric configuration also has reduced vacuum focus changes.

## **6 SUSTAINABLE FUTURE PROGRAMMES**

Stellenbosch University established the Electronic Systems Laboratory where SUNSAT 1 has been developed, constructed and tested since 1992. The need to provide a long term sustainable future for space activities in South Africa, requires a commercial interest which supports space research and development. This requirement led to the formation of Sun Space and Information Systems (Pty) Ltd with the University of Stellenbosch as the largest single shareholder. SunSpace has acquired the rights to all the technology in the SUNSAT 1 programme and is active with further initiatives to continue satellite engineering research and the development for commercial applications.

The synergy between Stellenbosch University doing research, the Electronic Systems Laboratory doing development and Sun Space and Information Systems doing commercial contracts provides the environment for cost effective sustainable space activities in South Africa.

## **7 CONCLUSION**

The strategy selected in 1992, of trying to make a large first step into the micro-satellite industry has proved successful. Sunsat's 15m imagery specification set a new norm for micro-satellite resolution when defined in 1991. The successful joint mission with NASA resulted in a useful multi-mission small satellite with the best performance imager for its size.

The highest goal of demonstrating for 15 m resolution, multispectral imagery from a micro-satellite has been achieved, but the drifting orbit and downlink failures limit image quantity. The co-aligned spectral channels have proven that high resolution pushbroom imagers can work on gravity gradient stabilised micro-satellite. The Sunsat-developed imager has also enabled Kitsat-3 to produce spectacular images in large quantity. The SUNSAT on-board JPEG compression will ultimately enable up to 3456 pixel x 3456 pixel images to be downloaded from the satellite on a daily basis.

The strong downlink signals from Sunsat are providing good service to the amateur radio community in FM repeater, parrot, and APRS modes. NASA has tracked Sunsat with its laser network, and has been provided with many Mbytes of GPS data. Code up-loads to the GPS receiver have also been performed.

The success of Sunsat has led to a large satellite training initiative near Stellenbosch, and has led to the formation of Sun Space & Information Systems Pty Ltd. This company will generate the commercial satellite activity needed in South Africa to sustain micro-satellite developments at the University of Stellenbosch.

Sunsat's success has also raised the visibility of satellite research at government level, increasing the possibility of a space research mandate being established within government structures. With the funding challenges under which the project was completed, the authors consider the project to be an

enormous success, and have expressed their confidence in continued space activities by forming Sun Space & Information Systems Pty Ltd.

#### **Acknowledgements:**

SUNSAT has been completed through friends and colleagues in many organisations. The following organisations have supplied funds or facilities:

Altech-Alcatel, ECS, First National Bank, FRD, Grintek, Houwteq, Irdeto, Malaysian Airlines, MTN, Orbicom, Plessey, Reumech, SARL, SA AMSAT, Siemens, Somchem, Telkom, University of Stellenbosch, Vodacom.

#### **REFERENCES:**

1. Schoonwinkel A and Milne GW. *Managing a Microsatellite Development Programme within the University Environment*. Technovation, Vol. 17, No. 1, January 1997, pp 1-9.
2. Schoonwinkel A and Milne GW. *University Research and Development of a Microsatellite*. R&D Management, Vol. 27, No. 1, January 1997, pp 37-44.
3. KITSAT-3 web site: <http://satrec.kaist.ac.kr/english/SaTReC.html>
4. Milne GW, Bakkes PJ, Schoonwinkel A, du Plessis JJ, Enslin JHR, Steyn WH, Mostert S, Palmer KD and Weber DM. *SUNSAT, Stellenbosch University and SA-AMSAT's Remote Sensing and Packet Communications Microsatellite*. Proceedings of the Conference on Small Satellites #7, Utah, USA, September 1993.
5. SUNSAT web site: <http://sunsat.ee.sun.ac.za>
6. SUNSAT - Launch and First Six Month's Orbital Performance. Garth W. Milne, A. Schoonwinkel, J.J. du Plessis, S. Mostert, W.H. Steyn\*, K vd Westhuizen, D.A. vd Merwe, H. Grobler, J.A. Koekemoer, N. Steenkamp.
7. Mostert S and Koekemoer JA. *The science and engineering payloads and experiments on SUNSAT*. Acta Astronautica, Vol 41, No 4-10, August-November 1997.

#### **Emails:**

[milne@ing.sun.ac.za](mailto:milne@ing.sun.ac.za),  
[mostert@ing.sun.ac.za](mailto:mostert@ing.sun.ac.za),  
[schoonwi@ing.sun.ac.za](mailto:schoonwi@ing.sun.ac.za),  
[jjdp@ing.sun.ac.za](mailto:jjdp@ing.sun.ac.za)

---

\* Presently at the University of Surrey

## The development of low cost missions at Surrey

Mark Allery

Surrey Satellite Technology Ltd.  
Centre for Satellite Engineering Research,

University of Surrey  
Guildford, Surrey GU2 5XH, UK

email: m.allery@eim.surrey.ac.uk

<http://www.sstl.co.uk>

### Abstract:

*Small satellites have become an established feature of the space industry and are now recognised as a fundamental element of many space programmes. The small satellite is rapidly becoming the ubiquitous 'pickup truck' of space as it is employed for its simplicity, flexibility and quick turnaround in missions where keeping time and cost low are key.*

*Over the last 20 years Surrey has specialised in the development of short timescale, low cost small satellite missions. Surrey is now working on a range of small satellite missions from 3 kg nano-satellites to 450 kg mini-satellites in a range of orbits, all of which share a common heritage in design and experience. With the launch of UoSAT-12 and Clementine in 1999 a total 16 Surrey designed small satellites have been launched, the older of which has now been operating on orbit for over 15 years. UoSAT-12 Surrey's first minisatellite mission was successfully launched on the first orbital launch of the Dnepr vehicle from Baikonur in April 1999. The minisatellite, which is primarily a research and development mission has successfully achieved all of its key goals and is currently supporting its remote sensing and communications missions as well as being used for research in propulsion, attitude control, GPS based navigation and attitude determination, autonomous orbit control and software development for IP experiments. Three further micro-satellites and Surrey's nano-satellite SNAP-1 are ready for launch in 2000.*

*This paper presents the performance of the latest small satellites being designed at Surrey in terms of the in orbit performance of those missions recently launched and the capabilities of missions being readied for launch.*

*Small satellites are often considered to be relatively low performance and unreliable systems by many if not most conventional areas of the space industry. Surrey's experience in orbit shows small satellites do combine short timescales and low cost without comprising lifetime and reliability. They do this through an appropriate choice of technology, often COTS, with a modern, flexible, management and system design approach. The paper also looks to the near future and the ability of small satellites to be used effectively in operational roles where they can be more efficient than their larger and more traditional relations.*



## **Introduction**

Small satellites have become an established element of low cost missions over the last decade. SSTL has been in the forefront of developing and evolving the capability of small satellites to meet more demanding payloads and more complex mission requirements. The mission philosophy which encompasses a low cost mission (and not all small satellites can be categorised as low cost) is much wider than just the use of a small platform. A low cost programme requires a management, system design, engineering, testing, operations and product assurance approach which embraces the introduction of new technology, shorter development cycles and flexible working practices. Managing this process is a particular challenge which needs a strong balance of risk management and value engineering within a team based project structure. SSTL has been particularly successful in combining these aspects of small satellite engineering and management to develop and extend the capability of small satellite missions for commercial exploitation.

SSTL has extended its small satellite philosophy to minisatellites with the successful launch of the 325kg UoSAT-12 minisatellite in May 1999. UoSAT-12 has been developed by SSTL to offer a level of payload capacity and platform capability which represents a step increase from the microsatellite but at a performance to price ratio which is significantly lower than previously available in this class of platform. This has been achieved by the scaling up of SSTL's small satellite philosophy. By contrast a number of organisations in the US and Europe have approached the minisatellite market by decreasing the size of their large platforms or designing new platforms along traditional lines.

Nanosatellites are of increasing interest to the small satellite community now that the continuous improvements in technology are allowing wide availability of miniaturised components. SSTL has completed the design and test of a nanosatellite platform with a wide range of applications making extensive use of COTS solutions. The first mission SNAP-1, with a formation flying/remote inspection objective, is scheduled to be launched in late June 2000.

Microsatellites are also rapidly increasing in capability and taking its pioneering lead in microsatellite design, SSTL has evolved the standard platform developed over almost 20 missions, and extended it to address remote sensing and communications constellation applications at the lowest end of the commercial exploitation market where the performance to price ratio is most sensitive.

To date Surrey's missions have demonstrated that low cost missions can be provided on a commercial basis especially in LEO. In the near future Surrey is working upon missions which will apply small satellite philosophy to highly elliptic, Lunar, Interplanetary and GEO missions.

## **Background**

The University of Surrey's first small satellite UoSAT-1 was launched in 1981. The second satellite UoSAT-2 was launched on 1<sup>st</sup> March 1984 and is still operational, controlled from the Surrey satellite operations centre in Guildford, UK after 16 years in orbit. With the commercial company Surrey Satellite Technology Ltd (SSTL), which is majority owned by the University of Surrey a further 15 missions have been launched based upon Surrey designs. These missions are listed in Table 1 which also lists the small satellite missions at Surrey now in preparation for launch in 2000 and those projects which are underway.

The recent microsatellites FaSAT-Bravo, Thai-Putt and CLEMENTINE were launched in 1998 and 1999 respectively and UoSAT-12 launched in 1999. The Tsinghua-1 microsatellite and SNAP-1 nanosatellite are preparing for launch at the end of June 2000. The TiungSAT-1 microsatellite is awaiting a DNEPR launch in August 2000 and the PICOSAT microsatellite is awaiting launch in the US scheduled for 2001.

Spacecraft	Launched	Current Status	Primary Mission
UoSAT-1	October 1981	Re-entered October 1989	Technology Demonstrator
UoSAT-2	March 1984	Operational	Store & Forward Prototype
UoSAT-3	January 1990	Operational	Commercial Store & Forward
UoSAT-4	January 1990	Non Operational	Tech demonstration, Earth Imaging
UoSAT-5	July 1991	Operational	Store & Forward, Earth Imaging
KITSAT-1	August 1992	Operational	Store & Forward, Earth Imaging
S80/T	August 1992	Operational	Commercial research
HealthSat-2	September 1993	Operational	Commercial Store & Forward
KITSAT-2 <sup>1</sup>	September 1993	Operational	Store & Forward, Earth Imaging
PoSAT-1	September 1993	Operational	Commercial research, Imaging
CERISE	August 1995	Operational <sup>2</sup>	Military payload
FASat-Alfa	September 1995	Non -operational	Imaging, space science, technology
TMSAT	June 1998	Operational	Imaging, technology, communications
FASAT-Bravo	June 1998	Operational	Imaging, space science, technology
UoSAT-12	May 1999	Operational	Imaging, communications, technology
CLEMENTINE	November 1999	Operational	Military payload
Tsinghua-1	Scheduled June 00	Awaiting Launch	Imaging & Communications
SNAP-1	Scheduled June 00	Awaiting Launch	Imaging (2.5 kg Nano-satellite)
TiungSAT-1	Scheduled Aug 00	Awaiting Launch	Imaging, technology, communications
PICOSAT	Scheduled 2001	Awaiting Launch	Research & Technology payloads
ESAT	Scheduled 2001	Under Construction	Communications
BiltenSAT	Scheduled 2002	Project commencing	Remote Sensing & communications

Table 1 : SSTL small satellite missions

#### UoSAT-12

On 21<sup>st</sup> April a DNEPR launch vehicle placed UoSAT-12 into a 650km, 65° orbit. UoSAT-12 is a 325kg mission which is based upon SSTL's flexible and adaptable minisatellite platform. The platform has been designed to support missions in the mass range of 200 to 450 kg. With payloads between 100 to 200kg. The UoSAT-12 mission is a research and development designed to demonstrate the platform technology and to support a number of key mission objectives.

Over the year since launch UoSAT-12 has achieved all of its key mission objectives and the spacecraft continues to provide demonstrations of the key platform technology and support its payload operations.

<sup>1</sup> KITSAT-2 was built in South Korea under licence as part of the technology transfer and training programme

<sup>2</sup> CERISE has been returned to operation following in orbit collision with debris in Sept 96.

UoSAT-12 is operated from SSTL's satellite operations centre in Guildford. The mission key objectives have been

- Use of range of attitude control modes including zero momentum bias, pitch bias 3-axis modes.
- Demonstration of SSTL's GPS receiver for in orbit position and orbit determination.
- Use of the GPS receiver as an orbital test bed for attitude determination in conjunction with ESA
- Demonstration of Attitude Agility, including off track target acquisition, target tracking.
- Demonstration of propulsion and orbit control systems
- Demonstration of Nitrous Oxide based resistojet motor for propulsion system.
- Integration of on board orbit control using the GPS and AOCS. UoSAT-12 has now been moved to a frozen orbit and is maintained in this orbit using on board control. (Recent tests have included demonstration of the Microcosm autonomous orbit controller OCK).
- Returned outstanding 32-metre multi-spectral and 10-metre panchromatic images of the Earth from a COTS-based imaging system.
- In orbit test bed for L and S-Band communications using the Merlion transponder payload developed in collaboration with NTU, Singapore
- Development packet communications using the VHF/UHF store and forward transponder.
- Development of IP compliant active node on board UoSAT-12 using TCP/IP protocols

The minisatellite platform is a flexible design which can be configured to address a wide range of mission applications including communications, remote sensing and science missions. The design of the platform housekeeping subsystems is developed from the microsatellite systems and offered increased power and data handling combined with a modular configuration of sensors and actuators which can be selected to suit the orbit and mission requirements. The platform features

- 28Volt distributed Power bus
- On Board TT&C LAN based upon CAN Bus
- Ethernet for on board data handling
- TCP/IP compliant packet system for up/downlinks
- 386 based OBC's with 128Mbytes SRAM
- 3-Axis Attitude control (reaction wheels, cold gas thrusters, )
- Attitude sensors include Sun Sensors, Star Sensors, Earth Sensor, Magnetometers, GPS
- GPS derived on board orbit determination
- Propulsion Systems (Cold Gas for orbit maintenance, Resisot-jet for Orbit control and manoeuvres)
- 1 Mbps S-Band downlink to low cost ground stations
- Modular payload accommodation with standard payload data and power interfaces

The UoSAT-12 minisatellite is shown in Figure 1 undergoing final tests at SSTL prior to launch. Figure 2 is one of the first 32m resolution images returned by the multispectral Earth Imaging system.

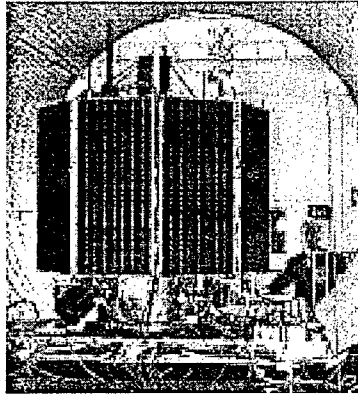


Figure 1 : UoSAT-12 under test prior to launch



Figure 2 : 10m resolution Pan image from UoSAT-12

### **Internet Compliant**

Recently UoSAT-12 has achieved another first in hosting an on-board TCP/IP stack on one of its three main on-board computers and for the spacecraft itself to become an active node on the internet. Under an experimental contract from NASA GSFC and in conjunction with Vytex LLC, the packet communications task on the OBC has been modified to accept TCP/IP frames and initial results from the trials indicate that reliable communications can be established with LEO spacecraft using internet compliant TCP/IP.

For the trials the modified communications task was loaded to UoSAT-12 by Surrey's operators and the only additional equipment required in the spacecraft control centre was a Cisco router. SSTL expects to continue this development and that internet compliant TCP/IP will prove to be an attractive communications standard for many applications.

### **Current Operations on UoSAT-12**

After over 1 year in orbit UoSAT-12 is currently supporting a range of activities in orbit. These are primarily based upon the development of flexible attitude control algorithms, the continued development of image targeting on demand, the maintenance of the frozen orbit, the development of improved real time positioning from the GPS receiver and the development of attitude determination using the GPS receiver.

## SNAP-1 Nano Satellite

SNAP-1 is SSTL's first Nanosatellite mission and is based upon the Surrey Nanosatellite Applications Platform (SNAP) which has been designed to provide for a range of missions. Unlike many proposed nanosatellite designs the SNAP programme has been conceived from the start to make the most extensive use possible of widely available miniaturised COTS technology and systems. Altogether, the SNAP-1 mission is 8.5kg including the launch vehicle attach fitting and its own payloads. Although small in size and mass SNAP-1 has a large number of mission objectives which are the focus of Surrey's R&D programme based upon Nanosatellite technology.

SNAP-1 will be launched together with another microsatellite, Tsinghua-1 a collaborative mission between SSTL and Tsinghua University, Beijing, on a Cosmos vehicle at the end of June 2000. SNAP's objective is to demonstrate the Nanosatellite platform through

- Imaging of the launch separation using the machine vision processing payload
- Demonstrate differential GPS using Tsinghua-1 GPS and SNAP-1 GPS
- Demonstrate ISL between the two satellites
- Demonstrate formation flying using SNAP-1 propulsion system
- Validate the SNAP-1 platform
- Earth Imaging
- Spread Spectrum downlink transmitter payload for communications demonstrations

SNAP-1 is approximately triangular in shape with a maximum diameter of approximately 350mm and a depth of 250mm. The antennas and sensors are mounted on the Nadir and Space facing facet with body mounted solar arrays on the 3 side facets. The structure is based upon Eurocard sized enclosures which are standardised for the platform systems and payloads. A generic payload interface for power and data services is provided.

The SNAP-1 platform features an ARM based (STRONGARM) 220MHz OBC used for platform housekeeping and general purpose data control. A controller area network for TLC/TLM, S-Band downlink, VHF uplink (can be configured with S-Band), Power system, Attitude control based upon 3-axis magnetometer with 3-axis magnetorquers and a single miniaturised reaction wheel.

The payloads comprise the Machine Vision Experiment (comprising a further STRONGARM based processor and 4 wide angle video cameras), the ORION miniature GPS receiver, the propulsion system and UHF receiver which are used to provide the formation flying demonstration. A further imager is provided for earth imaging and a spread spectrum transmitter is also on board as a communications payload.

The SNAP-1 structure is shown during integrated testing at SSTL in Figure 3 and the propulsion system for SNAP-1 is shown in Figure 4.

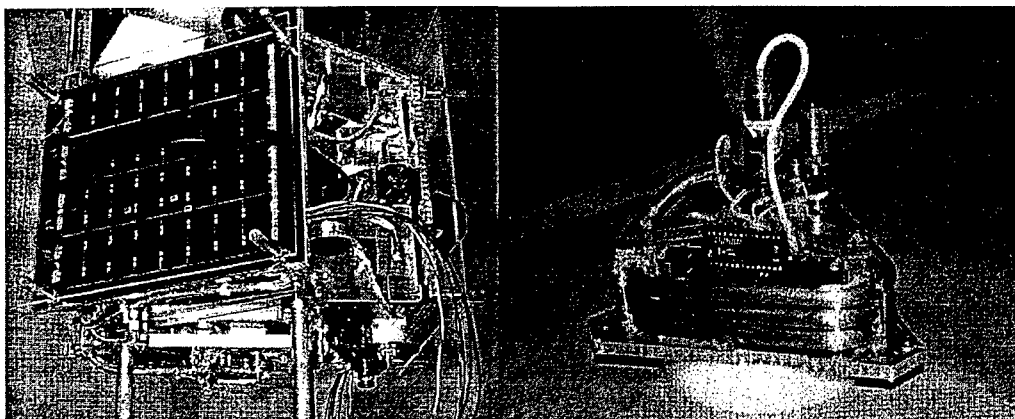


Figure 3 : SNAP-1 undergoing testing at SSTL

Figure 4 : SNAP-1 Propulsion System

SSTL sees the applications of the Nanosatellite programme to be very widespread. The SNAP-1 mission is aimed at an Educational and Technology Demonstration objective. The lessons to be learned from SNAP-1 will assist nanosatellites in developing formation flying and remote inspection mission in a variety of orbits. For the future these spacecraft are likely to be deployed in large formations or swarms for communications, remote sensing or space science applications.

### Enhanced Microsatellites

SSTL's microsatellite design has been evolved through a number of missions. Today's microsatellite mission is expected to meet complex mission requirements and to provide for a payload capacity far greater than only a few years ago. Many Microsatellite missions have been constrained by launch vehicle mass and volume requirements, for example the ARIANE-4 ASAP 50kg limits. SSTL has demonstrated the ability to provide for demanding missions within the 50kg limits, however the payload capacity and ability to support constellation requirements with on board propulsion and increased power generation can be met with a modular design that support missions from 50kg upto around 150kg.

SSTL has designed its enhanced microsatellite to meet the challenging requirements of both remote sensing and communications constellations. The microsatellite can be configured for a range of missions and applications from simple gravity gradient through to 3 axis, with propulsion and increased power capacity depending upon the mass and price/performance requirements.

Figure 5 shows the enhanced microsatellite platform in remote sensing configuration. Figure 6 shows a communications configuration which is currently under construction for the 6 micro-satellite ESAT little LEO constellation.

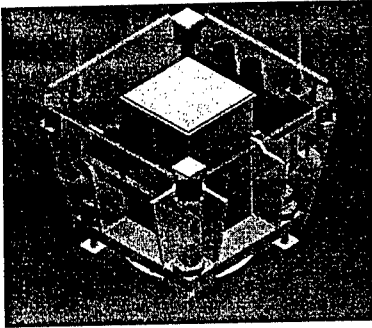


Figure 5 : Remote Sensing Configuration



Figure 6: Comms Configuration

In its remote sensing configuration the Enhanced Microsatellite platform has the following key features

- Modular stack type structure, with canted solar panels. Mass between 100kg and 130kg.
- Mission lifetime of 5 years plus extended mode of further 5 years
- 3 axis stabilisation with 30° off-pointing on demand for image acquisition
- Attitude acquisition by Astrolabe star cameras, SSTL Sun Sensors, SSTL Magnetometers and solid state gyroscopes.
- Attitude control by reaction wheels and magnetorquers
- On-board SGR-10 GPS receiver for autonomous orbit determination and positioning
- S-band communications system
- UHF/VHF system Store-and-Forward capability (and backup to S-Band system)
- 3 on-board computers plus 2 image processing computers
- CAN Bus for distributed on board TLC/TLM, Ethernet for onboard Data Handling
- High-resolution (12m) pan-chromatic camera and 32m resolution 4-band multi-spectral camera

The platform subsystem design provides a high level of reliability through the use of a core hard wired TLC/TLM system and a CAN based distributed TLC/TLM system which offers a high level of performance and flexibility for mission applications. The system configuration for a communications constellation application is given in Figure 7

Enhanced Microsatellite SYSTEM DIAGRAM

(Provisional: 30 November 1999)

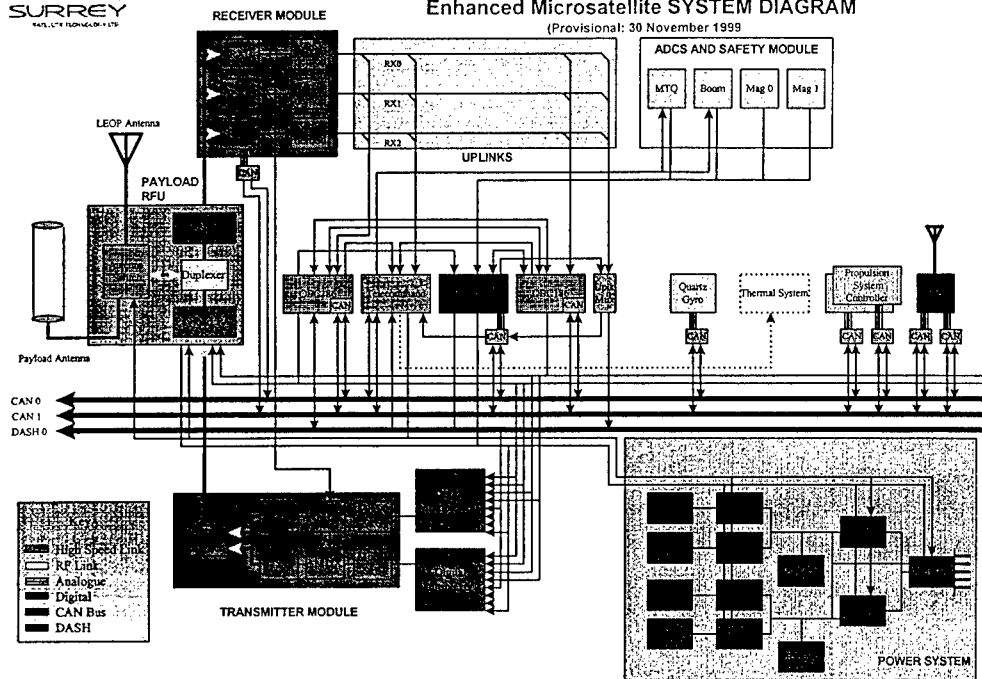


Figure 7 : Microsatellite System Block Diagram for Communications constellation application

**Summary**

The rate of evolution of small satellite capability and performance is increasing. Fed by the continuing advances in terrestrial electronic, software, wireless and increasingly MEMS technology it seems likely that the rate of evolution will continue to increase over the next few years. Surrey has demonstrated that these challenges can be met and at an affordable price. This results in the stimulation of further missions and missions which would not originally have been affordable. In turn this stimulates balanced approach to the management of risk on satellite programmes which helps to drive down the costs and continue the spiral of increasing numbers of small satellite missions in a range of orbits and for low cost interplanetary missions.

**Acknowledgements**

The author would like to thank all of the members of SSTL and the Surrey Space Centre. The outstanding success in development and operations of the UoSAT-12 mission has been achieved through the hard work and commitment of the whole organisation.

**References**

[1] Ward J.W. First In orbit results from the UoSAT-12 minisatellite, Proceeding of the Utah State University Small Satellite Conference 1999, SSC99-I-2.



## **SESSION 2 :**

### **Services de lancement de petits satellites** ***Launch services for small satellites***

*Présidents / Chairpersons: Udo RENNERT, Jean-Pierre REDON*

- (S2.1) EELV Secondary Payload Adapter (ESPA)**  
Haskett S.A., Weis S.C., Doggrell L.J., Fosness E.R., Sciulli D., Meink T. et al  
US Air Force Space Test Program, Kirtland AFB, NM, Etats-Unis
- (S2.2) DNEPR Space Launch System for Small Satellites**  
Andreev V.A., Drobakhin O.I., Konyukhov S.N., Milkhalov V.S., Us S.I., Solovey V.A.  
International Space Company Kosmotras, Moscou, Russie
- (S2.3) Rocket's Commercial Launch Service Debut**  
Viertel Y., Kinnersley M., Freeborn P., Eurockot Launch Services GmbH, Bremen, Allemagne
- (S2.5) Piggyback Satellite Launch by H-IIA Launch Vehicle**  
Ujino T., Shimizu R., Onoe I., Namura E., Terashima K., Matsunaga H.  
National Space Development Agency of Japan (NASDA), Tokyo, Japon
- (S2.6) First Leolink Launch from Alcantara**  
Oiknine C. Leolink, France
- (S2.7) STARSEM offer to launch small satellites on SOYUZ**  
Francis R., Schlosser Ph. STARSEM, Paris, France

## EELV SECONDARY PAYLOAD ADAPTER (ESPA)

Capt. Scott A. HASKETT, Mr. Steven C. WEIS, and Mr. Leslie J. DOGGRELL

*US Air Force Space Test Program*  
3550 Aberdeen Ave. SE  
Kirtland AFB, NM 87117-5776

Dr. Dino SCIULLI, and Dr. Troy MIENK, Mr. Jeff GANLEY

*Air Force Research Laboratory, Space Vehicles Directorate*  
3550 Aberdeen Ave. SE  
Kirtland AFB, NM 87117-5776

Mr. Joseph R. MALY

*CSA Engineering, Inc.*  
2565 Leghorn St.  
Mountain View, CA 94043-1613

Mr. Karl Jurisson

*TRW Incorporated*  
3550 Aberdeen Ave. SE  
Kirtland AFB, NM 87117-5776

*ABSTRACT - Despite growing international interest in small satellites, high dedicated expendable launch vehicle costs and the lack of secondary launch opportunities continue to hinder the full exploitation of small satellite technology. In the United States, the Department of Defense (DoD), NASA, other government agencies, commercial companies, and many universities use small satellites to perform space experiments, demonstrate new technology, and test operational prototype hardware. In addition, the DoD continues to study the role of small satellites in fulfilling operational mission requirements. However, the US lacks sufficient small satellite launch capability. Furthermore, US government agencies are restricted to the use of US launch vehicles, which eliminates many affordable launch opportunities. In an effort to increase the number of space experiments that can be flown with a small, fixed budget, the DoD Space Test Program (STP) has teamed with the Air Force Research Laboratory Space Vehicles Directorate (AFRL/VS) to develop a low-cost solution for the small satellite launch problem. Our solution, which can be implemented on both Boeing and Lockheed-Martin Evolved Expendable Launch Vehicle-Medium (EELV-M) boosters, is called the EELV Secondary Payload Adapter (ESPA). ESPA will increase the number of launch opportunities for 180kg-class (or smaller) satellites at prices highly competitive with other secondary launch services worldwide.*

## 1 - ESPA MOTIVATION

Many organizations around the world use small satellites for education and scientific research. Increasingly, small satellites are being used for commercial and military space missions as well. However, the United States lacks sufficient small satellite launch infrastructure and small satellite launch costs are currently very high. For example, the least expensive expendable launch vehicle available to US government agencies is the new Orbital/Suborbital Program (OSP, or "Minotaur"). OSP, which flew for the first time on 26 January 2000, uses the first two stages of a Minuteman II ICBM and the top two stages of a Pegasus XL to create a four-stage, solid propellant launch vehicle. Using a dual-payload adapter, the cost to launch a pair of small satellites on OSP is at least \$14M, or \$7M per spacecraft. Other small US launch vehicles are similarly expensive; Pegasus costs more than \$18M and both Taurus and Athena I/Athena II cost more than \$20M. For satellites smaller than 100kg, dedicated expendable boosters are currently not cost-effective means for launch.

The Space Shuttle has been used to launch small satellites, but the shuttle is limited to relatively low-altitude, low-inclination orbits which provide brief on-orbit lifetimes for small satellites. A good example is the Air Force Research Laboratory's MightySat-1 spacecraft. Launched from Endeavor (STS-88) in December 1998, MightySat-1 reentered in November 1999. Propulsion systems might be used to raise small satellite altitude and/or inclination at the expense of additional cost, complexity, and shuttle safety concerns.

Several foreign launch vehicles incorporate the ability to carry secondary payloads. Arianespace offers relatively inexpensive secondary payload flights on Ariane 4 and Ariane 5 boosters using an adapter called Ariane Structure for Auxiliary Payloads (ASAP) as shown in Figure 1. In May 1999, India launched two secondary payloads, South Korea's KITSAT-3 and Germany's TUBSAT, using the PSLV booster. Japan has also developed and used a secondary payload capability for the H-2 launch vehicle. Unfortunately, foreign launch systems are not currently available to DoD or other US government customers unless the White House grants a foreign launch waiver.

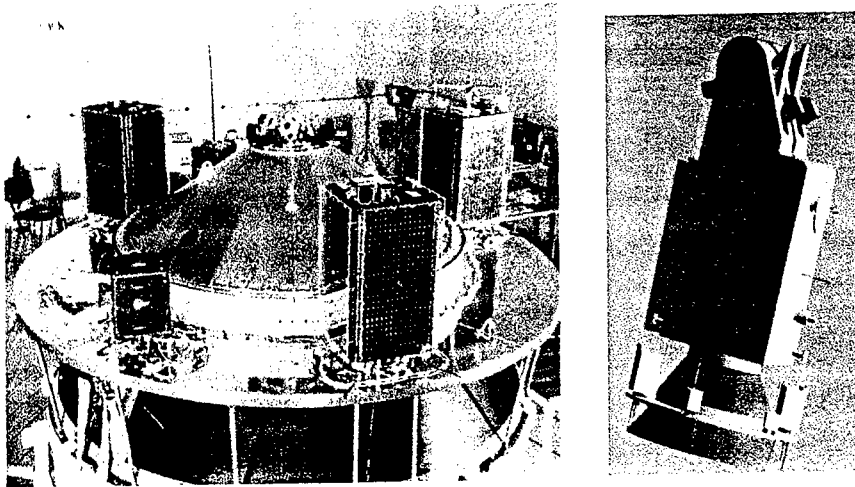


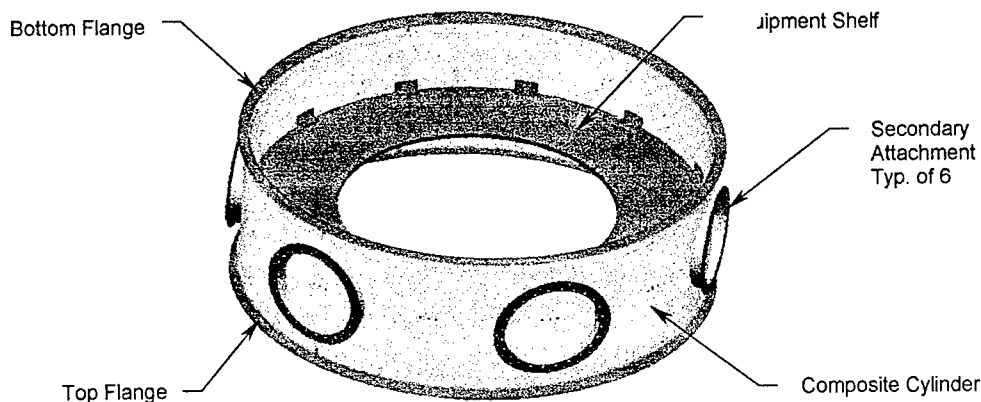
Fig. 1: Secondary Payloads on Ariane 4 Launch Vehicle.

Of America's larger expendable launch vehicles, only Boeing's Delta II has consistently been used to launch secondary payloads. Opportunities to fly secondary payloads on Delta II will become fewer as the Air Force is planning only a limited number of Delta II missions in the future. Beginning in Fiscal Year 2002 (FY02), all launches of large DoD payloads will be performed by the EELV family of boosters developed by Lockheed-Martin (with their Atlas 5) and Boeing (with their Delta IV). The EELV program office at Los Angeles AFB, California, recently awarded contracts for 28 EELV launches through FY06. All but two of these 28 missions will use the so-called EELV-Medium (EELV-M) configurations. Both the Atlas 5 (Medium) and Delta IV (Medium) are very capable boosters. On at least 15 of the 26 manifested flights for these vehicles (58%), there is usable performance margin of at least 2,000 pounds.

Currently, there is no capability for carrying secondary payloads on EELV. ESPA is designed to use large projected payload margins on EELV-M launches to orbit up to six small satellites plus a large primary payload on a single launch.

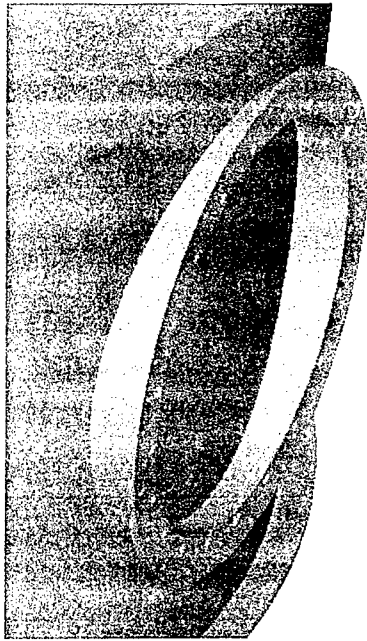
## 2 - ESPA DESIGN

The DoD Space Test Program (STP; office symbol SMC/TEL) has teamed with the Air Force Research Laboratory Space Vehicles Directorate (AFRL/VS) at Kirtland AFB, New Mexico, to design and build ESPA. ESPA, shown in Figure 2, consists of a 250-pound (114kg, estimated empty mass), 24-inch (61cm) tall cylinder with accommodations for six secondary payloads. The cylinder is composite, with aluminum top and bottom flanges and aluminum secondary payload attach rings. The secondary payloads are mounted at equal intervals around the cylinder. A close-up view of a secondary payload attach rings is shown in Figure 3. This configuration allows the secondary payloads to be released before the primary payload if desired, a capability not offered with ASAP. However, the cylindrical design was not driven by the desire to release secondary payloads before the primary payload (an unlikely scenario), but rather to define an annular volume between the booster and the primary payload that could be dedicated to secondary payloads.



Note: Bottom view given to show equipment shelf attachment method

Fig. 2: ESPA General Configuration.



**Fig. 3:** ESPA Secondary Payload Attach Ring.

ESPA is mounted to the EELV-M standard interface plane (SIP). The SIP, a 62.01-inch bolt circle, is the mechanical interface defined for all military EELV-M payloads (the SIP defined for EELV-Heavy uses a larger-diameter bolt circle). On any given EELV-M mission, the primary payload owner must provide an adapter cone to attach their satellite to the SIP. On a mission that includes ESPA, ESPA is attached to the SIP and the primary payload adapter cone is mounted to the top of ESPA. To alleviate primary payload mechanical interface concerns, the top of ESPA will replicate the SIP. Incorporating ESPA will impact the primary payload since ESPA raises the primary payload by 24 inches. This raises the payload center of gravity and reduces the usable volume inside the payload fairing. However, designing primary payload adapter cones with ESPA use in mind would minimize these effects.

The DoD is now considering the use of so-called EELV-Intermediate (EELV-I) vehicles (EELV-M launch vehicles with solid-propellant strap-on boosters for additional performance). ESPA should be compatible with EELV-I because EELV-I will use the SIP defined for EELV-M. However, this has not been studied in detail.

An optional feature under development for use with ESPA is a whole-spacecraft, passive vibration isolation system for the primary payload. Vibration isolation for secondary payloads was studied but later discarded due to the complexity of building a low-weight, cost-effective, low-frequency isolation system. The isolation system is intended for primary payloads that require an improved launch environment. With the isolation system in place, the ESPA system is 30.5 inches (77.5cm) tall, which increases the volume available for use by the secondary payloads. Other optional features under development are whole-spacecraft shock isolation systems for the primary and secondary payloads. Each of these systems is described below.

ESPA is designed to support a primary payload mass as large as 15,000 pounds (6,800kg). The design limit for secondary satellite mass on ESPA is 400 pounds (180kg) per spacecraft. However, secondary

payloads on ESPA will likely be limited more by usable volume rather than by weight. Secondary payload interfaces and usable volumes are described in detail in the next section.

### 3 – SECONDARY PAYLOAD INTERFACE

To simplify planning for potential ESPA secondary payload customers, a standard interface is being created for ESPA. Figure 4 depicts the secondary payload coordinate system used at each secondary payload attachment ring. ESPA can accommodate a secondary payload CG offset of 20 inches (50.8cm) in the  $X_{spl}$  direction. The allowable offset in the  $Y_{spl}$  and  $Z_{spl}$  directions are not yet known but will be defined by separation system requirements. The standard mechanical interface for ESPA will be a low shock, non-pyrotechnic clamp band separation system designed by Starsys Research, Incorporated, of Boulder, Colorado (in cooperation with Saab Ericsson Space of Linkoping, Sweden). This system, still in development, is depicted in Figure 5. The spacecraft adapter plate is 16 $\frac{3}{4}$  inches (52.55cm) in diameter, much like the Shuttle Hitchhiker Experiment Launch System (SHELS) developed for use on the Space Shuttle. The electrically redundant Clamp Band Opening Device (CBOD) can be reset and reused, offering the opportunity to ground test flight hardware.

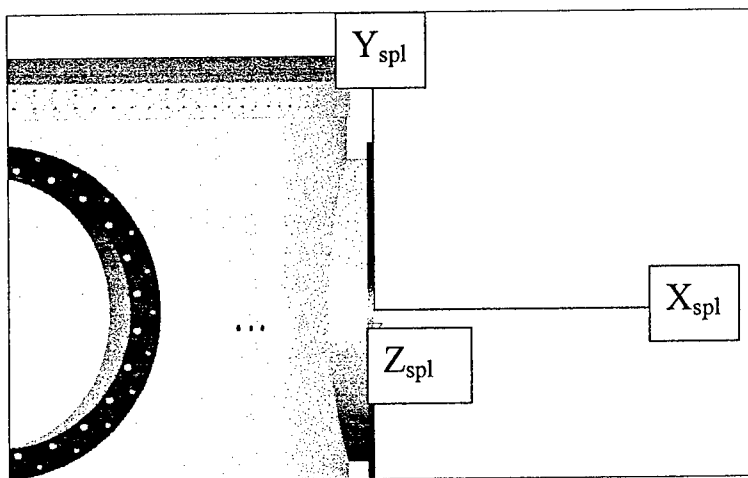
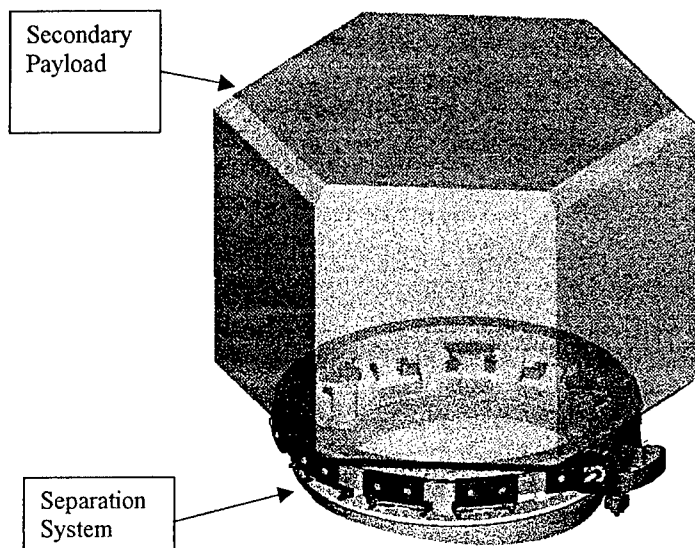


Fig. 4: Secondary Payload Coordinate System.

In the event this clamp band system is not suitable for a particular payload, a user-provided separation system (such as a single point separation system) may be substituted. However, it would be incumbent upon that customer to interface with the ESPA secondary payload attachment ring and to ensure their system is space qualified. Furthermore, non-pyrotechnic separation systems like the CBOD are still preferred to reduce safety concerns for the launch vehicle integrator and primary payload.

The STP/AFRL team investigated a number of different approaches to the ESPA electrical subsystem. The least expensive approach for the electrical subsystem is to have secondary payloads utilize launch vehicle electrical lines and umbilical lines not used by the primary payload. Studies showed this approach is feasible; EELV satisfies the electrical requirements of several DoD payloads with sufficient

unused capability available for secondary payloads. A more robust (and correspondingly more expensive) approach would be to incorporate a firing box within ESPA that could utilize a single redundant signal from the launch vehicle to command release of the secondary payloads. The lower-cost approach will be used for the first one or two ESPA missions, although system improvements in the electrical subsystem may be made in the future.



**Fig. 5:** Starsys Research Low-Shock, Non-Pyrotechnic Secondary Payload Separation System.

ESPA will incorporate a junction box to route umbilical and command signals to the secondary payloads. The cables and harnesses required for secondary payloads will also be provided with ESPA. Primary payload cables and harnesses will be the responsibility of the primary payload provider; ESPA will only accommodate passthrough mounting fixtures for these cables. Each secondary payload will have one zero-force connector with a 15-19-pin arrangement. Specific pin assignments will be made during interface control document (ICD) development. However, it is envisioned most payloads on ESPA will need only minimal connectivity. Since the time spent by EELV payloads on pad prior to launch is supposed to be very brief, most secondary payloads can probably omit payload monitoring and/or battery charging through the T-0 umbilical. Ideally, to keep costs down, each secondary payload will require only separation signals and a channel to confirm separation. As always, additional requirements incur additional integration costs.

The standard usable volume defined for ESPA secondary payloads is 38" by 24" by 24" (96.5cm x 61cm x 61cm) in the  $X_{sp}$ ,  $Y_{sp}$ , and  $Z_{sp}$  directions, respectively. The  $X_{sp}$  dimension includes the height of the separation system. Any spacecraft that fits within this usable volume can be accommodated on an ESPA. Figure 6 shows ESPA loaded with these "standard" spacecraft. The total usable volume available to secondary payloads depends on the particular launch vehicle (total usable volume varies between the Delta IV and Atlas V), the ESPA configuration (with or without primary spacecraft isolation), and the payload fairing diameter. Most DoD EELV-M launches are expected to use 4-meter diameter fairings (5-meter fairings are also available).

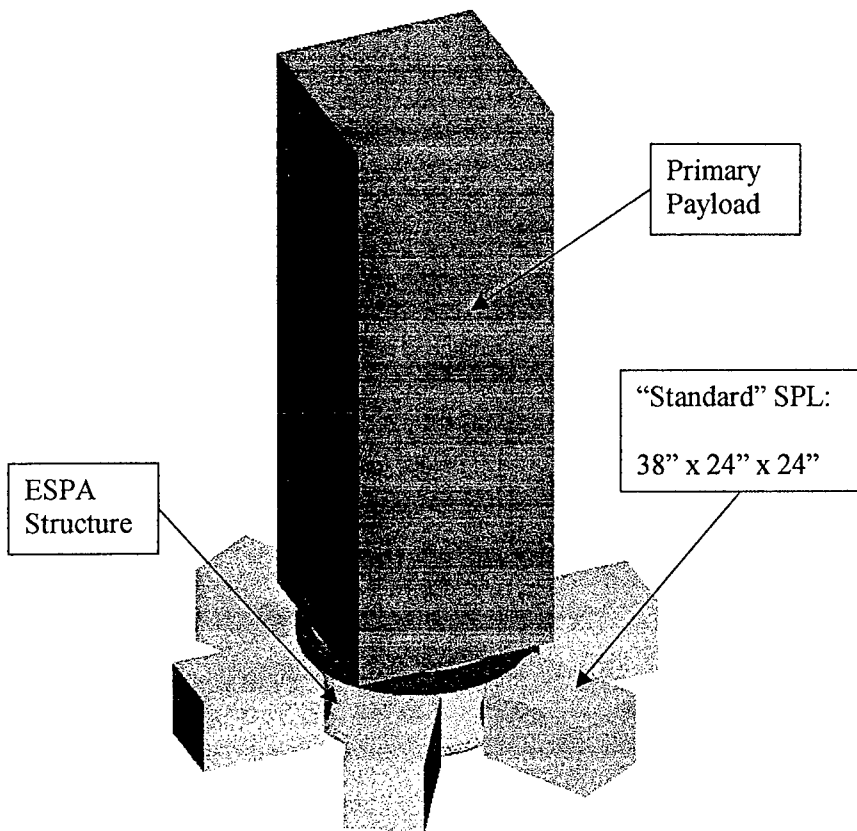


Fig. 6: ESPA Loaded with A Primary Payload and "Standard" Secondary Payloads.

#### 4 - VIBRATION ISOLATION

During the past decade, billions of dollars have been lost due to satellite malfunctions, resulting in total or partial mission failure, which can be directly attributed to launch vibration loads. AFRL and CSA Engineering, Incorporated, of Mountain View, California, have developed, designed, tested, and successfully flown the world's first whole-spacecraft launch vibration isolation system. Configurations of this system have successfully flown on three Taurus launch vehicle missions; the Geosat Follow-On (GFO) and Space Technology Experiment (STEX) missions launched in 1998 and the Multi-Spectral Thermal Imager (MTI) mission launched in March 2000. Additionally, vibration isolation was used on the first OSP/Minotaur mission in January 2000. The whole-spacecraft isolation systems that were developed and built for GFO, STEX, and MTI were low-risk, passive devices that provide isolation in the axial (launch) direction. For each of the Taurus missions, the whole-spacecraft isolation system performed extremely well, reducing the structural-borne vibrations at the worst loading conditions by up to a factor of five. Overall, the system also reduced vibration levels for the other load cases. In order to meet schedule and the stringent requirements for the GFO and STEX missions, the whole-spacecraft isolation system was designed, fabricated, and tested in less than 4 months. This accomplishment proved not only the technical performance of the isolation technology, but also the ease-of-use and flexibility required for routine use in operational systems.



The OSP/Minotaur mission used a system designed to reduce both axial and lateral loads. The data from this mission is still being analyzed, but the initial results appear consistent with the previous two missions.

By reducing structure-borne vibrations for spacecraft, whole-spacecraft launch isolation directly impacts the overall cost of a spacecraft's design, testing, and operation. With lower dynamic loads, spacecraft components such as solar arrays and other flexible structures can be made lighter and use less expensive materials, resulting in both mass and production-cost savings. This extra mass margin can be used to incorporate additional equipment into the spacecraft that will enhance mission performance.

Alternatively, the reduced weight will allow some spacecraft to be flown on smaller, less expensive launch vehicles. This technology will also enable the launching of more fragile spacecraft, such as advanced optical systems, and will enable the use of commercial off-the-shelf components. The potential savings using this technology could be several million dollars per launch and reach into billions of dollars over the next decade and beyond. Ball Aerospace and the Air Force's small launch vehicle office (SMC/TEB) estimated that whole-spacecraft isolation technology saved the GFO and STEX programs 6-12 months in schedule and \$8-10M in launch delay and redesign costs. Analytical results show an 80% reduction in dynamic loads due to resonant burn load cases. The flight data, shown in Figure 7, concurs with analytical predictions and shows an overall 50% g peak reduction seen from all loading conditions. The dark shade is the response below the isolation system; the lighter shade is the response above the isolation system (and therefore experienced by the spacecraft).

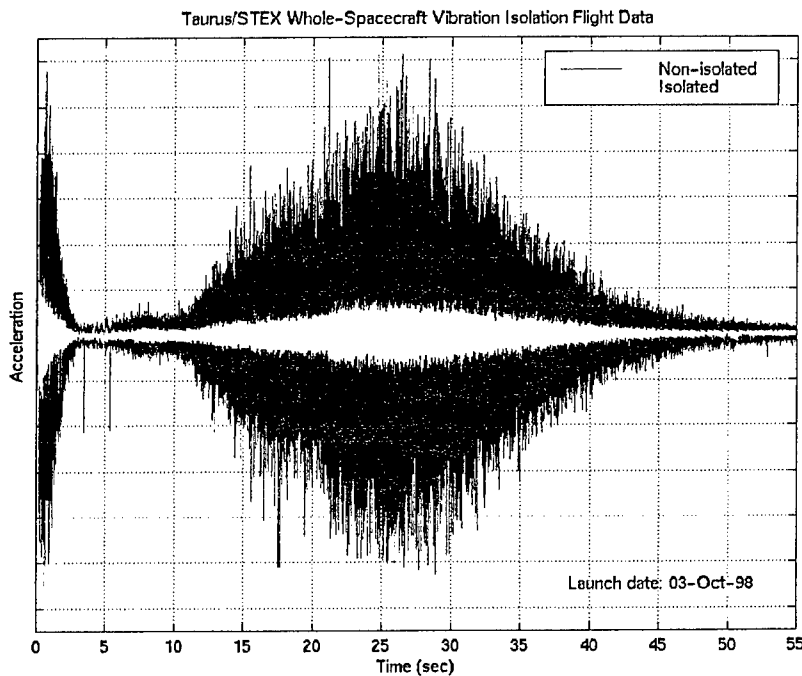


Fig. 7: Flight Data for STEX Spacecraft.

The primary payload on ESPA can opt to use a tunable vibration isolation system that should provide at least a factor of two reduction in vibration loads. A tunable system offers great flexibility, allowing the use of the same isolation hardware for many different payloads and on different launch vehicles. Depending on particular spacecraft needs, the vibration isolation system may be axial, lateral, or combined axial/lateral. Figure 8 shows ESPA with a primary payload vibration isolation system included.

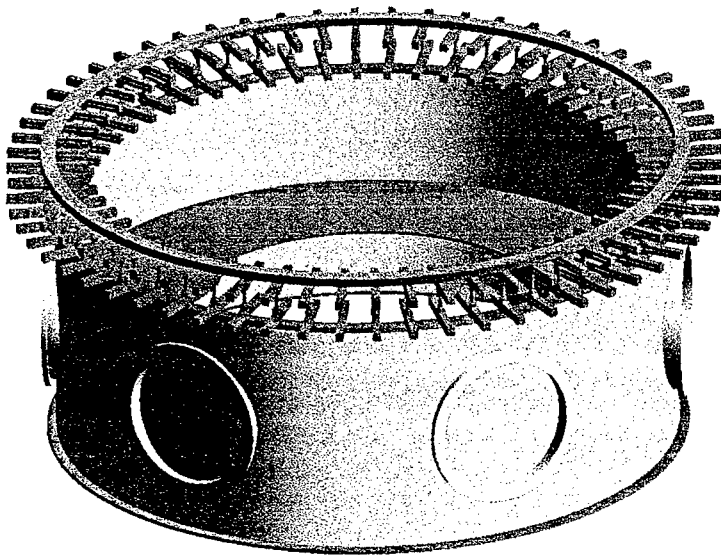


Fig. 8: ESPA with Primary Payload Vibration Isolation System.

CSA Engineering has also begun development of passive shock isolation systems. These systems are designed to protect spacecraft from shock and high-frequency structure-borne acoustics. The first flight of a shock isolation system on a Taurus launch vehicle is expected in December 2000.

A shock isolation system will be an option available to secondary payloaders using ESPA. Primary payload customers can choose between no isolation, whole-spacecraft shock isolation (high frequencies only) or whole-spacecraft vibration isolation, which works for both low and high frequency loads.

## 5 – THE ESPA PROGRAM

STP and AFRL/VS are working together to design ESPA and build two ESPA units. The first unit will be used for EELV qualification testing and the second will be a flight model to be used in a demonstration mission. ESPA Preliminary Design Review was held on 2 March 2000, and Critical Design Review is scheduled for September 2000. Both ESPA units will be finished in FY02 and STP hopes to have ESPA qualified and ready for flight as early as 2003. After the demonstration mission (and perhaps earlier), STP and AFRL/VS hope to “commercialize” ESPA. The goal is to find a commercial partner to produce ESPA hardware and to integrate the secondary payloads on future

missions. The commercial partner could use ESPA commercially as well. Presently, it is unclear what organization will take responsibility for ESPA.

The specific EELV mission that will host the ESPA demonstration flight has not been identified. The first military EELV mission is scheduled for 2002. Clearly, the Air Force is focused on the overall success of the EELV program and ESPA will not be included on the first EELV missions in order to avoid risk.

The demonstration mission is being planned with two primary considerations – sufficient booster margin and a useful mission orbit. Unfortunately, these two factors rarely come together on the same mission. Two EELV-M missions are considered likely candidates for the ESPA demonstration flight. The first is the 2005 Defense Meteorological Satellite Program (DMSP) mission to sun-synchronous orbit. The second is the STP-owned EELV mission also planned for 2005. The primary payload and orbit for the STP EELV mission have not been identified, but there is certain to be sufficient margin to accommodate ESPA. NASA has expressed interest in using ESPA to launch their ST-5/Nanosat Constellation Trailblazer (NCT) spacecraft to geosynchronous transfer orbit (GTO). STP is working with NASA to manifest ESPA/NCT with the Defense Satellite Communications System (DSCS) mission planned for May 2003. If this mission is successfully manifested, AFRL can provide the flight hardware but NASA will be responsible for secondary payload mission management and ESPA/NCT integration. Regardless of the NASA-lead mission, the 2005 Space Test Program ESPA demonstration mission would still occur.

## 6 – MISSION INTEGRATION

Many ESPA integration considerations are specific to the particular launch vehicle, mission orbit, and primary and secondary payload requirements. However, some general guidelines can be stated. Boeing and Lockheed-Martin have studied the tasks necessary to include ESPA and secondary payloads on an EELV mission. Both companies concluded ESPA could be accommodated in the typical 24-month launch vehicle processing timeline. However, this assumes the secondary payload manifest is fixed at L-24 months. Thus, time to identify and manifest secondary payloads (perhaps as long as 8 months, if the goal is a fully loaded ESPA ring) should be considered in the overall ESPA mission integration schedule. Adding ESPA to an EELV mission after L-24 months is possible, but the additional costs incurred by the secondary payloaders rapidly become prohibitive. To protect against late delivery of secondary payloads, each secondary payload may be required to provide a space qualified satellite mass/volume simulator which could fly in place of the actual spacecraft.

As a general requirement, secondary payloads must not prohibitively interfere with the primary payload. In order to minimize CG offset of the entire payload stack, maintaining mass balance will likely be a requirement for ESPA. Thus, spacecraft with very similar masses must be integrated in opposing pairs on the ring. In general, secondary payloads must meet primary payload environmental (for instance, gaseous nitrogen purge within the payload fairing), thermal, and EMI/EMC requirements. Secondary payloads will be electrically inactive during launch.

After primary payload release, a collision avoidance maneuver by the second stage is likely, followed by secondary payload release in pairs. Clearly, ESPA is ideally suited for launching constellations of small satellites. The ability of the EELV second stage to perform delta-V burns and reorientation maneuvers for secondary payloads will depend highly on the specific mission and residual booster capacity. These mission-specific capabilities would be defined during the 24-month launch vehicle processing timeline.

The cost goal for the ESPA program is to provide small satellite launches for less than \$1.0M per satellite. This goal assumes no launch vehicle cost sharing with the primary payload (a reasonable assumption for DoD launches). Furthermore, it assumes a fully loaded ESPA and six-way integration cost sharing among the secondary payloads. Finally, the cost goal assumes the secondary payloads and ESPA are manifested on the EELV mission and in place at the beginning of the launch vehicle processing timeline. This prevents duplicating analyses (such as coupled loads analysis) by having the flight configuration defined early. The recurring cost for ESPA hardware is estimated at less than \$1M (excluding optional isolation systems). The unknown quantity is the additional costs incurred from the launch vehicle contractor to develop ICDs, conduct additional coupled loads analyses, and integrate the loaded ESPA ring to the booster. These costs will not be defined until a demonstration mission is undertaken. Nevertheless, we are confident ESPA launch costs will be highly competitive with current US and international secondary payload launch costs and will offer significant savings as compared to US small expendable launch vehicle costs.

## **7 - CONCLUSION**

ESPA has the potential to make a tremendous impact on future military and commercial spacecraft programs by providing a fast and inexpensive way of launching small payloads. ESPA provides a cost-effective means for launching up to six small satellites, plus a large primary payload, on a single EELV-Medium booster. ESPA causes minimal impact to the primary payload and can provide the primary payload with an improved flight environment through the use of passive whole-spacecraft vibration isolation or shock isolation systems. For improved safety and ease of integration, ESPA incorporates a standard low-shock/non-pyrotechnic secondary payload separation system. Most importantly, ESPA can provide access to space for small satellites for far less than the cost of a dedicated launch vehicle.



## **DNEPR SPACE LAUNCH SYSTEM FOR SMALL SATELLITES**

**V.A. Andreev, O.I.Drobakhin, S.N.Konyukhov ,**

**V.S. Mikhailov, S.I. Us, V.A. Solovey**

**International Space Company Kosmotras, Moscow, Russia**

International Space Company (ISC) Kosmotras (joint stock company) was established in 1997 by aerospace organizations of Russia and Ukraine in accordance with the decisions of the governmental bodies of Russia and Ukraine in order to provide launch services utilizing SS-18 ICBM-based Dnepr Space Launch System ( SLS ). START Treaty provides for the use of decommissioned missiles for launching space payloads.

The governments of Russia and Ukraine through special decrees have gave to ISC Kosmotras the right to develop and commercially operate SS-18 ICBM-based Dnepr SLS. ISC Kosmotras shareholders include Russian and Ukrainian companies, the principal industrial company is State Design Bureau Yuzhnoye. Since July 1999 the representatives of the Governmental bodies of Kazakhstan have also been included on the company's Board of Directors. ISC Kosmotras maintains contacts with launch customers, signs the contracts with customers, organizes their fulfillment by companies – subcontractors from Russia, Ukraine and Kazakhstan, works in cooperation with the Russian Ministry of Defense, Russian Aerospace Agency, National Space Agency of the Ukraine and National Aerospace Committee of Kazakhstan.

US company Thiokol Propulsion from Cordant Technologies is the marketing agent of Dnepr SLS in the Western market.

The Dnepr program will be implemented using these key components:

- Near 150 SS-18 missiles suitable for conversion into Dnepr Launch Vehicle ( LV )
- Existing launch complex ( 4 silos ) and ground infrastructure at Cosmodrome Baikonur
- All means and qualified personnel required for SS-18 conversion into Dnepr LV.

Dnepr SLS consists of the following elements:

- Dnepr LV ;
- Launch complex ( silo tipe) with control center;
- Spacecraft ( SC) and Space Head ( SM) processing facility .

The based SS-18 ICBM has 20 years of mission success. Dnepr LV uses proven SS-18 processing and launch procedures. The confirmed reliability index is 0,97. The total sub-orbital number was more than150. First commercial space launch took place on April 21, 1999. The British Earth remote sensing satellite UoSAT-12 ( company Surrey Satellite Technology Ltd ) was launched into circular orbit 650 km altitude, 65 ° inclination .

The Dnepr LV is a three-stage rocket powered by liquid propellant motors on all stages. The launch of the vehicle from the silo is a gas eject-type. Already designated drop zones are used for the launches on Dnepr LV. Various inclinations are possible, such as:  $46^{\circ}$ ,  $51^{\circ}$ ,  $65^{\circ}$ ,  $87^{\circ}$ , and  $98^{\circ}$  (sun-synchronous orbit).

ISC Kosmotras plans to use two Dnepr LV configurations: Dnepr-1 and Dnepr-M.

- **Dnepr-1** is a basic configuration with maximum SS-18 heritage. It includes the modification of the control system, installation of payload adapter and protective gas-dynamic screen (protective encapsulation of the payload.). Dnepr-1 is capable of launching large payloads as well as clusters of small payloads. This configuration was used to launch UoSAT-12. *Fig.1* shows the Dnepr-1 LV performance curves for circular orbits (payload mass launched into various orbit altitude).
- **Dnepr-M** configuration includes the modification of the third stage propulsion system based on "push" scheme (as opposed to "drag" scheme on Dnepr-1 LV), installation of additional stabilization and altitude control thrusters, programmed turn-on and shut-off of the sustainer propulsion system, modification of the control system and introduction of a new extended faring. The operation of this configuration (beginning from 2002) depends on market demand.

### Dnepr-1 LV

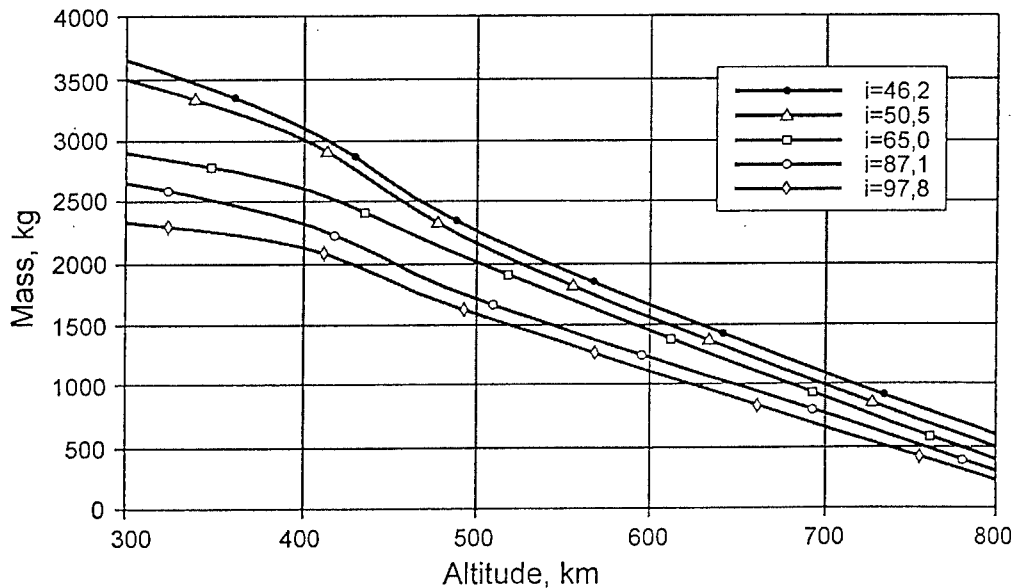
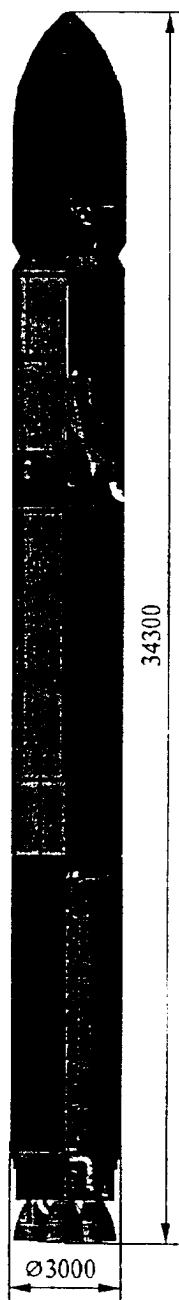


Figure 1. Dnepr-1 LV Performance Curves

Dnepr LV general view and principal characteristics are in *Fig. 2*.

Fig 2. DNEPR LY GENERAL VIEW AND PRINCIPAL CHARACTERISTICS



Total launch mass	211 t
Propellant components for all stages:	Amyl + Heptyl
Number of stages	3
Spacecraft injection accuracy	
-for altitude	± 4.0 km
-for inclination	± 2.4 angle minute
-for the right ascension of the ascending node	± 3.0 angle minute
Orbit inclination	46°, 51°, 65°, 87°, 98°
Flight reliability	0.97
Loads affecting the spacecraft:	
-maximum axial quasi-static g-load	7.5
-maximum lateral quasi-static g-load	0.8
-integral level of sound pressure	140 dB

Beginning from 2000 ISC Kosmotras approves a **program of multiple-payload (cluster) launches using Dnepr-1 LV**. The small and micro satellites commissioned by the universities, state and commercial customers will be launched. Kosmotras understands the trends in the area of small satellite technologies. These trends can provide the manufacturers of small satellites with an opportunity to have relatively inexpensive launches, which can be performed on the regular basis. The philosophy of ISC Kosmotras is that converted launch vehicles ( the most powerful of which is Dnepr LV ) should bring the maximum benefit to humanity during their "second lifecycle".

The principles of the program are as follows:

- A group of 2-8 satellites shall be deployed into orbit in one launch
- In the period between 2000 and 2007 there will 1-2 such launches each year
- Orbital parameters for cluster launches are as follows: altitude 650-700 km, inclination 65° and 98° (sun-synchronous orbit)
- Spacecraft should have simple interface with the launch vehicle without electrical connections
- Depending on the satellite integration complexity and processing requirements the price for the launch services shall be 10,000-15,000 USD per one kg of payload.

The assumption is that cluster launches will be more attractive and preferable for universities and other small satellite manufacturers than secondary payload launches. In a cluster launch each spacecraft is a "primary", and not a "secondary" payload.

ISC Kosmotras also is ready to use the scenario, in which there will be a "primary customer" who will pay the total launch price and will find the additional passengers to himself.

ISC Kosmotras program of the cluster launches of small satellites using LV Dnepr-1 received the support of the Russian Aerospace Agency and National Space Agency of Ukraine.

The first cluster launch in accordance with program planned to be **in the 3-d quarter of 2000**. Orbit parameters : 650 km altitude, 65° inclination . ISC Kosmotras have signed the contracts for launch of 5 satellites with the following companies:

Company	Country	Satellite
Rome University "La Sapienza"	Italy	UNISAT
MegSat S.p.A.	Italy	MEGSAT-1
Space Research Institute, King Abdulaziz City for Science and Technology	Kingdom of Saudi Arabia	SAUDISAT-1A SAUDISAT-1B
Astronautic Technology (M) Sdn.Bhd.	Malaysia	TIUNGSAT-1

The second cluster launch is planned to be in the 1-st quarter of 2001 into sun-synchronous circular orbit 700 km altitude.

ISC Kosmotras invites the manufacturers of small satellites ( universities, governmental and commercial customers ) interested in launch services to mutually advantageous co-operation.



## **ROCKOT'S COMMERCIAL LAUNCH SERVICE DEBUT**

**York VIERTEL, Mark KINNERSLEY, Peter FREEBORN**

*EUROCKOT Launch Services GmbH*

*D-28199 Bremen, Hünefeldstr. 1-5*

### Abstract:

*The commercial flight debut of the ROCKOT launch vehicle is described. The ROCKOT vehicle's maiden Plesetsk mission is also the vehicle's first flight under EUROCKOT auspices. ROCKOT which has flown successfully three times from Baikonur, will fly this mission in full commercial configuration and will fly a simulated commercial mission including injection of satellite simulators. It will be fully instrumented to verify the launch environment. The results of this mission will be described in detail within this paper.*

*ROCKOT can launch satellites weighing up to 1850 kg into polar, sun synchronous (SSO) or other low earth orbits (LEO). The ROCKOT launch vehicle is based on the former Russian SS-19 strategic missile. The first and second stages are inherited from the SS-19, the third stage has been newly developed and is characterized by multiple ignition capability. The extremely high flexibility of both the payload accommodation and the launch systems allows the fast service: a nominal launch campaign lasts 19 working days and consists of the operations regarding the launch vehicle, the spacecraft and combined system launch vehicle / spacecraft. The high degree of maturity of the launch vehicle and the launch systems contribute to the competitively fair price level. The ROCKOT launch system is flight proven and marketed by EUROCKOT. EUROCKOT Launch Services GmbH has been founded by DaimlerChrysler Aerospace of Germany and Khrunichev State Research and Production Space Center of Russia KSRC to offer world-wide cost effective launch services on the ROCKOT launch system.*

### **1 Launch Vehicle Heritage and Flight History**

The Rockot launch vehicle uses a decommissioned RS-18 ICBM (NATO designation: SS-19 Stiletto) as its first two stages. The RS-18 was developed between 1964 and 1975 by the Chelomei Design Bureau, which later evolved into the Khrunichev State research and Production Space Center.

A restartable, upper stage, called Breeze-K, had been developed by Khrunichev to make the launcher suitable for orbital launches. Three successful silo test launches have been conducted from the Baikonur Cosmodrome between 1990 and 1994, of which two were suborbital and one was orbital.

The Breeze-KM stage is a structurally modified version of the original Breeze-K stage. It provides more payload space.

A commercial demonstration flight with the newest Rockot configuration is scheduled from Plesetsk for May 2000. The launch will be conducted out of a transport- and launch container serviced by a launch tower.

## 2 Commercialization of the Rocket Launcher

To commercialize the Rockot booster and reach potential western customers, Khrunichev (KSRC) teamed with Daimler-Benz Aerospace (DASA), now DaimlerChrysler Aerospace, in 1995 to form a joint venture named EUROCKOT Launch Services.

KSRC provides the launch vehicle, refurbished the launch site and is responsible for conducting launch operations in conjunction with the Russian Military Space Forces. DASA contributed capital to complement the Rockot launcher launch site infrastructure in Plesetsk, to upgrade and refurbish the launch facilities. EUROCKOT is the single point of contact for the customer.

Marketing efforts began in 1997, and EUROCKOT has since signed contracts for several launches beginning in 2000. The most common potential payloads are satellites to make up LEO communication constellations or international small scientific satellites.

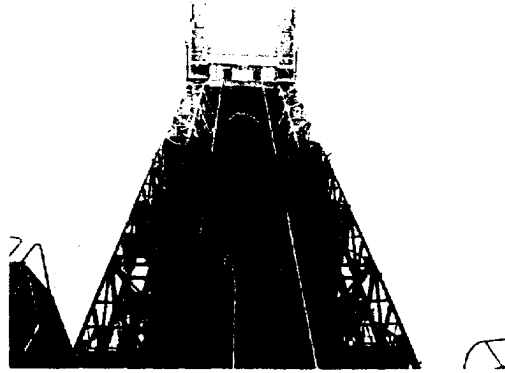


Fig. 1: Rockot launch service tower in Plesetsk

## 3 Rockot Vehicle Design

### 3.1 Lower Stages

The first and second stages of Rockot are decommissioned RS-18 ICBM stages providing about 80 tons of propellant in the first stage and about 14 t in the second stage, respectively. Propellant is  $N_2O_4$  and UDMH. The four 1<sup>st</sup> stage closed cycle turbopump RD-0233 engines with single axis nozzle gimbal on each engine provide main thrust and steering capability. The 2<sup>nd</sup> stage contains a closed cycle, turbopump engine designated RD-0235 and one vernier with swivelable nozzles for three axis control. As these stages have been described in many articles and as they are flight proven for more than 146 times, no stress will be laid on their description within this paper.

### 3.2 Breeze Upper Stage and Payload Fairing

The new Breeze-KM is a structurally modified version of the original Breeze-K stage. They are functionally identical; the weight of the KM-version differs slightly from the K-configuration. The stage includes a toroidal oxidizer ( $N_2O_4$ ) tank that encircles the main engine and shares a common bulkhead with the fuel (UDMH) tank.

The original conical equipment section has been flattened and widened to provide more room for the payload. The KM upper stage is no longer attached to the launcher at its base but hung within the extended transition compartment. Consequently, the fairing is now attached directly to the equipment compartment.

The Breeze houses a multiple restartable, closed cycle turbopump fed 20 kN main engine, a bipropellant pressure fed engine with four 400 N thrusters for ullage control and orbital maneuvers and an attitude control system providing 12 x 16 N thrusters. The avionics are located in the equipment bay on top of the Breeze stage. The guidance, navigation and control system controls the vehicle all stages of flight.

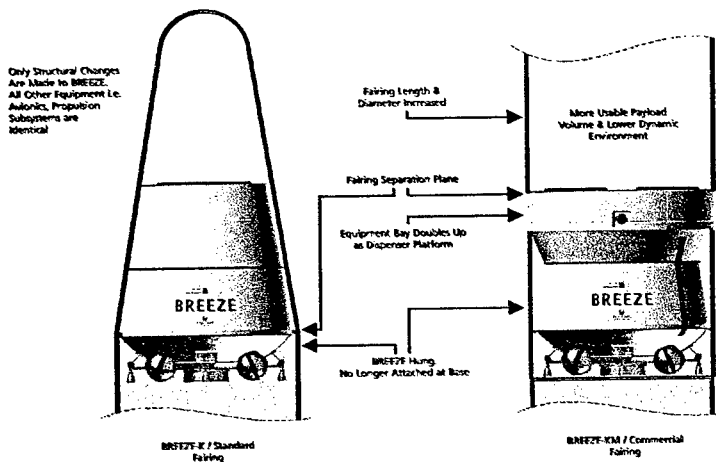


Fig. 2: Commercial Payload Fairing Heritage

It includes an inertial guidance system with a three-axis gyro platform, and a flight computer. Control commands are computed in three separate channels, with majority voting to correct errors.

The telemetry system includes onboard tape recorders to store in-flight data until it can be transmitted to an available tracking station. Vehicle tracking is facilitated by a beacon. The usual mission duration capability of five hours can be prolonged up to seven hours on customer's demand. This widens the mission flexibility to inject payloads into different orbits on one flight.

The new BREEZE-KM fairing replaces the former fairing of the Breeze-K stage used during three test flights. It is an enlarged version providing much more space for commercial usage. The new composite fairing is based on the design of the PROTON commercial payload fairing. The structure is a carbon fiber composite sandwich over an aluminum honeycomb core. Its two half-shells are released by mechanical locks along the vertical split line and firing pyrotechnic bolts along the horizontal split line of the fairing. The two halves are then pushed apart with springs and rotated around hinges at the top of the BREEZE stage. As an alternative to the existing Russian payload adapter system, a 937 mm Adapter (or smaller diameter) can be supplied and used for single payloads. The adapter is a structure in the form of a truncated cone providing standard diameters at the level of the spacecraft separation plane. It is attached to the lower 1920 mm ( 75.6 in ) bolted interface. The spacecraft is secured to the adapter interface by a clamp band. A multiple payload system designed to carry and deploy secondary payloads on Rocket is currently being defined by Eurockot for mixed manifest passengers and is intended to be offered soon. In this configuration, micro-and mini satellites are mounted on a platform around a primary payload in the rocket center line.

Eurockot is currently offering a CASA CRSS clamp ring separation system as baseline for the classic 937 mm ring adapters. Two remarkable features of this separation system are the low shock level induced by payload separation, and the uniform tension distribution. The clamp ring separation system will generally be offered for the diameters of 937mm and 1194 mm. Dispensers for satellite constellations can be mounted in the payload zone as well.

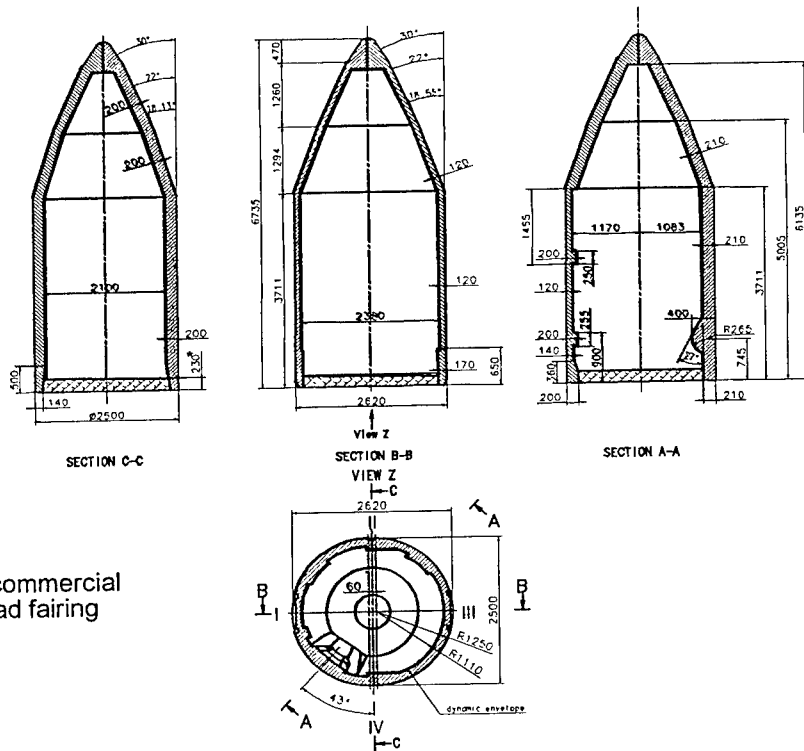


Fig. 3: New commercial payload fairing

#### 4 Performance

ROCKOT is launched from both Plesetsk Cosmodrome in Russia and Baikonur Cosmodrome in Kazakhstan.

Because both launch sites are landlocked, specific drop zones away from populated areas are reserved for the impact of separated rocket booster stages. Launch azimuths are therefore limited to those that will result in impacts in these zones. To reach orbit inclinations corresponding to other launch azimuths, ROCKOT trajectories can include a dogleg maneuver during the second-stage burn. If necessary, the restartable BREEZE upper stage can also perform plane change maneuvers. The multiple burn capability is also used to perform the circularization burn for orbits above approximately 400 km.

From Plesetsk available launch azimuths for Rockot launches are 90, 40, 18-7.5, and 345 deg. These correspond to inclinations of 63, 73, 82-86.4, and 97 deg, respectively. However, to avoid a second stage impact in foreign territorial waters, launch along the 345 deg launch azimuth must perform a dogleg

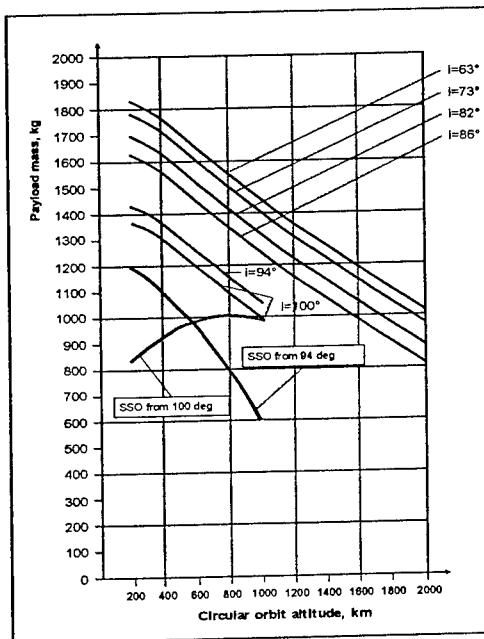


Fig. 4: Rockot payload performance from Plesetsk

during second-stage burn, which results in injection into a 94 or 100 deg-inclination transfer orbit rather than the expected 97 deg. Sun-synchronous or other retrograde orbits are reached from one of these two transfer orbits using a plane change maneuver. Thus, all usual SSO inclinations between a 96.4 deg km orbit to over 101° can be served.

From Baikonur, the restartability capability of ROCKOT's upper stage BREEZE allows to serve inclinations some degrees lower than 50- and higher than 53 deg, respectively, the exact inclination depending on payload target orbit - and mass. ROCKOT can also inject payloads into elliptical orbits.

Payload injection into earth escape and towards the moon is possible by using a suitable additional solid propellant kick-stage (eg Thiokol's STAR 37M) housed inside the fairing.

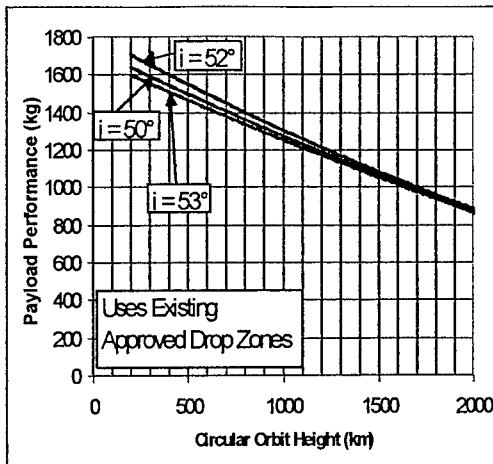


Fig. 5: Rockot payload performance from Baikonur

## 5 Rockot Commercial Demonstration Flight

A Commercial Demonstration Flight (CDF) is scheduled for May 2000 from the Plesetsk cosmodrome. The CDF will be performed

- to demonstrate the operational readiness of the newly installed Plesetsk launch infrastructure for commercial operations
- to provide flight verification of the commercial configuration of the Rockot launch vehicle incorporating the commercial payload fairing and the Breeze-KM stage. The flight vehicle will be fully instrumented.

Upon successful completion of this mission, Eurockot's Rockot Launch System will be declared ready for commercial operations from Plesetsk.

The Rockot launch configuration corresponds to the description in the paragraphs before and is identical to the version to be used for commercial flights.

The ground infrastructure in Plesetsk has been fully adapted and enlarged to the Rockot system. An existing launch pad which was formerly used for the COSMOS launch vehicle has been adapted exclusively for Rockot. The CDF will be the first Rockot launch from Plesetsk. The launcher will be started out of a launch container, a launch tower will provide service during launch preparation and countdown. The CDF comprises testing of the launcher and of the ground infrastructure. Two identical satellite simulators, named SIMSAT-1 and SIMSAT-2 will be deployed into Low Earth Orbit. The spacecraft environment will be typical for Rockot commercial flights.

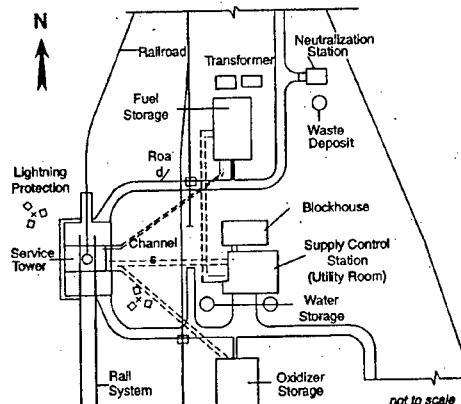


Fig. 6: Rockot Launch pad facilities

## 5.1 Performance and Flight Sequence

The CDF osculating parameters are typical for high inclined orbits..

Parameter	Value
Circular orbit altitude	547 km
Inclination	86.4°
Eccentricity	0
Right ascension of ascending node (RAAN) referred to Greenwich and fixed at launch ( $\Omega$ )	34.8°

Fig. 7: Osculating parameters

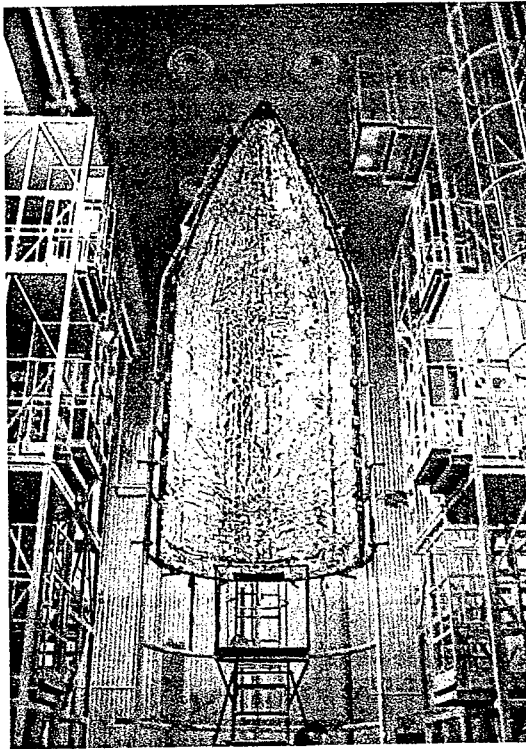
1<sup>st</sup> stage flight is ended after 136 s. Before separation of the 1<sup>st</sup> stage, 2<sup>nd</sup> stage's verniers are started-up. Fairing deployment is performed during 2<sup>nd</sup> stage's flight guaranteeing a flux lower than 1135 W/m<sup>2</sup>. Stage 1/2- and stage 2/3 separations are supported by retro rockets. The Breeze 3<sup>rd</sup> stage main engine is then fired. Before all firings of Breeze' main engine, propellant settling is performed by Breeze' verniers. After main engine shut down, Breeze moves on into an elliptical intermediate orbit of 153 x 547 km. Target orbit inclination of 86.4° is attained. During the following coast phase, a Breeze orientation towards sun is performed. Before circularization into the target orbit Breeze is turned into main engine firing position. After circularization at about 4500 s, Breeze is oriented into spacecraft separation position and another propellant settling maneuver is performed by help of the 4 x 400 N thrusters. Breeze angular velocity is decreased. The two identical spacecraft, SIMSAT-1 and SIMSAT-2 are separated from Breeze keeping up longitudinal axis orientation. Now, Breeze attitude control is permitted only by help of engines perpendicular to the flight plane. The upper stage is withdrawn from the spacecraft operational area. Once the spacecraft are in safe distance of the stage, attitude control is permitted by help of all thrusters. Breeze is then brought into position for final main engine firing bringing the upper stage into a safe orbit of 214 x 547 km. Flight data are down linked to the ground control station. Fuel residuals are burnt out and pressurization gases are released from all propellant tanks.

## 5.2 Typical Launch Campaign at the Plesetsk Range

A typical campaign representative of Rockot commercial flights is outlined below. Spacecraft processing is conducted within the existing cleanrooms. Launch Operations for Rockot are conducted by the Russian Strategic Missile Forces. Eurockot's Integration Facility (MIK) includes a state of the art western standard class 100000 cleanroom for testing the spacecraft., including a fuelling hall and CCTV monitoring systems (see photos below).

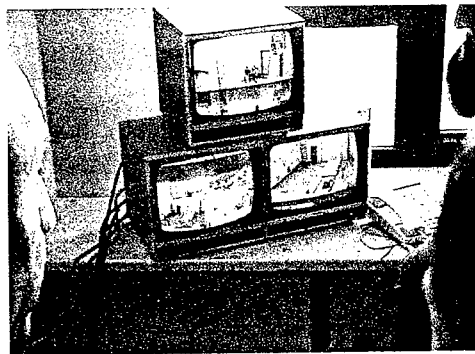
Eurockot's infrastructure includes a modern communications infrastructure enabling international communication within the Eurockot areas with handheld walkie-talkies as well as supporting fixed line phones and a local fiber optic network for communications from launch site / pad area, processing facility and the modern remotely located launch control center (LCC). A commercial high standard hotel operated by Eurockot's parent Khrunichev is also available with all the facilities expected of an international standard hotel.

Approximately two weeks are required for spacecraft operations and most tasks can be conducted in parallel. Combined launch vehicle and payload operations take about 10 days. The spacecraft are encapsulated into the fairing and attached to the Breeze upper stage. Five days before launch the booster is delivered to launch pad 11P865PR at launch complex 133, a former Cosmos launch facility. LC 133 includes a launch mount, a stationary umbilical mast, a mobile service tower with an overhead crane, and a blockhouse roughly 100 m from the launch mount. The booster is delivered in its

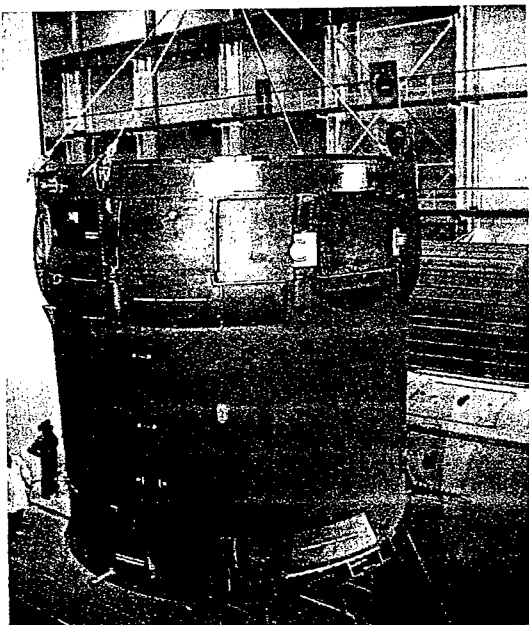


**Fig. 8:** Fairing preparation

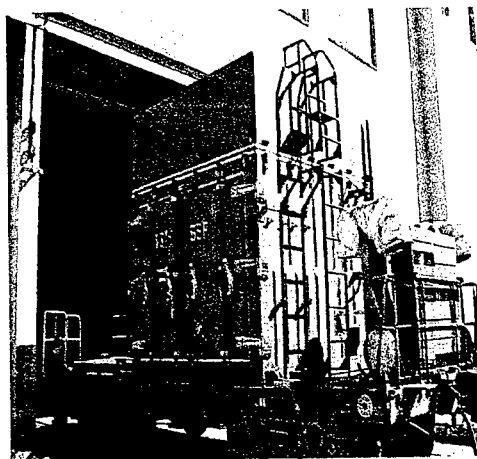
transportation container and lifted into vertical position. At L-5 days, the upper composite (Breeze, payload and fairing) is lifted within the service tower, fixed on the booster, and a launch transport container extension is put in place. One day before launch, the booster is fuelled through interfaces in the launch container. The service tower rolls back 10 minutes before launch. The status of the launcher, payload, pad facilities, downrange tracking and communications network is monitored .



**Fig. 9:** Status monitoring



**Fig. 10:** Loading into transport container



**Fig. 11:** Transport of Breeze-KM to fueling station

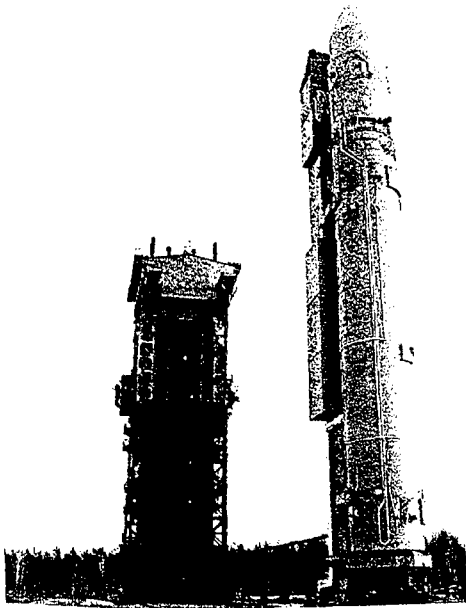


Fig. 13: Erected state

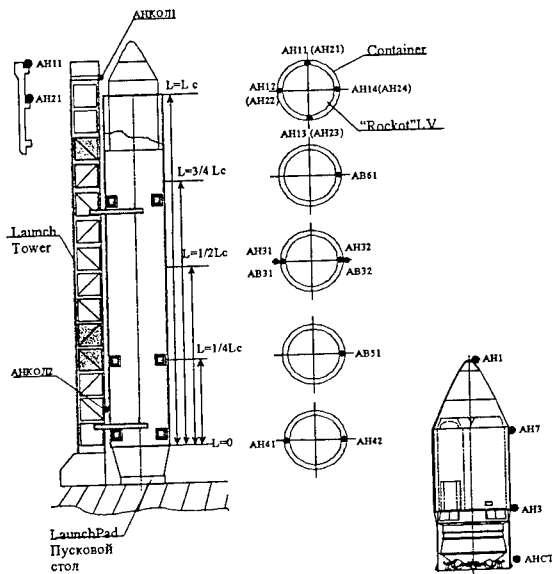


Fig. 14: Location of sensors

### 5.3 Rocket Radiovisibility during CDF

A great amount of downrange tracking and telemetry stations provide coverage up to Breeze first burn. Further data are stored onboard and down linked. Spacecraft deployment (5840 s) is tracked directly. The CDF radio visibility is typical for Rocket commercial, highly inclined ascent trajectories from Plesetsk.

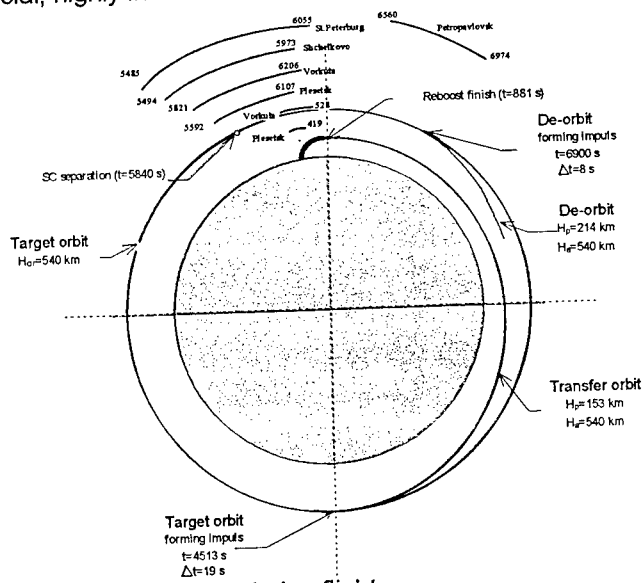


Figure 15: Radio visibility during flight



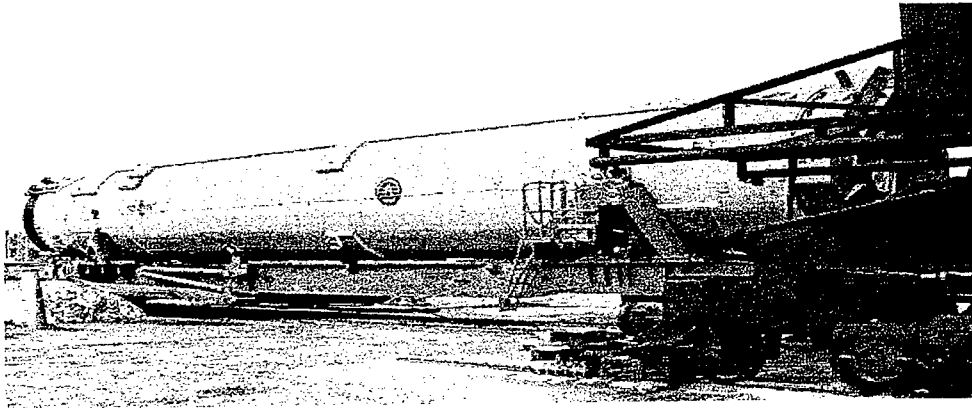
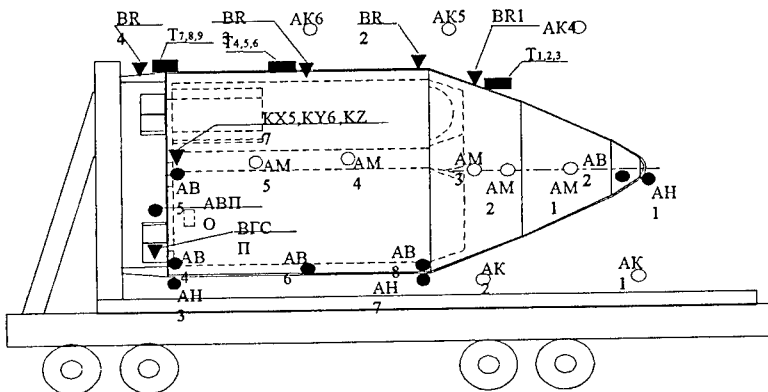


Fig. 11: Booster unit before erection at launch pad

### 5.3 Flight Environment during CDF

The mechanical and electrical environment on the payload will largely correspond to the conditions during future commercial launches. During ascent, the payload will experience flight time dependent quasistatic and dynamic loads in launcher longitudinal- and lateral direction. Accelerations are initiated by the launcher itself, by mission dependent events, the environment and the selected flight path.

The acoustic environment under and outside fairing will be tested during launch respectively all ascent flight long. The measurements designated "AB" and "AH" are used during flight, all others measured the acoustic noise field during tests in the acoustic chamber. Transducers are installed in the payload area and on the service tower.



- Acoustic sensors which are using in flight and tests in acoustic chamber
- Acoustic sensors which are using only during tests in acoustic chamber

Fig. 12: Location of acoustic sensors during test and flight

## PIGGYBACK SATELLITE LAUNCH BY H-IIA LAUNCH VEHICLE

Takumi UJINO, Ryuzo SHIMIZU, Ichiro ONOE, Eijiro NAMURA,  
Keita TERASHIMA, Hiroshi MATSUNAGA

*NATIONAL SPACE DEVELOPMENT AGENCY of JAPAN (NASDA)*

*World Trade Center Building 26F*

*2-4-1 Hamamatsu-cho, Minato-ku, Tokyo, 105-8060, JAPAN*

**ABSTRACT** – The H-IIA launch vehicle family is designed to meet diversifying launch demands in the 21st century with lower cost and high degree of reliability by making the best use of H-II launch vehicle technology. The H-IIA launch vehicle family consists of standard vehicle and augmented vehicle. The standard vehicle has launch capability of a 4-ton class payload into geostationary transfer orbit. The H-IIA launch vehicle can launch four piggyback satellites, if enough launch capability remains besides the main mission. We would like to introduce launch configuration of piggyback satellites by the H-IIA launch vehicle in this paper.

### 1-INTRODUCTION

The H-IIA launch vehicle family consists of standard vehicle and augmented vehicle. The standard vehicle has launch capability which can launch and inject a 4-ton class payload into geostationary transfer orbit. The H-IIA launch vehicle can launch four piggyback satellites, if there is enough launch capability is left besides the main mission.

This paper describes two launch configurations of piggyback satellite, one is a standard configuration and the other is a special configuration, and introduces the outline of a payload attach fitting for piggyback satellites.

### 2-OUTLINE OF THE H-IIA LAUNCH VEHICLE

#### 2.1-H-IIA Launch Vehicle Family

The H-IIA launch vehicle family is designed to meet various mission demands in the 21st century with lower cost and high degree of reliability using the technology of the H-II launch vehicle.

The H-IIA launch vehicle, in its standard configuration, is capable of launching a two-ton class payload into the geostationary orbit, the same as the H-II launch vehicle.

Fig.1 shows outline of the H-IIA launch vehicle. Table-1 shows the H-IIA launch manifest.

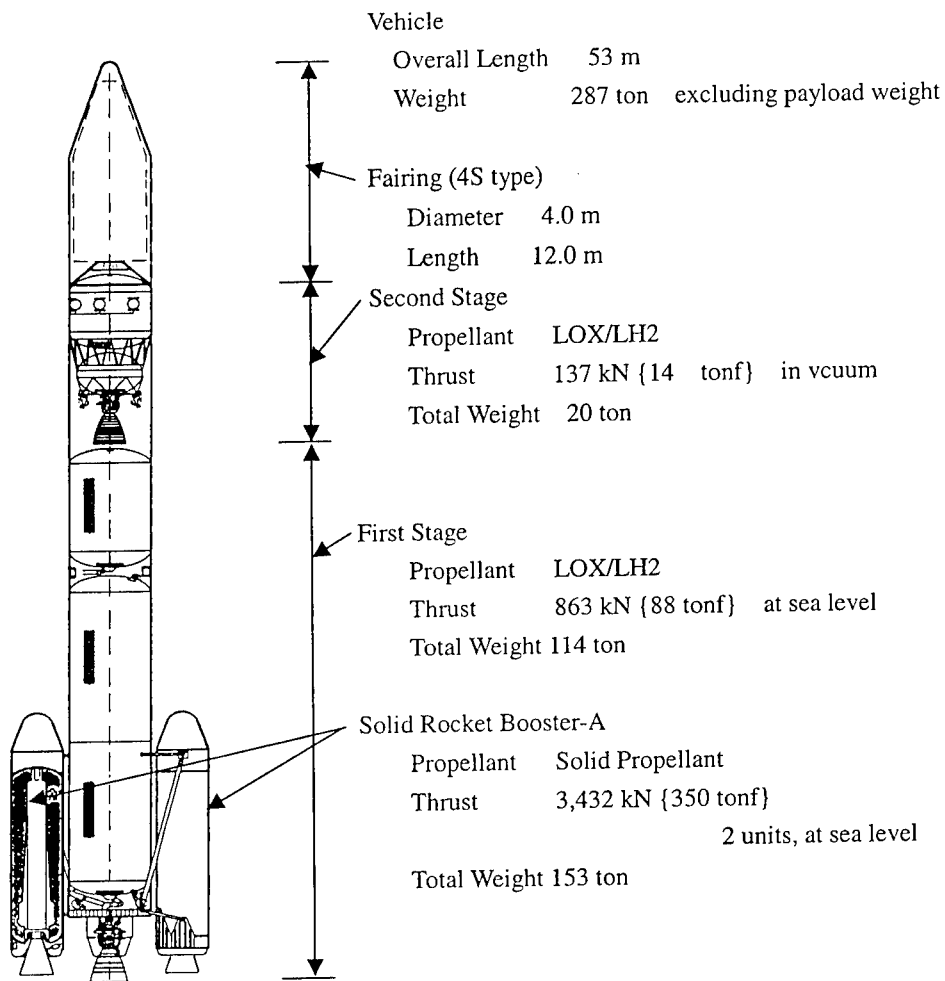


Fig.1 : H-IIA Launch Vehicle

Table 1 The H-IIA Launch Manifest

Flight No.	Main Payloads (orbit)	Piggyback Satellites	Launch Date
H-IIA TF#1	ARTEMIS (GTO)	DASH	Feb.2001
H-IIA TF#2	MDS-1/DRTS-W(TBD)	-	Summer 2001
H-IIA F#3	ADEOS-II (SSO)	WEOS, FedSat, $\mu$ -LabSat	FY2001
H-IIA F#4	ALOS (SSO)	-	FY2002

ARTEMIS : Advanced Relay and Technology Mission (ESA's mission)

MDS-1 : Mission Demonstration Satellite (NASDA's mission)

DRTS : Data Relay and Tracking Satellite (NASDA's mission)

ADEOS-II : Advanced Earth Observation Satellite (NASDA's mission)

ALOS : Advanced Land Observing Satellite (NASDA's mission)

### 3-LAUNCH CONFIGURATIONS OF PIGGYBACK SATELLITES

#### 3.1-Flight Configuration

The H-IIA launch vehicle has two types of fairing for launching a single main payload which are 4S type and 5S type.

Fig.2 shows standard flight configurations of piggyback satellites using "4S fairing-42 degree PSS", and Fig.-3 shows standard flight configurations of piggyback satellites using "5S fairing-25 degree PSS".

A main payload with a payload attach fitting (PAF) will be loaded on the payload support structure (PSS), and piggyback satellites will be located on side position of the payload support structure. Standard combinations of fairing and PSS are "4S fairing-42 degree PSS" and "5S fairing-25 degree PSS". Piggyback satellites will be separated from the H-IIA after main payload separation.

Standard Body size and weight of a piggyback satellite are shown in Table-2.

Table-2 Body size and weight of piggyback satellite

Size	500 mm ( Width ) 500 mm ( Depth ) 450 mm ( Height )
Weight	50 kg

#### 3.2-Piggyback Satellite Launch by First Flight of The H-IIA

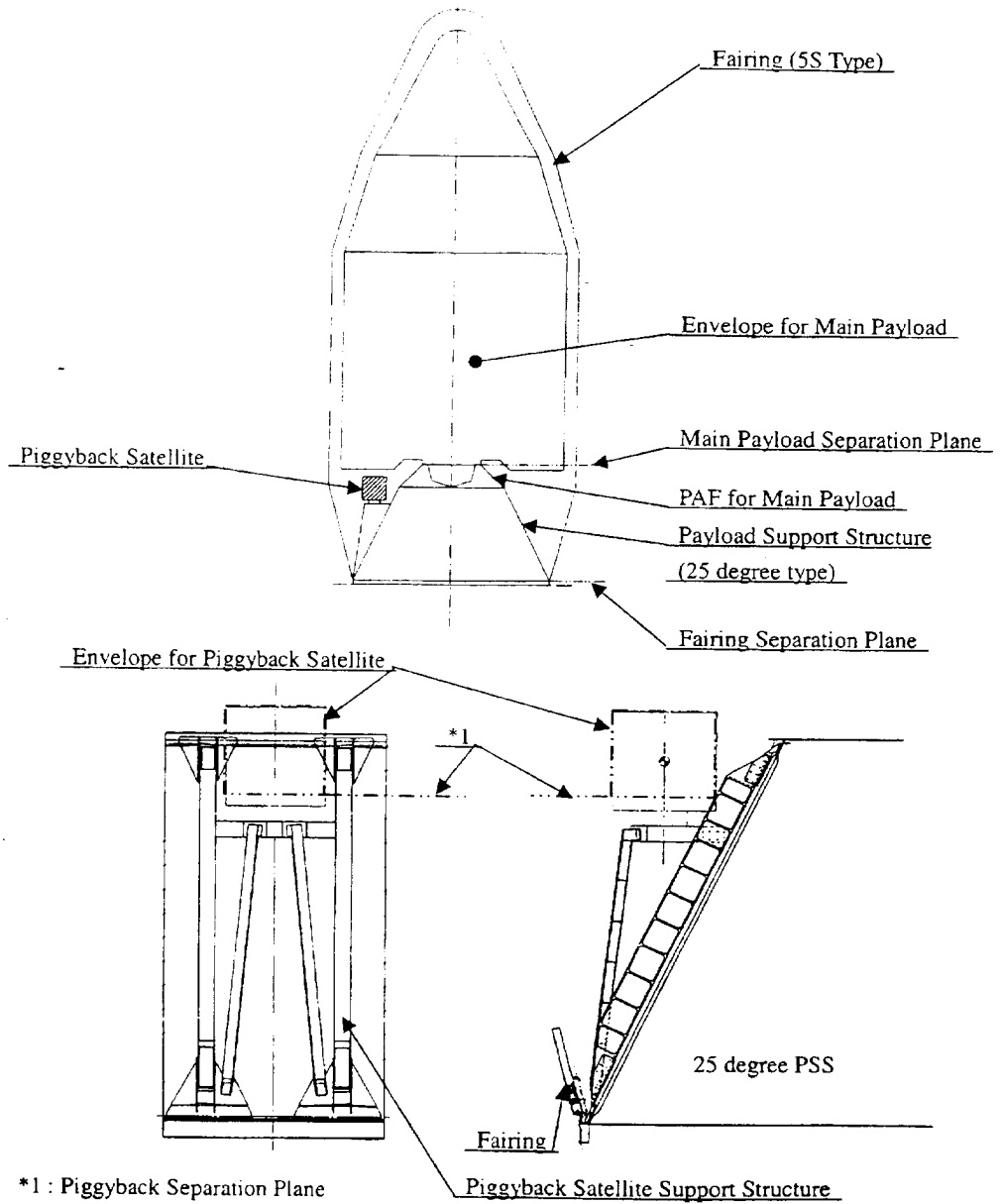
Advanced Relay and Technology Mission Satellites (ARTEMIS) which is developed by European Space Agency (ESA) will be launched by the first flight of the H-IIA in the standard configuration, the combination of "4S fairing-42 degree PSS". ARTEMIS is a main payload of the flight.

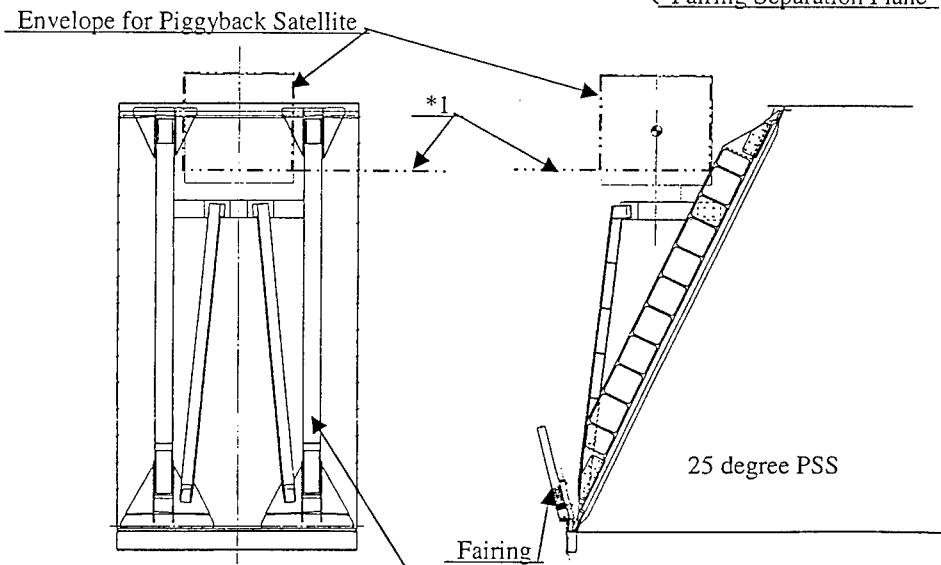
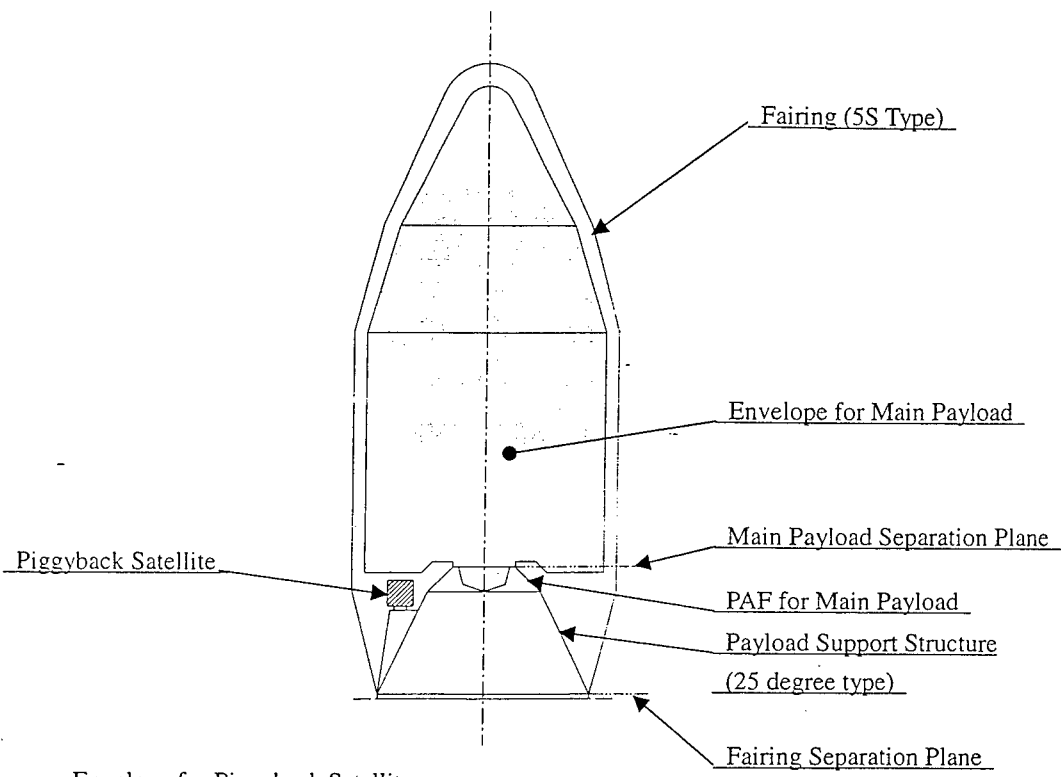
Demonstrator of Atmospheric reentry System with Hyperbolic Velocity (DASH) is a demonstrating spacecraft for high speed reentry and is developed by the Institute of Space and Astronautical Science (ISAS). DASH will be launched with ARTEMIS by the first flight of the H-IIA launch vehicle in February, 2001 as a piggyback satellite.

Table -3 shows main characteristics of the payload.

Table-3 Main characteristics of payloads (First flight of the H-IIA)

Payload	ARTEMIS	DASH
Weight (kg)	Approx. 3100	Approx. 70
Orbit	Geostationary Earth Orbit	-





\*1 : Piggyback Separation Plane

Piggyback Satellite Support Structure

Fig.3 : Flight configuration of piggyback satellites by H-IIA (5S fairing-25 degree PSS)

### 3.3-Piggyback Satellites Launch by the Third Flight of the H-IIA

Advanced Earth Observation Satellite-II (ADEOS-II) will be launched by the third flight of the H-IIA in the special configuration as a main payload, because of a large size of ADEOS-II. Due to its size, ADEOS-II can not be loaded into the combination of "5S fairing and 25 degree PSS". Therefore NASDA decided to use the combination of fairing and PSS that is "5S fairing- 42 degree PSS" with a cylindrical adapter in order to get sufficient envelope for ADEOS-II and to launch three piggyback satellites with ADEOS-II by using of excess launch capability.

The cylindrical adapter shall be installed between PAF for ADEOS-II and PSS to avoid interference between PAF and fairing, because the bottom part of 5S fairing would collide with PAF for ADEOS-II at the time of fairing separation if the combination of "5S fairing-42 degree PSS" were used, as way of H-IIA fairing separation is a clamshell type.

Three piggyback satellites with ADEOS-II are as follows ;

WEOS : Whale Ecology Observation satellite

FedSat : Federation Satellite

Micro-LabSat : Micro Laboratory Satellite

Fig.-4 shows the flight configuration of the third flight of H-IIA launching ADEOS-II, WEOS, FedSat and micro-LabSat.

The piggyback satellites will be loaded on the cylindrical adapter inside the PAF for ADEOS-II because, if piggyback satellites were located on the side position of the PSS, they would collide with the PAF for ADEOS-II after the piggyback separation. Table -4 shows main characteristics of the payload.

Table-4 Main characteristics of payloads (Third flight of the H-IIA)

Payload	ADEOS-II	WEOS	FedSat	Micro-LabSat
Weight (kg)	Approx. 3730	Approx. 50	Approx. 58	Approx. 65
Orbit	Sun Synchronous Subrecurrent			

### 4-PAYLOAD ATTACH FITTING FOR PIGGYBACK SATELITE

Payload attach fitting for piggyback satellite by H-IIA is a marman cramp band type which has an interface frame of 239 mm diameter, named PAF-239M. Fig.5 shows overview of PAF-239M. A piggyback satellite and PAF-239M are connected by two marman cramp bands, and two bands are fastened by two bolts. The piggyback satellite will be separated after cutting the bolts by bolt cutters which are pyrotechnics. The piggyback satellite separation will be successfully performed if one of the bolts is cut.

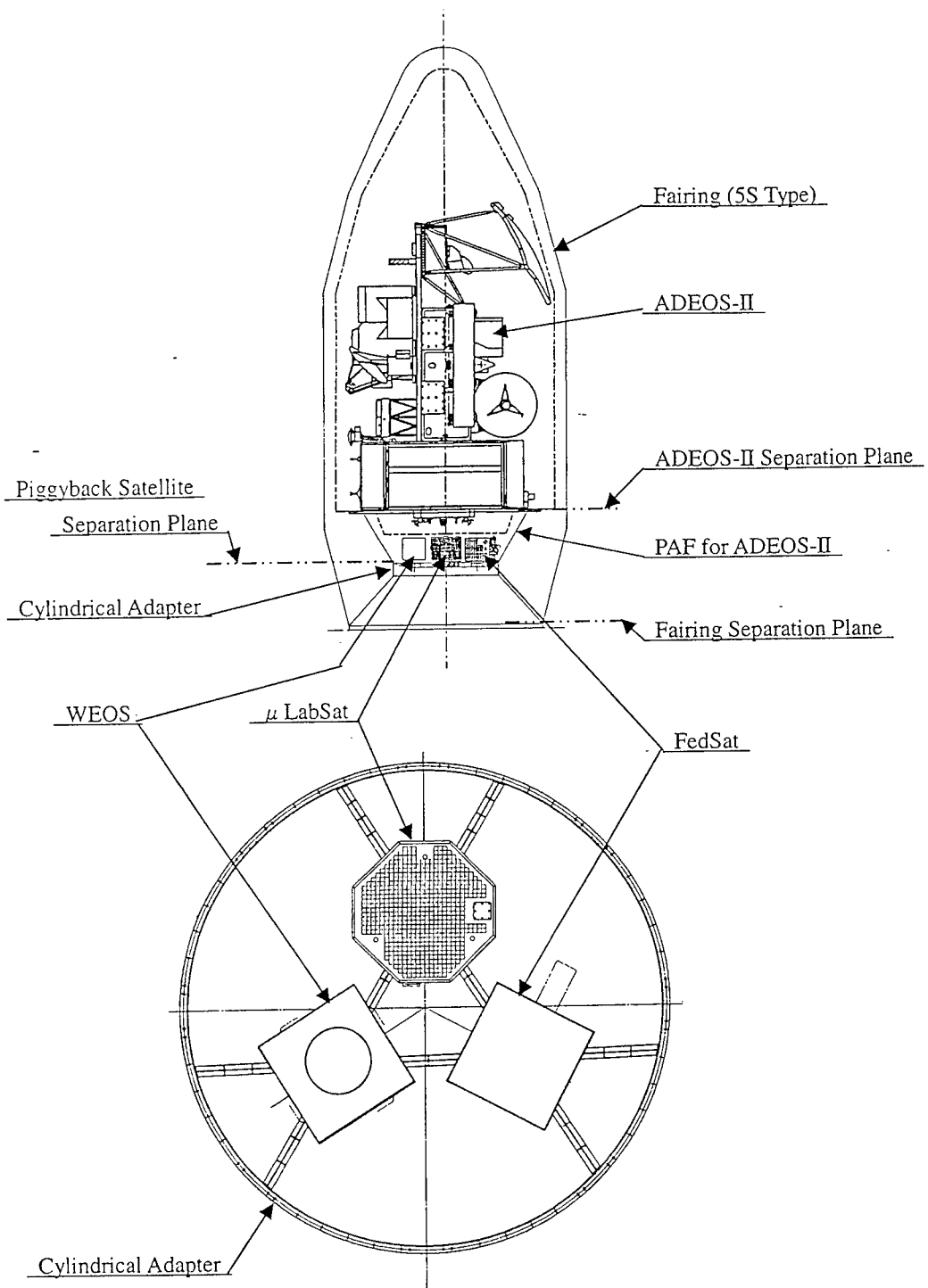




Fig.4 : Flight configuration of the third flight of H-IIA

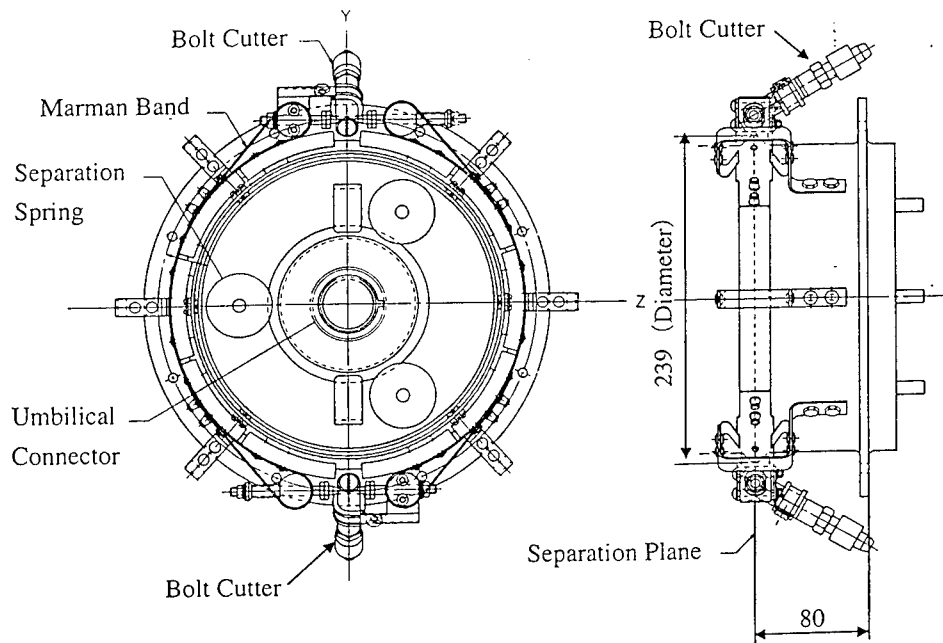
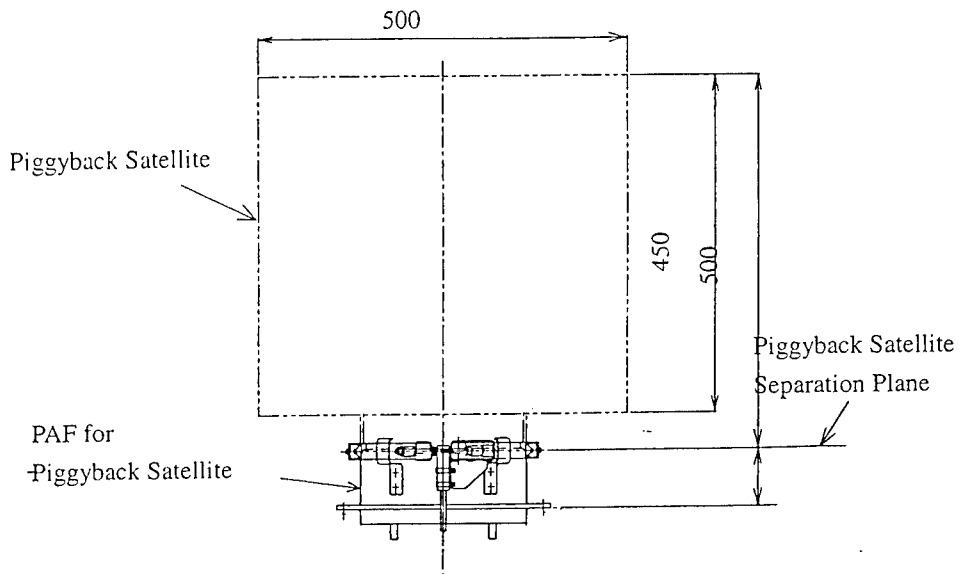


Fig.5 : Overview of PAF for piggyback satellites

## FIRST LEOLINK LAUNCH FROM ALCANTARA

C.OIKNINE

### *Leolink*

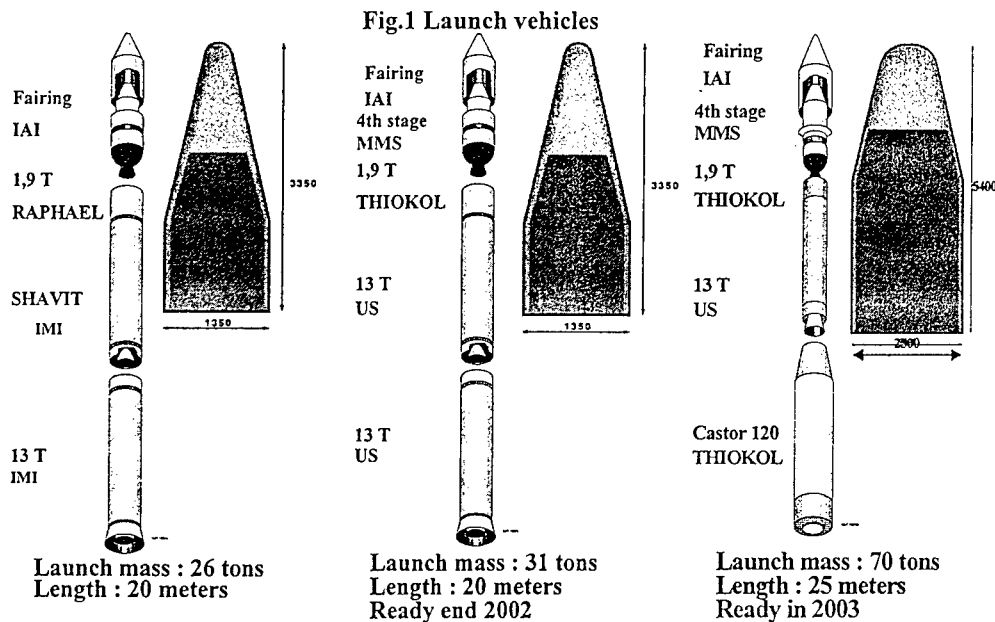
**RESUME** - LEOLINK JVC, une compagnie française en cours de création par ASTRIUM et Israel Aircraft Industries (IAI) propose sur le marché mondial une famille de petits lanceurs LK-A, LK-1 et LK-2 tous trois dérivés du lanceur Israélien Shavit . LK-A, actuellement en cours de fabrication à IAI devrait être lancé d'Israël prochainement. Le premier lancement de LEOLINK se fera avec LK-A à partir de la base de lancement Brésilienne d'Alcantara en 2001-2002

### 1. INTRODUCTION

LEOLINK JVC, a French company to be created by ASTRIUM (formally Matra Marconi Space) and Israel Aircraft Industries proposes on the worldwide market a family of small launchers LK-A, LK-1 and LK-2 all three derived from the Israeli launcher Shavit; LK-A is today in production at IAI and will be launched from Israel; The first Leolink launch will be with LK-A from the Brazilian launch site of Alcantara in 2001-2002.

### 2. LAUNCH VEHICLES DESCRIPTION

As the launch vehicles have already been described, we recall here the main characteristics and performances of the three launchers.



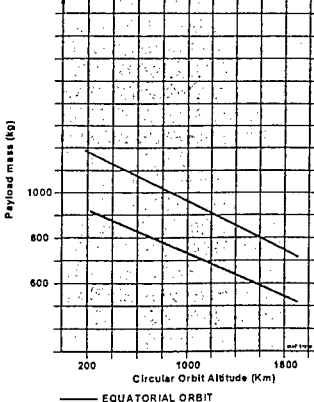
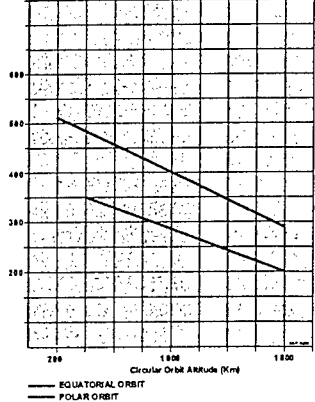
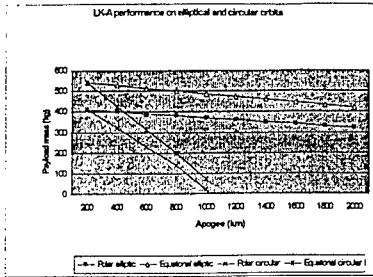


Fig. 2 LK-A Performances

LK-1 Performances

LK-2 Performances

3. GROUND SEGMENT

The ground segment is similar for the three Leolink launchers; it includes mainly a Transporter Erector ( T/E ) and a launch Preparation Van ( LPV ). The T/E allows an horizontal integration of the launcher, its transportation to the launch pad and includes the launch table and the launch stool. The same LPV is used for launcher integration and monitoring and for the launch commanded from the Telemetry, Launch and Control Centre of Alcantara (TLCC )

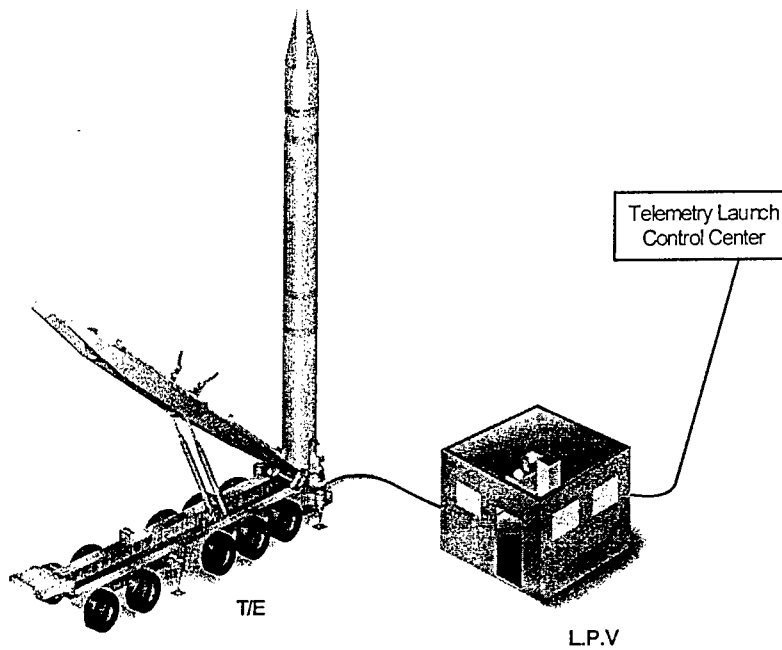
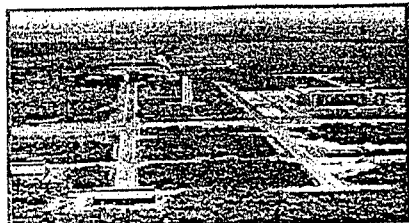


Fig.3 Launcher on the launch pad

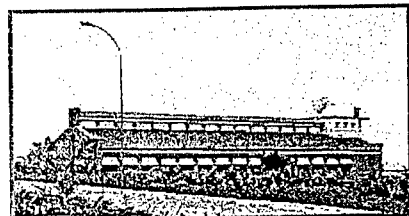




CONTROL CENTER INSTALLATIONS



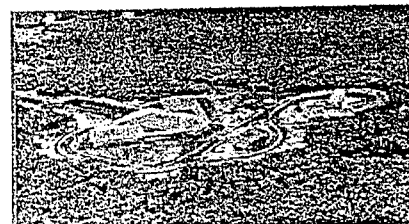
TELEMETRY SYSTEMS



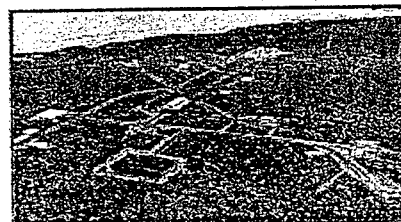
RADAR SYSTEMS



METEOROLOGICAL STATION



SATELLITE TRACKING STATION



LAUNCH COMPLEX

Fig. 5 Alcantara launch systems



## STARSEM OFFER TO LAUNCH SMALL SATELLITES ON SOYUZ.

Author : Philippe SCHLOSSER  
Sales Manager  
[Philippe.schlosser@starsem.com](mailto:Philippe.schlosser@starsem.com)  
0156800976

STARSEM intends to offer a low cost access to space for small satellites. The purpose is to design a structure allowing satellites within mass characteristics of 125 kg maximum, 600 x 600 mm length and width, 800 mm high.

The proposed structure is still in development, but the present design permits to assess that it is possible to fit with a main SSO payload up to four small satellites, depending on the performance of the launcher, the availability of these small payloads and the compatibility between their requirements and those coming from the main payload.

The dedicated Soyuz launchers to implement a small satellites adapter are the SOYUZ-FREGAT and the SOYUZ/ST-FREGAT.

Launched for the first time in 1957, the R-7 launcher was the precursor of the SOYUZ family which has been launched more than 1600 times. Nowadays, STARSEM is able to propose the SOYUZ launcher, built by the Samara Space Center and result of more than forty years of experience and flight-proven technology.

The FREGAT vehicle, a powerful upper stage designed and built by NPO Lavotchkine, will be used for ESA CLUSTER II and MARS EXPRESS missions. FREGAT first flight was performed in February 2000.

In order to get a launcher perfectly adapted to the market, STARSEM is developing a new version, the SOYUZ/ST which will permit to fit larger satellites. The main improvements are more powerful engines, a digital guidance control system and an ARIANE 4 - type fairing manufactured by CONTRAVES (Switzerland), developer of the ARIANE fairings.

## **SESSION 3 :**

### **Architecture et systèmes** *Architecture and systems*

*Présidents / Chairpersons: Antonio MARTINEZ DE ARAGON, Michel BOUSQUET*

- (S3.1) A Three-Axis Stabilized Microsatellite**  
Lew A.L., Schwartz P.D., Le B.Q., Radford W.E., Ling S. X., Magee T.C., Mosher L.E., Charles H.K., Wienhold P.D. John Hopkins University, Laurel, Etats-Unis
- (S3.2) The MITA Satellite: An Italian Bus for Small Missions**  
Sabatini P., Lupi T., Viola F., Falvella M.C., Carlo Gavazzi Space SpA, Milan, Italie
- (S3.3) MARS Micromission Spacecraft - A Flexible, Low-Cost bus for Near-Sun Investigations**  
Deininger W.D., Andreozzi L., Demara R., Epstein K.W., Overturf N., Reinert R.P., Ball Aerospace & Technologies Corp., Boulder, Etats-Unis
- (S3.4) CNES microsatellite product line, an approach for innovation**  
Bouzat C., CNES, Toulouse, France
- (S3.5) Proteus: European Standard for Small Satellites**  
Grivel C., Douillet F., Huiban T., Sainct H. et al, Alcatel Space Industries, Cannes-La-Bocca, France

---

## A THREE-AXIS STABILIZED MICROSATELLITE

Ark L. LEW, Paul D. SCHWARTZ, Binh Q. LE, Wade E. RADFORD,  
Sharon X. LING, Thomas C. MAGEE, Larry E. MOSHER,  
Harry K. CHARLES, Jr., and Paul D. WIENHOLD

*The Johns Hopkins University Applied Physics Laboratory  
11100 Johns Hopkins Road  
Laurel, MD, USA 20723-6099*

### ABSTRACT

The rationale for small and smaller space systems is given. Miniaturization is then discussed within the context of an integrated end-to-end system engineering effort. A miniaturization technology, chip-on-board (COB), is selected as an optimal approach for the implementation of onboard electronics systems. Examples of that implementation for a command and data handling system and miniature imager are given. A dual use technology initiative to address the quest to further miniaturize space systems is presented. Finally we pull together the methodologies and technologies discussed into a micro-satellite conceptual design.

### INTRODUCTION

Technology Roadmaps for current space system initiatives call for an emphasis on cost-effective development. An important aspect in lowering the end-to-end development cost is the miniaturization of space systems. With appropriate system engineering and current advanced packaging technologies the design of satellites with reduced mass, volume and power is highly feasible. The savings results from the total end-to-end program costs that are driven in a large part by the launching of small satellites with smaller and less costly rockets. Technologies for light-weight spacecraft include: advanced power and data bus architectures; densely packed integrated avionics; mixed-signal and ASIC integrated circuit development; advanced packaging methodologies and improved interconnect technology; dual-use technology; and, low-cost, light-weight structures.

### MINIATURIZATION

Miniaturization of space systems allows for innovative missions that have lower cost. Smaller, lighter satellites enable new science missions with formation-flying constellations of satellites. Miniaturization provides the ability to perform multiple *in situ* sensing, and adds the elements of closer time and space correlation of scientific data for expanded three-dimensional analysis, plus interferometric science and engineering. Smaller satellites permits cost-effective launching of instant constellations. Furthermore, small satellites allow for the launching of larger mother ships that can subsequently launch smaller onboard daughter satellites for additional exploration at remote sites.

Considerations for miniaturization in space electronics go beyond the usual requirements for small size and low mass. Miniaturization of current and future space electronics involves the overall end-to-end system engineering effort that encompasses the entire electronics development from the electronics architecture down to the chip-level design. This system effort is very sensitive to the packaging of the smallest chips and other components at the board level, how

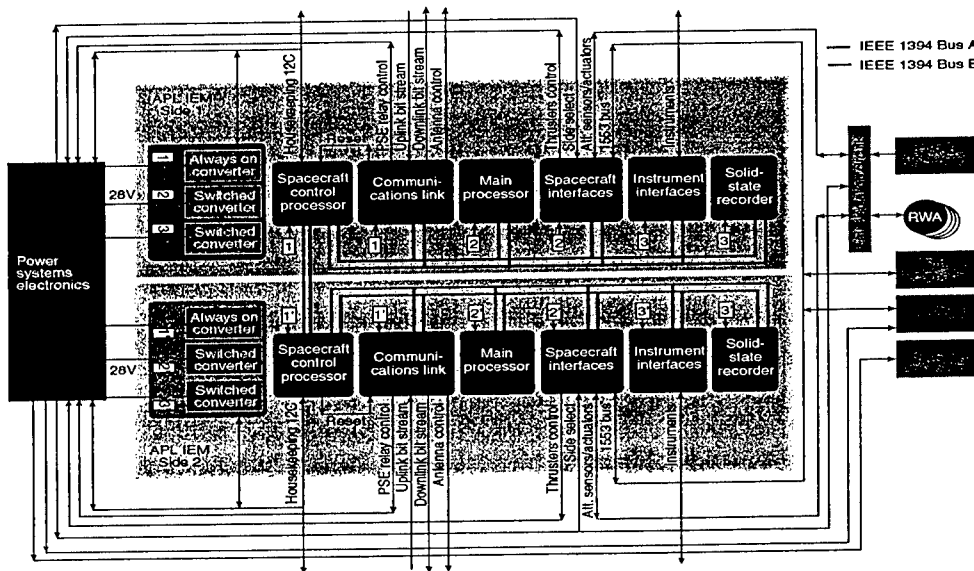


boards are connected or stacked, and how subsystems communicate with one another. As usual, this system effort involves considerations for designing for the lowest power consumption, an attribute that typically ripples through the program to simplify the thermal systems design, and allows for reduced power generation and management components. This design incorporates dual-use technologies (with the Integrated Power Source as an example) for contributing to the miniaturization of space electronics. All these considerations contribute to the miniaturization of space electronics and space systems.

### ARCHITECTURE

In the past, each electronics subsystem was housed in a separate chassis. Chassis are heavy and take up significant volume. The numerous cables that interconnect the many electronics boxes make up another significant fraction of the spacecraft mass. Integrating the onboard electronics within a single unit will eliminate many chassis and associated cabling, thus effecting a substantial size and mass reduction.

Figure 1 is a block diagram of an Integrated Electronics Module (IEM) developed at the Johns Hopkins University Applied Physics Laboratory. This particular IEM is designed to be modular and stackable [Fraeman 97]. Communications between boards are implemented using the commercially viable the IEEE-1394 communications protocol. The IEM design is scalable and implements redundancy. This is a highly reliable design that forms the basis for critical, long-duration missions that can withstand high radiation exposures with the selection of the proper components. Core satellite electronics costs and development schedule are reduced by re-use of hardware and software. The performance of this IEM can be varied to accommodate growing requirements. That is, if more data storage is needed, additional solid-state data storage cards may be added. Similarly, if higher throughput or computing power is needed, additional processor cards may be added.



Spacecraft Systems Architecture

Fig. 1: JHU / APL Integrated Electronics Module

The backplane communications is implemented via the IEEE-1394 High Performance Serial Bus. This is an emerging industry standard that is currently adopted by Apple, IBM, Microsoft, Sony, TI and others. This high-speed serial bus allows for flexible memory-mapped architecture; asynchronous and low latency isochronous block transfers; multiple bus master arbitration; and extensive error detection. Separate channel redundancy is easily implemented in a power efficient manner using IEEE 1394. Serial communication of course is interconnect-efficient; however, it cannot achieve the higher transfer rates of parallel buses. For this design, the 1394 high-speed serial circuit is initially implemented with FPGAs operating at 25 MHz, a speed limited by the FPGA technology. The commercial IEEE-1394 bus is designed to handle up to 400 Mbps. Downstream, this IEEE 1394 IEM BIU (Bus Interface Unit) chip will be implemented using a rad-hard ASIC fabrication line, and will provide data transfers at 100 Mbps.

## ELECTRONICS AND INTEGRATED CIRCUIT DESIGN

An important consideration in the development of miniaturized electronics is the partitioning of the system and subsystems requirements at the card level. The intent is to employ the fewest number of active and passive components per card. This involves maximizing the number of functions per integrated circuit, and, therefore, minimizing the IC count. This can be achieved by designing with radiation-tolerant/hard Field Programmable Gate Arrays (FPGAs), custom Application-Specific Integrated Circuits (ASICs), and mixed-signal ASICs that integrate analog and digital functions within the same monolithic chip. The Temperature Remote Input Output (TRIO) IC designed at the Applied Physics Laboratory is such a mixed-signal ASIC. TRIO is a monolithic integrated circuit that performs many data acquisition and control functions required by spacecraft instruments and subsystems [Paschalidis 98]. The TRIO IC, Figure 2, contains a two-wire I<sup>2</sup>C serial bus interface that runs at data rates up to 4 MHz and can support up to 128 devices. The TRIO IC implements an internal 10-bit A/D converter that digitizes eight platinum thermistor inputs plus eight single-ended voltage inputs.

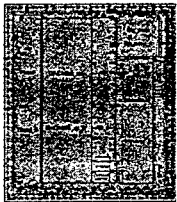
8 platinum thermistor inputs: -200° — +200°C, 1024 steps, 0.5°C resolution ( $\pm 625$ ppm)	Standard I2C three-wire serial interface, 40–640 kHz, supports up to 128 devices	Internal 10 bit analog-to-digital converter, 10 $\mu$ s or 100 $\mu$ s conversion duration
8 single-ended voltage inputs: 0 — Vdd (Vdd=3.3 or 5V), 1024 steps, high input impedance		Internal precision voltage reference, $\pm 500$ ppm over -55° — +125°C, for Vdd = 5V $\pm 10\%$
8 differential voltage inputs: 0 — 50 mV, 1024 steps, -1V — Vdd common mode, moderate input impedance		4 DACs (6-bit) set analog event thresholds
4 analog event inputs: analog comparator input with ~100 mV hysteresis, compares to output of 6-bit DAC	15 mW @ Vdd=3.3V	Four programmable pulse-width modulation signal generators
The Remote Input/Output (RIO) smart sensor is a monolithic integrated circuit (IC) that performs many data acquisition and control functions typically required on spacecraft instruments and subsystems. The IC was designed at JHU/APL and was fabricated in Honeywell's radiation-hardened 0.8 $\mu$ CMOS process. Future versions include the features shown in <i>italics</i> .		

Fig. 2: Temperature Remote Input / Output (TRIO) Smart Sensor

Future versions of this IC will implement eight differential voltage inputs, analog comparators to process four analog events with programmable thresholds, a 32-bit Input/Output port, 16-bit

transceiver, four 16-bit event counters, four programmable pulse width modulation signal generators, and an internal precision voltage reference. The TRIO IC dissipates only 15 mW at 3.3 volts.

### MINIATURIZATION WITH CHIP-ON-BOARD TECHNOLOGY

Using miniaturized electronics it is possible to do more with less.

It is helpful to examine the history of packaging technologies for electronics to see where we have been, where we are now, and then predict where we're likely to be headed. Silicon packaging efficiency, which is defined as the ratio of chip or die area to board area, is a good indicator of the level of miniaturization of the electronics. Using 1970s printed wiring board, PWB, technology, the silicon packaging efficiency is about 2%. Silicon packaging efficiency for the 1980s packaging technology hovered around 7%, still a rather inefficient packaging scheme. In the 1990s plastic and ceramic ball grid array packages were surfaced-mounted onto multi-layered PWBs, with discrete passive devices also surface-mounted. Silicon packaging efficiency for this technology rose to about 10%. In Figure 3 Tummala indicated that silicon packaging efficiency can reach 25% when chip scale packages and ball-grid array packages are implemented on high density PWB with micro-vias [Tummala 99]. Integrating passive components within the board substrate along with flip chip technology should yield a silicon packaging efficiency of greater than 75% (projected for 2005). The COB initiative at APL, which was started in the mid 1990s, implemented direct chip attach using wire bonding, and with surface-mounted discrete passives, onto multi-layer PWBs. COB technology is designed to incorporate both IC dice and packaged ICs with silicon packaging efficiency comparable to the projected 2000 technology silicon efficiency of 25%. This projection is based on flip-chips housed in chip-scale packages. Advanced packaging technologies discussed later will enable silicon packaging efficiencies approaching the projected 75% of the Future 2005 technologies delineated in Figure 3.

Package	Past		Current		Future
	1970s	1980s	1990s	2000	2005
Chip connection	Wire bond	Wire bond	Wire bond	Flip chip	Low cost High I/O Flip chip
Package	DIP	P-QFP	P/C-BGA	CSP	No package
Package assembly	PTH	SMT	BGA-SMT	BGA-SMT DCA-PWB	Direct to board
Passive components	C-discretes	C-discretes	C-discretes	C-discretes	Integrated
Board	Organic	Organic	Organic	Micro-via board	SLIM
Number of component types	5-10	5-10	5-10	5-10	1
Silicon packaging efficiency, %	2	7	10	25	>75

Note: CSP = chip scale package; DCA = direct chip attach; DIP = dual-inline package; P/C-BGA = plastic / ceramic ball-grid array; P-QFP = plastic-quad flat pack; PTH = plated through-hole; PWB = printed wiring board; SLIM = single-level integrated module; and SMT = surface-mount technology.

Fig. 3: Packaging Evolution

A schematic representation of chip-on-board (COB) technology in Figure 4 shows the surface mount of an IC die and a packaged part. The die is thermally bonded to the substrate and is shown wire-bonded to the organic substrate. The wiring is typically encapsulated to provide protection for the wire bonding and the die itself. This configuration significantly improves the

thermal design of the system as compared to the packaged parts since it reduces the thermal resistance from the die junction to the heat sink. It is important to note that not all parts will be available in die form; or, it may be that some parts are less expensive as a packaged part. Therefore, packaging technologies that can handle a mix of components will offer more flexibility. The fully assembled COB is usually coated after electrical debug with a thin protective cover. The board does not have an overall physical cover and consequently is not hermetically sealed; and, therefore, the board is repairable. To qualify COB for space electronics, COB test samples were subjected to different severe environments such as thermal cycling (-55°C to +125°C), vibration, and biased temperature humidity (85°C, 85% RH). These COB studies have demonstrated that with proper encapsulation and manufacturing processes, the reliability of die without hermetic packaging but with protective compliant coating is suitable for space flight hardware. When the trade space of cost, schedule, parts availability, reliability, performance, and, importantly, rework capability are factored into the selection of a miniaturization technology, Chip-On-Board comes out a winner.

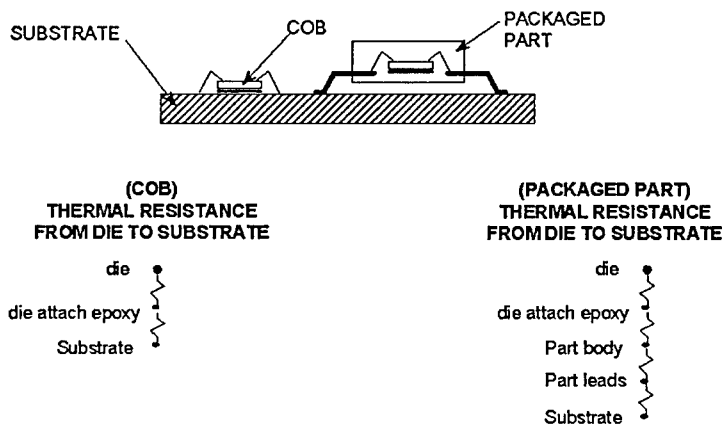
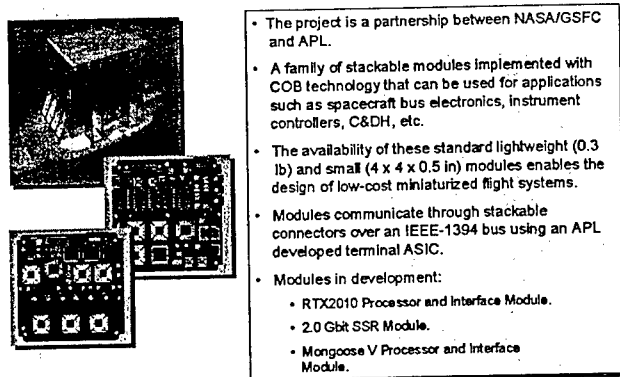


Fig. 4: Chip-on-Board Technology

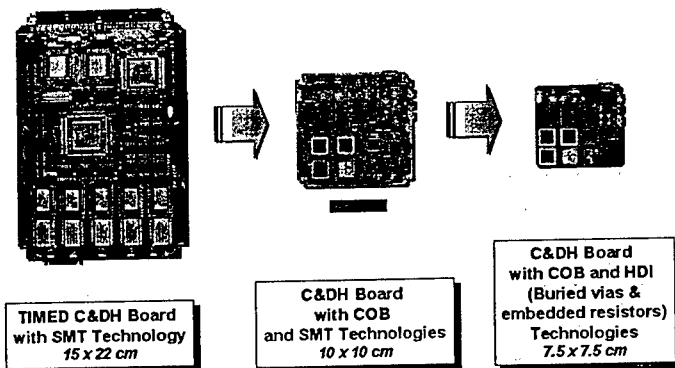
## MINIATURE ONBOARD ELECTRONICS SYSTEMS

In conjunction with NASA Goddard Space Flight Center (GSFC), APL is developing an integrated miniaturized command and data handling system (CDHIYP), shown in Figure 5, that is small enough to fit in the palm of one's hand [Conde 97]. The design consists of a critical embedded processor used for command and control of satellites, a solid-state data storage board, an interface electronics board, and a power module board. The embedded processor is the rad-hard RTX2010 microprocessor from Harris Semiconductor, programmed in the FORTH language. The solid-state storage board is designed with stacked DRAMs and has a capacity of 1.5 gigabits. The CDHIYP is designed as 11.4 cm x 11.4 cm electronics slices on the order of 1.9 cm thick. Each frame contains a 10.2 cm x 10.2 cm COB assembly that incorporates fuzz button connectors. The frames or slices stack on top of one another such that the fuzz button connector connects the adjacent boards. On a stack of these COB slices the fuzz button connectors emulate virtual backplane mother-board connections. The backplane electrical protocol is the IEEE-1394 Firewire that was previously described. Please note the combination of packaged and bare chips used in this design. Sometimes it is cheaper to buy packaged parts, and other times they are the only parts that you can procure.



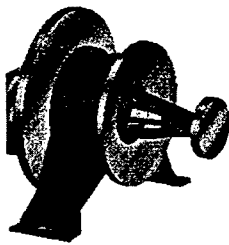
**Fig. 5: Command and Data Handling In Your Palm (CDHIYP) Basis for Micro-Satellite (MicroSat) Bus Electronics**

Figure 6 depicts the comparison of the miniaturized CDHIYP processor board achievable with COB technology, the NASA/TIMED spacecraft processor board, and a graphic of a further-miniaturized processor board that has high-density interconnect/embedded-passive technologies.



**Fig. 6: Miniaturization with HDI Technology**

Figure 7 shows another COB example of a miniaturized imager [Le 98]. A RS-422 interface is implemented. This imager incorporates reflective rather than refractive optics and commercial off-the-shelf and PEMS parts. The electronics are implemented with COB packaging with flex substrate. The 5.1 cm x 5.1 cm square electronics housing can be seen in back of the imager.



- Lightweight (0.5 kg - including optics)
- Small size (14.2 x 14.7 x 13.5 cm)
- Low power (1.9W operating, 0.5W sleep mode)
- Internal storage for 32 images (50 mbits)
- Chip-on-board and 3-D packaging
- Simple serial interface (RS422)
- Manual and automatic exposure modes
- Advanced reflective optics
- Passive thermal control
- Can accommodate a variety of CCD arrays
- FOV: 1.5° x 2.6°

Fig. 7: Miniaturized Scientific Imager

Figure 8 shows the COB-implemented imager electronics.

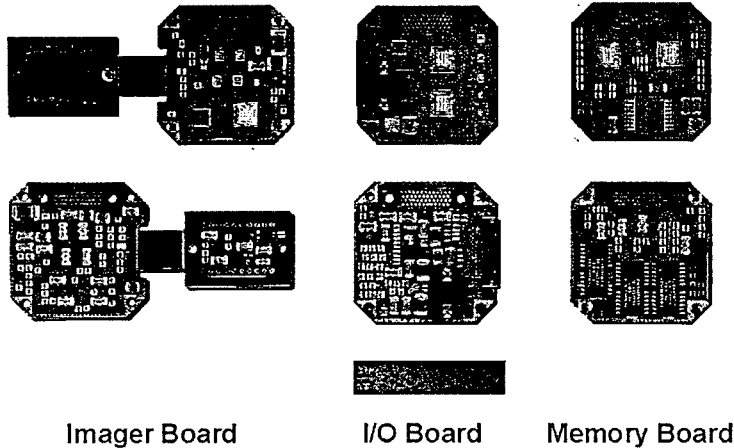


Fig. 8: COB Imager Electronics Board

### THE INTEGRATED POWER SOURCE

The Integrated Power Source (IPS) is a dual-use technology that can be designed to provide power using an independent power panel that can also serve as the side panel for a microsat or as deployed solar panels. The IPS technology, Figure 9, is patented (worldwide) technology that comprises three layers (solar cell layer, energy storage, and electronics) that are laminated to form an independent power panel [Lew 97]. The lamination is designed such that it can be load-bearing, and thus can serve structural functions as well. APL is currently working on an IPS power panel that consists of multi-junction solar cells layer-laminated on a matrix of batteries that are managed by the third layer of miniaturized electronics. This will be used for power generation, processing and distribution. The power management electronics (patent applied for)

allows for graceful degradation and serves also as an accurate fuel gauge. The APL is also working on a small version of the IPS for potential commercial portable handheld applications.

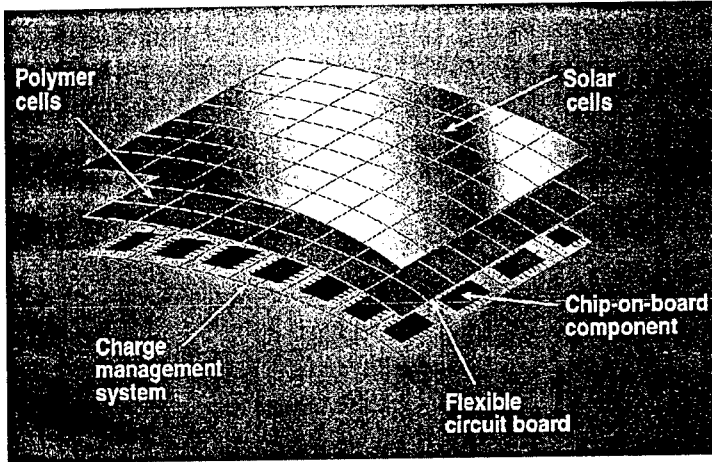


Fig. 9: Dual Use-Multifunction Technology Integrated Power Source (Patented)

### MICROSAT

Figure 10 shows how the technologies discussed in this paper may be integrated into the development of a cost-effective microsats bus weighing about 30kg. Starting at the chip level, circuits are implemented with the fewest number of chips using ASICs, FPGAs, and mixed-

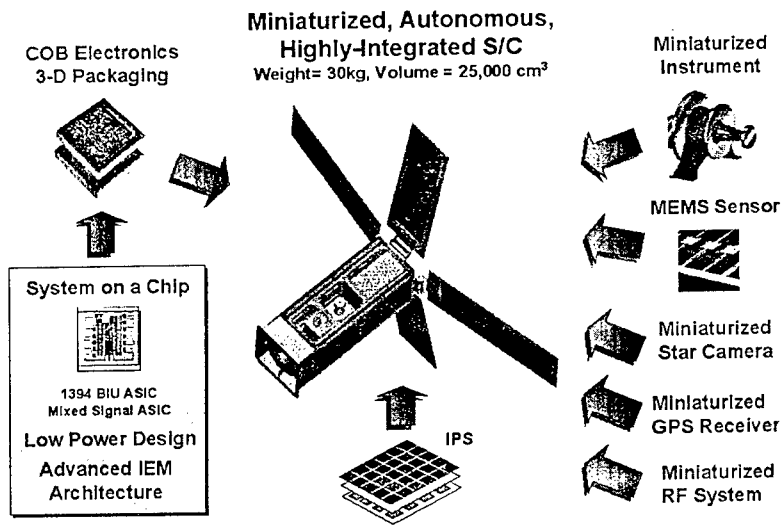


Fig. 10: MicroSat

signal ICs. The COB packaging technologies are used to miniaturize electronics subsystems, as may be seen with the CDHIYP and the miniature imager. An integrated electronic module architecture consolidates as much of the bus electronics as is feasible. The IPS panels generate the power for the microsat and can be used for side panels or deployed in the usual fashion for generating more power. Most of the electronics slices in the IEM are in development or can be developed. GPS receiver and transmitter slices are in development. A star camera with .01 degree accuracy based on the miniature imager can be developed. Purchased items include small reaction wheels and MEMS gyros. The propulsion is a cold gas blow-down design. A miniature MEMS xylophone magnetometer, based on the macro-bar design, can be implemented. Figure 10 depicts a full-sized model of the microsat, implemented with composite technology. The size of the microsat bus is 21 cm  $\times$  21 cm  $\times$  61cm. With the selection of appropriate components, this microsat can be designed for critical applications for commercial or government use.



**Fig. 11: Comparative Sizing**

The cost savings from this approach result from considering the total end-to-end costs for the development, production and launch of these micro-spacecraft. With microsats, smaller, less costly launch vehicles may be used. As an example, the difference between a Delta and a Pegasus or Taurus launcher is about \$30M. For a purely volumetric study, given a cylindrical microsat 1 foot in diameter by 3 feet high, a total of 10 microsats may be integrated within the fairing of a Pegasus; and 20 in a Taurus. This permits multiple launches, and almost instant constellations!

#### **REFERENCES**

- [Frae 97] M. E. Fraeman: "A Fault Tolerant Integrated Electronics Module for Small Satellites" *11<sup>th</sup> AIAA/USU Conference on Small Satellites*, Logan, Utah, September 1997
- [Pasc 98] N. Paschalidis: "A Remote I/O (RIO) Smart Sensor Analog-Digital chip for Next Generation Spacecraft" *12<sup>th</sup> AIAA/USU Conference on Small Satellites*, Logan, Utah, September 1998



- [Tumm 99] R. R. Tummula: "Electronic Packaging Research and Education: A Model for the 21<sup>st</sup> Century" *Johns Hopkins University Applied Physics Laboratory Technical Digest*, 20(1):111, Jan-Mar 1999
- [Cond 97] R. F. Conde, B. Q. Le, J. F. Bogdanski, A. L. Lew, J. A. Perschy, A. G. Darrin: "Command and Data Handling In Your Palm" *11<sup>th</sup> AIAA/USU Conference on Small Satellites*, Logan, Utah, September 1997
- [Le 98] B. Q. Le, P. D. Schwartz, S. X. Ling, K. Strohbehn, K. Peacock: "A Low-cost High Density Scientific Imager Design with Chip-on-Board Technology for NanoSat Applications" *Proc 2<sup>nd</sup> Integrated Nano/Microtechnology for Space Applications Conference*, Houston, Texas, November 1998
- [Lew 97] A. L. Lew, J. J. Suter, B. Q. Le: "Integrated Power Source" *United States Patent 5,644,207*, July 1997

**THE MITA SATELLITE:  
AN ITALIAN BUS FOR SMALL MISSIONS**

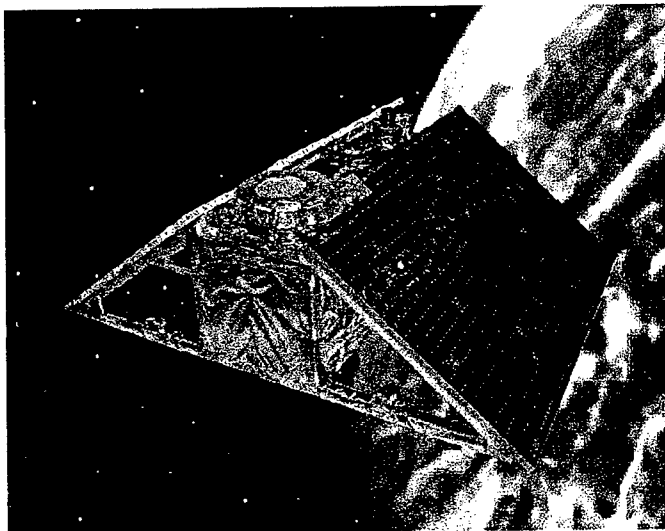
**Paolo SABATINI (CGS)  
Tito LUPI (CGS)  
Franco VIOLA (ASI)  
Maria Cristina FALVELLA (ASI)**

*CARLO GAVAZZI SPACE S.p.A.  
Via Gallarate 150 - 20151 MILANO (ITALY)  
Tel.: +39.02.38048.1  
Fax.: +39.02.3086458  
e-mail: [cgscgs@cgspace.it](mailto:cgscgs@cgspace.it)  
Internet: <http://www.cgspace.it>*

*ASI - AGENZIA SPAZIALE ITALIANA  
Viale Liegi 26 - Roma  
Tel.: +39.06.8567357  
e-mail: [viola@asi.it](mailto:viola@asi.it)  
Internet: <http://www.asi.it>*

**INTRODUCTION**

**M.I.T.A.** (Italian advanced technology minisatellite) is being developed with the prime contractorship of **CARLO GAVAZZI SPACE S.p.A.** (Milano, Italy), under an **A.S.I. (Italian Space Agency)** contract. The will be on 15<sup>th</sup> of July 2000 with COSMOS launcher and CHAMP satellite as primary payload. The project's aim is to design, develop and implement a low cost platform for small Earth missions in order to support a wide range of applications.



**Fig. 1 - in orbit view of MITA satellite**

The configuration of the satellite main body is based on a cubic-shaped module,

100 [kg] range, 3 axis stabilized and is designed especially for Low Earth Orbit (LEO) missions with a lifetime of 3 to 5 years.

The purpose of the programme is threefold: to get (in short time) a bus demonstrating the ability of the Italian aerospace industry to realise cost-effectively and efficiently this class of small space programmes; to dispose of a flexible and low cost vehicle to qualify in short time advanced space technologies; to promote and perform technological and scientific experiments in the frame of the ASI national programme involving University Institutes and Research Laboratories.

Design driver is that the spacecraft bus must support many different payloads: two way communications, Earth observation, remote sensing, radiolocalization, astronomy, scientific research, microgravity science.

This is achieved by a modular design in all the main satellite subsystems: data handling, electrical power, attitude control, structure.

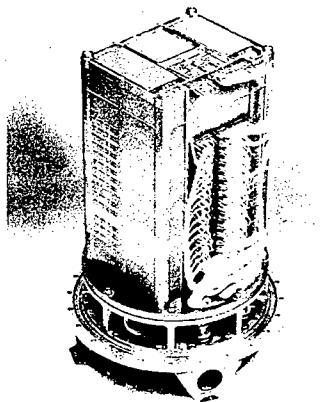
The satellite platform is based on a dual redundant data handling and telemetry/telecommunication subsystem. The other subsystems are partially redundant. This ensures that the satellite can operate after a failure, even if with reduced performance, while at the same time the cost/performance ratio is optimised.

### **THE FIRST MITA SCENARIO**

The first mission of MITA satellite, planned to be launched on 15<sup>th</sup> July 2000, is the "in orbit validation of the platform"; this is extremely important in order to qualify the bus for low Earth orbit missions, and to verify in advance its functionality for the future ASI scientific missions.

Furthermore, this first mission will provide also significant scientific returns, having as payload the NINA (Fig.2) instrument from INFN (Istituto Nazionale Fisica Nucleare - Rome); this payload, a silicon spectrometer for charged particles, is the Engineering Model (EM) version (refurbished for the MITA flight) of the other NINA instrument, which is currently flying attached to the Russian RESURS-04 platform.

At last MITA will carry the MTS-AOMS Payload (an Attitude sensor developed by DORNIER) for the in orbit qualification activity, in the frame of the ESA TFP.



**Fig. 2 : NINA payload**

The required orbit is circular, 450 [km] altitude, 87.3 [deg] inclination, and will be achieved by a COSMOS launcher from the Plesetsk launch site (Fig.3), in a double payload launch configuration (MITA and CHAMP), using a special launch adapter.

The Ground station Scenario is composed by two TT&C stations located at Malindi (Kenya) and Cordoba (Argentina) and the Mission Controller Centre (MCC) located in Rome.

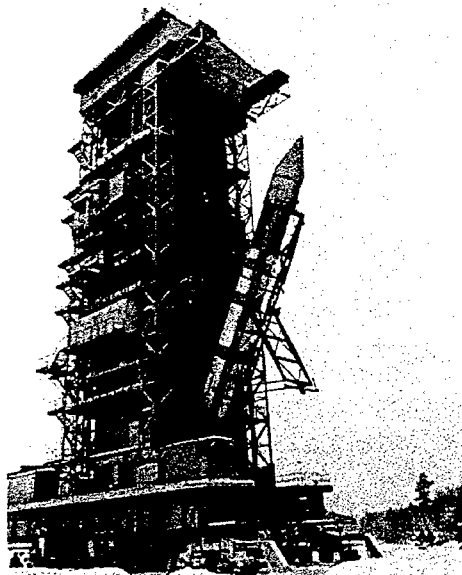


Fig. 3 : COSMOS rocket at launch pad

After that the launcher will reach its nominal orbit, the CHAMP satellite will be deployed first, approximately 1882 seconds after the lift-off, and then, after 1.25 seconds, also MITA will be separated from the adapter reaching its free-fly condition with a 93.5 minutes orbit period.

The satellite, after the activation, can be operated in three main modes:

1. **Acquisition.** The satellite, after performing the initial activation, goes automatically in the acquisition phase, where all the software tasks are activated. The main activities performed are: communication management with the Ground station, on board power management and attitude control (ACS). In particular, the attitude control performs its own activities passing through the ACS operational phases till the achievement of the nominal attitude.
2. **Nominal.** In this status, the nominal operations are performed, including the payload measurements and scientific data downloading. The attitude control loop ensures that the attitude of the satellite remains within its nominal range.
3. **Safe.** The satellite enters in this phase after an anomaly detection; the transition could happen automatically on board or by a telecommand, after the ground data processing. The satellite remains in this status till the recovery action is performed. In this frame, the payload is switched off in order to save the electrical power.

In the nominal operations, the Ground stations Network is able to see the satellite for a maximum of about 8 [min] for the Zenith passages and an average of 6 [min], with about 2 consecutive visible passages and 4 not visible passages. This ensures the time for the download of both the scientific and bus data, which are estimated to be about 10 [Mbytes] per orbit.

The design lifetime of the MITA standard bus is 5 years, while it is 3 years for the first mission; this is mainly due to the atmospheric drag that produce an orbit decay. This decay will cause the disruptive re-entry of the satellite after approximately 3 years because of the initial low altitude of the orbit and the very high Solar activity in the period 1999-2002.

### SYSTEM ARCHITECTURE

The key features of the MITA satellite configured for the first mission are presented in the Tab.1.

<i>Dimensions</i>	1800 x 1400 x 700 [mm]
<i>Mass</i>	169.9 [kg]
<i>Average power cons.</i>	85 [W]
<i>Peak power</i>	120 [W]
<i>Attitude control type</i>	3 axis stabilized, Earth pointing
<i>Attitude accuracy</i>	±1 [Deg] each axis
<i>Communications</i>	S-band
<i>Telemetry</i>	512 [kbps], ESA CCSDS
<i>Telecommand</i>	4 [kbps], ESA CCSDS
<i>Mass Memory</i>	64 [Mbytes]

Tab.1 : Main MITA Satellite characteristics

The satellite core, shown in Fig. 5 with all its internal equipment, is the On Board Data Handling (OBDH) which is in charge to manage all the control and operative functions; in fact, the SW implemented in the OBDH (bus controller), is devoted to manage the communications, the ground telecommands, the attitude control, the power management, and it constantly monitors all the parameters of the bus. All these functions are performed as separate tasks, thanks to the multi-tasking satellite operating system.

In addition, the MITA bus has a computer, dedicated to the payload NINA, which manages the payload itself and performs a pre-processing on the payload data so to send a reduced quantity of them to the Ground.

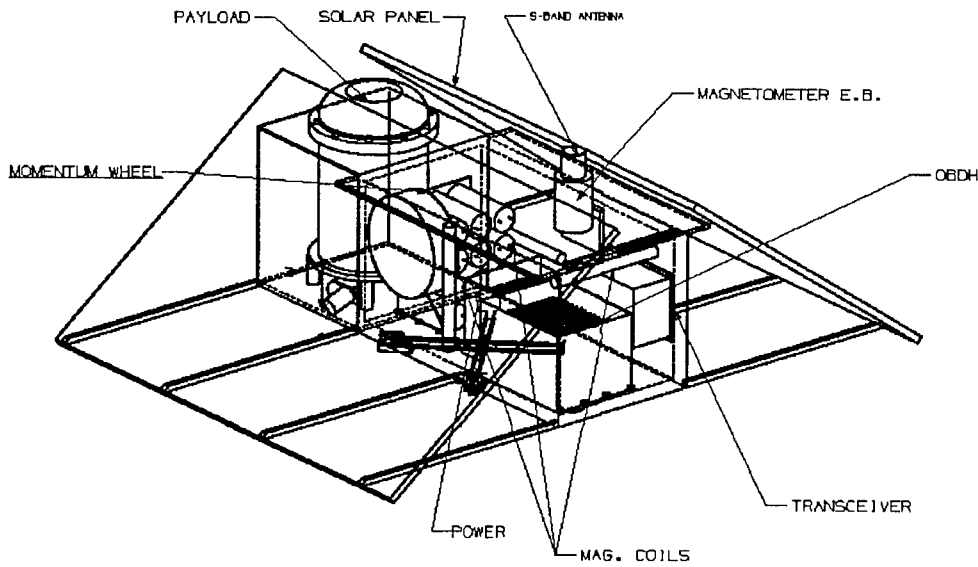
The downloading of the data, together with the uploading of the telecommands, are ensured by the telemetry & telecommand subsystem (TM&TC), which is composed by two S-band transponders, in cold redundancy. The two antennas are placed in a way to have the Ground link even if the satellite is not in nominal attitude.

The attitude control system (ACS) is composed by the Sensors and actuators described in Tab.2.

<i>Sensors</i>	<i>Actuators</i>
2 monoaxial horizon sensors	1 Momentum Wheel
1 triaxial magnetometer (redundant)	3 Magnetic coils (redundant)
5 coarse sun sensors (redundant)	

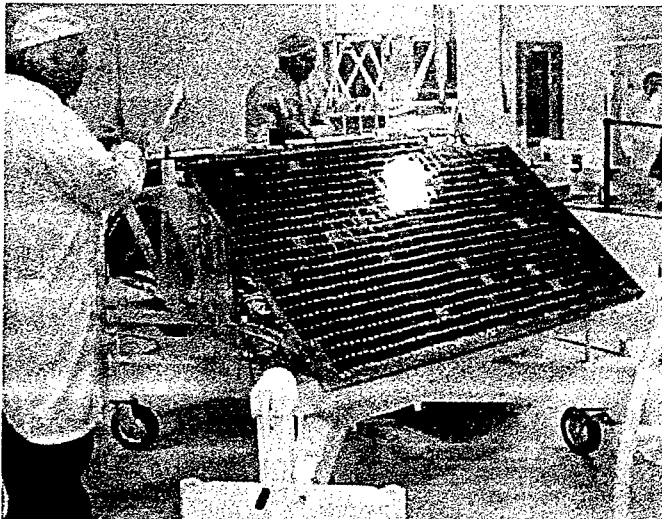
**Tab.2 : MITA Set of Sensors and Actuators**

The momentum wheel (Fig.12), whose spin axis is perpendicular to the orbit plane, gives the required stability with its gyroscopic stiffness, which is able to absorb the disturbances torques.



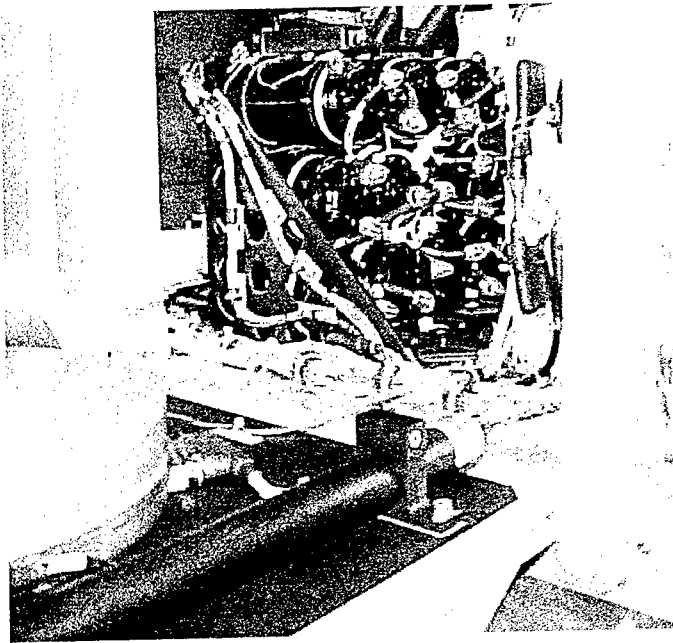
**Fig. 5 : MITA internal layout**

The electrical power of the satellite is ensured by two Solar panels equipped with GaAs solar cells (Fig.6); each panel is able to produce 200 [W] at End of Life (EOL) conditions, with the sun perpendicular to its surface.



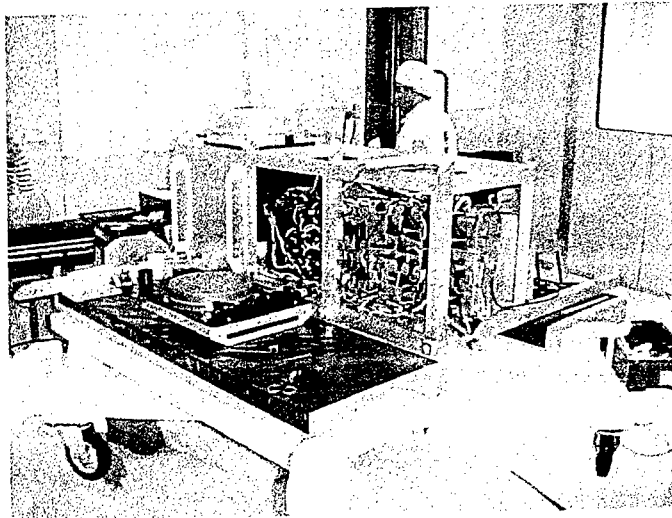
**Fig.6 : Solar Panels**

The secondary energy source is a NiH<sub>2</sub> battery (Fig.7), with a capacity of 150 [Wh]. The power conditioning and distribution is performed by the Power Electronic Unit, controlled by the OBDH by means of redundant interfaces.



**Fig.7 : Set of Cells of the NiH<sub>2</sub> battery integrated on board**

The satellite structure, visible in Fig.8 is designed to be modular, and is composed by tubular elements and closing sandwich panels. This design concept is well suited to be adaptable to the requirements of different missions.



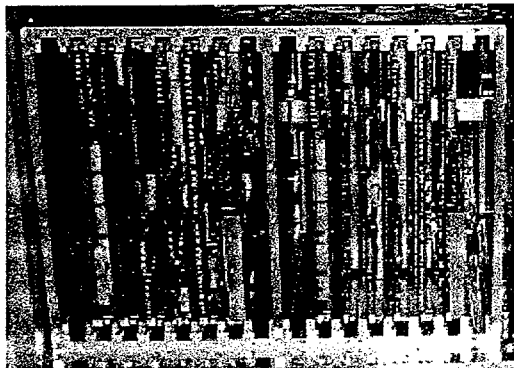
**Fig.8 : Structure during Integration**

The thermal control system is passive, in the sense that all the satellite units are maintained in the required temperature range by the optimisation of the internal layout of the dissipative units and by the use of appropriate materials as paints, Multi Layer Insulator blankets (Fig.9). The heat dissipation in the orbit is ensured by the bottom, front and rear surfaces, used as radiators.



**Fig.9 : MLI Integration**

The satellite is based on two fully redundant chains of OBDH (Fig.10) and TM&TC. The other electrical subsystems are partially redundant, in order to optimise the cost/benefit ratio. The redundancy concept ensures the success of the mission even after a failure; in some cases, this could lead to a reduction of certain bus functionalities (as, for example, the pointing accuracy), but without the loss of the mission.



**Fig.10 : Redounded OBDH**



## SYSTEM INTEGRATION

The Spacecraft integration, completed at the end of March 2000, has been performed following the above listed steps:

**1<sup>st</sup> Step:** Activities started with the *Pre-integration of the structural frame*, then in sequence, it has been performed the *Integration of the Harness supports, Battery, OBDH, PEB, Baseplate Harness and Magnetometers electronic integration, Coils and Wheel integration on lateral panels* and at the end *NINA integration* (Fig. 12). Then the 1<sup>st</sup> functional check was held.

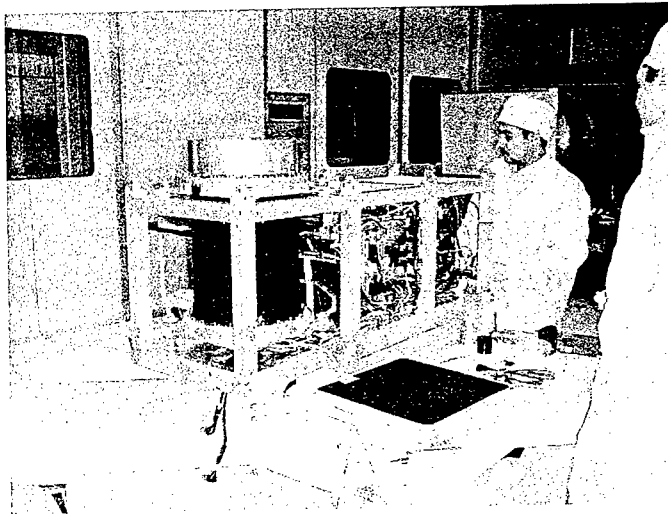


Fig.12 : Integration - 1<sup>st</sup> Step

**2<sup>nd</sup> Step:** Activities followed with the *Integration of the complete structural frame the ACS components alignment* (coils, wheel, magnetometers in Fig. 13) then have been integrated and fixed to the structural frame. 2<sup>nd</sup> functional check.

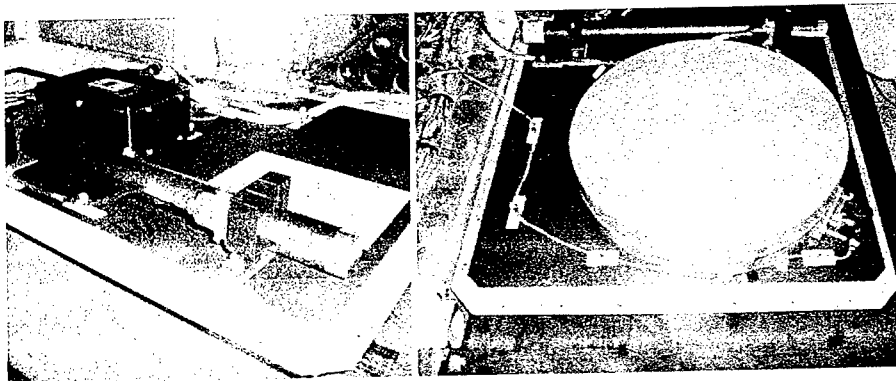
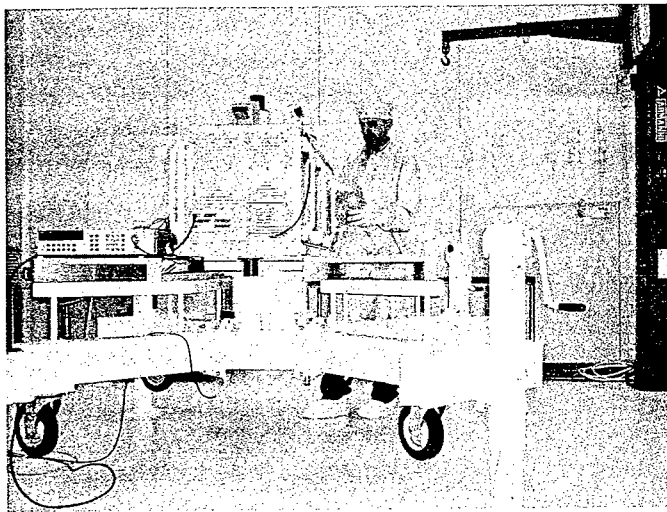


Fig.13 : Integration - 2<sup>st</sup> Step (ACS components)

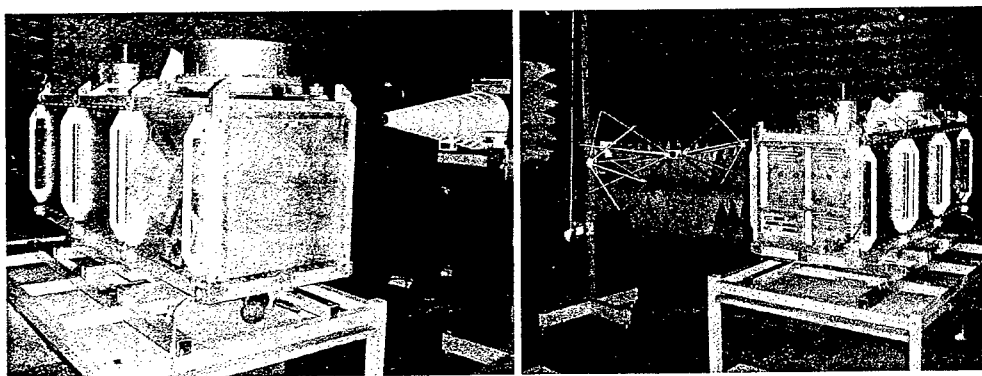
**3<sup>rd</sup> Step:** At this step were mounted the *top and bottom antennas*, then the *horizon Sensors* and the other payload, *MTS-AOMS*. 3<sup>rd</sup> functional check.



**Fig.14 :** Integration - 3<sup>rd</sup> Step

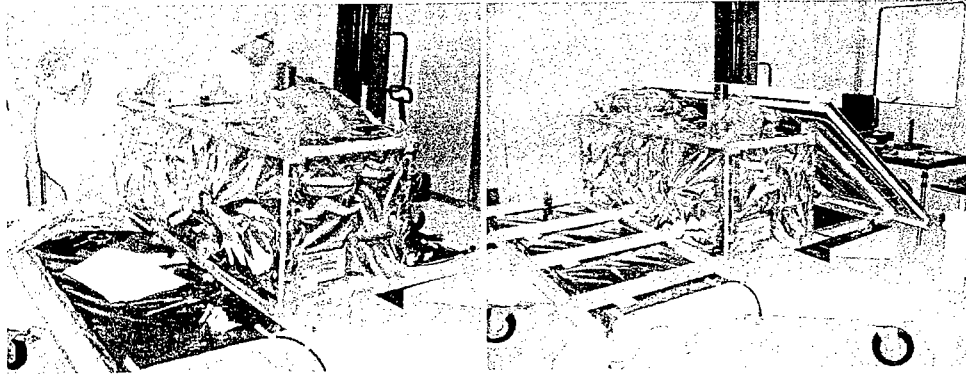
**EMC testing:** After the 3<sup>rd</sup> Step EMC tests have been performed in the configuration without Solar panels (Fig. 15). The following tests have been performed:

- bonding
- radiated emission H field
- radiated emission E field
- ambient noise H / E field
- arc discharge



**Fig.15 :** EMC Testing

**4<sup>th</sup> Step:** Last activities have been the integration of the thermal blankets and the of the Solar Array followed by the final Full functional test.



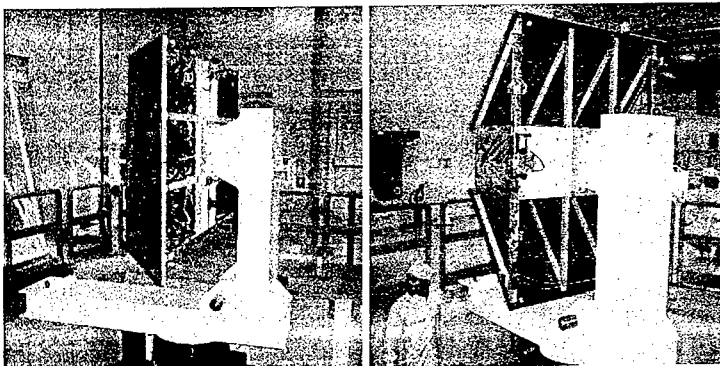
**Fig.16 :** Integration – 4<sup>th</sup> Step

## QUALIFICATION

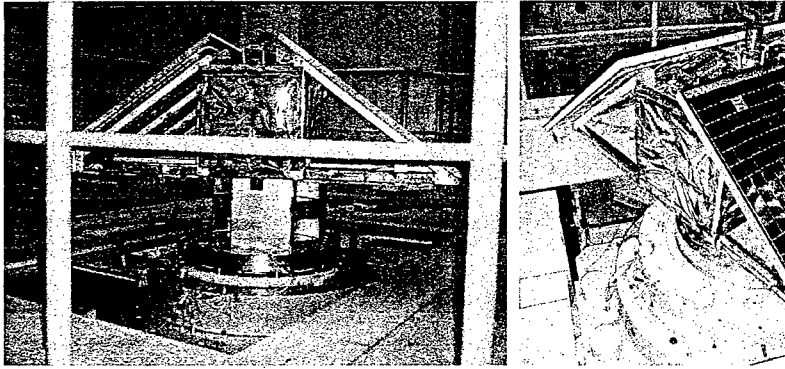
The qualification phase was completed at the end of April 2000. The activities performed during this phase were:

- Mass Property Measurement (Fig. 17)
- Vibration Testing (Fig. 18)
- Thermal Vacuum Testing (Fig. 19)

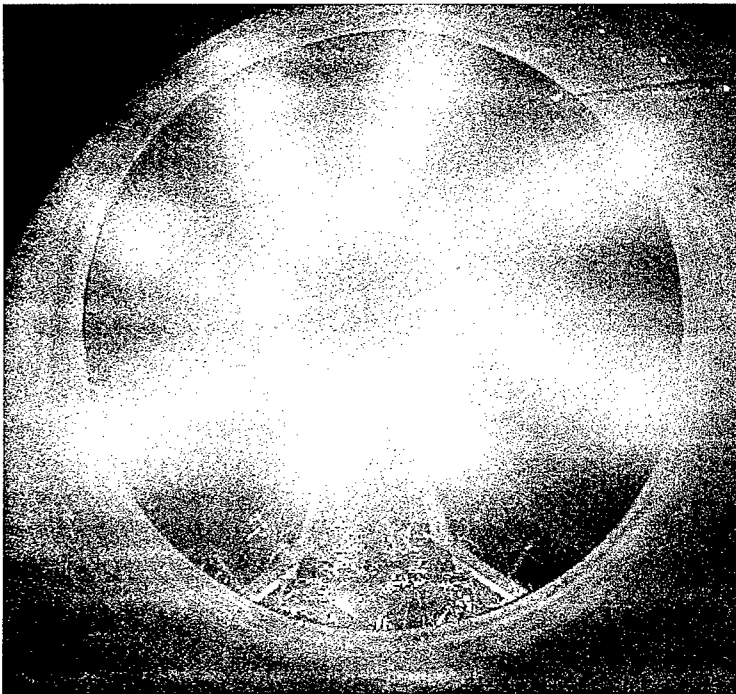
All the test were performed at Alenia, in the Globalstar facility, Rome



**Fig.17 :** Mass Properties Measurements



**Fig.18 : Vibration Testing**



**Fig.19 : Thermal Vacuum Testing**

#### **SYSTEM VALIDATION TEST WITH MITA GROUND SEGMENT**

The various sessions of System Validation Test with the MITA Ground Segment, using both the Engineering Model and the Flight Model, have been correctly executed, and the interface between the Space and the Ground Segment has been verified.

---

## **LAUNCH CAMPAIGN**

The launch campaign will start 26<sup>th</sup> of June, when the satellite will be shipped to the Plesetsk Launch Site in Russia. During the two weeks campaign, the satellite will be checked-out, the battery will be fully charged and the satellite will be integrated with the launcher. The launch will be on 15<sup>th</sup> of July 2000, at 15:00 local time (12:00 UMT).

## **CONCLUSIONS**

The MITA project has been here presented; the presentation focused mainly on the first mission of the satellite, but this platform is conceived for use in the future ASI scientific missions, where the selected payload will result compatible.

The current design of the spacecraft bus is able to accommodate different payloads such as telecommunications, Earth observation, Remote sensing, Re-localisation, Astronomy, Scientific research, Microgravity science.

The first mission shall demonstrate the capability of the platform to meet the technical requirements of the scientific programmes; furthermore, with a very tight time schedule and reduced costs, this will demonstrate the capability of the Italian small and medium enterprises to be competitive in the ever increasing market of the small satellites.

## MARS MICROMISSION SPACECRAFT – A FLEXIBLE, LOW-COST BUS FOR NEAR-SUN INVESTIGATIONS

W. D. DEININGER, L. ANDREOZZI, R. DEMARA, K. W. EPSTEIN,  
N. OVERTURF, and R. P. REINERT  
Ball Aerospace & Technologies Corp.  
P. O. Box 1062  
Boulder CO 80306-1062  
and  
S. N. SIEGER  
Aerojet  
P. O. Box 13222  
Sacramento, CA 95813-6000

### ABSTRACT

The Micromission spacecraft (MSC) is a multi-purpose platform capable of supporting science missions from 0.7 AU to 1.7 AU from the sun. For Mars missions, MSC enables orbiting Mars for science payloads and/or communications/navigation assets, or for precision Mars flybys to drop up to six probes. In the baseline scenario, MSC is launched as a secondary payload on an Ariane 5 rocket from Kourou, French Guiana, to GTO using the Ariane 5 structure for auxiliary payloads (ASAP5). The maximum launch wet mass is 242 Kg and can include up to 45 Kg of payload depending on  $\Delta V$  needs. The on-board propulsion system is used for maneuvering in the Earth-Moon system and injecting the spacecraft into Mars transfer orbit and, if needed, Mars orbit. The first Mars MSC is planned for launch in early 2003. JPL is responsible for the payload. Ball Aerospace, working with JPL, provides the multi-purpose spacecraft bus, system integration and test, and assists in operations over the mission duration. The micromissions spacecraft bus can be used for science targets other than Mars including the Moon, Earth, Venus, Mercury, asteroids, Lagrange points, or other small bodies. This paper summarizes the baseline spacecraft concept and describes the multimission spacecraft bus implementation in more detail.

### INTRODUCTION

Low-cost, scientific access to Mars is a specific thrust in the current Mars exploration architecture. Micromissions launches to Mars are planned to start in 2003 in support of this goal. The multi-mission Micromission Spacecraft (MSC) launches as a secondary payload on an Ariane 5 in cooperation with CNES (French national space agency).[Jordan 99, Hastrup 99, Hastrup 00, Matousek 99a, Matousek 99b] Launch as a secondary payload enables the low-cost nature of the Micromissions Program.

After a set of Phase A studies and a competition, the Mars Micromissions Program Office awarded Ball Aerospace & Technologies Corp. the role of MSC prime contractor. Ball, working with JPL, provides the multi-purpose MSC, system integration and test, and assists in operations. Aerojet is teamed with Ball and provides the tested propulsion system. JPL is responsible for the payloads and operations. A previous paper summarized the baseline concept for a first Mars MSC Comm/Nav mission.[Deininger 00a] This paper summarizes the MSC bus concept and discusses its multimission capabilities.

## LAUNCH AND MISSION DESIGN

Micromissions are designed for launch as secondary payloads to Geosynchronous Transfer Orbit (GTO) on Ariane 5 rockets. The Ariane 5 Structure for Auxiliary Payloads (ASAP5) [Arianespace 99] is used and has 8 attach points for micro auxiliary payloads of 120 Kg each. The ASAP5 twin configuration is used for MSC where 2 attach points are used for a single spacecraft. The launch site is Kourou, French Guiana. The launch window for the first Mars MSC opens on February 2, 2003 and closes on May 1, 2003. The specific launch date and time depends on the primary passengers. Therefore, the Mars MSC must carry sufficient propellant for maximum  $\Delta V$  (worst case) conditions. The MSC bus complies with center-of-gravity and thermal launch constraints for Ariane 5, and is designed for the Ariane 5 pre-flight and ascent environments. The MSC is launched as a dormant spacecraft, and is not activated until after separation. Launch on US launchers as secondaries with appropriate adapters is also being studied.

After the Ariane 5 launcher releases its primary passenger(s), the secondary payloads are released into GTO (nominally, apogee: 35,883 Km, perigee: 620 Km, inclination: 7.0°). As soon as is practical, the apogee is raised to place the MSC into a multi-day period orbit to minimize passes through the Earth's radiation belts. For missions to Mars, the spacecraft flies in the Earth-Moon system for between 1 and 6 months (depending on the launch date and time within the overall launch window) to achieve proper phasing for the next mission phase. The spacecraft then executes a lunar flyby to obtain the correct geometry for a powered Earth flyby for injection into a Mars transfer orbit. Cruise to Mars is largely spent with the solar arrays sun pointed. For the first MSC opportunity, arrival at Mars is expected on December 26, 2003. A high  $\Delta V$  Mars orbit insertion (MOI) burn is conducted on arrival. This burn places the MSC orbiter spacecraft in a loosely captured, retrograde Mars orbit with a nominal period of 3 Sols and a perigee of 250 Km. After essential operations are conducted, the spacecraft aerobrakes down into its final circular Mars orbit over a period of 3 to 4 months. Even with the use of aerobraking, approximately two thirds of the spacecraft wet mass (242 Kg) is propellant.

## MSC SPACECRAFT SYSTEM AND SUBSYSTEMS

Micromissions mission drivers included very tight mass constraints, streamlined launch site processing to support secondary payload status, packaging of the MM on the ASAP5 interface with two attach points, accommodation of multiple payload types, providing adequate  $\Delta V$  capability, allowing for passive aerobraking for orbiting missions, and autonomous capabilities typical of deep space missions. The main performance characteristics of the spacecraft are summarized in **Table 1**.

Table 1. MSC Typical Performance Parameters.

Parameter	Value
Launch Vehicles	Secondaries on Ariane 5, Atlas V, Delta III, Delta V
Missions	Sun distance of 0.7 AU to 1.7 AU (GEO, cis-lunar, Venus, Mars, near-Earth objects, Lagrange points)
Design Life	5 years
$\Delta V$ Capabilities	Up to 2750 m/s
Payload Mass	Up to 45 Kg depending on mission type
Nominal Payload Power	12 W
Downlink Data Rate	5.56 Kbps at 2.6 AU (Earth-MSC range)
Payload Commands/Telemetry	RS-422
Attitude Control Type	3-axis, zero-net momentum
Pointing Accuracy ( $3\sigma$ )	0.039 deg
Pointing Knowledge ( $3\sigma$ )	0.036 deg
Pointing Stability ( $3\sigma$ )	21 $\mu$ rad/s

### Spacecraft System Configuration & Operation

The core configuration is designed to accommodate multiple payload types, see Fig. 1. It has a large central payload volume (0.24 m<sup>3</sup>) and provides high  $\Delta V$  capability (up to 2750 m/s) to deliver payloads to a variety of targets. The MSC is a three-axis stabilized spacecraft bus with a truncated (80°), torroidal form and two distinct launcher attach rings.

Figure 2 shows a rear view of the stowed configuration of a MSC orbiter spacecraft mounted on the ASAP5 attach plane. The fuel and oxidizer tanks are mounted directly above the attach rings to efficiently transmit launch loads. The core structure has a deck that spans the attach rings and supports the remaining propulsion subsystem elements. Vertical members and the solar array panel stiffen the overall structure and mount the remaining components. A 0.8 m-diameter, x-band HGA, shown stowed in the central payload volume, enables high data rate communications with Earth.

Figure 3 shows a rear view of a MSC probe carrier spacecraft mounted on the ASAP5 attach plane with a single large probe. The 0.75-m diameter probe resides in the central payload volume. The probe system (attach cables, support structure, spin-up mechanism, aeroshell, and probe payload) has a mass allocation of up to 45 Kg.

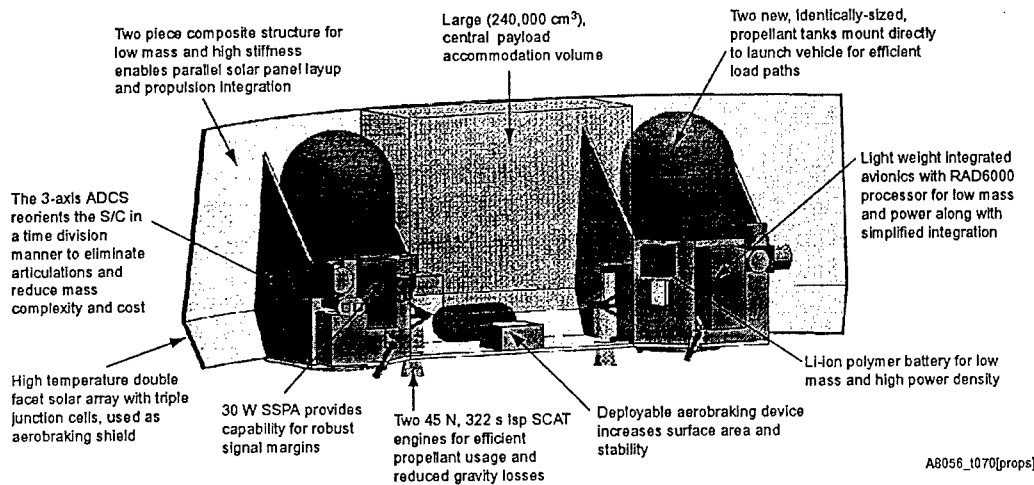


Figure 1. Key design features of the MSC bus.

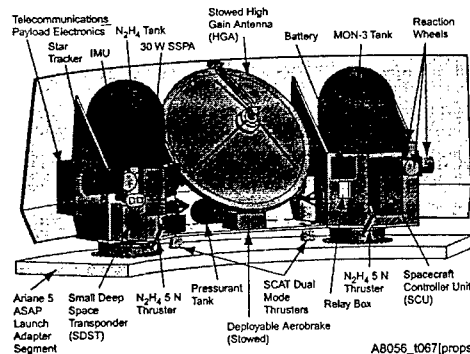
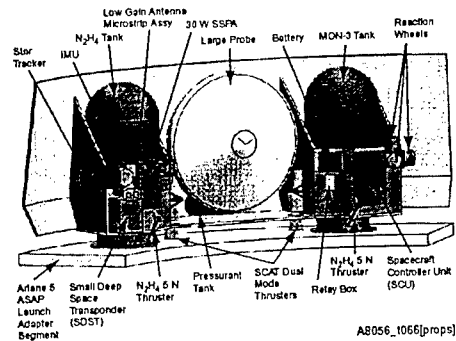


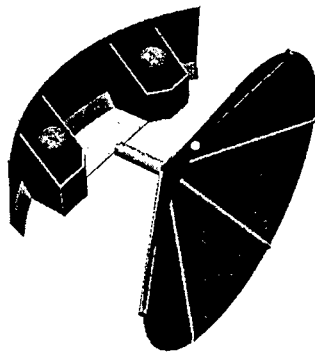
Figure 2. The MSC orbiter configuration on the launcher platform.





**Figure 3. Rear view of the MSC probe carrier spacecraft on the launcher platform.**

On the MSC Orbiter spacecraft, two deployments are needed. First, the high gain antenna (HGA) resides in the payload envelope between the tanks for launch. It does a single, 125° deployment above the array for operation so that its boresight is offset 20° from the array normal. The second deployable is a lightweight inflatable structure that provides passive stability during aerobraking. It is baselined for deployment after the orbit injection burn and is jettisoned after the MSC achieves its operational orbit. The baseline stabilizer concept consists of a 0.5 m-long inflatable main boom attached to a 2.5 m diameter 60° half angle cone formed from six inflatable struts and film to close the web (see Fig. 4). For a MSC probe carrier mission, the payload provides its own probe separation and spin-up hardware; no aerobraking is needed.



**Figure 4. Baseline inflatable stabilizer trailing cone concept provides a single point attachment for ease of deployment and simple jettisoning.**

### Spacecraft System Functional Architecture

The basic bus architecture is built around the use of a highly integrated avionics suite (spacecraft control unit (SCU)) to operate the spacecraft subsystems and maximize the commonality of components for diverse missions. **Figure 5** presents the overall MSC bus functional block diagram. The MSC bus is nominally, a long life, single-string architecture due to mass and volume constraints but includes functional redundancy in mission-critical areas to ensure mission success.

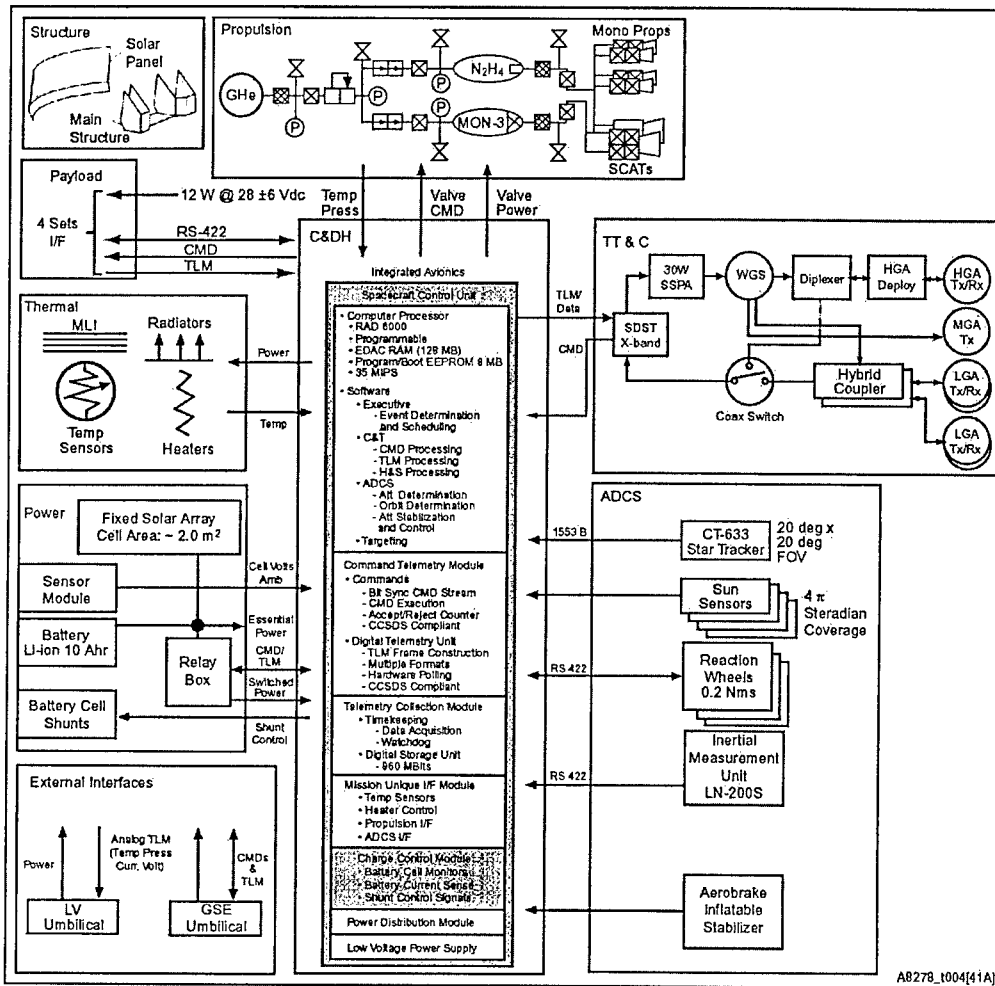


Figure 5. MMSC functional block diagram. The architecture is modular and processor-based.

The basic dry bus mass margin/contingency for the MSC spacecraft is shown in Table 2. The bus dry mass margin/contingency is calculated based on launching a spacecraft of 242 Kg assuming a full propellant load. This conservative approach means the complete margin/contingency is available for the bus and/or payload since the propellant to launch its target is already included.

Table 2. MSC Spacecraft Mass Breakdown.

Item	Value (Kg)
MSC Bus Dry Mass	72
Propellants	107 to 148
ASAP5 Scar Mass	2
Payload Mass	45 to 6
Mass Contingency	16 to 14
TOTAL (Wet)	242

## MSC Subsystem Descriptions

**Structure and Mechanisms.** The MSC bus core structure consists of just two parts, as shown in Fig. 5 (top left), the main structure and the solar array substrate. The primary structure and array substrate are constructed from composite honeycomb sandwich panels with graphite face sheets. The main design drivers for the structure are mass, cg location, and a 45 Hz minimum first lateral frequency. The (loaded) propellant tanks, which account for a majority of the spacecraft mass, mount directly to the two separation fittings. This keeps the cg low and on the centerline, minimizes structure mass, and maximizes resonant frequencies.

**Propulsion Subsystem.** The propulsion subsystem design is driven by the  $\Delta V$  requirements, mass constraints, and the need to conduct multiple large burns. The MSC dual mode propulsion subsystem supports all large  $\Delta V$ s with the bipropellant-side of the dual mode ( $N_2H_4/NTO$ ), pressure-regulated system using two 45 N secondary combustion augmented thrusters (SCAT). Momentum unloading and attitude control during  $\Delta V$ s are accomplished using four 5 N monopropellant RCS thrusters. Aerojet, building on their successful experience with the NEAR propulsion system, is teamed with Ball to provide the tested propulsion subsystem, test support at S/C level, and launch site support.

**Attitude Determination & Control Subsystem (ADCS).** The MSC bus ADCS is a zero-momentum, three-axis control system which uses reaction wheels with reaction control system (RCS) momentum dumping to minimize propellant usage. RCS control provides torque authority during  $\Delta V$  burns. The ADCS reorients the whole vehicle to accommodate its functions, one at a time: data transmission,  $\Delta V$ , aerobraking, power generation, or payload pointing. The control for this resides in the software. The MSC star tracker system provides attitude knowledge to within  $0.036^\circ$ ,  $3\sigma$  about the worst-case (boresight) axis. The spacecraft provides a  $3\sigma$  pointing control value of  $0.13^\circ$  for efficient propellant use in Thruster Control mode. Control is improved to  $0.039^\circ$  in Point mode. Simulation predicts a mean plus  $3\sigma$  stability value of  $21 \mu\text{rad/s}$ .

**Electrical Power Subsystem.** Power subsystem sizing for a Mars MSC orbiter mission is driven by both the transmit power and eclipse duration. The power budget and subsystem sizing for this case are shown in Table 3. The charge controller for the lithium-ion batteries is central to subsystem operation. This controller keeps the advantage of series-connected cells. Charge is controlled on a cell-by-cell basis by shunting current past fully charged cells. Individual charge control and ample battery size ensure battery life. The voltage limit can be adjusted downward in small increments to adjust the maximum state of charge based on flight performance.

Table 3. MSC Bus Power Budget.

Item	Power (W)
Nominal Bus Power	63.3 W
Power Generated, Earth-Moon	287 W
Power Generated, Mars	143 W
Payload Power	12 W
Battery Capacity	10 Ahr

Mass and surface area constraints drove selection of triple junction GaAsPz/GaAs/Ge cells. The solar array has a  $2.0 \text{ m}^2$  projected area with the spacecraft in the best attitude. The array substrate consists of two curved facets with a total area  $2.3 \text{ m}^2$ . Each solar cell string is confined to one or the

other facet with cells running across the short dimension so all cells in a string will have roughly the same sun incidence angle. Array voltage sizing is set by the hot operational temperature near Earth. There are nominally 18 cells in series in each diode-protected string and there will be about 60 strings depending on exact cell dimensions. Each cell has a 5 mil cover-slide.

**Thermal Control Subsystem (TCS).** The thermal control subsystem uses simple passive control with modest heater power for selective, active control. The spacecraft orientation is controlled to assist in thermal control throughout the mission.

**Command & Data Handling Subsystem (C&DH).** Ball's C&DH design incorporates other subsystem functions, integrating nearly all avionics into one, mass efficient, highly integrated, RAD-6000 computer-based electronics suite, the SCU, for data handling & storage and ADCS algorithm execution. **Figure 5** shows the functional support provided to the various spacecraft subsystems. This same approach has been baselined on both the Deep Impact Discovery Mission and ST3.[Deining 00b]

The approach minimizes total system cost by using standard core subsystem modules and standardized interfaces. The SCU is rad-hard to 60 Krads total ionizing dose (TID) while the computer can withstand 1 Mrad TID. The processor offers a mature software design environment, high fidelity target emulation and high throughput and memory margins which further facilitate software coding. Unit-level test and software qualification, at the level of the integrated avionics, verifies most cross-subsystem interfaces well ahead of spacecraft-level integration and test.

**Telecommunications Subsystem.** Link margins for carriers, ranging, commands and downlink data are >3 dB in all modes and in all mission phases. **Figure 5 (right center)** shows a functional block diagram of the RF equipment configuration for the MSC orbiter spacecraft. The heart of the telecom subsystem is the Motorola small deep space transponder (SDST). It provides X-band receiving, command detection, telemetry modulation, and telemetry encoding. The output preamplifier of the transponder feeds the solid state power amplifier (SSPA) which provides the necessary RF power. The MSC orbiter spacecraft bus Mars-Earth antennas consist of a 0.8 m HGA with a backup 0.1 m MGA. Standard off-the-shelf low-gain omni antennas (LGA) provide post launch and emergency omni coverage.

The Mars-Earth link budgets show that the bus antennas will provide robust margins well above 3 dB to the 34 m BWG DSN network. This ensures link closures in all conditions. A summary of the various link budgets is shown in **Table 4**.

**Table 4. Mars-Earth Link Margins Summary from Mars Orbit (maximum range, 2.7 AU).**

Item	Antenna Gain (dB)	Data Rate (bps)	Margin (dB)
TLM downlink	34.4	5556	3.12
Emergency downlink	14.5	10	3.19
CMD uplink	33.0	125	8.1
Emergency uplink	6.0	7.8215	3.31

### Aerobraking Approach

The baseline, passive aerobraking approach, a key operation for MSC orbiter missions, makes use of spacecraft shaping and a low mass, trailing drag cone deployed immediately behind the MSC spacecraft. The spacecraft aerobraking design is sized to achieve final orbit within 4 months of the start of aerobraking at Mars and can be scaled for use at Venus.

A wedge-shaped leading edge is employed and is formed by the two conical facets of the solar array substrate. This leading edge acts as a pseudo diamond airfoil. This provides a portion of the needed drag as well as some stabilizing effects in the hypersonic flow of the Martian atmosphere. This shape will be further optimized for localized aerodynamic flow and thermodynamic heating through analyses.

We augment aerobraking using an inflatable, trailing drag cone that shifts the center-of-pressure well behind the center-of-mass providing robust directional stability while simultaneously providing additional area in order to reduce aerobraking time and heating of the spacecraft. The deployed device assures positive yaw and pitch control authority. The symmetric shaping of the basic spacecraft and the proper center-of-pressure position relative to the center-of-mass helps increase passive roll stability. Initial assessments of roll stability show a worst case roll rate of approximately 1 rpm after an aerobraking pass. The NASA Langley Research Center is providing support in high performance CFD analysis and aerodynamic control simulations.

## FLEXIBILITY OF MSC DESIGN FOR FUTURE PAYLOADS

The Micromissions spacecraft can be used for science targets other than Mars, including the Moon, Venus, Mercury, asteroids, other small bodies, or the Lagrange points with minimal changes to the multi-purpose bus design. Technology demonstration missions in various Earth orbits or on interplanetary trajectories can also be accommodated. This ability is enabled by the high  $\Delta V$  capability discussed earlier and the flexible payload packaging and accommodation capabilities.

The MSC is designed to accommodate payloads in a large central payload volume with a common bus configuration. It is enabling to Mars Micromissions for two reasons. First, the large central volume has been designed to meet all current requirements for probe configurations as well as providing similar accommodation for the MSC orbiter HGA. Additionally, this same accommodation volume can accept science payloads with volumes of up to  $0.24 \text{ m}^3$ . The field-of-view (FOV) is slightly less than  $2\pi$ -steradians looking out the back of the spacecraft (partial blockages from the propellant tanks and bus equipment) and a full  $2\pi$ -steradians out the top of the spacecraft (good for sun-synchronous nadir pointing missions).

Spacecraft-to-payload electrical interfaces (4 sets) are shown schematically in **Fig. 5** and are via RS-422 bidirectional asynchronous serial data links. The electrical power interfaces are individually switched and fused 28 Vdc lines. The data interface rates (user-to-MS) range from 9.6 to 512 Kbps. There are nominally 960 Mbits of data storage space available.

The kinematic attach points on the structure allow easy change out of payloads if required. Additional payload attach points can be inserted into the structure after it has been fabricated, making accommodation of a new payload on an existing or spare structure relatively straightforward. The central payload volume accommodates one large probe, two medium probes, six small probes, or the 0.8 m-diameter telecom antenna and deployment mechanism along with the UHF payload.

The nominal spacecraft-to-payload thermal interface is conductive since the payload mounts directly on the spacecraft structural panels. Any required thermal isolation provisions are internal to the payload. This allows the payload to tune its thermal isolation from the spacecraft bus and provide its own thermal balance. Payload temperatures can be maintained using heater power supplied by the spacecraft, if required.

## FIRST MSC ORBITER MISSION SCHEDULE

The MSC contract began on February 9, 2000. The Phase 1 activities will be complete by Fall 2000 with the SRR scheduled for mid-summer and the PDR scheduled for early fall. CDR will occur during the early part of Phase 2. The launch window opens February 2, 2003 and closes May 1, 2003. Initial insertion into Mars orbit is scheduled for December 26, 2003.

## ACKNOWLEDGEMENTS

The work described in this paper was developed by a team of people at Ball Aerospace & Technologies Corp. and GenCorp Aerojet as part of the Mars Micromissions proposal effort. The authors would like to thank the proposal team for their work in developing this winning design.

## REFERENCES

- [Arianespace 99] Anonymous, "Ariane Structure for Auxiliary Payload (ASAP) 5 Users Manual," Arianespace, Issue 1, Rev. 0, April 1999.
- [Deiningner 00a] Deiningner, W. D., Epstein, K. W., Eterno, J. S., Andreozzi, L., Sieger, S. and Leschly, K., "Low Cost Access to Mars – Mars Micromissions Spacecraft," Paper IAA-L-1212P, Fourth IAA International Conference on Low-Cost Planetary Missions, Johns Hopkins University, Laurel, MD, USA, May 2000.
- [Deiningner 00b] Deiningner, W. D., Noecker, M. C., Wiemer, D. J., Eterno, J. S., Clevin, C., Patel, K. C., Blackwood, G. H., and Livesay, L. L., "Space Technology Three: Mission Overview and Spacecraft Concept Description," Paper IAA-L-1107, Fourth IAA International Conference on Low-Cost Planetary Missions, Johns Hopkins University, Laurel, MD, USA, May 2000.
- [Hastrup 99] Hastrup, R. C., Cesarone, R. J., Srinivasan, J. M., and Morabito, D. D., "Mars Comm/Nav MicroSat Network," SSC99-VII-5, 13<sup>th</sup> AIAA/USU Conference on Small Satellites, Logan, UT, USA, August 1999.
- [Hastrup 00] Hastrup, R. C., Bell, D. J., Cesarone, R. J., Edwards, C. D., Ely, T. A., Guinn, J. R., Rosell, S. N., Srinivasan, J. M., and Townes, S. A., "Mars Network for Enabling Low-Cost Missions," IAA-L-0509, Fourth IAA International Conference on Low-Cost Planetary Missions, Johns Hopkins University, Laurel, MD, USA, May 2000.
- [Jordan 99] Jordan, J. F. and Miller, S. L., "The Mars Surveyor Program Architecture," IEEE 1999 Aerospace Conference, Paper 2.201, Aspen, CO, USA, March 1999.
- [Matousek 99a] Matousek, S., Leschly, K., Gershman, R., and Reimer, J., "Mars Micromissions," SSC99-VII-6, 13<sup>th</sup> AIAA/USU Conference on Small Satellites, Logan, UT, USA, August 1999.
- [Matousek 99b] Matousek, S., "Low Cost Planetary Exploration Via Micromissions," AIAA 99-4446, Space Technology Conference and exposition, Albuquerque, NM, USA, September 1999.

**CNES MICROSATELLITE PRODUCT LINE,  
AN APPROACH FOR INNOVATION**

**By Charles BOUZAT (head of Microsatellite division)  
and the Microsatellite project team**

*Centre National d'Etudes Spatiales (CNES)  
18, Avenue Edouard Belin – 31401 Toulouse Cedex 4*

o **ABSTRACT**

*Taking into account the capability given by the low cost launch opportunities, specially with the ARIANE5 ASAP structure, and the evolution of technology and low cost industrialization development, CNES with a strong support of national scientific community, has decided in continuity of the PROTEUS product to develop a new Microsatellite product line.*

*This new product is built to be compatible with a secondary payload launch configuration on ARIANE 5 or PSLV (indian launcher ) and on the mid-term with the others launchers like STARSEM/SOYOUZ, ROCKOT, LEO-LINK... The goal corresponds to a cost objectif of 50 MF per mission, launch included, and an average capability of two missions per year.*

*A selection process of scientific missions initiated in early 97 showed the existence of a large request and lead the Scientific Program Committee of CNES (CPS) to choose last March 98 eight missions among 26 proposals corresponding to various thematic areas like Earth Sciences (Solid Earth, Atmosphere, Biosphere) and Science of Universe (Astronomy, Planetology, Physics of Plasma, Fundamental Physic). CPS has finally selected two of these missions by end of 98 and recently decided two additional missions in December99 :*

*\* the first one called DEMETER, of which launch is scheduled around mid-2002 with the indian launcher PSLV and which concerns the study, by observation of magnetic and electromagnetic effects, of ionospheric disturbances potentially linked to volcanic or seismic activities.*

*\*the second one, called PICARD, launched around mid-2003 , concerning the Sun observation (precise measurement of the solar diameter, of the solar constant and of their variations and variability). These measurements will be analyzed to improve the knowledge of the solar factors influencing on the Earth climate evolution (in particular its warming) and of the internal structure of the Sun (diameter oscillations).*

*\* the third one called PARASOL uses a recurring instrument POLDER for Earth atmosphere study particularly concerning aerosol and clouds radiative and microphysic parameters. This microsatellite will be part of a swarm composed by EOS-PM, PICASSO-CENA and CLOUDSAT and will be launch with Helios 2 beginning 2004.*

*\* the fourth one called MICROSCOPE is based on the ONERA high accuracy accelerometer and aims to verify the equivalence principle between inert mass and gravitational mass with an accuracy of 10-15 instead of 10-12 cooresponding to the today ground measurements. This is a drag-free microsatellite using electric*

*propulsion and planned to be launched in 2004.*

*This article describes the CNES microsatellite rationale, the organization and the methods used for suitable answer to the various missions needs while keeping in mind and making a reality the low cost objective.*

## **1 - INTRODUCTION**

Over the past 2-3 years CNES has studied the possibility to develop a microsatellite product line for scientific, technology demonstration or even for some radio-communication and earth observation mission. The success of microsatellite development in SSTL and DLR and the various experimentations undertaken by other countries wishing to develop a space activity show the growing interest for low cost mission taking benefit from opportunity like ASAP and PSLV or other launchers offering now capability for designing a microsatellite class that covers a satellite mass range up to 120kg.

After PROTEUS developed in partnership with ALCATEL SPACE, CNES decided to create a microsatellite project organization as a prime for controlling the industrial organisation and setting up the methods and tools which allow to adapt the product to each mission in low cost objective and short time schedule.

« Better, Faster, Cheaper » : of course, this slogan developed in USA during the 90's has inspired the CNES approach as it relies on use of technological developments and miniaturisation resulting from large electronic markets, but the CNES rationale is guided mainly by exploring new approaches.

This program which represents a 100 MF per year CNES funding since 2003 is the opportunity for CNES to test innovation in programmatic, system, technological and methodology areas.

### **THE MICROSATELLITE HELP NEW PROGRAMMATIC APPROACH**

*To develop a product line based on a system and functional chains reference allowing :*

- *a low cost (30MF payload excluded and launch included compared to 200 MF for medium satellite as type PROTEUS ones and some GF for heavy satellites)*
  - *a short development duration ( 18 to 24 months compared to 3 to 6 years needed for a classical program development)*
  - *while keeping a strict frame of Product Assurance*
- are the main goals of the CNES microsatellite programme.*

These characteristics allow a new programmatic approach as :

- To decide a short schedule programme offering the best phasing with technological evolution and permitting incoming experimentations
- To take risk at a higher level : programmes with uncertain scientific return can be decided, the scientific improvement perspective being very attractive compared to the funding
- To create opportunities for international cooperation or even access to space for new partners like University

### **THE MICROSATELLITE MODIFY THE SYSTEM APPROACH**

*A single Microsatellite is certainly less performant than a medium or heavy one, but several microsatellites in swarm configuration offer very interesting possibilities !*



To associate for a mission several satellites is not a new idea. In order to compensate their capacity limitation, use of microsatellite allows a different thinking. One can imagine :

- to establish interferometric basis with several microsatellites
- to create a phased constellation offering a service equivalent to a medium or heavy satellite

but with a cost reduction by a factor of 3 to 5

One of the main advantage of such a system is given by the soft degradation of service in case of failure of one of the microsatellites.

#### THE MICROSATELLITES ARE A KEY ELEMENT FOR TECHNOLOGICAL PROGRESS IN SPACE ACTIVITY

*The space industry is more or less conservative in the technological area : the risk reduction generally induces proven technological choices, and the long schedule resulting from classical programmes is an amplifying factor of delay.*

The microsatellites modify this situation :

- first, to achieve a performant microsatellite, it is mandatory needed to use miniaturized technologies and so the effort is amplified by necessity ;
- secondly the risk approach allows use of non space qualified technologies, and by that way one can benefit from progress coming from electronic industry development made for big markets( for example automotive or mobile phone).

#### THE MICROSATELLITE ALLOW TO EXPERIMENT NEW METHODS

*A microsatellite must be studied and develop in a short schedule by a limited team for low cost considerations : this is an opportunity to settle organizations, methods and tools to work differently.*

To make the foreseen benefit real, new design and development methods relevant to organization and tools must be used. One of the answer is given by the integrated design engineering workshop and associated system tools developed by CNES which will be operational beginning 2001 and will favor a better activities management between design phases (0, A or B) and development.

Another way is to create more flexible partnerships between programme industrial members. Such a scheme takes place with for example our usual Primes MMS and ALCATEL .

## 2 - THE PROBLEMATIC OF LOW COST

For the microsatellite development, the low cost objective has to be achieved in the following context :

- 1) to develop innovation
- 2) preference to design-in house in order to control cost
- 3) use technical knowledge spreaded in a large technical organization
- 4) try to find performance-cost optimum with targeted investment
- 5) no unique design and mission adaptability

To deal with that context and offer maximum low cost reduction, the following principles have been considered:

- o try to analyze in depth and freeze mission requirements during the feasibility phase,
- o design robustness but high performance avionics and powerful configuration (deployable and steerable solar array, 3-axes stabilization for fine pointing, CCSDS communication). No large margins are provided to ensure success and functional redundancy is used as much as possible with degraded mission modes in terms of performance. Reliability is not sacrificed but relaxed. Single string design, which reduces cost, can be reliable if it is built robust, with good quality control and thoroughly tested. Minimization of upset effect and latch up is achieved by specific protections in order to offer better availability but no more.
- o reuse of design at maximum extent from one mission to the other (at least for avionics),
- o use of commercial standard interfaces (RS422/RS485 data handling interfaces) which provide access to well debugged test equipments and parts,
- o use of cots devices at part level and for standard equipment (as parts could be heterogeneous in quality custom screening process and qualification tests must be applied for validation through an appropriate balance between part test and system test),
- o make strategic procurement to prevent obsolescence and develop futur equipment in parallel to follow technology evolution,
- o on board autonomy to simplify ground operations but no complex strategy of FDIR and use of a robust and reliable safe mode (this is achievable by hardware and software systems capability but limits the mission availability),
- o simplified and straight model philosophy (full qualification at equipment level, no satellite engineering model, thoroughly tested protoflight model),
- o management alleviation to focus on key points and minimize paperwork (documentation is issued only when value is added). Extensive use of PC based software tools and interactive teams with co-localization and high communication inside the group.

### 3 - ORGANIZATION AND METHODS

#### 3.1 ORGANIZATION

For the development of the product line CNES is responsible for the design and development of generic items (those ones corresponding to the ground segment being derived from PROTEUS development). The CNES technical departments are deeply involved in the design and, as far as possible, R&D developments are taken into account when mature with respect to the scientific mission schedule. At the beginning, Cnes is also responsible for the selection and procurement of the equipment level items and has selected the LATECOERE company for the satellite integration. This organization will evolve in order to transfer to this company recurrent equipment procurement and allow her to commercialize the product, CNES keeping in charge the system and satellite engineering and the scientific laboratories being responsible of the development of the payload and scientific data treatment ground segment.

In order to achieve various missions in a short schedule and limited cost, it is necessary to rely on competent and motivated teams. As this philosophy must be based on innovations outside the established norms, the team must adjust roles and responsibilities to best use of everyone's talent. With respect to the training objective of young engineers, it is necessary to accompany such people with senior engineers having in mind the essential rules which avoid major troubles. Besides, the institution must also admit that the team adapts its own management process while respecting the general approved guidelines defined for the program. At last it also must be clearly

identified the level of acceptable risk and in the beginning of the project both parties must be aware of critical points and associated methods of control.

### 3.2 METHOD

This program will be the opportunity to test new design and management methods (as concurrent engineering) which are more often promoted in USA. As low cost and short time scale means :

- o rapid mission assessment and feasibility,
  - o improved understanding (from experience and product evaluation) of the quality of material and behaviour under life environment
- it is necessary to make different competences work interactively.

For answering to the required objective, several aspects have been identified:

- o to organize multidisciplinary teams and facilitate their job in using informatic tools based on data banks of equipments relevant to all the different skills,
- o to favour development of modelisation approach and search for a global coherency between the different tools used by the various specialists,
- o to allow the customer to participate in the definition of the system requirements.

In order not to overspecify the system, the project team must interact with the principal investigator and the payload team to adjust the mission requirements to ensure the goals of the mission while taking into account resources limitation.

Based on competent technical team, the concurrent engineering must be encouraged by project management contributing in ideas at higher level to stimulate the team's problem-solving capabilities and to facilitate communication. Conducted by a strong system engineer, the project team (which could consist in engineers belonging to different technical hierarchical structures) must avoid to perform individual optimisation. There must be also a strong communication between « functional chains » engineers who must be preferably co-localized while equipment engineers can stay near their technical structures where they have access to peer support and technical tools.

These necessary means are being developed in CNES and will constitute the Microsatellite Project Design Office as those used by GSFC or JPL for team-X sessions.

Another area essential in the low cost approach is the risk control management. Change in the project management method and use of COTS components require to adapt the product and quality assurance process to that context. The risk control process is based on identification, assessment and reduction of risks of not satisfying the mission (having in mind that : "mission is perceived as successful only if it meets a useful purpose at an affordable cost and within an acceptable period"). In the design phase, safety construction is based on a functional analysis which allows to identify nonfunctioning risks, to evaluate them and to define corrective actions. This process is helpful to validate the design and focus quality effort only on critical functions.

Concerning COTS equipment, it is necessary first to evaluate the product in terms of performance and qualification status and also to evaluate the supplier in terms of quality assurance (this is achieved by qualification file analysis and audit of the supplier). The use of commercial parts leads to define a selection and evaluation methodology based on selection team including designers and parts experts. The risky part are identified and evaluation actions are settled to check their reliability.

Concerning management, in order to avoid major drift of cost and schedule due to technical difficulties, it will be necessary, by a close management, to take decision which performs the best compromise between requirements keeping or additional constraints applied to the product line and requirement relaxation.

#### **4 - MICROSATELLITE SYSTEM DESCRIPTION**

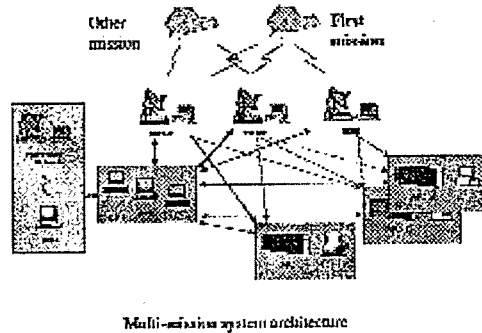
The CNES microsatellite product line development is characterized by a high performance design in terms of capability offered to the payload (mass, power, pointing accuracy, telemetry and processing) but with low cost objective given by COTS (parts and equipments) utilization and use of innovative methods of engineering and management (risk management, quality management, internal or external customer/supplier processus, design and manufacturing tool standardization). In particular, the objective is to settle concurrent engineering process by associating selected industrial companies in the design process. This interactivity shall be exercised in the frame of an engineering workshop developped by CNES. The computer structure, in which are centralized the system modelizations, will allow to make design iterations with industry taking into account manufacturing constraints and defining technically and costly optimized requirements.

The CNES microsatellite program is based on :

- o a reference subset of functional chains fully developped and qualified on the occasion of the first mission DEMETER,
- o options fully studied and available for new missions, most of them flying on DEMETER even if not required by the mission,
- o models and simulations, mostly but not exclusively software, allowing fast study of any new mission in the frame of the Engineering Center,
- o a ground system for multimission control.
- o a Command Control Center (CCC),
- o one Telemetry and TeleCommand Earth Terminal (TTCET),
- o a Data Communication Network (DCN),
- o an X band Telemetry Earth Terminal (TETX)
- \* two Mission Centers (MC), one for the scientific part of the mission (MC-S) and the other for the technological one (MC-T).

In addition this system has the capability to use CNES multimission resources (the CNES S- band stations network and the Orbitography Operational Center). This resources can be used for the station acquisition and in case of anomaly.

As described in the two following pictures the architecture of this system will evolve. Moreover, some components of this system are not dedicated to one mission but will be shared with other ones, when the next satellites will be launched.



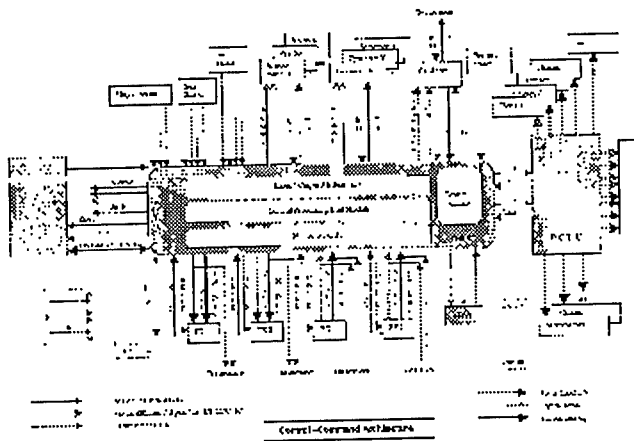
## Multi-mission system architecture

### 4.1 SATELLITE MAIN ON BOARD FUNCTIONAL CHAIN (HARD CORE OF THE PRODUCT LINE DEVELOPMENT)

The satellite architecture is mainly based on the following product line functional chains:

- 1 - An attitude and orbit control function which includes :
  - o an attitude determination system based on 3 coarse sun sensors (only used for the acquisition and the safe mode), a 3 axes magnetometer and a stellar sensor when precise attitude measurement is needed or when pointing accuracy must be better than few degrees. Three raw gyros (1 axis gyros) are added to the design to give attitude information during orbit manoeuvres.
  - o an attitude control system based on the use of up to 3 reaction wheels (fine attitude control and manoeuvrability) and 3 magnetotorquers, for reaction wheels unloading or coarse attitude control mode,
  - o and optionally an orbit control system assumed by an hydrazine propulsion subsystem with four thrusters corresponding to minimum configuration to have manoeuvre capabilities and 3 axes attitude control during manoeuvres.
  
- 2 - An electrical power generation, regulation and distribution function including one AsGa solar generator (with 2 deployable panels), one Li-Ion battery and a power regulation and distribution system. The power is delivered to the payload equipment on up to 5 non-regulated bus. The solar generator could be fixed (Sun pointing mission) or oriented with a 1-axis mechanism around the -Y axis (earth pointing mission case as the DEMETER one). The cant angle of the deployed solar array will depend on the mission.
  
- 3 - A control / command function which is implemented on:
  - o a central On Board Computer (OBC), including a 1 Gbit memory, based on a transputer T805 and several micro-controllers (PIC 16C76) for interfacing with the equipments.
  - o two S band link transmitter and receiver chains, with two sets of antennas (Tx /Rx) used to have a quasi-omnidirectional coverage. The TM data rate is 400kbits/s in operational modes and 25kbits/s in safe modes.

The command control chain with its interfaces to the other satellite equipments are shown in the following figure.



These functional chains will be slightly adapted for each mission, depending on their specific requirements. For example, in addition to the X band telemetry chain, the following specificity are taken into account for the DEMETER mission:

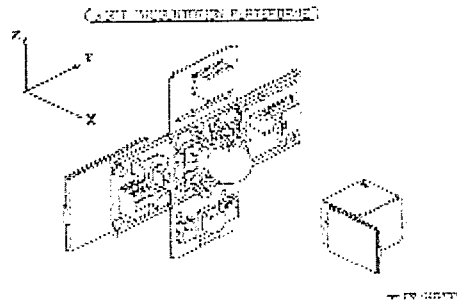
- o high satellite inertia and low natural frequencies due to some large appendages,
- o magnetorquers activation limited to the period without scientific measurements (terrestrial high latitudes  $> 60^\circ$  and  $< -60^\circ$ ),
- o specific EMC requirements (solar generator covered with ITO coating, ...).

#### SATELLITE MECHANICAL AND THERMAL ARCHITECTURE

The structure and the satellite thermal control will be customised for each mission, except in case the basic structure is able to accommodate the payload identified for the corresponding mission. The main drivers of the satellite architecture are:

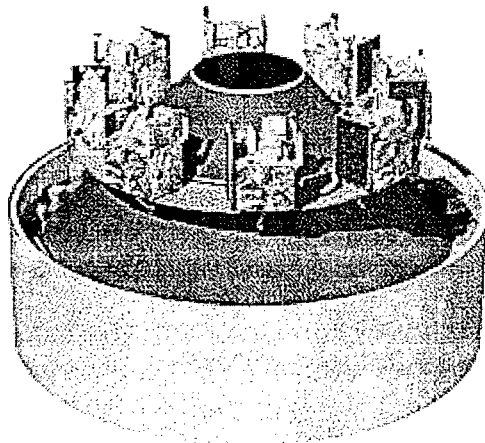
- o use of a generic rigid lower plate (interface with the launcher), including a shock damper system,
- o design of a modular architecture with an independent propulsion module directly integrated on the lower plate,
- o general design concept (mechanical, power generation and attitude control) allowing to systematically have a satellite face in the shadow. This face supports low temperature equipment (battery) and the stellar sensor which requires not only low temperature but also a field of view without any Sun parasitic illumination.

The following figure shows the basic structure, with the propulsion module and the lateral panels with the equipment of the 3 previously described functional chains. The 2 solar generator panels are folded on the -Y face, opposite to the battery and to the stellar sensor +Y face.



#### LAUNCHER :

Apart from ASAP ARIANE 5 opportunities, the PSLV launcher is considered. It has a capacity to launch up to 2 micro-satellites in addition to the main passenger. The PSLV requirements are quite identical to the Ariane5 requirements for an ASAP micro-satellite launch, with lower environmental loads (shock and random).



ARIANE5 ASAP configuration.

#### SATELLITE MAIN BUDGETS :

Mass budget: the DEMETER mass budget is approximately 110 Kg splitted in avionics (19 Kg including payload management/mass memory and X-band telemetry), structure and thermal (32 Kg), power supply ( 18 Kg), propulsion (8 Kg) and payload (33 Kg).

POWER BUDGET : the solar generator gives a 140W maximum power at 70°C after one year in orbit.

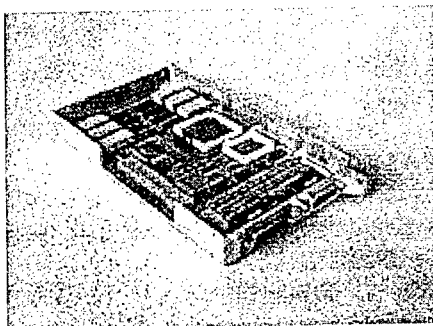
For DEMETER, the solar generator configuration (cant angle of 14°) and the local hour variations of the orbit ascending node lead to a maximum permanent available power higher than 75W for a satellite consumption of 59W in the survey or burst payload modes, up to 90W during the X band TM transmission.

ATTITUDE CONTROL PERFORMANCES : the raw attitude control mode has an attitude control accuracy less than  $5^\circ$ .  
With the use of the stellar sensor the attitude control and the attitude measurement accuracy is better than  $0.1^\circ$  worst case.

#### R&D DEVELOPMENTS FOR MICROSATELLITE PRODUCT LINE :

Some R&D developments have started in 1997 concerning microsatellite equipments. They concern the OBC computer and the S-band receiver/transmitter(RX/TX). Others R&D developments are in progress in order to make available advanced technology equipments corresponding to the needs of the Microsatellite product line in terms of technical and cost goals.

For the OBC computer, the goal was to fulfill the low cost/low mass/low power optimum while having a computing and communication performance similar to the state-of-the-art computers used in current projects. A 3Kg/5w/2 liters/2 Mips/ 1Gbits/ 15Krads goal was assigned. Even if in the conservative space domain it is not so difficult to get performance using current technology (SPARC processor,memory,rad-hard parts) the main challenge was to fulfill all the constraints together. Use of new architectural solutions was necessary.



OBC processor board

In practice, mass budget requirement allows to use conventional printed circuit boards populated both sides with plastic surface mounted parts(except for FPGAs and processor using ceramic packages). The use of internal serial buses for connecting the four baseline modules (Power,TMTC,CPU and I/O) allows to follow a network paradigm and provides enough adaptation margins: this is a direct application of what everybody sees when he uses a PC connected to a network ! For external interfaces the opposite was done,avoiding buses to simplify software but using direct and dedicated RS485 links. As the processor is not latch-up immune, specific circuits protect and allow a reboot of the computer when non recoverable error occurs. With regards to COTS use, some "system hidden" redundancy scheme was implemented for each critical internal node(watch-dog and over-current protection against heavy ions effects, coded command against failure propagation).Besides a reduced number of rad-hard parts are used to build an internal safety management core.

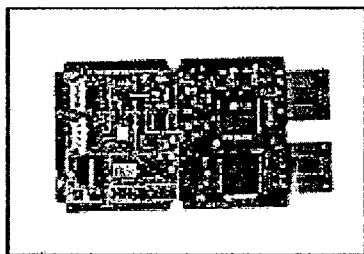
For the RX/TX equipment, low cost was achieved by miniaturization and technology used on commercial markets.To achieve low cost/low power/low volume the driving idea was to find and



use macro-parts for the heart of the equipment which belong to numeric TV or mobile phone electronic production (for example ASICs use for decoding and demodulation in TV receivers). These parts benefit from a very dynamic background in term of innovation and reliability. Of course these parts have undergone complementary tests(temperature, radiations...) but these targeted and simple tests do not change the cost efficiency in terms of integration,performance and global cost. Other functions are achieved in more conventional hardware but always with more advanced technologies (multi-layer circuits, CMS parts, automatic report as for radiotelephone devices).

Today, results are encouraging as with respect to a standard full space development a figure of 2 has been reached on the power consumption and volume, a figure of 5 to 10 has been obtained on the recurrent cost.

The constraints inherent to that type of development are nevertheless acceptable : more interaction with a industrial partner who has less knowledge of the space constraints, need to make a strategic active parts procurement, and full qualification tests campaign.



RX/TX board :

The first mission DEMETER will also include some technological experiments as on board autonomous orbit control system, and pyrotechnic priming by a laser system.

#### 4.2 GROUND SATELLITE INTERFACE

The communication between the ground segment and the satellite is performed through two links : the S band, and the X band. The S band link is full compliant to the CCSDS standard, whereas the X band link complies with this standard at the packet level.

The X band is devoted to scientific telemetry, whereas the S band is used for the housekeeping and technological telemetry. However, it must be possible to transmit telemetry through the S band link, in the limit of the actual S band link capability. All the TC are transmitted through the S band, using a protocol, which guarantees automatic re-emission of TC frames detected as erroneous or lost by the board peer.

For the S band, the specified performance objectives must be guaranteed for a minimum elevation of 10° with a system margin of 3 dB for the TM and 10 dB for the TC. The frequency, modulation and rate characteristics of the interface for LEO satellites are stipulated in the following table :

##### SAFE MODE

- o TM modulation and coding / Viterbi
- o TC modulation

##### NOMINAL MODE

- QPSK (1/2 Nyquist filter)    QPSK (1/2 Nyquist filter)
- +Viterbi+RS concatenated coding    RS concatenated coding
- QPSK (1/2 Nyquist filter)    QPSK (1/2 Nyquist filter)

and coding

Viterbi / Viterbi

For the X band, the specified performance objectives must be guaranteed for a minimum elevation of 15° with a TETX. The maximum data coded rate is 18 Mb/s. The modulation and coding used is a Multidimensional Trellis Coded Modulation Concatenated with Reed-Solomon bloc code (MCTMCRS).

### 4.3 COMMAND CONTROL GROUND SEGMENT (MIGS)

The MIGS inherits of the Proteus Generic Ground System.

As far as the CCC is concerned, it is in charge of :

- o preparing the programming messages taking into account the payload part which is built in the Mission Centers,
- o preparing and monitoring the communication with the satellite using a TTCET,
- o reconciling the TM for a quick look and for alarm generation,
- o evaluating the functioning of the platform,
- o orbit and attitude monitoring.

The CCC realizes the orbit restitution using Doppler measurements acquired by the TTCET on the down link.

The Data Remote Processing PC (DRPPC) is a PC which can be used in the CCC or outside, in order to treat the real time housekeeping telemetry, or to work on the archive stored in the CCC databases.

From an operational point of view, the operators work during administrative hours. This functioning requires :

- o the capability of performing automatic loading of programming messages in the absence of any operator, using an agenda function,
- o an automatic anomaly detection.

The TTCET are automatic S Band stations, in charge of :

- o establishing and maintaining the satellite to ground radio-frequency link for all programmed visibility passes (transits),
- o receiving and temporarily storing the received telemetry during a transit. This function concerns the House Keeping Telemetry to be Recorded, but also a part of the Payload Telemetry,
- o receiving and transmitting to CCC the Passage House Keeping Telemetry during a transit,
- o accepting the connection with CCC or a Mission Center for transmission of payload data and a part of the received platform data,
- o transmission of telecommand to the satellite for the transit in progress,
- o doing Doppler measurements during the transit, for orbit calculation and antenna positioning,
- o compensating Doppler effect on telecommand link,
- o contributing to the correspondence between on board and UTC time.

The TTCET has a 3.1 meters diameter antenna.

The last component of the MIGS is the Data Communication Network (DCN). Its main characteristics are :

- o the interfaces of the MIGS are based on Internet Protocol (IP), for real time transfer via service sockets, or file transfer using ftp,

o the MIGS subsystems are connected to the IP network by standard routers.

## 5 - CONCLUSION

Since the programme decision, we come to the following point :

- The CNES product line is now a national standard ; both industrial satellite Primes, MMS and ASPI, have been associated to our development through engineering partnerships which allows them to use the design for their own applications
- Four scientific missions have been decided ( Demeter, Picard, Parasol and Microscope), a cooperation with Brazil is settled to develop jointly a dedicated microsatellite for scientific and technological purpose, and a mission for the Defense Ministry based on four microsatellites will be developed by MMS , that means a total of 9 microsatellites based on the same CNES product line up to 2004.
  
- All the industrial organization involving manufacturing of generic equipment used in functional chains and their integration is settled. This process results from numerous request for proposals issued to european or international companies. The quality and high number of bids demonstrate the international credibility of such a product line.
- Large CNES staff relevant to all the competences developed in CNES is mobilized on that programme, and this is emphasized by the necessity to develop the product for the first applications and paralely to settle the engineering workshop and take into account the missions coming after Demeter.

The CNES Microsatellite program will be one of the opportunities for applying the trends of the strategic plan defined by CNES in testing new way of adaptation to the evolution of the space activity, either through use of other economical sectors or through search for innovative technology or methodology. The microsatellite product line defined as a subset of tools and functional chains (equipments, software, architectures, simulation test bench, engineering workshop) will be qualified in 2001 and first application for DEMETER mission will be flown beginning 2002. The CNES leadership in the industrial organization definition and the settlement of partnership with industry should allow the best use of every competence to contribute to the success of this ambitious program.

Beyond the first applications and the scientific microsatellite program, it is foreseen to extent the industrial organization for producing, and when needed, commercializing this product. This, in the long term, will allow CNES to concentrate on the main role of system and satellite prime responsibility for its own scientific and technological applications or for cooperations, in which the developed engineering and management tools will allow CNES and its partner to design a system offering the best answer based on the CNES microsatellite product line.

## PROTEUS : EUROPEAN STANDARD for SMALL SATELLITES

**Christine GRIVEL, Francis DOUILLET, Thierry HUIBAN** <sup>(1)</sup>  
**Hervé SAINCT, Yvan BAILLION, Philippe TERRENOIRE** <sup>(1)</sup>  
**Jacques SCHRIVE, Bruno LAZARD** <sup>(2)</sup>

<sup>(1)</sup> Alcatel Space Industries - 100 bd du midi - B.P. 99 - 06156 CANNES-LA-BOCCA cedex - France

<sup>(2)</sup> CNES - 18 Avenue Edouard Belin - Bpi 2532 - 31401 TOULOUSE cedex 4 - France

*RESUME – En Europe, la plate-forme PROTEUS tient la place de leader dans la classe dite des Petits Satellites, alliant un développement rapide et des performances, une robustesse et une fiabilité de haut niveau. Pour aider les utilisateurs potentiels, Alcatel Space Industries et le CNES proposent le Manuel Utilisateur PROTEUS, document standard destiné à vérifier la compatibilité des exigences d'une charge utile spécifique et d'une mission avec le système PROTEUS, qui permet à l'utilisateur final même non-spécialiste du spatial de définir complètement sa mission. Ce document est un manuel de référence qui présente les capacités de PROTEUS : une présentation générale de PROTEUS soulignant les services s'étendant de la fourniture d'une plate-forme à un système "clé en mains", un vaste domaine de vol offrant la flexibilité dans le choix des paramètres orbitaux, tous les types possibles de pointages, la compatibilité avec tous les petits lanceurs, une capacité élevée de charge utile et des interfaces pour une adaptation simple de chaque application, un segment sol et interfaces génériques, un planning et une documentation standards pour une mission typique PROTEUS. La première partie de cette publication se focalisera sur la présentation du Manuel Utilisateur PROTEUS et de la filière PROTEUS. Dans une deuxième partie, un panorama succinct des missions prévues pour utiliser la plate-forme PROTEUS sera présenté.*

*ABSTRACT - In Europe, PROTEUS platform leads the Small Satellites approach, aiming at both fast achievement and high standards of performances, robustness and reliability.*

*In order to help any potential User or Mission Planner, Alcatel Space Industries and CNES propose the « PROTEUS User's Manual » document which permits to quickly fit specific payload and mission requirements with PROTEUS system and teaches the end-User how to define entirely his mission. This document is intended to be a reference manual which presents PROTEUS capabilities: an overview of PROTEUS underlining services ranging from providing a platform to a full turnkey system, a large flight domain offering flexibility in choice of orbital parameters, any possible pointing kind, compatibility with all small launch vehicles, high payload capacity and interfaces for simple accommodation of each application, a generic ground segment and interfaces, standard schedule and documentation for a typical PROTEUS mission.*

*The first part of this publication will focus on the presentation of the PROTEUS reference manual « PROTEUS User's manual » and PROTEUS family. In the second part, an overview of the missions planned on PROTEUS will be presented.*

---

## **PART 1 : PROTEUS USER'S MANUAL**

Low Earth orbits missions have often required case by case solutions (in comparison with geostationary missions), implying non-recurrent satellite developments at high price and long delivery time. The innovative PROTEUS system permits to break this logic.

PROTEUS is a standard multimission system for Low Earth Orbits. The acronym means "Plateforme Reconfigurable pour l'Observation, les Télécommunications Et les Usages Scientifiques". This platform and the associated ground segment have been developed together by Alcatel Space Industries and CNES, upon CNES initiative.

In Europe, PROTEUS, launched this year, is a reference in the so-called Small Satellites family, aiming at both fast achievement and high standards of performances, robustness and reliability. It is specifically designed to offer accommodation of a large range of applications, flexibility in choice of orbital parameters, various pointing modes, and compatibility with all small launch vehicles. A typical satellite using PROTEUS weighs 500 kg for a mean electrical power of 600 W, which corresponds to the requirements of many current space missions. This system has already attracted a wide range of Customers concerned with an easy and fast mission achievement.

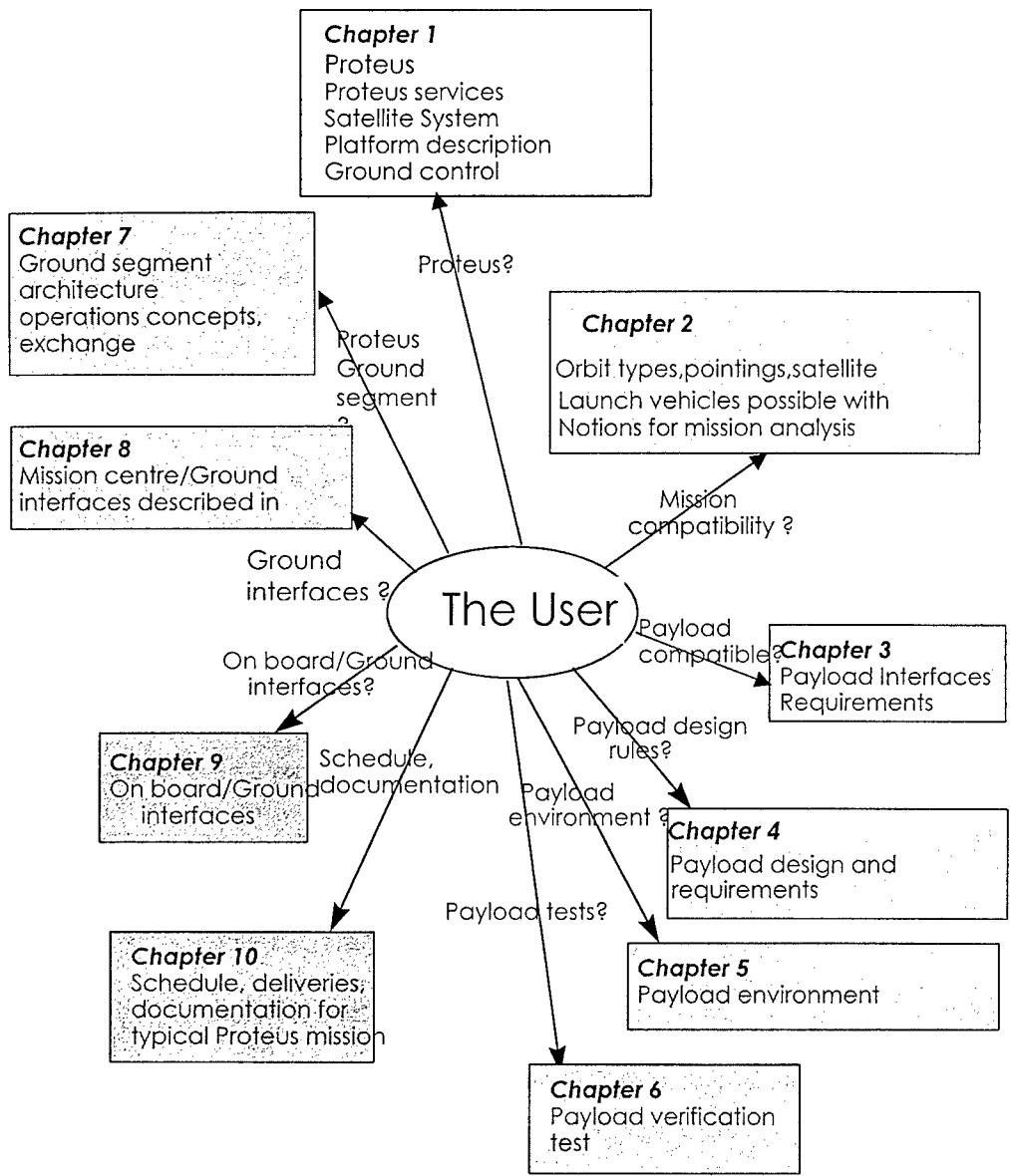
Today, in order to help any potential User or Mission Planner, Alcatel Space Industries and CNES propose the « PROTEUS User's Manual », document which permits to assess the compatibility of specific payload and mission requirements with PROTEUS system. This document is intended to be a reference manual which presents the general capabilities offered by the PROTEUS system. Indeed, its objectives are to allow a User looking for an efficient way to access space in low Earth orbits, assess different mission profiles and solutions to achieve his objectives, design User payload compatible with PROTEUS bus, launch vehicles and environment, build and verify his payload within the constraints imposed by the satellite bus, launch vehicles and environment, explain the ground segment functions, architecture, operations concepts, data exchanges, and prepare all technical and operational documentation for a mission based on a PROTEUS system.

The PROTEUS User's Manual is part of the PROTEUS interfaces documentation. It is written for three main Proteus Users groups: System Prime, Satellite Prime and Payload Prime.

It describes more particularly generic interfaces specifications between PROTEUS Platform and Payload. The Platform / Payload interfaces document specific for each mission (Payload Design Interfaces Specifications) is built from these generic specifications.

The PROTEUS User's Manual gives precisely the interfaces specifications of PROTEUS generic ground segment. It permits to build the Ground Segment Interfaces document specific for each mission.

The PROTEUS User's Manual objectives are shown on the Figure 1.



**Figure 1 : PROTEUS User's Manual objectives**

The main subjects dealt in the PROTEUS User's Manual are briefly presented hereafter.

## PROTEUS SERVICES

Together with the PROTEUS platform product, Alcatel Space Industries and CNES propose a panel of services to the Customers. Those are, separately or combined :

- to provide a generic PROTEUS platform qualified and accepted,
- to tune the mission parameters, called « missionization », that mostly consists in updating parameters tables in the on board software. This is part of the generic PROTEUS delivery,
- to provide the satellite assembly, integration and tests activities,
- to provide the satellite transportation and launch campaign activities,
- to provide the in-flight acceptance
- to provide a generic ground control segment including a ground station and a control centre.
- Extended services are also proposed from specific adaptations, payload instrument modules based on a standard design compared with PROTEUS platform and easily adaptable up to provide a full turn-key system if desired by the Customer.

## PROTEUS SYSTEM

The architecture of a space system based on PROTEUS is shown on Figure 2.

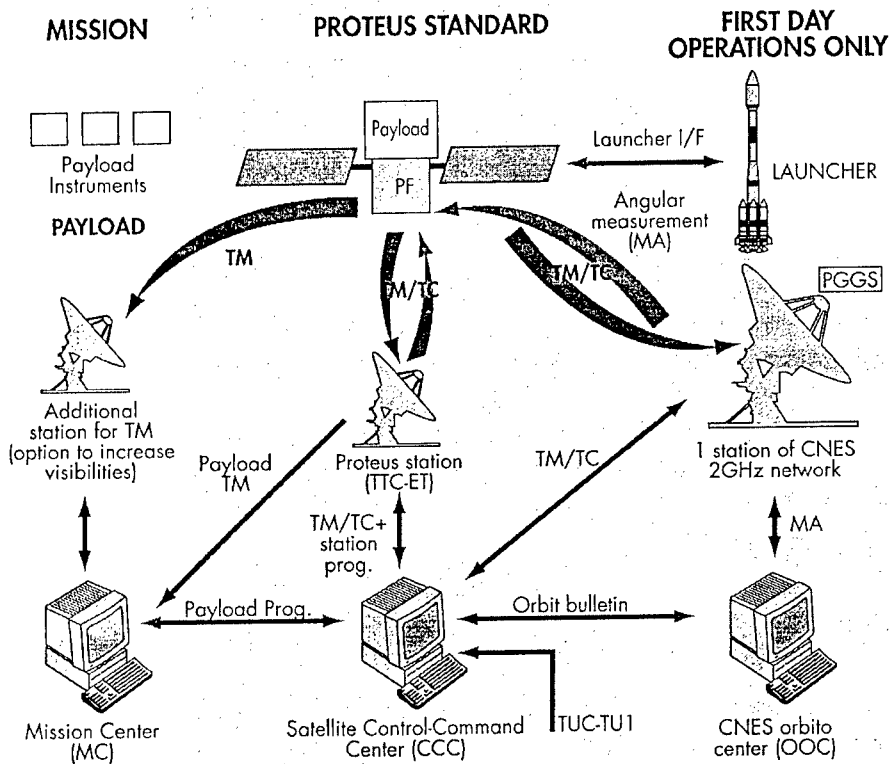


Figure 2 : PROTEUS system architecture

The main components of a standard PROTEUS system are the following ones :

- the satellite based on a standard PROTEUS platform
- the ground control segment composed of : the standard control command ground system with the S band station Telecommand and Telemetry Earth Terminal (TTC-ET), the satellite Control Command Centre (CCC), the Data Communication Network (DCN) and optionally the Mission Center (MC).

The TTC-ET ensures the on board/ground link. The CCC is responsible for processing the telemetry, the satellite orbit and attitude control functions, the generation and transmission of platform telecommands, the reception and transmission of mission telecommands from the MC. The DCN ensures data transfer by TCP-IP (internet protocol) for real time exchanges between the CCC and TTC-ET, FTP (File Transfer Protocol) for file transfer, HTTP and e-mail for data exchanged.

The mission specific contributions to the system are described on the left column of the Figure 2:

- the payload instruments,
- the mission control centre where the payload is programmed and the payload data is processed,
- an optional TM station used to increase the visibility duration or ground segment availability.

### PROTEUS MISSIONS ENVELOPE

The PROTEUS platform is compatible with all low cost launch vehicles in the 500 to 1000 kg class. It has been designed to be compatible with various orbits (phased, Sun synchronous, frozen and inertial orbits) at altitudes ranging from 500 km to 1500 km and for an orbit plane inclination typically between 20 deg to 145 deg. The platform provides a wide range of payload pointing capabilities (Earth, Inertial and Sun pointing) with a typical pointing accuracy of 0.05 deg ( $3\sigma$ ) meeting the most severe mission (observation) requirement. Its in-flight lifetime is five years.

In its flight domain, PROTEUS allows a payload of around 300 kg, an electrical power of 200 W to 300 W according to orbit.

### PROTEUS PLATFORM

The multimission design and the ability to accommodate various payloads and a wide range of launch vehicles resulted in two main features for the concept :

- a modular and very robust mechanical structure, based on flight proven technologies (Globalstar panel concept)
- an electrical, on-board avionics architecture centralised on a single computer the Data Handling Unit (DHU)

Figure 3 shows the general layout of a PROTEUS platform.

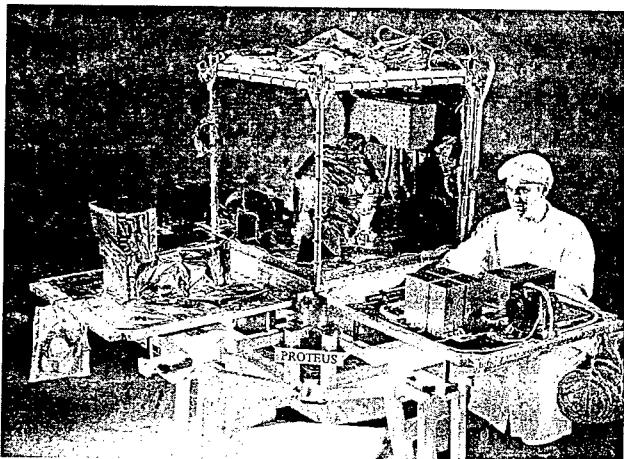


Figure 3 : General layout of PROTEUS platform



## PAYLOAD COMPATIBLE WITH PROTEUS

PROTEUS platform offers generic interfaces to the payload for an easy accommodation of any application:

- electrical interfaces with power supply through a non regulated bus (23/36 V), 16 power lines and 16 pyrotechnic lines
- thermal control managed by the platform DHU and heater power lines in all satellite modes
- standard mechanical interfaces through four points at the corners of the upper panel of the platform
- payload management data via MIL-STD-1553 B bus (redundant), high speed line, command and acquisition lines, datation lines delivering one pulse per second.

A synthesis of the main payload interfaces characteristics is given in the Table 1.

Payload Interfaces	Performances	Payload Interfaces	Performances
<b>Mechanical</b>		<b>Command Control</b>	
Maximum mass	up to 300 kg	<i>command lines</i>	
Maximum inertia in launch configuration	75 kg.m <sup>2</sup> 300 kg.m <sup>2</sup> (mission dependent)	MIL-STD-1553 B	1 bus (1N + 1 R)
Maximum payload Center Of Gravity distance vs Ys Zs plane	0.75 m	High speed serial line	2 high speed serial acquisition lines
<b>Thermal</b>		Relay command lines	56 HLC
Thermal decoupling with platform	maximum flux < 4*0.025 W/°C	Low level commands	20 LLC
Active thermal control of PL by PF	11 heater lines (11 N+ 11R) (maximum power distribution 3*50 W, 4*25 W, 4*10 W :)	16 bits Serial command lines	10 CS 16
<b>Electrical</b>		<i>Acquisition lines</i>	
<i>Power</i>		Digital Relay Status	28 DRS
Average payload power on every orbit	maximum power =200 to 300 W (mission dependent)	Digital Bi-level	10 DB
PL power during launch and SHM	30 W	16 bits serial acquisition lines	16 AS16
<i>power lines</i>		Analog acquisition lines	56 ANA
Number of power lines	16 lines 5A max non regulated	Temperature acquisition lines	48 lines
pyro-lines	16 pyro-lines	<i>Time reference (pps)</i>	8 pps
		PF mass memory area for PL data	2 Gbits (EOL)

Table 1 : Payload interfaces

## PAYLOAD ENVIRONMENT

The payload environment requirements relative to mechanical and thermal environment and also launch pressure profile, electromagnetic radiation, magnetic field, meteoroid and space debris, atomic oxygen are detailed in chapter 5 of the PROTEUS User's Manual.

Mechanical environment is imposed by the launch environment. The levels qualifying the mechanical environment (quasi-static acceleration loads, sine vibration, random vibration, acoustics, pyrotechnic shock) are specified considering all the launch vehicles compatible with PROTEUS : Ariane 5, Athena2, Cosmos, Delta2, LM2D, PSLV, Rockot, Soyuz, Taurus.

The fairing envelope of all potential launch vehicles is shown in Figure 4. The satellite container usable volume is also indicated on the same figure.

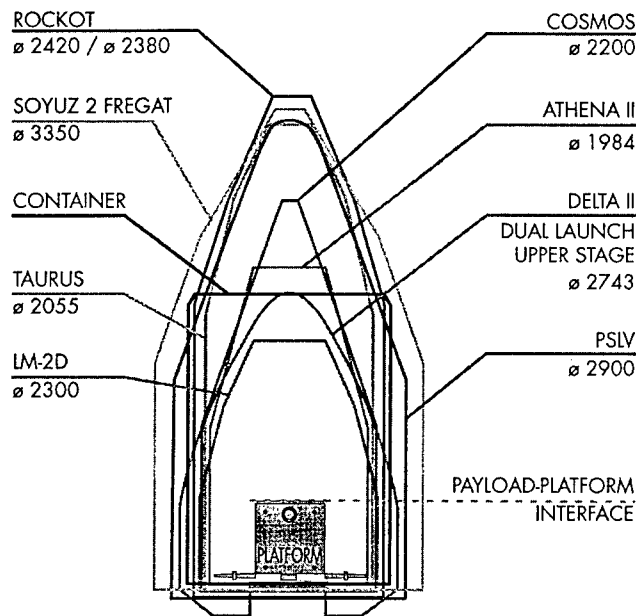


Figure 4 : Payload volume under fairings

## PROTEUS STANDARD SCHEDULE AND DOCUMENTATION

The preliminary generic schedule corresponding to the PROTEUS standard services is presented on Figure 5. This schedule is built with the following hypothesis :

- the satellite is based on a standard platform; the platform adaptations are limited to minor changes (standard missionization).
- Alcatel Space Industries and CNES lead activities on platform and satellite engineering, integration and tests.
- The generic ground control segment is procured including one ground station and one control centre.
- A single interface is considered between the mission centre and the control centre located in Toulouse.

- PROTEUS standard services include the transportation, the launch campaign activities, flight acceptance & first operations and the control centre operations too.
  - Pre-Phase B and phase B durations are indicative. They shall be adapted to fit with payload development and are generally shorter than the payload development itself.
- The documentation related to the PROTEUS mission can be divided in the main following parts :
- applicable documents (inputs) and interfaces documents, management documents, product assurance documents, documents describing the development and validation logic, system description and performances documents, justification documents, documentation related to operations, documentation dealing with the mission centre/PROTEUS Generic Ground Segment interfaces. The main documents to be delivered for each activity quoted above are listed in details in chapter 10 of the PROTEUS User's Manual.

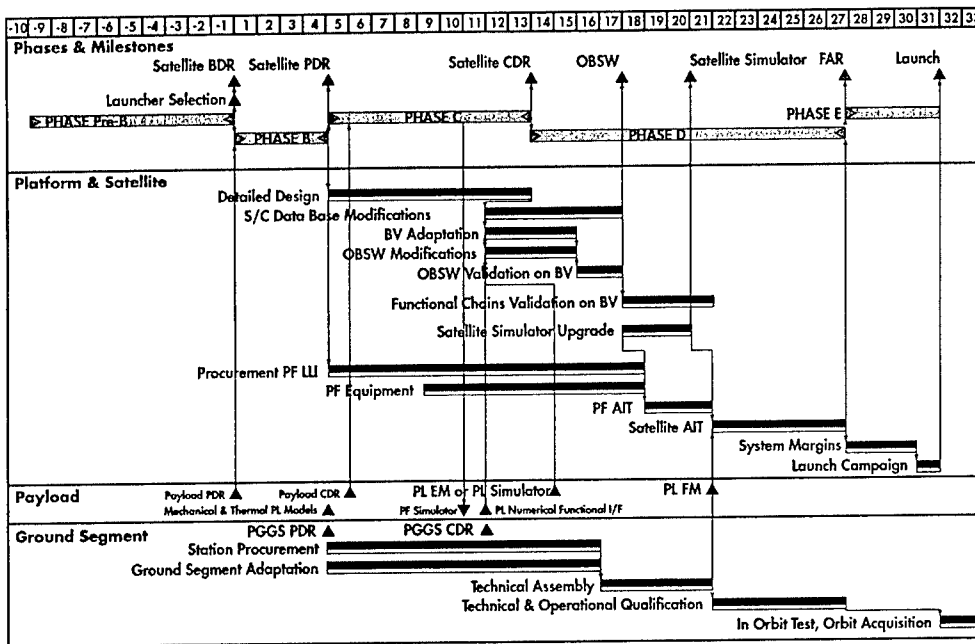


Figure 5 : preliminary issue of PROTEUS standard schedule

## PART 2 : PANORAMA OF THE FUTURE MISSIONS FLYING WITH THE PROTEUS BUS

At the origin of the PROTEUS project, there is a double statement :

- Most of the missions selected at the scientific prospective conference organised by CNES in 1993 at St-Malo were found to be compatible with a power / mass envelope for the payload around 200 Kg / 200 W;
- The emergence of small launchers (some of them being previous disarmed ballistic missiles) leads to reduced costs for access to space for satellites of the "mini-satellite" class (1000 Kg - 1000 Km).

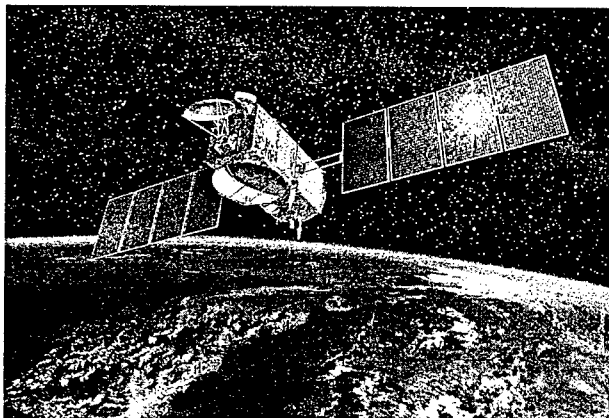
Phase 0/A studies have been performed at CNES and space industry, then later on within a CNES/ Alcatel Space Industries partnership frame from the B phase on. This leads to the development of a standard bus which will be used for the first time by the JASON1 mission, successor of the very well known TOPEX / POSEIDON mission dedicated to ocean altimetry data collection.

JASON1 will realize the flight qualification of the PROTEUS bus (launch scheduled end 2000).

In the frame of the JASON1 mission, the PROTEUS services are listed below:

- Bus delivery and "missionization" (i.e. bus parameters tuning according to the mission specificities);
- satellite integration and tests using test equipments belonging to the PROTEUS family;
- delivery of a command control center;
- satellite orbit targeting and in orbit control .

Deliveries external to the PROTEUS services are thus the payload, the launcher, and the mission center.



*JASON1 satellite (artist view)*

For the following missions using the PROTEUS bus, the different components of the system out of PROTEUS are delivered either by CNES, or by external entities, within the frame of bilateral co-operation programmes.

Now that JASON1 preparation activities progress allow to anticipate the launch of the JASON1 satellite by the end of year 2000, and following the recommendations raised during the scientific prospective conference of Arcachon in 1998, CNES decided to order 3 additional PROTEUS buses, for the next three missions using PROTEUS, among PICASSO-CENA, COROT, JASON2, SMOS, and MEGHA-TROPIQUES.

This decision allows to increase the PROTEUS family, and to guarantee stable costs for the PROTEUS services as defined above.

## MISSIONS OVERVIEW

### PICASSO-CENA

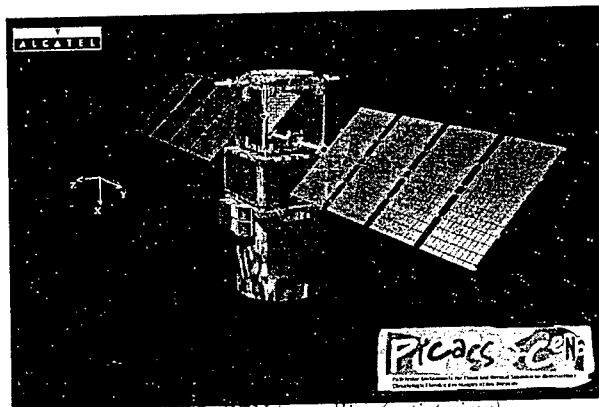
Dedicated to clouds and aerosols climatologic study, this mission is a co-operation programme between CNES and NASA. The satellite will be launched in 2003 by a DELTA2-74 rocket (version with 4 additional boosters) to fly in formation with CLOUDSAT, EOS-PM, and PARASOL (microsatellite) satellites. The main payload is a lidar. The other instruments are: an infrared imager, an A-band spectrometer, a wide field camera, and an X-band telemetry unit dedicated to the payload (80 Mbps with a mass memory of 60 Gbits).

In addition to the standard PROTEUS service, France is deeply involved in the infrared imager development, issued from development works performed for the IASI instrument.

For this mission, the PROTEUS bus will be used for the first time in the so-called vertical flight configuration, this means with satellite X-axis (axis vertical on the launch pad) pointed to Earth.

The payload mass, close to the bus mass threshold, due to extremely high lateral excitations because of the specific launcher configuration using four solid boosters, is about 250 Kg.

The main characteristics and performances of the PICASSO-CENA mission are gathered in the summary table attached at the end of the text.



*PICASSO-CENA satellite (artist view)*

### COROT

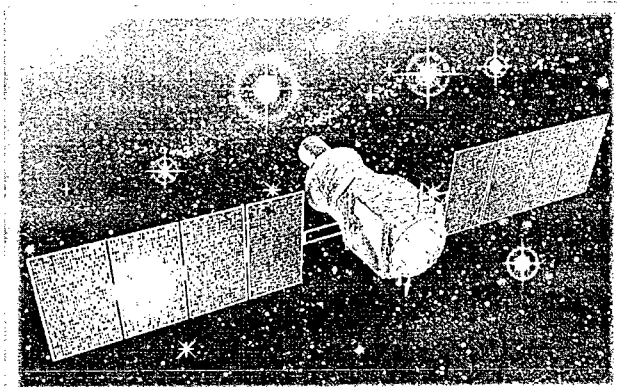
COROT is an astronomy mission originally developed by France, with now remarkable contributions to this programme of ESTEC, Austria, Spain, Belgium and Italy, dedicated to the study of internal behaviour of stars (asteroseismology) and detection of planets orbiting around other stars than the Sun (exoplanets).

The main technological performance of this mission is the fulfilment of the very severe pointing requirement (less than one arcsecond) during very long observation times (order of 150 days) in order to detect very tiny little light flux variations. To reach this objective, a special pointing mode was developed (specific on-board software) to servo control the pointing chain to the ecartometry data provided by the payload: PROTEUS star tracker data are replaced by those coming from the payload's telescope.

Satellite thermal control is another aspect which needs special attention due to the specific pointing mode (inertial) over very long durations (5 months). Severe thermal conditions result from the combination of the pointing duration and the kind of orbit used.

COROT launch should occur in 2004.

The main characteristics and performances of the COROT mission are gathered in the summary table attached at the end of the text.



*COROT satellite (artist view)*

## SMOS

SMOS was initially proposed by a french scientific laboratory, CESBIO, and selected by ESA in the frame of EARTH EXPLORER call for ideas. The scientific goal of this mission is to perform global monitoring of Soils Moisture and Oceans Salinity, which are necessary to improve atmospheric, oceanographic, and hydrologic predictive models.

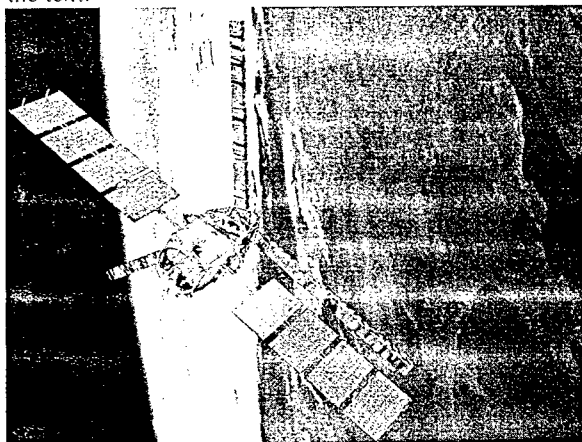
The payload consists in an interferometry L-band radar made of three 4.5 m long antennas every 120 deg. The satellite in this configuration looks a bit like an helicopter flying upside down ("quasi" vertical flight: the satellite is tilted 30 deg forward along track).

For this mission, France provides the standard PROTEUS service, but does not participate to the instrument development, which is issued from preparation works of ESA for MIRAS instrument.

Concerning the performances, the peculiarity of this mission is linked to the inertial and dimensional characteristics of the payload which lead to some improvements of the in-orbit satellite control system in order to :

1. keep acceptable stability margins, specially regarding couplings with the payload's flexible modes (3,6 Hz), and
2. allow correct compensation by the magnetic actuators of gravity gradients due to the tilted configuration.

The main characteristics and performances of the SMOS mission are gathered in the summary table attached at the end of the text.



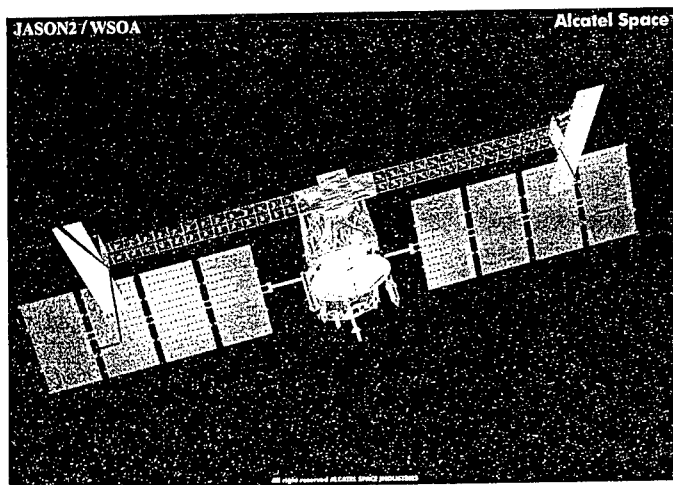
*SMOS satellite (artiste view)*

## JASON2

Nominally, this is a perfect replica of JASON1 in order to provide continuity of altimetry service from 2004 on. Nevertheless an option exists for embarking an experimental passenger, a wide swath interferometry altimetry radar (WSOA) operating in Ku band with a 7 m long antenna. This option was studied from the technical feasibility point-of-view and evidenced the need for an improved AOCS, if the need for pointing stability (0.1 arcsecond for 20-80 seconds) is confirmed.

The remaining part of the payload is identical to JASON1: POSEIDON2 altimetry radar and DORIS receiver for precise localisation of the satellite concerning the French part contribution, and a radiometer, a laser reflector, and a GPS receiver for the NASA part.

The main characteristics and performances of the JASON2 mission are gathered in the summary table attached at the end of the text.



*JASON 2 satellite (artist view)*

## MEGHA-TROPIQUES

Launch of MEGHA-TROPIQUES satellite is currently scheduled for late 2005, early 2006.

Jointly developed by CNES and ISRO (Indian space agency), the MEGHA-TROPIQUES mission objective is to analyze the water cycle in intertropical zone (influence of convective systems on climate: monsoons, tropical cyclones, squall lines,...).

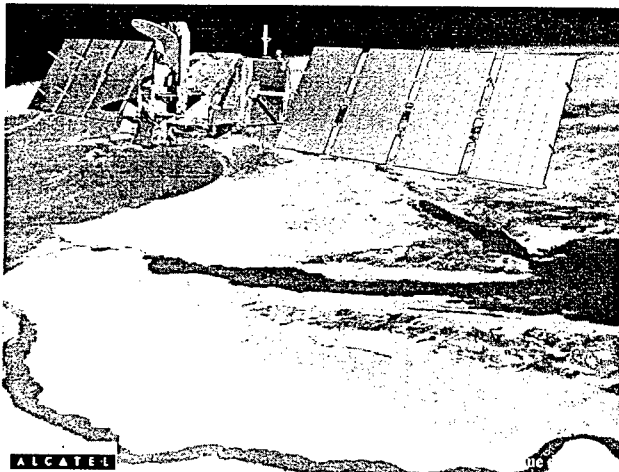
The main payload is a conical scanning radiometer of which the detection part is a turning mass of about 75 Kg (not including the scanning mechanism rotor) running at 25 rpm around an Earth pointing axis. The development of this instrument is under ISRO's responsibility, CNES providing the hyperfrequency detection chain (5 channels at 10, 18, 36, 89 and 157 GHz). Other instruments of this mission are SCARAB, a radiometer dedicated to energetic budgets monitoring (F), SAPHIR, a microwave sounder dedicated to provide humidity vertical profiles (F), and finally a GPS limb sounder, which is optional.

Concerning the use of the standard PROTEUS bus, this mission presents some remarkable particularities: the total payload mass and power current estimates are very close to the thresholds of 300 Kg and 300 W which are standard limits, taking into account, for the mass, the low orbit inclination (22 deg: this is close to the low limit of the PROTEUS bus flight domain) which is detrimental to the efficiency of the magnetic actuators of the satellite control system, and, for the power aspects, of dimensioning of the power chain on an orbit with high eclipse rate.

Otherwise, the turning part of MADRAS instrument, due to its high inertia, generates perturbations associated to static and dynamic imbalance which, in turn, impose requirements applied to the

payload (minimization of imbalance and distances to the satellite centre of gravity) in order to guarantee the fulfilment of the pointing requirements (pointing accuracy of 0.25 deg; 0.045 deg for short term stability).

The main characteristics and performances of the MEGHA-TROPIQUES mission are gathered in the summary table attached at the end of the text.



*MEGHA-TROPIQUES satellite (artist view)*

## CONCLUSION

All these missions and other opportunities under assessment (not mentioned here for conciseness, which were more or less deeply studied as potential users of the PROTEUS bus) allow to foresee a long life to the PROTEUS line of product. PROTEUS history is still young but has already demonstrated that iterations between the scientific need and the technical constraints of the existing product constitute a very powerful tool for maintaining the best economical efficiency.

This aim is achieved by an industrial approach that enables to quickly assess compatibility of candidate mission to PROTEUS design thanks to PROTEUS User's Manual. Missionization of PROTEUS is then anticipated: standard and/or specific adaptations. It enables secured development planning and costs. Moreover PROTEUS product line remains active and already benefits from return on JASON1 development experience and from the first results in orbit this year. The aim is to reach a more straightforward and secured development by a better knowledge of PROTEUS design performances.

Based on this first successful step, PROTEUS is able to engage evolutions to satisfy more potential Users and shall become a family of products best fitting a wide range of User's needs.



SATELLITE	JASON1	PICASSO-CENA	COROT	SMOS	JASON2	MEGHA-TROPIQUES
mission	ocean altimetry	atmosphere (clouds, aerosols)	Astronomy (asteroseismology and detection of exo-planets)	soils humidity and oceans salinity	ocean altimetry	Water cycle in intertropical zone
Launch	End 2000	March 2003	October 2004	June 2005	2004	2005
Launch vehicle	DELTA 2 7920	DELTA 2 7420-10	ROCKOT or PSLV	ROCKOT (TBC)	DELTA 2 7920	PSLV
Cooperation	NASA/JPL	NASA LANGLEY/ Ball Aerospace	ESA, ESTEC, Austria, Spain, Italy, Belgium (20% total)	ESA leadership	NASA/JPL	ISRO (India)
French payload	POSEIDON2 (altimetry radar) DORIS (precise localisation) LRA (laser reflector) TRSR (GPS)	Participation to the IR imager	Telescope (CCD) : unique payload with external contributions as detailed hereunder	No contribution on payload flight hardware, but development in France of a thematic scientific mission center for soils humidity	POSEIDON2 (altimetry radar) DORIS (precise localisation) LRA (laser reflector) TRSR (GPS)	SAPHIR (microwave sounder) SCARAB (radiative budgets) GPS (option) MADRAS detection chain
Partner payload	JMR (radiometer) LRA (laser reflector) TRSR (GPS)	lidar, wide field camera, A-band spectrometer	ESA/AIV telescope mirror (TBC) ESTEC : payload computer Austria : extractor card Italy : video electronics Belgium : case, baffle, AIT	L-band interferometry radar	JMR (radiometer) LRA (laser reflector) TRSR (GPS)	MADRAS (conical scanning radiometer)
Orbit	Circular altitude : 1336 Km inclination : 66 deg pointing : nadir yaw steering	quasi Sun Synchronous AN : from 14:10 to 12:50 over 3 years altitude : 705 Km pointing : geodetic	Polar (90 deg) Altitude : 900 Km Pointing : inertial	Sun Synchronous AN : 6:00 altitude : 757 Km pointing : geocentric with 30 deg yaw bias (front) and trace compensation	Circular altitude : 1336 Km inclination : 66 deg pointing : nadir yaw steering	Circular Altitude : 817 Km Inclination : 22 deg pointing : geocentric
S/L ground segment	3 stations : Fairbanks (USA), Aussague (F), Pasadena (USA)	1 station : Aussague (F)	1 station : Villafranca (E)	1 station : Kiruna (S), shared with other PROTEUS Users	3 stations : Fairbanks (USA), Aussague (F), Pasadena (USA)	2 stations : Kourou (F) and Bangalore (F)
TMCU	Via PROTEUS bus S-band	60 Gbits memory X-band TM : 80 Mbps	Via PROTEUS bus S-band	Via PROTEUS bus S-band	Via PROTEUS bus S-band	Via PROTEUS bus S-band
S/L mass	485 Kg	550kg	490 Kg	475 Kg	485 Kg	570Kg
PL mass	185 Kg	250kg	190 Kg	175 Kg	185 Kg	270 Kg
S/L power	470 W	550 W	450 W	520 W	470 W	590 W
PL power	170 W	282 W	150 W	220 W	170 W	290 W
Pointing accuracy	0.1 deg	0.06 deg (roll and pitch) 0.08 deg (yaw)	0.5 arcsecond over 5 months (telescope in AOCS loop)	+/- 0.3 deg	0.1 deg	0.25 deg

Table : summary of the main characteristics of some PROTEUS missions

## REFERENCES :

- [Prot 00] PROTEUS User's Manual, ref. PRO.LB.0.MU.003.ASC, issue 4, revision 1 (march 24, 2000)
- [Blou 99] J. Blouvac, Les nouvelles études de minisatellites PROTEUS, CNESQUISEPASSE N° 97, april 99
- [Hern 99] D. Hernandez, J. Dejoie, « CNES small satellites policy », *IAF specialist symposium « Novel concept for smaller, faster and better space missions »* Redondo Beach, 1999
- [Laza 99] B. Lazard, « Panorama des missions PROTEUS », *CST infos N° 47*, sept. 99
- [Blou 00] J. Blouvac, B. Lazard, JM. Martinuzzi, « CNES small satellites Earth observation scientific future missions », *ACTA ASTRONAUTICA* vol. 46, N° 2-6, pp. 75-79, 2000
- [Dech 00] J.J. Dechezelles, G. Huttin, « PROTEUS : a multimission platform for low Earth orbits », *Air and Space Europe*, vol 2 N°1, Jan-Feb2000
- [Paol 99] F. Paoli, F. Douillet, M. Jouret, J-B Dubois, « COROT : a small satellite in low Earth Orbit for asterosismology and the search of exoplanets », *IAF 99 Amsterdam*, 4-8 Oct. 99
- [Griv 99] C. Grivel, F. Douillet, J. Blouvac, J-M Martinuzzi, « PICASSO-CENA, NASA/CNES mission », *IAF 99 Amsterdam*, 4-8 Oct. 99

---

## **SESSION 4 :**

### **Outils et méthodes Methods and tools**

*Présidents / Chairpersons: Michel BOUSQUET, Antonio MARTINEZ DE ARAGON*

- (S4.2) **Station Multi-Mission de Natal - Brésil, Concept et Architecture d'une station TT&C bande S faible coût / Concept and architecture of a low cost TT&C ground station located in Natal - Brazil**  
Dubut J.P., de Carvalho M.J.M., Pereira R.A. Jr., Mattiello Francisco M.F. INPE/CRN, Natal, Brésil
- (S4.3) **Software Subsystem for a Small Earth Observation Satellite**  
Garrido B., Alfaro N., de Miguel J., Garcia A. Instituto Nacional de Tecnica Aeroespacial (INTA), Madrid, Espagne
- (S4.4) **L'atelier d'ingénierie simultanée  $\mu$ CE pour la filière  $\mu$ -satellites du CNES/  
*The Concurrent Engineering Workshop for the  $\mu$ -Satellite Productline at CNES*  
Delatte B., Rossiquet C. CNES, Toulouse, France**
- (S4.5) **Mars Proximity Link Operations**  
Kazz G.J., Greenberg E., MacMedan M.L. NASA/JPL, Pasadena, Etats-Unis
- (S4.6) **Prototyping the Space Internet with STRV**  
Blott R. The Defense Evaluation and Research Agency, Farnborough, Royaume-Uni
- (S4.7) **La maîtrise des risques lors des SAP (Sessions d'Avant Projet) sur la filière microsatellite du CNES/ Risk Management during "SAP" (Sessions d'Avant Projet) on Microsatellite Program**  
Douchin F., Lassalle-Balier G., CNES, Toulouse, France
- (S4.8) **A complexity-based risk assessment of low-cost planetary missions: when is a mission too fast and too cheap ?**  
Bearden D.A. The Aerospace Corporation, El Segundo, CA, Etats-Unis

**STATION MULTI-MISSION DE NATAL - BRÉSIL  
CONCEPT ET ARCHITECTURE D'UNE  
STATION TT&C BANDE S FAIBLE COÛT**

**Jean-Paul DUBUT** <sup>(1)</sup>  
**Manoel Jozeane Mafra de CARVALHO** <sup>(1)</sup>  
**Romualdo Alves PEREIRA Jr.** <sup>(1)</sup>  
**Maria de Fátima MATTIELLO FRANCISCO** <sup>(2)</sup>

*(1) INSTITUTO NACIONAL DE  
PESQUISAS ESPACIAIS - INPE/CRN  
Av. Salgado Filho, 3000  
CEP: 59001-970 – Natal, RN – Brésil  
jean@crn.inpe.br manoel@crn.inpe.br  
romualdo@crn.inpe.br*

*(2) INSTITUTO NACIONAL DE  
PESQUISAS ESPACIAIS – INPE/DSS  
Av. dos Astronautas, 1758  
CEP: 12227-010 – São José dos  
Campos, SP – Brésil  
fatima@dss.inpe.br*

**RÉSUMÉ** – Cet article décrit le concept, l'architecture et les critères qui ont été adoptés pour spécifier le cahier de charges de la station TT&C en bande S faible coût de Natal, ainsi que les solutions retenues pour l'intégration de l'ensemble. Décrit, également, les principales fonctionnalités des divers sous-systèmes, de la chaîne informatique, et les modifications qui ont été introduites postérieurement par l'INPE/CRN pour la transformer en station multi-mission et l'adapter aux exigences des nouveaux programmes. Les résultats obtenus dans la poursuite et la réception des satellites brésiliens sont aussi présentés et des améliorations sont proposées pour augmenter son actuelle performance.

**ABSTRACT** – *This paper describes the concept, architecture and criteria adopted for a Natal low cost S-band TT&C ground station specifications with the implemented solutions for integration system. Also describes the main subsystem functionalities and modifications introduced by INPE/CRN for providing a mutimission station and adapting it to the new mission requirements. Some obtained brazilian satellite tracking results are presented. Finally, it is proposed an upgrade to improve the current TT&C station performance.*

## **1. INTRODUCTION**

Natal, ville portuaire d'une population de près d'un million d'habitants, située dans le Nord-Est du Brésil sur la pointe orientale du continent sud-américain présente, de ce fait, un site géographique privilégié pour l'installation d'une station TT&C. Implantée initialement pour opérer avec les deux satellites de la famille SACI, la station TT&C s'est bien vite vue chargée d'autres missions. Opérant maintenant avec les satellites SCD-1, SCD-2 et CBERS-1, sa localisation particulière lui permet de compléter le trou de couverture présenté par les stations de Cuiabá (MT) et de Alcântara (PA), et de couvrir aussi tout le réseau de plate-formes de collecte de données (PCDs), disséminé dans le Nord-Est du pays. Étend sa couverture radio-électrique aux îles océaniques voisines et, notamment, à une grande partie de l'océan Atlantique Équatorial où divers programmes d'océanographie (PIRATA et REMAR) sont installés, en coopération avec des organismes internationaux congénères. D'autre part, considérant les nouveaux programmes qui seront implantés par l'INPE au long des prochaines années, la station TT&C de Natal devra être appelée à assurer un rôle significatif dans la poursuite et la réception de micros et petits satellites, qu'ils soient d'orbite équatoriale ou polaire.

## 2. CONCEPT ET ARCHITECTURE DE LA STATION TT&C

Définie à l'origine, dans le programme de micro-satellites SACIS de l'INPE, comme station TT&C principale du segment sol, la station de Natal a été spécifiée cherchant satisfaire à des critères de haute performance, sous faible coût. Tout ces critères, à leur tour, ont été définis en plein accord avec le concept philosophique de la mission pour le budget disponible à l'époque, c'est à dire d'un coût non supérieur à 2 millions de francs, "clés en mains". La station devrait présenter une structure modulaire lui permettant d'évoluer au long du temps, de façon à pouvoir s'adapter rapidement aux besoins des nouvelles missions. Pour cela, elle devrait être constituée, autant que possible, par des équipements dits d'étagère, standards et faible coût. Il avait été également défini, comme condition impérative du cahier de charges, qu'elle soit capable d'opérer en mode autonome sans la présence directe d'opérateur et soit aussi orientée vers la télégestion par réseau de communication Ethernet et TCP/IP. D'autre part, considérant le local où cette station serait installée, il était important que la maintenance soit simple, ne demandant pas de gros moyens techniques pour sa mise en oeuvre. De toutes les propositions et solutions présentées par les divers fabricants qui ont été consultés, celle de la société toulousaine ELFES-ELECTRONIQUES\* [1] a été retenue pour offrir un "système plus souple et plus ouvert", qui pourrait être facilement modifié ou adapté. La plupart des équipements proposés étaient du type étagère, de qualité reconnue, et le logiciel de télégestion, contrôle et orbitographie AURORE, fourni sous licence du CNES, avait déjà largement fait ses preuves et pourrait être facilement remplacé, petit à petit, par de nouveaux modules développés par l'INPE [2].

## 3. DESCRIPTION DE LA STATION TT&C DE NATAL

### 3.1. Localisation géographique et installations physiques

La station TT&C de l'INPE/CRN est située dans la banlieue de Natal, à une dizaine de kilomètres du centre-ville. Ses coordonnées géographiques sont les suivantes:

- Latitude: 05° 50' 10,06" S,
- Longitude: 35° 12' 27,34" W.
- Altitude: 56,25 m.

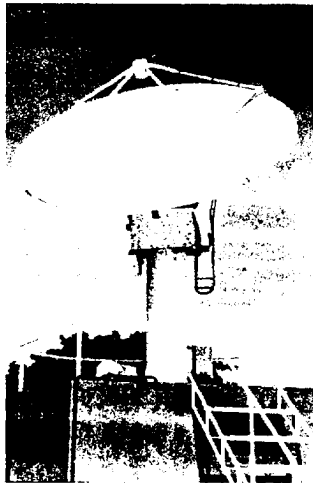


Fig 1 - Vue de la tour, positionneur et antenne



Fig 2 - Vue de la salle d'opération, baie principale et consoles

Un point de collimation a été également établi sur une colline proche de la station, pour permettre le calage des angles site et azimut de l'antenne et pour pouvoir en vérifier, périodiquement, le réglage. Ses coordonnées géographiques sont les suivantes:

- Latitude: 05° 48' 49,65" S;
- Longitude: 35° 11' 41,57" W;
- Altitude: 107 m;
- Distance à la station TT&C: 2.843,8 m;
- Angle compris entre le Nord géographique vrai et le positionneur: 29° 27' 35".

Les installations physiques de la station TT&C sont réparties dans trois salles principales. La tour, flanquée au bâtiment principal, où est monté le positionneur et son antenne, la salle d'opération regroupant la baie d'équipements et les consoles TM&TC, et la salle de traitement et dissémination des données. Toutes ces salles sont climatisées et les figures 1 et 2, présentées à la page antérieure, donnent un aperçu des installations physiques de la station TT&C de Natal.

### 3.2. Architecture de la station TT&C

La station TT&C de Natal est composée, au niveau des principales fonctionnalités, de cinq sous-systèmes: positionneur-antenne et RF, contrôle positionneur et télégestion, standard temps-fréquence et doppler, chaîne télémétrie et chaîne télécommande. Le schéma synoptique fonctionnel simplifié de la station TT&C est présenté à la page suivante, par la figure 3.

#### 3.2.1. Sous-système positionneur-antenne et RF

Ce sous-système est constitué par un positionneur à axes concurrents COAZE 150 de SOTEREM<sup>®</sup>, auquel est accouplé l'antenne parabolique. Le mouvement angulaire du positionneur permet de balayer, à une vitesse maximum de 35°/s et accélération de 20°/s<sup>2</sup>, une calote hémisphérique solide de 0° à 360° en azimut et de -3° à 182° en site. Chaque axe du positionneur est actionné par un ensemble moteur autosynchrone, réducteur coaxial, pignon et couronne. La position angulaire absolue de chaque axe est fournie par un resolver équipé d'un mécanisme de rattrapage automatique de jeu. La précision dynamique de pointement de l'ensemble, en site et azimut, est de l'ordre de 0,2°. Des butées logiques déportent le passage du point mort du positionneur sur le fût et des fin-de-course électriques, associés aux butées mécaniques, assurent la protection de l'ensemble. Le recalage en azimut du positionneur est fait par le logiciel interne du calculateur, qui prend en compte les nouvelles consignes introduites par le clavier. Le positionneur possède un frein électromécanique sur l'axe site et peut opérer, sans problème, avec des vents allant jusqu'à 75 km/h.

Le sous-système RF est constitué par un réflecteur parabolique en aluminium de trois mètres de diamètre, de RYAN<sup>®</sup>, assemblé à l'ensemble tête et contre-poids du positionneur par une interface mécanique. La source, fixée au réflecteur par quatre bracons, est reliée au duplexeur par un câble coaxial à très faibles pertes. L'ensemble source-parabole, configuré en polarisation circulaire droite, présente un gain maximum de 34,7 dB dans la bande TM comprise entre 2.230 et 2.280 MHz, et de 33,8 dB dans la bande TC, de 2.015 à 2.065 MHz. Un boîtier étanche, monté sur le plan arrière de la parabole, protège le duplexeur et le préamplificateur faible bruit des intempéries et des variations de température. L'amplificateur faible bruit, du type GaAs FET de MITEQ<sup>®</sup>, présente un gain nominal de 36 dB pour une figure de bruit de 0,45 dB @ 25°C et le duplexeur introduit une isolation de 130 dB entre les voies TM et TC. Le transfert des chaînes TM et TC au boîtier de raccordement est fait par deux câbles coaxiaux souples à faibles pertes qui possèdent un jeu suffisant pour accommoder les mouvements de rotation de l'antenne, par rapport au fût du positionneur.

#### 3.2.2. Sous-système pilotage, télégestion et orbitographie

L'électronique de contrôle et pilotage du positionneur est conditionnée dans deux tiroirs standard de 19 pouces, situés dans la baie principale de la station TT&C. Le tiroir de puissance regroupe les deux variateurs PWM, filtre de réseau, et tous les circuits auxiliaires d'actionnement et de contrôle des moteurs autosynchrones. Le tiroir de pilotage, à son tour, regroupe le module calculateur, les interfaces, les alimentations et les divers circuits de télégestion. Deux modalités de fonctionnement sont possibles:

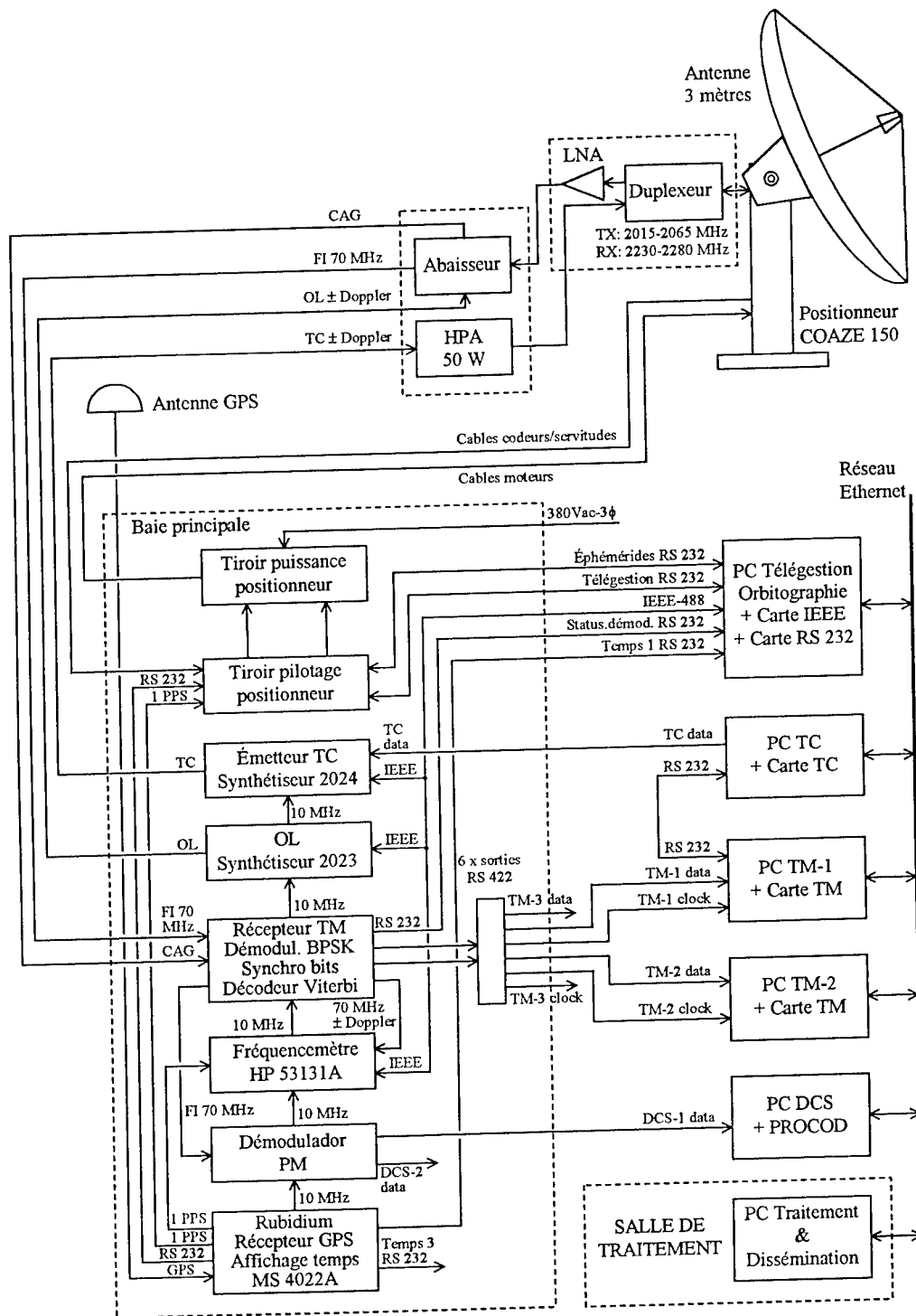


Fig.3 – Schéma synoptique simplifié de la station TT&C

- En mode manuel, le joystick permet de piloter, à vitesse réduite, les mouvements de l'antenne en site et azimut.
- En mode automatique, le joystick est inopérant et les commandes du positionneur sont télégérées par la liaison RS 232.

Les fichiers d'éphémérides sont téléchargés à 9600 bauds/s par la liaison RS 232, avant le passage du satellite. Ces fichiers sont également traités par le calculateur interne pour prendre en compte la butée mécanique, déterminant si la poursuite sera faite en cercle direct ou inverse. La stratégie de retournement de l'antenne est aussi prise en compte par le calculateur du tiroir de pilotage. Elle consiste à rejoindre, à vitesse constante, dès la rentrée de l'antenne dans le cône de retournement (pour angle site  $\geq 88,3^\circ$ ), le point de sortie de ce cône, tout en conservant la consigne en site.

Un micro-ordinateur PC Pentium<sup>®</sup>, équipé d'une carte FASTCOM/4W-GT<sup>™</sup> permettant d'établir quatre liaisons série RS 232, d'une carte AT-GPIB/TNT<sup>™</sup> pour liaison IEEE-488, et d'une carte 3COM<sup>™</sup> Etherlink pour réseau Ethernet, est affecté à la désignation antenne et à la télégestion de la station TT&C. La chaîne informatique AURORE, fournie sous licence du CNES, a pour rôle d'enchaîner, d'organiser et d'orchestrer les différentes phases nécessaires pour réaliser, de manière automatique, les restitutions d'orbite des passages sélectionnés. Les fonctions essentielles du logiciel AURORE sont l'initialisation du système, la gestion des prévisions et préparation des passages, l'acquisition des mesures de fréquence et la compensation Doppler, la supervision du positionneur durant le passage, la restitution de l'orbite et le calcul des prévisions d'éphémérides pour les prochains passages. Le moniteur d'enchaînement des tâches et les outils de maintenance sont développés en Visual Basic 4.0<sup>™</sup>, sous Windows NT<sup>™</sup>. Les logiciels d'orbitographie sont développés en FORTRAN sous DOS.

Récemment, des modules additionnels ont été introduits dans le logiciel de télégestion AURORE pour permettre l'opération simultanée de plusieurs satellites, en mode multi-mission. L'intention de l'INPE/CRN est remplacer le logiciel de télégestion AURORE de la station TT&C par un logiciel propre, en Open Source, et d'y incorporer ses propres modules d'orbitographie.

### 3.2.3. Sous-système télémétrie

La chaîne télémétrie est constituée par l'abaisseur, le synthétiseur de fréquence TM, le démodulateur BPSK avec correcteur d'erreurs Viterbi, le démodulateur PM, le décommutateur de trames et les micro-ordinateurs PCs.

L'abaisseur, d'ELFES ELECTRONIQUES<sup>®</sup>, monté en pied d'antenne dans un tiroir au standard 19 pouces, convertit le signal reçu du préamplificateur faible bruit sur une FI de 70 MHz. Du type double changement de fréquence, cet abaisseur assure une réjection de la fréquence image de l'ordre de 85 dB et maintient, à l'aide d'un AGC non cohérent, le niveau de sortie du signal FI constant, pour une plage dynamique d'entrée de -100 dBm à -50 dBm. L'abaisseur, dont l'entrée OL est excitée par le synthétiseur TM, permet de recevoir le signal de télémétrie dans la bande comprise entre 2.230 et 2.280 MHz, et d'introduire la compensation Doppler. Un diviseur de puissance passif à 3 dB sépare la FI de 70 MHz en deux voies distinctes. L'une de ces voies est utilisée pour la démodulation TM et l'autre pour la mesure de fréquence Doppler.

Le synthétiseur TM 2023, qui génère la fréquence OL de l'abaisseur, est un produit MARCONI<sup>®</sup>. Ce synthétiseur est paramétrisé au moyen de la liaison IEEE-488, sous contrôle du logiciel de télégestion de la station. Cela permet également d'introduire la compensation Doppler sur la voie TM, par pas de 5 Hz. La base de temps du synthétiseur est pilotée par la référence 10 MHz de l'oscillateur de rubidium du sous-système temps-fréquence.

La station TT&C possède deux démodulateurs de télémétrie. L'un est digital BPSK/QPSK, du type cohérent, et l'autre analogique, pour les signaux modulés en PM. Le démodulateur BPSK/QPSK, monté dans un tiroir standard de 19 pouces, est architecté sur une carte multi-rythme STEL 9258 de STANFORD TELECOM<sup>®</sup>, pourvue de décodeur convolutionnel Viterbi et de correcteur d'erreurs au standard 7, 1/2, G1=171 et G2=133 inversé. L'émulation et la programmation de la carte sont faites par un module micro-contrôleur et ce démodulateur possède actuellement deux rythmes de bits pré-programmés, en 250 et 500 kbps. En sortie, sont fournies les données TM démodulées,



l'horloge associée et les divers signaux de status. Une liaison RS 232 permet de déporter les informations de status sur le micro-ordinateur de télégestion.

Le décommutateur de trames a été développé spécifiquement par l'INPE/SJC pour la mission SACI. Ce décommutateur est constitué par une carte au standard ISA, architectée sur un micro-contrôleur de la famille 8051 et enfichable sur le bus du micro-ordinateur TM. Cette carte TM a pour fonction principale d'implémenter la couche de décodification, d'identifier les mots de synchronisation, de calculer le CRC et de séparer les trames en blocs de données pour le traitement TM.

Le micro-ordinateur PC Pentium III<sup>®</sup> TM-1, en plate-forme logicielle Windows NT<sup>™</sup>, traite et emmagasine les données TM sous contrôle du programme principal de télémétrie développé en LabVIEW<sup>™</sup> par l'INPE/SJC. Envoie éventuellement, au micro-ordinateur PC TC, des demandes de retransmission par la liaison série RS 232.

Un second micro-ordinateur PC Pentium III<sup>®</sup> TM-2, équipé aussi d'une autre carte décommutatrice de trames TM, permet de saisir et visualiser les données en temps réel, pour le contrôle d'opération. Le démodulateur PM [3], [4] est constitué par une maille PLL analogique, centrée sur le 70 MHz de la FI. Diverses bandes passantes peuvent être sélectionnées dans une gamme de valeurs pré-définies et la plage de poursuite du PLL permet d'accommoder et de suivre les écarts de fréquence dus au Doppler associé. L'ensemble, développé et construit par l'INPE/CRN, est conditionné dans un tiroir standard de 19 pouces et deux sorties démodulées sont fournies en face arrière.

#### 3.2.4. Sous-système télécommande

La chaîne TC comprend le micro-ordinateur pour la visualisation et l'envoi des télécommandes, la carte de génération des télécommandes, le modulateur et l'amplificateur de puissance en bande S. Le micro-ordinateur PC Pentium II<sup>®</sup> TC, fonctionnant sous ambiance Windows NT<sup>™</sup>, exécute les diverses routines du programme principal, le contrôle et l'assemblage des ordres de télécommande. Permet également de choisir et sélectionner, en mode manuel, à partir d'une table pré-définie, les télécommandes à envoyer. Les trames sont montées, agrupées et formatées par une carte spécifique, développée et construite par l'INPE/CRN. Cette carte, connectée au bus ISA du micro-ordinateur TC, a pour fonction d'implémenter la couche de codification des trames TC. Architectée sur un micro-contrôleur INTEL<sup>™</sup> de la famille 8051, cette carte insère les mots de synchronisation, découpe la trame TC en octets, introduit le CRC et génère une séquence de IDLE à la fin de chaque trame de télécommande. Les données TC, codifiées en NRZ-L, sont envoyés au rythme de 19,2 kbps au modulateur de la chaîne TC. Grâce à un logiciel spécifique développé en LabVIEW<sup>®</sup> et d'une liaison RS 232, le micro-ordinateur TC dialogue avec le micro-ordinateur TM, permettant que des trames mal reçues ou contenant des erreurs soient retransmises à partir d'un ordre de répétition de la télécommande. Bien que programmée initialement aux standards de la mission SACI, la carte TC offre une grande flexibilité de configuration et peut être facilement reprogrammée sur d'autres standards, de façon à satisfaire aux exigences des nouvelles missions. Cela est rendu possible grâce à l'adoption d'un logiciel développé en LabVIEW<sup>®</sup>, présentant une grande flexibilité d'utilisation. L'émetteur de TC est constitué par un générateur synthétiseur modèle 2024 de MARCONI<sup>®</sup>. Piloté par le logiciel de contrôle et de télégestion de la station, le synthétiseur est paramétrisé automatiquement au moyen de sa liaison IEEE-488. La compensation doppler de la voie TC peut être également activée, suivant la modalité de fonctionnement choisie, et divers types de modulation (FM, FSK, PM, PSK, BPSK et QPSK) peuvent être sélectionnés. Le signal modulé en sortie du synthétiseur est fourni à la fréquence nominale d'opération, dans la bande comprise entre 2,015 et 2,065 GHz. La base de temps est également référée au 10 MHz de l'horloge de rubidium du sous-système temps-fréquence.

L'amplificateur de puissance en bande S est un produit NUCLÉTUDES S.A.<sup>®</sup>, du type linéaire, fournissant une puissance nominale de sortie de 50 W, dans la bande de 2,0 à 2,1 GHz. Cet amplificateur, conditionné dans un tiroir standard de 19 pouces, possède des protections internes contre échauffement excessif et sortie désadaptée. L'ensemble est placé dans le haut de la tour, en pied d'antenne, en ambiance climatisée. Toutes les liaisons RF sont faites au moyen de câbles coaxiaux à faibles pertes.

### 3.2.5. Sous-système temps-fréquence

Le générateur de temps codé de MICROSYSTEMES® est constitué par un générateur IRIG-B asservi, un récepteur GPS et une source rubidium. Le générateur IRIG-B est contrôlé et géré par une carte mère, architectée autour d'un microprocesseur 68302 de MOTOROLA®. Ce générateur, asservi par un récepteur GPS modèle ONECORE-UT de MOTOROLA®, génère les signaux 1 PPS et les informations temps sous forme de liaison série RS 232. La datation et le temps GMT sont également fournis en face avant, par un afficheur à LCD. Un clavier permet aussi de paramétrer le générateur. Deux sorties RS 232, codifiées en ASCII, permettent de distribuer le temps au tiroir de pilotage du positionneur et au micro-ordinateur PC de pilotage, télégestion et orbitographie pour la datation des mesures Doppler. Ces mesures sont effectuées par le fréquencemètre HP 53131A sur la FI de 70 MHz. Pour les signaux reçus en BPSK/QPSK, la porteuse est reconstituée par un module PLL d'ELFES ÉLECTRONIQUES® formé par une boucle de Costas, avant d'être mesurée par le fréquencemètre. Les valeurs lues par le fréquencemètre, à la cadence du 1 PPS, sont transférées au micro-ordinateur PC de gestion et d'orbitographie par la liaison IEE 488, pour la détermination et la correction des orbites. Le rubidium est un module LPRO d'EFRATON® fournissant une référence de fréquence de 10 MHz sous une stabilité à court terme de  $1.E 10^{-11}$  sur 1 seconde. Toutes les bases de temps des divers équipements de la station TT&C sont référées au standard de fréquence.

## 4. RÉSULTATS OBTENUS

Les relevés de spectre présentés ci-dessous attestent la qualité de réception des signaux reçus et démontrent qu'il est possible d'obtenir des résultats satisfaisants à partir d'une station TT&C faible coût, bien dimensionnée et calibrée.

La figure 4 montre un relevé de spectre obtenu à la sortie FI de l'abaisseur, avant l'entrée sur démodulateur, d'un signal TM modulé BPSK à 500 kbps transmis à la fréquence nominale de 2.255,2 MHz par la nacelle de test du SACI-1. Cette nacelle était placée sur la tour de collimation, à environ trois kilomètres de la station.

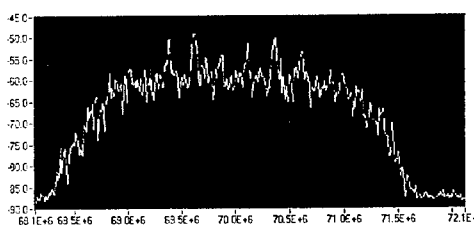


Fig. 4 – Spectre en 70 MHz d'une séquence test reçue de la nacelle TM SACI-1

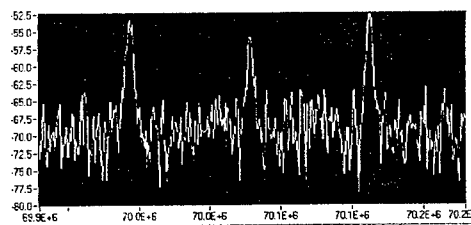


Fig. 5 – Spectre en 70 MHz d'une PCD-ARGOS reçue du DCS/SCD-1

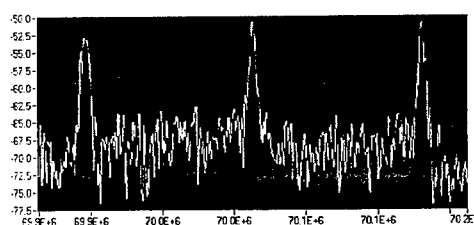


Fig. 6 – Spectre en 70 MHz d'une PCD-ARGOS reçue du DCS/SCD-2

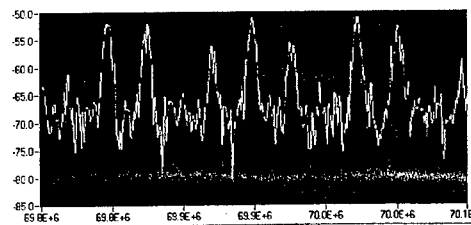


Fig. 7 – Spectre en 70 MHz de PCD's ARGOS et MECB reçues du DCS/CBERS-1

Les relevés de spectre présentés par les figures 5, 6 et 7 ont été enregistrés, respectivement, durant le passage des trois satellites brésiliens SCD-1, SCD-2 et CBERS-1, et permettent d'évaluer les

signaux reçus des DCS en 2.267,52 MHz, modulés en PM avec une déviation maximum de 1,8 rad., avant l'entrée sur démodulateur.

Bien que ces trois satellites utilisent des transpondeurs DCS similaires, d'une puissance nominal de 500 mW, il est facile de constater la nette amélioration de la relation signal-bruit sur le relevé de spectre du CBERS-1. L'absence de fluctuation du signal reçu provient, très certainement, d'un meilleur pointement des antennes de ce satellite vers la terre, en décurrence de sa stabilisation dans les trois axes.

## 5. AMÉLIORATIONS PROPOSÉES

La principale amélioration envisagée dans l'immédiat, est doter la station TT&C d'une deuxième voie TM, en polarisation circulaire gauche. Cette modification comprend le changement de l'actuelle source de l'antenne et l'addition d'une seconde chaîne avec préamplificateur faible bruit et abaisseur. Il sera également nécessaire d'incorporer un combineur pour sommer les deux FIs de 70 MHz, au niveau de l'entrée du démodulateur. Les entrées OL des deux abaisseurs seront excitées par le même synthétiseur 2023 de la station. Cette modification permettra d'améliorer sensiblement les conditions de réception pour les satellites qui ne possèdent pas un plan de polarisation stabilisé. La valeur estimée pour introduire cette modification à la station est de l'ordre de 200.000 Francs.

Une nouvelle chaîne DCS pour la décodification et le traitement des messages de PCDs devra être également ajouté à la station TT&C. Cette chaîne sera composée d'un micro-ordinateur PC Pentium III<sup>®</sup> PCD, fonctionnant sous plate-forme logicielle Windows NT<sup>™</sup>, et d'une carte de traitement PROCOD permettant la décommutation des données de PCDs et la mesure de fréquence Doppler pour le calcul de leur position. Le logiciel principal de contrôle sera développé en langage C++ par l'INPE/CRN et les données du DCS traitées seront envoyées par FTP au centre de dissémination, au moyen du réseau de communication Intranet de l'INPE.

## 6. CONCLUSION

À la vue des résultats obtenus il est aisément prouvé que, même pour un budget modeste et serré comme l'était, à l'origine, le segment sol du programme de micro-satellites SACIs, il a été possible doter l'INPE/CRN d'une station TT&C bande S performante et qualifiée. Le nouveau concept adopté, utilisant dans la mesure du possible des équipements standard dits d'étagère, des produits informatiques type grand public et des cartes commerciales spécifiques enfichables, le tout allié à une nouvelle philosophie de projet, a permis de réduire grandement le coût final de la station TT&C de Natal sans, pour autant, en sacrifier les performances. La modularité résultante de ce nouveau concept a aussi largement fait ses preuves, permettant que la station TT&C soit rapidement convertie, et à peu de frais, aux nouveaux programmes de l'INPE.

## RÉFÉRENCES

- [1] ELFES ELECTRONIQUES, "Users Manual – Estação Solo TT&C SACI, Notice Technique", Toulouse, France, Septembre 1998
- [2] J.P. DUBUT et M.F. MATTIELLO FRANCISCO – INPE, "Estação Solo TT&C SACI-1 Documento de Revisão Final de Projeto – MT-VER-024", São José dos Campos, SP, Brésil, Juin 1998
- [3] P.M. BARROS, "Ground Station Specification – A-ETC-0019", São José dos Campos, SP, Brésil, Juillet 1986
- [4] E. L. GRUENBERG, "Handbook of Telemetry and Remote Control", McGraw-Hill, New York, USA

## SOFTWARE SUBSYSTEM FOR A SMALL EARTH-OBSERVATION SATELLITE

**B. Garrido, N. Alfaro, J. de Miguel and A. García**

*Instituto Nacional de Técnica Aeroespacial (I.N.T.A.)  
Ctra. Ajalvir km.4, 28850 Torrejón de Ardoz (Madrid) SPAIN  
Tel.: 34-91-5201598, fax: 34-91-5202043  
garridobj@inta.es, alfaron@inta.es, miguelaj@inta.es*

**ABSTRACT** – *This paper aims to present an overview of the software subsystem for Earth Observation satellites of the Small Satellite Spanish Program and the life cycle model to be followed.*

### 1. INTRODUCTION

Inside the Small Satellite Spanish Program some Earth Observation satellites are going to be developed. From the On-Board Software Subsystem point of view, it has been attempted to develop a general subsystem, and then to particularize for each satellite.

This paper summarizes the main functions to be performed by the On-Board SW of such Earth Observation Satellites, the General SW Architecture and its relationship with the SW Life Cycle. Our Model is based in the concept that the SW Life Cycle should mirror the industrial scheme (i.e. the companies that do each different part of the job) for the software development and test tasks. In order to apply this idea we have defined a “Spread-V” Software Life Cycle, based in a typical “V” SW Life Cycle, that shows in only one diagram the whole embedded SW Program.

The SW Modes Management is also presented in this paper to be considered as one of the most important parts of the On-Board SW.

### 2. ON BOARD SW FUNCTIONS

There are some features common to small Earth Observation satellites, which have special influence on the software subsystem. The LEO orbit implies long time periods of autonomous control, which implies that the On-Board SW should be capable enough to operate during no visibility times. Fine attitude knowledge, very good pointing precision and stability is required for image acquisition, therefore, a complex attitude control software has to be implemented. The acquired images are downlinked only during ground station coverage, this makes necessary high storage capacity, which is achieved using mass memories.

On the other hand, the On-Board SW for a generic Earth Observation satellite should provide the following functions:

- Monitoring and Control of the Satellite Subsystems and Instruments,
- Control of the Satellite Operation Modes,
- Telecommand reception and distribution,
- Telemetry handling,
- Control of Image Acquisition of the Instruments,
- Attitude and Orbit Control,
- On Board Time Management,
- Error Management,
- In Orbit Code Maintenance.

### 3. SOFTWARE ARCHITECTURE

Taking in mind the nature of the above functions, we have divided the SW Subsystem in two parts. The first is called Application SW and includes all the functions which have no relation with Attitude and Orbit Control which are implemented by the second part called AOCS SW.

The main reasons for making this division are the following:

- Due to the throughput of actual processors and in order to get low program cost, we use only one OBDHP (On-Board Data Handling Processor), it implies to develop a unique and integrated SW subsystem. Thus, it is very sensible, when a SW division is performed, to keep the whole SW structure in one of the pieces. In our case it would be the Application SW.
- AOCS SW is managed by the Application SW just as another task. Then it is possible to develop both components separately just with a good interface definition.
- Although from the operational point of view the AOCS SW is only one task, it is the biggest one and the size of its code is similar to the Application SW.
- Since the special characteristics of the AOCS SW (as the extensive use of numerical computations, high requirements in real time, complex simulation platform requirements etc.), some companies are specialized in this kind of SW development.

In addition to these two components, we consider another one called Low Level Functions, which is developed to isolate the SW and HW. This SW component includes the I/O Drivers as well as the Interrupt Service Routines (ISR). The main goal of this component is to isolate as much as possible the SW and HW developments. For this reason, this S/W component will be ordered to the company which develops the OBDHP.

Under these components, there is a Real Time Kernel providing operating system basic services such as memory allocation, interruption management, tasks management, priority management, etc.

A graphic representation is shown in Figure 1.

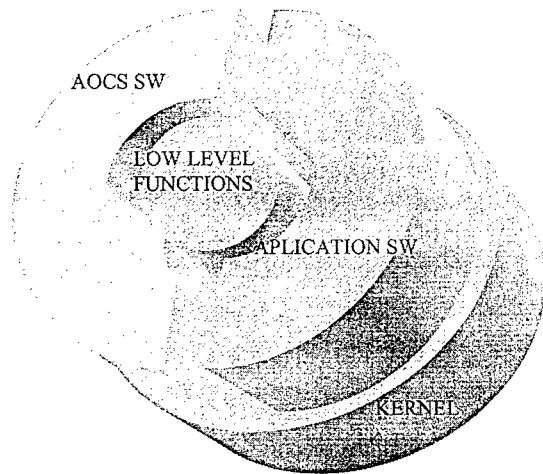


Fig. 1: On Board SW Components

One of the most important parts of the Application SW is the SW Modes Management. SW Modes are the way to define the behavior of the On Board SW, and are a consequence of the more general Satellite Functional Modes. Also the events that provide transitions between modes should be clearly specified. For the SW of a Small Earth-Observation Satellite the following diagram has been defined.

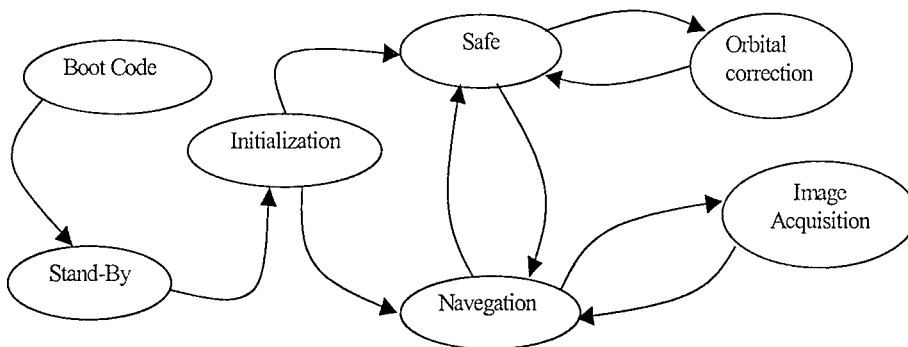


Fig. 2: Application SW Modes

Functions described in section 2 can be active or not, and they will perform different actions depending on the on-board SW mode.

Mode transitions can be automatic, that is, when an established event occurs the Application SW changes to the consequent mode; or may require Ground actuation so the change of mode is made only by Ground request.

In the "Boot-Code" mode an internal test is made to evaluate the status of the OBDH components (RAM, EEPROM, coprocessor, timers, etc.), the results are stored and will be sent to ground when contact is established. After that, the transition to the "Stand-By" mode is made automatically.

The "Stand-By" mode will be used during System Testing and Launch phases. The transition from this mode to the "Initialization" one will be produced after separation from the launcher, by ground request or after time-out.

In the "Initialization" mode satellite spin breaking, sun pointing, and panel and antennas deployment are performed. Monitoring and Control of all satellite subsystems is started at this mode and results are stored in telemetry. In case of successful initialization the automatic transition to the "Navegation" mode is made, else it is transited to the "Safe" mode. The transition to the "Safe" mode can be done also by ground request.

The "Navegation" mode is a waiting mode when no images are being taken. The battery should be charged due to the power consumed during image acquisition, so the satellite should be sun pointing. All equipment and systems are operative at this mode. Cameras are switched on. The transition to the "Image-Acquisition" mode should be made by ground request and the transition to the "Safe" mode may be by ground command or automatic if the on-board software detects an error in any subsystem.

In the "Image-Acquisition" mode cameras are observing the Earth. It is necessary to make a Nadir pointing maneuver of the cameras FOV (Field Of View), since it was sun pointing. In this mode stored and real-time images and housekeeping telemetry are downloaded to the Ground station during coverage. The transition to the "Navegation" mode will be made by ground command or automatically in case of error detection.

In the "Safe" mode, the on-board software places the satellite in a safe condition. The satellite should be positioned in acquisition three axis and sun pointing but with a low pointing accuracy. Power consumption should be minimized. Instruments should be switched off in this mode. If entering in this mode due an error, the Application SW will perform fault recovery tasks and execute any real or time-tag command in order to solve the problem. The transition to "Navegation" mode will be made by ground command when the problem was solved. The transition to "Orbital-Correction" mode will be made by ground command when orbit maintenance will be necessary.

At last, in the "Orbital-Correction" mode, orbital correction maneuvers are performed by mean of commands (real-time or time-tagged). It will be transited to this mode to correct the launch injected errors or for orbit maintenance. The transition to the "Safe" mode is made by ground command.

#### **4. ON-BOARD SW LIFE CYCLE MODEL**

In the development of a complex SW subsystem, very often it is necessary to split the SW in different components each one with its own "V" Life Cycle. Besides, these life cycles can start or finish at different time and, therefore, it is very difficult to have a good overview of the whole program.

For this reason we use the "Spread-V" Life Cycle Model in order to obtain in only one diagram a general program overview. This is advantageous for customers and subcontractors since it is clearly identified the activities to be done in each phase and who is the responsible at each moment; project organization and functional dependencies are also contemplated.

In the Figure 3 it is shown the “Spread-V” Life Cycle used for the Earth Observation satellites of the Small Satellite Spanish Program. As it has been explained in section 3, the On-Board SW Subsystem has been broken down in three components, so the Life Cycle presented hereafter contains only two levels, one for the whole SW Subsystem and the second one for the three SW components. However the methodology of the Life Cycle Model exposed in this paper can contain several levels depending on the SW partitioning.

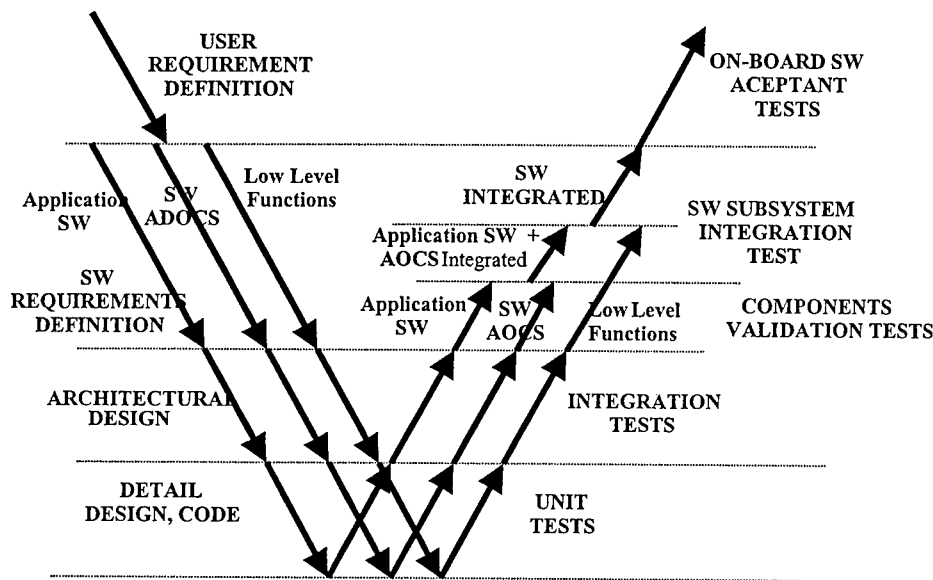


Fig. 3: “Spread-V” SW Life Cycle Model

In this way, we have only one User Requirements Document. At the next level, and taking into account the companies’ job assignment, the SW Requirement Specification is split in three parts, one for the ADOCS SW, one for the Application SW and one for the Low Level Functions. The customer can write a SW Requirements document and pass it to the subcontractors or he can ask the subcontractors to provide them. The stability of requirements is critical for projects, so the User Requirement Document and the Interface Control Document should be frozen at this state before starting the contract in order to guarantee alignment and consistency between all SW components.

From this point, the three components follow their own standard “V” life cycle diagram covering all activities from the statement of requirements to the entry of the software into service. Architectural Design, Detailed Design, Codification, Unit Testing, Integration Testing and Validation Testing phases are followed in an independent way by each sw component. Of course verification, configuration management, quality assurance and project control activities are carried out throughout all life cycle phases.

When these validated products are ready, we start the SW subsystem integration process in two steps. In the first one, the Application SW and ADOCS SW are integrated and after that, the Low Level Function SW component is added to the Integration process.



Finally, the validation of the whole subsystem is performed. Also for the whole On-Board SW Subsystem, verification, configuration management, quality assurance and project control activities are performed for the outer phases.

## **5. CONCLUSIONS**

The complexity of the On-Board SW for Earth Observation Satellites makes necessary to split it into different components to be developed by different companies. In our case three components have been identified: the Application SW, Attitude and Orbit Control System and Low Level Functions.

SW Modes Management is one of the most important functionality provided by the Application SW component.

For complex systems such a SW Subsystem of Earth Observation Satellites the use of a "Spread-V" Software Life Cycle Model is very useful. This Life Cycle Model allows to have a very good general overview of the SW Subsystem at each moment, which clarifies and makes easy to monitor the SW Development Plan, not only from the contractor point of view but also from the subcontractor one.

In addition, this approach reduces the complexity of the integration phase.

## L'ATELIER D'INGENIERIE SIMULTANEE $\mu$ CE POUR LA FILIERE $\mu$ -SATELLITES DU CNES

**Bernard DELATTE et Christian ROSSIQUET**

*CNES - Centre Spatial de Toulouse  
18, avenue Edouard Belin - 31401 TOULOUSE cédex*

**RESUME** – Depuis deux ans le CNES a mis en place une filière micro-satellites ; l'objectif de cette filière est de produire - en relation avec des Agences, des industriels et des laboratoires scientifiques - des satellites dans la gamme 120 Kg, à coût et délai de réalisation réduits, et au rythme de deux missions par an.

L'organisation suivante a été retenue : des Séances d'Avant-Projet permettent de sélectionner les missions à réaliser, puis des équipes multidisciplinaires développent le système correspondant en utilisant au maximum les équipements, logiciels et systèmes retenus dans le cadre de la filière.

Pour relever ce défi, un atelier d'ingénierie simultanée est en cours de déploiement. Il doit couvrir tout le cycle de vie des projets, être le référentiel unique utilisé par des équipes réparties à l'intérieur du CNES et à l'extérieur, faciliter l'échange d'informations et le travail coopératif (GroupWare et WorkFlow), et alléger au maximum la gestion projet.

Cet article décrit plus en détail l'Atelier  $\mu$ CE, puis la solution retenue pour traiter la documentation modulaire.

### L'ATELIER $\mu$ CE

L'Atelier  $\mu$ CE (Atelier de Concurrent Engineering pour les Microsatellites) a pour mission principale de favoriser les échanges d'information entre les équipes réparties, et de leur faciliter le travail par une automatisation des tâches.

L'Atelier  $\mu$ CE repose sur les 5 éléments suivants :

- une **structure d'accueil** qui fédère l'accès à l'ensemble des informations de la filière, et fournit les services de base de Groupware et de Workflow,
- le **référentiel** qui comporte une Base Documentaire Projet (BDP), une Base de Données Equipements (BDE), et une Base de Données et de Modèles Système (BDMS),
- des **outils métier** de simulation, de CAO, de calcul, de synthèse,
- des **moyens d'essai** dont le principal est le banc de validation système,
- et enfin la **Salle de Conception  $\mu$ Satellites**.

### **La Structure d'Accueil**

Elle est vue comme le portail d'accès à la filière : chaque utilisateur enregistré dispose d'un espace de travail qui lui est propre, d'une vue sur des espaces partagés par projets, et d'une vue sur le référentiel filière.

L'utilisateur peut traiter ses mails, accéder à des forums, lire les news, et gérer ses actions et les tâches qui lui sont assignées.

### **Le Référentiel**

Il est basé sur des SGDT.

La Base Documentaire Projet (BDP) repose sur l'outil Baghera qui est utilisé au CNES.

La Base de Données Equipements (BDE) est l'outil qui permet de gérer les équipements « sur étagère », c'est à dire l'ensembles des informations sur les équipements qui peuvent être utilisés dans le cadre de la filière.

La Base de Données et de Modèles Système (BDMS) est garante du référentiel de la filière : elle contient les informations de conception, de réalisation et opérationnelles pour toutes les missions de la filière. A ce titre elle contient : des modèles CAO, électriques, fonctionnels du système, les liasses de conception, des scénarios mission, les informations d'interface Bord/Sol (télémesure et télécommandes), les caractéristiques de chaque équipement composant le système, les contextes et résultats d'essais, et divers bilans.

### **Les Outils Métier**

Cette catégorie regroupe les outils utilisés par les divers ingénieurs qui constituent les équipes de spécialistes  $\mu$ Satellites ; ces outils concernent le contrôle d'attitude et d'orbite, la mécanique et la thermique, les télécommunications, la propulsion, la gestion Bord, l'alimentation, les opérations, et la sûreté de fonctionnement.

Actuellement, chaque métier travaille sur ses propres modèles; par contre, nous disposons du simulateur mission MILESIM qui permet de prendre en compte différents points de vue métier dans l'étude de la mission, et de travailler à divers niveaux de précision, selon le but recherché.

### **Les Moyens d'Essais**

Le Banc de Validation Système et Satellite (BVSS) est le moyen d'essais mis en place pour la filière ; plusieurs instances seront développées pour être utilisées en validation (potentiellement sur plusieurs satellites en parallèle), et en opération (pour valider des évolutions ou corrections d'anomalies par exemple).

### **La Salle de Conception $\mu$ Satellite**

C'est la salle qui est utilisée lors du travail en groupe. Elle est équipée d'un ensemble de PCs utilisables en terminaux X connectés à tous les moyens cités précédemment, et de moyens de téléconférence, et de projection des écrans des ordinateurs de la salle.

Ceci permet de faire des réunions ou des présentations à un groupe, mais est surtout indispensable aux Séances d'Avant-Projet (SAP) que nous allons présenter.

### **Les Séances d'Avant-Projet (SAP)**

Rappelons que la mission de la filière  $\mu$ Satellites peut se résumer ainsi : réaliser des  $\mu$ Satellites à partir d'équipements récurrents (dans la mesure du possible), à coût et délai réduits. Ceci nous conduit à systématiser les phases d'avant-projet qui consistent dans un premier temps à faire une

sélection parmi des expériences candidates à l'emport sur un  $\mu$ Satellite (2 parmi une dizaine), puis à consolider la définition technique de la mission.

Ce travail est fait au cours des SAP pour lesquelles une équipe d'une quinzaine de spécialistes représentant les métiers spatiaux se réunit pendant quelques jours dans la Salle de Conception  $\mu$ Satellite.

De l'expression fonctionnelle de besoin, en passant par les divers calculs et simulations techniques et mission, par l'analyse de risque, jusqu'à la rédaction de la proposition du groupe au Comité des Programmes Scientifiques du CNES qui prend les décisions au niveau mission, tous les moyens et méthodes mis en place dans le cadre de l'Atelier  $\mu$ Satellites trouvent leur pleine justification.

## LE SYSTEME GOLD

### Définition du système GOLD

GOLD (Gestion des Objets et Liens Documentaires) est le nom d'un outil informatique, destiné à s'intégrer dans le système d'information technique des projets du CNES.

GOLD peut être globalement défini comme un *système d'aide à la production collective de documentation technique*.

Il est important de comprendre qu'il n'est pas axé sur la consultation ou la diffusion des informations, mais sur leur *production*. L'adjectif *collective* est également important dans cette définition, car l'outil est conçu pour que plusieurs personnes travaillent en parallèle sur le même document.

### Objectifs du système

L'objectif prioritaire du système est de traiter correctement le problème de la *réutilisation* dans la documentation. Que ce soit entre deux projets successifs (filiale), entre deux projets parallèles partageant une base commune (on parle de communauté ou de multi-projet) ou même à l'intérieur d'un seul projet (répétition de l'information), cette réutilisation doit être à la fois simple et fiable.

Le deuxième objectif du système est de diminuer l'énergie et le temps nécessaire à la création, la maintenance, la validation et la gestion (classement, réorganisation, traçabilité, etc) des informations écrites.

### Public visé

Le public principal de GOLD est celui des rédacteurs de documents techniques dans le cadre des projets de type *filiale* : projets à part entière ou sous-systèmes réutilisables voire communs à deux projets. Ces filiales (au sens large du terme) sont de plus en plus nombreuses aujourd'hui au CNES (Microsat, Spot, Hélios, Proteus, Doris, etc). Leurs besoins en matière de production documentaire sont complexes et souvent spécifiques, comme on le verra plus loin.

Par extension, toutes les personnes concernées par la réutilisation des informations documentaires devraient également être intéressées par le système, par exemple dans le domaine de l'exploitation (procédures) ou de la qualité (spécifications et plans).

### Principe de la solution fonctionnelle

Dans l'absolu, une documentation structurée du type SGML ou XML serait probablement la meilleure solution, mais elle a cependant été écartée. En effet, elle représenterait un changement considérable dans les méthodes de travail. L'impact technique serait énorme dans le contexte CNES,

où la plupart des ingénieurs produisent eux-mêmes leur documentation, sans pour autant être (ni souhaiter devenir) des spécialistes de la rédaction. Le coût financier aurait également été bien supérieur.

C'est pourquoi le concept de *documentation modulaire*, présenté succinctement dans la suite de cet article, a obtenu la préférence. A la fois souple et naturel, il représente un bon compromis à moyen terme ; il offre de nombreux avantages sans susciter de révolution. Si les utilisateurs le demandent, il sera possible à terme d'évoluer vers le concept qui est actuellement le plus abouti dans ce domaine, celui de documentation modulaire structurée (dans laquelle les modules sont conservés mais eux-mêmes structurés avec SGML ou XML).

### Modules et publications

Au lieu de continuer à raisonner en pages et en documents, les utilisateurs de GOLD manipulent des *modules*, des *publications* et des *liens*. Les personnes possédant une culture informatique n'auront aucun mal à faire le rapprochement avec l'approche objet.

Pour simplifier, les **modules** servent à *encapsuler* des portions de texte autonomes, correspondant le plus souvent à un paragraphe, un chapitre, une section, etc. Un module peut être vu comme un micro-document, possédant une cohérence interne et une unité sémantique.

L'utilisateur peut *assembler* plusieurs modules (comme dans un jeu de Lego) pour composer un module plus "gros". Il peut ensuite répéter l'opération, créant ainsi une arborescence dont chaque nœud est un module.

La racine d'une *arborescence* de modules est une **publication**. Dans la philosophie GOLD, c'est le produit fini de l'assemblage, le plus proche équivalent d'un document traditionnel.

L'*unité* de gestion et de modification n'est plus la page d'un document papier, mais le module d'information, géré dans une base documentaire informatique qui sert de référence. La taille des modules n'est pas fixée à l'avance, elle dépend de la nature des informations et de l'usage auquel on les destine.

Un même module peut apparaître dans plusieurs publications, mais il n'est modifié et géré qu'en *un seul exemplaire*, d'où l'intérêt évident pour la réutilisation. Son responsable connaissant à tout moment l'ensemble des publications dans lesquelles est utilisé un module, il peut en tenir compte dans l'évolution de celui-ci.

### Liens entre modules

Les **liens** entre modules et publications permettent de décrire et de conserver dans la base documentaire GOLD des données qui, jusqu'à aujourd'hui, n'existent que dans la tête des rédacteurs. Ces liens décrivent le contexte d'un module, c'est-à-dire ses relations avec les autres modules : l'expérience montre que c'est souvent utile pour en comprendre le contenu, surtout quand le temps a passé.

En dehors des liens de composition, l'utilisateur dispose de liens de type parenté, traçabilité, traduction, référence, etc. Cet aspect est assez novateur et complexe, mais la place nous manque ici pour le développer davantage.

### Projets Filières et documentation modulaire

Dans le cadre d'un projet filière, l'ingénieur responsable d'un document est souvent confronté au problème suivant : il doit élaborer un document "générique" et le décliner (l'instancier) selon plusieurs satellites ou produits (deux, trois, ... parfois plus de dix). Certaines des informations sont communes à deux ou plus de ces instances, d'autres sont spécifiques à l'une d'entre elles.

Bien entendu, le contenu de ce document générique varie au cours du temps, et il est important que tous les intervenants aient une version à jour en permanence. En l'absence d'outil dédié, ce casse-tête prend vite l'allure d'un cauchemar, sans parler des risques d'incohérence associés.

Sous GOLD, chacune des instances de ce document est une publication, donc une arborescence de modules. L'utilisateur (ou un de ses collègues) a d'abord créé les modules, puis construit chaque publication en sélectionnant les modules qui conviennent, compte tenu du satellite ou du produit visé.

Lorsqu'un module commun à plusieurs publications est modifié, celles-ci sont - par défaut - automatiquement mises à jour, puisqu'il s'agit non pas d'une information dupliquée mais de la *même* information. Le responsable d'une publication peut néanmoins, en le justifiant, refuser ou repousser une telle mise à jour.

Il est très simple de créer une nouvelle publication "à la demande", même si elle n'intéresse qu'une seule personne (par exemple avec tous les modules communs à deux des satellites).

#### **Travail de groupe et documentation modulaire**

A chaque fois qu'un module est modifié, le système prévient tous les utilisateurs concernés : cet aspect information est déjà en soi une composante du travail coopératif (*groupware* pour les anglophones).

Pour les modules et publications gérés en configuration, le circuit de relecture éventuelle et le circuit de validation sont également intégrés dans le système. Chaque utilisateur consulté dans un tel circuit peut donner son avis, émettre des commentaires, proposer des modifications : on entre ici dans le domaine du *workflow* documentaire (en bon français : gestion automatisée des procédures).

Le circuit est totalement transparent : chacun peut à tout moment prendre connaissance des remarques des autres utilisateurs (si on oublie, pour simplifier, la problématique des droits d'accès). Après une courte phase d'apprentissage, le gain en rapidité et en efficacité est notable.

## MARS PROXIMITY LINK OPERATIONS

Greg J. KAZZ  
Edward GREENBERG  
M. L. MACMEDAN

*Jet Propulsion Laboratory  
California Institute of Technology  
4800 Oak Grove Dr.  
Pasadena, CA 91109  
greg.j.kazz@jpl.nasa.gov*

**ABSTRACT** - *Given the recent setbacks of the Mars 98 missions, the NASA/ Jet Propulsion Laboratory (JPL) is reassessing its approach and architecture for future Mars exploration. One of the preliminary focuses of rearchitecting the Mars Program is to first establish an infrastructure at Mars that will extend key ground network services of the existing earth-based Deep Space Network, (DSN), managed by the Telecommunications and Mission Operations Directorate, (TMOD), at the NASA/JPL. Missions in the 2003 to 2005 time frame that plan to extend these network services are: NASA/JPL Mars Surveyor Project 2001, ESA Mars Express, and NASA/JPL Mars Network. For all of these missions, extending reliable communication, navigation, and time management to inbound Mars assets creates unique and challenging issues for operations. This paper addresses three of these key issues. First, it describes the operational scenarios involved in operating point to point, point to multipoint, and multipoint to multipoint links between orbiting relays and Mars based assets. Secondly, it examines mechanisms that help transform the current schedule/manual based mode of operations into a more autonomous demand driven approach. Last, it presents a plan to transition to file transfer services using Consultative Committee for Space Data Systems (CCSDS) Proximity Space Link Protocol [Ccsd 00] and File Delivery Protocol (CFDP) [Ccsd 99] recommendations for these missions.*

### 1 - INTRODUCTION

Over the next decade, international plans and commitments are underway to develop an infrastructure at Mars to support future exploration of the red planet. The purpose of this infrastructure is to provide reliable global communication and navigation coverage for on-approach, landed, roving, and in-flight assets at Mars. The claim is that this infrastructure will: 1) eliminate the need of these assets to carry Direct to Earth (DTE) communications equipment, 2) significantly increase data return and connectivity, 3) enable small mission exploration of Mars without DTE equipment, 4) provide precision navigation i.e., 10 to 100m position resolution, 5) supply timing reference accurate to 10ms. [Bell 00, Hast 00] This paper in particular focuses on the **operability** of that infrastructure. [Cesa 00, Kuo 00] Operability in this context means flight and ground system visibility, controllability, and accountability of data products managed and transported across the local proximity and long haul deep space links.

The second key aspect of this infrastructure is **interoperability** with the future international armada that is planned for robotic exploration of Mars culminating with a man presence. Interoperability in this context means providing for standard communication, navigation, and time

services including strategies to recover gracefully from interruptions and interference while ensuring backward compatibility with previous missions from previous phases of exploration. [Kazz 98]

This paper describes proximity link operations for the Mars environment. First, the mechanism for link negotiation between a caller and a responder for communication services is described. Once the link is established, link maintenance including real-time link dynamics (frequency and data rate changes) takes place. A summary of link termination options follows. The possibility of having more than one Mars asset simultaneously in view raises issues of contention. Although studies have shown that through the 2005 period contention is rare (highest probability of an orbiter simultaneously in view of two landed assets limited to 7% of the planned contacts), it will become an increasingly important issue as the infrastructure expands. [Bell 99] In order to understand the applicability of the protocols to future mission contexts, a set of four operational scenarios in terms of increasing complexity is provided. Another aspect of operations is to enhance operability and lower cost by enabling automation. A set of automation enablers is proposed. Finally, in order to benefit from the rich set of capabilities of the CFDP, the existing ground and flight systems must establish three proposed mechanisms to monitor, account, and manage files end-to-end.

## **2 - PROXIMITY ENVIRONMENT FOR ESTABLISHMENT, MAINTENANCE, TERMINATION OF COMMUNICATION SERVICES**

For the purposes of discussion, this section assumes communication is to be established between an orbiting relay (caller) and a landed asset (responder) during a session. A session is the period of time over which the proximity link is operational. It consists of three phases: link establishment, data service, and link termination.

### **2.1 - Link Establishment**

Operations at the Earth schedule the deep space link between the orbiter and Earth. The proximity link between the relay and landed asset is demand driven. The orbiter knows where the landed assets are located. The orbiter is the master and will hail to alert the asset that it is in view and available for telemetry or command relay. The asset can refuse a proximity link session for numerous reasons including: lack of data, power limitations, or instrument operational constraints. The orbiter command and data handling system (C&DH) knows what asset to address and supplies the known spacecraft ID to the Ultra High Frequency (UHF) radio. If more than one asset is within the field of view of the orbiter, the orbiter can poll for the assets it desires to communicate with by cycling through the potential spacecraft IDs until a contact is made. The orbiter can also use this as a technique for gathering initial status and priority from each asset to determine the servicing priorities for the return link (assigning portions of the session to each asset).

During the 2003 time period when the possibility of link contention is not possible, operations will be carried out on the hailing frequency pair. Later, operations will switch as soon as possible from the hailing frequency and onto a working frequency pair based upon the type of data service e.g., Doppler, high or low data rate communications. Since the orbiter has knowledge of where the assets are, it is possible that future assets could be assigned different channels and the orbiter will need to establish contact on those channels instead of on the hailing channel.



## 2.2 - Data Service

In the data services phase, both user and protocol information is passed using the communications link provided by the transceivers. Two grades of service are provided: expedited service guarantees only that the data units accepted are error free. Sequence controlled service assures that the data units accepted are in order, without gaps or duplications within a session. The orbiter keeps the carrier on throughout the entire session to indicate it's present. If data communication is interrupted during a session, the UHF radio informs the C&DH (via status reports) and awaits instruction whether to terminate the session or reestablish the link by re-hailing. Data rate or frequency changes can also occur during this phase. A data rate/frequency change procedure is defined to minimize data loss during the transition. [Ccsd 00]

## 2.3 - Link Termination

Since the orbiter knows the ephemeris of the orbit at the expected point of loss of signal, the UHF radio is commanded by the C&DH to the inactive state or the on-board carrier loss timer expires. (This also covers the contention case because the C&DH takes appropriate action after it is notified of the contention.)

## 2.4 - Considerations

Duplication of data may occur during multiple proximity sessions using sequence-controlled service. Handling of data between sessions is outside of the Proximity-1 protocol. Controlling the sequence number count between sessions or deleting duplicate frames can be dealt with by the C&DH.

CFDP, which works on a transaction basis, provides continuity between proximity sessions. It provides the capability of delivering duplicate free data across multiple sessions and for integrating data collected/relayed from multiple orbiters.

## 3 - PROXIMITY OPERATIONAL SCENARIOS

The following scenarios examine operations across two separate links: proximity (landed assets to orbiter) and deep space (orbiter to Earth). The proximity link is characterized by short distance (within 400,000 km), moderate signal strength, and single sessions. The CCSDS Proximity-1 Space Link protocol [Ccsd 00] is the specification that defines both the physical and data link layers. The CCSDS File Delivery Protocol (CFDP) [Ccsd 99] is run on top of Proximity-1 at the data transport layer. It utilizes a selective repeat mechanism for retransmission of unacquired portions of a transaction. The deep space link is characterized by long delays, and weak signals. The data link layer in this case is supported by CCSDS Telecommand (TC) Recommendation in the forward direction [Ccsd 92] and CCSDS Telemetry (TM) Recommendation in the return direction [Ccsd 95].

### 3.1 – Point-to-Point (Simple Relay)

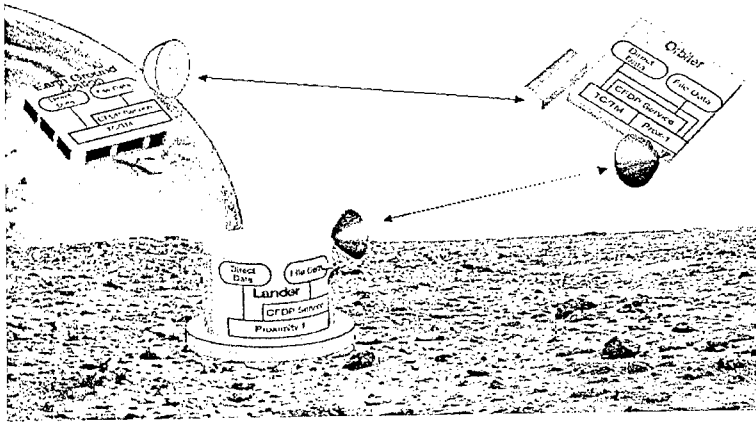


Fig. 1: Point-to-Point (Simple Relay)

The objective is to transfer a file by means of an orbital relay. A file may be transferred from a lander to the Earth or from the Earth to the lander. The orbital relay functions as a store and forward node. The on-board command and data handling system manages the data it receives from Earth or the lander, as a file in its on-board file management system. In those cases where the lander does not manage data as a file, the relay orbiter can accept data not organized in files e.g., byte streams, CCSDS packet sets, and create one or multiple files from this data on-board. Once the file is successfully transferred to the orbiter, it takes custody of the data (custody transfer), and relays status back to the lander acknowledging its receipt. Given adequate resource margins on-board the orbiter, the lander can now delete this data providing storage space for future data acquisition.

### 3.2 - Point-to-Point (Multi-hop Relay)

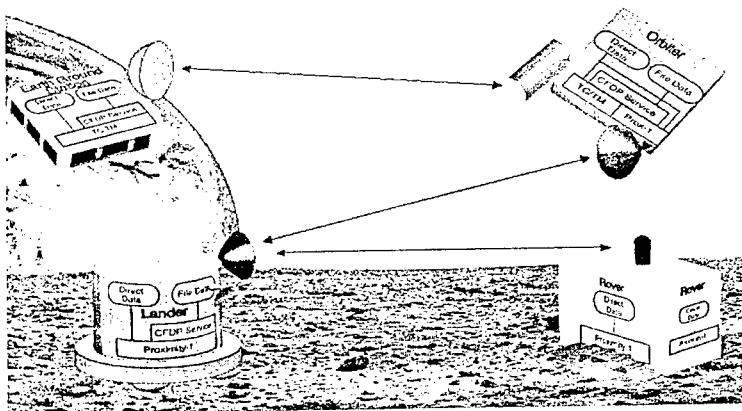


Fig. 2: Point-to-Point (Multi-hop Relay)

Now a rover enters the environment and transfers its data to the lander. The rover having limited computing power and storage does not have the resources to run CFDP. Depending upon the required completeness of the data transfer, the rover utilizes either the expedited or the sequence controlled service. Both the lander and orbiter function as store and forward nodes. Custody transfer occurs first between the lander and the rover and later between the orbiter and the lander.

### 3.3 - Point-to-Multi-Point (Forward/Return Link)

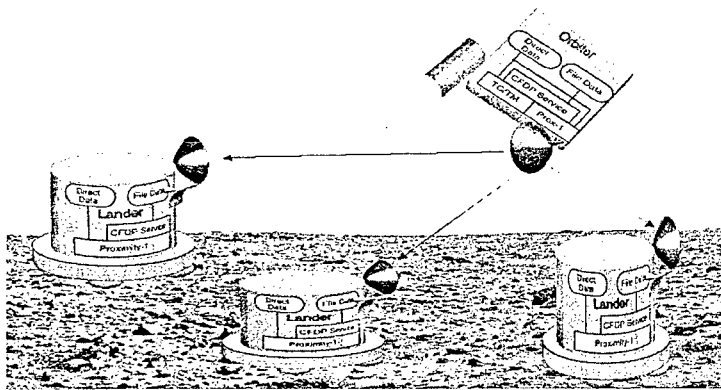


Fig. 3: Point-to-Multi-Point (Forward/Return Link)

Within the proximity link environment, an orbiter encounters multiple landed assets. Assuming the orbiter has only one transceiver, it can simultaneously communicate to all or a subset of the landed assets within its field of view. By cycling through a set of spacecraft IDs during the hailing period, the orbiter can a) broadcast commands for all landed assets, or b) multicast commands to a subset of landed assets e.g., all landers, or c) poll each landed asset to determine the priority of its return link data transfer and once determined choose the asset with the highest priority. The proximity-1 protocol frame verification rules specify that only data marked with the asset's specific spacecraft ID or multicast address will be accepted by the asset.

### 3.4 - Multi-point to Multi-point

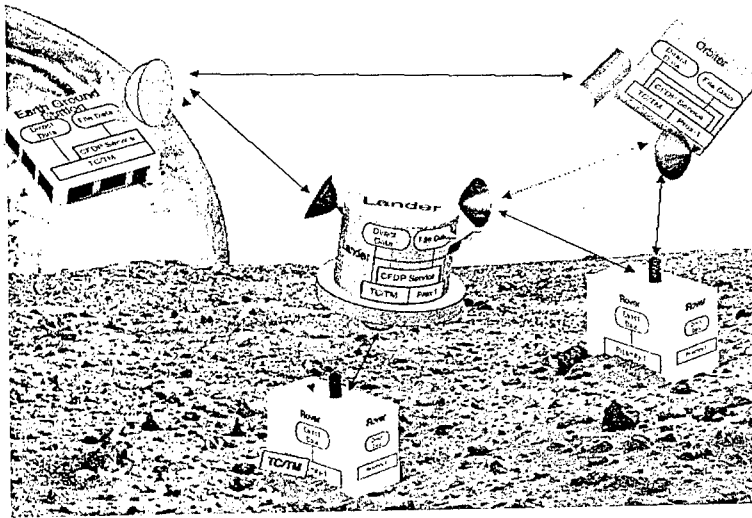


Fig. 4: Multi-point to Multi-point

This scenario will require some form of multiple access scheme. Candidates under study at this time are frequency division multiple access (FDMA), code division multiple access (CDMA), and time division multiple access (TDMA). FDMA has the advantage that spectrum is available on Mars but it forces landed assets to have frequency agile transponders. CDMA is beneficial where ranging is a requirement for navigation however it imposes a power level control problem which results in more complicated hardware on the landed assets. TDMA in the true time slotted approach imposes tight oscillator requirements on the landed assets and time coordination between them and the orbiter relay.

## 4 - AUTOMATION ENABLERS

### 4.1 Orbiter shall provide demand access to landed assets.

Nominal proximity link detailed level scheduling for data transfer of navigation, command, telemetry products shall be done without ground intervention. Scheduling of landed asset contacts shall occur by means of the hailing procedure, knowledge of lander position and orbit ephemeris, instrument and power constraints. The orbiter knows when a contact is possible. The lander may reject a contact due to instrument or power constraints.

### 4.2 The proximity link shall be operated in a modeless fashion.

Data transfer is data driven and is independent of mode. This eliminates the costly testing of operational modes. It enhances operability by multiplexing expedited and sequence controlled data across the link. An infrequent small message that does not require sequence control can be multiplexed into a sequence controlled series of messages. This makes the content of the data transferred transparent to mode.

### **4.3 Dynamic control of transaction relay**

Data quality needs shall be signaled in the data. Each transaction should have a Quality of Service (QOS) indicator and a priority indicator to allow the orbiter to dynamically control relaying of the transaction without intervention from the ground.

### **4.3 On-board network wide priority scheme**

This scheme replaces the timely and costly ground negotiation process of prioritizing data transfer amongst multiple users and moves it to the spacecraft. On-board data prioritization schemes such as the downlink priority table on Mars Pathfinder were used to prioritize the return link for two spacecraft (lander and rover) within the same mission. The challenge is to develop a scheme across multiple missions with multiple applications. Unlike the Mars Pathfinder mission, future missions will require that all data be prioritized at the product level i.e., file level.

## **5 – TRANSITION STEPS TO FILE TRANSFER**

### **5.1 Use of on-board file directory mirrored by the ground**

In order to catalog files end-to-end between the orbiter and the ground, an on-board file directory is required. It shall identify file characteristics e.g., file size, file name, originator, file creation time and transfer status. The ground shall maintain an identical directory so that operations can manage the prioritization, monitor the status, and account for file transfer end to end.

### **5.2 End-to-End accountability at the file level**

End-to-End data accountability shall occur at the file level. This includes all files received or transmitted by the orbiter including those internally generated.

### **5.3 On-board managers control CFDP protocol**

The host (e.g. Orbiter, Mars landed asset, ground station/Project Operations Control Center) system will need to manage its own resources. There are Resource and Data Management functions within the orbiter that manage onboard data storage, assign downlink priorities, and control communications channel availability. There is also a Communications Manager function which has knowledge of space link communications issues such as data rate (which relates to the data volume transfer per pass), one way light time (which is required by CFDP for automated reliable data transfer operations), the network routing issues (which transactions to send on which links, virtual channels, or passes) and handles the delivery of prioritized data that is to be transferred. Thus the Communications Manager must have visibility into the operational status of all CFDP transactions and must be capable of providing the required parameters and external controls to partner with CFDP and the lower level communications elements in providing a complete service.

The Data Transport Manager is the host's agent for the transfer of data between itself and the remote world. It is the exclusive user of CFDP. The Data Transport Manager controls the ordering of transmission of transactions and provides the high level controls needed to prioritize the data transfers and control which transactions occur on a pass or link. The CFDP Put directive enables the Data Transport Manager to initiate a transaction. The suspend and resume directives enable the Data Transport Manager to stop and restart transactions on the proper link after a transaction is initiated. It must also be capable of terminating a transaction when required or

preventing the acceptance/continuation of a transaction being received. Thus the Data Transport Manager can provide the high level control of CFDP operations by controlling which transactions occur on which links, and the ordering of their transfer on the link. The Data Transport Manager controls the logical transfer of data between the host and external delivery points.

The internal operations of CFDP, for reliable transaction operations, requires that CFDP know the round trip communications delay time. This time is required for control of retransmissions; when to expect reports and when to re-send unacknowledged transmissions. This delay time is an ever-changing value that can be significantly different on different links associated with a node. The delay time for a Mars orbiter with Earth could be the round trip light time (between 10 to 25 minutes) or may be substantially increased because of occultation or ground station scheduling factors. CFDP must also have awareness of the state of underlying data link and physical communication channel elements. It must know when a link has been established and when it is lost. The Communications Manager works with these protocol layers, and with external elements that provide operating schedules, ephemerides, and estimated round trip light time to establish and control the link and physical aspects of data transfer.

#### REFERENCES:

[Ccsd 00] Consultative Committee on Space Data Systems Proximity-1 Space Link Protocol, CCSDS 211.0-R-2, Red Book Issue 2, Jan. 2000. Available at <http://www.ccsds.org/>

[Ccsd 99] Consultative Committee on Space Data Systems File Delivery Protocol, CCSDS 727.0-R-3, Red Book Issue 3, May 1999. Available at <http://www.ccsds.org/>

[Bell 00] Bell, David J. "Mars Network: A Mars Orbiting Communications & Navigation Satellite Constellation," IEEE Aerospace 2000 Conference, IEEE publication 0-7803-5846-5/00, Big Sky MT, March 18-25, 2000.

[Hast 00] Hastrup, R.C. "Mars Network for Enabling Low-Cost Missions," Fourth IAA International Conference on Low-Cost Planetary Missions, IAA-L-0509, Laurel, Maryland, 2-5 May 2000.

[Cesa 00] Cesarone, R.J. "Design Considerations for the Mars Network Operations Concept," Paper No. 211, SpaceOps 2000, Toulouse, France, June 2000.

[Kuo 00] Kuo, N.R. "Mars Network Operations Concept," IEEE Aerospace 2000 Conference, Paper Id. 163, Big Sky MT, March 18-25, 2000.

[Kazz 98] Kazz, G.J. "Application of an Extended CCSDS Telecommand Standard for all Mars In-Situ Telecommunication Links," First ESA Workshop on Tracking, Telemetry, and Command Systems, ESTEC, Noordwijk, Netherlands, June 24-26, 1998.

[Bell 99] Bell, David J. "Variable Data Rate Analysis for Maximizing Pre-aerobreaking Data Return," Presentation at the Mars Network Meeting, JPL, December, 1999.

[Ccsd 92] Consultative Committee on Space Data Systems Telecommand Part 2 – Data Routing Service. CCSDS 202.0-B-2, Blue Book Issue 2. Nov. 1992. Available at <http://www.ccsds.org/>

[Ccsd 95] Consultative Committee on Space Data Systems Packet Telemetry, CCSDS 102.0-B-4, Blue Book Issue 4, Nov. 1995. Available at <http://www.ccsds.org/>

## **ACKNOWLEDGMENT**

The authors would like to acknowledge the work of Richard Carper for supplying the scenario layouts. The work described in this report was conducted at the Jet Propulsion Laboratory, California Institute of Technology, under contract with the National Aeronautics and Space Administration.

## PROTOTYPING THE SPACE INTERNET WITH STRV

Author: **Richard BLOTT**  
STRV Programme Manager  
*Space Department*  
*The Defence Evaluation and Research Agency*  
*Farnborough*  
*Hampshire GU14 0LX*  
*England.*

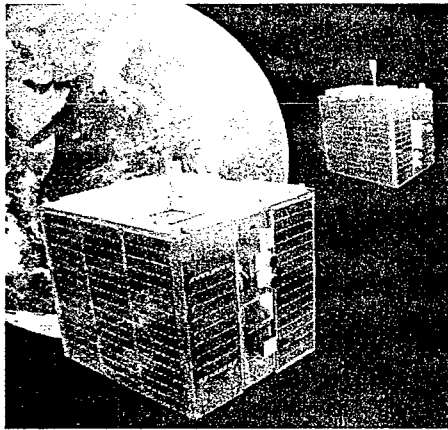


Figure 1. Artists Impression of STRV 1c&d in orbit.

### ABSTRACT

Interest in extending the Internet into space has been increasing with the perceived benefits of providing direct and easy access to in-orbit instrument and spacecraft performance to remote Principal Investigators or system managers and engineers. Such a development is anticipated to be particularly useful for future constellations of satellites with high levels of co-operative working. Enthusiasts, however, tend to focus on the benefits of a 'space internet' rather than the difficulties and dangers which must be overcome to realise this ambition.

DERA started the initial prototyping of the 'space internet' concept when a software experiment was uploaded to STRV 1b in orbit in 1995. The Space Communications Protocol Standard (SCPS), provided adaptations of the TCP/IP transport and file transfer protocols which achieved efficient data transfer to and from the spacecraft to a remote internet user through DERA and NASA ground stations. The adaptation overcame the vulnerability of the normal commercial TCP/IP protocols to long, interference susceptible space transmission paths. STRV 1b was the first spacecraft to have its own IP address, to respond to e-mailed commands and send e-mailed data. The experiment also demonstrated an internet security standard but the spacecraft had insufficient memory to demonstrate the networking protocol.

STRV 1c&d are both equipped with the ERC 32 radiation tolerant Sparc processor. The capability for the STRV 1d Sparc has been enhanced with a board support package, which supports the VX Works operating system, and an experiment management package for multi-tasking operations. This combination provides a uniquely powerful testbed for space software development and it is being used to support an exciting range of novel software experiments. Associated with the Sparc is an interface to permit the decryption of received secure commands and the encryption telemetry for down loading. This performs two essential functions: it provides a mechanism for restricting access to the spacecraft



to valid internet users and the flexibility to compare the performance of different internet protocols in space from LEO to GEO. In parallel, DERA has developed the first implementation of the CCSDS packet TT&C standard which incorporates a security layer and implementations of simplified version and the full CCSDS File Delivery Protocol (CFDP). This provides the capability to conduct full in-orbit demonstration and performance characterisation of orbiter/lander/ground control linking and networking for future Mars and other interplanetary missions.

The STRV 1d Sparc testbed and DERA's state of the art control centre is therefore taking the lead to prototype and demonstrate how the internet can be safely and successfully developed for linking and networking between space and terrestrial users. The presentation will describe the capabilities which make this possible and information on the latest in-orbit results.

## INTRODUCTION

In recent years there has been a rapidly growing interest in investigating how the benefits of terrestrial internet services could be realised in space. It has raised the expectation that users of space generated information such as imagery or a scientific experiment could link directly with the source of the data rather than by sending requests for information to an operations centre. It has raised the expectation that flexible communication could be achieved through a variety of communication paths between the terrestrial customer and the space entity such that the connectivity was transparent to the user of the service. It has also raised the expectation of networking to remote interplanetary spacecraft, such as Mars landers.

These expectations have been encouraged by early trials with STRV 1b during 1996/7 and more recently by a NASA Goddard OMNI experiment with SSTL's UoSAT 12. However, there remains an enormous difference between the robust, flexible, well-developed, high-capacity communications infrastructure, which supports terrestrial internet and current space communications. This is particularly true as one moves away from fixed, bent-pipe satellite communications links or dedicated Low Earth orbiter support. The other main difference is that the majority of spacecraft are unmanned and therefore a space 'internet node' must provide the 'intelligence' to respond to 'e-mails' in addition to the protocols and communication interface. This raises the question of which applications a space internet should support and the applications will in turn define the necessary characteristics of the service.

The Consultative Committee for Space Data Standards (CCSDS) has long recognised the potential benefits and dilemmas of developing a space internet. In addition to identifying the full range of potential applications, much thought has been devoted to establishing a sufficiently robust communications infrastructure to enable the benefits of a space internet to be realised. This is to be seen in a progression of initiatives: CCSDS standards for packet TT&C, the Space Communications Protocol Standard (SCPS), the CCSDS File Delivery protocol and the Space Link Extension (SLE) development.

Studies during the 1980s indicated that without such developments the basic HDLC based TCP/IP was unlikely to function reliably in space. Since then, TCP/IP has been further developed and the OMNI trial is now claiming success although it is understood that the basic protocols require 'frame relay' and packet switching support. An early implementation of the CCSDS packet TT&C was successfully demonstrated on STRV 1 a&b, launched in 1994, and STRV 1b, the first spacecraft to be given an IP address, was able to demonstrate reliable internet connectivity between space and ground. CFDP and SLE implementations have been prepared for demonstration on STRV 1d planned to be launched in August this year. STRV 1d also provides a platform for comparison between the CCSDS standards and the HDLC based approach and it is intended to compare the relative merits and disadvantages of the two approaches.

interplanetary backbone, deployed internets, an inter-internet dialogue and interplanetary gateways. An example of an interplanetary backbone might be a link between an Earth gateway and a Mars gateway. It would have to cope with very long delays, a 'high cost per bit' and a low SNR. The link and physical layers would probably be based on existing sub-net technology with buffering in a non-volatile media and an efficient mechanism for congestion control.

'Deployed internets' may be expected to operate over shorter distances and therefore exhibit features more similar to the 'Earth internet'. However, the space environment may still be expected to enforce the adaptation of terrestrial standards. SCPS, for example, introduces modifications to the internet FTP and TCP-UDP to achieve a significant increase in efficiency over long distance links which may be prone to higher bit-error rates. PROXIMITY-1 is designed for low power links such as from a lander to an orbiter. CFDP incorporates a number of features to protect against the frailties of very long distance file transfer. At this stage, it is envisaged that 'deployed internets' may have to incorporate some or all of these features to meet the requirements of a particular application or service and that the 'gateways' would therefore have to support the full range of capabilities.

The degree to which 'Earth-internet' requires modification to operate efficiently in space to meet the full range of applications is the subject of much current debate. The potential benefits will be greatly enhanced if little or no modification is required. Equally, the dangers of underestimating the constraints of operating in the space environment are unfortunately likely to be very costly. There is therefore a very strong case for evaluating the performance of the options for implementing the space internet over live space links to demonstrate how the required robustness and efficiency can be achieved most cost-effectively. This must be achieved against an evolving scenario in which the applications are still in the first stages of definition.

### **PAST STRV DEMONSTRATIONS**

STRV became involved with the CCSDS standards first through the STRV 1 a&b implementation of the packet TT&C and the through the STRV 1b SCPS experiment. A key theme in both was to demonstrate the benefits of interoperability. An additional benefit was the subsequent savings in being able to use an 'off-the-shelf' product rather than a 'bespoke' system.

In 1994, the National Aeronautics and Space Administration (NASA), the DoD and DERA jointly started a standardisation initiative to develop a new space communications system, known as the Space Communications Protocol Standards (SCPS) initiative. The SCPS standards are designed to complement and expand the current CCSDS TT&C standards. The objective is to provide a more comprehensive set of spacecraft control and monitor data handling services based on and compatible with commercial Internet protocols but adapted to the specific needs of space communications links. It was envisaged that these would serve a wide range of civil and military space missions for the foreseeable future. A key application of SCPS is to increase data transfer efficiency and overcome the vulnerability to longer time delays and higher error rates in space based communications links, supporting Internet type data transfers.

Although the CCSDS packetised standards provide the underpinning for the automated, error-free exchange of data between space and ground stations, it is limited to basic data transfer. SCPS provides the additional capability to aggregate both telecommand and telemetry data into recognisable files and transport them end-to-end through the data networks containing space links in a reliable and secure manner. To prototype this, a 'skinny stack' of upper layer space data protocols was developed to eliminate the need for "project uniqueness" and provide:

- an efficient file handling protocol based on FTP,

## WHAT IS THE SPACE INTERNET

The Interplanetary Internet Research Group (IPNRG) presented a view of the space internet to the IEE Satellite Services and Internet Seminar on 17 February this year under the title of the Interplanetary Internet (IPN). This envisages an end-to-end information flow across the solar system, an IP-like protocol suite able to operate over long round trip light times and a layered open architecture to support evolution and international interoperability. It recognised that today's (terrestrial) internet relies heavily on high rate fibre backbones with negligible delays and errors, symmetrical data channels and continuous connectivity. Tomorrow's 'Earthnet' will be based more on mixed environments including satellites, wireless/untethered cable, cable/copper upgrades and 'edge-market plug-ins' to the fibre backbone which could introduce significant delays and errors, power and bandwidth constraints, disjointed connectivity, corruption as a source of loss and asymmetric channels.

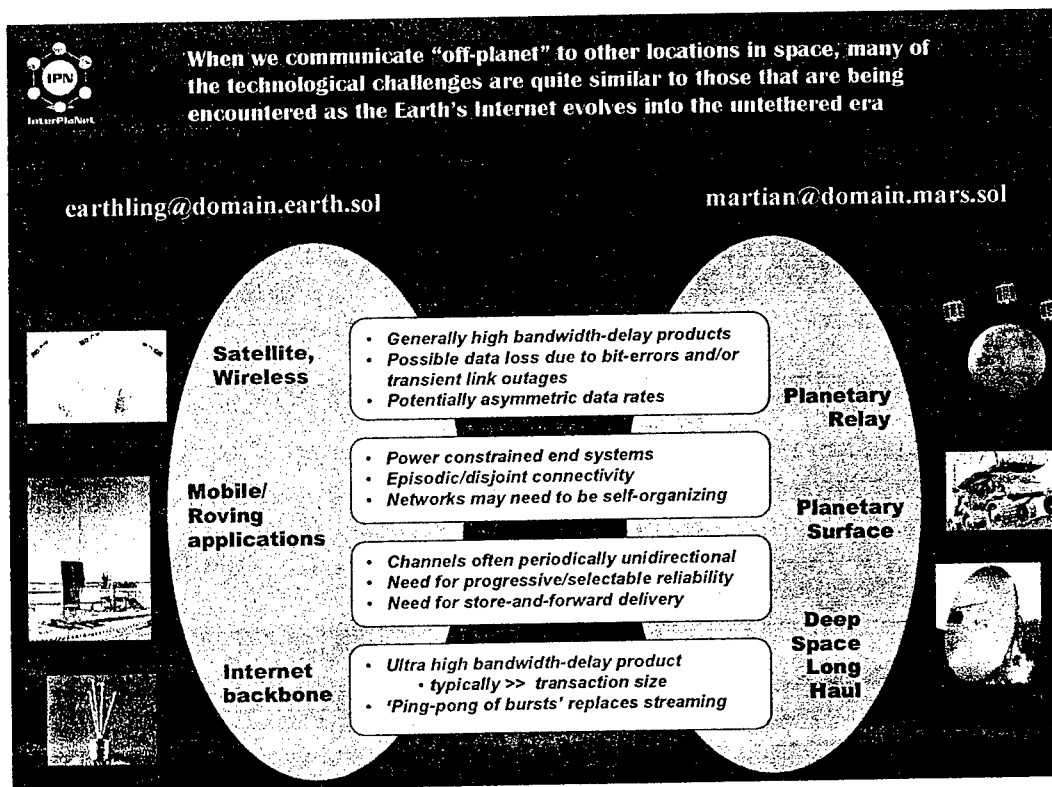


Figure 2. Synergy between the developing 'Earthnet' and a space 'internet'.

Figure 2 illustrates some of the similarities which can be identified between the challenges posed by the 'Earthnet' developments with those required by a space internet. For example, both an internet backbone and a Deep Space Long Haul link will result in an extremely high bandwidth-delay product. Both terrestrial satellite/wireless and planetary relay links are more subject to bit errors and transient link outages. Mobile/roving applications and planetary surface (e.g. landers) applications are power constrained, have episodic/disjointed connectivity and may require self-organising networks.

The IPNRG's view envisages an open architecture, open specifications, open implementations and demonstrations. The four main technical challenges are seen to be the development of a stable

- a retransmission control protocol based on TCP with various modes of operation and for use over networks with one or more unreliable space data transmission paths,
- an optional data protection mechanism which can assure end-to-end security and integrity of message exchange,
- a scalable networking protocol to support both connectionless and connection oriented message routing through networks with space data transmission paths.

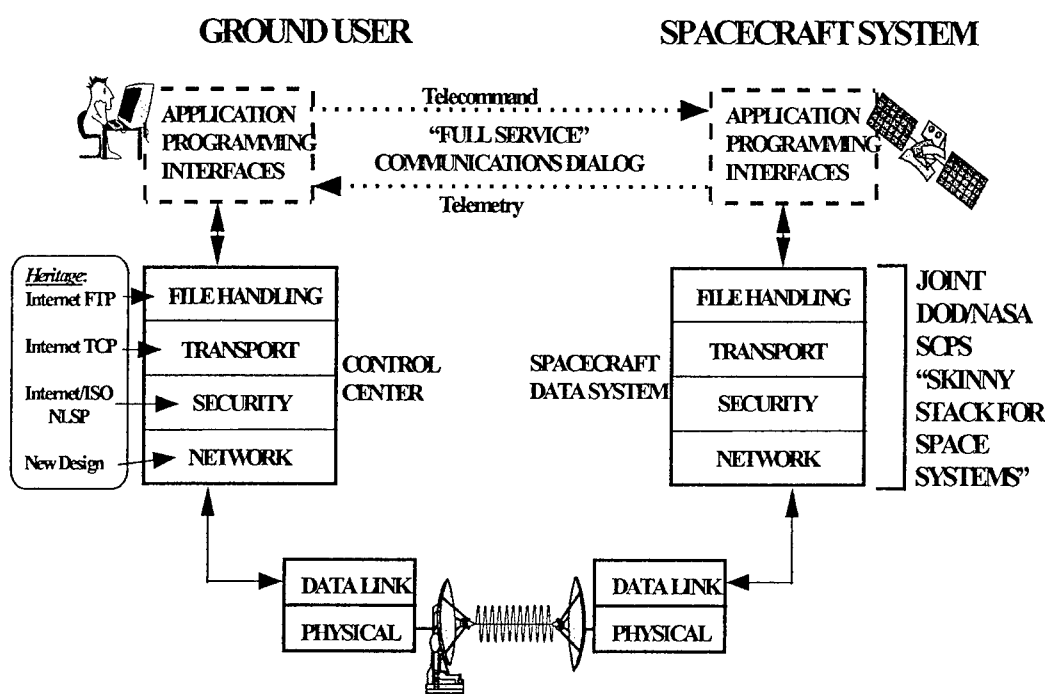
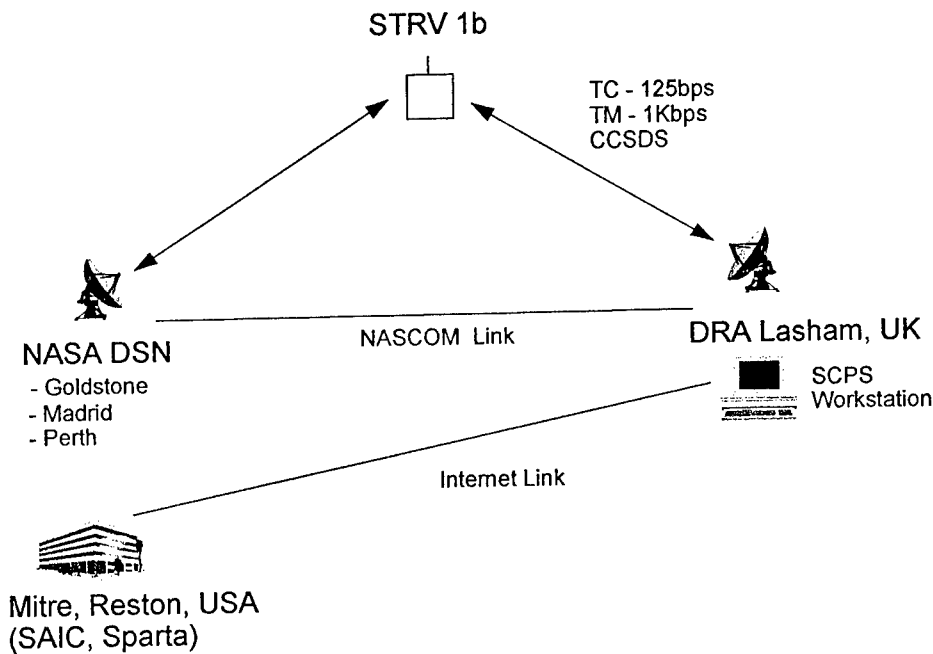


Figure 3. Scope of the SCPS System

More details of the four SCPS protocols are given in Reference XX. The scope is shown in Figure 3, illustrating how the 'skinny stack' for space systems interfaces with the application programmes and the physical data links. The CCSDS working group accepted the four specifications as a new work item in November 1995 to be developed to full international standards over the next two years.

The ESA CCSDS TT&C standards, which are now finding widespread international application, found their first European implementation in an operational mission in the STRV 1a&b. Together with the re-programmable onboard computers, the spacecraft provided an excellent vehicle to prove the SCPS protocols over a live space link. New SCPS software was hosted on one of the STRV 1b spacecraft Mil Std 1750A, (dual-redundant) computers with 128Kbyte SOS RAM. The SCPS development team produced a 'lightweight' version of the Transport, File Transfer and Security protocols which were compiled into 1750 assembler code and debugged using an STRV engineering model. After debugging, the software was uploaded to STRV 1b with the assistance of an operating system (Kernal), developed by the Mitre Corporation to provide the interface to the onboard computer, taking up 120Kbytes of the available RAM. Two 486 PCs were added to the original Ground Station configuration: one for secondary CCSDS processing and one, the SCPS Workstation, to host the SCPS ground protocol software. An Internet link with Mitre in Reston Va enabled the trials to be supervised

remotely from the USA. The general arrangement, showing the alternative links through Lasham or the DSN to the spacecraft and the NASCOM link between Lasham and Goldstone, is illustrated in Figure 4.



**Figure 4. SCPS experiment arrangement.**

In 1996, the SCPS flight software was uploaded to the spacecraft in orbit and the ground software ran as an application on the SCPS workstation. The SCPS workstation received instructions from the Internet and forwarded them, using the SCPS protocols, to a telecommand workstation, which transmitted them as STRV CCSDS packets to the spacecraft. Software in the spacecraft monitored the received instructions and provided performance feedback through the telemetry downlink. As a part of this experiment, STRV 1b was given its own Internet Protocol (IP) address. We believe that this was the first spacecraft to do so, and to demonstrate that instructions could be sent by Internet from remote sites to an operational spacecraft.

Trials were conducted in a suitably stressful environment provided by low data rates (125 bps uplink and high error rates). The data from the supported laboratory predictions, which had indicated that the SCPS Transport protocol was 8 to 30 times more efficient than the commercial Internet TCP over stressed links with high error rates. Moreover, SCPS still achieved data transfer at error rates where conventional TCP/IP broke down altogether. In addition the functionality of the File Transfer and Security protocols were successfully demonstrated. The command to open a SCPS File Transfer connection, transfer a file from space to ground, read a file record and edit a file proved very reliable.

## CURRENT AND FUTURE STRV DEMONSTRATIONS

The STRV 1 a&b demonstrations provided valuable experience in the baseline capabilities which would be needed to support a space internet at a time when the concept was in its early conception. They also revealed a number of important issues, which needed to be addressed, if the concept was to become viable. The first in-orbit investigation of SCPS was constrained by the small STRV 1b memory. As interest has grown in the relative merits of CCSDS link protocols when compared to, for example HDLC, there has emerged a need for a quantitative evaluation of the different standards over a range of operating conditions. At the same time, there have been other new developments such as the CCSDS File Delivery Protocol (CFDP), for efficient space file transfer over very long distances, and PROXIMITY-1 for low power 'lander to orbiter' communication. The performance of these equally need to be evaluated in a 'working' space environment before being baselined for future missions.

Initially a more capable in-orbit test bed was deemed necessary to support a wider evaluation of SCPS and the introduction of link-layer security into the CCSDS packet TT&C. Not only was this required to have greater processing power and memory but also more flexibility to allow for the addition of software based experiments late in the build process or the uploading of new code after launch. Following the STRV 1 a&b experience, the STRV 1d has therefore been equipped with a powerful processing capability, based on the ERC 32 Sparc chipset, in the form of the SMX2 experiment. The implementation uses the VX Works Operating System to facilitate the porting of software developed for terrestrial applications to the space environment. It also includes an experiment management package (XMS), provided by a UK company, Systems Engineering Analysis (SEA), which permits several experiments to be run in series or parallel. Some are associated with on-board autonomy, but only those for evaluating communications are considered in this paper.

The other main feature of the in orbit test bed is the addition of the electronics to provide the encrypted CCSDS packet TT&C interface, to SMX2, to enable the encryption and decryption process to be hosted by the SMX2. This has the added benefit of permitting SMX2 to appear as a 'remote' controller to the spacecraft. Experimental features hosted on SMX2 can be run 'off-line', using real-time spacecraft sensor and housekeeping data, until demonstrated to be reliable in the space environment. Once proven they can have control of the spacecraft with the risk mitigation that control will revert to the on-board data handling system in the event of a shortcoming in the experimental control. The architecture is shown below in Figure 5.

#### ENCRYPTED CCSDS PACKET TT&C

The STRV 1a&b CCSDS packet TT&C implementation proved both robust and reliable but lacked security. Initially this was seen as a shortcoming which would have to be resolved before the implementation would be acceptable for military use. However, as the benefits of interoperability and the wider application of the standards was appreciated, security became attractive to civil and commercial applications. To overcome the shortcoming, DERA developed an implementation of the CCSDS Packet TT&C, which includes a link security layer. To demonstrate its operation, DERA developed a terrestrial test bed and arrangements were made to evaluate the effectiveness of the implementation during the follow-on STRV mission using the STRV 1d spacecraft.

For the purposes of the demonstration, the encryption/decryption algorithm in the spacecraft is lodged in SMX2 as a software package. On the ground, a similar software package is hosted by a workstation in the Operations Centre. (The Operations Centre workstations are linked by a LAN and can be used to host the 'ground segment end' of a wide range of communications standards and protocols or automation programs.) Before launch, secure packet TT&C has been exchanged between the spacecraft and the ground segment using a simple encryption/decryption algorithm. Once this has been successfully demonstrated in space, more sophisticated encryption/decryption algorithms will be progressively introduced to evaluate performance and capability envelopes. The design is such that straightforward modification would permit the replacement of the STRV 1d and ground segment

demonstration software with military or commercial security cipher equipment on the ground and firmware for the spacecraft encryption/decryption.

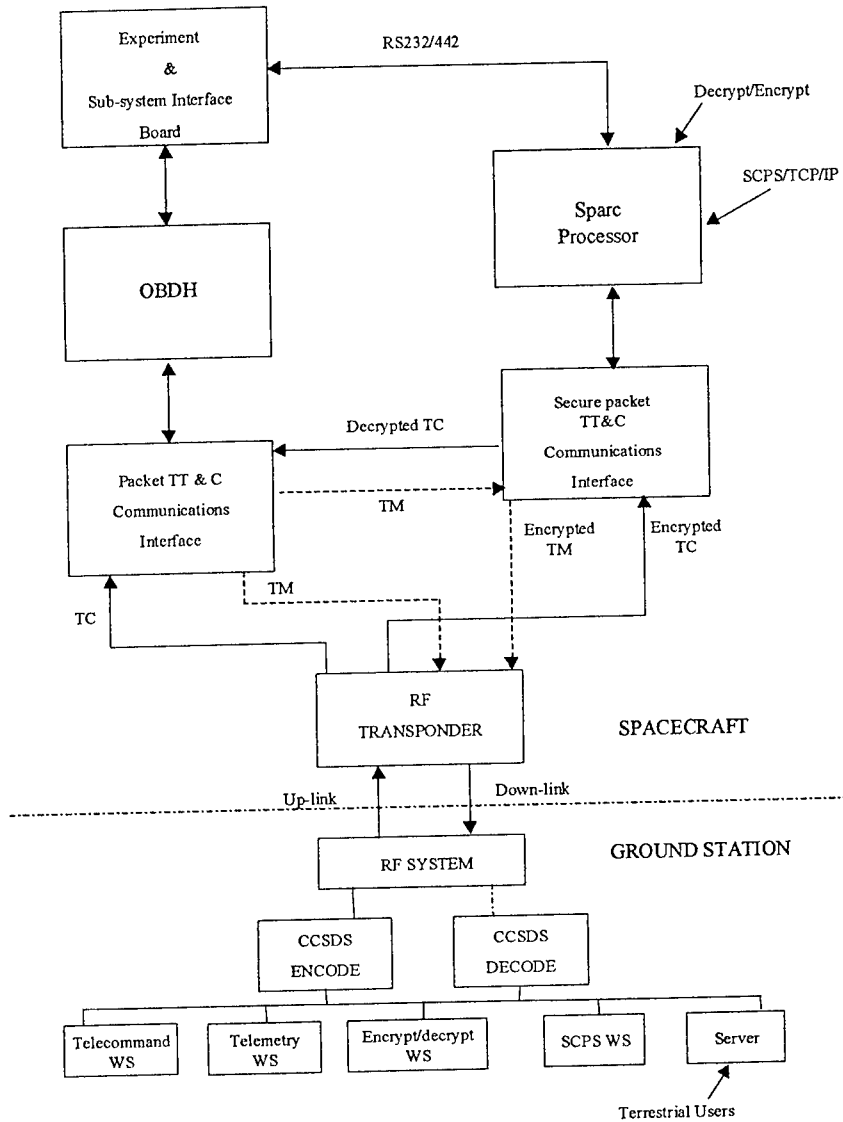


Figure 5. The STRV 1d in-orbit test bed architecture.

### SCPS FOLLOW-ON

A key role for SCPS is seen to be to provide efficient data transfer between remote sensing spacecraft and data relay satellites. The attractions of using global data relay coverage, which include near real-time commanding, much faster delivery to the point of use and a shift from direct ground control to 'phone home' operations, depend on a number of developments. Not the least of these are the reliable transport, security and networking standards which SCPS offers. Although the STRV 1b experiments were able to demonstrate the robustness and high efficiency of the transport, security and file transfer

protocols under realistic operating conditions, it was not possible to demonstrate the networking capability.

The prototype SCPS demonstrated on STRV 1b has now been updated to a full implementation and ported to run on the VX Works operating system. On the ground, it will be hosted on a workstation in the Operations Centre and linked to the external community through the DERA firewall and the STRV server. The operation of SCPS between the Operations Centre and the spacecraft is transparent to the external user who will send and receive what appear to be normal terrestrial e-mail.

The testbed also provides the facility to compare the effectiveness of CCSDS supported SCPS with the HDLC and Frame Relay operation understood to have been used in the recent demonstration by OMNI and UoSat 12. Both can be operated with STRV 1d and this provides an excellent opportunity to compare the effectiveness of the two methods, particularly under stressed communication conditions. Also, because the STRV 1d orbit extends to GEO altitudes every 10 hours, performance over greater distances can be evaluated.

#### CCSDS File Delivery Protocol (CFDP)

CFDP has been developed in response to the identified problem of transferring data files reliably between two points in a space network. Existing ground-based network protocols have been considered as solutions but are generally impractical due to the differences in nature between space- and ground-based network connections. The key features of a space-based network connection are long delay transit time, unreliable data integrity, bandwidth restrictions and lack of multiple connection paths. CFDP has been designed to address these issues and attempt to transfer the file in the most efficient way, given the potential modes of failure and restrictions imposed. The STRV test bed will provide the comparison of the efficiency of CFDP with SCPS and other protocols over a variety of distances and operating conditions.

#### PROXIMITY-1

As described earlier, PROXIMITY-1 is designed for the difficult communications experienced in remote lander to orbiter connectivity. Very recently, STRV 1d has been identified as a suitable vehicle for investigating the performance of this protocol and we are evaluating how to conduct a suitable trial.

### CONCLUSIONS

The 'space internet' remains undefined but the emerging view shows considerable synergy with the developing 'Earthnet'. This is particularly true for the wider use of more error prone links and roving or intermittent applications. A key difference, however, is the very long distances over which a future space internet backbone will have to operate. Even within domains the distances will usually greatly exceed those found in terrestrial applications. The degree to which terrestrially used communications standards and protocols need to be modified or redesigned to meet the particular requirements of the space environment is the subject of some debate. This is only likely to be sensibly resolved through practical evaluation in the space environment.

STRV 1c&d are planned for launch on Ariane 5-07 in October this year. The spacecraft have completed AIT and the intervening period is being used to up-load software experiments onto the in-orbit test bed provided by the SMX2 and ECSE experiments. Further uploads will inevitably be required after launch. Many of these experiments were born out of the STRV 1b experience, which identified the value of high efficiency data transfer over error prone space links and the benefits of in-orbit reprogramming. The limitations of the lack of processing power, limited memory and lack of



link layer security in the CCSDS packet TT&C standards were also recognised. STRV 1d has been equipped to overcome these limitations and the growing interest in using the capability is reflected in the range of experiments planned and under consideration. More importantly, the design has the flexibility to permit comparative performance demonstrations between the different approaches to future data transfer and routing.

### ABBREVIATIONS

ASAP	Ariane Structure for Auxiliary Payload
BNSC	British National Space Centre
CCSDS	Consultative Committee for Space Data Standards
CFDP	CCSDS File Delivery Protocol
COTS	Commercial off the Shelf
ECSE	Encrypted CCSDS Experiment.
DoD	Department of Defense
DSN	Deep Space Network
ESA	European Space Agency
FTP	File Transfer protocol
GEO	Geostationary Orbit
GTO	Geosynchronous Transfer Orbit
IP	Internet Protocol
IPNRG	Interplanetary Internet Research Group
IPN	Interplanetary Internet
LAN	Local Area Network
LEO	Low Earth Orbit
MoD	Ministry of Defence
NASA	National Aeronautics & Space Agency
NLSP	Network Layer Security Protocol
OBDH	Onboard Data Handling System
RF	Radio Frequency
SLE	Space Link Extension
SMX2	Sparc Microprocessor Experiment.
STRV	Space Technology Research Vehicle
TC	Telecommand
TM	Telemetry
TT&C	Telemetry, Telecommand and Control
XMS	Experiment Management Software
UoSat	University of Surrey Satellite

### LIST OF ILLUSTRATIONS

- Figure 1: . Artists Impression of STRV 1c&d in orbit  
Figure 2: Synergy between the developing 'Earthnet' and a space 'internet'.  
Figure 3: Scope of the SCPS System  
Figure 4: SCPS experiment arrangement.  
Figure 5: The STRV 1d in-orbit test bed architecture

### REFERENCES

- 
1. N Shave, DERA(F) "Development of a Secure Packet-based Military Comsat Control System" MILCOM 96, Washington DC, October 1999.
  2. R Blott, N Wells, DRA(F) "The Space Technology Research Vehicles STRV 1a,b&c, 10<sup>th</sup> AIAA/USU Conference on Small Satellites, September 1996.
  3. S Foley, N Shave "A Secure Packet Based Command and Telemetry System for future Communications Satellites", July 1997.
  4. R Blott, N Wells, J Eves, DERA(F) "The STRV 1 Microsatellite Series: Exploiting the Geosynchronous Transfer Orbit" September 1998.
  5. R Blott, DERA(F), "STRV as a testbed for small interplanetary mission technologies ", IAF Amsterdam October 1999.

**LA MAITRISE DES RISQUES  
LORS DES SAP "SESSIONS D'AVANT-PROJET"  
SUR LA FILIERE MICROSATELLITES DU CNES**

**Françoise DOUCHIN, Gérard LASSALLE-BALIER**

*CNES, 18 avenue Edouard Belin - 31401 TOULOUSE Cedex 4 - France*

## **1. INTRODUCTION**

Dans le cadre de sa nouvelle filière de micro-satellites, outre le défi que représente parfois certaines missions ambitieuses sur le plan technique enveloppées dans un champ de contraintes très important (masse, volume, débit d'informations ...), le CNES a décidé d'investir dans des méthodes de management de Projet adaptées à ce contexte.

S'inspirant des " Team X" du Jet Propulsion Laboratory, des groupes de Sessions d'Avant Projet (SAP) sont en cours de mise en place dans la filière Micro-satellite. Il s'agit, à partir d'un besoin exprimé par un client (laboratoire scientifique dans la plupart des cas), et dans une enveloppe budgétaire fixée, de démontrer la faisabilité de l'emport de l'expérience proposée sur la plate-forme "adaptable" qui est à l'origine de la filière Micro-satellite et d'identifier le plus tôt possible les risques associés à l'architecture proposée.

Ces "SAP" consistent alors à soumettre le besoin exprimé rigoureusement par le "client" à un groupe d'experts (un expert par chaîne fonctionnelle) reconnus pour leurs compétences professionnelles, leur aptitude au travail en équipe et leur réactivité face à des évolutions permanentes. A l'issue d'une durée qui ne devrait pas excéder une quinzaine de jours, un ensemble de solutions techniques alternatives sera proposé par le Groupe qui devra en outre démontrer leur compatibilité avec l'objectif de coût fixé.

La célèbre formule qui nous vient d'outre-atlantique concernant les nouvelles méthodes de développement de Projets : "Better, Faster, Cheaper" nous est désormais familière. Certes, il devient plus que jamais nécessaire de réussir son Projet avec les meilleures performances, rapidement, et à moindre coût. Il convient cependant de rajouter : mais pas n'importe comment. Un certain nombre d'exemples pris au spatial, mais les autres domaines ne sont pas en reste, nous amènent à nous interroger sur les options de management de Projet prises ces cinq dernières années et si elles n'ont pas conduit à des impasses techniques ou organisationnelles lourdes de conséquences.

Si le principe n'est certes pas remis en cause, il convient de mettre en œuvre, pour qu'il satisfasse ses objectifs, une méthode de travail rigoureuse qui, si elle conduit à faire des impasses (d'analyses, d'essais ...), permet au responsable de connaître, à tout moment de la vie du Projet, les risques associés à tel ou tel choix.

Si une telle méthode de travail a déjà été éprouvée dans le domaine de la Sécurité de Fonctionnement au travers des Analyses de Risques, de nombreux risques non techniques (approvisionnement, organisation, choix industriels ...) ne sont pas aujourd'hui traités sur le même pied d'égalité ou tout au moins ne bénéficient pas de la même rigueur d'analyse.

S'inspirant donc de ce qui fonctionne de façon opérationnelle dans le domaine de la Sécurité de Fonctionnement, une méthode de travail est en train de se mettre en place au CNES qui se propose de donner au Chef de Projet, à tout moment, une cartographie la plus exhaustive et précise que possible des risques inhérents à son Projet. Pour ce faire, un pré-requis

indispensable est une intervention précoce, bien évidemment sous-tendue par une parfaite connaissance du Projet par l'analyste.

## 2. L'HISTORIQUE

Au cours de l'année 1998, plusieurs agents du CNES ont effectué un voyage dans de grands centres techniques américains du spatial pour assister, voire même participer, à ce que les Américains appellent une "TEAM-X". Le grand principe de fonctionnement de cette méthode originale de travail est de réunir, pendant une durée limitée, un groupe d'experts reconnus représentant un panel de connaissances couvrant tous les domaines du produit à concevoir (un véhicule spatial en l'occurrence), pour aboutir, en fin d'exercice, à une esquisse d'architecture qui réponde au besoin du client de la mission. Convaincue qu'il s'agissait là d'une orientation intéressante à explorer plus avant, la direction du CNES a demandé à ce que soit engagé un travail collectif ayant pour objectif l'étude de l'adaptation à la "culture CNES" de cette méthode de travail. Après une année de réflexion collégiale de tous les métiers concernés, le Centre de Toulouse s'apprête à mettre en œuvre sa première SAP "Session d'Avant Projet" dont les grandes caractéristiques d'organisation sont décrites dans le texte qui suit.

## 3. LES OBJECTIFS DE L'INGENIERIE CONCOURANTE

Tout d'abord, et puisque l'Ingénierie Concourante est le principe de management qui sous-tend les TEAM-X et autres SAP, rappelons quels en sont les objectifs principaux :

- Diminuer les délais de conception (Phase 0 et A).
- Conduire rapidement à des bilans masse, énergie, coût.
- Rechercher la standardisation à tous les niveaux (processus, modèles, moyens de validation ...).
- Faciliter l'accès à l'information.
- Réutiliser au maximum les éléments de solutions sur étagère au CNES ou ailleurs.
- Gérer l'information nécessaire à tous les acteurs en respectant les protocoles d'échanges retenus.
- Gérer en configuration toute information dès sa production.
- Gérer automatiquement le circuit de validation et d'approbation de ces informations.
- Permettre la production rapide d'une documentation décrivant la solution et les points de non-faisabilité.

## 4. LES OBJECTIFS DES SAP

Voyons maintenant quel est le cadre environnemental dans lequel la notion de "Session d'Avant Projet" a été développée et quels sont les objectifs qui leur ont été assignés :

Un certain nombre de laboratoires scientifiques sont, chaque année, candidats à l'emport de leur(s) expérience(s) sur une plate-forme spatiale. Nous nous intéresserons ici aux candidatures à l'emport sur une plate-forme de type Micro-satellite. Le Comité des Programmes Scientifiques du CNES (CPS) a alors la charge de "sélectionner" les missions qui participeront à cette aventure. A cette fin, il dispose aujourd'hui de dossiers fournis par les scientifiques eux-mêmes, dossiers de complétude diverse tant sur le plan descriptif du besoin à satisfaire que sur celui de la démonstration de l'adéquation de cette expérience à un embarquement sur une plate-forme de type Micro-satellite (aspect technique, calendaire et financier).

---

A des fins d'homogénéisation des dossiers et de démonstration de faisabilité permettant de fournir les données nécessaires à une décision sereine du CPS, il a été décidé de mettre en place la première phase du processus de Sessions d'Avant-projet décrit dans les chapitres suivants (Phase 0).

Une fois la (ou les) missions candidates sélectionnées (2 parmi 10 candidates) et leurs risques majeurs identifiés, le processus se poursuit qui permet de montrer la possibilité d'associer à cette mission principale une ou des missions secondaires de type "technologiques", missions proposées par le CNES lui-même ; une deuxième phase du processus se déroule alors par une étude technique de l'optimisation de toutes ces missions sur la même plate-forme (Phase A).

Enfin, une fois établie dans les grandes lignes l'architecture de référence (et éventuellement les solutions alternatives), une étape d'identification et d'évaluation des risques associés est réalisée ; elle doit permettre de donner une cartographie instantanée des risques techniques, financiers et calendaires associés à ce choix.

## **5. L'ENCHAINEMENT DES ACTIVITES**

L'enchaînement des activités à réaliser une fois prise la décision de soumettre une mission candidate devant un Groupe SAP pour se découper en huit phases.

### **Phase I : "Expression Fonctionnelle du Besoin "**

L'animateur Analyse Fonctionnelle a la charge de rédiger le Cahier des Charges Fonctionnel qui décrit les besoins exprimés par le scientifique en termes de fonctions et doit faire apparaître la flexibilité qu'il existe sur chacune des fonctions c'est à dire le degré de négociation possible dont il est possible de disposer vis à vis des caractéristiques du besoin scientifique.

Le scientifique qui propose la mission dite "principale" doit décrire son besoin en évitant rigoureusement de faire état de solutions techniques ; c'est le rôle de l'animateur Expression Fonctionnelle du Besoin que de veiller à éviter cette dérive.

L'Ingénieur Système est chargé d'apporter la vision "contraintes filière Micro-satellite" pour la rédaction du Cahier des Charges Fonctionnel (CdCF). Il est un membre permanent de l'équipe Micro-satellite.

### **Phase II : " Préparation SAP "**

Dans le but de perdre le moins de temps possible, le Cahier des Charges Fonctionnel est distribué assez tôt aux experts Métiers pour que les questions de compréhension soient traitées en préalable à la SAP.

### **Phase III : " SAP Phase 0"**

Cette phase, courte, d'une durée estimée à 3 jours environ, a pour objectif de statuer sur la faisabilité de l'emport de la Charge Utile "principale" sur une plate-forme de type Micro-satellite.

L'animateur SAP est en quelque sorte le "chef d'orchestre" des réunions de travail. Très proche de la notion d'Analyse Fonctionnelle Interne, la SAP est une phase de recherche de solutions techniques répondant au besoin décrit dans le Cahier des Charges Fonctionnel.

Concernant la présence permanente du scientifique lors de cette phase de recherche de solutions : elle sera profitable au Groupe car on considère que les scientifiques sont, par nature, très créatifs, quand bien même (comme cela sera probablement souvent le cas) celui-ci se présente à la SAP dans le but de spatialiser une expérience déjà complètement réalisée en laboratoire, voire même une expérience ayant déjà volé.

Sa présence peut cependant n'être sollicitée que ponctuellement, dans le cas par exemple d'une incompatibilité entre les possibilités techniques et le besoin exprimé ; dans ce cas, il est souhaitable de pouvoir revenir sur le degré de flexibilité qu'il existe réellement sur une ou plusieurs fonctions, pour s'assurer que la solution retenue répondra à un besoin scientifique (même plus faible que le besoin initial). Le scientifique sera également sollicité pour définir les modes dégradés potentiels de la mission.

#### **Phase IV : " Analyse de Risques Projet " PHASE 0**

L'Analyse des Risques qui sera menée au cours de la Phase 0 aura pour objectif de rechercher les risques qui peuvent mettre en péril la mission. La couverture est globale ; en effet, elle couvre non seulement les risques techniques et qualité, mais également les risques programmatiques, organisationnels, industriels, etc. ...

Les conséquences des risques sont examinées sur plusieurs composantes du niveau satellite :

- impacts coûts (coûts de développement),
- impacts délais (calendrier de développement),
- impacts performances.

Cet exercice intervient en amont du développement ; la caractérisation des risques et de leur portée s'accompagne donc des incertitudes et manques d'information inhérents à cette étape d'avancement. En dépit d'une recherche très étendue des risques, l'exercice ne prétend pas être exhaustif. Le but de cette analyse n'est pas d'aboutir à une liste complète de tous les risques élémentaires, trop importante par nature, mais d'en retenir les plus dimensionnants en nombre raisonnablement gérable pour une meilleure efficacité.

#### **Phase V: " Rédaction de la documentation PHASE 0 "**

La documentation de synthèse devra démontrer la faisabilité de l'emport de la Charge Utile candidate, décrite par le besoin exprimé au travers du Cahier des Charges Fonctionnel, sur une Plate-forme de la filière Micro-satellite. Elle comportera à ce stade une description succincte du principe, la liste des principaux points durs associés, un budget et un plan de développement prévisionnels.

#### **Phase VI : " SAP Phase A "**

Une fois assurée dans les grandes lignes la faisabilité de l'emport de la mission "principale" proposée par le scientifique, une phase, plus longue cette fois (environ une semaine) permet d'approfondir le concept esquissé lors de la SAP Phase 0, et d'introduire les besoins des Charges Utiles technologiques proposées à l'emport par le CNES. A l'issue de cette phase, une définition d'architecture préliminaire est proposée qui résultera d'une optimisation globale des ressources plate-forme, des besoins de la Charge Utile "principale" et de ceux des Charges Utiles technologiques.

La particularité de ce type d'exercice, basé sur un besoin clairement exprimé (sans proposition externe d'une solution technique de référence), est de libérer complètement la créativité des ingénieurs présents, l'objectif à garder en point de mire permanent étant la minimisation du non récurrent. Sans parler d'exhaustivité, on peut cependant espérer qu'un certain nombre de solutions, différentes et alternatives, répondant toutes au même besoin, seront proposées.

Une fois réalisée l'opération dans son ensemble, l'équipe devra statuer sur la faisabilité de l'emport de la mission candidate sur une plate-forme de type Micro-satellite ou identifier les compléments pour arriver à un dossier de Phase A et prononcer alors la faisabilité.

## Phase VII : " Analyse de Risques Projet " PHASE A

Plus complète que l'analyse réalisée en fin de Phase 0, cette analyse permettra d'identifier, au niveau Système, les points durs relatifs à l'architecture retenue et de proposer les actions en diminution de ces risques à mener lors des phases ultérieures.

## Phase VIII : " Rédaction de la documentation PHASE A "

La documentation de synthèse devra démontrer la faisabilité du besoin exprimé. Il s'agit alors de rédiger un dossier de recherche de solutions techniques en réponse au besoin, une seule de ces solutions ayant été instruite de façon approfondie par le Groupe SAP, les solutions alternatives ou "de repli" étant citées, sans rentrer plus avant dans les détails.

## 6. LA NOTION DE LIGNE DE PRODUIT (OU DE FILIERE)

Le processus des SAP va s'intégrer dans le déploiement de la filière Micro-satellite avec comme but d'améliorer le mécanisme de sélection des missions scientifiques candidates à l'emport sur une Plate-forme de type Micro-satellite et de réaliser des phases de pré-définition dans un temps limité. La filière est constituée aujourd'hui de quatre produits : DEMETER (en cours de phase C/D), PICARD, S1 et FBM (en cours de phase B). Au cours des études qui ont permis d'élaborer chacun d'entre eux, un certain nombre de concepts de chaînes fonctionnelles a été élaboré et une collection d'équipements testés et validés, de manière à constituer un vivier de "briques de base" destinées à la récurrence d'utilisation sur les produits futurs de la filière. Il va de soi que les équipements en question, approvisionnés en quantités susceptibles de diminuer les coûts à l'achat, seront préférés à tout autre, équivalent, lors de la conception des produits à venir. Cependant, les techniques et technologies évoluant, l'éventail des besoins s'élargissant au fur et à mesure des demandes scientifiques, ce vivier se complétera par des éléments plus performants et les premiers approvisionnements taris seront remplacés par de nouveaux, plus adaptés aux nouveaux contextes.

## 7. L'ORGANISATION DU GROUPE DE TRAVAIL

### 7.1. Les types d'intervenants

Un certain nombre d'interlocuteurs indispensables à l'élaboration des solutions et à l'amélioration du processus d'ensemble ont été identifiés. On peut les classer en différents groupes selon la nature de leur apport. Une telle répartition est proposée dans le tableau ci-joint :

Besoin	Cohésion d'ensemble	Elaboration des solutions	Maîtrise des Risques	Validation	Retour d'Expérience
Scientifique*	Animateur SAP	Experts " métiers"***	Expert SdF	Expert validation	Organisateur
Animateur EFB	Responsable des bilans Système **		Expert AV	Architecture Intégration & Tests	
Responsable Charge Utile*	Expert mission		Expert Analyse des Risques Projet	Opérations	

\* Extérieur au CNES

\*\* Equipe structurante Projet (non considérée comme un support)

\*\*\* A détailler suivant les chaînes fonctionnelles principales

## **7.2 Aptitudes, compétences et motivation**

Les intervenants étant définis en théorie, il reste à mettre en place une organisation pratique au sein du CNES qui permette de répondre à ces objectifs. Les intervenants devront donc être identifiés par leur motivation, leurs aptitudes et les compétences que l'exercice requiert d'eux.

### **7.2.1 Aptitudes**

Pour l'ensemble des intervenants, il va de soi que la participation à de tels exercices nécessite un certain nombre de prédispositions personnelles : la capacité à supporter une charge de travail importante et à réaliser un effort soutenu pendant une période d'environ 15 jours (rédaction de la documentation comprise), une faculté à se remettre sans cesse en question en tenant compte de façon souple des contraintes provenant des autres membres de l'équipe et, bien entendu, une aptitude au travail en équipe indispensable.

### **7.2.2 Compétences**

Associées à ces aptitudes personnelles, la compétence technique et la maîtrise du domaine d'expertise supposant une certaine expérience dans la spécialité sont évidemment indispensables.

### **7.2.3 Motivation**

Un exercice du type de celui que le CNES s'apprête à mettre en place ne pourra déboucher sur la réussite que si les équipes en place fonctionnent sur la base d'une réelle motivation pour ce nouveau défi. Il faudra donc faire un gros effort de promotion de cette nouvelle méthode de travail afin de recueillir l'adhésion de chacun. Pour ce faire, il est nécessaire de mettre en avant le fait qu'une grande part de créativité sera nécessaire lors des exercices et qu'une valorisation des agents par la participation aux SAP sera reconnue.

Compte tenu des contraintes de la filière exprimées auparavant dans le texte, cette créativité s'exprimera principalement dans la conception technique de la Charge Utile (si celle-ci n'est pas "livrée" par les scientifiques), dans la personnalisation du satellite et dans l'optimisation des ressources bord/sol en accord avec les besoins en performances de cette Charge Utile ainsi que dans l'aménagement de celle-ci sur la Plate-forme.

Un cas mérite d'être traité indépendamment des autres du fait de sa fonction au sein du Groupe :

### **L'Animateur de la SAP**

Sorte de chef d'orchestre, il devra coordonner les travaux de l'équipe. Son apport ne se situe pas essentiellement dans le domaine technique bien qu'il doive avoir des compétences transverses mais dans sa capacité à animer les débats sans les orienter et conduire à la remise en cause des propositions pour converger en final vers des bilans compatibles des caractéristiques de la filière. Cela nécessitera une grande capacité d'écoute, une maîtrise des situations conflictuelles qui peuvent subvenir, devra avoir la reconnaissance de chacun comme chef d'équipe et un sens affirmé du compromis.

### **Le choix des participants**

Indépendamment des aptitudes et des compétences dont il vient d'être question, un pré-requis a été mis par l'équipe Projet qui concerne la connaissance des caractéristiques de la filière Micro-satellite par les participants. L'équipe qui servira de base à la première SAP sera



constituée, pour chaque métier, de binômes dont un "instructeur" qui travaille aujourd'hui sur DEMETER ou plus généralement sur la filière, et d'un "disciple" dont on pressent des dispositions et une motivation particulières pour cette activité. Ce dernier acquerra par la pratique les compétences filière et, moyennant un investissement personnel adapté, deviendra "titulaire" lors des futures SAP.

## 8. LES ACTIVITES PROPREMENT DITES

Deux types d'activités ont été identifiés :

- Des activités communes (réalisées en SAP) qui regroupent :
  - La démonstration de la faisabilité,
  - Une proposition d'architecture de conception préliminaire,
  - L'identification des points durs.
  
- Des activités spécifiques (réalisées hors SAP, en amont ou en aval de celles-ci) que sont :
  - L'Analyse de mission,
  - L'Expression Fonctionnelle du Besoin,
  - L'Analyse de la Valeur
  - Les Opérations,
  - La Validation,
  - L'Architecture Intégration et Tests.

## 9. LES OUTILS

On distinguera dans ce paragraphe les outils destinés à la réalisation des bilans, et les outils techniques spécifiques à chaque métier.

### 9.1 Outils de bilan

Schématiquement, les tableurs ou logiciels classiques de traitement de texte permettent de faire des bilans très rapidement et surtout, dans des formats facilement interprétables par quiconque. On retiendra donc, que, pour chaque corps de métier qui interviendra dans le processus des SAP, les informations de nature à enrichir un bilan quelconque de niveau Système, devront être présentés sous un format de ce type dont une trame sera fournie en début d'exercice.

### 9.2 Outils métiers

Dans un tout autre registre, un certain nombre d'outils traditionnellement utilisés par les experts de chaque corps de métier sont nécessaires à ceux-ci pour élaborer leurs modèles ou estimer les grands paramètres qui sont de leur ressort. Ces outils devront être à la disposition des experts lors des travaux communs, soit directement sur les machines de la salle "Atelier µCE" soit émulables à distance à partir de celles-ci.

## 10. LES BASES DE DONNEES

La notion de filière Micro-satellite suppose, si l'on veut pouvoir appliquer un principe de récurrence, la constitution de Bases de Données, qu'elles soient composées d'informations utiles à tous ou regroupant seulement des éléments qui constitueront le Retour d'Expérience de chaque corps de métier.

## 10.1 Bases de données communes

Trois bases ont été proposées dans le cadre de l' "Atelier  $\mu$ CE" pour être mises à disposition des experts :

### 10.1.1 BDP (*Base Documentaire Projet*)

- Elle contient :
  - Le référentiel de spécifications structuré autour de l'Arborescence Produit
  - Les documents de type fax, mémos ...
- Elle s'appuie sur le SGDT Baguera Doc et Web.
- Autour de cette base vont être testées des fonctions de workflow, pour permettre :
  - La diffusion de l'information,
  - L'insertion de documents de manière répartie avec gestion automatique de circuits d'approbation, et de l'état du document (document de travail, document partiellement approuvé, document applicable).
  - Raccourcir les délais.

### 10.1.2 BDE (*Base de Données Equipements*)

- Rôle de cette base : Capitaliser le savoir sur des équipements candidats à être utilisés ou déjà utilisés dans le cadre de la filière....
- La filière Micro-satellite va s'appuyer sur un ensemble d'équipements préalablement sélectionnés :
  - Initialement, ces informations ne proviennent que du fabricant,
  - Par la suite, si l'équipement est testé au CNES, ou utilisé en vol, ces informations peuvent être corrigées et enrichies au fur et à mesure de leur disponibilité par différents modèles (CAO, modèle fonctionnel, modèle électrique ...).
  - Cette base est gérée en configuration.

### 10.1.3 BDMS (*Base de Données et de Modèles Système*)

- Gestion des données techniques des différents Projets de la filière,
- Elle est la garante de la configuration. Rôle complémentaire de la BDE.
- Utilisée par les logiciels nécessitant des données techniques (logiciels de simulation et de conception mais aussi les bancs) .
- Les informations de cette base de données sont :
  - La caractéristique de chaque équipement dans le contexte d'un projet,
  - Des modèles représentatifs des équipements (CAO, électrique, fonctionnel...),
  - Des scénarios mission typiques et pires-cas,
  - La description de I/F bord/sol i.e. de la TM et des TC,
  - Les liasses de conception,
  - Les bilans (mission, MCI, SCAO ...),
  - Des contextes et résultats d'essais,
  - ....

## 10.2 Bases de données spécifiques

Pour chaque métier cette fois, un certain nombre de données devront être accessibles lors des travaux de SAP. De la même façon que pour les outils "métier", elles devront être à la disposition des experts lors des travaux communs, soit directement sur les machines de la salle " Atelier  $\mu$ CE" soit émulables à distance à partir de celles-ci.

## 11. LES MOYENS DE SIMULATION

Les moyens mis en place ont pour fonction :

- de permettre une étude de faisabilité d'une mission,
- de concevoir à la fois la mission et le satellite, en rebouclant sur le besoin, et ceci jusqu'à convergence du processus.

Un outil permet aux ingénieurs missions et plus généralement aux membres de l'équipe d'ingénierie système, qui ne sont pas des spécialistes de CAO, de pouvoir procéder avec les clients scientifiques à des aménagements simplifiés, puis d'alimenter le Simulateur Mission.

Le logiciel MILESIM, en cours de développement, permet d'analyser l'interaction de différents paramètres sur une mission et de visualiser la mission en 2D ou 3D.

Une mission est définie par :

- La fourniture de l'orbite, de l'attitude, et éventuellement de stations sol.
- La description de divers équipements du satellite (antennes, senseurs ...).

L'outil permet de calculer l'évolution simultanée des diverses données au cours du temps, avec la possibilité de simuler des événements dynamiques venant modifier l'état du système.

L'outil MILESIM intègre les fonctions :

- d'orbitographie, d'attitude,
- de calcul d'accessibilité i.e la capacité pour un instrument d'accéder à une zone sur terre, de pointer sur une étoile, une planète,...
- de calcul de visibilité station,
- de calcul de bilan liaison,
- de vérifications de conditions d'éclairement, de masquage, d'éblouissement instrumentaux (CU, senseurs, ...), de calcul de durée d'éclipse,
- ...
- un outil d'animation qui permet de visualiser le déroulement de la mission.
- un outil de conception et de dimensionnement de la chaîne puissance.
- un outil permettant de faire des aménagements au niveau satellite.
- un outil de conception et d'analyse en Thermique.
- un outil de conception et d'analyse du SCAO.
- un outil de dimensionnement en propulsion.

## 12. LA SALLE "μCE "

### 12.1 Les conditions de travail

Il va sans dire qu'atteindre l'objectif fixé dans le temps imparti entraîne des conditions de travail particulières. D'une part, quelle que soit l'attention qui sera portée à l'ergonomie des postes de travail et l'adaptation des locaux à ce besoin spécifique, la multiplicité des participants génère une ambiance très bruyante et la nécessité d'une attention soutenue pendant des périodes relativement longues est particulièrement fatigante. Il sera donc nécessaire de prendre en considération ces diverses contraintes pour organiser de la manière la plus confortable possible ces séances de groupe et surtout d'y intercaler des périodes de relâche où chaque participant pourra réintégrer sa structure d'origine et mettre à profit ce répit pour approfondir un point particulier, recueillir l'avis d'experts dans sa spécialité ou affiner un modèle le cas échéant.

### 12.2 Les équipements logistiques

Outre les postes de travail de type PC et terminaux X qui sont mis à disposition des participants (une quinzaine environ), un ensemble de moyens audio et vidéo de qualité sont installés en permanence dans la salle. Les fichiers de bilan (masse, puissance ...) pourront être constamment affichés sur un écran dédié et leur mise à jour visualisée en temps réel. Les PC sont eux-mêmes reliés à un système de rétro-projection de manière à pouvoir instantanément mettre à la disposition de la communauté, un schéma d'explication, un premier bilan, ...

C'est cette salle qui donne aux participants l'accès à tous les moyens qui composent l'Atelier  $\mu$ CE. Tout est mis en place pour que l'ingénierie simultanée prenne ici sa pleine signification durant les SAP.

### 13. LA DOCUMENTATION

Dans un but d'harmonisation de toutes les documentations futures relatives aux SAP, ne serait-ce que pour fournir des dossiers équivalents pour des missions concurrentes dans la perspective d'un choix, il est nécessaire de se doter d'une trame documentaire efficace, lisible, aisée à remplir par les participants et simple à analyser pour les futurs lecteurs.

### 14. LE RETOUR D'EXPERIENCE

La première expérience qui sera tentée en juin 2000 revêtira à la fois un caractère probatoire et opérationnel. En effet, même s'il s'agira d'une première expérience qui devra servir à "déverminer" le processus et à réajuster certains paramètres techniques, logistiques ou méthodologiques, le sujet traité n'est pas virtuel et les équipes scientifique et technique attendent de cet exercice une appréciation sur la faisabilité de l'emport de cette mission sur une Plate-forme de type Micro-satellite.

Afin de mettre toutes les chances de notre côté pour réussir cette première expérience, il sera bien sûr nécessaire, de la part des organisateurs, de faire preuve de beaucoup de vigilance et d'observation durant toute la durée de la SAP, mais il va de soi qu'il faudra s'appuyer également sur tous les participants afin de recueillir leur sentiment sur les réussites et les échecs. A cette fin, il est prévu une séance de debriefing de toutes les équipes en fin d'exercice, de façon à ne pas interférer avec le processus technique.

Comme cela a été écrit dans le paragraphe concernant la notion de filière, le "vivier" d'équipements évoluera au cours du temps et un des principaux points du retour d'Expérience post-SAP sera d'identifier le ou les types de "briques de base" qu'il est nécessaire d'approvisionner et de valider afin de répondre aux nouveaux besoins.

### 15. PERSPECTIVES

Dans un premier temps, les travaux envisagés se dérouleront dans un cadre exclusivement CNES (hormis la participation des scientifiques extérieurs et de l'industriel retenu pour l'élaboration de la Charge Utile). Si la sortie des SAP devait déboucher sur un relais industriel pour la réalisation du satellite, ne pourrait-on imaginer la participation de celui-ci, voire même, dans le cas d'une mise en concurrence, de tous les compétiteurs lors d'une "SAP concurrentielle", comme cela est le cas au JPL et au GSFC ?

Par ailleurs, il serait intéressant, une fois l'opérationnalité des SAP acquise sur la filière Micro-satellite, d'essayer de tirer des enseignements génériques sur la conduite des phases amont, et de tenter une expérience similaire sur un produit complètement externe à la filière.

L'intervention Analyse de la Valeur pourra prendre toute sa mesure une fois que les premiers Micro-satellites auront été développés, que l'on aura donc un retour sur les coûts consommés

---

et que l'on pourra " piloter " les développements suivants sur un principe de maîtrise du compromis Risque / Coût (Conception à Coût Objectif).

---

A COMPLEXITY-BASED RISK ASSESSMENT OF LOW-COST PLANETARY MISSIONS:  
WHEN IS A MISSION TOO FAST AND TOO CHEAP?

David A. Bearden\*

The Aerospace Corporation  
PO Box 92957  
Los Angeles, CA 90009-2957

**Abstract.** Under constrained budgets and rigid schedules, NASA and industry have greatly increased their utilization of small satellites to conduct low-cost planetary investigations. Recent failed small planetary science spacecraft such as Mars Polar Lander (MPL) and Mars Climate Orbiter (MCO), and impaired missions such as Mars Global Surveyor (MGS) have fueled the ongoing debate on whether NASA's "Faster, Better, Cheaper" (FBC) approach is working. Several noteworthy failures of earth-orbiting missions have occurred as well including Lewis and the Wide-field Infrared Experiment (WIRE). While recent studies have observed that FBC has resulted in lower costs and shorter development times, these benefits may have been achieved at the expense of lowering probability of success. One question remaining to be answered is when is a mission "too fast and too cheap" that it is prone to failure? This paper assesses NASA FBC missions in terms of a complexity index measured against development time and spacecraft cost. A comparison of relative failure rates of recent planetary and earth-orbiting missions are presented, and conclusions regarding dependence on system complexity are drawn.

#### INTRODUCTION

During the last decade the traditional approach to planetary spacecraft design, driven almost solely by performance characteristics and high reliability to meet mission objectives, with cost and schedule as secondary concerns, has been completely reversed. Designers have been asked to meet mission objectives within rigid cost caps and tight schedule constraints in an environment characterized by rapid technological improvements, unprecedented budgetary constraints and distributed acquisition authority. During this time NASA's Administrator has instituted a "Faster, Better, Cheaper" approach to satellite missions as the solution, however a number of recent noteworthy failures have called FBC into question. With a decade of experience and over two dozen scientific spacecraft developed, a significant data set exists with which to conduct a thorough examination.

At the heart of the matter is allocation of cost and schedule. The critical question is when do performance and technology-utilization requirements reach a threshold that, while ostensibly achievable within the allocated budget or schedule, leads to failures due to unprepared for circumstances? Risks may not manifest themselves ahead of time or in obvious or typical ways (e.g. within the reliability budget or as a result of peer reviews). However, when examined after the fact, loss or impaired performance is often found to be the result of mismanagement or miscommunication. In combination with a series of "low probability" events, these missteps, which often occur when the program is operating near the budget ceiling or under tremendous

---

\* Systems Director, Civil and Commercial Division, The Aerospace Corporation

schedule pressure, result in failure due to lack of sufficient resources to test, simulate or review work and processes in a thorough manner.

#### DATA ON WHICH STUDY IS BASED

To examine the relationship among risk, cost and schedule for low-cost planetary missions, several factors were assessed with respect to a well-defined and normalized complexity index, defined in the next section. Data were assembled for a number of small-satellite missions launched over the past decade (1990 to 1999). The basis for the relationships discussed later is a database of technical specifications, costs, development time, mass properties and operational status for the small spacecraft shown in Table 1. These data fall into three general categories: (1) NASA low-cost planetary missions; (2) NASA earth-orbiting small satellites; and (3) U.S. government, non-NASA small-satellite missions serving as a baseline for comparison.

To isolate the relationships between complexity and cost, schedule and risk, only science and technology-demonstration missions that meet certain criteria were considered. Small planetary and earth-orbiting missions (Discovery-class or smaller) were included. Landed systems (e.g. MPL, Mars Pathfinder) are included with the caveat that when a larger data set becomes available sometime in the future, the technical drivers used to calculate the complexity index may differ from those used for orbiting systems. Missions that have recently been launched, but have yet to complete a significant portion of their science missions (e.g. Stardust) are included, but it is noted that success has yet to be determined. Any missions that had foreign sponsorship or relied heavily on international contributions were not considered. Also, shuttle science experiments and university-developed spacecraft were not considered since these approaches are typically not relevant to planetary mission design applications. All of the data collected, except for the cost information, is from public sources. The cost information is from a database maintained by The Aerospace Corporation and is therefore presented only in aggregate form without reference to specific programs.

#### DEFINING THE COMPLEXITY INDEX

Since our goal is to understand how technical and programmatic complexity relates to cost and schedule, it is hypothesized that a *complexity index* may be derived based on performance, mass, power and technology choices, to arrive at a broad representation of the system for purposes of comparison.<sup>1</sup> Furthermore, we might expect that a correlation to spacecraft cost and/or development time based on actual program experience might be apparent. In examining previously built systems, cost data are generally not publicly available at the subsystem level. Schedule data can also be elusive since in many cases it's not clear which element - spacecraft, payload, launch vehicle, or some combination - is driving the development time. A method to assess complexity at the system-level should allow more informed overall decisions to be made for new systems being conceived.

The complexity index proposed here uses a matrix of technical factors to ascertain complexity relative to a baseline data set. Typical complexity drivers include both general programmatic knowledge (heritage, requirements changes, amount of redundancy, contractor experience, specification level, etc.) that require some measure of subjective judgment, and demonstrable objective subsystem technical parameters (mass, power, performance, pointing accuracy, downlink data rate, technology choices, etc.). In this case we have chosen to utilize objective

subsystem technical parameters only. This level of analysis requires an extensive database of cost, technical, and programmatic information.<sup>2</sup>

**Table 1: Programs Used for this Analysis**

Program	Sponsor	Spacecraft Contractor	Launch Mass (kg)	Launch Date	Launch Vehicle	Mission	Failure
<b>NASA LOW-COST PLANETARY</b>							
Clementine	BMDO/NASA	NRL	494	Jan-94	Titan IIG	Lunar mapping	I
NEAR	NASA	JHU/APL	805	Feb-96	Delta 7925-8	Asteroid mapping	I*
MGS	NASA	Lockheed Martin	651	Nov-96	Delta	Mars mapping	I*
Mars Pathfinder	NASA	JPL	890	Dec-96	Delta II	Mars lander and rover	
ACE	NASA	JHU/APL	785	Aug-97	Delta II	Low energy particle	
Lunar Prospector	NASA	Lockheed Martin	295	Jan-98	Athena II	Lunar science	
DS-1	NASA	JPL/Spectrum Astro	486	Oct-98	Delta 7326	Asteroid/comet flyby	P*,I*
MCO	NASA	JPL/Lockheed Martin	629	Dec-98	Delta II	Mars remote sensing	C
MPL	NASA	JPL/Lockheed Martin	583	Jan-99	Delta II	Mars science	C
Stardust	NASA	JPL/Lockheed Martin	250	Feb-99	Delta II	Comet sample return	
<b>NASA EARTH-ORBITING SMALL SATELLITES</b>							
SAMPEX	NASA	NASA GSFC	161	Jul-92	Scout	Science experiments	
MICROLAB	OSC/NASA	Orbital	75	Apr-95	Pegasus	Lightning experiment	
METEOR	NASA	CTA (Orbital)	364	Oct-95	Conestoga	Microgravity experimen	L
TOMS-EP	NASA	TRW	295	Jul-96	Pegasus XL	Ozone mapping	
FAST	NASA	NASA GSFC	191	Aug-96	Pegasus XL	Auroral measurements	
HETE	NASA/MIT	AeroAstro	128	Nov-96	Pegasus XL	High energy experimen	L
Seastar	NASA	Orbital	372	Aug-97	Pegasus XL	Ocean color	P*
TRACE	NASA	NASA GSFC	250	Apr-98	Pegasus XL	Solar coronal	
Lewis	NASA	TRW	385	Jul-98	Athena I	Hyperspectral imaging	C
SWAS	NASA	NASA GSFC	288	Dec-98	Pegasus XL	Astronomy	
WIRE	NASA, JPL	NASA GSFC	250	Mar-99	Pegasus XL	Astronomical telescope	C
Clark	NASA	CTA (Orbital)	-	cancelled	Athena I	Science experiments	P
<b>BASELINE SMALL SATELLITES</b>							
GLOMR II	DARPA	DSI (Orbital)	68	Apr-90	Pegasus	Message relay	
POGS/SSR	STP, ONR	DSI (Orbital)	68	Apr-90	Atlas E	Geomagnetic survey	
SCE	ONR	DSI (Orbital)	56	Apr-90	Atlas E	Communications	
TEX	STP, ONR	DSI (Orbital)	67	Apr-90	Atlas E	Communications	
MACSAT	DARPA	DSI (Orbital)	61	May-90	Scout	Communications	
REX	STP	DSI (Orbital)	77	Jun-91	Scout	Radiation	
LOSAT-X	SDIO	Ball Aerospace	76	Jul-91	Delta II	Sensor experiments	
MICROSAT	DARPA	DSI (Orbital)	26	Nov-91	Pegasus	Communications	
MSTI-1	SDIO	Spectrum Astro/JPL	144	Nov-92	Scout	Sensor experiments	
ALEXIS	DOE	AeroAstro	113	Apr-93	Pegasus	X-Ray mapping	
RADCAL	STP, NRL	DSI (Orbital)	91	Jun-93	Shuttle, Scout	Radar calibration tests	
DARPASAT	DARPA/AF	Ball Aerospace	161	Mar-94	Taurus	Classified	
STEP 0	STP	TRW	489	Mar-94	Taurus	Autonomy experiments	
MSTI-2	SDIO	Spectrum Astro	170	May-94	Scout	Sensor experiments	
STEP 2	STP	TRW	180	May-94	Pegasus	Signal detect/modulation	
STEP 1	STP	TRW	352	Jun-94	Pegasus XL	Atmospheric physics	
APEX	STP	Orbital	209	Aug-94	Pegasus	Power experiments	
STEP 3	STP	TRW	295	Jul-95	Pegasus XL	Science/communications	
REX II	STP	DSI (Orbital)	110	Mar-96	Pegasus XL	Radiation	
MSTI-3	SDIO	Spectrum Astro	212	May-96	Pegasus	Hyperspectral imaging	
FORTE	DOE	LANL/SNL	210	Aug-97	Pegasus XL	Science	
GFO	U.S. Navy	Ball Aerospace	357	Feb-98	Taurus	Radar altimetry	
MIGHTYSAT	STP	CTA (Orbital)	69	Jul-98	STS/GAS	Science	

Notes: C = catastrophic P = programmatic \* = ultimately successful  
I = impaired L = launch

The process used here to measure spacecraft complexity consists of: (1) Identifying the parameters that drive or otherwise contribute to a spacecraft design; (2) Quantifying the identified parameters; and (3) Combining the parameters into an aggregate complexity index.<sup>3</sup> The parameters that contribute to the calculated spacecraft complexity index, statistics of interest





Correlation of variables has the potential effect of weighting the estimate toward a single subsystem if an excessive number of interdependent parameters are used (e.g., solar array area is dependent on solar cell type, orbit geometry and required end-of-life power, all of which also contribute to the complexity calculation). Correlation also has the potential effect of under-representing the contribution of a particular subsystem to overall system complexity if an insufficient number of parameters are used (e.g., thermal uses only one factor). It is expected that this work is a first step in an ongoing research project to examine the potential application of a complexity index to cost and schedule estimation. In the near-term, this issue is addressed by assuring that at least one parameter and at most six parameters are used to represent each of the traditional spacecraft subsystems (with a total of 21 parameters, a single subsystem represents at most 30% of the total). Future analysis will focus on a more in-depth understanding of the problem and take into account subsystem interrelationships to more closely interrogate the nature and interdependencies among variables contributing to the complexity index calculation. Readers are invited to contribute to this analysis and publicly report their own results.

All drivers are demonstrable, measurable parameters driven by mission or system requirements. The strength of using a number of interrelated parameters is that peculiarities associated with the specific implementation approach for a given system will be averaged out. These descriptive parameters (number of instruments, mass, technical performance, subsystem characteristics, technological choices, etc.) are normalized based on the applicable range as designated by the programs in the database. There are two types of calculations:

- (1) Discrete choices such as battery type (Nickel Cadmium or Nickel Hydrogen) or propulsion type (none, cold gas, monoprop, biprop, or ion engine); and
- (2) Continuous parameters (e.g. mass, power, pointing accuracy) that represent a range of potential values bounded by a minimum and maximum.

Discrete choices are determined as follows:

$$f_i = \begin{matrix} (0,1) & \text{for two options} \\ (0, \frac{1}{2}, 1) & \text{for three options, etc.} \end{matrix}$$

$i = 1 \dots m$ , where  $m$  is the number of discrete choices

Continuous (non-discrete) parameters are analyzed using the Microsoft Excel<sup>®</sup> function PERCENTRANK that returns the rank of a value in a data set as a percentage of the data set. This function is used to evaluate the relative standing of a value within the data set. For example, PERCENTRANK can be used to evaluate the standing of launch mass among all launch masses in the database. If the value does not match one of the values in array, PERCENTRANK interpolates to return the correct percentage rank. The syntax is as follows:

$$f_j = \text{PERCENTRANK}(\text{Array}, X) \quad j = 1 \dots n$$

where, *Array* is the range of data with numeric values that defines relative standing<sup>†</sup>, *X* is the value for which we want to know the rank, and *n* is the number of continuous parameters. With  $f_i$  and  $f_j$  representing discrete and continuous complexity parameters, the overall complexity factor,  $F_c$ , is defined as:

<sup>†</sup> Note that for pointing accuracy and pointing knowledge where a smaller number implies a more strenuous requirement that  $F_j$  is calculated as  $1 - \text{PERCENTRANK}(\text{Array}, X)$ .

$$F_c = (\sum f_i + \sum f_j) / (m+n) \quad i = 1 \dots m, \quad j = 1 \dots n$$

The mean complexity index is determined by averaging the individual factors. Equal weighting is used so that analysis does not differentiate among parameters or allow any particular parameter to dominate.  $F_c$  is then normalized relative to the maximum and minimum to arrive at a normalized complexity index expressed as a percentage between 0 and 1.

#### EXAMINATION OF FASTER, BETTER, CHEAPER

An obvious use of the complexity index is to use it to specify the percentile within a estimated cost and schedule risk probability density function (typical output of cost models). For example, if  $F_c = 90\%$  then a 90<sup>th</sup> percentile cost might be appropriate. The inherent assumption is that if all cost- or schedule-driving parameters were to be considered, then scatter about a parametric regression line could be explained. This assumes that complex missions are more likely to experience cost and schedule growth. A key issue that has not been approached is a method for determining when a development is *too fast* or *too cheap* so that even if it is under budget and on schedule, it is still prone to failure. There are two facets to this problem: the relationship between "faster" and "better", and the relationship between "cheaper" and "better." However before we examine dependencies, a definition of the elements in this elusive triad is needed.

"Faster" and "cheaper" are relatively straightforward to measure. For the purposes of this study, "faster" is measured in terms of total development time, defined as the period of time from authority to proceed (ATP) until ship. This was between 11 and 84 months with an average (mean) of 35 months for the data set used. "Cheaper" is measured in terms of total spacecraft bus cost which ranged from \$1M to \$135M with an average (mean) of \$25M. Payload costs were excluded due to a lack of sufficient data, although many of the requirements included in the complexity index calculation are payload-derived. Launch and operations costs were excluded because planetary and earth-orbiting requirements differ dramatically such that inclusion would not allow direct comparison.

"Better" is highly subjective and remains undefined. This is primarily due to fundamental differences in stakeholder perceptions (i.e., what one perceives as better is different from what another thinks). One metric that shows promise of circumventing this dilemma is failure rate (i.e. ratio of failed missions to the total number of missions attempted).<sup>4</sup> Failures are categorized as partial, where the mission was impaired in some way, catastrophic, where the mission was completely lost or programmatic where the mission was never realized due to cancellation or experienced greater than 50% schedule and/or cost growth. Clearly a failed mission is *not* "better." Failure rate (and its corollary success rate) possesses the attractive feature that it makes no comment on the relative quality, diversity of science or amount of specific data. It therefore avoids the controversy associated with a debate of this nature.

#### COMPARISON OF PLANETARY AND EARTH-ORBITING MISSIONS

Using the process above, a complexity index was calculated for all of the programs in Table 1. Also calculated are average spacecraft cost, development time and success ratio for both low-cost planetary and earth-orbiting mission types. Launch-related failures (HETE and METEOR) are included in the complexity calculation, but excluded from the comparative risk analysis since system performance is undemonstrated (i.e. it is unknown whether these systems would have failed or succeeded once on orbit). Earth-orbiting missions suffered 2 catastrophic failures

(Lewis and WIRE) and 2 programmatic failures (Clark and Seastar) out of 14 missions. Clark is considered a programmatic failure since the program was cancelled; Seastar since it experienced over 120% schedule growth. Planetary missions experienced 2 catastrophic failures (MCO and MPL) and 4 impaired missions (Clementine, DS-1, MGS and NEAR) out of 10 missions. It is noted however that several of the impaired missions ultimately overcame their problems to be deemed successful. Comparative statistics are summarized in Table 3.

**Table 3. Comparison of NASA Small Planetary and Earth-Orbiting Missions**

	NASA Small Planetary	NASA Earth Orbiting	All NASA Missions	All Missions	Non-NASA Missions
Average Complexity of Failed Missions	95%	84%	89%		
Average Complexity of Impaired Missions	92%	80%	90%		
Average Complexity of Successful Missions	65%	53%	56%		
Overall Average Complexity	77%	61%	66%	50%	31%
Success Ratio: "Better"	40%	71%	58%		
Average Development Time: "Faster"	35	42	39	35	31
Spacecraft Bus Cost: "Cheaper"	71	20	41	24	11

There are a number of observations that can be drawn from this analysis. First, the average complexity of missions that failed or were impaired is significantly higher than that of successful missions. Second, the complexity of small planetary missions is higher than that of earth-orbiting missions; however the success ratio is lower (i.e. according to this metric, earth-orbiting missions are "better"). Another interesting observation is that in general planetary missions are "faster." This makes sense since often these missions are subject to periodic launch windows (e.g. every 26 months for Mars) which impose an immovable schedule constraint. NASA planetary missions also in general cost more (average \$71M vs. \$20M) than do earth-orbiting missions.

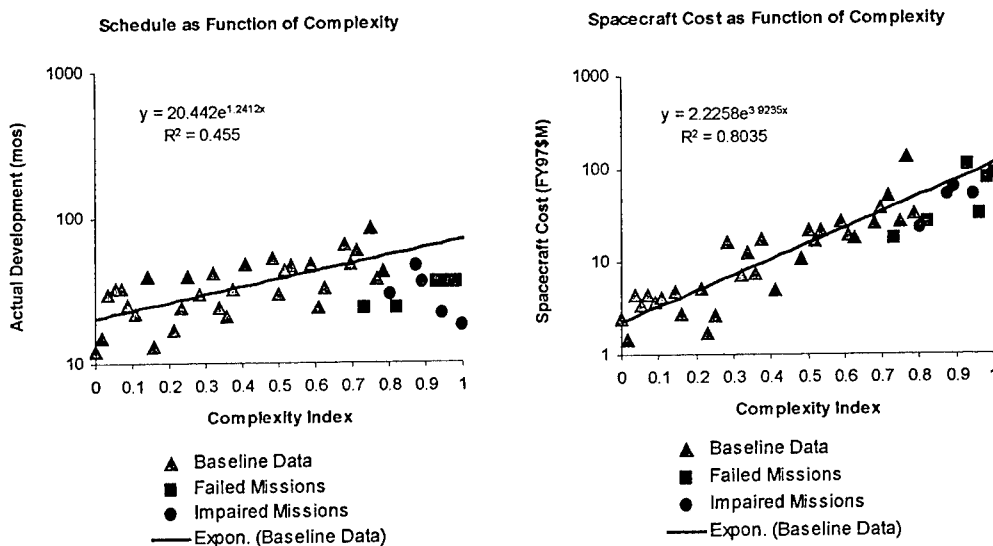
Cost and schedule plotted against spacecraft complexity are shown in Figure 1. Correlation between complexity and cost/schedule is evident. Note that the number of data points shown may differ between the two plots depending on whether cost and/or schedule data were available for a given program. The regression curves shown may be used to back out allowable complexity for a set budget or development time. The NASA programs that failed or were impaired in some way are called out. A threshold is apparent at which allocated project resources (time, funds) may be insufficient. While the complexity index does not identify the manner or subsystem in which a failure is likely to occur, it does identify a regime under which an index calculated for a new mission being considered may be compared against missions of the recent past. It is unknown whether allocation of additional resources (cost, schedule) would have increased the probability that a given mission would have succeeded, but this much is clear: When NASA fails it appears that they are beyond a discernable threshold where resources are insufficient.

## CONCLUSION

Under constrained budgets and rigid schedule, NASA has embraced the "Faster, Better, Cheaper" approach to conducting planetary investigations. Recent failed or impaired small planetary science satellites have brought into question NASA's FBC approach to missions in both the planetary and earth-orbiting applications. While recent missions have resulted in lower costs and shorter development times these benefits have, in some cases, been achieved at the

expense of increasing performance risk. To address the question of when a mission becomes "too fast and too cheap" such that it is prone to failure, a complexity index is presented to normalize development time and spacecraft cost per mission. Complexity indices were derived for over 40 small-spacecraft missions and equations relating complexity to cost and development time presented. A clear dependence of success rate on system complexity was identified. A comparison of NASA planetary and earth-orbiting missions showed that low-cost planetary missions cost more, are developed faster, and fail more often than do earth-orbiting missions.

Figure 1. Cost and Schedule as a Function of Complexity



ACRONYMS

ACE	Advanced Composition Experiment	EOL	end of life
ADCS	Attitude Determination and Control Subsystem	FAST	Fast Auroral Snapshot Explorer
ALEXIS	Array of Low-Energy X-ray Imaging Spectrometers	FBC	Faster, Better, Cheaper
APEX	Advanced Photovoltaic and Electronics Experiment	FY	fiscal year
APL	Applied Physics Laboratory	GaAs	gallium arsenide
ATP	authority to proceed	GFO	Geosat Follow-on
au	astronomical units	GG	gravity-gradient
A-hr	Ampere hours	GLOMR	Global Low-Orbiting Message Relay
Biprop	bipropellant	GSFC	Goddard Space Flight Center
BMDO	Ballistic Missile Defense Organization	HETE	High Energy Transient Experiment
BOL	beginning of life	JHU	Johns Hopkins University
DARPA	Defense Advanced Research Project Administration	JPL	Jet Propulsion Laboratory
deg	degrees	Kbps	kilobits per second
DOD	Department of Defense	kg	kilogram
DOE	Department of Energy	km	kilometer
DS-1	Deep Space 1	LANL	Los Alamos National Laboratory
DSI	Defense Systems, Inc.	LaRC	Langley Research Center
		LEO	low Earth orbit
		LLNL	Lawrence Livermore National Laboratory
		LOSAT-X	Low-Orbit Satellite Experiment
		m	meter

MACSAT	Multiple-Access Communications Satellite	SAMPEX	Solar Anomalous and Magnetospheric Particle Explorer
Mbytes	megabytes	SCE	Selective Communications Experiment
MCO	Mars Climate Orbiter	SDIO	Strategic Defense Initiative Organization
MGS	Mars Global Surveyor	sec	second
monoprop	monopropellant	Si	silicon
mos	months	SMEX	Small Explorer Program
MPL	Mars Polar Lander	SSTI	Small Spacecraft Technology Initiative
MSTI	Miniature Sensor Technology Integration	STEP	Space Test Experiment Platform
NASA	National Aeronautics and Space Administration	STP	Space Test Program
NEAR	Near-Earth Asteroid Rendezvous Mission	STS	Space Transportation System (Shuttle)
NiCd	Nickel Cadmium	SWAS	Submillimeter Wave Astronomy Satellite
NiH <sub>2</sub>	Nickel Hydrogen	TEX	Transceiver Experiment
NMP	New Millennium Program	TOMS-EP	Total Ozone Mapping Spectrometer – Earth Probe
NRL	Naval Research Laboratory	TSX	Tri-Service Experiment
OSC	Orbital Sciences Corporation	UHF	Ultra-High Frequency
ONR	Office of Naval Research	VHF	Very-High Frequency
POGS/SSR	Polar-Orbit Geomagnetic Survey/Solid-State Recorder	W	Watt
P/L	payload	WIRE	Wide-field Infrared Experiment
RADCAL	radiation calibration		
REX	Radiation Experiment		

## REFERENCES

- <sup>1</sup> Sarsfield, Liam, "Federal Investments in Small Spacecraft," Report for Office of Science and Technology Policy, RAND Critical Technologies Institute, DRU-1494-OSTP, September 1996.
- <sup>2</sup> Smith, Keith, "Development of a Complexity Generator with the NASA Cost Model (NASCOM)," Science Applications International Corporation, NASA Cost Symposium, 1995.
- <sup>3</sup> "Standardization and Program Practices Analysis Final Report. Volume II: Technical Analysis of Program Practices," prepared for Low Cost Systems Office, NASA, The Aerospace Corporation, Report No. ATR-78(7659)-1, Vol. II, 30 November 1977.
- <sup>4</sup> Mosher, Todd, Robert Bitten, et al. "Evaluating Small Satellites: Is the Risk Worth It?," SSC99-IIA-1, 13<sup>th</sup> AIAA/USU Conference on Small Satellites, Logan, Utah, Sept. 1999.

## **SESSION 5a :**

### **Technologies Petits Satellites : Propulsion** ***Small Satellites Technologies: Propulsion***

*Présidents / Chairpersons: Jerry SELLERS, Michel BOURDEIL*

- (S5a.1) An Alternative Geometry Hybrid Rocket for Orbit Transfer.**  
Haag G.S., Sweeting M., Richardson G. Surrey Space Centre, Guildford, Royaume-Uni
- (S5a.2) Nitrous Oxide as a Rocket Propellant for Small Satellites**  
Zakirov V., Lawrence T., Sellers J., Sweeting M. Surrey Space Center, Surrey, Royaume-Uni
- (S5a.3) Combined Ammonia Propulsion System**  
Smith P. Polyflex Aerospace Ltd, Cheltenham, Royaume-Uni
- (S5a.4) Orbit Control of MITA-Class Satellites with FEEP Electric Propulsion System**  
Bianco P., De Rocco L., Omer O.M.M. Carlo Gavazzi Space SpA, Milan, Italie
- (S5a.5) Aerobraking Design and Study Applied to CNES Microsatellite Product Line**  
Brezun E. CS SI, Toulouse, France, Bondivenne G., Keller P. CNES, Toulouse, France
- (S5a.6) A Cold Gas Propulsion Module for Small Satellites**  
Cardin J.M., Acosta J. VACCO Aerospace Products, South El Monte, CA, Etats-Unis

## AN ALTERNATIVE GEOMETRY HYBRID ROCKET FOR ORBIT TRANSFER

**Gary S. HAAG**  
**Prof. Martin SWEETING**  
**Dr. Guy RICHARDSON**

*Surrey Space Centre*  
*University of Surrey*  
*Guildford, Surrey GU2 7XH, UK*

*Tel: (44) 1483 259278 Fax: (44) 1483 259503*  
*internet: m.sweeting@eim.surrey.ac.uk*  
*WWW: <http://www.sstl.co.uk>*

### ABSTRACT

This paper summarises recent research into alternative geometry hybrid rockets at the Surrey Space Centre (SSC). Presented is an all new geometry hybrid rocket dubbed the Vortex Flow "Pancake" Hybrid Engine (VFP). This engine offers all the advantages of the conventional hybrid whilst improving or possibly eliminating the geometric and thermal implications associated with placing a conventional hybrid within a small spacecraft. In addition, the VFP promises to improve performance over conventional hybrid designs by decreasing the inefficiencies associated with poor fuel and oxidiser mixing. Finally, a VFP engine configuration is presented that minimises the volumetric impact of the engine on small spacecraft.

Although the VFP is by definition a hybrid rocket, there are considerable differences between the conventional hybrid and the VFP. The VFP employs a short but wide cylindrical combustion chamber, the oxidiser is injected tangentially into this cylinder inducing a strong vortex flow toward a centrally mounted rocket nozzle. The induced vortex flow provides a centripetal force that acts to keep cooler, denser media toward the combustion chamber wall while hotter, lighter, products of combustion exit through the exhaust nozzle. The configuration has demonstrated smooth, uniform fuel regression, stable combustion, and a decreasing O/F trend over the operational regimes tested.

This paper provides an overview of the SSC hybrid to include a comparison with conventional hybrid configurations and results obtained from an experimental investigation of this new design. The paper also presents lessons learned, and improvements made to this new hybrid rocket configuration.

### SYMBOLS / ACRONYMS

VFP - Vortex Flow "Pancake" Engine

Gox - Gaseous Oxygen

PMMA - Polymethyl Methacrylate

HTP - High Test Peroxide (89%)

N<sub>2</sub>O - Nitrous Oxide

L/D - Length of combustion port divided by diameter of the combustion port

O/F - Oxidiser mass flow rate divided by the fuel mass flow rate

Go - Oxidiser mass flow rate divided by port cross sectional area (kg/m<sup>2</sup>-s)



## INTRODUCTION

The hybrid rocket has been widely recognised by the Aerospace community as an inherently safe and operationally flexible rocket design. The availability of high performance fuels and oxidisers that also produce environmentally friendly exhaust constituents is yet another benefit of this technology (gaining greater importance within the aerospace community). However, it is the potential for cost effective propulsion systems that make this technology so very attractive for low-cost space missions. Safety, environmental friendliness, relatively high performance and robustness of the technology all contribute to lowering cost over currently available chemical propulsion alternatives.

Low cost, small spacecraft missions are increasingly popular due to the global capability provided by these cost effective platforms. While payloads and most spacecraft subsystems have scaled down in price and size, propulsion for the small spacecraft has remained cost prohibitive for many of these missions. Since a sizeable portion of small satellite missions are launched as secondary spacecraft to less than optimal operational orbits, it stands to reason that these missions would benefit immensely from a cost effective propulsion system for orbit transfer.

Similar to a few other spacecraft propulsion technologies, the hybrid rocket has a strong launch vehicle and missile heritage; however, hybrid rocket technology has not evolved much from its traditionally long and slender lineage, making the technology cumbersome, at best, for small satellite applications. SSC research has identified an alternative geometry hybrid rocket configuration that is far better suited to small spacecraft orbit transfer applications, the VFP. The differences between the conventional hybrid and the VFP will first be described to provide insight into the design, followed by performance and advantages provided by this exciting new hybrid engine.

## CONVENTIONAL HYBRID ROCKETS

The hybrid rocket engine has been in existence since the late 30's [Humble 95],[Marxman 63],[Green 63]. The term "hybrid" comes from the combination of a fuel and oxidiser that are in different physical phases (i.e. solid, liquid, gas). Although other combinations have been tried [Marxman 63],[Green 63], hybrids usually employ a liquid oxidiser and a solid fuel grain. The bulk of hybrid research has been conducted on "conventional hybrids" which shall be defined as hybrids employing an axial orientated combustion chamber (lined with solid fuel) with oxidiser flowing from an injector at one end to the nozzle at the other end. Conventional hybrids can be characterised as having poor fuel regression rates (compared with solid rockets), low volumetric loading and decreased combustion efficiency (1-2%) in comparison with all solid or all liquid technologies [Humble 95]. In addition, the conventional hybrid requires long and slim shapes with a combustion chamber L/D ratio of 20-30 in order to facilitate adequate fuel liberation and an optimal O/F ratio (fig 1).

As the solid fuel burns or regresses, the conventional hybrid combustion chamber diameter increases exposing more fuel area. However, this increase of fuel area is accompanied by a subsequent decrease in heat transfer and fuel liberation. Through the combustion process, fuel mass flow rate decreases and the O/F ratio increases. This shift to a higher O/F is common to all conventional hybrids at a fixed oxidiser flow rate [Humble 95].

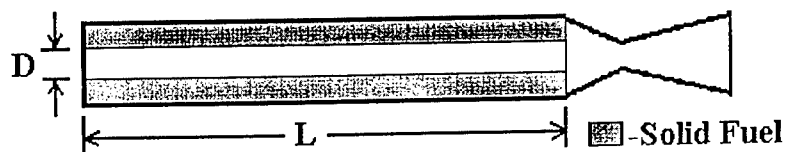


Fig.1 Conventional Hybrid Rocket

The shifting O/F ratio, and corresponding shift in performance of the conventional hybrid is the source of its primary operational disadvantage. As the fuel mass flow rate decreases (at a constant oxidiser mass flow rate), thrust, chamber pressure and efficiency decrease as well. Upon ignition, conventional hybrids typically increase to operational thrust and soon afterward begin to tail off. For operations, the variable performance profile must be previously characterised in order to allow compensation of the total manoeuvre impulse with a variable burn duration. Conventional hybrid rocket designers often employ multiple ports in order to increase exposed fuel area and help reduce the variation of O/F during the course of the burn. However, multiple ports increase the complexity of the design and increases the risk of fuel breaking off and entering the nozzle prior to combustion.

Oxidiser mass velocity,  $G_o$ , is the primary driver of the solid fuel regression rate. Conventional hybrid regression analysis is most commonly stated in reference to this parameter which is calculated by dividing the oxidiser mass flow rate by the port cross-sectional area (perpendicular to the oxidiser flow). Common forms of the regression rate equation can be expressed based upon the oxidiser mass velocity, following the form:

$$R = aG_o^n X^m \quad (1)$$

Where:

$R$  - fuel regression rate (m/s)

$a$  - regression rate coefficient (properties of propellants, blowing)

$G_o$  - Oxidiser mass flux ( $\text{kg/s}\cdot\text{m}^2$ )

$X$  - distance along the combustion port (m)

$n, m$  - empirically determined regression rate exponents (fluid dynamic driven [Humble 95])

### ALTERNATIVE GEOMETRY HYBRIDS

The motivation for the alternative geometry hybrid came from the resistance of the conventional hybrid to integrate and perform within the confines of the small, cost effective spacecraft. Small, densely-packed spacecraft with delicate components and electronics provide little flexibility for the addition of long and slender rocket engines that require alignment with the centre of gravity and generate large amounts of heat. External mounting of the conventional hybrid is a difficult option because it would drastically increase the volume required from the launch vehicle. Although hybrid propulsion is very attractive for small, low-cost missions, the integration requirements imposed by a conventional hybrid rocket would make its operation and application impractical [Sellers 96]. Therefore, the challenge is to find a hybrid rocket geometry that would:

- Lend itself to modular integration with the small spacecraft
- Occupy as little spacecraft volume as possible
- Minimise the thermal impact of the rocket engine on the spacecraft
- Sacrifice little (if any) hybrid rocket performance
- Be scaleable for multiple mission scenarios

The VFP addressed all of these challenges. With this configuration, the engine could be mounted on or near the external surface of the spacecraft using little internal spacecraft volume (oxidiser tanking and plumbing would still be internal to the spacecraft). The solid fuel could be configured to present the same amount of burn surface throughout the duration of the burn. Waste heat from the engine (and possibly a catalyst pack) could be radiated to space via the engine's

exposed surface area. This configuration promised to be easily scalable by adding significant amounts of fuel with only a modest increase in engine radius.

### IMPLEMENTATION

Since the VFP presents a short and squat profile, it can be mounted totally external to the spacecraft. By combining the positioning, strength and size requirements of a separation system and the VFP, a synergistic, combined system that leverages characteristics from each component becomes possible. Figure 2 compares and contrasts three different microsatellite configurations, a microsat without propulsion (A), a microsat with a conventional hybrid (B) and a microsat with the VFP (C). Table 1 provides figures for the conventional vs. VFP comparison; the figures are based on a 50kg (initial weight) microsat, utilising HTP and polyethylene propellants (@280s ISP), providing a 200m/s change in velocity (~400km altitude change in LEO). In addition to occupying internal volume within the spacecraft, the conventional hybrid will almost certainly drive oxidiser tanking to a less volumetrically efficient (and more costly) multiple tank design. Reserving 20% ullage for HTP decomposition [Whitehead 99], the mission outlined would require a single 17.5cm dia. tank or two tanks having a 13.88cm dia. (each).

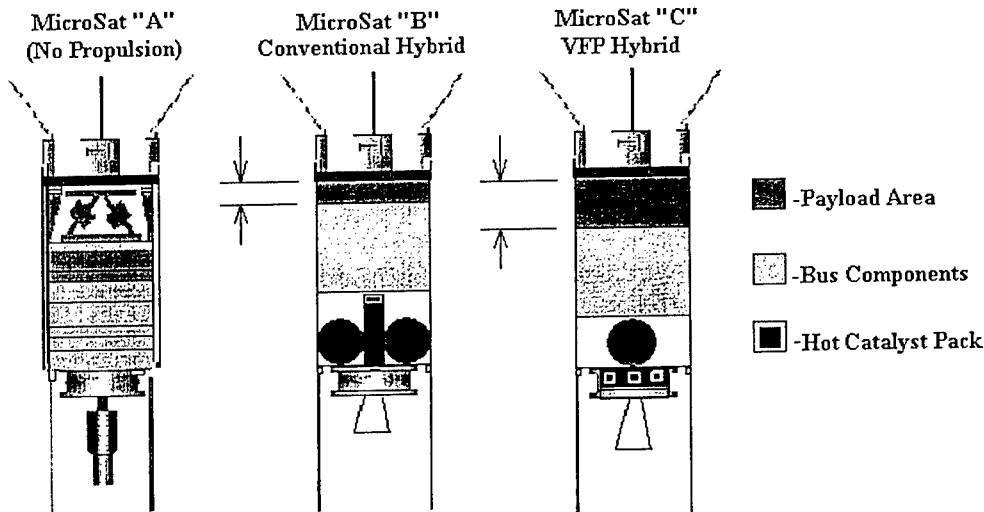


Fig. 2 Hybrid engine layout (Note: figures do not address expulsion systems).

Table 1 VFP vs. Conventional hybrid design.

	Height* (cm)	Width* (cm)	Internal s/c volume (cm <sup>3</sup> )	Port Dia. (cm)	Chamber Height (cm)	Vol. Loading Efficiency
Conventional	25	5.19	529+	2	N/A	85%
VFP	5	12	N/A	N/A	1.0	80%

\*Internal dimensions of Combustion Chamber

### ENGINEERING MODEL

The primary concern of using a pancake engine configuration is fuel utilisation. Research on a pancake-shaped hybrid at Purdue University indicated that radial injection of the oxidiser led to channelling of the fuel grain from the injector to the nozzle [Caravella 96]. Tangential injection promised to provide a sweeping effect over the fuel surface, therefore, this method was chosen.

Figure 3 illustrates the sweeping motion of the oxidiser over the fuel surface as seen through the clear PMMA fuel grain. The first engine used a steel ring with two tangential oxidiser injectors and two PMMA fuel end-caps (one containing a centrally located nozzle, the other kept clear to permit viewing the combustion process), the engine was clamped together using six bolts around the periphery (figure 4).

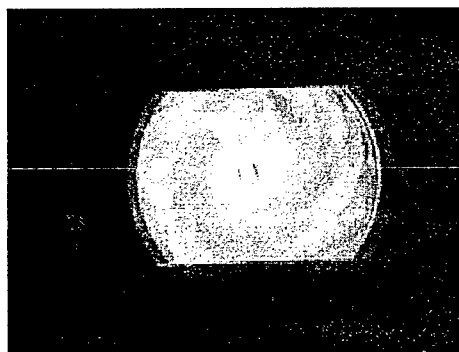


Fig 3. VFP firing (UV filtered)

Although the engine reliably ignited and produced smooth combustion chamber pressures, the mixture ratio continually ran rich (as indicated by a smoky, raging orange flame and poor performance). In an effort to expose fuel that was trapped within the boundary layer to the mixing action of the vortex, boundary layer steps (manufactured of pyrolytically coated graphite) were added. The design then evolved to include:

- Multiple injectors (1, 2, 4)
- Multiple diameter injectors
- Water cooled nozzle

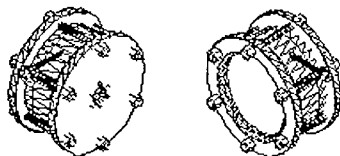


Fig 4 Original VFP Engineering Model

## PERFORMANCE

### -Combustion Stability

Combustion chamber pressure stability has been one of the most remarkable attributes of the VFP. VFP combustion chamber pressure is measured at two locations, the first tap is opposite the nozzle in the centre of the engine and the second tap is located on the steel combustion chamber wall near the oxidiser injectors (fig 5).

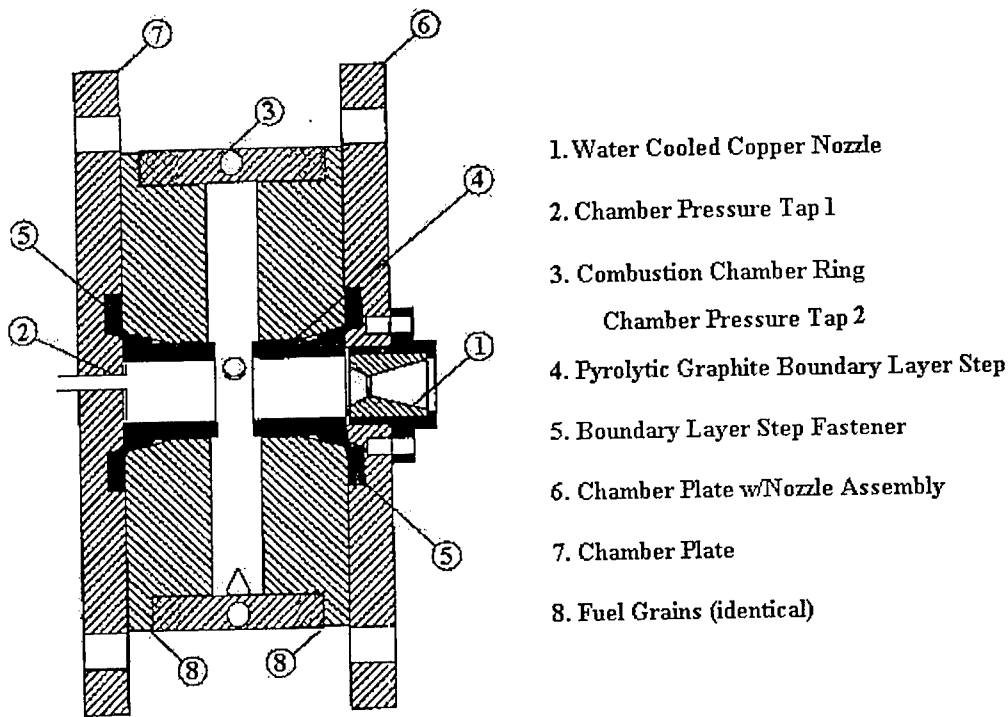
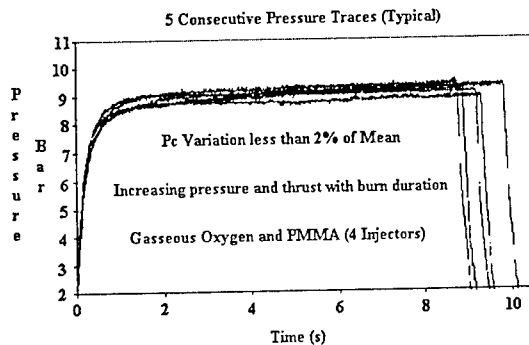


Figure 5. VFP Engineering Model

At low oxidiser injection velocities, the two chamber pressures track remarkably close to each other, while at higher injection velocities, they tend to diverge indicating the presence of a slight pressure gradient. "Smooth combustion" is characterised by steady state combustion with less than  $\pm 5\%$  pressure fluctuations from mean chamber pressure [Sutton 92]. The VFP raw data has repeatedly demonstrated average steady-state pressure fluctuations of less than  $\pm 1\%$ , chart 1.

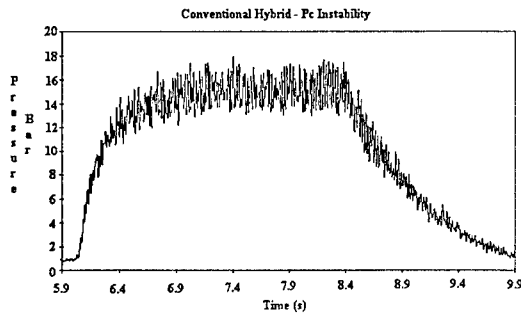
Chart.1 Typical VFP Chamber Pressure Stability.



For comparison sake, chart 2 illustrates raw data from a short conventional hybrid rocket (50N thrust, initial L/D of 15); this experimental rocket used the same data acquisition system, fuel/oxidiser combination and control infrastructure as the VFP. Unsteady combustion can have

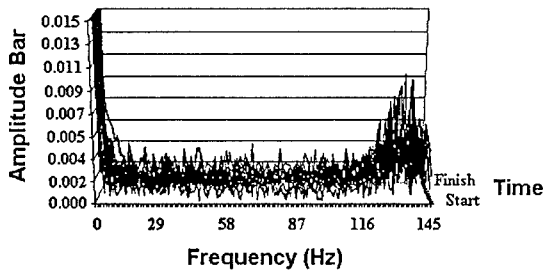
severe effects on fuel regression and overall hybrid rocket performance. Therefore, the seemingly inherent combustion stability of the VFP is a welcome characteristic.

**Chart 2 Low L/D Conventional Hybrid Pc Trace**



Fast Fourier Transform (FFT) analysis of unfiltered VFP combustion chamber pressure data for several injector configurations was unremarkable except for a preferential waveform centred at 130Hz (Chart 3) on the two injector configuration. This waveform was theorised to have been caused by a pressure oscillation between the two injectors. However, since all data sampling has been conducted at 290Hz (with a corresponding Nyquist cut-off frequency of 145Hz), only non-acoustic variations were observed [Wernimont 00]. Future analysis will focus on frequencies up to 1000Hz.

**Chart 3. VFP 2 Injector FFT Waterfall Chart**



**-Solid Fuel Regression**

Solid fuel regression is critical to all hybrid rocket performance analysis. In conventional hybrids, regression rate is often quoted as a function of propellant or oxidiser mass flux. However, within the VFP it becomes difficult to apply the mass flux metric through the “port” because the flow direction and therefore velocity is (by design) continually changing. Regression analysis in the VFP has been correlated to various parameters (number of injectors, injector area, chamber height, injection velocity). Chart 4 illustrates solid fuel regression rate vs. O<sub>2</sub> injection velocity at a constant O<sub>2</sub> mass flow rate. As one can see, there is a strong correlation between solid fuel regression and oxidiser injection velocity. While O<sub>2</sub> injector velocity appears to be a useful regression control mechanism, it does appear to have some limitations at higher velocities. Although the chamber pressure has remained stable, the uniformity of the fuel regression and overall rocket performance can be erratic at the higher O<sub>2</sub> injection velocities (~80m/s).

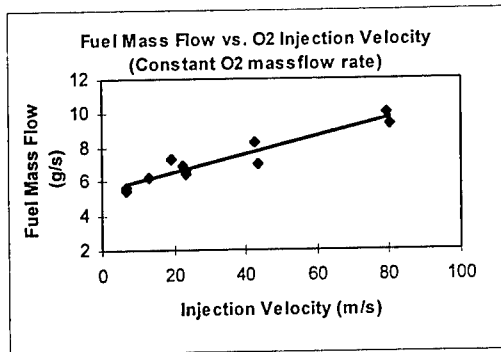


Chart 4. Solid Fuel Mass Flow vs. Injector Velocity

Contrary to conventional hybrid wisdom, the VFP has exhibited a shift to *lower* O/F (or higher fuel mass flow) under most regimes tested. The conventional hybrid experiences a shift to higher O/F because of a net loss in heat transfer to the solid fuel as the burn progresses. It is currently thought that the shift to lower O/F within the VFP is caused by increased turbulence and increased convective heat transfer as the fuel grains regress away from each other (Chart 5).

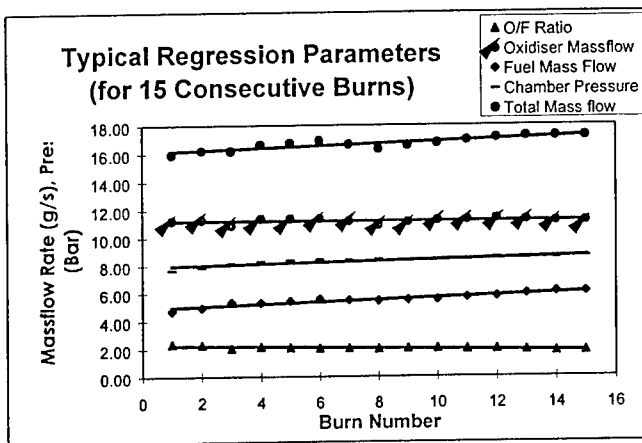


Chart 5. Consecutive Burn Trends

A decreasing O/F (or increasing fuel mass flow) opens up possibilities for improving or possibly eliminating the shifting performance of this hybrid rocket. An increasing O/F leaves few options for consistent hybrid operations because fuel liberation is tied to the (decreasing) amount of heat available. A decreasing O/F provides the opportunity to add burn inhibitors to different burn levels of the solid fuel grain or other mechanisms in order to produce steady, consistent hybrid rocket operations.

#### -Efficiency

Rocket combustion chamber performance is most often stated in terms of Characteristic Exhaust Velocity or "C\*". C\* provides a ratio of pressure achieved for a given propellant mass flow rate (considering the nozzle throat area). This ratio can then be compared with the theoretical C\* (determined from thermochemical parameters) to determine combustion efficiency. For one dimensional flows, C\* is straightforward. However, research by Goldman and Gany [Goldman 96] has indicated that swirling flows can alter the effective area of the nozzle throat; in essence, large

swirl velocities would impose a *vena contracta* within the nozzle that would manifest itself as a higher chamber pressure for an apparent nozzle area. In order to accurately gauge this effect, one needs to consider the swirl velocity entering the rocket nozzle. While this measurement is not within the scope of the current research program,  $C^*$  is used to compare performance from run to run in the VFP program.

At high oxidiser injection velocities ( $\sim 80\text{m/s}$ ),  $C^*$  measurements can be erratic providing values that are higher than theoretically possible ( $\pm 9\%$  demonstrated), the low oxidiser injection velocities  $\sim 6\text{m/s}$  (that significantly decrease the swirl effect) provide more consistent measurements with values falling within 2% of theoretical performance.

The most generic measure of rocket efficiency is Specific Impulse (Isp). VFP Isp has been measured on approximately 50 firings (at sea level) with PMMA and Gox producing Isp's that equate to a vacuum efficiency of between 270 and 280 seconds (at stoichiometric mixture ratios - expansion ratio of 150).

#### -Thermal Considerations

It was expected that the VFP would get good chamber cooling effects from the centripetal acceleration (gas separation) within the vortex and the oxidiser film cooling effect on the combustion chamber wall. By extending a thermocouple through the combustion chamber wall, temperature just inside the wall was measured (fig 4). With a thermocouple located at a depth of 1 mm into the combustion chamber, the engine was fired 29 times delivering temperatures of less than  $180^\circ\text{C}$  on all but 1 run (when temperature reached  $600^\circ\text{C}$ ), chart 6;

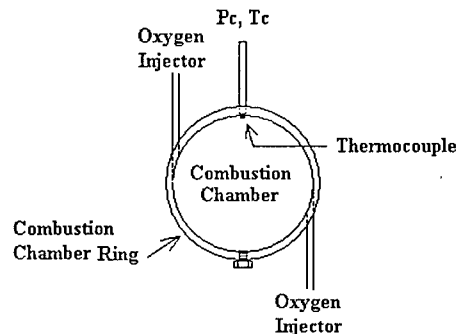


Fig.4 Chamber wall thermocouple location

This anomalous temperature was most likely due to a piece of fuel or engine sealant that had broken loose and burned on the thermocouple during this run. Extending the thermocouple 5mm into the combustion chamber (for 8 runs) resulted in temperatures routinely reaching  $500^\circ\text{C}$  and higher (the thermocouple was destroyed on the 8<sup>th</sup> run as temperature climbed through  $900^\circ\text{C}$ ), chart 7.



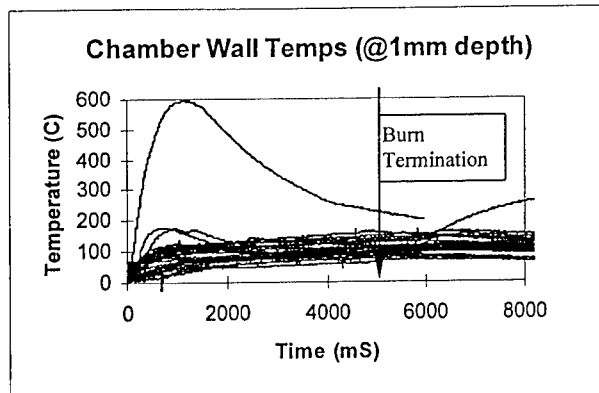


Chart 6 Temp vs. Time 1mm inside the VFP combustion chamber

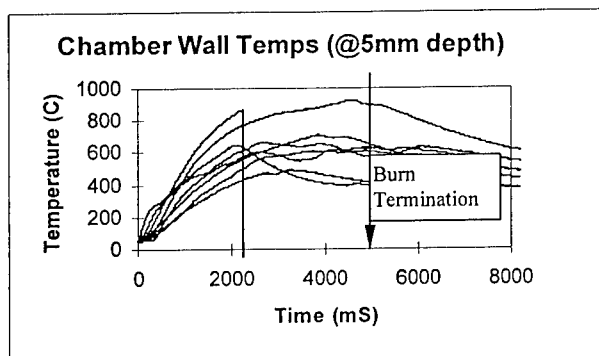


Chart 7 Temp vs. Time 5mm inside the VFP combustion chamber

It was also theorised that the centripetal acceleration within the VFP would keep solid particulate (such as solid fuel slivers) from approaching and potentially blocking the nozzle. The risk of fuel slivering and nozzle blockage within the conventional hybrid necessitates leaving unburned fuel within the combustion chamber; by reducing or eliminating the risk of nozzle blockage the VFP could use more fuel or possibly be burned to completion. Although there hasn't been any specific "fuel sliver" experiments conducted within the VFP, there is evidence that this characteristic is present. Occasionally, the silicon sealant used to seal the surface between the fuel grains and combustion chamber wall frothed into solid stone-like objects. After such a firing, small particles of the stone-like objects would be distributed around the perimeter of the combustion chamber. On one occasion, a large silicon "rock" was filmed circulating around the chamber in a polygonal path colliding with the wall of the engine as the oxidiser flow subsided. It is anticipated that any slivered fuel would continue to circulate within the vortex flow-field until it was fully consumed by combustion or smashed to bits by collision with the wall in true vortex mill fashion [UoH 99].

## FLIGHT PROPELLANTS

Although most testing at SSC has been conducted with gaseous oxygen and PMMA to keep consumable costs low, preliminary trials have begun with two different oxidisers, HTP and N<sub>2</sub>O; these oxidisers have the following characteristics:

### HTP (89%)

#### *Positive*

Excellent storage density (~1.39g/cm<sup>3</sup>)  
Catalytically decomposes to provide ignition  
Re-startable  
Freezing point of (-12°C)  
Non-toxic  
Environmentally friendly

#### *Negative*

Sealed storage issues  
Requires a pressurisation system

### N<sub>2</sub>O

#### *Positive*

Good storage density (~.75g/cm<sup>3</sup>)  
\*Catalytically decomposes to provide ignition  
Re-startable  
Operational temperature range (-34 to 60°C)  
Self pressurising  
Non-toxic  
Environmentally friendly

#### *Negative*

Lower storage density than HTP  
\*Requires some spacecraft power

HTP operations entail passing the oxidiser through a catalyst pack composed of tightly packed silver screens. The HTP quickly decomposes into superheated steam (690°C observed) and oxygen which spontaneously ignites the PMMA fuel. Originally, HTP ignition was sporadic with delays of up to ten seconds prior to ignition (due to adiabatic expansion of the catalyst products into the combustion chamber). However, as the supply pressure was increased from 20 to 50 Bar, the ignition delay reduced to one and a half seconds (fig. 5).

N<sub>2</sub>O operations were conducted with the aid of a parallel propulsion research program at the University of Surrey [Zakirov 00]. This particular research program is focused on catalytic decomposition of N<sub>2</sub>O for propulsion applications.

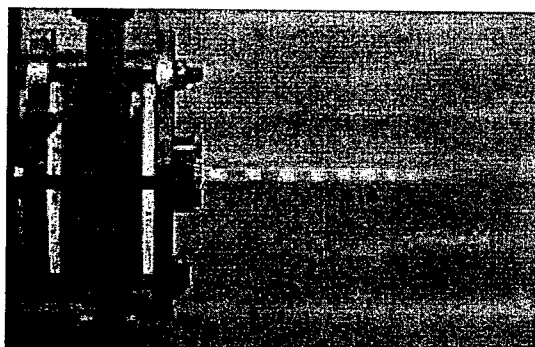


Fig. 5 VFP firing with HTP and PMMA

N<sub>2</sub>O will thermally decompose in an exothermic reaction to N<sub>2</sub> and O<sub>2</sub>; however, under non-catalytic conditions this reaction consumes a large amount of precious spacecraft energy. SSC research has shown that by using a catalyst, this activation energy can be significantly reduced [Zakirov 00]. By using a preheated catalyst bed composed of Shell 405, N<sub>2</sub>O decomposition temperatures in excess of 820°C were achieved in the VFP prior to ignition.

Both oxidisers produced smooth combustion with PMMA fuel in the VFP. Current work with these oxidisers is concerned with establishing the minimum ignition delay in order to start a comprehensive characterisation of the propellants within the VFP.

## **CONCLUSIONS**

An alternative geometry hybrid rocket engine has been developed and tested for the specific application of spacecraft orbit transfer.

The VFP design provides smooth, stable combustion with Gox, HTP and N<sub>2</sub>O, providing great promise with respect to performance, fuel utilisation, and scale-ability. In addition, the design has demonstrated an inherent chamber cooling mechanism that allows high performance with readily available construction materials.

The VFP has shown a strong correlation between oxidiser injection velocity and solid fuel regression (independent of oxidiser mass flow), providing an additional means to design for optimal O/F operation. The design also demonstrates a decreasing O/F trend (contrary to conventional hybrid operations), providing many interesting implications for non-shifting hybrid rocket performance.

Finally, the VFP offers the potential for a synergistic, multifunctional separation system and hybrid engine. By addressing small spacecraft integration realities, hybrid propulsion becomes a more viable option for the small spacecraft.

## **ACKNOWLEDGMENTS**

The authors would like to thank Mr. Malcolm Paul for sharing his expertise of practical rocket testing and for his assistance during the build and test of the VFP engine. In addition, thanks goes to Vadim Zakirov for his assistance in catalytic decomposition of N<sub>2</sub>O.

## REFERENCES

- [Caravella 96] Caravella, J.R., Heister, S.D., Wernimont, E.J. "Characterization of Fuel Regression in a Radial Flow Hybrid Rocket", 32<sup>nd</sup> AIAA/ASME/SAE/ASEE Joint Propulsion Conference and Exhibit, July 1-3, 1996, Lake Buena Vista, FL.
- [Goldman 96] Goldman, C., Gany, A., "Thrust Modulation of Ram Rockets by a Vortex Valve", Technion- Israel Institute of Technology, Israel, AIAA96-2624.
- [Green 63] Green, L. Jr., "Introductory Considerations on Hybrid Rocket Combustion", AIAA Heterogeneous Combustion Conference, Palm Beach, Florida, Dec 11-13, 1963.
- [Humble 95] Humble, Ronald, W., Henry, Gary, N., and Larson, Wiley J., "Space Propulsion Analysis and Design", New York: McGraw-Hill, Inc., 1995.
- [Marxman 63] Marxman, G.A., Woolridge C.E., Muzzy, R.J., "Fundamentals of Hybrid Boundary Layer Combustion", AIAA Heterogeneous Combustion Conference, Palm Beach, Florida, Dec 11-13, 1963.
- [Sellers 96] Sellers, Jerry J., "Investigation into Cost-Effective Propulsion Systems for Small Satellites", PhD Thesis, University of Surrey, 1996
- [Sutton 92] Sutton, G. P., "Rocket Propulsion Elements", Sixth Edition, John Wiley and Sons, New York, 1992.
- [UoH 99] University of Houston website: [www.ifdt.uh.edu/vtc/rotate.html](http://www.ifdt.uh.edu/vtc/rotate.html)
- [Wernimont 00] Wernimont, E., Heister, S., "Combustion Experiments in Hydrogen Peroxide/Polyethylene Hybrid Rocket with Catalytic Ignition", Journal of Propulsion and Power Vol. 16, No. 2, March-April 2000.
- [Whitehead 99] Whitehead, J., "Progress Towards Hydrogen Peroxide Micro-propulsion", "13<sup>th</sup> AIAA/USU Conference on Small Satellites, Logan, Utah, 23-26 August 1999.
- [Zakirov 00] Zakirov, V., Lawrence, T., Sellers, J., Sweeting, M., "Nitrous Oxide-A Rocket Propellant for Small Satellites", 5<sup>th</sup> International Symposium, Small Satellites Systems and Services, La Baule, 19-23 Jun, 2000.

## NITROUS OXIDE AS A ROCKET PROPELLANT FOR SMALL SATELLITES

Vadim ZAKIROV

*Surrey Space Centre, University of Surrey, Guildford, Surrey, GU2 7XH, UNITED KINGDOM*

Timothy LAWRENCE and Jerry SELLERS

*European Office of Aerospace Research and Development, London, NW1 5TH, UNITED KINGDOM*

Martin SWEETING

*Surrey Space Centre, University of Surrey, Guildford, Surrey, GU2 7XH, UNITED KINGDOM*

**ABSTRACT** – Nitrous oxide as a multi-purpose propellant for small satellites is discussed. Potential space applications of this propellant are given. Performance of nitrous oxide in cold-gas, monopropellant, resistojet, and bipropellant thrusters is compared to other conventional and alternative propellants. Surrey's previous experience and achievements regarding the use of this gas for propulsion applications are reported. A multi-mode nitrous oxide propulsion concept is presented and shown to deliver higher performance in comparison to conventional systems. A nitrous oxide catalytic decomposition technique is suggested for restartable spacecraft propulsion. A conclusion describes the long-term feasibility of novel nitrous oxide propulsion option concepts.

### 1 – INTRODUCTION

The small satellite industry depends on secondary launch opportunities. The limited number of such opportunities restricts the variety of satellite orbits. Therefore, for a spacecraft to continue to exploit the availability of launches and expand its capability for more ambitious communications, remote sensing and science missions, a propulsion system is required.

There are three main propulsion system functions for satellites:

1. Attitude Control - keeping a spacecraft pointed to the desired direction.
2. Orbit Maintenance (station-keeping) - keeping a spacecraft in the desired mission orbit.
3. Orbit Manoeuvring - moving a space vehicle to another desired orbit.

On larger spacecrafts (>500kg), these needs have been traditionally satisfied by the following system options:

- Cold-gas propulsion – mainly using nitrogen for attitude control
- Hydrazine-based systems – for attitude control, station-keeping and orbit manoeuvring
- Solid rockets – for orbit manoeuvring

However, scaling a satellite down imposes unique integration requirements and constraints for propulsion systems. For example, low specific impulse performance of cold-gas propulsion (typically 60s) aggravated by severe volume constraints (propulsion envelope volume of about 7 litres), limits the range of typical (<75kg) micro-satellite orbital transfer manoeuvres to approximately 5m/s. Hydrazine-based systems rely on highly toxic propellants. This demands elaborate system development and pre-flight safety requirements. To reduce mission life-cycle costs, spacecraft manufacturers would prefer to reduce or eliminate this expense that can be prohibitive for small, university-based missions. Solid rocket motors have similar expensive requirements for safety and handling that also increase their life-cycle costs. In addition, the "single-shot" nature of solids makes them unsuitable for multi-thrust mission requirements. Furthermore, micro-satellite power systems deliver <50W (orbit average) making it difficult to cope with the high power demands

(>100W) associated with off-the-shelf electrostatic and electromagnetic propulsion systems. Thermoelectric systems are feasible. However, total power available and the choice of working fluids both are critical to spacecraft integration and will be addressed later in this paper.

To overcome the inherent limitations of existing propulsion technology for small satellites, recent research at the *University of Surrey* has focused on nitrous oxide (N<sub>2</sub>O). Nitrous oxide (known as “laughing gas”, dinitrogen oxide, or dinitrogen monoxide) is a colourless, non-toxic, liquefied gas with a slightly sweet taste and odour. It is non-corrosive and may be used with common structural materials. Nitrous oxide is stable and comparatively unreactive at ordinary temperatures. [Brak 80] It is decomposed into nitrogen and oxygen by heating above 520°C. [Dain 96] Furthermore, this decomposition reaction can be accelerated by a catalyst. At elevated temperatures, nitrous oxide supports combustion. It is classified by the U.S. Department of Transportation as a non-flammable, compressed gas and is shipped with the required “Green Label”. [Brak 80]

Three basic properties of nitrous oxide make it attractive as a multi-purpose rocket propellant:

- Stored as a liquid (~745kg/m<sup>3</sup>) with a vapour pressure of ~51bar (at 20°C)
- Decomposes exothermically with maximum decomposition temperature reaching ~1640°C
- Free oxygen available by decomposition can be combusted with a wide variety of fuels

Taking advantage of these properties space propulsion applications of nitrous oxide may be extended to:

- Cold-gas propulsion for attitude control of a spacecraft
- Monopropellant thruster for spacecraft station-keeping and small orbit manoeuvres
- Hybrid or liquid bipropellant rockets for large orbital manoeuvring

Since the whole range of propulsion functions can be covered by one self-pressurising propellant, multi-mode propulsion systems can be envisioned to satisfy a wide variety mission requirements. Such systems would employ different types of thrusters fed by nitrous oxide from a single, simply designed storage tank.

This paper introduces nitrous oxide as a multi-purpose propellant for small satellites.

## 2 – STORABILITY

To become a feasible option for application, a propellant must be storable on-board a small satellite for the required mission lifetime. Nitrous oxide is a storable propellant that does not require an expulsion system. It can be stored as liquid or compressed gas (above the critical point) through a wide temperature range, limited by thermal decomposition temperature of 520°C [Dain 96] on the upper end and the triple point (-90.8°C) [Brak 80] on the lower end of the scale. The maximum storage temperature limit is dependant on provisioned tank pressure and ullage volume. The practical maximum operational temperature number for designed tank pressure of 200bar would be 60°C. The recommended low operational temperature of -34°C would allow nitrous oxide vapour pressure to stay above 11bar.

Recent experience of storing nitrous oxide on-board the *UoSAT-12* mini-satellite for more than one year indicates that storage of the gas in-orbit is not a problem.

## 3 – PERFORMANCE COMPARISON

The arguments in favour of nitrous oxide application on small satellites are discussed below by comparing it to conventional and alternative propellants.

### 3.1 – Cold-gas

Cold-gas propulsion is typically used for spacecraft attitude control because of its small minimum impulse bit. Ten common, easily available gases were selected for comparison. The results of the comparison are presented in fig. 1.

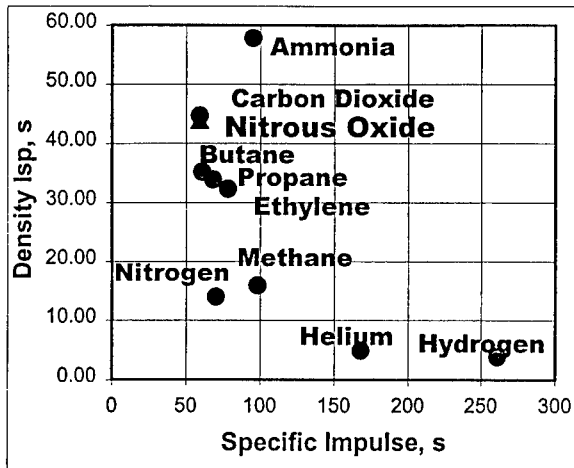


Fig. 1: Theoretical performance comparison of cold-gas propellants. (nozzle expansion ratio = 200)

Although nitrous oxide (along with carbon dioxide) provides the lowest theoretical specific impulse it has the second highest storage density amongst the selected cold-gas propellants. Therefore, it is able to deliver a higher change in total spacecraft velocity per unit volume of propellant (i.e. density Isp) than butane, propane, ethylene, methane, nitrogen, helium and hydrogen, all of which provide higher specific impulses but lower densities. Denser propellants are preferable for small satellites, which are volumetrically constrained by launch requirements as secondary payloads. Nitrous oxide has the third highest density Isp after ammonia and carbon dioxide. Ammonia, however, is a toxic, highly reactive chemical that in combination with air may present an explosion hazard. Ammonia is incompatible with copper, tin, zinc and their alloys. Due to its high triple point, carbon dioxide may solidify in the feed lines and requires a thermal control system. Conversely, nitrous oxide is non-toxic, non-flammable; it has a low triple point and is compatible with common structural materials.

### 3.2 – Monopropellants

Recent achievements in development of nitrous oxide decomposition catalysts for automotive industry have made nitrous oxide monopropellant applications feasible. Theoretical specific impulse of such a thruster is evaluated using the *USAF ISP* computer code written by Curt Selph. The result of the computation is shown in fig. 2. The specific impulse monotonically rises with increasing decomposition temperature until it reaches its maximum at about 1640°C.

The performance of nitrous oxide monopropellant was compared with that of hydrogen peroxide and conventional hydrazine thrusters. (see table 1) The results reveal that a nitrous oxide monopropellant thruster is capable of moderate theoretical specific impulse performance, 16% lower than that of hydrazine but 15% higher than that of hydrogen peroxide thrusters. Each of these propellants can be stored on board spacecraft. Although storage density of liquefied nitrous oxide is 26% lower than that of hydrazine and 45% lower than that of hydrogen peroxide, the low vapour pressure of these two propellants requires the use of a separate propellant expulsion system.

The storage temperature range of nitrous oxide is discussed earlier in this paper. In general, this range is broader than that of hydrogen peroxide and hydrazine. Storage temperature ranges for hydrogen peroxide vary as a function of its concentration. For the case of 89% strength hydrogen peroxide the low temperature limit is defined by a freezing point of -12°C. Five-degree margin between low operational limit and freezing point is a precaution against formation of slush. A similar estimate is applied to hydrazine that has a freezing point of about 2°C. Although the boiling temperature of hydrogen peroxide is 141°C, the strong temperature

dependence of its decomposition rate [JANN 84] limits the storage temperature to below 38°C. For hydrazine the upper storage temperature is limited to 40°C although the boiling point is 113°C.

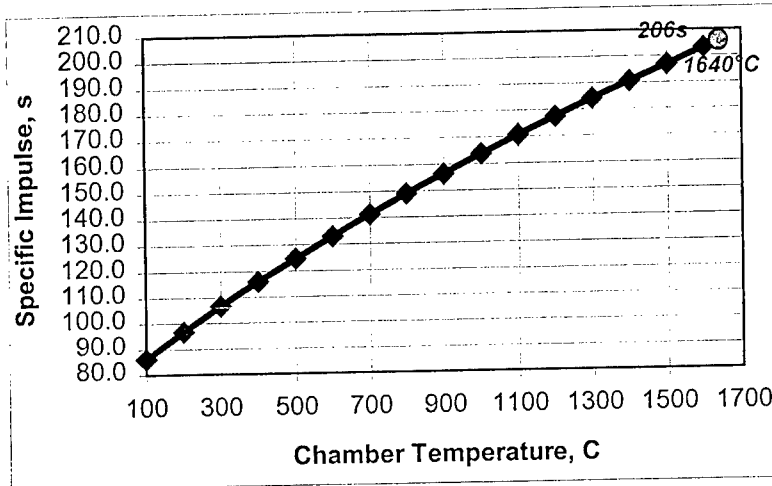


Fig. 2: Theoretical specific impulse of nitrous oxide monopropellant thruster as a function of chamber temperature (chamber pressure = 3bar; nozzle expansion ratio = 200).

TABLE 1: Properties of selected monopropellants.

Propellant	Nitrous Oxide	Hydrogen Peroxide	Hydrazine
Chemical Formula	N <sub>2</sub> O	H <sub>2</sub> O <sub>2</sub>	N <sub>2</sub> H <sub>4</sub>
Specific Impulse (theoretical), s	206	179	245
Storability	Storable	Storable (decomposes)	Storable
Storage Density, kg/m <sup>3</sup>	745 @ 21°C 52.4 bar	1347	1004
Vapour pressure	50.8bar @ 20°C	0.00345bar @ 20°C	0.0214bar @ 26.7°C
Storage Temperature Range, °C	-34—60	-7—38	9—40
Toxicity	Non-toxic	Burns skin	Very Toxic
Flammability	Non-flammable	Non-flammable	Flammable
Flight Heritage	feed system UoSAT-12	flown	flown

Notes: All propellants are stored in liquid state. Hydrogen peroxide is 89% strength. Theoretical specific impulse data obtained for nozzle expansion ratio of 200.

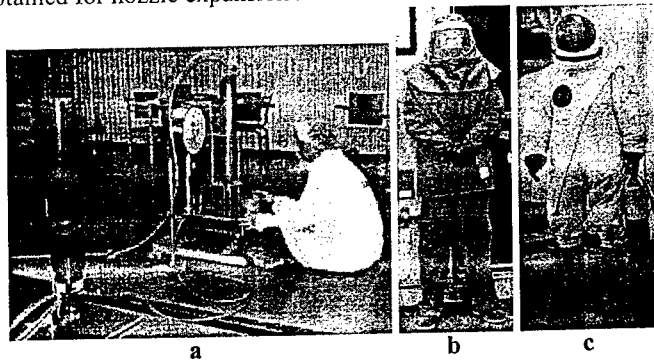


Fig. 3: Protective handling equipment:  
a) UoSAT-12 Nitrous Oxide loading;  
b) Chemical boiler suit for Hydrogen Peroxide handling;  
c) SCAPE suits for Hydrazine and Nitrogen Tetroxide operations



In addition to raw performance, propellant handling is another significant issue to consider. Nitrous oxide handling requires minimal safety equipment (fig. 3a), while splash protection is necessary for hydrogen peroxide (fig. 3b). Complete protection is essential for hydrazine handling (fig. 3c). Nitrous oxide presents no fire or explosion hazard, while hydrogen peroxide may spontaneously ignite on contact with hydrocarbons. Contaminated hydrogen peroxide is unstable and presents a serious explosive hazard. High fire and explosion hazards are associated with hydrazine.

Although a nitrous oxide monopropellant thruster has yet to be flown, the feed system is currently under test on-board the *UoSAT-12* mini-satellite. Hydrogen peroxide monopropellant thrusters were employed on the number of missions. [McCo 65, Sell 96, Whit 98] Presently, hydrazine monopropellant thrusters are an extensively used space technology. [Sutt 92]

### 3.2.1 - Decomposition

A catalytic decomposition technique is suggested for a nitrous oxide monopropellant thruster. Inside the thruster, nitrous oxide decomposes according to the reaction equation:



The reaction generates hot oxygen-rich mixture. Once the heat balance is achieved, this exothermic reaction becomes self-sustaining.

In general nitrous oxide can be decomposed thermally, for example, in a resistojet. Thermal decomposition, however, requires high power input. The activation energy barrier for nitrous oxide is about 250kJ/mole [Atki 97]. Therefore, in order to attain the required rates of thermal decomposition, the gas must be heated to above 1000°C.

A catalyst lowers the activation energy barrier. Thus, the decomposition occurs at much lower temperatures. Another advantage of catalytic decomposition is that once the catalyst is heated to activation temperature, the power input is no longer required to support the process. Therefore, the use of a catalyst leads to significant power savings over thermal decomposition technique employed in a resistojet. This approach makes nitrous oxide propulsion a feasible option for small satellites, extending its application range from mini-satellite (100-500kg) to micro-satellite (10-100kg) platforms.

### 3.2.2 – Results

The potential for nitrous oxide catalytic decomposition technique has been demonstrated in dozens of experimental tests at Westcott test facility of *Surrey Space Centre* (U.K.). During these tests:

- The proof-of-concept was demonstrated.
- Repeatable, self-sustaining, decomposition of nitrous oxide has been achieved using different catalysts.
- Hot restarts at zero-power input have been repeatedly shown in operation.
- More than 50 different catalysts have been tested.
- A catalyst activation temperature as low as 250°C has been recorded.
- Nitrous oxide mass flow rates above 1.1gm/s have been supported.
- Decomposition temperatures in excess of 1500°C have been demonstrated.
- Electrical power input as low as 24W has been used.
- The time required to heat the catalyst from ambient to activation temperature has been as short as 3min.
- A catalyst lifetime in excess of 76min. was demonstrated.

Despite these achievements, the problems associated with high temperature (>1100°C) instability of the catalyst materials remain. Although the existing catalysts work well, high-temperature stable catalyst materials would enhance the performance of a monopropellant thruster. The detailed report regarding nitrous oxide catalytic decomposition research at Surrey will be presented in future publications.

Current research at Surrey is focused on development of nitrous oxide monopropellant thrusters and high-temperature decomposition catalysts.

### 3.3 – Resistojets

Heating a propellant in a resistojet improves specific impulse performance in comparison with cold-gas thrusters. Due to low heat transfer rates, resistojets are preferable for long duration firings. Therefore, orbit maintenance (or station-keeping) is a suitable function for such a thruster. Since power is the major constraint for electric thrusters on small spacecraft, specific impulse of several resistojet propellants is compared (in fig. 4) by consumed energy. From that perspective, an “ideal” resistojet propellant for a small spacecraft would deliver the highest specific impulse at minimum input power. Therefore, it would locate itself towards top left corner of the figure. In this figure, a curve for more efficient propellant would be steeper than that of for a less efficient one. Ordinate axis of the graph corresponds to zero-power operational modes. Two of such modes are possible, when a resistojet is run as a cold-gas system, and when the heat generated as a result of initiated self-sustaining exothermic decomposition reaction is used. This latter feature can be described as a monopropellant mode.

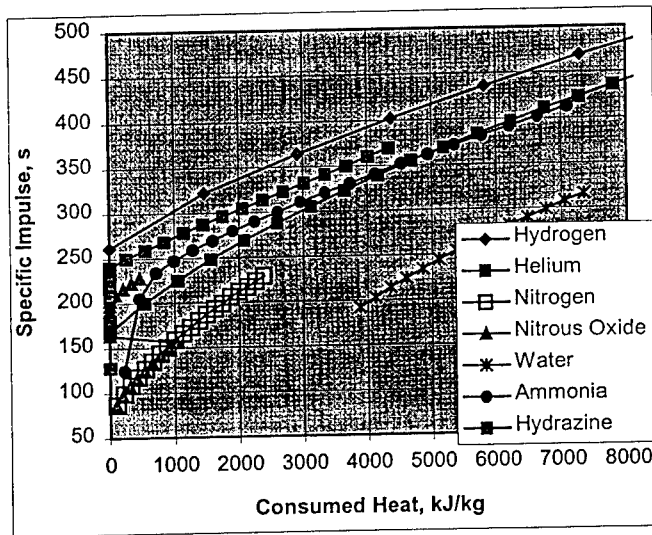


Fig.4: Theoretical performance comparison of resistojet propellants: specific impulse vs. heat required for heating propellant to the process temperature.

From this figure, hydrogen is a good propellant because its basic high specific impulse grows fast with only little additional heating. However, its low density violates volumetric constraints for small satellite discussed earlier. The next best option would appear to be hydrazine.

Nitrous oxide resistojet is a special case. From the start, its performance almost overlaps that of nitrogen resistojet until self-sustaining decomposition is initiated. At that point, power input can be turned off, and the thruster will continue to operate as a monopropellant. Since the maximum temperature of nitrous oxide decomposition (~1640°C) is high, heating of its reaction products in resistojet is impractical due to the challenging choice of high temperature construction materials. Thus, the practical temperature operating range for nitrous oxide resistojet coincides with that of a monopropellant described above. The power savings associated with nitrous oxide catalytic decomposition in a monopropellant, however, support its use instead of resistojet.

On the whole, the specific impulse that can be delivered by hydrazine resistojet is higher than that of nitrous oxide resistojet or monopropellant. However, hydrazine toxicity and higher powers (>100W) required for

such a resistojet might become the prohibitive drawbacks for small satellite applications. In this case, non-toxic nitrous oxide resistojet or monopropellant operating at zero-power mode are desirable. The work on low-power resistojets started at Surrey by Timothy Lawrence in 1995. [Curi 99, Lawr 98, SSTL] Since then:

- The highest recorded specific impulse of the *Mark-III* nitrous oxide resistojet was 148s.
- During vacuum test of the *Mark-III* resistojet at the US Air Force Research Lab at *EDWARDS* Air Force Base, CA, a self-sustaining decomposition was observed for longer than 18 hours.
- The first (0.1N and 100W) nitrous oxide resistojet thruster *Mark-IV* has been successfully commissioned on board the *UoSAT-12* mini-satellite with 2 firings on 27 July 1999 and 11 April 2000 from a 700 km orbit. Discussion of these flight results will be presented in future papers.

### 3.4 – Bipropellants

A hot nitrogen-oxygen mixture generated by nitrous oxide decomposition can be used to combust a fuel. Therefore, bipropellant thrusters employing nitrous oxide as an oxidiser are feasible.

Theoretical performance of several nitrous oxide bipropellant combinations has been evaluated to determine their feasibility for future applications. The consideration criteria are:

- Storability in orbit
- Density Isp (volumetric constraint for small satellites)
- Specific impulse
- Toxicity
- Availability and low cost

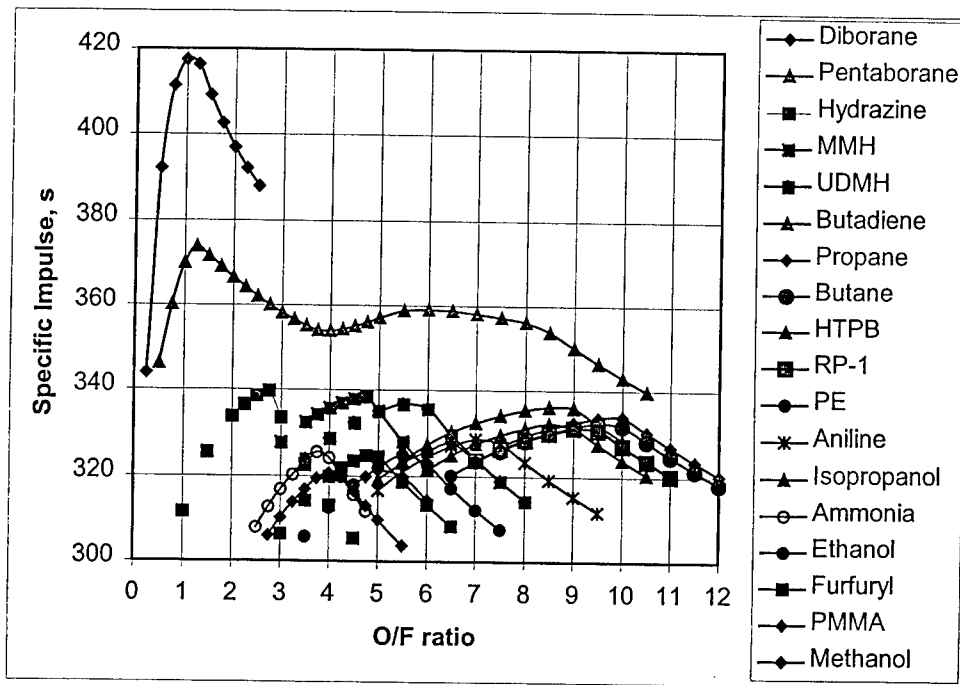


Fig. 5: Theoretical performance of nitrous oxide/fuel propellant combinations. (O/F – oxidiser-to-fuel)

The results of the analysis are presented in figs. 5, 6, and table 2. Toxic boranes and hydrazine family fuels deliver remarkable performance when combusted with nitrous oxide. However, toxicity and other safety factors can significantly raise the total cost of a given mission. For some missions, especially very low-cost

ones such as those undertaken within a University environment, the increased mission safety "overhead" required by the use of these propellants can increase the total system cost to point that the mission is no longer feasible. [Sell 98] For this reason these fuels along with aniline currently are not considered for small satellite applications.

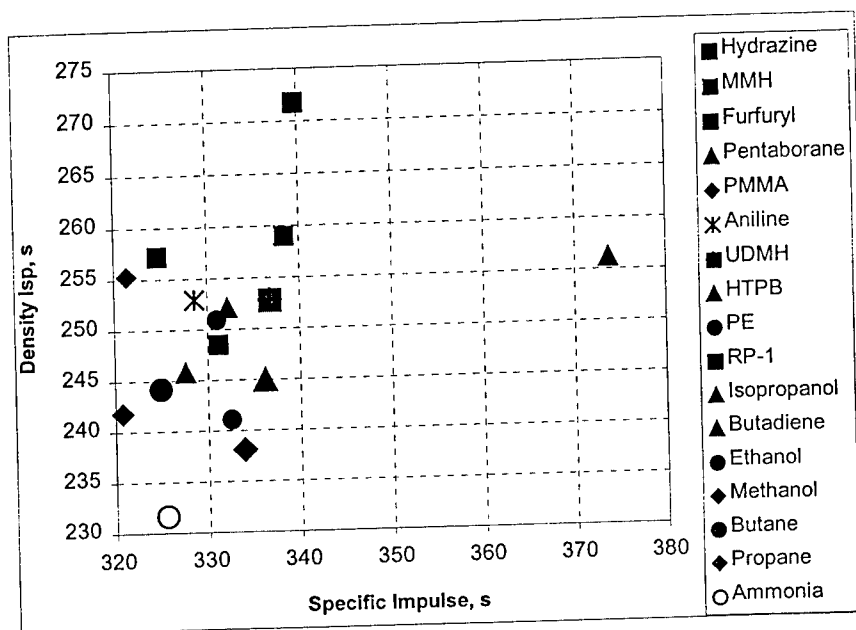


Fig. 6: Theoretical performance of nitrous oxide bipropellants.

Non-toxic plastics (HTPB, PE, and PMMA) along with kerosene deliver moderate performance, are easily available, and inexpensive. Of these, HTPB provides better performance; polyethylene might be preferable due to its ease of being machined; kerosene might be used in liquid rocket engine; PMMA has higher density but delivers lower specific impulse.

Flammable liquefied gases (butadiene, butane, propane) deliver only slightly higher specific impulse performance than non-toxic plastics and kerosene but are less dense. The associated fire hazard, however, would require more careful consideration raising the total system cost. On the whole, they are recommended for small satellite applications.

The performance of alcohols, except furfuryl one, and ammonia are lower than the performance of non-toxic plastics and kerosene. Therefore, they are not preferable fuel options at present. Furfuryl might be employed when tighter satellite packaging is required.

In general, the variety of fuel combinations with nitrous oxide is more numerous. Bowman [Bowm 50] gave theoretical performance examples for some common and exotic fuels. Most of them can be considered as currently impractical for small satellite applications. Gardner [Gard 42] recommended carbon disulfide ( $CS_2$ ) as "the most practical fuel" for use with nitrous oxide. This combination gives high theoretical combustion temperature. Although liquid carbon disulfide has high storage density ( $1255kg/m^3$  at  $20^\circ C$ ), it is highly toxic and flammable. Therefore, at present it is unfeasible on a small satellite.

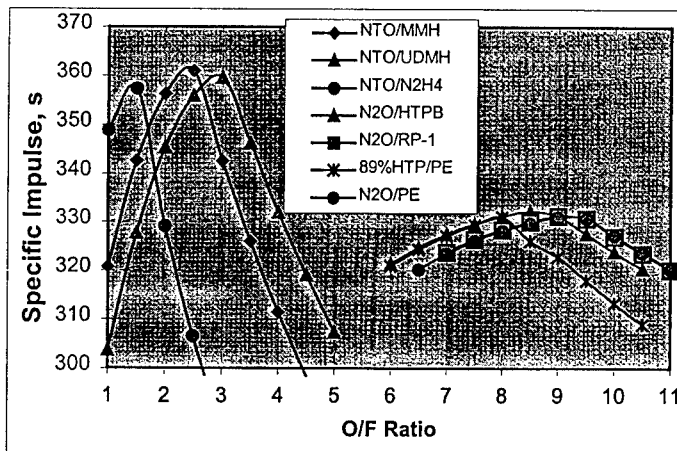
Overall, the comparison reveals that HTPB, PE and RP-1 are three the most practical fuels for nitrous oxide bipropellants on small satellites and upper-stages.

In fig. 7, the performance of these three is compared to conventional propellant combinations. Although the theoretical performance of the non-toxic bipropellants is somewhat lower than that of highly toxic conventional nitrogen tetroxide/hydrazine family propellant combinations it is still high enough (330s) to be considered for small satellite applications.

**TABLE 2: Fuels for use with nitrous oxide**

Name	Alternative Names	Storability	Flammability	Toxicity	Availability	Cost	Remarks
<i>Ammonia</i>	Anhydrous ammonia	l/g	N	T	E	L	Corrosive
<i>Aniline</i>	Aniline oil; aminobenzene; phenylamine	l	N	T	A	M	non-corrosive
<i>Butadiene</i>	1,3- Butadiene	l/g	F	L	E	L	non-corrosive
<i>Butane</i>	n-Butane	l/g	F	L	E	L	non-corrosive
<i>Diborane</i>	Diboron hexahydride; boroethane	g	F	H	D	H	Cryogenic; unstable
<i>Ethanol</i>	Ethyl alcohol; grain alcohol	l	N	L	E	L	
<i>Furfuryl</i>	Furfuryl alcohol	l	N	L	E	L	
<i>HTPB</i>	Hydroxyl-Terminated Polybutadiene; Rubber	s	N	N	E	L	Easily Cast
<i>Hydrazine</i>		l	F	T	A	H	
<i>Isopropanol</i>	Isopropyl alcohol	l	N	L	E	L	
<i>Methanol</i>	Methyl alcohol; wood alcohol	l	N	L	E	L	
<i>MMH</i>	MonoMethyl Hydrazine	l	F	T	A	H	
<i>PE</i>	Polyethylene	s	N	N	E	L	Easily Machined
<i>Pentaborane</i>	Pentaboron; ennahydride; pentaborane-9	l	F	H	D	H	
<i>PMMA</i>	Poly-Methyl Methacrylate	s	N	N	E	L	Easily Machined
<i>Propane</i>	dimethylmethane	l/g	F	N	E	L	
<i>RP-1</i>	Rocket Propellant; Kerosene	l	F	N	E	L	
<i>UDMH</i>	Unsymmetrical DiMethyl Hydrazine	l	F	T	A	H	

Notes: s – solid; l – liquid; g – gas; F – flammable; T – toxic; N – non-flammable, non-toxic; A – available; E – easy; D – difficult; L – low; M – medium; H – high.



**Fig. 7: Theoretical performance of bipropellant combinations using nitrous oxide as an oxidiser. The performance is calculated by USAF ISP computer code. (N2H4 – Hydrazine; N2O – Nitrous Oxide; NTO – Nitrogen Tetroxide)**

Nitrous oxide has already been used in bipropellants. A small research motor called *Hecht* developed by the Germans used nitrous oxide in combination with aqueous methyl alcohol (28% methanol) fuel. [Noeg] American Rocket Company (*AMROC*) used nitrous oxide as an oxidiser in its hybrid rocket motors. [SDHR

00] Presently nitrous oxide is used in amateur rocketry in combination with solid (polypropylene, HTPB, asphalt, etc.) and liquid (alcohols, etc.) fuels. [AIIR, Fink 98, FTSO 97, McGa, RATT] The Space Cruiser System, a fully recoverable and reusable piloted passenger carrying sub-orbital 2-stage space-plane, is proposed on using three nitrous oxide/propane pressure fed, rocket engines. None of these applications, however, were provisioned for in orbit start-up and restart. Meanwhile, start-up in vacuum and in the micro-gravity environment is not a trivial task, and restartability is an essential feature for spacecraft propulsion when more than one in-orbit manoeuvre is required. The technique for nitrous oxide decomposition investigated at the University of Surrey further promotes the use of the gas in bipropellants for restartable spacecraft upper-stages since it has been shown to ignite solid fuel (PMMA). A vortex flow “pancake” hybrid rocket motor was successfully ignited by injection of hot gaseous products of nitrous oxide decomposition into the combustion chamber. [Haag 00] In the test, a well-known hydrazine decomposition catalyst (*Shell 405*) was used to decompose nitrous oxide.

### 3.5 – Multi-Mode Propulsion Systems

Nitrous oxide may be used as a propellant for multi-mode propulsion system. For advanced small satellite missions multi-mode propulsion system operations are essential. Looking at the performance values for individual system applications of nitrous oxide, one may not be convinced of benefit. However, when an integrated system approach is taken, considering the varied propulsion requirements during a typical mission, the versatility of nitrous oxide make it a compelling choice.

Simple dual-mode cold-gas/monopropellant propulsion (fig. 8) is taken out of a variety of possible multi-mode systems as an example to illustrate advantages of nitrous oxide propellant applications. The results of the comparison summarised in fig. 9 show that:

- Starting at the point when velocity change by cold-gas propulsion is ~7% of total spacecraft velocity change, nitrous oxide propellant storage system is more compact than that of hydrazine monopropellant/nitrogen cold-gas;
- Starting at the point when velocity change by cold-gas propulsion is ~13% of total spacecraft velocity change, nitrous oxide propulsion system is lighter than that of hydrazine monopropellant/nitrogen cold-gas;
- The both parameters improve with increasing cold-gas propulsion fraction.

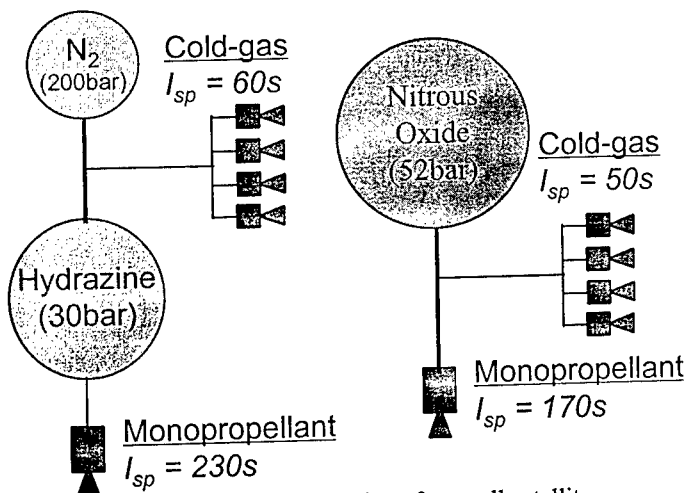


Fig. 8: Schematics of dual-mode propulsion system options for small satellite.

In addition, non-toxic nitrous oxide system is of simpler design than that of using toxic hydrazine propellant.

Furthermore, in the case of nitrous oxide system the propellant may be used till depletion by either mode with no restrictions except provision required for total spacecraft velocity change. Meanwhile, in the case of hydrazine, margins for use of the propellants by each mode must be imposed. Hence, application of nitrous oxide system would give an important advantage of the flexibility in firing strategy during a mission. Therefore, since the propulsion requirements are more relaxed for nitrous oxide systems the number of firings considered in orbit mission scenarios can be increased. This feature is important especially for a spacecraft launched as a secondary payload since launch itself is often undefined until a few months to the launch date.

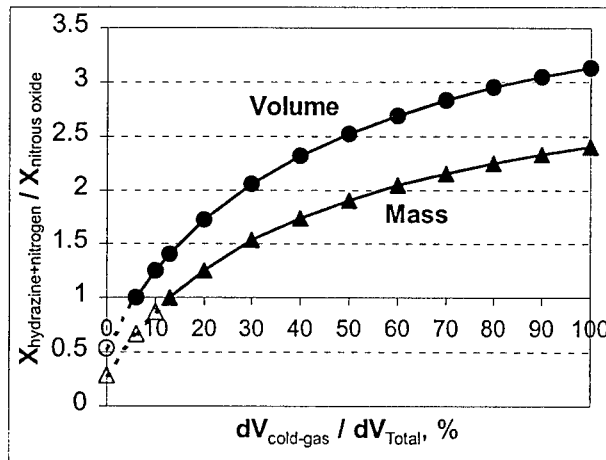


Fig. 9: Performance comparison of hydrazine monopropellant/nitrogen cold-gas to nitrous oxide monopropellant/cold-gas dual-mode propulsion. ( $dV$  – spacecraft velocity change;  $X$  denotes propulsion mass or volume respectively)

#### 4 – CONCLUSIONS

Nitrous oxide is a promising propellant for future low cost, small satellite missions. The research regarding application of this gas as a rocket propellant for small satellites is currently under way at Surrey Space Centre.

The experience obtained shows that:

- It can be stored/operated in orbit.
- It can be decomposed on a catalyst.
- The decomposition generates heat and thrust.
- Self-sustaining nitrous oxide decomposition is achievable.
- Generated hot exhaust can ignite fuel upon contact.

Therefore, nitrous oxide cold-gas, monopropellant, resistojet, and bipropellant thrusters are feasible.

The results of performance comparison of these systems show the application of nitrous oxide:

- Dense, liquefied gas for cold-gas propulsion is beneficial for volume-constrained small satellites.
- Resistojet is beneficial for power-constrained small satellites.
- Monopropellant and bipropellant will reduce major “safety overheads”.
- Multi-mode systems will be more effective over conventional single-mode alternatives.

The following advantages of nitrous oxide multi-mode propulsion offer:

- Higher total spacecraft velocity change performance over conventional single-mode alternatives.
- Spacecraft power budget reduction.
- Design simplicity.
- Ease of packaging and integration on spacecraft.

- Firing strategy flexibility.
- Increased number of mission scenarios and launch opportunities.
- Reduction in propulsion system cost.

To develop nitrous oxide multi-mode propulsion further research is required in:

- Catalytic decomposition for monopropellant thruster application.
- Bipropellant combustion.
- High-temperature stable catalyst materials.

The research will lead to the development of low cost propulsion system for small satellites.

## ACKNOWLEDGEMENT

The authors would like to express their deep appreciation to the following people contributing to this research: Volker Goeman, Peter Slater, Malcolm Paul, Gary Haag, Guy Richardson, David Gibbon, Jeff Ward, Lee Cowie and John Leigh.

This work is partially funded with a research grant from the European Office of Aerospace Research and Development under Contract #994100. Mr Peter Ouzts of NASA Glenn is the program manager.

## REFERENCES:

- [AIIR] AIIR Novel Research Page, "Hybrid Rocket Requirements". Internet:  
<http://business.fortunecity.com/rowling/167/NOVRES.html>
- [Atki 97] P. W. Atkins, L. L. Jones : Chemistry: Molecules, Matter, and Change, 3<sup>rd</sup> Edition, W. H. Freeman and Company, New York, 1997, pp. 685, 691, A10.
- [Bowm 50] N. Bowman : "Nitrogen Dioxide Derivatives in Rocket Fuel", *The Journal of Space Flight*, Vol. 2, No. 4, April 1950.
- [Brak 80] W. Braker, A. L. Mossman : "Matheson Gas Data Book", 6<sup>th</sup> Edition, *Matheson*, 1980.
- [Curi 99] A. S. Curiel, V. Zakirov, D. Gibbon : "Resistojet Research at the University of Surrey", 1999, Internet: <http://www.ee.surrey.ac.uk/CSER/UOSAT/research/resisto.htm>
- [Dain 96] J. Daintith : "A dictionary of chemistry", 3<sup>rd</sup> Edition, *Oxford University Press*, 1996.
- [Fink 98] L. Fink : "Propulsion and Energy: Hybrid Rockets", *Aerospace America*, December 1998.
- [FTSO 97] "Amateur Rocket Attempts Historic Launch on Saturday", FLORIDA TODAY Space Online, March 19, 1997. Internet:  
<http://www.floridatoday.com/space/explore/stories/1997/031997d.htm>
- [Gard 42] T. S. Gardner : "The Rating of Rocket Fuels. I. The Determination of Approximate Relative Ratings by the Use of the Heat Capacities of the Discharge Gases", *Journal of Tennessee Academy of Science*, 17, 1942, pp. 302-308.
- [Haag 00] G. S. Haag, M. N. Sweeting, G. Richardson : "An Alternative Hybrid Rocket for the Orbit Transfer of Small Spacecraft", 5<sup>th</sup> International Symposium, *Small Satellite Systems and Services*, France, 19-23 June, 2000.
- [JANN 84] JANNAF : "Chemical Rocket/Propellant Hazards, Vol. III, Liquid Propellant Handling, Storage, And Transportation", *CPIA Publication 394*, 1984.



- [Lawr 98] T.J. Lawrence : "Research into Resistojet Rockets for Small Satellite Applications", *PhD Thesis*, University of Surrey, UK, 1998.
- [McCo 65] J. C. McCormick : "Hydrogen Peroxide Rocket Manual", *FMC Corporation*, Buffalo, New York, 1965, pp. I-2, III-6, VII-33.
- [McGa] L. McGaffey : "LR-5 Experimental Vehicle". Internet: <http://www.energyrs.com/aero/lr5.htm>
- [Noeg] W. Noeggerath : Preliminary report on the completion of the 'Hecht' power unit; specification of the unit which could be built on the basis of this knowledge, Volkenrode Translation LF 12, GDC/684T.
- [RATT ] R.A.T.T. Works, "Bipropellant and Hybrid Rockets". Internet: <http://www.rattworks.night.net/>
- [SCDS] "Space Cruiser®- Designed for Space Tourism": Internet: <http://www.spaceadventures.com/suborbital/cruiser.shtml>
- [SDHR 00] SpaceDev: "Hybrid Rocket Program", 2000. Internet: <http://www.spacedev.com/>
- [Sell 96] J. J. Sellers : "Investigation into Low-Cost Propulsion Systems for Small Satellites", *Ph.D. Thesis*, University of Surrey, UK, 1996, p.4-8.
- [Sell 98] J. J. Sellers, et al : "Investigation into Cost-Effective Propulsion System Options for Small Satellites," *Journal of Reducing Space Mission Cost*, Vol. 1, No. 1, 1998.
- [SSTL] Surrey Satellite Technology Limited, Internet: <http://www.sstl.co.uk>
- [SVVD] "Space Vehicles – Vehicle Designs", Internet: <http://www.spacefuture.com/vehicles/designs.shtml>
- [Sutt 92] G. P. Sutton : "Rocket Propulsion Elements", 6<sup>th</sup> Edition, *John Wiley and Sons, Inc.*, 1992, p. 18.
- [Whit 98] J. C. Whitehead : "Hydrogen Peroxide Propulsion for Smaller Satellite", 1<sup>st</sup> *Hydrogen Peroxide Propulsion Workshop*, 1998. Internet: <http://www.ee.surrey.ac.uk/SSC/H2O2CONF/index.htm>

## COMBINED AMMONIA PROPULSION SYSTEM

Peter Smith  
Polyflex Aerospace Ltd  
Chellenham, U. K.

### ABSTRACT

*This paper is presented as a discussion document in which a high performance, low cost propulsion system is described. The system is based on the use of ammonia as a cold gas propellant for attitude control and also as the propellant for an arcjet or resistojet for orbit raising and orbit control. The paper describes the storage requirements, vapouriser, (which could be based on the design flown on Exosat in the early '80s), valve drivers, cold gas thrusters, arcjets, arcjet power supply, resistojet, development requirements, performance and ground servicing equipment.*

*The system concept described could be used for geostationary as well as LEO satellites.*

*Such a system offers several improvements over conventional cold gas, hydrazine, bipropellant or electric systems in terms of performance, cost, processing, and risk with reduced operating pressures and safety requirements.*

*The comparable performance and costs with alternative electric, hot gas and cold gas propulsion systems are reviewed for some typical missions.*

### INTRODUCTION

The use of cold gas propulsion systems for attitude control of satellites has been demonstrated many times, for example on ESA's COS-B, Exosat, and Hipparcos. For small, low inertia satellites with fine pointing requirements, there is sometimes no satisfactory alternative to the use of such systems. However, such systems can also offer a low cost solution to the attitude and orbit control requirements of many satellites, and it is this aspect which is considered in this paper.

The ammonia propellant proposed for the cold gas system could also be used in resistojets and arcjet thrusters, thereby offering a wide range of performance figures from the 100s Isp cold gas thrusters through hydrazine equivalent performance for the resistojet to a performance in excess of that achievable with bipropellant systems with the arcjet. The relatively simple system design and low cost components of the Combined Ammonia Propulsion System together with its potential to offer a very wide performance capability leads to an attractive package for future propulsion systems.

Several other aspects of the use of ammonia as a propellant are addressed; such as storage and operation in zero gravity, compatibility, and launch site servicing equipment and associated safety requirements.

### SYSTEM DESCRIPTION

The system described in this paper is based on a number of existing components, and with the exception of the ammonia arcjet and resistojet, are all flight qualified. The system schematic is shown in Figure 1 and shows a redundant system for use on a 3-axis stabilised spacecraft.

Ammonia (ref 1) is stored as a compressed gas at a pressure of 8.5bar at 20C and a density of 0.61gm/cc (ref 2). At 50C the vapour pressure increases to 20bar. Figure 2 shows the approximate relationship between temperature and vapour pressure.

The propellant tank is a simple shell design with no propellant management device necessary, other than an external heater. This heater ensures the propellant supply pressure is maintained at the required value. The environmental temperature requirement drives the tank maximum operating pressure and hence its design. However there are many qualified tanks available with operating pressures in the region of 20bar. The propellant leaving the tank could be in either liquid or vapour form,

but at the inlet to the plenum, the propellant passes through a heated vapouriser which ensures that propellant vapour only flows into the plenum.

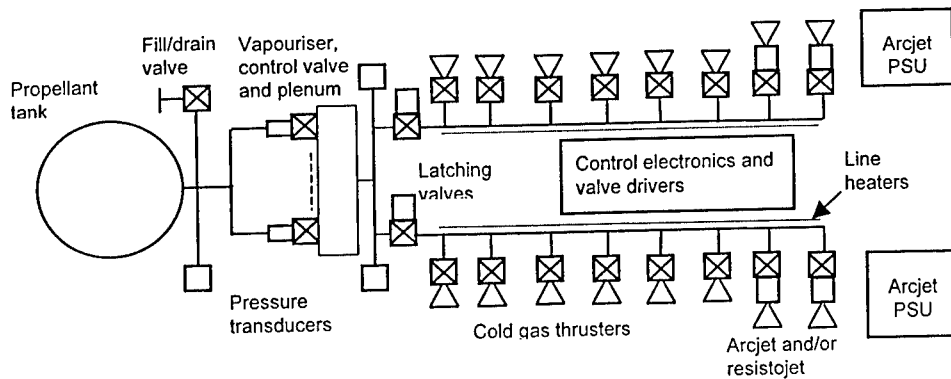


Figure 1

The plenum pressure and temperature are monitored. A logic circuit is used to check that the temperature exceeds a preset value before the flow control valve is opened to admit more propellant into the plenum, so ensuring that the flow control valve is not actuated as a result of low pressure caused by low temperature. The propellant lines to the active set of thrusters are fitted with heaters and temperature sensors to maintain the required line pressure.

The control electronics consists of a number of heater controllers, using thermistors as the active element, and a plenum inlet flow control valve driver which relies on inputs from both the plenum pressure transducer and plenum and downstream propellant line temperature sensors. Each section of pipework is independently monitored and heated to ensure equal pipe temperatures at all points around the spacecraft. For 3-axis stabilised satellites the temperature difference across the structure must be considered.

The heaters consist of derated resistors, bonded to stainless steel pipework, with thermal wrap and low conductivity pipe supports. The use of stainless steel ensures good thermal conduction along the pipe, and keeps the cost down; thermal wrap reduces radiation losses, and resistors are much less costly than foil heaters.

The flow control valves at the inlet to the plenum also act as isolation valves, such that safety requirements for three independent barriers is met with the downstream latching valves and thruster inlet valves.

The performance of cold gas thrusters is maximised if the volume downstream of the thruster valve seat is minimised. Such a design gives sharp pressure pulses when the valve is actuated, so ensuring that the specific impulse is maximised by maximising the pressure at the nozzle throat, and impulse bits are repeatable. (Ref 3,4).

By controlling the plenum and propellant line temperatures, the inlet pressure to all the thrusters may be controlled at the required constant value or varied via ground command.

Variation in arcjet performance with operating lifetime as a result of electrode wear could be accommodated by adjusting the propellant feed pressure. The system described has this capability. As mentioned above, the vapour pressure of ammonia and hence thruster inlet pressure may be controlled by controlling the plenum and line temperatures, as shown below in Figure 2.

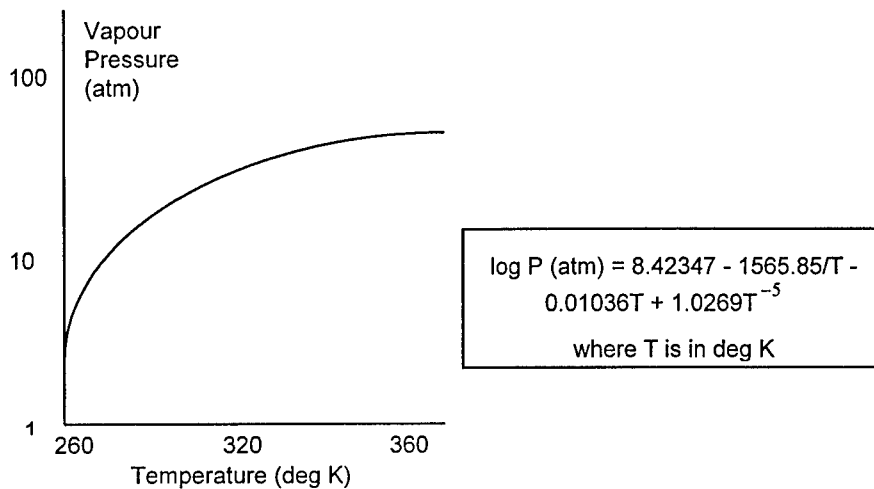


Figure 2

## COMPONENT DESCRIPTIONS

### Propellant Tank

The propellant tank requirements for this application are as follows:

- MEOP of 20bar at 50C
- No Propellant Management Device required
- Tank cooling method to aid propellant loading would be advantageous
- Good thermal conductivity of shell would be advantageous
- Compatible with ammonia
- Fitted with heaters, thermal wrap and temperature sensors.

### Fill and Drain Valve

The fill and drain valve is assumed to be a standard flight qualified unit, of which there are many types available.

### Pressure Transducer

The system is fitted with three pressure transducers, of which one monitors the tank pressure and the other two monitor the plenum pressure. The maximum operating pressure is 20bar, so standard flight qualified units are available.

### Vapouriser

The vapouriser is a heat exchanger designed to ensure that propellant vapour only enters the plenum. The vapouriser consists essentially of a stack of heated stainless steel filter elements or stainless steel wool. The use of stainless steel ensures good thermal conduction from the heater to the filter element and hence to the propellant.

The vapouriser heater power is determined from the maximum propellant flow rate and propellant temperature, and the control electronics is designed to ensure that the vapouriser temperature is always higher than the tank temperature and the critical point.

A sketch of the vapouriser is shown in Figure 3.

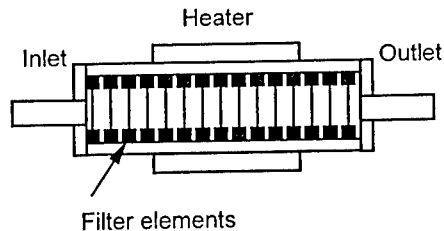


Figure 3

### Flow Control Valve

The flow control valve is a normally-closed solenoid valve, of the same design as the cold gas thrusters, but without the nozzle. Typical requirements are:

- MEOP of 20bar at 50C
- All welded construction
- Compatible materials
- Internal leakage less than 10<sup>-4</sup>scc/s He
- Maximum operating temperature of 80C

### Plenum

The plenum is an all welded construction sized in conjunction with the vapouriser heater to meet the maximum flow rate demand while ensuring that vapour only is fed to the thrusters. The plenum is also fitted with a heater/thermistor combination to maintain the required line pressure. The plenum must be compatible with the propellant and capable of supporting an operating pressure of up to 20bar.

### Cold Gas Thrusters

The cold gas thrusters are normally-closed solenoid valves fitted with nozzles to produce a thrust in the range 20 to 100 mN at a specific impulse of 1000Ns/kg. The volume between the valve seat and the nozzle throat is minimised to produce accurate, repeatable short pulses, of minimum duration in the order of 3ms, at high specific impulse.

### Resistojet

The resistojet consists of a cold gas thruster with a heater and heat exchanger between the thruster valve and nozzle. By raising the propellant temperature, the specific impulse is increased and performance close to that of hot gas monopropellant thrusters can be achieved.

### Arcjet

Hydrazine fuelled arcjets have been qualified and flown (ref 10).

Ammonia fuelled arcjets could readily be developed, based on the hydrazine arcjet experience, and are assumed to produce similar specific power levels. For the purposes of this paper a specific impulse of 4500Ns/kg at 8.2W/mN has been assumed. Because the ammonia feed system offers constant thruster inlet pressure, rather than the usual blowdown method with the hydrazine system, the arcjet performance is assumed to be constant over life.

### Arcjet Power Supply Unit (PSU)

The hydrazine arcjet PSU is of a flight qualified standard, (ref ), with an efficiency of over 90% for a power input of 1.8kW.

One point which has not been addressed to date is the use of one PSU for two or more arcjet thrusters, on condition that the thrusters cannot be operated simultaneously. By connecting in parallel a number of arcjets to a single PSU, such that all the arcjets are 'live' when the PSU is enabled, a reliable, low cost system can be achieved without the use of switching or isolation relays. The propellant flow through the thruster completes the electrical circuit, and this is controlled by the thruster inlet valve.

Redundant thrusters could therefore be fitted to a system without adding additional PSUs.

## Control Electronics

The control electronics is required for the following functions:

- Heater/thermistor monitoring and control of the Tank, Vapouriser, Plenum, Pipework and Resistojet
- Pressure monitoring
- Plenum inlet flow control valve drivers
- Latching valve drivers
- Thruster valve drivers
- Arcjet PSU enable
- Control logic

A redundant set of control electronics is assumed.

All the functional sections of the control electronics have been qualified and flown on various spacecraft in the past. By using thermistors in conjunction with heaters, plus control circuits which allows ground station adjustment, the thermal behaviour of the system can be monitored and controlled to give optimum performance.

## GROUND SUPPORT EQUIPMENT

The ground support equipment required to service an ammonia propulsion system is significantly simpler and has a smaller impact on safety than similar equipment for hydrazine or bipropellant systems.

Ammonia is transferred by heating the supply tank and evacuating and then if possible, cooling the receive tank. The supply tank should be weighed to determine the amount transferred. Trying to rely on tank pressures and temperatures is not recommended.

Other ground equipment consists of an electrical test set and a helium leak detector.

## SYSTEM PERFORMANCE

The specific impulse of the cold gas thrusters is typically 1000Ns/Kg for ammonia (ref 4), and for the ammonia arcjets is between 3000 and 5000Ns/Kg (refs 5,6,7,8,9). Reference 10 describes the flight qualification of a 1.8kW hydrazine arcjet which gives an average specific impulse in excess of 5000Ns/Kg and a total impulse of 866,000Ns at a thrust level of approximately 220mN. With ammonia as the propellant, the specific impulse may be slightly less, as there is no heating of the exhaust gases from exothermal decomposition. However the lower average molecular weight of ammonia when compared with the average molecular weights of hydrazine decomposition products will offset to some extent the inherent thermal energy of hydrazine.

For the comparative analysis below, a specific impulse of 4500Ns/Kg has been assumed for an ammonia arcjet, and 1700Ns/Kg for the resistojet.

The comparison between various systems and applications for mass, power and recurring costs is shown in Table 2.

## CONTENTS GAUGING

The propellant quantity remaining in the storage tank can be determined at any time during the mission by one of two methods.

The first is valid so long as all the propellant is in vapour form, i.e. at conditions above the critical point. Monitoring the tank pressure and temperature (and knowing the tank volume) allows the contents to be determined using the normal gas laws.

The alternative method is applicable if there is a possibility of the propellant being in liquid form. The technique then used is the thermal capacitance method in which a known quantity of heat energy is applied to the propellant tank and the rate at which the tank temperature rises is monitored. In simple terms, a slow rise in temperature is associated with a large quantity of propellant. This process must be repeated several times to eliminate the effects of propellant movement, as the propellant will tend to

vapourise at the heater location. The technique was demonstrated on Exosat with propane propellant, and is also used on Eurostar applications.

#### HARDWARE MASS BUDGET

The hardware mass for a typical system as described in Figure 1 is given below in Table 1. In the case of the propellant tank, a relationship between the tank mass and the propellant mass has been estimated, based on the mass, volume and operating pressure of existing propellant tanks. This gives a tank mass of approximately 15% of the propellant mass assuming a volume of less than 100litres and a maximum operating temperature of 50C, or 20bar. For larger propellant volumes, the tank mass:volume ratio is reduced slightly.

<u>COMPONENT</u>	<u>UNIT MASS (Kg)</u>	<u>TOTAL MASS (Kg)</u>
Tank	-	0.15xMf
Fill/drain Valve	0.1	0.1
Pressure Transducer	0.1	0.3
Vapouriser	0.1	0.2
Flow Control Valve	0.1	0.2
Plenum	0.5	0.5
Latching Valve	0.2	0.4
Cold Gas Thruster	0.1	1.2
Resistojet	0.2	0.4
Arcjet	1.3	2.6
Arcjet PSU	4.3	8.6
Control Electronics	1.0	2.0
Pipework	1.0	2.0
Heaters & wrap	0.5	1.0
Harness	0.5	1.0
Brackets	1.5	3.0

Table 1

#### PROPELLANT BUDGET

The propellant requirements depend primarily on the mission total impulse. Typical values of mission total impulse are given below for an Ariane-launched geostationary mission and a typical LEO mission which requires orbit raising from 300km to 1200km with subsequent de-orbit at the end of life:

Geostationary mission:

- Apogee burn =  $M_o(\text{kg}) \times 1188 \text{ Ns}$  (Ariane)
- NSSK (10 yr) =  $M_{bol}(\text{kg}) \times 460 \text{ Ns}$

where  $M_o$  = launch mass and  $M_{bol}$  = mass at beginning of life on station

Low Earth Orbit Mission

- Orbit raise =  $M_o(\text{kg}) \times 600 \text{ Ns}$  (Typical)
- Orbit decay =  $M_e(\text{kg}) \times 500 \text{ Ns}$  (Typical)

where  $M_e$  is the mass at the end of life on station.

## POWER BUDGET

The power necessary to maintain the propellant at the required inlet pressure is determined by the propellant mass flow rate, the effectiveness of the thermal insulation between propulsion system components and the structure, and the temperature of the environment. With good insulation it is estimated that 10 Watts should be sufficient to maintain the tank, and one vapouriser, plenum and propellant line at around 20C under all normal operating conditions.

The specific heat of ammonia is 2.06 kJ/kg/K, so with a typical flow rate of 50mg/s, the heater input power is around 2 watts assuming a 20K rise in temperature is required.

The power input to the resistojet depends on the performance required and the thrust level. An estimated 100W is required to achieve 170s at a thrust level of 100mN.

For the arcjet, the power requirements are much higher, of the order of 8.2watts/mN. As a result, the array power output, battery capacity and arcjet thrust level can only be determined from a system level study.

One other point to take into account in deriving the required thrust level and hence array power output is the time to achieve the required orbital station.

## COST BUDGET

The cost of a propulsion system is made up of the non-recurring design, development and qualification, and the recurring cost. For this system, with only the ammonia resistojet and/or arcjet requiring qualification, the development costs should be relatively low. Some development effort will be required for the control electronics, but this is seen principally as a packaging exercise, as there is little design or development effort required. Hence the cost budget is limited to a discussion and comparison with other systems of the relative recurring costs.

Table 2 gives this comparison for various systems; 2a for ammonia, 2b for hydrazine, 2c for bipropellant, and 2d for cold gas systems.

## DISCUSSION

The relative merits of the various types of propulsion system are plotted against total mission impulse in Figure 4. This indicates the performance and cost improvements which can be achieved (as the total impulse increases) as a result of selection of the most appropriate propulsion system, and is based on the values of Table 2.

It should be noted that the use of arcjet thrusters (or any other type of electric propulsion) for significant manoeuvres introduces an additional parameter which has not been considered in this evaluation, that of the manoeuvre duration. With a high thrust level, any manoeuvre can be completed within a few tens of hours, but the low thrust levels associated with electric thrusters, such as the arcjets discussed here, require much longer manoeuvre durations which may have commercial implications. This aspect must be included in any specific mission trade-off study.

Other points which should be considered in evaluating the relative benefits of the various systems are:

- the procurement schedule for the equipments
- system budgets
- system complexity, reliability and risk
- safety requirements
- system test requirements
- propellant loading requirements
- in-orbit monitoring, control and adjustment

The cost of a programme is often related to its duration. Short, intensive programmes can be more cost effective than longer ones, especially if recurring system designs are used. With the exception of the propellant (and in some cases pressurant) tanks, especially if titanium alloy forgings are required, the lead time for most off-the-shelf equipments can be restricted to around 6 months. The delivery timescale of the titanium forgings tends to drive the overall schedule of a propulsion system. The use of stainless



steel or even aluminium alloy as a material for the propellant tank can help reduce this. In the case of the ammonia system, the majority of the equipments are off-the-shelf with short delivery timescales. Only the tank is a potential driver, but if stainless steel is used, this is no longer the case.

The mass and power budgets are covered in Table 2. For the ammonia system, the thermal design is more important than for the other systems, but with the use of an active control system using the output from thermistors to allow ground-control updating of the heater/thermistor set points, the required temperatures can be achieved and maintained under all orbital conditions. This technique also reduces the amount of effort needed at the design stage, and reduces the risk of any design errors.

The complexity of the design of the system generally drives the system cost. Because the ammonia system is relatively simple, the costs associated with procurement, assembly and test are low.

The safety requirements of the ammonia system have a much smaller impact on cost than for a hydrazine or bipropellant system, as the operating pressures are lower and the propellant is much less hazardous. When compared with a cold gas system, the high storage pressure creates a significant safety hazard at system level and for loading. If the temperature of the storage tank could be kept to 20C while on the ground, i.e. in a manned environment, the tank could be designed for a 4:1 burst factor, so reducing further the recurring cost by minimising tank testing. Specifically, by designing to a 4:1 burst factor, the NDT requirements associated with fracture mechanics and crack propagation can be eliminated, so a lower cost product can be offered.

System test requirements are limited for the ammonia system to the usual proof pressure, leakage and electrical tests, plus a comprehensive thermal vacuum test to validate the thermistor/heater set points and to check the pressure control system. Such tests could be performed using nitrogen as a simulant. Because the system operates at a relatively low pressure, the risk of failure due to leakage is also reduced.

The equipment required for propellant loading is mentioned above and is simpler and lower risk than the hydrazine or bipropellant equivalents.

In-orbit monitoring and control is similar to equivalent systems, but the ability to change thrust levels simply by altering the plenum and line temperatures and hence thruster inlet pressure is unique to this type of propellant.

## CONCLUSIONS

The cost effectiveness of using ammonia as a propellant for many spacecraft applications is apparent from this brief review. Further studies are required for specific applications, and other additional relevant parameters may need to be considered, such as the duration of an orbit raising manoeuvre, and the possible commercial considerations.

The use of a low risk, low cost, high performance, common monopropellant for thrusters for all aspects of spacecraft propulsion is a major advantage over the current generation of propulsion systems. For all satellites therefore, the Combined Ammonia Propulsion System should be considered.

## REFERENCES

1. MIL-P-27406
2. USAF Propellants Handbook (AFRPL-TR-69-149)
3. Smith P., 'Performance and Design of an Attitude Control Subsystem using Nitrogen Dioxide as a Cold Gas Propellant'. AIAA-88-3285.
4. Smith P., 'Design and Performance of Low Thrust Cold Gas and Hot Gas Thrusters using Vapour Phase Propellants'. IAF-88-240.
5. Ghislanzoni L, Petagna C, and Trippi A., 'The Application of Arcjet Propulsion Systems for Geostationary Satellites'. AIAA-90-2548.
6. Curran F M, Sarmiento C J., 'Low Power Arcjet Performance Characterisation.' AIAA-90-2578.
7. Sovey J S, et al., 'Development of Arcjet and Ion Propulsion for Spacecraft Stationkeeping.' IAF-92-0607.

8. Cruciani G, and Deininger W D., 'A 300hr Endurance Test of an Arcjet Thruster at 1kW'. AIAA-93-1900
9. Knowles S C, Yano S E, Aadland R S., 'Qualification and Life Testing of a Flight Design Hydrazine Arcjet System'. AIAA-90-2576.
10. Smith R D, Roberts C R, and Aadland R S., 'Flight Qualification of the 1.8kW MR-509 Hydrazine Arcjet System'. IEPC-97-081.

	<u>Unit Mass</u> (kg)	<u>System Mass</u> (kg)	<u>Unit Power</u> (kW)	<u>System Power</u> (kW)	<u>Unit Cost</u>	<u>System Cost</u>
<b>Ammonia System</b>						
Tank	0.15xMf	0.15xMf	0.003	-	20	20
Vapouriser etc	0.7	1.4	0.004	-	10	20
Latching valves	0.2	0.4	0	-	10	20
Cold gas thrusters	0.1	1.2	0.005	-	5	60
Resistojets	0.2	0.4	0.1	-	20	0 (40)
Electronics	1.0	2.0	0.010	-	50	100
Pipes, bkts, heaters and sensors	3.7	7.4	0.003	-	20	40
<b>TOTAL</b>	-	<b>12.8+tank</b>	<b>0.125</b>	-	-	<b>260 (300)</b>
Ammonia arcjet	1.3	2.6	1.5	-	75	150
Arcjet PSU	4.3	8.6	0.15	-	100	200
<b>TOTAL</b>	-	<b>24.0+tank</b>	<b>1.775</b>	-	-	<b>610 (650)</b>

Table 2a Ammonia System

	<u>Unit Mass</u> (kg)	<u>System Mass</u> (kg)	<u>Unit Power</u> (kW)	<u>System Power</u> (kW)	<u>Unit Cost</u>	<u>System Cost</u>
<b>Hydrazine System</b>						
Tank	0.12xMf	0.12xMf	0	-	50	50
Latching valves	0.2	0.4	0	-	10	20
Thrusters	0.35	4.2	0.010	-	30	360
Electronics	0.6	1.2	0.010	-	40	80
Pipes, bkts, heaters and sensors	3.7	7.4	0.010	-	20	40
Pressurant tank	0.1xMf	0.1xMf	0	-	30	30
Pressure regulator	1.0	2.0	0	-	20	40
Isolation valves	0.2	0.8	0.020	-	5	20
<b>TOTAL</b>	-	<b>16.0+tank</b>	<b>0.050</b>	-	-	<b>640</b>
Hydrazine arcjet	1.3	2.6	1.5	1.5	75	150
Arcjet PSU	4.3	8.6	0.15	0.15	100	200
<b>TOTAL</b>	-	<b>27.2+tank</b>	<b>1.70</b>	-	-	<b>990</b>

Table 2b Hydrazine System

	<u>Unit Mass</u> (kg)	<u>System Mass</u> (kg)	<u>Unit Power</u> (kW)	<u>System Power</u> (kW)	<u>Unit Cost</u>	<u>System Cost</u>
<b>Bipropellant System</b>						
Tanks	0.1xMp	0.1xMp	0	-	40	80
Latching valves	0.2	0.8	0	-	10	40
Thrusters	0.5	6.0	0.010	-	40	480
Electronics	1.0	2.0	0.020	-	50	100
Pipes, bkts, heaters and sensors	5.7	11.4	0.020	-	40	80
Apogee engine	5.0	5.0	0.050	-	100	100
Pressurant tank	0.1xMp	0.1xMp	0	-	30	30
Pressure regulator	1.0	2.0	0	-	20	40
Isolation valves	0.2	0.8	0.020	-	5	20
<b>Total</b>		<b>22.6+tank</b>		Minimal		<b>970</b>

Table 2c Bipropellant System

	Unit Mass (kg)	System Mass (kg)	Unit Power (kW)	System Power (kW)	Unit Cost	System Cost
<b>Cold Gas System</b>						
Tank	0.6xMf	0.6xMf	0	-	50	50
Thrusters	0.1	1.2	0.010	-	5	60
Electronics	0.5	1.0	0.010	-	20	40
Pipes, bkts, heaters and sensors	3.5	7.0	0	-	20	40
Pressure regulator	1.0	2.0	0	-	20	40
Isolation valves	0.2	0.8	0.020	-	5	20
<b>Total</b>	-	<b>12.0+tank</b>	-	Minimal	-	<b>250</b>

Table 2d Cold Gas System

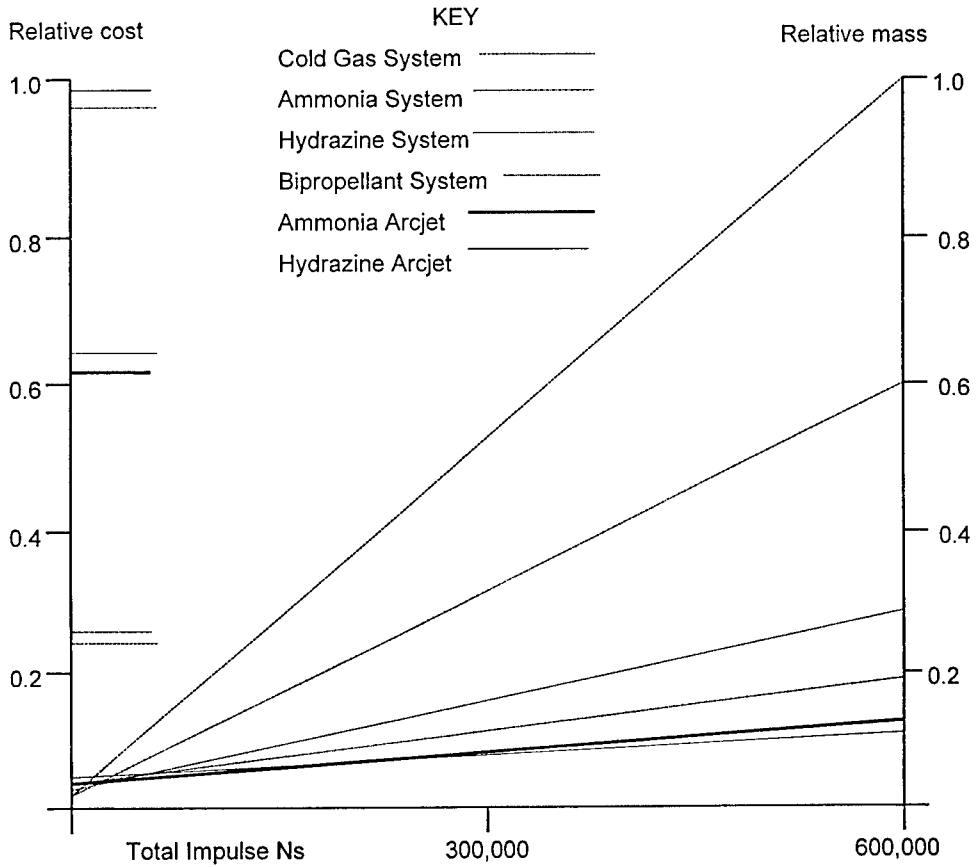


Figure 4

---

## ORBIT CONTROL OF MITA-CLASS SATELLITES WITH FEEP ELECTRIC PROPULSION SYSTEM

Paolo BIANCO<sup>1</sup>, Luca DE ROCCO<sup>1</sup>, Ossama M. M. OMER<sup>2</sup>,

<sup>1</sup>: Small Satellite Dept., Carlo Gavazzi Space SpA,

<sup>2</sup>: visiting researcher from NARSS, Egypt, at Carlo Gavazzi Space SpA.

Tel. +39.02.38048.1

Fax. +39.02.3086458

e-mail: pbianco@cgspace.it, lderocco@cgspace.it

Via Gallarate 150, 20151 Milano, Italy

**ABSTRACT** - The late technology developments and the demand for low-cost space missions have raised the interest in small satellites and in their potential use, especially for remote sensing missions.

Such missions are becoming increasingly challenging in terms of target observation schedule and precision: orbit control is therefore starting to become a must also for small satellite that, in previous missions, did not have any. This is the case of MITA (Advanced Technology Italian Minisatellite), a multipurpose small satellite platform.

Yet, "small satellite" should still mean "cheap satellite": adding a propulsion system for performing orbit manoeuvres and control shall not impact the low-cost philosophy that is typical of these small satellite missions.

The present paper introduces a novel system based on FEEP (Field Emission Electric Propulsion) technology featuring a low-thrust plug-on propulsion unit and its application on MITA class satellite for orbital manoeuvres and orbit control.

Thanks to the self-contained concept of FEEP thrusters and to the plug-on feature of the whole system, a very low cost-impactive propulsion system can be implemented onboard MITA class satellites. Thus, MITA class satellites will be capable to perform both orbital manoeuvres (orbit rising and adjusting, constellation / formation deployment) and orbit maintenance (drag compensation, station keeping relative to ground targets or to other satellites).

Most convenient strategies to operate such propulsion systems with respect to orbital requirements, in terms of orbit control and orbital manoeuvres, are presented and discussed as well as practical case study and simulations results performed at Carlo Gavazzi Space.

## 1 INTRODUCTION

### 1.1 About FEEP Propulsion System Concept

#### 1.1.1 Propulsion System Concept

FEEP technology, whose acronym stays for 'Field Emission Electric Propulsion', is characterised by a very high specific impulse and a very high specific power consumption in order to achieve such

impulse. Nevertheless the overall process efficiency -in terms of electric power transformed into propulsion power- remains rather high (actually the highest) when compared with other electric propulsion concepts.

So far, field emission thrusters have been envisaged only for:

- for large satellites only
- as attitude thrusters and/or low-authority altitude maintenance thrusters only. In fact, FEEP technology represents a world benchmark for residual atmospheric drag build up counteracting and/or drag-free flying propulsion.

Following these considerations, at Carlo Gavazzi Space SpA we have first thought to fit small field emission thrusters to MITA (Advanced Technology Italian Minisatellite) class satellites (around 150 - 250 kg) for drag compensation. Then, as formation deployment needs arose, we have tried to accommodate them with FEEP thrusters too.

Following the successful results of such study, we have also investigated the feasibility of other orbit transfer manoeuvres like orbit rising and lowering, inclination and eccentricity adjustment.

Again, the feasibility of such manoeuvres has been confirmed, so that the FEEP propulsion system envisaged for MITA class satellites has established itself as a compact, plug-in, impact free and low-mass solution for the low segment of small satellites that have not onboard propulsion autonomy as baseline.

With an ability to deliver up to 80 m/s  $\Delta V$  (or even more) and an overall mass (propellant included) of less than 8 kg, the FEEP propulsion system for MITA is basically an orbit control propulsion system that is also able to perform orbit transfer manoeuvres when needed.

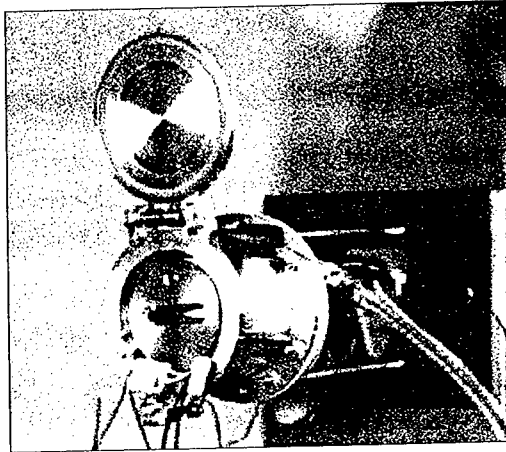


Fig. 1: A single FEEP thruster in its case (set open) on a test rig.

Forthcoming optimisations in terms of electric power consumption and component masses, will further benefit the application of a FEEP propulsion system on minisatellites.

#### 1.1.2 Rationale for FEEP Propulsion System

A lot has been reached in terms of attitude performances for minisatellites, so that now is possible to have minisatellites almost peering larger satellites in term of pointing knowledge, accuracy and stability.

Yet, some applications that could be fulfilled in terms of attitude requirements are currently out of reach because of their requiring certain autonomy of on board propulsion.

Examples of these missions are remote sensing of specific and limited target areas and formation flying in general.

On board propulsion on minisatellites is limited to either general orbit transfer manoeuvres (e.g. orbit rising, inclination changes, station acquisition) or orbit maintenance (altitude maintenance of various kinds, eventually up to some envisaged drag-free flying configurations).

In both cases, the impact of the propulsion subsystem is rather heavy on the spacecraft design, becoming one of the design drivers of following subsystem:

- attitude determination and control subsystem
- structural subsystem
- thermal control subsystem

Following these considerations, the mission designer faces trade-offs between on board propulsion autonomy and launch vehicle performances: the lesser the autonomy of the spacecraft, the more the requirements on the launch vehicle. This means that if the designer wants to reduce spacecraft costs she/he has to spend more on the launch and vice-versa. A balanced solution can be sometimes found, yet this would be far from robust for a minisatellite: small fluctuations in launch vehicle costs would result in major programme cost variations.

For certain missions needing both capability of general orbit transfer and orbit (or formation) maintenance, it is either possible to carry the mission with a larger (by far) class of satellites or to produce a custom minisatellite that should be a kind of technology jewel. In the former case we are not talking about minisatellite anymore, in the latter case "minisatellite" does not mean cheap satellite anymore.

Piggyback launched minisatellites can easily be part of this category needing both orbit transfer and orbit (or formation) maintenance capability. The same fact of being piggyback flyers, thus belonging to low-cost missions, makes an on board propulsion subsystem to be a conceptual contradiction because of its high additional cost.

Thus, some of the minisatellite potentialities resulting from improved Attitude Control Subsystem (ACS) performances are anyway limited by on board propulsion autonomy that usually results in relatively high costs.

These are either higher costs related to main redesign of the minisatellite system because of on board propulsion presence or higher costs related to a dedicated launch.

In particular missions needing precise orbit injections and orbit maintenance, minisatellites could be not applicable because of costs of the needed technology in terms of on board propulsion.

From today on, a novel propulsion subsystem devised at Carlo Gavazzi Space for MITA class based on FEEP technology, is going to revolutionise on board propulsion autonomy of small as well as of minisatellites. It makes general orbit transfer and/or orbit maintenance affordable and applicable at low cost to minisatellites, the only price to pay being an extended manoeuvring time.

### *1.1.3 Advantages and Disadvantages of FEEP Propulsion System for Minisatellites*

FEEP thruster technology is one of the best candidate as minisat propulsion technology because of its self contained characteristics (low mass, low size, no pressurised vessels, no plumbers) and because of its very-low impact on the remaining minisat subsystems (see above).

With respect to available solutions, for a minisat would be possible to eliminate the control electronics box (80% of propulsion system mass) by adding one (or more) board in the OBDH unit (control electronics of propulsion) and one (or more) board in the PDU (for high voltage supply to thrusters). This can reduce the overall propulsion system mass up to 30% with respect to what presented above, with no impact on performances.

Thanks to its thrust generation features, it is possible to perform very fine orbit control (up to drag-free) as well as orbit transfer manoeuvres limited by available time. Also, thanks to the very low-thrust features, propulsion induced torques can be easily managed by ACS with a minimum of on-board autonomy, so that ground segment costs can be reduced also during long manoeuvres. Fine orbit control capabilities of FEEP are only limited by available GPS precision, thus allowing extremely fine constellation and/or formation control capabilities. Following, in Fig. 2 are presented the advantages of FEEP thruster technology with respect to other thruster technologies, while in Fig. 3 are presented the disadvantages.

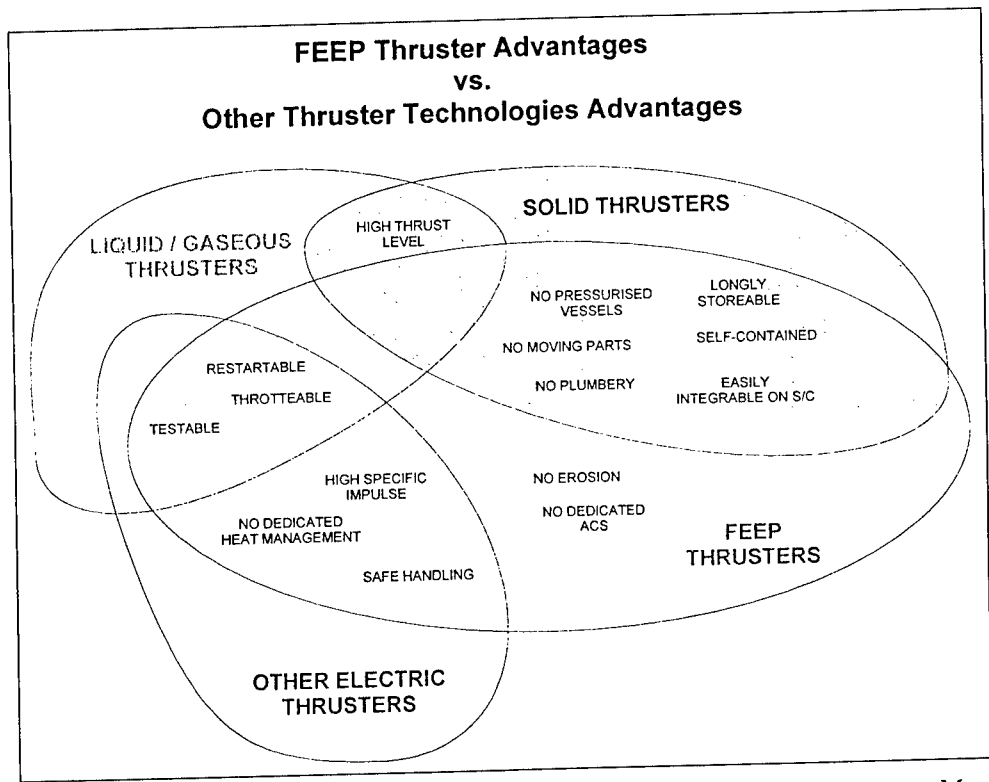
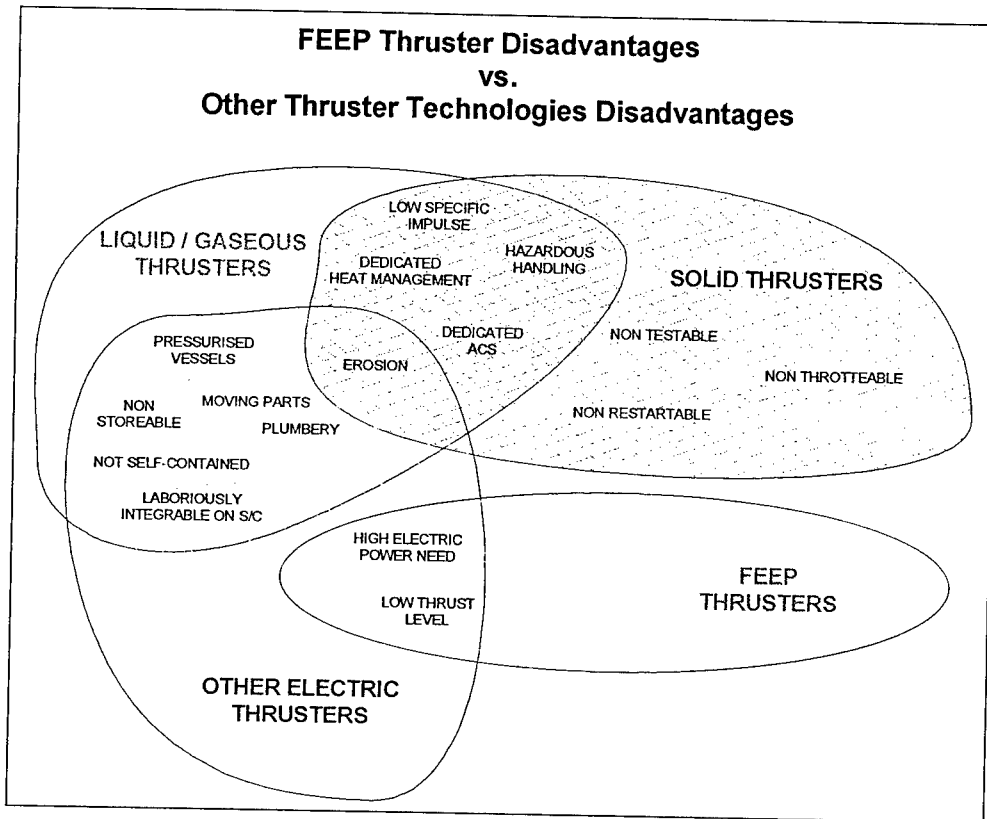


Fig. 2: FEEP thruster advantages with respect to other thruster technologies advantages. Most required advantages of other technologies are common to FEEP technology too.





**Fig. 3:** FEEP thruster disadvantages with respect of other thruster technologies disadvantages. Whilst retaining almost all advantages of other technologies, the main disadvantages are only low thrust and high electric power need, which are common to all electric propulsion technologies.

## 1.2 FEEP Propulsion Subsystem for MITA Class Minisatellite

### 1.2.1 Propulsion System General Description

#### 1.2.1.1 General Architecture

The presented propulsion system is made up by following components:

- 2 FEEP thrusters, 0.5 mN each
- thruster casing and casing cap
- control electronics
- internal harness and system interface

The field emission thrusters of the proposed propulsion system are designed and produced by Centropazio.

Typically, thrusters of the presented propulsion system shall be mounted on the wake panel of a microsat class spacecraft: this allows performing orbit maintenance routine without leaving the

nominal attitude in the most common case of a Nadir-pointing attitude. Other thrust directions can be achieved by turning the spacecraft around its yaw axis.

The thrusters' thrust axes are aligned along the geometric line that joins the thrust centre with the spacecraft gravity centre, since this would ideally prevent the generation of a thrust induced torque during nominal firing of both thrusters.

In the real world, thrust induced torques are anyway existing because of mounting tolerances. These torques can be easily handled by the attitude control system.

Major torques are generated when one of the two thrusters is failed: also in this case, the attitude control system can bear a long heavy-duty manoeuvre by means of a frequent reaction/momentum wheels desaturation.

Thruster firing is decided and commanded by the allocated computer unit of the spacecraft. The propulsion subsystem control electronics carries on firing procedures and yields back housekeeping data on the propulsion subsystem status.

In following Fig. 4, the positioning of the two FEEP thrusters with respect to a nadir pointing spacecraft is presented in a sketch. Accelerator grid, neutralisers and thruster casing have been blanked for the sake of clarity.

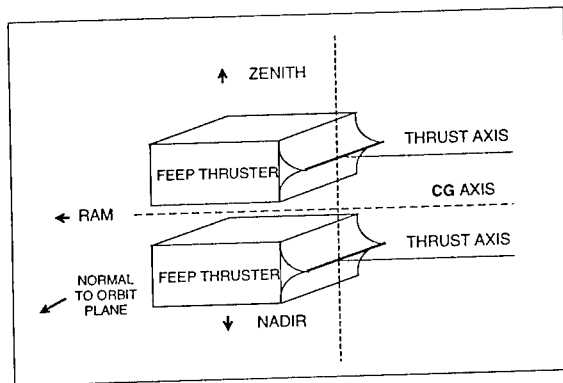


Fig. 4: FEEP thruster alignment with respect to a nadir pointing spacecraft axes.

#### 1.2.1.2 Technical Characteristics

In following table 1, the main envisaged technical characteristics of the proposed propulsion subsystem are presented.

Such Fig.s are coming from existing laboratory hardware, which is not optimised for mass and power savings: this is clearly a conservative perspective. Nevertheless, the presented Fig.s will become better as the optimisation of flight hardware will proceed and could further improve as FEEP technology will progress.

"Baseline" indicates the characteristics that have so far been assumed for minisatellites, while "Range" indicates reasonable boundaries of customisation within which is possible to investigate applicability to various missions.

Technical Characteristic	Baseline	Range
Nominal Thrust (single thruster)	0.5 mN	0.25 - 2.0 mN
Nominal Thrust (whole subsystem)	0.5 - 1.0 mN	0.25 - 4.0 mN
Nominal Specific Impulse	6000 s	6000 s
Electric Power Specific Consumption	60 W/mN	60 W/mN
Heaters & Neutralisers Power Consumption	3 W	3 - 6 W
Control Electronics Power Consumption	6.5 W	6.5 W
Propellant Mass	200 g	20 - 500 g
Overall Subsystem Mass (propellant, electronics & harness included)	7.5 kg	6 - 10 kg

**Table 1:** technical characteristics of the presented propulsion system and its customisation boundaries.

### 1.2.1.3 Optional Propulsion System Architectures

According to mission requirements and spacecraft design choices it is also possible to envisage optional architectures of the presented propulsion systems.

The core of the system is represented by what stated above (2 FEED thrusters, thruster casing and casing cap, control electronics, internal harness and system interface as shown in Fig. 5), to which further thruster clusters (1 or 2 FEED thrusters, thruster casing and casing cap) might be added.

This will allow to have more thrusters aiming in different directions and those avoiding attitude manoeuvres that would be necessary to repoint the spacecraft in order to fire in other directions than the nominal one.

As example, is possible to have a further thruster cluster on the ram panel (as shown in Fig. 6), so that is possible to fire in two opposite directions without turning the spacecraft of 180 degrees each time. Assuming we have a nadir pointing spacecraft, this would be particularly helpful for orbit inclination adjustments: by turning the spacecraft of 90° around the yaw axis, we need to fire one cluster for half orbit and the other one for the remaining half orbit, instead of turning the spacecraft of 180° each half orbit to redirect the thrust of a single thruster cluster.

In such a way is possible to have just two attitude manoeuvre for the whole inclination adjustment duration, instead of two attitude manoeuvres per orbit.

Another example is to fit clusters of lower thrust in other directions (than the along-the-path one) that need to be controlled for formation flying.

The main strategy is to fire one cluster per time, thus maintaining power request of propulsion system as the one for a single cluster only.

The penalties to pay are the weight of the additional thruster clusters (around 1 kg each) and to provide the control electronics with internal interfaces (and harness) for such additional clusters.

Decision upon optional architectures of the presented propulsion system is anyway a system level decision up to mission analysts and designers: if such optional architectures are going to benefit the overall mission, then they can be available.

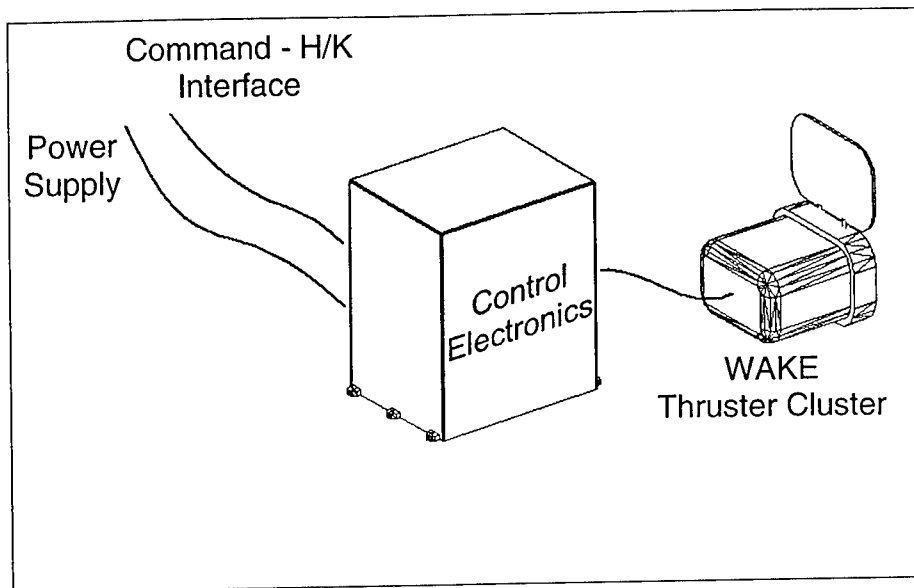


Fig. 5: FEPP propulsion system in its baseline configuration (only one cluster with two thrusters on the spacecraft wake side).

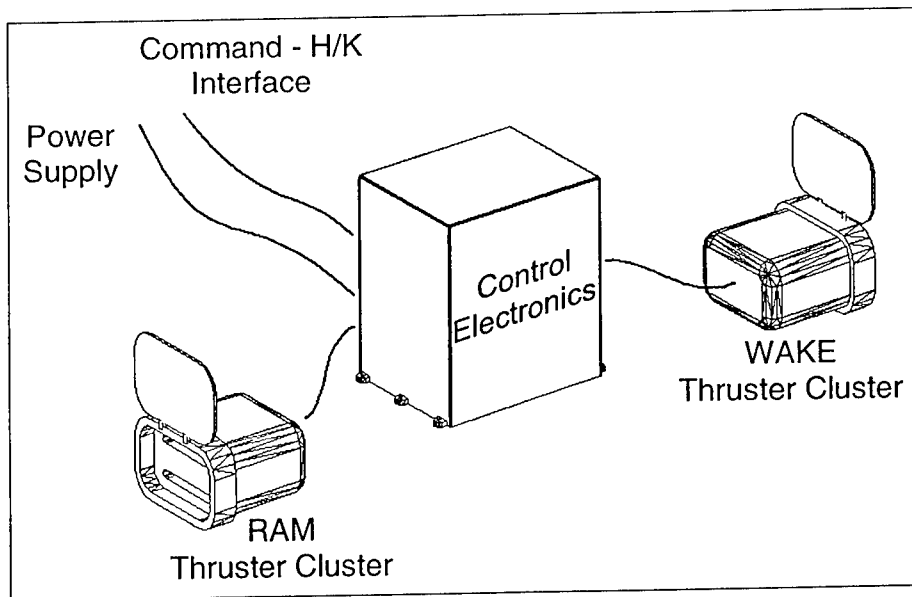


Fig. 6: FEPP propulsion system in one of the possible optional configurations (two clusters with two thrusters each, on both ram side and wake side).

## *1.2.2 Capabilities of the proposed system*

### *1.2.2.1 Orbital Manoeuvring with FEEP Propulsion System*

Possible manoeuvres for low-thrust propulsion are the same achievable with chemical propulsion, generally excluding impulsive ones.

Because of the low-thrust, when compared with chemical propulsion, electric propulsion features longer manoeuvring time but, thanks to higher specific impulses, much smaller propellant mass for a given  $\Delta V$ .

The achievable  $\Delta V$  is not actually limited by any particular constraint: generally, keeping manoeuvring time within certain limits, which are held as reasonable, is the limiting factor for the maximum  $\Delta V$  of a manoeuvre.

For FEEP technology, because of the inherent high specific impulse (from 6000 up to 10000 s), for a given amount of available electric power the resulting thrust is much lower, so all about general electric propulsion is more enforced.

The thrust level becomes 'very-low', the amount of propellant for a given  $\Delta V$  becomes practically negligible, when compared with traditional chemical propulsion, and manoeuvring times become the real limiting factor of this technology.

Another important parameter is the very-low-thrust authority on residual atmospheric drag: the larger is this latter one, the more manoeuvres will be affected in terms of manoeuvring time and also estimation errors. At certain low orbital altitudes, atmospheric drag becomes as big as the available thrust and all margins for manoeuvring are eroded. Such critical orbit altitude can be as high as 350-400 km.

Therefore, with a very-low-thrust on board electric propulsion system, such as the presented one based on FEEP technology, is possible to perform orbit rising, orbit lowering, station acquisition (by combining orbit rising and lowering) and also orbit inclination adjustments, only limit being the available time for manoeuvring.

### *1.2.2.2 Possible Orbital Manoeuvres*

Unless one of the above mentioned optional propulsion system architecture is adopted, in order to achieve different thrust directions it is necessary to operate attitude manoeuvres with the whole spacecraft, since thrusters are both fitted aiming to the same direction. Useful directions are these contained onto the tangential plane to the orbit in the point occupied by the satellite. For a nadir pointing satellite on a circular orbit (most common situation) this reduces to a plane which is perpendicular to the yaw axis. In this way, any useful thrust direction can be achieved by an attitude manoeuvre around the yaw axis.

Following in table 2 there is a brief list of the possible manoeuvres. Such manoeuvring capability is just limited by the residual atmospheric drag: the higher the altitude, the better it is. As lower bound of altitude, we can expect 350 - 400 km, while upper bound practically does not exist.

The "Orbit Transfer" type requires a heavy duty, typically full throttle, use of thrusters.

The "Orbit Maintenance" type implies only light duty (back-throttled) use of thrusters.

Type of Manoeuvre	Manoeuvre
Orbit Transfer	Orbit Raising and Lowering
Orbit Transfer	Constellation/Formation Deployment
Orbit Transfer	Adjusting Orbit Inclination
Orbit Transfer	Adjusting Orbit Eccentricity
Orbit Maintenance	Altitude Keeping
Orbit Maintenance	Station Keeping and Constellation/Formation Keeping
Orbit Maintenance	Drag-Free Flying

**Table 2:** possible orbit manoeuvres for the proposed propulsion system.

### 1.2.3 Impact on minisatellite busses

The introduction of a propulsion system on a (micro) satellite platform that as baseline has no on board propulsion like MITA always has dramatic impacts on the whole system design.

In table 3 is presented a short overview on such impacts for a FEEP propulsion subsystem with their relative ratings, also presenting a rationale for such ratings.

Thank to both very-low-thrust and self-contained characteristic of field emission thrusters, impact are either negligible or quite low.

Impact on:	Level of Impact	Rationale
<b>Attitude Control Subsystem</b>	very low	Thanks to the very-low-thrust feature of field emission thrusters, the residual torque generated by the presented FEEP propulsion subsystem can be easily managed by traditional minisatellite attitude control actuators such as momentum/reaction wheels and magnetic torquers.
<b>Power Generation Subsystem</b>	low	A general method for avoiding power generator oversizing when using electric propulsion is to set in stand-by or switch off as many components as possible during heavy-duty thruster firing. This method proves effective with FEEP thrusters too.
<b>Structure Subsystem</b>	negligible	With respect to other propulsion subsystems, the presented one is extremely compact (the FEEP Thruster casing is a box with all dimensions measuring few centimetres), does not need fuel pipes, valves and external tanks. Thanks to the very-low thrust level, spacecraft structure and appendages are subject to a resulting very low acceleration that is far from inducing low frequency vibration modes that could potentially bother the ACS system.
<b>Thermal Control Subsystem</b>	negligible	Impact on thermal control subsystem is comparable with other subsystem electronics, since the major part of the electric power is vented off board in the propellant exhaust.
<b>Assembling, Integration and Verification</b>	very low	Impact on assembling and integration is extremely small: there is no plumbery, there are no pressurised tanks and there are no valves, but just a minimum of harness like for a standard electronic unit. The absence of plumbery, tanks and valves also makes qualification tests much simpler and faster.
<b>Operations</b>	very low	Thanks to the very low-thrust features, propulsion induced torques can be easily managed by ACS with a minimum of on-board autonomy, so that ground segment costs can be reduced also during long manoeuvres.
<b>Overall Mission Risk</b>	very low	Unlike other cold gas, liquid fuel and other electric propulsion technologies, the presented FEEP system has no moving parts (but the case cap that is opened only once), no valves and no pressurised vessels. Unlike solid boosters, the presented FEEP system thrusters are fully testable (prior to integration) and fully restartable during in-orbit operations.
<b>Accommodation onboard existing platforms</b>	very low	According to already mentioned impacts on spacecraft subsystems, it is clear that the presented FEEP propulsion system has got plug-and-play features in many ways, especially when compared with traditional propulsion systems.
<b>Overall System Additional Cost</b>	low	Altogether, the cost impact on the whole system cost should be in the same range of an additional major ACS component.

Table 3: impact of the propose FEEP propulsion system on a minisatellite platform

## ORBIT CONTROL TECHNIQUES

In this section the approach followed for the analysis and design of an orbit control system featuring FEEP thrusters on board a small-mini satellite is presented. First the s/c orbit dynamics state space representation is reported. Next, the orbit controller design approach as well as numerical simulations of the control system are assessed.

### 1.3 Mathematical model

State space representation of the orbital dynamics with reference to a target position and velocity (Euler-Hill equations) is:

$$\frac{d\vec{x}}{dt} = \vec{F}\vec{x} + \vec{G}\vec{u}$$

$$\vec{x} = \begin{bmatrix} \delta u \\ \delta w \\ \delta x \\ \delta z \end{bmatrix} \quad \vec{F} = \begin{bmatrix} 0 & n & -n^2 & 0 \\ -n & 0 & 0 & 2n^2 \\ 1 & 0 & 0 & n \\ 0 & 1 & -n & 0 \end{bmatrix} \quad \vec{G} = \begin{bmatrix} 1/m & 0 \\ 0 & 1/m \\ 0 & 0 \\ 0 & 0 \end{bmatrix} \quad \vec{u} = \begin{bmatrix} T_{dx} \\ T_{dz} \end{bmatrix} \quad (1)$$

where  $\delta u$  and  $\delta w$  are the components of the velocity deviation vector expressed in orbital axes.  $\delta x$  and  $\delta z$  are the position errors along the  $x$  and  $z$  orbital axes respectively.  $n$  is the orbital angular velocity.  $m$  is the satellite mass. Fig 7 clarify the notation used.

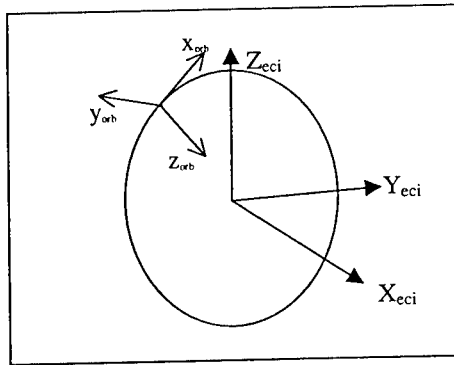


Fig. 7: orbital reference frame

### 1.4 Control algorithms

This section proposes two controller types well suited for in-plane orbit control: a derivative-proportional control and a bang-bang type one.



### 1.4.1 Thrust proportional controller

To control the satellite orbital motion the displacement error (as well as its rate of change) between the satellite position and a propagated target one must be known. These errors are then processed by the controller to actuate FEFP thrusters accordingly.

A preliminary analysis showed that it is not possible to control the in plane satellite motion by feedback of  $\delta x$  or  $\delta z$  only using a PID type control law, even if negative thrust is allowed; the system is intrinsically unstable.

Full state feedback proved to lead to asymptotic stability. The general control law expression is:

$$\vec{T}_x = -\vec{K}^T \vec{x} \quad (2)$$

where  $\vec{K}$  is the feedback gain vector.  $\vec{K}$  computation was carried out using linear quadratic regulator design method with the following performance of index:

$$J = \int_0^{\infty} \vec{x}^T A \vec{x} + \vec{T}^T B \vec{T} \quad (3)$$

$\vec{T}$  is the control thrust vector (only x component in this case), A and B are weighting matrices. The above performance index optimizes the thrust value and consequently the error in the forward displacement  $\delta x$  and the error in altitude  $\delta z$ . Final value theorem applied to the closed loop transfer functions results in zero steady state error for a step disturbance  $Tdz$ , while a step disturbance along x gives rise to a non zero steady state error  $\delta x$ . However this error resulted to be small ( $\cong 0.2m$ ) for usual drag forces.

Digital implementation of the continuous controller was done by emulation design, i.e. finding the digital control law which best match the continuous one. This task was accomplished using Tustin approximation. Design was verified by numerical simulations.

To implement the above control law digitally a proper sampling period is to be set. Sampling rate setting is directly related with the spacecraft orbit dynamics natural frequency " $\omega_n$ ". A number of Numerical simulations proved that:

- For sampling rates below approximately  $5\omega_n$  the system is not stable,
- For sampling rates below  $10\omega_n$ , performance is degraded in term of damping capabilities.
- For sampling rate above  $20\omega_n$ , system performances are comparable with the continuous controller case.

As a result, a sampling rate of  $30\omega_n$  was chosen. The basic block diagram of this control system is depicted in Fig. 8.

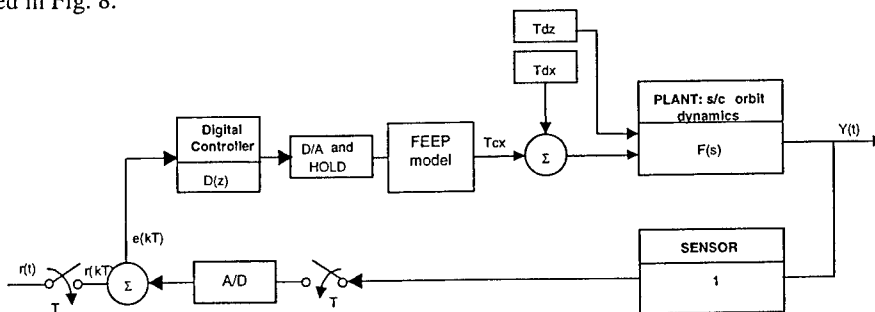


Fig. 8: control system block diagram

The above control system block diagram was implemented using "Matrixx/System Build" software tool. A number of numerical simulations were made with the following reference scenario:

- Orbit: Sun-synchronous : altitude 567km – inclination 97.66°
- Attitude: Earth pointing (assumed to be ideal)
- Actuators: two FEEP thrusters of 0.5mN each placed along the x orbital direction (positive thrust only)
- Sensor: ideal unity gain sensor or GPS receiver

Each plot below displays three curves according to the thrust computation sampling rate: 1Hz (the smoothest curve in each plot), 1/90 Hz and 1/300 Hz. Thrust level will be higher for lower sampling rates and hence more and more sharp responses result.

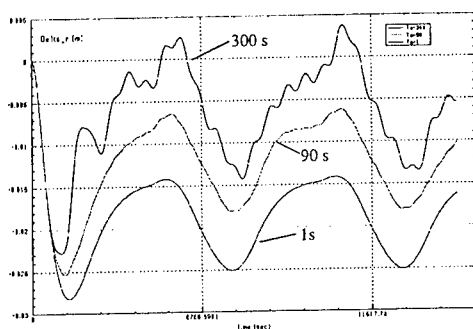


Fig 9: Altitude error time response

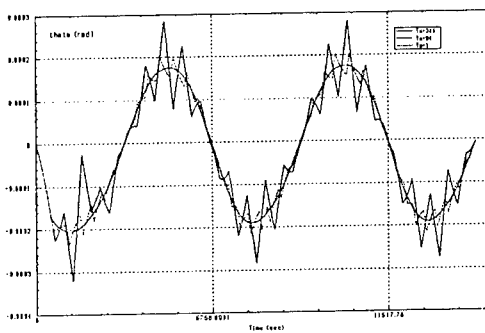


Fig 10: True anomaly time response

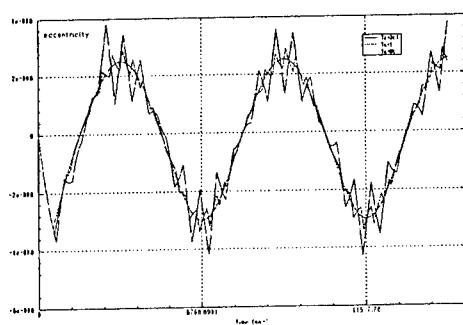


Fig 11: Eccentricity time response

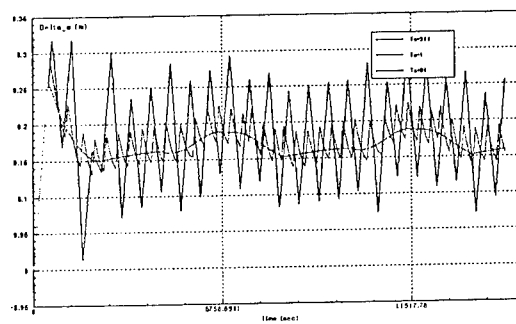


Fig 12: Semimajor axis error time response

It is clear from the above charts that the variation in 'r' is better for  $T_s = 300$  sec. However, fast but limited variations occur in theta, eccentricity, and semi major axis.

Thrust level is another key factor. For  $T_s = 300$  sec. the maximum thrust is 0.132 mN. As the sampling rate decreases, thrust level increases. So, the maximum available thrust will also limit the maximum sampling period.

A point which must be taken into account is that the life time of a typical thruster is independent on the thrust level. So working with lower duty cycle is better than working with a higher one from the life time point of view. Duty cycle of the thruster for  $T_s = 300$  sec. is minimum, thus working with a higher sampling rate is better as long as the required thrust level is achievable.

The above results refer to the ideal perfect state knowledge case. Adding GPS selective availability (SA) typical noise ( $100\text{ m } 1\sigma$ ) requires some sort of noise reduction. For the present study a least square estimator was developed and implemented to perform noise rejection. Such process minimizes the square of the difference between measurements and their model.

The orbital state estimator processes successive estimates of the orbit states. So given an initial estimate for the states, one can use a number of measurements to update this initial estimate. In state estimation processes, there are two basic ways to update the states. If a new estimate of the state vector is obtained after each observation the process is called a sequential estimator, or recursive estimator. If all observations are processed and then combined to produce a single update to the states, the process is called batch estimator. The batch approach is the one used for this study, state is updated by collecting 100 measurements, thrust is applied at the same rate. Following is the modified control block diagram which includes the GPS model and the estimator algorithm.

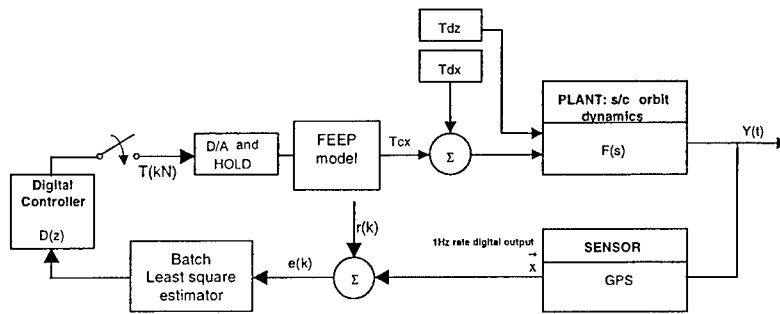


Fig 13: control block diagram with GPS receiver and state estimator

The error in altitude and thrust are showed below for a simulation time of 25 orbits. Negative values of thrust were forced to zero.

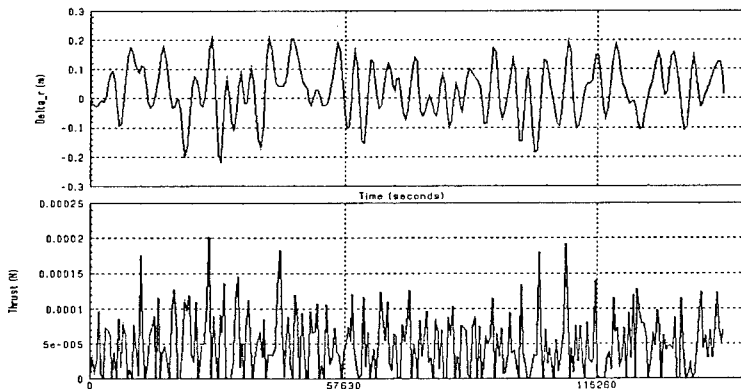


Fig 14: time response of altitude error and applied control thrust

### 1.4.2 Orbit parameter control

The second orbit control algorithm is a bang-bang type control law based on the variation occurred in semimajor axis "a" and eccentricity "e". An error bound for "a" and "e" is to be set first. Then, thrusters actuation is performed according to a set of conditions. The following plot shows the resulting time response under the assumption that "a" and "e" are perfectly known (unity gain sensor).

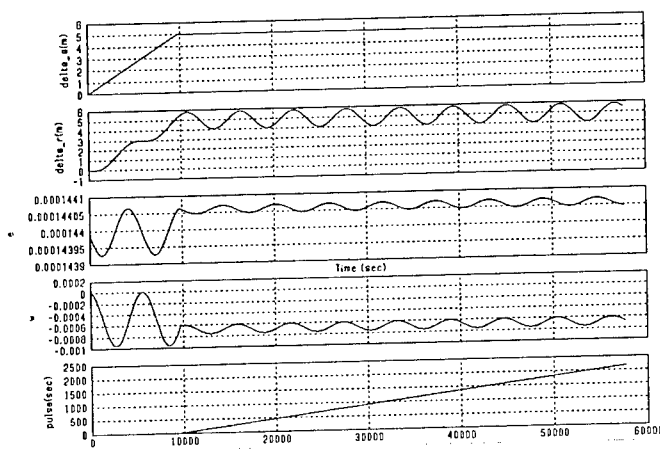


Fig 15: orbit parameter control time response with 1Hz sampling rate

In this simulations the semimajor axis allowed error bound is 5 meters. As shown, The error in altitude is kept around 5m. The argument of perigee is also kept very low, The fourth curve is the difference between the actual and nominal value of the argument of perigee. The fifth curve is the number of seconds in which the thruster was switched on. From this curve we see that if we neglect the first free motion period we have a duty cycle of 0.045. It must be noted also that we control every second. If we change the control step time to be 100 seconds instead of one, we get the following results:

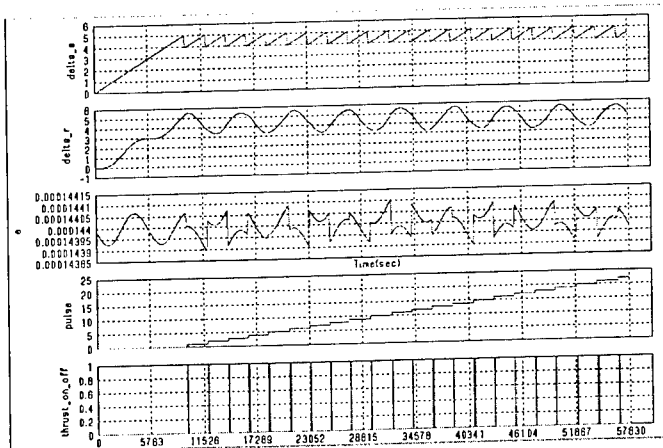


Fig 16: Orbit parameter control time response with 1E-2Hz sampling rate

Less thrust, higher amplitudes of oscillations but nearly constant orbit are the main features as the control time step increases.

After having developed the control law for the ideal noise free case the GPS sensor model is added. Noise rejection can be accomplished by modifying the least square estimator of the previous section for example. However a third order frequency filter was used to lower noise level:

$$G_3(s) = \frac{a^3}{(s+a)^3} \quad (4)$$

the cutoff frequency "a" was set to  $a = 40 \omega_{orb}$ . The results are plotted below for a simulation time of 100 orbits:

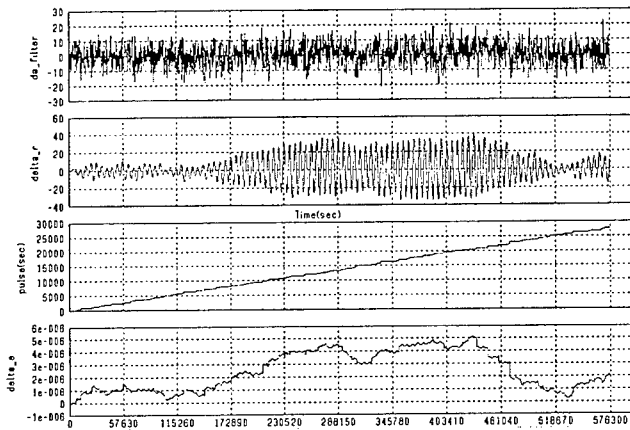


Fig 17 : simulation result of the orbit parameter control with GPS sensor

Position keeping is maintained with a maximum error in altitude of 40m. The duty cycle is 0.048. Only positive thrust is required at a level of 1mN.

## 2 ACKNOWLEDGMENTS

The authors thank Paolo Sabatini head of the Carlo Gavazzi Space Small Satellite Dept. for the precious advises and feedback at system level on fitting the presented propulsion system on MITA platform, Massimiliano Asara for the propulsion system 3D drawings and Danilo Morea for feedback on control issues.

The authors also thank Leonardo Biagioni, Fabio Ceccanti, Salvo Marcuccio, Luca Paita and Marco Saviozzi of the FEEP Team of Centrosazio, for their needful feedback on state-of-the-art FEEP technology, for their support in providing data and drawings as well as collaborating on studying the application of the presented propulsion subsystem on MITA platform.

### 3 REFERENCES

- [Anno 99] G. Annoni, E. De Marchi, F. Diani, M. Lovera, G. D. Morea, "Standarding Tools for Attitude Control System Design: the MITA Platform Experience", *DASIA Conference proceeding*, Lisbon, Portugal, May 1999.
- [Bian 98] P. Bianco, P. Sabatini, "Specifiche per propulsori di tipo FEEP da adottare per i satelliti della missione STRATUS 3D", *internal document of Carlo Gavazzi Space SpA, Milano, Italy*, July 1998
- [Biag 99] L. Biagioni, F. Ceccanti, S. Marcuccio, "DesertSat Orbit Maintenance with FEEP Thrusters", *internal document of Centrosazio, Pisa, Italy*, July 1999.
- [Marc 96] S. Marcuccio, A. Genovese, M. Andrenucci, G. Saccoccia, J. Gonzales del Amo, "FEEP Thrusters Applications to Constellations and Small Satellites", *Proceedings of the Third International Conference on Spacecraft Guidance, Navigation and Control System*, ESTEC, Noordwijk, The Netherlands, November 1996.
- [Marc 97] S. Marcuccio, S. Giannelli, M. Andrenucci, "Attitude and Orbit Control of Small Satellites and Constellations with FEEP Thrusters", *paper of the Electric Rocket Propulsion Society, Pisa, Italy*, 1997.
- [Guzz 98] R. Guzzi, P. Bianco et Al, "Spectral TRidimensional ATmospheric investigation from Uv to near infrared by Satellite - STRATUS 3D" *ASI (Italian Space Agency) Small Mission Phase A Report*, CNR (National Research Centre) IMGA Bologna, Italy, October 1998.
- [MITA 99] CGS MITA Team, "MITA System Description", *internal document of Carlo Gavazzi Space SpA, Milano, Italy*, March 1999.
- [Saba 98] P. Sabatini, T. Lupi, "The MITA Satellite: an Italian Bus for Small Missions", *Fourth Small Satellite System Symposium paper*, Antibes, France, September 1998.
- [MITA 98] CGS MITA Team, "Mission and Reference Payload Analysis Report", *internal document of Carlo Gavazzi Space SpA, Milano, Italy*, April 1998.
- [Bian 99] P. Bianco, "Electric Propulsion System for Constellation Deployment and Orbit Control of Minisats", *IAF-99-S.4.10, 50<sup>th</sup> IAF Congress*, Amsterdam, The Netherlands, October 1999.
- [Ogat 95] K. Ogata, "Discrete Time Control Systems", *Prentice Hall International Editions*, USA, 1995.
- [Sidi 97] M. J. Sidi, "Spacecraft Dynamics and Control", *Cambridge University Press*, USA, 1997.

**AEROBRAKING DESIGN AND STUDY  
APPLIED TO CNES MICROSATELLITE PRODUCT LINE**

**Edouard BREZUN**

*CS Systèmes d'information  
13 rue Villet  
F-31029 Toulouse Cedex  
Tél.: (33) 5 61 17 66 66  
Fax: (33) 5 61 17 64 89  
([edouard.brezun@c-s.fr](mailto:edouard.brezun@c-s.fr))*

**Guy BONDIVENNE**

*CNES  
18 avenue Edouard Belin  
F-31040 Toulouse Cedex 4*

**Pierre KELLER**

*CNES  
18 avenue Edouard Belin  
F-31040 Toulouse Cedex 4  
Tél.: (33) 5 61 27 37 22  
([pierre.keller@cnes.fr](mailto:pierre.keller@cnes.fr))*

**RESUME** – Le CNES au travers de sa filière microsatellite a décidé de s'équiper d'un outil lui permettant la réalisation d'expérimentations scientifiques et technologiques à faible coût récurrent.

Arianespace offre la possibilité de lancer avec Ariane 5 jusqu'à 8 microsatellites de 120 kg au moyen de la structure ASAP 5 (Ariane Structure for Auxiliary Payload).

La plupart des lancements Ariane 5 délivrent une orbite GTO (90%). L'utilisation de la propulsion chimique pour passer d'une telle orbite à une orbite mission plus utile de type LEO nécessiterait une quantité d'ergols incompatible avec le bilan de masse d'un microsatellite. Ceci a conduit le CNES à étudier le concept de freinage atmosphérique comme alternative aux moyens de propulsion classiques.

Ce papier présente les études sur le freinage atmosphérique menées par le CNES avec le support de CS SI.

La première partie présente l'historique des études ayant conduit au concept de descente (GTO→LEO) par freinage atmosphérique au périégée en traversant les hautes couches de l'atmosphère.

Après l'énoncé du principe de freinage atmosphérique, le document décrit les exigences mission et les contraintes spécifiques qui lui sont associées.

Le papier s'attache ensuite à détailler le scénario du transfert depuis l'orbite GTO vers l'orbite LEO ainsi que les stratégies de contrôle retenues.

Enfin, nous décrirons comment le couplage dans la simulation d'un modèle d'évolution d'orbite avec un modèle thermique du satellite nous a aidé à valider les concepts d'analyse de mission.

**ABSTRACT** - CNES has decided to get equipped with a tool allowing the realisation of scientific and technological experiments at low recurring costs through its microsatellite product line.

Arianespace offers the capability of launching with Ariane 5 up to 8 microsatellites, with individual mass of max 120 kg, by means of the Ariane Structure for Auxiliary Payload (ASAP 5).

Most of the Ariane 5 launches (90%) are configured for GTO. The necessary propellant to move from this orbit down to the useful LEO by use of chemical propulsion would overpass the specified allowed mass. This has led CNES to study the concept of aerobraking as an alternate solution.

This paper presents aerobraking studies carried out by CNES with CS SI support.

*The first part of the paper presents the historical record of what has led to the concept of a descent (GTO→LEO) by aerobraking at every perigee pass through the uppermost atmosphere.*

*After addressing the principle of aerobraking, the paper describes the mission requirements and associated specific constraints.*

*Besides, the paper details the scenario for GTO to LEO transfer as well as the selected strategy of control.*

*Finally, we describe how the coupling of a model of orbit evolution with a spacecraft thermal model in a simulation helps to validate mission analysis concepts.*

## 1 INTRODUCTION

Le développement d'une filière microsatellite par le CNES est issu d'une volonté d'offrir un accès à l'espace à moindre coût à des expériences scientifiques et technologiques.

Dans cette optique, dès le début des études de faisabilité, une réflexion s'est engagée sur la possibilité de réduire les coûts de lancement par une utilisation des capacités d'emport auxiliaires du lanceur européen Ariane 5, le lancement étant en grande partie payé par le passager principal.

Le problème se pose alors de pouvoir rejoindre depuis l'orbite GTO délivrée par la majorité des lancements Ariane 5, une orbite mission de type LEO.

Le freinage atmosphérique s'est imposé comme le complément d'Ariane 5 pour la mise en orbite des microsatellites. Sa contribution pour un transfert depuis l'orbite GTO (36000-600 km inclinée à 7°) vers l'orbite LEO circulaire d'altitude comprise entre 800 et 1300 km inclinée à 7° est de l'ordre de 2200 m/s pour supplément de masse de 10 kg.

Réaliser le même  $\Delta V$  avec un système de propulsion chimique ou électrique conduirait à des incompatibilités en terme de masse, d'énergie et de coûts (cf. Fig. 1).

Propulsion électrique				Propulsion chimique		
Type moteur	Poussée (mN)	Nombre	Puissance nécessaire (W)	Type ergols	ISP (s)	Masse nécessaire (kg)
SPT 70	39	4	2560	Mono-ergol N2H4	210	67.5
SPT 100	80	2	2700	Mono-ergol HAN	250	61.1
SPT 140	249	1	4050	Bi-ergol UDMH/N2O4	290	55.7

Fig. 1 : tableau comparatif du coût du transfert avec un système de propulsion classique

Les études sur le concept d'aérofreinage ont été menées en parallèle au développement de la plate-forme commune aux microsatellites, le freinage s'inscrivant comme une option proposée par la filière.

Le projet microsatellite ayant évolué depuis les dernières études menées sur l'aérofreinage, les résultats présentés ci-après sont provisoires et susceptibles de changer.

## 2 PRINCIPE DU FREINAGE ATMOSPHERIQUE

Afin d'abaisser progressivement l'altitude d'apogée du satellite, on force celui-ci lors du passage au périhélie à pénétrer dans les hautes couches de l'atmosphère (120km<altitude<135km). Le satellite présentant une surface frontale perpendiculaire à la vitesse, celui-ci est soumis à la force de frottement atmosphérique. Cette force opposée à la vitesse va permettre de diminuer l'altitude de l'apogée.

L'intensité de la force de frottement s'exprime ainsi :



$$F_f = \frac{1}{2} \cdot \rho \cdot S_f \cdot \cos \alpha \cdot V^2 \cdot C_d \text{ (Newton)} \quad (2.1)$$

- $\rho$  est la masse volumique de l'air à l'altitude du satellite ( $\text{kg/m}^3$ )  
 $S_f$  est l'aire de la surface soumise au flux de particules ( $\text{m}^2$ )  
 $\alpha$  est l'angle entre la normale à la surface soumise au flux et la vitesse (degré)  
 $V$  est la vitesse relative du satellite par rapport à son milieu (m/s)  
 $C_d$  est un coefficient caractéristique du frottement moléculaire, pris égal à 2,3 (sans dimension)

Un élément de la surface absorbe un flux thermocinétique donné par l'équation suivante :

$$\Phi_a = K \cdot \frac{1}{2} \cdot \rho \cdot V^3 \text{ (W/m}^2\text{)} \quad (2.2)$$

- $K$  est un coefficient d'adaptation pris égal à 0,8 (sans dimension)

Une partie du flux absorbé est évacué par couplage radiatif avec l'espace, il s'exprime ainsi :

$$\Phi_r = \varepsilon \cdot K_B \cdot T^4 \text{ (W/m}^2\text{)} \quad (2.3)$$

- $\varepsilon$  est le coefficient d'émissivité de la surface  
 $K_B$  est la constante de Boltzman, elle vaut  $5,67 \cdot 10^{-8}$   
 $T$  est la température de la surface (degrés K)

Lors de la phase de freinage on a  $\Phi_a > \Phi_r$ , cette différence se traduit par une augmentation de la température de la surface soumise au frottement.

L'équation qui régit cette variation de température est la suivante :

$$M_f \cdot C \cdot \frac{dT}{dt} = \Phi_a \cdot S_f \cdot \cos \alpha - \Phi_r \cdot S_r \quad (2.4)$$

- $M_f$  est la masse de la surface frottante (kg)  
 $C$  est la capacité calorifique du matériau (Joule/kg . K)  
 $S_r$  est la surface radiative ( $\text{m}^2$ )

En résumé, l'énergie absorbée par la surface de frottement est transformée en chaleur entraînant une augmentation de température de la surface.

L'énergie cinétique ainsi absorbée sera dissipée par couplage radiatif avec l'infini en sortie de la phase de freinage.

A titre d'information, la configuration retenue pour le système de freinage est représentée sur la figure suivante (Fig. 2).

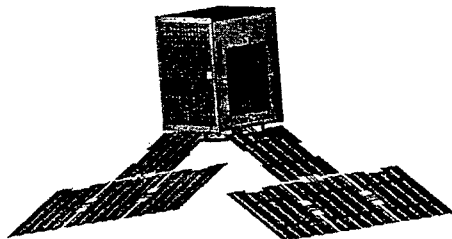


Fig. 2 : représentation du satellite voileure déployée

- Les cotes utilisées sont les suivantes :
- |   |  |
|---|--|
| Surface du bouclier avant               | $S_b = 0,36 \text{ m}^2$                         |
| Surface totale des voilures de freinage | $S_v = 2,76 \text{ m}^2$                         |
| Inclinaison des voilures                | $\beta = 20^\circ$                               |
| Surface totale de frottement            | $S_f = S_b + S_v \cos \beta \cong 3 \text{ m}^2$ |

Surface radiative  
 Epaisseur des voilures  
 Matériau des voilures

$$S_r = S_b + 2 \cdot S_v \cong 5,9m^2$$

$e = 0,4 \text{ mm}$   
 aluminium

### 3 CONTRAINTES ET EXIGENCES DE LA MISSION

L'option freinage atmosphérique doit respecter l'ensemble des exigences suivantes :

#### Contraintes et exigences sur la mise à poste :

Le satellite de masse initiale 100 kg est mis sur une orbite 36000-600 km inclinée à 7°. Il doit rejoindre une orbite mission circulaire d'altitude comprise entre 800 km et 1300 km d'inclinaison 7°. La durée de mise à poste ne doit pas excéder 3 mois.

Les opérations liées à la phase de freinage doivent être réduites au maximum, un contrôle continu longue durée est exclu. Seules deux stations sol sont disponibles.

#### Contraintes et exigences sur le contrôle en vol :

Le système de contrôle d'attitude oriente l'axe longitudinal du satellite parallèlement à la vitesse juste avant la phase de freinage. Pendant cette phase l'attitude n'est pas contrôlée de façon active en dehors de l'axe de roulis (à confirmer).

La perte momentanée pendant trois jours du système de contrôle en vol ne doit pas avoir de conséquence catastrophique sur le déroulement de la mission ; dans ce cas le flux maximum ne doit pas dépasser 10kW/m<sup>2</sup>.

Le principe du contrôle est de type temps différé avec possibilité de réagir à un événement imprévu à la visibilité station suivante.

### 4 SCENARIO DE MISE A POSTE ET STRATEGIE DE CONTROLE ORBITAL

#### 4.1 Scénario de mise à poste

Le scénario de mise à poste est un enchaînement de phases permettant au satellite, en utilisant le système de freinage atmosphérique et la propulsion, de rejoindre l'orbite finale depuis l'orbite délivrée par Ariane 5.

Ce scénario se décompose en 4 phases comme décrit dans le schéma suivant (Fig. 3).

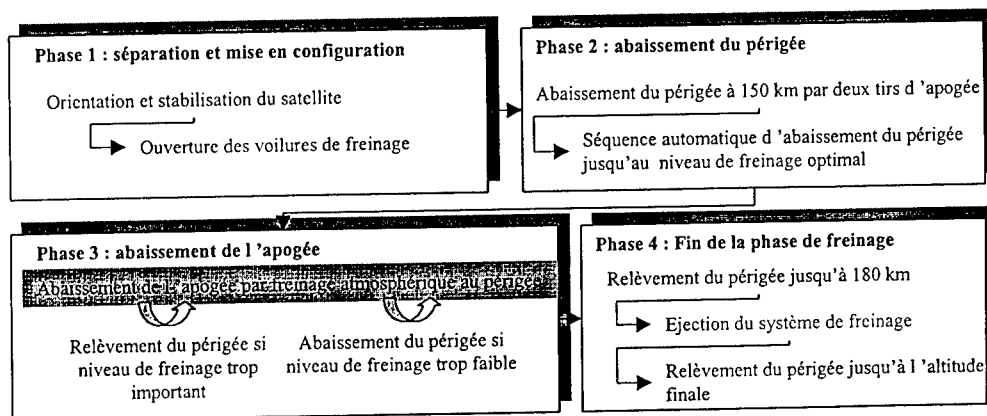


Fig.3 : scénario de mise à poste

En début de phase 2, le logiciel bord calcule les manœuvres à effectuer pour abaisser le périégée à 150 km. Les manœuvres sont commandées par le sol qui fournit également les paramètres orbitaux. Ces deux tirs d'apogée permettent en outre d'effectuer la calibration du système de propulsion.

Le sol commande ensuite le début de la séquence automatique d'abaissement du périégée. Cette séquence s'achève lorsque le niveau de freinage est optimal. La fin de cette séquence initie le début de la phase suivante (i.e. phase 3).

La phase 3 correspondant à l'abaissement de l'altitude de l'apogée par freinage atmosphérique au périégée, se décompose en deux sous phases :

Une sous phase d'abaissement de l'apogée qui s'arrête automatiquement lorsque :

- l'altitude de l'apogée atteint l'altitude finale, on passe alors en phase 4,
- le niveau de freinage est hors limite du point de vue des lois de contrôle utilisées (voir paragraphe 4.2.3)

Une sous phase d'abaissement ou de relèvement de l'altitude périégée. Lorsque le niveau optimal de freinage est à nouveau atteint on retourne à la sous phase précédente.

La phase 4 débute dès que l'altitude de l'apogée finale est atteinte. Elle comprend une manœuvre automatique de relèvement du périégée à une altitude de l'ordre de 180 km afin d'arrêter le freinage. Après avoir ordonné l'éjection du système de freinage, le sol initie une série de manœuvres permettant le relèvement du périégée à l'altitude finale.

Le scénario de mise à poste décrit, nous allons nous attacher à détailler les stratégies de contrôle orbital utilisées lors des phases principales du freinage atmosphérique.

## 4.2 Stratégies de contrôle orbital

### 4.2.1 Hypothèses

Les stratégies adoptées doivent permettre d'atteindre et de maintenir en toute sécurité une intensité de freinage permettant en particulier de respecter la durée maximale allouée à la descente.

Les *perturbations* à prendre en compte sont :

- La variabilité de la haute atmosphère très peu prévisible
- L'influence de la lune sur l'altitude du périégée
- La présence ou non du flux solaire pendant le freinage

Les *risques* identifiés sont :

- La rencontre d'une densité atmosphérique élevée conduisant à une élévation catastrophique de la température des surfaces du satellite. Ce risque est principalement lié à une altitude trop faible du périégée
- La perte momentanée du contrôle orbital par indisponibilité du calculateur de bord

Les *contraintes* fondamentales que l'on doit intégrer sont :

- Le principe de contrôle est de type temps différé, le sol ne pouvant agir qu'en période de visibilité
- On ne dispose pas à bord d'une orbitographie précise sur l'ensemble du domaine de vol.
- Il n'y a pas de contrôle d'attitude actif hors axe de roulis pendant le freinage (à confirmer)

### 4.2.2 Principes de contrôle retenus

Le contrôle du freinage atmosphérique s'appuie sur une mesure de température des surfaces frottantes. En effet les équations du paragraphe 2 nous permettent d'écrire que la température des surfaces  $T$  et l'intensité de la force de frottement appliquée à ces surfaces  $F_f$  sont liées par une relation du type  $T = K F_f^{1/4}$ .

Afin de prévenir le risque d'une élévation catastrophique de la température des surfaces frottantes, la température de ces surfaces est limitée à une température  $T_{opt}$  au-delà de laquelle une manœuvre sera effectuée afin de relever le périhélie.

De même, afin d'optimiser la durée de la descente, une température minimale  $T_{min}$  est définie en deçà de laquelle on effectue une manœuvre d'abaissement du périhélie pour augmenter l'intensité du freinage.

Le contrôle d'attitude pendant la phase de freinage est passif (ce sont les forces aérodynamiques qui doivent générer les couples stabilisateurs), le satellite doit avoir une seule position d'équilibre stable autour de l'axe longitudinal du satellite. Cet axe est placé parallèlement au vecteur vitesse satellite juste avant le début du freinage atmosphérique.

#### 4.2.3 Application du principe de contrôle du freinage

On ne détaille ici que le contrôle des phases du scénario de mise à poste concernant le freinage atmosphérique :

L'abaissement du périhélie à 150 km s'effectue par deux manœuvres d'apogée toutes deux initiées par le sol. C'est une phase d'approche qui permet également la calibration de la propulsion.

La première manœuvre de l'ordre de 30 m/s amène le périhélie autour de 300 km, la seconde, de l'ordre de 15 m/s, amène le périhélie à 150 km  $\pm$  1.5 km.

La séquence automatique d'abaissement du périhélie jusqu'au niveau de freinage opérationnel est caractérisée par une série de manœuvres dont le  $\Delta V$  est calculé après lecture dans une table (Fig.4) donnant le  $\Delta Z_{périhélie}$  à réaliser en fonction la température maximale  $T_{max}$  rencontrée au périhélie précédent. Ce  $\Delta Z_{périhélie}$  est corrigé de l'effet prédit de l'attraction lunaire.

Cette séquence est interrompue dès lors que la température optimale  $T_{opt}$ , dépendante de l'altitude de l'apogée (Fig.5), est atteinte ou dépassée.

La phase d'abaissement de l'altitude de l'apogée débute dès que le niveau de freinage opérationnel est atteint. Pendant cette phase, on laisse évoluer naturellement l'orbite du satellite tant que la température maximale mesurée au périhélie  $T_{max}$  est comprise entre  $T_{min}$  et  $T_{opt}$ . Du fait des perturbations et notamment de l'attraction lunaire, cette température peut sortir de la plage de température bornée par  $T_{min}$  et  $T_{opt}$ . Dans ce cas :

- Si  $T_{max} > T_{opt}$ , on effectue deux manœuvres à l'apogée pour augmenter l'altitude du périhélie. Le  $\Delta V$  délivré est forfaitaire et dépend de l'altitude de l'apogée (Fig.6)
- lorsque  $T_{max} < T_{min}$  on passe en mode abaissement du périhélie jusqu'à retrouver le niveau opérationnel de freinage (idem à la séquence d'abaissement du périhélie de la phase 2)
- 

La transition de mode et le calcul des manœuvres sont exécutés en mode automatique par le bord.

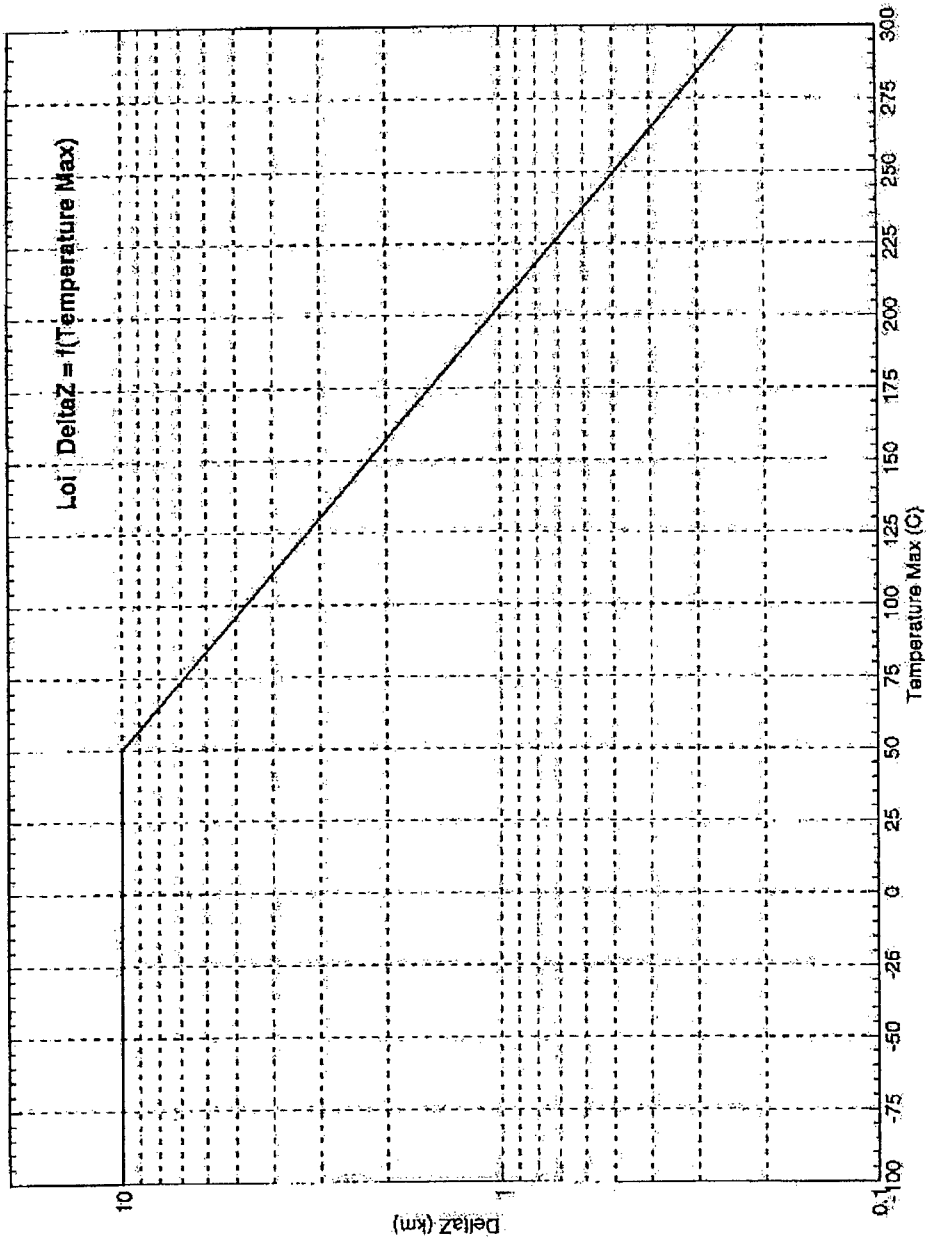


Fig. 4 : loi  $\Delta Z = f(T_{\max})$

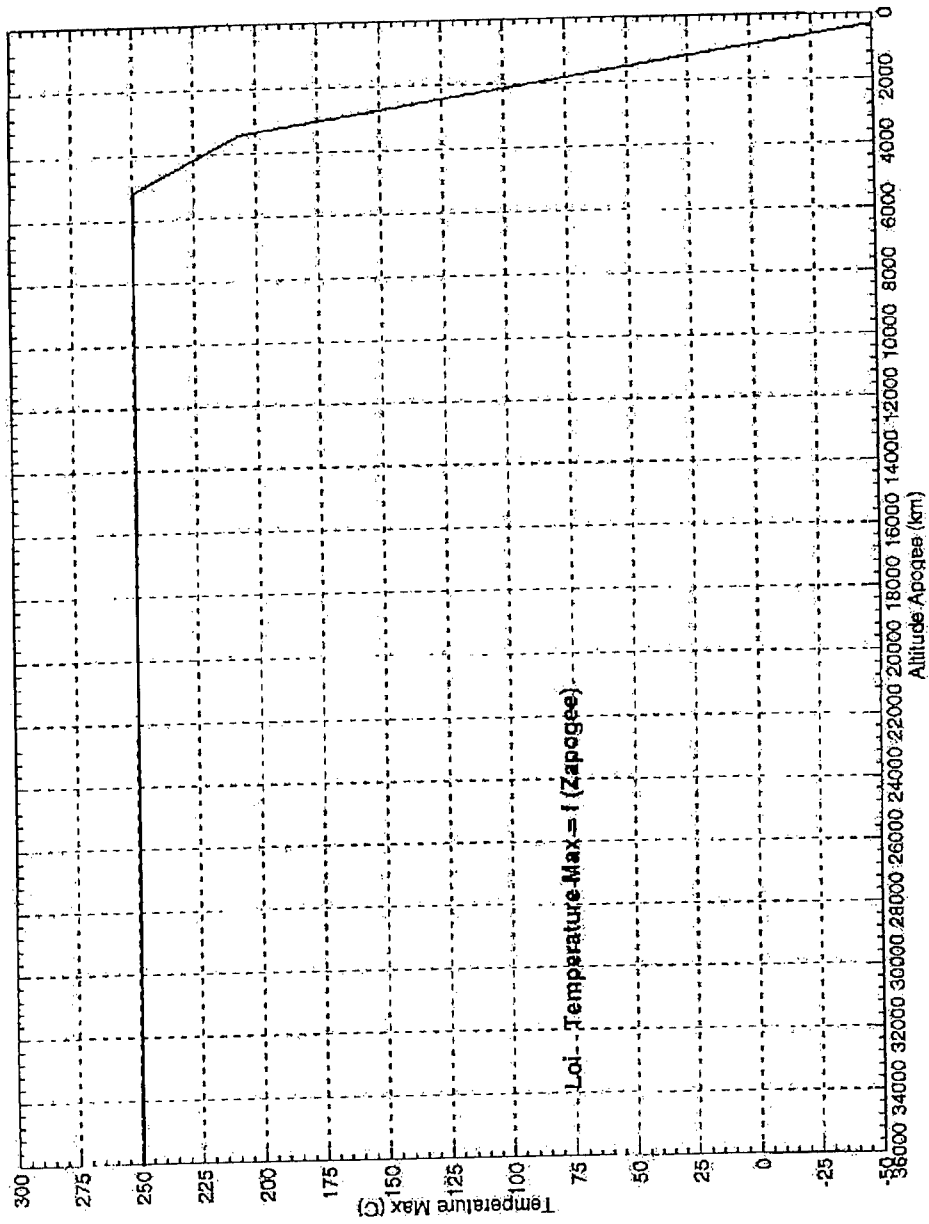


Fig. 5 : loi  $T_{opt} = f(Z_{apogée})$

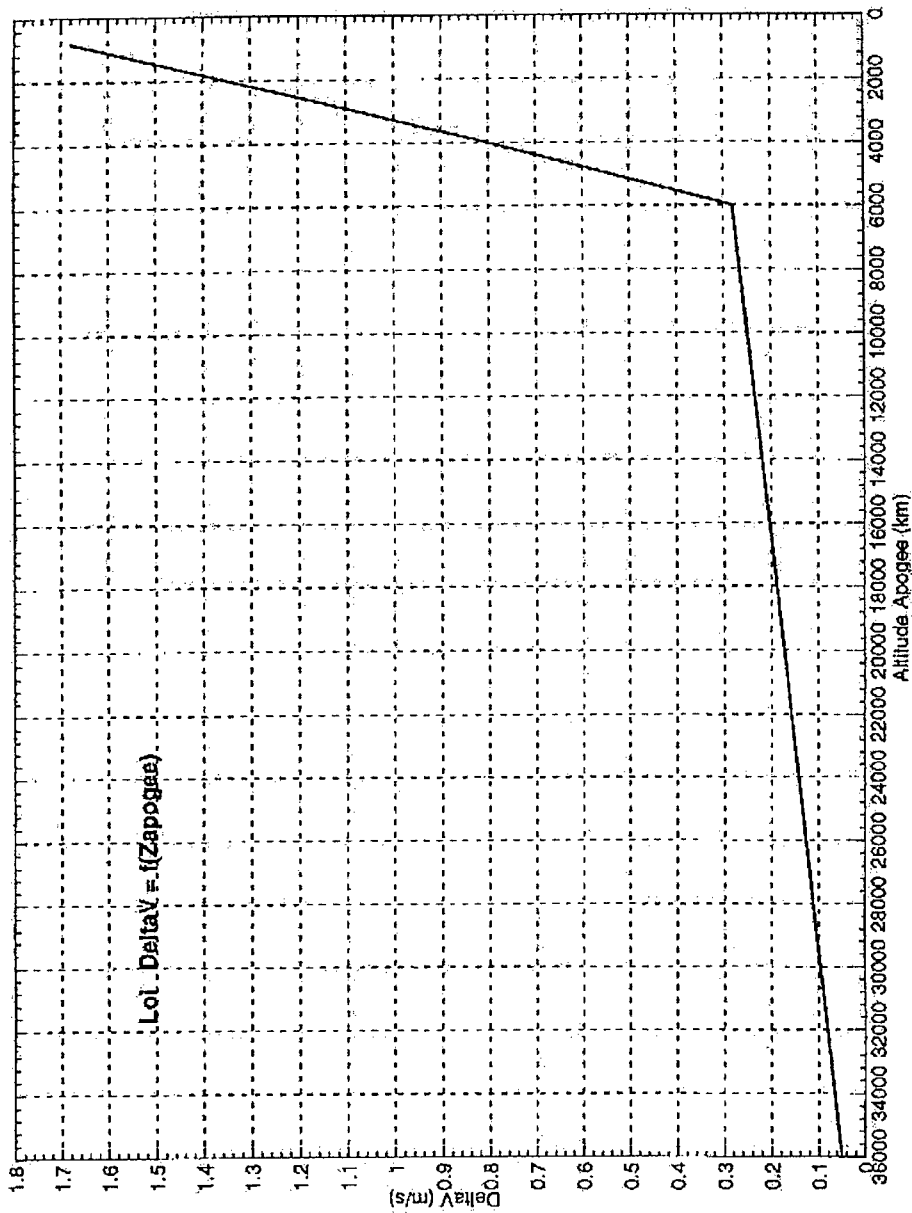


Fig. 6 : loi  $\Delta V = f(Z_{apogée})$

Les lois de contrôle retenues prennent en compte plusieurs dispositions permettant de sécuriser la descente.

Lors de la phase d'abaissement du périgée jusqu'au niveau de freinage opérationnel, on passe par une première étape contrôlée par le sol d'abaissement à 150 km, cette altitude ne présente pas de risque quelle que soit la variabilité de la densité atmosphérique.

La deuxième étape est pilotée au travers de la température  $T_{\max}$  mesurée. Pour cela la loi  $\Delta Z_{\text{périgée}} = f(T_{\max})$  est logarithmique ainsi plus la température mesurée est proche de la température  $T_{\text{opt}}$ , plus le  $\Delta Z_{\text{périgée}}$  est faible.

Ainsi comme le montre la figure 5 on s'interdit lors de la phase de régression de l'apogée de dépasser une température  $T_{\text{opt}}$  supérieure à  $250^{\circ}\text{C}$ . Cette limite permet dans le cas dégradé où on perd le contrôle de la descente pendant trois jours, d'assurer que la température ne dépassera pas  $400^{\circ}\text{C}$ , température que peuvent encore tolérer les surfaces de freinage. De plus l'évolution de la loi  $T_{\text{opt}} = f(Z_{\text{apogée}})$  au-dessous de 5500 km permet pour un cas dégradé identique au précédent, de s'assurer que l'altitude apogée sera toujours supérieure à 400 km, altitude que l'on peut rattraper avec la propulsion dans le budget alloué.

## 5 MODELE DE SIMULATION

La validation des concepts décrits précédemment ainsi que la phase d'analyse de mission se sont appuyés sur un modèle de simulation tournant sous le progiciel Matrix<sub>x</sub> qui peut se décomposer ainsi (Fig.7) :

Un modèle d'orbitographie à trois corps (satellite, Terre, Lune) prenant en compte le J2, les forces d'inerties, la propulsion et le frottement atmosphérique.

Un modèle de satellite dans lequel sont simulés :

- La thermique des surfaces de freinage (modèle purement radiatif à un nœud) prenant en compte le flux solaire et le flux thermocinétique lié au frottement.
- La propulsion (non impulsionnelle) mise en œuvre au travers des lois de contrôle.

Un modèle d'environnement orbital qui comprend :

- Les éphémérides Lune et Soleil
- Un modèle d'atmosphère standard de type US 76, qui donne la densité de l'atmosphère en fonction de l'altitude. La variabilité de l'atmosphère est introduite en multipliant la valeur lue  $\rho = f(Z)$  par  $K=1+\gamma$ .  $\gamma$  est un nombre aléatoire de moyenne nulle et d'écart type 3% ; cette valeur retenue au départ des études est certainement pénalisante.

Le moteur d'intégration numérique choisit, fourni par Matrix<sub>x</sub>, est de type Runge-Kutta à pas variable.

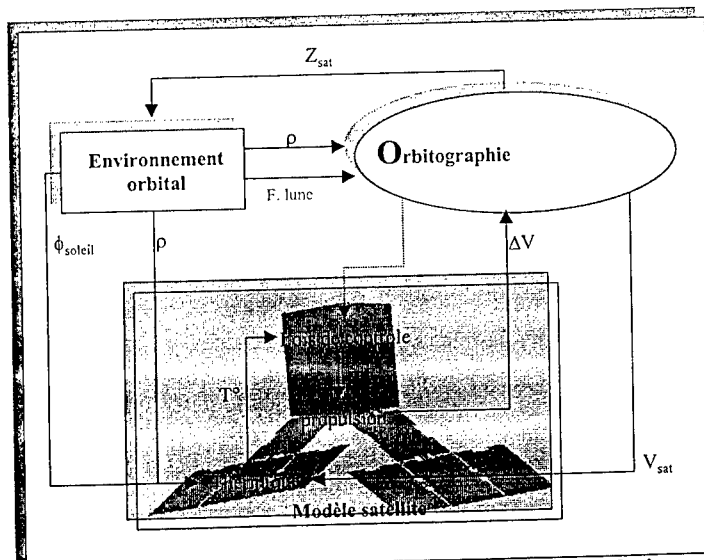


Fig. 7 : représentation simplifiée du modèle de simulation



## 6 CONCLUSION

Les résultats des simulations d'ensemble utilisant le modèle décrit précédemment ont montré que le contrôle de la descente peut se faire de façon quasi automatique à bord du satellite en utilisant trois lois, fonction uniquement de l'altitude de l'apogée, de la température maximum mesurée au périégée et prenant en compte les éphémérides de position de la lune.

Une première campagne d'évaluation a permis de montrer que ces lois étaient robustes vis à vis des contraintes mais perfectibles notamment dans les domaines suivant :

- réduction du nombre de manœuvres pour atteindre le niveau opérationnel de freinage,
- modulation du gabarit de température (Fig. 5) en fonction de la position de la lune pour garantir un flux maximum inférieur à  $10\text{kW/m}^2$  en cas de panne.
- En dessous de  $1500\text{ km}$  d'apogée le flux cinétique est de l'ordre de  $500\text{ W/m}^2$ , en présence du soleil l'élévation de température au passage au périégée est principalement liée au flux solaire ( $\cong 1360\text{W/m}^2$ ), le contrôle du freinage atmosphérique par la température se fait donc en aveugle. Une solution serait de remplacer le contrôle en température par un contrôle accélérométrique ou un contrôle par mesure du flux cinétique.

---

## A COLD GAS PROPULSION MODULE FOR SMALL SATELLITES

Joseph M. CARDIN, Jesus ACOSTA

VACCO Aerospace Products

10350 Vacco Street, South El Monte, CA 91733, [JCardin@VACCO.com](mailto:JCardin@VACCO.com), (626) 450-6435

***ABSTRACT** - Small Satellites are emerging as the preferred platform for a wide variety of earth orbit and even interplanetary missions. These spacecraft are, by their very nature, extremely limited in budget, volume, mass and power. Existing fluid propulsion options are too large, costly and complex for many small satellite applications. In an attempt to address this problem VACCO has produced an inexpensive, modular system specifically designed for the special needs of small satellites. This paper documents the results of a development program conducted for NASA and administered by the Applied Physics Laboratory of Johns Hopkins University.*

*The Cold Gas Propulsion System (CGPS) resulting from this effort is unique in several ways. It utilizes a simple "blow down" architecture which requires the entire system to operate at up to full storage tank pressure. The traditional pressure regulator has been eliminated. This required the development of unique thrusters capable of functioning with inlet pressures to 207 bar. To minimize power consumption, the thrusters feature latching valves that require an electrical pulse to open and another to close. Between pulses the thruster is magnetically latched in either the open or closed position as required. This dramatically reduces the power required by the thruster valves while preserving small impulse bit capability.*

*In order to minimize mass and cost, the system uses only four thrusters. By mounting these thrusters in a double canted orientation to the spacecraft, pitch, yaw and roll control as well as delta V can be accomplished.*

*In conclusion, the subject Cold Gas Propulsion System represents an important advance in propulsion technology suitable for small satellites. As a result of this work, the size, mass, power requirements and cost of these systems has been reduced.*

### 1 - INTRODUCTION

The Cold Gas Propulsion System (CGPS) resulting from this effort is unique in several ways. It utilizes a simple "blow down" architecture which requires the entire system to operate at full storage tank pressure. The traditional pressure regulator has been eliminated. This required the development of unique thrusters capable of functioning with inlet pressures to 207 bar. The thrusters are also unique in that they utilize a latching valve design that requires a short electrical pulse to open and another to close. Between pulses the thruster is magnetically latched in either

the open or closed position as required. This dramatically reduces power required by the thruster valves while preserving the option for small impulse bits.

In order to minimize mass and cost, the system uses only four thrusters. By mounting these thrusters in a double canted orientation to the spacecraft, pitch, yaw and roll control as well as delta V can be accomplished.

Our approach was to define a set of requirements that would be relevant to a substantial segment of the small satellite industry. We began by developing a set of propulsion requirements based on a hypothetical, but realistic spacecraft and mission. This included the real-world constraints of mass, envelope and cost.

From this we developed the system design concept. Component performance requirements were then derived and suitable component designs selected. Piece parts were fabricated or procured for one unit. Each component was individually assembled and tested. The module was then integrated and tested in the VACCO Aerospace Products facility in South El Monte, California.

## **2 - REQUIREMENT DEFINITION**

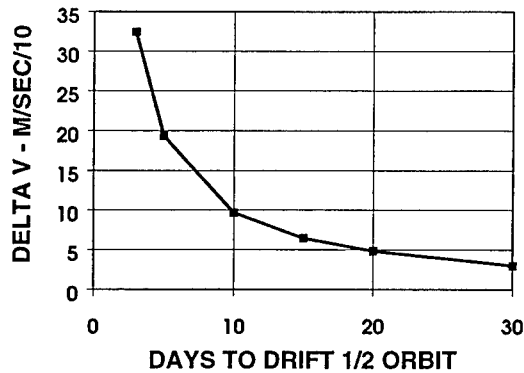
For the purposes of this study, satellites in the 20-100 kg class are considered "small". Their mission and system requirements have a broad range depending on the details of their specific mission. This nitrogen cold gas propulsion system is aimed at missions with low available power, mass constraints and rather meager delta V and therefore small total impulse requirements. The required thrust level could vary up or down within the range of 0.1N to 5.0N depending whether attitude control precision or the time available to impart a given delta V dominate the impulse requirements. A strawman mission has been generated to illustrate the advantages of the proposed system.

### **2.1 - Strawman Mission Description**

The mission is a communication constellation of small spacecraft that are launched into multiple planes of a 700 km orbit inclined 63°. It has a 5-year mission lifetime since technology improvements will most likely make it obsolete beyond that time frame. A target spacecraft mass of 30 kg is established assuming an advanced miniaturized bus that is earth pointing and maintains 3-axis attitude control via wheels and torquer bars.

### **2.2 - Strawman Mission Propulsion Requirements**

Each plane of the constellation is populated by the single launch of 6-8 spacecraft into a 700 km circular orbit. After correcting the tip-off rates induced by separation from the dispenser (2.0 degrees/sec) the onboard propulsion system must provide impulse to evenly distribute the spacecraft around the orbital plane. This is accomplished by raising the apogee or lowering the perigee of a spacecraft while adjusting the inclination to match the nodal drift rate of the baseline constellation. The spacecraft will then be allowed to drift around the orbit until it has achieved the desired position and finally lowering the apogee or raising the perigee and adjusting the inclination to match the baseline orbit. If the dispenser were able to do the initial orbital adjustments, the required delta V would be halved. The required delta V is a function of the duration allowed to accomplish drifting as well as how far the spacecraft is required to drift around the orbit. For this study it is assumed that there are 30 days available for the drifting and the drift distance is the maximum of 180°. This results in a tip off rate cancellation propellant mass requirement of 0.011 kg and a constellation establishment delta V requirement of 30 m/sec. Any delta V required to correct the initial launch vehicle injection error is assumed to be included in the 30 m/sec.



**Figure 1:** Constellation Establishment Delta V vs. Days to Drift 1/2 Orbit

Maintaining the desired spacing between each spacecraft during the mission lifetime requires additional delta V. Data from IRIDIUM indicates that about 4 m/sec/year is sufficient allowance for this function. For the 5-year mission life this results in a 20 m/sec requirement.

On spacecraft with a lot of functional redundancy, thrusters are often used to backup the wheels for attitude control and the torquer bars for momentum dumping. For this multiple spacecraft constellation no backup function from the propulsion system is required. For a spacecraft this size however, momentum dumping for 5 years would only require about 0.2 kg of gas and the attitude control backup requirement could most likely be accommodated by the planned impulse margin.

De-orbiting the spacecraft at the end of its useful life is a capability sometimes required of the propulsion system. Unfortunately, it usually dominates the mission propellant requirements and is identified as an optional requirement for this spacecraft. The NASA 1740.8 requirement for LEO satellites is to place the spacecraft in an orbit that will naturally re-enter in 25 years. This mission's 700 km orbit and 0.01 m<sup>2</sup>/kg spacecraft area to mass ratio requires lowering the orbit perigee to 550 km which results in a de-orbit delta V requirement of 40 m/sec.

Once the baseline requirements are established it is prudent to provide propellant capacity for creep, leakage and an adequate safety margin. Early in the formation of a program 20% is the value of margin usually allocated. After CDR the comfort zone is 10%. The subject system is so simple that leakage can be predicted with confidence. For this reason a margin of 10% is adequate. The cold gas system leak sources include the thruster seats (2X10<sup>-5</sup> sccs each), the fill/drain valve, the tank, the pressure transducer (future) and the manifold (1X10<sup>-6</sup> sccs). Over a 5 year mission this amounts to 0.016 kg of propellant. If excess capacity exists in the propulsion system at launch, any unused dry mass margin can be loaded as propellant. Table 1 summarizes the propellant requirements for the 30 kg spacecraft assuming a GN2 Isp of 65 sec.

Mission Element	Delta V (m/sec)	Impulse n-sec	Mass (kg)
Injection Trim / Constellation Establishment	30	-	1.379
De-Spin	-	-	0.000
Tip-Off Nullification	-	7.0	0.011
Momentum Dump	-	-	0.000
Constellation Maintenance	20	-	0.927
Leakage Allowance	-	-	0.016
Margin	-	-	0.231
<b>Mission Total</b>	<b>50</b>	<b>7.0</b>	<b>2.564</b>
De-Orbit (optional)	40		1.825

Table 1: Propellant Requirements Summary

### 2.3 - Derived Propulsion System Requirements

Once the required propellant quantity is determined, tank sizing and system component requirements can be derived. The higher the storage pressure, the more compact the resulting system will be. For the purposes of this study, cost was the dominant factor. In order to utilize existing off-the-shelf components, an MEOP of 207 bar was selected. Given a maximum temperature of 40°C, 2.564 Kg of useable nitrogen would require a storage volume of 13.2 liters. For this demonstration system an off-the-shelf 8 liter tank was selected.

The thrusters are designed to provide a thrust of 0.5N at 21 bar inlet pressure. The vast majority of the propellant will be used for delta V for injection trim and constellation establishment early in the mission when tank pressure is highest. At 207 bar inlet pressure the thrusters will deliver approximately 5N of thrust. Thrust over the blow-down range of 207 to 21 bar will be directly proportional to inlet pressure as shown in Figure 2.

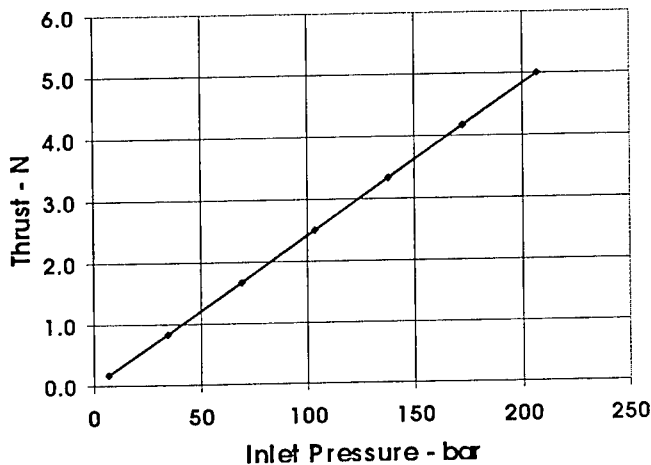


Figure 2: Thrust vs. Inlet Pressure

Low system mass is achieved by using only four double canted thrusters to achieve all the required propulsion maneuvers. By mounting the thrusters in a 15° double canted orientation, 3-axis control and delta V can be achieved. This is illustrated in Figure 3 using unit vectors. When thrusters are fired as delineated in Table 2, the thrust vectors combined to achieve pitch, yaw, roll and translation. These maneuvers also impart a delta V to the spacecraft. If this is undesirable, it can be cancelled with a pure delta V firing.

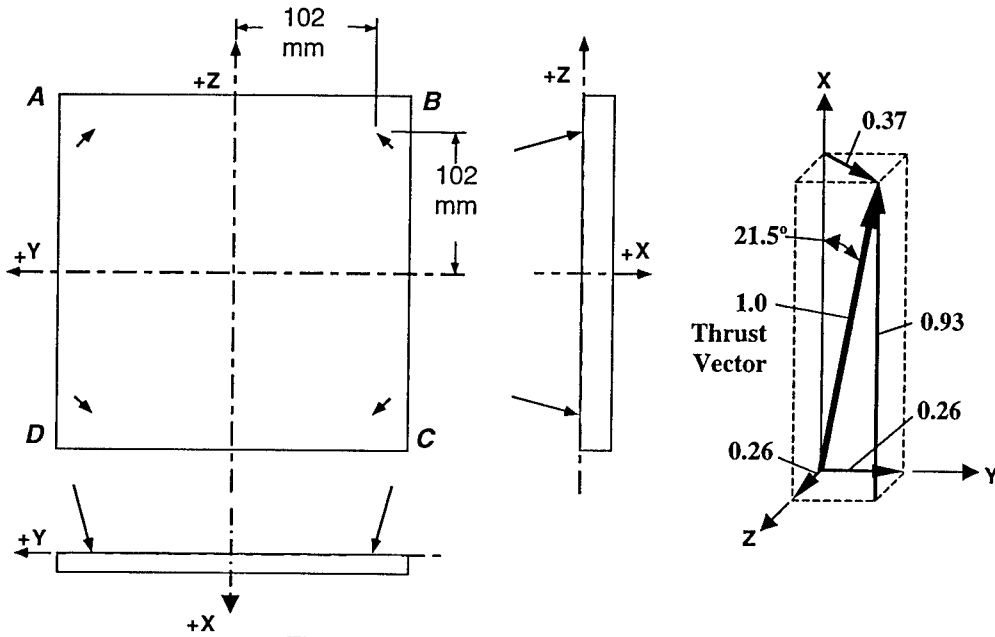


Figure 3: Thrust Vector Diagram

Maneuver	Thruster	Torque/Force
+Pitch	AB	0.948 N-M
-Pitch	CD	0.948 N-M
+Yaw	BC	0.948 N-M
-Yaw	AD	0.948 N-M
CW Roll	AC	0.439 N-M
CCW Roll	BD	0.439 N-M
Delta V	ABCD	18.6 N

Table 2: Thruster Force/Torque

### 3 - PROPULSION SYSTEM DESCRIPTION

#### 3.1 - Overview

The subject propulsion system is a cold gas system using nitrogen as the propellant. To minimize mass and cost, the demonstration system, as shown in Figure 4, is very simple.

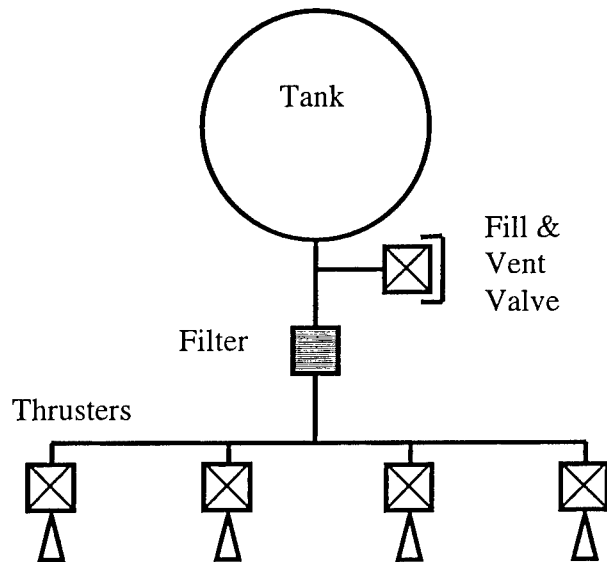


Figure 4: Demonstration System

Nitrogen is stored at 207 bar in the 8.0 liter Tank. A Fill & Drain Valve facilitates filling and venting nitrogen from the system. This fitting also allows the ground test system to be hooked up to external pressure sensors. A 20 micron filter protects the Thrusters from particulate contamination that might enter the system through the Fill Valve.

As shown in Figure 5, a manifold consisting of  $\frac{1}{4}$ " CRES tubing interconnects the functional components of the system. The Mounting Plate acts in conjunction with the Tank as the primary structural element of the system. For the ground test system, the Mounting Plate is fabricated from 6.4mm thick aluminum plate. For an eventual flight unit, this part will be replaced with an aluminum honeycomb or composite plate. The Mounting Plate is connected to the Tank by a harness with four CRES padded straps. Each strap is connected to an arm of the Mounting Plate by a "T" bolt and turnbuckle.

Each of the four thrusters are fastened to a mounting bracket. The bracket is, in turn, attached to the Mounting Plate. The Thrusters are tilted  $21.5^\circ$  from the X-axis toward the tangent. This is mathematically equivalent to the  $15^\circ$  double canted orientation discussed earlier.

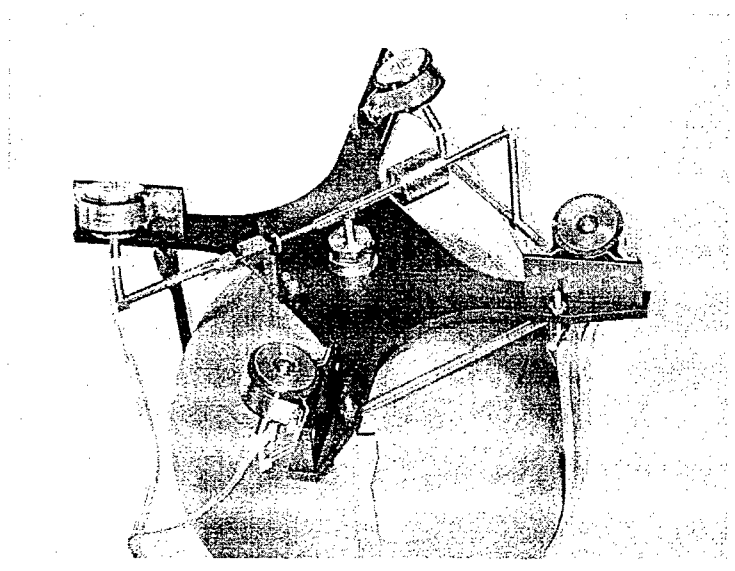
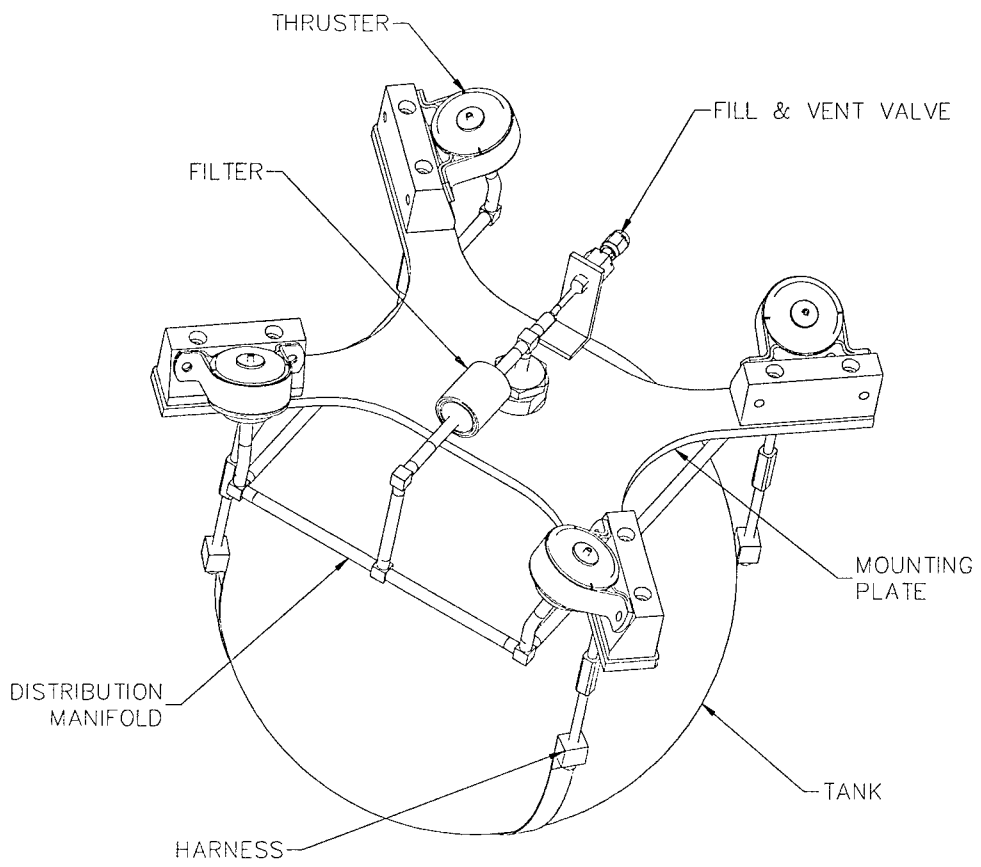


Figure 5: Cold Gas Propulsion Demonstration System



### 3.2 - Propellant Tank

The primary requirement of the CGPS is to provide the impulse required for various mission phases. Since the propellant is simple pressurized GN<sub>2</sub>, a variety of suitable tanks can be utilized. The tank selected for the demonstration CGPS, as shown in Figure 6, is an 8-liter Lincoln Composites unit, P/N 220063. It consists of a spherical aluminum shell with a Kevlar filament over-wrap.

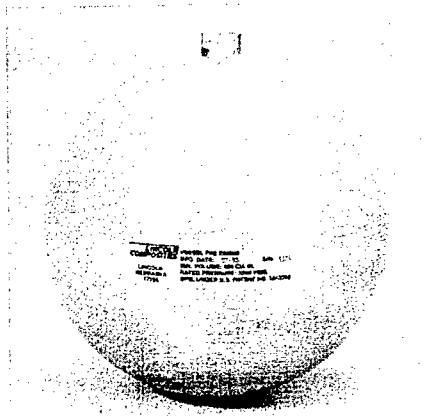


Figure 6: Propellant Tank

This tank has been in production for many years and has been used in a variety of aerospace applications including the Clementine spacecraft.

### 3.3 - Fill & Vent Valve

The miniature Fill & Vent Valve selected for this application is VACCO Industries P/N V1D10874-01 shown in Figure 7. This valve is identical to our production unit except the body is CRES instead of titanium. When closed and capped the valve provides two interrupts against external leakage. Should the valve seat be damaged after installation it can be disassembled and refinished in place. Using CRES for the Body drives the mass of the valve to about 40 grams.

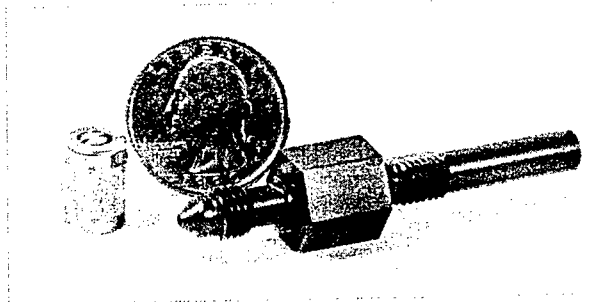


Figure 7: VACCO Fill & Vent Valve

Hundreds of these valves have been used in applications to pressures as high as 690 bar.

### 3.4 - Filter

The Filter selected for this application is a 20 micron absolute, diffusion-bonded, etched disc design per VACCO P/N F1D10744-01 (Figure 8). This advanced design features hundreds of titanium discs with thousands of individually etched flow passages. Each flow path is held to micro-scale tolerances. This insures that the passages will be small enough to prevent passage of particles greater than 20 microns while providing a large flow area.

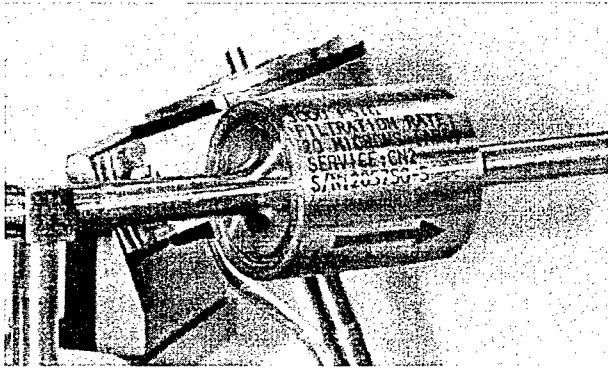


Figure 8: VACCO Nitrogen Filter

### 3.5 - Cold Gas Thrusters

The four cold gas thrusters per VACCO P/N V1E10703-01 (Figure 9) are an adaptation of a latch valve design currently in production. They are unique for a thruster in that they are designed to magnetically latch in their last commanded position when electrical power is removed.

The thrusters are all-welded against external leakage. Materials in contact with the propellant are limited to CRES and Kel-F. Separate coils control opening and closing respectively. The expansion nozzle is built into the thruster valve body immediately downstream of the seat.

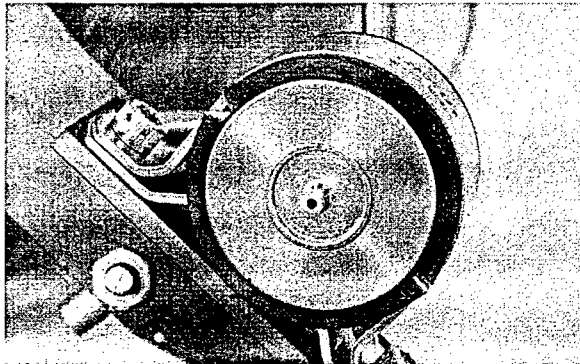


Figure 9: Cold Gas Thruster

Power is only consumed during the 20 millisecond electrical pulse while the valve is changing state from open to closed or from closed to open. Unlike typical normally closed thruster valves, they do not consume power during most of the duration of the thruster firing. Assuming a delta V of 50 m/s is required, a conventional normally closed thruster valve will consume approximately 7,600 watt-sec of energy. Assuming 100 thruster firings, the latching thruster valve will consume only 352 watt-sec of energy. This reduces the power consumed by the valves by over 95%.

## 4.0 – SYSTEM TESTING

### 4.1 - Test Plan

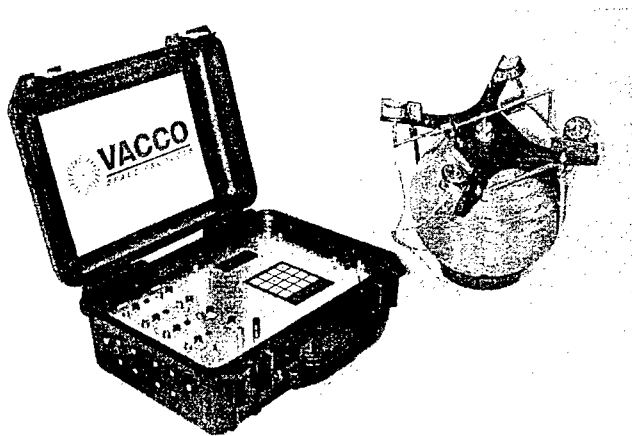
Due to funding constraints, minimal functional testing of the demonstration Cold Gas Propulsion System was performed. The testing was performed per VACCO Test Procedures ETP-XV1E10718 and ETP-V1E10718. All of the components were tested at the component level to verify performance before integration. An outline of the system test plan is as follows:

1. Visual Inspection
2. Proof Pressure Test
3. External Leakage Test
4. Internal Leakage Test
5. Extended Applied Voltage Test
6. Coil Resistance Test
7. Power Consumption
8. Dielectric Strength Test
9. Pull-In Voltage Test
10. Thruster Response Test
11. Flow (Thrust) Test
12. Minimum Impulse Bit Test

Testing was designed to confirm functionality of the design and act as a baseline for comparison against future testing.

### 4.2 – Test Specimen

The Cold Gas Propulsion System test specimen and control box is shown in Figure 10.



**Figure 10:** Cold Gas Propulsion System Test Specimen and Control Box

In addition to the CGPS an electronic controller was developed. The electronic control box is a microprocessor-based controller, which has programmable settings between 1 and 65000 millisecond resolution. Three settings are programmed into the controller T1, T2, and T3. T1 is the opening pulse duration, T2 is the "dead time" or lag between open and closing pulses, and T3 is the closing pulse duration. Each of the thruster valve's setting are programmed independently.

### 4.3 – Test Results

The Cold Gas Propulsion System met or exceeded all of the design requirements established during the design phase. The results of this testing is delineated in Table 3 and Table 4 below.

	<b>THRUSTER VALVE #1</b>	<b>THRUSTER VALVE #2</b>	<b>THRUSTER VALVE #3</b>	<b>THRUSTER VALVE #4</b>
<i>Opening Coil Response @ 21 bar, 24 VDC</i>	3.7 msec	3.75 msec	3.55 msec	3.5 msec
<i>Closing Coil Response @ 21 bar, 24 VDC</i>	4.05 msec	3.75 msec	3.9 msec	3.5 msec
<i>Minimum Pulse Bit @ 21 bar, 24 VDC</i>	7.75 msec	7.5 msec	7.45 msec	7.0 msec
<i>Opening Coil Response @ 69 bar, 24VDC</i>	3.65 msec	3.85 msec	3.6 msec	3.6 msec
<i>Closing Coil Response @ 69 bar, 24VDC</i>	3.95 msec	3.85 msec	3.85 msec	3.6 msec
<i>Minimum Pulse Bit @ 69 bar, 24 VDC</i>	7.6 msec	7.7 msec	7.45 msec	7.2 msec
<i>Opening Response @ 138 bar, 24 VDC</i>	3.65 msec	3.85 msec	3.85 msec	3.6 msec
<i>Closing Response @ 138 bar, 24 VDC</i>	3.85 msec	3.85 msec	3.85 msec	3.55 msec
<i>Minimum Pulse Bit @ 138 bar, 24 VDC</i>	7.5 msec	7.7 msec	7.7 msec	7.15 msec
<i>Opening Response @ 248 bar, 17.2 VDC</i>	6.6 msec	7.8 msec	6.6 msec	6.8 msec
<i>Closing Response @ 248 bar, 17.2 VDC</i>	6.8 msec	6.8 msec	6.2 msec	7.0 msec
<i>Minimum Pulse Bit @ 248 bar, 17.2 VDC</i>	13.4 msec	14.6 msec	12.8 msec	13.8 msec

**Table 3: Cold Gas Propulsion System Test Data**

	<i>THRUSTER VALVE #1</i>	<i>THRUSTER VALVE #2</i>	<i>THRUSTER VALVE #3</i>	<i>THRUSTER VALVE #4</i>
<i>Internal Leakage @ 248 bar</i>	3.2x10 <sup>-7</sup> sccs GHe	5.4x10 <sup>-7</sup> sccs GHe	3.2x10 <sup>-7</sup> sccs GHe	9.0x10 <sup>-7</sup> sccs GHe
<i>External Leakage @ 248 bar, 17.2 VDC</i>	Not Detectable w/ Pipette.	Not Detectable w/ Pipette.	Not Detectable w/ Pipette.	Not Detectable w/ Pipette.
<i>Opening Coil Response @ 248 bar, 17.2 VDC</i>	6.6 msec	7.8 msec	6.6 msec	6.8 msec
<i>Closing Coil Response @ 248 bar, 17.2 VDC</i>	6.2 msec	6.8 msec	6.2 msec	7.0 msec
<i>Power Consumption Opening Coil @ 32 VDC</i>	28.2 watts	28.4 watts	28.4 watts	29.0 watts
<i>Power Consumption Closing Coil @ 32 VDC</i>	28.4 watts	28.7 watts	28.4 watts	28.6 watts
<i>Flow Rate @ 21 bar</i>	41.1 l/m	42.5 l/m	39.6 l/m	39.6 l/m
<i>Flow Rate @ 34 bar</i>	68.0 l/m	70.8 l/m	65.1 l/m	66.5 l/m

**Table 4:** Cold Gas Propulsion System Test Data

## 5.0 - FLIGHT SYSTEM CONFIGURATION

Due to the flight-like nature of the demonstration system design, a future flight system will be very similar. In order to minimize size and mass while accommodating 2.564 Kg of nitrogen, the maximum operating pressure would increase to 5000 psia. The design shown in Figure 10 includes an additional latching isolation valve to prevent leakage and a pressure transducer.

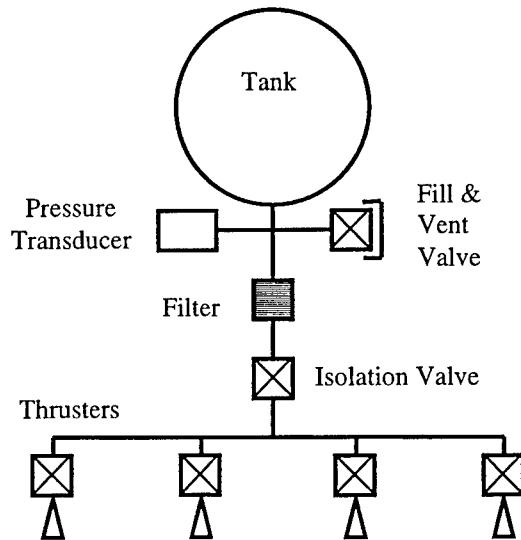


Figure 10: Flight System Schematic

## 6.0 - SUMMARY

The subject Cold Gas Propulsion System represents an important advancement in low power propulsion technology suitable for small satellites. As a result of this work, the size, mass, power requirements and cost of these systems has been significantly reduced. The objective of this work is to document the capabilities and attributes of the low power Cold Gas Propulsion System in sufficient detail to allow designers of small satellites to consider it as a practical propulsion system option.

## ACKNOWLEDGEMENTS:

The authors would like to thank the following personnel at VACCO Industries without whom this paper would not be possible:

Ben Otsap  
Greg Terrones

Larry Mosher (APL)  
Gary Grant

## REFERENCES:

J.M. Cardin, Larry E. Mosher : "A Low Power Approach to Small Satellite Propulsion", 13<sup>th</sup> AIAA/USU Conference on Small Satellites, Logan, Utah, USA, August 1999.

J.M. Barnett, B. Otsap, "Diffusion Bonded, High Efficiency Etched Disc Filters", 35<sup>th</sup> AIAA/ASME/SAE/ASEE Joint Propulsion Conference, Los Angeles, California, USA, June 1999.

## **SESSION 5b :**

### **Technologies Petits Satellites : Autres technologies** ***Small Satellites Technologies: Other technologies***

*Présidents / Chairpersons: Virendra JHA, Simona DI PIPPO*

- (S5b.8) Micro-Satellite Based, On-orbit Servicing Work at the Air Force Research Laboratory**  
Madison R.W., Davis M.J. Air Force Research Laboratory, Kirtland AFB, MN, Etats-Unis
- (S5b.9) Digital Reaction Wheel Assembly RSI 01-5 for Small and Low-Cost Spacecraft**  
Landes A., Boettcher-Arff S. Teldix GmbH, Heidelberg, Allemagne
- (S5b.10) Lightweight Lithium ION Batteries for Microsat Applications**  
Lagattu B., SAFT Defense and Space Division, Poitiers, Gave G. CNES, Toulouse, France
- (S5b.11) "THE BITSYtm" Spacecraft Kernel: Reducing Mission Cost with Modular Architecture and Miniature Technology".**  
Chabert N., London Satellite Exchange Ltd, London, Royaume Uni, McDermott S.A., Goldstein D.J., AeroAstro Inc., Etats-Unis
- (S5b.12) Experimentation de contrôle d'orbite autonome sur le microsatellite Demeter / An autonomous orbit control experiment for the DEMETER microsatellite**  
Charneau M.C., Lamy A., Laurichesse D., Grondin M., CNES, Toulouse, France
- (S5b.13) The Nanosol Biaxial Sun Sensor**  
Doctor A., Glaberson J., BFGoodrich Aerospace, Barnes Engineering, Shelton, Etats-Unis
- (S5b.15) Active Permanent Magnetic Attitude Control for Small Satellites**  
Fullmer R., Florin D. Space Dynamics Laboratory, Utah State University, Logan, UT, Etats-Unis
- (S5b.16) High Speed, Miniature Momentum/Reaction Wheels**  
Kestleman V.N., Brothers L.J., Valley Forge Composite Technologies, Inc., Carlisle, PA, Etats-Unis
- (S5b.17) The PRIMA Electrical Power System**  
Crocì L., Beltrame G., Officine Galileo B.U. Spazio, Milan, Italie

---

## MICRO-SATELLITE BASED, ON-ORBIT SERVICING WORK AT THE AIR FORCE RESEARCH LABORATORY<sup>1,2</sup>

Richard W. MADISON & Capt Mark J. DAVIS

*Air Force Research Laboratory, 3550 Aberdeen Ave SE, Kirtland AFB, NM 87117-5776  
Phone: 505-846-9459, Email: [mark.davis@kirtland.af.mil](mailto:mark.davis@kirtland.af.mil)*

*Abstract— On-orbit servicing can dramatically reduce the life cycle cost, and increase the utility, of expensive space assets. However, previous servicing attempts have generally been too large, complex, and expensive to be effective. Newer, streamlined approaches, such as the Air Force's Modular On-orbit Servicing (MOS) concept, might make on-orbit servicing feasible. The Air Force Research Laboratory (AFRL) is developing many of the technologies required for the MOS concept. AFRL's Experimental Satellite System (XSS) demonstration program is developing technologies for the micro-satellites that are at the core of the MOS concept. AFRL is also working on many of the supporting technologies for MOS. This paper describes the XSS program, how it will develop the micro-satellite technologies required for MOS, how other AFRL programs will provide additional technologies, and what technologies must still be developed to make on-orbit servicing a reality.*

### TABLE OF CONTENTS

1. INTRODUCTION
2. MODULAR ON-ORBIT SERVICING
3. THE XSS PROGRAM
4. XSS-10: GROUNDWORK
5. XSS-11: COMPONENTS
6. XSS-12: SERVICING
7. RELATED TECHNOLOGIES
8. CONCLUSIONS
9. REFERENCES

### 1. INTRODUCTION

On-orbit servicing can be defined as manipulating satellites on-orbit to extend their life or capability. This can be divided into three tasks: diagnosis, supply, and repair. Diagnosis means assessing damage to a satellite. This is not actually manipulation, but is a necessary precursor, determining what servicing is needed. Supply is the set of manipulation tasks that can be accomplished by docking and transferring something to a satellite. The most obvious examples are adding, upgrading, or replacing components, and refilling expendables. Less obvious tasks include providing trickle power, towing to a new orientation or orbit, or assembling a satellite from modules. Repair is the set of manipulation tasks that involve fixing, not replacing. Examples include decontaminating optics, adding or replacing coatings or structural material, cutting or bending fixtures to recover from failed deployments, and assembling items such as trusses.

---

<sup>1</sup> U.S. Government work not protected by U.S. copyright

<sup>2</sup> Updated November 26, 1999



## Benefits of On-orbit Servicing

The ability to perform these servicing tasks opens up a whole new way of thinking about operating satellites, in the same way that the existence of gas stations allows a different way of thinking about operating cars.

Enhancing operational availability of satellites is the primary benefit of servicing. When a satellite fails or runs out of consumables, servicing with on-orbit components can return it to operation, generally much earlier than a replacement satellite can be launched. Spare satellites on-orbit are even more timely, but are not effective if a large number of satellites are disabled at once. Beyond component failures, servicing can rescue healthy, misplaced satellites, such as those that are deposited in the wrong orbit, point their antennae the wrong direction, fail to deploy properly, or never power up. In addition, servicing makes satellites available for more operations. Drastic orbit changes may improve theater coverage, aiding the war fighter, but they drain propellants, the life-blood of the satellites. Thus, such maneuvers must be reserved for critical operations. Servicing can replace the propellants, making the maneuvers feasible much more often.

A second benefit of servicing is mission flexibility. Satellites are designed for a certain purpose, such as sensing a certain set of threats or communicating at a certain rate. As technology improves and threats evolve, a satellite can become obsolete. Adding or replacing components on a satellite can keep the satellite current, without the development cost or launch delay associated with fielding a new satellite system. This will become increasingly important as satellites are built for longer lives, while technology advances ever quicker. A recent study on GPS satellites [1] demonstrated the utility of a variety of servicing concepts, over the current, replacement, strategy.

Scalability is the third benefit of on-orbit servicing. The most straightforward option for increasing the capability of satellites is to make them larger. Advantages include more power, more aperture, and more immediately usable consumables. Many satellites being planned today (lasers, telescopes, space stations, etc.) anticipate reaping these benefits. However, satellites are constrained by the size of available launch vehicles. With servicing, satellites can be assembled on-orbit from modules, each of which could fill an entire launch vehicle. If launch weight is the problem, a satellite could be launched dry, then fueled from a separate launch, once it checks out on-orbit. Elements such as antennae, which might typically be deployed on-orbit, could be assembled instead, without complex deployment schemes. This could significantly increase the packing efficiency, allowing much larger antennae to fly on the same launch vehicle [2].

Extending satellite life is the next benefit of servicing. This goes beyond the obvious issues of remedying failures or obsolescence. By decontaminating optics, reapplying coatings that have abraded or out-gassed, filling cracks before they spread, or lubricating joints, servicing keeps a satellite in peak condition. By cleaning space debris from around a satellite or from intersecting orbits, servicing prevents life-threatening accidents. This can be increasingly important as increasingly powerful small satellites and increasing availability of launches facilitate the rapid accumulation of satellites and associated space junk.

Finally, servicing has the potential to reduce the life cycle cost of satellites. If components will be replaced periodically, as technology advances, their success is less critical. Satellite components need not be as redundant, and need not meet the radiation requirements they face today. Satellite components can be salvaged and reused, removing the cost of space lift from the servicing equation. Other, common components can be lifted at convenient times, in anticipation of their need, again reducing the cost of space lift. Formerly deployed appendages, now lifted in tight, well-secured bundles, do not require as much over-design, reducing launch weight. And of course, even a plain old servicing mission that rescues a satellite or only requires a few space-lifted components, can be cheaper than lifting a whole new satellite. An internal AFRL study recently found ten existing

satellite systems for which cost analyses predicted large savings from on-orbit servicing, and three satellites worth 2.7 billion dollars, launched to wrong orbits in 1999, that could have been saved by on-orbit servicing

These five benefits allow a vision of a future of satellite operations, much like aircraft operations, as opposed to current satellite acquisitions. With servicing, satellites will be available when needed, sized and equipped to handle the demands they will face, and cost effective in a budget constrained world.

### **A Philosophy for On-orbit Servicing**

The benefits of servicing have been obvious for a long time. Manned Russian and American space stations were serviced because periodic supply was critical. Successful missions to Solar Max and the Westar and Palapa satellites, to name a few, proved that astronauts could service satellites. Very expensive assets, such as the Hubble Space Telescope, rely on this servicing. However, astronaut-based servicing only works for satellites in space shuttle orbits, and costs more than replacement for all but the most expensive assets. Attempts at robotic servicing, such as the Flight Tele-robotic Servicer and Orbital Maneuvering Vehicle, have also proven to be too large, complex, and expensive to tip the balance.

However, a new vision of servicing may provide the answer. Instead of large, complex service vehicles, performing complex servicing tasks, newer concepts consider small, simple service vehicles, and smart satellites designed to be serviced. This concept becomes more feasible each year, as smaller components, faster processors, and smarter algorithms reduce the minimum size of servicing vehicles, and allow satellites to make better use of the aid that a small servicer can provide.

This paper presents the path AFRL is currently taking to implement servicing. It begins with a more detailed description of the vision of on-orbit servicing. It then explains how the XSS micro-satellite program is developing the central technologies needed to implement the concept. Finally, it describes the complementary technologies that must still be developed, identifying which will be developed at AFRL, and which remain as research challenges.

## **2. MODULAR ON-ORBIT SERVICING**

Modular On-orbit Servicing (MOS) [3][4] is an Air Force concept to enable routine satellite servicing. It was developed with contributions from representatives of the Air Force Research Laboratory, the Air Force Institute of Technology, United States Space Command, Air Force Space Command, and the Space and Missiles Systems Center (SMC). It is part of SMC's development plan for satellite operations. MOS involves five types of vehicles, interacting to form a complete servicing infrastructure. The features of each vehicle group are described below.

### **Next Generation Satellites**

The key to MOS is a new generation of satellites, designed for servicing. Eliminating the need to peel back insulation, unbolt panels, or solder wires simplifies the task of the service vehicles, and thus their design. In fact, the goal of the next generation satellite architecture is to allow most servicing operations, namely the supply operations, to be recast as simple, docking problems.

There are four features of next generation satellites. First, the new satellites are plug-and-play. Components are connected with busses, not point-to-point connections. New components can be attached to these busses and automatically assimilated into the satellite, so that they can replace old components, or add new capabilities. Second, the satellite is functionally modular, so that systems can be easily shut down and replaced. Unlike physical modularity, which is common to earlier

servicing schemes, functional modularity does not constrain the physical design of the satellite. It only requires that related elements can be disabled and replaced as a logical unit. Third, the new satellites can automatically detect, isolate, and attempt to remedy faults. Rather than simply sending telemetry about anomalies, the satellite requests specific servicing activities. Intelligent fault prediction, done by observing trends in the performance of components, allows the satellites to schedule needed preventative maintenance, reducing the chance of a disabling failure, and reducing the price associated with quick response. Fourth, the new satellites have docking ports, connected to their plug-and-play busses. After the satellite calls for a new component, the part can be plugged into a port, where the satellite automatically detects it, shuts down the modules it replaces, and reconfigures itself to use the new part. The docking ports have standardized interfaces, facilitating the creation of cheaper, off-the-shelf components. The only thing missing is a way to plug the new part into the satellite.

### **Micro-satellite Service Vehicles**

Micro-satellites are the work-horses of MOS. They are small, agile satellites, weighing 100kg or less. They are designed to travel short distances and safely dock with next generation satellites. They carry hardware components or connect tanks of expendables, which they connect to the serviced satellite during docking. Being only a fraction of the mass of the serviced satellite, the micro-satellite can be space lifted at a fraction of the cost of a replacement satellite, making servicing economically viable. Larger satellites, built along the same lines as the micro-satellites, can service larger customer satellites. In addition to its duties as a supply ship, the micro-satellite also serves as a free flying, diagnostic imager, plug-in test equipment for an uncommunicative satellite, a short distance or re-orienting tug, and a ferry for small robots. Finally, the micro-satellite can perform some repair tasks, using spray jets while precision flying next to a customer satellite, to decontaminate optics, add coatings, etc.

### **Robots**

Not all servicing functions can be optimally performed by micro-satellites. Thus, MOS includes plans for robots of two sorts. The first are large robot arms, suitable for large assembly and deployment tasks, where muscle power and reach are important considerations. A second group is micro-robots, which can crawl around satellites, performing repairs that require precision but less strength. Example tasks include repairing cracks, clipping errant thermal blankets, and performing diagnostic tasks that require contact with the satellite. They also provide a general-purpose set of eyes and hands, for solving unexpected spacecraft problems. Both sets of robots could operate autonomously, under supervised autonomy, or under direct tele-operation, allowing normal operations without constant or high-bandwidth contact, plus short windows of direct control for novel activities.

### **Orbit Transfer Vehicles**

Orbit transfer vehicles (OTVs) carry micro-satellite, micro-robots, and supplies between customer satellites, depots, and supply rendezvous points. Phasing around an orbit to reach a ring of satellites is much cheaper than launching service vehicles to each satellite. Transferring between different orbits and reusing a service vehicle is often cheaper than launching a new service vehicle. This is particularly true with newer, high specific impulse propulsion schemes, which trade speed for fuel economy. At the extreme, electro-dynamic tethers allow almost fuel-less orbit transfer, over long intervals. The orbit transfer vehicles simply sit in a home orbit or a safe distance from their last customer, and wait to be dispatched to a new customer.

---

## **Launch Vehicles**

The remaining component is the launch vehicle that brings supplies into orbit. MOS supports many variations, allowing the user to trade response time for price. Launch-on-demand concepts [5] allow immediate launch of micro-satellites with small payloads, directly to customer satellites. Deployment from a Space Maneuvering Vehicle allows slightly slower response, for heavier payloads. If more time is available, OTVs can bring servicers and supplies at a more or less leisurely pace, with less speed translating to less cost in propellants. On orbit depots, such as space stations or simple caches, provide staging points, where OTVs can pick up supplies launched on convenient vehicles, perhaps as secondary payloads. Alternately, an OTV can simply rendezvous with a launch vehicle carrying a load of supplies. In essence, there is a continuum of launch possibilities, wherein more advanced notice of the need for servicing translates into less cost for the associated launch.

## **Summary**

The MOS concept is a description of five sets of vehicles, which together form an on-orbit servicing infrastructure. Advantages over previous concepts include simplicity and low launch mass, translating into cost savings, plus the ability to reach any orbit. The SMC development plan calls for initial operational capability (without the robots) in 2005, and full capability in 2013.

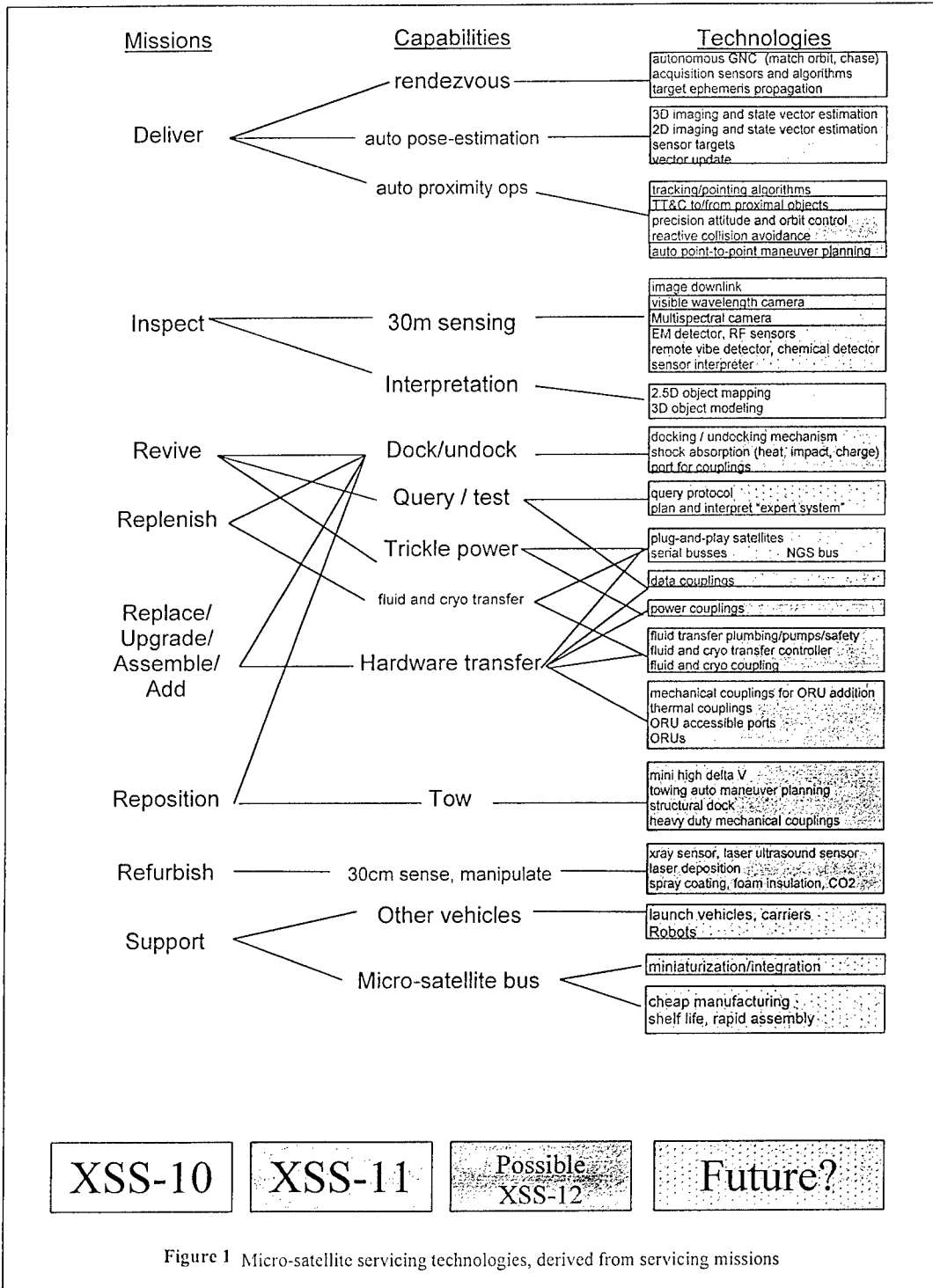


Figure 1 Micro-satellite servicing technologies, derived from servicing missions

### 3. THE XSS PROGRAM

The XSS series of micro-satellite servicing demonstrations is the center of AFRL's on-orbit servicing program. Three XSS experiments have been formulated, in conjunction with the MOS concept, to mature and demonstrate the full set of micro-satellite technologies needed for on-orbit servicing.

Figure 1 shows a flow-down from the micro-satellite missions that are part of MOS, to the capabilities required for those missions, to the technologies that enable them. Color-coded boxes show which XSS experiments, if any, will demonstrate each technology. Boxes with multiple colors show technologies that will be demonstrated in steps. Technologies have been assigned such that each demonstration mission both evolves technologies proven in the previous mission, and spring-boards off of them to test new technologies. Thus, each XSS mission moves one step closer to full on-orbit servicing capability. In addition, each XSS demonstration proves a useful capability in its own right. For the three missions, these are inspection, supply, and repair.

### 4. XSS-10: GROUNDWORK

#### Mission

The XSS-10 experiment will lay the groundwork for micro-satellite based servicing, by demonstrating the ability to safely fly a micro-satellite close to another satellite, and to point at that satellite. The experiment is scheduled to fly in 2001.

The XSS-10 experiment will consist of a single micro-satellite and its host, an upper stage. The micro-satellite will detach and fly a preset pattern around the upper stage, staying about one hundred meters away. It will stop at four points in the upper stage's orbital plane, once directly above the upper stage, and once directly below. At each of these stops, it will hover, point at the upper stage, take video images, and relay them to Earth. After flying this pattern, the micro-satellite will continue pointing at the upper stage, and approach along the pointing vector. This sequence of maneuvers, by itself, will demonstrate the ability to provide imagery for visual diagnosis, which will often be the first step in servicing. More importantly, it will demonstrate several capabilities that are necessary for even the most rudimentary on-orbit servicing experiments. These include imaging, pointing, and proximity flying.

#### Imaging

The primary payload on XSS-10 will be a visible light camera, which will prove the ability to provide imagery for diagnosis. Beyond proof of concept, the imagery will be used to ground test image processing algorithms that recover the pose, motion, and shape of the imaged satellite. Once verified, the algorithms can be used in later experiments, to control docking and close-up maneuvers. The testing will also indicate whether and how the imager must be improved, for instance having better resolution or dynamic range, to increase the precision of the algorithms.

#### Pointing

The second servicing capability demonstrated by XSS-10 will be pointing of the imager. The micro-satellite will plan its flight path based on the position of the upper stage, as seen by the imager. Path planning in later experiments will use additional information such as rotation rate, extracted from the images. This will require the micro-satellite to maintain precision pointing at its patient. XSS-10 will demonstrate that it can keep the patient in view during fly-around and axial approach. In addition, it will show how precisely the pointing can be controlled, to determine whether the pointing control must be improved before later experiments are allowed to approach to docking or close-up-inspection distances.

### **Proximity Flying**

The third servicing capability demonstrated by XSS-10 will be the ability to safely fly near another satellite. This includes circumnavigation at about one hundred meters, hovering at several points, and axial approach and retreat. In each maneuver, the micro-satellite will demonstrate a combination of precision position and attitude sensors, actuators, and control. All three maneuvers will test capabilities that are critical for later servicing experiments. Circumnavigation, along a pre-planned path, will test how accurately the micro-satellite can control to that path. In later docking and up-close inspection experiments, errors in reaching the endpoint of a path will result in collision. Hovering will test how accurately the micro-satellite can control its position. Later experiments will require tight positioning to steady up-close sensors, and the ability to carefully adjust position during docking. Axial movement will test the ability to control an approach. This will be the basis for docking in later experiments.

Thus, in addition to proving the ability to image at a safe distance, the maneuvers show the precision of the control system. This in turn shows whether the control system is sufficiently precise for the maneuvers of later experiments, and, if not, how much it must be improved. Finally, as the micro-satellite and upper stage will both return telemetry (and imagery) through the same ground site, the maneuvers provide an opportunity to test that a ground crew can follow and control two proximal satellites. The ground crew will need this control to command specific hover points during imaging. Such control will also be important in later experiments, where the satellites intentionally come close enough that the crew may need to command an abort.

### **Summary**

XSS-10 provides an initial demonstration of micro-satellite capability. On the surface, it demonstrates the ability to image a satellite and relay the imagery to the ground for diagnosis. More importantly, it provides experimental data indicating how precisely the micro-satellite can recognize the pose, motion, and shape of a satellite, keep the satellite in view, and control its position relative to the satellite. These numbers will provide either confidence that the micro-satellite has sufficient precision to handle later experiments, or an indication of the difference between ground and on-orbit performance, and resulting target precision for the next generation of controllers.

## **5. XSS-11: COMPONENTS**

The XSS-11 experiment will both test the viability of a first generation of servicing hardware, and demonstrate incremental improvements to the imaging technologies demonstrated by XSS-10. The experiment will consist of one micro-satellite and a carrier satellite. The micro-satellite will demonstrate servicing capabilities, using the carrier to simulate a patient. The micro-satellite will also demonstrate improved imaging capabilities, viewing either the carrier or a resident space object, such as a dead satellite whose cause of failure is suspected to be visible (e.g. failure to deploy solar arrays). The XSS-11 experiment is intended to fly in 2004. It is currently in conceptual design phase.

### **Experimental Docking**

The first experiment for the XSS-11 micro-satellite will be to demonstrate preliminary on-orbit servicing capability, with a series of servicing operations that require nothing more complicated than docking. The micro-satellite will dock and undock several times, to demonstrate and compare the utility of several docking sensors and algorithms. While docked, the micro-satellite will perform servicing experiments, exchanging electricity and fluid, with the carrier. The carrier will be three-axis stabilized, but will not broadcast helpful information. This provides a first step toward docking with a dead satellite.

The first task for this experiment will be to determine the *state* (relative position, orientation, and motion) of the docking port on the carrier satellite. This will likely involve 2D or 3D imaging, coupled with model matching, image processing algorithms. These algorithms will determine the state of the entire satellite, then infer the state of the docking port, even if that port is not visible. This allows the micro-satellite to approach from any angle, and not waste fuel circumnavigating to find the docking port. It also does not require the satellite to broadcast information, which would be impossible when servicing an un-powered satellite. In addition to determining the state of the carrier satellite, the micro-satellite will demonstrate the ability to track the carrier's state during a docking approach, when the entire satellite is not visible due to limited field of view of the docking sensor. This both facilitates control during the final phases of docking and prepares the way for close in, precision-positioned inspection. Several sets of sensors and algorithms will be used, in several docking runs. Image processing algorithms will be ground tested on real data, using imagery acquired during the XSS-10 mission.

The second task for this experiment is to convert the state of the carrier satellite into a docking approach. The state should be fairly accurate, as a satellite's equations of motion are well known, and parameters can be estimated from a large set of observations, continuing even as the docking approach progresses. The docking algorithms must simply determine a course to intercept the docking point at a certain relative state, within some error tolerance. This will not be a line of sight approach, in general. It should attempt to minimize either fuel use or time, subject to some maximum on the other. In addition to plotting a course, the micro-satellite must demonstrate sufficient attitude and motion control to fly the path. Hopefully, this will not require much improvement over the precision demonstrated in XSS-10's maneuvers. Also hopefully, it will demonstrate enough improvement to be sufficient for XSS-12's precision maneuvers. The docking maneuvers will be tested in simulation, using error models for the attitude and motion controllers, as well as the image processing algorithms.

At the end of its docking approach, the micro-satellite must physically dock to the carrier satellite. This will require a docking port and mechanism. There will likely only be one of each, but improvements can be tested on XSS-12. The docking port (micro-satellite and carrier sides) will include sufficient mechanical connections for the experiments discussed below, and devices to absorb any physical, thermal, and electrical shock of docking. The port will also have power and data couplings, which will be used to test power and data transfer across the port. This will demonstrate the feasibility of servicing tasks such as trickle powering a satellite, recharging micro-satellite batteries, and querying a satellite to diagnose problems.

Once docked, the micro-satellite will engage a fluid coupling, and transfer either cold gas or liquid hydrogen. Transfer and venting would be performed several times, allowing instruments in the fluid dewars to investigate the nature of zero gravity fluid transfer. It will also be performed after multiple dockings, to test the reusability of the couplings. Cold gas is the simplest fluid, and its transfer would demonstrate micro-satellite propellant refueling. Liquid hydrogen transfer, on the other hand, would show servicing with one of the most difficult fluids, which is useful to many of the likely customers of on-orbit servicing: solar thermal orbit transfer vehicles, orbiting telescopes, and lasers. The key to a liquid hydrogen experiment would be to ensure that the transfer is scalable for these applications. Liquid hydrogen transfer has been proposed [6] but never performed on-orbit.

### **Improved Imaging**

The second experiment for the XSS-11 micro-satellite will be to demonstrate improvements in imaging capability, over what XSS-10 demonstrated. It will rendezvous with a satellite, test the ability to understand the geometry of a novel satellite, use better imaging sensors, fly autonomously and in closer, and image from a miniature platform.



The first task of this experiment will be to autonomously rendezvous with the carrier. However, it could be the XSS-11 carrier, in which case the micro-satellite will back away and change orbits, then return. Either way, the micro-satellite will know the rough ephemeris of the satellite, based on ground tracks. As with docking, it will not receive any assistance from the satellite, as a typical patient would often be un-powered or not interested in broadcasting coordinates. Also, at least at the beginning of the rendezvous, the satellite will likely be invisible, either due to distance or an intervening Earth. The rendezvous will end when imaging sensors locate the satellite, allowing the imaging flight controller to take over.

The next improvement over the XSS-10 micro-satellite will be in the sensing instruments and algorithms. This will begin with a higher performance camera, providing color and increased resolution. This will likely be augmented with additional sensors, taking data in additional spectral bands, such as the infrared. Better interpretation algorithms will complement better sensing. The improved imager will endeavor to create a model of a novel satellite as opposed to a known satellite model. Such a model would allow ground teams to examine a novel or disfigured object in real time, rather than tasking the micro-satellite to fly back and forth between interesting views. It also opens the possibility of understanding, and consequently docking with, a disfigured satellite, such as one where the solar arrays never deployed, or broke off during launch.

Another improvement over the XSS-10 micro-satellite will be in precision flying. Instead of a hundred meters away, the micro-satellite will move in to tens of centimeters. It will demonstrate flying that avoids collision and has sufficient precision to enable the use of instruments such as a laser ultrasound, which must be held close to the patient and very still. These maneuvers will also test the ability to control two satellites that, for all intents and purposes, are collocated. This precision flight test would likely be performed near the mother ship, as a stabilized satellite reduces risk to the experiment, without detracting from the results. Sensing algorithms will test the ability to track features on an arbitrary part of the satellite, during close approach. Should this fail, the precision flying algorithms and effectors can still be tested on an easy sensor target, such as the docking port. However, the goal of these tests is to ensure that precision flying near an arbitrary point is possible, allowing XSS-12 to test servicing activities while flying in this close.

A third improvement will be to demonstrate autonomous path planning for diagnostic imaging. The micro-satellite will recover the rotation of the imaged satellite, novel or otherwise. From this, it will determine the most efficient path that would allow it to map the satellite. As before, efficiency would likely be in terms of fuel or time, subject to some constraint on the other. Combined with successful results of the other tests, the micro-satellite will have shown that it can autonomously rendezvous with, map, and send down a 3D model of, a novel or disfigured satellite, and that it could fly in close to bring arbitrary sensors to bear.

The final improvement to the micro-satellite is an investigation of just how small it can be. The micro-satellite may carry and deploy a hitch hiker pico-satellite. This pico-satellite will use MEMS technology being developed by AFRL/IF [7], allowing a short range imaging craft weighing less than 10 kilograms. The pico-satellite will have very short range and short life span, but this should be sufficient for an adjunct satellite, whose only purpose is to ride an upper stage or full sized satellite, pop off for a quick visual diagnostic if there is trouble, then dock again to recharge. The final step, docking and recharging, will not be demonstrated, as the servicing micro-satellite will test these features at a large scale, and miniaturization of these features is being tested elsewhere [8].

## 6. XSS-12: SERVICING

The XSS-12 experiment, intended to fly in 2006 or 2007, is not currently defined. However, one option is to demonstrate improvements in the docking and docking-based servicing technologies proven by XSS-11, as well as test precision flying technologies required for refurbishing satellites without docking. XSS-12 would consist of two micro-satellites and a mother ship. The first micro-satellite would demonstrate improved docking and servicing with the mother ship. The second would demonstrate very close proximity, non-docked, servicing operations with the mother ship or a resident space object, such as a dead satellite.

### Improved Docking Micro-satellite

The improved docking micro-satellite would perform a complete, worst case, servicing operation, including docking to a disfigured, dead, tumbling micro-satellite, bringing it back to life, and towing it to its proper orbit. This would require improvements to the micro-satellite and an initial demonstration of a next generation satellite. In addition, the mission would demonstrate improvements in all facets of fluid/hardware transfer, which would be the staple of on-orbit servicing.

The docking micro-satellite would demonstrate advanced docking sensors, algorithms, and mechanisms. These would be improvements on the best of the sensors, algorithms, and mechanisms tested in XSS-11. Improvements are expected in three areas: recognition, precision, and tumbling. First, the micro-satellite would need to recognize a disfigured satellite. Combining the results of XSS-11's docking to a satellite of known geometry, and its object modeling of novel satellites, XSS-12 would first model, then dock with, the unmodeled host. Second, XSS-12 would fly much more precisely than its predecessors, allowing more subtle maneuvers, and docking at more restricted error margins. Third, XSS-12 would dock to a slowly tumbling satellite. This is a realistic servicing scenario, as a dead or out of control satellite is likely to tumble. It may require redesign of the dock and docking mechanism, as even docking to a slow tumbler is more difficult than docking to a stationary satellite. It would definitely require much tighter control, but this would be achieved as part of the micro-satellite's precision flying.

The micro-satellite would demonstrate a second generation of transfer capability. This would include transfer of several fluids, including cryogen for the customers, and immediately useful fluids such as hydrazine and nitrogen for the micro-satellite. Taking advantage of the increased understanding of fluid transfer gained in XSS-11, the transfers would be optimized to increase transfer speed and decrease the weight of mechanisms and couplings, without compromising safety.

In addition, the experiment would transfer hardware to the host satellite. The micro-satellite would carry an on-orbit replaceable unit (ORU) on its nose, such that docking will actually be between the ORU and the host satellite. The ORU may hold the electrical and fluid transfer experiments, or they could reside in the micro-satellite and use connections through the ORU. Once the experiments were done, the micro-satellite would release the ORU and depart, leaving it attached to the satellite. The ORU would be designed to not adversely affect the thermal control capability of the carrier. Obviously, it would impact the attitude control. In an operational scenario, the micro-satellite would upload a new control law to the patient, to account for the new ORU. In the experiment, the carrier may simply switch control laws, then execute maneuvers to prove it retains precise control

The host satellite for this mission would be designed not just to accept the transferred fluid and hardware as part of an experiment, but to actually use it, as in a real servicing operation. Upon docking, the micro-satellite would begin trickle powering the host satellite, to bring it back to life. It would test that the host is in working order, then relinquish control to the host. The host would

query the micro-satellite to determine the nature of the hardware and fluids to be transferred. It would control the transfer of fluids, and transfer them into operational tanks. It would reconfigure itself to use the new hardware, shutting down old items whose failure may have shut the satellite down earlier. It would then dismiss the micro-satellite, and perform operations to demonstrate that the new fluid and hardware are being used.

As a final experiment, the docking micro-satellite would demonstrate the ability to tow and reorient the host satellite. The primary consideration would be the ability of the micro-satellite to produce enough thrust to move a much larger satellite. In addition, the host satellite would need to include a much stronger dock than XSS-11 used. Path planning would be important, taking into account the dynamic model of the docked satellites, and the ability of the patient, possibly with deployed appendages, to absorb the imparted thrust. Although re-orienting after a failed launch is a rather obvious application, using a micro-satellite to tow a large satellite may seem somewhat silly. Still, towing a satellite to its intended orbit, from wherever a failed launch left it, will be an important on-orbit service. Hopefully XSS-12 could summon enough delta-V for an impressive orbit transfer. If not, it would still demonstrate the required, scalable, docking and towing technologies.

#### **Experimental Refurbisher Micro-satellite**

The second micro-satellite would demonstrate the final micro-satellite based, on-orbit servicing capability: close-proximity, precision inspection and refurbishing. It would fly within tens of centimeters of the host satellite or another satellite, keeping station to high precision, as it performed experiments such as finding cracked or abraded areas on the satellite bus, and re-coating them. The host satellite could be stabilized for this experiment, as a stable host makes station keeping much easier, a spinner could be de-spun prior to refurbishing, and a tumbling satellite would be revived and stabilized prior to refurbishing.

The first experiments on this micro-satellite would be to apply instruments [9] that could detect problems such as abraded coatings, micrometeorite impacts, blistering, and cracks inside the satellite structure. The goal of these experiments would be to test both the sensors and the ability of the XSS-12 micro-satellite to hold still enough to use them properly. In all likelihood, the sensors would be tested before the micro-satellite is deployed, to ensure that they work, and then again after the micro-satellite is released, to test the operational scenario.

A second set of experiments would test the micro-satellite's ability to use spray jets to refurbish a satellite. Three possible fluids for the jets would be carbon dioxide, to decontaminate optics, a thermal coating, to replace out-gassed or abraded coatings, and self-setting structural material, to mend cracks. A more complex possibility would be to combine a jet with a laser, to chemically modify surfaces rather than deposit new coatings [10]. As with the sensors, these jets are novel technology, and experiments would need to test both the efficacy of the jets, and the ability of the micro-satellite to hold still enough to apply them.

Through both sets of experiments, the micro-satellite would need to demonstrate extreme precision flying, at distances of tens of centimeters or closer. The micro-satellite would also need to plan maneuvers at this distance, shifting along the surface of the satellite as it senses and sprays. Exact tolerances and distances would depend on the exact choice of experiments. To be safe, XSS-11 would test the ability to control to these tolerances, as the choice of XSS-12 experiments would be made before XSS-11 flies. It would also test the ability to plan maneuvers around a novel or disfigured satellite. XSS-12 would improve algorithms, sensors, and actuators as necessary to cover any shortfall in the required precision. In addition, its algorithms would be improved to handle the roughly predictable accelerations caused by the jets.

## 7. RELATED TECHNOLOGIES

The XSS micro-satellite demonstrations provide a vehicle to prove most of the technologies required by the MOS micro-satellites. They can demonstrate docking to a dead satellite, towing it to a new orbit or orientation, reviving it, and transferring expendables and hardware to it. They can demonstrate components of the Next Generation Satellite (NGS) bus. They can also demonstrate intelligent diagnostic imaging and standoff refurbishing, such as decontamination. However, as figure 1 showed, many technologies needed for MOS will not be tested in the XSS program. In particular, XSS will not develop a full NGS bus, the other MOS vehicles, or the final word in micro-satellite bus and payload technologies.

### Next Generation Satellite

As mentioned before, the four defining features of the NGS are plug-and-play capability, functional modularity, automatic fault handling, and docking ports. XSS-12 will demonstrate the ability of a satellite to accept and use new modules, when it flies in 2006 or 2007. If the technologies required for the four next generation satellite features could be developed in the mean time, XSS-12 would provide an optimal demonstration platform, showing both the fixable satellite and the fixer satellite at once. AFRL is working on some of the required technologies, and these can be demonstrated piecemeal on XSS-12 if necessary. However, the demonstration would be more meaningful if all aspects of an NGS could be developed. It would be yet more meaningful if industry participated, testing not just NGS concepts, but components that would actually be incorporated into new satellites.

The first feature of the NGS is plug-and-play capability. Guidelines for protocols exist, in the form of current personal computers. In addition, the 1553 and 1773 bus standards are already used to distribute data in satellites. New standards must now be added to cover distribution of power, heat, and fluids as well. An AFRL project [11] is currently looking at multi-functional structures (MFS), which embed various busses inside structure, with the goal of eliminating the weight and complexity of cabling. The follow-on project, programmed for the 2001-2005 time frame, will build plug-and-play MFS panels that can be removed and replaced, or stacked together. This will implement the plug-and-play busses, but may or may not determine the best set of busses and protocols. That remains a research challenge.

The second feature of the NGS is functional modularity. The research question here is what components should be grouped into functional modules. Not all components even need to belong to modules, as some are simply too large to be worth replacing. The choice of modules in turn drives the components to be grouped into ORUs, and may drive the details of plug-and-play busses. Identification of the commodities transferred between modules will definitely drive the design of optimal ports. The XSS demonstrations will develop and test optimal couplers for a range of connections, but the identification of the optimal set of connections remains a research challenge.

Fault handling is the third NGS feature. This includes component level fault understanding and prediction, as well as high level reasoning to interpret large-scale problems from the reports of individual components. It also includes query protocols that allow a micro-satellite to detect problems in an uncommunicative satellite, and high level reasoning that tells the micro-satellite what questions to ask. Much research has looked into prognostic health management for terrestrial applications [12] and high-level fault management for spacecraft [13], but neither is likely to develop a full fault management system. The XSS micro-satellites will not develop or demonstrate these technologies, because they can be ground tested. However, they are required for a fully operational NGS, and thus remain a research challenge.

Docking ports are the fourth NGS feature. Docking mechanisms, couplings, and layouts will be developed under the XSS program, but the best choice of couplings may remain unknown,

depending on the development of other NGS features. AFRL work [14] is looking at reconfigurable interfaces, which use micro-switches to change the usage of a single set of couplings. That facilitates upgrades after an unfortunate choice of interface, but configuring ports on the fly adds complexity to the plug-and-play protocols. Thus, the development of optimal docking ports remains a research challenge.

### **Other MOS Vehicles**

Three groups of MOS vehicles remain not fully developed, and are not really addressed by the XSS program. These are orbit transfer vehicles, launch vehicles, and robots.

Orbit transfer vehicle work at AFRL includes investigation into solar-thermal, solar-electric, and electro-dynamic tether propulsion. The Solar Orbit Transfer Vehicle, which hopes to fly sometime around 2007, would demonstrate a high efficiency, solar-thermal orbit transfer, suitable for carrying MOS style micro-satellites and robots on their appointed rounds. A large research question for these vehicles is whether large-scale cryo-cooling technology can keep the liquid hydrogen in the fuel tanks from boiling off. Electro-dynamic tether work, currently being performed under the Small Business Innovation Research program, is a potential source for collaboration between AFRL and NASA, as both are interested in the ability of tethers to re-boost and de-orbit large satellites. The tethers also provide a low speed but very high efficiency propulsion scheme for orbit transfer. However, whether the various orbit transfer technologies will receive sufficient support to mature into on-orbit technology demonstrations, particularly in time to participate in a 2006 on-orbit servicing demonstration, is an open question.

Conventional launch vehicles are being developed outside the laboratory, but many technologies that make the vehicles more useful present research challenges. Preliminary studies have indicated the feasibility of a missile-like, air-launched launch vehicle for micro-satellites or servicing payloads. Additional research could produce an operational capability. A second area is secondary payload launch. The Ariane Structure for Auxiliary Payloads (ASAP) allows the French to cheaply launch small payloads, but this is not very useful for US military satellites. AFRL is investigating this area, with its Evolved Expendable Launch Vehicle (EELV) Secondary Payload Adapter (ESPA) program [15], scheduled for completion in 2003. A third useful area is containerized payloads, which could ride as secondary payloads on arbitrary launch vehicles, and guarantee a standard, reduced, vibration environment. This would allow standardized, next generation spacecraft components to be tested once, then space-lifted on any convenient vehicle. Vibration reduction would reduce the mass of the components, and thus their launch cost, by reducing the over-design required to survive launch vibration. Finally, there is no current work on on-orbit depots. Certainly the use of space stations is technically feasible, and will be demonstrated by the International Space Station, but there is some question as to political and economical feasibility of using that station as a warehouse, particularly for military parts. The possibility of a scaled down, automated warehouse, visited by orbit transfer vehicles, should be investigated. Eliminating the concerns for life support and human safety aboard such a depot could dramatically lower its cost, compared to a full space station. A related area for study is the feasibility of performing more difficult maintenance tasks at such a depot. This mimics current two level logistics schemes, but may or may not add value to the house-call scheme that is the center of MOS.

Robots, both large and small, will need significant development efforts. Certainly, robot arms are feasible, as demonstrated by the space shuttle Remote Manipulator System. The University of Maryland's Ranger tele-robotic flight experiment will demonstrate, in the near future, the feasibility of remotely controlled on-orbit robotics. Remaining challenges include the development of robotic manipulators, and algorithms that allow autonomous operation of large robots, for instance by controlling the pointing of a satellite, a grappled robot, and the orbit transfer vehicle that carries the robot, as the robot changes configuration during its operations. Micro-robots have about the same

issues. Work in micro-robots for unexploded ordnance detection and destruction will provide basic micro-robot capabilities. Additional technology will be required to make these robots space worthy, and additional algorithms and hardware will be required to keep micro-robots attached to satellites as they work, and keep satellites stable with micro-robots crawling around on them.

### **Micro-satellite busses**

Micro-satellite busses will be demonstrated in the XSS missions. However, additional miniaturization and integration of satellite sub-systems allows ever-smaller micro-satellite busses. This in turn facilitates more efficient orbit transfer or larger servicing payloads. Thus, the XSS program will leverage technology developed by the micro-satellite research community.

The principal source of information about leveragable technology is the Space Technology Alliance's micro-satellite IPT. Their roadmap, currently unpublished, shows the planned and on-going development efforts, broken out by satellite sub-system and the organization performing the work. If maintained, this roadmap will facilitate contact between the relevant organizations, and ensure incorporation of the latest technologies into the XSS and other micro-satellite demonstrations.

A second source of information is an on-going study by AFRL, to investigate the feasibility of mass producing launch-on-demand micro-satellite for servicing and other tasks. Looking at current and projected technologies, it considers the cost reductions to be achieved when micro-satellites are built in quantity, like many other products. This is one of the many benefits of routine servicing, and follows in the tradition of transitioned military technologies such as the ubiquitous GPS receiver. Results of this study should be available in early to middle 2000, in plenty of time to influence the second and third XSS missions.

### **Micro-satellite Payloads**

The tasks associated with docking should be relatively well developed in their second generation, on XSS-12. Further improvements would likely wait for requirements from specific customer systems, as they are designed. In addition, XSS will prove the micro-satellite technologies required for diagnostic imaging and refurbishing. However, supporting technologies needed for operational systems will remain undeveloped. There are three groups of these supporting technologies.

The first group is diagnostic imaging sensors. The XSS series will demonstrate only a few of the multitude of useful diagnostic sensors. Sensors that detect specific frequencies of electromagnetic radiation or vibration, or specific chemicals, would allow much wider applicability for failure diagnosis and localization.

The second group is expert systems for diagnosis. Certainly, a map or model of a satellite, taken with any particular sensor, is useful to a ground team. So is the ability to issue high level commands to make the micro-satellite hover at a point of interest or map with a certain sensor, as the team iteratively interprets the down-linked data. However, these activities still require potentially large ground crews to interpret sensor data, and waste time as both the micro-satellite and ground crew wait for over-flight windows to exchange data. A better solution would be to automate the tasks of the ground crew. An expert system, looking at the imagery from an initial imaging pass, might be able to determine which areas warrant additional sensing. It might be able to determine which additional sensors should be brought to bear. Such software would allow the micro-satellite to collect data in less time, and down-link information to guide decisions, not data to interpret.

A third group of useful technologies is standoff effectors. XSS-12 will demonstrate a single such effector, such as a carbon dioxide jet for decontamination. There are many chemicals that are potentially equally useful, such as foam for insulation, coatings for thermal protection, solid lubricants for articulated components, or caulking to fill radiation-leaking cracks. There are undoubtedly many other non-jet applications of even greater value, such as clipping a thermal blanket that prevents an antenna from deploying. Such effectors dramatically increase the usefulness of on-orbit servicing, without requiring additional micro-satellite development.

## 8. CONCLUSIONS

The MOS concept provides a way to implement on-orbit servicing that may be cost effective. This would provide the Air Force with an ability to operate spacecraft much as it operates aircraft. It would increase availability, flexibility, capability, life span, and cost effectiveness of space assets. Unlike previous concepts, MOS does not rely on expensive and range limited astronauts, or large, complicated robotics.

AFRL is pursuing many research directions that will lead to the technologies required to implement MOS. Chief among these is the XSS program, whose three demonstrations will develop and prove many of the technologies for MOS micro-satellites. The remaining micro-satellite technologies are being investigated by various groups across the country, and are coordinated through the Space Technology Alliance. Diagnostic and stand-off repair technologies, including sensors, effectors, and algorithms for autonomous yet intelligent operation, still need to be developed.

Technology programs for other vehicles are fewer and farther between. Next generation satellites require research on all four of their defining features. Orbit transfer vehicles require bolstered engine development efforts, investigation into large-scale cryo-cooling, and space demonstration of full capability. Launch vehicles require additional investigations into air-launched micro-satellite launchers, secondary payload dispensers, standardized environment launch "suitcases" for replacement components, and small scale on-orbit depots. Space robots have almost no development within AFRL, and will eventually require development efforts, but can probably benefit most by waiting. Large robots will be proven by NASA efforts, while micro-robots will be proven for naval applications. Development would then consist of space qualifying the robots and producing algorithms for autonomous operation of the robots and the satellites on which they operate.

## 9. REFERENCES

- [1] Gregg Leisman et. al., "Analysis and Preliminary Design of On-orbit Servicing Architectures for the GPS Constellation," *AIAA Space Technology Conference & Exposition Proceedings*, September 28-30, 1999.
- [2] Ronald M. Muller & Dipak P. Naik, "Robotic Assembly Concept for the Next Generation Space Telescope," [http://ngst.gsfc.nasa.gov/public/unconfigured/doc\\_272\\_1/RobotDep.pdf](http://ngst.gsfc.nasa.gov/public/unconfigured/doc_272_1/RobotDep.pdf) Boeing robotics study, December 1998.
- [3] Richard Madison, "Modular On-orbit Servicing (MOS) Concept Definition and Description," *draft FY98-99 Air Force Modernization Planning Satellite Operations Sub-Mission Area Development Plan*, SMC/XR, 1999.
- [4] Richard W. Madison, "A Concept for Cost-effective, Satellite Servicing," *Space Technology & Applications International Forum Proceedings*, Jan. 31 - Feb. 4, 1999.

[5] Kevin D. Bell and Ruth L. Moser, "Conceptual Designs for On-demand Microsatellites and Air-launched Launch Vehicles," *AIAA Space Technology Conference & Exposition Proceedings*, September 28-30, 1999.

[6] David J. Chato & William J. Taylor, "Small Experiments for the Maturation of Orbital Cryogenic Transfer Technologies," *NASA Technical Memorandum 105849*.

[7] David Williamson, "MEMS Based Pico-Satellite Inspection (MEPSI) – First Flight Development Plan," AFRL/IFTE, 29 March 1999.

[8] K. Böhringer et al., "Computational Methods for Design and Control of MEMS Micromanipulator Arrays," *IEEE Comp. Sci. & Eng.*, Jan-Mar 1997.

[9] Curt Fiedler, Nathan Diedrich, & Bryan DeHoff, "NDE Capabilities for Space: Computed Tomography, Ultrasonics and Vehicle Health Monitoring," *National Missile and Space Materials Symposium Proceedings*, October 1998

[10] Brice Bible, "A Technology Prospectus for Laser Induced Surface Improvement (LISI)," *University of Tennessee Space Institute*, July 1998.

[11] James Guererro et. al., "Overview Of Multifunctional Structure Efforts At The Air Force Research Laboratory," to appear in *Proceedings of the Seventh International Conference and Exposition on Engineering, Construction, Operations, and Business in Space*, February-March 2000.

[12] *Proceedings of the 53rd meeting of the Society for Machinery Failure Prevention Technology*, April 1999.

[13] Paul Zetocha, "Satellite Anomaly Diagnosis Using Model-Based Reasoning," *2<sup>nd</sup> Annual Symposium on Reducing the Cost of Ground Operations*, July 1997.

[14] Jim Lyke, "Malleable Signal Processor: an Embeddable Reconfigurable Processor," *Government Microcircuits Application Conference Proceedings*, March 1999.

[15] Eugene R. Fosness et. al., "Secondary Payload Adapter for EELV," *AIAA Space Technology Conference & Exposition Proceedings*, September 28-30, 1999.

*Rich Madison is the principal investigator for the XSS-11 demonstration. He has spent the last two years refining the MOS concept, legitimizing it through the Air Force Integrated Planning Process, and developing experiments to test the relevant micro-satellite technologies. He holds a BS in engineering from Harvey Mudd College and an MS and PhD in electrical and computer engineering from Carnegie Mellon University.*

*Capt Mark Davis is the Deputy Program Manager and Mission Operations Director for the XSS-10 demonstration program. He has spent the last two plus years defining the specific mission and technologies that XSS-10 will demonstrate. He holds a BS in Engineering Science from Colorado State University and an MS in Systems Management from the Air Force Institute of Technology.*



## DIGITAL REACTION WHEEL ASSEMBLY RSI 01-5 FOR SMALL AND LOW-COST SPACECRAFT

Armin LANDES, Stephen BÖTTCHER-ARFF

*TELDIX GmbH, P.O. Box 105608, 69046 Heidelberg, Germany*

### 1. ABSTRACTS

The RSI 01-5 is a ball bearing momentum/reaction wheel system with digital electronics completely integrated in the wheel housing. It was developed and manufactured for Orbital Sciences Corporation, USA to be used in the ORBCOMM data communication system (a constellation of up to 36 satellites in low Earth orbit). All wheels are in orbit representing a cumulated lifetime of approx. 40 years.

An extended version was designed and manufactured for PROBA, an European Space Agency mission to be launched in 2000.

### 2. INTRODUCTION

For more than 20 years TELDIX has been very successful in the field of gyroscopic actuators like momentum and reaction wheels for satellites.

Our momentum wheels DRALLRAD® are utilised for the stabilisation of communication satellites. In 1990 TELDIX started the development of an experimental low cost reaction/momentum wheel with integrated Drive Electronics for the use in small satellites in cooperation with the Technical University of Berlin. In order to achieve the cost goal, commercial parts were used. The wheels of this type were delivered in 1993 for the satellites TUBSAT B and TUBSAT C, built by the Technical University of Berlin, MAROCSAT and KITSAT-3 and were furthermore selected and delivered for a small spacecraft to be built by DASA, Bremen named INSPECTOR.

The more stringent requirements of small commercially used satellites necessitate an adaptation of the experimental design to a high reliable, medium-life space-qualified Reaction Wheel.

The technical discussion whether to use a conventional analog electronics or to design a state-of-the-art digital electronics led to the decision for a fully digital system. The main arguments for the decision to use a digital system were:

- Only 1 Central Processing Unit, universally adaptable by software to any kind of wheel (large/small reaction/momentum wheel). Hardware development to be carried out only once. The central processing unit co-operates with any kind of DC-motor (typically 3-phase, 8 poles) by use of an appropriate universal commutation logic.
- Implementation of a Digital Controller permits versatile adaptation of control laws and extension of parameter ranges. Control parameters are software parameters. There is no need for hardware modification to adapt parameters to special wheel requirements (e.g. different moment of inertia).
- Simple Upgrading for New Features by loading new software version via (serial) customer interface.
- Parameters (typically time constants) are free of ageing and temperature drift effects.
- Very high noise immunity.

### 3. TECHNICAL DESCRIPTION MECHANICS

The RSI 01-5 is a ball bearing momentum reaction wheel system with digital electronics completely integrated in the wheel housing. The complete wheel is protected by an airtight housing, which is sealed by bonding and filled with a special Helium/Nitrogen mix at ambient pressure. It is designed for a in-orbit lifetime (at 775 km) of 5 years. The total mass is less than 0,6 kg; the dimensions are Ø 95 mm and 102 mm height.

The wheel RSI 01-5/15 provides an angular momentum storage capacity of 0,04 Nms and a reaction torque of 10 mNm at start-up and 5 mNm at 1500 rpm. The serial interface (RS-485) handles commands/data with a rate of 9600 baud. The bus capability allows to address up to four small wheels connected to one serial data bus.

An extended version RSI 01-5/28 with a momentum storage capacity of 0,12 Nms and a reaction torque of 10 mNm at start-up and 5 mNm at 2800 rpm is available.

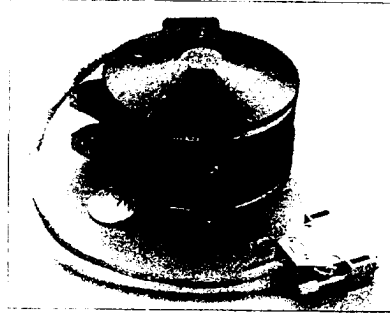
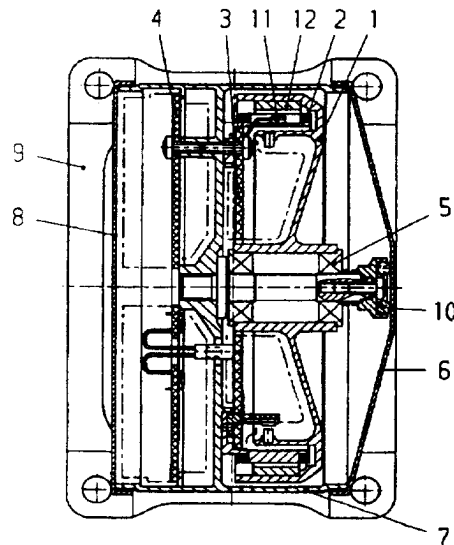


Figure 1: TELDIX Digital Reaction Wheel Assembly RSI 01-5/15

#### 3.1. Mechanics

Figure 2 shows a cross-sectional view of the Reaction Wheel Assembly RSI 01-5/15. Main parts and subassemblies as described below and shown in figure 2.

Position:	Designation:
1	Rotating Mass/Motor Rotor
2	Stator
3	Power Stage Printed Circuit Board (PCB)
4	Signal Stage PCB
5	Ball Bearings
6	Cover
7	Housing
8	Bottom Cover
9	Baseplate
10	Damping Ring
11	Hall Effect Switch
12	Magnets



### ***The Rotating Mass with Motor Rotor (1)***

The rotating mass and the motor rotor are essentially one unit made of steel alloy. The simple turned part features a substantial hub construction. The rotating mass is screwed to the shaft of the DC Motor. It is suspended by two solidly pre-loaded ball bearings (5). They are located on the axis which again is elastically fixed into the Cover (6) by means of a damping ring (10). In this way, radial oscillations of the rotating mass are suppressed. The rotating mass-motor-unit will be balanced as an assembly. Correction of the static and dynamic unbalance is carried out by means of adding balancing screws to the rim in two separate planes.

### ***The Housing***

The complete wheel is protected by an airtight housing, which is hermetically sealed and filled with a special Helium/Nitrogen Mix at ambient pressure. This procedure/material is qualified and approved in various military applications (mainly gyroscopes). The housing consists of three major parts, the housing (7) with an upper cover (6) and a bottom cover (8). The mechanical interface is defined by the baseplate (9), which is mounted to four feet of the housing resulting in a high vibration load capability.

### ***The Motor***

The motor of the wheel can be subdivided into three subassemblies:

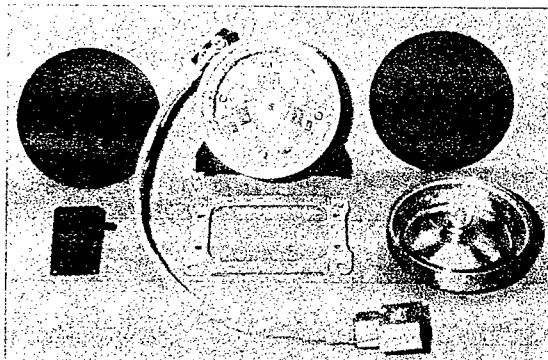
- Motor Rotor/Rotating Mass
- Stator
- Power Stage PCB including Commutation and Speed Sensor System

The motor of the RSI 01-5/15 is a brushless 3 phase DC motor (8 pole pairs). The motor consists of an ironless stator or coil-carrier and a permanent magnet rotor. Commutation is performed electronically, using Hall sensors responding to the permanent magnets of the rotor.

The motor rotor contains the permanent magnets and an integrated feedback ring. The stator coils form the three motor phases which are electrically 120° apart. The electronic commutation triggered by Hall sensors avoids the possibility of life restrictions caused by wear since physical contact is avoided completely. Twelve position sensors are mounted to the motor coils which generate 192 pulses/revolution for high resolution and extremely precise speed/torque loop characteristics also for very low speeds (< 10 rpm).

### ***The Bearings***

The ball bearings used are preloaded and in accordance with the dimensional and running accuracy requirements of the Quality Standard ABEC 9P. The retainer is made from Meldin 9000 ROD and had been developed by TELDIX especially for this type of bearing and was used in TELDIX gyros with speeds of up to 25000 rpm. In order to improve the lubrication and running characteristics the balls are TiC coated. Life calculations show that the bearing life  $L_0$  (non failure lifetime) is appr. 90 years for reaching the max. number of revolutions.



*Figure 3: Main Subassemblies of RSI 01-5/15*

## 4. TECHNICAL DESCRIPTION ELECTRONICS

### 4.1. General Design

The electronics for the momentum wheel consist of two sections which are physically located on two separate Printed Circuit Boards (PCB). The first PCB accommodates the Signal Electronics (Signal PCB), the second PCB the Drive Electronics (Power PCB). Both PCBs are designed and manufactured in accordance with MIL-STD-275. Conformal coating is used to prevent microcircuits from moisture.

The Signal Electronics is dominated by a high speed fix point Digital Signal Processor (DSP) with 16-bit architecture which operates the main functions:

- Command and Data I/O via serial interface (RS-485)
- Speed/Torque calculation for loop-modes and telemetry
- PWM management (for motor current regulation)
- Telemetry-Data acquisition management
- Monitoring and limitation of motor current and speed
- Watchdog management
- Correction of non-linear behaviour of electromechanical and thermal influences to the system to guarantee high precision performance

The commutation electronics for operating the brushless 3-phase 8-pole DC motor is programmed into a Field Programmable Gate Array (FPGA) as well as digital subunits to support the DSP. Motor management is also integrated in the FPGA and is realised through Pulse Width Modulation (PWM) with a fixed frequency of 40 kHz. The digital input for the commutation section is generated by twelve Hall sensors which are located on the Power PCB; one additional Hall sensor generates an additional index pulse (1 pulse/rev) for synchronisation. This signal is directly available at the interface connector. This magnetic sensor system leads to a resolution of 192 pulses/rev.

The embedded Software is re-programmable (via serial interface) and stored in a EEPROM to permit an update/adaptation of software without any hardware modification. After Power-on the application software is loaded automatically from the external EEPROM into the DSP on-chip program memory. This allows high speed performance by use of a standard EEPROM as an external boot memory.

Using the serial interface, the wheel is capable to operate in a RS-485 bus system. Wheel address is determined by two hardware pins available on the wheel interface connector. So up to four wheels can be operated on one bus system.

The Drive Electronics interfaces the commutation signals from the DSP and is supporting digital logic to the motor windings. It mainly consists of 6 power FETs in 3 H-Bridge configuration with its integrated drivers and the above described Hall Sensors for speed control. The driver supply voltage is decoupled from the power bus by a low dropout linear voltage regulator.

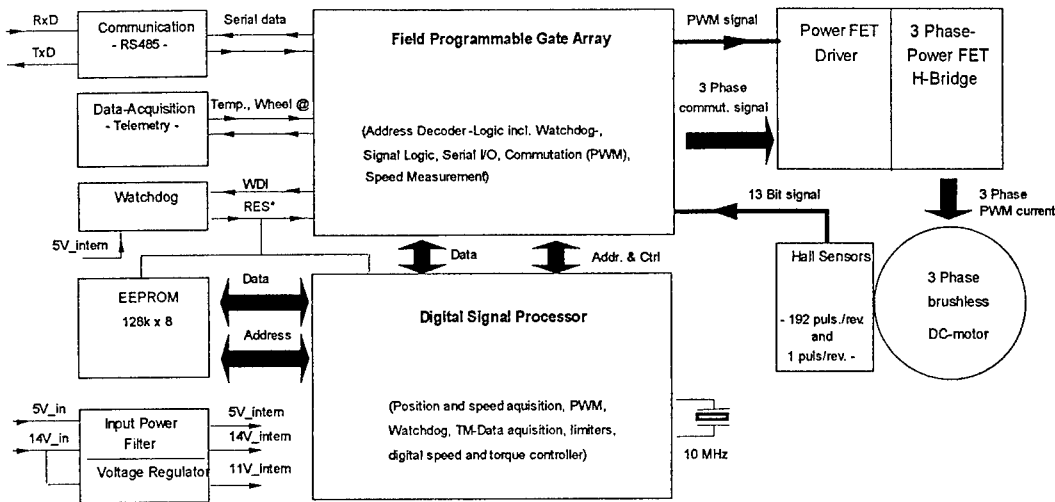


Figure 4: RSI 01-5/15 Functional Block Diagram

## 4.2. Detailed Design

### The Microprocessor

The microprocessor used is a single chip high speed and high reliable 16-bit fixed point Digital Signal Processor with on-chip memory in CMOS technology with low power consumption. This processor is optimised for digital signal processing and other high speed numeric processing applications. Other features are integrated I/O peripherals e.g. serial ports and timer.

### The FPGA

The commutation, most of the signal logic and the watchdog generator are implemented in a Field Programmable Gate Array (FPGA). This device is user programmable and non-volatile and offers gate array flexibility, high performance reliability under minimum need of space. It is fabricated in 1.0 micron CMOS technology for low power applications and replaces up to 50 TTL packages.

### The EEPROM

The operational software is programmed into an electrically erasable and programmable memory (EEPROM). It is organised as 131072-word x 8 bit and realises high speed, low power consumption and a high level of reliability, employing advanced MNOS memory technology and CMOS process and circuitry technology. During operation the software is write protected.

### The Watchdog

For monitoring the supply voltage and the correct microprocessor activity respectively a microprocessor supervisor circuit is used. The watchdog service routine is triggered by the DSP internal 1 kHz Timer-Interrupt and resets the watchdog regularly. If the watchdog times out a „System Reset“ is generated. In order to recover the system in case of radiation single event upsets (SEU) autonomously the software implemented is verifying the program memory integrity online („Checksum Calculation“). In case of a bad checksum, a „System-Reset“ will be generated and the application software is loaded from the EEPROM into DSP program memory once again.

### ***Communication***

ACS communication is possible via a full duplex serial differential RS-485 interface in asynchronous mode. Commanding and message response operates at a rate of 9600 Baud, no parity, eight data bit and one stop bit (9600,n,8,1). The used interface circuit is full compatible with EIA Standard RS-485.

To operate the wheels in a RS-485 bus system wheel address (@00 to @03) is determined by two hardware pins available on the interface connector.

### ***The Internal Power Distributor***

The wheel is operating with an non-regulated power source ranging from 11 to 17 VDC and a regulated power source of  $5V \pm 0.25$  VDC with an transient in-rush ripple of 50 mV. For EMI purposes both input lines are filtered. A low dropout linear voltage regulator generates the decoupled 11 V supply voltage for the motor driver section.

### ***The Data Acquisition (Telemetry)***

The data acquisition block prepares all peripheral data for telemetry response. Thus the wheel address, wheel status, motor current, readback of set speed and torque, wheel speed and wheel inner temperature are available. They are reported via the Reaction Wheel software interface.

### ***The Motor Driver Section***

Wheel motor is driven by 6 Power FET in a bipolar H-Bridge configuration with 3 integrated drivers. The Power FETs are operated from a 11 VDC supply decoupled from the motor supply. Commutation signals are provided by 3 of the 12 Hall Sensors, electrically  $120^\circ$  apart. During active braking the power is delivered back into the power capacitor respectively into the satellite bus system.

### ***The Hall Sensor System***

The Hall Sensor System is part of the stator and consists of 12 position sensors plus 1 additional sensor for synchronising. The motor magnets located in the motor rotor generate 24 leading and trailing edges, electrically  $15^\circ$  apart. Choosing 8 pairs of motor poles thus 192 pulses per revolutions are generated. Motor position is identified using the additional sensor as a reference signal („zero sensor“) for synchronising.

## **4.3. Operation Philosophy**

The wheel can be switched either to speed or to torque mode by an 8-bit command via the software interface. In speed mode the resolution of 192 pulses/rev guarantees a high precision speed control down to 4 rpm with an accuracy of better than 1 rpm for the whole speed range of  $\pm 1500$  rpm. In torque mode the DSP calculates the set speed in dependence of the moment of inertia of the rotating mass, which is an individual programmed parameter, and the desired torque value. This feature avoids the influence of loss torque which is always present in traditional analogue motor current setting electronics.

To achieve very high precision measurement between two Hall sensor signals and to overcome non-avoidable tolerances during rotating mass assembly the wheel is self-calibrating. These correction data are gained during wheel final assembly and are permanently stored in the EEPROM.

The wheel provides three operational modes:

- Stand-by
- Speed Control
- Torque Control

#### 4.4. Control Loop Design

##### Global Structure

Figure 5 presents the global structure of the wheel control loop including the major I/O signals.

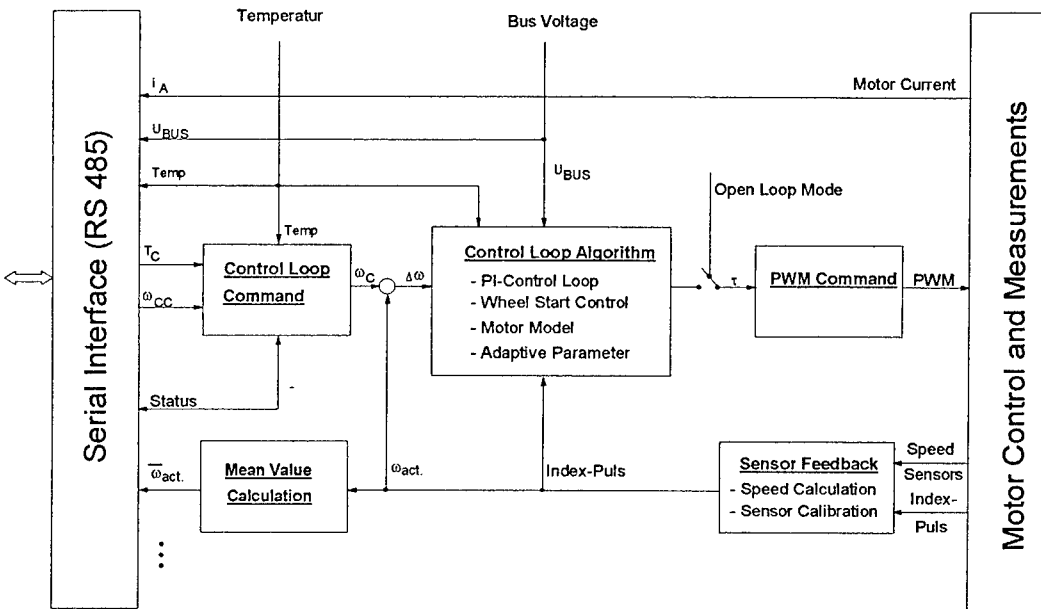


Figure 5: Control Loop Structure including major I/O Signals

A Torque Command ( $T_c$ ) respectively Speed Command ( $\omega_{cc}$ ) via the serial interface triggers the calculations in the Control Loop Command block. The output in both cases is the speed command  $\omega_c$ . This value is compared continuously with the actual speed value  $\omega_{act}$ , which is the result of the sensor feedback derived from the 12 Speed Sensors. Using Hall Effect switches the passed angle in a definite time period is measured. Noise minimisation is achieved by sensor calibration during manufacturing process. An additional sensor generates an Index Pulse (1 pulse/rev.) for synchronising. The difference of commanded and actual value ( $\Delta\omega$ ) is the input for the Control Loop Algorithm block. This stage includes the PI-Control Loop itself, the Wheel Start Control, the Motor Model and the Adaptive Parameter Set. A multiple polynomial describes the motor model and is programmed in the wheel operation software. Wheel Start Control as well as operation through zero speed is realised as a pulse mode.

The PWM Command block generates the motor input current calculated in the control loop algorithm stage for each operational range. For measurement purposes the control loop can be switched to an Open Loop Mode (during manufacturing process only).

The mean value of the actual speed ( $\omega_{act}$ ) together with other output signals e.g.  $i_{Mot}$ ,  $U_{Bus}$  and Wheel Status is available via the serial interface.

**Control Loop simplified Model**

Figure 6 shows a simplified model of the Reaction Wheel Control Loop. This model is valid for the linear operation mode only. The existing limits are not schematised.

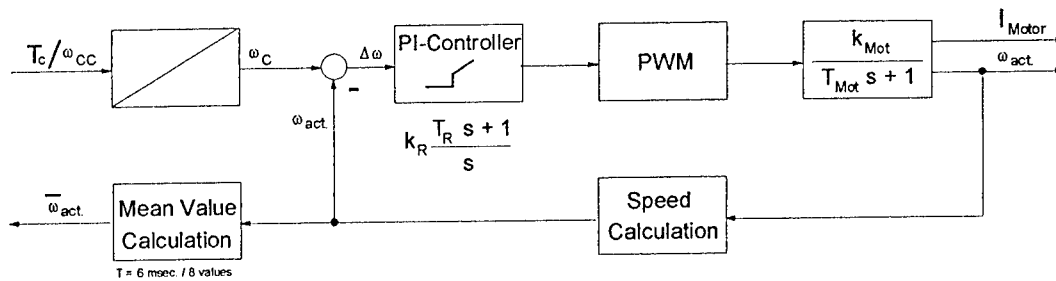


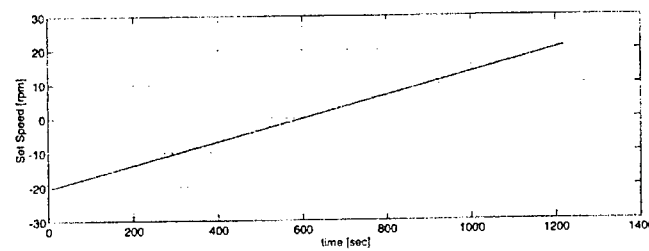
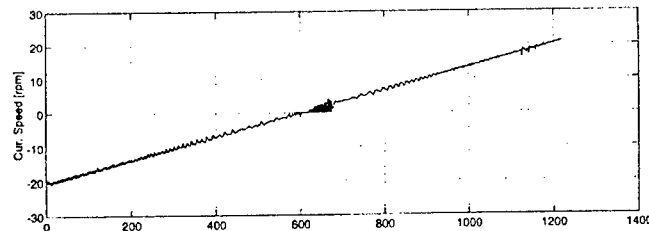
Figure 6: Simplified model of the Reaction Wheel Control Loop

The abbreviations  $T_R$ ,  $k_R$  respectively  $T_{Mot}$  and  $k_{Mot}$  are the constants of the control loop and are variable depending on the wheel actual operation range.

**4.5. Closed Loop System Performance Data (extracts)**

- Constant Torque Spinup for Torque Command = +1  $\mu\text{Nm}$

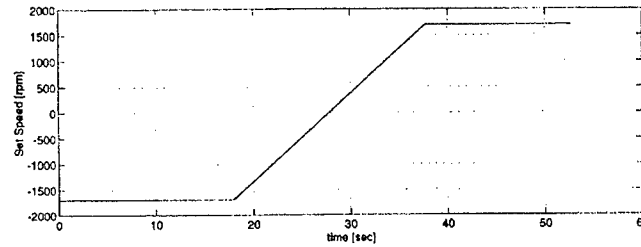
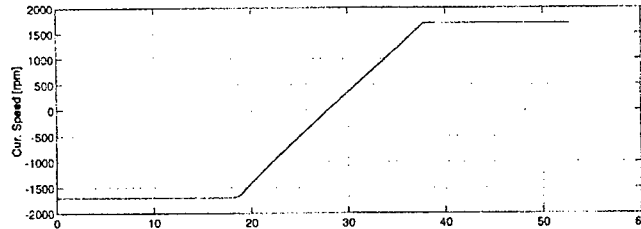
Reported is current speed [rpm] versus time [sec.] in the critical speed range through zero speed in acceleration mode. Wheel Reaction Torque Output is very linear.





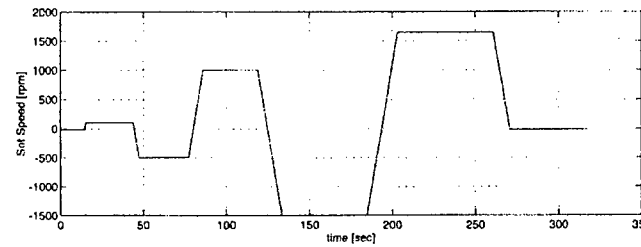
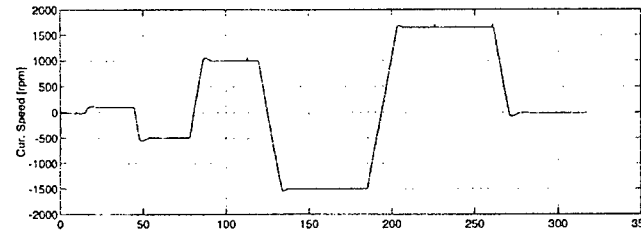
- Constant Torque Spinup for Torque Command = +5 mNm

Reported is current speed [rpm] versus time [sec.] for constant torque in acceleration mode. Risetime is less than 9 sec (starting from zero to max. speed) with an overshoot < 10 % for  $t < 3$  sec



- Stair Stepped RPM Output

Reported is current speed [rpm] versus time [sec.] for constant speed. Speed accuracy is better than 1 rpm over complete operation range.



## 5. PERFORMANCE SUMMARY RSI 01-5/15 (RSI 01-5/28)

Angular Momentum at Nominal Speed	0,04 Nms (0,12 Nms)
Operational Speed Range	$\pm 1500$ rpm ( $\pm 2800$ rpm)
Software Speed Limiter	$< 1700$ rpm (3800 rpm)
Reaction Torque (1500 rpm)	5 mNm
Torque Mode Accuracy	1 $\mu$ Nm averaged over 30 sec.
Speed Mode Accuracy	$< 1$ rpm (operation range $\pm 20$ to $\pm 1500$ rpm)
Operational Modes	Standby • Speed-Loop • Torque-Loop

### Mechanical:

- Dimensions: Diameter x Height	95 mm x 102 mm
- Mass	$< 0,6$ kg (0,7 kg)
- Static Imbalance	$< 0,050$ gcm
- Dynamic Imbalance	$< 0,025$ gcm <sup>2</sup>
- Alignment Spin Axis to Mounting Plane	$< \pm 0,4^\circ$

### Electrical:

- Power Consumption:	
- Steady State at nom. Speed	$< 1,5$ W ( $< 1,8$ W)
- Max. Torque at nom. Speed	$< 3$ W ( $< 3,8$ W)
- Supply Voltage	14V $\pm$ 3V, 5V $\pm$ 0.25V (20V - 0,2V, 5V $\pm$ 0.25V)
- Input Current (14&20V / 5V-line)	$< 0,30$ A / $< 0,15$ A
- Serial I/O	RS-485, full duplex (9600, n, 8, 1)
- Connector	15 pin high density (GFSC type)
- Telemetry Data	Speed • Torque • Motor current • Inner Temperature

### Environmental Conditions:

- Operating Temperature	- 20 °C ... + 60 °C
- Non-operating Temperature	- 35 °C ... + 70 °C
- Random Vibration	7 grms (max. flight level)
- Life Time	5 years (in-orbit) 2 years (storage)

## LIGHTWEIGHT LITHIUM ION BATTERIES FOR MICROSAT APPLICATIONS

**Benoît LAGATTU**

*SAFT Defense and Space Division, Poitiers*

*benoit.lagattu@saft.alcatel.fr*

**Gérard GAVE**

*CNES Centre Spatial de Toulouse*

*gerard.gave@cnes.fr*

### Résumé

Cet article décrit comment SAFT envisage de répondre à la demande du CNES pour une batterie lithium ion de faible capacité. Après avoir considéré la possibilité d'utiliser des éléments de faible capacité fabriqués par SAFT pour des applications de type ordinateur portables ou téléphones cellulaires, SAFT a choisi une solution innovante en se basant sur un élément lithium ion de forte capacité couplé à un convertisseur DC/DC. Cet élément est basé sur l'élément industriel fabriqué à Bordeaux pour les applications véhicule électrique, avec des adaptations mineures pour l'espace. Maintenant, SAFT a lancé le processus de design, qualification et industrialisation d'une batterie modulable pour toutes les applications spatiales nécessitant une faible capacité.

### Abstract

This article deals with the qualification of lithium ion batteries for microsatellite applications.

SAFT has considered two approaches for microsatellite application:

- Development of specific batteries based on commercial cells,
- Development of a specific single cell module, using the qualified space adapted cell VES, associated with a DC/Dc converter.

The latter option has been chosen by SAFT and is detailed in this article.

Large VES 40 Ah cell, manufactured in SAFT Bordeaux, has been initially designed for Electrical Vehicle applications and with a few adaptations for Space use. Cell qualification has been fully obtained in the frame of STENTOR program, included in a conventionally wired battery with cells in serie.

Now, SAFT is in the process of design, qualification and industrialization of fully modulable battery for all small capacity batteries.

### Abbreviations

- LiIon : Lithium Ion
- MP : Medium Prismatic
- NiCd : Nickel Cadmium
- NiH2 : Nickel Hydrogen

### Introduction

As the sole European industrial battery manufacturer, SAFT Defense and Space Division has for over thirty years reliably supported the aerospace industry with NiCd, NiH2 high technology cells

and batteries for satellites. SAFT has supplied numerous French (SPOT, HELIOS,...) and International (GPS, SIRIUS, ARABSAT,...) satellites projects. Now, SAFT has engaged the qualification of Lithium Technologies for satellites, based on standard and industrial process and products.

SAFT is the only batteries manufacturer in the world to dispose of the whole panel of technologies.

SAFT LiIon products range consists in :

- Small MP cells, from 2 to 6Ah, manufactured in Poitiers for Portable devices such as cell phones, laptop computer, military devices,...
- Large VES 40Ah cells manufactured in SAFT Bordeaux plant and issued from Electrical Vehicle applications (same stack but with a space adapted design). This cell has been space qualified for STENTOR program.

In the frame of the CNES project of microsattellites platform in which low weight, low size and low recurrent prices are important requirements, SAFT has been consulted for the supply of battery. Considering the maximum allowed mass and the power requirements , Li ion technology is the only way which allows to reach the objectives.

The first approach was to evaluate the use of small MP cells in with a specific battery design for space environment. In this case, thermal and mechanical conception was close to classical NiCd batteries like for SPOT satellites. A preliminary view of a MP battery is shown here :

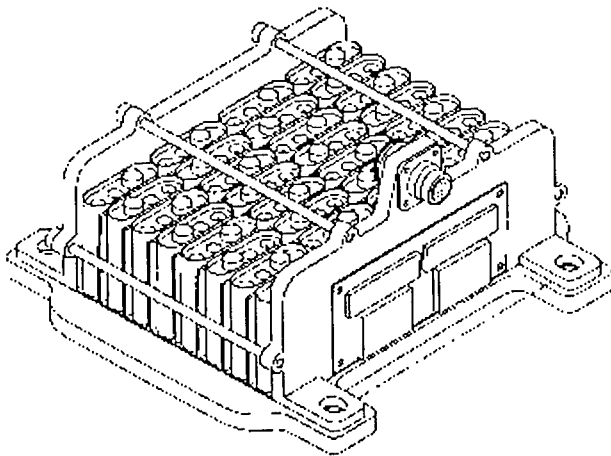


Fig 1 : MP battery concept

Advantages of this concept are :

- Cell recurring cost (mass production),
- Flexibility to adapt battery sizing to energy and voltage requirements.

Drawbacks are :

- No standardization, as each specification requires a specific battery design,
- Cell has not been designed for space,
- Cell definition is driven by core business and mainstream production constraints,
- Complex balancing electronics.

The second concept consists in a VES40 cell associated to a DC/DC converter to obtain 28 V standard bus requirement( see reference 1), this solution compliant in terms of energy density and power has the following advantages :

- use of already space qualified cells,
- simple mechanical and thermal design,
- simplified management mode.

To answer to CNES requirements, SAFT task is to design and qualify a complete battery system, including :

- DC/DC converter, provided by CNES and currently under evaluation by CNES,
- Cell and support structure,
- Heaters,
- Thermistors,
- Fixtures relevant to Microsat interface.

Advantages of this concept are :

- Voltage modularity of concept, through adaptation of conversion rate,
- VES : EV cell adapted for space market and manufactured for it,
- Large database (LEO, GEO, EV),

Drawbacks are :

- No modularity in energy,
- Dimensional constraints due to cell size.

After this evaluation SAFT choose to focus on the second approach and proposed it to CNES.

### **Microsat Program and Battery Specifications**

The proposed Microsatellite program heavily supported by the Comité des Programmes Scientifiques (CPS) is considered as a CNES priority.

It consists in setting the human and financial resources needed for the manufacturing, assembling and testing of 2 microsatellites per year after the 2002 year, mainly for scientific applications or international cooperation.

This program has been formally decided at CNES administration council level.  
At least three scientific missions are today already decided.

Aimed orbits are as follows :

- Polar orbit (including SSO) with altitude from 500 to 1000 km,
- Equatorial orbit with altitude from 500 to 1000 km,
- GTO orbit (600 – 36 000 km).

Other applications can use the CNES microsatellite product line. Depending on the needs of external customers, this product line may offer an opportunity of commercialization for answering to others needs than CNES ones (defense ministry, industrial operators).

Specification for the battery are the following :

*Mechanical requirements :*

- Allocated space : 250x210x100 mm,
- Mass Budget : 3.3 kg,
- Sine Vibrations :

	Frequencies (Hz)	Level
3 axes	4 - 6	25 mm
	6 - 100	15 g
Speed (Oct./min.)		2

- Random Vibrations :

	Frequencies	Level g <sup>2</sup> /Hz
Vertical axis	20-100	+ 3 dB/octave
	100-400	0,3 g <sup>2</sup> /Hz
	400-2000	- 3 dB/octave
Horizontal axis	20-100	+ 3 dB/octave
	100-200	0,3 g <sup>2</sup> /Hz
	200-2000	- 4 dB/octave
	DURATION	2,5 mn/axis

Shock :

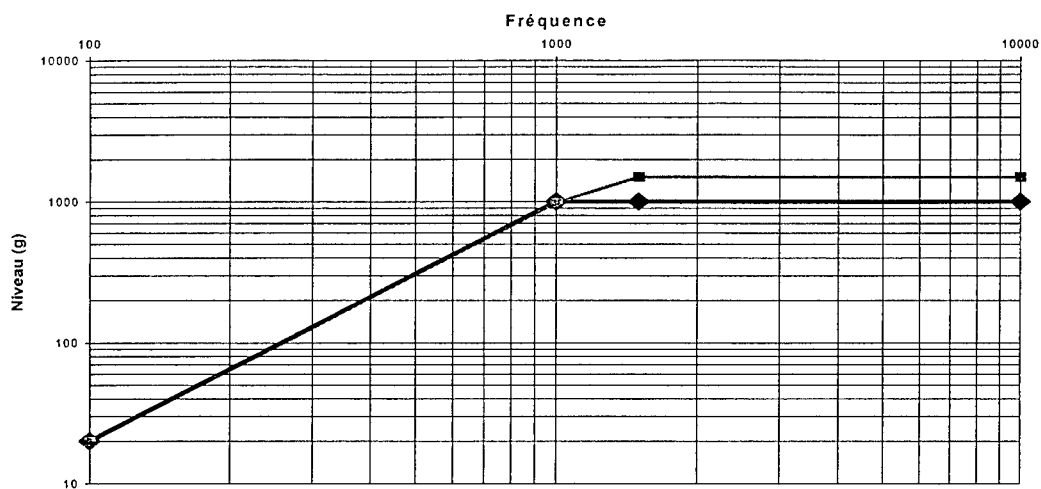


Fig 2 : Shock Level

*Thermal requirements :*

- Heat dissipation through baseplate,
- Heating and temperature monitoring system should keep battery between 15°C and 30°C during operational life,

➤

*Electrical requirements :*

- Minimum charge duration : 65 minutes,
- Maximum discharge duration : 35 minutes,
- Mission duration : one year or 5000 cycles, with the possibility to be extended to 3 years for specific applications.
- Mean Power : 70 Watts
- Peak Power: 130 Watts
- Nominal Voltage : 28 V
- Minimum Voltage : 24 V
- Peak Energy to be supplied at Satellite orbitation : 250 Wh

## Battery Concept

This battery concept in association with a DC/DC converter integrated in the same structure forms a module, several of them can be associated in parallel (two modules of this type need to be mounted in the Microsat platform) and this flexible solution would fulfil the power requirements of numerous types of projects.

SAFT decided to focus its effort on enforce cell qualification, design and qualify battery including structure, heaters and thermistors. CNES will supervise electronics qualification.

A preliminary view of the battery (without electronics) is shown here below :

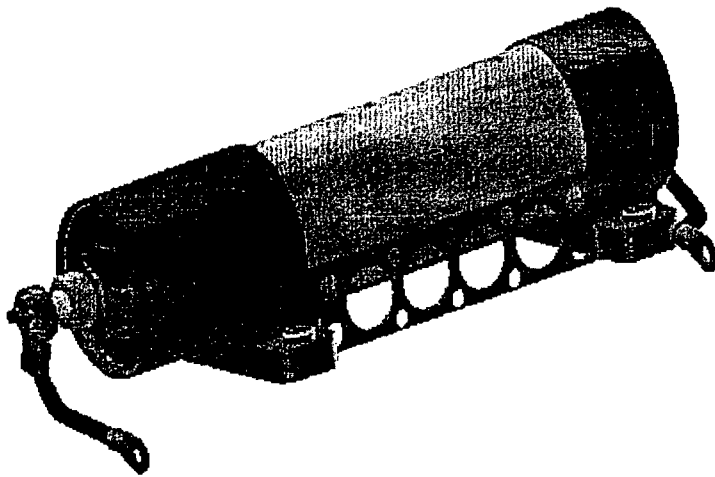


Fig 3 : VES40 module concept

This preliminary design gives a maximum mass of 1500g, to be improved by optimization of structures.

### Cell Status and Qualification

*A short summary of the cell :*

- Weight <1132g
- Overall dimensions : Diameter 54, length 250 mm
- Energy >139 Wh @ 4.10 V
- Leakage current < 10 mA
- Impedance <3 mOhm @ 20 and 60% DOD
- Air transportation authorization N° 903-99

As already mentioned, VES cell has been qualify for STENTOR program. No major study is planned for cell qualification, except one aspect of microsattellites requirements tougher than STENTOR ones : pyro shock level.

- A detailed description of the SAFT's Li-ion cell has been given at the 33<sup>rd</sup> IECEC (Ref.2).

*Demonstration of the cyclability :*

For LEO :

- 40.000 cycles at 10 % DOD



- 23.000 cycles at 20 % DOD
- 14.000 cycles at 30 % DOD

For GEO :

- 1914 cycles at 60 % (Fading 15 %)

These results have been obtained with accelerated tests and are also confirmed by real time LEO cycling running at CEAT, under CNES supervision. These tests have already proven a very low capacity loss after one year and a half of cycling.

*Validation tests :*

These cells have undergone successfully extensive validation/qualification tests, which included:

- Electrical characterization at several temperatures in the range 0 degree C to 40 degree C.
- Abuse testing with overcharge, overdischarge and short circuit tests.
- Mechanical tests with sine and random vibrations with level up to 44 gRMS.

## **Battery Qualification Program**

Qualification program consists in the following sequence :

- Electrical tests (verification of compliance to specifications),
- Insulation tests,
- Sine vibrations including frequency search
- Random vibrations,
- Shock Test (Half sine to be performed at cell and / or module level),
- Thermal vacuum.

This test sequence is to be started shortly at SAFT facilities with CNES technical support in the goal to achieve a complete qualification of the microsat Li Ion battery before the end of the year 2000.

## **Conclusion**

SAFT and CNES consider that qualification status of this module can be achieved at the end of the year 2000. This will open a market opportunity for all small capacity batteries applications, from microsat to interplanetary probes.

## **References**

- 1 : S.H Weinberg, F.H. Pedersen, H. Barde, C. Balard : "A Modular Battery Power Pack for Regulated bus Applications", *5<sup>th</sup> European Space Power Conference*, Tarragona, Spain, 21-25 September 1998
- 2 : Semerie J. P. : " Modular Concept Of Lithium-Ion Battery For Geosynchronous Orbit Satellites.", *33<sup>rd</sup> IECEC*, Colorado Springs, USA, 1998, 98-089

# The Bitsy™ Spacecraft Kernel: Reducing Mission Cost with Modular Architecture and Miniature Technology

**Mr. Scott A. McDermott**  
*AeroAstro, Inc.*  
520 Huntmar Park Drive  
Herndon, VA 20170  
(703) 709-2240  
Scott@aeroastro.com

**Mr. David J. Goldstein**  
*AeroAstro, Inc.*  
327 A Street, Fifth Floor  
Boston, MA 02210  
(617) 451-8630  
David@aeroastro.com

Presented By:  
**Mr. Nathanaël Chabert**  
*London Satellite Exchange Ltd,*  
16 St Martin le grand  
London EC1A 4NA –UK-  
+44 (0)207 397 8724  
nat@e-sax.com

*Abstract*— AeroAstro has adopted several advances in technology and architecture that have enabled significant reduction in cost and increase in flexibility for multiple nanosatellite missions. This Bitsy™ Spacecraft Kernel technology will enable recurring spacecraft mission costs of under \$1M, including space and ground systems and launch interfaces.

This is made possible by:

- A standardized core of spacecraft capabilities based on commercial-off-the-shelf technologies;
- Miniaturization, which reduces recurring costs and makes a minimal demand on launch vehicle services.

The spacecraft ‘kernel’, as opposed to bus, does not have a traditional division into discrete subsystems, but rather manages power, thermal control, ACDS, C&DH, and communications in a package of a few kilograms.

Bitsy’s small size, lightweight, and unique extensible architecture enable a variety of customizations to be added as needed to expand the range of achievable missions. In principle, the size and complexity of payloads Bitsy can accommodate is limitless.

## TABLE OF CONTENTS

1. INTRODUCTION
2. THE FUTURE-X MISSION (BITSY-SX/SPASE)
3. THE BITSY KERNEL ARCHITECTURE
4. BITSY KERNEL DESIGN OVERVIEW
5. THE APPLICATION OF A SPACECRAFT KERNEL
6. MINIATURIZED TECHNOLOGIES
7. LONG-TERM BITSY KERNEL LINE
8. CONCLUSION
9. BIOGRAPHIES

## 1. INTRODUCTION

AeroAstro has adopted several advances in technology and architecture that have enabled significant reduction in cost and increase in flexibility for multiple nanosatellite missions. To demonstrate this, a team led by AeroAstro, Incorporated was selected under the Future-X program to fly an experiment in late 2000 utilizing the Bitsy™ Spacecraft Kernel technology. The Small Payload Access to Space Experiment (SPASE) is funded through the Future-X program, and is to be launched in late 2000 using the Space Shuttle. The mission will also carry a small microgravity payload.

The entire first mission, including space and ground systems and launch interfaces, will cost under \$2M. The recurring cost for follow-on microgravity spacecraft will be under \$1M. Achieving on-orbit science missions with a cost comparable or below that of suborbital flights is made possible by:

- Creation of a *standardized core of spacecraft capabilities*, not a standard bus, based on commercial-off-the-shelf (COTS) technologies, which the science team uses to manage spacecraft functions (patent pending);
- Miniaturization, which both reduces recurring costs (fabrication and parts) and makes a minimal demand on launch vehicle services with very high reliability.

The spacecraft 'kernel', as opposed to bus, does not have a traditional division into discrete subsystems, but rather manages power, thermal control, ACDS, C&DH, and communications in a package of a few kilograms. Its small size, light weight, and unique extensible architecture enables a variety of customizations to be added as needed to greatly expand the range of achievable missions. These added capabilities include modest in-space propulsion, which enables missions including those requiring large  $\Delta V$  for spacecraft inspection, orbit initialization or station keeping, or achieving unusual or energetic orbits without requiring very expensive launch capability. While Bitsy technology enables flying significant science, communications, and remote sensing missions with total mass of 10-60 kg for costs similar to sub orbital flights, there is in principle no limit to the size or complexity of payloads it can accommodate.

The spacecraft program currently underway will demonstrate the capabilities provided by the combination of miniaturization and nanospacecraft architectures. It will perform a flight demonstration of the spacecraft, ground station, and flight operations control software offering standard interfaces to payloads and to launch systems, to be launched in late 2000 on the Shuttle Hitchhiker accommodation. The Bitsy kernel concept, progress to date on the SPASE mission, and the fundamental design and architecture decisions for each will be discussed in this paper.

## 2. THE FUTURE-X MISSION (BITSY-SX/SPASE)

The goal of the NASA Future-X program is to reduce the cost of access to space. While their focus is on launch vehicle technology, they funded the SPASE satellite program in recognition of the fact that 'access to space' encompasses the entire mission process, including satellite creation, launch, and orbital operations. A pathfinder program of this type is then essential in reducing the total real cost of access to space.

Future-X, managed out of Marshall Space Flight Center, is funding AeroAstro and its subcontractors to

produce, launch, and operate the SPASE vehicle. Marshall Space Science Laboratory (SSL) is providing the science experiment and science operations management. The experiment explores protein crystal growth in microgravity: in a sealed and temperature-controlled chamber, crystals are grown, back-illuminated and imaged, melted, and regrown. Since the idea of Bitsy is of a spacecraft kernel, which attaches to a vehicle to provide essential functions, the science experiment housing itself will be the primary vehicle structure.

The demonstration technology to be flown is the Bitsy Spacecraft Kernel. Proving this architecture will enable significant progress in reducing space mission costs by using the architectures and technologies unique to the growing field of nanosatellites.

### 3. THE BITSY KERNEL ARCHITECTURE

All spacecraft have substantially the same basic requirements: power, communications, guidance and navigation, and command and data handling. Conventionally, the design of a spacecraft is effected by partitioning the spacecraft into two independent sub-systems: a payload system and a transport system. The payload system comprises the mission-specific equipment, such as a collection system that collects data in a research satellite, a relay system that retransmits signals in a communications satellite, and so on. The transport system, or 'bus', comprises the equipment required to effect the mission in space, including: the power generation and storage system, the attitude determination and control system, the command and data handling system, the communications system, and the infrastructure and superstructure to support each of the components of each system.

Although the functional partitioning of tasks between payload and bus provides the desired degree of functional independence for effective system design, the physical constraints inherent in spacecraft design often forces a structural dependence that minimizes the advantages that can be gained by this functional partitioning. If the mission is to visually collect data related to the earth's surface, for example, the solar panels must be arranged so as not to obscure the view of the earth, and the spacecraft must be controlled to orient the visual collection device toward the earth. Conversely, if the mission is to measure the effects of weightlessness on crystal growth (as in the SPASE mission), the solar panels can be placed anywhere on the exterior of the spacecraft, whereas the spacecraft propulsion and control system must be designed to minimize acceleration in any direction.

These kinds of interactions between the payload and the bus, requiring bus redesigns often late in the development process, as unexpected issues are encountered in payload development, are often a major contributing factor to the high cost, in time, effort, and material, of conventional spacecraft development programs. Because of the interdependencies imposed between the payload and bus, the re-use of systems or sub-systems among spacecraft having different missions is a sought-after but often unachievable goal.

The Bitsy kernel approach, then, is not to attempt to draw the line between bus and payload, but rather between mission-specific and cross-mission or 'kernel' functions. Instead of trying to design a generic bus that meets the needs of a wide variety of mission types, Bitsy selects the functions that are in common across a variety of mission types and provides them in a single, reliable, standard unit.

#### 4. BITSY KERNEL DESIGN OVERVIEW

Bitsy is an enabling technology, meaning that one does not fly a Bitsy *per se*, but rather uses Bitsy as the starting point of the development of a full spacecraft. By using the twin approaches of COTS and standardization to their fullest extent, this kernel offers significant cost and turnaround advantages over traditional bus development.

##### *Standardized Core of COTS Technology*

Two primary cost drivers of any engineering product, particularly space borne devices, are part costs and integration time. S-class parts and units are prohibitively expensive, by a necessity since they are low-production, labor-intensive products themselves. The domino effects of 'a few minor changes' on a previously built product, where long hours are spent in integration trying to get the system to work together as a whole again, are well known to all who have worked on such a project. These are the issues AeroAstro addresses in Bitsy through the use of a standardized core of COTS technologies.

In this context, COTS is more literally meant than usual in the aerospace business. By 'commercial', true commercial suppliers are intended. For example, one can order from DigiKey, D-style connectors that might otherwise have been found on the back of a personal computer, or radios with a history of ruggedness but which have not before been attempted in space because of the absence of an explicit MIL-STD-883 rating. By 'off-the-shelf, products with a more immediate, consumer-product level turnaround are preferred with a delivery time measured in days or weeks, not months or years.

While the use of this level of COTS components addresses the part cost issue, the 'standardized core' addresses the runaway integration times that turn each spacecraft bus production into an individual development project. Each Bitsy model will have a well-defined set of capabilities and a well-defined means of interface - a 'solution space' of missions for which that model can be effectively employed. The performance of Bitsy within that solution space will be extremely well tested, understood, and reliable. The mindset of the customer is then to pick the model of Bitsy which will provide the power, communications, and C&DH performance required, and build from there. This is highly preferable to the other way around, where the customer comes to the bus supplier with a set of requirements that does not quite fit any device the supplier has, and as a result the bus supplier takes a working device and makes 'a few minor changes'.

In order to make the solution space as large as reasonable and therefore serve a significant number of missions, the capabilities of a given model of Bitsy must be broad from the outset. The power system must be capable of handling (for example) supplies and loads from 0 to 100 Watts, with between 0 and 16 individual solar panel strings, 0 to 200 Watt-hours of Lithium-ion secondary batteries, and 0 to 700 Watt-hours of Lithium-Thionyl-Chloride primary batteries, delivering individual switched circuits that can supply 0 to 30 Watts each, and established as part of the standard core of a particular Bitsy model.

An analogy here is to the purchase of a car. One does not approach the auto dealer with requirements for cylinder bore and stroke, acceleration performance, and seat dimensions; the auto manufacturer makes models of car with various engines and abilities, and includes adjustable seats: the customer chooses from among these well-tested production-line units. The dealer offers options, air conditioning or a better stereo or a service plan, which the dealer is confident is either a known and tested addition to the vehicle, or will not affect its production.

The final note of standardization here is standardized interfaces. The Bitsy kernel will always have to interact with unique, new, mission-specific items. In order to retain the advantages of standardization and reliability, then, these interactions must be through well-documented and well-understood interfaces: bolt hole patterns, power supplies, and data throughput will all be standardized. Simple data interface is through analog and digital discretes; basic information exchange is through RS-232/422/485; and more complex missions requiring more complex buses, such as 1553/1773, CAN, or FireWire, would be supported in future models of Bitsy.

##### **5. THE APPLICATION OF A SPACECRAFT KERNEL**

The Bitsy model being developed for the Future-X SPASE mission is the most basic version: the Bitsy-SX. It communicates at an average of 9600 baud from LEO to a very moderate-gain ground antenna. In addition, it supports power consumptions up to at least 50 Watts and power supplies from solar panels and/or Lithium-Ion rechargeable batteries and/or Lithium-Thionyl-Chloride one-time batteries. Bitsy-SX uses RS-232 in addition to analog and digital discretes to communicate with the payload, and supports simple timed commanding (turn this device on at time T1, send these bytes at time T2, and so forth). It monitors telemetry and performs a specified action when an input value crosses a threshold; the most basic type of housekeeping, but still sufficient to perform thermal control and simple ACS.

SPASE will use Bitsy-SX on an octagonal spacecraft that fits inside a Shuttle GAScan, with the spacecraft covered in solar panels and carrying 7 Watt-hours of Lithium-Ion batteries; net orbital average power is near 5 Watts. ACS is passive, using hysteresis rods and permanent magnets to keep the vehicle body rates below  $10^{-5}g$  for the crystal growth experiment. The payload interaction consists primarily of keeping the crystal growth cavity within a specified temperature range, commanding a digital camera to take images periodically, and downloading those images when a ground station contact occurs. These requirements, then, are well within the Bitsy-SX solution space; other missions can then use Bitsy-SX, with no modifications to Bitsy itself, only the addition of mission-specific elements which act through the standard interfaces.

The AeroAstro Small Payload ORbit Transfer vehicle, or SPORT, is a new approach to getting spacecraft to Low-Earth Orbit. There are many inexpensive secondary launch opportunities, particularly on Ariane; but they are to GTO. There are many spacecraft whose small size and low cost can take advantage of secondary launch slots; but they need to go to LEO. SPORT is a transfer vehicle that uses a combination of propulsion maneuvers and aerobraking to bridge the gap between these two. And SPORT uses a Bitsy-SX. It uses Lithium-Thionyl-Chloride primary batteries instead of solar panels and rechargeables; it is a spinning vehicle, which uses Bitsy's sense-and-threshold function to govern an analog ACS; it has no RS-232 discretes, but a number of valves, heaters, and regulators that use Bitsy's analog and digital discrete channels. Since the development of SPORT can focus on only the SPORT-specific issues, propulsion and related ACS, the amount of energy needed in the primary batteries, the satellite carrier structure and treat power regulation and switching, communications, and monitoring / control functions as 'solved problems', the development of SPORT is that much faster, cheaper, and more reliable.

KITComm Pty. of Australia commissioned AeroAstro to do an initial design of a constellation of spacecraft to perform remote asset tracking. AeroAstro designed a bent-pipe system that offered near-

real-time communications with all assets within thousands of kilometers of each ground station, placing system complexity (and therefore upgradeability) on the ground instead of in the spacecraft. This spacecraft also was designed around a Bitsy-SX. It used body-covering solar panels and Lithium-Ion batteries, like SPASE, but is a spinner, like SPORT. The payload was a radio repeater, which required only simple monitoring and power control. The KITComm spacecraft required much more power than either SPASE or SPORT, but still well within Bitsy-SX's capabilities. Bitsy-SX could thus be used unchanged for the KITComm constellation as well.

AeroAstro recently completed a study for NASA's New Millennium Program, studying the spacecraft bus portion of the Disturbance Reduction System spacecraft currently under consideration by the New Millennium Program for ST-5 (DS-5). This vehicle requires significantly greater capabilities than Bitsy-SX, hence calling for a different model of Bitsy. In keeping with the kernel concept, however, this new model of Bitsy would be given a sufficiently broad solution space beyond the DRS mission to be usable, without modification, in other spacecraft of similar scale. It would have a low-power commercial microprocessor on-board, with 16 Megabytes of memory, 32 independent RS-422 channels for communication with mission-specific subsystems and devices, a 300 Watt capable power system, up to 20 Watts EIRP out of the radio, and commensurately greater numbers of discrete inputs and outputs. Note that the intended ultimate cost and time savings here comes from not trying to stretch Bitsy-SX to work with the DRS mission, but recognizing that a new Bitsy model serving a new solution space is called for.

## 6. MINIATURIZED TECHNOLOGIES

One fundamental fact of spaceflight is that mass is money. The smaller, lighter, and more compact a vehicle (and hence its parts) can be, the more launch opportunities become available, and the lower the cost. It is therefore a priority of the Bitsy product line to be as miniaturized as possible while still offering the cost savings of COTS parts and standardized capabilities and interfaces.

### *Technology Goals and Priorities*

The technology development efforts at AeroAstro to advance the Bitsy product line are twofold: technologies that advance the Bitsy core itself; and technologies which use Bitsy's standard interfaces to create an extended product that is more immediately useful to a class of customers. Bitsy core technology developments include

- Industrial-grade microprocessors and embedded controller units which can be used in space, including the extensibility (PC/104, compactPCI, ISA) that this implies
- Information transfer protocols applicable to spacecraft, making not only communication but actual information exchange among spacecraft devices standard
- Batteries with ever higher power density and longer lifetime
- High-efficiency power regulators and DC-DC converters
- MMIC devices offering an entire radio system on one or two integrated circuits

Bitsy extension technologies include

- High-efficiency solar arrays, including multijunction, multispectral, and other cell technologies

- Deployable, articulated, and inflatable devices, so that a spacecraft which is compact on launch is not handicapped by its small surface area on orbit
- Smaller and less expensive launch vehicle mating systems than are currently used, including multi-spacecraft deployment mechanisms
- Nanospacecraft propulsion provides the low minimum impulse bit required to control very small spacecraft

AeroAstro has researched each of these items to some extent in the interest of advancing the Bitsy product line. Some highlights include

- Space-ready Lithium-Ion and Lithium-Thionyl-Chloride battery systems, including recharging circuitry and structures highly resilient to physical and thermal shocks, developed for and delivered to the Air Force for rigorous testing
- Vaporizing-liquid propulsion units, also for the Air Force, built and tested to demonstrate their compact size, high degree of controllability, and inherent safety
- A miniaturized, low-power X-band radio system, described in detail in the next section.

#### *Miniaturized, Low-Power X-band Transponder*

AeroAstro's most recent kernel technology development effort has produced a design and a production plan for an X-band spacecraft transponder weighing only 150g, consuming under 8W, and fitting on miniature PC boards in a space less than 5x5x7.5cm. It produces 2W EIRP and supports up to 750kbps downlink with CCSDS formatting. This level of miniaturization and power efficiency is far beyond anything available on the market today. The transponder is designed to proceed smoothly from this mini-PC-board product to even further miniaturization and power reduction by employing hybrid construction, followed by ASIC development, followed by Low-Temperature Cofired Ceramic (LTCC) production.

AeroAstro chose communications systems as our next step in technology development, in recognition of a lack of comparable products in the commercial marketplace. Although there has been a strong recent push toward reducing spacecraft mass and cost, there is no commercially available communications equipment that will significantly contribute to that reduction. While spacecraft mass has dropped over an order of magnitude in the past ten years, radios have not followed this trend. Since there was no COTS solution available to meet the needs of true nanosatellites, and the COTS solutions for the Bitsy product line were sub-optimal at high data rates, AeroAstro is developing the solution itself.

While this miniature X-band radio will be offered for sale as an independent unit, it will also be incorporated into the Bitsy product line, and thus be presented to the user simply as a capability of Bitsy, with the internal details transparent to the user. However, by reducing the radio size and mass so drastically from existing solutions, the Bitsy kernel itself will drop in size and mass, making spacecraft built from Bitsy that much more lighter and more compact and therefore less expensive to fly.

#### **7. LONG-TERM BITSY KERNEL LINE**

The Bitsy product series is expanding to offer increased flexibility. There are customers with specific kernel requirements that cannot be served by the Bitsy models available, and for them AeroAstro is



developing a series of advanced products with increased capabilities such as higher processing power, precise pointing, and extremely capable on-orbit maneuvering. Many customers require a full bus in the traditional sense, with mission-specific bus functions such as solar panels and ACS actuators and the like, who will be served by custom buses based on standard Bitsy kernels. However, many customers require a spacecraft very similar to one that has already flown, to perform a very similar mission. These can now be served for very low cost by customizing to their specific mission needs using fully developed Bitsy-based standard spacecraft kernels.

Some mission-specific Bitsy Spacecraft Kernel products that AeroAstro is developing are:

- Microgravity research vessels the SPASE vehicle
- Product demonstration vehicles, where a star tracker, IMU, small thruster, radio, solar panel, deployable structure, or any other individual device which fits in a certain envelope can be flight-tested on a Bitsy-based nanosatellite
- Radio relay constellations, such as KITComm or similar venture in which there is much interest today
- Sensor constellations, where a fleet of Bitsy-based nanospacecraft carrying the same sensor suite fly through an interesting region of space

Every custom bus AeroAstro builds will also be designed with an eye toward reuse within that mission type.

#### ***The First Bitsy Mission: SPASE Program Overview***

The first Bitsy will fly on the SPASE vehicle in late 2000. Future productions of the Bitsy-SX kernel are planned to take 6 months after receipt of order, with the schedule driven by long-lead acquisitions; hence the priority for locating or developing faster-turnaround products.

Bitsy-SX will be mated with the Marshall Space Sciences Lab Microgravity Crystal Growth Demonstration at Marshall Space Flight Center. The integrated unit will be functionally and environmentally tested, and delivered to the Hitchhiker office for integration onto Shuttle. Shuttle integration is of course a concern, which has been allotted for in the budget, although AeroAstro and the Future-X office hope that SPASE will be a pathfinder for establishing more straightforward integration methods for small, simple satellites.

The SPASE vehicle will be deployed from a GAScan at an altitude high enough above the atmosphere to remain under the  $10^{-5}g$  requirement for the science experiment. There is no electrical connection between the SPASE vehicle and the Shuttle, and no requirement for Shuttle crew attention beyond the deployment of the satellite.

Communications with the spacecraft will be conducted from the University of Alabama at Huntsville, offering an educational outreach benefit to the program where students will be directly (not tangentially) involved in the actual operations of the vehicle. The SSL science team will establish the operations for the crystal growth experiment, which will produce information on micro gravity crystal growth that has not been acquired before, and which does not require the costly return of the sample to Earth. The science mission is designed to last 6 months, with operations after that being an opportunity to test the duration limits of the technologies on-board.

## 8. CONCLUSION

Bitsy-SX is the first of a line of spacecraft 'kernel' modules offered by AeroAstro. By delivering a standard, consistent, reliable spacecraft kernel, or core module, AeroAstro will reduce the cost and the turnaround time for future space missions because a core of spacecraft functions can be built into a low-cost, customizable, extensible 'kernel' product. The SPASE mission, in addition to performing valuable micro gravity science, will demonstrate the applicability and benefits of the spacecraft kernel approach for single and multiple nanospacecraft.

## 9. BIOGRAPHIES

### *Scott A. McDermott*

Experienced in both hardware and software disciplines, Scott was a high-speed ASIC designer with Lockheed - Martin Federal Systems, and is the primary creator of HETE and TERRIERS on-board payload data processing software. He holds a patent on an efficient position determination algorithm using electromagnetic patterns. He is currently working on the next generation of AeroAstro processing systems. Scott led (both as manager and systems engineer) projects to: develop minispacecraft radio, battery, and command/data handling systems; create a stratospheric vehicle behavior simulator; bring automotive technology to space use; and bring the Bitsy spacecraft kernel to market. Scott also debugged the existing HETE and TERRIERS spacecraft processors and system software, bringing both successfully through pre-launch environmental tests. He created the TERRIERS payload data processing software and supported customers on-site nationwide and internationally.

As an Associate Engineer for the LORAL Corp., Scott was involved with the PLASMA PCI/P1394 bus bridge interface ASIC. He modified and augmented existing test equipment for use with the Globalstar and Mars Surveyor spacecraft processors. Scott was also a key member of the Advanced Tactical Air Reconnaissance System software team where he developed system firmware, utilities, and procedures central to product development. He designed and implemented the dual-DSP image processing system, as well as numerous pre-launch test suites, for the HETE spacecraft. For Digitechnique, Scott designed and tested prototype portable electrocardiogram analyzers and recorders and realized a site programmable, banked memory, point of sale and accounting device incorporating the Minitel system..

Scott has a BS and an MEng in Electrical Engineering and Computer Science from MIT.

### *David J. Goldstein*

Mr. Goldstein is responsible for technical marketing and strategy at AeroAstro. As an entrepreneur and AeroAstro's vice president of Business Development, he develops and implements AeroAstro's strategy, including development of AeroAstro's concepts, product lines, and expanding company technology into the developing nanosatellite marketplace. Mr. Goldstein has built a business development team with the addition of several sales, marketing, and support personnel. He works with both the Board and with AeroAstro's employees to develop technology and product direction.

With a technical background, Mr. Goldstein has led several spacecraft system designs, led design of the Encounter 2001 commercial spacecraft, and has written a number of successful technical proposals.

Previously, Mr. Goldstein worked at NASA Goddard Space Flight Center, where he was a member of a team developing a high-resolution angular accelerometer for the Super conducting Gravity Gradiometer Experiment. He was also a member of the Engineering staff at Brown University, where he conducted research on ceramic composite materials.

Mr. Goldstein served as a technical consultant to the Great Southern Temple archaeological excavations in Petra, Jordan. He has an Sc.B. with honors in Mechanical Engineering from Brown University.

*Nathanaël Chabert*

Director – space department at the London Satellite Exchange. E-sax.com under the umbrella of The London Satellite Exchange is the satellite communications industry online marketplace. E-sax supports the entire vertical satellite value chain: from satellite manufacturers, rocket launchers, satellite operators, ground segments services, to satellite service providers.

Live traders, available online & offline, provide real-time, unbiased, first come first served, space capacity bandwidth trading to satellite service providers. Satellite professionals are further assisted for ground segment hardware and teleport services online procurement. E-sax is currently representing AeroAstro interests in Europe.

## EXPERIMENTATION DE CONTROLE D'ORBITE AUTONOME SUR LE MICROSATELLITE DEMETER

Marie-Claire CHARMEAU, Alain LAMY, Denis LAURICHESSE, Michel GRONDIN

*CNES, Centre de Toulouse, 18 av. Edouard Belin - 31401 Toulouse cedex 4*

**RESUME** - Dans le cadre des études de recherche et technologies menées actuellement au CNES, une expérimentation de contrôle d'orbite autonome va être embarquée sur le microsatellite DEMETER. Cette expérimentation fait partie de la charge utile technologique du satellite, et consiste à calculer et exécuter à bord de façon autonome les manœuvres de corrections d'orbite nécessaires pour maintenir le satellite sur une orbite de référence définie de façon simple. Pour cela, on dispose à bord d'un récepteur TOPSTAR 3000 équipé d'un navigateur DIOGENE qui détermine l'orbite à partir de mesures GPS. Des algorithmes spécifiques de calcul de manœuvre seront implantés dans le récepteur. Les manœuvres de correction d'orbite calculées seront converties à bord en commandes destinées à la plate-forme, pour activer son système de propulsion. Dans une première phase d'exploitation, les manœuvres ne seront pas exécutées mais validées au sol, puis l'expérience pourra fonctionner en boucle fermée de façon autonome.

**ABSTRACT** - *An in-flight demonstration of autonomous orbit control will be performed on the first CNES microsatellite DEMETER. This experiment is included into the technological payload of the satellite, where orbit control corrective impulses are calculated. The navigational data are provided by a TOPSTAR 3000 GPS receiver using the DIOGENE software. Specific orbit control algorithms will be added to the TOPSTAR 3000 software for the demonstration. The calculated  $\Delta V$  will be translated into commands to the propulsion system of the satellite. During the first months of orbital life, commands to the propulsion system will not be executed, but only transmitted to the ground for validation. Afterwards, the demonstration will be allowed to run on its own and control the spacecraft.*

### 1 - INTRODUCTION

L'autonomie des satellites est un thème de recherche qui prend actuellement de l'ampleur parallèlement à l'accroissement des capacités de calcul et traitement des données offertes par l'informatique embarquée. Une activité de recherche et technologie a été lancée au CNES en 98 sous la forme d'une action de développement exploratoire dont l'objectif est de démontrer la faisabilité et la maturité de différentes techniques visant à rendre les satellites plus autonomes. Cette autonomie permettrait de réduire les coûts d'exploitation des satellites, surtout dans le cas de constellations, en déchargeant les opérateurs de tâches de routine simples mais coûteuses en temps.

Les activités liées à la localisation des satellites et au maintien de leur orbite représentent une part importante des activités d'un segment sol, en dehors des activités liées à la programmation de la mission, et il est donc particulièrement intéressant de les rendre autonomes.

Le CNES travaille depuis longtemps sur la navigation et le contrôle d'orbite autonome, dont la faisabilité technique est acquise. Cela fait plus de quinze ans que des études ont été entreprises sur ce thème, le contrôle d'orbite autonome étant une suite logique à l'avènement des navigateurs de bord [Rene 1984]. La principale difficulté pour faire adopter ces nouvelles techniques est plutôt d'ordre culturel, car elles viennent à l'encontre des habitudes des opérateurs qui les considèrent comme un risque supplémentaire. Pour lever ces réticences et montrer l'apport du contrôle d'orbite autonome, une phase de démonstration en vol est nécessaire avant de pouvoir décider de l'embarquer dans un contexte opérationnel.

Des expériences de contrôle d'orbite autonome ont déjà été menées sur une courte durée, en orbite basse sur UoSAT-12 [Wertz 2000], et sur trajectoire interplanétaire avec la sonde Deep Space 1 que le JPL a également utilisée pour tester un système de propulsion électrique. Le CNES travaille sur une nouvelle expérimentation qui vise à montrer l'utilisation d'un système de contrôle d'orbite autonome adapté aux contraintes imposées par la mission principale du satellite. Elle sera réalisée en 2002, en orbite basse, sur le microsatellite DEMETER.

## **2 - LE PRINCIPE D'UN CONTROLE D'ORBITE AUTONOME**

Le maintien de l'orbite d'un satellite se fait traditionnellement depuis le sol à partir de mesures permettant de localiser le satellite. Lorsque l'orbite mesurée s'éloigne trop de l'orbite de consigne, on programme des manœuvres de correction d'orbite qui sont téléchargées au satellite pour être exécutées au moment voulu.

Le contrôle d'orbite est dit autonome si les deux étapes de localisation et de correction sont faites entièrement à bord, sans aide du sol. Il faut pour cela disposer d'un navigateur qui reconstitue l'orbite à bord à partir de mesures de position et vitesse du satellite. Ces mesures peuvent être, en orbite terrestre, fournies par un récepteur GPS embarqué ou par un récepteur DORIS, qui fonctionne sur le même principe qu'un récepteur GPS, mais à partir de signaux émis par des balises au sol.

L'orbite restituée doit être comparée à bord à une orbite de référence, et en cas d'écart, on calcule également à bord la poussée qu'il sera nécessaire d'appliquer au satellite pour corriger sa trajectoire. Cette poussée doit être traduite en commandes qui sont transmises au système de propulsion du satellite. La réalisation de la poussée est prise en charge par le système de contrôle d'attitude et d'orbite du satellite, de la même façon que lorsque la correction d'orbite est commandée depuis le sol.

Un contrôle d'orbite autonome permet de réaliser des poussées plus souvent que lorsqu'elles sont gérées par le sol, et ainsi de corriger l'orbite de façon plus serrée sans avoir besoin d'une très grande précision sur la réalisation des manœuvres. On se rapproche du fonctionnement d'un système asservi. On peut même imaginer un vrai asservissement de l'orbite pour des satellites disposant d'une propulsion électrique qui permet de réaliser de petites poussées fréquentes perturbant peu le satellite. Certaines études portent sur l'application des méthodes modernes de l'automatique qui pourraient s'appliquer avantageusement dans ce contexte [Parvez 1996].

### 3 - LES POSSIBILITES OFFERTES PAR LE MICROSATELLITE DEMETER

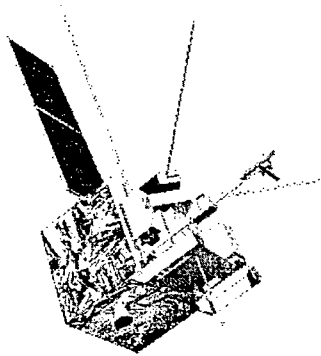


Fig. 1 : le microsatellite DEMETER  
(vue d'artiste)

DEMETER est le premier microsatellite de la filière mise en place par le CNES pour répondre aux besoins d'expérimentateurs scientifiques désireux d'embarquer des instruments dans un délai court et à coût réduit. Il doit être lancé en début 2002. La mission principale de DEMETER est la détection de signes avant-coureurs de séismes dans le champ magnétique terrestre. Sa charge utile comprend plusieurs instruments de mesure du champ magnétique destinés à surveiller ses évolutions, plus particulièrement au-dessus des zones de forte activité sismique.

DEMETER est également un satellite à vocation technologique. Il est équipé d'un système de propulsion, bien que sa mission scientifique ne nécessite pas de maintien d'orbite, pour répondre à un besoin de qualification au titre de la filière microsatellite. Cette particularité en fait le satellite idéal pour une expérimentation de contrôle d'orbite autonome, d'autant plus qu'il sera placé directement sur une orbite basse (entre 700 et 800 km), quasi héliosynchrone.

L'expérimentation de contrôle d'orbite autonome fait donc partie de la charge utile technologique de DEMETER. Toutefois les microsatellites de la filière CNES sont conçus comme des satellites classiques et non comme des satellites autonomes, et la configuration du système de contrôle d'attitude et d'orbite empêche la réalisation de manœuvres de correction d'orbite rapprochées: en effet, les tuyères du système de propulsion sont situées sur la face opposée à la Terre, ce qui suppose de réaliser avant chaque correction d'orbite une manœuvre de basculement du satellite pour les amener dans la direction voulue. Ces manœuvres d'attitude ne peuvent se faire qu'après interruption de la mission scientifique. Pour ne pas l'interrompre trop souvent, un compromis a été trouvé sur un rythme de manœuvre de deux corrections d'orbite par semaine au maximum.

Ces manœuvres doivent également tenir compte de contraintes supplémentaires dues au fait que le satellite est suivi par le segment sol de la filière microsatellite avec les moyens destinés à un maintien d'orbite classique: localisation au sol, et extrapolation d'orbite pour calculer les passages au-dessus des stations. Ce n'est pas l'orbite de référence du contrôle d'orbite autonome qui est utilisée pour le suivi du satellite par le sol. Il ne faut donc pas que les corrections calculées à bord de façon autonome gênent le suivi du satellite par le sol.

L'expérience doit de plus respecter des contraintes draconiennes de masse et consommation liées à l'embarquement sur un microsatellite dont la masse totale ne doit pas dépasser 110 à 120 kg, selon le lanceur choisi.

### 4 - LES GRANDS CHOIX DE L'EXPERIMENTATION SUR DEMETER

DEMETER ne dispose pas de récepteur GPS ou d'un autre moyen de mesure d'orbite parmi les équipements de sa plate-forme. Pour pouvoir réaliser le contrôle d'orbite autonome, il faut donc embarquer un navigateur dans la charge utile.

Les contraintes de masse et de consommation ont conduit à choisir le récepteur GPS TOPSTAR 3000, développé par ALCA TEL pour le satellite STENTOR, à défaut d'une version de récepteur DORIS miniature qui n'était pas disponible dans les délais voulus pour DEMETER. Le logiciel du TOPSTAR 3000 comprend le navigateur DIOGENE mis au point par le CNES qui calcule la position et la vitesse du satellite à partir des mesures faites par le récepteur au moyen des signaux délivrés par les satellites GPS en visibilité. Le récepteur est également capable de s'initialiser sans aide si un nombre suffisant de satellites GPS est visible.

L'expérimentation de contrôle d'orbite autonome étant située dans la charge utile de DEMETER, elle n'est pas intégrée dans le système de contrôle d'attitude et d'orbite de la plate-forme, contrairement à ce que pourrait être le système de contrôle d'orbite d'un satellite autonome. Elle doit respecter les interfaces de commande-contrôle pour adresser les commandes de manœuvre vers la plate-forme de la même façon que le sol le ferait lors de la programmation du satellite. Il faut donc prévoir de constituer, au niveau de la charge utile, des télécommandes à l'attention de la plate-forme qui lui seront envoyées sous forme de télémessures à interpréter comme des commandes. La plate-forme de son côté doit être capable de reconnaître et d'interpréter ces télécommandes en provenance de la charge utile. C'est le seul impact que l'expérimentation de contrôle d'orbite autonome a sur la conception de la plate-forme.

En raison des délais courts imposés au développement de cette expérimentation, on a choisi de réaliser un contrôle d'orbite simple dans le plan de l'orbite uniquement, sans chercher à corriger l'inclinaison.

Le maintien à poste doit reposer sur une stratégie proche de celle utilisée classiquement au sol tout en étant simple et robuste. Pour cela plusieurs stratégies de maintien à poste seront définies et testées successivement.

## 5 - L'ARCHITECTURE MATERIELLE ET LOGICIELLE

Sur DEMETER, la charge utile est gérée au moyen d'un calculateur spécifique qui communique avec le calculateur de la plate-forme. Le récepteur GPS est relié à cet équipement de gestion de la charge utile (EGCU) par une liaison série par laquelle transitent les télémessures et télécommandes. L'alimentation électrique du récepteur est également assurée par cet équipement de gestion. Le système de propulsion de DEMETER est simple: un réservoir d'hydrazine alimente 4 tuyères situées sur la même face du satellite.

Le logiciel utilisé pour le contrôle d'orbite autonome se compose de plusieurs éléments:

- la partie "navigateur DIOGENE", qui est dans le récepteur TOPSTAR 3000,
- la partie "suivi de l'orbite et calcul des manœuvres",
- la partie "préparation des commandes pour réaliser les manœuvres".

Cette dernière partie, qui consiste à traduire les manœuvres issues du calcul en séquences de commandes qui seront adressées au système de contrôle d'attitude et d'orbite de la plate-forme, est très dépendante du satellite et de la configuration de son système de propulsion.

Dans un vrai satellite autonome, il serait assez naturel de l'intégrer dans le logiciel de vol de la plate-forme. Sur DEMETER, on cherche à limiter les adaptations spécifiques du logiciel plate-forme pour respecter la logique de la filière microsatsellite, c'est donc l'équipement de gestion de la charge utile qui assurera cette préparation des commandes.

La partie "suivi de l'orbite et calcul des manœuvres" reçoit les informations de position et vitesse du satellite calculées par DIOGENE, les traite pour identifier l'écart par rapport à l'orbite de référence et calcule la poussée à appliquer au satellite pour corriger sa trajectoire. Elle se situe comme DIOGENE au niveau du calculateur du TOPSTAR 3000. On a cherché à définir pour cette partie, de même que pour DIOGENE, une interface la plus générique possible qui facilite la réutilisation. Le résultat du calcul de manœuvre est exprimé sous la forme d'un incrément de vitesse ( $\Delta V$ ) associé à une date d'exécution.

Les algorithmes de calcul de manœuvre et DIOGENE font appel à des fonctions spécifiques de calcul de mécanique spatiale qui seront présentées sous forme d'une bibliothèque pour faciliter les évolutions futures.

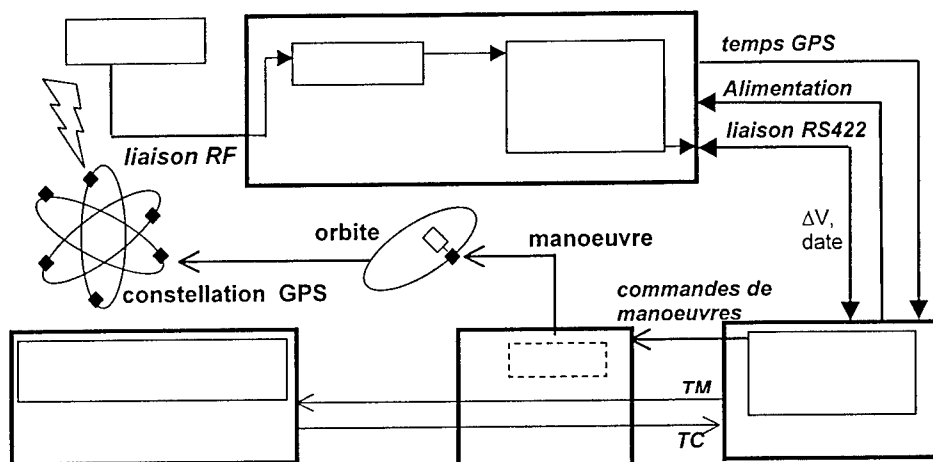


Fig. 2 : schéma de principe de l'expérimentation de contrôle d'orbite autonome

Le récepteur GPS disposera d'une antenne située sur la face opposée au générateur solaire. Cet emplacement permet de conserver le même champ de vue sur la constellation GPS lors des manœuvres de changement d'attitude qui précèdent les corrections d'orbite. Ces manœuvres en attitude devront également être autonomes, ce qui suppose que l'EGCU génère des profils de guidage pour la plate-forme au moment de chaque manœuvre.

## 6 - LES DIFFERENTES ETAPES DE VALIDATION ET D'EXPERIMENTATION

Le passage à un contrôle d'orbite totalement autonome sur DEMETER se fera très progressivement en plusieurs étapes permettant de valider le fonctionnement correct de l'expérience. Pendant les quatre premiers mois qui suivront le lancement du satellite, les manœuvres de correction d'orbite ne seront pas réalisées et le résultat du calcul des manœuvres sera seulement transmis au sol pour analyse. Cela permettra de vérifier que les algorithmes donnent, avec de vraies mesures GPS et sur l'orbite atteinte après le lancement, des résultats conformes à ceux attendus, et éventuellement d'affiner les réglages des paramètres de contrôle. L'orbite ne sera pas contrôlée lors de cette phase.



La propulsion sera dans un premier temps activée depuis le sol dans le cadre de tests de recette. Le récepteur GPS subira après le lancement des tests de démarrage sans aide du sol dans plusieurs configurations par rapport à la constellation GPS, pour vérifier sa capacité à s'initialiser de façon autonome.

Une fois cette étape de validation passive franchie avec succès, on pourra basculer sur un fonctionnement autonome, avec réalisation des manœuvres calculées à bord. Une correction d'orbite commandée depuis le sol permettra de placer le satellite sur l'orbite de référence choisie, puis toutes les corrections d'orbite seront effectuées par le système de contrôle d'orbite autonome.

Avant le lancement, le fonctionnement du contrôle d'orbite autonome sera validé par simulation. Un logiciel de simulation est en cours de développement pour tester les algorithmes de façon aussi réaliste que possible. Il permettra de tester dans un premier des maquettes des algorithmes, et quand elles seront disponibles, les versions « bord » définitives de DIOGENE et du calcul de manœuvres.

Dans un second temps, le logiciel bord sera validé sur un banc de test permettant d'intégrer une maquette du récepteur GPS contenant le logiciel de vol dans un environnement représentant complètement la constellation GPS. Ce banc de test a été modifié pour permettre de prendre en compte la réalisation de manœuvres de correction d'orbite, afin de pouvoir tester des scénarios de contrôle d'orbite autonome.

## 7 - CONCLUSION

Le contrôle d'orbite autonome est probablement une technologie qui sera utilisée couramment dans un futur proche. Quelques expérimentations en vol sont nécessaires pour montrer la maturité technologique de ce concept, sa fiabilité et l'intérêt qu'il présente pour simplifier les opérations et le suivi des satellites. L'expérimentation de contrôle d'orbite autonome sur DEMETER permettra de faire une démonstration en vol basée sur des algorithmes simples. Un maintien d'orbite plus élaboré ne pose pas plus de difficultés techniques. La mise à poste et la désorbitation autonomes peuvent également être envisagées et s'avérer économiquement intéressantes dans le cas d'une constellation de satellites.

## BIBLIOGRAPHIE :

- [Rene 1984] Z.X. Rene : "Autonomous Satellite Navigation and Orbit-Keeping Using Attitude Sensors", *35<sup>th</sup> Congress of the International Astronautical Federation, octobre 1984, Lausanne, Suisse*
- [Wertz 2000] J. R. Wertz : "Autonomous Orbit Control: Initial Flight Results from UoSAT-12", *23rd Annual AAS Guidance and Control Conference, février 2000, Breckenridge, Colorado.*
- [Parvez 1996] S.A. Parvez, G.Q. Xing : "Autonomous on-board orbit control / maintenance system for satellites", *brevet international n° WO 98/25156, publié le 11 juin 1998.*

## THE NANOSOL BIAxIAL SUN SENSOR

Alan Doctor  
John Glaberson

*BFGoodrich Aerospace  
Barnes Engineering  
88 Long Hill Cross Road  
Shelton, Connecticut 06484  
U.S.A.*

**ABSTRACT** - *A new precision biaxial sun sensor has been developed which uses a single optical assembly to sense the sun angle in two axes. It has a very large dynamic range and thus combines the functions traditionally performed by separate fine and coarse sensors. This Nanosol sun sensor provides high accuracy, wide field of view, high reliability, radiation tolerance, small size, and low mass all of which are important or use in ACS of small satellites.*

*A "Proof of Concept" model and prototypes have been assembled and tested. Preliminary test results including a discussion of error sources are presented. Development status and qualification plans are also discussed.*

### 1 - INTRODUCTION

Nanosol is a new method of sensing sun angle, with improved accuracy, field of view, size, weight, and ease of use, when compared to conventional approaches.

The Nanosol sun sensor is a *unitary* sensor. It combines the functions which were customarily performed by fine and coarse sensors; it also senses both axes ( $\alpha$  and  $\beta$ ) of sun angle. In addition, the optics and electronics are housed in a single compact housing, using a single optical path.

The Nanosol sensor is a *high accuracy, wide field* sensor. Its  $3\sigma$  error is  $.03^\circ$  over a range of  $\pm 64^\circ$ . In addition, it can function with reduced accuracy over a  $\pm 80^\circ$  cone. And it is virtually immune to Earth Albedo.

Combining the two axes, the coarse and fine functions, and the optics and electronics in a single package has many advantages, including reduced size and weight, simplified testing and calibration, and simplified integration.

## Theory of Operation

Present day sun sensors are based on technology, which has been in use for many years. These devices although having extensive flight, require substantial resources and are expensive to produce. The Nanosol, which is currently in development, promises to be simple to assemble and the highest performance.

The Nanosol Sun Sensor uses the well known principle of Moiré Interferometry, which has been used successfully in fine sun sensor (FSS) designs on many missions. Moiré techniques allow extremely high accuracy to be achieved with simple hardware.

Using two-dimensional Moiré patterns enables a single sensor to measure two axes simultaneously without an accuracy penalty. Previous Moiré sensor designs used one-dimensional Moiré patterns to perform single axis sun angle measurement, requiring the use of two separate sensors for the fine measurement function. This represents a vast improvement over previous Moiré sensors.

The Nanosol also eliminates the need for separate coarse sensors. The output of a Moiré sensor is cyclic, and therefore gives an attitude measurement, which is ambiguous. In prior systems, a separate coarse sensor was used to resolve this ambiguity. By contrast, the Nanosol sensor performs the coarse and fine measurement functions in a single sensor. This is accomplished by arranging the Moiré patterns so that multiple signals are available in which the phase changes at differing rates as a function of sun angle. By combining these signals, it is possible to deduce which of many cycles the current measurement represents.

The construction of the Nanosol sensor is simple. A fused silica block is coated on one side with a two-dimensional Moiré "encoder" pattern. The opposite side of the block is coated with an "analyzer" pattern, which is optimized to operate with the encoder pattern. Behind the block is a set of silicon photodiodes, connected to a multiplexer and preamplifier.

The output of the mux. goes to an A/D converter, which is connected to a digital circuit that performs the demultiplexing, formatting, and communications functions. The digital values are transmitted to the mission computer where they are translated to attitude measurements.

This technique leads to dramatic improvements over conventional approaches including:

- Small size because both axes of angle are measured with a single component
- High accuracy due to extreme mechanical rigidity and non-critical alignment
- High reliability and low cost due to low parts count
- Wide angular range, approaching  $2\pi$  steradians
- Excellent immunity to Earth Albedo effects

Table 1 below shows the expected performances from the Nanosol sensor.

Performance Parameter	Expected Performance
Pointing Accuracy	0.01°, 1 $\sigma$
Resolution	0.0003°
Field of View	±80° Cone
Spacecraft Spin Rate	>40 RPM
Power	0.03 Watt
Mass	0.05 Kg
Total Radiation	1000 Krad
Bus Voltage	3.3 Volts

Table 1

#### Configuration of Essential Elements

There are three elements that are essential to the operation of the Nanosol sensor, as shown in Figure 1. The *Mask* “encodes” the sun’s light with a periodic two-dimensional “cross hatch” shadow pattern. The Mask is formed of an opaque optical coating on the surface of the Silica Spacer.

The *Silica Spacer*, as its name suggests, maintains an accurate optical spacing between the Mask and the Die.

The *Die* contains twenty-four optical detector elements along with A/D converters and the logic necessary to control the converters, and to format and communicate the data to the host computer.

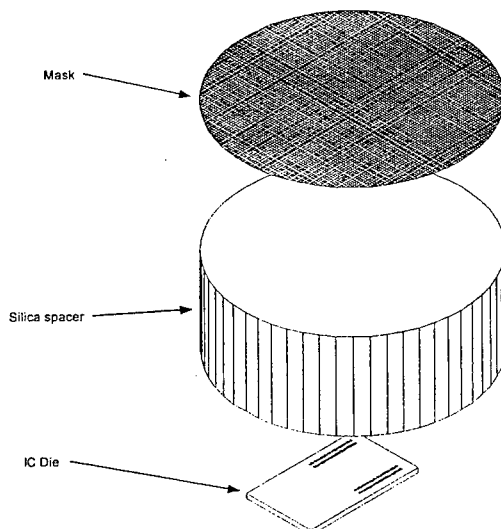


Fig. 1: Configuration of Essential Elements

## System Considerations

The Nanosol sensor provides serial digital outputs. 78 bytes are required to transmit the information for one full attitude update from one sensor. With a bit rate of one megabit per second and (N,8,1) asynchronous communications parameters, it would take 780 microseconds of bus time to transmit the data. At four samples per second, this represents a bus utilization of 0.3%.

The algorithms required to support an earlier Nanosol sensor have been coded in C and benchmarked on a 100 MHz 80486 computer. The time required to execute the algorithms is about 64 $\mu$ sec. Assuming the same update rate as above, this represents a processor utilization of 0.025%. The required code space is 4 Kbytes (assuming that floating point libraries will be available) and the required data space is less than 2 Kbytes.

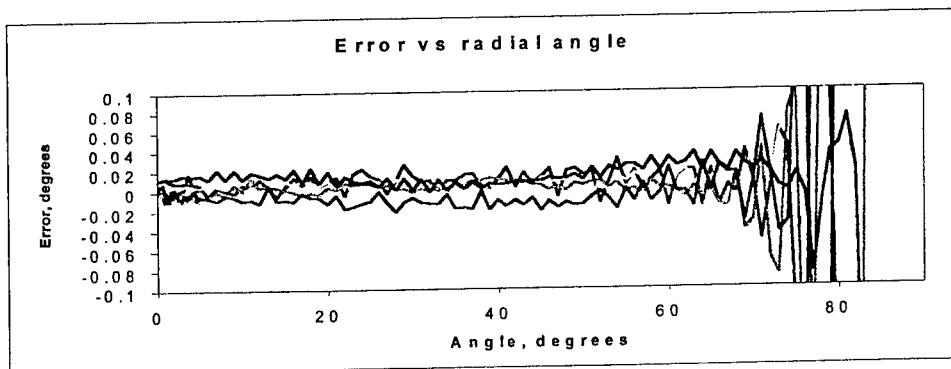
Initial analysis shows that the sensor can operate with reduced accuracy, even if calibration coefficients are lost. Optionally, all calibration constants could be encoded in the hardware as select-at-test resistor values, which would be interrogated by an additional A/D converter.

## Performance

The performance of the Nanosol sensor has been verified both by analysis and by test.

A breadboard of the Nanosol sensor has been built and tested, verifying the fine sensing accuracy of the technology. The performance of the Nanosol sensor, including coarse sensing, has been demonstrated by a software model and will be verified shortly.

Testing of the breadboard was performed at JPL's Table Mountain heliostat facility with encouraging results – a standard deviation of .01° was achieved over a  $\pm 60^\circ$  range. The  $\alpha$  and  $\beta$  errors from this test are shown in Figure 2.

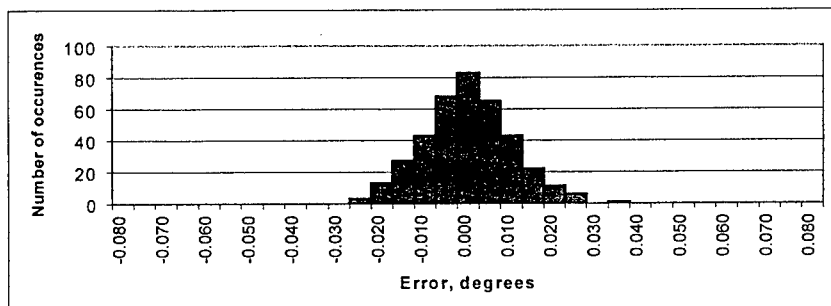


*Errors recorded at Table Mountain Heliostat using hand built breadboard shown above*

**Fig. 2**

While the test results were excellent for a hand built breadboard, certain deficiencies in the design and construction were demonstrated by the test. These can be seen in the small scale "ripple" in the plot, and in the dramatic increase in the errors above 70°. Some of these errors can be attributed to specific errors in materials or assembly, while others can be removed in the algorithms.

Even with these problems, the standard deviation of the errors was .01°. The distribution of the errors is shown in the following histogram. (Figure 3) note that the distribution does not have long tails - this is a product of the underlying error phenomena, which are inherently bounded. The "3σ" error will therefore be smaller than would otherwise be indicated by this standard deviation.



*Distribution of errors from 0 to 60°*

**Fig. 3**

### Conclusions

We have described a new state of the art multi-mission (coarse and fine) Sun Sensor which provides measurements of the angle to the sun over an included angle of  $\pm 64$  degrees with an accuracy of  $0.03^\circ$  ( $3\sigma$ ) and a reduced performance accuracy to  $\pm 80$  degrees.

### REFERENCES

John Glaberson "Sun Sensor Miniaturization Study Phase I, Final Report" NASA Contract S-17640-G 21 January 1999

John Glaberson "White Paper- Nanosol Suns Sensor" BFG Aerospace Barnes Engineering Internal Document

## **Active Permanent Magnetic Attitude Control for Small Satellites**

**Rees FULLMER  
Dominic FLORIN**

*Space Dynamics Laboratory, Utah State University, Logan UT, USA*

**ABSTRACT** – Magnetic torque generation for spacecraft attitude control has typically relied on electromagnetic coils. This paper describes an alternative method of generating magnetic torques using rare earth permanent magnets attached to a gimbaling mechanism. The magnetic moment orientation and magnitude can be completely controlled by using a simple mechanism with two magnets and three motors. The principal advantage in this approach is the reduction in energy required for control when compared to equivalent strength torque coils.

### **1. INTRODUCTION**

The use of low cost nanosatellites (e.g., those in the 10-kg. range) has been proposed for many missions of scientific value. A class of cost constrained missions exists where modest attitude control accuracies in the one to three degree range is sufficient. In many cases, the more traditional methods of momentum control or thruster systems simply prove to require too much power, mass or cost.

The method of creating control torques by generating on-board magnetic moments to interact against earth's magnetic field has been used extensively in attitude control applications. In most cases, magnetic control has been used to augment a more conventional attitude control system. Magnetic attitude control has been used for spinning spacecraft [1,2], for momentum unloading [3], damping [4] and it has been coupled with single axis momentum wheel designs [5,6]. In a few cases, torque coils have been considered exclusively for control, with pointing accuracy in the three to ten degree range [13].

Traditionally magnetic moments have been generated by torque coils. This method of actuation has several advantages for nanospacecraft. It uses very low cost, reliable actuators, while expending no propellant. There are disadvantages to coils as well, including a relatively low torque authority plus high power consumption. On-board magnetic moment generation also effects magnetometer readings, which are extensively used for science and attitude measurements in small satellites.

This paper presents an alternative method for active magnetic three axis control by orienting a pair of permanent magnets using a simple gimbal mechanism. This method is referred to as Active Permanent Magnetic Torquing (APMT).

The reason for selecting permanent magnets over torque coils is the potential energy savings. Nanosatellites typically must operate on very low power and energy budgets due to the small available external surface area for solar cells. Torque coils use relatively high amounts of power when active. The magnetic torque generated is directly proportional to the current. With the limited amount of torque available from these coils, the power must be supplied for a significant duration, causing a energy drain to the spacecraft. On the other hand, permanent magnets require no power for torque generation. The only power costs come during the reorientation of these magnets. For the same mass, permanent magnets can be selected to provide considerably more torque authority than a coil with significantly lower total energy costs.

The APMT method will be flown as a technology demonstration experiment on board *USUSat*, a small satellite developed under the U.S. Air Force's University Nanosatellite Program. *USUSat*, developed at Utah State University along with *HokieSat* from Virginia Polytechnic Institute and *DawgStar* from the University of Washington create a three member formation known as ION-F. The objectives for this formation include the distributed ionospheric electron density measurements, formation flying efforts, and technology demonstrations [7]. This formation is currently waiting for the assignment of a launch date, expected to be in mid to late 2002.

## 2. ACTIVE PERMANENT MAGNETIC TORQUING

Recent advances in materials have created magnets with high magnetic densities [8,9]. Rare earth magnets are typically made from Neodymium-Iron-Boron (Ne-Fe-B), Samarium Cobalt (Sm-Co) and Aluminum-Nickel-Cobalt (Al-Ni-Co). These magnets offer magnetic densities of up to 0.147 Am<sup>2</sup> per gm.

Magnetic moments are generated according to the vector equation [10]:

$$\vec{T} = \vec{M} \times \vec{B}$$

where  $\vec{T}$  represents the magnetic torque vector,  $\vec{M}$  the magnetic moment vector (generated either by a magnet or a coil), and  $\vec{B}$  the Earth's magnetic field vector. Since the magnetic torque is always perpendicular to the magnetic field, no torque can be applied about an axis aligned with the earth's magnetic field. This condition is referred to as the magnetically uncontrollable axis. Magnetic torques are quite small. For example, a large magnetic moment of 60 Am<sup>2</sup> results in maximum moments of under 4x10<sup>-3</sup> Nm.

Torque coil design represents a sometimes subtle tradeoff between mass, power, size and magnetic moment. Commercial systems made with advanced ferromagnetic cores are readily available [11]. Alternatively, some manufacturers of small satellites prefer to wind air coils about the body of their spacecraft, using the large cross-sectional areas to generate satisfactory magnetic moments.

Permanent magnets offer significant mass and power advantages to coils in generating magnetic torques. Table 1 compares the relative mass, power and size requirements for permanent magnets, torque coils and air coils of a common strength. Note that there are several trade-off's between power and mass for torque coil designs, and nominal values have been selected.



Type	Magnetic Moment (Am <sup>2</sup> )	Mass (kg.)	Size (mm)	Power (W)
Permanent Magnet (Nd-Fe-B)	60	0.4	38 mm x 25 mm x 25 mm	0
Commercial Torque coil	60	1.7	640 mm x 25 mm x 25 mm	2.1
Air Coil	60	1.5	500 mm (diam.)	30

Table 1: Comparison of Magnetic Moment Generation

The obvious advantage in using torque coils over permanent magnets for attitude control lies in their controllability. Their magnetic moment can be varied by simply regulating the current through the coil. To use permanent magnets for attitude control, they must be properly oriented with respect to both the spacecraft body and the Earth's magnetic field. One method which can be used to accomplish this is to mount the permanent magnets on a controlled two-axis gimbal. This allows the axis of the magnetic moment to be positioned as needed with respect to the body of the spacecraft. Further, if two separately controlled, identical permanent magnets are mounted along the same rotational axis, the magnitude of the magnetic moment vector can be controlled by simply summing the two magnetic moment vectors, as shown in Figure 1. Notice that the magnitude ranges from near zero when the magnets are opposed to twice the moment when they are constructively aligned.

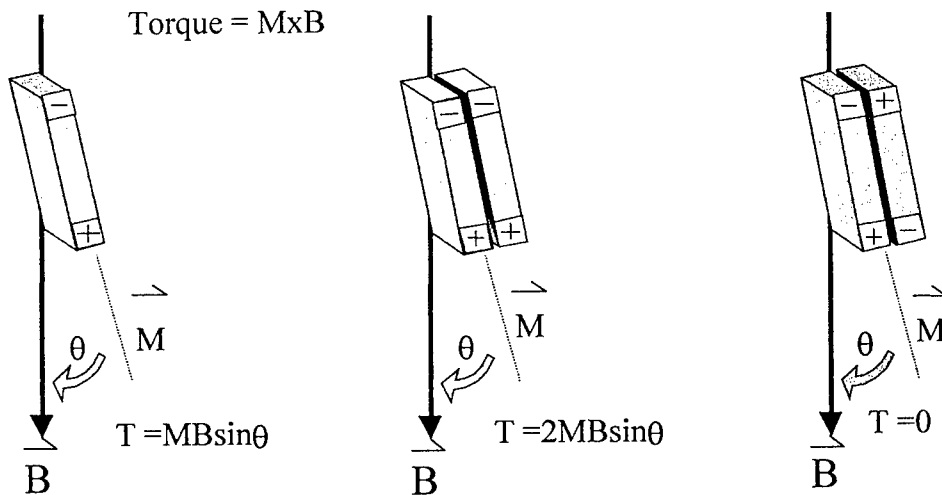


Figure 1: Magnetic Moment Magnitude Control with Dual Magnets

A two axis gimbal is required to place the magnetic field vector arbitrarily with respect to the spacecraft body axes. A third drive is required to control the amplitude of the magnetic moment. For the class of spacecraft which might consider using the APMT method, positioning accuracies of the magnetic moment vector to within 1 to 3 degrees are assumed to be sufficient.

Most gimbal drive methods require power comparable to that of torque coils. In order to reduce the total energy used by this method, the gimbal drives should be unpowered except during motion, yet able to hold a relative position with respect to the spacecraft. The approach taken here is to select commercial geared stepper motors for the drive mechanism. These motors have a sequence of magnetic poles on the rotor and teeth on the stator which result in a set of discrete magnetic equilibrium points, or steps. Even unpowered, there is a restoring torque which attempts to maintain position. The maximum torque which can be produced in the unpowered motor is referred to as the detent torque. This torque can be significant, especially when it is mechanically amplified through a gear train.

The APMT method requires stepper motors with sufficient detent torque to hold position without powering the coils. Power is applied to the drive motors only when they need to be moved, resulting in a very low total energy torquing system. As seen from the spacecraft, the magnetic field oscillates twice per orbit, defining the nominal motor rotation rate.

The detent torque must be able to sustain the maximum torque generated by the magnets interaction with the Earth's field. Of significantly greater impact is the relative torque between the magnets. Note that the magnets tend towards an equilibrium state, shown on the right diagram of Figure 1. This magnetic interaction torque defines the minimum acceptable detent torque for the stepper motor systems.

In addition to the magnetic torques, the reaction to the motion of the gimbal generates undesirable torques on the spacecraft. While small, especially for the low angular rates expected by the motors, these disturbance torques need to be included in the final control logic.

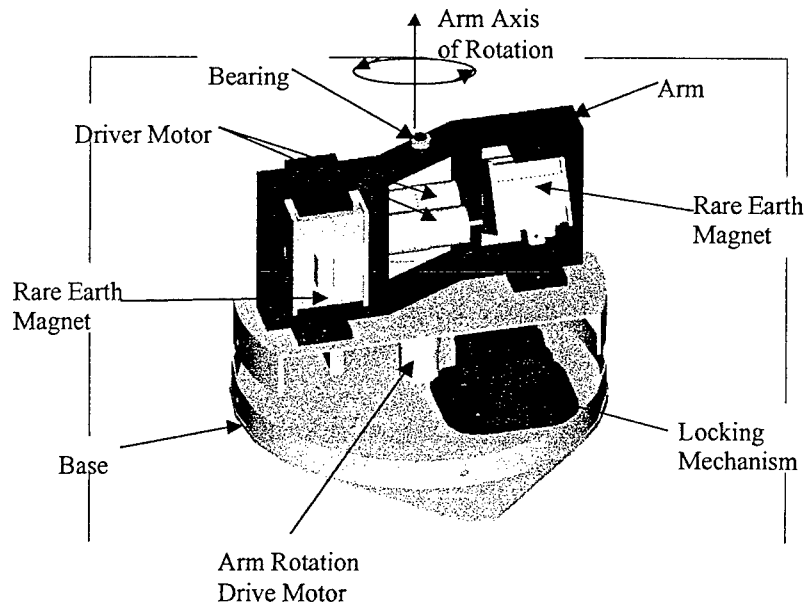
### 3. USUSAT ACTIVE PERMANENT MAGNETIC TORQUE

USUSat has chosen to fly the APMT system as a technology demonstration project. USUSat is designed to fly in a nadir pointing orientation in a low earth orbit approximately 350 km. in altitude and at an inclination of 51 degrees. Mission duration is expected to be two months. For formation flying reasons, the spacecraft must be controllable about its yaw (nadir) axis. Torques capable of causing rotation about this axis are achievable by orienting the magnets perpendicular to both the desired rotational axis and the magnetic field vector.

The APMT controller will be built using two 30 Am<sup>2</sup> Neodymium-Iron-Boron (Nd-Fe-B) permanent magnets attached through a planetary gear to the stepper motor shafts. This provides torque authorities of up to  $3 \times 10^{-3}$  Nm., which can provide rotations of 90 degrees within one minute under ideal conditions. The stepper motors and the drive electronics use small, high grade commercial components. The motors are selected so that the maximum magnetic torque, back-driven through the motor, will not exceed the nominal no-power detent torque. A single optical trigger on each motor is used to identify the home orientation for each magnet. The angular momentum generated by the motors is expected to be negligible during nominal control operations. The motors will move typically two revolutions per orbit, the rotational rate of the magnetic field vector. However, the motors must have sufficient speed to keep up with and reduce the initial spacecraft tip-off rates.

Figure 2 shows the basic design of this system, while the prototype components are listed in table 2. Notice the addition of a fourth deployment motor which is used to remove a one-time-only locking mechanism after orbital insertion. Stepper control is provided by the embedded spacecraft controller

driving commercial stepper motor drive electronics. These electronics are only powered slightly before and after a motor motion command.



**Figure 2: The USUSat Magnetic Gimbal Assembly**

Data for the selected stepper motor is shown in Table 2. A 60:1 planetary gear reduction unit was mounted as a gearhead for this motor.

Stepper Motor	Mass (gms)	Detent Torque (mN-m)	Drive Torque (mN-m)	Speed (steps/sec)	Steps/Rev	Power
Donovan AM1524	12.1	0.9	1.7	600	24	1.8

**Table 2: Selected Stepper Motor Characteristics**

In total, the entire APMT mechanism had a total mass of 0.96 kg., a height of 140 mm and a diameter of 140 mm. With all three motors active, power consumption is 5.4 W. Experimental tests with a torque balance indicated that using prototype magnets the actual magnetic moment is 52 A-m<sup>2</sup>. In comparison, a set of three torquer coils (required for three axis control) of similar capacity would have a total mass of 5.1 kg. and consume 6.3 W at full power. Further, preliminary simulation results for a 45 degree rotational maneuver indicate that the APMT system consumed a total of 22 W-sec, while an equivalent torque coil system consumes 195 W-sec. In summary, the initial APMT system appears to offer similar performance with less power and mass than a torque coil system.

#### **4. Three Axis Control**

Three axis magnetic control using either the APMT or torque coils must address the problem of not being able to create a torque about the axis defined by the magnetic field vector. Simply ignoring this axis and applying torques in the plane perpendicular to the magnetic field vector can result in accurate control in that plane. However, small rotational rates about this axis can cause drifts which can grow into large displacement errors.

USUSat is currently looking into several approaches to address this issue. For attitude maintenance operations, the uncontrollable axis will rotate in time. Therefore, over a portion (e.g. one fifth) of an orbit an average torque can be applied about any axis. Algorithms based on this concept have been developed and successfully applied in simulation [13], and this method will be base-lined for USUSat attitude maintenance.

Larger maneuvers require significant planning, since it is easy to induce rotational velocities about the uncontrollable axis. One approach is to include this constraint in an open loop optimal maneuver. This approach is currently being studied.

An alternative approach, again under study, takes advantage of the momentum exchange capability of the motor-driven magnets. If the magnets are rotated together rapidly for one complete revolution, the net magnetic torque on the spacecraft due to the rotating magnetic moment will be very small. However, the rotation of the two magnets will cause an opposite rotation of the spacecraft about that axis. In order to generate a maximum magnetic torque, the rotational axis of the magnets has to be as nearly aligned to the magnetic field vector as possible. This means that the rotational errors about the magnetic uncontrollable axis can be reduced by magnet rotation. While promising, this approach greatly increases the energy costs for the APMT. For USUSat, a complete rotation of both magnets through one revolution results in a rotation of 0.5 degrees of the spacecraft about the same axis.

#### **5. Conclusions**

An alternative method to torque coils for magnetic torque generation has been introduced. This method, referred to as Active Permanent Magnetic Torquing, offers some advantages over torque coils in terms of lower mass and energy consumed. Initial simulations indicate that the ratio of total energy consumption using the APMT method over comparable torquer coils is nearly an order of magnitude for a specific slew maneuver. This method also has some drawbacks, however. The motor driven gimbal mechanism is considered to be less reliable than coils. Further, magnetic disturbances to on-board components (e.g. magnetometers) are expected to be greater for the permanent magnet design. Finally, for three axis magnetic control, both magnetic torque methods must overcome the problem of being unable to apply a torque about the magnetic field vector. The APMT will be flown on USUSat, which is expected to be launched from the Space Shuttle sometime in Summer, 2002.

#### **6. Acknowledgements**

The authors of this paper acknowledge support of this project from the Space Dynamics Laboratory's Internal Research and Development Office. They would also like to acknowledge the mechanical design of the gimbal mechanism by Brian Rasmussen and Jason Topham of Utah State University.

## 7. References

1. Goel, P. S., Rajaram, S., "Magnetic Attitude Control of Near-Earth Spinning Satellites," Journal of the British Interplanetary Society, July 1978.
2. Stickler, A. C., Alfriend, K. T., "Elementary Magnetic Attitude Control System," Journal of Spacecraft and Rockets, May 1976.
3. Muhlfelder, L., Prustiner, J., Hill, L., "Spacecraft closed loop three-axis momentum unloading system," Washington D.C.: U.S. Patent # 4010921, 1977.
4. Arduini, C., Baiocco, P., "Active Magnetic Damping Attitude Control for a Gravity Gradient Stabilized Spacecraft," Journal of Guidance, Control and Dynamics, January 1997.
5. Goel, P. S., Rajaram, S., "Magnetic Attitude Control of a Momentum-Biased Satellite in Near-Equatorial Orbit," Journal of Guidance and Control, July 1979.
6. Sidi, M. J., "Spacecraft Dynamics and Control," Cambridge University Press, New York: N.Y., 1997.
7. Campbell, M., Fullmer, R., Swenson, C., Hall, C., "Ionospheric Observation Nanosatellite Formation (ION-F)", 5<sup>th</sup> Int. Symposium on Small Satellite Systems and Services, La Baulle, France. June 2000.
8. Stanford Materials Co., "www.stanfordmagnetics.com/magnet," San Mateo, CA, May 2000.
9. Hangzhou Permanent Magnet Group, "www.permanentmagnet.com/ndfeb", Xiaoshan, China, May 2000.
10. Chobotov, V. A., "Spacecraft Attitude Dynamics and Control", Krieger Publishing Co., Malabar, FL, 1991
11. Ithaco, "www.ithaco.com/TorqRods", Ithaca, New York, April 2000.
12. Junkins, J. L., Carrington, C. K., "Time-Optimal Magnetic Attitude Maneuvers," Journal of Guidance and Control, July 1981.
13. Haskell, J. D., "Control of spacecraft with magnetic torque coils," M.S. thesis, Utah State University, 1997.

## **HIGH SPEED, MINITATURE MOMENTUM/REACTION WHEELS**

**Prof. Vladimir N KESTLEMAN  
Louis J BROTHERS**

*Valley Forge Composite Technologies Inc., Carlisle, PA United States*

Advancements in several critical areas have made possible lightweight, strong, and highly reliable momentum / reaction wheels. The development of reliable bearings with design features that allow high-speed operation for space flight applications has significantly altered the weight / speed / momentum wheel design considerations. Current designs typically operate at speeds at or below 6000RPM. The new retainerless can achieve speeds 10 times that and meet or improve all other significant bearing operating parameters. These bearings offer a design life of up to 20 years and are free from retainer caused anomalies. The development and testing of these bearings coupled with the development of composite rotors allows for miniaturization of MRW assemblies with unprecedented reliability, performance, and cost.

We will discuss several breakthrough technologies, which should prove critical to the future miniaturization and exploration of space.

First, we will discuss bearing failure modes and how current bearing designs place limits on reliability and size. We will then discuss retainerless full complement bearings and how they offer particular advantages to the satellite community.

To take advantage of the higher speeds and capabilities of these retainerless bearings we will discuss composite rotors. Finally, we will put the composite rotor together with a high-speed retainerless bearing and show how these technologies will impact miniaturization, reliability, weight and size of future satellites.

### **RETAINERLESS BEARINGS -- TECHNOLOGY AND ADVANTAGES OF FULL BALL & FULL ROLLER COMPLEMENTS FOR SPACE**

During a span covering 20+ years, more than 150 wheels have accumulated more than 15 years each in space with no anomaly.

In order to accomplish this an extensive bearing screening program was required. This screening was long, tedious, and very expensive. It is impractical for today's market. Roughly, 50% of all bearings flunked this screening test and were discarded.

The discarded bearings were *identical* to the acceptable bearings *in every measurable way*. They just did not run well.

Over time a quantitative, predictable, repeatable, and successful theory of instrument bearing failure was developed. When this theory is applied to retainerless bearings, a definite life with guaranteed stability results.

Retainerless bearings based on this theory have run for years (with periodic tear down inspection) without any failure or internal damage. In addition, these bearings require no screening. They are all good.

These retainerless full complement bearings, we believe, offer unique advantages to the Small, Micro, and Nano satellite community.

### **Major Failure Modes of Instrument Bearings**

Instrument bearings do not fail by fatigue. The contact stress is too low. Instrument bearing failure is caused by:

- Retainer Instability
- Lubricant Breakdown

Retainer instability accounts for failure or serious "anomalies" in approximately 40% of all bearings manufactured. This major failure mode is absent in retainerless bearings.

In about 10% of manufactured instrument bearings the failure mode results from lubricant breakdown. What is the mechanism of this failure mode?

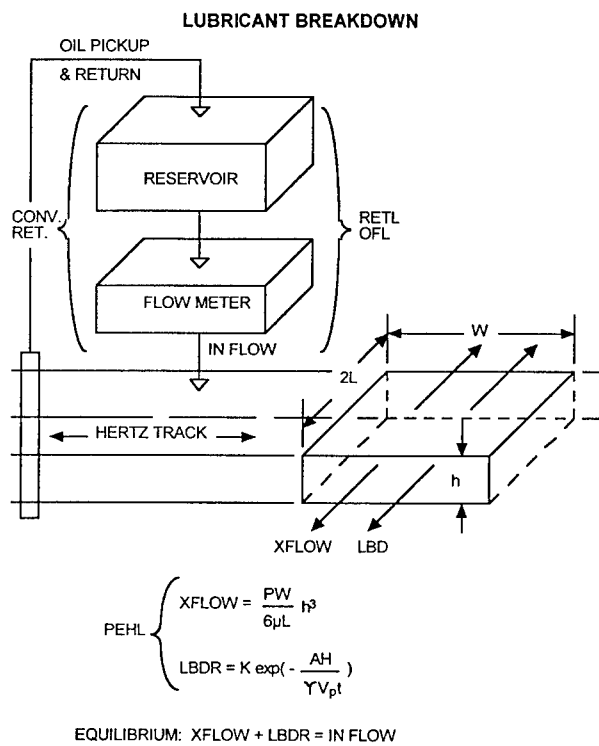
Suppose that two identical instrument bearings are manufactured at exactly the same time with identical conditions. By every measurable, analytical technique, they are identical. The first bearing passes extended run test. However, the second bearing fails in a few hours when its lubricant turns to sludge. What happened? It failed because its Parched ElastoHydrodynamic Lubricating film (PEHL) has become too thin.

Polymerization reactions in the lubricant are activated by mechanical shear energy. This reaction rate is exponential with decreasing film thickness. Lubricant film thickness cannot be set or controlled in a conventional retained bearing. However, film thickness can be analyzed and controlled in a retainerless bearing using PEHL considerations.

- Calculate the lubricant crossflow rate, load, speed, and film thickness.
- Determine a lubricant thickness sufficient for negligible friction polymer formation.
- Supply fresh oil from a reservoir to the bearing track at the same rate that oil flows out.

The bearing lubrication cartridge designed to perform this works with duplexed full ball complement angular contact ball bearings.

This bearing is oiled by one shot, oozing flow-lubricator.



**Fig 1: Lubricant Breakdown**

Advantages of Full Ball Complement/Oozing flow lubricator cartridge bearings.

- Operates in a vacuum
- Offers a definite design life
- Lube demand is calculable
- Friction polymer formation eliminated
- Churning losses eliminated
- No oil jags
- Lubricant supply rate can be tested prior to bearing assembly
- Can be smaller than conventional bearings



- High-speed capacity
- High external load capacity
- No degradation during shelf storage

Hollow roller bearings use solid lubrication, which eliminates the weight, cost, and testing of lubricant systems. Hollow roller bearings with solid lubricant films provide the maximum longevity, reliability, and performance for space applications.

### **Hollow Roller Bearings**

Hollow Roller bearings provide advantages for space instruments in reliability, jitter free operation, and miniaturization.

Hollow roller bearings use hollow cylindrical rollers in place of solid balls or rollers. These hollow rollers are always preloaded.

Preloading the hollow rollers results in several advantages when compared to typical ball or roller bearings. Some of these advantages are:

- High-speed operation at great reliability and life
- High degree of radial stiffness
- Extremely low radial runout
- Significant vibration dampening

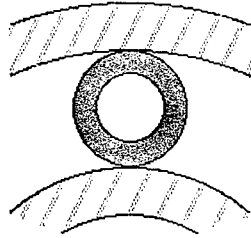
These qualities are enhanced in hollow roller bearings because the preloaded rollers are positively driven at all times by the rotating inner ring and cannot skid or twist.

Hollow roller bearings have existed for 20 years in various spindle applications where speed and a high degree of accuracy are required.

Bending stress in the hollow rollers is the primary factor in determining bearing life. Tensile stress is compared to stress limit data accumulated over decades of research and testing. With this data, optimum bearing life for any speed and load can be calculated very accurately.

The life of regular bearings is often limited by contact spalling. Not hollow roller bearings. Contact stresses are low and brinelling is unlikely to occur because the flexible hollow rollers absorb shock loads such as occurs during launch.

### PRELOADED HOLLOW ROLLER



**Hysteresis in Bending Causes  
Hollow Rollers to Damp  
Radial Vibrations**

Fig 2: Hysteresis Causes Dampening of Radial Vibrations

Radial runout is a critically important measure of bearing accuracy. The variation in radial distance from the bearing bore surface to the bearing outside diameter, as the bearing rotates, is a measure of radial runout.

Accuracy measurement is used to select bearings for quality. Precision bearings are classed according to their radial runout as shown in the following chart. Bearing accuracy varies from a radial runout of .0008" (class ABEC-1) to .0001" (class ABEC-9).

Hollow roller bearings have a radial runout of only .00005". This is *half* the runout of a class ABEC-9 bearing.

Three factors explain the high degree of accuracy obtained with hollow roller bearings.

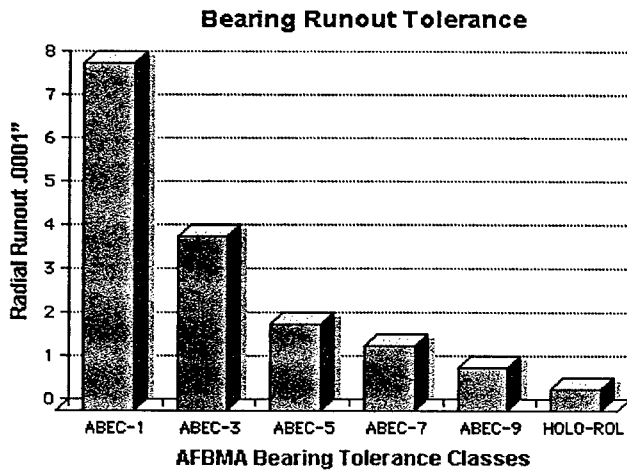


Fig 3: Bearing Runout Tolerance

1. Preloaded hollow rollers eliminate all internal radial clearance in the bearing.
2. Hollow rollers absorb minute variations in the ring surfaces and maintain a constant rotating center.
3. Hollow rollers are compressed to the same radial height and rotate as if they were all exactly the same diameter.

All rollers are selected to a diameter tolerance of .00005" or better. Total bearing runout is composed of two parts: repeatable runout and non-repeatable runout. Repeatable runout is the difference between the high and low readings for one revolution of the bearing. This is often the result of concentricity error of the inner ring.

Non-repeatable runout is the difference between the high and low readings as measured for one revolution of the complement of rollers or balls. Several shaft revolutions may be required to obtain the maximum difference. Hollow roller bearings have extremely small non-repeatable runout -- usually less than .00002". The accuracy of hollow roller bearings is maintained throughout their life -- perfect for space instruments.

Deflection Resistance is a measure of a bearing's radial stiffness. Increasing radial stiffness produces greater accuracy.

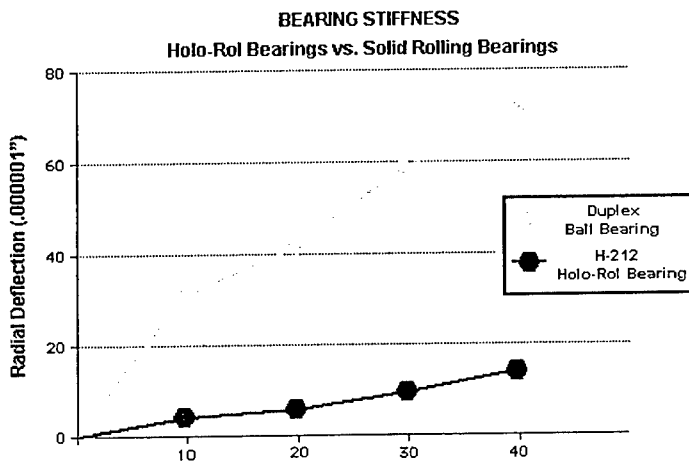
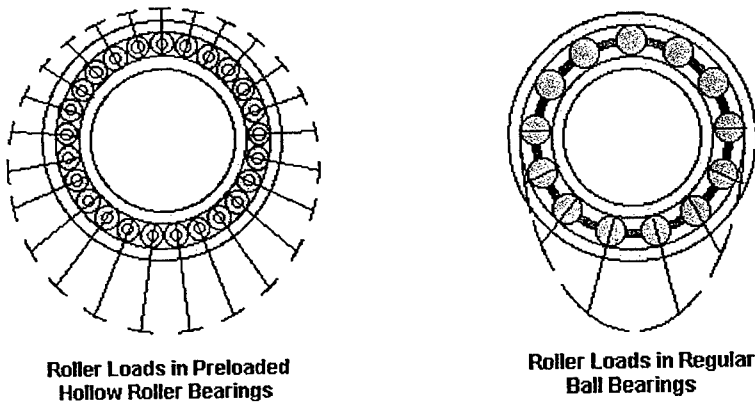


Fig. 4: Bearing Stiffness

Hollow roller bearings have several times greater radial stiffness than regular bearings. This is achieved by radially preloading the hollow rollers.

Two effects produce this high degree of stiffness. First, all rollers are in tight contact with the bearing rings and all work together to carry the load. Secondly, roller contact deflection against the rings is taken up before a load is applied to the bearing.

Figure 4 shows the difference in load carrying patterns between hollow roller bearings and regular ball bearings.



**Fig 5: Comparison of Load Carrying Patterns**

Regular ball bearings must have some internal clearance for lubrication, with the result that less than half the rollers carry the radial load.

Angular contact ball bearings can be preloaded, but the ball contact area is small and allows for further radial deflection. In fact, the rapid ball deflection causes vibrations.

The final technology we will discuss is composite rotors for reaction or momentum wheels.

Composites are 10x stronger than metal rotors. The expansion due to thermal variance is zero. Composite rotors do not fatigue.

In addition to these advantages, composite rotors in quantity are far less expensive to manufacture when compared to metal rotors.

In looking for composite components for space applications these are the criteria which we feel to be most important.

First, the fiber and resin system must have a space heritage. Previous knowledge and experience is critical in selecting the proper composite system.

When the proper composite wheel is designed and fabricated it has the ability to safely operate at speeds of 75,000 rpm or greater. When this high-speed composite rotor is combined with a high speed bearing significant reductions in mass and size occur.

Composite rotors offer the best solution of placing the weight required at the exact location for optimum performance while eliminating unwanted weight in the hub and spoke areas. Composite rotors offer advantages for both large and small satellites.

Now let us examine the benefits resulting from the use of instruments designed with these concepts.

	Low Speed Bearing Metal Rotor	High Speed Retainerless Bearing High Strength Composite Rotor
Housing	Partial Pressure with seal	Not required
Lubricant	Oil	Solid lubricant system
Rotor speed at failure	9,000 rpm	100,000 rpm
Vibration Dampening	No	Yes
Spin During Launch	Required	Not Required
Retainer Jittering	Present	Absent
Radiation Resistance	Low to Moderate	Highly resistant
Bearing Life	5 - 7 years	>20 years

It is clear that the technology now exist for a new generation of momentum / reaction wheels, which will help to reduce size, weight and power consumption. By utilizing this technology further improvement to small, nano, and microsats will occur.

One example of this is a new Pico Sat wheel, which will be less than 1/2 inch in diameter. It will operate with solid lubricated hollow roller bearings in a pure vacuum. It will not need to be spinning during launch. The designed-in reliability provides for reduced cost and jitter, or "anomaly" free operation, which is crucial to these, the tiniest of satellites. The first of these Pico MRWs is scheduled to be launched this fall.

We would like to conclude by pointing out that higher capability wheels, designed with proven, innovative technologies, can provide the increased reliability, light weight, and reduced cost that are the essence of small, Micro, Nano and even Pico satellites.

## THE PRIMA ELECTRICAL POWER SYSTEM

Luciano CROCI, Gwenael BELTRAME

*Officine Galileo B.U. Spazio\*, Milano Plant  
Via Montefeltro 8, 20156 Milan Italy*

*ABSTRACT – PRIMA (Piattaforma Riconfigurabile Italiana Multi-Applicativa) is a multi-application standard platform. The design of the relevant elements, like the Electrical Power System (EPS), is driven by the need to optimise the performances and cost to a variable mission scenario and operative requirements. The paper describes how this goal is achieved for the EPS, by a modular design of its components and the use of the MPPT (Maximum Power Point Tracker) solar array power control strategy.*

### 1 - INTRODUCTION

The Italian national space plan foresees the launch of 2 small/medium satellites every 3 years for different scientific missions. Furthermore a constellation of medium satellites is foreseen in LEO orbits to satisfy the earth observation needs.

To meet some of the above objectives, the Italian Space Agency set up a contract of phase A/B for the development of a modular platform called PRIMA, with Alenia Aerospazio as Prime Contractor and Officine Galileo in charge of the development of the EPS.

The main objective of the entire project is to develop a multi-mission platform for LEO orbits, allowing rapid, efficient and “low cost” adaptable bus to a multi-mission scenario. The design of the EPS is driven by the need to optimise the performances towards low recurring cost flight hardware.

The main requirements of PRIMA Platform, which its design is addressed to, are:

- Platform mass including payload up to 1000Kg
- Platform power demand including payload up to 800W<sup>†</sup>
- Envelope orbits
  - ✓ Orbit type: any LEO including SSOs
  - ✓ LTN: any
  - ✓ Altitude: from 500 to 1500Km
  - ✓ Inclination: from 0 to 100°
- 5 years in-orbit lifetime

\* An Alenia Difesa/Finmeccanica S.p.A. company

<sup>†</sup> P/L peak power up to 10KW for few minutes are also required.

## 2 - SYSTEM ARCHITECTURE

The PRIMA EPS block diagram is shown in fig. 1. It is composed of the following components:

- The Solar generator with 2 different configurations depending on the specific P/L power demand:
  - ✓ 2 Multi-Panel Wings (MPW) configuration with 4 panels each for high power applications
  - ✓ 4 Single-Panel Wings (SPW) configuration for low power applications
- A single battery composed by 23 cells with variable capacity depending on each specific application
- The PCU (Power Control Unit), including the power conditioning and distribution electronics and the electronics for auxiliary functions (thermal control heater supply, pyro devices commanding).

The EPS is characterised by a common architecture for the various missions, with different operational orbits and power profiles required by the platform and P/L subsystems.

It generates an unregulated battery bus (voltage range 21V ÷ 35V), which is distributed to the loads. According to what above the PCU electronics is configured in such a way to get an effective modularity. Each function is assembled into a self-standing module which is designed taking into account the need for interfacing with other modules/functions (i.e. standard module dimensions are used).

By this way, different system requirements can be satisfied simply changing the number of modules.

The modules are assembled into a mechanical box which layout has been designed to be adapted to the specific modules number by changing one dimension only, thus reducing to the maximum extent the development effort to get an effective cost optimisation.

The Solar Generator and the Battery, which are the largest and the heaviest element of the platform, are sized taking into account the possible applications.

The tailoring to the specific programme requirements is done by changing in a modular way the number of the Solar Generator panels (e.g. standard panels dimensions are used) or acting on the battery cells capacity (e.g. possibility to select the optimum number of cells/capacity configuration) maintaining the same mechanical arrangements.

The SA and the PCU main functions are described in detail in the following paragraphs, while the selected battery is made with consolidated technology cells and it is considered an *"off the shelf"* component.

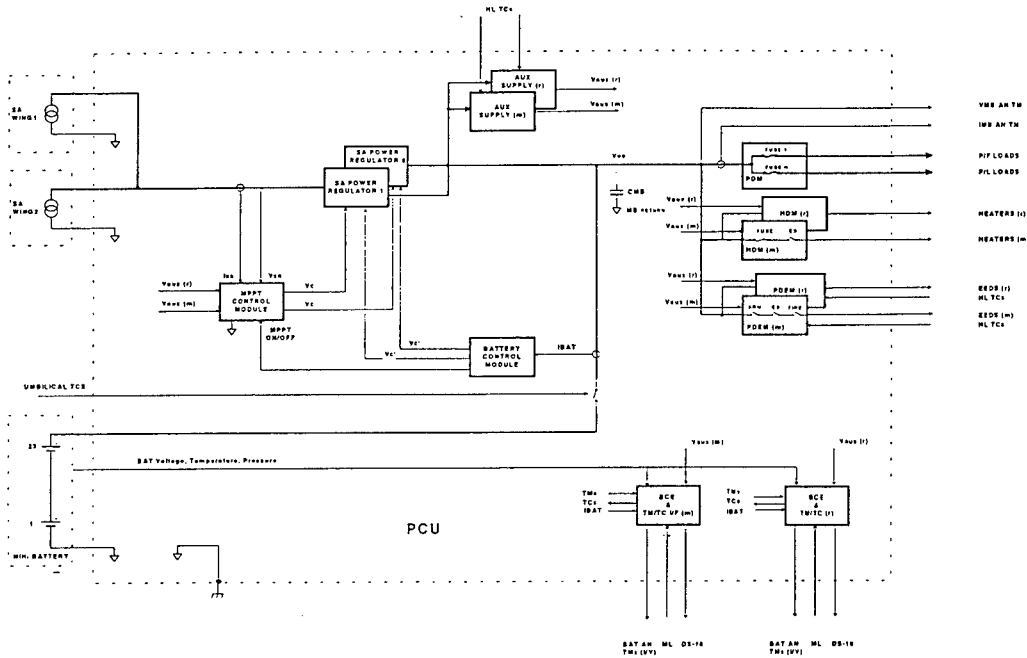


Fig.1: PRIMA EPS Block Diagram

### 3 - SOLAR ARRAY

The scope of the PRIMA program is to have a reusable substrate for a very large range of missions and for different solar array configurations; the configurations envisaged and analysed are the following:

- MPW, Multi-Panel Wing, each wing is envisaged to be composed by a number of panel that vary from 2 to 4, while the number of wings is 2 (symmetric);
- SPW, Single-Panel Wing, each wing is composed by one single panel; the number of wing shall be 4.

Each wing is rotated by a mechanism (SADM) in order to point the array active surface sun-facing in nominal condition. A yoke shall support and locate each wing and shall interface it with the SADM. The SADM is relevant only to the MPW configuration.

Each PRIMA 1300x1200 mm<sup>2</sup> panel will be realised with GaAs/Ge solar cells produced by ENEL (Italy), one blocking diode per string, shunt diode if cells are shadowed in particular missions, a bleeding resistors network: the minimum EOL power is 1000W for SPW\_4, 1000W for MPW\_2, 1500W for MPW\_3 and 2000W for MPW\_4 configurations, guaranteeing the  $V_{Pmax}(EOL) \geq 40V$  and the maximum  $V_{oc}(BOL) \leq 70V$ .

The maximum short circuit current at the maximum expected temperature is 6A and the maximum residual magnetic moment of a single wing must be less than 2Am<sup>2</sup>.

The envisaged panel is fully populated without any hold-down, but a 14 mm stay-out zone border, in order to optimise the power output; the dimensions of dedicated solar cell are about 4 x 4 mm<sup>2</sup>.



The GaAs/Ge selected power generating elements present the following performances:

- Efficiency : 19.5%;
- Dimensions: about 4 x 4 mm<sup>2</sup> ;
- Thickness: 200µm.

At first, a degradation factors table has been created for three different missions (500km, 800km, 1500km) and then the worst situation, determined mainly by the operative temperature and the radiation doses, has been studied in depth. Up to now the mission worst case is the 1500km, as a loss factor compromise between operative temperature and radiation doses, (Table 1).  
If a detailed shadow figure will be defined, an adequate shadow protection philosophy will be implemented using external shunt diodes, for the shadowed cells or using cells with integral shunt diode.

CONDITION	SS-EOL 1500km		EQX-BOL 500km	
	Current	Voltage	Current	Voltage
Parameters				
Relative Sun Intensity	0.968		1	
Sun incidence angle	23.5 + 7÷9		7÷9	
1 MeV equivalent fluence [e/cm <sup>2</sup> ] (*)	1.7 E14	5.97E14	0	0
UV & Micrometeorites	0.98		1	
Misalignment	1		1	
SADM pointing error	1		1	
Pointing error due to inter-panel angle	1		1	
Calibration Error	0.98		1.02	
Cell Mismatch	0.99		1	
Max Temperature	87	87	94	94
Random Losses	0.9464		1	
Wiring & Diode Loss	SPW MPW	1 Volt 2 Volt		1 Volt 2 Volt

(\*) The value above reported is related to the 1500km/EOL maximum radiation doses at an inclination between 30°-40°.

Table 1

The above two worst missions cases indicated in Table 1 are relevant to:

- the *SS-EOL* is the design factors table to calculate the maximum power: it is relevant to the 1500km orbit, which summarised the worst operative mission condition, as compromise effects of operative temperature and radiation doses.
- the *EQX-BOL* is the design factors table to determine the number of sections: it refers to the 500km orbit especially for the higher operative temperature, that causes the worst value in current.

### 3.1 - Electrical Network

The electrical part of PRIMA solar panel consists of the covered interconnected solar cells, thermistors, one blocking diode in parallel per string, termination bars, two grounding points per panel each one connected to one bleeder resistor, connectors, all the electrical interconnections and wiring.

PANEL Fully & Border	Ns (n° of cells in series)	Np (n° of strings)	Ntot_cells (per panel)
≈ 4 x 4 [mm <sup>2</sup> ]	62	14	868

Table 2

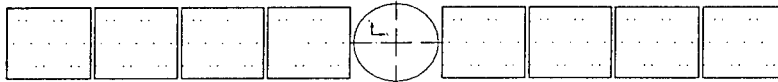


Fig. 1

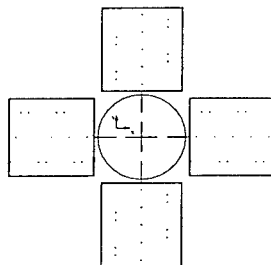


Fig. 2

In order to satisfy the maximum short circuit current requirement of 6A, two separate sections of 7 strings each has been envisaged.

### 3.2 - Solar Array Power Performance Prediction

The solar array sizing has been carried out starting from the requirements of EOL voltage at maximum power point,  $V_{Pmax}(EOL) \geq 40V$ , the maximum open circuit voltage,  $\max Voc, \leq 70V$ , the degradation factors table and considering the dimensions of the panel and its useful area.

The solution of the electrical design has been computed for two PRIMA GaAs/Ge configurations, and considering a dedicated total loss voltage due to wiring and diodes both for the SPW PRIMA configuration and for the MPW PRIMA configuration: 14 strings of 62 solar cells in series has been defined.

#### 4 - PCU

The main functions of the PCU are the following:

- A Modular Power Regulator to transfer the SA power to the main bus for load supply and battery charge
- A MPPT control module to manage the battery/discharge power tracking the SA MPP when the load power demand exceeds the SA available one
- A Power Distribution Module (PDM) to provide the main bus to the satellite loads via dedicated protected lines
- A Battery Control Electronics (BCE) Module to monitor the battery parameters and to manage the automatic functions/protections and to interface the On Board Data Handling (OBDH) with serial telemetry/telecommand channels
- A Heaters Drive Module, to switch and supply power to the satellite thermal control heaters
- A Pyro Drive Electronics Module (PDEM) to supply and command the electroexplosive devices.

The mechanical housing of the PCU is designed according to the modular PCU concept. It provides means for modules mechanical allocation taking into account the need to provide a good mean for heat exchange with the PCU thermal interface for the power dissipating components.

##### 4.1 - Modular Power Regulator

The modular power regulator is made of up to 8 dc/dc converter modules each one providing 330W (the number of modules is adjusted according to the specific power demand).

A "n/(n+1)" redundancy concept has been selected, so that the PCU can deliver up to 2000W on the main bus, also in case of a single failure.

The converter is based on a well-known step-down BUCK topology (40÷75V input SA voltage, 28 V output nominal voltage), operating at 100KHz switching frequency with efficiency higher than 94%.

Two converters are located on each module and are driven with 180° phase shift to reduce the current ripple on the input and output lines.

Each converter is self-protected against overload by use of fuses in redundant configuration and it is on/off switchable by telecommands.

A solid state power controller is put upstream the converter to protect the solar array against short failure or overload and to avoid the short circuit between solar array and the battery due to a failure of the BUCK transistor.

##### 4.2 - MPPT Control Module

The MPPT control board is made of the circuitry to monitor the SA parameters and to track its maximum power point on the SA characteristic. It includes all the redundancies as necessary to guarantee the failure recovery and the required reliability according to the selected majority voting logic concept.

The MPPT control is based on the so-called “Perturb & Observe” algorithm.

It consists in starting to increase by discrete steps the reference to the MPPT voltage regulator and measuring, after a fixed time, the related SA operating point.

At the next step, the decisions whether to increase again or decrease the reference will be taken in order to always pursue an increase of the SA power.

The MPPT will maintain, with a very good tracking accuracy, the SA voltage around the value equivalent to the SA MPP. Figure 2 shows the MPPT control algorithm.

The main characteristics of this MPPT concept are:

- Applicability to each power system architecture
- Capability to work with any type of switching regulator topology
- Flexibility to interface and control different SA technologies without dedicated tuning
- Power tracking accuracy better than 1% at a tracking frequency of 1KHz.

A specific feature implemented in the MPPT control algorithm is the positioning of the working point of the SA in the constant voltage area when the MPPT controller is put in OFF state.

The simple and very efficient structure of the tracking algorithm allows the implementation of the algorithm with reliable digital circuitry made by means of Field Programmable Gate Arrays (FPGA).

In addition to the above, the MPPT module controls the battery charge, which is performed in two steps. In the first one all the available charge current is fed into the battery until the End of Charge (EOC) is detected. After that, the charge current is reduced to the trickle charge level.

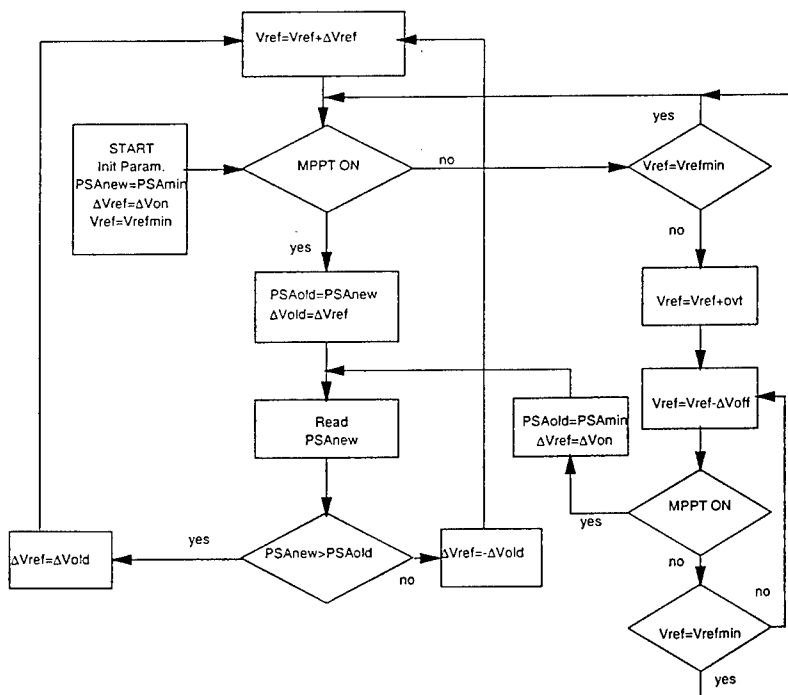


Fig.2: MPPT Algorithm

#### **4.3 - BCE and TM/TC Interface Module.**

This section includes the circuitry for the monitoring of the battery parameters (voltage, temperature and pressure), for automatic protections and for telemetry / telecommand interface with the OBDH. It performs also an automatic control of battery charge via an Ah-meter method, with a K-factor that can be set by ground commands.

The BCE is composed of two identical modules (main and redundant) operating in hot redundancy. Each one of the modules is associated with its own TM/TC interface. All the automatic functions of the battery management electronics are overridable by external telecommands.

The BCE processing core is based on a 8086  $\mu$ Processor and 80XX family peripherals with embedded software.

#### **4.4 - Power Distribution Module (PDM)**

The protection of the main bus lines is realised by means of fuses in redundant configuration as a baseline circuit, but in case of specific requirements a solution based on Latching Current Limiter (LCL) circuits is available.

#### **4.5 - Heater Drive Module (HDM)**

This module includes the electronics related to the satellite thermal control heaters switching. The PCU will include two modules, operating in cold redundancy. Each module is capable to provide 32 power outlets rated to:

- 20W (30 lines)
- 40W (2 lines)

The 32 heater lines are divided in groups of 8 and each group will be switched ON/OFF by means of a dedicated switch.

#### **4.6 - Pyro Drive Electronics Module (PDEM)**

This module includes the circuitry necessary to supply and command the electroexplosive devices (EED).

The PCU includes two PDEM modules, one for the main and the other for the redundant devices supply. The two modules are operating in cold redundancy.

Each module is capable to provide 16 power outlets, each rated to 5A with a pulse duration of 40msec.

Three inhibit levels are foreseen on the EED supply lines:

- ARM/DISARM switch
- Activation (fire) switch
- Current limited electronic switch for supply of all the fire switches

## 5 - CONCLUSIONS

The PRIMA EPS components design is currently running.

The PCU DC/DC converter and the MPPT control, which are in charge of the most important operational functions of the equipment, are under testing. The preliminary results of this activity show a good agreement with the relevant design requirements.

The design phase will be completed with the manufacturing of an elegant breadboard of the PCU and a coupon of the S.A.

The PCU elegant breadboard will be fully tested for the design verification.

### Acknowledgement

The authors wish to thank the Italian Space Agency and in particular Mr. Claudio Portelli for his support and invaluable contribution all along the development of the activities.

Particular thanks to Alenia Spazio and their PRIMA team for the effective cooperation provided during the specification definition phase and the development activities.

## **SESSION 6 :**

### **Missions en cours de développement** *Missions under development*

*Présidents / Chairpersons: Bob HUM, Philippe WALDTEUFEL*

- (S6.1) **CESAR mission.**  
Caruso D., Yelos J., Comision Nacional de Actividades Espaciales, Buenos Aires, Argentine, Acedo L., Urech A, Instituto Nacional de Tecnica Aeroespacial, Madrid, Espagne.
- (S6.2) **ESA's new Earth Observation Programme : Starting with Small Satellite Missions**  
Tobias A., Fuchs J., Aguirre M., Silvestrin P., ESA / ESTEC, Noordwijk, Pays Bas
- (S6.3) **PROBA (Project for On-Board Autonomy)**  
Bernaerts D., Teston F., Bermyn J., Verhaert Design and Development nv, Kruikebeke, Belgique
- (S6.4) **The Scientific Multi-Experiment Mission DAVID of the Italian Space Agency**  
Ruggieri M., Bonifazi C., Paraboni A., Capobianco F., Capsoni C., de Fina S., Pratesi M.  
Universita' di Roma "Tor Vergata", Rome, Italie
- (S6.5) **SMART-1 Technology Experiments in Preparation to Future ESA Planetary Missions**  
Marini A., Racca G., Foing B., ESA/ESTEC, Noordwijk, Pays Bas
- (S6.6) **Small Satellites as Complex Systems: Management Tools and Techniques in the FedSat Project**  
Moody J. Australia-Asia School of Management, Australian National University, Canberra, Australie
- (S6.7) **PICARD microsatellite program**  
Damé L., Meissonnier M. CNRS, Verrières-le-Buisson, France, Taty B., CNES, Toulouse, France
- (S6.9) **Les missions microsatellites DEMETER, PARASOL et MICROSCOPE. / DEMETER, PARASOL and MICROSCOPE Microsatellites Missions**  
Taty B. CNES, Toulouse, Parrot M. CNRS/LPCE, Orléans, Tanre D., CNRS/LOA, Touboul P., ONERA, France
- (S6.10) **Les missions PROTEUS / CNES Minisatellite missions**  
Rougeron M. CNES, Toulouse, France

## **CESAR MISSION**

### **COOPERACION ESPAÑOLA-ARGENTINA**

**Daniel CARUSO, Juan YELOS**

*Comisión Nacional de Actividades Espaciales  
Av. Paseo Colón 751 – 1063 – Buenos Aires, Argentina*

**Lucía ACEDO, Alvaro URECH**

*Instituto Nacional de Técnica Aeroespacial  
Carretera de Ajalvir, Km.4-28850 Torrejón de Ardoz – Madrid, España*

**ABSTRACT** – *This paper describes the CESAR Mission, an Earth Observation Satellite Mission developed in cooperation between INTA (Instituto Nacional de Técnica Aeroespacial) from Spain and CONAE (Comisión Nacional de Actividades Espaciales) from Argentina. The Mission, with a proposed launch date of the corresponding CESAR satellite circa 2003 / 2004, consists in the design, construction, launch and operation of a small satellite, around 500 kg, and the update of the existing Ground Segment capabilities in Spain and Argentina to receive and process the CESAR generated data. The primary objectives will be: Cartography, Thematic Studies and Geophysics. A 5-year lifetime is planned for the satellite, orbiting at 613 Km height in a sun synchronous orbit, with a proposed 23:30 hrs local ascending node allowing Nadir revisit times of 6 / 7 days in multispectral and 47 days in panchromatic, both for 60 km x 60 km scenes. Furthermore, the spacecraft will allow across and along track movement of the cameras pointing axes, to provide high quality stereopairs and to improve the revisit times.*

#### **1 - OBJECTIVE**

Remote sensing by satellite has proved to be one of the most effective ways to survey the surface of the Earth. Argentina and Spain, due to the maturity of the Remote Sensing communities in both countries, have decided to join their efforts and expertise in an international cooperative project called CESAR, that would be a follow on of their national satellite programs, SAC and Minisat respectively.

#### **2 - INTRODUCTION**

The CESAR system is a multipurpose remote sensing system with the objective of fulfilling the demands of the user communities of both countries related to cartography, topography, land registry (basically rural land registry), crop evaluation, harvest predictions, knowledge of water quality, detection of underground water, evaluation of forest mass, oceanic and mineral resources, evaluation of ground and water contamination, as well as the evaluation of damage caused by fires and other natural disasters. The system will also provide data for geophysics applications, specially in the field of atmospheric composition and behavior, ozone destruction processes, etc.



To achieve the specified mission objectives, the satellite will carry the following instrumentation:

- Panchromatic camera (IRIS): 5 meters geometric and 10 bits radiometric resolutions, in the visible range in the spectrum; it will be used for cartography and topography studies. This camera will be provided by INTA.
- Multispectral camera (MUS): with six bands in the visible and near infrared range of the spectrum, with 10 bits radiometric resolution (VNIR bands with 35 meters geometric resolution and SWIR with 70 meters); it will be used for natural resources applications. This camera will be furnished by CONAE.
- Spectrometer (MEGA): It will provide vertical spectra of the atmosphere using the technique of direct sun occultation in two selectable ranges (330-460 nm and 470-600 nm). This will deliver numerical data of atmospheric constants concentration [O<sub>3</sub>], [NO<sub>2</sub>], [OCIO], etc. It will be provided by INTA.
- High sensibility panchromatic camera (PAS): in the visible range of the spectrum, and very high sensibility; it will be used to take images, 8 bits radiometric resolution, at night time of forest fires and clouds. This camera will be furnished by CONAE.
- Data Acquisition System (SAD) composed of a UHF Receiver System to collect and centralize environmental data generated by on-ground distributed Data Collection Platforms. These data will support the multispectral camera applications. It will be provided by CONAE.

To fulfill the mission requirements in terms of illumination and revisit times, a sun-synchronous orbit with an average height of 613 Km and a time of pass through the ascending node at 23:30 was selected.

The mission lifetime of the system will be 5 years and its launch date circa 2003/2004.

The CESAR program has successfully completed its Phase A, Viability, and it is currently averaging Phase B, Preliminary Design.

### 3 - THE CESAR SYSTEM

In the configuration approved at the end of Phase A, the CESAR system is composed of the following segments:

- Space segment: The satellite, which is composed of the payload and the bus or service module.
- Ground segment: It comprises the tracking stations as well as the mission and control centers.

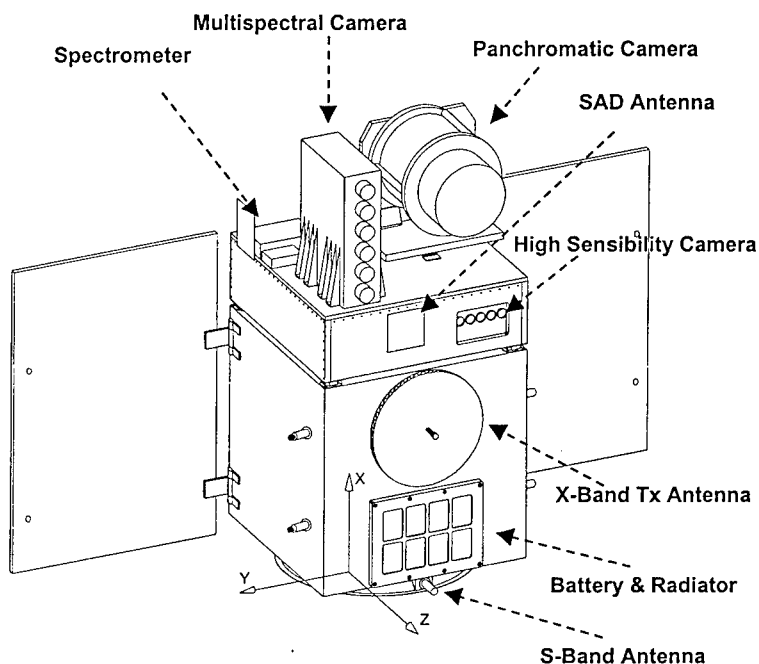
The Launcher market was analyzed, and several launchers were pre-selected as viable. Among them we can find European (Cosmos, Rockot), American (Athena, Taurus, Delta) and Asian (CZ-2D) launchers. The satellite envelope is in the range of 1.7 m diameter (CZ-2D) up to 2.1 m diameter (Rockot). The satellite envelope for the preliminary design phase has been selected as 1.7 m to be able to fit in all the pre-selected launchers and, in case of using a wider fairing launcher with higher launching mass capacity (like the Rockot), to be able to share the launch with other spacecraft in the microsatellite range; for instance one microsatellite Ariane 5 type (60x60x80 cm, less than 100 Kg) and two microsatellites of the Space Shuttle Gas Can type (34x34x40 cm, less than 68 Kg).

#### 4 - SPACE SEGMENT

The CESAR satellite current configuration is that of a small satellite following a modular approach in its design. It is functionally divided in two modules: the Payload Module, which carries all the instrumentation and the mission specific equipment, and the Service Module or bus, which is in charge of supporting the Payload in terms of power, pointing, etc.

In order to reach a viable configuration, the system was framed in the small satellite segment (mass less than 500 kg), and the configuration proposed at the end of the High Level System Specification (averaging Phase B) is well within that segment, with a launch mass of about 425 kg, including margins, with 178 kg. devoted for the Payload Module, 224 kg for the Service Module and 22 kg. for fuel.

The CESAR satellite flight configuration is shown in the following figure.



*Spacecraft body ~ 1100 x 1100 x 2200 mm*

*Solar Padles - 2 wings ~ 1100 x 1600 mm each*

The Payload is composed of the cameras mentioned above and other mission specific equipment as:

- Payload data processing and storage subsystem (PAD): It will collect the data provided by the instruments and, after some processing, it will store them in an on board solid state memory with 64-96 Gbits capacity, from where they will be dumped to ground through the TMI subsystem.

- Image telemetry subsystem (TMI): It will dump payload data to ground using an X Band link with up to 150 Mbps data rate. It will use QPSK modulation and a conformed beam antenna.
- Payload Structure and Thermal Control subsystems to accommodate the module equipment and maintain the assembly temperatures within the required limits.

The table below shows the characteristics of the cameras.

**Payload Cameras Characteristics**

Camera	IRIS	PAS	MULTISPECTRAL					
			VNIR – SWIR					
Band	1	2	B0	B1	B2	B3	B4	B5
Spectral range $\mu\text{m}$	0.45 - 0.8	0.4 - 0.9	0.43 - 0.45	0.48 - 0.50	0.54 - 0.56	0.62 - 0.66	0.78 - 0.82	1.60 - 1.70
Geometric resolution $\text{m}$	5	1000	34	34	34	34	34	80
Radiometric resolution $\text{bits}$	10	8	10	10	10	10	10	10
Swath width $\text{km}$	60	2100	420	420	420	420	420	420
Revisit time @Nadir $\text{day}$	47	2	6/7	6/7	6/7	6/7	6/7	6/7
Sensibility $\text{mW} / \text{cm}^2 \text{sr} \mu\text{m}$	0.03	$10^{-6}$	0.01	0.01	0.03	0.02	0.02	0.003

The service module that supports this payload includes all the generic and support systems of the satellite. Using a monocoque (box) structure, it will have the following general subsystems:

- On Board Data Handling (OBDH): This on board computer initially based on an ERC-32 processor is in charge of collecting house keeping telemetry and executing telecommand, as well as maintaining the system integrity during non contact periods. The mission control software will be run in this computer.
- Attitude Determination and Orbit Control Subsystem (ADOCS): In charge of the pointing and orbit control of the satellite. To comply with the mission requirements [pointing error  $\leq 0.5^\circ$  ( $3\sigma$ ); low frequency pointing stability  $\leq 0.05^\circ$  ( $3\sigma$ ); and high frequency pointing stability  $\leq 0.2$  arcseconds ( $1\sigma$ )], it will use star sensors, coarse sun sensors, and magnetometers for attitude determination, and four reaction wheels and three torque rods as actuators. It will also control the propulsion subsystem.
- Power: It will provide the energy necessary for the operation of the satellite by means of two solar panels ( $3.5 \text{ m}^2$  providing  $\sim 500 \text{ W}$ ), and a NiH battery (with at least 20 Ah capacity). It will also control power generation and distribution through two specific boxes.
- Telemetry, Tracking and Command Subsystem (TTC): It will use an S Band link to receive telecommands and transmit the housekeeping telemetry. The actual configuration is under study, but currently it will use an S Band transponder with ranging capabilities and two hemispheric antennas to provide omnidirectional coverage.
- Propulsion: It will provide orbit injection correction capability, as well as orbit correction during the lifetime of the satellite. It will be a monopropellant system (Hydrazine). It will be controlled by the ADOCS that will be able to use the thrusters as emergency attitude control actuators.

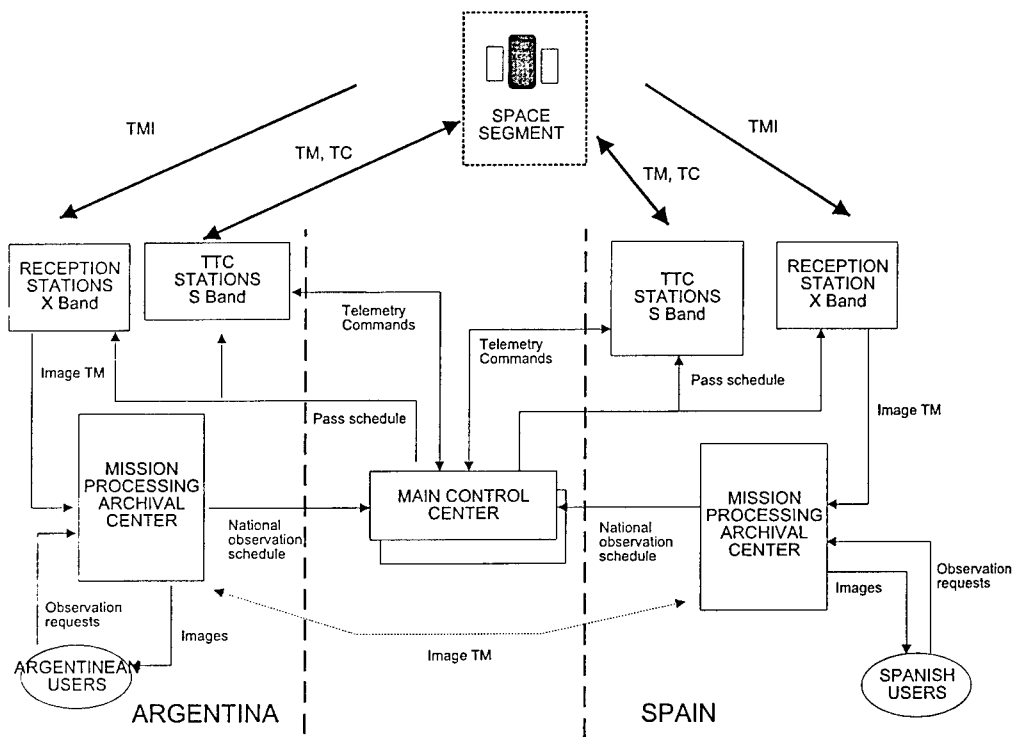
## 5 - GROUND SEGMENT

The Ground segment is in charge of the CESAR system operation. Among its functions are collecting user requests, generation of the mission operation schedule, orbit determination, telecommand uploading, real-time and stored spacecraft housekeeping telemetry reception, payload telemetry reception, and processing, storage and distribution of the received data.

Argentina and Spain intend to use the existing capabilities in both countries, with the corresponding update, to perform the functions assigned to the Ground Segment. This includes specially, the ground stations at Maspalomas (Spain) and Falda del Carmen (Argentina).

The following figure shows the configuration of the Ground Segment.

**CESAR Ground Segment**



The basic building blocks of the ground segment are:

- Control center: The control center is in charge of preparing the mission schedule. It will also prepare the telecommands as well as analyze the housekeeping telemetry to monitor the state of health of the satellite. Due to the dual nature of the CESAR system (Spain and Argentina), there will be two identical (as far as possible) control centers, but only one of them will operate alternatively (for periods of several months) as the main control center; the other will be operating as backup or as alternative.

- Mission center: There will be two mission centers, one in Argentina and one in Spain. These centers will collect the observational requests from the user communities of each country, generating a national observation schedule that will be sent to the main control center. The CESAR mission centers will have the capabilities to process the images up to five different levels including raw data in scenes, radiometric correction, standard systematic correction, precision systematic correction, and correction with ground control points.
- Receiving Stations. These stations will receive via an X Band link the payload data at a rate of up to 150 Mbps. The data will be transmitted to the respective mission center. The 15m station at Maspalomas and the 13m and the 7m (backup) stations at Falda del Carmen will be used.
- TTC stations. These stations will use an S Band link to receive housekeeping telemetry and to uplink telecommands. The TTC stations in both countries will be controlled by the main Control Center that could use both of them. The 5m and the 15m stations at Maspalomas and the 13m and the 3.6m stations at Falda del Carmen will be used.

## 6 - CONCLUSION

CESAR is a model example of profitably accomplishing good earth observation and space science at low national cost by means of international cooperation. The complications arising from the international interfaces are more than made up for the ultimate results and reasonable costs. The process affords a positive synergism between the scientists and engineers from the participating countries, which forges pleasantly productive and lasting ties with colleagues from other lands and societies.

---

**ESA's NEW EARTH OBSERVATION PROGRAMME:  
STARTING WITH SMALL SATELLITE MISSIONS**

Alberto TOBIAS, Joachim FUCHS, Miguel AGUIRRE, Pierluigi SILVESTRIN

*European Space Agency - Noordwijk - The Netherlands*

***ABSTRACT** The first missions of the new ESA Earth Observation Programme have been selected and implementation has started. They belong to the Earth Explorer line of research oriented missions. CRYOSAT will be launched in 2003 to measure the variations in the elevation of the ice sheets and sea ice. GOCE will be launched in 2005 to provide the Earth's gravity field and its geoid with high accuracy at high spatial resolution. SMOS will be launched in 2005 to measure soil moisture and ocean salinity. The ADM / Aeolus mission will provide from 2006 onwards direct measurements of wind profiles with high accuracy and vertical resolution up to 20 km. All missions are implemented with satellites of less than 1000 kg, launched with small launchers to low Earth orbit.*

## **INTRODUCTION**

The new ESA Programme for Earth Observation [ESA 98] is implemented in two lines of user driven missions, namely the operational, service oriented Earth Watch missions and the research oriented Earth Explorers. The Earth Explorers are fully implemented within the Earth Observation Envelope Programme (EOEP) which is an element of ESA's Earth Observation Programme. The first slice of the EOEP has been approved and covers the implementation of the first Earth Explorer missions for launch between 2003 and 2007. The EOEP covers also the initial phase of the Earth Watch missions. Full implementation should be the subject of the dedicated Earth Watch programme element, which is being established. This paper is limited to the first Earth Explorer missions. It also discusses the use of formation of satellites but only as a way to replace a large satellite by smaller ones.

### **Earth Watch**

Apart from the well-known operational meteorological missions, no Earth Watch mission has been selected yet. Concepts are considered at European and national level, under both institutional and industrial leaderships. These candidate missions would be implemented with satellites of different size driven by the mission requirements and the engineering and financial constraints. Their mass may range from a few hundreds of kg, e.g. a superspectral system for agriculture applications, to more than two tons, e.g. a system with an L-band SAR. Some Earth Watch mission concepts require the deployment of constellations of satellites, e.g. for support to risk management. Small satellites and small launchers are almost a pre-requisite for affordability and sustainability of these missions. Small satellites will play a role in the Earth Watch line of missions.

## Earth Explorer

There are two classes of Earth Explorer missions, the larger Core Missions and the smaller Opportunity Missions. These missions address the science objectives formulated in an established science plan [ESA 98]. The missions are proposed, reviewed, selected, defined and exploited by the research community. Two "core" and two "opportunity" missions have been already selected for implementation according to well-defined selection mechanism and criteria.

The Gravity field and steady state Ocean Circulation Explorer (GOCE) and the Atmospheric Dynamics Mission (ADM) have been selected for implementation as first Core missions after phase A studies of a set of four candidates. This set, that included also the Earth Radiation Mission (ERM) and the Land-Surface Processes and Interactions Mission (LSPIM), had been pre-selected out of an initial group of nine mission concepts [ESA 96].

Out of the twenty-seven proposals received in the context of opportunity missions, two have been selected for implementation, namely CRYOSAT and the Soil Moisture and Ocean Salinity (SMOS) mission. A third mission, the Atmospheric Climate Experiment (ACE), is in standby as a potential replacement for CRYOSAT or SMOS. ACE would consist of a constellation of six microsattellites with GNSS sounding receivers. Two more missions were selected though not funded: SWARM, a constellation of microsattellites with a magnetometry package, and SWIFT, a mission with a 80 kg payload compatible with a minisatellite.

## CRYOSAT

CRYOSAT will be the first mission of the new programme. It is planned for launch in 2003 for a 3-year mission. CRYOSAT [UCL 99] will measure the variation in the thickness of perennial sea and land ice fields to the limit allowed by natural variability, on spatial scales varying over three orders of magnitude.

Requirement	Arctic Sea Ice $10^5 \text{ km}^2$	Ice Sheets $10^4 \text{ km}^2$	Ice Sheets, $13.8 \times 10^6 \text{ km}^2$
Residual uncertainty	3.5 cm/year	8.3 cm/year	1 cm/year, i.e. (130Gt/year)
Measurement accuracy	1.6 cm/year	3.3 cm/year	0.7 cm/year

CRYOSAT will achieve most of the objectives of the Earth Explorer Topography mission previously proposed as candidate Earth Explorer Core Mission [ESA 96].

The satellite will carry a Ku-band altimeter, derived from ENVISAT's RA-2 or from Jason's Poseidon instrument, and include new operation modes. The concept was outlined in [ESA 96] but had not been sufficiently studied at that time. Several additional concepts were proposed, including concepts based on laser and real aperture 94 GHz altimeters. The laser altimeter concept would suffer from cloud coverage, while the 94 GHz concept would not be feasible within the programmatic, time and / or financial, constraints of the first Earth Explorer Core or Opportunity mission.

The confirmation of the Ku-band instrument concept in technology preparatory studies has therefore been essential to select CRYOSAT as the first Earth Explorer mission.

The CRYOSAT altimeter can work in pulse limited mode as in ENVISAT or Jason. Over sea ice, higher spatial resolution is required, 300 m, and is achieved by synthetic aperture. Over the ice

sheet margins the surface requires a method for determining the echo-location. A second synthetic aperture channel is added and used to form an interferometer across the satellite track.

In the concept outlined in the mission proposal, the altimeter has two 1m diameter antennas separated by 1 m. The antenna arrangement, the solution for stowage and deployment, the requirements on the stability and the knowledge of the orientation of the antenna baseline are satellite configuration drivers.

The CRYOSAT orbit has to cover at least up to  $84^{\circ}$  latitude, i.e. sun-synchronous orbits are not acceptable. This has consequences for the design of the satellite configuration and systems, especially of the power and thermal control systems. The orbit altitude has to meet several criteria derived from the repeat period requirements. Furthermore, lower orbit altitudes are desired for the altimeter but higher altitudes are preferred for orbit determination accuracy. The Mission Requirements Document proposes an altitude around 650 km.

CRYOSAT will be a small satellite, 600 kg, compatible with a Rockot class launcher. At the time of presenting the paper two parallel phase A/B studies are ongoing. Satellite concepts considered at the beginning of phase A are outlined in figure 1.

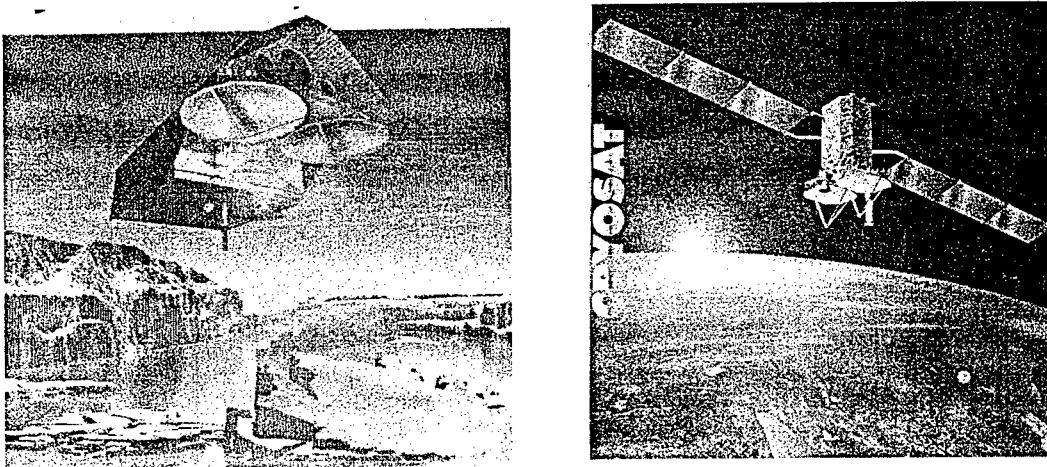


Figure 1. CRYOSAT satellite concepts

## GOCE

The Gravity field and steady-state Ocean Circulation Explorer [ESA, 99a] (GOCE) is the first Earth Explorer Core Mission. It is planned for launch at the end of 2004 or mid 2005. GOCE will provide the Earth's gravity field and its geoid with high accuracy, 1 mgal, 1 cm, at high spatial resolution, 100 km. This is required for research and applications in areas as solid earth, oceanography, geodesy, glaciology and sea level studies.

To achieve the mission objectives the GOCE satellite, figure 2, carries a dual-frequency GNSS receiver and an Electrostatic Gravity Gradiometer (EGG) in a sun-synchronous dawn-dusk orbit of 250 km altitude. The duration of the mission will be 20 months.

The EGG is based on capacitive accelerometers with a sensitivity 10 times better than those used for the American – German GRACE mission. The EGG consists of six 3-axis accelerometers arranged in three pairs, each pair separated by 0.5 m, the gradiometer baseline. Contributors to its extreme stability are an ultra-stable structure in C-C and a dual domain thermal control strategy.



The EGG is used to retrieve the high frequency terms of the gravity field. The GNSS receiver is a dual-frequency combined GPS and GLONASS receiver, which is used to retrieve the low frequency terms of the field.

GOCE is a small satellite in terms of mass. It is however not a simple satellite and it is very far from the concepts of standardised busses with 'bolt-on' payloads. Particular features of GOCE are: the integration payload – platform; the external primary structure; the thermal control of the gradiometer; the drag free (drag compensation) and attitude control system (DFACS) which uses also the EGG as sensor; the two novel propulsion systems; the electric power system; the orbit choice adapted to the actual air density encountered in orbit, the operation concept; etc. Only the data handling and communication systems are standard and not demanding.

Though GOCE will fly at 250 km altitude, the gravitational signal is already very weak while the perturbations induced by air drag are still relatively high. It is therefore necessary to eliminate the effects of air drag.

This is achieved by wise configuration design and by active compensation. The satellite cross-section is only 0.8 m<sup>2</sup>. The configuration also offers maximum symmetry to avoid torques. The driver for the satellite length is the size of the fixed solar array. Width and length are as allowed by the launcher fairing. The length of the satellite is approximately 4 m.

The drag compensation is achieved at all frequencies until the high limit of the measurement bandwidth of the gradiometer, i.e. 0.1 Hz. This is performed by ion thrusters capable of providing both "high" thrust, 20 mN, for orbit recovery, and fast, accurate thrust variation up to 10 Hz for drag compensation.

Reaction wheels are not used, as it could not be guaranteed that high frequency vibrations would not appear at unacceptable levels in the measurement bandwidth. Instead micro-thrusters are used, capable of providing up to 1 mN with high accuracy and very low noise.

The use of two propulsion systems has to be considered in the design of the configuration. The arrangement of the elements has to guarantee that the centre of mass deviates very little due to fuel depletion during the mission duration.

Gyros are not used either. The gradiometer itself provides the angular accelerations and rates, and the linear accelerations required by the DFACS. Attitude determination requires also star sensors. The GNSS receiver included in the payload is also a critical element of the DFACS.

GOCE is a small satellite. The estimated mass is 800 kg, including 60 kg of propellants and 10 % margin. The power requirement is around 1 kW including battery charge, and the energy storage requirement is of 300 Wh. The main consumer is the electric propulsion system. The data generation rate is slightly above 5 kbps. Assuming a single ground station at Kiruna, a very modest onboard data storage is required, which can be transmitted to ground in S-band at less than 1 Mbps.

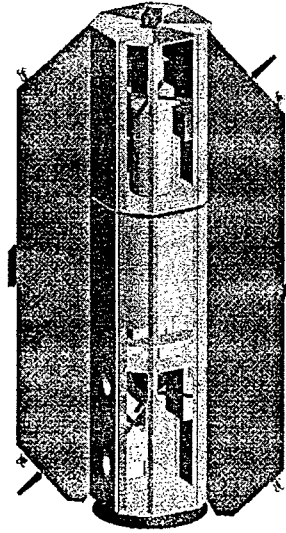


Figure 2. The GOCE satellite

## SMOS

The Soil Moisture and Ocean Salinity (SMOS) mission [Kerr, 98], illustrated in figure 3, will be the second Earth Explorer Opportunity Mission and the third Earth Explorer in general. It is planned for launch in mid 2005 and for a lifetime of three years. It is funded by ESA with CNES and the Spanish CDTI.

The mission is intended to provide soil moisture (SM) and ocean salinity (OS) information on a global scale and with a high revisit rate (global coverage in three days). On land, water and energy fluxes at the surface/atmosphere interface depend strongly on SM. SM is a key variable in the hydrological cycle and an important parameter for numerical weather and climate models. In the oceans, OS fields are fundamental to study deep circulation, heat transport and near-surface dynamics of tropical areas. They constrain the water cycle and the coupled ocean-atmosphere models. The accuracy requirement set for SM retrieval is of 4 % (in volume) for a 50 km resolution, while for OS it is of 0.1 – 0.2 psu for a 200 km resolution. Currently no capability exists to measure directly and globally SM and OS.

Both SM and OS can be inferred from brightness temperature observations since the soil and seawater emissivity depends strongly on SM and OS. A passive microwave technique, imaging radiometry by aperture synthesis, has been preferred to an active one because of the more favourable signal-to-noise ratio and of the easier data interpretation. The SMOS instrument is the Microwave Imaging Radiometer using Aperture Synthesis (MIRAS), which operates in a protected region of the L band at ~1.4 GHz. MIRAS has been developed since 1993 by ESA and a demonstrator is being realised to prove the (novel) concept of 2D imaging radiometry.

MIRAS consists of a large number (approx. 80) of antenna/receiver elements, whose digitised outputs are cross-correlated on-board. The correlation results provide information directly linked (by inverse Fourier transformation) to the brightness temperature of the scene. It is a rather complex instrument, since a large number of receivers has to be arranged in a symmetrical Y-shaped configuration to achieve the required spatial resolution and spatial/temporal coverage. Each of the three coplanar arms is ~60 cm wide, ~5 m long and is composed of three segments, which will be

stowed either on top of the platform or along its sides. The MIRAS structure is in CFRP. High-speed optical links are used to transmit all receiver signals to the correlator unit located in the hub. In addition to the receivers and the optical link equipment, the calibration hardware is also distributed along the arms. Geometrical and thermal variations along the arms greatly affect performance, so they have to be carefully limited by design and controlled in orbit.

The SMOS observation requirements will be met using a sun-synchronous dawn-dusk orbit at an altitude yet to be selected during the Phase A but expected to be comprised between 600 and 800 km. The proposed platform to carry the MIRAS instrument, as well as any ancillary payload equipment required, is the Proteus platform developed by CNES and Alcatel. The launch will be realised with one of the available small launchers such as Rockot. The Proteus platform will in principle be identical to that used for the Jason and Corot missions, however payload and platform compatibility has still to be analysed in depth during the Phase A studies and this may lead to adaptations of both elements. Areas currently perceived as critical relate to antenna size/mass; AOCS capabilities; data storage and communication capabilities; AIV and schedule aspects.

SMOS will be a small satellite. The estimated mass is ~500 kg and the total power requirement is around 600 W. Use of the standard S-band link with a single ground station at Kiruna is assumed, although the compatibility of this with the payload design remains to be verified in detail.

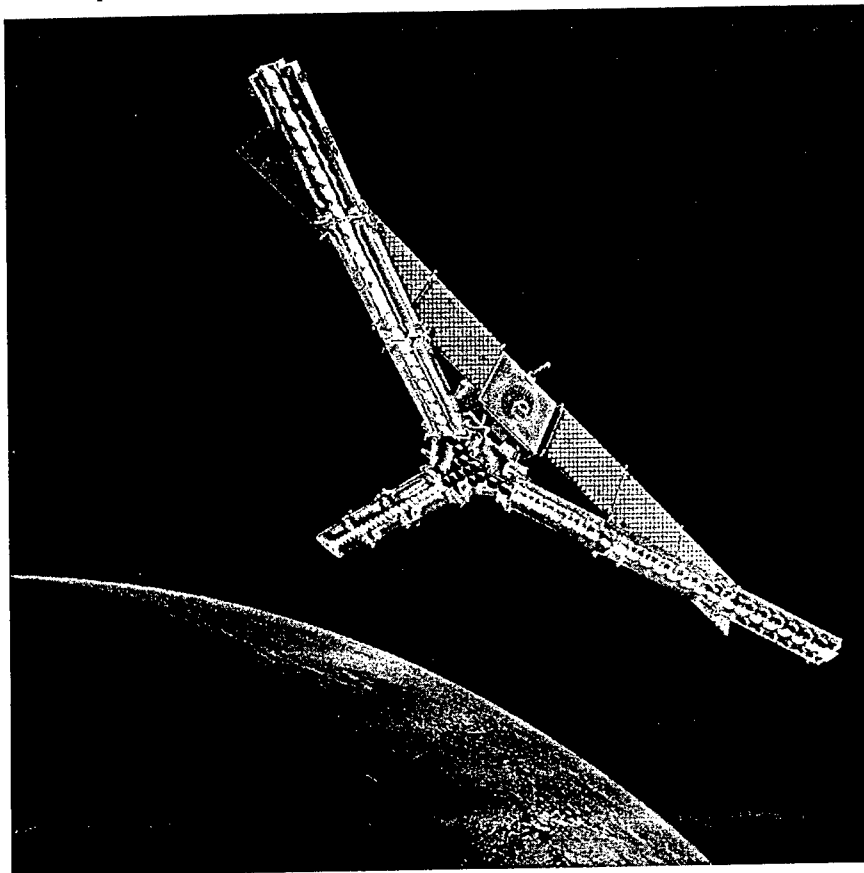


Figure 3. SMOS satellite concept

The Proteus platform proposed for SMOS is now ready. Detailed interface documentation is available to the payload designer. This helps payload design work, but it is still the complexity of MIRAS that drives the schedule and the cost of the mission. The development of the MIRAS instrument will take several years. Campaigns are needed for salinity and soil moisture that in turn imply the development of ground based instruments. By measuring for the first time globally SM and OS, this mission may have large scientific impact. These high expectations are also a challenge for the implementation of SMOS as "opportunity" mission with the associated programmatic constraints. Despite these constraints, for SMOS to make sense, it must provide substantial, long lasting contribution to Earth sciences.

#### ADM / Aeolus

The ADM / Aeolus mission is the second core explorer mission and is planned to fly in 2006/2007. The primary objective of Aeolus is to provide improved analyses of the global three-dimensional wind field and to demonstrate the capability to correct the major deficiency in wind-profiling of the current Global Observing System (GOS) and Global Climate Observing System (GCOS). In order to achieve this, Aeolus will provide wind-profile measurements with an accuracy of 2-3 m/s, from the ground to an altitude of 20 km minimal.

The main element of the mission comprises a Doppler Wind Lidar instrument, called ALADIN, on a dedicated satellite and a ground segment providing facilities for command and control and for data processing and dissemination. As baseline a sun-synchronous dawn-dusk orbit has been selected. It offers quasi-global wind profile measurements and corresponds to lower cloud coverage. In addition it facilitates the satellite design by allowing fixed solar arrays and a very stable thermal environment.

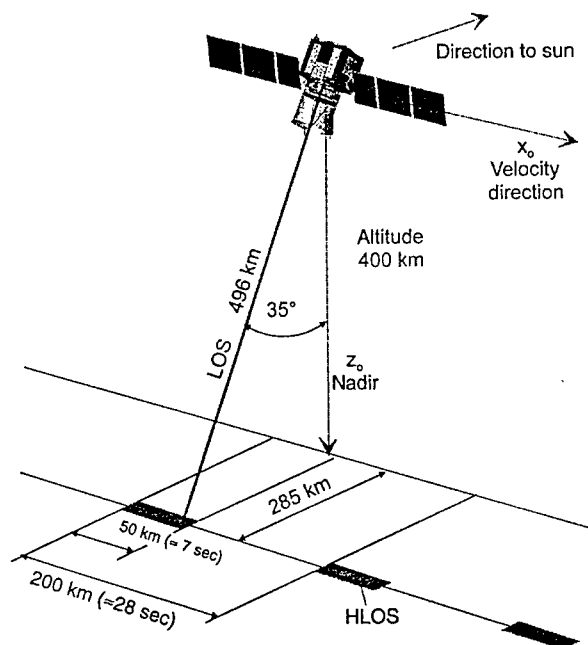


Figure 4. Observation geometry of ADM-Aeolus

The Line Of Sight (LOS) of the instrument will be  $35^\circ$  off nadir, for giving best instrument performance and quasi  $90^\circ$  across the flight direction to minimise the Doppler frequency shift caused by the satellite velocity. A specific yaw steering has been implemented for the satellite, to basically compensate the velocity contribution of the satellite at the point of measurement.

The instrument fires 130 mJ laser pulses at 100 Hz towards the atmosphere and measures the Doppler shifts of the return signal backscattered from air volumes at different height levels. The 355 nm transmitted pulses are generated after frequency tripling from the 1064 nm Nd:YAG source laser. The Doppler frequency shift results from the relative movement of the scattering elements along the Line Of Sight (LOS). The light is scattered either by interaction with aerosol particles, which are typically larger than the wavelength of the employed laser pulse (Mie scattering) or by interaction with air molecules, which are significantly smaller than the wavelength (Rayleigh scattering). Both scattering mechanisms require different reception techniques.

ALADIN has a two-channel receiver to exploit the two backscattering principles. The Mie-channel is based on a Fizeau interferometer and provides the wind speed in the lower part of the atmosphere. The Rayleigh channel is based on a double Fabry-Perot etalon and provides the observations in the upper part of the range. The complementarity of the two channels provides good performance for a wide range of atmospheric conditions. Both channels use accumulation CCD as detectors. A Cassegrain 1.1 m diameter telescope is used for both emission and reception.

The satellite design is adapted to the instrument and is optimised in terms of thermal stability and minimised cross section in flight direction. The satellite consists of a conventional box structure with a central cone, upon which the instrument is mounted via three isostatic bipods. The central cone feeds the launch loads of the instrument directly to the launch adapter on the bottom side. Its standard diameter of 937 mm allows maximum flexibility in selecting an adequate launcher.

Due to the dawn-dusk orbit the solar arrays can be kept in fixed position. The power consuming subsystems of the instrument are mounted on the primary structure and on the top panel of the satellite. This ensures short lines for power supply of the pump diodes and a good thermal decoupling of electrical and optical elements. The power of these boxes is dissipated by radiators on the anti-sun side of the satellite providing best thermal stability for the instrument.

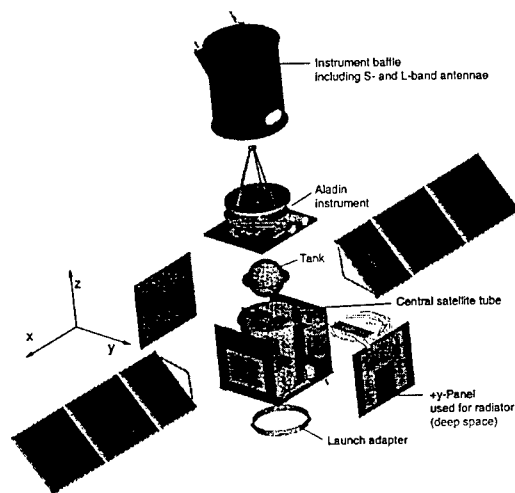


Figure 1: Main components of ADM / Aeolus satellite

The 560 W average electric power demand is provided by a 8.5 m<sup>2</sup> solar array capable of delivering 920 W at end-of-life. The NiCd battery provides 18 Ah energy storage capacity. Data are generated at a very modest rate, less than 15 kbps which is stored onboard in a small memory and transmitted to ground once per orbit in L-band to stations in Kiruna and Barrows (Alaska). The performance of the attitude and orbit control system (AOCS) is essential for the accuracy of the mission product. The AOCS is based on gyros and star sensors.

The launch mass of the ADM satellite is 785 kg, including 100 kg of fuel compatible for the required lifetime of 3 (+1) years. This is fully compatible with the proposed ROCKOT launcher for the 400 km sun-synchronous orbit.

The ADM / Aeolus mission illustrates the need for end-to-end mission architecture engineering. Measurements of wind profiles were required since long time. However, it was only recently that the interaction between users and engineers allowed establishing the requirements for single line-of-sight observations, spatial sampling and data averaging strategies compatible with the available technology. Advances in technology allowed the use of an alternative to the difficult CO<sub>2</sub> laser technology considered at the beginning. Multi-telescope concepts could be abandoned by concentrating on the single component measurements. Instruments of several tons and kW were not required any longer. The interaction platform - instrument also simplified the instrument design, for instance by implementing an adapted yaw steering by the platform. The ADM / Aeolus mission can now be implemented with a small satellite compatible with small launchers and therefore is a good candidate for later deployment as operational constellation.

### Satellite Formation

Studies are ongoing to identify the interest of formation of satellites to enable new missions or to facilitate the implementation of missions that would be very complex on a single platform. In principle, two big classes of formations have been identified. On one side there are formations with two (or more) satellites flying together in order to observe the same scene with different instruments ("ground track oriented"), and on the other side formations where a specific relative geometry of two parts of an "instrument" is required to enable observations ("geometry oriented").

The former principle has been considered early in the definition of the Earth Explorer missions, in particular for the Atmospheric Chemistry mission as a candidate Earth Explorer Core Mission [ESA, 96]. The observation requirements called for several instruments with different observation geometry (limb sounding and nadir sounding). This would have led to an expensive suite of instruments on a large platform, requiring a large launcher. A solution was proposed that consisted in flying a new satellite in formation with *MetOp*. The new satellite would carry a microwave sounder (MASTER) and fly in the same orbit and ahead of *MetOp* so that MASTER would sound in the limb the same volume of atmosphere observed by the nadir looking instruments of *MetOp*, in particular GOME, IASI and AVHRR. This implementation was cheaper than the single platform concept, as it resulted in a single instrument on a 800 kg satellite compatible with a small launcher. It also provided better performance as the observations by the limb and nadir looking instruments could be truly made simultaneous. This case shows that small satellites can implement new missions, when flying in formation with existing satellites.

The Earth Radiation Mission [ESA, 99c] (ERM), also candidate for the "core" missions, required a backscatter lidar, a cloud profiling radar, a multi-spectral imager and a broadband radiometer. A concept studied early in phase A considered the distribution of the payload complement on two satellites flying in formation. Each satellite would fly an active instrument and the support passive instrument. This split scenario was attractive for international cooperation, as a partner Agency could have developed one of the two satellites. The split scenario, that has later been used in America for Picasso and Cloudsat, was not selected in the case of the ERM for its lower scientific performance, in particular for the retrieval of micro-physical properties of clouds. Furthermore, if

both satellites had to be developed new and deployed by the same Agency, there would be no economic benefit in the formation alternative.

The latter case of formations ("geometry oriented") can be illustrated by the example of the implementation of a high resolution SMOS mission using three satellites in formation. The three satellites would have to be maintained in a close fixed relative geometry with very tight accuracy requirements. The complexity however seems insurmountable at this stage.

The ERM case as well as the high resolution SMOS case illustrate that not all missions can easily be implemented with small satellites and that satellite formation always requires careful evaluation before being proposed for mission implementation.

## CONCLUSIONS

Small satellites are understood in broad sense, as satellites compatible with small launchers, i.e. less than 1000 kg to low Earth orbit on a medium price launcher, less than 20 MEURO. The user-driven character of the Earth Explorers leads to focused missions. These missions can be often implemented with small satellites as shown by the first four Earth Explorer missions. These small satellites are not simple. End-to-end mission architecture engineering is essential for sound implementation concepts. The concept of standard busses is not always applicable, e.g. GOCE. The instrument is the driver of the schedule and the cost of the mission. Often benefit may be obtained by departing, at least partially, from the standard busses. When considering changes to standard elements, the total cost of the mission must be considered, augmented by the cost in research and other user organisations. The potential long-lasting negative effects on science must be considered before embarking on missions, that though of low cost, provide also limited performance. Not all missions can be implemented with small satellites, e.g. ERM. Small satellites can enable new missions by flying in formation. Formations of small satellites are, however, not always a substitute for a larger satellite.

## REFERENCES

- [ESA, 96] Reports for Assessment. The Nine Candidate Earth Explorer Missions, ESA SP-1196 (1) to (9)
- [ESA, 98] The Science and Research Elements of ESA's Living Planet Programme, ESA SP-1227
- [ESA, 99a] Reports for Mission Selection. The Four Candidate Earth Explorer Core Missions. The Gravity Field and Steady State Ocean Circulation Mission, ESA SP-1233(1)
- [ESA, 99b] Reports for Mission Selection. The Four Candidate Earth Explorer Core Missions. The Land-Surface Processes and Interactions Mission. ESA SP-1233(2)
- [ESA, 99c] Reports for Mission Selection. The Four Candidate Earth Explorer Core Missions. The Earth Radiation Mission. ESA-SP1233(3)
- [ESA, 99d] Reports for Mission Selection. The Four Candidate Earth Explorer Core Missions. The Atmospheric Dynamics Mission. ESA-SP1233(4)
- [UCL, 99] CRYOSAT Mission Requirement Document. CS-RS-UCL-SY-0001
- [ESA, 2000] ADM Phase A Final Summary Report
- [Kerr, 98] SMOS - Proposal in answer to the call for Earth Explorer Opportunity Missions, Y. Kerr et al., Nov. 30th, 1998, available at URL: <http://www-sv.cict.fr/cesbio/smos/Proposal.html>

**PROBA  
(PROJECT FOR ON-BOARD AUTONOMY)**

**Dirk BERNAERTS<sup>1</sup>, Frederic TESTON<sup>2</sup>, Jo BERMYN<sup>1</sup>**

<sup>1</sup>*Verhaert Design and Development nv, Hogenakkerhoekstraat 9, B-9150 Kruibeke, Belgium*  
<sup>2</sup>*ESA/ESTEC, Keplerlaan 1, 2201 AZ Noordwijk, the Netherlands*

**ABSTRACT** – *Proba is an ESA mission dedicated to in-orbit technology demonstration, earth environment monitoring and preparatory earth observation. Proba is a small spacecraft equipped with a selected set of technologies providing advanced on-board functions to support mission operations with minimum ground involvement. This spacecraft autonomy is exercised and demonstrated in realistic scenarios through the utilization of the payload instruments.*

## **1 - INTRODUCTION**

Proba is a mission included in the ESA's General Support Technology Programme [Teston 1999]. The project is currently in its final phase: the integration of the flight spacecraft. This mission is part of an overall effort to promote technological missions using small spacecraft. The next step is a follow-on project (Proba 2) which is included in the next phase of the GSTP and is due to start in 2000.

An industrial team led by Verhaert Design and Development (Belgium) is responsible for the project. It is supported by several European subcontractors and suppliers. The payload instruments are provided to the industrial team under ESA's responsibility.

This paper presents a description of the Proba mission, the spacecraft and ground segment design, and the payload instruments.

### **1.1 - PROBA MISSION SUMMARY**

#### ***1.1.1 - Launch and Orbit***

Proba is planned to be launched in 2001 on a PSLV from Antrix (India). It will be injected directly into its final polar, sun-synchronous orbit at an altitude of 817 km, 98.7 degrees inclination. The orbital drift (away from sun-synchronism) amounts to about 2 degrees per year and is compatible with the PROBA mission requirements. There is thus no need for on-board propulsion.

Navigation of the spacecraft is performed autonomously on-board by the Attitude Control and Navigation Subsystem (ACNS) with a combination of GPS measurements and orbit propagation. The spacecraft is kept three-axis stabilised by means of attitude measurements provided by an autonomous star tracker and by on-board control through a set of reaction wheels and magneto-torquers.



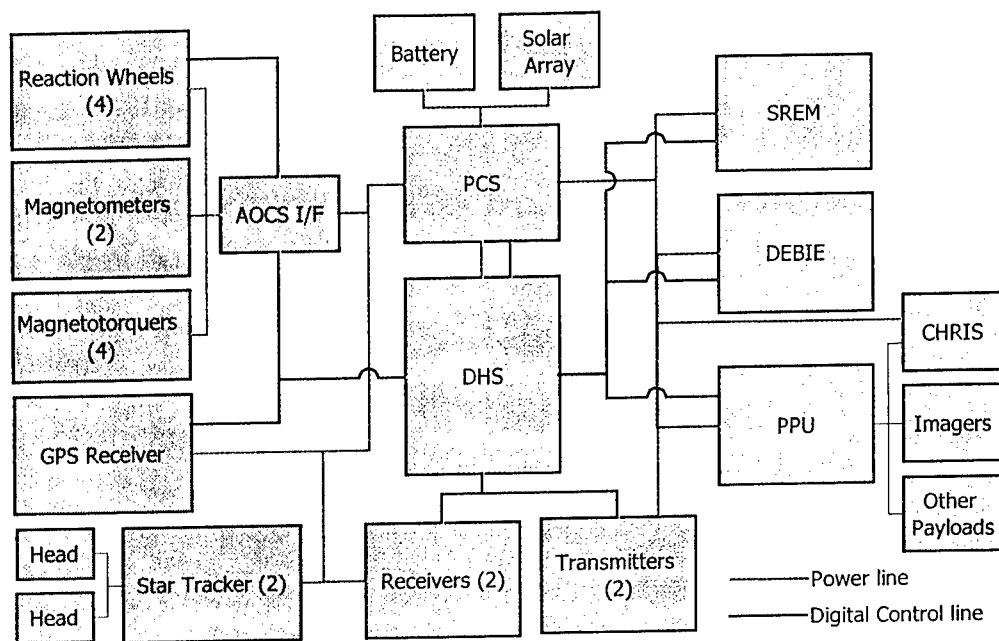


determination, a high-performance computer, a DSP for on-board scientific data processing and analysis, and a solid state mass memory.

Table 1 provides an overview of the PROBA platform specifications and Figure 2 presents a block diagram of the PROBA spacecraft.

System		Description
Orbit	LEO Altitude 817 km Sun-Synchronous (right ascension node at 345 degrees) Near-polar (inclination 98.7°)	Optimisation for the requirements: <ul style="list-style-type: none"> <li>• Best orbit for main imager</li> <li>• Good orbit for other payloads</li> <li>• Selection of low cost launcher with flight opportunity in a short time.</li> </ul>
	Operational Lifetime	2 years for consumables (battery and solar cells)
Mechanical	Dimensions	600 x 600 x 800 mm
	Mass	< 100 kg
Thermal	Passive thermal control	
ACNS	Attitude control	3-axis stabilised providing high accuracy nadir and off-nadir pointing capabilities.
	Sensors	Cold redundant dual head advanced star trackers, redundant 3-axis magnetometers, GPS receiver.
	Actuators	4 Magnetorquers, 4 Reaction Wheels
	Absolute Pointing Accuracy	Better than 360 arcsec
	Absolute Pointing Knowledge	Better than 125 arcsec.
Avionics	Processor	Cold redundant radiation tolerant ERC32 RISC processor
	Memory	8 Mbyte RAM, 2 Mbyte FLASH
	Interfaces	RS422, TTC-B-01, analog and digital status lines, direct high speed interface to Telemetry.
	Uplink Communications	Hot redundant S-band receivers, 4kbps
	Downlink Communications	Cold Redundant S-band transmitters, 1 Mbps
	Communications Packet Standard	CCSDS
Power	Solar Panels	5 body mounted GaAs panels, 90W peak power
	Battery	36 Li-ion cells, 9Ah, 25V
	Power Conditioning System	28V regulated power bus, redundant battery charge and discharge regulators, power distribution system and shunt regulators.
Software	Operating System	VxWorks
	Data Handling/Application Software	Newly developed for PROBA

Table 1 : PROBA platform specifications overview



**Figure 2:** PROBA block diagram showing the AOCS units (left), the power and avionics Units (centre) and the payload units (right). Power and digital commanding and control interconnections between the units are shown. Other interconnections such as analog and digital monitoring lines are not shown.

## 2.1 - Mechanical and Thermal

The PROBA structure was designed to meet the following requirements:

- to provide a carrying structure compatible with the ASAP5 and PSLV launcher requirements
- to accommodate mainly off-the-shelf units and payloads with frozen mechanical design
- to provide easy unit access and modularity compatible with a flexible integration and checkout approach
- to be reusable to maximum extent for other technology demonstration missions.

The carrying part of the structure is composed of 3 aluminium honeycomb panels mounted in an H-structure and a bottom board. Almost all units are mounted on these inner panels. The nadir pointing bottom board of the spacecraft acts as the interface with the launcher. The outside panels have body-mounted Gallium Arsenide solar cells.

The thermal control of the spacecraft is completely passive, by an appropriate choice of the different paints, by the application of Multi-Layer-Insulation and by control of the conductive links between the different units and the carrying structure.

## 2.2 - Attitude Control and Navigation System

The autonomy requirements for the PROBA bus and the requirements imposed by the selected payloads have led to the implementation of a complex ACNS. The main requirements on the PROBA ACNS are:

1. Provide 3-axis attitude control including high accuracy nadir and off-nadir pointing and manoeuvring capabilities in accordance with the selected Earth observation instrument requirements
2. The ACNS software shall control the spacecraft based only on target oriented ground commands (i.e. commands specifying the targets longitude, latitude and altitude). The spacecraft sensors shall acquire all required information autonomously.
3. Provide technology demonstrations of GPS attitude and the use of Computer-Aided Software Engineering tools for the development of the ACNS software.

To meet these requirements, PROBA has been fitted with a high-accuracy double head star tracker, with a GPS receiver and with a set of reaction wheels for the nominal ACNS operation. This set of sensors and actuators is complemented with the magnetotorquers and 3-axis magnetometers to be mainly used for momentum dumping and during the initial attitude acquisition operations after separation or non-nominal events (Figure 3). Finally, the core of the ACNS subsystem consists of the ACNS software.

The autonomous star tracker is the main attitude determination sensor during nominal mission phases. It provides full-sky coverage and achieves the high accuracy required in Earth observation. The sensor can autonomously reconstruct the spacecraft's inertial attitude starting from a "lost in space" attitude without any prior estimates of the spacecraft orientation. This is done with a typical performance of a few arc-seconds up to an arc-minute. The attitude can be reconstructed at relatively high inertial rates, which allows the ACNS software to perform gyro-less rate measurements which are sufficiently accurate to control large-angle precise and stable manoeuvres. The star tracker selected for PROBA is provided by the Technical University of Denmark.

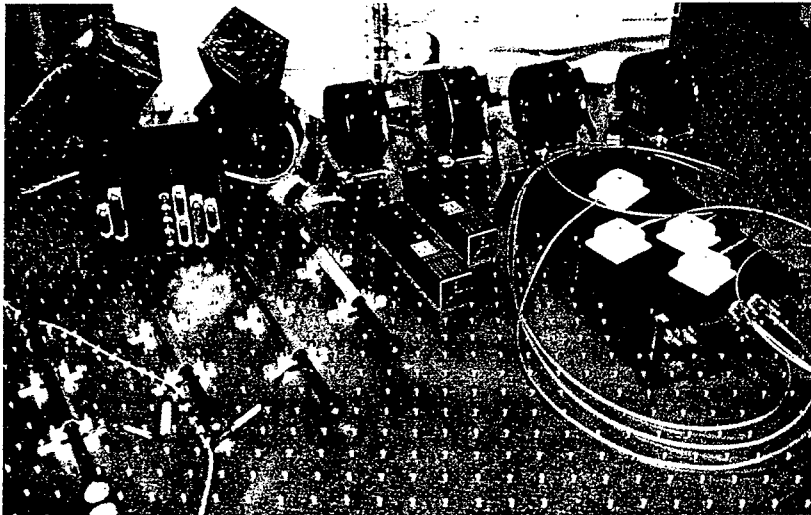


Figure 3: ACNS sensors and Actuators: 4 magneto-torquers, dual head star tracker, 4 reaction wheels, 2 magnetometers, GPS receiver

Knowledge of the PROBA orbit is acquired autonomously with a GPS receiver, supplied by SSTL (UK). The provision of range data from GPS satellites (or pre-processed position, velocity and time measurements from the GPS receiver software) will allow on-board determination of the osculating orbital elements of the spacecraft and a correlation of on-board time with Universal Time Coordinated (UTC) required in the various on-board ephemeris generators. Knowledge of the orbit will allow pointing the spacecraft to any orbit-referenced attitude (including the normal-mode nadir pointing) without the need for an Earth sensor. In addition, using an on-board Earth-rotation

ephemeris calculator, pointing to any user-selected Earth coordinates is also possible. The GPS receiver thus forms a crucial component in the on-board autonomy demonstration. In case of GPS failure, the ACNS software obtains the navigation data from NORAD two-line elements automatically uplinked by the ground. Finally, the GPS receiver will be used for the GPS-based attitude determination demonstration.

During nominal operations, the generation of control torques is ensured by four Teldix (Germany) reaction wheels mounted in a tetrahedron configuration. Their storage capacity is 0.04 Nms and their maximum torque capability is 5 mNm at 1500 RPM. As already indicated, momentum dumping is ensured by two redundant, three-axis magnetometers and by four magneto-torquers.

All ACNS sensors and actuators are controlled by the ACNS software (developed by Université de Sherbroock) running on the central ERC 32 computer and provides complete flight dynamics calculation functions, including:

- Navigation function: the autonomous estimation of the orbit using GPS measurements and the autonomous determination of attitude using the advanced star sensor.
- Guidance functions: the prediction of orbital events (eclipses, next target passages, next station passage etc) and the on-board generation of the reference attitude profile during imaging. These functions provide essential support to the on-board mission planning system.
- Control function: the execution of the attitude control commands for attitude acquisition and hold.

In performing these functions, the ACNS software has to deal with further complications such as latency of the detectors and synchronisation between the different on-board clocks.

Pointing to geographical Earth references will either be to a fixed target (e.g. during ground station overfly for antenna pointing or during utilisation of one of the imagers) or in a scanning motion over a 19 km user-selected target area during the CHRIS imaging mode. Each of the five scans over the target area are executed back and forth at 1/3 the nominal nadir push-broom velocity in order to increase the radiometric resolution. A detailed description of the ACNS can be found in [de Lafontaine 1999].

## **2.3 - Avionics**

The avionics is composed by:

- a high-performance redundant central computer (DHS) responsible for spacecraft telecommand and telemetry, all spacecraft computing tasks and interfaces to every unit of the spacecraft,
- a Payload Processor (PPU) with a solid-state recorder and a DSP for payload processing and data storage,
- a redundant set of S Band receivers and transmitters.

### **2.3.1 - DHS**

The DHS unit was designed to integrate in a single redundant unit all the core functions of the spacecraft avionics (Figure 4) and to provide sufficiently high-performance computing to support not only the traditional attitude control and data handling tasks but also spacecraft autonomy (i.e. the processing normally performed on-ground has been migrated on-board in the case of Proba). It is provided by SIL (UK).

To this end a high-performance RISC processor, the ERC 32, has been used. The ERC 32 is a radiation tolerant (> 80 Krad) SPARC V7 processor providing 10 MIPS and 2 MFLOPS with a floating-point unit. A memory controller includes all the peripheral functions needed by the processor, such as the address decoders, the bus arbiter, the EDAC, 2 UARTS, 3 timers and a

watchdog. The chip set is manufactured with the MHS 0.8 micron CMOS/EPI radiation tolerant technology.

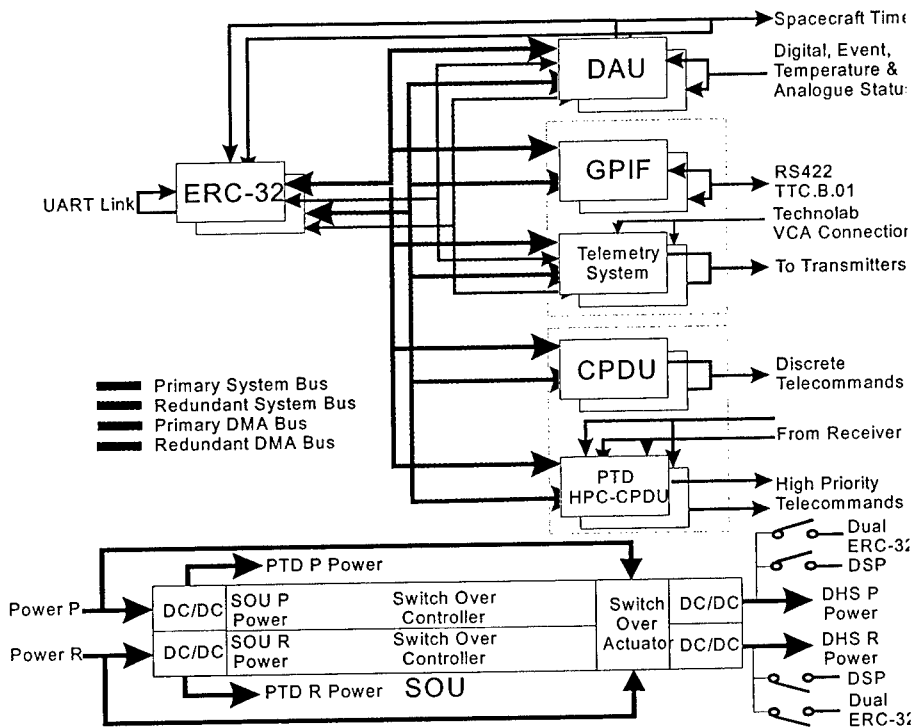


Figure 4: DHS block diagram

The DHS includes 2 of these processors. They are normally used as cold redundant hardware. However, in order to cope with potentially higher processing demands, it is also possible to run the DHS in dual processor mode, where both processors are running concurrently and exchanging data with high speed serial links.

The other functions of the DHS are:

- 2 hot redundant telecommand decoders supporting COP-1 packet telecommanding and direct (MAP-0) ground commands,
- cold redundant spacecraft interfaces, RS-422 or TTC-B-01 for data exchange, pulse, analog, digital, ... for commanding, house-keeping and time distribution,
- 2 cold redundant telemetry generators, each supporting 3 Virtual Channels,
- a reconfiguration unit performing the reconfiguration of the DHS in case of software and hardware failure or transient (e.g. Latch-up)

### 2.3.2 - PPU

The PPU is mainly the computer controlling the imaging instruments (provided by MMS UK). It includes a DSP, the TCS21020 for high capability data processing and improved usage of the on-board mass memory through compression.

The TCS21020 is a radiation tolerant (> 100 Krad) 32 bit DSP. It is fully compatible with the ADSP 21020 from Analog Devices. It provides 15 MIPS and 45 MFLOPS. The chip is manufactured by the TEMIC/MHS 0.6 micron SCMOS/2RT+ process.

The mass memory is 1.2 Gbit and uses three-dimensional packaging technology for high-density storage.

The PPU provides also several additional interfaces for other on-board experiments, interfaces to solid state gyroscopes (SSG), an interface to an extra star tracker (PASS), and an interface to a house-keeping bus.

This latter will be used on PROBA to measure temperatures and radiation dose in remote locations of the spacecraft. It uses a collection of devices called SIP (for Smart Instrumentation Point) which are small modules of 15 mm/7,5 mm/5 mm, weighing less than 3 g. They use advanced packaging and include the temperature and total dose sensors, the Analog to Digital converter, and the bus interface. The SIPs were developed by Xensor Integration (NL).

The PPU controls also the imagers (indicated Micro Cameras on Figure 5) covered in the payload section of this paper.

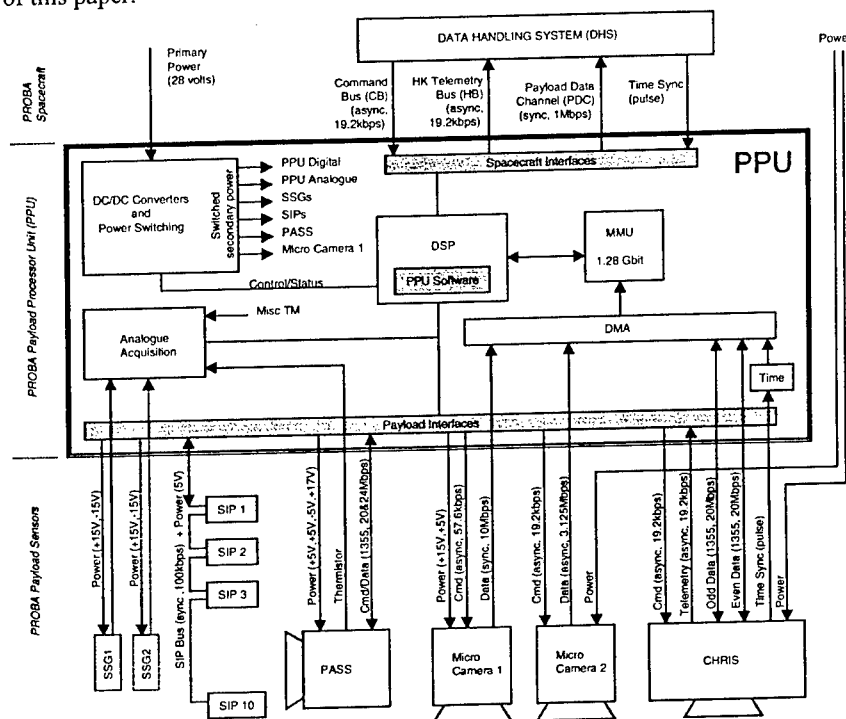


Figure 5: Block diagram of PPU and attached payloads

### 2.3.3 - TT&C

The S band link capacities are 4 Kbit/s for the packet telecommanding and a maximum of 1 Mb/s for the packet telemetry. Standard ESA modulation scheme (PSK/PM) is used for the uplink and BPSK for the downlink.

Off the shelf units from SIL (UK) have been used for TT&C support.

Two hot redundant receivers are connected through a combiner/diplexer to Zenith and Nadir antennas providing omni-coverage commanding of the spacecraft.

Two cold redundant transmitters are connected through a switching unit to Zenith and Nadir antennas providing also omni-coverage telemetry of from the spacecraft.

## 2.4 - Power

The basic power consumption of the platform is 35 W. The excess of power will be allocated to the payload. The duty cycle of the instruments will be calculated on board taking into account the available power and energy but also the scientific requests and the available data storage.

The body mounted solar arrays will provide a worst case (end of life, summer solstice) peak power generation ranging from 45 to 67 W per panel. Averaged along the sunlit part of the orbit, the power generation at bus level will be 85 W. The solar arrays are built with 22 strings of 39 to 41 cells grouped in 6 sections. The cells are of a standard size of 3.8x3.5 cm with integrated diode. The panels are provided by Officine Galileo (Italy).

The 9 Ah Li-ion battery will be used mainly in eclipse as the peak power demands in day phase will be almost all covered by power from the arrays. The duty cycle of the instruments will not create a Depth of Discharge higher than 20 %.

The battery is built using standard Li-Ion cells that are screened and matched. Ground testing has demonstrated the compatibility of the battery with the 2 years mission of PROBA.

The battery weights 2.2 kg. It is provided by AEA (UK).

The functions of the PCS are:

- conditioning and distribution of power to users by means of a 28 Volt regulated bus, four non-switchable power lines to the essential sub-systems and twelve switched power lines to payloads and non-essential sub-systems (PDU),
- sourcing of the power from six solar array sections and control by a Sequential Switching Shunt Regulator (S3R),
- sourcing of the power during eclipse or peak power loads, from one battery through two Battery Discharge Regulators (BDR),
- battery monitoring and management (BME),
- battery charging by means of two Battery Charge Regulators (BCR)

Failure tolerance of the PCS is provided by:

- redundant PCS interfaces, BDRs and BCRs,
- majority voting of 3 independent voltages in the Main Error Amplifier controlling the BCR, the BDR and the S3R,
- each of the 6 sections being made of one shunt transistor and two output diodes in series and a seventh "section" connecting a resistor across the power bus,
- redundant End of Charge detection in the BME,
- over-current output protection in the PDU.

The PCS also protects the spacecraft against a power bus under-voltage by turning off all switched power outputs in case of bus or battery under-voltage.

The PCS is controlled by the on-board computer through a redundant 16-bit memory load interface (TTC-B-01) and discrete ground commands. It is provided by SIL (UK).



## 2.5 - Payloads

### 2.5.1 - CHRIS

The larger instrument is a Compact High Resolution Imaging Spectrometer (CHRIS) provided by Sira Electro-Optics Ltd (UK) (Figure 6). The scientific objective is to provide multi-spectral data (up to 62 bands) on Earth surface reflectance in the visible/near-infrared (VNIR) spectral band (415 to 1050 nm) with a spectral sampling interval ranging between 2 and 10 nm at high spatial resolution (25 m at nadir). The instrument will use the PROBA platform pointing capabilities to provide Bidirectional Reflectance Distribution Function (BRDF) data (variation in reflectance with view angle) for selected scenes on Earth surface. The instrument will be used mainly to provide images of land areas, and will be of interest particularly in recording features of vegetation and aerosols.

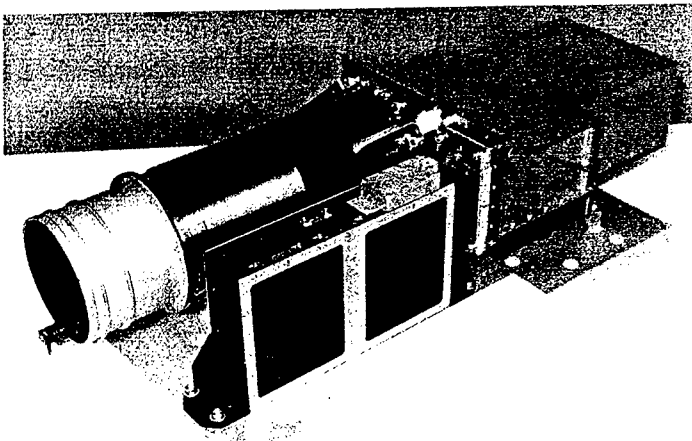


Figure 6: CHRIS instrument

The objective is also to validate techniques for future imaging spectrometer missions possibly on agile small satellite platforms, particularly with respect to precision farming observations, regional yield forecasting and forest inventory.

The instrument is an imaging spectrometer of basically conventional form, with a "telescope" forming an image of Earth onto the entrance slit of a spectrometer, and an area-array detector at the spectrometer focal plane. The instrument will operate in a push-broom mode during Earth imaging. The detector is a thinned, back-illuminated, frame-transfer CCD. CCD rows are assigned to separate wavelengths, and CCD columns to separate resolved points in the Earth image. The platform will provide slow pitch during imaging in order to increase the integration time of the instrument. This increase in integration time is needed to achieve the target radiometric resolution, at the baseline spatial and spectral sampling interval.

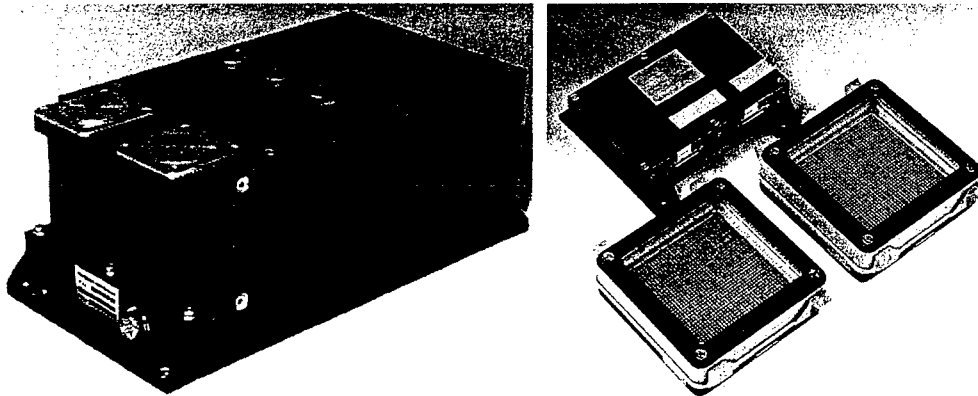
The platform will process imaging demands from ground control specifying:

- target location - requiring roll manoeuvres to point across-track for off Nadir targets,
- viewing directions for each target in one orbit - requiring pitch manoeuvres to point along-track,
- spectral bands and spectral sampling interval in each band,
- spatial sampling interval.

The platform will perform the required pitch and roll manoeuvres and transmit control signals to CHRIS to initiate and terminate imaging, with the required spectral and spatial characteristics.

In-flight calibration for radiometric response, using a dark scene on Earth or the calibration device, will also be supported by CHRIS and the platform.

The digitised data from CHRIS will be stored in a mass memory unit, processed and compressed with a DSP and transmit to ground on command.



**Figure 7:** The SREM (left) and DEBIE (right) payloads. Both the processing unit and the 2 sensors of DEBIE are displayed.

### 2.5.2 - SREM

The primary objectives of ESA's Standard Radiation Environment Monitor (SREM) are for space environmental technology research. That is, to derive understanding of the environment which is a hazard to future missions, develop models for engineering, and collaborate in research on the effects of radiation on space systems. However, the SREM data are also available for scientific studies such as particle sources, transport and loss, energisation of radiation belt particles. These activities are strengthened by the availability of SREM data from many different spacecraft.

The path of PROBA will cover the "polar horns", where energetic electrons of the outer radiation belt are transported to low altitudes, as well as the South Atlantic Anomaly (SAA) with its enhanced proton fluxes (the inner part of the inner radiation belt). PROBA will also be exposed to energetic particles from the sun during energetic events, and cosmic rays. These latter environments are modulated by the earth's magnetic field. With SREM, mapping (1), temporal variations (2) and possibly directional measurements (3) of these particles populations will be carried out. The measurements of SREM will also be correlated with on-board degradations caused by radiation on the electronic parts, the CCDs, the solar cells.

(1) Through continuous operation of SREM, the models of the radiation belt positions, the particle fluxes and the geomagnetic shielding will be compared, updated or renewed for various electron and proton energies, and for cosmic rays.

(2) Through long-term operation of SREM, the radiation belt flux variations (storm injections, radiation belt motions), the solar particle event variations, the variation in geomagnetic shielding in response to storms, and the long-term variations in the SAA and Cosmic Rays (CR) fluxes will be studied. The measurements will be correlated with other spacecraft STRV, SOHO, GOES, etc.

(3) Using the manoeuvring capability of PROBA, the anisotropy of the radiation environment at low altitude can be measured. PROBA will be rotated such that the SREM points locally vertically

(up and down), and collects particular angles at different locations. In the SAA, PROBA will be slewed up to  $\pm 45^\circ$ . In order to obtain good statistics, this procedure should be performed repeatedly and over a period of time to see long-term flux variations, and during high solar activity to observe possible short-term atmospheric influences. Finally, since the SREM has measurement channels for high-energy protons and heavy ions, asymmetries in cosmic ray fluxes may be observed.

SREM was developed by Contraves (Switzerland).

### 2.5.3 - *DEBIE*

The DEBris In-orbit Evaluator (DEBIE) detector (Figure 7) on PROBA will measure for the first time the small size particulate fluxes in a polar type orbit. Information on the sub-centimetre size meteoroid and space debris population in space can only be gained by the analysis of returned material (for lower orbits) or by in-situ measurements.

DEBIE, developed by Patria Finnavitec (Finland) uses a combination of impact ionisation, momentum transfer and foil penetration for the detection of impacting particles. Mass and velocity of the impacting particle can be deduced from the recorded signals. The lower detection threshold is about  $10^{-14}$  g.

Two separate sensors facing in different directions (velocity direction and normal to the orbit plan) are mounted on the external walls of PROBA. According to the present models a few impacts per day are expected. The impacts measurements will be sent to ground at each contact together with the time and the sensors attitude and location at the time of the impact.

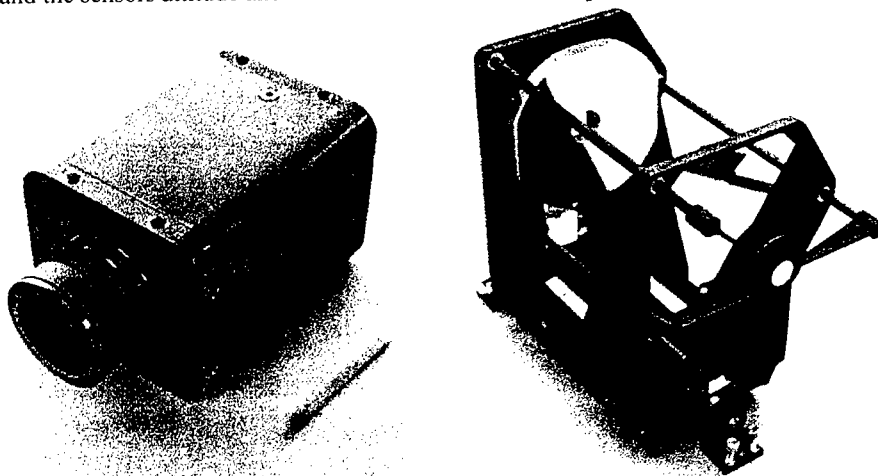


Figure 8: The two imagers to be accommodated on PROBA: the Wide Angle Camera (left) and the High Resolution Camera (right) providing 10 m resolution.

### 2.5.4 - *Imagers*

PROBA accommodates two imagers from OIP (Belgium), a Wide Angle Camera and a High Resolution Camera (Figure 8).

In orbit usage of the imagers will be through high level imaging requests which will be scheduled using the fly by prediction and planning functions of the spacecraft. The spacecraft can store and compress hundreds of these images between ground visibility. Images sent to ground will then be distributed using the Web.

WAC is a miniaturised (7x7x6 cm) black and white camera using a 640x480 CMOS Active Pixel Sensor with a field of view of 40 by 31 degrees. Images are digitised on 8 bits before transmission to the spacecraft.

HRC is a miniaturised black and white imager with 10 m ground resolution. The telescope is of the Cassegrain type with an aperture size of 115 mm and a focal length of 2296 mm. The detector is based on a CCD and uses 3D packaging technology. It contains 1024 x 1024 pixels of 14 µm size. The field of view (along the diagonal of the detector) is 0.504°. Images are digitised to 10 bits before transmission to the spacecraft.

## **2.6 - On-board Software**

The on-board software, which is running on the central Data Handling System, is a new development for PROBA. It uses VxWorks as operating system and is implemented in C by Spacebel (Belgium). Apart from the classical functionality of performing the spacecraft control, housekeeping and monitoring tasks, it contains also the autonomy related functionality such as the failure detection, identification and recovery functions, the ACNS software and the on-board mission planner. The latter function plans ground requests for payload operation tasks taking into account the available on-board resources and target visibility as predicted by the ACNS software. The ACNS software, described previously, is produced by the autocoding tool of Xmath and integrated in the rest of the on-board software. The on-board software follows the ESA Packet Utilisation Standard for the communications with the ground. PROBA and its software is designed such that it can be completely reprogrammed in flight.

## **3 - DEVELOPMENT**

The classical ESA development approach has been adapted to the objectives and the constraints of Proba. The project life cycle has been split in 3 main phases, the System Design Phase, the Production and Qualification phase and the Integration and Acceptance phase. Between each phase a peer review is performed by Estec.

The model philosophy adapted for PROBA is based on a Structural and Thermal model and the Proto-Flight model of the spacecraft. The PFM approach at spacecraft level was further supported by partial electrical models of most of the bus units.

In the area of software validation, spacecraft testing and operations preparation, the project has tried to optimise the available resources. This has been translated into the usage of a common environment for spacecraft testing and operations and the production of a Software Validation Facility (provided by SSF Finland) the early phase of the project. This latter tool simulates the entire spacecraft and allows that the on-board software executable code is executed in this facility as if it was running in the real hardware while enhanced testing and debugging capabilities are available. This facility is also connected to the common spacecraft test and spacecraft operations environment to provide a spacecraft simulator for the operation teams.

## **4 - GROUND STATION AND OPERATIONS**

One of the benefits of on-board autonomy is the reduced need for ground operators involvement in the mission operations and the associated reduction in ground-station operating costs. To exploit this to a maximum extent, the PROBA ground segment has been automated as much as possible while maintaining the required facilities limited.

With the ground station located in Redu (Belgium) about 4 times 10 minutes of visibility per day will be available in average.

The station, provided by SAS (Belgium), consists of a portable 2.4-m dish with S-band RF front-end and a control centre with limited facilities. The ground station provides the following functions:

1. Automatic link acquisition based on Norad elements and spacecraft navigation data;
2. Communications set-up protocol for the types of data (and their bit-rates) to be received;
3. Automatic uplink of previously screened observation requests and spacecraft planning commands;
4. Automated call of ground staff in case of detection of on-board anomalies;
5. Automated science data filing, notification of scientists and data distribution.

It is the intention that with the combination of on-board autonomy and the automation in the ground station, the involvement of ground operators during nominal and routine mission phases is limited to routine maintenance tasks on (typically) weekly basis. This ground operator receives after every pass a pass report summarising the spacecraft and ground station status. Furthermore, remote access to the ground station via a local network or via the internet provides the operators with the capability to access the downlinked spacecraft data whenever they wish.

To implement the described automations, the ground segment provides besides classical telecommand and telemetry also operation procedures support. These procedures implement the automatic link acquisition, setup procedures, routine spacecraft operation procedures and (limited) telemetry analysis. The same operations environment will also be used during subsystem and system check-out tests performed during the spacecraft integration and validation phase.

## 5 - CONCLUSIONS

The Proba mission design fulfils the ESA objectives of in-orbit technology demonstration, earth environment monitoring and preparatory earth observation. Technological units represent a significant part of the spacecraft and provide the advanced capabilities required by the instruments. The instruments will provide valuable scientific or preparatory data.

Proba demonstrates also that micro-satellite can efficiently combine in-orbit technology demonstration and operational missions and also be sufficiently flexible to be reconfigured for other missions.

## ACKNOWLEDGEMENTS

The authors would like to thank E. Daly, P. Nieminen, G. Drolshagen, D. Olsson (ESA/ESTEC), and SIRA for their valuable inputs to this paper.

## REFERENCES:

- [de Lafontaine 99] J. de Lafontaine, J. Buijs, P. Vuilleumier, P. Van den Braembussche, K. Mellab "Development of the PROBA Attitude Control and Navigation Software", *ESA-SP-425, Proceedings of the 4<sup>th</sup> ESA International Conference on Spacecraft Guidance, Navigation and Control Systems*, ESTEC Noordwijk, 18-21/10/1999, p. 427-441.
- [Teston 1999] F. Teston, R. Creasey, J. Bermyn, K. Mellab "PROBA: ESA's Autonomy and Technology Demonstration Mission", *Proceedings of the 13<sup>th</sup> Annual AIAA/USU Conference on Small Satellites*, August 23 - 26, 1999

## THE SCIENTIFIC MULTI-EXPERIMENT MISSION DAVID OF THE ITALIAN SPACE AGENCY

Marina RUGGIERI (\*)

Carlo BONIFAZI (°)

Aldo PARABONI (\*\*) Fabrizio CAPOBIANCO (°°) Carlo CAPSONI (\*\*)

Silvia DE FINA (\*)

Marco PRATESI (°°°)

(\*) *Università di Roma "Tor Vergata" - DIE, Via di Tor Vergata - 00133 Roma - Italy*

*ph: +39-06 7259 7451; fax: 7435; ruggieri@uniroma2.it, defina@eln.uniroma2.it*

(°) *Agenzia Spaziale Italiana, Via di Villa Patrizi, 13 - 00161 Roma, Italy*

*ph: +39-06 8567 425; fax: 406; bonifazi@asi.it*

(\*\*) *Politecnico di Milano - DEI, Piazza L. Da Vinci, 32 - 20133 Milano - Italy*

*ph: +39-02 23993586; fax: 3413; {paraboni,capsoni}@elet.polimi.it*

(°°) *DAVID Project Office c/o Università di Roma "Tor Vergata" -DIE*

(°°°) *CNIT, Parco Area delle Scienze, 181/A - 43100 Parma, Italy*

*ph: +39-0521 905 757; fax: 753; pratesi@nausicaa.eln.uniroma2.it*

**ABSTRACT** - *The DAVID mission of the Italian Space Agency will test the viability of W-band for the very wide-band satellite transmission of the forthcoming decades and the effectiveness of resource sharing techniques to countermeasure the propagation channel behaviour. The mission will allow the investigation of propagation constraints on the physical channel and the test of some advanced techniques for transferring high data volumes between remote and hardly accessible sites by maximising the transmission performance. The Program is presently undertaking phase B activities.*

### 1. INTRODUCTION

The DAVID (DATA and Video Interactive Distribution) mission is carried out in the framework of the Italian Space Agency (ASI) *Science Small Missions* Programme [1].

The scientific mission, proposed by M. Ruggieri, F. Vatalaro (*Università di Roma Tor Vergata*) and A. Paraboni (*Politecnico di Milano*) [2], is one of the eight proposals selected by ASI for the phase A study in 1998. Among the eight missions, DAVID has been, then, one of the two selected by ASI for deployment [3]-[5]. It will be embarked on the ASI platform *PRIMA (Italian Multi-Application Re-configurable Platform)*, under development at Alenia Aerospazio, and launched in 2003. The DAVID Program is presently undertaking phase B activities. The financial budget of the Program has been approved for the time-period 1999-2005.

The DAVID mission is aimed at the deployment of two scientific communications experiments on *PRIMA* in Low Earth Orbit (LEO) [6], [7].

One of the two experiments (labeled **E1**), proposed by the *Università "Tor Vergata"*, envisages the pioneering use of a 94 GHz link to collect and forward interactively to Internet a high volume of information data, through a LEO-GEO network architecture by using the *ARTEMIS* satellite. The experiment architecture will allow to explore a number of innovations from the radio-communications point of view. An additional feature concerns the possibility to test an experimental service towards very remote regions of the Earth, like Antarctica.

The other experiment (labeled **E2**), proposed by the *Politecnico di Milano*, envisages the validation at 22 GHz of a novel technique for sharing common system resources (power, codes, time) among a grid of Earth terminals, and the characterisation of the satellite-to-multipoint transfer medium. As an input, the experiment accounts for meteorological data of the area where the grid is located.

The experiments common operation will also contribute to the assessment of the satellite-channel behaviour at very different frequencies (22-94 GHz) for future telecommunications systems.

The paper describes the two experiments architecture and data handling, which have been optimised - during the present activity phase - to account for the improved performance of the *PRIMA* platform, with respect to those envisaged in the frame of the DAVID phase A.

## 2. THE EXPERIMENT E1

In Fig. 1 the architecture of E1 is depicted. The system adopts a link for the data collection in the 94 GHz range and an inter-satellite-link towards the *ARTEMIS* satellite in Ka-band (26 GHz; 23 GHz in the opposite direction). The collected data - in the order of 1 Gbyte per satellite pass - are forwarded through *ARTEMIS* transparently, reaching an Earth station at ESA/ESRIN in Frascati (Italy). The *ARTEMIS* transparent operations imply that a high volume storage capability is envisaged on-board the LEO, in order to guarantee the data collection from the sites independently on the visibility between the LEO and *ARTEMIS*. At ESA/ESRIN the received data, after some processing, will be located on a key-based INTERNET site, where they can be finally accessed by the DAVID experimental users [8]-[10].

Two 94 GHz Earth terminals are envisaged at the moment: one located in Italy (Spino d'Adda) and one in the Antarctica (at the ENEA-PNRA premises).

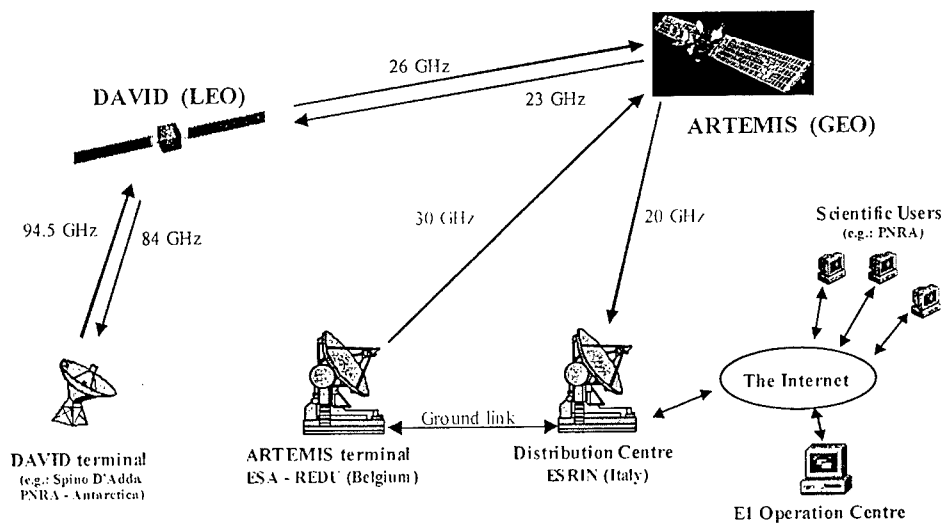


Fig. 1: E1 Experiment architecture

On the opposite link, a connection between ESA/ESRIN and the *ARTEMIS* gateway station located in Redu (Belgium) is envisaged. From there a transparent connection to the LEO through

*ARTEMIS* will be again achieved. From the LEO a down-link at 84 GHz is then carried out towards the W-band terminal, after an on-board storage. All the reverse links operates at a much smaller rate than the forward ones. A baseline of 2 Mbit/s is actually envisaged, although this figure may change to hundreds of kbit/s if a different E1 Earth terminal configuration will be selected.

The experiment implies various innovative features:

- a hybrid LEO/GEO architecture with exploitation of existing space and Earth segments (*ARTEMIS*, Redu and Frascati Earth stations) and terrestrial networks (*INTERNET*);
- use of the 94 GHz range for telecommunications purposes;
- high volume storage on-board a LEO;
- high data volumes collection capability from very remote areas (e.g. the South pole).

### 3. THE EXPERIMENT E2

This experiment is aimed at validating the effectiveness of one of the most promising fade countermeasures envisaged for the future Ka, V or W bands: the shared resource technique.

In such systems, the common resource in the down link can be realised in many ways: variable directivity pattern of the transmitting antenna, power control, back-up carrier at a lower (and less attenuated) frequency or burst length control. This last form is the one which has been assumed for the experiment, considering the economy constraints posed by the project, the non-necessity of a power back-off in the final amplifiers and the fact that this form is the simplest to be implemented, the most flexible to possible architecture reconfigurations and probably the nearest to the future applications. The experiment will be based on a set of terrestrial stations sharing the common resource, which is allocated by the satellite - at any instant - in an optimised form. The experiment consists basically in the following phases:

- Preliminary inspection on the general weather conditions, to estimate the variation range of the attenuation and noise in the various terminals. Moving from the inspection results, the type of signals and the power profile transmitted from the satellite in any position of his trajectory are determined.
- Station state assessment: in a period of about 1 sec. any terminal measures its BER and acknowledges to the central facility (located in Spino d' Adda) the measured value. This operation (called *assessment phase*) is repeated at least once per minute in average, i.e. 8 times during each satellite passage.
- The central facility optimises the system situation either by minimising the number of stations undergoing outage if the rate is fixed or, viceversa, by determining the data throughput which allows the station to keep in service. Whichever the optimisation may be, the central station gives a command to the stations indicating which file, among the many variously coded present in the transmitted frame, has to be utilised.
- The stations obey to the command and determine the variation of the optimised situation with respect to the situation in which the resource (the total fraction of time) is evenly distributed, i.e. non optimised (this operation is said *optimisation phase*).
- The gain so obtained is recorded and stored for further analyses off-line.

The experiment (Fig. 2) will be conducted at 22 GHz and will involve, as mentioned earlier, some Earth terminals (no more than 16) spread within an area allowing a maximum distance up to 300 km across track and a distance more than doubled (even if available only when the satellite is at low elevation) along track. The effectiveness of the system obviously lay on the de-correlation of the weather conditions in the various locations.



In the *assessment phase*, the parameters of the experiment have been determined under the basic constraint that the station state assessment should be completed with a precision better than 0.1 dB in about one second time. Using the original chip rate, these two constraints lead to a measurement range spanning from BER of  $10^{-5}$  at the satellite zenith position and the station nearly centrally located in the served zone (Spino d'Adda) and BER of  $2 \times 10^{-1}$  at 10 deg satellite elevation at the end of coverage. If necessary, this value can be kept more constant by attenuating the transmitted power during the passage, thereby simulating a "cosec<sup>2</sup>" type antenna which partially compensates for the variable distance with the directivity pattern.

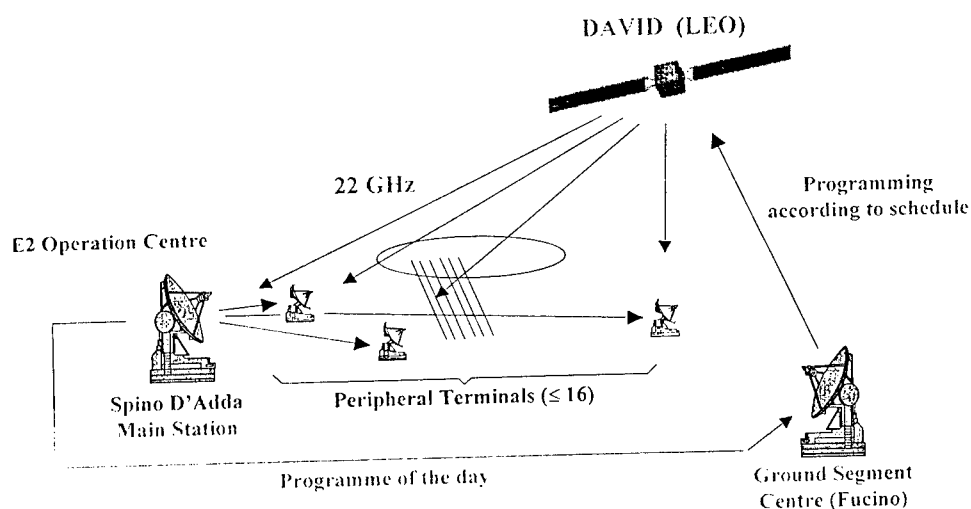


Fig. 2: E2 Experiment architecture

In the *optimisation phase*, the BER of the order of  $10^{-1}$  can be lowered of about 2 decades, thereby reaching a value suitable to the transmission of medium quality video signals, by means of coding. Actually the same message will be coded with various convolutional coding indexes and various de-spreading factors, being these replicas all accommodated in the transmitted frame and made available to the stations which will decode them according to the dispositions coming from the central station of Spino d'Adda. Naturally the dispositions are, on the whole, constrained to the fact that, in an actual system, the total time occupied by all messages does not exceed the allowed frame duration.

#### 4. DATA HANDLING

The data from the two experiments are collected by two different centres, either directly or through ARTEMIS. ESA/ESRIN, in Frascati (Italy), collects experiment E1 Data, while the Spino D'Adda Centre collects experiment E2 Data. Then the collected data are sent by both facilities to the ASI Data Centre in Italy for final archiving and distribution. During their latency in the two receiving centres, the data are also made available to authorised experimenters, scientists or users. At both centres, system managers and operators have tools to check, with different level of details, the status of the system and its components and to take appropriate corrective actions if necessary. These tools include: graphic display of system/sub-system status,

displaying of alert messages with various severity levels, list of available procedures (shutdown/restart, back-up/restore, process reset, etc.), etc.

The data exchanged with DAVID can be grouped into experiment data and service data. DAVID is interfaced with:

- Fucino station, which controls the satellite and up-links E1, E2 and DAVID service data;
- E1 sites, for collecting E1 data and down-linking user and protocol service data;
- E2 site, including a dispersed cluster of receiving antennas, for down-linking E2 data;
- ARTEMIS, to send to ground E1 data and receive user and protocol service data.

## 5. CONCLUSIONS

The experiments envisaged in the DAVID mission has been described, pointing out their optimised configurations, assessed in the frame of the actual activity phase. Aspects of data handling have been also pointed out.

An intense activity is presently being undertaken to define the payload and its the interface with the *PRIMA* platform.

## 6. REFERENCES

- [1] S. Di Pippo, *The ASI "Science Small Missions" Program*, in Proceed. 4<sup>th</sup> International Symposium on Small Satellites Systems and Services Antibes-Juan Les Pins, September 1998, Session 3.
- [2] A. Paraboni, M. Ruggieri, F. Vatalaro: Proposal of a Telecommunications Mission with a Low Earth Orbit Small Satellite, in Response to the ASI Small Mission Call for Ideas, June 1997.
- [3] M. Ruggieri: *The DAVID Mission: Cost Report*, ASI Contract. n. ARS-98-6, September 28, 1998.
- [4] M. Ruggieri: *The DAVID Mission: Final Report*, part I, ASI Contract. n. ARS-98-6, October 28, 1998.
- [5] M. Ruggieri et alii: *The DAVID Mission: Final Report*, part II, ASI Contract. n. ARS-98-6, October 28, 1998.
- [6] M. Ruggieri, F. Vatalaro, A. Paraboni, C. Bonifazi: *DAVID: A Small Satellite Mission for Data Distribution*, Proceed. 4<sup>th</sup> International Symposium on Small Satellites Systems and Services, Antibes-Juan Les Pins, September 1998, Session 3.
- [7] M. Ruggieri, A. Paraboni, S. Greco, E. Saggese, C. Bonifazi: *The Use of Ka-band in the DAVID Small Mission*", Proceed. 4<sup>th</sup> Ka-band Utilisation Conference, Venice, November 1998, pp. 357-363.
- [8] M. Ruggieri, C. Bonifazi, S. Falzini, E. Saggese, F. Corbelli: *Scientific Data Collection from Remote Areas through the DAVID Satellite 94 GHz Experiment*, EUROSPACE Data Systems in Aerospace International Conference (DASIA) '99, Lisbon, May 1999, SP-447 pp. 351-355.
- [9] M. Ruggieri: *Integration of High Volume Data Collection Systems with Mobile Networks*, IMSC '99, Ottawa, June 1999, pp. 361-365.
- [10] M. Ruggieri, M. Pratesi, M. Donati: *A Protocol Architecture for the Data Collection Experiment of the DAVID Satellite*, Proceed. ECSC-5, Toulouse, November 1999.

---

## SMART-1 TECHNOLOGY EXPERIMENTS IN PREPARATION TO FUTURE ESA PLANETARY MISSIONS

Andrea MARINI, Giuseppe RACCA, Bernard FOING

*European Space Agency - ESA/ESTEC  
Noordwijk - The Netherlands*

**ABSTRACT** - *SMART-1 is the first ESA Small Mission for Advanced Research in Technology, with the prime objective of demonstrating the use of Solar Electric Primary Propulsion in a lunar mission. Further to this, SMART-1 spacecraft will rely on novel technologies (such as Lithium-ion batteries, a CAN bus for on-board data handling and miniature star trackers) and will embark six instrument carrying out nine technology and science experiments, all aimed at preparing future ESA planetary missions, such as the Mercury cornerstone.*

### 1. INTRODUCTION

SMART-1 is the first of the Small Missions for Advanced Research in Technology of the ESA Horizons 2000 Science Plan, aimed at preparing the key-technologies of future ESA scientific missions. SMART-1 has been conceived to demonstrate the enabling technologies for next planetary missions such as the Mercury Cornerstone, in a mission to the Moon. The prime technology objective of SMART-1 is the demonstration of the use of the Solar Electric Primary Propulsion for reaching the planetary target and of the relevant technique of flight control and operations. The spacecraft, though limited in size and mass, is designed against the challenging power and thermal requirements of the electric propulsion sub-system and is conceived to incorporate both cost-effective and off-the-shelf units and components and innovative on-board technologies to test. Furthermore nine technology and science experiments carried out by six on-board instruments - selected by means of two Announcement of Opportunities [1] - are completing the technology demonstration program of SMART-1.

### 2. THE MISSION AND THE DEMONSTRATION OF THE ELECTRIC PROPULSION

The SMART-1 spacecraft will be launched in late 2002 by an Ariane-5 as a Cyclade auxiliary passenger. Once delivered in Geo-stationary Transfer Orbit, the electric propulsion will be switched-on and the spacecraft will spiral out to reach the boundary of the moon orbit in 15 to 17 months, depending on the launch date. Optimisation of the orbit by means of coast arcs (once out of the main radiation belts) and exploitation of weak gravity assists to change the orbit plane and capture the lunar orbit are foreseen [2]. The electric propulsion will be used also to insert the spacecraft in an observational orbit around the Moon to be maintained for at least six months of Moon science and technology operation: with this mission profile, the flight dynamics and control of a full-scale planetary mission will be tested with SMART-1. The target Moon orbit will be polar with the pericentre close to the lunar South Pole at an altitude ranging between 300 and 1900 km, whereas the Apocentre will extend up to 10000 km. The argument of the perilune will drift from 235° to 305° during the six months, allowing to observe with unprecedented resolution the southern lunar hemisphere.

The selected thruster for the electric propulsion is a Stationary Plasma Thruster (or Hall Effect Thruster) called PPS-1350 and is manufactured by Snecma. It provides the relatively high thrust

force of 70 mN with a specific impulse of about 1500 s. At the power level of SMART the electric propulsion subsystem consumes 1350 W. To cope with the high power demand of the electric propulsion, the spacecraft is equipped with two individually steerable large solar arrays (14 m tip-to-tip) based on multiple-junction cascade cells able to deliver 1845 W at the beginning of life. The thermal load of the power conversion and thrusters is dissipated by radiators on the side of the spacecraft body and with the aid of heat pipes to convey the high thermal load of the power conversion unit. The thruster is mounted on a gimbal which allows the orientation of the thrust vector within a few degrees and which permits to exploit it also in the attitude control and maintenance manoeuvring. An artist impression of the thruster mounted on the orientation mechanism is shown in Fig.1 .

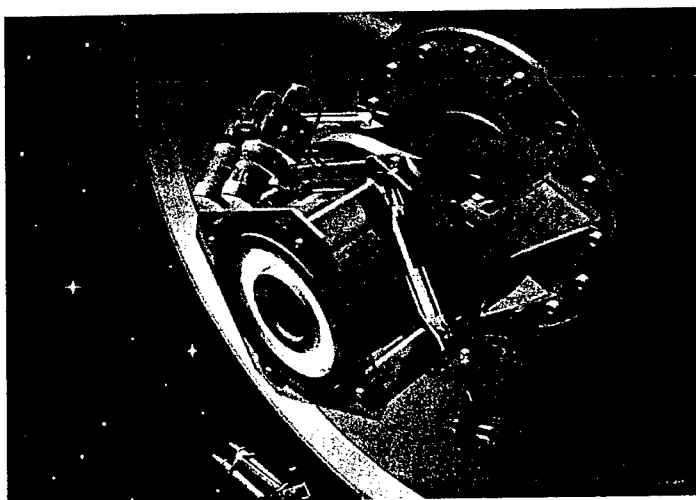
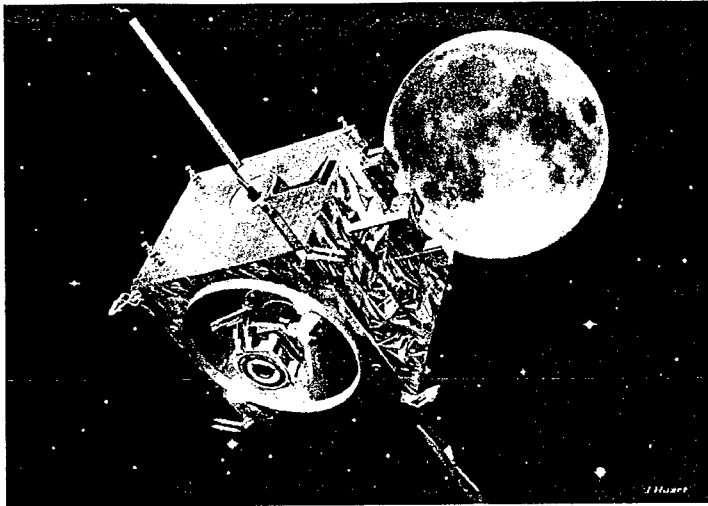


Fig.1: Artist's view of the gimballing PPS-1350 thruster.

### 3. THE SPACECRAFT TECHNOLOGY AND THE EXPERIMENTS

The SMART-1 spacecraft is a small platform shaped as a box of about 1 m side, weighing 350 kg at launch and carrying about 80 kg of Xenon fuel for the electric propulsion. Further to the mentioned high-efficiency solar arrays, new technology items on-board the spacecraft are the five Lithium-ion secondary batteries, which provide high energy storage per unit mass (130 Ah per ~ 1.2 kg cell), the two miniaturised autonomous star-trackers and the CAN-bus for data handling, derived from commercial automotive applications [3]. The spacecraft is designed to operate with minimum ground intervention and use of ground stations on availability basis with - in average - a pass every 4 days. Autonomous thrusting for periods up to 10 days and autonomous restoration of thrusting after identified on-board single failures is implemented in the on-board software. The attitude and orbit control system is completed by sun sensors, gyro's, reaction wheel and a redundant four-thrusters hydrazine system to desaturate the wheels.

An artist's view of the spacecraft en route towards the moon is shown in Fig.2



**Fig.2 :** Artist's view of SMART-1 spacecraft: close-up on the spacecraft body.

The spacecraft embarks six instruments - for a total of 15 kg mass - which carry out nine experiments in science and technology. All the instruments are designed to high miniaturisation and exploit technologies which shall be used for future planetary missions. In spite of being not the primary objective, science data are expected from SMART-1 mission especially in the field of Moon geo-physics and mineralogy, completing and integrating the current databases established with missions as Clementine and Lunar Prospector. During the long cruise phase, in coincidence of the coast arcs cruise science will be performed and the spacecraft will be pointed to stare at selected celestial sources or to the Earth.

Plasma and Electric propulsion diagnostics are addressed by **SPEDE** (Spacecraft Potential, Electron and Dust Experiment) and **EPDP** (Electric Propulsion Diagnostics Package). **SPEDE** is a spacecraft potential, plasma and charged particles detector which characterise both spacecraft and planetary environment in the 0-40 eV range, by means of two Titanium-nitride probes mounted on booms on the side panels of the spacecraft. Both sensors can monitor the potential difference between the sensor and the spacecraft (in a current-biased mode), or measure the electron flux (in a voltage-biased mode) and any combination is possible. Continuous plasma and potential measurements are foreseen, both to monitor the Electric propulsion and to study space weather and solar wind interaction with the Earth and the Moon. **EPDP** monitors more closely the electric propulsion and its effects on the spacecraft by means of a suite of sensors detecting secondary thrust-ions in the 0-400 eV range by means of a Langmuir probe and a retarding potential analyser. Contamination and deposition effects on the spacecraft are monitored by means of a quartz-crystal micro-balance and a solar cell.

The performance of the Electric Propulsion are also monitored by high-accuracy tracking in Ka-Band, making use of **KATE** (Ka-band TT&C Experiment), an experimental X/Ka-band deep-space transponder, with a potential resolution of  $1.5 \cdot 10^{-6} \text{ m/s}^2$  acceleration and  $5 \cdot 10^{-4} \text{ N}$  thrust force variation, for an integration time of about 10 s . The main objective of KATE, however, is to test all the standard TT&C functions (Telecommand, Telemetry, Doppler tracking and Ranging) and additionally - for the first time - to demonstrate Turbo-coding in space and possibly the VLBI (Very Large Base Interferometry) tracking technique. With a medium gain horn antenna and making use of turbo-coding, KATE is able to transmit from lunar orbit up to 500 Kbps and it will be used to dump (at a lower data rate) the data from the spacecraft mass memory via the CAN bus, contributing to the throughput of the science observations. KATE

represents also the on-board equipment for the **RSIS** (Radio-Science for SMART-1), a set of radio-science and technology investigations, aimed at characterising the Ka-band communication channel and at verifying from Moon orbit the measurement method of libration properties of the planetary target, by means of imaging the Moon surface and tracking with high accuracy the spacecraft orbit at the same time. **RSIS** is of great relevance for the forthcoming ESA Mercury Cornerstone mission.

A set of miniaturised instruments for imaging and spectrometry are testing novel technologies and support original lunar science investigations. **D-CIXS** (Demonstration of a Compact Imaging X-ray Spectrometer) is an X-ray spectrometer based on novel Swept Charge Device (SCD) detectors and a micro-structure collimator realised with micro-lithographic techniques and it weighs about 3.5 kg. With its 36° by 12° field-of-view, **D-CIXS** aims at observing both diffused celestial X-ray sources and at measuring secondary X-ray emissions for lunar crust global elemental mapping in the 0.5-10 keV spectral range, with 140 eV resolution. **D-CIXS** is supported by two wide-field-of-view (104°) X-ray Solar Monitors (**XSM**) to calibrate the **D-CIXS** spectra with respect to the background flux and to map solar X-emissions in the 0.8 -20 keV spectral range.

**SIR** (SMART-1 Infrared Spectrometer) is a miniaturised quasi-monolithic point-spectrometer, operating in the Near-Infrared, resolving 256 spectral channels in the 0.9 ÷ 2.4 µm wavelength range. The quartz spectrometer core is derived from a commercial device and it is coupled to a folded lightweight off-axis telescope with an aperture of 70 mm and a field-of-view of 1mrad. **SIR** weighs less than 2 kg. It will be tested in lunar orbit to survey the Moon surface of the Southern hemisphere in previously uncovered optical regions.

**AMIE** (Asteroid and Moon micro-Imager Experiment) is a miniature camera imaging with 4 different spectral bands (450, 750, 847 and 950 nm) by means of a thin film filter deposited on the CCD surface. It has a square field-of-view of 5.3° and weighs about 1.8 kg. **AMIE** has autonomous signal processing and image storage capabilities and is designed with highly integrated and miniature 3-D packaged electronics. High-resolution images will be taken at the lunar South Pole and throughout the whole mission. Earth and Moon images for PR and public outreach will be made available. Furthermore **AMIE** is supporting three guest investigations: **Laser-link**, **OBAN** and **RSIS**. **Laser-Link** will demonstrate the acquisition of a deep-space laser-link from the ESA Optical Ground Station at Tenerife and the use of a sub-aperturing system to mitigate turbulence effect on the laser beam propagation in atmosphere. **OBAN** is the off-line demonstration of an autonomous navigation code, based on the processing of images from **AMIE** and from the star-tracker. Support to **RSIS** is given for testing the method of measuring libration from orbit, as described above.

#### 4. REFERENCES

- [1] - G.D.Racca et al: "An overview of the first ESA small Mission for advanced research and technology"- Proc.of 4<sup>th</sup> Symposium on SSSS - Antibes - Sept.1998.
- [2] - G.D.Racca, B.H.Foing, P.Rathsman:"An overview of the status of the SMART-1 mission" - Proc.of 50<sup>th</sup> IAF Congress - Amsterdam - Oct. 1999.
- [3] - A.Elfving, L.Stagnaro, A.Winton:"SMART-1: Key technologies and autonomy implementations" - Proc.of 4<sup>th</sup> IAA Intl.Conf. on low-cost planetary missions- John Hopkins Univ.,USA- May 2000.

**SMALL SATELLITES AS COMPLEX SYSTEMS:  
MANAGEMENT TOOLS AND TECHNIQUES  
AND THE FEDSAT PROJECT**

**James Bradfield MOODY**

*Australia-Asia School of Management  
Australian National University  
Canberra, ACT, 2600, Australia.  
jimmy@ieee.org*

**ABSTRACT** - *It has been widely recognised that the management of small satellites requires new and innovative tools and techniques. This paper describes a number of management tools for the development of small satellites, and relates these to the ideas behind small satellite philosophy. It places these tools within the Complex Product Systems (CoPS) framework, an area of management theory which concentrates on the development of complicated, once-off systems.*

*A case study investigation of the development and implementation of the FedSat small satellite project is presented, within the context of the Complex Product System. FedSat, a low-cost satellite being developed jointly by the CRCSS and Space Innovations Limited (SIL), will conduct communications, space-science and engineering experiments orbiting 800km around the Earth. The paper describes the current status of the FedSat platform, and describes some of the lessons learnt over the development of the FedSat mission.*

*The FedSat bus is a 3-axis stabilised micro-satellite with a mass of 58kg. It is shown that the complexity of this and other small satellites is comparable to that of a large satellite. The use of small satellite management tools with a focus on Complex Product Systems led to a different management style to that of traditional programs.*

*There has been no study to date looking at the relationship between small satellites and Complex Product Systems and the benefits that can be gained by analysing them in this way. In this paper we show that the complex product system is a more meaningful means of analysing this complicated industry and point towards areas of future investigation.*

## **1 - INTRODUCTION**

A large amount of research into the effective management of space projects has been undertaken in recent years (see for example Bearden 1995; Callen 1999; NASA 1999). However, there have been few attempts to place this industry, and specifically small satellite projects within contemporary innovation theory.

This paper focuses on the tools required for the effective management of a small satellite project and relates this to a particular field of management theory, Complex Product Systems (CoPS). CoPS are highly customised, one-off or batch products, embodying a large number of customised, interacting sub-assemblies and components. They are typically high-cost, long-term projects with complex interfaces and high technology elements.

Section 2 of this paper outlines the basic theory of Complex Product Systems and describes their characteristics in selected areas of project management. Section 3 builds upon this to outline different tools that can be used in the development of CoPS.

Section 4 of this paper relates the Complex Product System to the space industry, and shows that the Small Satellite can be analysed using this framework. It also outlines the small satellite philosophy and the different management characteristics of small satellite projects.

A case study of the development and implementation of a small satellite is then presented in Section 5. The FedSat satellite, currently to be launched in 2001, is described and the different tools used in its development are detailed. The small satellite philosophy is then analysed from the perspective of the Complex Product System in Section 6, which outlines a number of tools and techniques that could be used for the effective management of the FedSat project.

## **2 - COMPLEX PRODUCT SYSTEMS**

A new field of innovation research is developing around the theme of Complex Product Systems (CoPS). These are high-cost, complicated systems which embody a large number of customised, interacting sub-assemblies and components (Hobday 1998).

Complex Product Systems are usually supplied in unit or batch production and are tailored to meet the requirements of particular large users (Davies 1996). They undergo continuous innovation and development and often have long service life expectancies. Examples of Complex Product Systems include intelligent buildings, telecommunications exchanges, flight simulators, aeroplanes, weapons systems and manufacturing plants.

(Brusoni, Prencipe et al. 1998) suggest that there are four characteristics of CoPS that set them apart from mass produced goods. These are (a) they are high cost systems composed of many interacting and often customised elements; (b) their design, development and production usually involve several firms; (c) they exhibit emerging and unpredictable properties; and (d) the degree of user involvement is usually very high.

In CoPS, the project and the product need to be considered together, as each have a direct impact on the other. In many cases the product shapes the project and the project determines the quality and use of the product (Davies 1997). This is different to traditional, batch processes, where the management of the project may not be greatly influenced by each and every product.

CoPS are developed under a customer-driven rather than a supply driven system. As opposed to many mass produced systems where the product is produced and then a customer is found, CoPS production only begins after an order has been placed. This results in a customer-pull, rather than a supplier-push system of innovation



CoPS industries are typically bilateral oligopolies with a few large suppliers conducting business with a few large customers. Governments are often involved directly as partners (Davies 1997) or through the purchasing of equipment and the establishment of standards. As a result of this involvement, CoPS industries may often become highly politicised as alliances are formed between system suppliers, large users, standard making bodies and regulators.

Over the past years there has been a shift towards CoPS industries, particularly in advanced industrial nations. Only recently, however, has the importance of CoPS been recognised and systematically investigated.

### **3 - COPS MANAGEMENT TOOLS AND TECHNIQUES**

There has been a considerable amount of research into different management tools and techniques in the area of innovation theory. However, most of these tools were developed for managing mass-produced goods which follow the product life-cycle model (Brady 1995). While not attempting to be a rigorous survey of everything available, this section outlines some the different tools that are used, and gives their applicability to the CoPS domain.

#### **3.1 - Project Wide Tools and Techniques**

A number of tools and techniques have been developed to facilitate the development of an entire project. These include strategic tools such as innovation models as well as diagnostic and auditing tools such as benchmarking to assess management performance.

Learning and technology transfer tools can be used to ensure the smooth transition of information and resources from one project to another. In Complex Product Systems this is particularly important as it is the main method for capacity building within a company.

#### **3.2 - Research & Development Tools and Techniques**

High technology industries invest heavily in Research & Development and the development of new technology and products. It is widely recognised that R&D creates competitive advantages, allows high technology companies to establish business opportunities, supports existing activities and predicts future trends (Dodgson 2000).

There have been numerous different tools and models developed to address the management of R&D within the innovation process. Over 250 models have been cited which are designed to assist in the R&D project selection process and numerous literature has evolved to facilitate the introduction of successful R&D campaigns (Brady 1995).

Firms producing Complex Product Systems have been slow to adopt these tools into their innovation management processes. The more complex decision-event tools have been ignored by industry, although simpler models involving checklists and weighting of alternatives have been used. Especially in the area of CoPS, there is much progress to be made.

#### **3.3 - Product Innovation Tools and Techniques**

A number of tools exist to assist in the development of the product innovation process. These are used in the process of incorporating the voice of the customer in product design and offer systematic approaches to improving products at a reduced cost.

This type of tool includes areas such as Value Engineering/Value Analysis (VE/VA) and Quality Function Deployment (QFD) which both attempt to capture user requirements and translate them into a minimum cost for the project (Clausing 1991). Unfortunately, many of these tools are not sufficiently developed to handle the complexity of the typical Complex Product System

### **3.4 - Process Innovation Tools and Techniques**

This area of process innovation encompasses the fields of continuous improvement and quality. (Slack 1995; Brady 1995). Whereas R&D focuses on the development of radical innovations, these tools facilitate the incremental innovations within a firm. This is the philosophy behind many of the Japanese product management techniques that western companies have tried to emulate.

In addition, quality and continuous improvement are becoming increasingly important as firms become more customer-oriented. A number of tools have been developed to ensure that quality is an integral part of process development, including TQM, fishbone diagrams, pareto charts and many more (Dodgson 2000).

For Complex Product Systems, the product and the project must be analysed together. As a result, process innovation becomes integrated with product innovation, blurring the line between the two. However, tools focussing on quality can still be used on a product to product basis.

### **3.5 - Project Management Tools and Techniques**

Project management is concerned with the planning, scheduling and control of projects. This is the area which is most applicable to the CoPS domain, as many of tools were developed for the defence and missile industry to assist the development of these systems.

The Gantt chart was the first such tool developed for project management purposes. Used extensively for project scheduling, it unfortunately starts to prove ineffective for more complex projects with a large number of interdependencies and is unable to incorporate uncertainties into activity durations. Network planning tools such as PERT (program evaluation and review technique) and CPM (critical path method) were mainly used to take account of both time and cost scheduling, using ideas such as work Breakdown Structure and Earned Value (Brady 1995).

Risk management is also an important tool in the development of CoPS. Many projects require effective risk management to anticipate future problems and facilitate contingency planning.

Despite the universal adoption of some of these tools, care has to be taken in their use. Some of the more developed tools should not be regarded as a panacea; nor are they applicable to the management of all projects. Many have their main strength in small projects where time is of the essence and may not deal effectively with the complexity of a CoPS project.

It is interesting to note that even with these tools in widespread use, projects still continue to be plagued with cost and schedule overruns and technical difficulties, questioning the extent of their success in the effective management of a project.

### **3.6 - Software Development Tools and Techniques**

Software engineering has become more prevalent in the production of large systems over the last twenty years. With the introduction of embedded software, the control, flexibility and performance of many products have been improved, while systems integration and software engineering have become central to the mechanisms of innovation in many CoPS (Hobday and Brady 1997).

In software project management it is especially important to manage distributed development processes that have to bridge between organisational boundaries. In addition, the appropriateness of formal methods, the selection of tools and methods (seeing through the hype) and software re-use are the key to major productivity increases.

The most often used software development tool is the Capability Maturity Model (CMM), developed by the US Department of Defence (Hobday 1996). The idea behind this model is that the quality of the software output relies on the management of the software and classifies software design into one of five levels depending on the quality of the organisation's software processes

#### **4 - THE SMALL SATELLITE INDUSTRY AND COPS**

Satellites are an excellent example of Complex Product Systems. Initially developed from another CoPS industry, the defence and missile industry, they provide a good means for CoPS investigations. Previous research has shown that they exhibit many of the characteristics of these systems (Moody 2000), including:

- The satellite industry is a market-pull industry, where projects are tendered and then bid for.
- Satellites are never mass-produced, and in only a few instances (such as the Iridium network) have they been batch-produced. This results in different approaches to technology transfer and project-project learning.
- Satellites are high cost projects with long product cycles
- Satellite projects are engineering intensive with complex interfaces. They have interfaces with a potentially large number of subcontractors and suppliers.
- There is usually a large amount of policy involvement in the development of satellite projects. Governments have often been purchasers or producers of satellite technology, and even with the current trend towards commercialisation the involvement of government is still prominent.
- Satellites are built on a project basis, rather than product basis. Companies with satellite projects typically work on a project-to-project basis, unlike many mass produced industries which concentrate on the continuous development of one or more products.

There has been no study to date looking at the role of CoPS in the small satellite industry, and the benefits that can be gained by analysing it in this way. The following sections outline the applicability of the CoPS framework to the management of small satellites and the implication of this analysis.

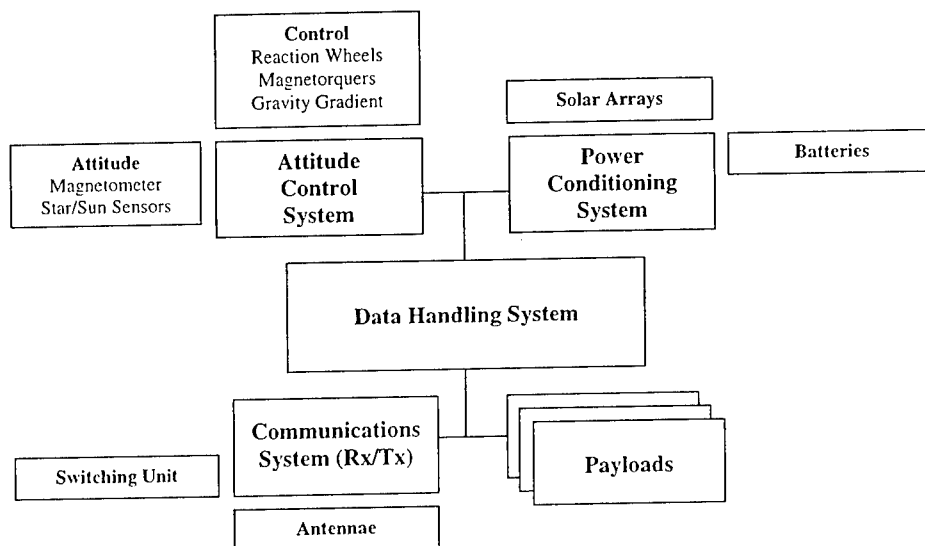
##### **4.1 - Small Satellite Complexity**

Small Satellites are becoming more prominent in today's space industry (Kingwell 1999). Although smaller in scale than the traditional satellite, small satellites also exhibit many of the characteristics of complex product systems. In this section we argue that the complexity of a small satellite is comparable with that of a larger satellite mission, and requires a similar range of management techniques.

Small Satellites are typically consist of the same basic 'building blocks' as large satellites, in that they contain a Data Handling System, Communications System, Power System, Attitude Control System and payloads as shown in Figure 1 (Vesely 1999). The interfaces between these different components is similarly complex and needs to be managed accordingly.

Recent improvements in computer technology have also resulted in the software complexity of small satellites becoming comparable to that of larger ones, especially as small satellites become asked to meet more requirements and perform greater tasks. In addition, as small satellites start to use techniques such as three-axis stabilisation for control, the complexity of the software is at the same level as that of large satellite projects.

As small satellites are often launched alongside large satellites, they are given similarly rigorous testing requirements by the launch authority. It is recognised, however, that the design and manufacture of a small satellite structure is made easier by the reduction in size.



**Figure 1:** Example of small satellite architecture

A small satellite project also exhibits all of the features that normally indicate a Complex Product System, in much the same way that large satellites do. Small Satellite Projects exhibit all of the characteristics of large satellites listed above, except, perhaps for the long product cycles and high costs. Indeed, this also results in different approaches to managing the project and in some cases increases the complexity due to the added efficiency that must be obtained from the project resources.

As a result, for the sake of analysis it is suggested that small satellites can be treated as CoPS alongside large satellites. The impact of the reduction in timescales and cost on the small satellite project is outlined in the following section.

#### 4.2 - The Small Satellite Philosophy

Traditional space missions require a large resource base and have taken many years to complete. As such, space programs were limited to relatively large and wealthy nations or international agencies. However, this is no longer the case; advances in microelectronics have made small-scale space missions both affordable and practicable, delivering valuable results (Sweeting 1996).

The Small Satellite Philosophy is the philosophy behind the management and operation of these smaller space missions. This philosophy is reflected in the now well established promotion of 'faster, better, cheaper' (FBC) space missions at NASA (Watzin 1998), and requires a new way of approaching complex systems. The context for the implementation for these small missions is summarised in the table below (NASA 1999):

Faster	Smaller	Cheaper
Reduce time from selection to launch	Spacecraft to fit capabilities of med-life, Pegasus and Ultra-lite launch vehicles	Cost has become a primary evaluation and selection criteria and performance measure
Reduce Mission Operations duration	Simpler Implementation of ground segment	Capped yearly and total budgets for mission operations phase
Develop enabling technology	Develop enabling technology	Develop enabling technology

(Watzin 1998) also gives some of the characteristics of small satellite projects as:

- Principle Investigator focused teams
- Agile, balanced project management
- Strong Systems Engineering
- Active Principle Investigators with hardware experience
- Dedicated lead engineers with "systems perspective"
- Decision-making at the lowest possible level
- Minimal documentation - documents only when value is added and to facilitate communication
- Compressed Schedule
- Partner-like relationship with vendors

The small satellite management philosophy implies effective management of fewer resources and accelerated deadlines. However, it first requires a number of issues to be resolved; reduced resources require trade-offs between risk and cost, complexity and utility; advanced timelines have an impact on component ordering and project monitoring. As such, the small satellite philosophy requires innovation to be managed more effectively at a much faster rate.

### 4.3 - Small Satellite Management

One of the outcomes of the small satellite philosophy is a much closer scrutiny of the project, in order to deliver a more cost-effective implementation of a mission. Management procedures must be continually revisited to ensure their effectiveness for each situation.

Under the FBC small satellite philosophy, Quality-based management practices are key to the implementation of the project. To obtain a low cost solution, mission development time must be minimised, requiring the ruthless removal of activities or practices that do not add value. Bureaucratic processes must be eliminated and replaced with the flexibility to change quickly and often.

In the development of small satellites, past experiences have shown that Smaller Project Teams with closer and informal communication channels is necessary, with open communication between science, engineering and management. Teams need to be collocated, should be insulated by management from the day-to-day operation of the business and close contact between all members of the team is encouraged. Trust and respect are key factors in the operation of these teams.

The importance of maintaining the original cost commitment requires that experienced development managers and personnel in key disciplines are selected early, remaining through the duration of the mission. Simple tools must be established and accepted by all from the beginning to provide insight of potential problems well before the contingency threshold is reached. With the aid of these tools the performance of the teams must be reviewed frequently and thoroughly down to manpower levels (NASA 1999).

In summary, all programs have found that the management of these projects requires a focus on competence, empowerment with responsibility and freedom to innovate outside the norms (Watzin 1998). It is recognised that the FBC Small Satellite Philosophy is a mechanism to promote creativity and responsibility on the part of the mission teams, obtaining an order of magnitude improvement in schedule and cost while maintaining the mission effectiveness.

## 5 - THE FEDSAT PROJECT

In November 2000, the Cooperative Research Centre for Satellite Systems (CRCSS) is launching Australia's first satellite mission for more than 30 years (Kingwell 1999). FedSat, one of the CRCSS's major projects, is a joint government-private sector initiative designed to unite the different components of the Australian Space Industry. The low-cost, 58kg satellite will conduct communications, space-science and engineering experiments orbiting 800km around the earth and will be launched in time to celebrate Australia's Centenary of Federation in 2001.

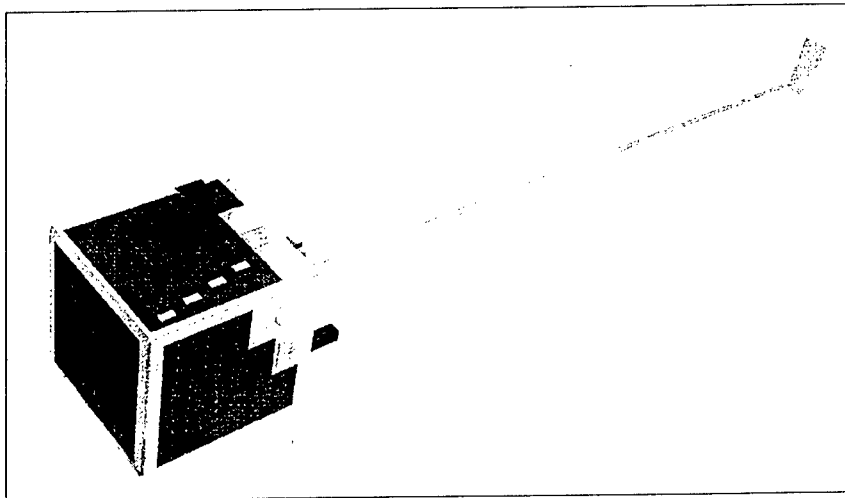


Figure 2: The FedSat Small Satellite

### 5.1 - Project Outline

The satellite is being built under an international collaboration between the CRCSS and Space Innovations Limited (SIL), a small satellite company located in the heart of the United Kingdom. SIL is providing their experience in small satellite systems to produce the spacecraft platform, which will interface to the Australian payloads (Moody 2000).

There are a large number of sub-contractors for the mission, coming from different countries including South Africa, Canada, the United Kingdom, the United States and Japan. In addition, the

payloads for FedSat are being built by five separate universities distributed around Australia. This requires effective interface management between each of the different partners.

The project attempts to use the small satellite philosophy during the project development, and accepts higher risks in return for reductions in necessary project resources. The satellite platform is being implemented by a small, flexible team aiming to promote problem solving at the lowest level.

One of the important goals of the FedSat mission is to facilitate technology transfer to following projects, with an aim of developing a sustainable Australian Space Industry. For this reason, two CRCSS employees have been placed with SIL to assist in the development of the satellite bus. Not only do these engineers add to the resources available within the project, but they are also effective technology transfer agents for the contracting companies.

## **5.2 - Satellite Characteristics**

FedSat will conduct communications, space-science and engineering experiments orbiting 800km around the Earth (Vesely 1999). Consisting of a 3-axis stabilised micro-satellite with a mass of 58kg, the structure is a variant of the standard MicroSIL™ structure adapted to interface with the NASDA H-IIA launcher. The cubic satellite is 50cm in length, with a small addition on one face for the stowed boom. The design is based around six honeycomb outer panels and an interior double shelf dividing the platform equipment from the payloads.

The Data Handling System and Power Conditioning System platform sub-elements are used as load bearing parts of the primary structure. This simplifies the design considerably, and minimises the mass while efficiently utilising the available volume. This structure requires careful and rigorous design however; should any member of the load-carrying path change, the complete design requires verification once more.

Two S-band patch antennae, and the communications payload antennae (UHF quarter-wave whip, and Ka-band isoflux) extend down below the nadir face. Of these, only the UHF antennae will be folded away for launch. The other two S-band antennae will be accommodated on the zenith face, and the GPS payload patch antenna is placed on the negative velocity face.

The structural design is intended to ensure that there is no requirement for active thermal control and preliminary analyses of the system show no serious thermal problems in the body of the satellite. However, it may be necessary to provide heating for the payload magnetometer on the end of the boom.

## **5.3 - Tools and Techniques**

A preliminary case study was undertaken to address the issues of tool use within the FedSat project from a CoPS perspective. This was part of a larger case study undertaken as part of the analysis of the management of the entire FedSat system. The case study was undertaken using structured interviews and a CoPS interview template supplied by the CENTRIM/SPRU in Brighton. In addition, as a member of the project team, the investigator had the opportunity to gain information and experience as part of a larger project-group study.

In the implementation of the FedSat project a range of innovation management tools were used, similar to the management of other high-technology projects. Throughout the life of the project, traditional project management and scheduling tools were used to monitor the progress of the project. The evolution of these tools, from project conception and tender to design, implementation and finally Assembly Integration and Testing (AIT) are described below.

Initially, a mixture of professional and in-house tools were used to develop both the request for proposal and the main proposal from the subcontractor. These tools used a mixture of information from previous projects and in-house research. In addition, in-house accounting packages and engineering estimation tools provided information on costing for the project tender.

In the design phase different techniques were used to manage the effective execution of the project. Once again, the traditional scheduling and accounting tools were used to main control of costs and schedules. In addition, as opposed to general procedures and system, specific stand-alone management tools were designed to achieve particular tasks.

Finally, in the Assembly, Integration and Testing (AIT) phases, tools were used to transfer learning from the design team to the testing team. Much of the design knowledge was stored in tools developed in-house to speed the operation of AIT.

Tools were also used to maintain company wide technology and experience, essential for project-to-project learning. The prime-contractor developed a large number of in-house systems engineering and design tools for use in the development of satellite projects. These tools retained much of the engineering knowledge stored within the company and also resulted in large efficiency improvements in later satellite development phases.

It was also noted that the nature of this small satellite project meant that larger tools cannot be bought due to the prohibitive cost. As a result many management tools needed to be developed in-house, or existing tools were used in innovative ways. In addition, there were very few software management tools used in the development of the project software, other than a version control system.

It was apparent in the case study that additional tools could result in more effective management of the project. This was limited by the difficulty in finding the correct tools as many were aimed at mass production industries and not the speciality satellite market. It was also noted by some that certain tools were not being used effectively by management to maintain firm control of the project.

Focussing on the small satellite philosophy, it was believed that certain tools could be used to make the project more cost and time effective. It was asserted that project costs and schedules could be reduced if much of the design and testing phases were performed using engineering prototyping and modelling tools.

## **6 - FEDSAT AS A COMPLEX PRODUCT SYSTEM**

By Analysing FedSat as a Complex Product System, we can gain an insight into the tools that might be desirable in such a project.

### **6.1 - Project Wide Tools**

Although there is already a focus on learning within the CRCSS, there are no tools to facilitate this. Procedures to ensure that the intellectual property generated from the FedSat project is retained could be put into place to ensure that it is available for the next project. In addition, tools to assist with the technology transfer mechanisms from the prime contractor to the CRC could ensure that the money spent on technology is used in the most effective fashion.



Diagnostic or benchmarking tools might be used to compare the efficiency and success of the project. However, as with many Complex Product Systems this is difficult as the number of independent variables makes finding comparable products difficult. Another important component of the Project could be the ex-post evaluation, using tools to facilitate this.

## **6.2 - Research and Development**

More attention might have been given to product selection tools in the developing phases of the FedSat project. Many of the decisions that have been made in an ad-hoc fashion using tacit experience of employees.

## **6.3 - Product Innovation**

Product analysis tools such as QFD could be very useful in the FedSat project to effectively capture requirements at an early phase of the project development. This is particularly important in the specification of payload requirements, which have undergone a number of changes over the development of the project. Cost management tools (Bearden 1995; Bell 1995) could also facilitate the management of the satellite by ensuring that financial resources were available when required.

## **6.4 - Process Innovation**

As with any project, a focus on Quality will offer benefits to both the customer and the supplier. In the FedSat project Lean Production techniques (Dodgson 2000) could have been useful to form a closer integration between the contractor and suppliers through the integration of information systems and joint problem solving. Focussing on Just-in-Time chain management techniques might have also helped with the management of available resources.

## **6.5 - Project Management**

There are a large number of risks inherent in the FedSat project, due to it's developmental nature. Effective risk management tools (Mosher 1999) (Hauge 1995) could help with the identification of these risks and effective mitigation and contingency planning.

Specific tools for managing the arrangements with suppliers and other outside company stakeholders could also have been useful for the prime-contractor to ensure that the externally manufactured goods were produced to schedule and specification.

## **6.6 - Software Development**

Finally, software management tools could be very useful in the development of the FedSat flight code. Due to the nature of the project and the requirement for risk-adverse code, it could be good to analyse the project using the CMM model to determine the current level of project management. This model could point to areas in need of improvement as well as areas of excellence.

## **7 - CONCLUSION**

This paper has outlined the basic theory behind Complex Product Systems and applied it to the management of small satellite projects. While there are many tools available to the management of these projects, there has not previously been an attempt to link them to the space industry from an innovation theory perspective.

The tools currently used in the FedSat mission were presented as the results of a case study analysis. In addition, the application of CoPS theory to the FedSat project was presented, as an example of the outcomes of analysing the space industry from a CoPS perspective.

There is still much work to be undertaken in the investigation of management techniques within the small satellite industry. Future research might look at other areas in which CoPS theory might be applicable to the management of these projects, or conversely, areas in which the management of Small Satellites has an impact on the understanding of Complex Product Systems.

## 8 - REFERENCES

- [1995] Bearden, D., Burgess, E. & Lao, N. : "Small Satellite Cost Estimating Relationships". 46th International Astronautical Conference, Oslo, Norway.
- [1995] Bell, K., Dawdy, A., Grasmeyer, J. & Hsu, L. : "Reducing Acquisition Costs Through Use of a Cost Engineering Model". 46th International Astronautical Congress, Oslo, Norway.
- [1995] Brady, T. : "Tools, Management of Innovation and Complex Product Systems", CENTRIM/SPRU/OU Project Working Paper, Brighton.
- [1998] Brusoni, S., A. Prencipe, et al. : "Mapping and Measuring Innovation in Project-based Firms". Brighton, ESRC.
- [1999] Callen, D. : "Management Challenges of Launching Multiple Payloads for Multiple Customers". 13th Annual AIAA/USU Conference on Small Satellites, Utah.
- [1991] Clausing, D. P., S. : "Enhanced Quality Function Deployment. Design and Productivity" International Conference, Honolulu, Hawaii.
- [1996x] Davies, A. : "Innovation in Large Technical Systems: The Case of Telecommunications." Industrial and Corporate Change.
- [1997] Davies, A. : "Government Policy and Innovation in Complex Systems Industries: The Cellular Mobile Telephone System Industry". 1st International Conference on Technology Policy and Innovation, Macau.
- [1997] Davies, A. : "The Life Cycle of A Complex Product System." International Journal of Innovation Management 3 September: 229-256.
- [2000] Dodgson, M. : "The Management of Technological Innovation: An International and Strategic Approach". Oxford, Oxford University Press.
- [1995] Hauge, L. W., J. : "A Multiobjective Risk Management Model". 46th International Astronautical Congress, Oslo, Norway.
- [1998] Hobday, M. : "Product complexity, innovation and industrial organisation." Research Policy(26): 689-710.
- [1997] Hobday, M. and T. Brady : "A Fast Method of Analysing and Improving Complex Software Processes". Brighton, SPRU.

- [1996] Hobday, M. B., T. : "Software Processes and Practices in Complex Product Systems: An Exploration of the Flight Simulator Domain", CENTRIM/SPRU/OU Project Working Paper.
- [1999] Kingwell, J. : " Better ways of getting into the space business: Microeconomic Reform in Australian Space Affairs." Space Policy 15(1): 33-40.
- [2000] Moody, J. : "Innovation in Complex Product Systems: The Case of the International Satellite Industry". Canberra, Australia Asia Management Centre.
- [1999] Mosher, T., Bitten, R., Lao, N., Mahr, E. & Musani, R. : "Evaluating Small Satellites: Is the Risk Worth It?" 13th AIAA/USU Conference on Small Satellites, Utah.
- [1999] NASA : "An Evaluation of Faster, Better, Cheaper". First Goddard Workshop on Small Satellites, NASA.
- [1995] Slack, N., Chambers, S., Harland, C., Harrison, A. & Johnston, R. : "Operations Management". London, Pitman Publishing.
- [1996] Sweeting, M. : "Space Engineering and Technology Transfer Training at Surrey". 47th International Astronautics Federation Conference, Beijing, China.
- [1999] Vesely, M. R. : "The FedSat Platform". International Astronautics Conference, Adelaide, Australia.
- [1998] Watzin, J., McCarthy, D., Faful, B., Day, R. & Claffy, R. : "A GSFC Perspective on the Execution of Faster, Better, Cheaper", Goddard Space Flight Centre.

# PICARD MICROSATELLITE PROGRAM

Luc Damé<sup>1</sup>, Mireille Meissonnier<sup>1</sup> and Bernard Tatry<sup>2</sup>

<sup>1</sup>Service d'Aéronomie du CNRS, BP 3, F-91371 Verrières-le-Buisson Cedex

<sup>2</sup>Division Microsatellite CNES, 18 avenue Edouard Belin, F-31401 Toulouse Cedex 4

**ABSTRACT** – The PICARD microsatellite mission will provide 2 to 6 years simultaneous measurements of the solar diameter, differential rotation and solar constant to investigate the nature of their relations and variabilities. It will provide an absolute measure of the diameter and the solar shape better than 10 milliarcsec. The 100–110 kg satellite has a 40 kg payload consisting of 3 instruments: SODISM, which will deliver an absolute measure (better than 10 milliarcsec) of the solar diameter and solar shape, SOVAP, for the total solar irradiance measure, and PREMOS, dedicated to the UV and visible flux in selected wavelength bands. Now in Phase B, PICARD is expected to be launched before mid-2003. We review the scientific goals linked to the diameter measurement, present the payload and instruments' concepts and design, and give a brief overview of the program aspects.

**RESUME** – *Le programme microsatellite PICARD de mesures simultanées du diamètre solaire, de la rotation différentielle, de la constante solaire et de leurs variabilités, a été sélectionné par le CNES. Les travaux de définition et de réalisation sont maintenant engagés depuis plus d'un an et le lancement aura lieu avant la mi-2003 (durée de la mission : 2 ans, extensible à 6 ans). Nous présentons la mission (un microsatellite de 100–110 kg), ses objectifs et les mesures qui seront effectuées par 3 instruments (charge utile de 40 kg) et qui intéressent directement la Physique Solaire, l'Héliosismologie, la Climatologie de la Terre et la Météorologie de l'Espace. Les excellentes performances de la plateforme permettent de mettre en place une charge utile relativement complexe (plusieurs instruments, un télescope optique stabilisé avec pointage actif, des miroirs SiC et des structures stables, un grand CCD rétroéclairé et aminci de 2048 x 2048 pixels utiles, etc.) dont nous présentons les caractéristiques les plus importantes.*

## 1 – INTRODUCTION

Since the solar energy is one of the major driving inputs for terrestrial climate and since it exists some correlations between surface temperature changes and solar activity, it appears important to know on what time scale the solar irradiance and other fundamental solar parameters, like the diameter, vary in order to better understand and assess the origin and mechanisms of the terrestrial climate changes.

Global effects, such as diameter changes, large convective cells, the differential rotation of the Sun's interior and the solar dynamo at the base of the convective zone, can probably produce variations in the total irradiance or, at least, correlate with these variations associated, during maximum, with the changing emission of bright faculae and the magnetic network. The aim of these correlations is double: on one side prediction and on the other explanation of the past history of climate, like the Maunder minimum period.

To establish long-term links and trends between solar variability and climate changes, it is necessary to achieve not only high precision but also absolute measurements, what the diameter measurements of PICARD shall bring. Further, this high precision allows "instantaneous" monitoring of the diameter changes, i.e., with a proper orbit for the microsatellite, oscillations and, in particular, the gravity modes.

## 2 – SCIENTIFIC OBJECTIVES

### 2.1 – Why the diameter?

From 1666 to 1719, Jean Picard and his student Philippe de la Hire measured the solar diameter, observed the sunspots and determined the Sun rotation velocity. Fortunately, these measurements covered the Maunder minimum and some time after. The data were re-examined by Ribes *et al.* (1987) who, after removing the seasonal variation of the solar diameter, obtained the annual means at 1 AU. These values, averaged for the Maunder minimum period, and after while the Sun recovered a significant activity, show a definitive difference of the order of 0.5 to 1 arcsec, corresponding to a larger Sun diameter during the Maunder minimum. As expected, few sunspots were observed. However, Picard's data also showed a slow down of the Sun rotation velocity at equator and significantly more sunspots in the south Sun hemisphere than in the north.

### 2.2 – Diameter and Earth's climate

The solar constant measurements performed in space by the radiometers since 1978 were modeled using the sunspots number and faculae. This allowed to reconstruct the solar constant variation till 1610 (Lean, 1997). This showed that the solar constant experienced a significant decrease during the Maunder minimum. The temperature in the northern hemisphere has been also reconstructed for the same period. The cooling of this period is known as the Little Ice Age. The similarity of the temperature and solar constant variations strongly suggests the Maunder minimum as the cause of the Little Ice Age. To assess this suggestion, climate models were run by Sadourny (1994) that showed the Maunder minimum as the possible cause of the Little Ice Age. Volcanic eruptions (major ones) also play a certain role, but their effects do not extent more than a few years.

As during the Maunder minimum where, as suggested by Picard's data, the Sun radius experienced a significant change, the modern data of Sun diameter measurements and sunspots number, set together by Laclare *et al.* (1996), reveal a relation between the Sun radius and solar constant variations corresponding to an increase of the Sun radius for a decrease of the solar constant (cf. Fig. 1). Therefore, in order to establish experimentally without ambiguity the Sun constant and diameter relationship, we propose to operate from space by measuring simultaneously both quantities from the same platform and in non-magnetic lines or continua. The importance of the measurements for climatology is straightforward taking into account the Little Ice Age and the Maunder minimum events.

### 2.3 – Prediction and precision

The total solar irradiance measure made by radiometers from space over the last 20 years, is excellent in relative terms ( $10^{-5}$ ) but poor in absolute. The amplitude of the variation over the cycle (0.1 %) is small and is about the same than the uncertainty on the absolute value from one instrument to the other. Prediction tendency of climate change from such data is not straightforward and adjustment of data sets of different origins an art (cf. Fröhlich and Lean, 1998). On the contrary, and if the relation irradiance-diameter is established by PICARD, the diameter measure

which is precise, reproducible and absolute to 10 mas (or even better when the HIPPARCOS data will be recalibrated by FAME or GAIA) and which, accordingly to Laclare *et al.* (1996), has an amplitude over the solar cycle of 0.4–0.6 arcsec or so, provides a proper — and quantified — sampling of the activity change over the cycle. Furthermore, the diameter measure will be done in the visible but also in the UV at 230 nm a wavelength band much more variable (6 to 8%) with the solar cycle and well known for its role in the chemistry of ozone, incidentally one of the possible links between solar activity and Earth climate.

#### **2.4 – Lyman alpha monitoring**

Lyman alpha irradiance has been monitored since 1977 and more recently by UARS since 1991. The EOS/SOLSTICE experiment will be launched in late 2002 and it will also monitor Lyman alpha irradiance. Since these irradiance monitoring experiments observe the Sun as a star, there is no information about the physical causes of the observed irradiance changes. To identify the causes of changes in Lyman alpha, one needs to compare the full disk irradiance data with images. PICARD will provide high spatial resolution (1 arcsec) and continuous (every 45 minutes) Lyman alpha images which will complement the EOS/SOLSTICE measurements. These images will make possible to better account for the observed Lyman alpha changes and also for a better reconstruction of the long-term Lyman alpha data set. Lyman-alpha irradiance is important for the ozone changes and for the formation of the ionospheric D-region in the Earth's atmosphere. Its understanding should result in significant progress in atmospheric science and aeronomy.

## 2.5 – Oscillations

Another major objective of PICARD is to attempt the detection of the gravity modes (g-modes) of the Sun. These modes are of prime importance to understand the structure and dynamics of the solar core which cannot be studied by using solar pressure modes (p-modes) alone. So far the g-modes have not been discovered by any set of instruments onboard the SOHO spacecraft (Appourchaux *et al.*, 2000). The 1- $\sigma$  upper limit of g-mode amplitude at around 200  $\mu\text{Hz}$  is typically 1 mm/s or 0.1 ppm (Fröhlich *et al.*, 1998). Given a velocity amplitude of 1 mm/s at 200  $\mu\text{Hz}$ , the displacement of the solar surface would be of about 1.6 m p-p which is equivalent to a variation of solar radius of about 2  $\mu\text{arcsec}$ . This level could be marginally detected by PICARD although this is not the method we are using for detecting the g-modes with our instrument. Nevertheless, it is worth noticing that MDI/SOHO was able to — without an optimized, stable and distortion free telescope as SODISM/PICARD — to observe a 10  $\mu\text{arcsec}$  high frequency p-mode (5 min.) solar limb oscillation signal (Kuhn *et al.*, 1997).

With PICARD we want to detect intensity fluctuations at the solar limb that will perturb the equivalent solar radius signal. Appourchaux and Toutain (1997) reported to have detected p-modes using the limb data of the LOI instrument. In some case the amplification with respect to full-disk integrated data is about 4, i.e. it means that a p-mode with an amplitude of 1 ppm in full disk is observed with an amplitude of 4 ppm at the limb (cf. Damé *et al.*, 1999). This amplification factor was roughly predicted by theory (Appourchaux and Toutain, 1997). If we hope that the same amplification factor holds for the g-modes, we may detect them faster with the limb data of PICARD than with the SOHO data. A pessimistic derivation gave 20 years for the detection of the first few g-modes with SOHO (Fröhlich *et al.*, 1998). With PICARD we can seriously envisage detecting them in 16 months with the amplification factor above.

## 3 – PICARD PAYLOAD

To carry the proposed measurements PICARD has 3 instruments: SODISM, the "Solar Diameter Imager and Surface Mapper", for the measure of the diameter and differential rotation (this is, therefore, a whole Sun imager), SOVA (SOLAR VARIABILITY), for the measure of the total absolute solar irradiance (correlation with SODISM measurements) and PREMOS (PRECISION MONITORING OF SOLAR VARIABILITY), a package of 3 set of 4 UV and visible Sun photometers. Fig. 2 presents an artist view of PICARD's microsatellite. SODISM is realized by the Service d'Aéronomie du CNRS, France, in collaboration with the Space Science Department of ESTEC, SOVAP by the Royal Meteorological Institute of Belgium, and PREMOS by the World Radiation Center of Switzerland.

### 3.1 – SODISM/PICARD

SODISM is a simple telescope of useful diameter 110 mm. It forms a complete image of the Sun on a large, back thinned, CCD of 2048 x 2048 useful pixels. The pixel, 13.5  $\mu\text{m}$ , corresponds to 1.05 arcsec (at 1 AU) and the effective spatial resolution is also about an arcsec (at the limb). SODISM observes in 4 wavelengths bands the whole Sun (230 nm, 548 nm, 160 nm and Lyman alpha) and 2 calibration channels (cf. Table 1) accessible through the use of 2 cascading filterwheels, each with 5 positions.

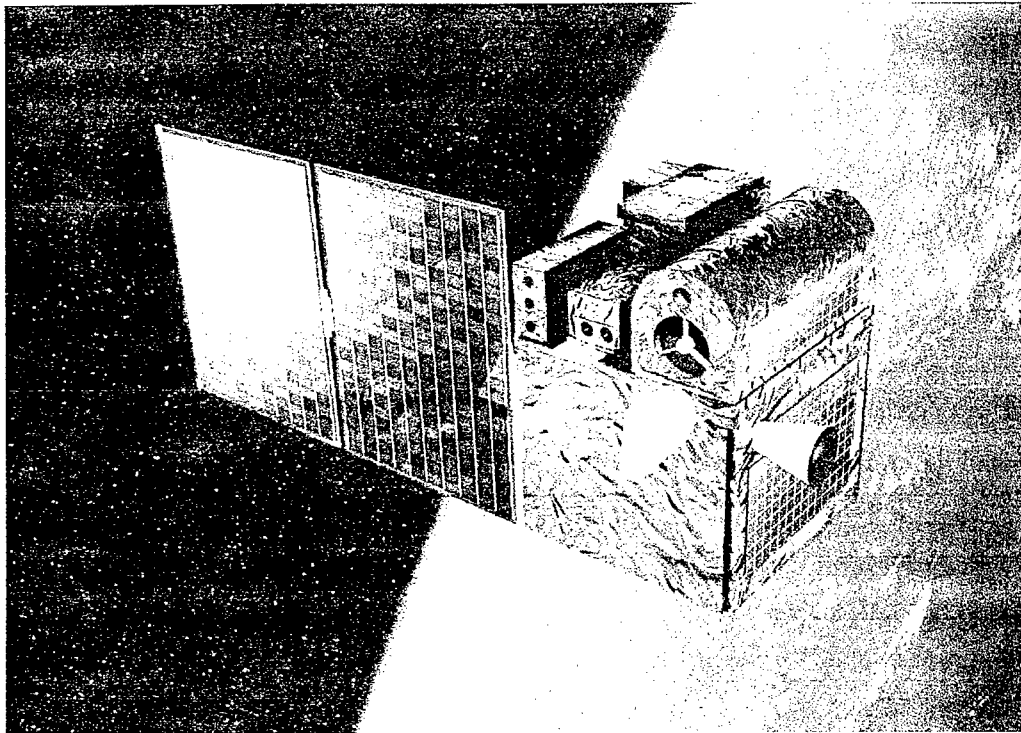


Fig. 2 – Artist view of PICARD microsatellite: 60x60x80 cm<sup>3</sup> only! Shown are the 3 instruments: SODISM, telescope and guiding, right, SOVAP, differential radiometer, center, and PREMOS (flux monitors) left, near the solar panels. Behind, one can see the electronics box supporting two S-band antennae and a solar pointer (acquisition maneuvers).

UV nominal mode	230 nm
Visible	548 nm
Active regions	160 nm
Prominences and ionosphere	Lyman alpha
CCD Flat Field	"Diffusion"
Scaling factor	"Star field"

**Table 1** – Observing and calibration modes of SODISM/PICARD.

#### *Operational modes*

The main observing wavelength is 230 nm (8 nm bandwidth). It corresponds to a mostly flat UV continuum formed in the high photosphere. It is the best possible choice of wavelength since it is sensitive to UV variations (about half of the MgII index variability for instance), it corresponds to the ozone bands (and by chemical interaction in the stratosphere, the UV may affect the stratospheric dynamics and, consequently, the clouds coverage — which may be one of the paths of the Sun influence on the Earth's climate) and the limb darkening in this continuum is limited.

In addition, SODISM/PICARD observes 548 nm which is near the center wavelength of the 100 nm bandpass used by Francis Laclare CERGA's group for the solar diameter measurement with the Astrolabe (and, in the near future, with the new DORAYSOL instrument). The 160 nm and Lyman alpha filters are used for identification of active regions and prominences. This is essential to



prevent activity manifestations to affect the "quiet" radius determination. This possibility to avoid, in the diameter computation, the pixels at the limb affected by faculae, active regions, prominences, sunspots or pores, is an essential feature of SODISM/PICARD since activity, therefore, does not add noise to the diameter measure (active solar pixels are not accounted).

The diffusion plates are simply used to monitor the CCD response and sensitivity (Flat Field). The CCD itself is a complete state-of-the-art system (EEV 4280 2048x4096 pixels back thinned and with frame transfer) hopefully developed in parallel of our program for the COROT asteroseismology CNES/PROTEUS program.

Finally, specific to PICARD — and providing an ABSOLUTE diameter reference better than 10 mas (milliarcsec)— is the "Star field" channel. It provides access to stellar fields in which (with a limit magnitude of 7 or so) stars' triplets of the HIPPARCOS reference catalog are imaged, allowing to scale our diameter measure and, if required, to identify and to follow any structural change in the focus or CCD dimensions which could affect the diameter measure.

#### *Optical concept*

SODISM has a sound optical concept allowing to achieve a distortion free and dimensionally stable image of the solar limb. It has a symmetry of revolution (no complex optics — filters at normal incidence — nothing else than the two mirrors and a filter set in the optical path) and a single telescope-detector-guiding telescope support structure for common referencing and stability. The telescopes mirrors are made of SiC without coatings (reflectivity of 35–40 % in the UV and yet 20 % in the visible). Advantage is indeed that the photometry will not change by aging and degradation of coatings since there are no coatings. Further, the primary and secondary mirrors will help to remove 96 % of the visible solar flux, preserving the filters from degradation and, due to the high conductivity of SiC, this flux will be evacuated to external radiators.

#### *Mechanical/thermal stability*

To provide a stable measurement of semi-diameters to a couple mas over the two to six years duration of the mission, SODISM/PICARD mechanical stability has to be excellent intrinsically and controlled. The design selected achieves mechanical and thermal stability because of the choice of a single monolithic structure — a tube of carbon-carbon — to link the SiC mirrors of the telescope and to the detector. As well the guiding telescope is in the same structure, its mirrors and the 4-quadrant detector being directly linked to the carbon-carbon structure. This new type of structure (developed for example by ALCATEL SPACE, cf. Bailly *et al.*, 1997) allows to reduce the thermal regulation to a couple tenths of °C for a relative change of the diameter < 1 mas (1 thousand of a pixel). The isotropic property of carbon-carbon and a detailed knowledge of the experiment (interferometric calibration), will help to further gain, by modelisation, a factor 100 to 1000 on the short term diameter variations (useful for the solar limb oscillations). This means that 10 to 1  $\mu$ arcsec could be inferred, allowing a direct monitoring of limb oscillations. Note that, beside focusing, the only other systematic error which affects the diameter directly is the size of the detector (silicium has an expansion coefficient of  $\sim 2 \cdot 10^{-6}$  and requires, to keep errors below  $\pm 0.5$  mas, a  $\pm 0.1$  °C temperature regulation).

Fig. 3 shows the structure design of the SODISM/PICARD telescope and, in particular, its dynamical behavior. Note the important flexure of the small titanium feet which account for the dilatation of the platform instrumental plateau.

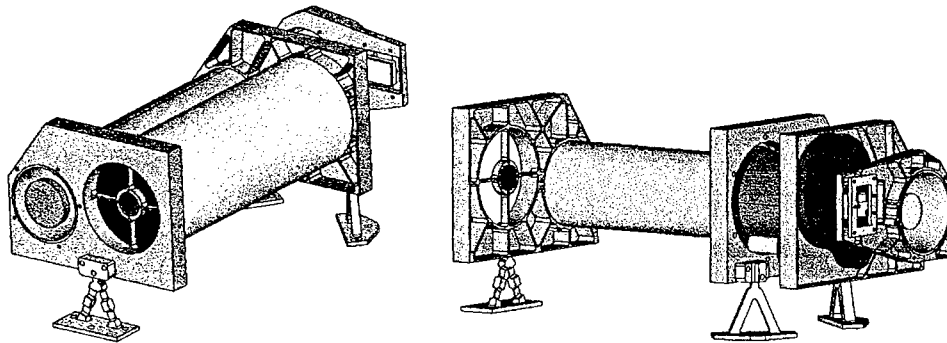


Fig. 3a – Mechanical structure of the SODISM/PICARD telescope (350 mm between the primary and secondary mirror and 150 mm between the primary and the CCD surface: total length without cover of 550 mm). Note the 3 Invar plates linked together with the 550 mm long carbon-carbon (shown in light brown) tube of Ø100 mm. The primary mirror is mounted on 3 piezoelectrics driven by a guiding telescope directly placed inside the C-C tube. The CCD (cooled to  $-40^{\circ}\text{C}$ ), is decoupled of the Invar plate by a Cordierite support.

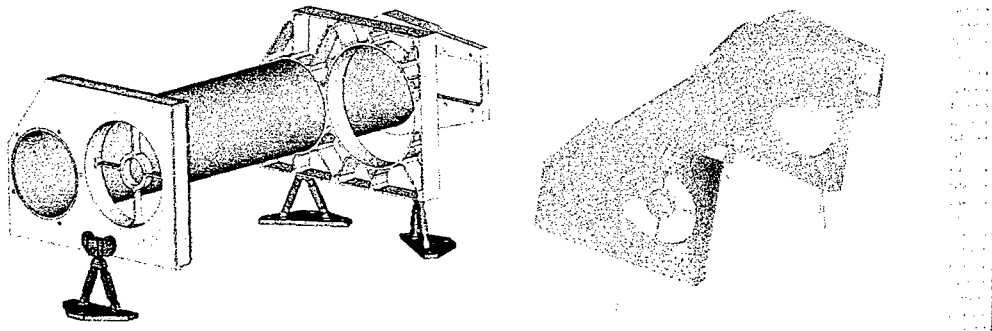


Fig. 3b – Mechanical and dynamical (under 15 g) models of SODISM. Notice that the distance between the SiC mirrors is maintained to a fraction of a micron by a very low dilatation ( $-0.1 \cdot 10^{-6}$ ) tube in carbon-carbon of 100 mm diameter and 4 mm thickness.

Measurements	Solar diameter(s), differential rotation and full Sun UV and visible imaging
Number of channels	6 (230, 548, 160 nm, Ly $\alpha$ , "Flat Field" & "Star Field")
Telescope focal length— solar image	2650 mm — Ø25 mm
Telescope optics	Primary Ø120 mm (used: 110 mm) Secondary Ø34 mm (used: 25 mm)
EEV-4280 back thinned CCD detector	2048x4096 square pixels of 13.5 $\mu\text{m}$ (frame transfer: 2048x2048 pixels used)
Guider acquisition range	$1.2^{\circ}$
Guider nominal pointing range	$\pm 30''$
Guider servo bandwidths	0 to a few Hz (platform) a few Hz to 50 Hz (fine guiding on the primary mirror)
Quad-cell image displacement sensitivity	$< 10^{-2''}$
Piezo displacement range	$\pm 6 \mu\text{m}$ ( $\pm 1$ arcmin)
Absolute solar shape precision	Better than 10 mas (HIPPARCOS calibration in 2003)
Relative semi-diameter precision	Better than 1 mas

Table 2 – Characteristics of SODISM.

### Pointing

Image guiding and stabilization is provided by an off-axis telescope with the same optical properties than the main telescope and directly implemented in the carbon-carbon structural tube. The 4-quadrant detector assembly is fine guiding the piezoelectrics which activate the primary mirror of the telescope. Fine guiding is used so that the image of the Sun on the CCD does not move by more than 0.1 arcsec, i.e. 1 tenth of a pixel (about 1 tenth of the Airy disk as well at 230 nm). The 4-quadrant detector will also provide (by access to the low frequency part of the control signal) accurate guiding to the microsatellite itself. In that case the coarse guiding of the stellar sensor is overruled by our sensor when the Sun acquisition is effective in the nominal  $\pm 0.6^\circ$  field of view. The 4-quadrant detector is provided by ESTEC and similar to the one used with success on SOHO by the LOI/VIRGO instrument.

### Ground program: PICARDSOL

The Engineering Model of SODISM will be used in CERGA, France, in conjunction with the newly working DORAYSOL and the longstanding (25 years of observations) Astrolabe of Francis Laclare. As such, and for the first time, the same instrument will be used in space and on ground to measure the solar diameter, deduce atmospheric bias and state on ground instruments possible accuracy. It is expected that the ground instrument will operate for more than a solar cycle. A new generation seeing monitor, measuring the coherence length and temporal coherence, will be used in conjunction with PICARDSOL and DORAYSOL to better assess atmospheric effects on the ground diameter measure (in order to validate the past historical measurements).

### 3.2 – SOVAP

To measure the solar constant, PICARD will use a SOVA 1 type radiometer, SOVAP, the "P" standing for PICARD. SOVA 1 is a differential absolute solar radiometer developed at the RMIB, Royal Meteorological Institute of Belgium (Crommelynck and Domingo, 1984). The RMIB radiometers have been flown in Space 8 times from 93 to 98. SOVAP radiometric core is formed by two blackened cavities constructed side by side on a common heat sink. In between each cavity and the heat sink a heat flux transducer is mounted. The difference between the two transducers' outputs gives a differential heat measurement, in which the common part of the thermal surrounding radiation seen by the two cavities is eliminated. By the symmetrical construction and good insulation thermal asymmetry is minimized. SOVAP characteristics are summarized in Table 3.

Measured quantity	Total irradiance ( $\text{Wm}^{-2}$ )
Number of channels	2
Number of reference voltages	6
Cavity type	Cylindrical, diffuse black
Diameter precision aperture	1 cm
Slope angle	$2.5^\circ$
Solar sampling period	3 minutes
Duty cycle	50 %
Instrument noise	$< 0.1 \text{ Wm}^{-2}$

Table 3 – Characteristics of SOVAP (default measurement mode).

### 3.3 – PREMOS

This instrument is provided by the World Radiation Center, Davos, Switzerland. It consists in 4 "filter radiometers", based on the same principle than a radiometer (equilibrium of the flux inside a cavity) but with the preselection of a known and reduced spectral bandwidth. These photometers are observing in the UV and the visible, at the same wavelengths, 230 and 548 nm than SODISM and in two other UV wavelengths: 311 and 402 nm. 3 sets of these 4 photometers are used — one being a reference — in order to monitor aging effects. The 230 nm channel has a dual function: it estimates the UV flux in this ozone sensitive bandwidth, and it indicates a possible degradation of SODISM's CCD.

Measured quantity	Spectral irradiance at 230, 311, 402 and 548 nm ( $Wm^{-2}$ )
Number of photometers	12 (3 sets of 4)
FWHM bandwidth	8 nm (except at 402: 5 nm)
Cavity type	Cylindrical, diffuse black
Full view angle	2.5°
Slope angle	0.7°
Diameter precision aperture	3 mm
Accuracy of aperture area	$<10^{-3}$
Cross-Talk	$<10^{-5}$

Table 4 – Characteristics of PREMOS.

### 4 – THE PICARD MISSION

The PICARD's system uses most of the basic components of the CNES microsatellite product line, namely, the ground segment (MIGS) made of the "Centre de Contrôle Microsatellites" (CNES Toulouse), a band S station (and most probably a complementary station at high latitude) and the flight microsatellite segment. These components will be qualified by the first microsatellite mission of the product line, namely, the mission DEMETER. The PICARD system is operated mostly the same way than DEMETER and, in this way, confirms the generic character wanted and developed for the microsatellite product line.

#### 4.1 – Orbit

The PICARD's mission requires, ideally, an orbit with constant viewing of the Sun or, at minimum, with limited or short duration eclipses. The mission lifetime is 2 years nominally with a possible extension to 6 years. A study of the launch opportunities on such orbits has shown that the highly elliptical Geostationary Transfer Orbit (GTO) envisaged as an option by the microsatellite program cannot be accounted for without very important modifications of the product line (both on the ground and flight segments). Accordingly, and in view of the costs involved, this type of orbits has been abandoned.

The other opportunities are essentially Sun Synchronous Orbits (SSO) with local time 6h/18h (little or no eclipses) or between 10h and 14h. Several scenarios are still under consideration for the PICARD flight which is due before mid-2003 (the launch date is important since the diameter/constant relationship will definitively be better determined during the near linear part of the cycle, rising or falling — our case — than at minimum or maximum when the "constant" is mostly "constant"...). The favored orbits are those providing only brief or non-eclipsing Sun-synchronous viewing in order to achieve both the thermal stability for the absolute long term diameter measurement and the near continuous sampling for the long periods *g*-modes oscillations.

At present launch is planned nominally on a Sun Synchronous Orbit (SSO 12h or so), as a secondary passenger of the Indian PSLV rocket.

Opportunities for 6h/18h are fewer and may result in larger launch costs. These alternatives, optimizing the mission throughput since providing nearly continuous Sun viewing (no eclipses allowing to carry the oscillations' program) could be a launch with Radarsat 2 (Canadian satellite) which has a high (800 km) full Sun SSO orbit or, with comparable characteristics, a dedicated launch with the Dnepr Russian rocket.

#### 4.2 – Pointing needs

The pointing needs on the PICARD satellite (for the scientific measure) is a pointing in the Z axis (telescope axis), towards the Sun, and with a precision of  $\pm 0.01^\circ$ . This performance will be achieved by the attitude control system using an ecartometry information from the payload (from the SODISM guiding telescope: pointing differences between the telescope and the Sun center direction). This, by itself, illustrates nicely the optimization capacity offered by the microsatellite system.

Pointing needs also imply a specific configuration of the stellar sensors to preserve a permanent stellar pointing calibration along the orbit (stellar calibration need for the SODISM telescope scaling factor).

#### 4.3 – Characteristics

To the exception of the attitude control system, the microsatellite platform for PICARD is very similar of the one of DEMETER. Globally, the adaptations are reasonable (in cost and complexity) and confirm the right choice of recurring technologies in the initial microsatellite product line.

Characteristics	PICARD's Microsatellite
Size (cm <sup>3</sup> ) [L x W x H]	60 x 75 x 80
Mass (kg)	Platform (with lest): 65 kg Payload: 45 kg max Total 110 kg (for 120 kg nominal: 10 kg margin)
Power (w)	Platform: 30 W (average on an orbit) Payload: 48 W maximum on average on an orbit Total: 78 W maximum (critical)
Pointing accuracy	3 axis stabilized, 0.1°
Pointing stability	0.01°
Mass Memory	1 Gbits
Telemetry flow	400 Kbits/s
TC (commands)	10 Kbits (immediate or delayed)
Orbit restitution	1 km
Onboard datation	< 0.5 s (TU difference)

**Table 5** – Performances and characteristics of PICARD microsatellite.

Table 5 summarizes the essential characteristics of the present PICARD's microsatellite. The performances are derived, mostly, from the microsatellite product line. To the exception of the power allowance, somewhat critical, these are well along the payload needs (cf. Table 6).

Characteristics	PICARD Payload	SODISM	SOVAP	PREMOS	Electronics boxes (2)
Mass (kg)	40.4	17.5	5.8	4.1	9 & 4
Size	60x60x30 20x20x20†	60x27x28	35x15x15	30x9x14	<20x26x15 <20x20x20†
Power (W)	28.5*	19.9*	4.2	4.4	NA
Thermal Control (W)	19.8*	16.3*	2	1.5	NA
Average Telemetry (Mbits/day)	1210–1810‡	1200–1800‡	5	5	NA

†this electronic's box is placed under the microsatellite platform

\*average between measures, stand-by and eclipses (PSLV/SSO)

‡as a function of the orbit: with eclipses (e.g. PSLV/SSO) or without eclipses (e.g. Radarsat 2)

**Table 6** – Major characteristics of PICARD model payload.

Table 6 summarizes the mass, power and nominal telemetry characteristics of the PICARD mission. Note that the PICARD Mission Center will normally be operated by the RMIB and that, most probably, antennas (S band) in Toulouse and Kiruna will be used for telemetry needs (about 1.2 Gbits per day). In the case of a non-eclipsing orbit, telemetry might be higher (1.8 Gbits per day), requiring a third antenna.

*Acknowledgements.* We are thankful to the CNES Direction des Programmes and in particular to J.-Y. Prado, F. Dulac and N. Papineau for their support to the mission, and would like to acknowledge the PICARD project and scientific teams (10 collaborators, 27 Co-Investigators) and our partners, Belgium and Switzerland, who are doing a remarkable work towards a successful PICARD's mission.

## REFERENCES

- Appourchaux, T. *et al.*, Observational Upper Limits for Low-Degree Solar g-Modes, *Ap. J.*, in press (2000).
- Appourchaux, T. and Toutain, T., in *Sounding Solar and Stellar Interiors*, IAU Symposium 181 (Poster Volume), Eds. J. Provost and F.X. Schmider, 5 (1998).
- Bailly, B. *et al.*, High Stability Carbon/Carbon Telescope Structure, Proc. ICSO'97, CNES International Conference on Space Optics, Ed. G. Otrio, S4, 1–11 (1997).
- Crommelynck, D. and Domingo, V., Solar Irradiance Observations, *Science* 225, 180–181 (1984).
- Damé, L. *et al.*, PICARD: Simultaneous Measurements of the Solar Diameter, Differential Rotation, Solar Constant and their Variations, in *Symposium on Helioseismology and Solar Variability*, *Adv. in Space Research* 24(2), 205–214 (1999).
- Fröhlich, C. and Lean, J., The Sun's total irradiance: Cycles, trends, and related climate change uncertainties since 1976, *Geophysical Research Letters* 25(23), 4377 (1998).
- Fröhlich, C. and the Phoebus Group, in *Structure and Dynamics of the Sun and Solar-like Stars*, Proceedings of the SOHO 6 / GONG 98 workshop, Boston, USA, ESA SP-418, 67 (1998).
- Kuhn, J.R. *et al.*, Precision Solar Astrometry from SOHO/MDI, in *Sounding Solar and Stellar Interiors*, IAU Symposium 181, Eds. J. Provost and F.X. Schmider, 103–110 (1997).
- Laclare, F., Delmas, C., Coin, J.P. and Irbah, A., Measurements and Variations of the Solar Diameter, *Solar Physics* 166, 211–229 (1996).
- Lean, J., The Sun's Variable Radiation and its Relevance for Earth, *Annu. Rev. Astron. Astrophys.* 35, 33–67 (1997).
- Ribes, E., Ribes, J.C. and Bartholot, R., Evidence for a Larger Sun with a Slower Rotation during the Seventeenth Century, *Nature* 326, 52–55 (1987).

---

Sadourny, R., Sensitivity of Climate to Long-term Variations of the Solar Output, in The solar engine and its influence on terrestrial atmosphere and climate, Ed. E. Nesme-Ribes, NATO ASI Series I, vol. 25, 479-491, Springer Verlag (1994).

**LES MISSIONS MICROSATELLITES  
"DEMETER", "PARASOL" ET "MICROSCOPE"**

**Bernard TATRY  
Michel PARROT  
Didier TANRE  
Pierre TOUBOUL**

*CNES - DSO/ED/MS/MI - 18, Avenue Edouard Belin, 31055 Toulouse  
CNRS/LPCE - 3A, Avenue de la Recherche Scientifique, 45071 Orléans Cedex 2  
CNRS/LOA - Bât. P5, U.S.T. de Lille, 59655 Villeneuve d'Ascq  
ONERA - Département Mesures Physiques, BP 72, 92322 Châtillon Cedex*

**RESUME:** Ce document présente les missions scientifiques décidées par le Comité des Programmes Scientifiques du CNES, qui seront effectuées à partir de la Ligne de Produit Microsatellites du CNES. Les objectifs scientifiques des missions DEMETER, PARASOL et MICROSCOPE sont décrits (la mission PICARD fait l'objet d'une publication particulière). La définition de chacune des charges utiles et des adaptations effectuées sur la Ligne de Produit Microsatellites sont présentées.

***ABSTRACT:** This paper presents scientific missions decided by the CNES Scientific Program Comettee, which will be performed on the basis of the CNES Microsatellites Line of Product. Scientific objectives of DEMETER, PARASOL and MICROSCOPE missions (PICARD mission is presented in a dedicated paper) are described. Definition of payloads and adaptations on the Microsatellites Line of Product are presented.*

## **1. INTRODUCTION**

C'est en 1998 que le CNES a décidé de développer une filière de microsatellites dans le but de disposer d'un système de satellites à faible coût, capable d'être utilisé pour des missions à caractère scientifique et/ou technologique.

Cette filière appelée "Ligne de Produit microsatellites" est aussi une opportunité d'innovations, tant dans les nouvelles technologies (miniaturisées, ...) que dans de nouvelles méthodes de gestion et d'ingénierie (outils de modélisation système, banque de données, traitement de la documentation, ...).



Les caractéristiques de cette Ligne de Produit et des méthodes associées sont décrites dans des présentations spécifiques.

Ce papier décrit plus particulièrement et successivement les missions décidées par le Comité des Programmes scientifiques du CNES, bâties à partir de la Ligne de Produit microsattelites. De plus, les aspects adaptations du microsattellite pour la mission et description de la charge utile seront abordés.

## 2. LA MISSION DEMETER:

Parmi tous les précurseurs des tremblements de terre, ceux liés au champ électromagnétique sont les plus intrigants, et les nombreuses autres sources possibles de rayonnement électromagnétique sont la cause de nombreuses controverses. Un grand nombre d'expériences de laboratoires suggère clairement que les micro-fractures sont associées avec l'apparition d'une production de charges (électrification) et d'une émission électrique ou électromagnétique transitoire. De nombreux effets électrique et magnétique, pré-séismique et co-séismique ont été observés dans le passé ainsi que des perturbations ionosphériques. Des données satellite montrent aussi des émissions électromagnétiques (EM) transitoires liées à l'activité séismique, mais jusqu'à maintenant les observations n'étaient pas réalisées avec des expériences dédiées à cette étude. Les objectifs scientifiques de DEMETER sont liés aux études des perturbations ionosphériques dues à l'activité séismique, et aussi à l'étude globale de l'environnement électromagnétique de la Terre. Les expériences à bord du micro-satellite DEMETER sont proposées par un groupe de scientifiques comprenant des géophysiciens internes et externes dont la liste est donnée en Table 1.

Laboratoires	Expérimentateurs
LPCE (France)	D. Lagoutte, F. Lefeuvre, M. Parrot, B. Poirier, J.L. Pinçon
CESR (France)	J.-A. Sauvaud, A. Cros
CETP (France)	J.J. Berthelier, M. Menvielle
IPGP (France)	J. Artru, P. Bernard, Y. Cohen, G. Hulot, J.F. Karczewski, J.L. Le Mouël, P. Lognonné, J.P. Montagner
LDG/CEA (France)	E. Blanc, J.L. Plantet
DESPA (France)	M. Maksimovic
LPSH (France)	A. Kerdraon
Univ. of Electro-Comm. (Japan)	M. Hayakawa J.P. Lebreton
SSD/ESTEC (ESA)	J. Blecki, J. Juchniewicz
CBK (Poland)	

**Table 1:** Liste des expérimentateurs DEMETER.

## 2.1. Les objectifs scientifiques de la mission DEMETER:

L'existence d'effets magnétiques de faible intensité associés aux séismes ou à l'activité volcanique a été soulignée dès les années 50. Depuis, plusieurs expériences ont confirmé que les variations de contrainte associées à un séisme ou à une éruption volcanique pouvaient affecter le champ magnétique naturel [1]. Outre des expériences de laboratoire, des observations récentes ont montré des variations du champ magnétique terrestre et du champ tellurique (champ électrique dans le sol) associées à une crise sismique ou volcanique. Etant donné les difficultés techniques que présentent les mesures du champ tellurique, les observations de variations du champ électrique continu associées à l'activité sismique ou volcanique sont moins nombreuses. De telles observations ont néanmoins été rapportées pour des séismes observés au Japon ou en Grèce.

Les observations actuellement publiées ne concernent qu'un nombre limité de cas et ne démontrent pas l'existence d'une relation entre le signal observé et l'activité sismique [2], [3]. Une telle démonstration est d'ailleurs difficile à produire du fait que les enregistrements existants sont toujours incomplets et ponctuels. Des observations continues pendant des mois, voire des années, de tous les paramètres associés aux tremblements de terre sont nécessaires. Un traitement statistique de ces observations doit précéder tout essai d'interprétation. Des études intensives tant théoriques qu'expérimentales sont aussi nécessaires pour élucider les processus physiques responsables des variations sismo ou volcano-électriques, et comprendre leurs relations avec les variations de résistivité électrique, les effets électrocinétiques associés à la dilatance ou les effets électromagnétiques observés dans l'ionosphère. Ces études impliquent des expériences en laboratoire (mesures sur échantillons et/ou modélisation numérique) et des mesures actives contrôlées, comme celles effectuées lors du foudroiement de piliers dans des carrières.

Les observations actuellement publiées concernent des mesures effectuées au sol, dans l'ionosphère et dans la magnétosphère avec des capteurs électriques et/ou magnétiques opérant dans des gammes de fréquences très diverses. Elles mettent en évidence des augmentations de l'intensité des signaux dans l'étape finale de préparation d'un tremblement de terre, c'est-à-dire entre quelques dizaines de minutes et quelques dizaines d'heures avant le séisme. En outre un certain nombre d'observations de l'ionosphère effectuées à partir du sol ou plus récemment à partir de satellites, et au moyen de techniques de mesure différentes, ont montré l'existence de perturbations notables après mais également avant les séismes [4].

La compréhension de tous ces phénomènes nécessite un développement simultané des expériences au sol et des mesures à bord de satellite. Les campagnes sol, proches des épicentres, sont à priori plus faciles à conduire et peuvent combiner un très grand nombre d'expériences complémentaires. Elles ont par contre pour défaut de poser des problèmes: (1) de localisation géographique, tant que l'on ne sait pas quelles sont les conditions géophysiques qui doivent être réunies pour avoir une source émettrice, (2) de positionnement des différents capteurs, tant que l'on ne comprend pas pourquoi des mesures faites à quelques kilomètres de distance par la méthode VAN ne donnent pas les mêmes indications, (3) de temps d'observation. Aussi imparfaites et limitées qu'elles soient, les observations à bord de satellites sont actuellement les mieux adaptées pour la phase préliminaire de démonstration et de caractérisation des phénomènes électromagnétiques. Elles permettront d'améliorer la qualité des observations au sol en précisant

aussi bien les régions d'implantation les plus favorables que les équipements scientifiques à réunir pour de futures expériences sol.

Les observations faites par satellite ont pour avantage majeur de couvrir très rapidement la quasi-totalité des régions sismiquement actives du globe. Mais ces observations n'auront véritablement d'utilité que si l'on peut démontrer leur origine sismotectonique et en définir l'ensemble des caractéristiques et leur variabilité en fonction des conditions de la rupture et de son environnement. Malheureusement jusqu'à présent, de telles observations n'ont été effectuées qu'avec des équipements qui n'étaient pas spécifiques à cette étude. Elles souffrent ainsi des défauts suivants:

- elles sont discontinues dans le temps,
- elles sont effectuées dans des bandes de fréquence étroites et souvent inadaptées,
- elles sont généralement limitées à une seule composante du champ électromagnétique.

Toutes ces circonstances font qu'il n'est pas possible avec les observations existantes de déterminer le spectre en fréquence de ces ondes, et d'établir de façon indiscutable leur origine sismotectonique [5]. On ignore, en particulier, si les signaux séismo-électromagnétiques sont dus à une augmentation d'intensité des émissions naturelles, observées habituellement dans l'ionosphère et la magnétosphère, ou à la production directe d'un signal spécifique par le séisme.

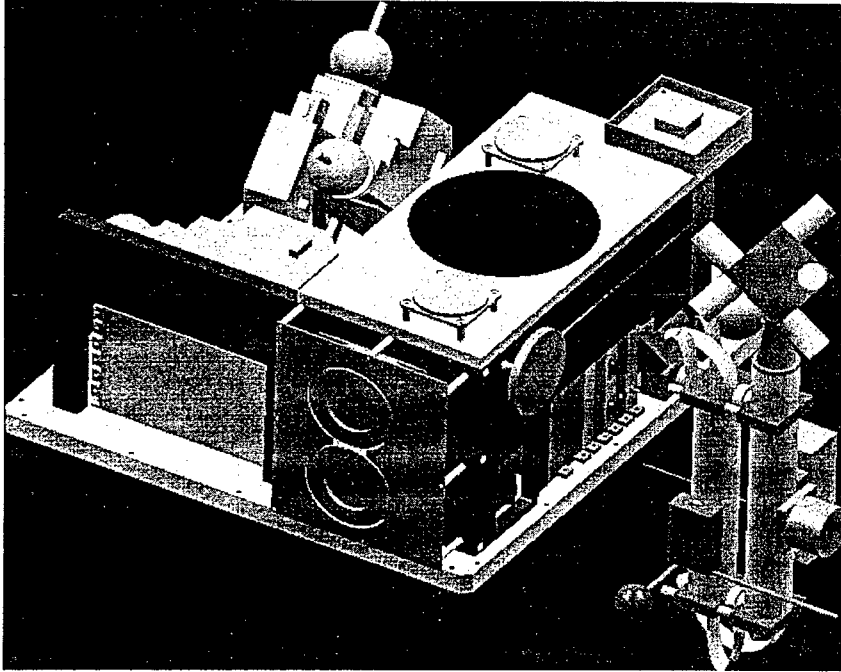
Les mesures effectuées par l'expérience DEMETER ont pour but d'étudier de façon systématique les émissions d'ondes électromagnétiques observées lors de tremblements de terre et d'éruptions volcaniques, les perturbations de l'ionosphère et de la haute atmosphère, ainsi que les précipitations de particules associées (Parrot et al., 1993). Une telle expérience a été suscitée par les observations faites dans les années 80, au départ de façon tout à fait fortuite et non systématique, par des scientifiques soviétiques et japonais, puis par des scientifiques français. Elle constitue le prolongement naturel de ces travaux, et une étape fondamentale vers l'établissement de ces phénomènes et leur compréhension complète.

Le second objectif scientifique de DEMETER est en liaison avec le PNST (Programme National Soleil Terre). Il permettra d'effectuer une surveillance globale de l'environnement électromagnétique autour de la Terre car depuis AUREOL-3 en 1981 aucun satellite scientifique basse altitude n'a effectué de mesures dans les régions de moyenne latitude. Sans modification de la charge utile, DEMETER pourra par exemple étudier l'influence des orages dans les relations Soleil-Terre, et évaluer l'impact de l'activité humaine sur l'ionosphère [6], [7].

## **2.2. Description de la charge utile scientifique DEMETER:**

La charge utile scientifique de DEMETER est représentée sur la Figure 1. Elle est composée de plusieurs capteurs:

- Quatre capteurs électriques sphériques (deux d'entre eux sont représentés en haut de la Figure 1) afin de mesurer les trois composantes du champ électrique,
- Trois capteurs magnétiques (montés au bout du bras à droite sur la Figure 1),
- Une sonde de Langmuir (montée sur le même bras que les capteurs magnétiques, c'est une sonde double avec une sphère segmentée et un capteur cylindrique),



**Figure 1:** Vue de la Charge Utile DEMETER

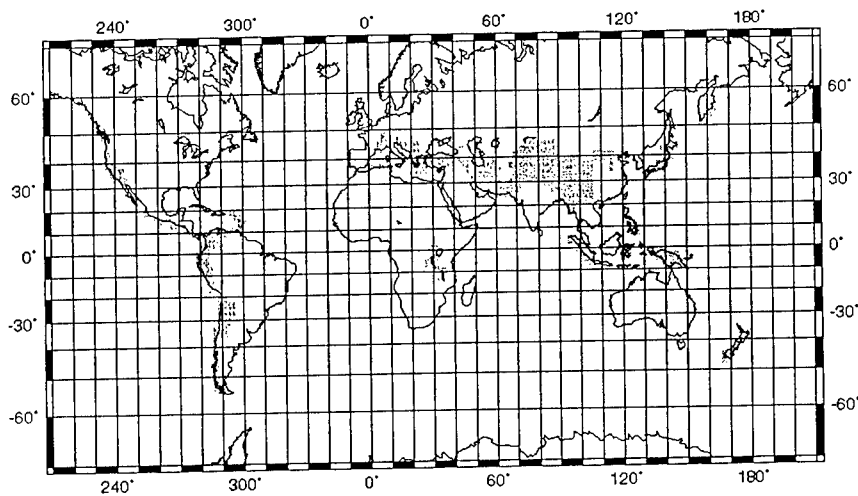
Ces capteurs sont associés à un boîtier électronique pour numériser le signal et effectuer des traitements préliminaires à bord. Ce boîtier communique avec les équipements électroniques de gestion des données scientifiques (stockage dans une mémoire, transmission vers le sol, ...). Les mesures effectuées par DEMETER sont résumées dans la Table 2. La puissance nécessaire à la charge utile scientifique est de l'ordre de 15 W.

Gamme de fréquence, B	10 Hz - 17 kHz
Gamme de fréquence, E	DC - 3.5 MHz
Sensibilité B :	$2 \cdot 10^{-5} \text{ nT Hz}^{-1/2}$ at 1 kHz
Sensibilité E :	$0.2 \mu\text{V Hz}^{-1/2}$ at 500 kHz
Particules: électrons	30 keV - 10 MeV
Particules: ions	90 keV - 300 MeV
Densité ionique:	$10^2 - 5 \cdot 10^6 \text{ ions/cm}^3$
Température ionique:	1000 K - 5000 K
Composition ionique:	$\text{H}^+, \text{He}^+, \text{O}^+, \text{NO}^+$
Densité électronique:	$10^2 - 5 \cdot 10^6 \text{ cm}^{-3}$
Température électronique:	500 K - 3000 K

**Table 2: Mesures expérimentales.**

Traitement des données à bord:

Il y a deux modes d'opérations: (i) un mode "survey" pour enregistrer des données à faible résolution tout autour de la Terre, et (ii) un mode "burst" pour enregistrer des données à haute résolution au dessus des régions sismiques (voir Figure 2).



**Figure 2: Emplacement des zones de mesure en mode burst (en gris) (Pascal Bernard, IPGP)**

Pendant le "survey mode" la télémessure est de l'ordre de 25 kb/s et pendant le "burst mode", elle est de l'ordre de 1.7 Mb/s.

Pour l'expérience onde, les données suivantes sont recueillies:

- . Pendant le mode burst:

- Formes d'onde des trois composantes électriques jusqu'à 15 Hz,
  - Formes d'onde des six composantes du champ EM jusqu'à 1 kHz,
  - Formes d'onde de deux composantes (1B + 1E) jusqu'à 17 kHz,
  - Spectre d'une composante électrique jusqu'à 3.5 MHz
  - Forme d'onde d'une composante électrique jusqu'à 3.5 MHz (snapshots).
- . Pendant le mode survey:
- Formes d'onde des trois composantes électriques jusqu'à 15 Hz,
  - Spectre de 2 composantes (1B + 1E) jusqu'à 17 kHz,
  - Spectre d'une composante électrique jusqu'à 3.5 MHz,
  - Résultats d'un réseau de neurones pour détecter des sifflements.

Pour les autres expériences, la différence entre les modes "burst" et "survey" concerne seulement la résolution temporelle des données. Le nombre de télécommandes est estimé à 600 octets/3 jours.

### 2.3. Le Centre de Mission DEMETER

La télémétrie scientifique sera reçue à Toulouse. Le Centre de Mission qui traitera les données sera localisé à Orléans au LPCE.

Le volume de données produites est de 1.4 Teraoctets pour la mission de 2 ans, soit 2 Goctets environ par jour. Ces données de type spectre ou forme d'ondes sont numérisées à bord et formatées au standard CCSDS avant d'être stockées dans la mémoire de masse puis transmises au sol et récupérées par le Centre de Mission.

Le plan des télécommandes sera préparé dans ce centre en tenant compte des contraintes des autres expérimentateurs. Les corrélations avec l'activité sismique se feront avec des données sismiques provenant du réseau GEOSCOPE. Les produits de ce centre de mission seront mis à disposition sur un serveur spécialisé avec plusieurs niveaux d'accès. Les quick-looks des données seront en libre accès. Ils représenteront des paramètres clés avec une résolution temporelle réduite. Les expérimentateurs invités auront un accès restreint aux données. Un appel d'offres pour ces expérimentateurs invités sera émis par le CNES avant la fin 2000. Le centre de mission aura aussi des relations privilégiées avec des expériences effectuant des mesures au sol dans les zones sismiques. Il est prévu d'avoir des échanges avec des expérimentateurs mesurant au sol : les champs continus, le bruit EM dans diverses bandes de fréquence, les paramètres ionosphériques, des paramètres optiques,... Les données satellite donneront un aperçu des paramètres ionosphériques au-dessus de ces régions où les mesures sol sont effectuées. La comparaison de ces paramètres permettra de comprendre le mécanisme de génération des perturbations électromagnétiques observées durant une activité sismique.

### 2.4. Le reste de la charge utile DEMETER:

### 2.4.1. La charge utile technologique:

Les équipements de la charge utile technologique ont pour objet de permettre aux métiers des techniques de base d'expérimenter en orbite, au cours ou à l'issue du programme de R&T, des produits ou systèmes nouveaux afin de réduire les risques et accroître les bénéfices des futures missions opérationnelles.

Les expériences technologiques sélectionnées sont au nombre de 5

#### 1- le COA-GPS (Contrôle d'orbite autonome):

Cette expérience a pour but de démontrer en orbite que l'on sait réaliser un contrôle d'orbite autonome et de démontrer son intérêt pour des missions opérationnelles. L'expérience COA est constituée d'un récepteur GPS TOPSTAR 3000 (fabriqué par Alcatel Space Industries) dans lequel sera implanté le code de restitution d'orbite DIOGENE, auquel on ajoute un module spécifique pour le calcul des manœuvres d'orbite. L'expérimentation est mise en œuvre de façon progressive, mais peut aller jusqu'à la réalisation autonome des manœuvres calculées à bord dans le respect des créneaux autorisés par la mission DEMETER.

Le contrôle d'orbite comprend les différentes étapes suivantes:

- Mesure et restitution d'orbite,
- Comparaison à une orbite de référence,
- Calcul de manœuvres de correction d'orbite en tenant compte des contraintes,
- Elaboration de commandes pour la réalisation des manœuvres (les manœuvres seront exécutées par le satellite).

Nota : la mise en œuvre de l'expérience s'effectuera de manière compatible avec l'exécution de la mission scientifique.

Le contrôle d'orbite est autonome quand l'ensemble de ces étapes est réalisé à bord. Le sol ne fournit au satellite que la définition de l'orbite de référence et l'expression des contraintes à respecter pour rester compatible avec les autres activités du satellite.

L'expérience a deux objectifs qui sont complémentaires:

Le premier est la validation fonctionnelle de DIOGENE, et de son initialisation à froid dans différentes configurations par rapport à la constellation GPS. La performance recherchée est la fourniture de données d'orbite de précision 100 m en position et 0.1 m/s en vitesse, dans un délai de 4 h. Cette validation doit avoir lieu en début de vie du satellite. Elle nécessite de pouvoir mettre le récepteur GPS en mode navigation, et de retransmettre les données de ce mode au sol. Le deuxième est le test du COA dans différentes configurations (la performance recherchée est le fonctionnement correct et conforme aux prévisions des simulations sol) :

- une configuration test du COA sans exécution des commandes calculées pour validation du fonctionnement correct de la partie calcul des manœuvres et des commandes. C'est la deuxième étape de validation. Elle nécessite de faire fonctionner le récepteur GPS en mode COA et de retransmettre les données de ce mode au sol.
- Une configuration expérimentation complète du COA en exécutant les manœuvres calculées, en respectant les orbites réservées à cet effet. Le récepteur GPS fonctionne en mode COA et les commandes de manœuvre sont envoyées à la plate-forme. Les manœuvres doivent rester

compatibles de la poursuite du satellite par les stations de réception bande S et bande X. Les données du mode COA sont envoyées au sol ainsi que les données plate-forme permettant de vérifier la réalisation correcte des manœuvres.

Il est prévu de tester successivement au cours de la mission au moins deux algorithmes différents de contrôle d'orbite:

l'un pour le contrôle du phasage en maintien à poste, l'autre pour le contrôle du demi grand axe en phase de désorbitation et l'arrêt automatique de poussée.

De manière générale les exigences sont les suivantes :

- démarrage sans aide du navigateur : fourniture de mesures d'orbite correctes dans un délai inférieur à AD après la commande d'initialisation,
- précision de restitution d'orbite à 3 sigma de : 100 m en position , 0,1 m/s en vitesse
- calcul de manœuvres conforme aux prévisions effectuées au sol par simulation,
- calcul des commandes pour l'exécution des manœuvres conforme avec les résultats du calcul de manœuvre et correctement transmis à la plate-forme.
- recevoir du logiciel, des données et des ordres de configuration.

## 2- la Mémoire de Masse:

Il s'agit de profiter du besoin important de stockage de données scientifiques, exprimé par la mission DEMETER pour développer une mémoire de masse composée de technologies nouvelles à bas coût. L'équipement est constitué de mémoires dont la capacité globale est de 8 Gbits (besoin DEMETER).

Trois objectifs ont été définis à la Mémoire de Masse.

- l'objectif principal est, sur ordre du calculateur Charge Utile, d'acquérir puis de mémoriser les données scientifiques issues du boîtier BANT afin de pouvoir les fournir ultérieurement au boîtier TMHD pendant les visibilités avec le sol.
- le deuxième objectif est l'embarquement de nouvelles technologies susceptibles d'être utilisées ultérieurement dans des équipements mémoire de masse de missions opérationnelles futures (retour d'expérience en vol sur ces nouvelles technologies).
- le troisième objectif est la recherche dans la mesure du possible d'un produit potentiellement intéressant afin d'être réutilisable éventuellement pour d'autres missions embarquées sur une plate forme MicroSatellite (produit générique).

Ci dessous sont rappelées les principales spécifications fonctionnelles de l'utilisateur de la fonction mémoire de masse:

- Rétention des données : capacité mémoire début de vie : 8 Gbits, et taux d'erreur de bits de  $10^{-6}$  pour une durée de rétention de 24 heures.
- Ecriture seule des données: un canal d'entrée, avec un débit moyen d'entrée de 1,8 Mbits/s en mode burst et de 25 Kbits/s en mode survey.
- Lecture seule des données: deux canaux de sortie, soit un canal de sortie A vers la TMHD (bande X) et un canal de sortie B vers le calculateur charge utile (bande S), avec un débit moyen de sortie de 16,8 Mbits/s en utilisant la liaison bord/sol en bande X, et de 400 Kbits/s en utilisant la liaison bord/sol en bande S.
- Ecriture / Lecture simultanée des données: débit moyen d'entrée de 1,8 Mbits/s en mode rafale et de 25 Kbits/s en mode surveillance, avec un débit moyen de sortie de 16,8 Mbits/s en



utilisant la liaison bord/sol en bande X et 400 Kbits/s en utilisant la liaison bord/sol en bande S.

- Gestion des ressources à bord de la mémoire de masse: enregistrement linéaire des données entre une adresse de début d'enregistrement et une adresse de fin d'enregistrement, gestion des données par blocs mémoires, gestion des adresses invalides dans le plan mémoire, gestion des modes internes et des transitions entre ces modes, commandabilité du sol sur les ressources bord et observabilité du sol sur les ressources bord.

### 3- la TMHD (Télémesure Haut Débit):

Cette expérience a pour but de valider les nouveaux concepts explorés par les développements de la R et T. L'expérience est constituée d'un boîtier d'électronique (interface MdM, partie numérique TMI, partie hyperfréquences) et d'une antenne patch (AC) avec plan de masse associé. Cette chaîne de télémesure est indispensable à la mission DEMETER (débit de données de 18 Mbits/s environ).

L'équipement TMHD satisfait à deux objectifs :

L'objectif vis à vis de la mission scientifique est de recevoir les données numériques issues de la MdM et de les transmettre à la station de réception au sol.

La TMHD récupère les données provenant de la MdM sous forme de paquets (au standard CCSDS) avant de les mettre en forme pour le transport. La transmission proprement dite est obtenue par modulation sur une porteuse en bande X puis amplification et enfin émission via une antenne orientée vers la Terre. Le flux reçu au sol sera suffisant pour assurer, dans quasiment toutes les conditions, la réception de ces données au sol, sans erreur.

Dans le cas de la mission " technologique ", la TMHD doit générer les paquets nécessaires pour les mesures de validation puis effectuer comme précédemment une mise en forme pour le transport puis la transmission. Dans ce cas, on recherchera un comportement de la TMHD aux limites de flux sol pour analyser les pertes de paquets induites (Taux d'Erreurs de Bits TEB et Taux de Pertes de Paquets TPP en fonction de ce flux).

Par souci de simplification, toute la connectique externe de l'émetteur (TX) TMHD est en liaison avec le boîtier EGCU sauf pour l'émission proprement dite où la connection est faite par câble avec l'antenne (Ant.) TMHD.

Les données mission proviennent de l'EGCU (partie MdM) par un interface parallèle (bus 8 bits) TM\_scientifique.

### 4- l'amorçage PYRO-LASER:

Cette expérience a pour but de valider le fonctionnement opérationnel d'une chaîne d'initiation photonique d'un composant pyrotechnique en lieu et place d'une chaîne électro-pyrotechnique. Elle est constituée d'une diode laser, d'un dispositif d'initiation photonique, ces deux éléments étant reliés par une fibre optique. L'initiateur photonique est inséré dans une cisaille.

Cette expérience est utilisée en mode nominal pour initier le déploiement du bras déployable, lequel supporte les capteurs IMSC de la charge utile scientifique. Elle ne sert qu'en début de vie pour la commande de déploiement du bras. Des paramètres spécifiques, tels la mesure de courant de la diode laser ou la mesure d'un flux lumineux, seront mesurés.

#### 5- THERME:

THERME a pour objectif d'étudier le vieillissement des matériaux de contrôle thermique. Cette expérience est essentiellement constituée de capteurs calorimétriques (thermistances) dotés des revêtements de contrôle thermique à qualifier dans l'espace. Elle est mise en route très rapidement après la mise en orbite, afin d'observer la dégradation des revêtements (due à la contamination) qui se produit surtout les premiers jours pendant le dégazage initial des matériaux du satellite.

#### 2.4.2. La gestion de l'ensemble charges utiles scientifique et technologiques:

Les expériences à caractère technologique et les équipements scientifiques DEMETER sont développées sur le principe d'une charge utile unique et autonome qui fédère toutes les expériences autour d'un équipement de gestion, interface fonctionnelle unique avec la plate forme (sauf pour le cas particulier THERME, gérée par le calculateur de la plate forme):

Il s'agit de l'Équipement de Gestion Charge Utile (EGCU). Cet équipement comporte les fonctions de gestion bord des expériences et de stockage centralisé de données.

Lui seul est donc raccordé au bus local de charge utile qui assure l'accès à la liaison bord-sol (liaison montante/descendante par bande S) pour les servitudes : réception des télécommandes et transfert des données technologiques de servitudes.

Les données scientifiques sont stockées dans la mémoire de masse (incorporée à l'EGCU). En mode nominal, la liaison descendante des données scientifiques est réalisée en bande X par la TMHD, laquelle est développée comme démonstrateur des nouvelles technologies qui la constituent, avec une station sol dédiée. En secours les données scientifiques sont routées vers l'EGCU, pour être descendues par la bande S.

L'expérience scientifique DEMETER est raccordé à l'EGCU par le boîtier d'acquisition, de numérisation et de traitement (BANT).

Les équipements sont alimentés électriquement par la barre non régulée du MicroSatellite.

L'ensemble, ainsi constitué de l'EGCU et des expériences, repose sur le plateau de charge utile doté du contrôle thermique nécessaire au bon fonctionnement des équipements.

#### 2.5. Le Centre de Mission Technologique:

## **2.5. Coordination entre les Centres de Mission Scientifique et Technologique:**

En phase d'opération, afin de résoudre les conflits potentiels entre les besoins missions scientifiques et technologiques, les demandes respectives devront être coordonnées à une fréquence de l'ordre de 4 à 6 mois par un groupe mission incluant des représentants des utilisateurs scientifiques et des responsables des expérimentations technologiques.

Il peut aussi se réunir suite à une anomalie bord ne permettant plus un fonctionnement nominal de toutes les expériences bord. Ce groupe mission sera coordonné conjointement par le PI scientifique et le PI technologique.

Cette coordination est essentiellement nécessaire vis à vis des expérimentation COA et TMHD.

Typiquement la mission scientifique DEMETER sera interrompue, au profit d'une mise en oeuvre de l'expérimentation COA, au maximum :

- deux fois par semaine à partir du 4ème mois après la recette,
- une semaine tout les 6 mois, à partir du 6ème mois après la recette, afin d'expérimenter un mode de contrôle à impulsion plus faible mais fréquente et un fonctionnement entièrement autonome sans intervention du sol pour la définition des créneaux de manoeuvre.

Le reste du temps, et en particulier les 3 premiers mois, sera utilisé pour vérifier le comportement du COA sans réalisation effective des manoeuvres.

Quand aux expérimentations sur la TMHD (vidage de données technologiques sur tout un passage), elles devront minimiser les impacts sur la mission scientifique. Elles se feront par conséquent en exploitant de façon prioritaire des passages stations non utilisables ou de faible intérêt pour la mission scientifique. Une centaine de passages par an, au dessus de la station de Toulouse, seront réservés à cet effet en visant les périodes météo favorables (conditions orageuses ou de fortes pluies).

## **2.6. Description des caractéristiques générales de la Ligne de Produit microsattelites:**

### **2.6.1. Le système DEMETER:**

Le système DEMETER a été développé pour répondre aux besoins de la Ligne de Produit microsattelites du CNES. Il est composé (figure 3):

- d'un segment sol (MIGS), constitué du Centre de Contrôle multimissions microsattelites (CNES Toulouse), d'une station bande S et d'une station bande X
- des Centres de Mission Scientifique et Technologique
- d'un segment vol, c'est à dire un microsattelite qui sera construit à partir de l'assemblage de chaînes fonctionnelles à caractère générique (mais susceptibles d'être adaptées aux besoins spécifiques des missions) et d'une charge utile scientifique et technologique.

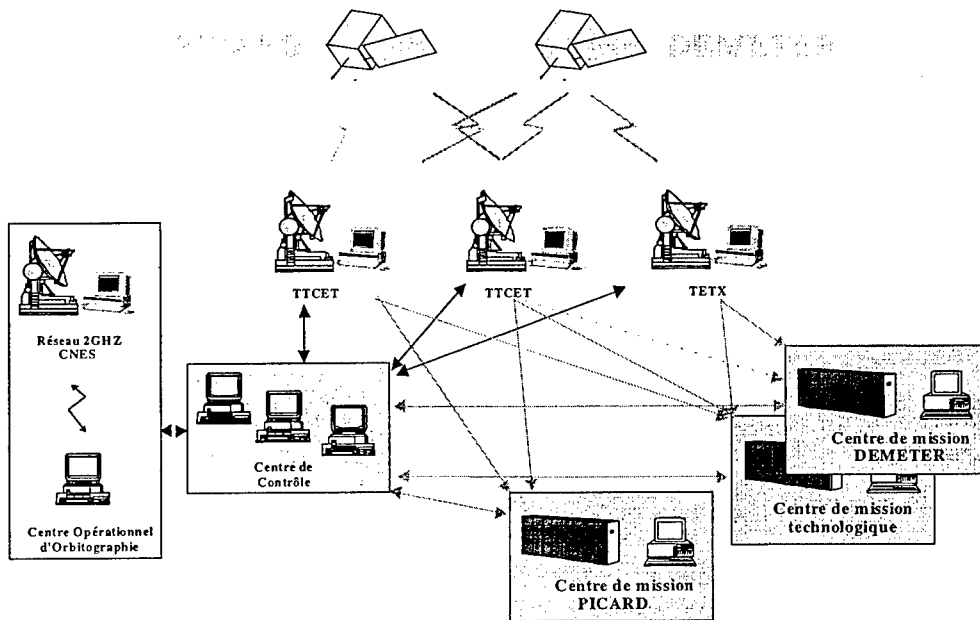


Figure 3: Le MIGS (Microsatellite Ground Segment) et les Centres de mission

Les éléments de base sont développés pour la première mission DEMETER qui offrira donc l'opportunité d'une première qualification en vol.

En phase opérationnelle, le Centre de Mission scientifique DEMETER enverra périodiquement au Centre de Contrôle la programmation de la charge utile scientifique. Il ira chercher sur le serveur adéquat du Centre de Contrôle les données de servitudes dont il a besoin (paramètres orbitaux, données satellite telles que l'attitude, ...). De même, il ira chercher les données scientifiques soit sur un serveur au pied de la station de réception bande X (mode nominal), soit sur un serveur au pied de la station bande S (mode de sauvegarde).

Le Centre de Mission Technologique utilise le même principe, mais les données sont envoyées sur la station bande S.

### 2.6.2. La mission et la définition du satellite DEMETER:

L'orbite souhaitée pour la mission DEMETER est une orbite basse circulaire d'inclinaison élevée. Une SSO, quasi polaire, avec une altitude de 800 km environ est parfaitement adaptée. Le lancement est prévu en 2002 avec un lanceur indien PSLV, la durée de la mission étant de 2 ans.

Le satellite est constitué de deux parties (plate-forme et charge utile), mais ces deux parties sont considérées comme un ensemble dont on cherchera à optimiser les performances de mission. La figure 4 représente une vue du satellite complet en mode gerbé (configuration de lancement sous coiffe du lanceur.

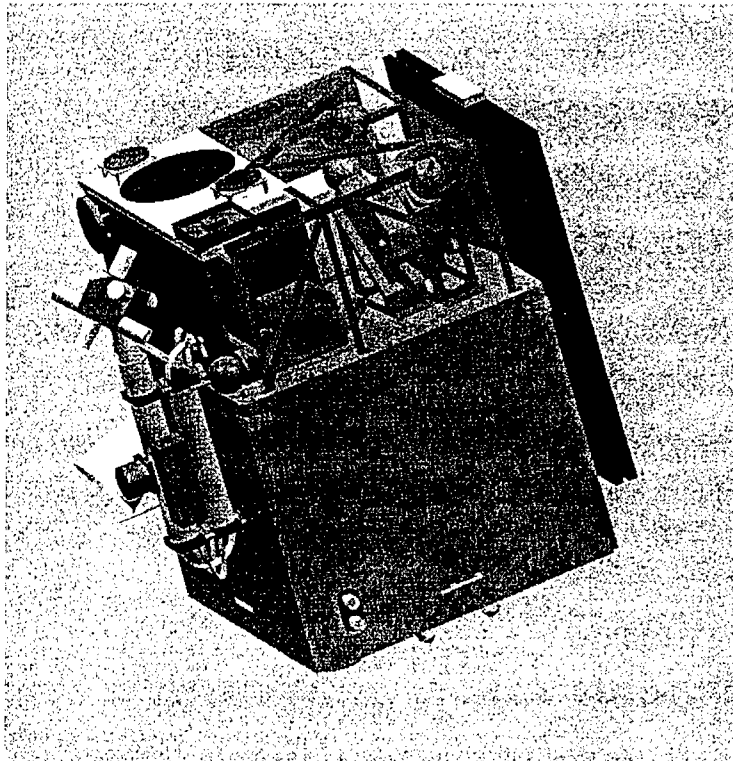


Figure 4: Vue du satellite DEMETER en mode gerbé

La plate-forme est constituée d'une structure parallélépipédique qui assure l'interface avec le lanceur et qui accueille les chaînes fonctionnelles de la mission. Cette plate-forme supporte aussi la charge utile. Elle a été conçue pour être suffisamment générique et donc pouvoir être réutilisée sur les missions microsattelites suivantes avec des adaptations limitées.

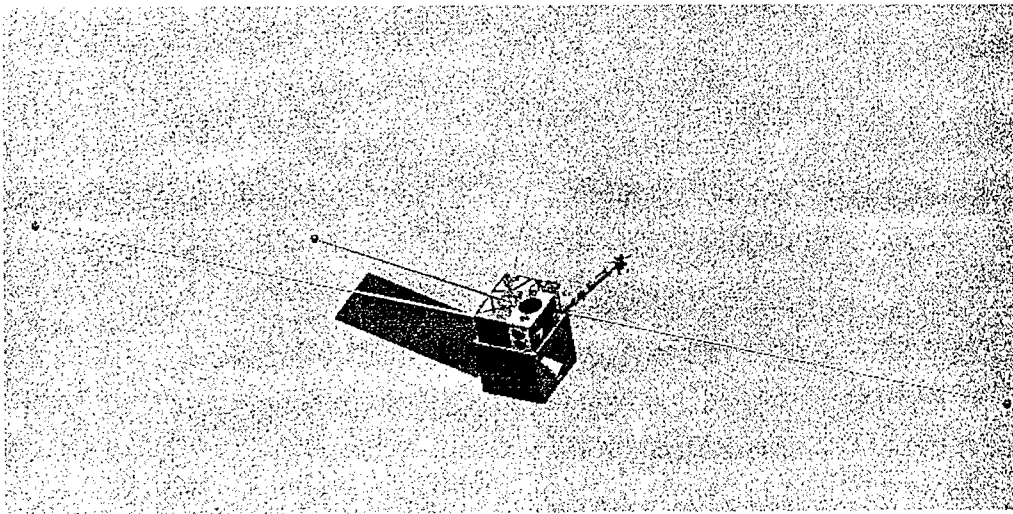
Les caractéristiques du satellite DEMETER sont les suivantes:

- encombrement en mode gerbé (sous coiffe): 600 x 750 x 800 mm
- masse:   plate-forme:                               72.2 kg (incluant 2.5 kg d'hydrazine)  
              charge utile scientifique:               20 kg  
              charge utile technologique:           8.5 kg

servitudes charge utile (structure, harnais, ...): 9.3 kg  
soit un total de 110 kg.

- puissance consommée: plate-forme: 35.6 W maximum moyennés sur une orbite  
charge utile: 25.8 W moyennés sur une journée

La figure 5 suivante représente le satellite DEMETER en mode opérationnel (configuration orbitale).



**Figure 5:** Vue du satellite DEMETER en configuration orbitale

Les performances du satellite DEMETER sont dans l'ensemble représentatives des performances de la Ligne de Produit microsattelites:

- Puissance électrique délivrée par le satellite de l'ordre de 78 W (en moyenne par orbite SSO)
- Stabilisation 3 axes avec précision de pointage de l'ordre de  $\pm 0.1^\circ$
- Mémoire de masse plate-forme de 1 Gbits
- TM avec débit de 400 Kbits/s
- TC avec 4 Kbits/s (immédiate ou différée)
- Localisation par le sol (1 km) ou par GPS (quelques m)
- Datation bord mieux que la s par rapport au TU
- Capacité de propulsion de 100 m/s

### 3. LA MISSION PARASOL (Polarisation & Anisotropie des Réflectances au sommet de l'Atmosphère, couplées avec un Satellite d'Observation emportant un Lidar)

#### 3.1. Les objectifs scientifiques:

Un observatoire spatial sans précédent se met en place à l'horizon 2003 pour l'étude des nuages et des aérosols. Il est constitué du vol en formation de 4 satellites qui observeront la Terre à quelques minutes d'intervalle. Le premier est AQUA, deuxième plate-forme du programme EOS développé par la NASA pour un tir dès la fin de cette année. Il sera rejoint en Mars 2003 par 2 mini-satellites PICASSO-CENA et CloudSat qui seront lancés simultanément par la NASA sur une fusée Delta 2. Le CNES participe à la mission PICASSO-CENA, deuxième client de la filière de plate-forme multimitations PROTEUS. Il est responsable de l'intégration du satellite et fournit un instrument imageur infra-rouge intégré à la charge utile. Le micro-satellite PARASOL viendra rejoindre cette formation au plus tard en 2004, en passager du lancement du satellite Hélios2. Basée très largement sur les acquis du programme POLDER et de la récurrence de la filière microsatellite, la mission PARASOL a pu se concrétiser en moins de 1 an et saisir ainsi l'opportunité de ce rendez-vous sans précédent dans l'espace.

Les objectifs scientifiques de cet observatoire sont centrés sur l'étude de l'atmosphère: il s'agit de caractériser les propriétés radiatives et microphysiques des nuages et des aérosols en utilisant au mieux la complémentarité des données fournies par les différents capteurs, actifs ou passifs de ces plate-formes. Le but scientifique ultime est de cerner les forçages radiatifs direct et indirect des nuages et des aérosols, d'estimer le bilan radiatif de la planète, de chiffrer sa réponse aux modifications anthropiques et son évolution au cours du temps. Il s'agit donc d'utiliser les observations afin de comprendre les différents processus (comme par exemple les interactions nuages-aérosols ou nuages-rayonnement), de les modéliser et de fournir *in-fine* aux modèles climatique, météorologique ou chimique, ces modélisations et les paramètres associés.

La plateforme AQUA embarque deux radiomètres passifs à grand champ de vue: MODIS pour l'étude des aérosols et des nuages, et CERES pour la mesure du bilan radiatif. PICASSO-CENA qui embarquera le premier lidar opérationnel dans l'espace, permettra d'obtenir des profils verticaux des nuages hauts, type cirrus, et des aérosols. CLOUDSAT, grâce à un radar à 94 Ghz, fournira des profils verticaux des nuages denses, type cumulus, ou hétérogènes.

Qu'apportera la mission PARASOL dans ce contexte?

POLDER est un radiomètre imageur à grand champ de vue très complémentaire par rapport à MODIS. En effet, il apporte deux types d'informations dans le domaine solaire, une information angulaire et une information de polarisation, inaccessibles par les autres instruments. Grâce à ces mesures originales, POLDER contribuera à répondre à certains des objectifs scientifiques et ceci parfois de façon unique. Il sera, par exemple, le seul à fournir la signature angulaire des différents types de nuages, à discriminer les différentes sources d'aérosols d'origine anthropique, à fournir, au-dessus des océans la composition chimique des aérosols par la détermination de leur indice de réfraction. L'originalité des mesures POLDER, déjà démontrée par les mesures sur ADEOS en 96-97, se trouvera ainsi complètement valorisée en contribuant à la banque de données unique fournie par cet observatoire.

La mission PARASOL a bénéficié d'une conjoncture extrêmement favorable. Le plan de développement court, de l'ordre de 3 ans, n'est réalisable que parce que POLDER est un instrument existant, dont les coûts et la réalisation sont parfaitement maîtrisés. De même, elle bénéficie directement pour les autres éléments de toutes les études techniques réalisées pour DEMETER. La conjonction de l'opportunité de mission de PARASOL et l'opportunité de lancement en passant du lancement d'Hélios 2 est, elle aussi, tout à fait exceptionnelle. Enfin, elle doit beaucoup à la filière microsatellite qui permet à des missions d'opportunité de voir le jour.

La référence [8] fournit des informations pour obtenir des renseignements ou des contacts relatifs à la mission PARASOL.

### **3.2. Description de la charge utile scientifique PARASOL**

La charge utile scientifique est constituée par l'instrument POLDER, radiomètre imageur à champ large, qui a servi, lors d'une précédente mission sur le satellite ADEOS, à mesurer les caractéristiques du rayonnement solaire réfléchi par la Terre et son atmosphère.

Pour PARASOL, cet instrument sera quasiment identique à celui d'ADEOS, aux choix des canaux près (9 canaux de 443 à 1020 nm), et il aura une fauchée de 1600 km avec une couverture de 2120 km le long de l'orbite (pixel de 5.5 x 5.5 km<sup>2</sup>).

Il est composé d'un bloc optique, d'un boîtier vidéo et d'un boîtier de servitudes.

Associé à l'instrument, un boîtier d'interface spécifique assurant l'interface entre le boîtier vidéo et l'électronique de gestion de la charge utile (EGCU) est prévu.

La charge utile comprend de plus:

- une mémoire de 16 Gbits, dont la technologie sera qualifiée par la mission DEMETER
- la chaîne de télémesure haut débit (TMHD à 18 Mbits/s) qui sera elle aussi qualifiée par la mission DEMETER
- l'EGCU (qualifiée par DEMETER) qui assure la gestion de la charge utile et la communication avec la plate-forme
- un GPS Topstar 3000 pour assurer une restitution précise de l'orbite du satellite et une datation précise des données scientifiques.

### **3.3 Le Centre de Mission PARASOL:**

L'exploitation des données des missions POLDER 1 et 2 a nécessité la création du Centre de Production POLDER (CPP) au CNES (Toulouse).

Il est envisagé d'utiliser les mêmes algorithmes pour traiter les données PARASOL, même si les modifications proposées (canaux, orientation différente de l'instrument, altitude et heures de passage différentes, ...) entraînent des changements dans les traitements de niveau 1.

Des moyens de traitement des données POLDER existent aussi dans les laboratoires impliqués (LOA, LSCE et LMD).

Le jeu de données réduit PARASOL correspondant à l'ensemble des observations PARASOL, PICASSO/CENA, CLOUDSAT et EOS-PM doit être rendu disponible à l'ensemble des scientifiques impliqués.

Les réflexions sur l'organisation des activités du Centre de Mission se poursuivent.



### **3.4. Description des adaptations apportées à la Ligne de Produit microsattelites:**

#### **3.4.1. Le système PARASOL:**

Le système PARASOL reprend les composantes essentielles du système de la Ligne de Produit microsattelites, c'est à dire un segment sol (MIGS) constitué du Centre de Contrôle microsattelites (CNES Toulouse), de la station bande S et de la station bande X, et la composante vol microsattelite.

Ces composantes de base auront déjà été qualifiées par la mission DEMETER.

Un Centre de Mission scientifique s'y ajoute.

Le système PARASOL est opéré de manière très semblable à celle de DEMETER et confirme bien le caractère générique du système développé pour la ligne de produit microsattelites.

#### **3.4.2. Le satellite PARASOL:**

La mission PARASOL implique que l'orbite finale soit celle de PICASSO (705 km, 98.08°, 14 h10 à 12h50 montante). L'analyse de mission a montré que la solution consistait, à partir d'un lancement sur l'orbite d'injection d'Hélios 2, à rejoindre dans un premier temps (3 mois) une orbite intermédiaire d'attente (celle de MODIS) puis celle de PICASSO, et suivre cette dernière.

Le satellite PARASOL doit donc utiliser le système de propulsion de la filière, capable d'assurer les changements d'altitude et/ou d'inclinaison et les maintiens à poste jusqu'à un  $\Delta V$  total de 100 m/s.

La spécification de précision de pointage de l'instrument POLDER est inférieure à 1° ce qui est compatible de la précision de pointage de la plate-forme (0.1 °).

La spécification de localisation au sol des images de POLDER implique des restitutions précises de la direction de visée, ce qui est possible grâce à la précision de la mesure d'attitude du senseur stellaire (une restitution à 0.01 ° près est envisagée).

La plate-forme de PARASOL sera donc totalement récurrente de celle de DEMETER.  
La figure suivante montre une vue d'artiste du satellite PARASOL sur son orbite.

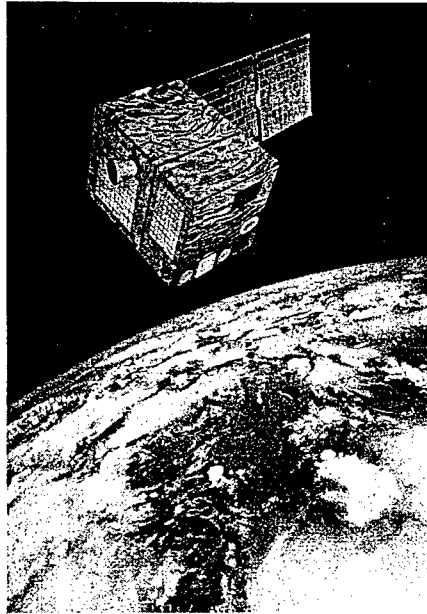


Figure 6: Le satellite PARASOL sur son orbite

Les caractéristiques actuelles du satellite PARASOL sont les suivantes:

- encombrement en mode gerbé (sous coiffe): 600 x 750 x 800 mm
- masse:     plate-forme:                 75 kg (incluant 5 kg d'hydrazine)  
          charge utile scientifique:     40 kg max  
  soit un total de 115 kg.
- puissance consommée:  plate-forme:  35.6 W maximum moyennés sur une orbite  
                                  charge utile:  35 W moyennés sur une journée

Les performances du satellite PARASOL sont celles de la Ligne de Produit microsattelites:

- Puissance électrique délivrée par le satellite de l'ordre de 78 W (en moyenne par orbite SSO)
- Stabilisation 3 axes pointage géocentrique avec précision de pointage de l'ordre de  $\pm 0.1^\circ$
- Mémoire de masse plate-forme de 1 Gbits
- TM avec débit de 400 Kbits/s
- TC avec 10 Kbits/s (immédiate ou différée)
- Localisation par le sol (1 km) ou par GPS de la charge utile (quelques m)
- Datation bord mieux que la s par rapport au TU
- Capacité de propulsion de 100 m/s

Les performances de la charge utile sont indiquées dans le chapitre précédent.

#### 4. LA MISSION MICROSCOPE:

##### 4.1. Les objectifs scientifiques de la mission MICROSCOPE:

La mission Microscope est la première mission spatiale européenne dont les objectifs scientifiques concernent avant tout la Physique Fondamentale. Il s'agit en effet de réaliser le test du principe d'équivalence avec une précision de  $10^{-15}$ , soit trois ordres de grandeur de mieux que la précision déjà obtenus avec des expériences terrestres.

##### *Le Test du principe d'équivalence :*

Énoncé par Einstein en 1911, ce principe est à la base de la relativité générale. Sa seule justification demeure expérimentale, en particulier avec son implication la plus évidente, à savoir, l'identité du mouvement des corps soumis au même champ de gravité, indépendamment de leur masse et de leur composition. Au delà de la relativité générale qui décrit très précisément la gravitation dans ses formes 'classiques', les approches cohérentes de la théorie quantique de la gravitation restent encore en devenir. De même, le modèle Standard des interactions fortes, électromagnétiques et faibles reste incomplet et de nouvelles interactions pourraient s'ajouter en plus de la gravitation.

Les calculs récents de T. Damour et S. Polyakov [9,10] suggèrent que la violation du PE induite par certaines interactions prédites par les théories unificatrices pourraient se produire à partir d'un niveau de précision de  $10^{-13}$ .

La violation du principe d'équivalence, démontrée par la mission Microscope, pourrait donc être la remise en cause de la relativité générale dans son formalisme actuel, ou les premiers pas vers la détermination d'une nouvelle interaction susceptible de permettre de réaliser une avancée vers les théories de grande unification.

La démonstration à un niveau plus grand de précision du principe d'équivalence est une contrainte plus forte pour l'élaboration de nouvelles théories [11] et il demeure indispensable, quelque soit la précision atteinte, de tester les fondements de ces théories.

##### *Microscope, laboratoire technologique spatial :*

D'autre part, la mission Microscope est également un formidable démonstrateur technologique, préparant la réalisation de missions spatiales encore plus ambitieuses avec le test du principe d'équivalence à  $10^{-17}$ - $10^{-18}$  ou l'observation d'ondes gravitationnelles, dans le domaine de la Physique Fondamentale, ou avec d'autres missions exigeant des laboratoires spatiaux dont l'accélération résiduelle non gravitationnelle est la plus réduite possible. Ceci est rendu possible au moyen de satellites à traînée compensée exploitant des propulseurs électriques de poussée modulable et des senseurs inertiels de très grande résolution [12,13,14].

Le microsatellite porteur de la charge utile sera compatible d'un lancement en passager sur Ariane 5. L'attitude du satellite sera soit inertielle, soit spinnée (quelques  $10^{-3}$  rd/s) autour de l'axe normal au plan orbital.

##### 4.2. Description de la charge utile scientifique MICROSCOPE:

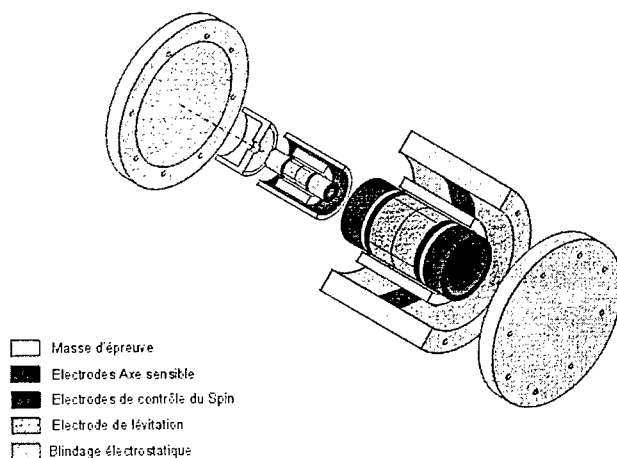
La charge utile, d'une masse de 25kg est constituée de deux paires d'accéléromètres électrostatiques, différentiels et concentriques, qui fonctionnent à température ambiante et présentent une résolution de  $10^{-12} \text{ms}^{-2}\text{Hz}^{-1/2}$ . Chaque accéléromètre comprend :

- un cœur (voir figure 7), composé d'une masse d'épreuve et d'une " cage " d'électrodes réalisé en silice 'ULE' présentant une très grande stabilité thermique et une géométrie de précision micrométrique ;
- une électronique associée permettant des mesures de position de précision picométrique et l'asservissement des masses d'épreuve à cette précision.

L'emport de deux accéléromètres différentiels, l'un avec deux masses constituées de matériaux distincts (A et B) et l'autre de masses d'épreuve d'un même matériau (A,A), permet de discriminer les erreurs systématiques d'un éventuel signal de violation.

La géométrie cylindrique adoptée limite la sensibilité de l'accéléromètre aux fluctuations du gradient de gravité dans la direction privilégiée pour les mesures différentielles.

Le principe d'un accéléromètre électrostatique est le suivant : une masse d'épreuve est maintenue en lévitation au centre d'une cage portant des électrodes servant conjointement à la détection capacitive de la position de la masse et au développement des forces électrostatiques assurant sa suspension selon les six degrés de liberté. La mesure des forces nécessaires au contrôle des six degrés de liberté permet de déterminer les trois composantes des accélérations linéaires et angulaires utilisées pour les mesures scientifiques et le système de contrôle d'attitude et d'orbite. Les lois de commande peuvent utiliser les mesures de l'un ou de plusieurs accéléromètres.



*Figure 7: Configuration de l'accéléromètre différentiel*

Le développement des accéléromètres tirera profit de l'expérience acquise avec la réalisation de l'accéléromètre ASTRE qui a volé trois fois à bord de la navette Columbia, de l'accéléromètre STAR charge utile du satellite allemand CHAMP livré en 1999 pour un vol en 2000 et de son dérivé Super-STAR, actuellement en cours de qualification, qui sera embarqué à bord de chacun des deux satellites de la mission GRACE en 2001.

### ***Microscope, mission internationale :***

La mission Microscope a été proposée dans le cadre des microsattellites du CNES en partenariat avec le CERGA, laboratoire de l'Observatoire de la Côte d'Azur. D'autres collaborations françaises sont également envisagées comme l'IHES et l'ENS ou le GRGS (Toulouse) pour l'exploitation des résultats et l'évaluation Physique de l'expérimentation.

Outre ces collaborations, des partenaires internationaux sont également invités à participer :

- ? Centrosazio (Pise - Italie) et/ou l'ARC (Seibersdorf - Autriche) pour la propulsion électrique ;
- ? Le ZARM (Brême - Allemagne) pour des étalonnages de l'instrument en microgravité par des essais en tour d'impesanteur ;
- ? Le BIPM (Sèvres) pour la réalisation et la caractérisation des masses d'épreuve ;
- ? L'Université de Birmingham (Angleterre) pour les lois de contrôle du système de contrôle d'attitude et de compensation de traînée.

### **4.3. Le Centre de Mission MICROSCOPE:**

### **4.4. Description des adaptations apportées à la Ligne de Produit micosatellites:**

#### **4.4.1. Le système MICROSCOPE:**

Le système MICROSCOPE reprend lui aussi les composantes essentielles du système de la Ligne de Produit microsattellites, c'est à dire un segment sol (MIGS) constitué du Centre de Contrôle microsattellites (CNES Toulouse) et uniquement de la station bande S, et la composante vol microsattellite.

Un Centre de Mission scientifique s'y ajoute.

Ces composantes de base auront déjà été qualifiées par la mission DEMETER.

Le système MICROSCOPE est opéré de manière très semblable à celle de DEMETER et de PARASOL, et confirmer bien elle aussi le caractère générique du système développé pour la ligne de produit microsattellites.

#### **4.4.2. La mission et le satellite MICROSCOPE:**

La durée de la mission MICROSCOPE est de moins de un an. La majeure partie de la mission concerne la caractérisation en orbite de l'instrument, du système de traînée compensée et de contrôle d'attitude et des accélérations appliquées sur les accéléromètres, en particulier l'effet du gradient de gravité. La durée d'une mesure individuelle est comprise entre quelques heures et un jour. Le temps restant après le test du principe d'équivalence pourrait être utilisé pour des expérimentations technologiques de la plate-forme à traînée compensée. En particulier, différentes lois de contrôle seront testées en préparation des missions de détection des ondes gravitationnelles.

La mission MICROSCOPE demande une orbite quasi-circulaire (excentricité  $< 10^{-2}$ ) d'altitude 600/1200 km. Une orbite d'injection type Hélios 2 remplit ces caractéristiques et a donc été prise comme option de base. Avec cette option, et compte tenu de l'absence de besoin de correction d'orbite pendant la mission, la chaîne fonctionnelle propulsion de la filière microsattellites n'est pas nécessaire.

La mission est caractérisée par le besoin d'un satellite à compensation de traînée avec spin autour de l'axe Y du satellite (axe du senseur stellaire).

La compensation de traînée doit être assurée à mieux que  $10^{-10}$  g et le spin à  $10^{-3}$  rd/s doit être réalisé avec une stabilité de  $10^{-5}$  rd/s<sup>2</sup>.

Ces besoins nécessitent une architecture satellite adaptée:

- configuration avec une rigidité importante et des inerties faibles
- pas de couples perturbateurs tels que mouvements/déplacements de pièces, pas d'interaction entre les jets de propulseurs et les surfaces du satellite
- centre de gravité du satellite et de la charge utile confondus

L'architecture du satellite MICROSCOPE a donc été construite à partir de l'utilisation des chaînes fonctionnelles de la Ligne de Produit, avec les adaptations suivantes:

- structure parallélépipédique englobant la plate-forme et la charge utile (placée au centre de gravité du satellite)
- générateurs solaires avec cellules à haut rendement sur la peau du satellite
- système de contrôle d'attitude et de compensation de la traînée utilisant les signaux du senseur stellaire de la chaîne fonctionnelle SCAO et des accéléromètres de la charge utile pour les mesures, et des propulseurs électriques à effet de champ (FEEP) comme actuateurs.

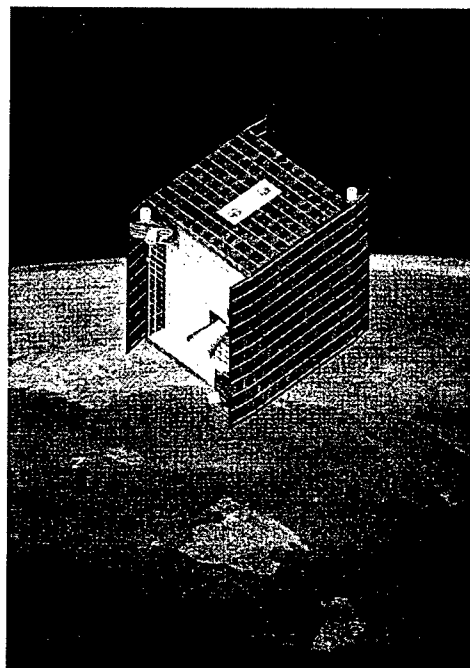


Figure 8: Le satellite MICROSCOPE sur son orbite

Le satellite MICROSCOPE illustre la possibilité d'adaptation des chaînes fonctionnelles de la Ligne de Produit à des besoins spécifiques.

Les caractéristiques actuelles du satellite MICROSCOPE sont les suivantes:

- encombrement en mode gerbé (sous coiffe): 600 x 750 x 800 mm
- masse: satellite: < 120 kg  
dont charge utile scientifique: 22 kg
- puissance consommée: < 70 W (dont 13 W pour la charge utile)
- système de contrôle d'attitude basé sur l'utilisation de 4 pods de 2 propulseurs FEED
- poussée unitaire des FEED de 50  $\mu$ N environ

Les performances du satellite MICROSCOPE sont:

- Puissance électrique délivrée par le satellite de l'ordre de 70 W (en moyenne par orbite SSO)
- Compensation de traînée assurée à mieux que  $10^{-10}$  g
- Spin autour de Y à  $10^{-3}$  rd/s
- Précision de pointage de Y à  $\pm 0.5^\circ$  près perpendiculairement au plan de l'orbite
- Accélération linéaire: <  $10^{-9}$  m/s<sup>2</sup>/Hz<sup>-1/2</sup> autour des 3 axes
- Vitesse angulaire: <  $10^{-5}$  rad/s/Hz<sup>-1/2</sup> autour des 3 axes
- Mémoire de masse plate-forme de 1 Gbits
- TM avec débit de 400 Kbits/s
- TC avec 10 Kbits/s (immédiate ou différée)
- Localisation par le sol (1 km)
- Datation bord mieux que la s par rapport au TU
- 

Le satellite MICROSCOPE a donc pu être conçu en adaptant de manière judicieuse les concepts de la Ligne de Produits microsattelites.

## 5. CONCLUSION:

Les missions microsattellites DEMETER, PARASOL et MICROSCOPE ont été présentées. Avec la mission PICARD, ces quatre missions démontrent que la Ligne de Produit microsattellites développée par le CNES apparaît bien adaptée aux besoins de ces missions:

- Le microsattellite DEMETER est le premier microsattellite de la Ligne de Produit et va donc qualifier l'ensemble du système. La mission est ambitieuse et elle mettra en évidence les très bonnes performances de la filière.
- La mission PICARD utilisera la Ligne de Produit avec des adaptations relativement mineures, en particulier le système de contrôle d'attitude qui assurera un pointage très fin du satellite (à 0.01 ° près grâce à l'utilisation du signal d'écartométrie de la lunette guide du télescope de la charge utile).
- Pour la mission PARASOL, peu de modifications sont envisagées, la récurrence avec DEMETER sera forte.
- Pour la mission MICROSCOPE, des modifications un peu plus conséquentes du satellite, en particulier de la structure, des générateurs solaires, du système de contrôle d'attitude et de compensation de traînée, ... sont prévues.

Les charges utiles de ces missions, qu'elles soient scientifiques ou technologiques, sont très performantes eu égard à leurs dimensions et masses qui restent limitées par la capacité d'emport du satellite.

Néanmoins, la démonstration est faite qu'avec des technologies miniaturisées on peut concevoir un système globalement très performant.

Les avant-projets de microsattellites qui succéderont à cette première série sont aujourd'hui nombreux. Ils témoignent de l'engouement suscité par cette Ligne de Produit, lié essentiellement au très bon rapport performances/coût des missions construites avec ce produit.

Les microsattellites sont dimensionnés pour pouvoir être lancés en passagers sur des lancements par Ariane 5, mais aussi sur des lancements par le lanceur indien PSLV, ou sur d'autres lanceurs (russes, ...).

Il faut cependant noter que les opportunités de lancement sur les orbites le plus souvent demandées (orbites SSO) restent aujourd'hui assez rares.

Il faudra donc certainement rechercher, et favoriser éventuellement, un éventail plus large de possibilités pour pouvoir lancer les microsattellites déjà décidés et leurs successeurs qui s'annoncent nombreux.



## 7. REFERENCES:

- [1] M. Parrot, et al., *High-frequency seismo-electromagnetic effects*, Phys. Earth Planet. Int., 77, 65-83, 1993.
- [2] M. Parrot, *Electromagnetic noise due to earthquakes* in Handbook of Atmospheric Electrodynamics, v.II, Ed. by H. Volland, CRC Press, Boca Raton, pp. 95-116, 1995.
- [3] O.N. Serebryakova et al., *Electromagnetic ELF radiation from earthquake regions as observed by low-altitude satellites*, Geophys. Res. Lett., 19, 91-95, 1992.
- [4] O.A. Pokhotelov et al., *Response of the ionosphere to natural and man made acoustic sources*, Ann. Geophys., 13, 1197-1210, 1995.
- [5] M. Parrot, *Statistical study of ELF/VLF emissions recorded by a low altitude satellite during seismic events*, J. Geophys. Res., 99, 23,339-23,347, 1994.
- [6] M. Parrot, *Observations of PLHR by the low-altitude AUREOL-3 satellite*, J. Geophys. Res., 99, 3961-3969, 1994.
- [7] M. Parrot and Y. Zaslavski, *Physical mechanisms of man made influences on the magnetosphere*, Surveys in Geophysics, 17, 67-100, 1996.
- [8] Responsable Scientifique PARASOL: D. TANRÉ \* (email: tanre@loa.univ-lille1.fr)  
Laboratoire d'Optique Atmosphérique, UMR/CNRS 8518  
U.S.T. de Lille 1, Bat. P5, 59655 – Villeneuve d'Ascq  
En plus du Laboratoire d'Optique Atmosphérique de Lille, sont impliqués dans le projet PARASOL, le Laboratoire de Météorologie Dynamique, le Laboratoire des Sciences du Climat et de l'Environnement et le Service d'Aéronomie.  
Pour plus d'informations sur les missions d'accompagnement PARASOL, voir les sites suivants
- [9] : Testing the equivalence principle : why and how ? T. Damour, Class. Quant. Grav. 13 (1996) A33.
- [10] : String theory and Gravity, T. Damour and A.M. Polyakov , Gen. Rel. Grav. 26 (1994) 1171.
- [11] : New interaction and the standard models, P. Fayet, Class. Quant. Grav. 13 (1996) A19.
- [12] : The inertial reference sensor CAESAR for the LISA mission, P. Touboul, M. Rodrigues & G. M. Le Clerc, Class. Quantum Grav. 13 (96)
- [13] : Electrostatic accelerometers for the equivalence principle test in space, P. Touboul, M. Rodrigues, E. Willemenot & A. Bernard, Class. Quantum Grav. 13 (96)
- [14] : Electrostatic space accelerometers for present and future missions, P. Touboul, B. Foulon & E. Willemenot, to be published in Acta Astronautica Journal in 98.
- [15] : Field Emission Electric Propulsion: Experimental Investigations on Microthrust FEED Thrusters, J. Gonzales, G. Saccoccia, H. von Rohden, AIDAA/AIAA/ DGLR/JSASS 23rd International Electric Propulsion Conference, Seattle, WA, Sept. 1993.
- [16] : A Flight Demonstration of FEED : Electric Thrusters for Microgravity Laboratories and Drag-Free Spacecraft, S. Marcuccio, M. Andrenucci, G. Saccoccia, J. Gonzalez, V. Zolesi, ESA/ESTEC Workshop on In-Orbit Technology Demonstration, June 1994.

**CNES MINISATELLITE MISSIONS  
LES MISSIONS PROTEUS**

**Michel ROUGERON**

*Centre National d'Etudes Spatiales  
18 avenue Edouard Belin – 31401 Toulouse Cedex 4*

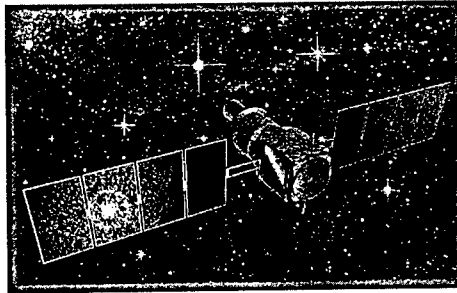
**RESUME** – Mi-96, le CNES décidait simultanément de développer une nouvelle filière de plates-formes minisatellite reconfigurables (PROTEUS) en partenariat avec ALCATEL SPACE INDUSTRIES et d'engager une première mission utilisant cette plate-forme, la mission JASON (suite de TOPEX-POSEIDON). Aujourd'hui, alors que se prépare le lancement de JASON, l'avenir de la filière est assuré avec la commande, début 2000, de trois plates-formes récurrentes, le démarrage du projet PICASSO-CENA en coopération avec la NASA (actuellement en fin de phase B), la relance du projet d'astronomie COROT prêt à passer en phase C/D, et des perspectives de missions nouvelles, objet d'études de phase A, SMOS en coopération avec l'ESA et l'Espagne, MEGHA-TROPICQUES en coopération avec l'Inde et, bien sûr, JASON 2 pour assurer la continuité des mesures d'altimétrie océanographique initiées avec TOPEX-POSEIDON et JASON.

*ABSTRACT* – Mid-96, CNES decided in the same time to develop in partnership with ALCATEL SPACE INDUSTRIES a new minisatellite product line, using a versatile platform (PROTEUS), and to realize a first PROTEUS mission, JASON (TOPEX-POSEIDON follow-on). Today, JASON satellite being prepared for launch, the future of the product line is secured with an order (beginning of 2000) for three recurrent platforms, the PICASSO-CENA project decision in cooperation with NASA (now at the end of the phase B studies), the restart of the COROT astronomy project ready for phase C/D development, and new missions perspectives (phase A studies), SMOS in cooperation with ESA and Spain, MEGHA-TROPICQUES in cooperation with India, and of course, JASON 2 for ensuring the continuity of the altimetry measurement on the oceans, after TOPEX-POSEIDON and JASON.

## **1 - INTRODUCTION**

Les prochaines missions PROTEUS, au delà de JASON (qui devrait être suivi en 2004 d'un JASON-2 récurrent) sont COROT, PICASSO-CENA, SMOS et MEGHA-TROPICQUES.

## 2 – COROT



### 2.1 – La mission

COROT est une mission de photométrie stellaire de très grande précision comportant deux volets :

- **L'étude de la structure interne des étoiles** : L'outil utilisé est l'astérosismologie, c'est-à-dire l'analyse fréquentielle des modes d'oscillation des étoiles, de leur amplitude et de leur durée de vie.
- **La recherche d'exoplanètes** (hors système solaire) : La méthode utilisée est celle des occultations ou transits, seule méthode permettant d'espérer une première détection de planètes « habitables ».

### 2.2 – Description technique

• L'**instrument** COROT est un photomètre en lumière blanche utilisant un télescope miroir hors d'axe réducteur de pupille, un objectif imageur dioptrique et des détecteurs CCD de grandes dimensions (4 matrices 2000 x 2000), légèrement défocalisés.

Les exigences principales sont :

- Une réjection quasi-parfaite de la lumière parasite. Le baffle du télescope autorise un coefficient d'atténuation de  $10^{-14}$  (pour un angle de garde de  $20^\circ$ ).
- Un contrôle thermique très précis du bloc focal avec une stabilité meilleure que 0,05 degrés / heure.
- Une précision de pointage exceptionnelle, inférieure à 0,5 secondes d'arc, qui est assurée par l'utilisation dans la boucle de contrôle d'attitude de la plate-forme PROTEUS d'informations d'écartométrie venant de l'instrument.

La charge utile COROT pèse environ 200 kg et mesure quelques trois mètres de long.

• L'originalité du **satellite** COROT, au sein de la filière PROTEUS, est son mode de pointage inertiel qui induit quelques difficultés pour le contrôle thermique des batteries, avec de plus comme indiqué ci-avant, un pilotage faisant intervenir des mesures issues de la charge utile.

Sinon, les ressources disponibles de la plate-forme PROTEUS en particulier pour ce qui concerne la puissance électrique et la capacité de stockage et transmission des données (via l'émetteur bande S standard) sont en parfaite adéquation avec les besoins mission.

- Pour observer une même zone du ciel pendant une longue période comme cela est nécessaire pour l'astérosismologie, COROT est placé sur une orbite polaire (inclinaison 90°) circulaire à 800 km d'altitude. Ceci permet des observations continues pendant un peu moins de 6 mois ; le satellite est ensuite tourné de 180° pour étudier la zone opposée du ciel. Les panneaux solaires sont ré-orientés tous les 10 jours environ.

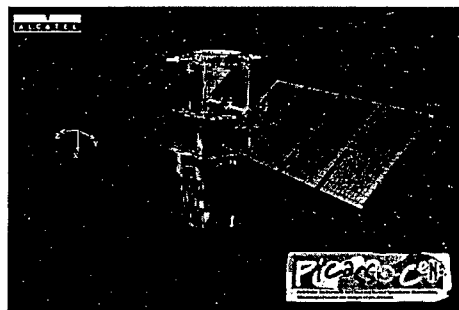
- La charge utile COROT génère environ 500 Mbits de données par jour. Celles-ci sont retransmises à une station sol au cours de quatre passages chaque jour en moyenne, reçues par le Centre de Contrôle du satellite qui est un produit de la filière PROTEUS puis traitées par le Centre de Mission.

### 2.3 – Organisation - Calendrier

A l'issue de la phase A (en mars 98), il était prévu que COROT prenne la suite de JASON dans la série des missions PROTEUS, pour un lancement au deuxième semestre 2002. Mais, conçu dès l'origine comme un partenariat entre le CNES et plusieurs laboratoires scientifiques français, le projet COROT s'est révélé, au cours de la phase B, trop ambitieux par rapport aux moyens que ces derniers étaient susceptibles de mettre en place. Une nouvelle organisation dans laquelle le CNES assume lui-même la maîtrise d'œuvre de l'instrument avec une intervention de l'industrie plus importante a été mise en place, mais conduit à augmenter le coût du projet. Les moyens consacrés par le CNES aux différentes missions scientifiques PROTEUS étant, par principe, plafonnées, l'engagement de la phase C/D de COROT a été ajourné afin de permettre une européanisation plus large du projet. Aux partenaires initiaux (ESA, Autriche; Espagne) sont venus se joindre d'autres pays (Belgique, Italie), une augmentation de la participation de l'ESA étant par ailleurs espérée.

Cette démarche devrait permettre le redémarrage du projet en octobre 2000, en réponse à une recommandation positive du Comité des Programmes Scientifiques du CNES. Il resterait alors à finaliser le choix du lanceur qui a fait l'objet d'une consultation très large mais n'a pu se concrétiser compte tenu des incertitudes programmatiques. Le lancement interviendrait en octobre 2004, COROT se plaçant en troisième position dans la série des missions PROTEUS après JASON et PICASSO-CENA.

### 3 – PICASSO-CENA



#### 3.1 – La mission

La mission PICASSO-CENA est une mission d'études des nuages et des aérosols. Il est en effet établi que les principales incertitudes sur la prédiction de l'évolution du climat sont associées à l'impact radiatif des aérosols et des nuages.

La détermination précise des paramètres microphysiques des nuages et des flux de surface reste en effet un objectif majeur des observations spatiales, pour déterminer leur effet sur l'évolution du climat. Les techniques passives classiques utilisant des radiomètres imageurs dans le domaine visible ou proche infrarouge, ne donnent pas accès à la structure tridimensionnelle de l'atmosphère. Afin de permettre une avancée significative, la NASA, en coopération avec le CNES dans le cadre ESSP (Earth System Science Pathfinder), a sélectionné la mission PICASSO-CENA mettant en œuvre une technique active, le LIDAR, pour voler en formation avec la mission EOS-PM. Il s'agira du premier lidar atmosphérique embarqué sur satellite pour une mission de 3 ans (les vols LITE sur navette avaient un caractère expérimental de courte durée).

En outre, la NASA a également sélectionné la mission complémentaire CLOUDSAT qui embarquera un radar nuage à 94 GHz et sera également coorbitante de PICASSO et EOS-PM. Les deux satellites, dont le lancement double est prévu en mars 2003, seront placés avec EOS-PM sur une orbite circulaire à 705 km quasi-héliosynchrone à 13 :30. Enfin, la sélection de la mission PARASOL sur un microsatellite du CNES complètera le système d'observation.

La formation EOS / PICASSO / CLOUDSAT / PARASOL est ainsi une opportunité exceptionnelle qui fournira aux scientifiques un ensemble complet de mesures de nature à permettre de résoudre les incertitudes actuelles.

### 3.2 – Description technique

• L'**instrument** principal de la mission PICASSO-CENA, sous responsabilité de la NASA/LARC, est un lidar à rétrodiffusion bifréquence (532 et 1064 nm) avec mesure de polarisation sur une des fréquences, fournissant une résolution verticale allant de 30 m près du sol à une centaine de mètres à haute altitude, avec un échantillonnage spatial au sol de l'ordre du kilomètre.

La charge utile est complétée par :

- Un spectromètre ABS mesurant l'absorption de l'oxygène autour de 765 nm (NASA).
- Un imageur infra-rouge 8, 10,5 et 12,5 microns utilisant une tête optique dérivée de celle développée par le CNES dans le cadre du projet IASI (détecteurs bolométriques 64 x 64 pixels).
- Une caméra grand champ (résolution 125 m au sol) dans le visible.

La charge utile d'une masse de 250 kg et consommant 280 W environ est intégrée aux Etats-Unis sous la responsabilité de NASA/LARC par BALL AEROSPACE, avant d'être livrée à ALCATEL SPACE INDUSTRIES responsable, en partenariat avec le CNES, de la fourniture de la plate-forme PROTEUS ainsi que de l'ingénierie et de l'AIT satellite.

• Le **satellite**, d'une masse de 500 kg et disposant au total d'une puissance de 600 W s'inscrit bien dans le standard PROTEUS quoique les exigences de la charge utile en termes de puissance électrique soient à la limite des possibilités de la plate-forme.

Cette mission est l'occasion de mettre en œuvre une nouvelle configuration de vol, celle du vol « vertical », c'est-à-dire avec l'axe du satellite dirigé vers la Terre. Les analyses montrent en effet la faisabilité de cette option qui ouvre de nouvelles possibilités pour l'observation ou les sciences de la Terre.

Le lancement est effectué par un lanceur DELTA-2 de la NASA en lancement double avec CLOUDSAT à partir de Vandenberg.

• Le satellite PICASSO-CENA est placé sur une **orbite** quasi héliosynchrone à 705 km d'altitude (heure locale dérivant de 13h à 14h environ). La spécificité de la mission est un vol « en formation » avec EOS/PM (lancé fin 2000 pour 5 ans de durée de vie), CLOUDSAT et PARASOL, de façon à pouvoir observer la même zone nuageuse avec les différents instruments des quatre satellites à moins de quelques minutes d'intervalle.

• La charge utile PICASSO-CENA générant une quantité de données très supérieure aux **capacités de transmission** standard de PROTEUS, la charge utile NASA inclut une mémoire de masse et une télémétrie scientifique fonctionnant en bande X. Le **contrôle du satellite** est assuré par le CNES à partir de Toulouse en utilisant une antenne de réception et un Centre de Contrôle « standard PROTEUS ». Les données scientifiques sont reçues par la NASA à la station de Poker Flat qui autorise un grand nombre de visibilités chaque jour, et transmises au **Centre de Mission** situé au LaRC. Un Centre Scientifique est également installé en France (traitement des données de l'image IR, archive, produits de haut niveau, ...) une interface directe avec le Centre de Mission.

### 3.3 – Organisation - Calendrier

Suite au séminaire de prospective scientifique d'Arcachon en mars 98, PICASSO-CENA a été jugé comme une priorité par le CNES. L'IPSL, sur le plan scientifique, et le CNES, sur le plan technique, se sont associés au LaRC pour répondre à l'appel d'offre ESSP lancé par la NASA. Cette proposition a été sélectionnée fin 98 et la participation française entérinée par le CNES début 99.

Le calendrier est le suivant :

- **Phase B** : Janvier 2000 / août 2000. A l'issue de cette phase, confirmation formelle de la mission par la NASA (tenue des délais, des coûts et d'un niveau de performances minimum).
- **CDR** : Avril 2001.
- **Livraison de la charge utile** en France : Mars 2002.
- **Lancement** : Mars 2003.

Ce calendrier est très contraint et constitue une démonstration de la capacité de PROTEUS à s'adapter rapidement à une nouvelle mission.

### 4 – SMOS



#### 4.1 – La mission

L'objectif de la mission SMOS est double :

- Mesurer l'humidité des sols à quelques centimètres de profondeur, paramètre déterminant pour la compréhension des cycles végétaux.
- Mesurer la salinité des océans, indicateur de première importance des mouvements verticaux se produisant dans le milieu marin (en zone sub-polaire Nord-Atlantique en particulier) et venant compléter les données altimétriques et de température de surface déjà utilisées dans les modélisations climatologiques.

Ces deux types de paramètres n'ont jamais été mesurés depuis l'espace avec une résolution spatiale correcte. La mission SMOS constitue donc une première et peut être considérée comme une démonstration basée sur une approche innovante.

#### 4.2 – Description technique

• L'**instrument** utilisé est un radiomètre interférométrique en bande L (1,46 Hz). Les récepteurs individuels (25 par bras) sont disposés le long de trois bras en forme de Y de 4,5 m de long chacun. La résolution spatiale au sol est obtenue par interférométrie entre les signaux reçus par les différents récepteurs (corrélateur). Cette résolution est de quelques dizaines de kilomètres, avec une sensibilité radiométrique de l'ordre du degré K.

La charge utile a une masse 175 kg environ et consomme quelques 220W. Les bras, repliés au lancement (5 éléments par bras), sont déployés après la mise en orbite.

• Le **satellite** SMOS semble s'inscrire dans le standard PROTEUS avec, comme dans le cas de PICASSO-CENA, une configuration de vol « vertical » donnant au satellite une allure d'hélicoptère volant sur le dos. La principale difficulté identifiée à ce jour, compte tenu de la taille et de l'inertie des antennes du radiomètre ainsi que des modes souples inévitables, est le risque de couplage entre le contrôle d'attitude du satellite et la charge utile.

• L'**orbite** choisie est une orbite héliosynchrone 6h/18h, idéale du point de vue des ressources en énergie (nœud ascendant 6h), circulaire, à 757 km. L'échantillonnage temporel obtenu va de 1 à 3 jours selon la latitude de la zone observée.

• Grâce à un traitement des données à bord, la mission SMOS peut se contenter de la télémétrie standard bande S de PROTEUS (environ 500 kbit/s disponibles pour la charge utile). La **station de réception** transmet les données au **Centre de Contrôle** (standard PROTEUS) installé à Toulouse. L'Espagne abrite le **Centre de Mission** qui interface avec une Centre Scientifique d'expertise français, dédié à la thématique « humidité des sols ».

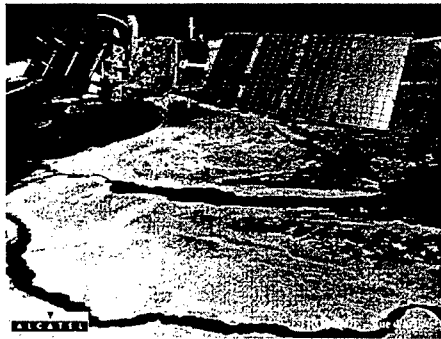
#### 4.3 – Organisation - Calendrier

Le séminaire de prospective scientifique d'Arcachon avait conduit le CNES à considérer comme prioritaire une mission de type SMOS. Le CESBIO sur le plan scientifique, et le CNES sur le plan technique, se sont donc associés pour répondre au premier appel d'offre de l'ESA sur les « missions d'opportunité » de son programme enveloppe en Observation de la Terre, en partenariat avec l'Espagne.

Le schéma retenu était celui d'une mission sous leadership ESA qui fournissait l'instrument et le lancement et participait pour 50 % à l'ingénierie et l'AIT satellite (tâches déléguées au CNES). Le CNES était responsable du satellite, en partenariat avec ASPI, fournissait la plate-forme PROTEUS et contribuait pour 50 % aux tâches d'ingénierie et d'AIT (placées sous sa responsabilité, par délégation de l'ESA). Il assurait également la mise en place du Centre de Contrôle et les opérations satellite. L'Espagne enfin assurait la responsabilité du Centre de Mission. Cette proposition, émise fin 98, a été retenue par l'ESA comme deuxième mission d'opportunité pour un lancement en 2005.

La phase A démarre actuellement, avec un contrat mission / système / instrument de l'ESA vers CASA (Espagne), comportant en particulier un maquetage poussé au niveau instrumental, élément le plus innovant de la mission, ce qui justifie une durée d'étude plus longue qu'à l'accoutumée (jusqu'au deuxième semestre 2001). Lorsque, fin 2000, CASA aura progressé dans la définition de l'instrument, le CNES entamera avec ASPI la phase A satellite. A court terme, il apporte un support « système satellite » à l'ESA. Les phases B, C, D se dérouleront de 2002 à 2005.

## 5 – MEGHA-TROPIQUES



### 5.1 – La mission

L'objectif de la mission MEGHA-TROPIQUES est l'étude du cycle de l'eau et des échanges d'énergie dans la zone tropicale. Cette région est en effet le siège de phénomènes énergétiques fondamentaux pour la compréhension du climat. L'énergie considérable apportée par le Soleil est dissipée et transportée vers les plus hautes latitudes à travers une variété de processus physiques dans lesquels l'eau, sous forme gazeuse ou condensée, joue un rôle primordial.

La majorité des satellites dédiés à l'étude de l'environnement sont placés sur des orbites polaires pour une observation globale de notre planète. En zone tropicale, l'échantillonnage est donc assez pauvre et le plus souvent calé sur une heure locale fixe. Or, l'évolution diurne des phénomènes en zone tropicale (orages, ...) ne peut être considérée comme secondaire et doit être intégrée dans les observations. Le satellite MEGHA-TROPIQUES est donc placé sur une orbite faiblement inclinée de façon à assurer l'échantillonnage spatio-temporel indispensable à la compréhension de ces phénomènes convectifs.



## 5.2 – Description technique

• L'**instrument** principal est le radiomètre micro-ondes MADRAS (masse 120 kg). Muni d'un mécanisme de balayage, ce radiomètre offre 6 fréquences (10, 18, 23, 36, 89 et 157 GHz) en double polarisation pour la plupart. La résolution au sol dépend de la fréquence, de 64 km à 10 GHz jusqu'à 6 km aux plus hautes fréquences. Deux autres instruments, plus petits, sont également inclus dans la charge utile :

- SCARAB (12 kg) pour l'étude du bilan radiatif, dérivé de l'instrument ayant déjà volé sur les satellites russes METEOR et RESURS.
- SAPHIR (18 kg), nouvel instrument pour la mesure du profil de vapeur d'eau (radiomètre micro-ondes à 183 GHz).

La charge utile MEGHA-TROPIQUES pèse au total environ 275 kg et requiert une puissance de 200 à 250 W.

• Le **satellite**, pesant quelques 600 kg, est pointé nadir. En termes de masse et surtout de puissance, il se situe à la limite haute des capacités de la ligne de produit PROTEUS. En outre, toute la partie RF de l'instrument MADRAS, qui pèse environ 85 kg, est en rotation à 23 tours par minute. Une attention toute particulière devra être apportée à l'équilibrage statique et dynamique de ce sous-ensemble afin d'éviter tout risque d'instabilité des boucles de contrôle d'attitude de la plate-forme en raison des excitations engendrées. Notons enfin que la faible inclinaison de l'orbite rend assez peu efficaces les actionneurs magnétiques utilisés pour la désaturation des roues et que leur puissance devra probablement être augmentée.

• Les raisons qui conduisent au choix d'une **orbite** peu inclinée pour MEGHA-TROPIQUES ont déjà été présentées. L'inclinaison finale retenue ( $i = 22^\circ$ ) est un compromis entre les différents objectifs scientifiques et certaines contraintes opérationnelles liées au lancement PSLV par l'Inde. L'altitude de l'orbite circulaire est de 800 km, ce qui permet d'obtenir jusqu'à six observations par jour sur chaque point de la zone inter-tropicale.

• Les capacités mémoire et télémesure standard (bande S) de la plate-forme PROTEUS sont suffisantes pour assurer la transmission des données scientifiques. Deux **antennes de réception** seront vraisemblablement utilisées, l'une en Guyane, reliée au Centre de Contrôle PROTEUS installé à Toulouse, l'autre en Inde, reliée au Centre de Mission (celui-ci recevant par ailleurs les données complémentaires transitant par Toulouse). Un Centre de Traitement scientifique français en liaison avec le Centre de Mission Indien complètera le dispositif.

## 5.3 – Organisation - Calendrier

La mission TROPIQUES est identifiée de longue date comme une des priorités de la communauté scientifique française (séminaire de prospective scientifique de Saint-Malo en 93). Par contre, la définition précise de l'instrumentation nécessaire à l'étude du cycle de l'eau en zone tropicale a fait l'objet de longs débats et ce n'est que fin 97, avec l'amorce d'une coopération franco-indienne (ISRO), que le contour technique du projet s'est progressivement stabilisé. Fin 99, le CNES et l'ISRO ont signé un accord de coopération pour la phase A qui se déroulera jusqu'à fin 2000. Le lancement est aujourd'hui prévu au deuxième semestre 2005.

Le partage des tâches envisagé entre l'Inde et la France est le suivant :

- **Inde** : Service de lancement PSLV, maîtrise d'œuvre de la charge utile et, au sein de cette dernière, de l'instrument MADRAS, Centre de Mission (avec antenne de réception en Inde).
- **France** : Maîtrise d'œuvre du satellite PROTEUS, fourniture du sous-ensemble RF de MADRAS, maîtrise d'œuvre de SCARAB et SAPHIR, Centre de Contrôle satellite, Centre de Traitement des Données.

## 6 - CONCLUSION

La perspective de missions scientifiques à coût modéré, en complément des grandes missions de l'ESA, a été pour le CNES un des moteurs de l'initiative PROTEUS.

Son ambition de réaliser une mission tous les 18 mois environ, non pas dans un cadre purement national mais dans une perspective de coopération bilatérale ou multilatérale, semble aujourd'hui se concrétiser.

Ces perspectives ont permis d'obtenir un accord pour une commande groupée de trois plate-formes PROTEUS (début 2000). Ces plates-formes devraient couvrir une bonne partie des besoins pour des lancements dans la période 2003 / 2006. Au delà, il est vraisemblable que, compte-tenu de l'évolution des technologies (calculateur de bord en particulier), une version améliorée de PROTEUS devra être mise sur le marché.

Enfin, en parallèle avec la négociation sur l'approvisionnement des plates-formes, le CNES et ALCATEL SPACE INDUSTRIES se sont mis d'accord sur le contour des contrats de « missionisation » (ingénierie et AIT satellite) qui, le moment venu, seront nécessaires pour compléter la fourniture de la plate-forme.

## **SESSION 7 :**

### **Missions futures** *Future missions*

*Présidents / Chairpersons: Daniel CARUSO, Michel ROUGERON*

- (S7.1) IRIS : First steps of the service**  
Sansone F., Larock V, Rehorst H.,SAIT, Bruxelles, Belgique
- (S7.2) SMART-2, A Small satellite system to change the way scientific satellites are flown**  
Garcia C., Whitcomb G. ESA-ESTEC, Noordwijk, Pays-Bas
- (S7.3) Mars Micromissions: Providing Low Cost Access to Mars**  
Willis J., Leschly K., Lehman D. Jet Propulsion Laboratory, Pasadena, Etats-Unis
- (S7.4) The concept of the function demonstration satellite of advanced micro satellite (MICROSAT)**  
Kogure S., Satori S., Nakasuka S., Okamoto H. NASDA, Ibaraki, Japon
- (S7.5) Earth Observation Program at the Khrunichev State Research and Production Space Center**  
Glazkova I. Khrunichev State Research and Production Space Center, Moscou, Russie
- (S7.6) AMS - an Advanced free flying Mailbox Satellite : some choices and solutions**  
Galligan K.P. ESA/ESTEC, Noordwijk, Pays-Bas

## IRIS: THE FIRST STEPS OF THE SERVICE

Fulvio SANSONE  
Business Development Manager  
[fulvio.sansone@saitrh.com](mailto:fulvio.sansone@saitrh.com)

Victor LAROCK  
Future Projects Manager  
[victor.larock@saitrh.com](mailto:victor.larock@saitrh.com)

Hermen Rehorst  
IRIS Product Manager  
[hermen.rehorst@saitrh.com](mailto:hermen.rehorst@saitrh.com)

*SAIT-RadioHolland - Business Unit SPACE  
Chaussée de Ruisbroek, 66  
B-1180 Brussels BELGIUM*

**ABSTRACT** – The history of the IRIS LEO satellite messaging system continues to track that of the 4S conferences. Introduced as a concept in Biarritz [Laro 94], a development update was given in Annecy [Jong96]. In Juan-les-Pins [Laro98] first technical results were provided. The pre-operational phase of the system has now started, and its current results are the main subject matter of this paper. We will start, however, by a summary of the various technical and programmatic achievements of the last two years. Then, some examples of pre-operational usage will illustrate the interest for IRIS in the market niches for which it was designed: maritime applications, missions in remote areas... The paper ends with a view of future evolutions. These include the development, already started, of a generation of microsatellites, key to the system's growth.

**RESUME** - *L'histoire du système de messagerie à satellites en orbite basse IRIS continue à se confondre avec celle des congrès 4S. Introduit au stade du concept à Biarritz (1994), un point sur son développement fut donné à Annecy (1996). A Juan-les-Pins (1998), de premiers résultats techniques après lancement furent présentés. La phase pré-opérationnelle du système a maintenant démarré, et ses résultats actuels font l'objet principal de l'exposé. On donnera néanmoins pour commencer un aperçu des diverses étapes techniques et programmatiques accomplies depuis deux ans. Ensuite, quelques exemples d'utilisation pré-opérationnelle illustreront l'intérêt manifesté pour le système IRIS dans les créneaux pour lequel il fut conçu : navigation, missions d'exploration, ... Cette communication se terminera par une vue sur les perspectives d'avenir du système. Celles-ci comportent notamment la mise en chantier, déjà entamée, d'une génération de microsatellites, clé de l'expansion du système.*

## 1 INTRODUCTION

In this new era of communication solutions that seems to offer us unlimited capabilities to communicate voice, images and data from anywhere to anywhere on this planet, a search for a low cost means of data transfer to and from remote locations still yields little result. Those wanting to send messages to or retrieve data from areas deprived of traditional communications infrastructures are forced to turn to overqualified solutions that will provide the service required, but at a cost that is too high for many.

To service the demand for low cost, non-voice, non-real-time messaging and data retrieval the SAIT-RadioHolland Group, in the framework of the Little LEO Messaging System (LLMS) programme of the European Space Agency (ESA), is developing the IRIS system for Intercontinental Retrieval of Information via Satellite.

IRIS is a service that uses payloads in Low Earth Orbit (LEO) to deliver and retrieve information to and from terminals in locations without an (affordable) telecommunications infrastructure. With one payload in orbit IRIS can already provide solutions today. Thanks to a phased approach and a modular design, additional payloads that will be deployed in the next three years will bring IRIS to its full functionality in terms of performance and capacity.

## 2 THE IRIS SYSTEM

### 2.1 An Overview

The IRIS system consists of three major elements: the User Terminal (Modem), the Space Segment and the Ground Segment (see Figure 1).

To illustrate how the system works we will use the example of a project manager at the headquarters of an aid organization, who needs to exchange information with a fieldworker in a remote area. However, replace the project manager by an operator and the fieldworker by an

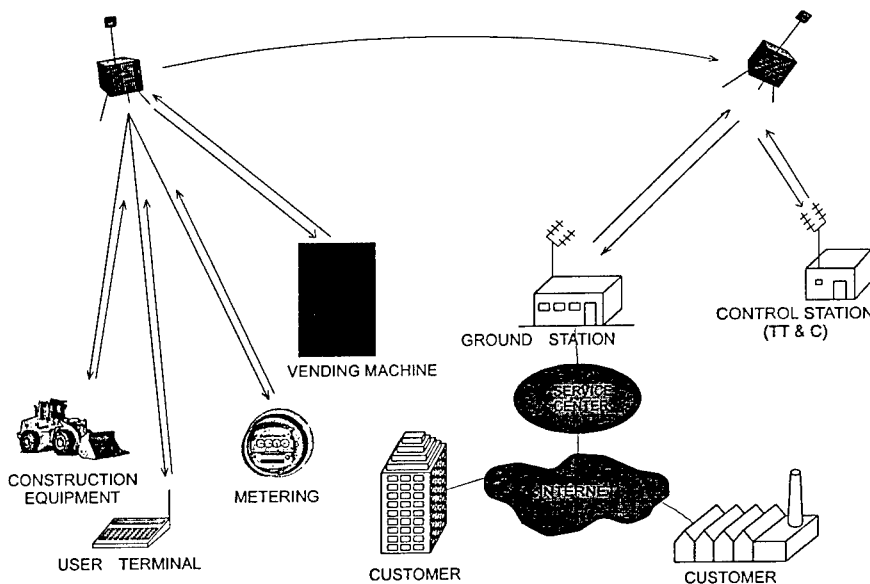


Figure 1: An overview of the IRIS system

automated meter and you have an example of remote data retrieval. To send a message to the field worker, the project manager simply composes an e-mail containing the message, and sends it to the IRIS Internet address of the fieldworker. The email is routed through the Internet to the IRIS Operations Center in Belgium from where it is forwarded to one of the IRIS Hubstations. The Hubstation uploads the message to one of the Satellites of the Space Segment and as soon as it comes in view of the Terminal, the message is downloaded to the Terminal. The fieldworker may use a desktop, laptop or palmtop computer to read the message.

To reply, the fieldworker composes an e-mail using standard client software like Eudora®, Netscape® or MS Outlook® and queues it for transmission. As soon as one of the Satellites comes into view of the Terminal, the message is uploaded to the Satellite and stored on-board. When the Satellite comes into view of a Hubstation, the message is downloaded and forwarded to the IRIS

Operations Center in Belgium. From the Operations Center the message is sent to the project manager over the Internet.

To communicate from Terminal to Terminal, two methods can be utilized. In Direct Mode two terminals that are both in view of a Satellite (no more than approximately 4000 km apart depending on the altitude of the Satellite) can exchange messages in quasi-real-time. A message uploaded to a Satellite is directly downloaded to the intended Terminal provided it is in view. In Normal Mode the message is uploaded, stored on-board and downloaded to a Hubstation when one comes in view. From there it is forwarded to the IRIS Operations Center in Belgium which sends it on to a Hubstation and subsequently to a Satellite that delivers it to the intended Terminal.

## **2.2 The LLMS Development Program**

The technological foundations and the first elements of the IRIS system were developed within the ESA sponsored LLMS program. This included:

- The design of the system architecture and its spread-spectrum communication links;
- The development and manufacturing of the communication payload and related ground spares;
- The design and development of the ground segment consisting of the Spitzbergen Hubstation, the Kortrijk TTC station; the messaging control center and the gateways to the Internet and the other terrestrial based communications networks;
- The design and manufacturing of a first series of industrialized user terminals.

## **3 THE PRE-OPERATIONAL PHASE**

The paper presented at the previous edition of the 4S conference [Laro 98] described the very first in-orbit experience. Since then, SAIT RadioHolland has run a pre-operational phase with a set of early triallists. This yielded further technical results [Laro 99] and first service experience.

### **3.1 Regulatory progress**

But to begin with, it is of some interest to report on the regulatory status of the system. The spread-spectrum communications of IRIS uses an UHF down-link coordinated according to RES 46 and an UHF up-link with quasi-secondary status (under S9.21). Since the last 4S conference :

- The down-link coordination procedure was concluded and the network was notified and published by the ITU with weekly circular 2409/21.12.1999 Special Section RES46/D/105
- The Earth stations (=terminals) were coordinated and published by the ITU with weekly circular 2225/30.04.1996 Special Section AR14/C/839. ITU notification was done but not yet published due to delay in ITU.
- After sharing studies and measurement campaigns leading to the definition of operating constraints, the terminals were accepted for free circulation, use and exemption from individual licensing by the CEPT (ERC Dec 99/05) in accordance with ERC dec 99/06 on the harmonized implementation of SPC-S below 1 GHz.
- The current IRIS terminal was the first spread-spectrum device to be type-approved according to the relevant ETSI standard EN 301 721 (previously EN 300 721). They also operate according to the following standards : ETS 300 722 Network Control Facility and EN 301 489 Electromagnetic compatibility (previously ETS 300832)

The regulatory and licensing process indeed has time constants that exceed the time span needed to build and launch a spacecraft. In the last two years IRIS has achieved its intended regulatory status in an environment not very favourable to satellite communications, which always take second place when competing for spectrum with terrestrial systems.

## 3.2 Technical findings

### 3.2.1 Sharing the spectrum – a global picture

The spectral analysis capability of the IRIS payload was discussed in [Laro98]. We are now able to present some results of world-wide up-link spectral recordings. Figure 2 plots the level of in-band interference seen by the satellite as it orbits the Earth. The overall intensity of the interference is depicted by the hue of the dots. (one display dot per minute)

It is apparent that the interference is maximum in two zones, notably around Brazil. Nonetheless, the interference situation is relatively benign especially in those parts of the world where the market of the current IRIS system lies. The link margin and inherent resilience of the spread-spectrum communications used, even without the on-board adaptive interference cancelling mechanism – effective against e.g. the stationary interference around Brazil-, can generally deal efficiently with the level of interference encountered.

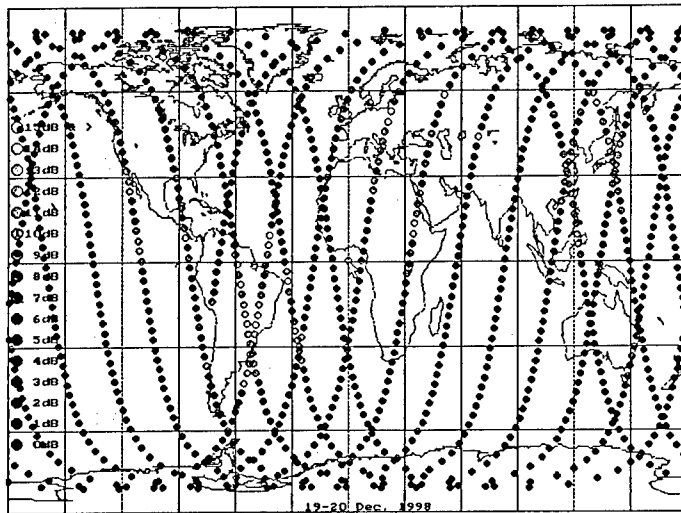


Figure 2: World-wide interference assessment

### 3.2.2 A special case

However, a particularly noxious case of interference prevails to the North-East of Europe. It was unambiguously attributed, after protracted investigation, to an extremely high-powered, omnidirectional, wide-band, ground-based pulsed source. Initially, before countermeasures were devised, this source even caused the on-board latch-up overcurrent protection devices to trip.

Figure 3 is the result of a location attempt of this source using IRIS.

The apparition and disappearance of the interferer over the satellite's horizon is plotted (solid dots) and the probable location (arrow) appears as the intersection of the visibility footprints. The outline of dots also show that this interferer impedes communications in a large area; as soon as it is out of view, the link error rate again assumes its theoretical value, as observed above in the rest of the world.

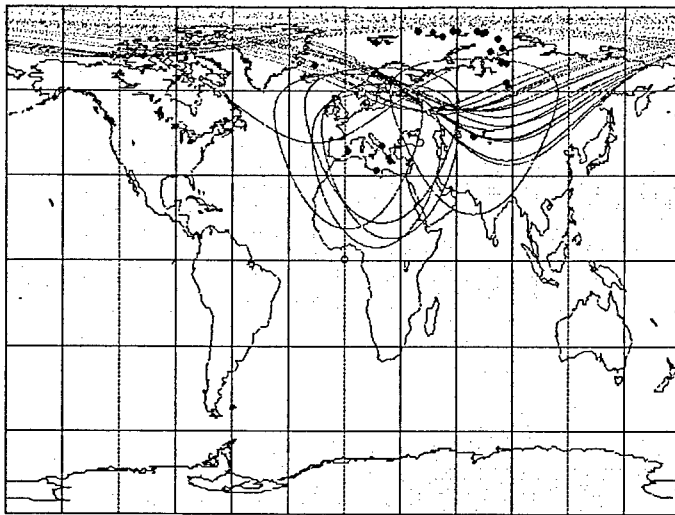


Figure 3: Location of an interference source in Europe

Table 1 is based upon data collected during Orbit 3633 on 22 March 99. It gives, as a function of the satellite's elevation, the number of times the terminal in Brussels had to retry in order to get a short message (132 user bytes) up to the satellite.

Initial Send Time	Approx. Sat. Elevation (°)	# Retries
21:11:49	15	6
21:13:59	30	2
21:15:29	43	0
21:15:50	50	1
21:20:21	30	0
21:20:54	17	4

Table 1 : Retries in Presence of Interference

On the average, we have observed that while the spacecraft is in view of the interferer, messages transmitted in Belgium have a 50 to 70 % probability of being correctly received on board. Tests in Helsinki, Finland, have shown that this proportion can fall to zero for orbits passing directly above the interferer's suspected location, and is around 33% for orbits seen at low elevation (17°) by both terminal and interferer. Communications over the whole of Northern Europe and Russia will be affected. This may not be IRIS' intended market area, however it makes tests and demos arduous. Conversely, the capability of IRIS to continue offering some service in the presence of such interference is definitely encouraging.

This experience also demonstrates that the proper observance of regulatory procedures does not necessarily avoid cases of interference by unwanted emissions of out-of-band sources.

### 3.2.3 Radiation effects

The use of bulk-CMOS (non-hardened) devices in the Communications Payload did not lead to record any Single Event Latch-Up (SEL) in 20 months of operation since launch. Indeed, in the light of section 3.2.2, the lesson learned is rather not to make the latch-up detectors overly sensitive.

On the other hand, the LLMS-1 mission confirms that Single Event Upsets are of concern in those circumstances. Figure 4, relating to SEUs in the RAM memory of the CDMA modem DSP, exhibits the typical pattern of trapped proton events in the South Atlantic Anomaly (SAA) and heavy-ion effects in the polar regions. In LLMS-1, EDAC RAM is used for the message store itself, and a detection mechanism was likewise instrumented for the DSP RAM.



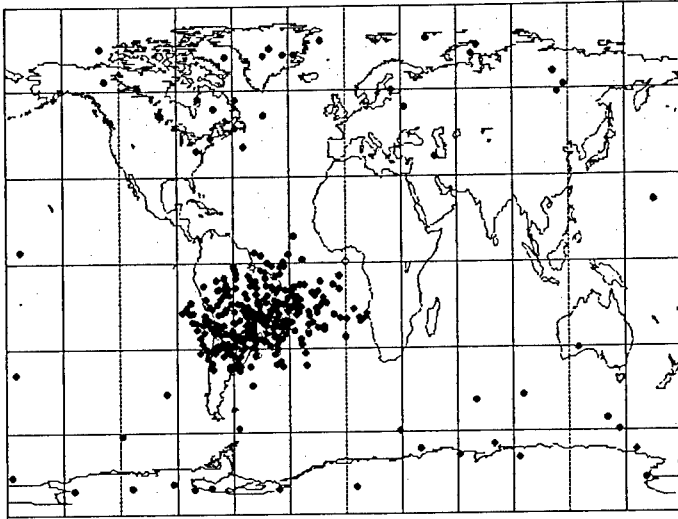


Figure 4: Plot of SEU events during 1999

### 3.2.4 Terminal Clock Calibration

The IRIS terminal uses the highly stable down-link carrier and a very simple orbital model to factor out the down-link Doppler shift and calibrate its own local oscillator's drift. This is important in order to send its up-link messages to the satellite at the correct frequency. In order for spread-spectrum signal acquisition to occur within the 100ms message preamble, the frequency error cannot be greater than +/- 400Hz (1ppm of carrier frequency). In Figure 5, we plotted the frequency error of incoming messages sent during Orbit 3015 as measured by the satellite. We see that the calibration process (patent applied for) results in an error on the order of 40Hz, or an order of magnitude below what is tolerated. The Doppler compensation also appears to perform excellently, as a drift of only 10Hz shows up over the passage's 15 minutes.

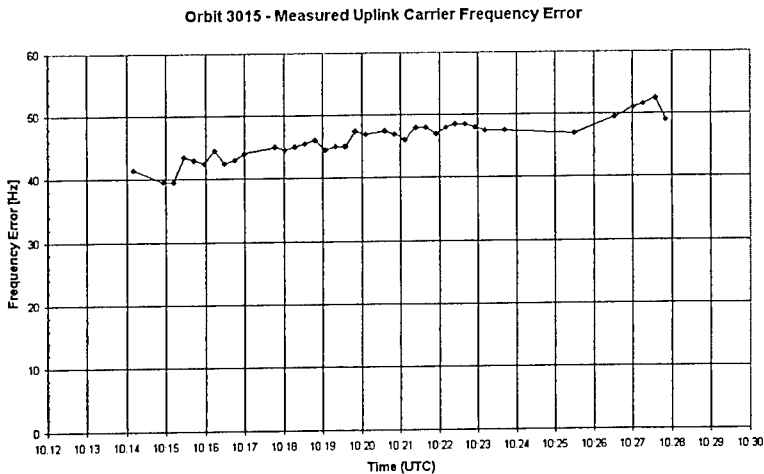


Figure 5: Frequency calibration and Doppler compensation performance

### 3.3 The User Trials

In order to test the system in the field, promote it within specific target market segments and provide it with media coverage, SAIT-RadioHolland launched in the late summer of 1999 the IRIS pre-operational phase that eventually deployed some 25 terminals world-wide.

Figure 6 illustrates the deployment status as it was in December 1999. Crosses represent deployed terminals and circles represent terminals scheduled for deployment at the time. The ocean location of several terminals testifies to the strong interest in the IRIS service expressed by the maritime community and in particular by yachts owners and operators. Other testers were explorers, scientific missions, environmental monitoring organisations, aid and development workers, and candidate distributors.

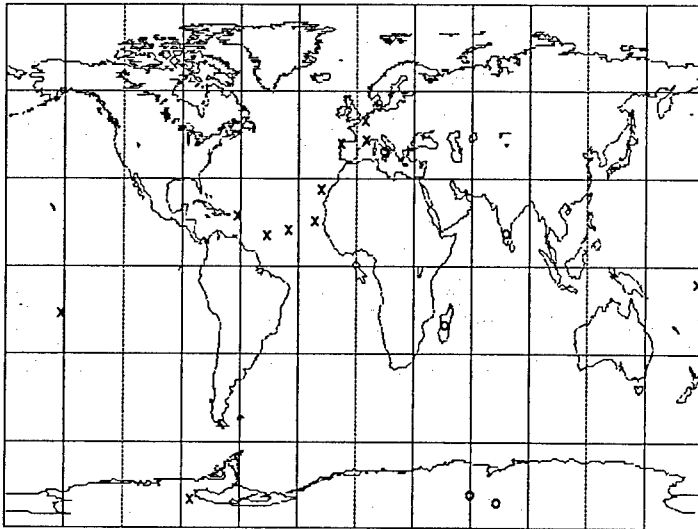


Figure 6: Deployment status December 1999

We will highlight two examples of such user trials.

#### 3.3.1 Mission to Tibet

The tests were performed in July 1999 over a four week period in remote areas of Sicuan Province, China, during an expedition grant-aided by the Care & Share Foundation called "Project Dengke 99". Such missions have an educational purpose, and they bring the benefits of modern technology to some of the remotest regions on Earth. They also serve to test the products of that technology in fairly harsh environments, with e.g. large daily temperature cycles.



The relevance of IRIS is evident in communicating from villages hundred kilometers away from any town with communications. Moreover, the expedition packed two IRIS terminals with a view to performing communications in Direct Mode between two encampments 50km apart. RF communications are impossible because 7000m-high

mountain ridges separate the two locations. (This was not in the end possible because the vehicle which was to help set up the second camp broke down)

The use of IRIS itself was not without difficulties because mountain slopes sometimes obstructed the view up to about 30 degrees above the east and west horizons. (see picture on previous page, taken in a large village in the Yangtze river valley, which shows the IRIS antenna and terminal, connected to a PSION3 organizer used to draft the messages). In these circumstances only one passage per day was useable. Non-ideal antenna deployment conditions also led to more shadowing and multipath effects, resulting in very fluctuating signal levels. This notwithstanding, messages in the range of 1kB were successfully sent to the expedition's family members in Europe.

### 3.3.2 Antarctica 2000

In December 1999 and January 2000, power-kite Antarctica crossing veteran Dixie Dansercoer, his wife Julie Brown and Everest climber Rudy Van Snick set out on a three-week trek in the Ellsworth mountain chain of the White continent, scaling its summit Mount Vinson (4,879m) on the way. Figure 7 shows how, using the Normal Mode of IRIS, reports on the expedition's daily life were

transmitted back to Antarctica 2000 headquarters in Belgium after having been beamed down over Spitsbergen near the other Pole. These reports, routinely 3-4KB long, can still be read on the expedition's site [www.antarctica.org](http://www.antarctica.org). IRIS with its near-polar spacecraft was of course ideally suited to communicate from regions at 82° latitude, with plenty of available passages and definitely no uplink interference.

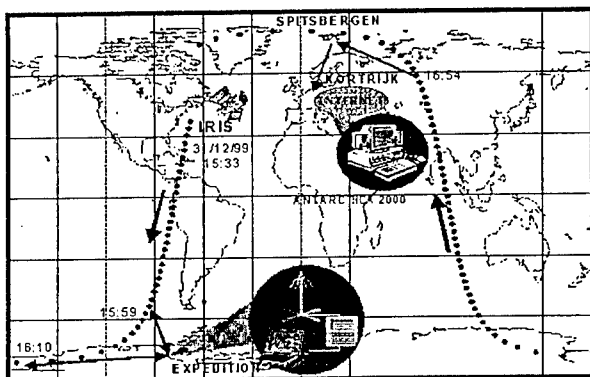


Figure 7: Reporting from Antarctica



### 3.3.3 Feedback

Examples of comments and suggestions received from beta-testers are the following:

- For maritime users a sealed antenna with no protruding parts is highly desirable. This is indeed under development at this time.
- Some users suggested that although the "Harpoon Antenna" is well suited for portable applications an easier way to deploy it would be advantageous. As a consequence, a foldaway mechanism for the antenna arms is considered.
- The possibility to use on the PC a user friendly, Windows-based interface is desirable for many non-technical users. SAIT-RadioHolland has, in the meantime, already developed such an interface for the messaging applications and a more general MAPI-based interface is under test.

- In some installations the constraints on the antenna cable length could be an issue. SAIT-RadioHolland is considering the possibility of developing a terminal version in which the antenna is coupled with an outdoor unit including the Radio Frequency front-end, or the whole terminal itself. This would probably be of interest in conjunction with the maritime antenna version.
- Some users suggested replacing the AA battery box in the terminal case with an equally sized space where a rechargeable battery pack can be accommodated.

Such comments, although they could appear trivial, are indeed of great help in order to bring to the market a service that really satisfies customers in their day-by-day operations.

#### 3.3.4 Summary

The results and feedback from these trial users can be summarised as follows:

- The system is well suited for e-mail remote communications, and the terminal is easy to deploy.
- In general, apart from local problems due to specific interference, the radio communications between the terminals and the satellite exhibit very good quality both in the up and down-link.
- 'Long' message transmissions in the range of 4-5 Kbytes were successfully tried out.
- IRIS emerged as the only truly useable messaging system in very remote regions like, for example, Antarctica.

## 4 FUTURE EVOLUTIONS

### 4.1 The Next Generation Satellite

The economics of a LEO system dictate to make the satellite as capable as possible in terms of data-gathering capability, in order to generate as much revenue per orbit as possible. Moreover, tracking a growing market demand and replenishing the space segment commands to have at one's disposal a free-flyer microsatellite for which launch opportunities are more plentiful than for Attached Payloads such as LLMS-1.

In 1999, a feasibility study showed that a payload with 8 up-link channels instead of 3, yet compatible with the mass and power budget of an 80kg microsatellite could be developed thanks to:

- The use of custom on-board microelectronics. The study issued a detailed design specification for an ASIC which performs the CDMA modem function including fast acquisition and interference-filtering. This ASIC is now nearing design completion.
- An enhanced High-Power Amplifier design, based on a technique called Envelope Elimination and Reconstruction, with an efficiency of 30 to 50 %

Benefits of in-orbit experience, like enhanced anti-interference capability and defences against SEUs, were injected into the new design.

The resulting programme, called AMS for Advanced Mailbox Satellite, is presented in another paper at this Conference.

### 4.2 The New Generation Terminal

In order to expand the usage of IRIS both in the currently addressed markets and to additional markets/applications, a main point is the performance, size and cost of the user terminal.

SAIT-RadioHolland has set itself a very challenging objective: miniaturise the terminal in order to achieve high portability and very low cost.

The retail price of the new generation terminal targets an order-of-magnitude reduction compared to the current terminal.

This will be achieved, together with the other main two objectives of power consumption and size reduction mainly through microelectronics integration and through increased production numbers.

SAIT-RadioHolland has foreseen massive investments for the development of such a new generation terminal. The development is planned to start before the end of the year with first samples being available before end-2002.

### **4.3 The Satellite Constellation**

SAIT-RadioHolland is currently considering the opportunity to carry IRIS well beyond its original scope. This would be afforded by setting up a true, though reduced, satellite constellation. Such a constellation and its associated Ground Segment would be optimised to provide reliable, store-and-forward data communications with typical message latency of a few hours.

This enhanced system performance would allow the IRIS Operator to enlarge the customer base in the current messaging application markets and to extend its offer to additional applications like fixed and mobile asset monitoring.

A first top-down market research confirmed the market's existence. The main applications foreseen were automatic meter reading, plant and storage monitoring, vending machines monitoring, fleet management and vehicle tracking, personal messaging.

The unique selling points of IRIS compared to potential competitors are world-wide coverage, very low usage tariffs and capital cost to access the service, as well as long message functionality.

SAIT-RadioHolland is currently running a bottom-up market research to validate the results of the first research. This activity includes an extensive interview campaign with key players in the identified main potential market segments. The results will be available shortly and will orient the direction of the future investments of the company in the IRIS system.

At the same time SAIT-RadioHolland is actively looking for partners in the IRIS consortium. Such partners will extend from industrialists involved in the capital through vendor financing, to distributors and business partners to venture capitalists. SAIT-RadioHolland is in negotiation with a handful of such partners and will select the most suitable ones in the next few months.

## 5 REFERENCES

- [Laro94] V. LAROCK & A. GINATI: 'TRIS, A World-Wide Messaging System using Microsatellites', *International CNES Symposium on Small Satellite Systems and Services*, Biarritz, June 1994
- [Jong96] A. JONGEJANS, V. LAROCK et al.: 'TRIS, A Development Update', *International CNES Symposium on Small Satellite Systems and Services*, Annecy, June 1996
- [Laro98] V. LAROCK & A. JONGEJANS: 'TRIS, First Operations', *International CNES Symposium on Small Satellite Systems and Services*, Juan-les-Pins, September 1998
- [Laro99] V. LAROCK: 'In-Orbit Testing Results, and the Future', in *Special Issue on Iris of the Revue HF-Tijdschrift*, published by SITEL, Belgium, vol. 1 & vol. 2, 1999

## 6 ACKNOWLEDGEMENTS

The authors are indebted to Dr Daniel HEYNDERICKX of the Belgian Institute for Space Aeronomy (BIRA-IASB) for extracting the data for Figure 4 from one year's in-orbit telemetry files of the LLMS-1 Attached Payload.

Credits also to Pr. Mel RICHARDSON of Loughborough University and to Dixie DANSERCOER for the two pictures which illustrate the section on user trials.

## SMART-2, A SMALL SATELLITE SYSTEM TO CHANGE THE WAY SCIENTIFIC SATELLITES ARE FLOWN

César GARCÍA, Gordon WHITCOMB

*Future Projects and Technology Office  
Directorate of Scientific Programme, ESA-ESTEC  
P.O. Box 299, 2200 AG Noordwijk, The Netherlands*

**ABSTRACT** – *The European Space Agency (ESA) is defining the second mission of the SMART series of the Horizons 2000 scientific programme. SMART-2 is intended to demonstrate innovative and key technologies for the detection of gravitational waves and of extraterrestrial planets. For this purpose, it will encompass Formation Flying technologies and Drag-Free Flight Control.*

*The paper describes the main mission requirements, which are being derived from those of the “customer” Cornerstone missions, and the status of the on-going system definition. Furthermore, viable options of the mission and satellite design are described.*

### 1 - INTRODUCTION

SMART-2 is the second of the Small Missions for Advanced Research in Technology within ESA's Mandatory Scientific Programme. These missions have been introduced by the Agency as one of the strategic elements for reintroducing balance and flexibility into the Horizons 2000 Science Plan. They constitute a preparatory technology-development programme focusing on items identified as critical to the success of the Cornerstone missions, including flight demonstrations where deemed appropriate.

The justification of SMART missions resides in the technological preparation by flight demonstration of future missions, rather than in specific scientific observations made during the mission. Consequently, the mission statement of SMART-2 will include the relevant technology demonstrations. The question whether SMART-2 should take in some scientific experiments in addition to the technology experiments is outside the scope of this paper. Key considerations which will have to be assessed in these respect include the use of the SMART-2 flight opportunity, the additional complexity of the mission design due to the incorporation of scientific payload, and the limitations imposed by the mission cost ceiling.

SMART-1 is already dedicated mostly to the Mercury Cornerstone, now known as BepiColombo. The GAIA Cornerstone does not need any pre-project flight verification. Therefore, SMART-2 will be dedicated to technology needed for the LISA and DARWIN Cornerstone missions: the *customer* missions.

Concerning the selection of the technology for the SMART-2 mission, a technology list has been established considering the industrial studies of the LISA and DARWIN missions. In the broad sense, these technologies can be categorised in *Formation Flying (FF) technologies and Drag-Free Flight Control*.

## REQUIREMENTS FOR THE DEMONSTRATOR MISSION

European firms have recently concluded feasibility studies for both DARWIN and LISA. As part of these studies and of ESA's overall definition of the Cornerstone missions, technologies which are still immature have been identified for development. In addition to many individual component-level items, some of the critical technologies cannot be demonstrated on ground, either because ground tests would not allow an end-to-end, representative test-bed, or because the terrestrial environment would mask the required performance of the systems. An example of the latter is the negative effect of the gravitational forces and parasitic accelerations of ground testing on the sensitive accelerometer which is the core of the LISA mission.

There is the natural tendency, however, of suppressing the risk of implementing new technologies by flight-demonstrating exact replicas of the equipment which would later be part of the Cornerstone missions. This approach is similar to a qualification programme in which a qualification model, identical to the flight model, is thoroughly tested. In many other space projects the decision is made not to include any hardware which has not been "space qualified" in a previous flight. There are two reasons why these approaches will not be followed by SMART-2. Firstly because the technical requirements of the Cornerstone missions are so demanding that the equipment which will meet these does not exist yet; this entails that the development of the Cornerstone equipment will continue in parallel to the development phases of SMART-2. Secondly because the lessons learnt through SMART-2 will be fed into the definition and development of the two Cornerstones, and this requires a time separation between the launch dates of SMART-2 and LISA or DARWIN of about five years.

### 2.1 - Technology Demonstration for DARWIN

The primary mission objective of DARWIN is the direct detection of terrestrial exoplanets together with the characterisation of the physical conditions on these planets, particularly with respect to atmospheric composition and the detection of signs of life as we know it.

The DARWIN mission concept consists of an infrared space interferometer with six collector telescopes each one of them mounted on a free-flying spacecraft, a central optical hub system which is also a free-flying spacecraft, and a data-relay and control spacecraft.

Direct detection of Earth-like planets orbiting a bright star is essentially a matter of contrast. In the optical range, where most of the energy is emitted by the star, the rejection ratio (ratio of the emission of the parent star to the subject planet) should be larger than  $10^{10}$  in order to allow planet detection. In the near infrared (6-18  $\mu\text{m}$ ), however, the rejection ratio required for planet detection falls to  $10^5$ . This means that the infrared light emitted by the star has to be suppressed, or *nulled*, to this extent. The technique proposed by the scientific community is called *nulling interferometry*. It consists of creating a destructive interference of the wave-fronts coming from objects exactly on the optical axis of the telescopes, whereas a constructive pattern emerges from objects slightly off-axis, i.e. the orbiting planets (Information on DARWIN is available at <http://sci.esa.int/home/darwin>).

The technology demonstration which SMART-2 will undertake relates to the formation flying performance of a flotilla of spacecraft in order to *enable the nulling interferometry*, but not to the realisation of such interferometry.

Given the high accuracy required for the GNC (Guidance, Navigation & Control) and the wide range of *baselines* of the flotilla (spacecraft distance ranging from 100 to 500 m), DARWIN's control system will consider three *metrology levels*:

- Coarse metrology: Based on *RF ranging and goniometry*, at this level the six degrees of freedom of each satellite are measured with an accuracy of the order of one centimetre and



one tenth of a degree. The flotilla GNC system controls the relative distance and attitude of the satellites within similar figures.

- Intermediate metrology: A *Laser metrology* system supports the flotilla GNC to freeze the spacecraft distances and attitudes with an intermediate accuracy.
- Operational metrology: through *Optical Path Difference (OPD)* measurements, using the observed target star, the components of the interferometer are positioned with an accuracy of about 10 nm and 0.002 arcsec (2 mas), i.e. the requirement for nulling.

The information provided by the metrology system is fed into the free-flying control system, which in turn actuates through proportional thrusters to control the spacecraft position and attitude, for the coarse and intermediate levels. The high precision, operational level is achieved by means of delay lines and active optics assembled on highly stable optical benches. This last level will not be demonstrated through the SMART-2 mission, but rather on ground.

Although nulling interferometry has never been tested in space, several demonstrators will be performed on ground, both in the laboratory and with ground-based telescopes. On the other hand, the formation flying (FF) control system (determination and actuation) must be space demonstrated in order to reduce the risks of the DARWIN mission.

A summary of the FF-related performance requirements for DARWIN showing the subset which SMART-2 will demonstrate is shown in table 1.

Technology for DARWIN			
	Function	Requirement	Comments
Coarse, Baseline Control Mode	To deploy and configure the relative positions of the spacecraft. Safe-mode operation.	Range: 50-100 m Range accuracy: 1 cm Attitude accuracy: 0.1 deg	Implemented through RF ranging and goniometry sensors. Trade-off: actuator design versus constellation configuration time. Requirements are $1\sigma$ .
Intermediate, Freezing Control Mode	Acquisition of the metrology links, and freezing of array geometry.	S/c drift rate: 0.5 $\mu\text{m/s}$ Position accuracy: 1 cm Attitude accuracy 4 arcsec	Trade-off: spacecraft drift rate requirement versus requirement on range accuracy (better than 100 $\mu\text{m}$ ). Based on laser metrology (or differential drift laser metrology) and $\mu\text{N}$ thruster control.
Fringe Acquisition Mode	Search for fringes by the Fringe Tracker and OPD stabilisation.	Attitude accuracy: 1 mas @ 1 Hz	Not demonstrated in SMART-2: milli-arc-second (mas) pointing is not possible without a wide-field camera.
Science Mode	Routine observation mode.	OPD control: 1 nm Attitude accuracy: 1 mas @ 1 Hz Observation time: hours	Not demonstrated in SMART-2.

Table 1: Requirements for formation flying

The FF demonstration package is not a conventional payload with respect to the allocation of spacecraft resources: the GNC is both part of the spacecraft bus and of the technology package. However, it is envisaged to allow for some 10 kg and 10 W for the RF metrology and for the laser metrology systems on each satellite.

## 2.2 - Technology Demonstration for LISA

The main objective of the LISA mission is to observe gravitational waves from galactic and extragalactic binary systems, including gravitational waves generated in the vicinity of the very massive black holes found in the centres of many galaxies. Gravitational waves are one of the fundamental

building blocks of our picture of the universe. Although there is strong indirect evidence for the existence of gravitational waves, they have not yet been directly detected.

The Laser Interferometer Space Antenna (LISA) mission consists of three spacecraft flying 5 million kilometres apart in orbits around the sun. The three LISA spacecraft, flying in formation, will act as a giant Michelson interferometer, measuring the distortion of space caused by passing gravitational waves. Each spacecraft will host two free-floating "proof masses", i.e. two metal objects which are not subject to any external force other than gravitation. The proof masses will define optical paths 5 million kilometres long, with a 60 degree angle between them. Lasers in each spacecraft will be used to measure changes in the optical path lengths with a precision of  $40 \text{ pm}/\sqrt{\text{Hz}}$  (1 picometre is  $10^{-12} \text{ m}$ ) in the measurement bandwidth, *MBW*, of interest (0.1 mHz to 0.1 Hz). See <http://lisa.jpl.nasa.gov> for a description of LISA and the rationale for the relevance of such low frequency band.

SMART-2 will demonstrate LISA technologies in two areas: inertial sensor performance and spacecraft position control. The first area relates to the demonstration of a spacecraft trajectory free of non-gravitational forces in the frequency band between 1 mHz to 0.1 Hz. The second area concerns the demonstration of spacecraft position control to a fraction of the optical wavelength, i.e. to the nanometer level.

As a means to achieve these goals, SMART-2 will perform systematic tests on technologies like  $\mu\text{N}$  thrusters, accelerometers, and a laser interferometer system for position control. Furthermore, other related technologies will be flight tested, e.g. electrostatic discharging of test masses, calibration and control strategies.

#### *The inertial sensor*

The first SMART-2 technology is an inertial sensor providing a reference mass which follows a trajectory in space influenced only by gravity, i.e. the reference or proof mass will be isolated from other external forces like solar wind pressure, electrostatic forces or aerodynamic drag. The sensor must also provide a means for measuring the position of the proof mass with respect to its housing. The spacecraft must be kept centred on the proof mass to shield the reference mass from external forces. On SMART-2, two such sensors will be installed in the LISA payload. One will be used as the proof mass for the drag-free control system, and the other mass will act as a reference in inertial space.

#### *$\mu\text{N}$ thrusters*

The second SMART-2 technology is a set of  $\mu\text{N}$  thrusters used to control the spacecraft position to a few nanometers in the inertial frame of reference. The capability of controlling the spacecraft position to this tolerance is a system-level operation applicable to many future separated spacecraft interferometer missions.

#### *Position readout system*

The third SMART-2 technology is a laser interferometer system for position readout. This measures the difference in the displacement of the two proof masses to validate that each is "drag-free" within the requirements. Additionally, the interferometer provides the mechanical support for the inertial sensors and the other optical and electro-optical components.

The goals for each of these three technologies are summarised in table 2. The inertial sensor performance goals are one order of magnitude more benign than the equivalent goals for LISA. Instead of attempting to reach the performance of LISA, SMART-2 proposes to reach a somewhat more modest performance level, and will include specific tests for measuring performance as a function of the disturbance level. If the tests prove successful, the SMART-2 inertial sensor

performance can be confidently extrapolated to the LISA performance level. The  $\mu\text{N}$  thruster performance goals are those necessary to control the position of a 100 kg spacecraft to 10 nanometer accuracy. This level of control is needed to reach the desired inertial sensor performance level. The interferometry performance goals are those needed to validate the performance of the inertial sensor.

Technology for LISA			
	Function	Requirement	Comments
Inertial sensor	To follow inertial trajectory with low disturbance forces.	Force noise $< 3 \times 10^{-14}$ m/SMART-2/ $\sqrt{\text{Hz}}$ Measurement Bandwidth (MBW): 1 mHz to 0.1 Hz	Disturbance forces are generated by spacecraft self-gravity, the thermal environment, electrostatic forces, the control loop outside the measurement bandwidth, and by external effects.
$\mu\text{N}$ thruster	To provide control forces and torques for the spacecraft guidance and control system	Thrust: 1 to 20 $\mu\text{N}$ Thrust noise $< 0.1 \mu\text{N}/\sqrt{\text{Hz}}$ MBW: 1 mHz to 0.1 Hz	FEEP (Field Emission Electrical Propulsion) systems are expected to provide the required levels of thrust and thrust noise.
Laser metrology (interferometer)	To measure position changes between the two test masses	Accuracy $< 10 \text{ pm}/\sqrt{\text{Hz}}$ , MBW: 1 mHz to 0.1 Hz	The two proof masses are inside the optical path of the metrology interferometer.

Table 2: Requirements for drag-free flight control, the inertial sensor and the metrology.

The LISA technology package, depicted in fig. 1 consists of:

- Two proof masses inside a rectangular box of goldised carbon-epoxy,
- Capacity sensor electronics
- Charge control system, based on UV discharging, to ensure that force noise induced by Lorentz forces (and electrostatic forces) are acceptable. SMART-2 will have a requirement on magnetic noise at the LISA experiment in the order of  $B_{n, s/c} < 10^{-8} \text{ T}/\sqrt{\text{Hz}}$  at 1 mHz.
- Laser head: likely the laser head will be a diode laser-pumped monolithic miniature Nd:YAG non-planar ring oscillator. The power of the infrared beam at 1064 nm will be about 1 mW. In addition to the power stability requirement, the laser head will have frequency noise requirement in the order of  $\partial f < 1.5 \cdot 10^3 \text{ Hz}/\sqrt{\text{Hz}}$  over the MBW.
- Electronics for the capacity sensor, the laser and the interferometer.

The development of this package is on-going. Currently, the best estimate of the mass of the LISA experiment is around 30 kg, and of its power consumption, around 35 W.

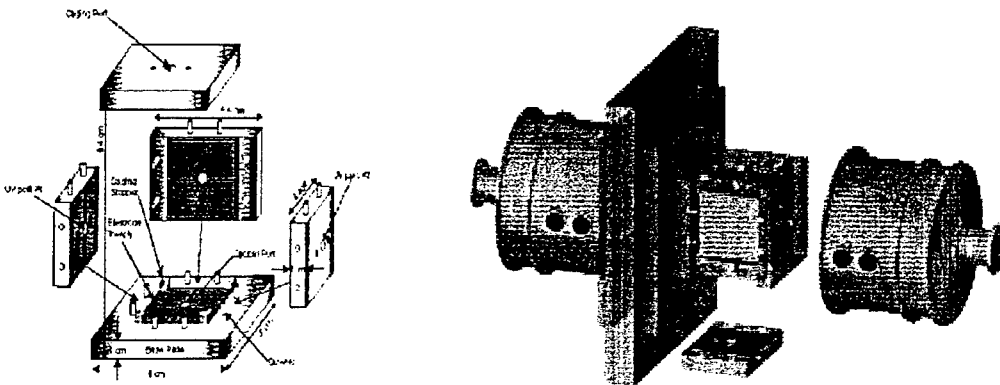


Fig. 1: (a) The proof mass (not shown) floats inside an electrostatic housing  $0.1 \times 0.1 \times 0.1 \text{ m}^3$  box. (b) The two proof masses are covered and assembled on an optical bench.

## 2 - SMART-2 MISSION OPTIONS

It is premature at this moment to identify a baseline mission for SMART-2. Rather than the level of definition of technology demonstration requirements, it is the status of the related technologies and the "essential mission trade-offs" which have not been consolidated. However, a number of key trade-offs and potential baselines has been performed and are described hereafter.

### 3.1 - Mission scenarios

Three classes of missions are being investigated:

- Autonomous European mission based on a single satellite to demonstrate LISA technologies
- Autonomous European mission based on two satellites to demonstrate both the identified technologies for LISA and DARWIN. The second satellite will be the active wing of the spacecraft carrying the LISA payload, carrying the active technologies related to flotilla position control.
- Co-operative mission with NASA-JPL with three satellites to demonstrate LISA and DARWIN technologies, and to perform stellar interferometry with two collector spacecraft and one combiner spacecraft.

### 3.2 - Orbit options

Both LISA and DARWIN will eventually fly into highly stable orbits, either around the sun-earth L2 point or in earth trailing orbits. Consequently, SMART-2 would greatly benefit from the quiet environment these orbits provide. However, other considerations, mostly related to launch costs and operations costs, come into play. At the present time, the most likely orbit for SMART-2 will be one of the following:

- Highly elliptical orbits around the earth, e.g. a GTO (geosynchronous transfer orbit). Although these orbits are subject to atmospheric drag and earth gravity disturbances near the perigee, the part of the trajectory around the apogee would be adequate for formation flying and LISA demonstration. The project would benefit from cheap launch opportunities for auxiliary payloads to larger telecommunication satellites. However, there are limitations with respect to formation flying as both spacecraft should follow the same trajectory. Furthermore, the electrostatic charging of the proof masses of the LISA experiment could suffer problems of discharging in the limited time when the satellites are outside the Van Allen belts.
- GEO's (Geosynchronous Orbit, although other high altitude circular orbits could also be feasible) are more stable with respect to gravitational effects for the short baseline distance between satellites. With respect to the LISA demonstration, GEO or quasi-GEO orbits appear feasible, although the effects of J<sub>2</sub> on the test masses might not be negligible. The satellites would have to incorporate a propulsion module to raise the perigee up to the final orbit.
- Orbits around the L2 libration point will require orbit correction manoeuvres, but these are feasible orbits both from the point of view of formation flying and of drag-free control. The DARWIN mission has Lissajous orbits around the L2 point as baseline, and SOHO is on a HALO orbit around L2. Longer transfer time and operations complexities are inherent to this type of spacecraft location.
- HETO (Heliocentric Earth Trailing Orbits) have been proposed for LISA and for US missions like ST-3 and TPF. These orbits are the most stable, being the solar pressure the most significant external disturbance to the free flying of the spacecraft. Due to the drift of the satellites with respect to the earth, all satellites should be launched with the same vehicle. Typical telecommunication system problems, associated with deep space missions, arise, e.g.

the availability of ground stations and the limitation of TT&C bandwidth, particularly in safe mode.

### 3.3 - Launcher options

Closely related to the orbit selection, the launcher definition will also be driven by the number of satellites, the total mass, and the need for additional propulsion stages. Whereas launching as an auxiliary payload with Ariane 5 could be feasible for the one-spacecraft scenario, the launcher in case of a co-operative mission with NASA, would be a Delta II 7925.

Being SMART-2 a low budget mission, price will be a driver for the procurement of the launcher services. Furthermore, the mission and orbit trade-offs will be heavily influenced by the availability of cost effective launchers.

### 3.4 - Highlights of SMART-2 spacecraft design

CASA has performed a study on behalf of ESA which included, among other topics, a preliminary design of a pair of satellites that would be compatible with the mission goals in the case of a European-only mission. This section presents some of the trades identified in their study and one feasible configuration.

Formation flying is mostly about GNC strategies and implementation. A centralised GNC architecture, with one spacecraft performing all the estimation and control computations, could distribute position and velocity commands to both satellites. Alternatively, a distributed GNC system would have each satellite performing its own control based on their own estimations.

The AOCS will not be typical for a small satellite in low earth orbit. On the contrary, it is likely that star sensors, inertial reference units, and fine sun sensors will become necessary. On the actuator side, it seems that the vibrations induced by spinning wheels would not be compatible with the acceleration noise of the inertial sensor.

Radio frequency systems for trajectory and attitude determination, including multiple antennas on each vehicle, are at the core of the technology demonstration of SMART-2. Additionally, a UHF radio link will be established between the two satellites for FF management and TT&C relay. It is envisaged that this system will be similar to or compatible with US missions to planet mars. Finally, it is envisaged that only one of the two satellites carries equipment for nominal TT&C with ground, whereas both will have low-gain antennas.

A regulated power subsystem is envisaged which would also include body-mounted solar arrays, and batteries. Satellite installed power will be slightly less than 250 W.

The structure subsystem will have to ensure enhanced dimensional stability at the interfaces with the sensors: the DARWIN laser metrology system and the LISA unit. No moving parts are envisaged on SMART-2 in order to prevent variations of the self-gravity field and spurious accelerations.

SMART-2 will not implement any sensors that require low temperature environment in contrast to DARWIN and LISA. Consequently, the thermal control subsystem will likely rely on passive means. However, it should be noted that the LISA payload will demand to control the temperature fluctuations of the optical bench and the fluctuations of the temperature difference across the proof mass cavities. Furthermore, thermal effects on self-gravity will have to be compatible with the acceleration noise requirement.

The selection of the propulsion system, if needed, will depend on the selected orbit.

The reaction control system will be based on  $\mu\text{N}$  thrusters, but it is also envisaged to include other, larger thrusters in order to reduce reaction time in case of safe mode or for reconfiguration of the flotilla baseline. The baseline  $\mu\text{N}$  thrusters are field emission electrical propulsion (FEEP) proportional thrusters.

Fig. 2 shows a viable satellite design in the launch configuration and an open view of the LISA-demonstrator satellite. Total system mass would be around 300 kg, of which 160 kg corresponds to the spacecraft with the LISA payload, 125 kg to the other satellite, and the rest to the launch adapter. Additionally, the configuration shown in the figures includes provisions for a kick-stage to place the flotilla in a HETO orbit.

### 3.5 – Operations

The Phase F of the project will span for 12 months. Following the LEOP, and the coasting to the destination orbit, the satellites will separate and initiate a short commissioning period. Then the period of technology demonstration tests will commence. Tests will be performed for the two Cornerstone payloads alternatively, starting with DARWIN.

For DARWIN, SMART-2 will perform tests of:

- Trajectory stabilisation: to demonstrate that separating spacecraft can be controlled to a predefined distance and attitude. The maximum distance between satellites will be in the order of 100 m.
- Change of baseline distance: tests in which the two satellites go from one baseline distance to another.
- Radial displacement: one of the satellites varies the radius of its orbit so that there is a 30 deg offset between the inter-satellite vector (i.e. the baseline) and the velocity vector, both in the common orbital plane.
- Normal displacement: one of the satellites slightly varies its orbital plane, corresponding to a rotation of the baseline around the nadir vector.

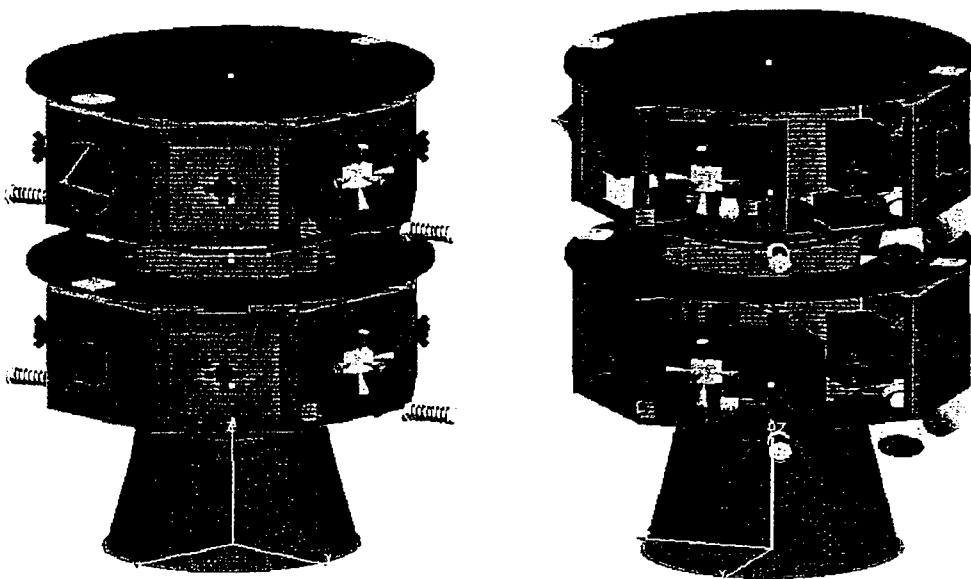


Fig. 2: Launch configuration and open view of a possible SMART-2 flotilla

- Simulated third satellite: the two spacecraft are commanded to move around an imaginary point in space according to a predefined pattern. This mode aims at demonstrating plane changes of a three-satellite flotilla with the limitations of a two-satellite mission.

For all these tests the reconfigurations will be performed while maintaining the Coarse Baseline Control Mode (see table 1). After the satellites get to their final relative positions for each test, the Intermediate-Freezing Control Mode will be activated for a few hours, up to a day.

Once these tests for DARWIN, which require less stringent trajectory and AOCS control, the LISA demonstration will begin. Most likely, the inertial sensors of the LISA experiment will remain locked in their launch configuration until then. Once released, three test modes will be sequentially pursued:

- Drag-free System Validation Mode: The two proof masses are left to follow purely inertial trajectories and an independent read-out system will directly measure their relative displacement. This requires the following requirements to be fulfilled:
  1. The test mass must be shielded from all external non-gravitational effects.
  2. The spurious forces acting on the test mass due to gravitational and magnetic interaction with the satellite should be kept to negligible values.
  3. The back action of the readout system for the test mass position itself should be negligible.

In this mode, gain, roll-off and bandwidth of the feedback system will be varied to learn about its performance and about how it can be optimised.

- Charge Control Mode: It will compare and trade off the various options of operation models for the charge control system, e.g. continuous versus discontinuous sensing, and continuous versus discontinuous discharging. The disturbances created on the proof masses will also be measured by, on purpose, letting charge accumulating on them.
- Laser Readout and  $\mu\text{N}$  Thrusters Validation Mode: In this mode, the performance of both systems will be investigated, noting that this can only be done through an iterative process. As it is expected that the noise the thrusters generate will be the dominant source of spurious acceleration, they will be operated in different conditions, i.e. by stimulating different thrust and noise levels. The ensuing displacement and acceleration of the proof masses will be measured by the capacitive read-out and the laser interferometric sensor. On its side, the laser readout system will be investigated by applying controlled forces on the proof masses through the electrostatic suspension system. With laser stability and lock acquisition under adverse conditions, the displacement readout performance will be characterised.

Finally, it should be noted that spacecraft operations are an essential constituent of the flight demonstration of these technologies.

### 3 - PROGRAMMATICS

It is intended to present SMART-2 to the SSAC (Space Science Advisory Committee) in September 2000. Following, and subject to, SPC's (Science Programme Committee) endorsement in October a competitive invitation to tender would be issued for the performance of two parallel definition studies. The objectives of such studies would be the definition of the system and the submission of firm fixed price proposals for Phase B/C/D for a SMART-2 launch date in 2006. It is envisaged to kick off these studies in February 2001.

ESA is implementing the R&D programme for a number of technologies that will be flight demonstrated on SMART-2. These are activities not strictly related to SMART-2, but to the two Cornerstone missions, LISA and DARWIN, of which SMART-2 is a demonstrator. However, as

they should be flight demonstrated before the start of the Phase C/D of the Cornerstones, their development schedule has been linked to that of SMART-2. These individual technology developments relate to:

- Formation Flying GNC systems
- RF strategies and equipment for FF
- High precision optical metrology
- Highly stable laser systems and related electronics
- Low frequency interferometer detectors
- Inertial sensor
- Charge control management
- FEPP's

Being SMART-2 a technology demonstration mission itself, the development of some of the individual technologies will span into the Phase B of the project.

#### **4 - CONCLUSIONS**

SMART-2 will set out to flight test challenging technologies which must be mastered before missions such as LISA or DARWIN are undertaken. The requirements for SMART-2 have been derived from both Cornerstone missions, noting that a certain degree of extrapolation and further technology work will be necessary in addition to the demonstrator. SMART-2 constitutes an intermediate step in the development of these two programmes. However, an essential one for the reduction of technological and programmatic risks of the Cornerstones.

A small industrial contract and in-house work provide the confidence that these objectives can be met through a SMART type mission.

Key mission trades have not been closed yet and a significant evolution of the mission concept is expected in the coming months.

#### **5 - ACKNOWLEDGEMENTS**

The authors acknowledge the fruitful discussions with scientists of both communities, particularly Dr K. Danzmann, Dr R. Reinhard and Dr M. Fridlund. They also recognise the enthusiastic effort developed by Mr S. Garcia and Mrs I. Cabeza from CASA and by their team in identifying the possibilities and pitfalls of technology demonstration with SMART-2.



## MARS MICROMISSIONS: PROVIDING LOW COST ACCESS TO MARS

Jason Willis, Kim Leschly, and Dave Lehman  
Jet Propulsion Laboratory  
4800 Oak Grove Drive  
Pasadena, California 91109, USA

The Mars Micromissions will be the first planetary mission launched as a secondary payload on the Ariane 5 Structure for Secondary Payloads (ASAP5). The development of a common Mars Micromission Spacecraft (MMSC), which is capable of delivering one or more lightweight probes to Mars or be inserted into Mars orbit, was initiated in 1999 by the U.S. National Aeronautics and Space Administration (NASA) in cooperation with the French Centre National D'Etudes Spatiales (CNES), who is providing the ASAP5 launch. The Mars Micromission project is being managed by NASA's Jet Propulsion Laboratory, who recently selected Ball Aerospace as the system contractor for the first MMSC.

The Mars Micromission concept supports multiple mission types including, the delivery of probes (penetrators, landers, airplanes/gliders, and balloons), orbiting science missions, and telecommunications-navigation orbiters. The plan is to launch one or more MMSC during every Mars opportunity - every 26 Months - allowing for frequent, low cost access to the planet.

The first MMSC launch is scheduled for February 2003, and will carry one or two telecommunication orbiters, which will be the first element of a 4-6 spacecraft Mars Network constellation, intended to improve the data return for future Mars missions within the NASA Mars Surveyor Program.

The paper will provide a description of the common MMSC design, the key system design trades, and the resulting baseline payload capabilities and constraints. An overview of the 2003 mission design will also be provided, involving a novel multi-burn Lunar and Earth flyby trajectory to get from the initial GTO orbit to the desired Mars access trajectory. Finally, the paper will discuss the potential use of the MMSC/ASAP5 launch for other planetary missions beyond Mars.

## THE CONCEPT OF THE FUNCTION DEMONSTRATION SATELLITE OF ADVANCED MICRO SATELLITE (MICROSAT)

Satoshi KOGURE<sup>1</sup>, Shin SATORI<sup>2</sup>, Shinichi NAKASUKA<sup>3</sup>, Hiroyuki OKAMOTO<sup>4</sup>

<sup>1</sup>NASDA, Office of Satellite Systems/Mission Planning Department,  
Tsukuba Space Center, 2-1-1 Sengen, Tsukuba, Ibaraki, 305-8505 JAPAN

<sup>2</sup>Hokkaido Institute of Technology,  
7-15-4-1 Maeda Teine, Sapporo, Hokkaido, 006-8585 Japan,

<sup>3</sup>University of Tokyo, Dept. of Aeronautics & Engineering,  
7-3-1 Hongo, Bunkyo-ku, Tokyo, 113-8656 Japan,

<sup>4</sup>Astro Research Corporation,  
Fujisawa Central BLDG. 4F, 1-1-4 Kuganuma Tachibana, Fujisawa, 251-0024 Japan,

**Abstract.** - *The concept of the function demonstration satellite of advanced micro satellite (MICROSAT) is based on those experiment proposals for the demonstration of the nano-satellite technology and in-orbit service which were proposed and selected for Announcement of Opportunity for MDS research mission. Breadboard model of MICROSAT has been completely designed and it is now being developed.*

*This paper describes the concept of MICROSAT and its current status and plan of development. The phase A and B of this project have been authorized as MDS research mission. However, subsequent phases are not approved yet so far.*

*This project is eagerly desired to be realized since vigorous development of small satellite in universities would be contributed toward advanced technology development in this area.*

### 1 - ANNOUNCEMENT OF OPPORTUNITY FOR MDS SERIES

Mission Demonstration test Satellite (MDS) series are aiming at timely and economical space demonstration using medium/small-sized satellite. The main objectives of MDS-1, which is now under development and will be launched in 2001, are to confirm functions of commercial parts in orbit, to demonstrate component and to measure radiation in space environment. As to MDS-3, the missions were selected through Announcement of Opportunity in order to expand the area of space utilization and to seek various kinds of social needs.

In Announcement of Opportunity for MDS series, there are two stages: "Ground Research Mission" and "Onboard Mission". A/O for an "Onboard Mission" selects a mission and an onboard equipment which will be launched and demonstrated in orbit, while A/O for a "Ground Research Mission" chooses some ideas, concepts, or subjects of study which will be researched aiming at future space demonstration. The concepts of MICROSAT are based on the experiment proposals for the demonstration of the nano-satellite technology and in-orbit service which were proposed and selected for MDS Research Mission in 1998. In this Announcement of Opportunity, 7 mission proposals were selected from among 46.

In "Ground Research Mission", proponent and NASDA conduct feasibility study for future MDS Onboard Mission. In order to carry it on MDS, proposals should be selected for "Onboard Mission".

## **2 - THE CONCEPT OF MICROSAT**

### **2.1 The Significance and Plan of MICROSAT Development**

The conventional space engineering development using large-size satellites has got so many problems, such as lengthy development cycle, growing risks due to multiple onboard missions and increasing cost due to large-size and prolonged project, that it can not keep up with the recent technology innovation.

On the other hand, downsizing satellite can contribute to reduction of launch cost, shortening manufacturing period and development cycle. In addition, it can provide a low-cost and timely test bed for space demonstration.

Then, a low-cost test bed would facilitate many researchers and venture corporations to be involved in satellite utilization, build a new space utilization industry and expand the area of space development. In short, it should greatly contribute toward diversifying and expanding space activities.

MICROSAT is aiming at diversifying functions of satellite bus system and mission instruments into multiple small satellites, building "Network Satellite System", which is operated like network and connecting it with ground through internet. And eventually, it is aiming at materializing "Space Laboratory" through which many people like researchers, students and corporations can easily access to space.

### **2.2 Development Objectives of MICROSAT**

The primary objective of MICROSAT, aiming at the above-mentioned "Space Laboratory", is to develop and demonstrate in orbit a less than 10 Kg-weight of small-sized satellite, so called "Nano-satellite". Target weight and demand power are 3kg and 20W, respectively.

The demonstration items of MICTOSAT are as follows:

#### **1 Fundamental Key Technologies for a Nano-satellite**

- 1) Reaction Wheel for a Nano-satellite
- 2) Electric Propulsion for a Nano-satellite
- 3) Docking System for a Nano-satellite
- 4) Image Identification Attitude Control Software
- 5) Functional Demonstration of 3-axis Control MICROSAT Bus System

#### **2 Future Architecture and Mission using multiple nano-satellite**

- 1) Mothership-Daughtership Technology
- 2) Formation Flying Technology
- 3) Eyeball (monitoring and inspection) Function

Furthermore, as it is also important objective to build a new space technology development system by university leadership and to invite students to satellite development for educational purpose, MICROSAT will be provided for domestic and overseas universities as a research test bench.

### 2.3 Experiment System Configuration

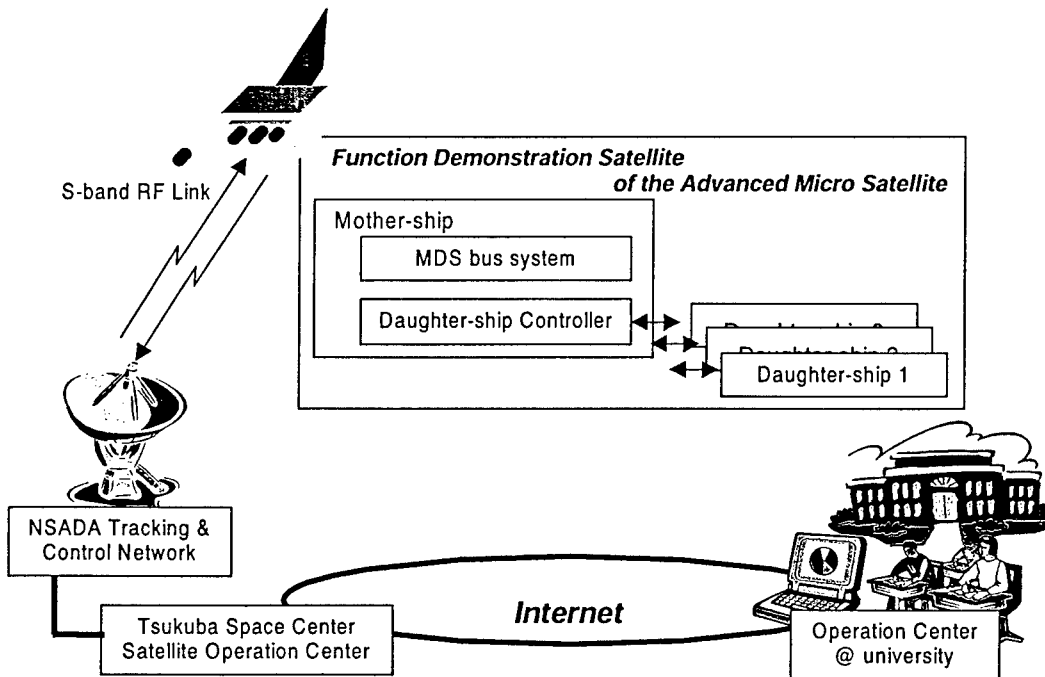
The mission equipment consists of three MICROSATs (Daughter-ship) and MDS onboard equipment (Daughter-ship controller) responsible for docking, separation and attitude control of MICROSAT.

MDS, as a Mother-ship, is responsible for communication with ground station, power supply to mission equipment and storage of experiment data.

Three MICROSATs consist of an onboard computer (OBC), a wireless CCD camera, a wireless modem, a gas jet thruster, reaction wheels, a secondary battery (Lithium Ion), a gyro sensor, an acceleration sensor, a GPS receiver, a space strobe floodlight and a propellant tank. Each MICROSAT has the additional function required for its own demonstration item: MICROSAT electric propulsion system, MIRCOSAT rendezvous docking mechanism and mother-ship fly-around experiment.

While the attitude and maneuver of MICROSAT are controlled by Daughter-ship controller carried on Mother-ship, OBC carried on MICROSAT processes commands from Daughter-ship controller and send telemetry data to mother-ship.

Figure 1 shows a conceptual drawing of the whole experiment system, Figure 2 an outward appearance of function demonstration satellite of the advanced MICROSAT, Figure 3 an outward appearance of Daughter-ship and Figure 4 its block diagram, respectively.



*Fig.1: Conceptual Drawing of Whole Experiment System*

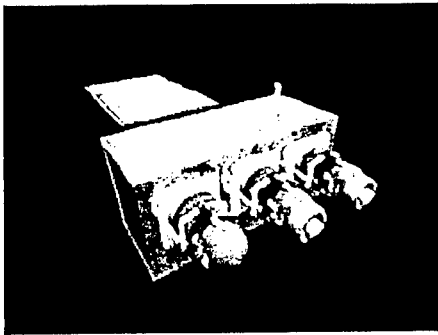


Fig.2: Outward appearance of function demonstration satellite of the advanced MICROSAT

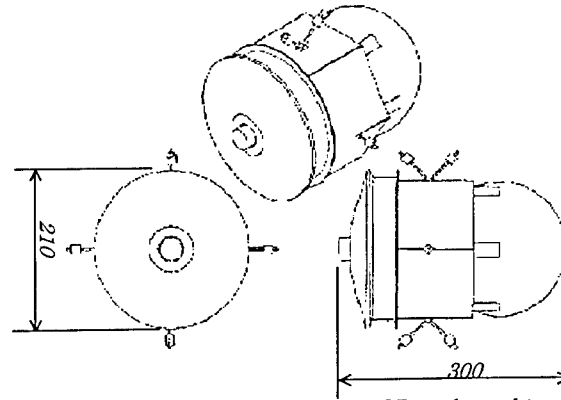


Fig.3: Outward appearance of Daughter-ship

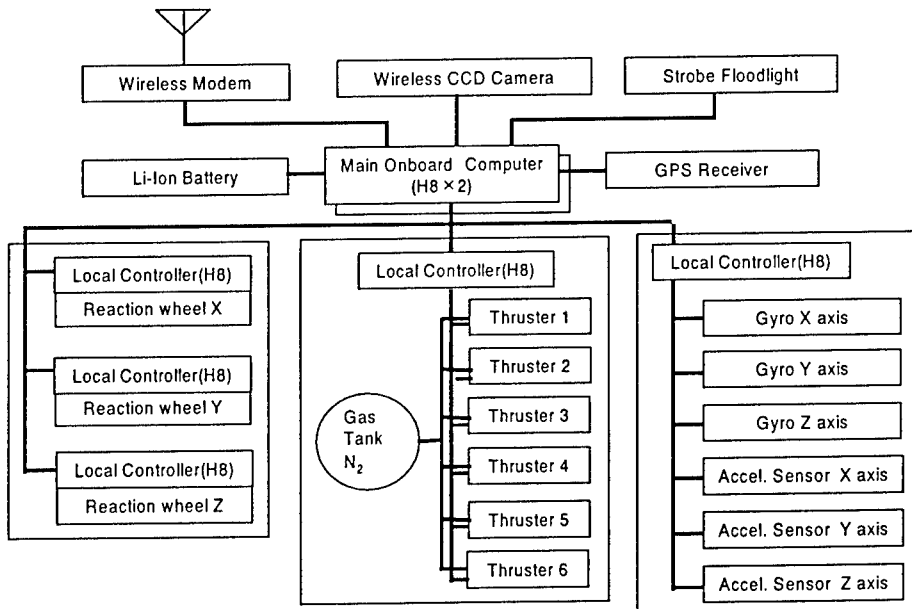


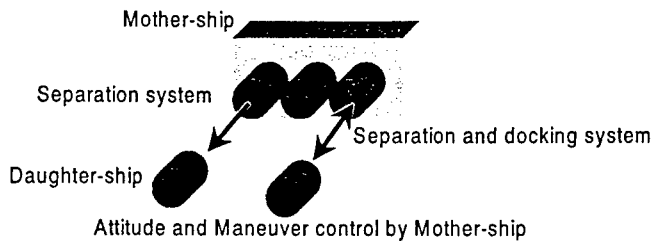
Fig.4: Block Diagram of Daughter-ship (MICROSAT)

## 2.4 Demonstration Experiment

Three experiments to be conducted are as follows:

### 1) Mothership-Daughtership Technology Demonstration Experiment

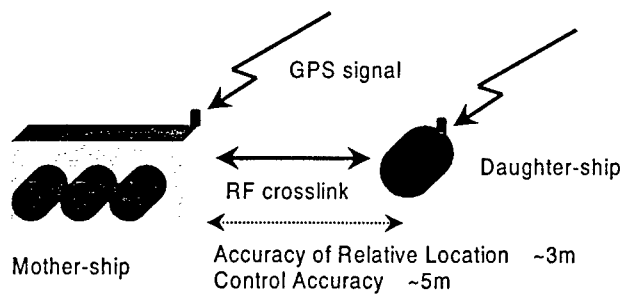
In order to build a network of satellite, many functions will be demonstrated such as Daughter-ship control by Mother-ship through wireless LAN, CPU reprogramming, separation from Mother-ship and docking and so on.



*Fig. 5: Mothership-Daughtership Technology Demonstration Experiment*

2) Formation Flying Demonstration Experiment

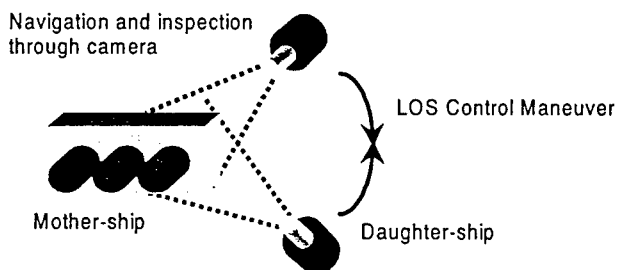
Mother-Daughtership and Inter-daughtership relative location control through DGPS will be conducted.



*Fig.6: Formation Flying Demonstration Experiment*

3) Mother-ship Fly-around Experiment

In this experiment, MICROSAT will fly around Mother-ship through Navigation control of LOS control with image of CCD camera aiming to apply it to the future orbital maintenance satellite. An operation experiment during dark portion will be conducted using strobe floodlight.



*Fig.7: Mother-ship Fly-around Experiment*

### 3 - DEVELOPMENT STATUS

Breadboard model of MICROSAT has been designed and is now being manufactured.

As to a wireless LAN, a wireless CCD camera, CPU and various sensors like a gyro, an acceleration sensor and a GPS receiver, commercial parts for ground use will be partly refined for space environment, while reaction wheel for MICROSAT and strobe floodlight and software like control algorithm will be newly developed by universities.

Table 1 shows resource allocations of current weight and demand power. The gross weight is approximately 3.6 Kg and maximum demand power is approximately 8W. Current status of some components is as follows:

Item	Weight (kg)	Power(W)
On Board Computer	70	0.27
Wireless CCD Camera	170	1.55
Wireless RF Modem	150	0.85
Thruster + Valve Drive Electronics	150	2.00
Reaction Wheel + Drive Electronics	450	2.00
Sensors ( Gyro, Accelerometer, GPS receiver )	100	0.62
Strobe Floodlight	200	0.60
Battery (Lithium Ion)	420	0
Power Unit	50	1.62
Propellant Tank	1100	0
Structure	600	0
Total	3610	8.11

Table-1: Weight and Demand Power allocation for MICROSAT(Daughter-Ship)

#### OBC

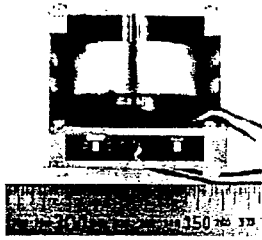
For MICROSAT CPU, a Hitachi H8/3048 will be used, which is also used for car control. Table 2 shows its specifications. It is radiation-resistant and will be used in  $\mu$ -LabSAT, NASDA's 50 Kg-class small satellite as well. So far, a simple radiation experiment using Cf as radiation resource was conducted and it was confirmed that probabilities of occurrence of SEL and SEU are sufficiently low for the assumed mission period.

#### Wireless CCD Camera

a wireless CCD camera for ground use, a RF-SYSTEM PRO-5, will be used after refined for space use. Its electrolytic condenser should be replaced with a tantalum capacitor. In order to evaluate its image degradation in radiation environment, radiation test will be conducted.

#### Reaction Wheel

The reaction wheel was newly developed for MICROSAT specification. Table 3 shows the specification of the reaction wheel. An endurance test is now being conducted to confirm the endurance in vacuum of a motor and bearing of the breadboard model. It has been conducted around 2000 hrs as of the end of April.



Item	Specifications
Weight (Total)	130 [g]
Structure	26 [g]
Motor	30 [g]
Control circuit + sensor	54 [g]
Rotor	130 [g]
Consumption Power	2 [W]
Maximum Torque	30 [gcm]
Maximum Angular Momentum	1.5E-2 [Nms]

*Table-2: Specifications of the Micro Reaction Wheel under development*

#### 4 - FUTURE PLAN

We will manufacture a breadboard model, conduct matching test between sensor, actuator and control algorithm, vibration test and thermal vacuum test, confirm MICROSAT feasibility and then consider the design of Daughter-ship Controller and interface conditions of MDS as Mother-ship.

As we mentioned above, the phase A and B of this project have been authorized as MDS Research Mission, while subsequent phases are not. Due to the launch failure of H-II launch vehicle last November, the launch schedule for NASDA's satellite program must be delayed. Therefore, the succeeding satellite of MDS, MDS-3 scheduled in around 2004 must be also delayed. In fact, the next Announcement of Opportunity of Onboard Mission is still unclear.

Given the above, we would like to consider other demonstration opportunities as well as MDS Onboard Mission. Cooperation with overseas institution can be strong alternatives.

In University Space System Symposium' last November, a Japan/USA inter-university joint project "TWIN STAR" was initiated. In this project, rendezvous and docking demonstration using micro satellites made by Japan and USA students individually is being planned. Japanese universities are participating in this project using same MICROSAT proposed for MDS A/O. Participant are, Hokkaido Institute of Technology, University of Tokyo and Tokyo Institute of Technology from Japan, Weber State University and Arizona State University from USA.

As of now, TWIN STAR is actively seeking fund, appealing its significance to some governmental organizations, in order to secure budget for after concept design.

#### 5 - SUMMARY

MICROSAT will demonstrate technologies and architecture required for building a simple space laboratory in order to facilitate more various people to participate in the future space activities. As a result, MICROSAT will help and progress space activities in universities.

This project is eagerly desired to be realized since vigorous development of small satellite in universities would be contributed toward advanced technology development in this area.

\*NOTE: a symposium organized by JUSTSAP (Japan-U.S. Science, Technology and Space Application Program) since 1998 for the purpose to promote US-Japan students participation in joint satellite-related projects.



**EARTH OBSERVATION PROGRAM  
AT THE KHRUNICHEV STATE RESEARCH AND  
PRODUCTION SPACE CENTER**

**Inessa GLAZKOVA**

*Khrunichev State Research and Production Space Center  
Novozavodskaja st., 18  
121087 Moscow, Russia*

Climate and environment changes, natural and man-made disasters raise worldwide concern and form the basis for new environmental monitoring concepts.

Decision-makers looking ahead have to take into account social, economic and ecological aspects. This requires the provision of a reliable and continuous system built on the base of space remote sensing facilities and up-to-date telecommunications technologies.

A tentative assessment of the Khrunichev Center shows that the future system should include multi-purpose space vehicles operating in real time. Timely data receiving might be provided by a constellation of small satellites fit with optoelectronic equipment (to provide earth resource data), radars (for all-weather sensing) and geophysics instruments (to provide near-earth data).

Creation of the system has the aim to improve the revisit rate, increase the information content by using various types of equipment, improve the resolution, deliver data to the user in time.

The current market of Earth observation has the following structure:

- spacecraft market;
- market of Earth observation data:
  - market of information products and services;
  - market of receiving equipment and data processing services.

At present Spot and Landsat SC have the leading position at the market of space information of Earth observation. The dominant position at the market of information products belongs to the thematically processed data.

The demand of the world service market for Earth observation information with quick revisit rate is high, is steadily growing and keeps the tendency toward further growth by 20-30% annually.

Commercially the best results will be achieved by operational space systems of Earth observation with sufficiently high resolution and wide swath width that include the space segment of Earth observation as well as the ground high-tech infrastructure for image receiving and processing, data storage and transmission via radio channels to "large" stations or immediate downlink to the user.

Gradual commercialization proceeds at the market of remote sensing facilities and data, initially this market has the budget sources of financing. In order to attract private

investments many companies have given up the idea of designing expensive multipurpose systems of heavy SC and have switched over to overspecialized systems based on small SC of remote sensing.

Minimization of costs of SC creation and launch, ground services along with active marketing strategy might be the guarantee of success in this case.

Russia has essential experience in the development and operation of remote sensing SC in using space information in various applications. SC "Resurs-O" №3, "Okean" №7, "Okean-O" are in the orbit now. Joint system "Resurs" existing now is subdivided into operational SC "Resurs-O" and "Okean" which transmit information in real time and photo SC "Resurs-F", which operates periodically.

In the nearest future it is planned to launch the operational meteorological spacecraft "Meteor-3M".

Federal space program assumes the development of advanced remote sensing SC "Resurs" №5, "Resurs-DK".

Taking into account the demand for the natural resource information the leading Russian space companies are carrying out their own works on creation of small SC.

The Khrunichev Space Center has been working to create remote sensing space facilities from the beginning of the 1990s.

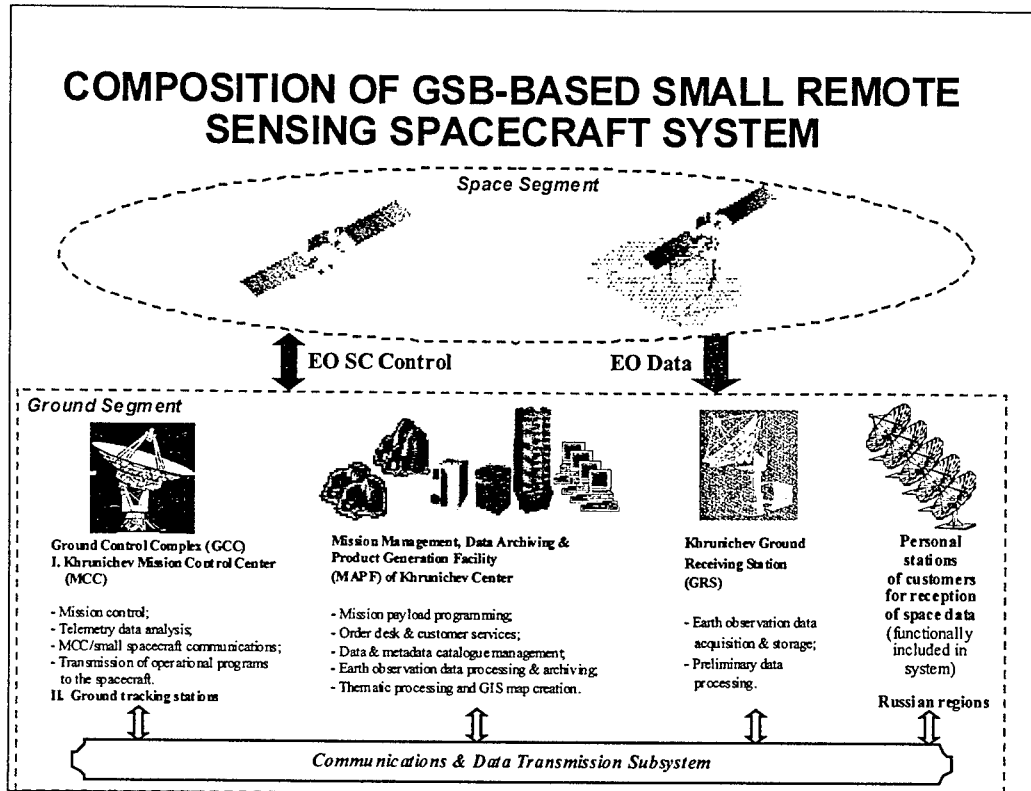
The scientific and technical potential and the experience accumulated at the Center through creating the space stations "Salut", "Almaz", "Mir", the modules "Spektr" and "Priroda", the Russian-German-Japanese spacecraft "Express", the Russian-American spacecraft within the framework of the RAMOS program and other facilities has enabled us to move on to create and work on remote sensing spacecraft:

- Generic space bus "Yacht" for the purposes of remote sensing and space communications;
- Small spacecraft "Monitor" with optoelectronic or radar on-board equipment to receive timely data on natural resources;

The program assumes the creation:

- orbital constellation of small SC of remote sensing,
- mission control center,
- ground receiving station,
- mission management, data archiving and product generation facility, designated for planning of mission equipment work, gathering and implementation of users' requests, data archiving, cataloguing and processing to the requested level.

## COMPOSITION OF GSB-BASED SMALL REMOTE SENSING SPACECRAFT SYSTEM



The ground segment includes: ground control complex, mission management, data archiving and product generation facility, ground receiving station of the Khrunichev Space Center, federal and regional data receiving stations (functionally), data communication and transmission system.

Mission management, data archiving and product generation facility, fit with up-to-date computer equipment, designated for planning of mission equipment work, archiving, cataloguing and processing of data received by the Earth Observation System.

The goal of the program is to provide Russian and foreign users with natural resource information.


Main tasks, solving by the system of Earth observation:

- Thematic mapping;
- Agriculture;
- Forestry;
- Risk management;
- Environmental monitoring;
- Mineral prospecting;
- Oceanology and fishery;
- Exploration, planning and construction;
- Land cadastres.


The EO orbital constellation of the Khrunichev Center assumes the creation of several types of optoelectronic and radar SC. The launch of the first SC with two cameras on board (resolution – 8 m, 25 m) is scheduled to be made at the beginning of 2001 by LV “Rockot” from the Plesetsk site (LV “Rockot” has been developed at the Khrunichev Center also). The first launch will be an experimental one and will be made with the aim of development testing of the payload and the bus “Yacht” service systems. That is why this SC has got the name “Monitir-E” (experimental).

The main applications are agriculture, environmental monitoring, geological mapping and mineral prospecting, risk management, mapping at scale up to 1:50 000.




## «MONITOR-E» SPACECRAFT



**EO data receiving**  
by stations of federal, regional  
and local levels



**Multilevel digital processing**

### Spacecraft Performance

<b>Orbital parameters</b>	
- Altitude, km	550
- Inclination, deg	97,5 (SSO)
Spacecraft mass, kg	700
Operational lifetime, years	5
Launch vehicle	“Rockot” LV
Altitude control accuracy, deg	0.1
Altitude rate control accuracy, deg/s	0.001
Power, W	1200
<b>Payload Equipment Performance</b>	
<b>Optical/Electronic Complex</b>	
Spectral bands, $\mu\text{m}$	(Panchrom) 0.54-0.59 0.58-0.85 0.63-0.88 0.73-0.90
Spatial resolution, m	8 25/50
Swath width, km	80-100 200
Coverage, km	730 890
Transmission rate, Mb/s	128 15,3664
Max power, W	450

### Final Product:

Panchromatic and multispectral digital images of standard processing levels;  
*Images with standard radiometric and geometric corrections; geocoded images in geographic projection; ortho-rectified images, mosaics; digital maps.*

### Applications:

Agriculture, forestry, environmental monitoring, geological mapping and prospecting of mineral resources, risk management, mapping at scale up to 1:50 000.

Mission control center, ground receiving station, mission management, data archiving and product generation facility that are under development at the Khrunichev Center will be ready for operation by the launch (mission control center will be used for the control of communications SC also).

In the case of success operation of experimental SC, other SC of this family would be injected into space.

# «MONITOR-I» SPACECRAFT



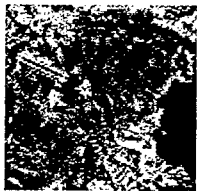
## Spacecraft Performance

Orbital parameters			
- Altitude, km	550		
- Inclination, deg	97.5 (SSO)		
- Spacecraft mass, kg	700		
- Operational lifetime, years	5		
- Launch vehicle	"Rockot" LV		
- Altitude control accuracy, deg	0.1		
- Altitude rate control accuracy, deg/s	0.001		
- Power, W	1200		
Payload Equipment Performance			
	Optical/Electronic Complex		
	I	II	
	0.41-0.46	I	
	0.48-0.53	I	
	0.54-0.59	3.55-3.95	0.54-0.59
	0.63-0.68	10.4-11.5	0.63-0.68
	0.79-0.90	11.5-12.6	0.79-0.90
	1.5-1.75		
	1.05-1.32		
Spatial resolution, m	5	60-90	25/50
Swath width, km	80-100	200	200
Coverage, km	730	890	890
Transmission rate, Mb/s		128	15, 36, 64
Max power, W			450

EO data receiving  
by stations of federal, regional  
and local levels



Multilevel digital processing



## Final Product

Panchromatic, multispectral and infrared digital images of standard processing levels;  
*images with standard radiometric and geometric corrections; geocoded images in geographic projection; ortho-rectified images, mosaics; digital maps.*

## Applications:

Agriculture, melioration, forestry, environmental monitoring, geological mapping and mineral prospecting, geodynamical hazards forecasting, risk management, hydrology, oceanology, mapping at scale up to 1:50 000.

At present the works on the development of three subsequent SC "Monitor" modifications: "Monitor-I", "Monitor-S" and "Monitor-O" are carrying out at the Khrunichev Center. "Monitor-I" is equipped with more complex mission observation instrumentation, with increasing the number of spectral bands and adding infrared band (including thermal IR).

## «MONITOR-R3» SPACECRAFT



### Spacecraft Performance

Orbital parameters	
- Altitude, km	400-500
- Inclination, deg.	80-90
Spacecraft mass, kg	900-1000
Operational lifetime, years	5
Launch vehicle	"Rokot" LV
Attitude control accuracy, deg	0.1
Attitude rate control accuracy, deg/s	0.001
Power, W	up to 2500

Payload Equipment Performance		Radar system	
Wavelength, cm		3.5	30-35
Spatial resolution, m		3-5	300
Swath width, km		20-30	300
Coverage, km		400	
Data transmission rate, Mbit/s		122.88 and 15.36/61.44	
Max power, W		1500-2000	

### Final Product

Radar images of standard processing levels: *annotated raw data (holograms); calibrated digital images with standard radiometric and geometric corrections; geocoded images in geographic projection; ortho-rectified images, mosaics; digital maps.*

### Applications:

ice condition control, oceanology, mapping at scale up to 1:25 000, geological mapping and mineral prospecting, risk management, agriculture, environmental monitoring.

EO data  
receiving by stations of  
federal, regional and local  
levels



Multilevel digital processing



“Monitor-S” is a stereo SC which will serve as a good supplement to the previous SC and will enlarge the list of solving application tasks.

“Monitor-O” has the high resolution camera on board of SC with 1-2 m resolution.

All types of SC will be equipped with instrumentation of allocated access (25 m with interswitching to 50 m) in order to transmit information directly to small ground stations developed by Russian company «ScanEx». The main idea of such decision is to deliver information to the user in time, to provide users with wide access to information.

In future it is planned to enlarge the orbital constellation, equipping of it with radar SC with 3.5 and 23 cm wave lengths.

Radar complexes of “Monitor-R3” and “Monitor-R23” will enable to obtain all-weather timely information.

“Monitor-R3” will be equipped with synthetic aperture radar, wave length — 3.5 cm (X-band), resolution 3-5 m and 30-35 m. Main applications are mapping, risk management, agriculture, oceanology, environmental monitoring.

“Monitor-R23” will be equipped with synthetic aperture radar, wave length — 3.5 cm, resolution 3-5 m and 23 cm (L-band), resolution 30-35 m. Main applications are mapping, risk management, forestry, geological mapping and mineral prospecting, hydrology, oceanology, environmental monitoring.

---

Users will be provided with the following products, derived from optical, IR and radar data processing:

- radiometrically corrected images (level 1A) and geometrically corrected images (level 1B);
- geocoded images geographic projection without control points (level 2A), with control points (level 2B);
- orthorectified images (geocoded images with control points and DEM-corrected) (level 2C);
- mosaics;
- digital thematic maps.

Complete deployment will be provided by 2006.

I would like to draw your attention to the fact that the proposed EO system will provide the comprehensive approach: not only the development of SC but also the creation of ground segment and subsystem of data communication and transmission. Herewith the question of delivering the information to the end user is of particular importance.

The Khrunichev Center has informed leading Russian ministries and institutions about the creation of such system and many of them have confirmed their interest in using space information received from SC "Monitor" for solving application tasks.

Furthermore the creation of such system raises the interest of foreign users also.

**AMS- an Advanced free flying Mailbox Satellite; *some choices and solutions.***

K P Galligan    European Space Agency

**Abstract:**

The Little LEO messaging system, LLMS, became operational earlier in 2000 under the banner of the IRIS service and that service evolution is traced in an companion paper at this conference by Sansone, Larock and Rehorst. LLMS provides a useful stable platform for such service launch

Early on however it became apparent that for service viability, mainly associated with flexibility, an essential element of the space segment was the availability of a free flying satellite.

In order to reach that situation a number of technical hurdles needed to be surmounted, most notably in the development of an integrated CDMA modem for the spacecraft. Further challenges are to be found in developing the provision of this new service..

This paper explores some of the issues and choices that have been faced in the development of an Advanced Mailbox Satellite as a complement to the technical expose of the basic system found in this conference and those in the literature.



## **SESSION 8 :**

### **Projets en liaison avec les universités** *Projects linked with Universities*

*Présidents / Chairpersons: Bénédicte ESCUDIER, Franco ONGARO*

- (S8.1) FalconSAT 1: Small Satellites as a Tool for Teaching Astronautics**  
Reeves E., Chesley B., Sellers J., Humble R. U.S. Air Force Academy, Colorado, Etats-Unis
- (S8.2) Naval Postgraduate School Graduate Education in Space Systems through Space Flight Experience**  
Sakoda D.J., Naval Postgraduate School, Monterey, Etats-Unis
- (S8.3) The Aries Project**  
Chavez Alcaraz E., Navarrete Parades E., ITESM CEM, Atizapan de Zaragoza, Mexique
- (S8.4) UNISAT Solar Array Integration and Testing**  
Agneni A., Santoni F., Ferrante M., Romoli A., Università degli studi di Roma "la Sapienza", Rome, Ferrazza F., Eurosolare SpA, Rome, Italie
- (S8.5) IONOSPHERIC Observation Nanosatellite Formation (ION-F)**  
Campbell M., Univ. of Washington, Seattle WA, Fuller R., Swenson C., Utah State University, Logan UT, Hall C., Virginia Polytechnic Institute, Blacksburg VA, Etats Unis
- (S8.6) The Emerald Nanosatellites: two student-built small satellites to explore robust distributed space systems**  
Townsend J. Stanford Space Systems Development Lab. (SSDL), Stanford, Etats-Unis
- (S8.7) The  $\mu$ SAT-EDU project**  
Murgio L.A., Rossa M.B., Gallino M., Instituto Universitario Aeronautica, Córdoba, Argentine

## **FALCONSAT 1: SMALL SATELLITES AS A TOOL FOR TEACHING ASTRONAUTICS**

Emery Reeves, Schriever Chair Professor Emeritus, Department of Astronautics  
Maj. Bruce Chesley, Small Satellite Program Manager, Department of Astronautics  
Maj. Jerry Sellers, Assistant Professor of Astronautics, Department of Astronautics  
Ron Humble, Schriever Chair, Department of Astronautics

2354 Fairchild Drive, Suite 6H65  
U.S. Air Force Academy, Colorado, USA 80840

The US Air Force Academy (USAFA) in Colorado Springs, Colorado, USA has been teaching undergraduate astronautics for nearly 40 years. Over the years, the Department of Astronautics has found that hands-on experience is the best teacher and have incorporated an extensive small satellite program into the curriculum. USAFA cadets and faculty have designed, built and launched get-away-special experiments for the Space Shuttle and a self-contained payload attached to a Centaur upper stage called FalconGold. Most recently, the department has designed and built its first "free flyer" satellite--FalconSAT 1. It was launched on January 14, 2000. FalconSAT 1 is a 44 cm cube, generates 20 watts of electrical power with skin mounted solar cells, communicates with the ground station at the Academy by UHF and VHF links, and uses a 486 class processor to control its operations and store and transmit housekeeping and science data. The science instruments are voltage and current sensors which measure accumulated spacecraft charge. Attitude is controlled magnetically with a postori attitude determination accomplished at the ground station using solar array current and a 3 axis magnetometer. The paper presents background information on the teaching and learning benefits of the small satellite program, offers information on previous programs at USAFA, then describes the FalconSAT 1 design and its initial operations, and summarizes the academic lessons learned by the project. Plans for future Academy projects are also discussed.

NAVAL POSTGRADUATE SCHOOL GRADUATE EDUCATION IN SPACE SYSTEMS  
THROUGH SPACE FLIGHT EXPERIENCE

Mr. Daniel J. SAKODA

*Naval Postgraduate School  
Space Systems Academic Group  
777 Dyer Road, Code (SP/Sd)  
Monterey, California 93943*

**ABSTRACT:** The Naval Postgraduate School (NPS) is a graduate university whose emphasis is on study and research programs relevant to the interests of the U.S. Navy and Department of Defense. Programs are designed to accommodate the unique requirements of the military including Space Systems Engineering and Space Systems Operations. The marriage of space research and a rigorous graduate education resulted in providing a hands-on experience for the students through the design, development, integration, test, and flight operations of a small satellite.

The Petite Amateur Navy Satellite (PANSAT) was launched aboard the STS-95 Discovery Shuttle in late October 1998. PANSAT is currently in a circular, low-Earth orbit at 550 km; and is the culmination of more than 50 officer students' graduate theses. The satellite continues to support the educational mission at NPS through space flight operations on a daily basis and as a point-of-reference in small satellite design. The research aspect continues with the development of software for the spacecraft and ground station work.

This paper describes the space research and education program at NPS focusing on hands-on, space-flight hardware development by officer students. A brief discussion of the space curricula at NPS is given including a description of the various resources available to officer students. Finally, the PANSAT small satellite is briefly presented as a case study of a successful university satellite project where a complete spacecraft was designed, developed, and integrated for space flight by officer students, and is operated by students and staff at NPS. One aspect of the PANSAT project that distinguishes it from other university projects is that the majority of its components and subsystems were developed at NPS, including the flight printed circuit boards, housings, structure, cabling, and software.

## 1. INTRODUCTION

The Naval Postgraduate School (NPS), located in Monterey, California, is the graduate university of the United States Navy. Various disciplines in areas of interest to the U.S. Navy are taught. In addition, research at NPS is conducted in many areas offering opportunities where officer students can focus on areas of specialization for their graduate degree. In Space Systems, research is ongoing in a number of fields, such as spacecraft design, sensors, attitude dynamics and control, and space environmental effects on semiconductors. A rigorous academic curriculum supported by a strong research environment provides the means for preparing officer students for their roles as space systems program managers or engineering duty officers.

## 2. NPS SPACE CURRICULA

The NPS Space Systems Academic Group (SSAG) was established in 1982 in recognition of the need for highly trained, knowledgeable personnel in Space Systems. NPS now offers graduate education and training in two space curricula, Space Systems Operations and Space Systems Engineering. Necessarily, the space curricula at NPS are highly interdisciplinary, reflecting the broad spectrum of issues related to space. In addition to the graduate-level course work, NPS strives to provide hands-on opportunities for officer students through hardware-oriented research topics.

The Space Systems Operations curriculum provides a broad technical introduction to the many issues related to a space system as well as topics important for Navy technical managers. Officer students study the technical aspects of space, such as orbital mechanics, launch vehicle systems, the space radiation environment, and spacecraft design while focusing on the operational aspects of space systems. In addition, the core courses include studies in information technology, operations analysis, and acquisition management. The eight-quarter program includes one quarter of refresher courses and a six-week experience tour where officer students visit off-site facilities in other Federal Government locations or places in academe or the private sector. Often, officer students visit multiple sites during their experience tour. Graduates in the Space Systems Operations curriculum receive a Master of Science in Systems Technology.

Officer students in the Space Systems Engineering curriculum fulfill graduate degree requirements in one of five science and engineering disciplines at NPS, Master of Science in Electrical Engineering, Physics, Astronautical Engineering, Computer Science, or Mechanical Engineering. Including one refresher quarter, nine quarters make up the program. The core courses include topics in astronautics, electrical and computer engineering, math, physics, management, and some specialized space courses such as remote sensing and military applications of space. In addition to the core courses, officer students elect seven specialization courses toward their respective Master of Science degree. The Space Systems Engineering curriculum also requires a six-week experience tour, similar to that of the Space Systems Operations curriculum. Table 1 shows the courses which constitute the Space Systems Operations curriculum and Space Systems Engineering curriculum.

A common theme in both space curricula is the study of a broad scope of disciplines, important to the space user, and a focus on a specialization through graduate thesis research. Each curriculum has a capstone design course which attempts to bring together the various disciplines into a one-quarter design project. Officer students work in a team toward a conceptual design of a spacecraft. The project topic is often one of interest to a Navy or other Department of Defense sponsor. The level of detail is that of a vendor's response to a request for proposal (RFP). The end product is an educational experience not only for the officer students involved, but typically adds to the knowledge of the sponsor as well.

Table 1. Space Systems Course Matrices.

Qtr	Space Systems Operations	Space Systems Engineering
1	(5-0) Math Refresher (5-0) Computer & SW Tech. (3-0) Physics (4-0) Strategy & Policy (0-1) Seminars	(4-0) Differential Equations (5-0) Electricity and Magnetism (4-1) Intro. to Linear Systems (4-2) Intro. to Obj.-Oriented Prog. (0-1) Seminars
2	(2-0) Acquisition Management (4-2) Intro. to Comms. Engr. (3-0) Networks (4-0) Phys. Space Env'ment. (3-0) Space Intro. (0-1) Seminars	(4-0) Intro. to Space Environment (4-0) Intro. to Orbital Mechanics (3-2) Intro. to Spcrrt. Structures (3-1) Signals and Noise (0-1) Seminars
3	(4-0) Probability/Statistics (4-1) Information Ops. (3-0) Sensor Tech/App (3-1) Orbital Mechanics (2-0) Launch Systems (0-1) Seminars	(3-2) Digital Logic Circuits (3-2) Air/Ocean Remote Sensing (4-0) Specialization Elective (3-2) Intro. to Spcrrt. Dynamics (0-1) Seminars
4	(3-0) Ops. Analysis (4-2) Comm Systems Analysis (3-2) Spacecraft Systems I (3-0) DS/Database (0-1) Seminars	(3-2) Spacecraft Propulsion (3-2) Control Systems (4-0) Specialization Elective (3-2) Mil. Applications of Space (0-1) Seminars
5	(3-0) SATCOM (4-0) Intro. to C4I (3-2) Spacecraft Systems II (4-2) Space Systems/Ops. I (0-1) Seminars	(3-2) Microprocessors for Space (3-2) Spacecr. AD&C (4-0) Specialization Elective (4-1) EM Waves Propagation (0-1) Seminars
6	Experience Tour (3-2) Mil. Applications of Space (4-0) Space Systems/Ops. II (0-1) Seminars	Experience Tour (0-8) Thesis Research (3-1) Space Pwr. & Rad. Effects (3-0) Thermal Ctrl. of Spacecraft (4-0) Strategy & Policy
7	(3-1) Systems Engineering (3-0) Info. Assurance (3-2) Space Architecture (0-8) Thesis Research (2-0) Tech. Writing (0-1) Seminars	(4-0) Spacecraft Design & Integ. (3-2) Spacecraft Comm. Engr. (4-0) Specialization Elective (4-0) Specialization Elective (0-1) Seminars
8	(3-0) C4ISR (2-0) CIO (0-8) Thesis Research (0-8) Thesis Research (0-1) Seminars	(4-0) Syst. Acq & Prog. Mgmt. (2-2) Spacecraft Des. & Integ. II (4-0) Specialization Elective (0-8) Thesis Research (0-1) Seminars
9		(4-0) Specialization Elective (4-0) Specialization Elective (0-8) Thesis Research (0-1) Seminars (4-0) N6 Capstone Course

### 3. ADVANCED TOOLS

A number of state-of-the-art tools are available for officer students to employ while either working on class projects or thesis research. These tools can be categorized as hardware facilities or software resources. One of the objectives in the deployment of these tools is to introduce them early in the applicable course so that the officer students can use them to their maximum benefit. For example, orbital analysis software is introduced early in the curricula while officer students are studying orbital mechanics. Familiarity with the orbital analysis software allows the officer students to engage in problem solving quickly in more advanced orbitology courses, or in their capstone spacecraft design course offered in the eighth quarter of the engineering curriculum, and fifth quarter of the operations curriculum.

The following is a list of some of the software tools available to officer students for analysis, design, and simulation. This is not an endorsement of any company product, although the products listed are widely used in industry and academe. In addition to the software listed in Table 2, common desktop computing software is also available for word processing, spread sheet calculations, and presentations as well as a number of software compilers for computer programming.

Table 2. Software Tools at NPS.

Software Title	Company	Description
Cadence	Cadence Design Systems, Inc.	Electronics Design, Analysis, and Simulation
I-DEAS	SDRC	Mechanical CAD/CAE; Thermal Analysis
Matlab and Toolboxes	MathWorks	Mathematical and Engineering Analysis
Matlab / Simulink	MathWorks	Controls / Simulation
MAPLE	Waterloo Maple, Inc.	Symbolic Mathematical Solver
Satellite Tool Kit	Analytical Graphics, Inc.	Orbital Analysis and Simulation

Hardware facilities at NPS for space research and education include almost all the necessary equipment for the full development cycle of a space system. Although electronics printed circuit boards (PCBs) are manufactured off-site, the design, populating with integrated circuit (IC) chips, and functional testing occurs at NPS. Flight PCBs are processed for launch, integrated with the housing, and conformal coated to protect electronic components from corrosion and foreign material. Electronics modules are tested at NPS using a closed-loop vibration shaker system to simulate the launch environment and a thermal-vacuum chamber to simulate the space environment. NPS is also home to five machine shops, one of which is dedicated to space research and education and includes a precision CNC milling center.

### 4. HANDS-ON EDUCATION

One characteristic that makes the NPS university space program unique is the capability to perform the majority of design, development, integration, and testing of a space system at NPS. The Petite Amateur Navy Satellite (PANSAT), which was built by NPS and is now in orbit has as its primary objective to enhance the education of officer students in the NPS space systems curricula. PANSAT succeeded in providing active participation from officer students in every aspect of the spacecraft's development. Many of the original design decisions were made to maximize officer student involvement, ultimately narrowing the scope of the project to remain within NPS

capabilities. This had the benevolent effect of maintaining simplicity in the design by removing complexities which may have added in mission capability but were above the minimum requirements. More than 50 officer students have contributed to the mission design, engineering, and operations of the spacecraft through their thesis research.

#### **4.1 Space-Flight Hardware Development**

Building a small satellite in an academic environment is a difficult proposition given that the development schedule may not synchronize with the talent available, and that this talent pool is a volunteer group. The labor challenges at NPS are further complicated by the fact that officer students have a set period of time at NPS until they graduate unlike at other universities, thus allowing only one or two quarters for direct contribution to the progress of the project. A small full-time engineering staff helps maintain the "corporate knowledge," and assists officer students to quickly merge into the project work flow through specialized skills in the use of the available design and test tools.

In addition to the technical areas of spacecraft design and mission operations, officer students were exposed to programmatic issues. Issues related to securing a launch, use of radio frequencies, and other external links are not typically dealt with in design projects performed on paper. All these problems were addressed in order for PANSAT to launch and operate from space. The Department of Defense Space Test Program (STP) provided the Shuttle launch and integration, which meant interfacing with NASA personnel for payload integration and payload safety. The Federal Communications Commission (FCC) was contacted and information filed for PANSAT as an amateur radio satellite. Naval Space Command was contacted to request on-orbit ephemeris data which is updated daily. Other organizations such as those sponsoring the space systems curricula were also involved and kept current with the project through design reviews and reports.

The PANSAT project began with a basic mission definition: to provide a low-cost, digital store-and-forward communication system on a small satellite in low-Earth orbit. Spread spectrum capability was added following a study by Paluszek [Palu 90] which, although it added more complexity to the communications payload and lengthened the development schedule, added immensely to the educational effectiveness of the project. This is especially true given the military advantages of spread spectrum communications. The Shuttle was chosen as the baseline launch carrier since as a manned vehicle, the factors-of-safety would be high enough to ensure a design amenable to other launch vehicles; and design requirements were well defined for payload volume, mass, and design loads. Figure 1 shows the payload envelope for PANSAT as a Hitchhiker payload.

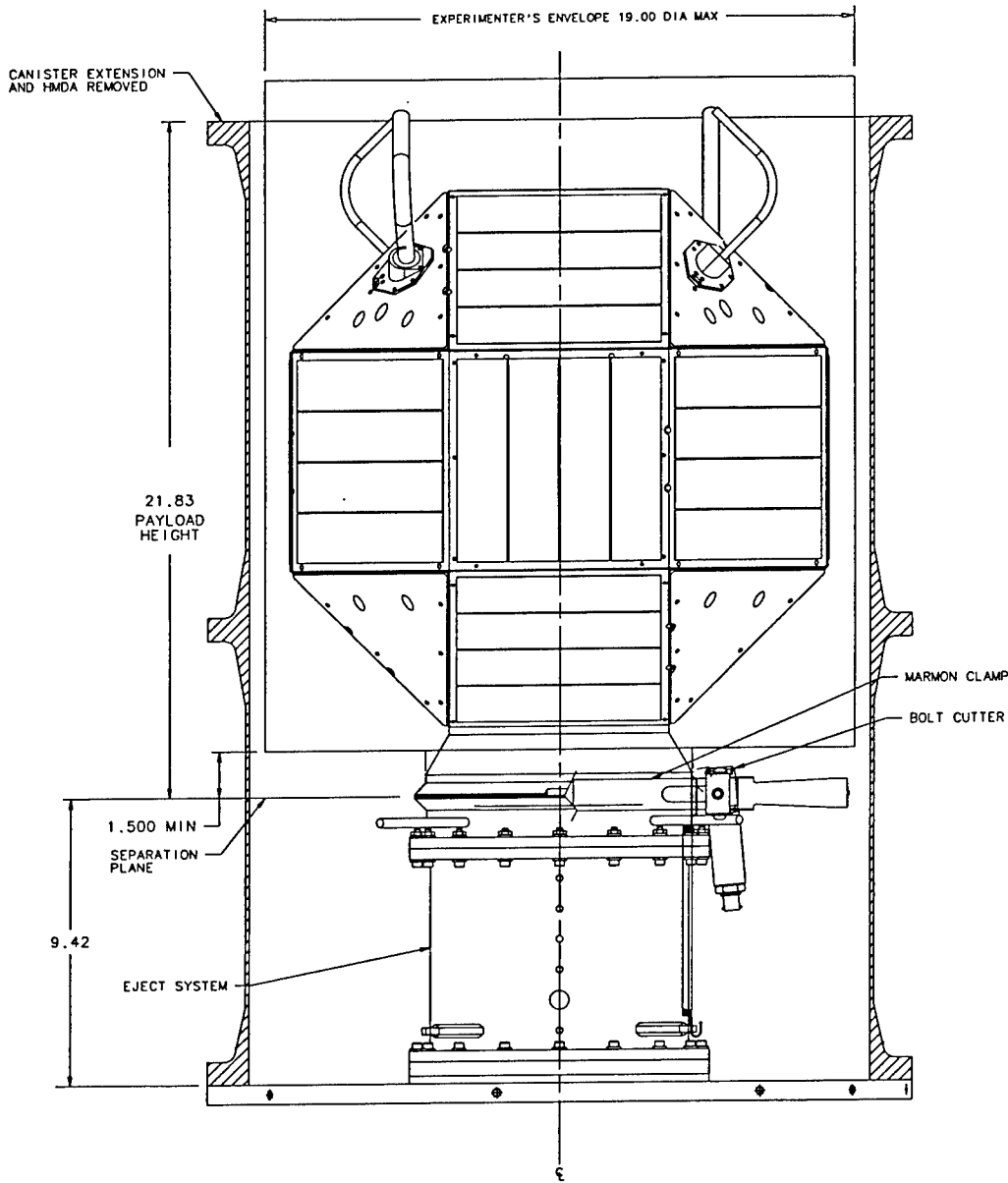


Figure 1. PANSAT in Hitchhiker Canister.

The configuration of PANSAT is that of an octagon from the front, side, and top views. Excluding the launch vehicle interface, PANSAT has 18 square faces and eight triangular faces. Two internal equipment plates are used for mounting the electronics housings and for cabling tie-down points. PANSAT was designed with no attitude control, and thus tumbles while in orbit. The spherical shape was chosen to allow a simple, body-mounted solar panel arrangement where solar illumination would not create wide excursions from minimum to maximum extremes as the spacecraft tumbles.



### 4.1.1 Subsystem Design

Following is a brief discussion of the spacecraft subsystems focusing on contributions by officer students on key elements of the project. A paper was presented at the 1999 AIAA/USU Conference on Small Satellites [Sako 99a] by the author with more technical information on spacecraft subsystems. Attracting officer students for various subsystem tasks as the project schedule progressed was a challenge. Organization was the key in communicating specific tasks suitable for a graduate thesis, and in outlining how prospective team members would proceed with their work. Officer student work generally was organized along the lines of the spacecraft architecture. The PANSAT space segment is composed of the electrical power subsystem (EPS), digital control subsystem (DCS), communications payload, and the mechanical structure. Figure 2 shows a block diagram of the spacecraft electronic subsystems.

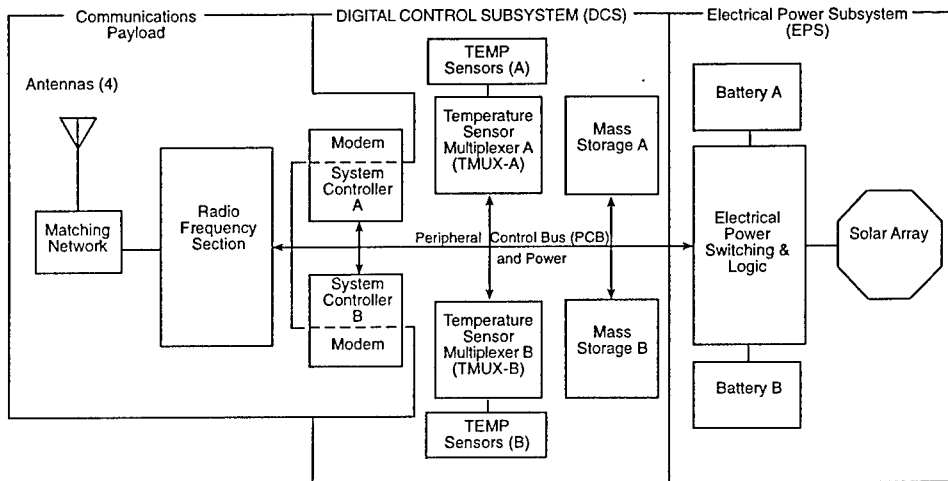


Figure 2. PANSAT Block Diagram.

The first iteration of the power budget and electrical power subsystem (EPS) design by Noble [Nobl 90] showed silicon solar cells were sufficient to provide a positive margin for spacecraft power. The power budget proved to be the major design constraint with the solar panels also being the most costly components. It should be noted that the solar panels and battery cells were the only components which were contracted for the spacecraft, other than piece parts, such as aluminum stock material and ICs. All other components were constructed at NPS, including the structure and electronics housings. The EPS design is a simple, yet robust, battery-dominated bus with a range of 9 V to 16 V.

A number of officer students contributed to the communications payload design over the development period of PANSAT. Through each iteration, design constraints narrowed the requirements as interfaces, or systems engineering issues manifested themselves. With each iteration, designs of the communications payload also became more compact. The flight modem is centered on an ASIC (application-specific integrated circuit) device which performs the acquisition, tracking, and demodulation of the received signal on a single chip. The use of advanced technology components offers a flexible and highly capable design option, however, in this instance it was accompanied by manufacturing hurdles in that the ASIC device is a surface-mount chip. Assembly of the modem board required acquisition of new tools for surface-mount technology and process improvements were required to ensure that these components could survive space flight.

The tumbling nature of the spacecraft posed an interesting problem regarding communicating with the spacecraft. With no pointing capability on the spacecraft, the antenna was required to provide a near-isotropic radiation pattern. The final antenna design configuration resulted from work by Ellrick [Ellr 91] and Karapinar [Kara 95] which defined a tangential turnstile antenna using four monopole elements driven at 90° phase from each other (0°, 90°, 180°, and 270°). The antennas when viewed from the top is that of a pinwheel. The antennas are canted 45° when viewed from the front or side. Analysis of the antenna showed worst-case nulls of -3 dBi. Field testing performed by Smilowitz [Smil 97] showed that the worst-case null was -8 dBi. However, the low gain value was at the very top and center of the spacecraft, opposite of the launch vehicle interface; and that gain increased significantly within 20° in each direction.

The digital control subsystem (DCS) consists of the processor board, memory storage modules for message and telemetry storage, and temperature multiplexer modules. Control of the spacecraft is performed by a single microprocessor. A military version of the Intel® 80C186 controls all on-board operations. The first PANSAT thesis published was on the conceptual design of the spacecraft processor by Hiser [Hise 89]. Other officer students provided valuable work on different areas of the DCS. Oeschel provided a working design for error-detection-and-correction (EDAC) RAM for system memory [Oech 95]. Each processor board has 512 kbytes of EDAC RAM divided into 64 kbyte segments. EDAC RAM can detect and correct single-bit errors in any segment of RAM. The processor board also includes analog-to-digital (A/D) converters, an on-board temperature sensor, drivers for the peripheral control bus, and a serial communications controller (SCC) device for communications with the modem. A detailed description of the processor board hardware and software is provided by Horning [Horn 97].

Mechanical areas of the spacecraft primarily include the spacecraft structure and electronics housings. The structure was designed to be robust with manufacturing to be done at NPS. The initial design of the PANSAT structure was done using finite element modeling with verification of the design through modal testing [Sako 92]. A number of students performed design and analysis on electronics housings working directly with the electrical engineering officer students to ensure proper mating of printed circuit boards (PCBs), connectors, and the system as a whole. As an example, Gericke [Geri 95] performed the design of the housings for the radio frequency (RF) electronics. This was particularly challenging in that the RF electronics were being designed in parallel, and the allowable volume was constrained to an oddly shaped envelope. Interference checks were done as well as provisions for allowable space for cabling and connectors. Figure 3 shows the PANSAT overall configuration. Some panels have been removed to show the spacecraft interior.

A number of these were dedicated to the thermal analysis of PANSAT, either on the spacecraft as a whole or on specific modules. As part of the NASA payload interface requirements, Smith [Smit 97] performed the thermal analysis of the spacecraft, both as it is mated in the Hitchhiker canister and as a free-flying satellite. The thermal model created was given to NASA to be merged with the other thermal models of the STS-95 mission. Other thermal analyses were performed on the spacecraft and its modules by Davinic [Davi 95], Patterson [Patt 94], and Victor [Vict 94].

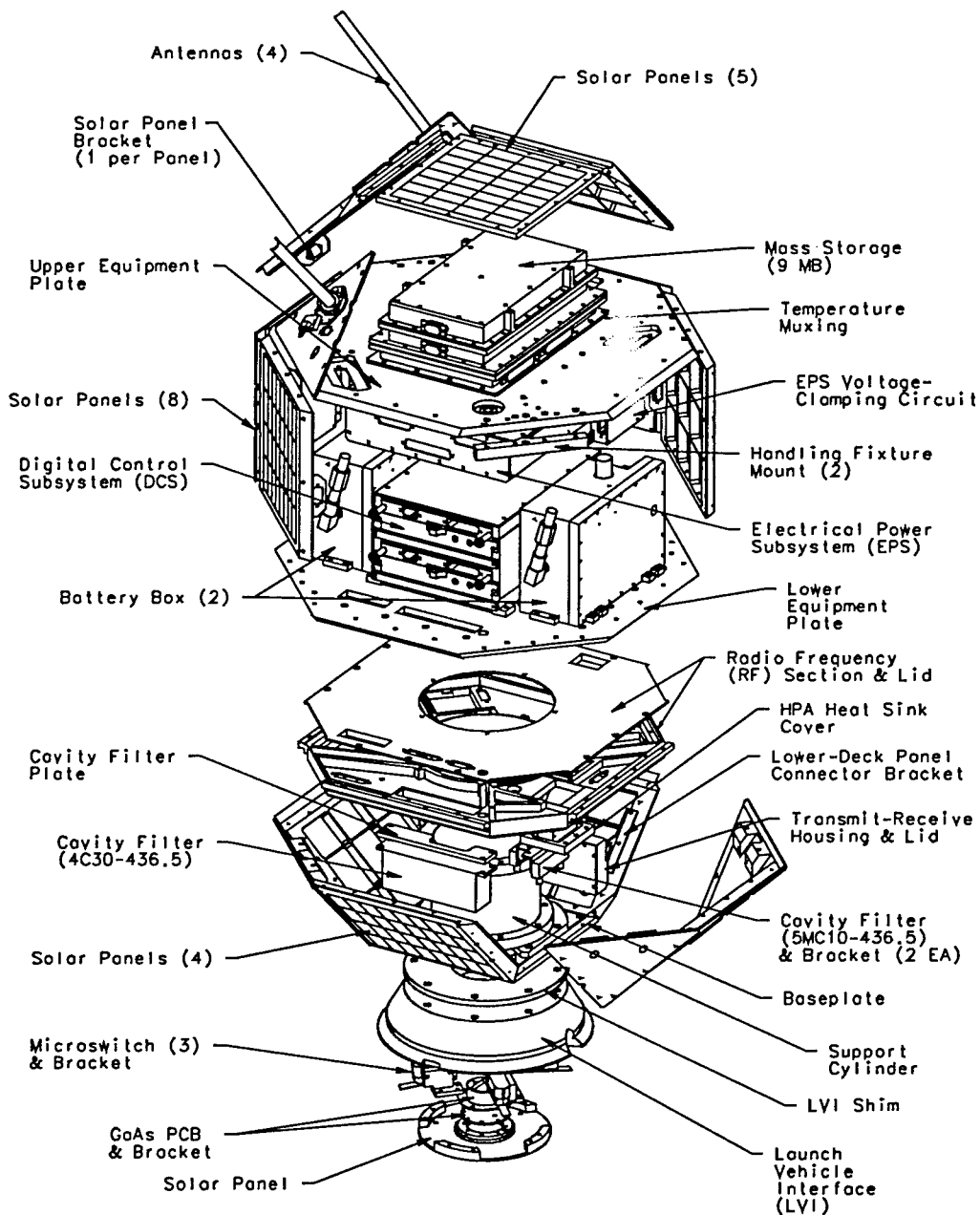


Figure 3. PANSAT Overall Configuration.

#### 4.2 Integration and Test

Integration and testing of the PANSAT spacecraft was performed both at NPS and at NASA Goddard Space Flight Center (GSFC). Testing at NPS was performed mainly for flight qualification on subsystem modules to ensure that the electronics would survive the Shuttle launch.

Overstreet [Over 97] provides a description of the test plan and test results for many of the PANSAT electronics modules. NPS testing included random vibration testing and thermal-vacuum cycling as well as functional testing. Testing at NASA/GSFC was done primarily for safety verification. This included system-level random vibration testing, mass measurements, and verification testing of safety inhibits.

A number of payload safety measures were taken in the design for PANSAT as a Hitchhiker experiment, largely at the cost of system reliability or functionality. These issues and how they were accommodated were presented at the 1999 Shuttle Small Payloads Symposium [Sako 99b]. Design features for payload safety were tested at NASA/GSFC to verify that the safety inhibits were in place, some of which required operational procedures. For example, the nickel-cadmium batteries were depleted in order to ensure that no energy capacity was stored in the spacecraft that could in any way cause a spark or other electrical discharge. Discharged batteries also ensured that if there were a short circuit within the battery that no explosive gases would be generated. Approved operational procedures were performed to discharge the batteries and measure sufficiently low voltage across the batteries for validation. Other testing included verification that three, series-connected microswitches created an open-circuit between the solar panels and the spacecraft electronics. The microswitches switched into the closed position after separation from the Shuttle carrier. It should be noted that these three microswitches constituted three, series-connected, single-points-of-failure.

A description of the functional testing performed for PANSAT at integration is provided by Horning [Horn 99]. Functional testing on the spacecraft was performed to ensure that no damage occurred to the spacecraft electronics; neither from transportation from NPS to NASA/GSFC, nor as a result of vibration or other verification testing. Testing at integration allowed for complete end-to-end testing of the electronics, including RF communications. The only apparatus required was a laptop, power supply, some cabling, and a briefcase-sized modem and RF electronics unit.

### 4.3 Space-Flight Experience

PANSAT was launched aboard the Shuttle, *Discovery*, on October 29, 1998, and deployed from the payload bay within 24 hours. Figure 4 shows the deployment of PANSAT as it leaves the payload bay of the Shuttle orbiter. PANSAT is seen at the base of the tail of the orbiter. Within a couple hours after deploy, PANSAT was within view of the NPS ground station site. Although PANSAT's batteries were not fully charged, the spacecraft was in full sunlight as it passed over Monterey, California, allowing sufficient power for communication. However, no communication with the satellite occurred. The first observation of PANSAT was achieved November 1, 1998 at approximately 11:00 AM (PST). PANSAT's transmission signature was identified on a spectrum analyzer following a request-to-connect command from the NPS ground station. On November 6, 1998, at 08:59 (PST), the NPS PANSAT ground station made a connect with the satellite. NPS sent a request-to-connect command, PANSAT received the command, replied with a verification/acknowledgment, and the NPS ground station was able to decipher the message as a reply from the spacecraft.

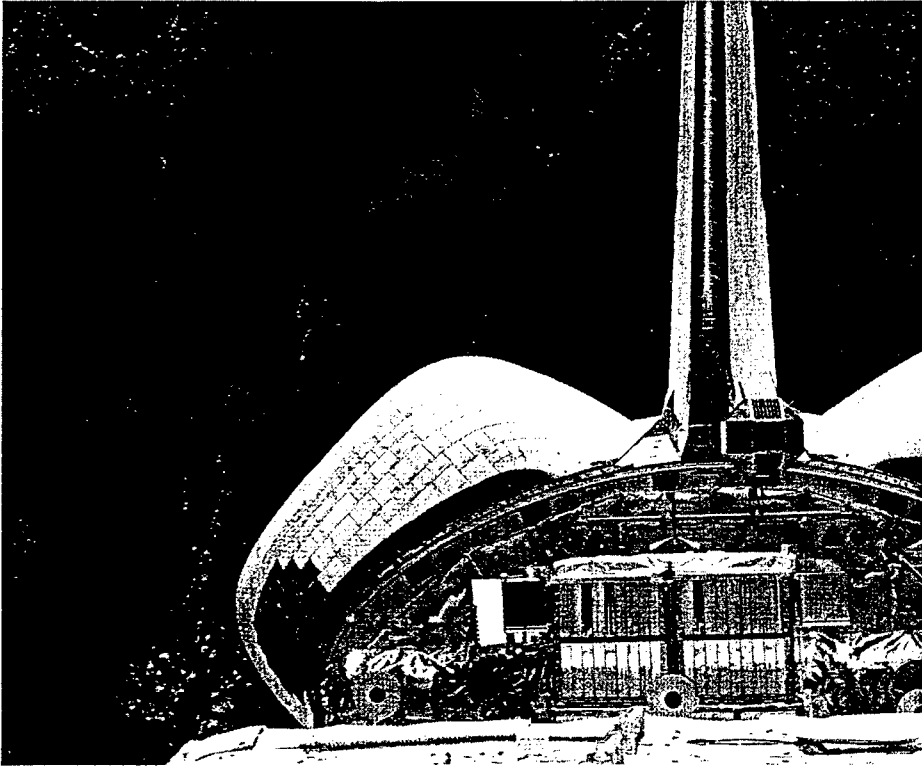


Figure 4. Deployment of PANSAT from the Shuttle, *Discovery*, [NASA Photo].

The PANSAT project is not unlike other space systems programs where the majority of the resources and attention is given to the space segment until hardware delivery. The ground segment usually receives attention last, but in copious amounts and generally more critical than productive. Many issues dealing with the ground station were yet to be resolved at the time of launch. It took roughly a week to identify faulty cables and components in the system, minimize losses to an acceptable range, and incorporate a reliable means of calibrating antenna pointing. However, the RF signature on the spectrum analyzer, seen on the PANSAT down-link two days after Shuttle deployment, showed that the spacecraft was functioning properly. The fact that PANSAT returned a signal meant that the microswitches and other safety inhibits worked properly. The EPS was providing power to the spacecraft, the boot kernel loaded and the processor board was functioning, and that the entire hardware path from the satellite's receiver, to the processor, and back through the transmitter was operating correctly. Knowledge that the space segment was working properly offered the luxury of focusing on the ground segment without worrying that the problem may be with the spacecraft.

Work on the ground segment continued with improving gains and reducing losses. Additionally, all spacecraft operations were automated allowing normal housekeeping functions to be performed without human intervention. This includes updating the ground station computer clock through a GPS receiver, downloading and updating PANSAT ephemeris data, automatically controlling antenna rotors, frequency synthesizers for Doppler shift, and RF switches for the simplex mode of communication, and running scripts for telemetry downloads or software image uploads. With a fully functional satellite ground station on campus, officer students gain immediate exposure and insights to the workings and interface requirements for satellite communications and control. Daily contacts with PANSAT provide satellite telemetry which is also automatically uploaded to a web

site which can then be used by students to perform analysis on the satellite's health and status; and not only at NPS, but by anyone with access to the Internet.

## 5. CONCLUSIONS

The PANSAT small satellite project demonstrates the value of hardware-in-the-loop in the educational process. Exposure to the many issues involved in the development of a space system, including engineering design, systems integration and test, on-orbit operations, and the fulfillment of programmatic requirements, served the educational mission well. It could be said that prior to the launch and deployment of the spacecraft, PANSAT was a success. The successful performance of the satellite on-orbit is merely a validation of the space systems educational program at NPS. Officer students continue to reap the benefits of PANSAT through on-orbit operations, where the focus has shifted from engineering a spacecraft to flying one in orbit.

## References

- [Palu 90] S. E. Paluszek, *Spread-Spectrum Communications for the Petite Amateur Navy Satellite (PANSAT)*, Master of Science in Electrical Engineering Thesis, Naval Postgraduate School, Monterey, California, June 1990.
- [Sako 99a] D. Sakoda, "Overview of the Naval Postgraduate School Petite Amateur Navy Satellite (PANSAT)," *Thirteenth Annual AIAA/Utah State University Conference on Small Satellites*, Paper SSC99-I-5, Logan, Utah, Aug. 1999.
- [Nobl 90] M. L. Noble, *Preliminary Design of the PANSAT Electrical Power System*, Master of Science in Electrical Engineering Thesis, Naval Postgraduate School, Monterey, California, June 1990.
- [Ellr 91] D. A. Ellrick, *An antenna design for PANSAT using NEC*, Master of Science in Electrical Engineering Thesis, Naval Postgraduate School, Monterey, California, June 1991.
- [Kara 95] E. Karapinar, *Modification and verification of an antenna design for Petite Amateur Navy Satellite (PANSAT) using NEC*, Master of Science in Electrical Engineering Thesis, Naval Postgraduate School, Monterey, California, June 1995.
- [Smil 97] G. J. Smilowitz, *Final Design, Integration and Validation of the PANSAT Antenna System*, Master of Science in Electrical Engineering Thesis, Naval Postgraduate School, Monterey, California, June 1997.
- [Hise 89] J. K. Hiser, *Design of a Reliable Computing System for the Petite Amateur Navy Satellite (PANSAT)*, Master of Science in Electrical Engineering Thesis, Naval Postgraduate School, Monterey, California, March 1989.
- [Oech 95] C. R. Oechsel, *Implementation of Error Detection and Correction (EDAC) in the Static Random Access Memory (SRAM) Aboard Petite Amateur Navy Satellite (PANSAT)*, Master of Science in Electrical Engineering Thesis, Naval Postgraduate School, Monterey, California, March 1995.
- [Horn 97] J. A. Horning, *System Controller Hardware and Embedded Software for the Petite Amateur Navy Satellite (PANSAT)*, Master of Science in Electrical Engineering Thesis, Naval Postgraduate School, Monterey, California, September 1997.
- [Sako 92] D. J. Sakoda, *Structural Design, Analysis, and Modal Testing of the Petite Amateur Navy Satellite (PANSAT)*, Master of Science in Astronautical Engineering Thesis, Naval Postgraduate School, Monterey, California, September 1992.

- [Geri 95] O. Gericke, *Design and Analysis of the Housing of the Communication Payload of the Petite Amateur Navy Satellite (PANSAT)*, Technical Report NPS-SP-95-001, Naval Postgraduate School, Monterey, California, September 1995
- [Smit 97] T. R. Smith, *Thermal Analysis of PANSAT*, Master of Science in Astronautical Engineering Thesis, Naval Postgraduate School, Monterey, California, December 1997.
- [Davi 95] N. M. Davinic, *Evaluation of the Thermal Control System of the Petite Amateur Navy Satellite (PANSAT)*, Master of Science in Astronautical Engineering Thesis, Naval Postgraduate School, Monterey, California, June 1995.
- [Patt 94] S. A. Patterson, *Thermal Analysis of PANSAT Batteries and Electrical Power Subsystem*, Master of Science in Astronautical Engineering Thesis, Naval Postgraduate School, Monterey, California, September 1994.
- [Vict 94] E. L. Victor, *Thermal Analysis of PANSAT Electric Power Subsystem*, Master of Science in Astronautical Engineering Thesis, Naval Postgraduate School, Monterey, California, June 1994.
- [Over 97] P. J. Overstreet, *Environment Testing of the Petite Amateur Navy Satellite (PANSAT)*, Master of Science in Astronautical Engineering Thesis, Naval Postgraduate School, Monterey, California, December 1997.
- [Sako 99b] D. Sakoda, "The Petite Amateur Navy Satellite (PANSAT) Hitchhiker Ejectable," *1999 Shuttle Small Payloads Symposium*, NASA/CP-1999-209476, NASA/GSFC, Greenbelt, MD. Sept. 1999.
- [Horn 99] J. A. Horning, "PANSAT Functional Testing Software and Support Hardware," *1999 Shuttle Small Payloads Symposium*, NASA/CP-1999-209476, NASA/GSFC, Greenbelt, MD. Sept. 1999.

---

## THE ARIES PROJECT

M.E. Ezequiel CHAVEZ ALCARAZ .  
M.E. Enrique NAVARRETE PAREDES

*Monterrey Institute of Technology and Higher Education CEM.  
Carretera a Lago de Guadalupe Km. 3.5. 52926 Atizapan de Zaragoza. Estado de Mexico,  
Mexico.  
Tel: (52 -5) 864 55 55 ext. 3208/5660. Fax. (52 -5) 864 5651.  
e-mail: echavez@campus.cem.itesm.mx.*

**ABSTRACT.-** Mission Statement: "The main goal of the Aries Project is to contribute to the professional and individual development of internationally competitive people, through the design, construction, launch and operation of a small class satellite. Aries must propose a new innovative and profitable perspective to promote aerospace research and development programs in Mexico and Latin America"

### INTRODUCTION

The development of space projects has not been an easy task for Institutions in Latin America. Whether they are governmental or private education or research institutes, space still remains as a non-priority area for our countries leading to disregard the importance of our future engineers' formation. A change in perspective must be undertaken by these entities in order to reactivate such progress. In the other hand links to the local and foreign industries must be set and strengthened and a new entrepreneurial point of view should be pursued.

This contribution proposes a new managerial local point of view that will be implemented as an educational project but that can be easily adapted to major programs in Mexico. This new approach will involve students, professors and industrials as well as government offices. The spacecraft by itself propose a local advance in technology development: a remote sensing payload for Earth observation and astronomy. Payloads were chosen based in the fact they represent priority but not exclusive development areas.

One of the objectives of this presentation is to extend an opened invitation to companies, educational centers or R&D institutes, desiring to validate technologies for space flight and to establish cooperation links with one of the most renowned private universities in the country.<sup>1</sup>

---

<sup>1</sup> For more information see: [www.cem.itesm.mx](http://www.cem.itesm.mx)



## **THE PROJECT**

ARIES project emerges from students and professors desire to impulse the application and development of high technology either in our Institute as in Mexico.

During the last 10 years two projects were created in the same direction, the UNAMSAT and the SATEX.1 project. Despite of their little success these projects managed to create a breakthrough in space sciences in our country. Although this was a very important step the momentum created was not sufficient to make space technology research and development take off in our country. Several factors may have an influence on this, the number of people involve still stays very small, there is no interest in funding this kind of research and a clear disregard of the benefits that could be gotten, still persists on behalf of the different authorities.

Further research on the above mentioned projects demonstrates that the main problem in their creation was organization. Aware of this and based on an evaluation of its existing resources, ITESM proposes to undertake a project of this size with the following objectives, issued mainly from the initial mission statement and from the Institute's mission.

Our first goal is to contribute to the formation of our students giving them the opportunity to put their hands on a project, and develop it through their class projects a real space engine. Likewise we would like to induce a greater participation in the industry environment and create conscience of the importance for them to develop professionals capable of working with highly complicated projects. Our main goal is to consolidate in Mexico a group of experts capable to develop a space system in all its parts.

ITESM is a pioneer in the implementation of "Redesigned Courses" by means of the use of Lotus Learning Space platform, which enable students to communicate asynchronously with other students and professors and provides a place for discussion on-line.

With the use of this tool (to which our almost 8000 students have access) we intend to allow all the members in the community to participate in the project sharing information, or just to get available information related to it.

## **THE PAYLOAD AND THE PLATFORM**

The main objective of the payload is to make photographic studies of the cartographic and meteorological earth conditions, and also making astronomical observations (the project was supported by the ITESM's Astronomical Student's Society).

For the ITESM-CEM the construction and launching a camera out of terrestrial atmosphere is a challenge for the academic community. It is a project that can help on the future professionals formation and reasearchers consolidation.

ARIES payload intends to be not only a contribution to the development of space and Earth sciences but also to be motivation for students through the idea of creating a profitable

business once the science mission has finished. This project is to be completely sponsored by external sources whether they are industrials or other kind of Institutions.

***General characteristics of the camera***

Visible Spectrum window.

CCD Sensor with a 1024 X 1024 pixels resolution.at a LEO sunsynchronous orbit (780 km)

Focal distance of 35 – 80 mm.

The camera will count with an auto-exposure and auto-focus neural-network-controlled intelligent system.

***Platform.***

The platform of the spacecraft shall count with the typical components that can assure the success of the mission. A three DOF attitude control system based on reaction wheels will be used. A CDMA code shall be employed for TT&C

**CALL FOR OPPORTUNITIES**

An opened invitation to participate in this project is made to all the community in order to propose experiments or space flight validate new or existing technologies of their own. Interested researchers or institutions shall communicate directly to the authors.

## UNISAT SOLAR ARRAY INTEGRATION AND TESTING

Alessandro AGNENI\*, Fabio SANTONI\*, Massimiliano FERRANTE\*, Andrea ROMOLI\*,  
Francesca FERRAZZA\*\*

\*Università degli Studi di Roma "La Sapienza", Dipartimento Aerospaziale  
Via Eudossiana 18 - 00184 Roma - Italia  
Email: f.santoni@caspur.it

\*\*Eurosolare S.p.A., Via A.D'Andrea 6, 00048 Nettuno (Roma) Italia  
Email: francesca.ferrazza@eurosolare.agip.it

**ABSTRACT** – The UNISAT microsatellite solar panels are manufactured following the standard technology developed by the photovoltaic industry for the terrestrial solar panels. Some improvements, necessary to make the solar panel withstand the effects of launch and space environment, have been introduced. This procedure has great benefits in terms of development time and cost, with respect to the space standard photovoltaics technology. However, since there is not space flight experience, many problems arise about reliability, performance degradation and lifetime of such systems. By a qualitative cost/benefit analysis, ground testing procedures have been selected for the UNISAT solar panels, in order to assess their suitability for use in space.

The test results predict a reliable lifetime of at least one year, which fits very well with the UNISAT mission requirements, and the developed integration procedure seems suitable for small low-cost missions, driven by tight time schedules and scarce available resources.

### 1 - INTRODUCTION

The Università di Roma microsatellite UNISAT is a 10 kg scientific/educational spacecraft, scheduled for launch in August 2000. Researchers and students are directly involved in the design and construction process, supported sometimes from industry, as in the case of the solar panels, in which Eurosolare provides the hardware and some of the test facilities. Designed and built in the academic environment of Scuola di Ingegneria Aerospaziale, UNISAT provides the scientific community with a small platform to conduct scientific experiments in orbit. The spacecraft bus is suitable for many small missions in low earth orbit. The satellite (fig.1) is spin stabilised, with active magnetic attitude control for spin axis and rate control. In this first mission it carries on-board few technological payloads: NiMH batteries, an EDAC (Error Detection And Correction) system for the on-board microprocessor integrated in the Università di Roma laboratories, a micro-scale magnetoresistive magnetometer, and terrestrial solar panels, which is the subject of the present paper. Students scientific payloads consist of a space debris impact sensor and a camera. In its first version, UNISAT is going to be launched in a 650 km height, 65° inclination circular orbit, by the Russian-Ukrainian launcher DNEPR, in August 2000.

Three factors have a major impact on the satellite design: limited funding, simple construction process for construction, constrained timeline. Limited funding granted to educational programs does not allow to use space qualified components and procedures for every subsystem. Whenever possible cheap terrestrial "off-the-shelf" components and technology have been modified and adapted to withstand the launch and the space environments, making the mission "medium-high risk". Simple process for construction is a requirement, since researchers and students should be

directly involved in the design and construction, using the facilities available at the University laboratories. The constrained timeline –the goal is two years time to launch- allows for terrestrial state of the art technology to be flown and “real time” tested in space.

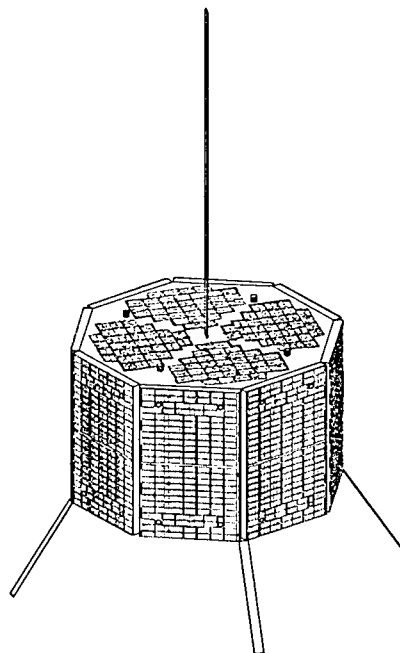
This philosophy has been also adopted for the satellite power system, including the photovoltaic one. The UNISAT solar panels are built using commercial silicon photovoltaic components and technology, tailored on very high reliability standards for terrestrial environment use, which include, for example, ten years reliable operation in extreme climate conditions, as Earth poles and tropical deserts.

The procedures developed by the terrestrial photovoltaic industry reduce costs and allows fast construction, and that fits exactly the UNISAT program objectives. Long times for delivery are in fact often typical of space qualified solar panels. This is due to the small number of companies involved in the space solar panels market, for which small projects are not a high priority, for obvious reasons. Moreover using space qualified solar panels increase, of course, cost.

However, employing not space standard procedures, many issues arise about the solar panels performance and space environment degrading effects evaluation.

Accurate assessment of all these effects would be much more expensive than the satellite itself, and it would not be in the framework on a small University microsatellite program. However this does not mean that ground tests are not required. It is necessary at least to assess the feasibility of flying terrestrial solar panels in space, which means to ensure a one year lifetime for UNISAT, even if the exhaustive prediction of in orbit performance might not be available before flight. It is, in fact, one of the main purposes of UNISAT to collect data about the terrestrial solar panels behaviour in orbit. The feasibility of this technological experiment is validated by experimental data assessing the most high risk of failure and unknown behaviours of these terrestrial photovoltaic systems in space, namely solar cells cover yellowing due to ultraviolet (UV) radiation and vibration environment during launch.

The solar panels, provided by Eurosolare, have been tested to evaluate the electrical parameters, in order to evaluate the performance in orbit, once the flight data will be available.



**Fig.1:** The UNISAT microsatellite.

Therefore the UNISAT solar panels are a technological in flight experiment, since exhaustive ground testing to accurately predict their behaviour in orbit is expensive and sometimes impossible.

## 2 – THE UNISAT SOLAR CELLS

The average power needed for UNISAT operations is less than 10 W. The external surface of the spacecraft is large enough that this amount of power can be provided by body mounted Silicon (Si) solar cells. Even if the common trend in spacecraft photovoltaic systems is to have very high efficiency solar cells, as Gallium Arsenide (GaAs) or multi-junction solar cells [1], [2], for UNISAT no one of these high performance components have been selected, for the reasons mentioned above.

The UNISAT solar cells are obtained from usual terrestrial size Si solar cells, cutting a standard monocrystalline Si cell [3] into smaller cells, dimensioned for optimal coverage of the external spacecraft surface. The only modification needed consist of an inexpensive custom design and deposition of the solar cell bus-bar. The cutting procedure leaves the designer free to choose the most appropriate cell size for the particular application, without limiting the size to the usual space standards (e.g. 2x4cm or 6x4cm). The UNISAT solar cell bus-bar layout is designed to have two soldering points on each connection side, which improves reliability in case of interconnection soldering failure. A standard terrestrial solar cell is shown in fig.2. From it 20 UNISAT 2x2.35cm solar cells are cut out (fig.3).

The solar cell efficiency has been measured using a sun simulator calibrated at AM1.5. The distribution of the solar cells efficiency, measured at 25 °C is shown in fig.4. The average efficiency is found to be 13.76%.

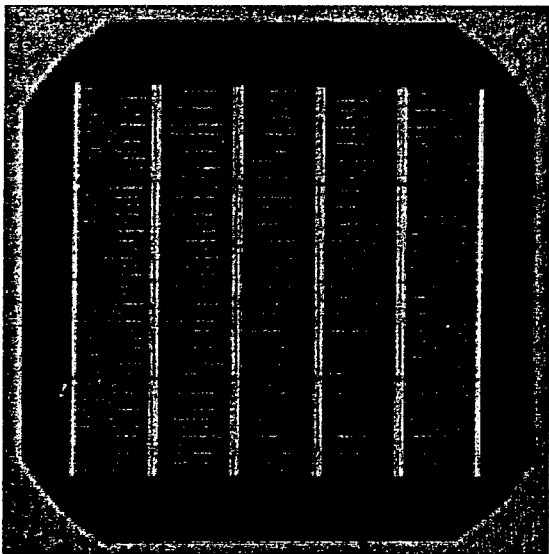


Fig.2: Standard terrestrial solar cell, from which the UNISAT solar cells are cut out.



Fig.3: UNISAT 2x2.3cm solar cell.

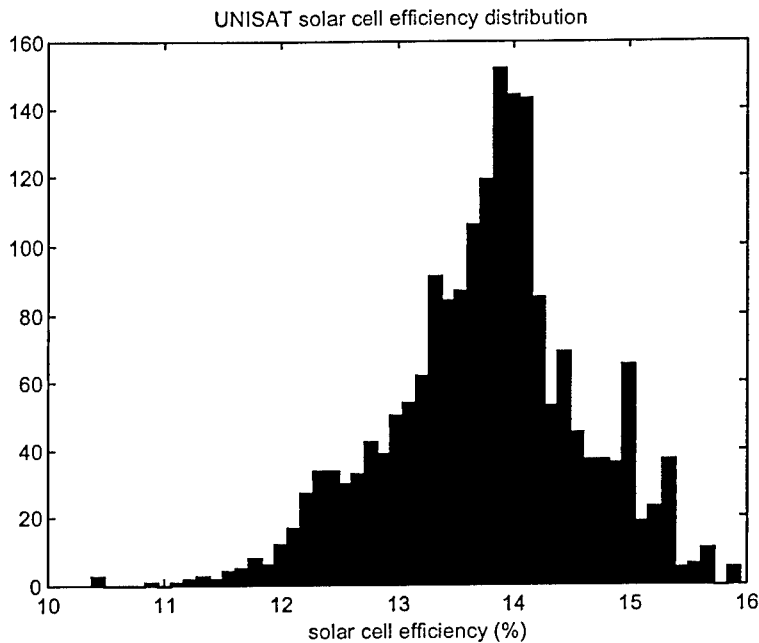


Fig. 4: UNISAT solar cells efficiency distribution.

### 3 – SOLAR PANELS INTEGRATION

#### 3.1 - Geometry

Three different solar panels layouts have been developed, according to the shape of the external surfaces available for the solar panels. On each side of the external octagon two solar panels are installed, made of 35 solar cells in series, as shown in fig.5. Four solar panels are positioned on the upper basis, with the geometry shown in fig.6, while only two solar panels are installed on the lower basis, to leave room to the launcher interface hardware (fig.7).

The electric connection path among the solar cells has been designed so that the current loops generated by two panels on the same spacecraft surface result opposite. Thus the total magnetic moment – in the order of  $1.8 \cdot 10^{-3} \text{ Am}^2$ , depending on the light intensity and the level of the solar panel degradation – is minimised [4].

#### 3.2 - Construction and materials

The current technology employed by Eurosolare for solar panels integration is a lamination process (fig.8, 9), in which solar cells are encapsulated between two layers of Tedlar® [5], a sun light transparent polymer, very stable in many environment conditions and already flown in space, and ethylene-vinyl-acetate (EVA) a light transparent polymer obtained by the polymerisation of polyethylene and vinyl-acetate [6]. Tedlar® gives mechanical stiffness to the solar panel and protects it from adverse environmental effects. EVA is used to seal the solar cell between the two layers of Tedlar®. The components are disposed in a lamination machine. A curing cycle, carried out at the proper temperatures and pressures, is employed for the polymerisation of EVA, after which the solar panel is sealed. The whole process lasts less than two hours.

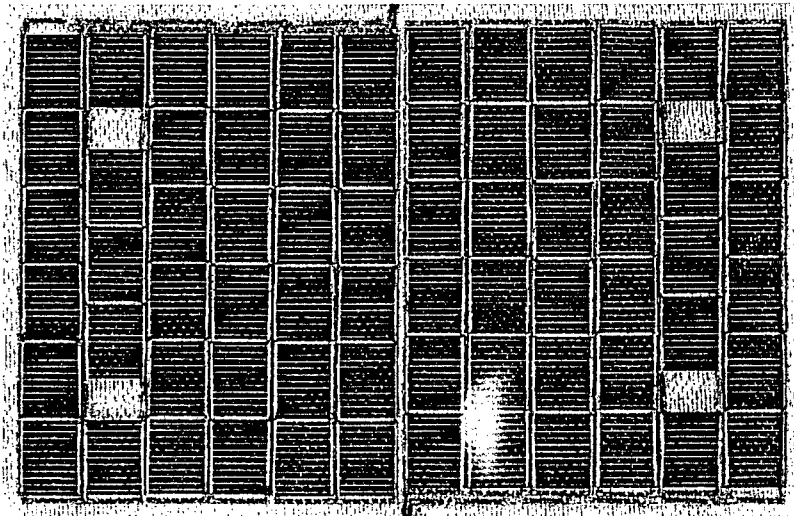


Fig.5: Lateral panel solar arrays.

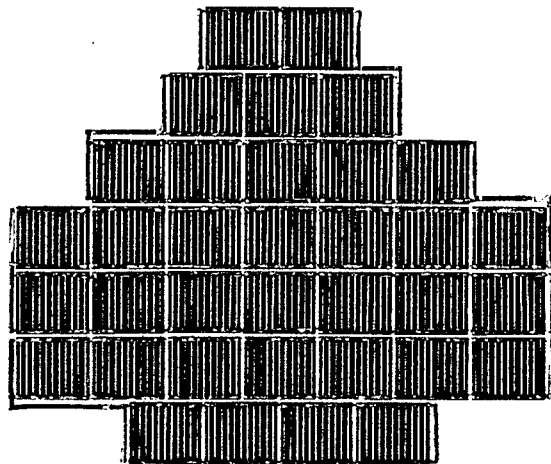


Fig.6: Upper basis solar array.

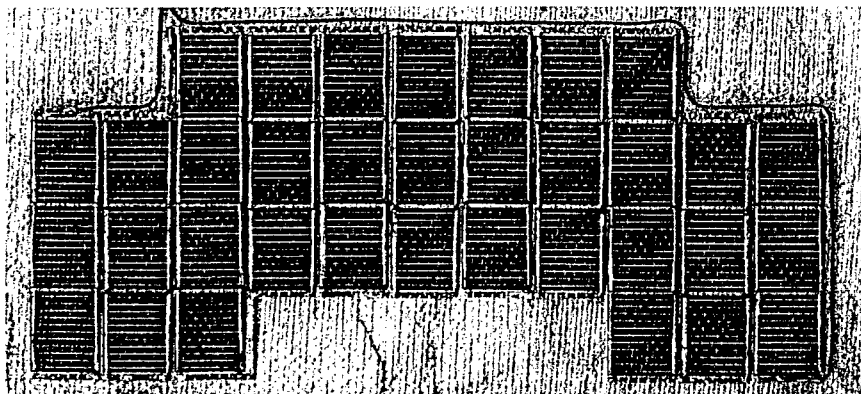


Fig.7: Lower basis solar array.

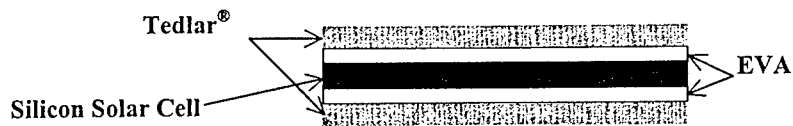


Fig. 8: Solar panel and encapsulants.

On the external surface of Tedlar® small pyramidal shapes (texturization) can be obtained during the lamination process, improving the solar array performances.

For the UNISAT solar panels, this same process has been used also to fix the solar arrays to the aluminium sandwich substrate, by using EVA as an adhesive. In this way the final product of the lamination is directly the flight panel of the satellite.

Solar cells interconnections have been soldered using usual commercial electronics soldering equipment and materials, and a soldering procedure has been developed, improving reliability with respect to the standard procedure of terrestrial solar panels. In fact the operating mechanical stress environment of space solar cells soldering during launch requires careful evaluation of the soldering reliability (par.5.2), which is usually superfluous when dealing with solar panels for terrestrial use.

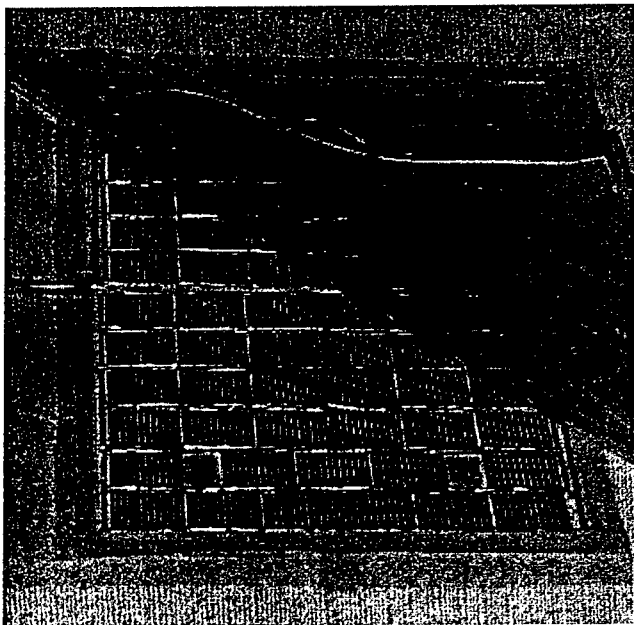


Fig.9: Solar panel, Tedlar and EVA before lamination.

#### 4 – ELECTRICAL CHARACTERISTICS

The i-v curve of one of the UNISAT solar cells is shown in fig.10.

For UNISAT, particular attention has been paid to the accurate evaluation of the solar panel behaviour with respect to the sun angle, since they are used in an on-board experiment as a sensing system of the sun direction [7]. Figure 11 shows the solar panel short circuit current<sup>1</sup>. The experimental data (asterisks) are compared with the theoretical "cosine law", represented by the solid line. The experimental data as a function of the angle of light incidence is different from the

<sup>1</sup> The graph in fig. 11 differs from the one in [5], because of the different solar cells cover material used.



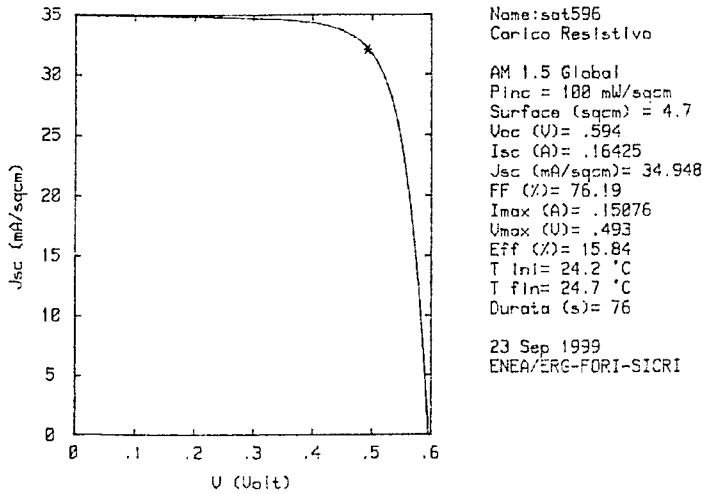


Fig.10: UNISAT solar cell i-v curve, as obtained by a AM1.5 solar simulator.

ones obtained for the usual space rated encapsulation technique, found in [8]. The deviation of the experimental data, in function of the angle of light incidence, from the theoretical behaviour and from the usual space encapsulated Si solar cells seems due to the presence of the covering layers mentioned before. They present lower transmissivity with respect to the space Si solar cells coverslide, as it is evident from the drop of  $I_{sc}$  even at 30° (or less). Obviously the transmissivity of the covering layers, as for other materials [9], decreases with increasing light angles, mainly because of the longer path of the light in the absorbing media.

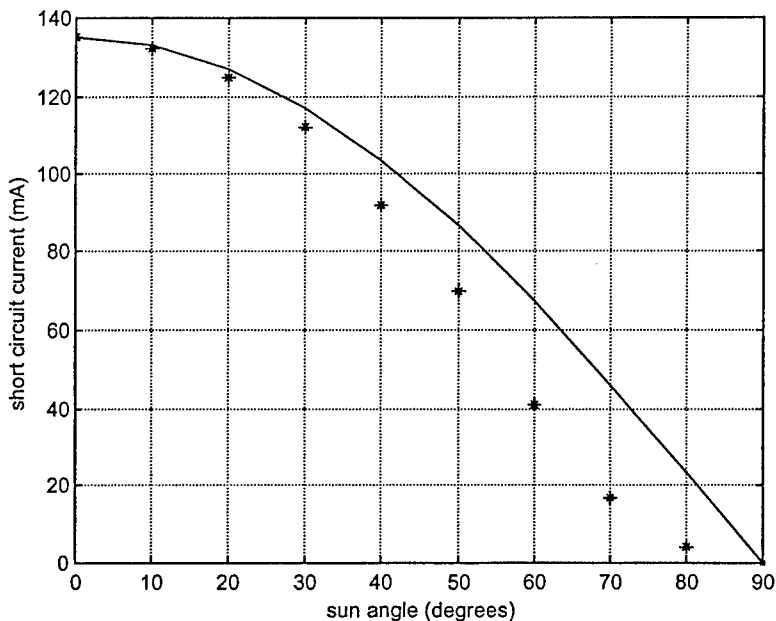


Fig.11: UNISAT solar array short circuit current as a function of the sun angle.

## 5 – SPACE ENVIRONMENT EFFECTS ASSESSMENT AND GROUND TESTING

Environment effects on solar array include degradation by space radiation, solar cells cover material light transmittance decrement due to UV solar radiation, interconnections soldering failure due to launch vibration, solar panels encapsulation mechanical failure due to launch vibration, thermal cycling and atomic oxygen erosion. To evaluate these effects a compromise must be reached between failure risks and testing cost and time, taking in particular into account the short time from the beginning of the program to the launch date.

By a qualitative cost/benefit analysis, performed for the selection of the environmental tests necessary to fly the system in space with some confidence, it was concluded that UV, vibration and thermal vacuum (TV) tests were to be performed, while the space radiation and atomic oxygen effects, happening on long timescales (years), could be evaluated by literature data and numerical simulation, which is accurate enough for our purposes. No tests are then scheduled to evaluate these effects, also due to the high costs involved.

### 5.1 - UV solar cells cover material transmittance decrement

The solar array encapsulation materials, namely Tedlar® and EVA, have proven to be stable to the sun UV radiation reaching the Earth surface [10], [11]. While Tedlar® is very stable to UV radiation, EVA decomposes in polyethylene and acetic acid. This acid is responsible for the encapsulation browning and, to a minor extent, of the metal interconnects corrosion. The EVA browning process have been sometimes observed in terrestrial application solar panels. However considerable progress has been recently achieved in EVA chemistry and in the manufacturing process, leading to very UV-stable EVAs, as reported in [11]. Moreover, protection layers are used to limit the total UV dose reaching EVA, made of UV absorbing materials, as *Cyasorb 501*.

The UV spectral intensity on the sun light in space, in the UV-A and UV-B wavelength region (280-400 nm), can be more than 100 times higher than on the Earth surface, since it is not filtered by the Earth atmosphere. Exposure of the encapsulation materials to such a high intensity radiation, makes the total dose accumulate very fast and the detrimental effects, as yellowing of EVA, to appear earlier than on the Earth surface.

High intensity UV is not completely filtered out by the protection layers and the long term degradation of EVA is a potential problem. It has been observed [10] that this phenomenon is more important in glass covered solar panels, while Tedlar® has a low, but finite, permeability allowing the acetic-acid to out-gas. This is confirmed by the evidence that in a module with EVA browning the edges remain clear. Tedlar® is also more transparent in the infrared band than glass. This makes the solar panels run cooler, thus at higher efficiency.

Data available for terrestrial use of EVA makes us confident that it is suitable to survive also the total UV dose of space, at least for the UNISAT one-year lifetime. However it is not known whether a dose rate effect exists. In particular the production of acetic acid might be so fast that it does not completely out-gas through Tedlar®.

UV testing for EVA yellowing has been performed exposing samples of encapsulated panels to a UV lamp emitting in the UV-B region (257 nm). A one year equivalent exposure to the sun UV light has been obtained with a light intensity roughly ten times higher than the sun in the UV-B region, thus accelerating the in orbit dose deposition by a factor of ten. Figure 12 shows the average spectral transmittance of 10 samples of encapsulated solar panels on which the UV exposure test was performed. The dashed line is the spectral transmittance at begin of life (BOL). The solid line is the spectral transmittance after one year equivalent exposure to the sun. Two performance degradation effects are evident. First, the transmittance decreases in the visible blue and near UV region (350-500 nm), where the BOL transmittance, almost 90%, goes down to an average 75% in the same band, after UV exposure. Second, transmittance increases in the UV region, which means a loss of UV protection of the solar cells. The total power loss due to these effects is evaluated

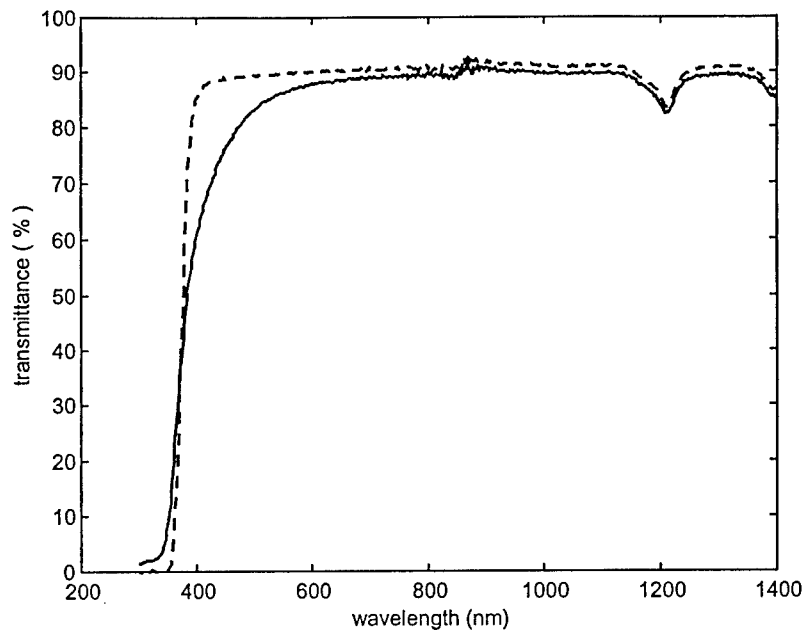


Fig.12: Encapsulated solar panel cover materials transmittance after one year equivalent exposure to the sun UV radiation.

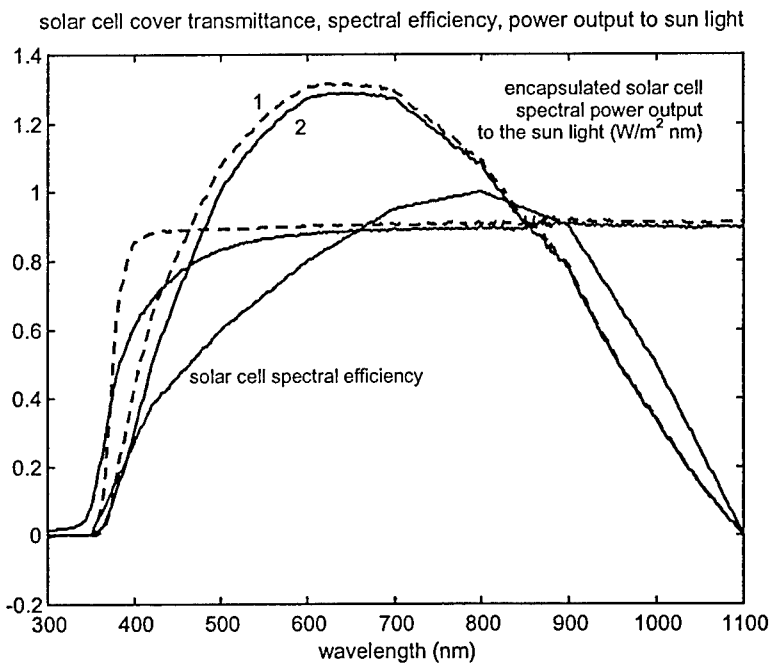


Fig.13: Solar cell cover transmittance, spectral efficiency, power output to sun light.

combining the spectral distribution of the sun light, the solar cell cover material transmittance and the solar cell spectral efficiency. After UV exposure, most of the transmittance is lost in the visible, where the sun light spectral distribution is maximum. However the solar cell spectral efficiency is maximum in the infrared (IR) (roughly 800 nm), where the transmittance remains close to the BOL values. The spectral combination of these effects is shown in fig.13. The total power output of the solar cell to the sun light is the integral of the curves 1, 2. It is less than 4%, assuming that the solar cell spectral efficiency does not vary in time under UV or other environmental effects.

### 5.2 – Mechanical test of solar cells interconnections soldering

The solar cells are electrically connected using terrestrial standard solar cells interconnections. These are soldered to the solar cells using the soldering Sn-Pb technique employed for commercial electronics components. The procedure developed improves reliability with respect to the standard procedure followed for terrestrial solar panels, as results from the mechanical tests performed. A mechanical traction test of the soldering reliability was performed, showing that the soldering is so reliable, that the solar cell breaks before the interconnect soldering fails, which does not happen with terrestrial soldering standards. The traction test is performed by a suitable mechanism, that permits to apply a tension to the interconnector by changeable weights, while the opposite side of the solar cell is fixed. When the weight reaches 0.3 kg, the solar cell breaks, as shown in fig.14. In any case the interconnections are made in such a way that relative movement between adjacent solar cells is allowed.

Atomic oxygen erosion of the interconnects is not a concern, since these are completely encapsulated in Tedlar and EVA, and do not come in direct contact with the external environment.

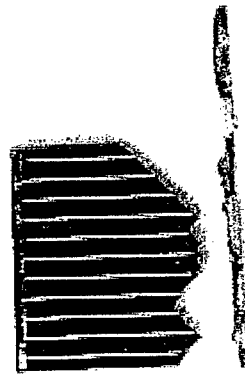


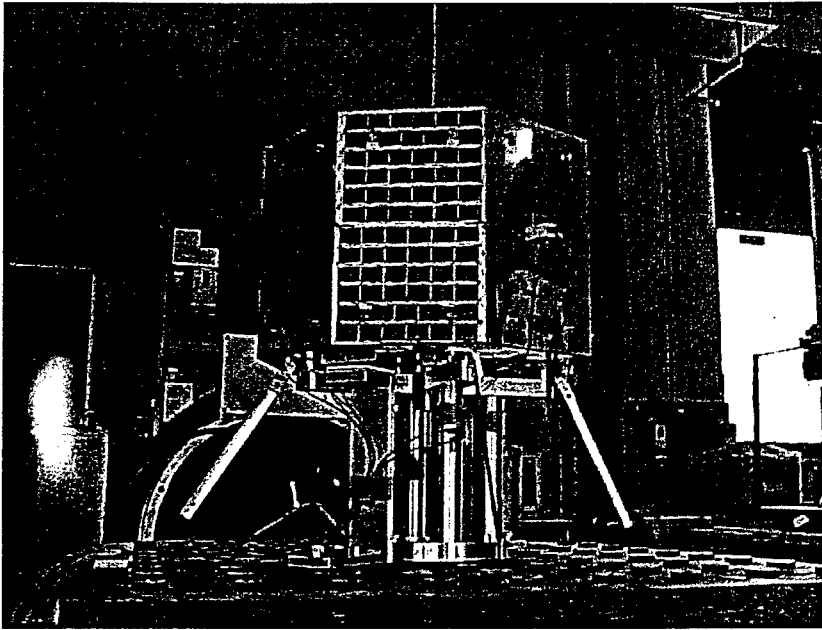
Fig.14: Traction mechanical test effect on the solar cell.

### 5.3 – Vibration test

The solar panel vibration test has been performed in the framework of the test required by the launcher for qualification. The details of the vibration test are described in [12]. As far as the solar panels are concerned, the test was intended mainly to assess the survival of the encapsulation and of the interconnections soldering, with a solar panel mounted on the satellite structure, as shown in fig.15. Vibration tests include a sinusoidal sweep in the 5-20 Hz range at 0.6g level and random test at 6.28g rms for all of the three satellite axes. Shock tests has also been performed, following the launcher requirements. No damage was detected on the solar panel. In particular the EVA used as an adhesive to encapsulate both the aluminium sandwich and the solar cell survived. Moreover the interconnections passed the test, since neither electrical or mechanical failures were detected on the solar panel.

### 5.4 – Thermal-vacuum and thermal cycling test

Thermal-vacuum testing of the whole satellite was performed, according to the MIL-STD-1540, as reported in [13] including four temperature cycles between  $-20^{\circ}\text{C}$  and  $61^{\circ}\text{C}$ . Since the temperature extremes expected for the solar panels may exceed this temperature range, a different TV test was performed for the solar panels alone, reaching the extreme temperatures of  $-50^{\circ}\text{C}$  and  $110^{\circ}\text{C}$ . These values are beyond the expected extremes and they have been set in order to test the system.



**Fig.15:** UNISAT vibration test: the solar panel tested is in the flight configuration.

Moreover, since the solar panels experience a strong thermal cycling environment in orbit, 80 cycles between the cited extreme temperatures were run, slightly exceeding the number of 78.5 cycles recommended by [14]. No failures have been detected after this test.

#### **5.5 – Space radiation and atomic oxygen effects**

Space radiation effects on Si solar cells and atomic oxygen erosion of Tedlar® are evaluated by literature data and numerical simulation. Testing in this field is prohibitively expensive and generalisation of results not always possible.

Equivalent 1 MeV electron fluence has been evaluated using the SPENVIS EQFRUX software, available in the web site [15], of the European Space Agency. For the UNISAT orbit, at the maximum of the solar activity, the efficiency lost by the solar arrays after one year is estimated about 4.1%.

The atomic oxygen effect can be evaluated using a SPENVIS code as well, available on the same internet site [15]. A fast assessment of the atomic oxygen effect can also be obtained by the data published in [16], where it is found that the Tedlar® reactivity with atomic oxygen causes an average loss of approximately 15 microns/year in the material thickness, for highest solar activity at 600 km, which is the worst UNISAT orbital condition.

The thickness of Tedlar® used for the UNISAT solar panel cover is 50 microns, then the lifetime of one year is guaranteed.

#### **6 – CONCLUSIONS**

The results of ground testing show that terrestrial solar panels can be flown with some confidence in space and that they are suitable for small missions, with lifetimes on the order of one or two years. Some improvements are necessary to make these systems withstand the launch vibration

environment. In particular the solar cells interconnectors soldering procedure requires much more care than the terrestrial standard does. The space environment has the well known detrimental effects typical of the space rated photovoltaic systems, such as the solar cells efficiency decrease due to space radiation. In addition to these, the sun light UV radiation is responsible for the yellowing of the solar cells encapsulation materials used in the terrestrial solar panels manufacturing, which causes a system efficiency decrease estimated in 4% per year with respect to the BOL performances, according to laboratory experimental data. This performance decrease is compatible with the UNISAT on board power requirements, and it is often admissible in small, low cost missions.

The terrestrial solar panel manufacturing procedure has been found cost effective for the UNISAT microsatellite, and we expect the flight behaviour to confirm the ground testing results.

## 7 - ACKNOWLEDGEMENTS

The authors wish to acknowledge the contribution of ENEA, Centro Ricerche Casaccia , ENEA Centro Ricerche Frascati , Oerlikon-Contraves Italia, for giving access to their facilities to the Università di Roma "La Sapienza" researchers and students involved in the UNISAT program.

## REFERENCES

- [1] H. Curtis, *Photovoltaics for space applications*, in 26<sup>th</sup> IEEE photovoltaic specialists conference, September 1997.
- [2] P. A. Iles, *Future of Photovoltaics for Spaced Applications*, Progress in Photovoltaics: Research and Application, 8, 39 -51, (2000).
- [3] <http://www.eurosolare.it/CM102.htm>
- [4] F. Santoni, *Dimensionamento degli attuatori magnetici del microsatellite UNISAT*, Quaderni di Astrodinamica n.4, Rome, 2000, in publication.
- [5] <http://www.dupont.com/corp/markets/aerospace/products/tedlar.html>
- [6] [www.plasticsusa.com/eva.html](http://www.plasticsusa.com/eva.html)
- [7] F. Santoni, F. Bolotti, *Attitude determination of small spinning spacecraft using three axis magnetometer and solar panel data*, 2000 IEEE Aerospace Conference, Big Sky, Montana, USA, March 18-15, 2000.
- [8] M. Di Ruscio, A. Agneni, J. H. Day Jr, *San Marco D/L Solar Array System Design and Performance*, NASA TM 86125, 1984.
- [9] C. Arduini, G. Ravelli, *A Non Conventional Solar Array for the San Marco C Satellite*, International Colloquium on Solar Cells, Toulouse, France, 1970.
- [10] S. B. Levy, *Oriented Fluoropolymer Films for Photovoltaic Applications*, 11<sup>th</sup> E.C.Photovoltaic Solar Energy Conference, 12-16 October 1992, Montreux, Switzerland.
- [11] W. H. Holloy, Jr., S. C. Agro, J.P.Galles, R. S. Yorgensen, *UV stability and module testing of non-browning experimental PV encapsulant*, in Conference record of the twenty fifth IEEE photovoltaic specialists conference, 13-17 May 1996, Washington D.C., USA.
- [12] F. Graziani, M. Ferrante, G. B. Palmerini, F. Santoni, P. Tortora, M. Muscinelli, F. Pirillo, *Mechanical Tests for Low Cost Microsatellite Programs*, to be presented at the 51<sup>st</sup> IAF Congress, Rio de Janeiro, Brazil, October 2000.
- [13] J. W. Welch, *Thermal Testing of Small, Class C Space Vehicles: A Case Study*, AIAA 26<sup>th</sup> Thermophysics Conference, Honolulu, Hawaii, June 24-26, 1991.
- [14] MIL-STD-1540C, *Test requirements for launch, upper stage and space vehicles*, 15 Sept.1994.
- [15] <http://www.spennis.ome.be/spennis>
- [16] L. J. Leger, J. T. Visentine, *A Consideration of Atomic Oxygen Interactions with the Space Station*, J. Spacecraft, Vol.23, No.5, Sept-Oct. 1986.

## IONOSPHERIC OBSERVATION NANOSATELLITE FORMATION (ION-F)

Mark CAMPBELL<sup>1</sup>  
Rees FULLMER<sup>2</sup>  
Charles SWENSON<sup>2</sup>  
Chris HALL<sup>3</sup>

<sup>1</sup>*University of Washington, Seattle WA, USA*

<sup>2</sup>*Utah State University, Logan UT, USA*

<sup>3</sup>*Virginia Polytechnic Institute, Blacksburg, VA, USA*

ABSTRACT - Utah State University, the University of Washington, and Virginia Polytechnic Institute are currently designing a system of three 15 kg spacecraft to investigate satellite formation control technologies and distributed ionospheric measurements. The three universities will coordinate on satellite design, formation flying management, mission development, and ionospheric measurements. This paper describes the current status of this program and discusses the advantages and ramifications of developing a student built spacecraft

### 1. INTRODUCTION

#### 1.1 Program Description

The Ionospheric Observation Nanosatellite Formation (ION-F) comprises three 15 kg. spacecraft designed and built in cooperation by Utah State University, University of Washington, and Virginia Polytechnic Institute. The ION-F satellites are being designed and built by students at the three universities, with close coordination to insure compatibility for launch, deployment, and the formation flying mission. The ION-F mission is part of the U.S. Air Force Research Laboratory (AFRL) University Nanosatellite Program, which provides technology development and demonstrations for the TechSat21 Program. The University Nanosatellite Program involves 10 universities building nanosatellites for a launch in 2002 on two separate space shuttle missions. Additional support for the formation flying demonstration has been provided by NASA's Goddard Space Flight Center.

#### 1.2 Objectives and Research Issues

The objectives of this formation are scientific research, formation flying research, technology demonstration and education. The specific objectives are outlined below.

##### 1.2.1 Scientific Research

The primary scientific objective for this mission is to investigate global ionospheric effects which impact the performance of space-based radar's and other distributed satellite measurements. This requires the three spacecraft to make simultaneous, spatially distributed ionospheric plasma electron density measurements. In addition, measurements from the GPS system will be used to make the first global multi-baseline RF-scintillation measurements of the ionosphere. The scintillation of GPS signals using receivers on each spacecraft will provide information about the scale sizes of disturbances between the nanosatellite constellation and the GPS transmitter.

### **1.2.2 Formation flying**

The ION-F formation will be used as a space-based distributed control testbed for active formation control using inter-satellite communications. Autonomous formation maneuvering and control will be performed. Maneuvers to be tested include controlling the in-track separation distance between spacecraft in the same orbit in a leader follower approach, maneuvering into common ground track orbits, and side by side operation. Positional feedback between spacecraft will be performed using a combined GPS and cross-link communications system developed by the Applied Physics Laboratory at Johns Hopkins University. Notice that the two scientific measurement experiments are enhanced by formation flying and place only limited constraints on the performance of any maneuvers.

### **1.2.3 Baseline potential new technologies**

Several new components and hardware concepts will be tested on the ION-F spacecraft. These include:

- The Applied Physics Laboratory GPS/inter-satellite "cross-link" communications system. This system will provide continuous communications on the spacecraft location within the formation as well as limited command and control between the spacecraft themselves.
- Micro pulsed plasma thrusters are being developed by Primex Aerospace Corporation and flown on the University of Washington and Virginia Polytechnic Institute spacecraft. These systems provide a controllable low thrust ( $70\mu\text{N}$  per thruster) with a minimal use in consumable propellant (Teflon).
- A controlled permanent magnet torquing method for attitude control. High strength rare-earth magnets are positioned using a gimbal system to generate magnetic torques on the spacecraft, requiring significantly less energy than equivalent strength torquer coils during maneuvering.
- Experiments in modulating the aerodynamic force vector for orbital control will be performed. Maneuvering the spacecraft attitude so that different cross sectional areas vary the effective ballistic coefficient for in-track maneuvers. Tests to determine whether small cross-track maneuvers can be achieved will also be made.
- Commercial CMOS cameras will be used for low power attitude measurements. Multiple cameras positioned around the spacecraft will be used for determining both horizon locations and sun position. The cameras pixel array will be directly memory mapped into the command processor.
- An internet based operations center will be developed to allow control of each satellite from the appropriate campus location. Ground site locations will be in Logan, Utah and Blacksburg, Virginia.
- A low mass separation system developed by Planetary Systems Inc. will be tested for inter-satellite separation.
- A new Air Force platform known as the Multiple Satellite Deployment System (MSDS) designed to work with the Space Shuttle Shels release system will be tested.

### **1.2.4 Education**

This program brings a unique, hand-on spacecraft design experience to undergraduate and graduate students beyond that taught in traditional spacecraft design courses [1,2].

## **1.3 ION-F Launch and Orbital Requirements**

The ION-F formation will be launched together as a single stack from the Space Shuttle. The ION-F formation is currently waiting for selection for a Shuttle launch in late 2002 or early 2003. In order to achieve the mission goal for two months of formation flying, the constellation has requested an



orbital insertion above 380 km. in altitude and an inclination of greater than 51.6 degrees for ground station reception. This orbit could be accommodated on a space station construction mission shuttle flight. The minimum requirements are no less than 350 km altitude and no less than 36 degree inclination.

The first set of satellites to be launched from the University Nanosatellite Program will be from Stanford and Santa Clara University. This launch is scheduled for February, 2002. ION-F will be part of the second launch, expected to occur in late 2002. The ION-F constellation will be mounted on the USAF Multiple Spacecraft Deployment System (MSDS) with one other nanosatellite stack, most likely the Three Corner stack, consisting of three identical spacecraft from the Universities of New Mexico, Colorado and Arizona. The MSDS will be deployed from the Space Shuttle using the Shels release system. The ION-F stack will be released as a single rigid body connected by the Lightband Separation System developed by Planetary Systems Inc. The ION-F stack will then separate into the three satellite system after a detumble maneuver and initial system checkout.

## **2. The ION-F SPACECRAFT DESCRIPTIONS**

The three ION-F spacecraft are similar in many respects. This section outlines the construction of the three partner spacecraft.

### **2.1 University of Washington "DawgStar"**

The University of Washington nanosatellite [3] is designed as a hexagonal Isogrid structure with a maximum diameter of 18 inches (45.7 cm.), a height of approximately 12 inches (30 cm.) and a mass of under 15 kg. Eight pulsed plasma thrusters [4], each with a thrust level of approximately 70 $\mu$ N, are used on this spacecraft for attitude and orbital control. Attitude determination hardware includes cmos cameras for sun and horizon measurements plus a magnetometer. Power includes body mounted solar cells charging a NiCad battery pack. Telemetry includes an L band up-link, an S band down-link, and an APL/GSFC developed GPS/cross-link for communications between spacecraft. The VxWorks operating system has been chosen as the desired operating system.

### **2.2 Virginia Tech "HokieSat"**

The Virginia Polytechnic Institute nanosatellite is also designed as a hexagonal Isogrid structure with a maximum diameter of 18 inches (45.7 cm.), a height of approximately 12 inches (30 cm.) and a mass of under 15 kg. Attitude control is implemented by a magnetic coil torquing system. For formation flying, HokieSat will use two Primex  $\mu$ PPT thrusters. Attitude determination hardware includes cmos cameras for sun and horizon measurements plus a magnetometer. Power includes body-mounted solar cells charging a NiCad battery pack. Telemetry includes an L band up-link, an S band downlink, and an APL/GSFC developed GPS/cross-link for communications between spacecraft.

### **2.3 Utah State University "USUSat"**

The Utah State University satellite, "USUSat" is a small nanosatellite designed to meet the launch conditions dictated by the AFRL/AFOSR Shels Launch Platform. The spacecraft is hexagonal with a maximum diameter of 18 inches (45.7 cm.) and a height of approximately 6 inches (15 cm.). Two 30 inch (76.2 cm.) booms will be deployed out the sides of the spacecraft to support a science instrument (the plasma impedance probe) and the magnetometer. The spacecraft is designed to fly primarily in a nadir pointing orientation to simultaneously provide for communications, solar power, and drag modulation.

USUSat, will not include any propulsion capability, but will be able to effect orbit control by controlling the drag force acting on the spacecraft. Using permanent magnets to control the attitude, the spacecraft's ballistic coefficient [ $m/(C_D A)$ ] will be controllable in a range of 34-80 kg/m<sup>2</sup>. The resulting change in aerodynamic force will be used to control the orbital motion of the spacecraft. Of course, this control will lead to a continual decrease in altitude during the mission, effectively limiting the time in which USUSat can remain within the ION-F formation.

#### 2.4 The ION-F Team

Several approaches have been used to ensure that three universities at three locations in the US can adequately team to develop a distributed satellite system. These include:

- ION-F stack Interface Control Document (ICD). This document, to be written in versions for PDR and CDR, includes all structural, electrical, software, and communication interface definitions. Structural interface is defined by bolt hole pattern and electrical connections of the Lightband system, zero force electrical connectors for easy stack integration and Lightband testing. The Electrical interface is integrated with inhibit strategy, allows battery top-off to all satellites, and there is no telemetry exchange, except with antennas. The Software interface includes the same data/packet structure between the satellites and shared ground stations. Risk is mitigated by using the same cross-link designed and built by APL.
- Communication via teleconferences, email communications, a common ftp site and face to face meetings.
- Integration and Testing. The USU Space Dynamics lab will supply two summer internship positions for team students to specifically prepare for integration. Although individual spacecraft testing will be done at each university, the ION-F stack integration and testing will occur at one site. The ION-F stack integration and testing will be supported by full time representatives from each university.
- Several subsystems will be common between the three satellites, including communications hardware, flight processor, solar cells, and attitude determination sensors.

#### 2.5 Hardware Commonality

The following nanosatellite subsystems will have commonality between the three university teams. This allows easier integration and faster development time:

*Structures:* The ION-F satellites will be built using Isogrid structures. Structural and thermal analysis for the stack will use IDEAS software package. Fasteners approved by NASA will be used in common.

*Propulsion:* Both Virginia Tech and University of Washington will use  $\mu$ PPT's from Primex Aerospace Corporation.

*Power:* Common solar cells (Techstar) will be used. The electrical interface while in the stack, including all inhibit lines will be in common.

*Attitude Determination:* The solid state rate sensors, the CMOS cameras and their memory mapped interface will be used in common.

*Flight Software:* ION-F will use VxWorks as a common operating system. Many software modules, such as CMOS camera image reduction, Kalman filtering, orbit propagation, data formatting and ground station interfacing will be common.

*Science Instrumentation:* A common plasma electron density probe will be used.

*Flight Computer:* Common hardware includes the main processor board, back-plane, and modular I/O boards as well as the electronics interfacing and enclosure.

*Communications:* All communications hardware and software protocols (cross-link/GPS, uplink, downlink, etc.) will be common.

*Formation flying:* High level control algorithms will be the same, but low level control will be different because of the different actuators.

*Safety and Integration:* Ground test and support equipment, plus the safety and integration documentation required by NASA for ION-F (structural, fracture, batteries, wires and fusing, inhibits). Will be developed in common.

## 2.6 Test and Integration

ION-F integration and testing will occur to mitigate as much risk as possible. During the summer of 2000, student interns from Virginia Polytechnic Institute and the University of Washington will finalize integration and test plans at Utah State University. Individual nanosatellite testing will first occur at each university. These tests will include static and dynamic loading, thermal cycling and operational checkouts. The three satellite stack integration and testing will include vibration, thermo-vac, radiation, magnetic and communications. The Lightband separation system will be used for moving and lifting both the individual satellites and the stack. All stack integration and testing including the separation system, will be completed at one site. At least one representative from each university will be present at all times. The initial site for integration and testing will probably be at Utah State University's Space Dynamics Laboratory, although other options are being explored.

## 3. ION-F Formation Flying Mission and Experiments

The following definitions are found in "Foundations of Formation Flying for Mission to Planet earth and New Millennium" Folta, Newman, and Gardner, NASA Goddard, 1996 [5]: A constellation is two or more spacecraft in similar orbits with no active control by either to maintain a relative position. Formation flying is two or more spacecraft that use an active control scheme to maintain the relative positions of the spacecraft. The ION-F mission will demonstrate formation flying using its unique *control* capability.

Autonomous formation flying using inter-satellite cross-links has never been accomplished previously. There are many cases of rendezvous in the past, and soon EO-1 will formation fly with Landsat. Additionally, the Stanford-Santa Clara team from the University Nanosat Program will also attempt formation flying maneuvers [6]. However, the former case will be accomplished through satellite-ground communication links, rather than autonomously through the satellite cross-links. Therefore, the formation flying mission objectives are qualitative rather than quantitative:

### *Primary Objectives:*

- Demonstrate inter-satellite communications
- Demonstrate autonomous formation keeping
- Demonstrate autonomous formation maneuvering

### *Secondary Objectives:*

- Demonstrate more than one formation
- Demonstrate three satellite formation maneuvering

With these objectives, the formations to be attempted within the ION-F mission for formation keeping and maneuvering will be very simple [7]. The primary focus will be on the leader follower formation. The leader-follower formation is exactly as the name implies: same orbital parameters, but at different times. Once the three satellites deploy and check out (for instance, the thrusters and

cross-link, attitude control), the satellites will be drifting apart because of the separation velocity and differences in drag. This separation will be primarily in the radial path. The ION-F satellites will then perform a series of experiments using the formation's control capability. These are described subsequently.

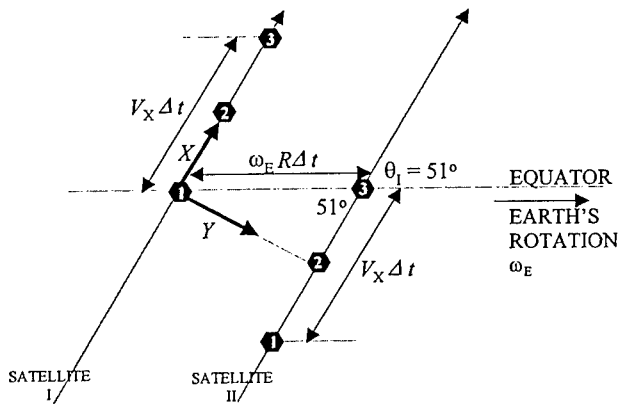
The same ground track formation, termed "ideal" by NASA Goddard [5], is one in which two or more satellites have identical ground tracks. Examining the same ground track formation more closely, consider Figure 1. Shown are two satellites as they cross the equator at slightly different times (1,2,3). In the upper left, the first satellite crosses the equator (1) and then moves on (2,3). In the lower right, the second satellite is lagging behind (1), but within a small amount of time, it too crosses the equator (3). The Earth, meanwhile, is rotating (center, between the satellites). For the same ground track formation, given the small amount of time it takes the second satellite to cross the equator, the Earth exactly rotates such that the two satellites fly over the same point on the surface of the Earth.

The Same Ground Track formation can be simplified to a change in time ( $\Delta T$ ) between when the satellites pass over the same point on the Earth. Using the geometry of Figure 1, we see that the relative separations are:

$$\Delta X = -V_x \Delta t + \omega_E R \Delta t \cos \theta_1$$

$$\Delta Y = \omega_E R \Delta t \sin \theta_1 \cos(\omega_E t)$$

where all parameters are known, and the initial condition for  $t = 0$  is defined at the equator.



**Figure 1: Picture of the same ground track formation as the satellites pass over the equator.**

Considering the objectives, two month minimum lifetime, and two simple formations described above, the following is an outline of the nominal formation flying mission:

**Table 1: ION-F Mission Timeline.**

Duration	Activity
5 days	Deploy as an ION-F stack from AFRL mother ship Checkout of GPS, attitude determination, thrusters, communications Downlink health data and debug
4 days	Deploy as individual nanosatellites from ION-F stack Checkout of attitude control, thrusters, inter-sat communications

MISSION  
TIMELINE

	Downlink health data and debug	
7 days	Maintain leader follower formation in 2-3 km separation range Both UW and VT fly relative to USU Debug as necessary, attempting to keep nanosatellites within 2-3 km separation	
21 days	Attempt various formation maneuvering and keeping algorithms (UW, GSFC, USU, VT, others)	MISSION SUCCESS
	Maneuver formation to a leader follower separation from 2-3 km separation to 10 km separation and back Formation keep at various points	
7 days	Maneuver formation to same ground track formation Formation keep to a separation of approximately 2-3 km Maneuver back to leader follower formation.	
3 days	Maneuver or drift out to an inter-satellite separation of approximately 20 km	
7 days	Attempt three satellite formation maneuvers	
7 days	Attempt formation keeping and pointing	
as long as possible	Orbit raising and mission life extension	

The nominal formation flying mission is four months, while the minimum formation flying mission is two months, based on the objectives listed above. However, with the uncertainty in the orbital parameters, the minimum numbers are used in simulations and calculations. For instance, based on a drag model for the Dawgstar satellite in Jan-Apr 2002, the lifetime of the satellite is approximately three months. If Dawgstar is to make its four month lifetime requirement, it must make-up drag at least by the end of the second month, which is approximately when the absolute drag of the satellite counteracts the maximum thrust (based on two thrusters). At this point the passive USUSat will drop out of the formation.

#### 4. Project Management

The Nanosatellite programs at the three Universities are supervised by academic faculty with one senior graduate student acting as the system engineer. The principal design work is performed by students from the Aerospace, Mechanical and Electrical Engineering departments. Approximate numbers at each school include 8 to 10 graduate students and 20 to 30 seniors. Although some students receive a stipend, most students perform their work as part of their thesis or senior design project. The student turnover at the end of an academic year requires considerable documentation to retain design continuity.

Communications between universities is performed primarily through email. A single ftp site is used for placing documents between schools. Group teleconference meetings between the academic advisors and system engineers are held on a weekly basis. Finally, group meetings are held two to three times yearly, where approximately ten students from each school get together for face-to-face meetings.

Common documents are developed and circulated for review, modification and approval with email. Common documentation for ION-F includes the Customer Payload Requirements, both the

individual spacecraft and stack Preliminary Design Review (PDR) and Critical Design Review (CDR). System Interface Control Documents (ICD's) and NASA Safety Documentation are also jointly prepared.

## 5. Conclusions

Despite very limited funding, the ION-F team has made significant progress towards completion of the design of three similar but unique spacecraft. Wherever possible, low cost commercial off-the-shelf (COTS) technology has been used. In other cases, novel and creative approaches to spacecraft systems have been developed. The ION-F team has been able to work together, despite geographic distances of over 4000 km. This program has had a significant impact on the students, with many of them graduating and finding excellent positions within the U.S. space industry, based on their experience with this program. At present, the three schools are preparing for an ION-F Critical Design Review for late summer of 2000, ION-F stack integration during the summer of 2001, and launch during the latter part of 2002.

## 6. References

- [1]. Pisacane, V. L., Moore, R. C., "Fundamentals of Space Systems", Oxford University Press, 1994.
- [2]. Wertz, J. Larson, W., "Spacecraft Mission Analysis and Design", Version 1, Kluwer Press, 1991.
- [3]. Campbell, *et. al.*, "UW Dawgstar: One-Third of ION-F," 1999 *USU/AIAA Small Satellite Conference*, August 1999, Paper No. SSC9-III-4.
- [4]. Rayburn, C., Campbell, M., Hoskins, A., Cassady, J., "The Micro-Pulsed Plasma Thruster for Small Satellites," submitted to the *AIAA/ASME/SAE/ASEE Joint Propulsion Conference*, July 2000.
- [5]. Folta, Newman, and Gardner, "Foundations of Formation Flying for Mission to Planet Earth and New Millenium", AIAA-96-3645-CP, NASA Goddard Space Center, 1996.
- [6]. Robertson, A.; Inalhan, G.; and How, J.; *Spacecraft Formation Flying Control Design for the Orion Mission*; AIAA Conference on Guidance, Navigation and Control, Portland, OR; pp. 1562-1575, 1999.
- [7]. Campbell, M., Schetter, T., "Formation Flying Mission for the UW Dawgstar Satellite," *IEEE Aerospace Conference*, Big Sky MT, March 2000.

**THE EMERALD NANOSATELLITES:  
TWO STUDENT-BUILT SATELLITES AS A TESTBED FOR  
DISTRIBUTED SPACE SYSTEM TECHNOLOGIES**

**Julie Anne TOWNSEND and Eric ALLISON**

*Space Systems Development Laboratory, Stanford University  
Department of Aeronautics and Astronautics  
Stanford, CA 94305-4035 USA*

***ABSTRACT** - Distributed systems of small satellites are currently of great interest in the space community. They offer increased scientific and technical capability at reduced cost. However, until the enabling technologies for distributed satellite systems have been developed and proven, distributed systems will be considered too risky for high profile missions. In general, the long timelines and exorbitant price tags of the space industry are prohibitive to the development of new space technologies. The aerospace community tends to forego innovative techniques in favor of methods that have been proven reliable in past missions. Student satellite development programs, like the Satellite Quick Research Testbed (SQUIRT) program at Stanford University, [Kitts 94] provide the industry with an opportunity for innovation. Because these programs educate students through hands-on experience in beginning-to-end design and construction of space systems, satellites are being built at low cost and on short timelines of a few years. This offers the space industry an opportunity to prove the functionality of new space technologies in the flight environment in return for a relatively minuscule monetary investment. The Emerald Nanosatellite program is an example of student-built satellites intended to verify the performance of emerging technologies. This paper will discuss the Emerald Nanosatellite project and the distributed space system technologies that will be demonstrated on Emerald's flight.*

## **1 - INTRODUCTION**

The term distributed space system refers to multiple satellites whose operations are coordinated to provide unified service. Such systems have already been proven to increase the value of space-based services in fields such as navigation and communications. For these applications, the use of multiple satellites spaced out over populated regions allows simultaneous coverage of large geographical areas. Often, these fleets utilize satellite technology which is no different from that used for a one-satellite system and perform all additional coordination and processing in the ground segment.

Another type of distributed space system, which is not yet commonly implemented but is of great interest to space system developers, requires a higher level of satellite coordination. This type of system incorporates multiple satellites into a closely-spaced interacting group. Ideally, these satellites operate with a high degree of autonomy, share information with each other directly, and respond to each others' needs, resulting in a fleet with the operational characteristics of a single,

complex satellite. A distributed system with these characteristics offers flexibility and economic advancement to satellite developers. The prospect of building numerous smaller and simpler spacecraft would allow components to become more standardized and processes more streamlined. In addition, a standardized bus design would become applicable to wider variety of scientific and technical applications.

Unfortunately, the current level of industry is not yet capable of producing multiple-satellite fleets with these characteristics. The navigation technologies needed for precise control of satellite relative position have not been proven. GPS-based position sensing, coupled with intersatellite communication and capable position control devices, is being explored from a variety of angles. [Baue 97, Zimm 95, Adam 96, Folt 96, Guin 96, Cora 97, Binn 97, Lau 96] More advancement is also needed to increase satellite autonomy in health management and low-level operational tasks. The NASA DS-1 Remote Agent experiment and the beacon-based health monitoring systems developed by NASA and SSDL are creating forward progress in this area. [Bern 98, Sher 97, Swar 98]

The Air Force Office of Scientific Research (AFOSR) is also sponsoring distributed space system research in support of space missions using large clusters of microsattellites. [AFOS 98] In particular, AFOSR's TechSat 21 Program involves satellites flying in formation that operate cooperatively to perform a surveillance mission. One TechSat 21 initiative, known as the University Nanosatellite Program (jointly sponsored by the Defense Advanced Research Projects Agency (DARPA)), involves the development of ten low-cost university spacecraft. These projects are intended to explore the usefulness of nanosatellites and provide opportunities for technology experiments supporting the development of distributed space systems. Experiments in formation flying, enhanced communications, miniaturized sensors, attitude control, maneuvering, docking, power collection, and end-of-life de-orbit are of particular interest. Selected universities in the Nanosatellite Program are funded at a level of \$100,000 to develop a spacecraft over a two-year period. In addition, a launch will be provided; currently a Shuttle launch is being planned for early 2002. As part of this program, the joint Stanford University - Santa Clara University Emerald mission is a testbed for validation and verification of advanced distributed Space System technologies.

## **2 - THE EMERALD TEAM**

Both Stanford University's Space Systems Development Laboratory (SSDL) and Santa Clara University's Intelligent Robotics Program (IRP) have histories of success in the development of low-cost small satellites. At each university, students take responsibility for project management, design, construction, and operations from project proposal through end of mission. The satellite development philosophy at both schools revolves around low expenditure and short timelines. Achievement of this philosophy is made possible by simple design, in-house construction and testing, rapid modification of low-cost commercial products, and industry sponsorship. While these methods produce spacecraft with a high risk of failure, the low costs and short turnaround times provide ideal opportunities for those who wish to prove new technologies via space flight for use in higher profile missions.

So far, all spacecraft produced by SSDL and IRP have served as flight testbeds for emerging technologies. Sapphire, a small satellite completed by SSDL in 1998 and currently awaiting launch, will test the functionality of Tunneling Horizon Detectors. IRP's Barnacle spacecraft hosts a MicroElectroMechanical (MEMS) sensor testbed. SSDL's Opal satellite was a testbed for mothership technologies and, following its launch in January 2000, successfully deployed six



picosatellites. Three of these were the Artemis picosatellites developed at Santa Clara University. The Emerald program builds upon the past experiences and successes of both laboratories.

### **3 - THE EMERALD NANOSATELLITES**

SSDL and IRP have designed and are constructing the Emerald nanosatellites to follow in the footsteps of their predecessors as a testbed for emerging distributed space system advancements. The two-spacecraft system will demonstrate several capabilities for cooperative operation. For this purpose, SSDL's heritage satellite design has been modified to support distributed experimentation.

The structural configuration of the Emerald vehicles will use SSDL's heritage satellite bus design. This consists of a 15 kilogram (33 lb), 30.5-cm (12-inch) tall, 48-cm (19-inch) diameter hexagonal configuration employing a modular, stackable tray structure made of aluminum honeycomb. Drag panels have been incorporated into this design through actuation of two opposite side panels to provide simple, though limited, position control.

Attitude determination on the order of +/-5 degrees, which is coarse but sufficient for experimentation, will be provided via a magnetometer and infrared light sensors. Attitude control will be achieved through drag stabilization.

For flight computers, the Emerald satellites will use the commercially available SpaceQuest FCV-53 flight processor running the BekTek operating system. This provides a radiation tolerant system with 1 MB RAM, a file system, and a schedulable command execution system. The processor will connect to PICmicro microprocessors in most subsystems through the use of an I<sup>2</sup>C serial bus. This data handling approach is part of Emerald's experimental internal distributed commanding architecture.

Intersatellite communications will be achieved via a UHF, half duplex, 9.6 kbs packet communications system. This will include a SpaceQuest digital modem and a modified amateur radio transmitter and receiver. A second receiver, on a VHF frequency, will be provided to enable full-duplex ground communications.

Power will be generated by GaAs solar cells, donated by Spectrolab, body mounted on the eight sides of each satellite. A single multi-cell NiCad battery will be used for storage, and regulated 5-volt and 12-volt power will be provided throughout the satellites. Passive thermal control will be achieved through the use of insulation and thermal coatings.

Each Emerald satellite will support a variety of experiments and payloads. Both satellites will have GPS receivers for navigation and Very Low Frequency (VLF) receivers for ionospheric science measurements. One satellite will carry a radiation testbed, and the other will host an experimental colloid microthruster. Software to support navigation and autonomy demonstrations will be included on both satellites.

### **4 - THE DISTRIBUTED SPACE SYSTEM TECHNOLOGY TESTBED**

Demonstration of advancements in distributed space system methods and technologies is the mission of the Emerald project. Using their payloads and subsystem capabilities, the Emerald satellites will attempt to verify the functionality and usefulness of several distributed system innovations. Emerald's demonstrations can be separated into two major categories, component verification and demonstration of high-level operational capabilities.

## **4.1 - Component Verification**

The Emerald system will attempt flight operation of two experimental components: a GPS receiver and a colloid micro-thruster. Both of these components are of interest for their potential use in satellite fleet formation control for distributed space systems. Currently, GPS is the leading potential method for accurate determination of relative position between satellites. The colloid microthruster is potentially a lightweight and fuel-efficient means of controlling spacecraft position. For both components, the Emerald mission will be the first attempt at operation in the space environment.

### **4.1.1 - GPS Receiver**

The GPS receiver to be tested on the Emerald mission is a modified Mitel 12-channel receiver developed in Stanford University's Aerospace Robotics Laboratory (ARL). Versions of these receivers have been used by ARL with a variety of mobile robot testbed systems to exhibit formation flying capabilities. [Zimm 95] A single receiver, which can support two hemispherical patch antennas, will fly on each Emerald satellite. The receiver will be tested for its ability to locate signals from at least four GPS satellites, calculate its position with acceptable accuracy, and transfer information for relative position processing. Once its functionality has been verified, the information produced by the GPS receiver will be used in higher-level demonstrations of distributed system capabilities.

### **4.1.2 - Colloid Micro-Thruster**

The experimental colloid micro-thruster is being developed in Stanford University's Plasma Dynamics Laboratory (PDL). The thruster accelerates charged liquid particles, typically glycerol, through an electrostatic field to produce thrust on the order of 100 micro-newtons. Its size, configurability, and efficiency, with an ISP of up to 1000 seconds, make the colloid micro-thruster an attractive tool for small satellite position and attitude control. [Pran 99]

The first test of the colloid micro-thruster will be survival of launch and functionality in the space environment. Next, thruster firing will be characterized by monitoring the currents produced by the charged particle stream. The force produced by the thruster will be estimated by its ability to affect the satellite's spin rate. If successful functioning is achieved, the micro-thruster's effectiveness may also be tested in higher-level applications, such as position and attitude control.

## **4.2 - High-Level Distributed Capabilities**

In addition to component verification, the Emerald nanosatellites will demonstrate a variety of autonomous distributed system capabilities. These include on-orbit relative position control, fleet-level health monitoring, and autonomous gathering of distributed science data. A fourth demonstration will illustrate the potential failure robustness of a cooperative satellite fleet.

### **4.2.1 - On-orbit Relative Position Control**

Autonomous formation flying capability is fundamental to the distributed space system concept. The Emerald system will make use of its GPS receivers and coarse position control capability to demonstrate autonomous navigation of a distributed system.

Once the functionality of the GPS receivers has been verified, their data will be used to calculate an accurate measurement of relative position between the two Emerald satellites. The satellites will

exchange GPS information via their intersatellite link and calculate a relative position solution. Based on this calculation, control commands will be generated for position changes using the drag panels on each Emerald satellite. While the drag panels offer only limited control authority to the system, the effects are predictable and sufficient to demonstrate the functionality of the closed-loop control algorithm. The goal of the navigation demonstration will be to maintain relative position within the linking range of the intersatellite communication system, around 100 km.

For a more complex formation flying demonstration, the Emerald Nanosatellites will fly a joint mission with the Orion microsatellite, which is being constructed concurrently in Stanford's SSDL. The Orion satellite is designed with advanced formation flying capabilities. It carries a more complex, six-antenna GPS receiver, a cold gas propulsion system for attitude and position control, and processing power far superior to that of the Emerald satellites. These capabilities will allow Orion to fly in a controlled formation around the Emerald spacecraft. In addition, Orion's more powerful processor will provide the Emerald satellites with more frequent and accurate control directions, raising Emerald's 2-body autonomous rendezvous operation to a more interesting and complex 3-body autonomous formation flying demonstration.

#### ***4.2.2 - Distributed Health Monitoring***

For a fleet of satellites flying in close formation, it will be operationally advantageous to obtain fleet level telemetry and health updates through contact with a single representative, rather than querying each satellite individually. Toward this end, the Emerald nanosatellites intend to demonstrate fleet level, beacon-based health monitoring.

The distributed health monitoring capabilities to be explored on the Emerald nanosatellites build upon the beacon-based health monitoring systems used on the Sapphire and Opal spacecraft. The heritage system is a periodic low data rate tone whose contents are set by the on-board processor to reflect the high-level health status of the spacecraft. This system will be upgraded such that the satellites share health information via the on-orbit intersatellite link, then produce a single beacon reflecting the fleet-wide health status. Although this demonstration requires only minimal information sharing between satellites, the approach can be expanded to accommodate larger amounts of information in systems with more advanced crosslinking and processing capabilities.

#### ***4.2.3 - Autonomous and Distributed Data-gathering***

A potential application of a coordinated system of satellites is improved scientific observation and experimentation. Coordinated observation of scientific phenomena from two locations provides results with a degree of dimensionality to aid data analysis. Using the VLF receivers, the Emerald satellites will demonstrate distributed science capabilities by gathering coordinated data during ionospheric lightning events.

Software within the VLF receiver experiment will contain the capability to coordinate data collection. The receiver on one spacecraft will make use of the intersatellite communications link to share its schedule for data collection with the receiver on the other satellite. Schedule coordination will result in stereoscopic observation of a single ionospheric event.

The schedule for scientific data collection may either be uploaded from the ground or autonomously selected by the receiver on orbit. When operated in an autonomous mode, the VLF receiver will passively observe ionospheric emissions until a threshold is triggered which suggests that an interesting phenomenon may be present. When this occurs, the receiver will coordinate with the receiver on the other satellite, then begin actively recording data. A successful performance will

demonstrate preliminary capabilities for autonomous scientific operations and coordinated data collection.

#### ***4.2.4 - Distributed System Robustness***

The flight computer is the heart of satellite operations. Without redundant systems, loss of the flight computer to radiation or other mishaps is catastrophic to mission success. Using the distributed internal commanding and data handling system implemented on the Emerald satellites, this may no longer be true. The Emerald mission intends to demonstrate how operational success may be achieved without a functional flight computer.

The design of the Emerald commanding architecture requires all subsystems and experiments to interface to the main data and commanding bus via a microprocessor. This microprocessor is programmed to provide low-level operational instructions to the subsystem or experiment hardware. Sequences of low-level instructions are implemented upon receipt of a high-level command from the central flight processor. Thus, the flight computer is mainly responsible for maintenance of the bus and scheduling of high-level commands.

Interestingly, these responsibilities of the central processor can be handled in a rudimentary fashion by a microprocessor similar to those integrated into the subsystems and experiments. A microprocessor module with these capabilities will be flown aboard each Emerald satellite. To demonstrate its capabilities, flight computer shutdown will be simulated, and commanding authority will be handed over to the microprocessor unit. Direct commanding of subsystems and experiments from the ground through the microprocessor and corresponding receipt of telemetry and experimental data will define a successful demonstration. Ideally, a subsequent demonstration will allow one satellite to command the other through the microprocessor module. Success of this demonstration will highlight the benefits of internally distributed spacecraft intelligence and open doors to the possibilities for operational robustness of interacting satellites.

## **5 - CONCLUSIONS**

University class spacecraft are a valuable asset to space system researchers. They serve as low-cost, albeit risky platforms that may be used to rapidly verify the capabilities of advanced technology. In addition, such projects often lead to innovative design approaches while they successfully promoting the education of a new generation of aerospace engineers.

The Emerald nanosatellite project provides a quick, low-cost testbed for emerging satellite technologies in distributed space systems. Cutting edge components for GPS-based position sensing and colloid micro-thruster control will be tested and verified in the space environment. Autonomous operations will be demonstrated in fleet navigation, high-level health management, and distributed science. Although simple in concept this project serves as a valuable prototype for more advanced formation flying missions being developed by Stanford, AFOSR, and NASA.

## **6 - ACKNOWLEDGEMENTS**

The authors wish to thank AFOSR and DARPA for their commitment to supporting university-based spacecraft development projects. Appreciation is also extended to NASA Goddard for their support of the distributed satellite control aspects of this project. In addition, the authors are grateful for the many individuals at NASA Goddard, NASA Johnson, and AFRL who continue to offer their support and experience through the design process. Finally, the faculty advisors at Stanford

University and Santa Clara University are thanked for their support and encouragement, and the students of both universities are praised for their hard work and dedication in the development of this mission.

## 7 - REFERENCES

- [Adam 96] Adams, J. C., et. al.: "Technologies for Spacecraft Formation Flying", *Proceedings of the ION GPS-96 Conference*, Kansas City, MO, September 1996.
- [AFOS 98] *AFOSR BAA on TechSat 21 (AFOSR BAA 98-6)*, Air Force office of Scientific Research, 1998.
- [Baue 97] Bauer, F., et al: "Satellite Formation Flying using an Innovative Autonomous Control System (AutoCon) Environment", *AIAA/AAS Astrodynamics Specialists Conference*, New Orleans, LA, August 1997.
- [Bern 98] Bernard, D., et. al.: "Design of the Remote Agent Experiment for Spacecraft Autonomy", *Proceedings of the 1999 IEEE Aerospace Conference*, Snowmass, CO, March 1998.
- [Binn 97] Binning, P. W.: *Absolute and Relative Satellite to Satellite Navigation using GPS*. Dept. of Aerospace Engineering Sciences, University of Colorado, April 1997.
- [Cora 97] Corazzini, T., et. al.: "GPS Sensing for Spacecraft Formation Flying", *Proceedings of the ION GPS-97 Conference*, Kansas City, MO, September 1997.
- [Folt 96] Folta, D., et. al.: "Foundations of Formation Flying for Mission to Planet Earth and New Millennium", *AIAA/AAS Astrodynamics Specialists Conference*, July 1996.
- [Guin 96] Guinn, J. and R. Boain: "Spacecraft Autonomous Formation Flying Earth Orbiters using GPS", *AIAA/AAS Astrodynamics Specialists Conference*, July 1996.
- [Kitts 94] Kitts, C. and R. Twiggs: "The Satellite Quick Research Testbed (SQUIRT) Program", *Proceedings of the 8th Annual AIAA/USU Conference on Small Satellites*, Logan, Utah, August 1994.
- [Lau 96] Lau, K., et. al.: "An Innovative Deep Space Application of GPS Technology for Formation Flying Spacecraft", *Proceedings of the AIAA GNC Conference*, San Diego, CA, July 1996.
- [Pran 99] Pranajaya, Freddy P.: "Progress on Colloid Micro-Thruster Research and Flight Testing", *Proceedings of the 13th Annual AIAA/USU Conference on Small Satellites*, Logan, Utah, August 1999.
- [Sher 97] Sherwood, R., et. al.: "Flight Software Implementation of the Beacon Monitor Experiment on the NASA New Millennium Deep Space 1 (DS-1) Mission", *Proceedings of the Second International Symposium on Reducing the Cost of Spacecraft Ground Systems and Operations*, Oxfordshire, United Kingdom, July 1997.
- [Swar 98] Swartwout, M., et. al.: "Experiments in Automated Health Assessment and Notification for the SAPHIRE Microsatellite", *Proceedings of SpaceOps 98: The 5th*

*International Symposium on space Mission Operations and Ground Data Systems,*  
Tokyo, Japan, June 1998.

[Zimm 95] Zimmerman, K. R. and R. H. Cannon Jr.: "Experimental Demonstration of GPS for Rendezvous between Two Prototype Space Vehicles", *Proceedings of the Institute of Navigation GPS-95 Conference*, Palm Springs, CA, September 1995.

## THE $\mu$ SAT-EDU PROJECT

MURGIO Luis Alberto, ROSSA María Beatriz, GALLINO Mónica

*Instituto Universitario Aeronáutico. Ruta 20, Km. 6.5, 5022 Córdoba, Argentina.*

*Phone : +54-351-4659017, Fax : +54-351-4333967*

*E-mail : < lamurgio@make.com.ar>*

*<mbrossa@iua.edu.ar>*

*<mgallino@iua.edu.ar>*

### **ABSTRACT**

*The high degree of interest shown by students about the  $\mu$ Sat-1 satellite, ("Victor") (The first Argentine-made earth satellite), drove the idea that "Space Thinking" could be integrated as part of their formation and at the same time use it as the motor to improve student interest in other related subjects in our country.*

*This goal could be attained by putting a Satellite Data Down-link and Up-link (Commands) "inside" the educational institutions. This means, that teachers and students should be able to operate the satellite according to their own ideas, obtaining a direct insight into Space Technology possibilities.*

*In other words, a very low cost "ground station" in order to have control over the satellite with a set of commands, and to receive the On-Board Status (temperatures, magnetic field, solar sensor, earth sensor, etc.) and pictures of ground surface or to send/receive mails to/from others Educational Institutions in any part of the world.*

*The  $\mu$ Sat-Edu project comprises two different aspects:*

*1. -Conception, construction and qualification of very low-cost earth stations, able to operate the satellite directly from educational institutions*

*Upgradeing the  $\mu$ Sat-2 capabilities to be operated from these stations. ( $\mu$ Sat-2 is scheduled to be launched in the first quarter of 2001)*

*2. -Research and development of new courses and ways of instruction, to lead the helpfulness generated in the students by this new "tool" for education. In other words to take advantage of the educational possibilities with this different approach.*

## 1. INTRODUCTION

Since the days of **Sputnik** satellites, scientist and engineers have gathered data, developed information and created knowledge from space-based sensors.

The earth has been imaged in virtually all electromagnetic wavelengths. Satellite based pictures are easily available at better than 100 meter resolution for the most of the world. In selected areas, intelligence sensors have returned pictures better than one meter resolution.

We are challenged to use this to impart knowledge, to excite and engage today's children.

Software to access, analyze and manipulate this data is difficult to find and use. The irony is that in an aged marked by such an overwhelming wealth of data, there is poverty of accessible and usable information available to the educational community.

The general objectives established for the first Argentine made earth satellite (launched in 1996), the  $\mu$ SAT-1 "Victor" mission, were:

- *To develop a space platform based upon low cost engineering techniques.*
- *To provide scientists and engineers with a quickly available tool for experiments and testing in space environment.*
- *To stimulate the interest of young people in space related activities by promoting their active involvement in schools and universities.*

Included in the overall success of  $\mu$ Sat-1 "Victor" mission (which ended in November, 1999, with the re-entry of the space vehicle), the third objective was achieved in an absolutely satisfactory way, with more than 50 conferences and lectures given since launch in Elementary, High and Technical schools, as well as at the University with highly stimulating results.

The high degree of interest shown by students about "Victor" drove the idea that "Space Thinking" could be integrated as part of their formation and at the same time to use it as the motor to improve student interest in other related subjects.

In other words, a very low cost "ground station" in order to have control over the satellite with a set of commands, and to receive the On-Board Status (temperatures, magnetic field, solar sensor, earth sensor, etc.) and pictures of ground surface or to send/receive mails to/from others Educational Institutions in any part of the world.

In order to improve the educational applications, we add to this system the possibility of receiving raw image data from NOAA and GOES satellites, including the software to manipulate and prepare them for further utilisation using some GIS software.

Access to data and tools to manipulate that data are the keys. Access implies not only the physical mechanism, but the knowledge that relevant data exists, the ability to find an access to that data, and the tools to make that data useful in the educator or learner context.

To better understand how to match the needs of education, a multidisciplinary team was formed in order to reach the goals mixing the specialists in education and technology. The result was  $\mu$ Sat-EDU, a project designed to organise, enhance and disseminate SPACE SCIENCE using local know-how and technology developments.

The  $\mu$ Sat-Edu project comprises two different aspects:



**a) Technical Aspect**

Conception, construction and qualification of a very low-cost earth stations, able to operate the satellite, directly from educational institutions  
Upgrading the  $\mu$ Sat-2 capabilities to be operated from these stations. ( $\mu$ Sat-2 is scheduled to be launch in the first quarter of 2001)

**b) Academic Aspect.**

Research and development of new courses and ways of instruction, to guide the helpfulness generated in the students by this new "tool" for education. In other words to take advantage of educational possibilities of this different approach.

**3. THE  $\mu$ SAT-EDU SYSTEM – TECHNICAL ASPECT**

**3.1. Space Segment**

Upgrading the  $\mu$ Sat-2 capabilities to be operated from ground stations installed at different high schools. (The  $\mu$ Sat-2 is scheduled to be launched in the first quarter of 2001).  
Mainly the  $\mu$ Sat-2 will have an extra set of commands that will allow its operation from the low-cost ground stations

**3.2. Ground Segment**

The equipment couples ideally with the emerging utilisation of new technologies in High Schools.  
Never before have the secondary schools been able to post-process raw satellite data, and now they can do it in real time.  
This is credited to advances in technology that have recently made the necessary equipment simple, inexpensive, powerful and available enough for any school to fit into their technology-educational curricula.  
The  $\mu$ Sat-Edu ground station will be able to:

- Follow the satellite in its orbit through software that permits the satellite's simulation in orbit and thus its position in relation to the ground station.
- Follow the satellite in its orbit, through a "pointed at" system that permits the receiving/transmitting antenna's orientation.
- Make connections via UHF in a bi-directional way.
- Send commands to the  $\mu$ Sat-2 (Figure 1) like:
  - Storing information (data) in  $\mu$ Sat-2 satellite's memory.
  - Making a request for the status of  $\mu$ Sat-2.
  - Reading on board appliances:
    - Solar sensor
    - Magnetometer
    - Horizon's sensor
  - Making a request for future readings, that are to be collected after.
  - Asking for "Satellite's Time", for ground operation.
  - Making a request for the orbit's Keplerian Data.
  - Asking for temperature on board.

- Consumed energy and battery status.
- Image reception of satellites shots.
- Stored information reception (messages, letters, etc.)
- Sensing meteorological ground station data (temperature, rain, received energy, etc.)

- Printing of Data and received images
- Software for pre-processing the received images.

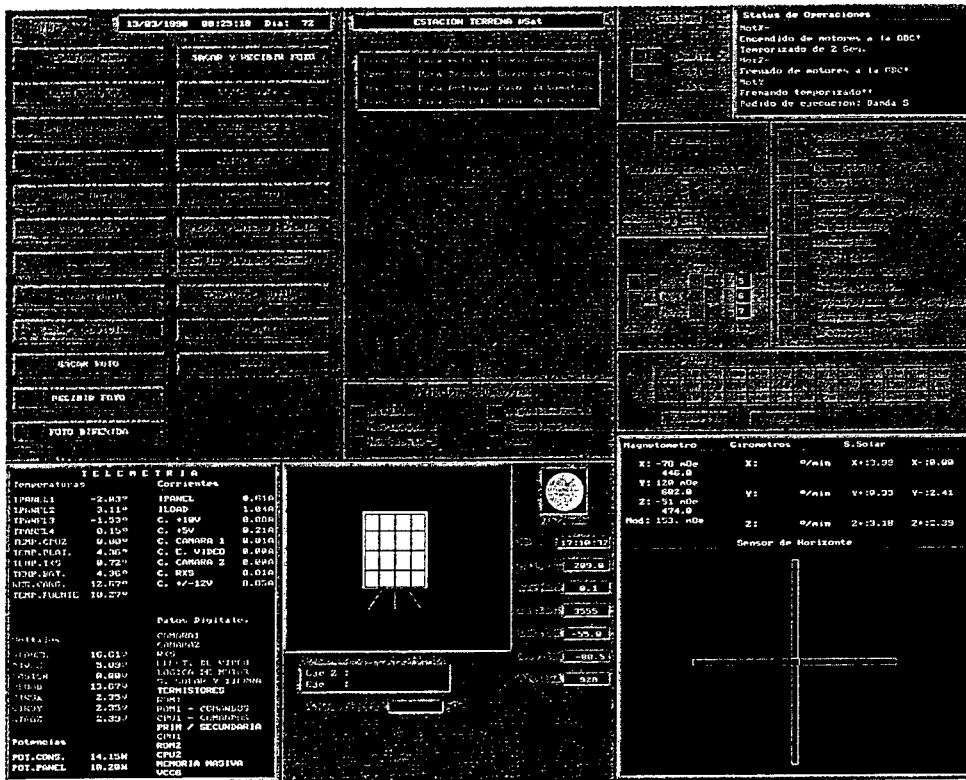
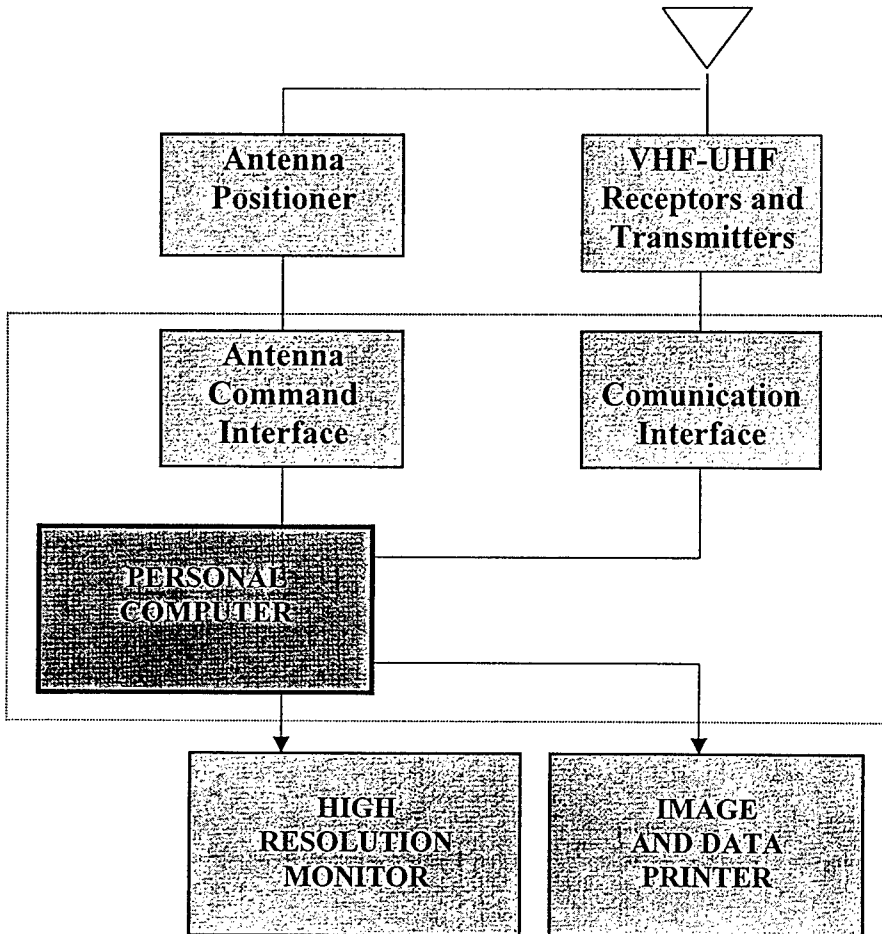


Figure 1: Monitor Screen showing Commands and Satellite's Status

### 3.3. Block's Diagram

The station has the following "blocks":



The equipment will provide Graphics Image Files, i.e. snapshot of scenes taken by  $\mu$ Sat-2 of the earth below or the polar orbiting (NOAA) and geo-synchronous (GOES) satellites respectively. A local design of the low noise amplifiers inside the antenna for better isolating the satellite down-link frequency and removing more of background noise. This signal is then down converted before more noise can be picked up. The lower frequencies preserves the signal to noise ratio along 50 meters of inexpensive coaxial cable.

In a next future we are planning to modify a standard antenna, used by homeowners for satellite T.V., keeping the costs to a minimum, in this way.

The radio receivers are inexpensive and standard, prepared to fit in a PC board, so that now the antenna feed plugs right into your PC with no external components.

Furthermore, using the continuous data from the geo-stationary satellite (GOES), students can apply their algorithms to the same scene every half-hour and put it in motion. Now they can watch the clouds and storm moving on the same scenario.

The software was written to work with Personal Computers using mainly Pascal and some parts in "C", this guarantees that the system will get faster, better and cheaper every few months.

### 3.4. Software Modules

The following modules are provided for a correct and simple operation:

- Orbit calculus and visualisation.
- Antenna control and command in order to follow the satellite in orbit in real time.
- Satellite operation in orbit, command remittance and data reception in real time.
- Software for images and data reception (messages, letters, etc.).
- Software for the pre-processing of received images.
- Software to capture raw image data from NOAA satellites.
- Manual for the station's maintenance and operation.

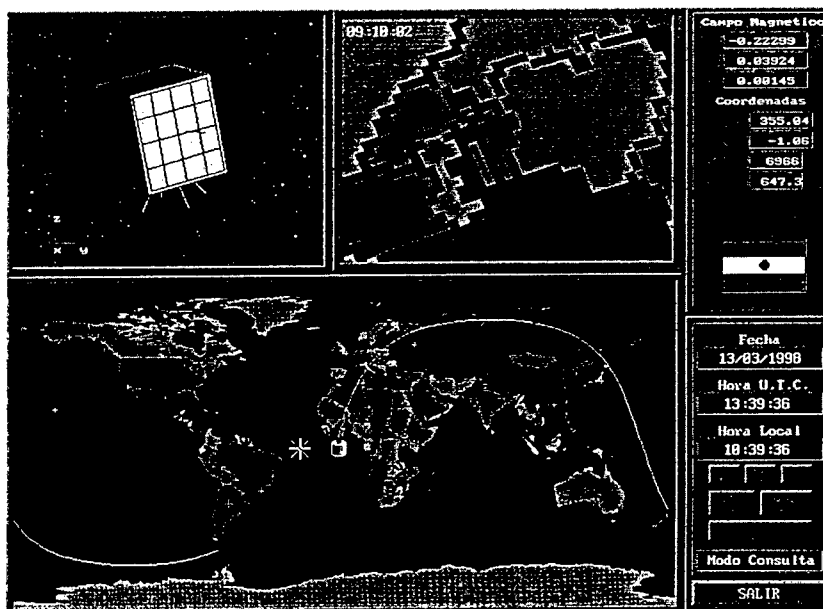


Figure 2: Simulation Software - Orbit and Satellite Alignment

#### 4. THE $\mu$ SAT-EDU SYSTEM - DIDACTIC ASPECT

The educational transformation that started in Argentina since the "*Ley Federal de Educación*" implies a series of processes that cause a critical and systematic analysis of educational practices and their relationship with the needs of society at a particular time. This places educational institutions facing new perspectives that model the teacher's formation for the XXI century.

The continuous updating of content, the necessity of paying attention to those peoples who need to be educated; interdisciplinary work, the permanent training of teachers and periodic evaluation of educational practices, all make universities the natural environment where new proposals are nurtured. They are needed for the development of human resources for teaching, taking those proposals as responses to the requirements mentioned.

In like manner, advances in the teaching of Science and Technology require from schools a reformulation, re-organisation and restructuring of methods and their conceptual relationships. This implies a restructuring both in the branches of study and in the methodological-pedagogic fields.

Here, the approach to Science, Technology and Society assumes a dynamic interaction between science and technology and its effect on the environment and on society. Reflecting on the influence of social, political and cultural forces on science and technology and examines the impact of technologies and scientific ideas on peoples' lives.

In this context, the micro-satellite as a product in itself and the  $\mu$ Sat-Edu station for its operation that exist in high schools, facilitate the access to satellite technology in teaching and learning contexts and environments that motivate teachers and students who are committed to the production and use of knowledge.

In this project we recognise a priori the following contributions of university education to other educational levels:

- To offer new technological resources for elementary education.
- To contribute in the improvement of technological training for teachers.
- To tighten the bonds among other levels of the educational system, and academic and research environments of our country.
- To contribute in the improvement of the learning quality of young people.
- To encourage the use and handling of technologies in daily situations, and the solution of problems.

The  $\mu$ SAT-EDU project works at two levels of educational institutions.

- a) Institutional
- b) Teaching-Learning

##### 4.1. Institutional

- It is from the institutional management that the integration of said project to the I.E.P. (Institutional Educational Project) will be made.
- The installation of the  $\mu$ Sat-Edu ground station will be done together with the infrastructure and equipment updating.

- A co-ordinating committee will be established. It will be responsible for the planning, starting and evaluation of the project and will be integrated by people from different institutional and professional levels of the  $\mu$ Sat.
- This committee will be trained according to a general program and will receive the required knowledge and proceedings to operate said stations.

#### 4.2. Teaching-Learning

Design and implementation of an interdisciplinary program for teacher training that takes into account conceptual, procedural and methodological concepts that make reference to:

- $\mu$ Sat micro-satellite series: Design, functioning and potential as a source of information, etc.
  - $\mu$ Sat-Edu Stations for the operation of satellites: Description, how to operate them, application potential, etc.
  - Methodological applications to the curricula: Learning activities designed for different subjects in the project: Physics, geography, technology, etc.
  - Interdisciplinary and extracurricular applications: For example, school newspaper, mini research projects done by students of the "*polimodal*" system, projects to be done within the community, etc.
- Forming of groups of teachers and students to begin research and to apply satellite technology guided by specialist in Space activities.
  - Development of areas for the presentation and debate of production and experience at the inter-institutional, provincial and/or national level, by using new information and communication technologies, mainly Internet and its interactive services.

A program will be elaborated, from this experience and its corresponding evaluation. It will be done for the insertion and definitive integration of satellite technology with the educational institutional project of the curricula of high schools.  $\mu$ Sat-Edu researchers will permanently update this project.

#### 5. CONCLUSIONS

Similar systems are partially used in some countries, in the United States there are technology – education programs. Our solution differs in two ways:

- a) This system is the only one that has a satellite (with special features designed for this purpose) that can be operated directly from schools.
- b) The systems not only promote space activities, they are also used to motivate other subjects of the school's curricula.

The learning potential is enormous. Students get marketable technology skills in the areas of electronic access of information, post processing of raw satellite image data, multimedia production, and both electronic and verbal communication skills, while performing really important school science projects.

The "**Direct Experience**" helps to prepare children for participation in an increasingly technological world

## POSTERS

- (P.1) **RESUME project**  
Roggero E., Cerocchi M., CONAE, Saray J., Baldelli D., UTN-FRH, Buenos Aires, Argentine
- (P.2) **Satellite Tracking from the Top of the World;**  
Operation of a Multi Purpose Ground Station at 80°N\*  
Skatteboe R. Norwegian Space Centre, Oslo, Norvège
- (P.3) **NOVEL Range Measurement System**  
Carayon J.L, Chatain C, CNES, Toulouse, France
- (P.4) **The Agile Mission**  
Musso C., Augelli M., Crisconio M., Falvella M.C., Giommi P., Pellizzoni A., Valentini G., Bignami G.F. Agenzia Spaziale Italiana, Rome, Italie
- (P.6) **Suivi de chargements sensibles ou dangereux par système satellite et solution proposée**  
Dubut J.P., de Carvalho M.J.M., dos Santos M.A.F. INPE/CRN, Natal, Brésil
- (P.8) **Xenon Feed Systems for Electric Propulsion**  
Smith P. Polyflex Aerospace Ltd, Cheltenham, Royaume-Uni
- (P.9) **The Design and Implementation of an Autonomous Ground Station for PANSAT**  
Horning J.A. Space Systems Academic Group, Monterey, Etats-Unis
- (P.10) **Near Equatorial Orbit (NEqO) Satellite Constellation for Remote Sensing and Digital Communications**  
Othman M., Arshad A. S., United Nations Office for Outer Space Affairs, Vienne, Autriche
- (P.11) **Space Systems Using GEO and LEO Satellites. Mission: Long Distance Activities Support**  
de Miguel J., Alfaro N., Garrido B. Instituto Nacional de Técnica Aeroespacial (INTA), Madrid, Espagne
- (P.12) **JAVA à l'épreuve des petits satellites / JAVA face to small satellites**  
Aprville L., Senac P., Richard F., Diaz M. Alcatel Space Industries, Toulouse, France
- (P.13) **A Gamma Ray Observatory on the MITA Platform Agile a Forerunner for ASI Small Satellite Scientific Programme**  
Crocco L. Carlo Gavazzi Space, Milan, Italie
- (P.14) **Open Source to Small Satellites Ground Station**  
de Carvalho M.J.M., Alves Pereira R. Jr, Mattiello Francisco M.de F., Dubut J.P.  
Instituto Nacional de Pesquisas Espaciais, Natal, Brésil
- (P.15) **Fifteen Years of Small Satellite Communications: A Lesson Learned**  
Pavesi B., Rondinelli G. Telespazio spa, Rome, Italie
- (P.17) **MINISAT-01: Tools for scheduling, data analysis and payload monitoring**  
Talavera A., Garcia J., Quintana C. Lab. de Astrofísica Espacial y Física Fundamental, Madrid, Espagne
- (P.18) **A Method for Predicting on Board Computers Single-Event Effects Induced Failure Rates, Based on Markov Chains**  
Ferreira P.A., Marques C.A., Gaspar J.P. Facultad de Matemática Astronomía y Física, Córdoba, Argentine
- (P.20) **Cryogenic Transition-Edge Microbolometers and Calorimeters with on-chip coolers for X-ray and Far-Infrared Detection**  
Kinnunen K, University of Jyväskylä, Jyväskylä, Finlande
- (P.21) **Design and development of on-board data handling (OBDH) software for a university micro-satellite**  
Ponte S. Department of Aerospace Engineering, Aversa, Italie
- (P.22) **Design of the Smart Microsatellite Electrical Power Subsystem**  
D'Errico M., Pastena M. Dipartimento di Ingegneria Aerospaziale, Aversa, Italie
- (P.23) **SMART Microsatellite structure, Mechanisms and Thermal Design.**  
Fragnito M. Aerospace Engineering Department, Aversa, Italie
- (P.24) **The European Spacecraft Platform Database**  
Lionnet P., Toussaint M., Debryne E. Eurospace, Paris, France
- (P.25) **Smallsats: from infancy to adulthood?**  
Lionnet P., Toussaint M., Debryne E. Eurospace, Paris, France
- (P.26) **Space School for Teenagers**  
Sausen M.T., Avila J. Ministerio da Ciencia e Tecnologia, Sao Jose dos Campos, SP, Brésil
- (P.27) **Station Faible Coût pour Micro-Satellites**  
Lemagner F., Thomas C., CNES, Toulouse, France
- (P.28) **Swedish Small Satellites**  
Lundahl K., Swedish Space Corporation, Solna, Suede
- (P.29) **Let it run Automation of Ground Mission Operations and Satellite Testing Activities**  
Aked R., Ilzkovitz M., Vlyminckx F., Lobbrecht I., Space Applications Services (SAS), Zaventem, Belgique
- (P.30) **Dial-A-Sat: Access Links for Small Satellites via Commercial MSS**  
Colzi E, De Caunes H., Ribes A., Winton A., ESA/ESTEC, Noordwijk, Pays Bas

## RESUME PROJECT

Edgardo ROGGERO<sup>(\*)</sup>, Marcelo CEROCCHI<sup>(\*\*)</sup>, Javier SARAY<sup>(\*\*)</sup>, Darío BALDELLI<sup>(\*\*)</sup>

<sup>(\*)</sup> COMISION NACIONAL DE ACTIVIDADES ESPACIALES  
Av. Paseo Colon 751 - (1063) Buenos Aires - Argentina

<sup>(\*\*)</sup> UNIVERSIDAD TECNOLOGICA NACIONAL - Facultad Regional Haedo  
Paris 532 - (1706) Haedo - Argentina

*ABSTRACT - One of the missions of the Argentine national space agency (CONAE) is to promote the development of space activities within the national universities. For that purpose, and through an agreement between CONAE and NASA, Argentine universities had the opportunity to take part in the Space Experiment Module (SEM) Program, the aim of which is to take small payloads to space on board the Space Shuttle. CONAE issued an announcement of opportunities for selecting experiments from all over the country, and RESUME (Restrain Release Using Melting-Wire Experiment) submitted by the Universidad Tecnológica Nacional (UTN) was one of the payloads finally selected. The aim of this project is to perform design, analysis, test and flight qualification of a multipurpose original restrain-release mechanism for fastening deployable systems in spacecrafts. The mechanism obtained, based on a melting wire triggered system, has some interesting advantages regarding the classical approaches.*

### 1 - INTRODUCTION

The SEM program originates from the Get-Away Special (GAS) program. The goal of GAS, an ongoing program in the Shuttle Small Payloads Project since 1982, is to provide access to space for everyone. Recognizing the need to provide an easier access to space, the SEM Program was started in 1995. SEM focuses on the educational aspect of creating the experiment rather than the complexities of engineering to put that experiment into orbit, therefore in the SEM program NASA provides the services for these experiments. In this context and through the agreement between CONAE and NASA, the Universidad Tecnológica Nacional, one of the largest universities in Argentina, devoted to the teaching of Engineering and Technology with more than 70.000 students, had the opportunity to involve its students in the SEM Program by means of the RESUME Project, which is under responsibility of the Grupo de Tecnología Aeroespacial at the Facultad Regional Haedo of the UTN.

### 2 - RESUME MAIN OBJECTIVE

The main objective of this project was to *train human resources* performing the design, analysis, fabrication, tests and flight qualification of a multipurpose original restrain-release mechanism that could be used in deployable systems of spacecrafts and that had some interesting advantages regarding the classical approaches.

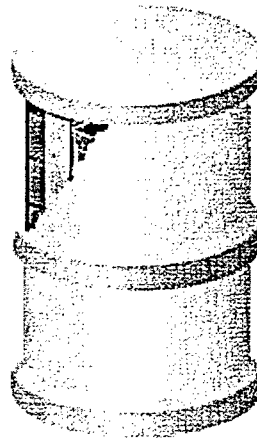


### 3 - SEM GAS CARRIER SYSTEM DESCRIPTION

As mentioned above, the RESUME shall be flown in a SEM, therefore in the following sections there is a brief overview of this carrier to describe its main characteristics from [Inter 00].

#### 3.1 - The Canister Assembly

The GAS Canister Assembly is a cylindrical housing used to support payloads in the Space Shuttle Cargo Bay. NASA has an entire fleet of GAS Canister Assemblies which are used to fly a wide variety of payloads. The Canister Assembly is made up of an open-ended aluminum canister with circular aluminum Upper and Lower End Plates. A canister may be attached to the Bay sidewall or on an across-the-cargo-bay bridge structure. Electrical cables connect the Lower End Plate to a computer located on the Space Shuttle flight deck. Astronauts use the computer to turn the SEM Carrier System ON and OFF. The inboard surface of the Upper End Plate provides the mounting surface for internal contents.

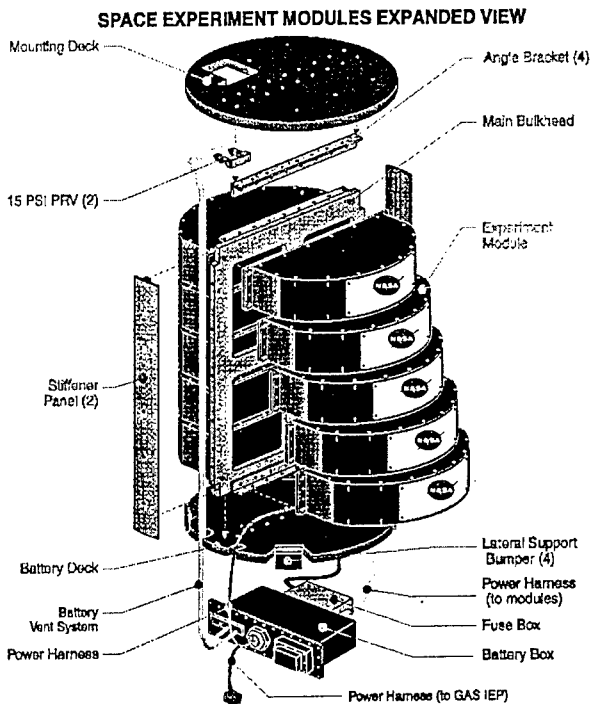


#### 3.2 - SEM Carrier System

The SEM Carrier System is a self-contained assembly of engineered subsystems which function together to provide structural support, power, and experiment command and data storage capabilities. The carrier system consists of a *canister* containing ten experiment modules. The SEM carrier hardware is contained in a standard, 5 cubic foot Get Away Special (GAS) canister.

#### 3.3 - SEM Support Structure

The support structure is the backbone of the SEM subsystems housed within the GAS canister. It serves as the mounting frame for the ten modules and the Power Subsystem components. Five basic components comprise the Support Structure: the Mounting Deck, Battery Deck, Main Bulkhead, two Stiffener Panels, and four Lateral Support Bumper Assemblies.



### 3.4 - Power Subsystem

Power is supplied to the SEM experiments by means of the Power Subsystem. The subsystem comprises the Battery Box, Fuse Box, and Power Harness. Both the Battery Box and Fuse Box are mounted on the Battery Deck. The active experiment modules are powered by one 12-Volt battery independent from the Shuttle power supply. Each powered module has an integrated programmable control circuit board or "Module Electronic Unit" (MEU) for power supply, data sampling and storage. The MEU processes the experiment-devised flight operations timeline, and its resources are utilized according to the experimenter's timeline. A *Ground Module Electronic Unit* is provided to selected active experimenters for development and testing purposes.

### 3.5 -SEM Software.

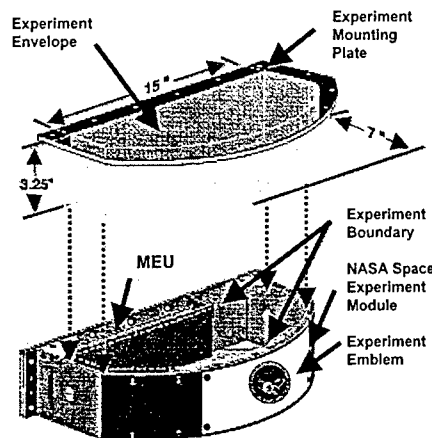
The SEM NASA-provided software is required for active experimentation. This software helps the experimenter describe the experiment. The data corresponding to power consumption, parts, materials, timeline and command & control are entered, and the information retrieved may be used to analyze the data for SEM compatibility and "post-flight" reports.

### 3.6 - The Space Experiment Module

The Experiment Module Subsystem of the SEM Carrier System has been designed as a generic housing to contain small (6 pound limit, 300 cubic inches) experiments. Each Module consists of a Frame, Electronics Bracket, Bottom, Cover, and Emblem Mount. The overall Module size is approximately 17.0 inches by 10.0 inches by 3.5 inches. Experiments may be active like RESUME or passive (depending on whether they use the power supplied by the carrier or are non-powered).

### 3.7 - Active SEM

The active experiment container uses the "Module Cover" as the Experiment Mounting Plate. The free space available for experiment apparatus in the Module is called the *Experiment Envelope*. The Envelope is a precisely defined volume outlined on the inside surface of the Experiment Mounting Plate and extends 3.25 inches below the inside surface. During the early state of the Shuttle flight, astronauts activate the SEM canister via the Payload and General Support Computer. For active experiments the MEUs carry out their unique programmed timeline defined by the experimenters.



### 3.8 - Miscellaneous

Experiments selected to participate receive a hardware package to support the construction and development of the selected experiment. The hardware package contents are determined by the proposed experiment design. Experiments must be shipped to NASA approximately four months prior to the scheduled flight. The SEM canister is generally installed three months prior to launch in the Space Shuttle cargo bay.

## 4 - EXPERIMENT DESCRIPTION

### 4.1 – Requirements

The experiment, as well as its components, must fulfill two types of requirements: those imposed by NASA for the SEM and those necessary to achieve a good performance system. It is thus necessary to look for a compromise solution where all simultaneous factors are taken into account, making all requirements compatible in order to obtain an optimum design. The main requirements that must be considered are summarized in the following table:

Origin	Main Requirements
NASA	Safety (Flammable, toxic, corrosive, explosive, etc.) Mechanical Interfaces (Mass, Volume, Shapes, Fasteners, etc.) Environmental (Vibrations, Temperatures, EMI-EMC, etc.) Electrical Interfaces (Battery Capacity, Voltages, Data Storage, etc.)
Product Performance	Originality, Low Cost, Reliability, Durability, Delivery Time.

Table 1: RESUME Requirements

### 4.2 – Mechanisms Category

Restrain/release (RR) mechanisms are essential elements in the space vehicles that must perform some kind of deployment operation in some of their components such as solar panels, antennas, booms, etc. There is a wide variety of these mechanisms that is not possible to describe in this paper. However these mechanisms can be divided in three different categories according to the kind of actuator that it is used. In the following table a description of the three categories is given with their corresponding typical actuators from [Farl 93]:

Category of the actuator	Typical Actuator
Pyro	Pin pullers, Bolt cutters, Separation nuts, etc.
Low shock	Non explosive initiators (NEI), Paraffin actuators, etc.
Miscellaneous	Thermal knives, Shape Memory Alloys (Frang a bolt or Sep nut), etc.

Table 2: Actuator Categories

As the first two categories are well known the RESUME attempts to explore a new concept in the range of the third category.

### 4.3 – RESUME Overview

Taking into account the objective mentioned in Section 2, and in order to obtain an efficient mechanism, the faster, cheaper and better concept was highlighted. How to go about to do it was the question. It is well known that some commercial mechanisms used on the ground are very cheap with a high reliability (for example automotive or industrial mechanisms cost one over hundredth or

less than the cost of each kilogram of space mechanisms; such parts also have a high reliability and are very easy to obtain) but only a few of them are able to satisfy the whole set of space environment requirements. Then the idea was to identify a mechanism which had been thoroughly ground tested and used for non-space purposes, then to adapt it in order that it might withstand the space environment with a satisfactory performance.

First of all an intensive study about space restrain-release mechanisms was performed; after that the investigation was focused on identifying which non-space mechanisms could perform an equivalent function. As a result of that investigation some devices were identified that could perform the functions wanted. From these mechanisms one was selected that could be analyzed, tested, easily built and handled in the most system harmonious and failure tolerant manner possible. Considerations included incorporating the entire life cycle loading and wear spectrum. The clearances between moving parts which undergo thermal expansions, and static and dynamic deflections both direct in nature or induced by spacecraft interface motions were also taken into account. After these studies only one system was adopted, considering a melting wire as actuator due to its interesting advantages over the classical systems in terms of safety, power consumption, simplicity, cost and delivery time.

#### 4.4 – Restrain-Release Functional Concept

As shown in Figure 1, the system is formed by two locks, Lower and upper, with balanced internal forces. Each lock has its own joint and are separated by Spring I that tends to separate them with great strength. The Lower Lock has a joint for the trigger on the right end. The Upper Lock has a wheel to facilitate the opening on the right end. On their left end, both locks are shaped as to allow for an effective restriction which may be changed without modifying the performance of the device. The trigger keeps the locks in position by pressing the wheel.

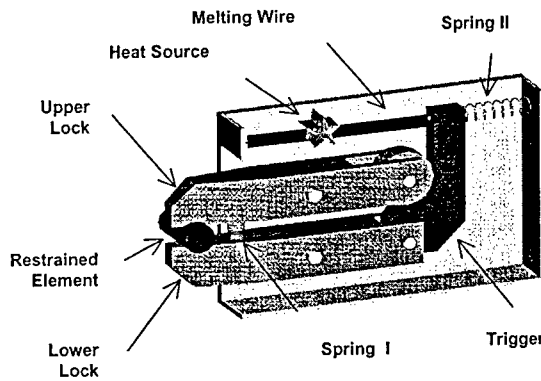


Fig. 1: Restrained State Scheme

In the restrained state position shown in the drawing, the force of Spring I is conveyed by the locks and is held by the trigger; here the system is stable and all reactions are internal. In order to open it, the trigger is rotated rightwards on its joint, it rests on the wheel (the movement is thus soft and continuous) until the Upper Lock is released. At this point the movement has become irreversible and due to the action of Spring I the locks quickly separate causing the release of the restrained element. Therefore, if the trigger is kept fixed it is not possible to liberate the restrained element; this is the purpose of the melting wire that fastens it to the housing. In turn, traction Spring II is installed from the trigger towards the body in order that when the melting wire (by means of a Heat source) is cut the Spring I may exert a force overcoming the resistance of the mechanism and open it, thus enabling the liberation of the restrained element.

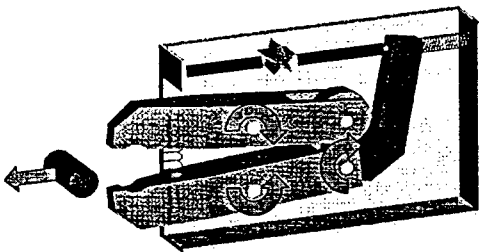


Fig. 2: Released State Scheme

To sum up, the operation is as follows: when connecting the Heat Source by the adequate command, the source shall start generating heat thus destroying the melting wire, Spring II shall act on the trigger liberating the locks which will rotate making it possible for the restrained element to be liberated. The Restrain-Release system can be divided in the following functional parts: *Mechanical System, Heat Source and Melting Wire.*

#### 4.4.1 - Mechanical System

Standard light-weight materials and corresponding aerospace manufacturing and design processes were used. All materials have outgassing rates lower than 1% T.W.L. and 0.1% CVCM, and all of them are also non magnetics. Metal parts are corrosion resistant or have a suitable protective coating applied. All part manufacturing, handling and assembling were done in a manner to ensure the highest practical level of cleanliness. For the performing Stress, Dynamic, Thermal deformation and Kinematics analyses, standard computational facilities were used, showing the results that the system behavior have good margins in all cases.

#### 4.4.2 - Heat Source

As mentioned above, the basic idea of the actuator consists of the heating of a melting wire until it is cut. The principle of operation consists then of heating, using Joule effect, a metal wire resistance (of an ad-hoc design) since it was shown that it was the most satisfactory cost-performance alternative. A series of development tests were performed under different environmental conditions in order to select the most suitable configuration and evaluate its performance. To summarize it may be said that from the moment when the Heat Source is enabled until its opening, the mechanism shall wait the times detailed further down (the opening itself lasts just a few tens of microseconds):

Temperature [°C]	Average Value [sec]	Standard Deviation [sec]
- 10	1,94	0,03
+ 50	1,48	0,03

Table 3: Release Time Duration

As it may be seen times are not significantly influenced by the environment temperature at the time of enabling the Heat Source; in addition, due to the design conditions the heat concentrates on the zone of the melting wire to be cut.

#### 4.4.3 - Melting Wire

As stated in Section 4.4, its purpose is to keep the system in restrain position until it is cut by the action of the Heat source. It is the only element that must be changed every time the mechanism is used, since it is a One Shot, mechanism. A largely varied series of materials and configurations was investigated and the development tests showed that polymers had a suitable behavior for the function of supporting the specific requirements of this element (tension loads, low aging, creep, fusion temperature, safety, just to mention some of them). Among polymers, a material from the family of polyamides was selected for the benefits rendered by its characteristics that were well above those of all other materials analyzed.

#### 4.5 – Electrical Unit

This unit is particular for SEM since it works as an electrical link between the restrain-release Mechanical System and the MEU provided by NASA. This electrical interface adapts the Power and Signal lines as to be fully compatible with the Power and Signal restrictions of the MEU. All components of this Electrical Unit are passive and all information shall be stored in the MEU. A summary of the lines used in the RESUME is shown in the following table (the returns are not included):

NASA Designation	Objective
Power Output 1 A +12V	To Supply Power to Experiment
Experimenter Analog 1	To compute the Power Consumption of the Heat Source
Thermistor 1	To Measure Experiment Temperature
Thermistor 2	To Measure Experiment Temperature
Thermistor 3	To Measure Experiment Temperature
Experiment Current	To Compute RESUME Power Consumption
SEM Battery Power Monitor (+12V)	To Monitor the Battery of all Experiments
MEU Power Supply (+5V)	To Supply RESUME MEU Power
MEU Thermistor	To Measure MEU Temperature

Table 4: Electrical Lines

#### 5 – QUALIFICATION TESTS

A test plan to perform a complete set of environmental qualification tests was already performed following the recommendations of [Miln 96] and [Prod 99]. At this time the Mechanical Qualification (Life Tests, Mechanical Function at extreme temperatures, Random, Sine Vibration and Sine Burst) of this experiment has been fully performed without degradation in the performance of any of the components.

#### 6 – FLIGHT EXPERIMENT

##### 6.1 – Components

In this Section the actual flight experiment will be described: which components shall be integrated to SEM and the way in which they shall operate, including the corresponding timeline. The system to be placed into orbit may be divided into 4 items with components bearing the following characteristics:

1. *Restrain-Release Mechanism A*: It is a complete RR mechanism, in restrain status, containing a restrained element for simulating the mechanical load of an actual application. It shall be electrically connected to the Electronic Unit and shall be activated in orbit to cause the release of the restrained element.

2. *Restrain-Release Mechanism B*: It is a complete RR mechanism, in restrain status, containing a restrained element simulating the mechanical load of an actual application. It will not be connected electrically and it will not be activated in orbit; its mission is checking the system integrity after experiencing launching, orbital flight, reentry and landing environments.
3. *Electronic Unit*: It shall fulfill the mission specified in Section 4.5, it will be connected to Restrain-Release Mechanism A, enabling its activation and data collection.
4. *Thermistor*: There will be three YSI 44006 provided by NASA and they will measure temperatures of three points on RESUME during its activation.
5. *Mounting Plate*: All other components shall be mounted on this NASA-provided hardware.

## 6.2 - Time Line

Power to the SEM carrier system is turned on hours after launch by Astronaut command. Following activation, the Module Electronics Unit (MEU) in each module will follow its unique experiment timeline to activate control and sampling functions. The RESUME timeline data is uploaded to the flight MEU. Only four simple commands are currently possible: a) turn on (SET) a power port, b) turn off (RESET) a power port, c) begin sampling a data channel at one of the allowed sampling rates, and d) stop sampling by setting the sample rate to zero. The experiment clock is started at the time the experiment system is turned on by the astronaut crew and the time interval increases at one second intervals. Experiment time is specified as days, hours, minutes, and seconds since turn-on. Successive times in the timeline file are the same or greater than previous statements.

A total of 60 watt-hours of power is available for the entire duration of the spaceflight. The ground software helped determine if this limit is exceeded. Data sampling for the various data channels is initially set to zero or no sampling. A rate (RATE) command sets the sample rate for the specified channel. Sampling continues at the specified rate until the rate is set again. The SEM software will also compute energy consumption, and memory used, and will flag any attempt to exceed the parameters allowed. In the following table there is a summary of the RESUME time line that permits us to understand the functioning of the experiment.

EVENT	START	END	EACH
Thermistor Measurements	0"	20'	5"
Heat Source Current Monitoring	4' 30"	5' 30"	0,2"
	9' 30"	10' 30"	0,2"
	14' 30"	15' 30"	0,2"
Heat Source Activation	4' 58"	5' 02"	Not Applicable
	9' 56"	10' 04"	
	14' 54"	15' 06"	

Table 5: Timelines

This sequence make it possible to identify the temperature at the release time, the time duration between the Heat Source Activation and the release, the power involved during release, the Heat Wire status during the experiment time. The release commands are twice redundant, increasing the time duration of the Heat Source activation.

With this process and using ground analysis of the information originated during flight (including inside measurements performed by MEU) and the visual inspection of flight Hardware, it will be possible to reproduce and interpret on the ground the orbital events, making it possible to evaluate the system during flight, taking into account that such qualification does not only include take-off but also orbital flight, reentry and landing.

**7 – CONCLUSIONS**

The main objective of this experiment was to train human resources: this has been achieved with success because it enabled engineering students to face the design, analysis and fabrication processes of an actual aerospace mechanism materializing a very useful link between the academic knowledge and an actual space application project.



As a secondary achievement, it has been possible to obtain mechanism which has some interesting differences over conventional solutions, some of which are described using the RESUME as a reference item in the following table. It is necessary to remark that the RESUME mechanism is available to any institution that considers such a mechanism useful for its space projects.

	Power	Mass	Cost	Safety
RESUME	1	1	1	High
Paraffin Actuators	100	2	> 2	High
Pin Pullers	0,01	1	> 2	Low

**Table 6:** RESUME Performance

And finally, *why RESUME should be flown in the STS*, our answer is because any design may be made to work. It is a matter of how much attention is given to the detail. Complexity and risk, cost and schedule will determine the level of required work for details, but only flight experience will give it the due respect.

**8 - ACKNOWLEDGMENT**

People from CONAE and UTN have contributed their time without which this project would have not been possible. Our special thanks to: Dr. Marcos Machado, Hilde Torres Perrén and Julio Vega from CONAE and Roberto Diaz and Elio Biagini from UTN-Regional Haedo.



## 9 – REFERENCES

- [Inter 00] "Internet SEM Page – [www.wff.nasa.gov/~sspp/sem/sem.html](http://www.wff.nasa.gov/~sspp/sem/sem.html)", *NASA*, April 2000.
- [Conl 98] Conley: "Space Vehicle Mechanisms", *John Willey & Sons, Inc*, March 1998.
- [Purd 94] Purdy: "Advanced Release Technologies Program", *Proceedings of the 28<sup>th</sup> Aerospace Mechanisms Symposium*, 1994.
- [Rogg 00] Roggero, Cerocchi, Saray: "Nota Técnica de Diseño, Ensayos y Construcción del Proyecto RESUME", *UTN-FRH*, March 2000.
- [Rogg 00] Roggero, Cerocchi, Saray: "Plan de Ensayos Funcionales y Ambientales del Proyecto RESUME", *UTN-FRH*, March 2000.
- [Miln 96] Milne, Garvin, Baumann: "General Environmental Verification Spec. for STS & ELV Payloads, Subsystems and Components", *NASA-GSFC*, June 1996.
- [Prod 99] "Product Verification Requirements for Launch, Upper Stage, and Space Vehicles, MIL-STD-1540D", *Department of Defense (USA)*, January 1999.
- [Astr 71] "Astronautics Structures Manual - NASA TM x 73306", *NASA-MSFC*, 1971
- [Dall 89] M. Dall Argine, E. Roggero, "Software for the Optimum Design of Spacecraft Structures", *Pan American Congress Of Applied Mechanics, Rio de Janeiro*, 1989
- [Stru 94] "Structural Materials Handbook - ESA PSS 03 203", *ESA*, 1994
- [Meta 92] "Metallic Materials and Elements for Aerospace Vehicle Structures, MIL-HDBK-5E", *Department of Defense (USA)*, June 1987.
- [Frac 88] "Fracture Control Requirements for Payloads using NSTS, NHB 8071.1", *NASA*, September 1988.
- [Desi 87] "Design Criteria for Controlling Stress Corrosion Cracking, MSFC-SPEC-522B", *NASA-MSFC*, July 1987.
- [Safe 87] "Safety Policy and Requirements, NSTS 1700.7B", *NASA*, January 1987.
- [Mech 94] "Mechanical Systems Safety, Memo JSC TA-94-041", *NASA*, 1994.
- [Camp 93] Campbell, Scialdone: "Outgassing Data for Selecting Spacecraft Materials, NASA RP 1124", *NASA*, September 1993.
- [Farl 93] Farley: "Spacecraft Deployable, Quick Reference Guide", *NASA*, December 1993.
- [Cust 94] "HH Customer Accommodations & Requirement Specifications, HHG-730-1503-07", *NASA*, 1994.

# SATELLITE TRACKING FROM THE TOP OF THE WORLD; OPERATION OF A MULTI PURPOSE GROUND STATION AT 80°N<sup>\*</sup>

Rolf Skatteboe  
Norwegian Space Centre  
P.O.Box 113 - Skøyen, N-0212 Oslo, NORWAY  
E-mail: [rolf.skatteboe@spacecentre.no](mailto:rolf.skatteboe@spacecentre.no)

## Abstract

Svalbard is ideally suited for services related to data reception and control of polar orbiting, earth observation and space science satellites. Data from which Norway utilities for near real-time services in areas such as ice monitoring and ship detection.

Recognising the demand for cost-effective and flexible solutions for the increasing number of Low Earth Orbiting Earth Observation and Meteorological Satellites, NSC has focused on flexible operation and multi-purpose use of ground station equipment. NSC has therefore developed a multi purpose ground station for satellite control and data reception called the Svalbard Satellite Station (SvalSat).

The overall satellite operation can be optimised because a ground station at Svalbard have contact with a satellite in polar orbit on all 14 of its orbits per day while two stations would be required at lower latitudes. This gives operational simplicity and cost savings.

Key words: satellitettracking, cost-effective operation,

## 1. Introduction

The Norwegian Space Centre (NSC) has as one of its priorities to develop new space related infrastructure where Norway has special advantages and needs.

The Archipelago of Svalbard, through its unique geographical location at almost 80° N and well developed infrastructure, opens for such developments.

Svalbard is ideally suited for operational services related to data acquisition and

control of low earth orbiting earth observation, meteorological, space science and other satellites in polar orbits. This paper introduces the Svalbard Satellite Station (SvalSat) which is designed by the Norwegian Space Centre as a multi purpose cost-effective ground station for satellites.

Locating a ground station at Svalbard opens for optimized and cost-effective operation, because such a ground station will have contact with a satellite in polar orbit on all 14 of its orbits per day (24 hours) for orbits over 500 km, while two stations would be required at lower latitudes.

Furthermore, Norway has a special interest in data from LEO earth observation satellites as a result of its long cost and large ocean area. Several institutions in Norway utilities data received from such satellites in near real-time services in areas such as ice monitoring and ship detection. These applications are briefly discussed in this paper.

## 2. Background

In the late 1960 the predecessor of the European Space Agency (ESA), the European Space Research Organization (ESRO) needed a high latitude ground

<sup>1</sup> Poster at the 5th International Symposium on Small Satellite Systems and Services, La Baule, France, 19 – 23 June 2000.

station for its science satellites. After a careful evaluation of candidate sites in northern Europe they decided to use Svalbard and a satellite ground station was built in the small township of Ny-Ålesund.

The ESRO-station served its missions successfully, but since Norway was not a member of ESA at that point in time, the station was closed down when the program ended.

However, since the mid 1970 when the station was closed, the idea of a multi purpose ground station at Svalbard has been kept alive. As a result of an agreement between the Norwegian Space Centre (NSC) and NASA together with requirements from the European Meteorological Organization, Eumetsat, NSC in 1996 decided to develop a multi purpose ground station for satellite control and data reception.

The station is called the Svalbard Satellite Station (SvalSat). As a result of the increased demand for cost-effective and flexible solutions and the increasing number of Low Earth Orbiting Earth Observation and Meteorological Satellites, NSC has focused on flexible operation and multi-purpose use of the installed equipment.

The station is currently in operation and serves the NASA Earth Observing System line of spacecraft.

### **3. The Svalbard Satellite Station (SvalSat)**

Satellites are essential for comprehensive monitoring of the global environment. Hence, such satellites today require an

extensive network of ground-based station to operate efficiently.

Svalbard, located at almost 80° N, is ideally suited location to perform operational services related to data reception and control of polar orbiting satellites. Such satellites are usually designed to store the data registered during an entire orbit and read it out on a down-link whenever they pass over a ground station. This is particularly important for global meteorological services.

Svalbard's location is shown in Figure 1. SvalSat has contact with a satellite in polar orbit on all 14 of its orbits per day (24 hours). For a typical earth observation satellite the connection time is above 15 minutes per orbit, using a two degrees horizon from the local masking. Overall, this is significantly better than any polar ground station in operation today. This is shown in Figure 2.

In comparison, the Tromsø Satellite Station (69° N) and other polar ground stations has contacts up to 10 of the 14 polar satellite orbits per day. Svalbard is also readily reachable, has proven telecommunication services and an efficient infrastructure. Consequently, the Svalbard archipelago is unique as a site for a ground station serving satellites in polar orbits. The location is shown in Figure 3.

This is the predominant motivation for the development of SvalSat. Because 100 % coverage is obtainable, it is the best location to access data stored on board polar orbiting satellites. SvalSat can in a one-station configuration can receive all the data and control the satellites, while two stations would be required at lower latitudes. This allows cost effective and competitive operation.

#### **4. Serving the Mission to Planet Earth Program and NASA satellites**

The fact that NASA selected Svalbard for their next generation Earth observing satellites, the Earth Observing System (EOS) of the Mission to Planet Earth program was the initiating factor to the SvalSat development. NASA and NSC entered into a cooperative agreement to install and operate a satellite and launch vehicle tracking station on Svalbard. The agreement is making SvalSat an integrated part of NASA's EOS Polar Ground System.

The general division of responsibility between NSC and NASA is that NSC will provide the infrastructure associated with the physical property where the tracking, data acquisition and control facility is located. This physical infrastructure is called Svalbard Satellite Station (SvalSat). NASA has provided the instrumentation, including the antenna(s) necessary for its mission unique requirements. NASA's installation is called the Svalbard Ground Station, SGS. This split of responsibilities allows NSC to optimise the mission independent ground infrastructure as well as operation and maintenance services.

#### **5. Ground station development**

The initial marked interest in 1996 resulted in the development of a multi purpose ground station for reception of global, stored data and satellite control on the Platåberget (450 m above sea level), close to the main settlement at Svalbard, Longyearbyen.

The station is equipped for ranging, health monitoring, tracking, data acquisition and control of LEO satellites and launch vehicles.

NSC's goal has been to build a flexible ground station with basic infrastructure required to facilitate the installation and operation of such a ground station, and to offer this infrastructure for use by satellite operators world-wide. As a part of SvalSat, reliable telecommunication services to and from the Svalbard are implemented.

The development of the basic infrastructure has been conducted in two phases and comprises the following items:

- Access to the plateau (Platåberget) and roads,
- Provision of basic utilities such as power, telephone and data communication, water sewage disposal,
- Provision of antenna and radome foundations for NASA technical installations,
- Site survey to define masking, antenna positions, boresight location etc.,
- Station building.

The development of SvalSat has been supported by the Norwegian Government, as one alternative to supplement the on going coal mining activity, upon which the economy of the Archipelago is dependent.

As a result of this, the baseline for the SvalSat Concept has been:

- Maximise the use of existing infrastructure,
- Reduced operational cost by joint development, as well as operation and maintenance services,
- Localisation based on operational requirements and cost-effective infrastructure,
- Development based on market demand,
- Satisfy as many potential users as possible, without violating individual requirements.

## 6. Good telecommunications

Reliable telecommunications are a prerequisite when a ground station for satellite operation is established. At Svalbard all the usual services such as telephone (voice and fax) as well as high speed data links are available. The communication and data transfer services are provided by the Norwegian PTT provider Telenor. The special feature is that all com links are using satellites.

Since 1976, Isfjord Radio, Telenor's node on Svalbard, has operated satellite links from Svalbard to the mainland. The reliability and accessibility of these services are now solidly documented. A 52 Mb/s satellite link through Intelsat 707 in 1° W is implemented between Isfjord Radio and NASA Goddard Space Flight Centre in Maryland, USA. In addition, a double redundant Earth-based microwave link with 150 Mb/s capacity is transferring the data from Longyearbyen, one of the redundant uplink sites at Isfjord Radio.

The link has been operated since 1987 with a reliability of 99.5 %, with a Bit Error Rate (BER) better than  $10^{-6}$ . The Ku and C-band antenna which is used for communication has an elevation of 2.9°. The excellent communication reliability is achieved because of the dry, arctic environment.

Consequently, a major advantage of a data down-link to Svalbard is that data can readily and inexpensively be distributed throughout Europe and the USA via satellite. See Figure 4 for details.

## 7. General comments

The Svalbard Archipelago where Spitzbergen is the main island, is a group of

islands located between 10° and 35° E, and between 74° and 81° N. The Svalbard Treaty of 9 February 1920, originally signed by 10 countries among them Norway, USA and Japan, states the full and absolute sovereignty of Norway over the Archipelago. The Act of 17 July 1925, implementing the Svalbard Treaty, includes Svalbard as a part of the Kingdom of Norway, thus placing it under full Norwegian jurisdiction.

Svalbard Longyearbyen is the Norwegian administrative centre on Svalbard. It has about 1000 residents and offers all customary governmental and private services. Longyearbyen has a coal-fired power station which supplies electricity and district heating to the whole town. There is an airport of international standard, with daily, scheduled flights and the quay can accommodate oceangoing cargo vessels. Hotels are available, and there are several restaurants and cafes. Climatically, Svalbard is an "arctic desert". The annual average precipitation is only 200-300 mm. The mean monthly temperature varies from -14° C in the winter to +6° C in the summer. The Gulf Stream, which flows up the West Coast of Svalbard, is the cause of the relatively mild climate. It also keeps the surrounding waters free of ice, normally from May to November. Longyearbyen enjoys the midnight sun from 20 April to 20 August, whilst the sun does not come over the horizon from 28 October to 14 February.

## 8. Serving meteorological satellites

The National Oceanographic and Atmospheric Administration (NOAA) in the USA has operated a meteorological system used for US and European weather forecasting. Its space segment comprises three satellites to achieve the required coverage.

Europe, represented by the European meteorological organization Eumetsat, has now agreed to assume responsibility for half of the system. Consequently, an around segment must be built. The demands on the ground station are strict, and include full redundancy, which requires two fully operational stations, one of which can assume operation if the other fails. The requirements for telecommunications services are equally strict, to ensure that information is always made available to users.

Eumetsat is therefore evaluating ground segment concepts, and will in the near future choose to include a main ground station at Svalbard. It provides Eumetsat with an independent flexible system, involving minimum installation. Financially, a station on Svalbard can be extremely efficient and can serve both EUMETSAT and NOAA. This has been proposed by NSC and the parties have agreed to jointly study this possibility further. This development is the next step to make SvalSat the full multipurpose ground station.

### **9. Multi purpose ground station**

A multi purpose ground station is in this context defined as a ground station designed to accommodate different types of equipment and to serve different spacecrafts for different users using standard and common equipment.

The ground station layout is also optimized with respect to operational efficiency and reliability.

To develop a true multi purpose ground station it is important to consider both technical, operational and managerial issues. In addition, the installation of the basic infrastructure must be carefully

designed for cost savings.

The basic infrastructure covers power, utilities, access roads and the station building. The actual layout of the antenna park is also important for an optimized operation. At SvalSat, the antennas are located in a web and around the station building to minimize the distance between the antennas. The latter is important to maintain sufficient spacing to avoid horizon blocking by local obstacles. A separation of 200 m between antennas gives a local horizon of less than two degrees, which is acceptable.

In the station building itself, the telemetry hall is the core of the station. Since the station is designed to serve several spacecrafts that may need different equipment, a common operation room is located close to the telemetry hall. Such a control room is a necessary prerequisite when a common crew is operating different types of equipment.

Traditionally a ground station is designed for one user, and this user, or satellite operator, may decide the amount of safety or redundancy needed to obtain the requested availability. If for example all the satellite owners should bring their own Uninterrupted Power Supply (UPS), it would have been difficult to maintain the system. It is much better to combine the primary power system with a flywheel (or similar) equipped diesel backup generator, and provide full UPS coverage for the entire station from a single source. This approach is too expensive for one user alone, but is affordable in a multi user set-up.

The operation and maintenance (O&M) is also an important area to consider for a multipurpose ground station. Today several

antenna installations are claimed to be automatic, or at least automatized, so that they can be remotely operated. To achieve the operational reliability of 99.98 % which is required by operational services, this is not achievable with an unmanned station. The European Meteorological organization Eumetsat, for example, has such requirements for its METOP series of satellites. The data from the satellites shall be delivered to the different European Meteorological Offices less than 24 hours after capture, and obviously, one cannot accept a lost part or delay because an automatic station fails. Of course redundancy may reduce the probability for such failures, but this again has a cost. At SvalSat the concept of a basic crew is introduced. All the users are sharing the cost of a basic crew, which provide standard O&M duties for all installations/users at the station. This is significantly cheaper than having all users independently employ O&M personnel.

Technical issues are important to streamline the operation. Traditionally, all technical installations (antennas) are controlled from separate consols. Scheduling information and other parameters are introduced directly from the consol, a method that is both time consuming and where errors do occur.

At SvalSat, the equipment is designed so that all monitoring and control can take place from a dedicated control room. The skill of the O&M personnel is also different from "traditional" operators to engineers with significant SW skills. If a malfunction occurs, the solution in most cases is only a SW-problem away. Redundant equipment will be interchangeable using SW controlled data routing. The different items discussed so far in this paper do not constitute any novel technical development when seen on detailed basis. Since cost

saving is the major driver for any new station, proven reliable solutions have been chosen. The new aspect is merely how they are combined and how the new station is designed.

#### **10. The Shopping Mall Model**

The management of a ground station will often become difficult when too many individual requirements shall be maintained. The NSC ground station SvalSat is therefore organized like a shopping mall, therefore the name "The Shopping Mall Model".

The owner of the station is like the owner of a shopping mall. He ensures that all the necessary services are operating cost-efficiently and that ample space is available for the shop owner, the tenants. The different antenna locations, currently 9 at SvalSat, are then rented out to the tenant, like store space in a shopping mall.

Figure 5 show how the Shopping Mall Model is implemented to serve several users, fulfilling the requirements set forth in the previous chapter.

For the satellite operator, life becomes much easier because they only have to think of the interface between the ground station and their precious satellite and not on infrastructure issues on the ground. It also accommodate the requirements, since most larger satellite owners/operators wish to have direct control of their satellites.

#### **11. Global Ground Network Services**

Recently several companies have presented their ideas of providing global network of ground solutions, so that a satellite owner can call up and request ground station support on a per pass basis. This approach

may very well serve users to smaller systems with less constraining operational requirements. For the larger institutional satellite owners, such as Eumetsat and NOAA, the data delivery requirements are so strict that they need a fixed set up. For these users, a multi purpose ground station, where cost saving is achieved by careful design and cost-efficient operation (splitting of costs) between the users, are preferred.

## 12. Earth observation applications

The space activity in Norway has been concentrated in a few areas. In addition to the development of space related ground-based infrastructure, the development of services and applications using data from earth observation satellites, are of particular importance.

Applications and operational services are developed with emphasis on near real time marine applications. Emphasis is on radar and other microwave sensors, in particular Synthetic Aperture Radar (SAR). Norway therefore participates in ESA's ERS-1, ERS-2 and the ENVISAT program. Norway has also agreements with RADARSAT data which has proven to be very useful for our applications.

The main applications areas are:

- ice mapping, monitoring and forecasting
- ship detection and surveillance
- oil spill detection and monitoring
- wind and wave input to meteorological models
- ocean pollution and biomass production monitoring
- atmospheric monitoring
- satellite calibration and validation

The geographical areas of interest are primarily those limited by the area covered from the Tromsø Satellite Station and

Svalbard Satellite Station (SvalSat). Emphasis is on the coastal zone and the marginal ice zone of the Arctic. A very interesting prospect for the future is the real time use of SAR-imagery for navigation through the North East Passage between the Barents sea and the Bering strait. This would support the shortest shipping route between Europe and Japan applying active ice monitoring and ship detection. The Norwegian offshore oil activity is using satellite imaging for oil spill and sea page studies.

The market for operational services is expected to increase considerably in the years to come and the development of dedicated hardware and software that has taken place over the last 10 years are starting to pay off.

The Tromsø Satellite Station (TSS), a subsidiary of NSC, is developing the new application and is providing all operation and maintenance services (O&M) at SvalSat. Examples are given in Figure 7 and 8.

## 13. International cooperation

Space related activities are international in nature. International and national cooperation is essential in the Norwegian strategy for research and industrial development.

Norwegian industry and organizations are working in an international market and have strong focus on the development of international relations. Hence, SvalSat is open for international cooperation.



#### **14. Conclusion**

Through careful design and implementation, SvalSat is developed as a multi purpose ground station. A combination of geographical location, technical design, carefully layout, and the operational model is making SvalSat a cost-effective alternative for satellite owners world wide

## "NOVEL RANGE MEASUREMENT SYSTEM"

**M. Jean-Louis CARAYON**

*CNES*  
ED/MS/IM Microsatellites Division  
18, Avenue Edouard BELIN  
Bpi 2220  
31 401 TOULOUSE Cedex 4

Tél : 33 (0)5 61 27 43 07  
Fax : 33 (0)5 61 27 42 28  
Email: [Jean-Louis.Carayon@cnès.fr](mailto:Jean-Louis.Carayon@cnès.fr)

**Christophe CHATAIN**

*ELTA*  
Commercial  
BP 48  
31702 BLAGNAC CEDEX

Tél. : 33 (0)5 61 16 32 00  
Fax : 33 (0)5 61 16 32 01  
E-mail : [c.chatain@elta.fr](mailto:c.chatain@elta.fr)

*" For more than 4 years CNES has been developing a mini and micro-satellite product range able to meet requirements with different scientific missions.*

*ELTA has added, in the automatic and modular TTC earth ground station operated for these projects, a novel "satellite-earth" range measurement system patented by CNES (M. Jean-Louis CARAYON). This system allows range measurement even for distances above 40 000 Kms.*

*ELTA has also manufactured the engineering model of the on-board measurement system, which is interfaced with the microsatellite on-board computer.*

*This novel solution:*

- *Allows resynchronisation of the on-board clock with UNIVERSAL TIME,*
- *Gives accurate measurement of the distance between Satellite and Earth Ground Station (EGS),*
- *Obviates on board GPS.*

*This new function reduces by the same way mission costs.*

*The DISTANCE is computed on-board with:*

- *The elapsed time between on-board TM emission and the beginning of EGS frame reception,*
- *The elapsed time between TC emission from the earth ground station and the beginning of on-board Frame reception.*

*The UNIVERSAL TIME is computed on-board with:*

- *The UNIVERSAL TIME coming from earth ground station TC emission,*
- *The satellite distance computed before.*

*This new system complements ELTA's range of mini and microsatellites TTC earth ground station products and the poster illustrates this new method to measure the Satellite - earth range".*

## THE AGILE MISSION

Carlo MUSSO, Mauro AUGELLI, Marino CRISCONIO, M. Cristina FALVELLA,  
Paolo GIOMMI, Alberto PELLIZZONI, Giovanni VALENTINI, Giovanni F. BIGNAMI

*Agenzia Spaziale Italiana, Viale Liegi, 26 - 00198 Roma, Italy*

**ABSTRACT** - In 1997 the Italian Space Agency (ASI) started a national Science Small Mission program selecting the first two missions of the program: AGILE & DAVID. Since the new passwords for approaching space are "cheaper, faster AND better", in order to do things really "better", some effort should be spent to define the right way to be "cheaper" and "faster".

First of all, science has to be dimensioned in a realistic way. The gamma-ray observatory AGILE is a technologically innovative, but simple payload. The punch of the mission relies on two simple ideas: i) AGILE will fill a gap in the high-energy astronomy during the first years of next century; ii) due to its very large field-of-view (~ 1/5 of the whole sky), AGILE will be able to complete its observational program within the two years of nominal life.

Moreover, for the first time in the Italian space panorama, a program will be managed at system level by ASI via an operational center created ad hoc, which coordinates industries and takes the responsibility to deliver the satellite.

Finally, ASI is developing a permanent Science Data Center which, in collaboration with the hardware institutes, will take care to process, archive and distribute them accordingly to the Science Management Plan, and will generate and maintain a multi-mission archive, including a variety of public multi-wavelength data.

### 1 - INTRODUCTION

Space activities in Italy are defined, at high level, via a political document, the National Space Plan (PSN), prepared by the Italian Space Agency (ASI) and approved by the Ministry for University and Scientific & Technological Research.

The PSN defines strategies and objectives of national space activities, both for applications and science, without entering into the details of their implementation. Therefore, in general, specific programs are not mentioned throughout the Plan. Exceptions have been made in a few cases, considered of crucial interest for the Italian space policy.

This is the case of the Science Small Mission program [Dipi 99], which is intended as a complement with respect to major international projects, in which Italian scientists are deeply involved. The requirements of the PSN were reflected into the operational guidelines of the Agency, which foresees to launch a small satellite every about two years, starting from 2002.

ASI started the program in 1997, issuing a "Call for Ideas" open to the whole Italian scientific space community, covering Astronomy, Fundamental Physics, Earth Observation and Science of Engineering. More than 50 proposals were submitted to ASI and, by the end of 1998, the first two missions of the program were selected: for the first flight opportunity the  $\gamma$ -ray mission AGILE - "Astrorivelatore Gamma a Immagini Leggero" or "Extremely Light Imager for Gamma Astronomy" -, has been chosen, while DAVID - "Data and Video Distribution" - will follow.

During last years, the new passwords for approaching space seem to become: *cheaper, faster AND better* (CF&B). Anybody can understand that such an objective is easier to be said than reached. In fact, in order to do things *really* better, particular care should be taken in defining the proper way to be cheaper and faster.

Hereafter we discuss some of the critical points which potentially can affect, positively or negatively, the development of a space mission, following the CF&B principles.

## 2 - SCIENCE

In a scientific space mission, the first attack to the CF&B philosophy generally comes, no to say, from science itself. In fact, it is obvious that, when a flight opportunity is given to some group of researchers, they will immediately try to maximize the scientific return, starting to improve the performances of, and therefore to increase the requirements on, the instruments. This attitude would cause the growth of all the payload budgets (power, mass, money, ...), especially in case the scientific objective of the program has not been clearly defined and dimensioned from the very beginning, accordingly with the class of the mission.

This does not mean that, if a mission is small, the science performed shall be 'small' as well. The point is that, in order to obtain remarkable results with limited resources, techniques and objectives must be clearly identified and linked each other in the most fruitful way.

The gamma-ray observatory AGILE [Tava 99] is a technologically innovative, but simple payload, composed by four instruments: a solid-state self-triggering silicon-tracker, providing both imaging and timing capabilities in the energy range from 30 MeV up to 50 GeV; a CsI(Tl) activated scintillation mini-calorimeter, which complete the  $\gamma$ -photon energy reconstruction; a coded-mask X-ray monitor, which will detect hard X-rays (10-40 keV) of transient sources exploiting the same technology developed for the tracker. The combination of  $\gamma$  and X data will provide a multi-wavelength information of the high-energy sky. The main characteristics of the AGILE mission are summarized in Table 1.

Optimal orbit	Equatorial, 550 km
Payload mass	~ 60 kg
Bus mass	120-130 kg
Spacecraft total mass	180-200 kg
Payload required power	~ 80 W
Downlink telemetry rate	~ 500 kbit/sec
Mass Memory	500 Mbit
Attitude control	3 axes stabilized
Pointing accuracy	0.5-1 degree
Pointing reconstruction	1-2 arcmin
Nominal lifetime	2 years

**Table 1:** AGILE mission main characteristics

The real punch of the mission, which makes of the small AGILE a very intriguing mission, relies on two simple ideas:

1. AGILE will found its natural and fruitful collocation filling a gap in the high-energy astronomy during the first years of next century. In fact no other gamma-ray missions are foreseen to explore the same energy range observed by AGILE in the same time (Fig.1).

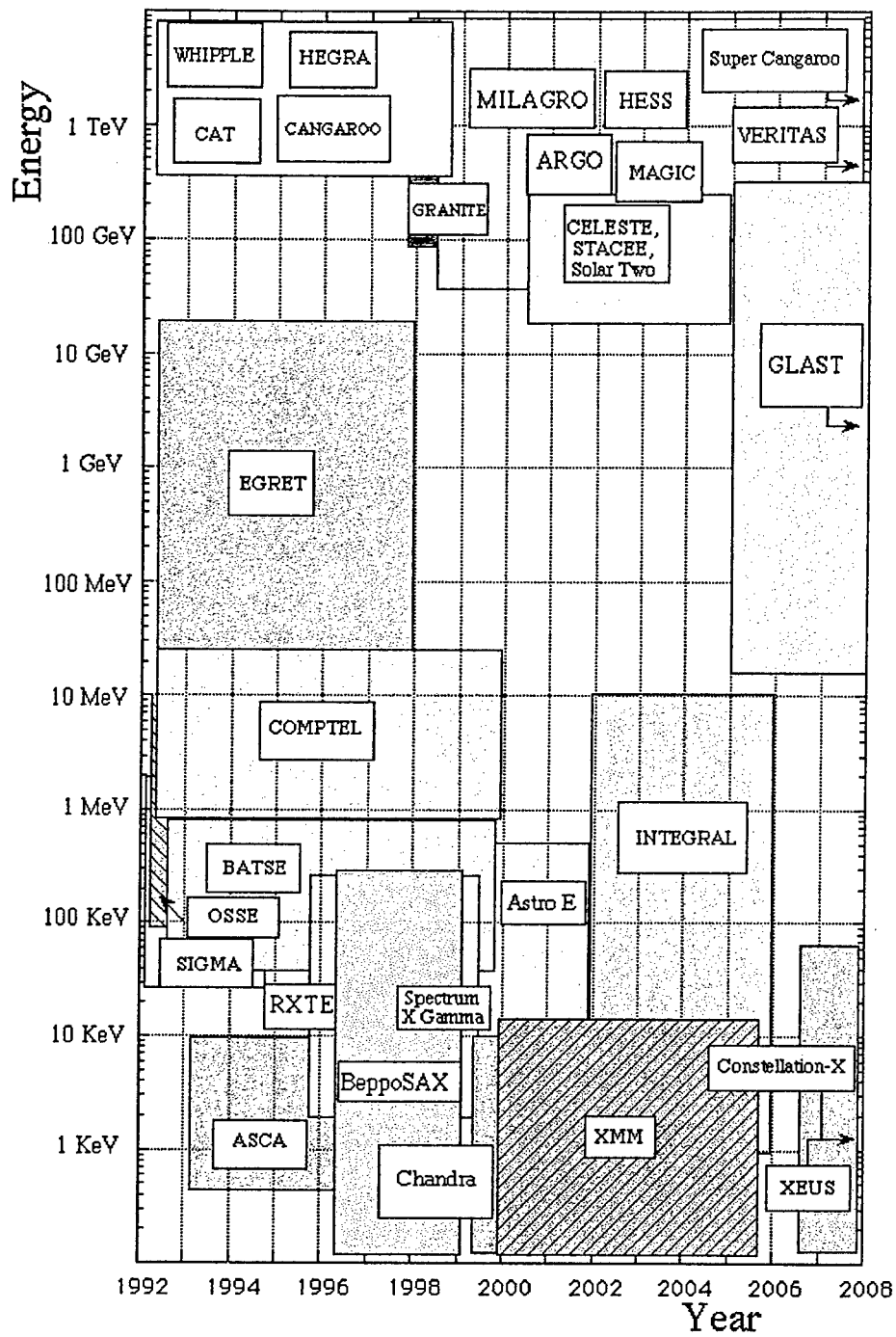


Fig. 1: Panorama of high-energy missions. AGILE will fill the ('02-'04) \* (30 MeV-50 GeV) gap.

2. AGILE will have a very large field-of-view (about 60 degrees or 1/5 of the whole sky!) with a flat response (Fig. 2). Thank to this peculiarity, AGILE will be able to detect a lot of sources in each 15 days observation and, therefore, to complete the approved observational program, including a number of key projects by the PI Team and a quite large Guest Observer program, within the two years of its nominal life (Fig. 3).

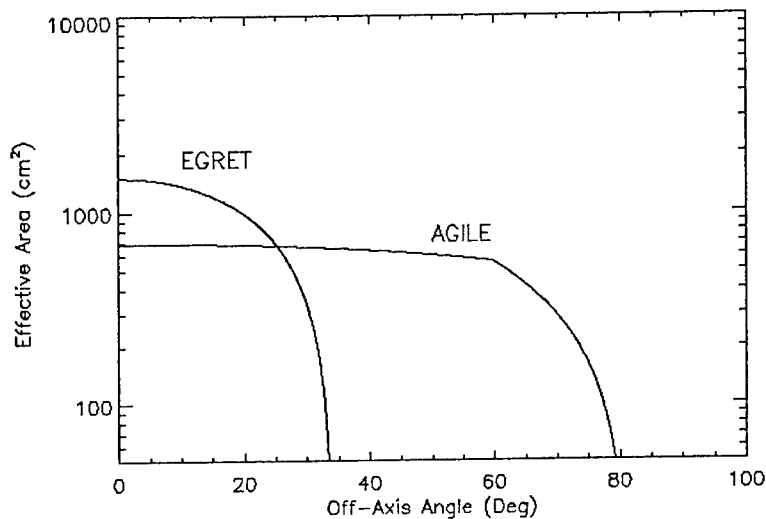


Fig. 2: The very flat response of AGILE, even at large (60°) off-axis angles

The combination of the previous two characteristics settle a solid basis for an authentically small mission able to do 'big' science.

### 3 - THE MISSION

If in the definition of the payload for a small mission, scientists could cause a cost increasing, because of their special (and justified) care to scientific goals more than to programmatic items, the involvement of research institutes in the system level activities could play a very important role in the crucial task of gaining in flexibility and constraining costs.

This kind of situation, even if not so peculiar in the international framework, is quite unknown in the Italian panorama. In fact in our tradition, even for scientific missions, the role of prime contractor has always been kept by an industrial subject. At this regard, a few comments are in order.

If, from one side, the industry guarantees several important points, e.g. an adequate P.A. level, on the other hand some problem could arise from a complete industrial approach, i.e. higher costs and lack of flexibility.

The strategy of ASI is to set up a directional and operational Center, hosted by a scientific Institute (or a group of Institutes) and populated by technical personnel contracted by the Agency or loaned by the Institute(s), which will carry out, *under the direction and on behalf of the Agency*, the responsibility of defining and monitoring all the interfaces between payload and spacecraft, and with the ground segment and the launcher. This Center will also define the test procedures and will manage, in cooperation with the industries which have the proper facilities, the AI&V activities

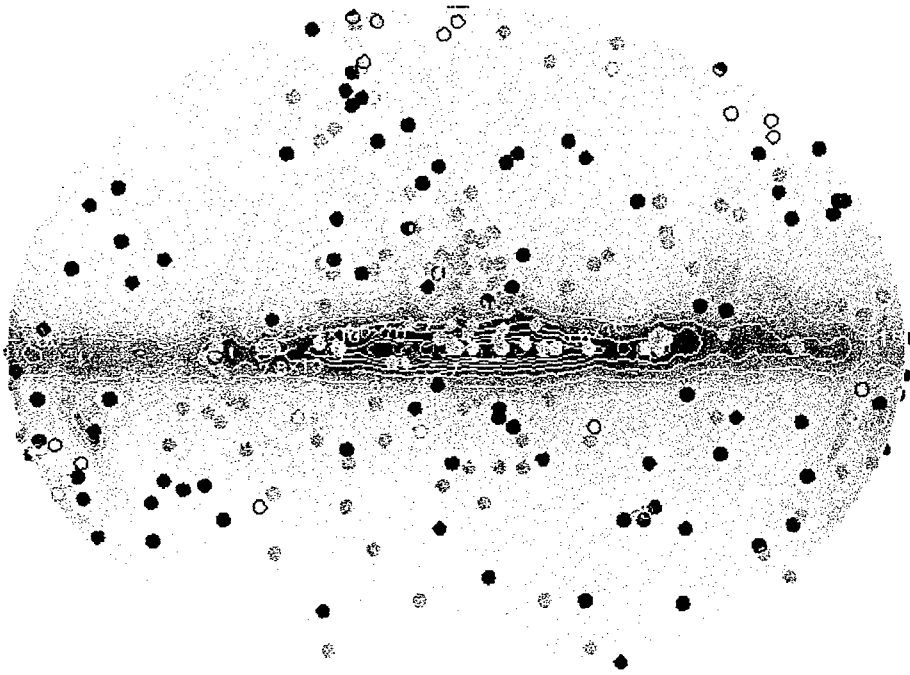


Fig. 3: A possible sky-coverage of AGILE (simulation, whole mission). The circles are EGRET sources; the filled ones will be observed by AGILE ( $\text{ph}/\text{cm}^2/\text{s}$  @  $E > 100 \text{ MeV}$ )

#### 4 - SCIENTIFIC POLICY

The rapid increasing in the years of the number of astrophysical missions from space provides the community with a huge amount of data throughout the whole electromagnetic spectrum. The possibility to have access to large multi-wavelength databases could really open a new era for astronomers, only if the data coming from new missions will be readily available in a format useful for scientific analysis and through on-line catalogues.

ASI acquired a great experience in the context of the BeppoSAX mission, developing the Science Data Center (SDC) as a multifunctional interface between the program and the community. The SDC provides the proper mission support (mission planning, Guest Observer program, data analysis, etc.) and manages all the scientific data: data archival, calibrations, creation and maintenance of catalogues and databases, data and calibration distribution.

Besides these activities, the ASI SDC offers to the users the possibility of making on-line pre-analysis of their observations, also through an interactive archive connected in real time with several public catalogues of different missions/instruments.

ASI will clearly profit of this experience for next missions, starting from AGILE, transforming the BeppoSAX SDC into a permanent structure with technical staff, capable to support the users in a scientific oriented way [Giom 99].

The data policy is going to be defined by means of a dedicated Science Management Plan, to be issued by ASI, in agreement with the AGILE PI and the Scientific Advisory Board of the Agency. Since AGILE has been approved as an observatory open to the whole international  $\gamma$ -ray community, ASI shall guarantee to astronomers all over the world the access to the instruments

through the emission of Announcements of Opportunity and the selection of the proposals by dedicated committees.

The SDC, in its final version, will be able to host users and visiting scientists and to support them in the analysis of data from all ASI science missions.

#### REFERENCES:

- [Dipi 99] S. Di Pippo & A. Pellizzoni, "The ASI 'Small Missions' Program", *50<sup>th</sup> International Astronautical Congress*, Amsterdam, NL, November 1999.
- [Giom 99] P. Giommi & F. Fiore, "The ASI Data Archive Research Center", *BeppoSAX-SDC TR/020*, September 1999.
- [Tava 99] M. Tavani *et al.*, "AGILE: a Gamma-Ray Mission", *1999 Meeting of the AAS - High Energy Astrophysics Division*, Charleston, South Carolina, USA, April 1999.



**STATION MULTI-MISSION DE NATAL - BRÉSIL  
CONCEPT ET ARCHITECTURE D'UNE  
STATION TT&C BANDE S FAIBLE COÛT**

**Jean-Paul DUBUT** <sup>(1)</sup>

**Manoel Jozeane Mafra de CARVALHO** <sup>(1)</sup>

**Romualdo Alves PEREIRA Jr.** <sup>(1)</sup>

**Maria de Fátima MATTIELLO FRANCISCO** <sup>(2)</sup>

*(1) INSTITUTO NACIONAL DE  
PESQUISAS ESPACIAIS - INPE/CRN*

*Av. Salgado Filho, 3000*

*CEP: 59001-970 – Natal, RN – Brésil*

*jean@crn.inpe.br manoel@crn.inpe.br*

*romualdo@crn.inpe.br*

*(2) INSTITUTO NACIONAL DE  
PESQUISAS ESPACIAIS - INPE/DSS*

*Av. dos Astronautas, 1758*

*CEP: 12227-010 – São José dos*

*Campos, SP – Brésil*

*fatima@dss.inpe.br*

**RÉSUMÉ** – Cet article décrit le concept, l'architecture et les critères qui ont été adoptés pour spécifier le cahier de charges de la station TT&C en bande S faible coût de Natal, ainsi que les solutions retenues pour l'intégration de l'ensemble. Décrit, également, les principales fonctionnalités des divers sous-systèmes, de la chaîne informatique, et les modifications qui ont été introduites postérieurement par l'INPE/CRN pour la transformer en station multi-mission et l'adapter aux exigences des nouveaux programmes. Les résultats obtenus dans la poursuite et la réception des satellites brésiliens sont aussi présentés et des améliorations sont proposées pour augmenter son actuelle performance.

**ABSTRACT** – *This paper describes the concept, architecture and criteria adopted for a Natal low cost S-band TT&C ground station specifications with the implemented solutions for integration system. Also describes the main subsystem functionalities and modifications introduced by INPE/CRN for providing a mutimission station and adapting it to the new mission requirements. Some obtained brazilian satellite tracking results are presented. Finally, it is proposed an upgrade to improve the current TT&C station performance.*

## **1. INTRODUCTION**

Natal, ville portuaire d'une population de près d'un million d'habitants, située dans le Nord-Est du Brésil sur la pointe orientale du continent sud-américain présente, de ce fait, un site géographique privilégié pour l'installation d'une station TT&C. Implantée initialement pour opérer avec les deux satellites de la famille SACI, la station TT&C s'est bien vite vue chargée d'autres missions. Opérant maintenant avec les satellites SCD-1, SCD-2 et CBERS-1, sa localisation particulière lui permet de compléter le trou de couverture présenté par les stations de Cuiabá (MT) et de Alcântara (PA), et de couvrir aussi tout le réseau de plate-formes de collecte de données (PCDs), disséminé dans le Nord-Est du pays. Étend sa couverture radio-électrique aux îles océaniques voisines et, notamment, à une grande partie de l'océan Atlantique Équatorial où divers programmes d'océanographie (PIRATA et REMAR) sont installés, en coopération avec des organismes internationaux congénères. D'autre part, considérant les nouveaux programmes qui seront implantés par l'INPE au long des prochaines années, la station TT&C de Natal devra être appelée à assurer un rôle significatif dans la poursuite et la réception de micros et petits satellites, qu'ils soient d'orbite équatoriale ou polaire.

nouvelles solutions pour inhiber les vols. Les escortes et patrouilles se montrent inefficaces et coûteuses, et la rare violence avec laquelle ces assauts sont généralement pratiqués décourage la plupart des interventions directes. Outre les pertes matérielles infligées, il existe le risque de contamination directe de l'environnement par les produits nocifs suivi des hauts coûts de nettoyage et de récupération des lieux endommagés. En effet, grande partie des produits qui ne peuvent pas être emportés sont simplement abandonnés dans les fûtes, jetés dans les rivières ou les étangs, causant d'importants préjudices à l'environnement et aux populations locales. La possibilité d'accompagner le transport d'un chargement et de le localiser rapidement en cas d'accident ou de vol, apporte une solution efficace et concrète à ce genre de problème.

La plupart des systèmes commerciaux de suivi et de localisation de chargements dangereux ou sensibles, existants à l'heure actuelle, utilisent le positionneur GPS comme élément principal de localisation. Bien que suffisamment précis pour ce type d'application, ces systèmes présentent de nombreuses restrictions d'opération, surtout en relation aux pertes fréquentes de liaison, en présence d'obstacles naturels tels que tunnels, hangars, ou même en région urbaine. Cela oblige à installer l'antenne GPS en local dégagé, forcément visible et vulnérable. Avec la sophistication des vols, l'antenne de ce genre de système est la première chose que les voleurs cherchent à neutraliser, soit en la détruisant simplement ou en l'enrobant avec du papier d'aluminium, par exemple. Le système proposé utilise des terminaux émetteurs ARGOS ou SCD pour la localisation, pouvant être facilement dissimulés dans les conteneurs et, additionnellement, un récepteur GPS accouplé à l'unité centrale du véhicule pour en donner la position, en situation normale de transport. Dans l'occurrence d'une situation anormale, même que le terminal véhiculaire vienne à être danifié postérieurement, par accident ou vandalisme, les terminaux mobiles dissimulés dans le chargement sont déclenchés automatiquement et peuvent être localisés par le réseau de satellites.

## **2. DESCRIPTION DU SYSTÈME**

Ce système utilise les informations de position fournies par les satellites nord-américains d'orbite polaire basse NOAA 12, NOAA 14 et NOAA 15, opérés par le service CLS/ARGOS et le satellite brésilien SCD-2, d'orbite équatoriale basse. Les deux systèmes, bien qu'utilisant l'écart Doppler comme moyen de détermination de la position du terminal, présentent des particularités. En effet, les satellites NOAA utilisés par le système ARGOS possèdent à bord un DCS élaboré qui reçoit les messages émis par les terminaux mobiles, mesure leur fréquence d'arrivée et les traitent, avant de retransmettre les informations vers la terre. Toutes ces informations sont également enregistrées à bord et seront télé-déchargées, à chaque passage du satellite, sur les centres ARGOS pour traitement et calcul éventuel de la position géographique du terminal.

Le satellite brésilien SCD-2, de conception plus simple, ne possède pas de traitement à bord et ne fait que translater et retransmettre les informations reçues des terminaux en terre. Le Doppler, existant sur la liaison montante, est conservé et retransmis sur la liaison descendante, en bande S. L'écart de fréquence Doppler est mesuré en terre par la station de réception qui, après traitement, fournit la position du terminal. Ce système bien sûr, ne possédant pas d'enregistrement à bord, ne permet que de fournir la position de terminaux se trouvant dans le cône de visibilité radioélectrique formé par le terminal, le satellite et la station de réception. Très prochainement, le CBERS-1 devra aussi être rendu disponible pour ce type de service.

En ce qui concerne le segment sol, le système est sous-divisé en quatre parties principales: les terminaux mobiles, l'unité véhiculaire centrale, le centre d'opération et contrôle, et l'unité mobile de localisation.

### **2.1. L'unité véhiculaire centrale**

Quand il s'agit du transport de grands chargements, comprenant plusieurs conteneurs réunis, l'unité véhiculaire centrale se conduit comme une centrale de contrôle qui vérifie, constamment, les principaux paramètres de marche et de route du véhicule, ouverture de portes, écoutes, etc, et

concentre les informations issues des divers capteurs sur les conditions et l'état du chargement. Cette centrale est aussi asservie à un récepteur GPS qui fournit, additionnellement, la position du convoi. Cette position est retransmise, périodiquement, aux terminaux mobiles installés ou dissimulés dans les conteneurs au moyen d'une liaison UHF faible puissance, en 433,92 MHz. L'alimentation de l'ensemble est fournie par la batterie du propre véhicule et, en cas de besoin, l'alerte peut être déclenchée manuellement par le chauffeur. La figure 1 présente, ci-dessous, le synoptique fonctionnel de l'unité véhiculaire centrale.

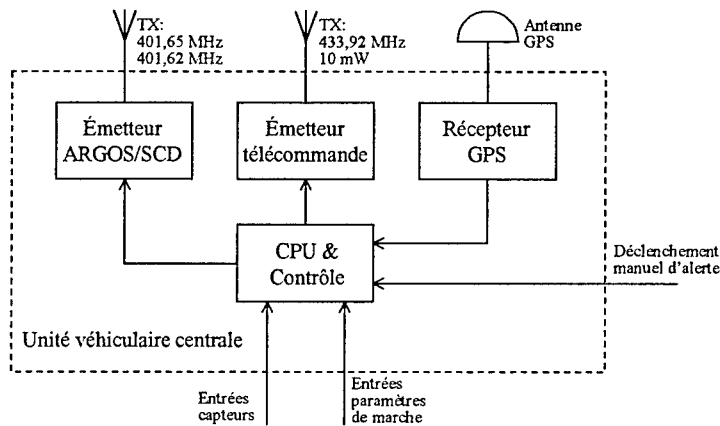


Fig. 1 – Synoptique simplifié de l'unité véhiculaire centrale

## 2.2. Le terminal mobile

Le terminal mobile est constitué par un émetteur miniaturisé ARGOS-SCD compatible, une antenne plate ou fouet UHF, un micro-récepteur UHF pour liaison avec l'unité véhiculaire centrale, un émetteur de homing en VHF faible puissance et une batterie de lithium rechargeable. L'ensemble est monté dans un boîtier moulé de matière plastique étanche de petites dimensions, résistant aux intempéries, et pouvant être facilement dissimulé dans le chargement ou monté directement sur le conteneur.

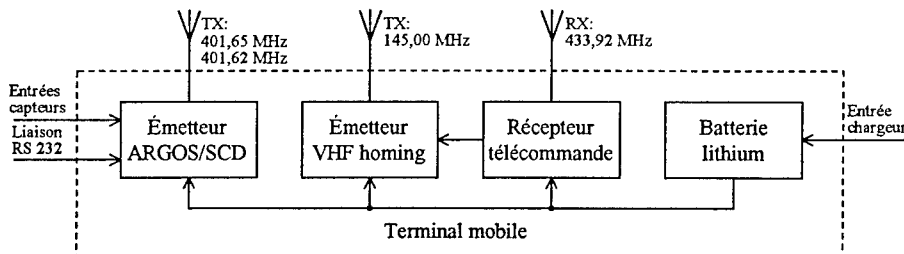


Fig. 2 – Synoptique simplifié du terminal mobile

L'émetteur satellite de localisation utilisé pour les essais pilote est un modèle ULT de la société toulousaine ELTA® [1], de dimensions extrêmement réduites. L'ensemble est architecté sur un microcontrôleur qui se charge de l'interface et du pilotage des principales fonctions. Une interface RS 232 permet de paramétrer le module et de programmer les délais avant émission, le cycle de fonctionnement et d'arrêt. Permet également d'émettre, périodiquement, des messages de

maintenance sur l'état de fonctionnement de l'électronique et d'envoyer aussi des messages datés par une horloge interne en temps réel. L'émetteur ULT, compatible avec les systèmes ARGOS et SCDS, émet sur les fréquences nominales de 401, 65 MHz ou 401,62 MHz, à la puissance de 2 ou 4 W, les messages collectés et permet le choix d'un canal dans les tables disponibles [2]. Permet également de lui accoupler, si nécessaire, des capteurs de pression, de température et de chocs pour accompagner les conditions de transport du conteneur. Le système irradiant est composé par une antenne plate ou du type fouet en  $\lambda/4$  [3]. L'émetteur de homing associé est maintenu en veille temporisée par un signal codé, émis périodiquement par l'unité véhiculaire centrale au moyen de la liaison UHF 433,92 MHz de télécommande. En cas d'interruption de cette liaison, l'émetteur de homing est automatiquement activé et commence à émettre un signal périodique pulsé d'une puissance de 50 mW, modulé en FM, sur la fréquence nominale VHF de 145,00 MHz. Ce signal sera utilisé pour faire l'approche finale sur le conteneur. Une fois déclenché, les émissions ne cesseront que par la désactivation du terminal mobile, via sa porte de contrôle ou, simplement, par épuisement de la batterie. Un micro-récepteur de télécommande, opérant à la fréquence nominale de 433,92 MHz, établit la liaison avec l'unité véhiculaire centrale et en reçoit les informations codées. À la page antérieure, la figure 2 présente le synoptique fonctionnel simplifié du terminal mobile.

### 2.3. Le centre d'opération et d'alerte

Le centre d'opération et d'alerte est doté des moyens informatiques nécessaires pour le traitement et l'analyse des informations de position des terminaux mobiles. Ces informations sont reçues des Centres CLS-ARGOS ou INPE par consultation directe, via réseau Internet, et sont plotées directement sur les cartes ou plans numériques de la région ou ville correspondante. Ce centre devra exécuter, postérieurement, la gestion et le contrôle des routes de transport et déclencher l'alerte auprès de l'unité régionale mobile affectée à localisation finale ou des groupes de sauvetage, département de police, défense civile, pompiers et autres autorités, suivant le cas demandé. Il nous paraît prématuré de vouloir donner, à l'heure actuelle, une dimension exacte à ce centre sans une connaissance plus profonde des besoins réels et des difficultés opérationnelles qui devront surgir. La tendance naturelle est de transférer la charge et la responsabilité de ce service à une société spécialisée dans le transport et l'accompagnement de valeurs.

### 2.4. Les unités mobiles de localisation

Quand la position fournie par la localisation satellite n'est pas suffisamment précise pour situer l'endroit exact où se trouve le terminal mobile, il est nécessaire de faire appel aux unités mobiles de localisation. Le schéma synoptique simplifié, présenté par la figura 3, illustre la configuration adoptée pour l'unité mobile de localisation.

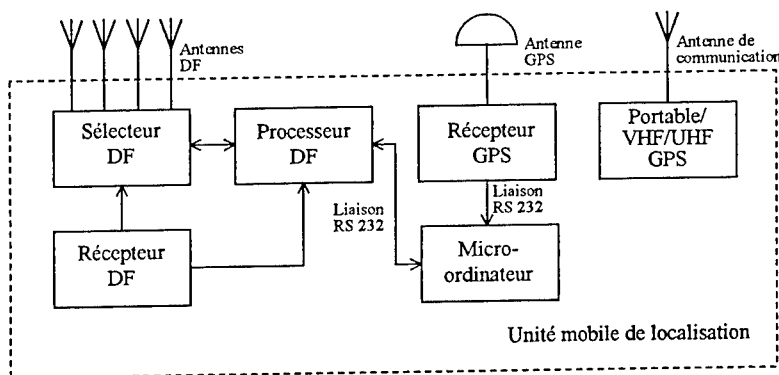


Fig. 3 – Synoptique simplifié de l'unité mobile de localisation

L'unité mobile de localisation est constituée par un véhicule léger pouvant se déplacer rapidement, équipé de moyens de communication radio ou téléphonique avec le centre d'opération et d'alerte, de récepteur auxiliaire GPS pour sa propre localisation, et de moyens informatiques pour le suivi final et repérage de la position du terminal mobile sur carte numérique, à partir de l'information de localisation initialement reçue. L'approche fine est faite sur le signal VHF de homing du terminal mobile, au moyen d'un système de goniométrie digitale utilisant la technique pseudo-doppler [4]. Ce système est constitué d'un récepteur radio synthétisé en VHF, d'un processeur goniométrique digital pour repérage et pointage du signal de homing, et d'un ensemble d'antennes commandées par le processeur, monté sur le toit du véhicule [5]. L'information de pointement issue du processeur digital est envoyée au micro ordinateur portable par une liaison RS 232. En fonction de la carte numérique sélectionnée, le point localisé est indiqué directement sur l'écran. Les cartes et plans numériques, logiciels de contrôle et de communication sont des produits commerciaux pour lesquels l'INPE/CRN a développé des interfaces spécifiques. Le récepteur ICOM® utilisé pour les testes présente une sensibilité minimum de  $0,5\mu\text{V}$  en 145,00 MHz et le processeur digital offre une précision de pointement nominale de l'ordre de  $0,5^\circ$ . Ceci permet que, même en région urbaine où prédominent des conditions sévères d'interférence, le terminal mobile soit rapidement localisé. Quand le système devra passer de la phase de test à la phase opérationnelle il sera nécessaire prévoir plusieurs unités mobiles de localisation pour couvrir les principales régions du pays et routes de transport. Il nous paraît prématuré fixer, à l'heure actuelle, le nombre d'unités mobiles de localisation qui devront être équipées ou disponibles pour assurer un service de localisation finale efficace et fiable. La tendance naturelle est de transférer la charge et responsabilité de ce service à une société spécialisée dans le transport et l'accompagnement de valeurs.

### 3. RÉSULTATS PRÉLIMINAIRES

Les premiers résultats obtenus démontrent la grande potencialité du système pour le suivi et la localisation de conteneur. Les figures 4 et 5, présentées ci-dessous donnent, respectivement, un aperçu du terminal mobile et de son antenne bien comme du caisson en bois simulant un conteneur et du véhicule utilisé pour le test.



Fig. 5 – Véhicule et conteneur utilisés pour le test

Fig. 4 – Vue du terminal mobile et de son antenne

Plusieurs essais ont été réalisés utilisant un terminal mobile monté dans un caisson, simulant un conteneur. Ce caisson, de son côté, était transporté dans un fourgon utilitaire et émettait directement avec une antenne fouet à travers les parois métalliques du véhicule. La position globale recouverte au moyen du service ARGOS était de l'ordre de 500 mètres et on a obtenu trois localisations du mobile durant la journée, soit une le matin et deux en fin d'après-midi. À partir de la dernière position satellite obtenue on a fait le suivi final du terminal mobile sur le signal de homing émis, ce qui a permis de localiser rapidement le véhicule, garé dans une rue de Natal, Brésil.

Des tests identiques, conduits à São José dos Campos et Cuiabá, Brésil, avec un autre terminal mobile de caractéristiques similaires sur le satellite SCD-2, ont permis d'obtenir des localisations de l'ordre de 3 km. Cette précision est parfaitement acceptable si on utilise le recours de l'émetteur auxiliaire de homing, pour l'approche finale. Ces résultats préliminaires sont extrêmement encourageants et permettent d'affirmer que les satellites SCDs pourront être aussi utilisés dans le service de localisation. Certainement, en apportant des améliorations aux algorithmes de calcul et sur les courbes de traitement, il sera possible d'augmenter la précision nominale des localisations faites par le SCD-2. D'autre part, des tests similaires devront être répétés, dès que possible, avec CBERS-1 et certainement devront conduire à des résultats très proches ou meilleurs. Les figures 4 et 5, présentées à la page antérieure donnent, respectivement, un aperçu du terminal mobile et de son antenne bien comme du caisson simulant le conteneur et du véhicule utilisé pour le test.

#### 4. CONCLUSION

Le système de suivi de chargements sensibles ou dangereux par satellite, bien que se trouvant encore en phase embryonnaire, a suscité un vif intérêt pour part de grosses entreprises de transport. Considérant les grandes sommes dépensées par les entreprises de transport et les compagnies d'assurance pour le dédommagement de pertes de chargements et la récupération de préjudices causés à l'environnement, en cas d'accident ou de vol, et qui pourraient être réduites à un minimum dans le cas d'une intervention rapide et précise, justifient pleinement l'implantation de ce système. L'investissement initial nécessaire pour équiper les conteneurs avec des terminaux mobiles et les frais engendrés par l'opération du système pourront être rapidement amortis par les réductions concédées aux primes d'assurance et par une meilleure gestion des itinéraires de transport. Il est également important souligner les résultats surprenants obtenus avec SCD-2 dans le suivi et la localisation de terminaux mobiles. Bien que n'étant pas comparable à la précision globale fournie par ARGOS, l'information de position obtenue par SCD-2 est suffisante pour être reprise par l'émetteur auxiliaire de homing.

#### RÉFÉRENCES

- [1] CEIS TM – L/CD: "ULT UHF Localisable Transmitter", *Notice d'utilisation*, Toulouse, France, Septembre 1998
- [2] CNES: "ARGOS Platform Transmitter Terminal (PTT) and ARGOS Platform Message Transceiver (PMT)", *Spécifications générales*, Toulouse, France, Juillet 1999
- [3] F.C. ALMEIDA, "Data Collection and Location Platforms – Experimental Network – A-REV-0032", São José dos Campos, SP, Brésil
- [4] RF PRODUCTS, "A Comparison of the Watson-Watt and Pseudo-Doppler DF Techniques", São Diego, CA, USA, Avril 1999
- [5] RF PRODUCTS, "Basics of the Watson-Watt DF Technique", São Diego, CA, USA, Décembre 1998

5<sup>th</sup> International Symposium

**SMALL SATELLITE SYSTEMS AND SERVICES**

**XENON FEED SYSTEMS FOR  
ELECTRIC PROPULSION**

Peter Smith  
Polyflex Aerospace Ltd  
Cheltenham Trade Park  
Cheltenham, U.K.  
GL51 8LZ  
Tel: (0)1242 228878  
e-mail [ps@polyflex.co.uk](mailto:ps@polyflex.co.uk)

(Poster Presentation)

**ABSTRACT**

*Spacecraft which take advantage of the benefits of electric propulsion need a pressure reduction and metering system to provide the xenon propellant at the required pressure and flow rate to the thruster or thrusters. Xenon is generally used as a propellant because of its high atomic mass, monatomic nature and relatively low ionisation potential.*

*Typically, for electric propulsion applications, xenon is stored at high pressure (between 70 and 200 bar, 1050 and 3000psi) and high density (1.5 to 2gm/cc) in a fibre wrapped vessel. At the inlet to the thruster, the xenon pressure is required to be around 200mbar (3psi), and the various flow rates controlled to between 0.2 to 10mg/sec.*

*There are currently two types of xenon electric propulsion system in orbit, the ion thruster, which usually requires 3 propellant feed lines for the main flow, cathode flow and neutraliser flow, and the Hall effect thruster or Stationary Plasma Thruster (SPT) which requires two feed lines, one for the main and one for the cathode, but which often has a redundant arrangement, so the feed lines are duplicated.*

*This paper describes a low cost xenon feed system design which is both low risk in that the components and processes used are well established, and high performance as a result of the innovative application of these simple, well established processes.*

*The Xenon Feed System being developed by Polyflex consists of two types of assembly: the High Pressure Regulator Assembly, and the Flow Control Unit Assembly. This arrangement allows quick and easy integration onto the spacecraft platform whilst maintaining a high degree of confidence in the reliability of the overall system.*

*The two assemblies incorporate innovative design features which reduce cost and risk while improving the overall performance. In the case of the high pressure regulator, a novel regulator design allows the valve to be positively closed and sealed by command during non-operating periods to minimise internal leakage rates for long duration missions. The flow controller unit design combines the flow controller and isolating valve for each flow path into a single low cost component, and the same type of isolating valve is used in place of the high pressure isolating pyrotechnic or latching valve. The Xenon Feed System also allows the tank residuals to be reduced to 0.5 bar at the end of life.*

## High Pressure Regulator Assembly

The High Pressure Regulator Assembly consists of two parallel arrangements of a thermal isolation valve, a high pressure isolating regulator, and a pressure switch. Two parallel sets of components are provided for redundancy, and a single system-level gas purifier is provided as part of the assembly, in the low pressure section.

The whole assembly is packaged and welded to enable integration and testing to be performed quickly and easily at spacecraft level, with interface connections limited to the inlet and outlet stub tubes for welding, electrical connections for power and signals, and mounting points for attachment to the platform. Thermal control hardware is also fitted. This design enables much of the acceptance testing to be conducted at assembly level, so reducing costs and schedule.

Table 1 below describes the performance of the HPRAs.

Parameter	Value
Inlet Pressure	4 to 250 bar
Outlet Pressure	2.5 +/- 5% bar
Proof Pressure	1.5 x MEOP
Burst Pressure	2.5 x Inlet
Burst Pressure	2.5 x Outlet
Lock Up Differential	0 bar
Flow	up to 11 mg/s (Xenon)
Mass	< 3.5 Kg
Voltage	22 to 35 or 42 to 50 Vdc
Power	< 25 Watts max. Typically 5W continuous
Operating temp	-40 to +70°C
Internal leakage	2.0E <sup>-6</sup> scc/s
External leakage	1.0E <sup>-6</sup> scc/s
Cycle Life (actuator)	100000
Constant Acceleration	+/- 22g
Mechanical Shock	200g
Random Vibration	TBA
Sine Vibration	TBA
Filtration	5 microns abs.
Operational Life	15 yrs.

Table 1 High Pressure Regulator Assembly Performance

## Components

### *Thermal Isolating Valve*

The Thermal Isolation Valve provides isolation of the high pressure gas from the rest of the system during loading operations and launch. Internal leakage of the valve, which is fitted with two in-line seals is less than 10<sup>-6</sup> scc/s of helium. Valve opening is by actuation of a low power heater, which also ensures that gaseous xenon only is processed through the regulator. Closing occurs when heater power is removed. A number of demonstration valves have been built and tested satisfactorily.



### *Isolating Regulator*

The isolating regulator is similar to a conventional mechanical regulator when operating, giving excellent pressure control and potentially high flow throughput. However, the regulator incorporates an additional actuator which ensures that the sealing force is independent of the pressure force when not operating.

This regulator design is based on many previous Polyflex regulators which are currently in service, and the actuator is a development of the magnetic solenoid qualified and flown in a number of valves.

### *Pressure Switch*

The pressure switch is fitted to prevent over-pressure of the downstream lines in the event of a failure of the regulator. Should the downstream pressure exceed a set value, the power to the isolation valve and regulator would be removed, so preventing further pressure build-up and isolating one half of the high pressure regulator assembly.

### *Gas Purifier*

The Gas Purifier is based on a commercially available unit, tested to meet qualification requirements and with appropriate Product Assurance provisions in place, and fitted with a flight qualified heater. The gas purifier will remove contaminants from the xenon gas such that levels of oxygen, carbon dioxide, etc are less than 1ppm. A single, system-level gas purifier is welded into the HPRA.

## **Flow Control Unit**

For applications involving the Hall effect thruster, or RIT thruster, each Flow Control Unit consists of a set of 4 combined flow metering and isolating valves, giving redundant flow control for the main and cathode lines. For electron-bombardment ion thrusters, 3 control valves are assumed.

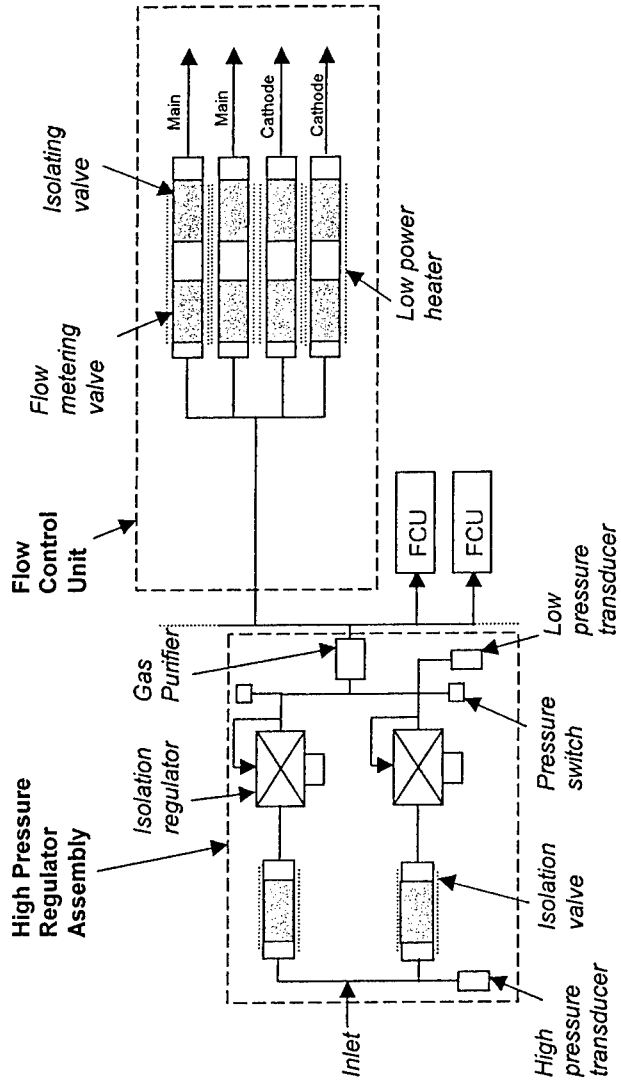
The FCU is an all-welded assembly, designed for easy integration, and small enough to be fitted close to the thruster. The assembly design follows the same philosophy as the HPRA, with minimal interface connections, and all testing and calibration performed during acceptance testing of the assembly. Thermal control provisions and temperature sensors are again built into the assembly.

## **Components**

### *Metering Isolation Valve*

The metering isolation valve is a new development which has been demonstrated as separate components. It relies on heating of the unit with a low power heater (~3 Watts). Adjustment of the flow rate is performed by increasing or decreasing the power to the heater and hence the unit temperature. The valve also incorporates a thermal isolating valve which opens on heating, the heater being common to both valve and metering element. This design is therefore extremely simple, reliable and effective. Feedback on flow rate can be either through a closed loop control of thruster parameters, or through temperature monitoring of the metering valve.

Figure 1 Polyflex Xenon Feed System



## THE DESIGN AND IMPLEMENTATION OF AN AUTONOMOUS GROUND STATION FOR PANSAT

Mr. Jim A. HORNING

*US Naval Postgraduate School  
Space Systems Academic Group  
777 Dyer Road, Bldg. 233, Rm. 125  
Monterey, CA 93943*

**ABSTRACT:** The Space Systems Academic Group at the U.S. Naval Postgraduate School in Monterey, California, has developed an autonomous system to function as the ground station for the Petite Amateur Navy Satellite (PANSAT) which was launched into orbit aboard the Space Shuttle Discovery in October, 1998. The system is built with commercial-off-the-shelf hardware controlled by one computer using a foundation of Open Source software. The use of these technologies reduced the cost and development time while at the same time increased the reliability and effectiveness of the ground station.

This autonomous system includes a two axis rotor control of an antenna with position calibration using a light sensor seeking the Sun, adjustment of oscillators to compensate for Doppler shifts, and programming of the modem and RF systems. Time synchronization is accomplished using a GPS receiver. Two line element sets describing the spacecraft's position are updated daily. Desired activities to perform are listed with the names of high-level executable scripts for each pass of the spacecraft over the ground station. Results of each pass, including downloaded data, are posted on a Web site for monitoring by humans. Electronic messages are generated when anomalies are detected or significant events have occurred.

This paper presents the hardware and software components of this ground station. Attention is given to the exploitation of Open Source software which uses GNU/Linux to provide an Internet-connected and fully automated ground station which runs under a single computer platform.

### 1. MISSION DESCRIPTION

PANSAT is a small satellite for digital store-and-forward communications in the amateur frequency band. It features a direct sequence spread spectrum differentially coded, binary phase shift keyed (DBPSK) communication system at an operating frequency of 436.5 MHz. Bandwidth requirements allow only a half-duplex link.

PANSAT was launched into orbit aboard the Space Shuttle Discovery in October, 1998 into a low-Earth orbit of 550 km and at an inclination of 28.5°. This orbit gives the Naval Postgraduate School approximately three communications windows per day, each about six to eight minutes in duration. Thus, limited bandwidth and limited duration of communication required automated sessions of contacting and controlling the spacecraft during the infrequent and short length passes each day.

## 2. GROUND STATION REQUIREMENTS

Since a majority of the time prior to the integration of PANSAT was spent producing the flight hardware, very little of the ground station was in place after integration. A choice to use commercial-off-the-shelf hardware controlled by one computer, using a foundation of Open Source software, was decided in order to reduce costs. The use of these technologies also reduced the development time while at the same time increased the reliability and effectiveness of the ground station.

## 3. RADIO FREQUENCY EQUIPMENT

The Radio Frequency (RF) equipment is divided into two sections [RIGM 98]. See Fig. 1, Ground Stations RF Equipment. The first section, as shown on the left of the figure, describes the electronics mounted at the top of the antenna tower. In order to minimize the signal losses from the down link filtering and conversion from RF to IF was performed just after the signal leaves the antenna. The second section, as shown on the right of the figure, describes the electronics found in an equipment rack within the ground stations room. This section performs the appropriate filtering and amplification necessary for demodulation. In addition, this section also provides the bit synchronization, up-conversion from IF to RF, amplification, and filtering to deliver the appropriate signal to the antenna. The electronic components are now listed in detail.

Starting back at the top of the tower, the antenna array is made of two right-hand circular polarized 436PC42 U/G by M<sup>2</sup> providing a system gain of 18.2 dB (dipole). The remaining electronics are for the down link signal. A DowKey microwave switch (4D1 220832A) provides transmit/receive switching with 0.1 dB loss. The filter closest to the switch is a KNL 436.5 MHz (center frequency) with 2.5 MHz bandwidth. The adjacent amplifier is a Landwehr 70 cm pre-amp. The mixing for down conversion is performed with a Mini-circuits ZFM-1W. The second stage filter is a Lark Engineering MC70-H2.5-3AA. And, the second stage amplifier is an Avantek UTC511.

Within the ground station equipment rack and continuing with the down link there is another 70 MHz (center frequency) filter with 5 MHz bandwidth manufactured by KNL. The cascade amplification is performed by two Avantek UTC517 amplifiers. A Mini-circuits signal coupler, ZFC 10-1, allows the insertion of a signal analyzer to monitor the IF signal of the spacecraft. The signal finally arrives at the demodulator board which is an EB-100 demodulator board by L3 Communications; clock and NRZI data leave the EB-100 board and enter the computer system which is described later. A Fluke 6060A/AN RF Signal Generator provides a RF to IF down conversion local oscillator to the top of the tower. This signal generator is attached to the GPIB and controlled by the computer system.

Additionally, within the ground station equipment rack, are the electronics for the up link signal. Starting at the far right of the figure there is another local oscillator, again connected to the GPIB, to provide direct RF. A Mini-circuits switch, ZSDR230, allows the RF signal to be switched off. Signal modulation is performed by an Anzac PM-101. The synchronous data stream provided by the computer system is bit synchronized by a custom Z-80 board built by the Space Systems Academic Group. The first stage of signal amplification is performed by a Mini-circuits ZFL 5000HLN. A variable attenuator, Texscan LA54, allows correct signal level adjustment for the later stages of amplification. The second level amplifier is a Mini-circuits ZHL-1A. A KNL filter at 436.5 MHz (center frequency) with 2.5 MHz bandwidth is in front of the last, amplifier, a Mini-circuits TIA-900-10, which provides 10 Watts of output power. A DowKey microwave switch is used to decouple the signal between the equipment rack and the tower box.

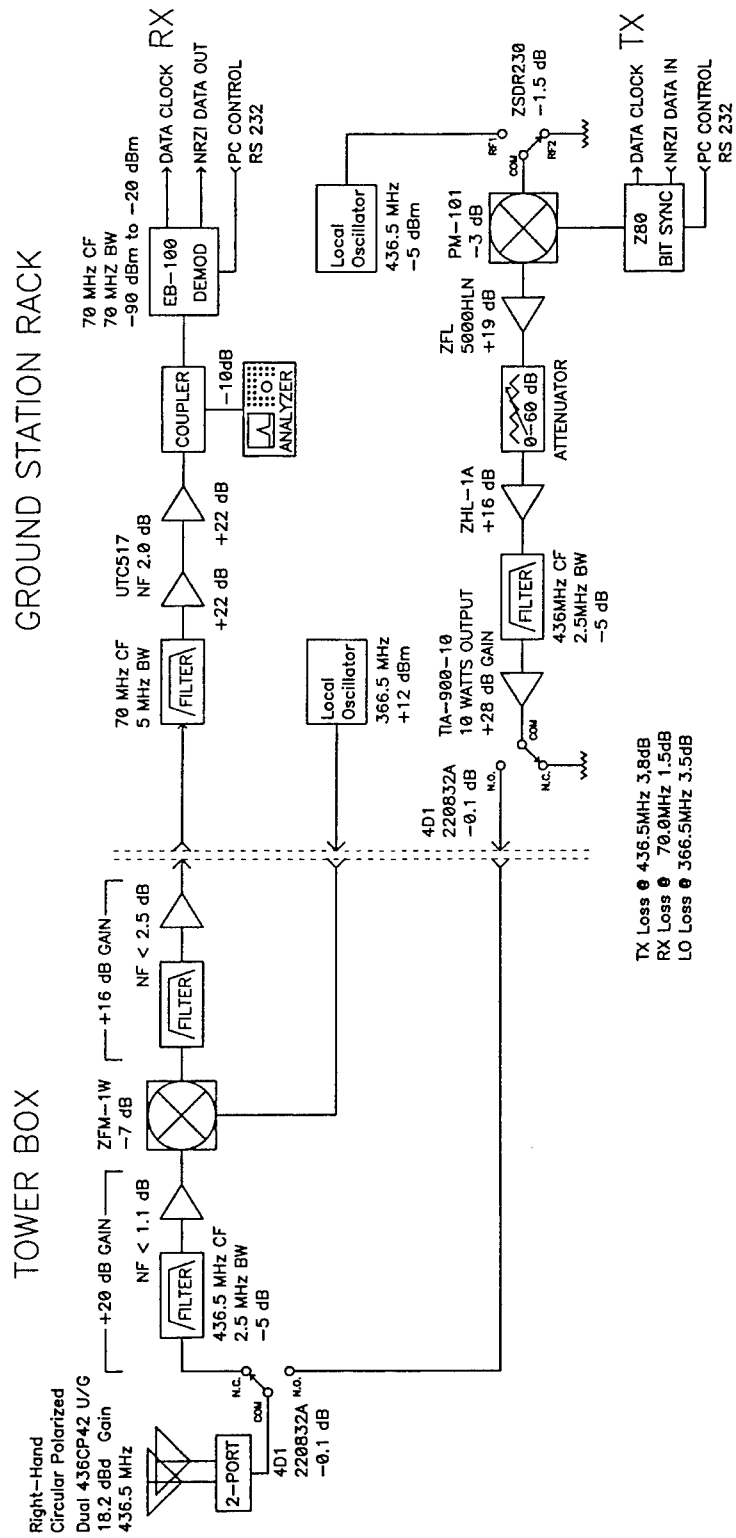


Fig 1: Ground Station RF Equipment.

#### 4. COMPUTER HARDWARE AND PERIPHERAL HARDWARE

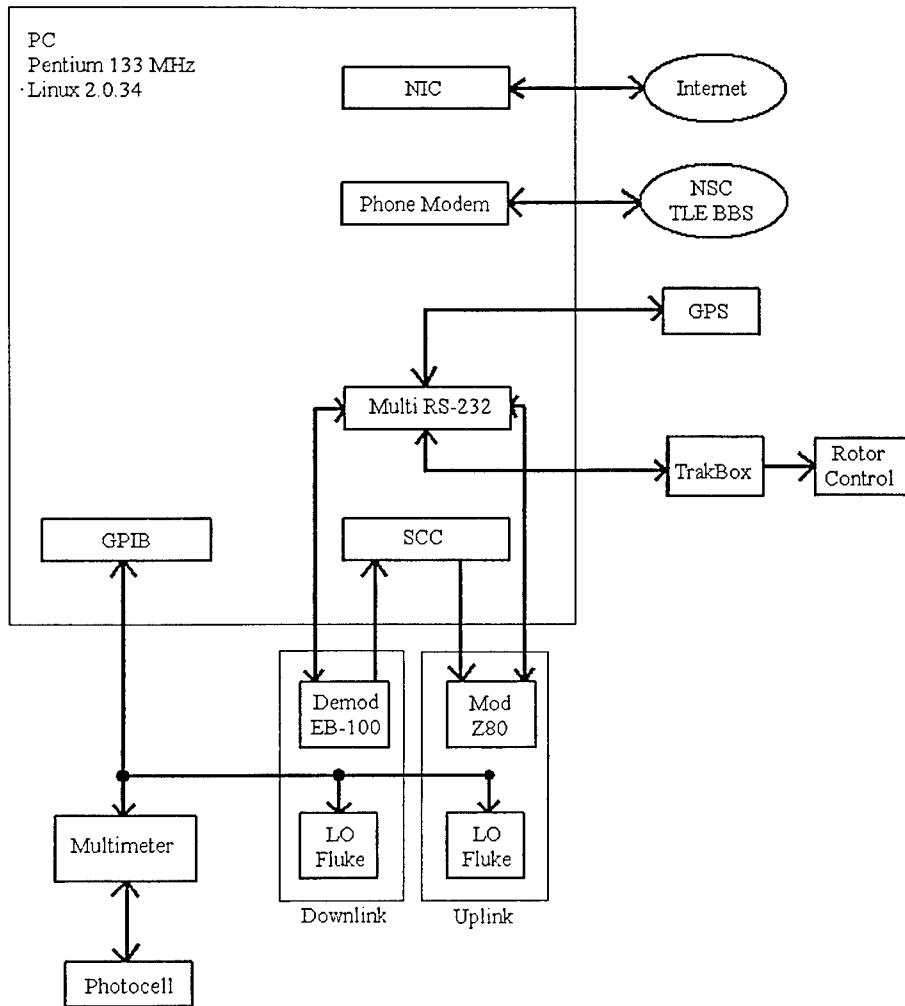
A generic PC houses several COTS peripheral cards to interface the computer with the ground station equipment as shown in Fig. 2, Ground Station Computer and Peripherals. The computer motherboard contains a Pentium 133 MHz with several ISA and PCI card slots since many are needed.

A Network Interface Card (NIC) provides a connection to the Space Systems Academic Group Ethernet, and thus allows access via the Internet. A US Robotics Courier 28.8 kbit/sec phone modem is used to dial out and attach to the Naval Space Command Two Line Element (TLE) Bulletin Board System (BBS) which provides daily updates for very accurate tracking of the spacecraft.

Control of the General Purpose Interface Bus (GPIB), the IEEE-488 instrument bus, is performed by a National Instruments AT-GPIB controller. Both the local oscillators for signal up and down link mixing, as well as a multimeter are attached to this bus. The local oscillators (listed in previous section) are programmed by the computer system during a satellite pass to compensate for Doppler shifts. The Space Systems Academic Group in Monterey, California experiences about a 20 kHz frequency shift in both the down and up links during a pass. The Multimeter is a Fluke 8842A. A photocell, which is located within one antenna and facing parallel to the direction the antenna array points, is used to detect sunlight intensity. The Multimeter allows monitoring of the photocell's response. The computer uses this to calibrate the pointing of the antenna.

Additional RS-232 ports are needed to control the various components of the ground station. A Cyclades 4YoPCI+ board supports four serial ports. One port is used to attach to a Trimble Trimpack GPS receiver which provides date and time. Another port attaches to a TrakBox which accepts ASCII-encoded commands to indicate elevation and azimuth positions and control a Yaesu G-5400B Elevation/Azimuth Dual Controller which connects to the rotors. The other two ports are used to control the modulation and demodulation boards. Both boards require various initialization and configuration commands from the computer system depending on the mode of communication desired. Simple ASCII-encoded commands are sent to the Z-80 bit synchronizer, a board built by the Space Systems Academic Group. The EB-100 demodulator board requires a cumbersome non-ASCII interface to initialize and configure the board for demodulation.

A Gracilis PackeTwin has an 85C30 serial communications controller (SCC) that provides a synchronous data stream between the EB-100 demodulation and the Z-80 modulation boards with the computer system. This card is programmed to receive the transmit and data clocks as derived from the demodulation and the modulation boards. These data rates are either 9.842 kbit/sec, in the spread spectrum mode, or 78.125 kbit/sec in the narrow band BPSK mode.



SEQARABE

Fig 2: Computer System and Peripheral Hardware.

## 5. COMPUTER SOFTWARE COMPONENTS AND ORGANIZATION

The Unix operating system was chosen because of its robust nature and ability to provide autonomous control with powerful software development tools. Linux, a Unix clone, was selected because it is both free and also a very reliable platform which the Space Systems Academic Group has used since 1994. At the time of development, Linux 2.0.34 was a release kernel. The Slackware 3.5 distribution of July 1998 was used for the operating system installation [SLAC 98]. In addition to providing a stable and powerful platform for program development, several software components used to perform the higher-level functions of the ground station control are open source program applications which run on top of Unix platforms. Fig. 3 shows a hierarchical view of the major software components.

Three significant low-level hardware device drivers are built into the Linux 2.0.34 kernel by third parties. These drivers are for the National Instruments GPIB, PackeTwin, and Cyclades multi-port serial boards. The GPIB driver is a suite of card-specific software along with a generic GPIB application programming interface (API) by C. Schroeter. Currently the Space Systems Academic Group is using Version 2.02 [SCHR 97]. This package is distributed under the GNU Public License (GPL) [GPL 91]. The SCC driver for the PackeTwin board was originally developed by Craig Small for Gracilis [SMAL 95] and distributed under the GPL. This driver was modified by the Space Systems Academic Group to remove the auto enabling for request to send (RTS) and clear to send (CTS) and allow interfacing with the PANSAT-specific modem hardware, requiring non-standard control which is not common to radio amateur equipment. Cyclades provides a driver for Linux to interface with the 4YoPCI+ multi-port serial (RS-232) board [CYCL 96]. This software is distributed under the GPL.

Also implemented within the Linux 2.0.34 kernel, but not a direct driver of hardware, is the AX.25 network software layer [AX25 97] providing a data-link layer protocol between higher-level software applications and the PackeTwin board driver. The ax25-2.0.34-2.1.47-4.diff patch was applied to build the AX.25 data-link layer. This AX.25 Utils are ax25-utils-2.1.42a. Both of these software components are distributed under the GPL.

The last component of software, not native to the Linux 2.0.34 distribution and not developed by the Space Systems Academic Group, is SatTrack by Manfred Bester of Bester Tracking Systems [BEST 95]. This is version 3.1.5 of SatTrack which is licensed by Bester Tracking Systems for use by consent of the author. SatTrack performs detailed satellite orbit calculations using Two Line Element (TLE) sets and determines when a spacecraft is above the horizon for a particular place on Earth. Furthermore, SatTrack determines the elevation and azimuth of a satellite and thus provides an easy method of controlling the TrakBox which accepts ASCII-encoded elevation and azimuth commands to control the Yaesu rotors.

The SatTrack software was modified extensively by the Space Systems Academic Group to customize its use specifically for PANSAT. As Doppler shifts are calculated when the spacecraft passes over NPS, the amount of signal frequency shifts are used to drive the Fluke local oscillators. This was accomplished by adding GPIB control. Furthermore, since SatTrack knows where a satellite is it can predict when PANSAT will come above the horizon; thus, using email, notifications of PANSAT future passes are sent to members of the Space Systems Academic Group during work hours. In addition, using email, anomalies and errors are reported. FCC rules dictate that communications with a spacecraft using the Amateur frequencies shall not occur below 10 degrees on the horizon. SatTrack was again modified to start and stop scripts (high-level commands for controlling the spacecraft) for a particular pass when the spacecraft is at or above 10 degrees. The scripts are chosen by members of the Space Systems Academic Group. Fig. 4 has an example of a schedule of PANSAT passes where at the far right of each line, for a pass of at



least 10 degrees above the horizon, a script is given which will be run at the appropriate time. If a script is not chosen, the system will use a default script. Fig. 5 has an example of a portion of a script, written in Python, to perform some PANSAT control functions. The final enhancement was for automatically updating TLE sets. SatTrack was designed to start running and load a given, fixed, TLE set. The software was modified so that new TLE files can be incorporated daily (performed by a separate task on the ground station computer and described later in this section) and reloaded without SatTrack needing to be restarted.

The Space Systems Academic Group created the low-level PANSAT interface software, called loader [HORN 98], which is distributed under the GPL. This software provides control to the PANSAT spacecraft using the loader-level communications protocol developed by the Space Systems Academic Group [HORN 97]. This software can be used via the command line but is most effectively used by higher-level scripting languages (e.g. Bash, Python, Perl).

Using cron certain daily housekeeping events are performed to keep the system well tuned. A simple application was written by the Space Systems Academic Group to interface with the Trimble Trimpack GPS receiver which provides date and time. Thus, the computer system time is synchronized daily. Time synchronization is important since a typical PC clock drifts by approximately three seconds per day. If left unsynchronized for a week, the time drift is sufficient to make the tracking of low-Earth orbit satellites inaccurate. In addition, archiving and backing up of this computer system is performed every evening. The data is backed up to another file server within the Space Systems Academic Group. Finally, every morning the system contacts the Naval Space Command via a phone modem connecting to a BBS to update the TLE for PANSAT.

Results of each PANSAT pass are published on the Internet in the form of Web pages. One page shows the latest *snapshot* of PANSAT. Snapshot data include temperatures, currents, voltages, and a few other statistics. Another page shows a log of all the commands sent by the script (or scripts) that executed and all of the responses received. A third page graphs some of PANSAT's data such as the temperatures, currents, and voltages over a period of up to a day. The graphs always reflect the most recent acquisition of data from the spacecraft.

Occasionally, calibration of the antenna is necessary since the antenna mounts slip small amounts over time. The photocell described earlier provides a simple detection of the Sun where highest Sun illumination produces the lowest impedance. Using the Fluke Multimeter 8842A, this impedance is monitored by a computer program. Since the position of the Sun in the sky can be calculated, and thus the Sun tracked, simply sweeping an area of the sky which includes the Sun and noting the brightest point is sufficient to calibrate the antenna to within one degree. The TrakBox and Yaesu rotors do not provide higher pointing accuracy. The Yagi antennae used are wide beam and thus pointing accuracy is not of a concern.

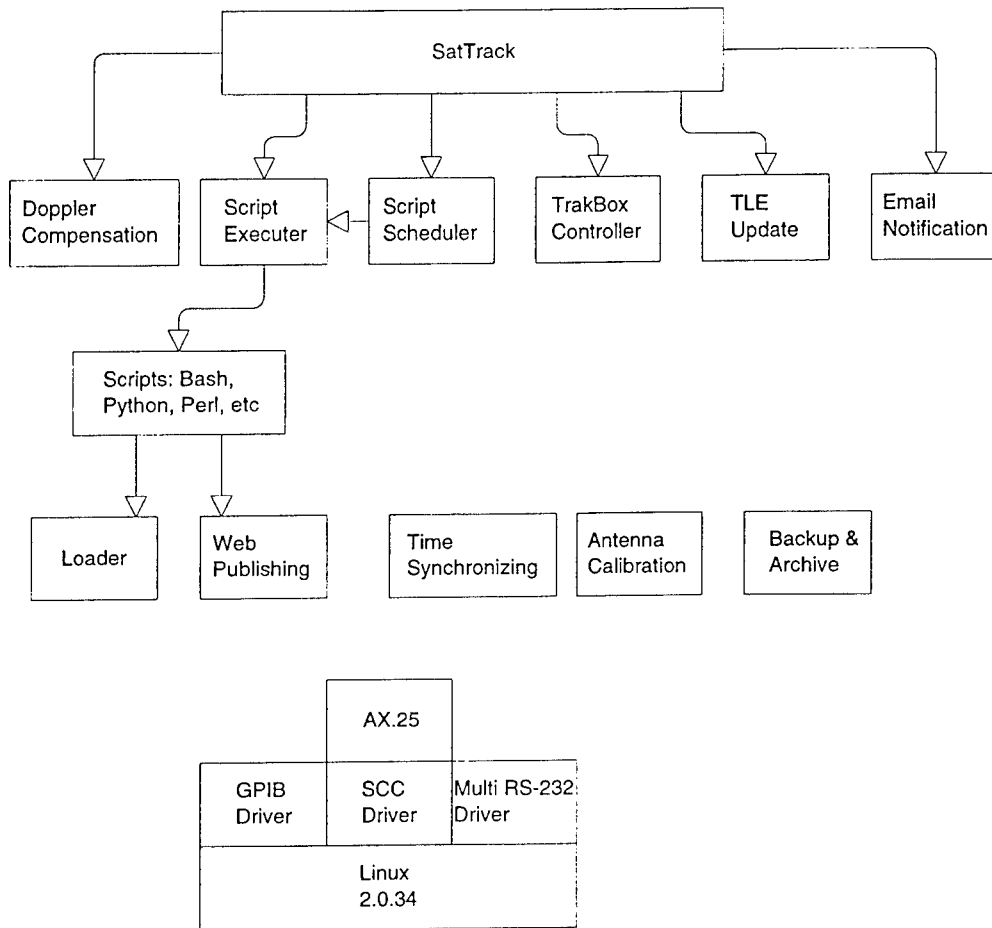


Fig 3: Software Components and Organization.

Mon 22-May-2000	12:08:42	12:12:47	12:16:59	00:08:17	6.0	8606	
Mon 22-May-2000	13:47:54	13:53:31	13:59:15	00:11:21	17.9	8607	hk.scr
Mon 22-May-2000	15:28:23	15:34:23	15:40:30	00:12:07	26.6	8608	hk2.scr
Mon 22-May-2000	17:09:30	17:15:22	17:21:22	00:11:52	21.8	8609	hk2.scr
Mon 22-May-2000	18:51:16	18:56:06	19:01:05	00:09:49	9.8	8610	
Tue 23-May-2000	12:01:04	12:05:40	12:10:23	00:09:19	8.5	8621	
Tue 23-May-2000	13:40:39	13:46:24	13:52:16	00:11:36	20.5	8622	up_s.scr
Tue 23-May-2000	15:21:24	15:27:23	15:33:30	00:12:07	26.7	8623	up_c.scr
Tue 23-May-2000	17:02:31	17:08:15	17:14:07	00:11:36	19.2	8624	up_c.scr
Tue 23-May-2000	18:44:39	18:48:59	18:53:35	00:08:56	7.2	8625	

Fig. 4: PANSAT Pass Schedule with Scripts.

```

# Download the data, and clear the logs on the spacecraft
while (gsmodules.do_cmd("slg", logdate) != 0):
    pass
while (gsmodules.do_cmd("slm", logdate) == 200):
    pass
while (gsmodules.do_cmd("slc", logdate) != 0):
    pass
commands.getstatusoutput("echo `HK Complete` >hk_done")

# Do supersnapshots if running UPLOAD software
if (dcs_id == 102):
    while (gsmodules.do_cmd("ssnaps 3 15", logdate) != 0):
        pass
    commands.getstatusoutput("echo `SSNAPS Complete` >ssnaps_done")

# Spend the rest of the pass getting snapshots
while (1):
    gsmodules.do_cmd("s", logdate)

```

Fig. 5: Portion of Python Script to Control PANSAT

## 6. CONCLUSIONS

Use of COTS hardware and Open Source software reduced the cost and development time to implement the ground station for PANSAT by the Space Systems Academic Group. In addition, the system is more reliable and flexible due to the nature of the openness of the software. Using a centralized computer, an entire ground station system was implemented to provide autonomous control of the PANSAT spacecraft.

## REFERENCES:

- [RIGM 98] D. Rigmaiden : *PANSAT Communications Drawing Set*, Naval Postgraduate School, Monterey, California, 1998.
- [SLAC 98] Walnut Creek CDROM : *Slackware 3.5*, Walnut Creek, California, 1998.

- [SCHR 97] C. Schroeter : *Linux-GPIB IEEE 488.2 Board Driver Package for Linux*, Version 2.02, Berlin, Germany, 1997.
- [GPL 91] Free Software Foundation : *General Public License*, Version 2, Boston, Massachusetts, 1991.
- [SMAL 95] C. Small : *PackeTwin Device Driver for Linux 2.0.x*, Gracilis, 1995.
- [CYCL 96] Cyclades Corporation : *4YoPCI+ Driver for Linux*, Fremont, California, 1996.
- [AX25 97] Linux Documentation Project : *Linux AX25-HOWTO. Amateur Radio*, October 1997.
- [BEST 95] Bester Tracking Systems, Inc. : *SatTrack*, Emeryville, California, 1995.
- [HORN 97] J. Horning : *System Controller Hardware and Embedded Software for the Petite Amateur Navy Satellite (PANSAT)*, Masters Thesis, Naval Postgraduate School, Monterey, California, September 1997.
- [HORN 98] J. Horning : *PANSAT Loader Software*, Naval Postgraduate School, Monterey, California, 1998.
-

**NEAR EQUATORIAL ORBIT (NEqO) SATELLITE  
CONSTELLATION FOR REMOTE SENSING AND DIGITAL  
COMMUNICATIONS**

By  
**Mazlan OTHMAN**  
*United Nations Office for Outer Space Affairs  
Vienna International Centre  
P.O.Box 500  
A-1400 Vienna, Austria  
E-mail: [mazlan.othman@unvienna.org](mailto:mazlan.othman@unvienna.org)*

**and**

**Ahmad Sabirin ARSHAD**  
*Astronautic Technology (M) Sdn. Bhd.  
Lot 3-2, Incubator 3, Technology Park Malaysia,  
Bukit Jalil, 57000 Kuala Lumpur  
Malaysia  
E-mail: [drasa@pd.jaring.my](mailto:drasa@pd.jaring.my)*

***ABSTRACT** - A constellation of Near Equatorial Low Earth Orbit (NEqO) satellites is proposed that consists of an affordable constellation of eight small satellites to provide digital communication and earth observation services that will best meet the requirements of multiple users in Malaysia, including among others, health, agricultural, natural resource and environmental management and education.*

*The project implementation and technology transfer strategies to be adopted will ensure that all related Government agencies and various sectors of industry will be deeply involved in the technology development and will benefit from the services offered by the constellation system.*

*The services will also benefit other countries in the equatorial belt, which are mostly developing and frequently experience natural and man-made disasters. The constellation allows Malaysia the opportunity to establish close cooperation with these countries during design, manufacture and operation.*

**SPACE SYSTEMS USING GEO AND LEO SATELLITES.  
MISSION: LONG DISTANCE ACTIVITIES SUPPORT**

**J. de Miguel, N. Alfaro and B. Garrido**

*Instituto Nacional de Técnica Aeroespacial  
Ctra. Ajalvir, km. 4, 28850 Torrejón de Ardoz  
Madrid, SPAIN*

miguelaj@inta.es, alfaron@inta.es and garridobj@inta.es

*ABSTRACT –An Earth observation programme is being developed under the support of the Spanish Ministry of Defense. Its main missions can be grouped into two different types: surveillance, as much as for national defense as for crisis zones, and support of long distance deployed troops, air forces, etc. When used with other elements it is able to fully accomplish these important tasks. The poster presents the main features of the Earth observation satellite, an overview of the complete system, including Earth observation and communication satellites, and the various missions that can be performed with the system.*

## **1 - INTRODUCTION**

The changes in the world defense scenario require coping with new kinds of missions. Among others, the long distance deployment of forces for peacekeeping or rescue tasks is one of the most difficult to fulfill without the required support. The same problem arises when deploying volunteers to provide help when a natural disaster happens in any part of the world.

The support of long distance deployed forces can take advantage of the capabilities of space systems, although demanding new systems or imposing new requirements to the already existing ones.

Currently, Geosynchronous Communications Satellites allow long distance (some times even global) communications, whereas Low Earth Orbit Observation Satellites provide information about things happening all over the surface of the Earth. Combining different already existing elements it is possible to create modern systems that comply with the new requirements.

The system shown in this poster accomplishes the required mission taking advantage of GEO communications satellites and Earth observation satellites, already operational or under development. In our case, the Earth Observation segment is being developed and their satellites take advantage of the small satellite philosophy to keep the costs low achieving good performances. The GEO communications segment is already operational and their satellites are of standard size. However, GEO communications small satellites are also under study to be used mainly for this kind of missions.

## **2 - THE EARTH OBSERVATION SATELLITE**

The ISHTAR Earth observation satellite is a member of the MINISAT family, whose first member, MINISAT 01, was launched April 21<sup>st</sup> 1997, and is performing successfully since then. ISHTAR reuses some of the know-how obtained during this first development while upgrading some other elements to cope with the new requirements.

The observation payload consists of two cameras that allow to record information in the panchromatic and infrared spectral bands. This information can be obtained simultaneously if required. Using these two spectral bands allows day and night capability. The capability of taking stereoscopic information using two or more pictures is also included. If the images are taken along track, the stereoscopic pair is obtained in one pass over the target; if the images are taken across track, two passes are needed.

The satellite has a pointing accuracy of 2 mrad. The processed geolocalization of the image is less than 100 m. The satellite orbit determination is done using GPS. A back up method using ranging in S band is also included. The images are temporarily stored in a high-capacity solid state mass memory. Image data are downloaded using very high transmission data rates due to the amount of data generated with the sensors. Furthermore, Earth observation and image download can be performed simultaneously. This feature is very important when providing information to a deployed force. The threatening surroundings can be surveyed during the download flight over the mobile ground station. The image data are transmitted to Earth in X band while the telemetry and telecommand data are sent and received in S band.

The power required to operate the payload is provided by two deployable solar arrays that are kept pointing to the Earth as much as possible. For the eclipse periods a Ni-H<sub>2</sub> battery is included.

The satellite includes a propulsion subsystem that is used to maintain the orbit height. This feature allows the satellite to repetitively take pictures of the same places providing information of the changes, being able to predict accurately when the next picture of the area is going to be taken.

The Earth observation satellite is placed in a sun synchronous orbit of 500 km of altitude approximately. This orbit ensures that global coverage is achieved, and provides an access time of less than three days to any point of the Earth surface using only one satellite. The revisit time could be reduced to one day by using a constellation of two satellites.

The satellite has been designed to be compatible with already existing commercial launchers and its has a operational life of more than five years. Following the small satellite philosophy the satellite has a weight of only 600 kg.

The satellite operation defines the target to look at on a daily basis. The spacecraft has autonomy of three days, being able to perform the required tasks during this time with no additional information from ground.

### **3 - THE COMPLETE SYSTEM**

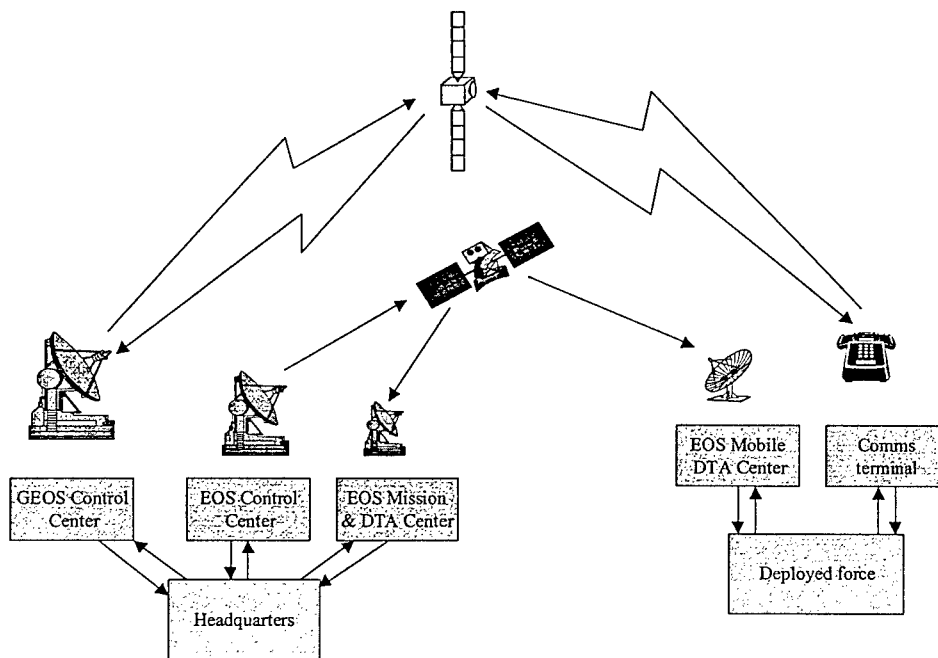
The new defense scenario requires new tools to accomplish the missions with lowest risks and minimum delays. The objective of our system is to support the deployment of forces outside of the national borders for peacekeeping and humanitarian purposes. The way to take advantage of our resources is to combine the use of two types of satellites. The information obtained using the Earth observation spacecraft is sent to the deployed force, along with additional data from the headquarters, by means of the geosynchronous communication satellite.

The complete system consists of:

- One (or more) Geosynchronous Communication Satellites (GEOS) with its Control Center.
- One (or more) Earth Observation Satellites (EOS) in Low Earth Orbit, with its Control, Mission and Data Treatment and Archive (DTA) Centers.

- The headquarters of the mission that manages the GEOS and EOS Control Centers, and the EOS Mission and DTA Center.
- A mobile DTA for the EO Satellite.
- A transmission and reception terminal to communicate with the headquarters of the mission by means of the GEO satellite.
- The deployed force that receives data from the EOS by means of the mobile DTA and communicates to the headquarters using the transmission and reception terminal.

A simplified picture of the system is presented below.



The Earth observation segment of the system consists of one or more spacecraft that, due to their swath width, guarantee a revisit time of less than three days for one satellite, and less than 24 hours when using two satellites. The satellites have day and night observation capabilities with global Earth coverage. There is a main mission and data treatment and archive center for nominal on-site operations and a mobile data treatment and archive center, including the receiving antenna, for using the system to support a deployed force.

The Geosynchronous communications segment consists of one or more, for redundancy purposes, satellites that allow the voice and data transfer between the headquarters and the deployed force. These satellites can be of standard size for a GEO communication satellite, sharing part of the payload for other purposes, or can be small satellites dedicated only to this mission.

The Earth observation satellite gathers information of the required area and the surroundings of the projected force. This information is downloaded to the mobile ground station operated at the deployed group position. The command of the satellite is done at the headquarters using the feedback from the projected force. The geostationary spacecraft is required for the headquarters to send orders and information about the Earth observation satellite to the deployed force, and for this force to update the information maintained at the headquarters to have a clear picture of the situation in order to take the required actions.



## JAVA FACE TO SMALL SATELLITES

Ludovic APVRILLE<sup>†‡</sup>, Patrick SENAC<sup>†</sup>, François RICHARD<sup>\*</sup>, Michel DIAZ<sup>‡</sup>

<sup>†</sup>ENSICA

DMI

1, Place Emile Blouin,  
31056 Toulouse Cedex 5,  
France

<sup>\*</sup>Alcatel Space Industries

Service DPT/TTS/I

26, av J.F. Champollion, BP 1187  
31037 Toulouse Cedex, France

<sup>‡</sup>LAAS-CNRS

groupe OLC

7, avenue du colonel Roche  
31077 Toulouse Cedex 4,  
France

Key words: software engineering, object-oriented, satellites, dynamic reconfiguration

**ABSTRACT** – *Small satellite systems and more particularly satellite constellations must evolve quickly as user needs change. Conventional space-based embedded software techniques cannot meet these constraints. Therefore, this paper describes a software methodology that offers a way to dynamically upgrade space-based embedded software. This methodology is introduced by studying the software's functional architecture and by pragmatically analyzing its constraints.*

**RESUME** – Afin de s'adapter aux nouveaux besoins des utilisateurs, les systèmes à petits satellites, et en particulier les constellations doivent pouvoir réagir rapidement aux évolutions. Les techniques traditionnelles de conception du logiciel embarqué sur satellite s'accommodent mal de ces contraintes. Partant de l'étude de l'architecture fonctionnelle d'un logiciel embarqué dans un satellite et de considérations pragmatiques sur les contraintes du logiciel embarqué en environnement spatial, cet article propose une méthodologie et des techniques permettant de mettre en œuvre une architecture logicielle évolutive et dynamiquement reconfigurable.

## 1. INTRODUCTION

Reducing the size of satellites seems to be the correct answer to the problem of launch costs. However the use of smaller architectures for certain satellites must go hand in hand with a reduction in production costs. Specifically, software costs for a geostationary satellite are equivalent to the software costs for a small satellite. However, the relative cost of the software is much lower for a geostationary system. The software costs for small satellites at the moment seem very high when compared with the total cost of the satellite. Other constraints are associated with software systems for small satellites. First, space-based embedded software is required to manage increasingly elaborate functions. Secondly, because of the upgradability of space-based systems user requirements, software systems are required to be reconfigurable with no interruption in service. All these constraints, in terms of costs, complexity and reconfigurability, lead us to say that current software techniques are obsolete with regard to these requirements: new software technologies will have to be used.

Specifically, on-the-shelf technologies, which therefore cost less, may be used to reduce the development cycle, reduce costs and increase functionalities while maintaining the same reliability. An interesting solution to on-the-shelf components is to use object-oriented technology and particularly the Java language. Java, with its large number of components, its portable nature (the independence of the developed software with regard to the underlying hardware architecture) and its object-oriented architecture which facilitates software re-use and maintenance, would at first glance appear to be a good solution, particularly as the Java language integrates mechanisms which may be used to extend the code dynamically within an application.

However, object-oriented technology has no built-in guarantees with regard to hot reconfiguration. Therefore when the software is upgraded, certain guarantees must be obtained concerning correct system operation, both during and after the upgrade. These constraints are mainly expressed in terms of resource availability and continuity of service from a user viewpoint.

The first part of this paper describes how reconfiguration may be performed with regard to space-based software architecture. The constraints inherent to these operations are provided. The second

part proposes a software methodology, which is compatible with these reconfiguration operations. A description of the software and hardware architecture of the dynamic reconfiguration is also provided. Finally, the last section shows how the dynamic reconfiguration is implemented.

## 2. DYNAMIC RECONFIGURATION

### 2.1. Software Architecture

The first step in the reconfiguration of a space-based embedded software is to analyze the software structure. These software applications are composed of inter-communicating software modules, which communicate by passing messages or by sharing memory. These modules are run concurrently i.e. one task is generally associated with each module. The functional architecture of this type of module is given in Figure 1.

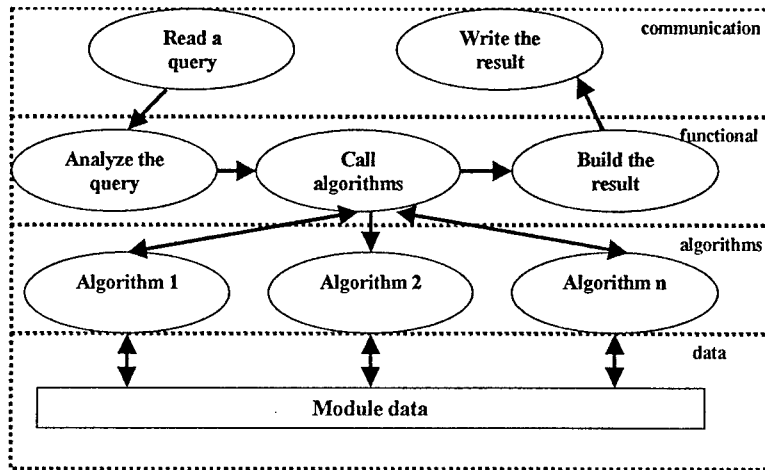


Figure 1: functional organization of an embedded software module

From an object architecture viewpoint, a module is composed of one or more active objects (tasks) which represent the functional part of the module. A specification (1) of the module's temporal constraints and (2) an object architecture specification is also associated with each module.

### 2.2. Dynamic reconfiguration operations

Dynamic reconfiguration operations thus affect space-based embedded software modules. At first it may seem complicated to be able to reconfigure any software component in the application. The dynamic reconfiguration depends on the software structure and therefore on the software breakdown into modules.

Reconfiguration operations take the form of orders, which are sent by an operator. At module level these orders are translated into lower level orders (system object and class levels) to be applied to the space-based embedded application.

Three high-level operations are defined: *add* a module, *modify* a module and *delete* a module.

- *Add a module* first consists in adding new objects (and therefore new classes) to the system and then starting the active objects, which correspond to the module.
- *Modify a module* first consists in loading the new classes and instantiating the new objects. For reasons of coherence, the modified module should then be stopped as should all interdependent modules. The new objects may then be inserted into the space-based embedded application. When this operation has been completed, the stopped modules are started again and the old and unused objects and classes are deleted from the system.

- *Delete a module.* This operation has two phases: the module concerned is stopped and then the old and unused objects and classes are deleted.

### 2.3. Constraints concerning operations on the modules

Operation	Constraints
Add	The resources required for this new module must be available. These resources may be static (memory) or dynamic (scheduling resources, synchronization resources).
Modify	Certain modules in the system must be stopped in accordance with the module temporal and synchronization constraints so that the stop is transparent for the users. As in the case of the addition of a new module, the inherent resources required for the modified module must be available.
Delete	The deleted module $m$ must not be interdependent with any other module in the system. Therefore this operation shall often be associated with operations modifying modules which are interdependent with $m$ .

## 3. SOFTWARE METHODOLOGY

The notion of reconfigurability must be introduced into the software life cycle explicitly. Figure 2 presents the various steps in the life of a software application, referred to as App<sub>1</sub>, to which module operations are applied. These operations generate a new application referred to as App<sub>2</sub>.

### App<sub>1</sub> modeling phase

The system is modeled using UML [UML], with classes (components) and a software development environment which may be capable of generating the code [ILO 99]. The resources of all the components are then modeled. This resource modeling is then embedded in each component, and in each component instance. At first, this modeling only integrates the size of memory available to instantiate one element of the component in question (i.e. instantiate a class object) and the UML diagram inherent to the component. This diagram mainly integrates relationships with the other classes of the system (use, inheritance and composition relationships). The RT-LOTOS language [RT-LOTOS], a real-time extension of the LOTOS language [LOT 87] is also used in this modeling phase. It is used to describe the real-time dynamic behavior of the system.

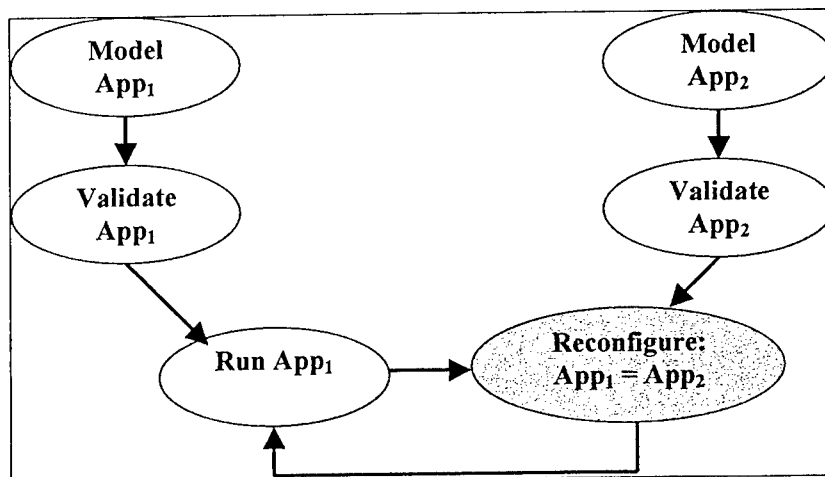


Figure 2: life cycle of a reconfigurable software application

### Application validation phase

The various states of application App<sub>1</sub> are analyzed to check system behavior with regard to (RT-LOTOS and UML) specifications. This validation stage is performed from the analysis of the global state of the system, a state which is obtained by merging the states of all the components. For example, a tool like RTL [RTL] may generate a timed state machine of the different system states, from the application's RT-LOTOS specification.

#### Execution phase

The App<sub>1</sub> application operates normally. A specific reconfiguration module is waiting for an order.

#### App<sub>2</sub> modeling phase

The modeling of the App<sub>1</sub> application is modified, which generates a new application (App<sub>2</sub>). App<sub>2</sub> is derived directly from a sequence of operations on the modules applied to App<sub>1</sub>.

#### App<sub>2</sub> validation phase

The same techniques are used as for the previous validation.

#### Reconfiguration phase

The operations on the modules, which must be applied to App<sub>1</sub> to obtain App<sub>2</sub>, are translated into operations on objects and classes. This integration phase is likely to generate constraints on the state of the other components. An engine then interprets the operations on objects and classes. When integration is completed, the software returns to a "normal" execution phase.

## **4. SUPPORT ARCHITECTURE**

This part is used to show how a dynamic reconfiguration may be installed in a space system. It first describes the constraints associated with the use of the Java language in a small satellite context. Then the second part explains how the dynamic reconfiguration is implemented with regard to real-time constraints and Java environment constraints.

### **4.1. Real-time Java**

The Java language [JAV 95] appeared at the end of 1995. A large number of the Java language functionalities such as its inherent multitasking, synchronization mechanisms, lack of pointers, ability to add C code and finally the virtual machine which makes the code independent of the hardware execution environment, appear to be very advantageous in a space-based real-time context. However, a number of limitations have been identified [DIB 98]: for example, the non-preemptive garbage collecting memory management, the fuzziness of Java task scheduling methods, the mediocre general performances, the lack of a standard API for driving external equipment [BUN 98], etc. A certain amount of research is aimed at defining real-time extensions for the Java language. Other research groups are concentrating on improving the Java language performances. Indeed, even if just-in-time compilation cannot be envisaged for real-time systems, AOT (Ahead of time) compilation techniques may be useful. The compatibility of certain solutions with the constraints of space-based embedded applications has already been demonstrated [APV 99]: in particular, the scheduling of Java tasks on real-time kernels is compatible with space application constraints. Even if the garbage collecting technique seems disappointing, simple solutions based on pools of objects or real-time analysis of applications have been proposed and tested successfully.

The Java language would seem to be well adapted for use with small satellites. Small satellite programs are either experimental projects in which this type of technology may be demonstrated, or the programs are for constellations of small satellites, constellations in which the distribution of Java type objects seems advantageous insofar as distribution need not be concerned with underlying hardware platforms.

Finally, hardware boards for microsattellites with the power required for this type of environment are available on the market (boards up to 500 Mips, with 32 MB RAM).

#### 4.2. Space-based embedded Architecture

The embedded architecture must enable both conventional reconfigurations with interruption of service (patch technique) and hot reconfigurations on the software in normal phase. A hardware and software architecture, which is compatible with both reconfigurations is described in Figure 3. The hardware architecture consists of a start-up PROM, two EEPROMs and a RAM. The software operating sequence in this type of environment is as follows:

1. The system boots up and enters a start-up mode (which is also the survival mode). An equipment self-test is obviously also performed during boot. When the boot-up has finished, the system manages minimum functions (attitude control, TM/TC). Patches may then be installed on the EEPROMs.
  2. The Java code and the associated real-time operating system (with an integrated Java virtual machine) are copied to the RAM
  3. The operating system starts up and the Java tasks are run (DHU and PMU tasks).
  4. In this phase, the software dynamic reconfiguration orders are accepted: certain software modules may be stopped temporarily and restarted.
  5. In the event of critical error, the system switches to survival mode (phase 1).
- Please note that the patches on the EEPROMs may be used to switch over at any time to a system programmed completely with more conventional methods (C or ADA on a task sequencer).

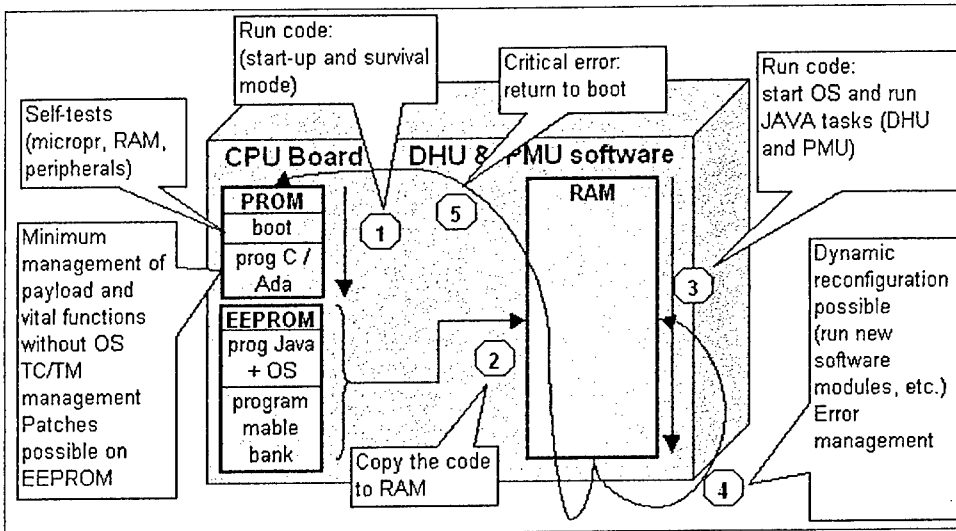


Figure 3: Hardware and software architecture

### 5. IMPLEMENTING THE DYNAMIC RECONFIGURATION

#### 5.1. System architecture

The system architecture (Figure 4) highlights the presence of a class server within the satellite operations center. This class server is updated when the software is specified and validated on the ground. When the operator runs an order, all the classes required for the space-based embedded application are downloaded via a TM/TC interface from a class server on the ground.

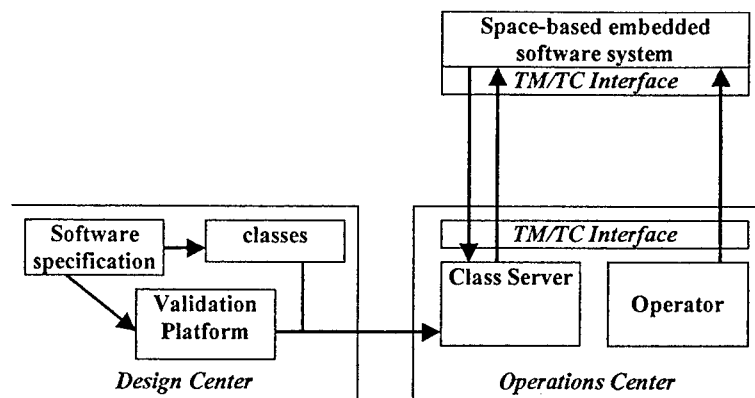


Figure 4: complete satellite / control center system architecture

## 5.2. Implementation in the space-based embedded system

The space-based embedded system must be capable of processing orders sent by the operator, translating them into lower level orders (orders on classes, objects), downloading the classes concerned, stopping certain modules, creating instances, restarting certain modules and then deleting the old objects and classes. Some of these processes are described in the following paragraphs.

### Downloading classes

The Java *ClassLoader* mechanism [LIA 98] may be used to download classes, which are not present in the system. The method consists in creating a class, which inherits the Java *ClassLoader* class, and in redefining the *findClass* and *loadClassData* methods. This method of downloading the data in a class mainly uses the TM/TC interface API. Once the class has been downloaded, an instance of this class may be created. This mechanism is used to create instances of a class, which was not part of the original application.

### Starting and stopping modules

We worked on the hypothesis that each system task has an asynchronous stop method (*stopAsap()* method). Once this method is called up, the task stops when it is at a stop point, which is compatible with its own constraints. A task may also, at any time, but according to the temporal constraints modeled in its specification (embedded with the task), provide its maximum stop time. When the time reaches 0, the task must be restarted immediately.

Starting or restarting a task is also performed by a method call on the task (*restart()*).

### Deleting objects / classes

Unused objects are deleted and their memory is either placed in a memory pool, or freed by a garbage collector. Classes are deleted from the memory by the garbage collecting mechanism.

## 6. CONCLUSION

This paper highlights the reconfiguration requirements within satellite systems. Pioneering embedded software architectures are proposed to offer dynamic reconfiguration mechanisms, a basic mechanism used to maintain the competitiveness of the system over the years.

In addition to the facilities offered by the Java type object environments, we demonstrated in this paper that this type of reconfiguration mechanism affects the entire software life cycle. From the specification stage it is fundamental to model the resources offered and used by the various components. Moreover this specification must be integrated in the component which thus becomes self-documented. From this basic principle, dynamic reconfiguration is then mainly based on off-

line analysis techniques which are used to highlight the coherence of integrating a new component with regard to the global state of the system and also based on coherent management of the abilities to issue a dynamic link, which are offered by the execution support environment.

The extensions of this research work deal firstly with research into telecommunication protocols used to optimize telecommunication resources and secondly with the software implementation of these protocols, by using analysis techniques which offer a good trade-off between analysis performances and the continuity of service of the software to be reconfigured.

## 7. REFERENCES

- [APV 99] Aprville L., Sénac P., Diaz M., "A Java Framework for Spatial Embedded Systems", Proceedings of the 13<sup>th</sup> annual AIAA/USU conference on small satellites, Logan, Utah, USA, August 23-26, 1999
- [BUN 98] Bunnell M., "Mixing Java and C in Embedded Systems". Real-Time Magazine, Internet Embedded – 98/1
- [DIB 98] Dibble P.C., "The reality of real-time Java". Computer design, August, 1998
- [ILO 99] [http://www.ilogix.com/prod\\_c.htm](http://www.ilogix.com/prod_c.htm)
- [JAV 95] Gosling J., McGilton H., "The Java Language Environment: a White Paper", Sun Microsystems Inc., 1995. <http://java.sun.com/whitePaper/java-whitepaper-1.html>
- [JCO 98] <http://www.j-consortium.org/>
- [LIA 98] Liang S., Bracha G., "Dynamic Class Loading in the Java Virtual Machine", in C chambers, editor, *Object-Oriented Programming Systems, Languages and Applications Conference*, in Special Issue of SIGPLAN notices, number 10, Vancouver, October 1998. ACM.
- [LOT 87] Bolognesi T., Brinksma E., "Introduction to the ISO Specification Language LOTOS", Computer Networks and ISDN Systems, Elsevier, vol. 14, 1987
- [RTL] <http://www.laas.fr/RT-LOTOS/>
- [RTLOTOS] Courtiat J-P., Cruz de Oliveira R., "About Time non Determinism and Exception Handling in a Temporal Extension of LOTOS", 14<sup>th</sup> international Conference on Protocol Specification, Testing and Verification (PSTV'94), June 1994, Vancouver, Canada
- [UML] <http://www.omg.org/uml>



**A GAMMA RAY OBSERVATORY ON THE MITA PLATFORM  
AGILE A FORERUNNER FOR ASI SMALL SATELLITE SCIENTIFIC PROGRAM**

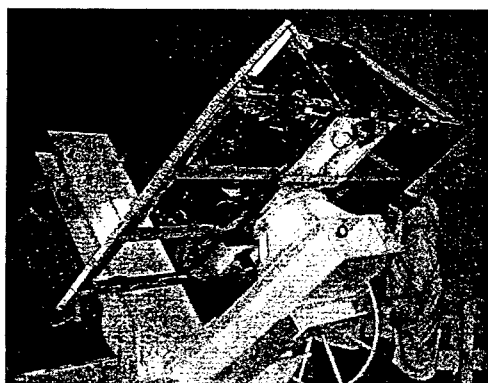
**Luigi CROCCO**

*CARLO GAVAZZI SPACE  
Via Gallarate, 150 - 20151 Milano ITALY  
Ph: +39 02 38048.1  
Fax: +39 02 3086.458  
Email: lcrocco@cgspace.it*

**INTRODUCTION**

Carlo Gavazzi Space (CGS), an Italian based company, is developing a small satellite platform, MITA whose acronym stands for "Italian Advanced Technology Mini satellite". MITA has been developed to provide the user community of a Small Satellite platform suitable for a wide range of mission scenarios.

The first MITA satellite, ready for the Launch Campaign (Fig.1), will fly as technology demonstrator on 15<sup>th</sup> of July 2000.



**Fig.1** :MITA Satellite during Mass Property Test

As result of an Announcement of Opportunities for Small Scientific Mission, ASI selected AGILE mission to be launched in 2002.

CGS, under ASI commitment, after the feasibility study has been then responsible in the Phase B, for the implementation of the MITA Platform for the first Italian Scientific Small Satellite.

Scientific Goal of this mission is to provide an Astronomical Observatory for the scientific community to perform a Sky Mapping in the high energy spectra by means of a solid state low-mass silicon Gamma Ray detector. The selected orbit is an equatorial LEO of 550 Km.

**FROM MITA TO AGILE**

The approach used in the study and definition of the mission started in the Phase A and then in the Phase B, led to the definition of two main different pathways: the first following the re-use and adaptation of MITA electrical subsystem, and the second exploiting several studies of the external configuration, more depending on the launch opportunity.

The MITA platform meets the observation requirement by means of a 3-axis stabilised Momentum bias control system, using 1 momentum/reaction wheel, magnetic coils as actuators and a set of Sun Sensors and 2 Star Sensors. The attitude control implement a Sun Pointing for a two weeks period with manoeuvring capability along the Sun-vector axis.

Most of the subsystems require minor changes or not at all as summarised in Tab.1.

<i>Subsystem</i>	<i>AGILE</i>
OBDH	Same as MITA
ACS	Different control same equipment as MITA
Power	Same as MITA (different battery)
TM&TC	Same as MITA

**Tab.1** : Main AGILE subsystems

Other subsystems (Structure, Solar Panels and thermal control) may differ from MITA, being strongly dependant from the Launch possibilities, not yet defined.

#### **STANDARDISING THE ELECTRICAL SUBSYSTEMS**

Following the MITA guideline, AGILE Bus has been designed to re-use as much as possible all the electrical subsystems.

The main difference respect to a “series” of satellites is that for Scientific mission the designers have always to cope with different requirements, this implies that each mission has a different spacecraft.

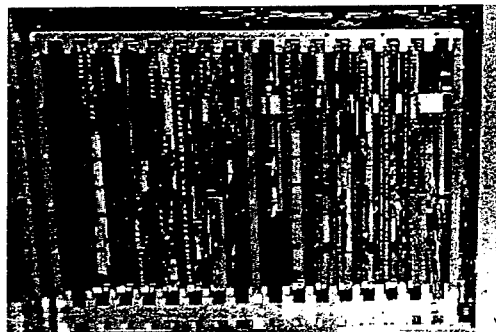
The limited budgets for small scientific missions is the winning driver to achieve a sort of standardisation in the small satellite production, essentially for the Platform.

This philosophy is reflected in the ASI call for proposal of 1998, when it was asked to the scientists of “thinking” a mission falling in a MITA-like envelope.

The missions presented, studied by CGS, performed an iterative process of scientific requirements definition together with the Bus specifications. The Bus designers studied all the necessary modifications starting from the existing subsystems obtaining a sort of a natural “evolution” of the system which adapted to each different “mission environment”.

As result of these studies designer came up to define a Standard Set of Units or Subsystem to be used in all the future mission, with the possibility of upgrading if required by any mission constraint.

In the Fig.2 is presented one of these Units mounted on board of the Flight Model of MITA, during integration, and to be reproduced for AGILE Bus.



**Fig.2** :OBDH (On Board Data Handling)

## FLEXIBLE CONFIGURATION

To cope with the uncertainty of the Launch opportunity several configuration have been studied from the early Phase A to the end of Phase B.

The SELVs (Small Expendable Launcher Vehicle) Class seems to be the natural target for such a Small Mission, with strong constraint on inclination (equatorial LEO for AGILE) and money budget.

The configuration studies were applied to this Class and two Launcher were selected as reference case: Pegasus XL from Orbital Science Corporation (USA) and START-1 Launcher from Puskovie Uslugi (Russia)

The “evolution” of the AGILE configuration started in Phase A with the Pegasus XL. Two different configuration were presented at the end of Phase A (Fig.3 and Fig.4):

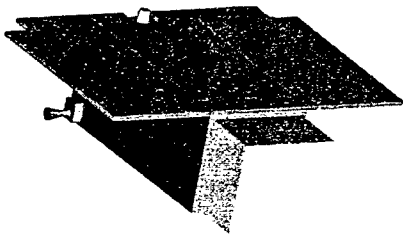


Fig.3 :Agile Long Version, for a dedicated Launch

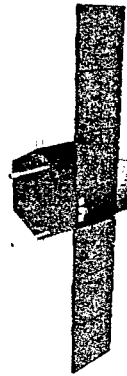


Fig.4 :Agile Hexagonal version, for a Piggy back launch

As output of the Phase B a new configuration was designed based on the Russian Launcher START-1 and for a dedicated launch. This configuration with fixed Solar Array, is at the moment, the last “evolutionary step” of the AGILE mission history.

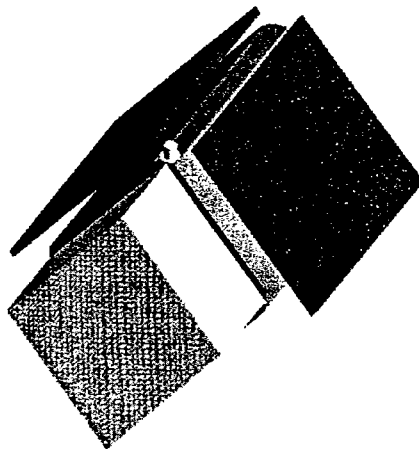


Fig.5 : AGILE Satellite for a dedicated Launch

## **Conclusions**

The AGILE design drivers aim to achieve compelling scientific mission goals in the simplest and reliable way, using the MITA platform characteristics of mission flexibility and modularity as well as re-use of standard equipment.

## OPEN SOURCE TO SMALL SATELLITES GROUND STATION

Manoel Jozeane Mafra de CARVALHO (manoel@crn.inpe.br)<sup>1</sup>  
Romualdo Alves PEREIRA Júnior (romualdo@crn.inpe.br)<sup>1</sup>  
Maria de Fátima MATTIELLO FRANCISCO (fatima@dss.inpe.br)<sup>2</sup>  
Jean Paul DUBUT (jean@crn.inpe.br)<sup>1</sup>

<sup>1</sup> Instituto Nacional de Pesquisas Espaciais – INPE  
Av. Salgado Filho, 3000  
59001-970 Natal – RN – Brazil  
Fax: (55) (84) 231 4941

<sup>2</sup> Instituto Nacional de Pesquisas Espaciais – INPE  
Av. dos Astronautas, 1758  
12227-010 – São José dos Campos – SP – Brazil  
Fax: (55) (12) 322 9285

*ABSTRACT – After being treated for long time by non-academic institutions as vulnerable technology, in terms of reliability, Open Source has recently being pointed out by suppliers as a good alternative for software developers. This paper presents an example of using Open Source Software in INPE/CRN Ground Station in order to control small satellites. There is an emphasis on using Linux Operating System, a low cost environment to provide effectiveness and support efficient solutions for an user-friendly web application.*

### 1. INTRODUCTION

Small satellite missions aim at high performance and low cost. At ground station context, some solutions have been failed to get these goals. Mainly in software concerns, where the reusability is frequent and the availability of the source code is a crucial factor since the use of existing ground station infrastructure is desirable or imperative.

A reasonable range of known Ground Station solutions for Microsatellite Missions are using even more widespread hardware open standards as the General-Purpose Interface Bus (GPIB), Ethernet, and PCI [Pres98] [Brow 98], permitting a real independence of equipment supplier. On the other hand, software solutions do not follow the same way. Considering just the machine, it is common to find references of Workstation based on Unix systems being substituted for PCs, because of both its low cost [Sore 98] and supplier independence [Gonç98]. Nevertheless, this independence is not reached when the software solution cannot accomplish this idea.

Software, which in theory is the easiest part to modify, update and aggregate new modules, loses these features when only the supplier can make any change. Open Source alternative is an excellent option to address these needs.

### 2. OPEN SOURCE

In this paper, the terms Open Source and Free Software are considered to have opposite meaning to the terms Proprietary Software and Commercial Software. The conceptual differences among them are well reported on the following sites: <http://www.fsf.org/philosophy/categories.html> and <http://www.opensource.org/faq.html>. This paper does not approach these differences. For the paper purpose, it is sufficient to understand the Stallman<sup>1</sup> explanation about Free Software philosophy, in

<sup>1</sup> Richard M. Stallman is the President of Free Software Foundation (USA); creator of both GNU Project and Free Software concept.

the First International Forum Free Software 2000, held in Brazil. According to him, "This paradigm started to develop in 1970 decade and fill three requirements: it has open source; their copies are distributed with no restrictions; and their changes and improvements must be widespread and distributed with no restrictions" (<http://ww9.terra.com.br/noticias/especial/>).

Traditionally, software has been delivered in binary distributions, where the developers are not able to modify the underlying source. In such case the developer must hope that it is flexible enough to be configured in binary form to meet local needs. Or, then, they have to pay to suppliers to make the needed modifications for them.

The basic idea behind Open Source is very simple: When programmers can read, redistribute, and modify the source for a piece of documented software, it evolves. Developers can improve it, adapt it, and fix bugs. And this can happen at a speed that, if one is used to the slow pace of conventional software development, seems astonishing.

The most commonly license used by Open Source Community is the General Public License (GPL). It grants users the freedom to modify the software and distribute this derived work only if, among other restrictions, the derived work is also licensed under the terms of the GPL. This license ensures that all users of a piece of software, even users of modified versions, have the freedom to see and modify the source code. The Free Software Foundation promotes the use of the GPL, producing a good contagious effect.

As the software becomes freely available under GPL, more developers will look at, examine, and critique the code. It is expected that additional people will add features and correct bugs, too. This will result in a stable software product and more efficient code. Also, software will be produced more quickly. As a consequence, the Open Source movement will have a major impact on the quality of code being produced. The Open Source community has learned that this rapid evolutionary process produces better software than the traditional closed model, in which only a very few programmers can see source and everybody else must blindly use an opaque block of bits.

Some years ago, Open Source was a restricted subject to hackers, but today the software industry is upholding this movement. For instance, IBM is giving perhaps the more emblematic and meaningful support to Linux, as announced in the IBM site at <http://www.ibm.com/linux>.

There are two basic ways to produce software in the Open Source Movement. It is possible to make changes, updates or improvements in an existent open source code; or develop a completely new source code creating a new community around. In these two cases the programmers can be sure that their contributions will be available to the community.

Actually, the running gears of the Internet (its mail transports, web servers, and FTP servers) are almost all open source. The Netcraft Web Server Survey (<http://www.netcraft.com/survey/>) tallies, which web servers, are used on the Internet. It consistently shows the open source Apache web server to have over 50% and steadily increasing market share, beating out better-hyped proprietary products like Netscape's and Microsoft's server suites.

### 3. LINUX

Linux, often known as GNU/Linux, is the leader, the principal success history and the greatest popularity in the Open Source Movement. Accordingly to the Linux Journal magazine [Rich 00], "Linux is a free, UNIX-like operating system, developed originally for home PCs, but which now runs on a variety of platforms including Alpha, SPARCC, PowerPC, Crusoe, ARM, MC680x0 and many others. Linux is a multi-user, multitasking operating system whose technological heritage hails from the mainframes and supercomputers for which the UNIX model was developed over three decades ago. Even today, Linux aims for POSIX compliance to maintain maximum compatibility with other UNIX-like systems".

Linux Journal magazine additionally published that: "Linux is also the birthplace of the open source methodology which, derived from the free software philosophy, has spawned a revolutionary, proliferation of free software, from compilers to word processors and GUIs. Today, with a firm base or at least 12 million users world-wide, Linux continues to grow exponentially as programmers, enthusiasts and end users exchange thoughts, implement ideas, contribute code and cooperate in the phenomenon known as open source to produce the operating system known as Linux"

Linux is very popular in education, Internet service applications, software development shops, and (increasingly) in small businesses. It is typically installed via a Linux distribution - a bundle containing the Linux kernel, applications, and utilities to form a complete working system. As a benefit to the source code for the Linux kernel being freely distributed, a number of companies have developed their own distribution of Linux. These distributions have their own feature set, and some are geared towards specific types of computer systems. In some cases, they are available at no charge via FTP and in other cases they may be purchased on CD for a relatively low cost, or as a companion to a Linux book. Several Linux distributions are available, some such as RedHat ([www.redhat.com](http://www.redhat.com)), Caldera ([www.calderasystems.com](http://www.calderasystems.com)), TurboLinux ([www.turbolinux.com](http://www.turbolinux.com)) and SuSE ([www.suse.com](http://www.suse.com)) also provide commercial support. These several successful companies sell Linux and other free software. Why to buy a software that could be free? One benefit for purchasing a commercial Linux distribution is that a limited support contract is generally included in the purchase price. These same companies have long-term, unlimited support contracts available for purchase by businesses that are new to Linux and apprehensive about making changes in their choice of operating systems.

The Linux community has known for some time that for many applications, Linux is a stable and robust product. Unfortunately, there are still many people, including key decision-makers, which are not aware of the existence of Linux and its capabilities. The reason that products of many companies have done well in the marketplace is not so much due to the product's technical superiority but the company's marketing abilities.

In much the same way that the Linux kernel has been written by software developers world-wide, users around the globe have also written much of the Linux documentation. A large segment of the written documentation is contained in the various HOWTOs and miniHOWTOs that make up the Linux Documentation Project. Other sources of free support may be found via IRC, mailing lists, and other website.

Linux is just the kernel. Without the efforts of people involved with the GNU project, MIT, Berkeley and others too numerous to mention, the Linux kernel would not be very useful to most applications. Thus, Linux is not the whole success story of open source. There are many other open source operating systems and applications available, including Programming Software, Database Tools and Utilities, Financial Programs, Text Editors, Spreadsheets, Networking Tools and Utilities, etc.

It has long been agreed that for Linux to succeed in a business environment, it needed to have a user-friendly desktop and included all the usual applications for the office. Today, much effort is directed to desktop development. There are two desktops being developed for Linux: KDE and GNOME.

KDE is a mature desktop suite providing a solid basis to an ever-growing number of applications for Unix workstations. KDE has developed a high quality development framework for Unix, which allows for rapid and efficient application development. Applications developed with this framework include KOffice, a full-featured Office Suite, KDevelop, a C/C++ IDE (Integrated Development Environment), and many others.

GNOME is the GNU Network Object Model Environment. The GNOME project intends to build both a complete, easy-to-use desktop environment for the user, and a powerful application

framework for the software developer. GNOME is part of the GNU project ([www.gnu.org](http://www.gnu.org)) and is free software compliant with the Open Source(tm) definition.

#### 4. EXAMPLE

A software system was developed at CRN/INPE using Open Source tools to support SACI Flight Plan Preparation through the Web. The system's main purpose is to allow the experiment scientific coordinator and ground station operators to have the use of all its resources independently of the place they are, since they have an internet connection with any browser. Basically, it is a client-server web-based system arranged in some interface pages with dynamic fill-out forms. The command data (telecommands) selected by the users are stored and maintained in a relational PostgreSQL database server.

The software system is organised in seven modules, succinctly explained below:

- **Authentication** - The authentication process occurs when users type their identification: username and password. Based on this information, the system is able to identify the available subsystems for a specific user, not permitting his/her entry in the system if absent in the cryptographer system permissions table. This module also deals with flight plans for more than one satellite. In case of SACI mission, the user must choose the satellite (SACI-1 or SACI-2) for preparing the wished flight plan (PVD).
- **Passage Updating** - A dedicated ephemeris software system produces a file with the previewed passages. The database server keeps this file and it is automatically updated. The main function of this module is to make this file information available for remote user since the Flight Plan is oriented by satellite data/time passages.
- **Passage Choosing** - Depending on the chosen satellite (SACI-1 or SACI-2), the system shows to the user the list of its passages previously calculated. The user selects a previewed satellite passage based on the operations needs and the interval of passage.
- **Planning and Visualisation** - From both the user identification and selected passage, the system recognise the user permissions and presents only the authorised destinations which correspond to the satellite subsystems, preventing impertinent requests. So, user may choose the sequence of telecommand to be transmitted, its order position and transmission time. There are operations for inserting, deleting and updating data; creating mnemonics; and generating the final flight plan file. Concerning to information safety through Internet, the TC planning looks after the traffic of non-final TC code. In the ground station operational routine, the TC code recognised by satellite is associated to each TC only when generating the .PVD file. Moreover, the user is able to see only the authorised destinations and subsystems related to him/her. Thus, each users group of the system has options for performing actions in a restricted universe ruled as shown in Table 1.

User Groups	Permission to VIEW TCs from	Permission to INSERT, UPDATE and DELETE TCs from
Coordinator	<ul style="list-style-type: none"> <li>• All Satellites</li> <li>• All Experiments</li> </ul>	<ul style="list-style-type: none"> <li>• All Satellites</li> <li>• All Experiments</li> </ul>
Technician	<ul style="list-style-type: none"> <li>• All Satellites</li> <li>• All Experiments</li> </ul>	<ul style="list-style-type: none"> <li>• Restricted Satellites Subsystems</li> </ul>
Investigator	<ul style="list-style-type: none"> <li>• Own Experiments</li> </ul>	<ul style="list-style-type: none"> <li>• Own Experiments</li> </ul>

**Table 1 – User Groups and Operating Permissions**



- **Additional Data** - This module deals with the telecommand additional data, which must be provided by the user to the system for particular chosen telecommands. Such telecommands, for instance configuration table, need the specification of a set of parameters value. In order to support the edition of that kind of telecommand, the Flight Plan Software keeps hierarchical pages per subsystem.
- **Operation Result Visualisation** - This module carries out the page that presents to the user the final result of the current operation.
- **File Generation for the Wished Flight Plan (PVD)** - This module generates a unique file containing the totality of records stored in the flight plan user database for a specific satellite passage. This file is generated following an autonomous operational routine [Pere00].

The adopted HTTP server, scripting language and database management system are respectively described below, everything running in a Linux platform:

- **HTTP server** - Apache Server (<http://www.apache.org>), the most popular web server on the Internet. It is a robust, secure, efficient and extensible server, which provides HTTP services in synchronisation with the current HTTP standards for various modern desktop and server operating systems, such as UNIX and Windows NT.
- **Scripting language** - PHP 3.0 (<http://www.php.net>), a server-side HTML-embedded scripting language. Much of its syntax is borrowed from C, Java and Perl with a couple of unique PHP-specific features thrown in. The goal of the language is to allow web developers to write dynamically generated pages quickly. A significant feature in PHP is its database integration layer. The source code is available for free use.
- **DBMS: PostgreSQL** (<http://www.postgresql.org>), a sophisticated open source Object-Relational Database Management System, supporting almost all SQL constructs, including subselects, transactions, and user-defined types and functions. It uses a client/server model of communication.

The basic process occurred in this environment for preparing the flight plan is presented in Fig. 1 where the user is connected to the Internet through a WWW Browser; and both the HTTP Server (Apache) and CGI Application (PHP 3.0) in a Linux platform.

Basically, user requests the forms for preparing the SACI Flight Plan, starting with URL: <http://saci-server.crn.inpe.br/cgi-bin/php/planodevoo/autenticacao.phtml>. Then, HTTP Server retrieves related forms sending them to the client. After filling out the forms, user submits them to a CGI Application through HTTP Server. Then, PHP application processes the requests based on the filled forms and sends back to the user the obtained result, via HTTP Server.

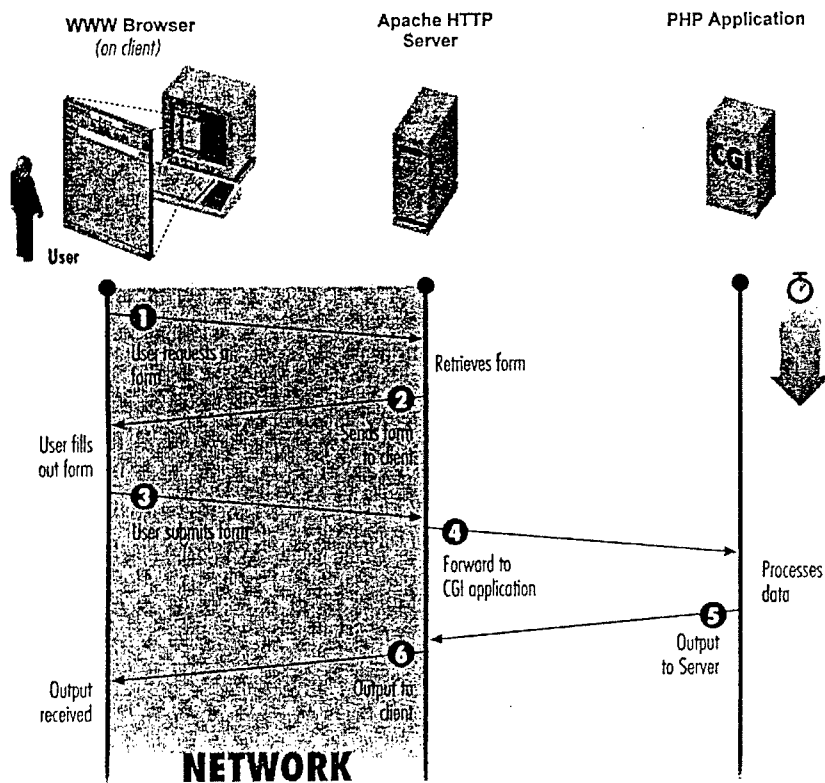


Figure 1 – CGI Process for Preparing the SACI Fight Plan via WWW

## 5. SOURCES OF INFORMATION:

For being a software development model based on the collaboration among numerous groups in different and possibly distant places, the information exchanging among the involved ones happens almost in the totality through Internet, although the number of conferences, symposium and meetings dedicated to this subject has increased every year.

As the mainly source of information and data repository related to this paradigm, Internet has excellent sites for a more detailed research, as:

- <http://www.linuxdoc.org> (Linux Documentation Project)
- <http://www.linux.org> (Linux Online)
- <http://www.li.org> (Linux International web site)
- <http://www.lpi.org> (Linux Professional Institute)
- <http://www.gnome.org> (GNOME project)
- <http://www.kde.org> (KDE project)
- <http://www.gnu.org> (GNU Project – Free Software Foundation (FSF) )
- <http://www.opensource.org> (The Open Source Page)

## 6. CONCLUSION

Nowadays, there is a large variety of software available as Open Source. In some cases, they are considered better than proprietary similar ones that are commonly very expensive. As presented in this paper, there are several reasons for Open Source recommendation, such as: the quick production and software efficiency as a consequence of the increased number of people working with. Also, the participants' contribution in testing and correction of bugs improving quality and maintainability of Open Source software.

In critical software systems like satellite ground station, reliability is a very expensive need to be reached. It requires so many tests. Still in ground station context, it is often that operation requirement being incorporated to the software system during the life cycle of a satellite mission, which demands software modifications. Beside common needs in maintainability, it is also desirable that ground station software system be used for new satellite missions.

In order to attend those requirements with low cost, software development based on the Open Source Technology is suggested. It grants important advantages for maintaining and updating ground station systems.

## REFERENCES:

- [Brow 98] A. J. B. Brown, A. K. Ward, R. M. Myatt : "High Performance Ground Stations for Low Cost Missions", *4<sup>th</sup> International Symposium Small Satellites Systems and Services*, Antibes Juan les Pins, France, September 1998.
- [Gonç 98] L. Gonçalves, P. Cardoso, A. Ambrósio : "Satellite Control Center: Solution for Adaptable System", *4th International Symposium Small Satellites Systems and Services*, Antibes Juan les Pins, France, September 1998.
- [Pere 00] Romualdo A. Pereira Jr: "Building a Telecommand Web System for Scientific Micosatellite Control Base on Open source Technology", *Symposium SPACE OPS 2000*, Toulouse, France – 19-23 juin 2000.
- [Pres 98] P. Pressecq, B. Roger : "La création d'une ligne de produit récurrente et économique", *4th International Symposium Small Satellites Systems and Services*, Antibes Juan les Pins, France, September 1998.
- [Rich 00] M. Richardson : "What Is Linux?", *Linux Journal – Issue 72*, Seattle – WA – USA , April 2000.
- [Sore 98] T. Sorensen, D. Bakeris, T. Probert : "Datalynx: A Commercial Ground Solution for end-to-end Satellite Operations", *4th International Symposium Small Satellites Systems and Services*, Antibes Juan les Pins, France, September 1998.

---

**FIFTEEN YEARS OF SMALL SATELLITE COMMUNICATIONS:  
A LESSON LEARNED**

**Brunella PAVESI ; Giuseppe RONDINELLI**

Telespazio s.p.a. – Via Tiburtina 965 – 00156 Rome – Italy

**ABSTRACT**

Since more than ten years the small satellite concept started to be used for communication system at low rate.

The idea of consolidated technology, risk distribution in adopting many satellites per constellation and finally the use of low earth orbit have brought to the realisation of commercial systems, convenient and effective for the application typology and for the costs.

The aim of this paper is to provide a picture of the market demand for these comm's sat systems; identifying the proved more attractive market segments and in perspective the most demanding geographical areas.

The match between service applications and specifics areas ready to adopt them will be derived aiming at both showing where and if investments for the preparation of new applications could be convenient and profitable and identifying the promising fields where funds will be concentrated coming from either private users and public investors.

The proposed suggestion wish to represent a point of view derived by experiencing on the field and in the believing in innovative solutions.

## MINISAT-01: TOOLS FOR SCHEDULING, DATA ANALYSIS AND PAYLOAD MONITORING

Antonio TALAVERA and Jesús GARCÍA

*Laboratorio de Astrofísica Espacial y Física Fundamental  
INTA, P.O. Box 50727, E-28080 Madrid, Spain  
(ati@laeff.esa.es and jess@laeff.esa.es)*

Carlos QUINTANA

*División de Ciencias del Espacio  
INTA, Ctra. Ajalvir km 4, E-28850, Torrejón de Ardoz, Spain  
(quintana@laeff.esa.es)*

*ABSTRACT - The Scientific Operations Centre (COC) takes care of all aspects of the Minisat-01 Mission related to the payload and its scientific instruments. Operations planning, preparation of commands, monitoring of the scientific instruments and data processing and distribution are the daily tasks carried out at the COC. We describe here the different tools developed at the COC for the fulfilment of these tasks, in particular scheduling and payload monitoring.*

### 1 - INTRODUCTION

Minisat-01 is the first satellite within the Spanish Mini-satellites Programme. It was launched on 21 April 1997 and it carries a scientific payload composed by two main astronomical instruments: EURD, a spectrograph for the study of extreme ultraviolet diffuse radiation and LEGRI, a gamma ray imager in the 20-100 Kev range. A micro-gravity experiment, CPLM, to measure the behaviour of liquid bridges, completes the payload. The mission is being operated by the Instituto Nacional de Técnica Aeroespacial (INTA) and its Ground Segment is distributed in three parts: the Mission Control Centre (MCC), located at the INTA premises near Madrid, the Science Operations Centre (COC), located at INTA's Laboratory for Space Astrophysics (LAEFF) also near Madrid, and the tracking station (ROT) which is located in Maspalomas, Canary Islands (Spain). There are also three Scientific Teams corresponding to each of the instruments on board, which are distributed in several research centres of Spain, United Kingdom and the U.S.A. For detailed information about Minisat-01, the system and operations, the reader is referred to another article in these proceedings [Talavera et al, 2000], and [Cerezo, 2000].

In this article we shall describe the main tools developed and used at the Science Operations Centre to carry out its operational tasks: operations planning and command preparation, data processing and distribution and monitoring of the scientific instruments which form the payload of Minisat-01.

### 2 - SCHEDULING AND COMMAND PREPARATION

The operation cycle starts with the preparation of the schedule, which in our case is done in a weekly basis. Fig. 1 shows a block diagram of this process, whose first step is the preparation at the MCC of orbital predictions which are delivered to the COC (see [Talavera et al, 2000] for a complete functional diagram of the mission).

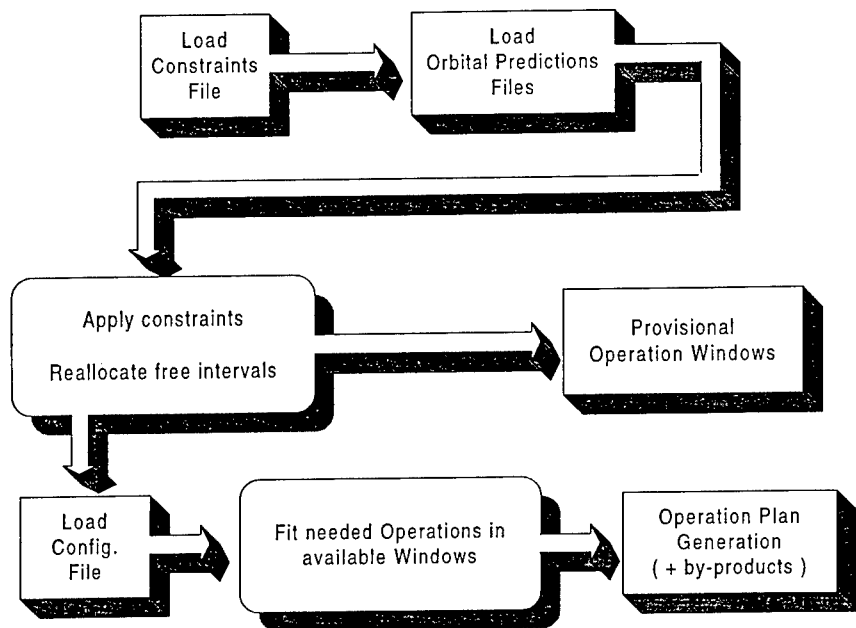


Fig. 1: Minisat-01 Scheduling Process

The scientific instruments operate alternatively and they impose the main operational constraints: EURD must be operated in the shadow part of the orbit and LEGRI can observe at any position but will normally work in the illuminated portion. Operations are restricted when the satellite goes over the South Atlantic Anomaly (SAA) and during the passage over the tracking station, which occurs only in a few orbits. In addition LEGRI, which can be pointed anywhere in a great circle, should avoid looking at the earth. The constraints file is the first input for the scheduling programme. It also contains time information, defining the period to be considered. Generic and specific operations are entered through a configuration file. The orbital predictions which define all orbital events (shadow periods, SAA passage, ground contacts) complete the input.

A series of possible operational windows is computed, and then the required operations are fitted accordingly. The characteristics of the instruments allow us to define a generic series of observations, carried out as consecutive activities defined as sequences of commands for each instrument. The scheduling programme permits to define also specific activities at a given time within the computed windows.

The output of the scheduling is a file containing the time ordered activities of the payload for the defined period. This operations plan, related only to the payload, is merged at the MCC with service module related activities. Possible conflicts are solved by iteration, changing the constraints and configuration files. Additional tools are used to generate the detailed command files and uplink procedures.

All software for scheduling has been developed at the COC using the "C" programming language .

## 3 - DATA PROCESSING

### 3.1 – Scientific Instruments Data

Once a day, the data stored in the satellite (10 Mbytes for each instrument) are dumped to the tracking station. Due to the duration of the passes (a little more than 10 minutes in average), the speed of the link (1 Mbps) and the need to provide redundancy, two passes are devoted to perform the payload data downlink, one for each instrument (LEGRI and EURD). We do not consider the time needed for dumping CPLM data as the amount it produces is insignificant compared with the other two instruments.

In order to perform this dump, the on board computer will start generating 256 byte “frames” (minor-frames) in which it will encapsulate the instruments data, including a few bytes of header and checksum in every frame. This process is cyclic, in the sense that it will dump the mass memory data of the computer reserved for the instrument several times, providing a mechanism for error detection and recovery.

These “minor-frames” are received at the tracking station, dumped to a regular file (the “capture” file), and then manually transferred to the COC through a dedicated link using a standard ftp over TCP/IP connection.

This is where data processing starts. The first step will be to extract the specific data of each instrument from those files. To accomplish this task, we developed a first tool, which we call “proc\_cap”. It will read the capture file, check the minor-frames checksum, select the most probable minor-frames based on statistics on all the minor-frames received (that’s why we needed cyclic memory dumping), select the data for the instrument we specified and save them to a file.

Due to the fact that each packet produced by an instrument is kept in the on-board computer together with the time it was read from the instrument, in the satellite’s own time scale, we must perform a second processing step in which we separate those time bytes from the original instruments data. We designed a tool for carrying this out, so we can actually get instruments data in the format that the instruments originally produced them. In addition, the tool will convert time references to an absolute UTC time scale, keeping track of the packet it was originally associated with. This tool is specific for each instrument, unlike the “proc\_cap” one.

Now we have “clean” instruments data. We still need to take a last third step in data processing in order to extract all the data we need to perform a successful instrument good-health supervision with the tools that will be introduced in the following sections. For this purpose we developed two specific tools, one for LEGRI and one for EURD. These tools will generate several different files containing all the information we might need: housekeeping, command response information, status information, etc.

In addition, we developed an extra “tool” for automatically performing all the Data Processing steps as soon as the data transfer from the tracking station has ended. It includes a basic checkup of the different processing steps and of some of the most important parameters of the instruments. This tool saves time and helps to make a fast first evaluation of the health of the instruments.

All these tools have been written in the “C” programming language, with the exception of the auto-processing one, which was developed using the “shell” scripting language and several standard UNIX tools.

### 3.2 - Attitude reconstruction

Satellite attitude reconstruction is provided by the on board control system in terms of Euler 'q' parameters and some earth and magnetic sensor data. From this input, the ACS ground software at the MCC computes Euler angles which define the pointing direction of Minisat-01 axes in the spacecraft body system. These data are delivered to the COC, where they are converted into astronomical pointing co-ordinates and orientation of both EURD and LEGRI fields of view.

Pointing reconstruction is verified with respect to commanded values and then the data are delivered to EURD and LEGRI scientific teams on a daily basis.

The tools for attitude reconstruction at the COC are procedures written in the IDL environment, which is also used for verification and display of the data. As the rest of the data processing, this part runs automatically upon reception of the satellite housekeeping data at the COC.

## 4 - DATA ANALYSIS AND PAYLOAD MONITORING

After obtaining the final products of the Data Processing phase, we can start the data analysis and the monitoring process. Our aim now is to certify that the payload is in a "healthy" condition, meaning that its instruments are operating normally, that they have not suffered any damage or anomaly during this interval and that their current conditions allow to operate them successfully for the next 24 hours while we will not be able to contact the satellite.

To accomplish this, we developed a series of tools with two objectives in mind: having a powerful data supervision module, to automatically check all the parameters boundaries, and a powerful and easy to use Graphical User Interface (GUI) which should provide a fast and flexible way to analyse the data. The underlying philosophy, code structure and appearance is the same for all of them, but, as the instruments data formats and contents were different, we adapted the general model to the instruments particularities. Apart from monitoring the instruments, we also needed to monitor all the parameters of the service module that might have an influence in the payload. That's why we developed one more tool specifically for this purpose.

The operation of the GUI is quite simple. First of all you must load the file(s) containing the data you want to analyse. It will be the one(s) obtained during the Data Processing phase, in the case of the payload instruments, or the one(s) provided by the MCC with the relevant housekeeping information obtained from the service module sensors.

After finishing the load, a module will automatically check all the parameters boundaries and dependencies, which, in the end, are nothing more than the in-flight specifications of the instruments. If the module finds something unexpected, a warning window will automatically raise and tell us what is wrong, and what the expected values should be. In order to make this efficient, we have developed a quite completed approach to limit handling that makes possible to define not only a higher and lower limit, but also ranges, red and yellow limits, cross-relations, etc. Any check-up may be accomplished by just including a small module in the system that performs the functions you want.

The tools have been designed in order to present related parameters as a "group". Through the "show group" button, we can access any of these groups. At a glance, we can quickly check if all the parameters are inside the expected boundaries (what we already knew from the warning window of the automatic checking module), and, what is even more important, if any parameter readout does not match with the expected subsequent value of any other of the related group parameters.



In case we need a more detailed view, we can use one of the two graphical windows embedded in the GUI, use the zoom functionality to augment any portion of the graphic, or even resort to the raw data view, where the values are shown in text mode with the maximum precision. If we require farther analysis, we can save the data to a file to be able to examine them in a data analysis environment. This flexible behaviour makes possible to fulfil an in depth, fast and easy monitoring of the different parameters.

We can find also the standard printing capability for generating printouts to add to reports or whenever they are needed, and a help facility to inform us about the acronyms used by the tool, etc.

On top of this general design, each different tool has a place for the peculiarities of each instrument. In this respect, the most complicated example is the EURD interface, which has a place for specific kinds of packets sent by the instrument under different conditions (memory full, software upload, command response packets, etc.). Using the same GUI you can access on the fly all the available information in case you need it to complete an in depth analysis.

We selected IDL (the Interactive Data Language) as the programming language for developing these tools. The reasons for this were that IDL is widespread in the Astrophysics environment, because of the great number of routines it provides for solving different astrophysics problems. In addition, IDL provides a very powerful and easy to use widget programming library and a very flexible data analysis environment. This was possible to use just one programming language and environment for all our purposes, providing a very high degree of integration between all our tools and efficiency when having to analyse the data manually.

Now that we have a general idea of the overall tool behaviour, we will analyse the peculiarities of each of the versions.

#### **4.1 Satellite Housekeeping Monitoring tool (hksat)**

The 'hksat' tool is the one used to analyse the data provided by the MCC with the service module sensors information about parameters related to the payload. In Fig.2, we can see the GUI that we already described in the previous section.

The first peculiarity of this version of the tool, shared with the LEGRI one, is that it is able to load information from a set of 9 different files, all in plain text, each one corresponding to each different group.

By examining the GUI you can easily determine the functionality of the tool. You can see we have different groups: temperature, attitude control system, power, battery and heaters.

In the central part of the interface, we find the number of samples taken for each of the groups. We have also represented two parameters (temperature and voltage of the satellite's battery) in the two embedded windows of the GUI.

To illustrate the group facility view we described above, we show the "temps.2" window (Fig. 3), accessible through the 'Show Group' deployable button on the main GUI screen. You can open as many pop-up windows as you want, either group, single parameter or zoom ones.

**MINISAT HOUSEKEEPING MONITOR (version 2.8)**  
 FILE NAME: /home/einstein3/jess/data\_hks/R001300\*.LOC

<b>TEMPS.1</b> [LEGRTP1] [THTEMP15] [THTEMP16] [THTEMP17]	<b>TEMPS.2</b> [THTEMP9] [THTEMP10] [THTEMP11] [THTEMP12] [THTEMP13] [THTEMP14]	<b>ACS.1</b> [WZEJC] [WYEJC] [WXEJC] [ACSMODST] [ACSRRELOU]	<b>ACS.2</b> [ACSR1] [ACSR2] [ACSR3] [ACSR4]	<b>ACS.3</b> [ALGEDSOL] [ALBEDD] [ACSZGEO] [ACSYGEO] [ACSKGEO]	<b>POWER</b> [PL10VC] [PL30VC] [IBUSP] [BATVP] [SBATVP] [PL20VC] [PL40VC] [IBUSR] [BATVR] [SBATVR]	<b>BATTERY</b> [IBAT1] [IBAT2] [IBAT3]	<b>THBAT</b> [THBAT1] [THBAT2] [THBAT3]	<b>CPLM</b> [TAC] [PSS1] [PSS2] [DIP] [ACLZ]	<b>HEATERS</b> [HEAT1STAT] [HEAT2STAT] [HEAT3STAT] [HEAT4STAT] [HEAT5STAT] [HEAT6STAT] [LAZ01STAT] [LAZ02STAT] [LAZ03STAT]
--	--	--	---	---	---	---	--	---	---

TEMPS.1: 1330    TEMPS.2: 665    ACS.1: 7980    ACS.2: 7980    ACS.3: 2660  
 POWER: 1330    BATTERY: 1330    CPLM: 133    HEATERS: 1330

**THBAT3**

Y-axis: THBAT3 (°C)  
X-axis: Time (Date: 129/2000)

[CLEAR] [ZOOM] [PRINT]

**BATVP**

Y-axis: BATVP  
X-axis: Time (Date: 129/2000)

[CLEAR] [ZOOM] [PRINT]

MESSAGES:

CURSOR POSITION:

[LOAD FILE]

[PS FILE]

[SHOW GROUP]

[SAVE IML]

[ASCII FILE]

[HISTORIC ANALYSIS]

[EXIT]

Fig. 2: Satellite housekeeping monitoring tool (hksat)

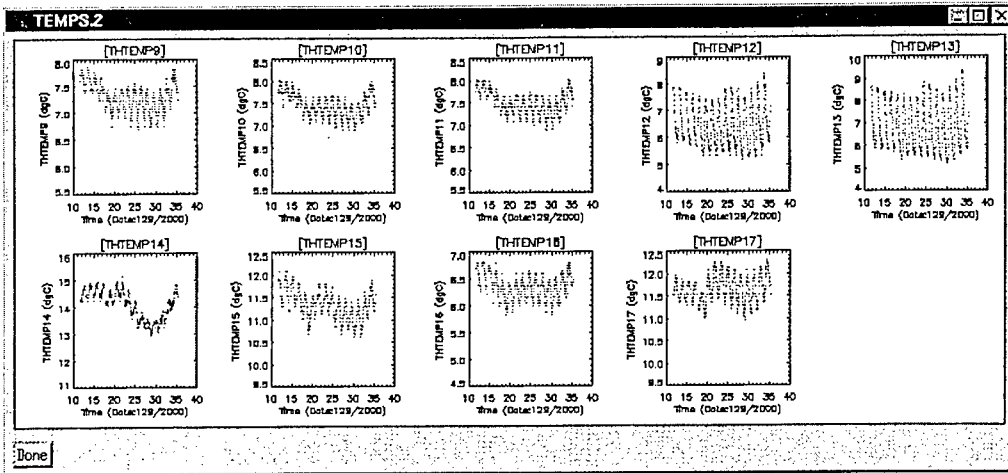


Fig. 3: Payload temperature monitoring within hksat

#### 4.2 – EURD Housekeeping Monitoring Tool (hkeurd)

The 'hkeurd' tool, devoted to the analysis of the EURD instrument's data, is shown in Fig. 4.

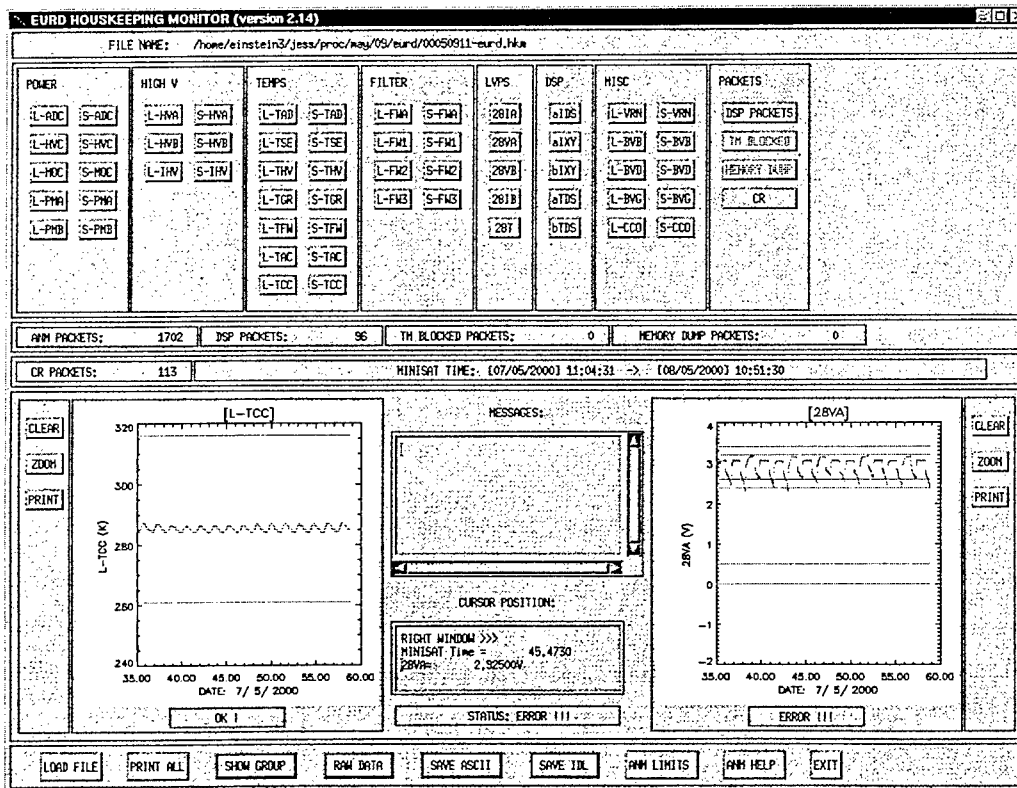


Fig. 4: EURD housekeeping monitoring tool (hkeurd)

The particularities of this tool start at load time. In this case we have only one binary input file containing all the information for the instrument. In this respect, we can say EURD provides a quite complete set of information about all its different subsystems.

As you can see, although it has a lot in common with the 'hksat' interface, a few modules will have to be adapted to this particular case, among them, the reading one, which must be able to understand the format of the binary file. To be able to avoid platform dependent issues we adopted the eXternal Data Representation (XDR) as the output format of the 'eurd\_read' tool (the one which performed the latest stage of EURD Data Processing, and which generates the input file that 'hkeurd' loads).

As in the 'hksat' GUI, we observe that there are different groups, eight in this case: power, high voltage, temperatures, filter (corresponding to the instrument filter wheel sensors), LVPS (low voltage power supply), DSP (Digital Signal Processors), Miscellaneous and Packets.

The 'Packets' block is not really a group. It brings together four buttons which provide access to the special packets information that we described above. In this case only two of them, DSP packets and CR (command response) packets, are highlighted. The other two ones are not accessible because in the current file we do not have any packet of that type.

In the command response window (Fig. 5), we can observe the execution status of every command sent to the instrument. In this case, all commands appear as executed.

TIME	Date	hh:mm:ss	A/V/X/U	COMMAND
111024226	07/05/2000	12:00:22	X	0E00 0000 0000 0000 DSP-status
111025720	07/05/2000	12:02:52	X	0C00 0000 0000 0000 Latchup-Protection-Disable
111025762	07/05/2000	12:02:56	X	0411 0000 0000 0000 Start-Observation-L
111025802	07/05/2000	12:03:00	X	0422 0000 0000 0000 Start-Observation-S
111025841	07/05/2000	12:03:04	X	0C01 0000 0000 0000 Latchup-Protection-enable
111047302	07/05/2000	12:38:50	X	0533 0000 0000 0000 Stop-Observation-LS
111047303	07/05/2000	12:38:50	X	0E00 0000 0000 0000 DSP-status
111080083	07/05/2000	13:33:28	X	0E00 0000 0000 0000 DSP-status
111081583	07/05/2000	13:35:58	X	0C00 0000 0000 0000 Latchup-Protection-Disable
111081624	07/05/2000	13:35:02	X	0411 0000 0000 0000 Start-Observation-L
111081664	07/05/2000	13:35:06	X	0422 0000 0000 0000 Start-Observation-S
111081703	07/05/2000	13:35:10	X	0C01 0000 0000 0000 Latchup-Protection-enable
111104416	07/05/2000	14:14:01	X	0533 0000 0000 0000 Stop-Observation-LS
111104417	07/05/2000	14:14:01	X	0E00 0000 0000 0000 DSP-status
111137180	07/05/2000	15:08:37	X	0E00 0000 0000 0000 DSP-status
111138680	07/05/2000	15:11:08	X	0C00 0000 0000 0000 Latchup-Protection-Disable
111138721	07/05/2000	15:11:12	X	0411 0000 0000 0000 Start-Observation-L
111138761	07/05/2000	15:11:16	X	0422 0000 0000 0000 Start-Observation-S
111138800	07/05/2000	15:11:19	X	0C01 0000 0000 0000 Latchup-Protection-enable
111161293	07/05/2000	15:48:49	X	0533 0000 0000 0000 Stop-Observation-LS
111161294	07/05/2000	15:48:49	X	0E00 0000 0000 0000 DSP-status
111194282	07/05/2000	16:43:48	X	0E00 0000 0000 0000 DSP-status
111195782	07/05/2000	16:46:18	X	0C00 0000 0000 0000 Latchup-Protection-Disable
111195824	07/05/2000	16:46:22	X	0411 0000 0000 0000 Start-Observation-L

(A) ARRIVED: 0 (V) VALIDATED: 0 (X) EXECUTED: 113 (U) SW UPLOAD: 0

Done

Fig. 5: EURD command response window

As you can see in the embedded windows of the main GUI screen (Fig. 4), to make easier the determination of the parameter boundary crossing, the plots include the valid limits for the parameter. In this particular case, you can see that 28VA crosses the lower permitted limit in the operational (high) range.

As this is an anomaly, you can also find a warning message in the warning window (Fig. 6), saying that 28VA minimum value is 23.09 V and the minimum Red limit was 24 V. In the warning window, you will also be able to find other warnings, which should be analysed carefully to determine if they are just a sensor problem or a real anomaly.

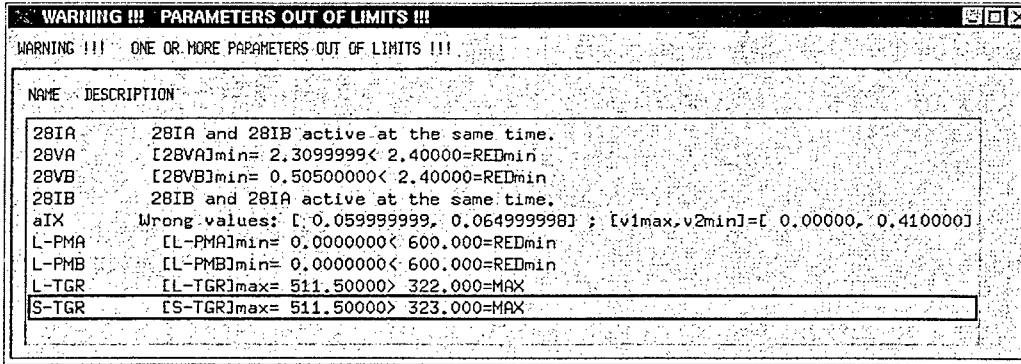


Fig. 6: EURD warning messages window

#### 4.3 – LEGRI Housekeeping Monitoring Tool (hklegri)

Now that we have already shown 'hksat' and 'hkeurd', 'hklegri', the tool for analysing LEGRI data must seem very similar (Fig. 7). In this case, there are only four groups of parameters, read from three different formatted ascii files, as in the 'hksat' case. These files are the output of the 'legri\_hk' tool, the last link in the Data Processing chain.

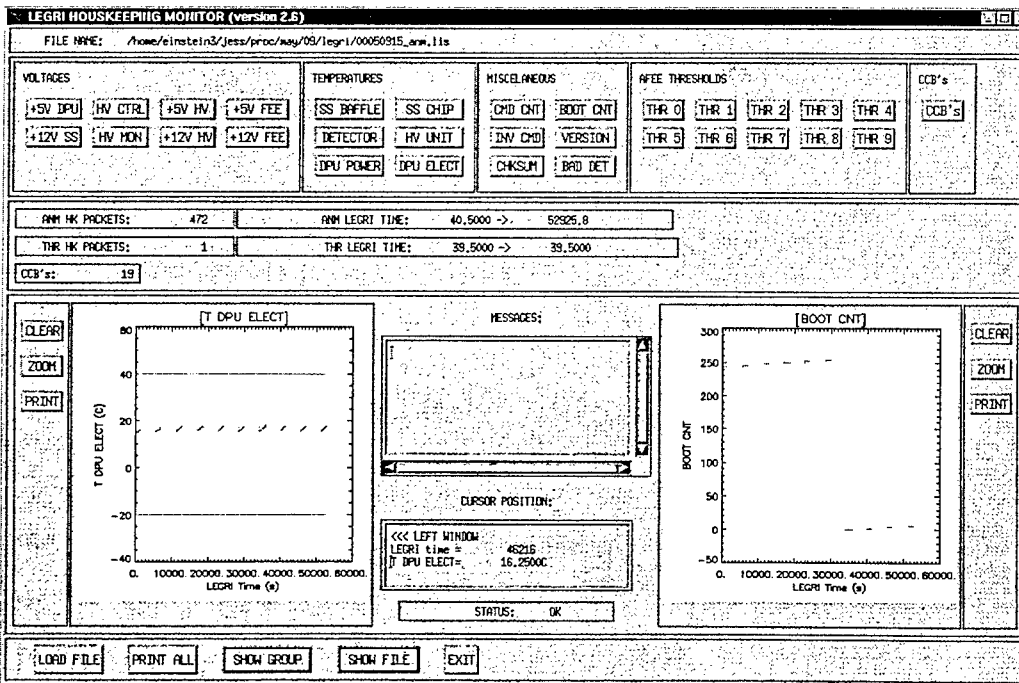


Fig. 7: LEGRI housekeeping monitoring tool (hklegri)

As we were saying, the four groups we find are: Voltages, Temperatures, Miscellaneous, which agglutinates a set of counters, and the detectors Thresholds. We can also access the LEGRI command responses through the CCB button, although in this case the output is quite concise compared with EURD's.

## 5 - DATA DISTRIBUTION

The last step in Minisat-01 data flow is the distribution to the Scientific Teams. After data processing and instruments health monitoring, all output data files are copied to the storage areas dedicated for each instrument in the COC computer system. Attitude reconstruction and selected housekeeping satellite data are copied also in these areas, from where the Scientific Teams can transfer them to their home institutes using the ftp protocol through Internet. The amount of processed data distributed to EURD and LEGRI is of the order of 8 to 10 Mbytes per day for each of them.

## REFERENCES

- [Cerezo, 2000] F. Cerezo, "Performances of Minisat-01 platform subsystems", *Proc. Science with Minisat-01*, Madrid, 1999, Astrophysics and Space Science, in press, (2000)
- [Talavera, 2000] A. Talavera, "Minisat-01: Three years of scientific operations", Proc. V Symposium on Small Satellites, Systems and Services, La Baule (France), 2000, Ed. CNES (these proceedings) (2000)

## **A METHOD FOR PREDICTING ON BOARD COMPUTERS SINGLE-EVENT-EFFECTS INDUCED FAILURE RATES, BASED ON MARKOV CHAINS**

**Pablo Alejandro FERREYRA, Carlos Alberto MARQUÉS, Javier Pedro GASPAR**

*Facultad de Matemática Astronomía y Física -  
Avenida Medina Allende y Haya de la Torre.  
Ciudad Universitaria. - 5000 - Córdoba - Argentina.  
PHONE: (+) 54-51-4334051 - FAX: (+) 54-51-4334054  
EMAIL: ferreyra@mail.famaf.unc.edu.ar*

***ABSTRACT** - The use of microprocessors and memories that are susceptible to Single Event Effects (SEEs) is becoming a common practice in the development of actual micro-satellites on board computer systems.*

*In this work we present a method based on the Markov chain model theory that allows us to obtain the mean time to failure and the mean time to self-repair of a fault tolerant computer in the space environment.*

*We also present a software tool that automatically obtains the model for a given application program, written in "C" language for a commercial of the shelf (COTS) microprocessor.*

*The model is validated by means of simulations of single-event up-sets during the program execution.*

### **1. INTRODUCTION**

The system under research involves a processor, a "watch dog" circuit and a periodical reset circuit. If the watch dog detects failure, the generated corrective action is a reset signal to the processor. In the same way, independently of the state of the system, the periodical reset circuit generates this signal at regular intervals of time.

Our aim is to obtain the Mean Time To Failure (*MTTF*) and the Mean Time To Repair (*MTTR*) of an application, that runs in a cyclical way in the processor when the system is being disturbed by radiations that cause "SEUPS".

### **2. "SIMAA": A TOOL USED FOR SIMULATING THE BEHAVIOUR OF THE SYSTEM SUBMITTED TO SEUPS.**

The first step we made to achieve our aim was to develop a "virtual prototype" of the system under research. The processor used for this was the "DSP32C" of AT&T. The DSP32C support software development tools, the same as most processors development tools, include a simulation program. In our case, the corresponding simulator is called "D3SIM" and is provided by AT&T.

D3SIM, like most simulators, lets us define break points to stop the simulation of the execution of a program. The commands for the simulator can be entered from the keyboard or from a file. As well, the output can be on the screen or re-directed to another file.

Figure 1 shows us the developed tool. The “general managing program” is in charge of generating the file of initial commands for the D3SIM. It defines two kinds of break points:

- a) “Break point” associated to the interaction of the processor with the watch dog circuit at regular intervals of time.
- b) “Break point” associated to the occurrence of a “SEUPS” at the time when the arrival of a radiation is simulated. For this sake, IID (Independent Identical Distributed). random variables with an exponential distribution and rate  $\lambda$  are generated.

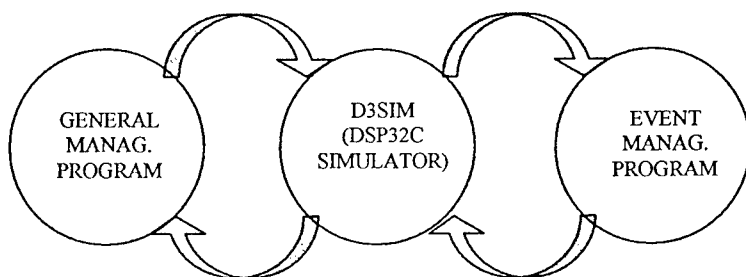


Figure 1: A general view of SIMAA

Next, the control is passed over to the “D3SIM”. This carries out the simulation until the next “break point” and passes over the control to the “events manager program”.

If the “break point” is associated to the occurrence of a “SEUPS” the alteration of a bit is generated in the memory. This implies the generation of another random variable, which represents the position of occurrence of the phenomenon. It is thought that all the positions have the same probability of being disturbed.

If the “break point” is associated to the interaction of the processor with the “watch dog” circuit, the “event manager program” “analyzes” the output of the “D3SIM” to detect the occurrence of failure, the same way the watch dog circuit would do it. If it does not detect any failure, it generates commands for the D3SIM for the simulation to be continued. In the case of failure, the simulation is over. The time of simulation measured in clock pulses from the reset is recorded and the control is transferred again to the “general managing program” to start a new cycle of simulation. The process is repeated automatically as many times as programmed and finally all the necessary information is obtained to get the statistics of the *MTTF*.

### 3. THE MARKOV MODEL TO GET THE *MTTF* OF THE SYSTEM

“SIMAA” allows us to find the *MTTF* of the system but to a computational cost excessively high. Therefore, the next step was to develop the model described below:

A processor is composed by some functional unites. Each module has bits of information bound to be altered because of the radiation. In a typical case, we have millions of bits of RAM memory and hundreds of bits associated to the internal registers of the processor. Part of the information stored in the memory can be protected by error detection and correction circuits.



During the execution of a program the processor essentially takes the data from some zone, processes and stores data somewhere else. Therefore, it is easy to see that in a given time the bits of information stored in the processor can be classified into:

- a) Bits of dispensable information, irrelevant or relevant but protected.
- b) Bits of relevant information unprotected.

The whole amount of bits of the computer is constant and is denoted by  $CT$ . The amount of bits in the second category is a function of time and is denoted by  $CND(t)$ .

In this work we considered only the processes which are cyclically repeated in time. Consequently,  $CND(t)$  will also be periodical.

We define the "sensitivity" of the system in an instant of time  $t$  like this:

$$S(t) = \frac{CND(t)}{CT} \quad (\text{Equation 1})$$

A graphic of  $S(t)$  in function of time will have in general the terraced form of Figure 2. In the  $i^{th}$  stretch the function will take the  $S[i]$  value, and this value will be repeated  $T$  seconds later.

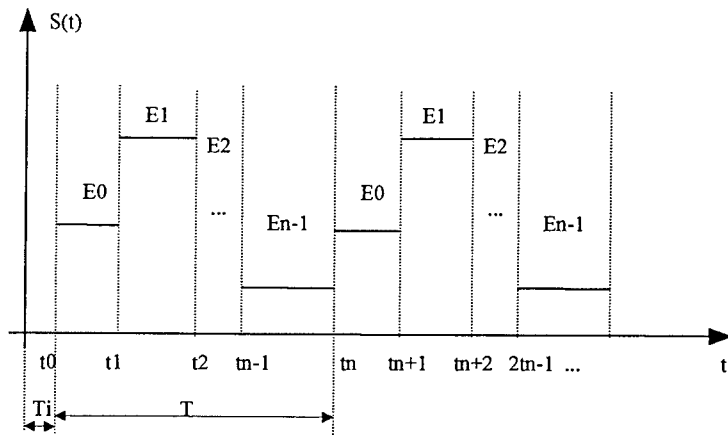


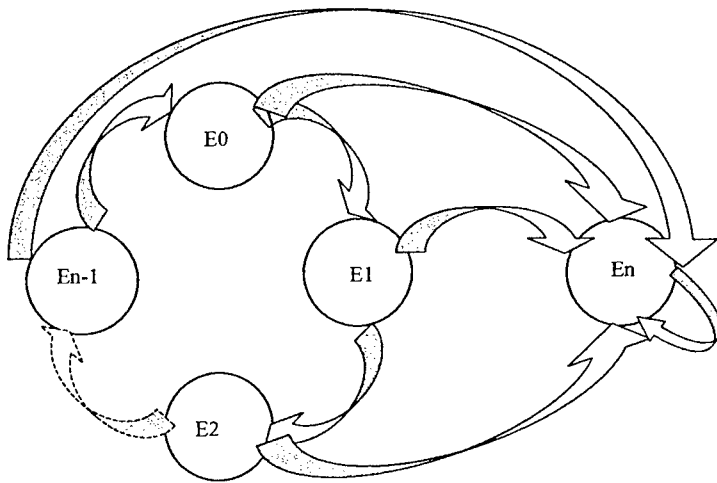
Figure 2: A typical shape of  $S(t)$ .

If we appoint a state to each stretch of the function, we can associate a Markov process to the system. In fact, a function of sensitivity with "n" stretches named  $E_0, E_1, \dots, E_{n-1}$ , as shown in Figure 2, has a Markov process associated to it which can be represented graphically in Figure 3. In case of failure the system will move on to the "E<sub>n</sub>" state, until the watch dog or the periodical reset circuits act. If no failure occurs, the system will go through  $E_0$  to  $E_{n-1}$  cyclically.

It is assumed that the radiations can be modeled through a Poisson process of rate  $\lambda$ . In the  $i^{th}$  state only two kinds of mutually exclusive events are possible; these are the change to the  $E_{i+1}$  state, or to the  $E_n$  state.

#### 4. A TOOL USED FOR GETTING THE SENSITIVITY FUNCTION $S(t)$ AND THE MTTF OF THE SYSTEM.

From the previous section it follows that all we need to determine the *MTTF* of the system is its sensitivity function  $S(t)$ . For simple programs,  $S(t)$  can be obtained "by hand". For complex programs it is necessary to develop an automatic method to obtain it. For this reason, we developed a software tool. This tool gets as an entry the "execution trace" of a cycle of the program under study and information on the memory map and its protected areas. You can obtain the execution trace using some facility generally provided in the support software development tools of all commercial processors.



**Figure 3:** A graphic representation of the Markov Chain associated to  $S(t)$ .

In our particular case we use some facility provided by D3SIM. This trace is essentially a list of two columns. The first column indicates the pulses of the processor clock, and the second shows the operation it performs. Basically, the tool reads both columns line by line and records the amount of relevant information in non-protected zones of the memory and in the registers of the processor. At the same time, it records the time instants when changes are produced in such quantities. To achieve this, an algorithm is necessary to identify the operation, which is the most complex part of the system.

At this point the program produces an intermediate output that is also a file made up of two columns: the first one gives us the pulses of the processor clock and the second one, the values of the sensitivity function.

Once  $S(t)$  has been obtained, it is possible to find the *MTTF* by analytical methods or by means of discrete events simulation models. In this work, this last approximation was used. It is easy to see that simulating the Markov chain associated to  $S(t)$  is a simple task. The program now takes as an input the intermediate file that defines  $S(t)$ , and by means of the methodology of discrete event simulation the *MTTF* of the system is finally obtained.

## 5. THE METHODOLOGY OF SUPERVISION OF THE SYSTEM AND THE MODEL TO OBTAIN ITS MEAN TIME OF RECOVERY (MTTR)

The mean time of recovery is strongly dependent on the method of supervision and correction of failure we use. In this work, we are considering a system composed by a processor, a watch dog circuit and a periodical reset circuit. If the watch dog detects failure, the generated corrective action is a reset signal to the processor. In the same way, independently of the state of the system, the periodical reset circuit generates such signal at regular intervals of time.

When the system has evolved to the  $E_n$  condition, it means a failure has taken place. In general, the universe of possible failures can be classified again into categories:

- a) Failure detected by the watch dog circuit.
- b) Failure non-detected by the watch dog circuit.

To deduce the mean time of recovery of the system we assume that the watch dog circuit monitors the function of the system every  $T_1$  seconds and that the periodical reset occurs every  $T_2$  seconds. Obviously  $T_1$  and  $T_2$  must satisfy the following relationship:

$$T_1 \ll T_2$$

The process under study is repeated periodically every  $T$  seconds.  $T$  is multiple to  $T_1$ . In general the relationship between  $T$  and  $T_1$  can be expressed as:

$$T = K \cdot T_1 \quad \text{with:} \quad K = 1$$

Time is a discrete variable, denoted by  $T_i$ , and is measured in pulses of the processor clock, taking 0 as the instant, the system reset. For each  $T_i$ , there are bits  $N_s(T_i)$  in use bound to be altered by a radiation. The watch dog circuit can only detect the alteration of a fraction of them denoted by  $N_c(T_i)$ . If an altered bit in the instant  $T_i$  produces a failure which is detected before the  $M^{\text{th}}$  cycle of the program ends, which happens at:

$$T_i = M \cdot T$$

then we will say that it belongs to the group of the bits covered by the watch dog, (the value of  $M$  is generally set in 1). For this kind of bits, the expression:

$$(M \cdot T - T_i)$$

gives us an upper bound of the recovery time. The rest of the bits that cannot be covered by the watch dog are denoted  $N_{nc}(T_i)$ . Note that:

$$N_s(T_i) = N_c(T_i) + N_{nc}(T_i) \quad \text{(Equation 2)}$$

The time of recovery for failures in these bits is given by the expression:

$$(T_2 - T_i)$$

The function of coverage of the system for each  $T_i$  is defined according to the equation:

$$C(Ti) = \frac{Nc(Ti)}{Ns(Ti)} \quad (\text{Equation 3})$$

In a complementary way we define the function of vulnerability of the system as:

$$V(Ti) = (1 - C(Ti)) \quad (\text{Equation 4})$$

Under this hypothesis and these notations, the Equation 5, gives us an upper bound of the *MTTR*.

$$MTTR = \frac{\sum_{Ti=1}^{Ti=M \cdot T - 1} \frac{Nc(Ti) \cdot (M \cdot T - Ti) + Nnc(Ti) \cdot (T2 - Ti)}{Nc(Ti) + Nnc(Ti)}}{M \cdot T - 1} \quad (\text{Equation 5})$$

This last equation can be rewritten using Equations 2 through 5 as:

$$MTTR = \left( \frac{\sum_{Ti=1}^{Ti=M \cdot T - 1} C(Ti)}{M \cdot T - 1} \right) \cdot (M \cdot T) + \left( \frac{\sum_{Ti=1}^{Ti=M \cdot T - 1} V(Ti)}{M \cdot T - 1} \right) \cdot T2 - \left( \frac{\sum_{Ti=1}^{Ti=M \cdot T - 1} Ti}{M \cdot T - 1} \right)$$

## 6. A TOOL FOR OBTAINING THE MTTR AUTOMATICALLY

To obtain the mean time of recovery all we need is to get the function of coverage of the system  $C(t)$ . To achieve this an adaptation of SIMAA is used.

This tool also receives as an input the execution trace of a cycle of the program under study and information on the map of the memory and its protected zones. The tool reads the file line by line with the trace and individualizes the susceptible bits. It determines their physical location and generates a matrix  $BS[Ti,j]$ .  $Ti$  represents the considered instant of time according to what was described in the previous section and  $j$  is an index that represents the physical location of the sensitive bit. Obviously there is a transformation table between the sub index  $j$  and the physical positions of the processor bits.

At this point an intermediate output is generated, which is a file where the matrix  $BS[Ti,j]$  is stored (it is important to notice that in this step a great part of the developed code to obtain  $S(t)$  is used again). The line  $i$  of the file represents the instant  $Ti$  and the columns represent the physical location of the sensitive bits.

Next, the adapted version of SIMAA takes place. This goes over the matrix line by line. Each bit is looked over in each line and the commands for D3SIM to alter the bit  $j$  in the instant  $Ti$  are generated. After this, the simulation is launched, waiting until the events manager program finishes it. The end of the simulation can take place because of two reasons:

- a) Because the events manager program detects failure.
- b) Because the time  $Ti$  is higher than the value  $M \cdot T$  defined in the previous section.

---

In the first case the index  $j$  is recorded in an output file. This file represents a matrix  $BC[T_i, j]$ . Each line of the file represents the time instant  $T_i$  and each column represents the physical position of a bit that is covered by the watch dog circuit. Hence, when finishing this process, we have all the necessary information to determine  $C(T_i)$ . In fact we just compare both matrix line by line and we can obtain  $Nc(T_i)$  and  $Nnc(T_i)$ .

## 7. CONCLUSIONS AND FUTURE WORK

By means of the technology presented in this work it is possible to systematically obtain the  $MTTF$  and the  $MTTR$  of an application, running in a processor submitted to disturb caused by radiations (SEUPS).

The tools used for obtaining the models need a moderate effort of development of software, but once available they can be used in any application running on a monoprocessor system.

To validate this methodology, variations of SIMAA were used which allow us to obtain the  $MTTF$  and the  $MTTR$  of the system and these were contrasted with the previewed values by the models. The obtained valued were concomitant.

At the moment we are developing parallel architectures for digital signal processing. Next, we will develop a fault tolerant operative system adapted to this architecture, and suitable algorithms for digital signal processing compatible with such operative system. Finally, we plan to extend this methodology to predict the  $MTTF$  and the  $MTTR$  of multiprocessing systems.

## ACKNOWLEDGEMENTS

We would like to thank the engineers Luis Alberto Murgio and Oscar Puigdelibol of the Instituto Universitario Aeronáutico for their gentle support, cooperation and counsel.

# CRYOGENIC TRANSITION-EDGE MICROBOLOMETERS AND CALORIMETERS WITH ON-CHIP COOLERS FOR X-RAY AND FAR-INFRARED DETECTION

Kimmo KINNUNEN

*University of Jyväskylä, Department of Physics  
P.O. Box 35, FIN-40351, Jyväskylä, Finland*

*ABSTRACT - Astronomical observations of cosmic sources in the far-infrared and X-ray bands require extreme sensitivity. The most sensitive detectors are cryogenic bolometers and calorimeters operating typically at about 100 mK. The last stage of cooling (from 300 mK to 100 mK) often poses significant difficulties in space-borne experiments, both in system complexity and reliability. We address the possibility of using refrigeration based on normal metal/insulator/superconductor (NIS) tunnel junctions as the last stage cooler for cryogenic thermal detectors.*

## 1 - DETECTORS

We are currently developing cryogenic transition-edge microbolometers and calorimeters for the European Space Agency. The operation principle of transition-edge sensors (TES) is based on the transition of a normal metal to superconducting state at a critical temperature  $T_c$ . When the sensor is operated using a constant voltage bias it can be held within its superconducting transition by a so-called electrothermal feedback effect [Irwi 95]. In this mode, the sensor is extremely sensitive to small changes in temperature. An increase in temperature is compensated by a decrease in the current through the TES (which decreases the bias power dissipated in the detector) and thus the temperature stays essentially constant. Changes in the current are measured using a SQUID. In the case of a bolometer, the heating is caused by input optical power whereas in the calorimeter an absorbed photon heats the sensor.

Our calorimeter is a superconducting Ti/Au bilayer with a 2  $\mu\text{m}$  thick Bi absorber on top and it is used to detect x-rays. An image of the detector is shown in Fig. 1a. The final operating temperature will be 100 mK. The resolution achieved so far with our detector is about 50 eV at 5.89 keV, which is still quite far from the theoretical limit of about 4 eV. Improvements in the detector design and SQUID readout electronics will allow us to get the resolution below 20 eV. The design of our bolometers is based on a dipole antenna. We have not performed any tests with them yet, but we have started processing them already.

## 2 - COOLING DETECTORS IN SPACE

The sensitivity of thermal detectors is strongly influenced by the detector temperature. The figure of merit for bolometric detectors is the noise equivalent power, NEP, and for optimised bolometers the limiting noise source arises from the fluctuations of enthalpy between the bolometer element and its heat bath. For space-borne low optical background measure-

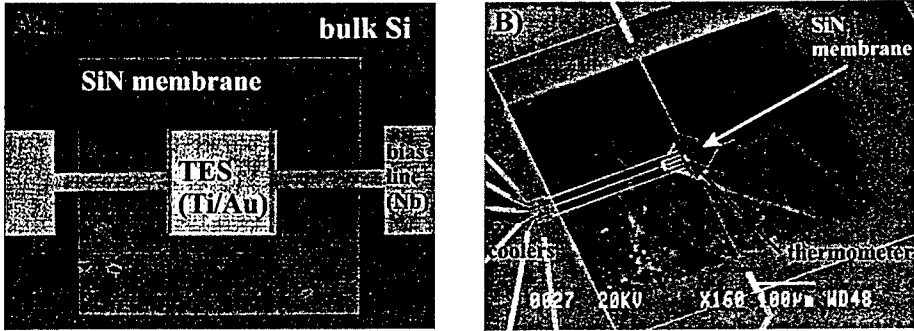


Figure 1: A) An optical microscope image of one of our x-ray detectors. The transition-edge sensor (TES) is  $300 \mu\text{m} \times 300 \mu\text{m}$  in size and is fabricated on a silicon nitride membrane. B) An electron microscope image of a SINIS membrane cooler. The three coolers on the left draw heat from the membrane via normal-metal coldfingers and dump it into the bulk silicon. A SINIS structure in the middle of the membrane is used as a thermometer.

ments, the NEP of the bolometer should typically be of the order  $10^{-17} \text{ W}/\sqrt{\text{Hz}}$ , which usually requires operation close to 100 mK, a temperature which can be achieved either by a dilution refrigerator [Sirb 98] or by an adiabatic demagnetization refrigerator (ADR) [Hagm 94]. With a much simpler system, the  $^3\text{He}$  sorption cooler, one can reach a temperature of 0.3 K, but with significant reduction in detector sensitivity: the NEP scales as  $T^{(n+1)/2}$ , and the NEP of a bolometer operating at 100 mK, assuming  $n = 5$  (originates from electron-phonon coupling), is 27 times better than of the one operating at 300 mK.

## 2.1 - A new cooling method

Recently, a novel cooling method (SINIS cooling) based on tunnelling of hot quasiparticles has been demonstrated [Leiv 96]. The cooler is based on two normal metal/insulator/superconductor junctions in a (SI)NIS<sup>1</sup> configuration, and when a bias voltage  $V < \Delta/e$  is connected across the junctions, only the hot electrons from the states above the Fermi level can tunnel through the insulating barrier to the superconductor side where there is a forbidden energy gap  $\Delta$ . In the process, the average energy of the electrons in the normal metal drops, i.e. the electronic temperature of the normal metal is lowered. The SINIS cooler shown in Fig. 1b is capable of cooling the center island from 300 mK to 100 mK. So far, the best cooling power obtained for one junction pair is 27 pW at 100 mK. The power can be increased by adding more pairs in parallel. The power load onto the 300 mK stage caused by one SINIS cooler is about 1 nW. There is an ongoing ESA project to develop the coolers. A control electronics unit for the cooler is also being developed.

## 2.2 - Combining the devices

Up to now, the devices presented in this paper have been developed in separate projects, but in the near future we plan to integrate the SINIS cooler with our detectors. There are two principal methods to cool the detector: direct cooling of the electron gas of the detector, or the indirect method in which case the cooler is used to lower the temperature of an intermediate

<sup>1</sup>We write (SI)NIS when the argument applies both to simple NIS structures and to symmetric SINIS structures.

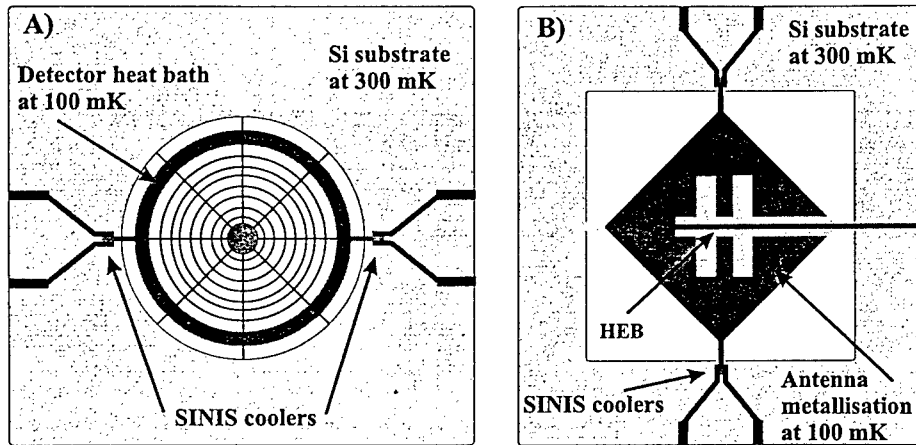


Figure 2: A) A schematic design of a SINIS cooled spiderweb bolometer and B) a double slot antenna-coupled hot electron bolometer (HEB).

heat bath. As recently reported [Luuk 00], using indirect cooling results in lower NEP. Another benefit in the indirect cooling method is that the heat capacity of the intermediate heat bath filters out high-frequency noise from the (SI)NIS refrigerator and other thermal noise by a factor proportional to  $(1 + \omega^2\tau_i^2)^{-1/2}$ , where  $\tau_i = C_i/G_i$  is the thermal time constant of the intermediate heat bath.

The implementation of the indirect cooling method to existing spider-web bolometer detectors [Gild 99, Maus 97] can be realised by fabricating an intermediate heat bath for example by a normal metal ring around the spider-web bolometer, as illustrated in Fig. 2a. With these detectors the use of direct cooling would be more difficult due to the high sheet resistance of  $377 \Omega/\square$  of the absorbing metal layer optimised for good FIR absorption. High sheet resistance translates to low thermal conductivity, resulting in a thermal gradient in the absorber mesh and degraded detector performance. In the case of lithographic antenna-coupled FIR bolometers the construction can be made very simple, since if the normal metal antenna is processed on a membrane, it can be used as the intermediate heat bath for the micron-sized bolometer placed at the feed of the antenna (Fig. 2b).

There exists an intriguing possibility to combine the two cooling methods: one cooler to pump a constant power out of the metal bolometer, allowing significantly larger dynamic range in terms of the input power, and another SINIS cooler to cool down the heat sink. The cooler connected directly to the bolometer would thus act as an 'offset' compensator, effectively reducing the temperature rise caused by the typically large background load. This scheme would allow the design of bolometers with much smaller thermal conductance (and thus much smaller phonon noise limited NEP) than currently is possible.

In summary, we have described a way of improving the noise equivalent power of cryogenic bolometers by a factor of 27, when operating the detectors at a user-friendly base temperature of 300 mK. The on-chip cooling can be implemented to existing spider-web bolometer technologies as well as to novel antenna-coupled transition-edge bolometers and X-ray microcalorimeters. The on-chip cooling method is expected to allow significant improvement in the sense of cooling system complexity and reliability, especially in space-borne applications.



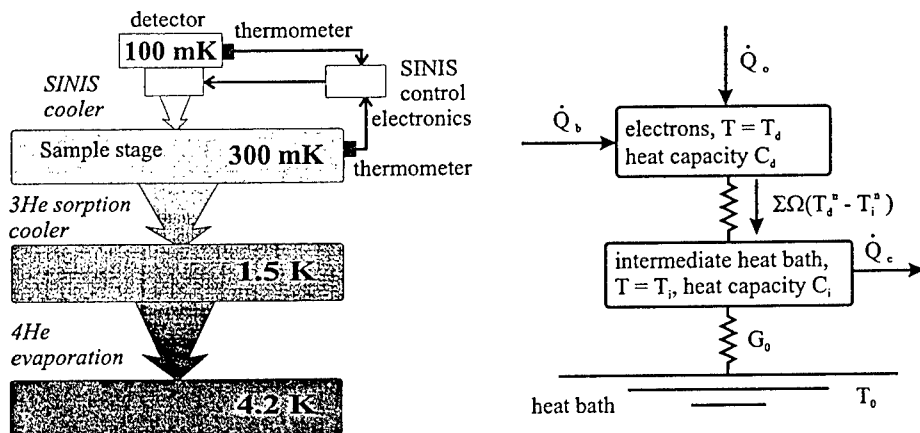


Figure 3: Left: One possible way of arranging the cooling stages onboard a satellite. Right: A thermal block diagram of an indirectly cooled detector.  $\dot{Q}_o$  is the input optical power and  $\dot{Q}_b$  is the bias power. The (SI)NIS cooler cools intermediate heat bath to a temperature  $T_i$ .

This work has been funded by the European Space Agency under contract Nos. 13006/98/NL/PA(SC) and 12835/98/NL/SB.

#### REFERENCES:

- [Irwi 95] K.D. Irwin, "An application of electrothermal feedback for high resolution cryogenic particle detection", *Applied Physics Letters*, 66(15):1998-2000, April 1995.
- [Sirb 98] A. Sirbi, B. Pouilloux, A. Benoit, and J.-M. Lamarre, "Influence of the astrophysics requirements for dilution design" *Space Cryogenics*, WPP-157, pages 99-103, ESTEC, July 1998. ESA.
- [Hagm 94] C. Hagmann and P.L. Richards, "A two stage magnetic refrigerator for astronomical applications with reservoir temperatures above 4K", *Cryogenics*, 34:221-226, 1994.
- [Leiv 96] M.M. Leivo, J.P. Pekola, and D.V. Averin, "Efficient peltier refrigeration by a pair of normal metal/insulator/superconductor junctions", *Applied Physics Letters*, 68(14):1996-1998, April 1996.
- [Luuk 00] A. Luukanen and J. Pekola, "Performance of cryogenic microbolometers and calorimeters with on-chip coolers", Submitted to *Applied Physics Letters*, May 2000.
- [Gild 99] J.M. Gildemeister, A.T. Lee, and P.L. Richards, "A fully lithographed voltage-biased superconducting spiderweb bolometer", *Applied Physics Letters*, 74(6):868-870, February 1999.
- [Maus 97] P.D. Mauskopf, J.J. Bock, H. Del Castillo, W.L. Holzappel, and A.E. Lange, "Composite infrared bolometers with Si<sub>2</sub>N<sub>4</sub> micromesh absorbers", *Applied Optics*, 36(4):765-771, February 1997.

---

## DESIGN AND DEVELOPMENT OF ON-BOARD DATA HANDLING (OBDH) SOFTWARE FOR A UNIVERSITY MICROSATELLITE

Salvatore PONTE

*Department of Aerospace Engineering  
Second University of Naples, Via Roma, 29 – I-81031 Aversa (CE), Italy  
Tel.: +39-81-5010286 Fax: +39-81-5010264 E-mail: salvatore.ponte@unina2.it*

**ABSTRACT** – *SMART (Scientific Microsatellite for Advanced Research and Technology), developed by the Second University of Naples, Italy, and the University of Naples "Federico II", Italy, is a 50-kg, 0.45x0.45x0.45-m<sup>3</sup> Low-Earth Orbit (LEO) platform hosting remote-sensing-oriented payloads. This paper describes the OBDH software architecture developed to meet the payload demands and implement the basic functionality required for correct operation of SMART subsystems. ESA-driven recommendations and object-oriented methodologies, which have been proven useful in setting up a hierarchical development of the data handling software, have also been used in the software requirements definition and in the architectural design.*

### 1 - INTRODUCTION

Great attention has been given in the last decades to the potentialities of microsatellites for scientific research in various fields, such as telecommunication, remote sensing, Earth observation, planetary exploration, due to modular architecture, easier design and realisation, lower costs, comparatively low launch fares, higher reliability, and potentiality of using constellations for specific applications. With more than 400 small satellites already launched [Yun 97], the microsatellite concept has opened to small groups the way to conceive new projects, acquiring useful technical lessons in developing space hardware and subsystems. Moreover, in the framework of university aerospace projects, the development of a scientific/educational microsatellite is undoubtedly a powerful tool for gaining insight into advanced methodologies, building up interdisciplinary system knowledge and developing a systems engineering approach to space missions.

Among the services provided to the spacecraft, it is well known that the on-board computer system is one of the most critical to develop, due to the broad spectrum of functions to be implemented, such as navigation, housekeeping and health monitoring, command processing, platform subsystem management and communication [Glas 91]. Modern spacecrafts rely quite heavily on software, both at subsystem, system and equipment level, and, typically, 15% to 25% of cost and effort of space projects is put into software design and management.

This paper reports the first steps performed in the SMART software development life cycle, with emphasis on the software requirements definition phase. In particular, the use of typical methodologies and formalisms [And 91] (functional partitioning, state transition diagram analysis, Object-Oriented Design (OOD)) is shown, and the major software building blocks, functionalities and application modules are presented. Based on lessons learned from parallel programming and transputer hardware configuration, the currently adopted solution is being developed around Analog Devices' AD-21020, a 32-bit floating-point digital signal processor (DSP) also available in a radiation-hardened version, developed by Temic, Nantes, France. DSPs offer high programming flexibility and processing capabilities, together with effective payload data processing and the possibility of multiprocessor architectures. In the last few years, several companies have been

developing space-qualified, cost-effective DSPs and the related software development environments [e.g. Char 97], whereas synergism with consumer and space electronics sectors is leading to reduced system development time and cost [Alka 00].

A brief overview of the microsatellite and of the OBDH hardware architecture is given to establish the problem domain and help the reader trace the logical thread outlined in the successive sections. After presenting the main software requirements envisaged for the SMART project, a logical model of the software is built after critical reviews of user requirements, mission analysis timeline and mission phases segmentation. Further refinements and the use of the HOOD approach, a powerful tool used in similar microsatellite projects [Sant 96], are shown to illustrate the whole concept design, leading to the realisation of prototypes for simple tasks such as solar panel deployment.

### 1.1 - Description of SMART

SMART is a joint project involving since early 1997 the Department of Aerospace Engineering of the Second University of Naples, Italy and the Department of Space Science and Engineering "Luigi G. Napolitano" of the University of Naples "Federico II". It is a 450x450x450 mm<sup>3</sup> microsatellite for multi-mission applications instruments in 400-1000-km sun-synchronous orbits (Tab. 1), with a structural design based on the mass and constraints of the Indian PSLV. The foreseen mission scenario encompasses atmospheric measurements, magnetic field studies, Earth observation, space environment parameters monitoring (e.g. radiation and ozone concentration measurements) In particular, a mission analysis for the integration of a light-weight reconnaissance camera in push-broom mode is being studied for medium-scale cartography applications [Der 97].

Bus mass	50 kg
Bus size	450x450x370mm <sup>3</sup>
Power budget	64 W average, 77 W peak
Payload mass	up to 10 kg
Payload power	10 W minimum
Downlink	Up to 1 Mbps @ 2.2 GHz
Orbits	Circular sun-synchronous
Time of the ascending node	10 pm -12 pm
Lifetime	8 months (minimum)
Operating altitude	400 to 1000 km
Launcher	PSLV, India

**Tab. 1:** SMART characteristics.

The engineering model (EM) of SMART (Fig. 1) had been presented at the 48<sup>th</sup> IAF Congress, held in Turin, Italy [Pon 97a]. Its modular structure allows flexibility during assembly, integration and test of the spacecraft subsystems prior to the final system integration. For easy payload accommodation, a cylindrical module has been designed, with mechanical and electrical interfaces to the bus standardised according to MIL-C-83527. The payload module (136-mm diameter, 370-mm height) supports 10 kg with 10-W power consumption. The main subsystems of the EM (data handling, power conditioning, S-band transceiver, attitude control electronics), the magnetometer (MTM), two magnetorquer rods (MTQ) and a digital sun sensor (DSS) have been provided by Space Innovations, Ltd. (SIL), Newbury, Berkshire, UK. Fine attitude control is implemented by three inertia wheels [Past 97] with their associated control electronics, whereas a low-cost spaceborne GPS receiver is planned to be integrated for on-board orbit determination [Pon 98]. SMART hardware architecture (a hybrid scheme, with a main spacecraft bus and multi-bus internal architecture) is shown schematically in Fig. 2. The spacecraft data bus connects the Data Handling Subsystem (DHS), the Power Control Subsystem (PCS), the Transceiver(SXR), the Spacecraft Attitude Control Electronics (SACE) and the Inertia Wheel Control Electronics (IWCE), the GPS sensor. The SACE and IWCE, in turn, have second-order interfaces with their sensors and actuators.

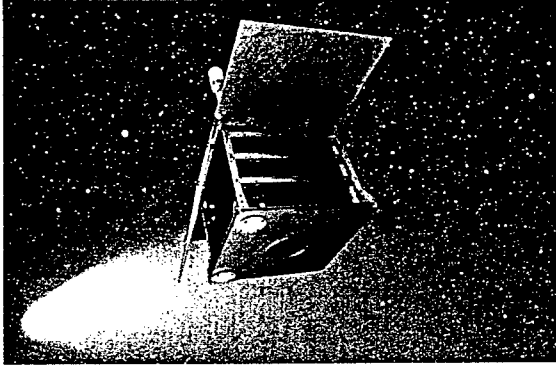


Fig. 1: Pictorial representation of the engineering model of SMART.

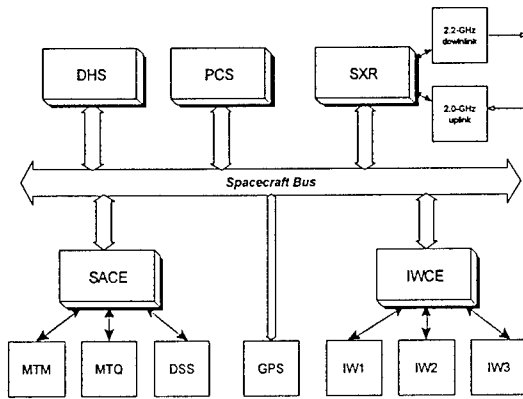


Fig. 2: Block diagram of SMART hardware architecture.

## 1.2 - SMART hardware for OBDH

In the starting phase of the OBDH software development, we decided to rely on transputer-based environments, due to successful usage of transputers in low-cost European small satellite programs, such as ABRIXAS [Zapp 97]. The OBDH hardware subsystem of SMART engineering model is based on the system DHS-848B, designed by SIL [SIL 97], whose internal architecture is shown in Fig. 3. Telecommands are processed by the Command Distribution Unit (CDU), and the DAU collects 125-Kbps housekeeping data and status information, passing it to the Telemetry Formatting Unit (TFU). Data storage is allowed in a Mass Memory Unit (MMU) and a Framestore area, via a high-speed interface (I/F). The DHS uses a redundant Space Processor Unit (SPU) based on the 32-bit, 20-MHz Inmos transputer T805, which processes, stores and formats payload and science data conforming to ESA standards [ESA 88, ESA 92, Pon 97b]. Each SPU contains 1 Mb of program ROM and 8 Mb of low-power static RAM, with a 32-Mb Mass Memory Unit (MMU), usable as extended workspace for user application software or as a storage area for scientific data. The DHS is equipped with bootstrap capabilities and a low-level operating system (a "kernel", see Sec. 4) providing access to the DHS hardware. A telemetry subsystem collects, formats and transmits via the SXR digital or analogue-to-digital converted data from the on-board temperature, attitude and power sensors, leaving room in the telemetry (TM) word for scientific data. The TC subsystem receives information from the ground station redistributing it to the various actuators (e.g. the voltage command sequence for IWCE operation).

The main OBDH functionalities are: initialization of the subsystems to a known state, and active monitoring of subsystem status, together with identification and diagnosis of faults; depacketization/packetization capability and telecommand (TC) distribution; generation of on-board timing references, and implementation of TC actions; management of the spacecraft interface data bus, and provision of a basic interface for supporting the development of on-board software, and allowing patching with user-defined software units to enhance subsystem performance.

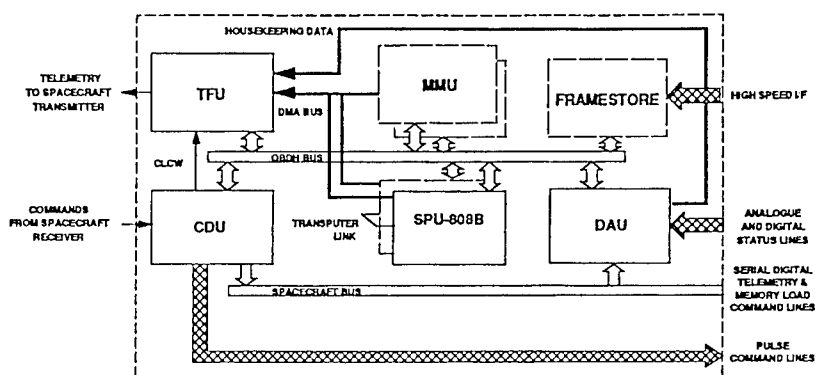


Fig. 3: Block diagram of the DHS-848B [SIL 97].

## 2 - CONCEPT DEFINITION AND USER REQUIREMENTS ANALYSIS

The user requirements definition phase sets up the preliminary step to the software development life cycle [ESA 91a]. This section captures the definition of the SMART mission from a user viewpoint, identifying the operational environment that the software will interface to, and defining an organised set of capability requirements. We found useful to formalise a segmentation of the different mission phases (Tab. 2), and a mission timeline (Tab. 3), describing and correctly allocating in the different phases the needed sequences of software operations. Finally, Tab. 4 relates each mission phase with the capabilities informally described in Tab. 3, showing which sensors and actuators are active during different software contexts, and identifying the algorithms needed to produce internal status information or scientific data for downlink to the ground station.

<i>Mission phase</i>	<i>Time frame identification</i>	<i>Software operations</i>
Ground Phase	Prior to launch.	Ground tests, sensor calibration, integration of software modules, functionality tests.
Launch Phase	From launch to separation from the launcher.	No on-board software activity.
Attitude Acquisition Phase	From orbit injection to the state "nominal attitude reached" (separation + N orbits).	General initialisation and integrity check, execution of application software, sensor data acquisition, attitude estimates, telemetry to ground.
Regular Housekeeping / Cruise Phase	From solar panel deployment to regular communication with the ground station.	Solar panel handling, telemetry to ground, decoding of telecommands.
Science Phase	From payload initialisation to regular collection of scientific data.	Acquisition of payload data and telemetry to ground.

Tab. 2: SMART mission segmentation.

$T_1$	Launch
$T_2$	Separation from launcher and orbit injection. Power-on sequence: PCS, DHS, SACE, Transceiver are turned on and a self test, controlled by the on-board software, is performed.
$T_3$	The SPU boots from EEPROM the mission application software. Elapsed Mission Time (EMT) is set to 00:00.000.
$T_4$	Attitude Acquisition Phase. First readings from the attitude sensors (magnetometer, sun sensor) and estimate of the attitude state after the separation. Estimates of magnetic field ( <b>B</b> ) and dB/dt, spin rate and sun elevation angle are obtained.
$T_5$	First attitude manoeuvres using the magnetorquer rods. The spin axis is oriented approximately normal to the sun direction.
$T_6$	After a number of orbits, a visibility window arises. The ground station sends a telecommand request invoking transmission from the satellite. If the RX antenna is properly oriented, the DHS processes the request, and transmits a telemetred data stream containing a status message, attitude data and the first housekeeping data, including the Command Link Control Word (CLCW) and the Frame Analysis Report (FAR).
$T_7$	Regular housekeeping collection by the DHS. Data from the data Acquisition Unit (DAU), payload and subsystems are gathered and stored for future ground-commanded telemetry.
$T_8$	Nominal attitude reached. Start of the Cruise Phase.
$T_9$	Solar panels deployment.
$T_{10}$	The ground station sends telecommands for solar array deployment, if necessary.
$T_{11}$	Validation of correct solar panel positioning, nominal attitude state reached and fine pointing.
$T_{12}$	Beginning of the Science Phase. The payload performs self-check and initialisation. Regular data collection and possible on-board pre-processing are performed.

Tab. 3: SMART timing sequence.

Mission phase	Sensors			Algorithms	Actuators		TM
	MTM	DSS	GPS		MTQ	IW	
Ground	♦	♦	♦	Ground tests, subsystems performance evaluation/validation	♦	♦	♦
Launch				None			
Attitude Acquisition	♦	♦	♦	Power-up and global initialisation Magnetometer acquisition Sun sensor acquisition Orbit information (s/c position) Magnetic field and spin rate estimate Coarse attitude manoeuvres Downlink processing	♦		♦
Housekeeping/ Cruise	♦	♦	♦	Kinematic integration Attitude determination and fine control Solar panel deployment Housekeeping data collection Uplink processing Downlink processing	♦	♦	♦
Science	♦	♦	♦	Payload operation Attitude determination and fine control Housekeeping data collection Uplink processing Downlink processing	♦	♦	♦

Tab. 4: Mission phases/software/sensors relationships.

### 3 - FLIGHT SOFTWARE REQUIREMENTS AND PROCESSING TASKS DEFINITION

In the following sections, by means of HOOD (Hierarchical Object-Oriented Design) methodologies [Hood 96], we will outline the software architecture derived from requirement analysis activities, identify software classes and build a Hierarchical Design Tree (HDT), breaking down the system to design (i.e. SMART flight software) into several lower-level objects.

On-board processing can be roughly partitioned into five principal classes [Glas 91], namely, control systems (e.g. attitude determination and control, orbit propagation algorithms), system management (e.g. bus handling, fault detection, payload management), mission-data (e.g. collection and storage of payload data), operating systems (e.g. kernel software, user interfaces) and communication software (e.g. TM formatting, packetization/depacketization). A block diagram of software classes is depicted in Fig. 4, in which the bi-directional data flow arrows highlight the centre role of the kernel software.

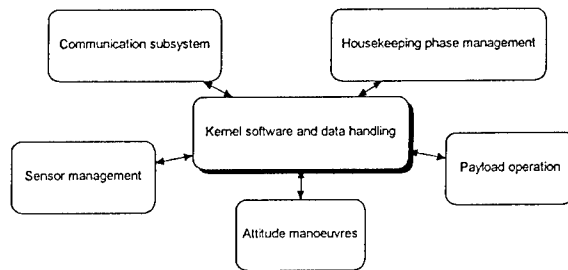


Fig. 4: SMART software functional objects.

According to ESA PSS-05 documents [ESA 91b, ESA 91c], we have identified a set of requirements, subdivided in interface (I) requirements, maintainability (M), operational (O), functional (F), quality (Q), security (S). SMART software requirements are as follows:

**Flexibility and modularity.** High degree of modularization, both of the data structures and of the executable code, is the main characteristic envisaged for software development, in order to provide ease of understanding of the different functions, minimise interactions among different routines, simplify substitution and/or integration of software segments with upgraded source code. (I)

**Open architectural design.** The SMART software should effectively accommodate reprogrammability via ground station telecommands. During-the-mission changes are planned in the form of software patching. This operation should not affect software integrity. (M)

**Independence of functions.** Different functionalities (e.g. test modules, error handling, fault protection, time-tagged command processing) should be kept as independent as possible from one another, thus ensuring high visibility for evaluation of current processing status and estimation of available resources. (O, F)

**High-level user interface.** The on-board data flow should be completely managed by a "kernel" software which acts as a basic operating system, providing easy and understandable user interfaces. Scientists and application software developers should handle a restricted command set which translates high-level requirements (e.g. read memory location, prepare telemetry streams, set data rate, etc.) into normal internal spacecraft operation. (I, F)

**Status reporting.** Telemetry data should contain adequate information to allow subsystem analysts to supervise and control the status and activity of the software routines. A flag or a special register carrying information on regular software operation is required. (F)

**Detailed diagnostic and monitoring capability.** During critical events, the telemetred stream should contain information on the reason for the occurrence of the unexpected event. Memory space should be reserved for recovering essential status information in the case of failures or non-normal

spacecraft operation, for efficient anomaly investigation. Moreover, the on-board computer should be able to execute, autonomously or via telecommand sequences, a set of diagnostic routines to assess the spacecraft health and perform extensive subsystem tests. Test results should obviously be stored in appropriate telemetry frames for information to the ground. (F)

**Software autonomy.** Due to relatively short visibility windows (up to 10 min per day), adequate software modules should be conceived for storage of software and hardware parameters necessary to “reconstruct” the on-board activities during the periods of no visibility of SMART. A safe, commandable spacecraft without uplink activity for a given period is a primary goal. (F)

**Compatibility with ESA standards.** The formatted telemetry stream should be fully compliant with ESA standards [ESA 88, ESA 92], as well as the implemented algorithms for error detection and correction, and for convolutional encoding. (I,Q)

**“Critical” execution of commands.** By the word “critical” it is meant that the data handling software, and particularly the attitude acquisition and control routines, should be designed to provide capability of protection against inadvertent command execution and conflict between resources. (S)

**Mass Memory Unit (MMU) protection.** The integrity of MMU contents should be assured against inadvertent overwriting from the ground or internal OBDH operations. Accidental rewriting due to buffer overflow should be avoided. (S)

**Fault protection.** The on-board software should be capable of resuming (or continuing, depending on the particular task) all its operational modules in the event of any spacecraft or computer fault conditions, to the extent allowed by the hardware. (F)

**Efficient subsystems management.** This operation should be the responsibility of the kernel software, which periodically or after a ground telecommand performs test routines on the different SMART subsystems, reporting health information and status of the checked hardware. (F)

OOD of SMART flight software projects software properties into behavioural descriptions, after the identification of mission phases (Tab. 2) and processing tasks (Tab. 3). Associating software state transitions to operation execution, a first logical architecture of (in HOOD notation [Hood 95]) the STD “SMART flight software” can be represented in Fig. 5, in which reusable objects such as the “Downlink processing” or the “Read from sensors” states can be clearly identified. As a further refinement, the Hood Design Tree (HDT) of SMART flying software is depicted in Fig. 6.

## 4 - KERNEL SOFTWARE AND GROUND TEST MODULES DEVELOPMENT

### 4.1 – Kernel software architecture

In a first developing phase of the kernel software and the scheduling of all on-board processes, based on a transputer-based OBDH hardware subsystem, we made use of the Occam language [SGS 95], suitable for use on transputer-based applications running concurrent real-time processes. The software has been developed and tested on a PC-hosted transputer development system (the INMOS Toolset Suite [Inmos 91]), which allows testing and debugging transputer-written applications and running bootable procedures on transputer networks. Successively, due to the obsolescence of the transputer technology, the hardware design of the on-board DHS has been based on the use of the 32-bit, floating-point, 40-MFLOP performance DSP (Digital Signal Processor) ADSP-21020, built by Analog Devices, Inc. [AD 94], of which a radiation-hardened version (TSC21020E) produced by Temic Semiconductors, France, under the sponsorship of ESA, exists [Temic 98, Park 98].

The TSC21010E internal architecture is fully compatible with the ADSP-21020, thus allowing software development on the non-hardened version. It is a floating-point microprocessor with three independent parallel computation units, a general purpose data register file, using a modified Harvard architecture, simple memory interfaces and high-performance instruction cache, with



hardware circular buffers. A DSP-based approach to the development of SMART flight software provides effective solutions for high-volume payload data processing and robust management of systems with real-time control loops. Low power consumption (less than 2 W), high computation speed, scalability and flexibility are the main characteristics of the DSP-based solution.

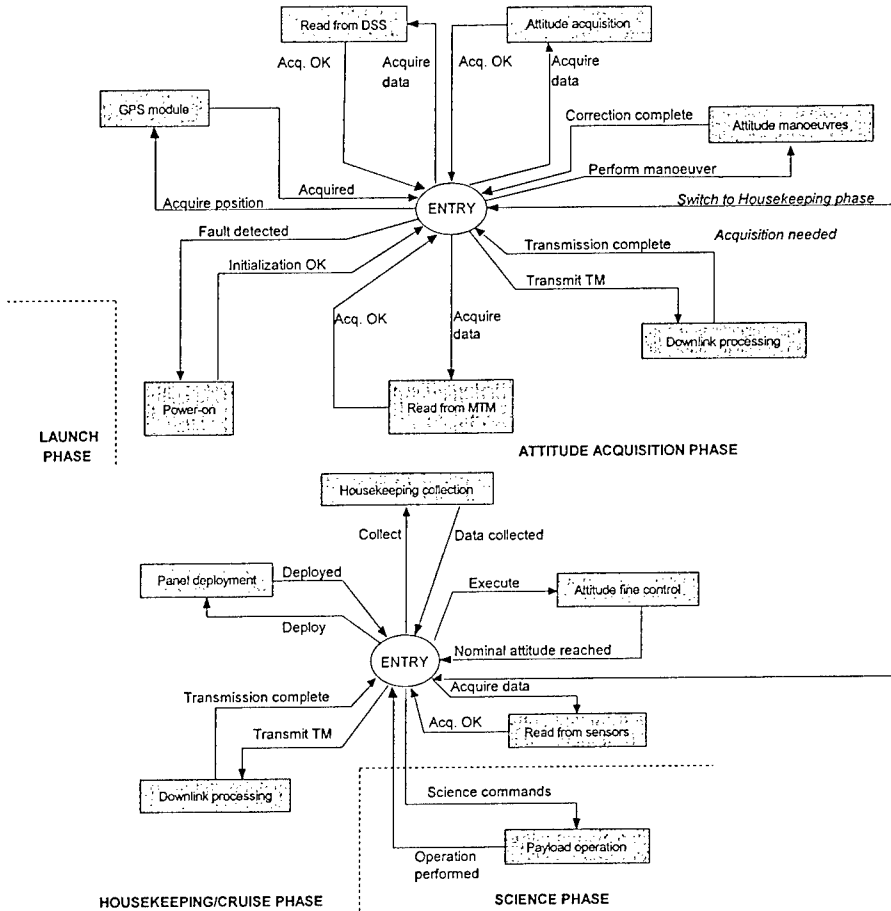


Fig. 5: Flight software tasks transition diagram, interfaced with SMART mission phases.

This section will summarize the main operations performed by the kernel software. The adopted approach in the development of the kernel software is centralised processing, with a single processing unit (eventually redundated in the final implementation of the on-board data handling subsystem) controlling all the subsystems and spacecraft functions.

The kernel is a basic multi-tasking interface, providing the minimum functionality required to support spacecraft integration activities. It has been built around the SIL DHS hardware architecture, starting from Occam routines for the management of simple functionalities. It is responsible for TC decoding and command distribution, and supports the CPDU, implemented by the DHS CDU, which provides TC packets decoding using an ESA-compliant PTD. Available downlink data rates range from 9.6 to 153.6 Kbps. The CPDU supports 128 pulse or bi-level command lines, 96 of these being available for the spacecraft (24 of these 96 lines are used as

power lines) [SIL 97]. Each request is passed to the kernel software via dedicated CPDU channels, which allow two-byte addressing to the CPDU lines. Acknowledgments are sent through reply channels. Interrupts are managed as local events, routed via DAU digital status lines.

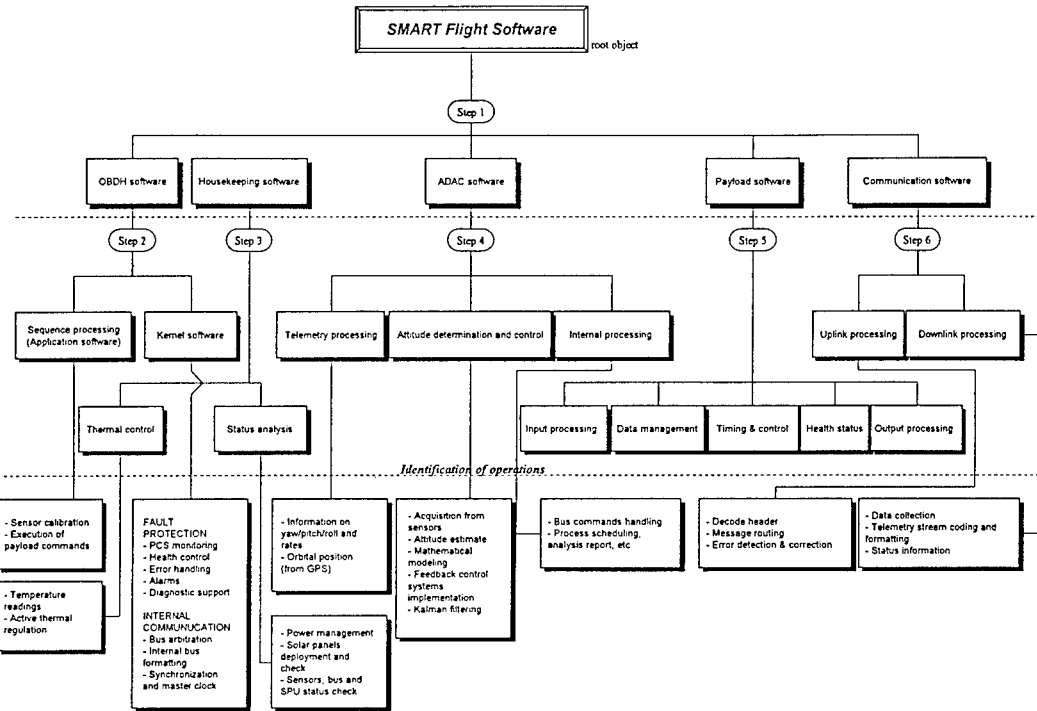


Fig. 6: HDT of SMART flight software.

Ground data passed to SMART are detected by the kernel, gathered by the CDU and validated before being processed by the user software modules. The PTD can also provide information concerning the status of the most recent TC frame, for assessing the physical link quality and check the causes of possible rejection of past packets, through a FAR [ESA 88] written in the most significant 24 bits of a reserved register. The two SPUs can be configured by the kernel via the CPDU, by setting flags for enabling/disabling EEPROM writing (the EEPROM contains the bootstrap software and the kernel, but can also store user-written software) resetting the transputers, deciding which of the two SPUs acts as master and which is redudated, etc. In addition, basic bootstrap software is available for starting execution of the user-defined, mission-dependent software patches, separately compiled and sent via TC packets: when the SPU is re-booted or powered up, the bootstrap simply performs a health check of the processor, passing the initial SPU status to the application software, and successively loads and executes the external uploaded modules. Moreover, the bootstrap software drives a test interface, which allows one to load software directly from the host computer, and to develop integration software for testing the peripheral devices connected to the DHS.

The operating system is being translated from Occam to C, and is being developed via a ground test environment based on a host computer communicating with a serial link with the ADSP21020 EZ-LAB board. Equipped with 32K words of program memory and 32K words of data memory, the board provides analog I/O devices and efficient interfaces to external memory, together with a RS-232 download path allowing one to write and run programs directly on the EZ-LAB. The Analog

Devices software development environment, containing an assembler, a C compiler and debugger, a linker, a simulator and an emulator, has been used to build and benchmark the software modules of the real-time processor.

C and assembler routines for event handling, status acquisition and failure detection perform effective control and diagnosis of the integrated sensors, actuators and subsystems. Simple 210XX-assembly routines have been developed to validate different low-level, time-critical functionality of the board, such as initialisation and configuration of the spacecraft subsystems, data transfer, error control, packet generation. Successively, longer segments of code implementing the basic tasks performed by the real-time kernel, such as control strategies, command distribution, telemetry formatting, status reporting and fault management, have been developed.

#### **4.2 - An example: design of the solar panel deployment software (SPDS)**

This section describes the HOOD design process of the development of different application software modules. As an example, we have chosen to illustrate the solar panel deployment software module. SMART solar panel deployment has been designed by using as actuators a new class of materials (SMA, Shape Memory Alloy), capable of changing shape when adequate currents are supplied (for SMART, supply current for the wires are of the order of 3 A) [Frag 99]. In particular, 0.4-mm diameter NiTi wires and a dedicated mechanism produce the necessary torques for correct deployment. In the following, a simplified version of the HOOD design scheme is developed.

The SPDS module monitors the deployment of SMART solar panels, providing power to the SMA wires and checking if after a predetermined time interval the panels have been successfully deployed, by analyzing the status of a line connected to the CPDU. In the software ground development phase, an I/O interface for user monitoring purposes is required. When started by an external request, the SPDS module initializes the SPU and sets communication between the kernel and the DHS hardware. Successively, the NiTi wires are powered on and an analog line is sampled to monitor a 5-V signal which indicates "successful deployment" If the timeout has expired without monitoring the "success" output from the analog status line, a message "panel not deployed" is issued, and the program stops. The output from the SPDS is a status message.

Omitting, for the sake of brevity, the definition phases of client requirements, software environment, functional and behavioral requirements, the OSTD and the HOOD diagram of the SPDS module are shown in Figs. 7 and 8 respectively. A description of the object modules is as follows:

##### **Object *I/O handler***

Allows screen handling and control of the different software states. Operations are **Cl**s (clear screen) and **Wr\_string** (write string and newline character).

##### **Object *invoke\_kernel***

Calls the DHS operating system, providing hardware functionalities and establishing a low-level interface between the SPU and the application software. Operations are **DAU\_control** (manages dataflow from/to the DAU) and **CPDU\_control** (manages dataflow from/to the CPDU).

##### **Object *delay***

Sets the correct rate of inspection of the deployment sensor. **Wait** waits for x processor ticks.

##### **Object *power\_on\_&\_configure***

Activates the CPDU, grants arbitration, configures the SPU and the analog line to be sampled. It interacts with the object kernel, to which issues hardware configuration commands. Operations are **Activate\_SPU** and **Activate\_NiTi\_wires**.

##### **Object *monitor\_deployment***

Reads the analog channel containing the information on deployment. Checks whether timeout has passed or the logical 1 has been detected. Operations: **Sample** (gets the current value of the analog

line), **Check\_timer** (checks if the timeout has passed), **Check\_deployment** (checks if logical level 1 has been detected or timeout has passed), **Final\_msg** (gives a fail/ success status message).

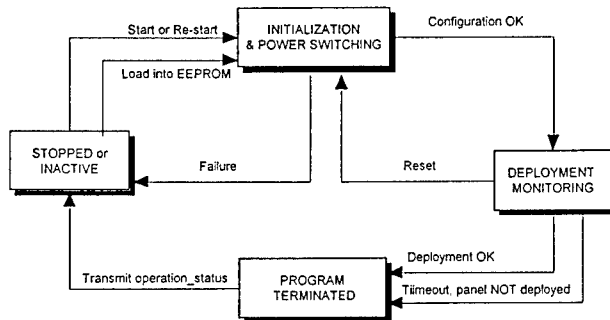


Fig. 7: Object State Transition Diagram (OSTD) of SPDS.

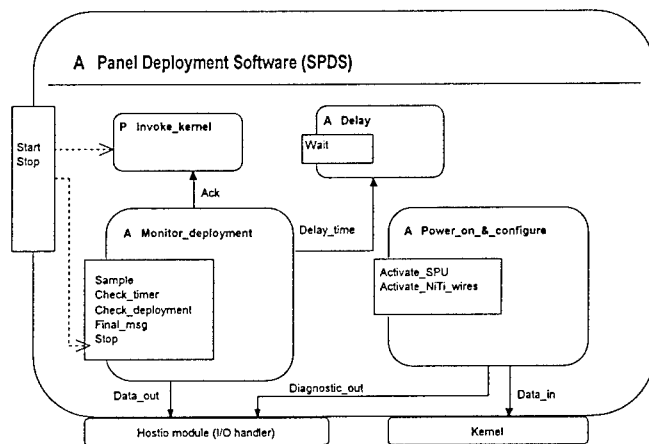


Fig. 8: HOOD Diagram of SPDS decomposition.

## 5 - CONCLUSIONS AND FURTHER WORK

This paper has presented and discussed the SMART on-board software development methodology and tools, describing the conceptual framework in which SMART mission requirements have been captured (mission phases segmentation, mission timing sequence). The analysis allowed us to identify different classes of software requirements, preliminary state transition diagrams, algorithms and hardware/software relationships. The software modules, being developed by means of the HOOD methodology (an HDT of SMART flight software and the design of the panel deployment software have been presented as an example) are being tested using a set of software and hardware development tools built around the Evaluation Board of the DSP ADSP-21020, communicating with a PC-hosted via a dedicated serial interface.

Future directions of this work will obviously involve detailed design of the actions envisaged, together with engineering issues like independent software validation and software quality assurance. Use of Computer-Aided Software Engineering (CASE) tools which allow automated generation of parts of the software project, starting from HOOD design of the modules, is planned. Work is currently underway in developing test software for acquisition and integration of

information collected by the attitude sensors used in our configuration, taking care of all time-critical operations, and in writing software interfaces for the ground station protocols necessary to format TC packets, perform effective bit synchronization, implement the required coding/ decoding schemes, generate and modulate properly the selected carrier. Currently, implemented functionalities of the ground test modules are:

- ♦transceiver check and status information collected via ESA-TTC-B-01-compliant [ESA 79] spacecraft interface;
- ♦MTM and MTQ tests, DSS control and data acquisition, PCS test;
- ♦software power-on/power-off of SACE and S-band transceiver;
- ♦monitoring of the current absorbed by all SMART subsystems, and digital status readout by analysis of the PCS status registers (tellback analysis).

These functionalities are part of a set of Occam modules written during the preliminary software development phase. They are being translated into C routines for use with the new selected SPU, based on the space-qualified DSP TSC-21020E. The future key activity will be software verification and validation, by extensive testing on module, subsystem and system level.

#### ACKNOWLEDGMENT

The SMART project is being carried out with the support of the Italian Ministry of University and Scientific Research, the Italian Space Agency (ASI) and European Community funds managed by Regione Campania, Italy.

#### REFERENCES

- [AD 94] Analog Devices, Inc., *32/40 Bit IEEE Floating-Point DSP Microprocessor ADSP-21020I, Rev. C, 1994*, One Technology Way, Norwood, MA, USA, 32 pp.
- [Alka 00] Alkalai, L., 1000, "Advanced microelectronics technologies for future small satellite systems", *Acta Astronautica*, Vol. 46, Nos. 2-6, pp. 233-239.
- [And 91] Anderson, C., Dorfman, M. (Eds.), 1991, *Aerospace Software Engineering*, AIAA Progress In Astronautics and Aeronautics, Vol. 136, AIAA, Washington, DC.
- [Char 97] Charbonnier, J. M., 1997, "Flight Software Development on Digital Signal Processors", *Proceedings of the DASIA '97 Conference on Data Systems in Aerospace*, Seville, Spain, 26-29 May 1997, ESA-SP-409, pp. 281-286.
- [Der 97] D'Errico, M., Vetrella S., 1997, "Mission Analysis of an Earth Observation Microsatellite", *Paper IAF-97-B.3.01, 48<sup>th</sup> International Astronautical Congress*, October 6-10, 1997/Turin, Italy.
- [ESA 79] European Space Agency, 1979, *Spacecraft data handling interface standards*, ESA TTC-B-01, Issue 1, Sept. 1979, ESA Publications Division, ESTEC, Noordwijk, The Netherlands.
- [ESA 88] European Space Agency, 1988, *Packet Telemetry Standard*, ESA PSS-04-106, Issue 1, ESA Publications Division, ESTEC, Noordwijk, The Netherlands.
- [ESA 91a] European Space Agency, 1991, *ESA Software Engineering Standards*, ESA PSS-05-0, Issue 2, Feb. 1991, ESA Publications Division, ESTEC, Noordwijk, The Netherlands.
- [ESA 91b] European Space Agency, 1991, *Guide to the software requirements definition phase*, ESA PSS-05-03, Issue 1, Oct. 1991, ESA Publications Division, ESTEC, Noordwijk, The Netherlands.
- [ESA 91c] European Space Agency, 1991, *Guide to the user requirements definition phase*, ESA PSS-05-02, Issue 1, ESA Publications Division, ESTEC, Noordwijk, The Netherlands.

- [ESA 92] European Space Agency, 1992, *Packet Telecommand Standard*, ESA PSS-04-107, Issue 2, ESA Publications Division, ESTEC, Noordwijk, The Netherlands.
- [Frag 99] Fragnito, M., Vetrella, S., 1999, "A space release/deployment system actuated by shape memory wires", 50<sup>th</sup> International Astronautical Congress, 4-8 Oct. 1999, Amsterdam, The Netherlands, paper IAF-99-I.4.09.
- [Glas 91] Glaseman, S., Hansen, L. J., Pollock, C. H., Thimlar, M., 1991, "Spacecraft Computer Systems", in Wertz, J. R. and Larson, W. J. (Eds.), *Space Mission Analysis and Design*, Kluwer Academic Publishers, Dordrecht, The Netherlands, Chap. 16.
- [Hood 95] HOOD Technical Group, 1995, *HOOD Reference Manual*, Release 4.0, Ref. HRM4-9/26/95.
- [Hood 96] HOOD Users Group, 1996, *HOOD User Manual*, Release 1.0, Ref. HUM3-1.
- [Inmos 91] INMOS, 1991, *OCCAM2 Toolset User Manual*, INMOS Ltd., Doc. No. 72 TDS 275 02.
- [Park 98] Parkes, SM, 1998, "DSP (Demanding Space-based Processing!): the path behind and the road ahead", *Proceedings of DSP '98, 6<sup>th</sup> International Workshop on Digital Signal Processing Techniques for Space Applications*, ESTEC, Noordwijk, The Netherlands, 23-25 Sep. 1998, ESA WPP-144, Paper 4.1.
- [Past 97] Pastena, M., Grassi, M., 1997, "Design and Test of a Small Reaction Wheel for a Remote Sensing Microsatellite", *Proc. AIDAA Congress*, Naples, Italy, 20-24 Oct. 1997.
- [Pon 97a] Ponte, S., 1997, "Engineering Model of the University Educational Microsatellite (UNISAT)", Paper IAA-97-IAA-11.2.04, 48<sup>th</sup> International Astronautical Congress, October 6-10, 1997/Turin, Italy.
- [Pon 97b] Ponte, S., and Vetrella, S., 1997, "Analysis Of Telemetry, Tracking And Command Requirements And Design Of On-Board Data Handling Software for a Multi-Mission Microsatellite", *Proc. AIDAA Congress*, Naples, Italy, 20-24 Oct.
- [Pon 98] Ponte, S., De Paris, G., 1998, "SMART Orbit Determination by Means of GPS Techniques: Accuracy and Simulation Results", Paper IAF-98-A.2.02, 49<sup>th</sup> International Astronautical Congress, Melbourne, Australia, Sept. 28-Oct. 2.
- [Sant 96] dos Santos, M. E. S. W. A., 1996, "The object-oriented analysis of the on board computer software for the Brazilian scientific microsatellite - SACI-1", *International Conference on Small Satellites: Missions and Technology*, Madrid, Spain, Sep. 9-13, 1996.
- [SGS 95] SGS-Thomson Microelectronics Ltd., 1995, *Occam<sup>®</sup> 2.1 Reference Manual*, Doc. No. 72 occ 45 03, SGS-Thomson, first publ. 1988 by Prentice Hall International, Ltd., UK.
- [SIL 97] Space Innovation Limited, 1997, *DHS-848B Data Handling System - User Manual & Description Document*, 538-UM-7001, Issue 1.
- [Temic 98] TEMIC Semiconductors, 1998, *Radiation Tolerant 32/40 Bit IEEE Floating-Point DSP Microprocessor, TSC21020E, Rev. D, May 1998*, pp. 37.
- [Yun 97] Chen Fang-Yun, Zhou Tong-Hao, Lin Lai-Xing, Wang Jin-Tang, 1997, "The possibility of Extending the Utilization of Small Satellites to Applied Space Systems and Key Technologies Related", Paper IAA-97-IAA.11.1.01, 48<sup>th</sup> International Astronautical Congress, October 6-10, 1997/Turin, Italy.
- [Zapp 97] Zappen, F.-P., Winkler, A., Koopmann, O. Hulsing, T., 1997, "The ABRIXAS on-board software design, development and verification approach", *Proceedings of the DASIA '97 Conference on Data Systems in Aerospace*, Seville, Spain, 26-29 May 1997, ESA-SP-409, pp. 31-35.

## DESIGN OF THE SMART MICROSATELLITE ELECTRICAL POWER SUBSYSTEM

Marco D'ERRICO\* and Massimiliano PASTENA\*\*

\* Dipartimento di Ingegneria Aerospaziale - Seconda Università di Napoli  
Real Casa dell'Annunziata, 81031 Aversa (CE), Italy

\*\* Dipartimento di Scienza e Ingegneria dello Spazio - Università di Napoli "Federico II"  
P.le Tecchio 80, 80125 Napoli, Italy

*ABSTRACT* – Design, assembly procedures, and test programmes for the SMART solar array are presented. It consists in four deployable solar wings and in one fixed panel and it is able to supply the bus for the 1-year lifetime with 46.1W (average) and 110.5W (peak). The power conditioning unit main functions and subsections are also described. The 28V fully regulated bus is achieved by a shunt regulator. Finally, students' activity is summarised.

### 1 - INTRODUCTION

In the last two decades microsatellites have been more and more often used to carry out low cost missions. They have been firstly aimed at radio amateur communications and technology demonstrations with the AMSAT [Jans 87] and UoSAT [Bean 88] programmes. Successively, a large variety of applications has been identified: ocean radar altimetry [Kilg 89], Earth electric field measurements [Redd 90], debris study [Gina 90], radiation measurements in the near-Earth environment [Unde 91], Earth magnetic field mapping [Baro 92], detection of Earth radio frequency [Seve 93]. Further few examples are given by the German BREMSAT, aimed at microgravity experiments [Koni 94]; ASTRID (Swedish) for measuring auroral plasma and for auroral imaging [Norb 95]; the South African SUNSAT for Earth remote sensing [Miln 99] and many others.

Smaller spacecrafts imply a reduced development time and cost. These main advantages result in the possibility of flying a more up-to-date technology and in frequent/multiple flights. Moreover, the great decrease of space mission costs allows universities and small companies to access space. In particular, universities can take great advantage from an educational point of view, by involving students in the design, development, and test phases.

In this context, the SMART (Scientific Microsatellite for Advanced Research and Technology) programme was started at the two universities of Naples. It is being supported by the Italian Space Agency, the Italian Ministry for University and Research, and the European Community. SMART (Fig. 1) is designed as a multi-mission bus, which allocates 10kg and 10W for payloads. The design lifetime is of 1 year in circular, sunsynchronous orbit (altitude between 400km and 1000km). The configuration is based on a main bus (45cm×45cm×36cm, ~40kg) with four lateral deployable panels. The spacecraft design has been carried out in order to achieve a configuration compatible with a large number of launch vehicles. In particular, ARIANE and the Indian Polar Satellite Launch Vehicle (PSLV) have been selected as candidate launchers.

The electrical power subsystem (EPS) consists in a 28V fully regulated bus. The electrical power in sunlight is provided by GaAs solar cells, while one NiCd battery guarantees electrical power in eclipse. The solar array consists in a body-mounted upper panel and in the four deployable wings [D'Er 98].

The three-axis attitude determination and control subsystem [Past 98] integrates a three-axis fluxgate magnetometer, a sun sensor, a star tracker, two torquods and three reaction wheels. The possibility of using GPS for orbit determination is under study.

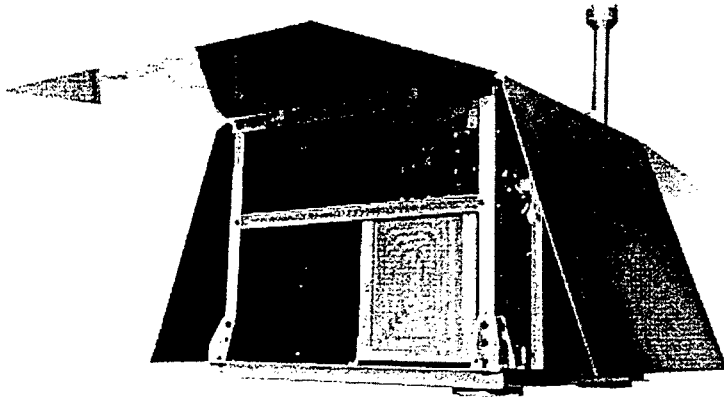


Fig. 1: SMART configuration (preliminary engineering model)

Furthermore, the project is also aimed at the realisation of a laboratory where the spacecraft is integrated, tested, qualified, and accepted for launch. To this end, it has been equipped by a clean room (cleanness class 10000), a thermal-vacuum chamber, a shaker, an inertia simulator, and an electromagnetic field simulator.

In particular, the thermal vacuum chamber (test volume  $660\text{mm}\varnothing\times 800\text{mm}$ ) has been acquired for environmental simulation. Pressure can be reduced till  $1\times 10^{-9}$  bar, while temperature can be varied ( $2^{\circ}\text{C}/\text{minute}$  on the cold plate) within the range  $-60^{\circ}\text{C}\div +100^{\circ}\text{C}$  on the cold plate and  $-180^{\circ}\text{C}\div +100^{\circ}\text{C}$  on the shroud. Temperature accuracy on the cold plate is  $\pm 1^{\circ}\text{C}$  in steady conditions.

The shaker (vibration simulation) operates in the frequency range DC/4000Hz, simulating a maximum acceleration of 111g and a speed of 1.9m/s. It will be used to test the structure for the launch loads.

The inertia simulator is an equipment for laboratory simulation of the rotational dynamics of an aerospace platform by means of an airbearing system. It is coupled with an electromagnetic field simulator for the simulation of the on-orbit Earth's electromagnetic field. Therefore, torqrods, magnetometers and attitude control laws based on the Earth's electromagnetic field can be tested on ground. Both the inertia and electromagnetic field simulators have been designed and developed at the Universities of Naples by undergraduate and graduate students.

Moreover, a solar simulator for AM0 solar simulation is being acquired to test solar cells, solar cell assemblies, and solar panel modules. Its test area is  $20\text{cm}\times 20\text{cm}$ , where the collimated light ( $\pm 2^{\circ}$ ) has a uniformity of  $\pm 5\%$ . The power density is  $980\text{W}/\text{m}^2$  within the range of wavelength  $250\div 2500\text{nm}$  ( $715\text{W}/\text{m}^2$  within  $250\div 1100\text{nm}$ ). In the near future, the laboratory will be also equipped by a climate chamber to perform acceptance tests.

In the following, the authors put in evidence how SMART EPS is being designed and developed. In particular, the authors analyse the design phase and the integration and test procedures.

Firstly, the power budget is discussed, considering both the hardware which is already integrated in the SMART engineering model and the technological state of the art. Then, EPS design (solar array, battery and power conditioning unit) is showed. Successively, the procedures which have been developed to assemble and test the solar panel are described. Finally, the authors put in evidence how students of different levels are involved in the project, in both the spacecraft and laboratory development.



## 2 - EPS DESIGN

SMART power budget (Fig. 2) has been carried out considering the engineering models which have been already integrated. With reference to the under-development hardware, the power consumption has been budgeted on the basis of the technological state of the art [Wert 92].

In particular, ADACS has a large impact on the power budget (12.1W). It integrates, a sun sensor (1.6W) and a magnetometer (1.0W) for attitude determination during the attitude acquisition phase. The star tracker (5W), which is under development, is used during the station-keeping, as well as the magnetometer. The control hardware is based on three reaction wheels (1.0W), which operates during the station-keeping, and two torquods (2.5W), which are used during both the phases of attitude acquisition and wheel unloading. The attitude control electronics has a power consumption of 1.0W.

Moreover, the telemetry and command subsystem (TT&C) consists of a receiver (3.5W), which is always switched on, and a transmitter (9.0W), which does not operate continuously along the orbit. The power conditioning unit (PCU) is based on control (4.0W) and distribution (1.5W) hardware. Besides the components' power consumption, the efficiencies of control ( $\eta_{PCU}=0.95$ ), battery charge ( $\eta_{BCR}=0.85$ ) and discharge ( $\eta_{BDR}=0.85$ ) regulations must be taken into account.

Finally, the on-board data handling (OBDH, 5.0W), the thermal control subsystem (1.0W), and the payload (10.0W) must be included. The latter has been fixed as a design figure.

If all the hardware is continuously switched on, the loads require 46.1W. In order to keep the latter as small as possible, a strategy to use the payload and the transmitter is identified. In particular, the payload is assumed to operate only for 40% of the orbit. Furthermore, considering a ground station for data downlink located in Naples (42°N) and the 3dB apertures of the communication antennae, a maximum transmitting time of 4.33 minutes per orbit can be envisaged. In conclusion, the average power required by loads is 31.5W.

The logical scheme of SMART EPS which has been designed to meet the above power requirement is shown in Fig. 3. In the following subsections, the EPS components are analysed.

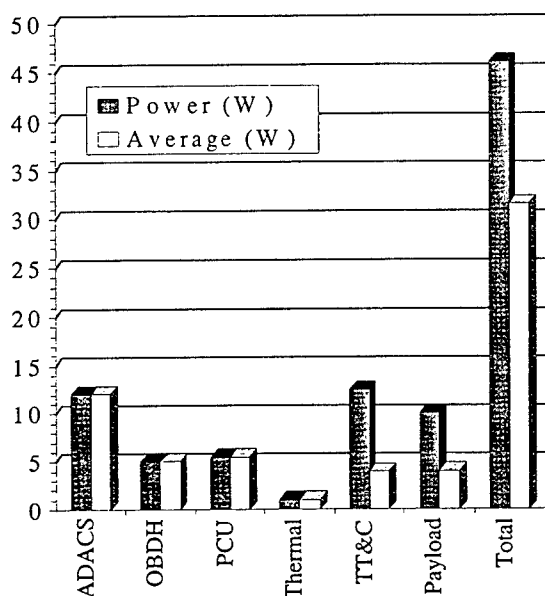


Fig. 2: Power budget

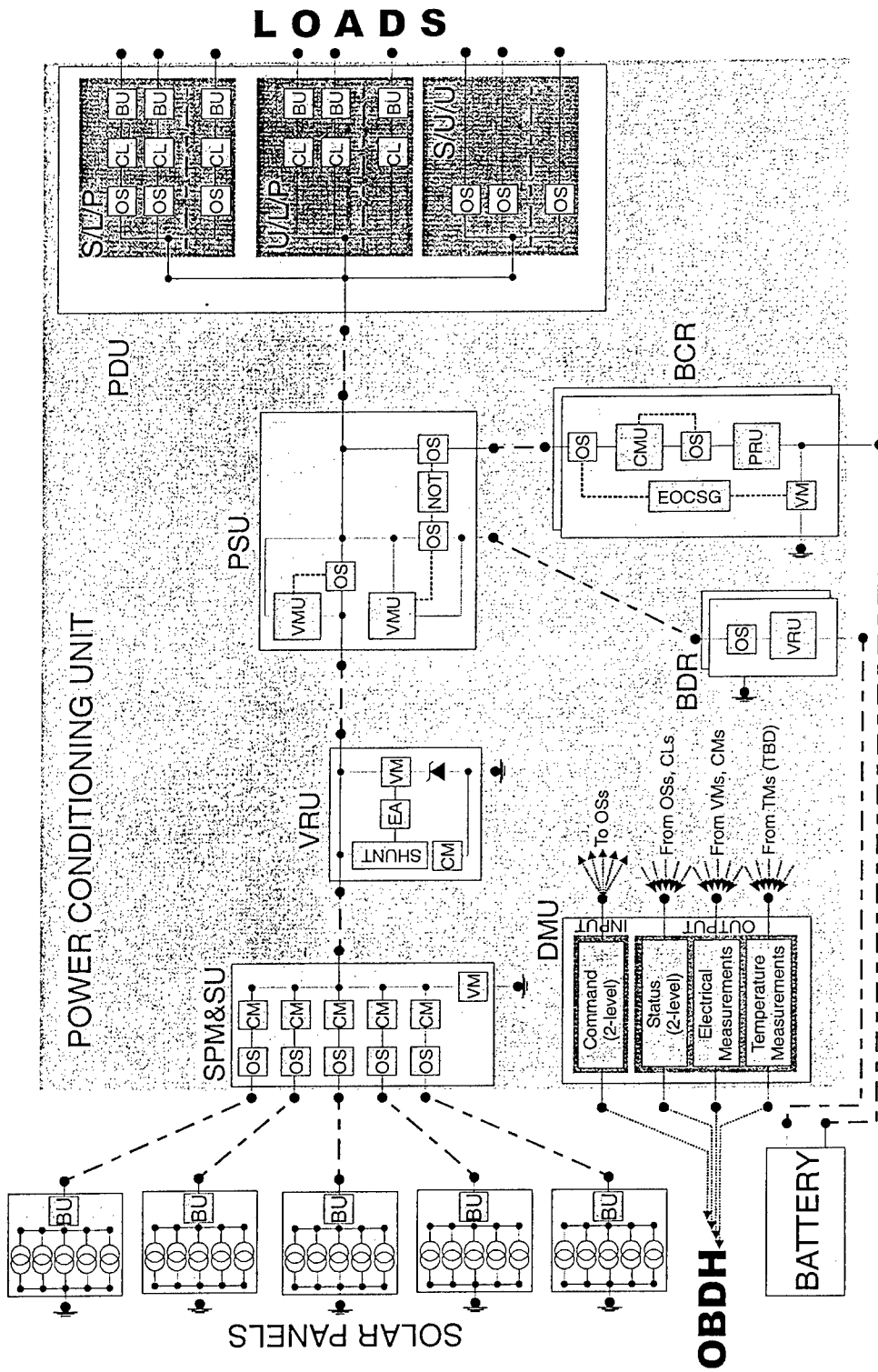


Fig. 3: EPS scheme

## 2.1 Solar Array and Battery

SMART dimensioning has been primary driven by considerations about launcher compatibility and structure design. Therefore, the solar panel dimensions are fixed by the upper panel (42cm×42cm) and the four lateral surfaces (45cm×36cm). Moreover, GaAs solar cells have been selected (§3.1).

Solar panel deploying angles were selected by means of an optimisation technique which contemporaneously accounts for an high average power requirement and uniformity in power generation [D'Er 99]. By this method, the battery charge regulator (BCR) and the battery requirements were also fixed. These calculations were carried out for a 800km-altitude, sunsynchronous orbit, which are the typical injection parameters of the PSLV launcher. For the selected orbit, an equivalent radiation damage of  $3 \times 10^{13}$  MeV must be envisaged. The procedure resulted in the determination of the solar panel deploying angles ( $16^\circ$  and  $90^\circ$ ), which give the configuration shown in Fig. 1. Moreover, the NiCd battery capacity, used with a DOD of 20%, is dimensioned (5Ah). The BCR must be supplied with 55.1W in order to charge at C/2.6.

Each deployable solar panel integrates 5 strings of 34 solar cells [D'Er 98]. Since power conditioning is achieved by means of a shunt regulator which controls the operating voltage (28V), this dimensioning was worked out at the end-of-life (EOL) and at the maximum operating temperature ( $38.3^\circ\text{C}$ , during summer solstice). To this end, the equilibrium temperature was computed considering the heat flux from the Sun and the Earth (albedo and infrared emission), the output flux from the microsatellite, and the internal heat production. Therefore, Sun and Earth positions with respect to the satellite surfaces, satellite geometry to determine the shadow of one satellite surface on the others, surface thermal properties, solar cell thermal properties and efficiency (as a function of temperature) were taken into account. The internal heat production was computed considering the average power requirement, but taking into account the efficiency of battery charge and discharge phases. Moreover, a blocking unit (BU), consisting in a blocking diode, is used to protect panels. Blocking diodes are not needed on each string since all the strings of the same panel are always under the same illumination condition.

The upper, body-fixed panel has a larger area, but it is also used to allocate the magnetometer and the sun sensor. Besides the area decrease, the magnetometer shadow must be also considered. To reduce its effects, 4 strings of 34 solar cells and 1 string of 47 cells have been envisaged [D'Er 98]. The over-dimensioned string is the one partially shadowed by the magnetometer. In normal operating conditions, string over-dimensioning does not produce any effect, due to the flatness of the string's characteristic curve in the current-tension plane. But in this case, if each solar cell is connected in parallel with a shunt diode, the configuration let the string operate with at least 34 active solar cells. Of course, diode power losses must be taken into account. In particular, diodes are assembled in order to reduce conduction losses [D'Er 98]. By using this technique, the overall effect of the magnetometer shadow on the five solar panels is a mean decrease of the average power of about 0.4% with respect to the value attainable by means of five panels of five strings.

The solar array design was, then, numerically verified. A computer code was developed to this aim [D'Er 98]. Firstly, it integrates the microsatellite orbital dynamics and determines the Sun and the Earth geometry in the satellite-fixed reference frame. Afterwards, it integrates the microsatellite temperature equation along the orbit, considering non-equilibrium, global conditions and taking into account the electric power sub-system operations. In particular, it accounts for the solar array configuration in term of number of panels, number of strings and number of cells per string. Therefore, the characteristic curve of the solar array is simulated in order to determine the supplied current at the working point (28V). Considering the load current profile, it finally determines: (1) the power to be dissipated through the shunt regulator; (2) the available power for battery charge or the power being supplied by the battery; (3) the battery charge level. Then, these data are fed back to the temperature equation in order to properly evaluate the internal heat production. Simulations were conducted for orbits in different periods of the year and at the end-of-life. They showed the solar array capability to supply the bus and charge the battery even in the worst case condition for the whole microsatellite lifetime.

## 2.2 Power Conditioning Unit

The power conditioning unit (PCU) is divided into different logical and physical parts which manage different functions. PCU design has been carried out with the aim of modularity.

Currents delivered by the solar panels (SPs) are firstly managed into the solar panel monitoring and switching unit (SPM&SU). In particular, SPs currents (CM) and their parallel connection voltage (VM) are measured in order to in-flight verify SPs performance. An ON/OFF switch (OS) is also integrated on each line. Therefore, the SPs can be switched off to reduce the total current in the case that failures arise within the shunt regulator. Moreover, they can be used to force battery discharge. Each OS is duplicated for redundancy. Therefore, the SPM&SU electrical inputs are the five lines from the SPs, whereas the output is the current of the SPs parallel connection. OSs commands are the logical inputs, while OSs statuses, CMs and VMs measurements are outputted to the computer.

The voltage regulation unit (VRU) regulates the bus voltage at 28V by means of a shunt regulator. The voltage is measured with respect to a reference level (Zener diode) and the error signal is amplified (EA), giving the shunt the command signal. The current dissipated into the shunt is measured. While supplying the power selection unit (PSU), the VRU is supplied by the SPM&SU. Voltage and current measurements are VRU logical outputs.

PSU switches the battery discharge regulator (BDR) whenever the solar array is not able, partially or totally, to supply loads. PSU also enables the supply line to the battery charge regulator (BCR) whenever possible. BDR switching is determined by two voltage monitoring units (VMU) which monitor the voltage difference between the solar array and BDR. BCR is enabled whenever BDR is disabled and vice versa. PSU only enables electrical lines from BDR and to BCR. Battery charge/discharge is controlled by the relative regulators. PSU has two electrical inputs (PRU and BDR) and outputs (BCR and PDU). On the other hand, it has no logical inputs, while OSs statuses are outputted to the computer.

The power distribution unit (PDU) supplies the loads with the required power and it is divided into three sub-sections. The first one (S/L/P) is dedicated to the switchable, current-limited loads. These lines are also protected against load failures by a blocking unit (capacitive/inductive loads). CLs limit load currents to a fixed limit. The OSs, which are duplicated for redundancy, allows the computer to switch on/off the loads. The U/L/P section supplies the receiver and the computer, which are always switched on during the whole operational life. Therefore, OSs are not integrated on this lines. CLs and BUs are still present. Finally, the S/U/U section supplies the one-event loads like the MEMs which are used for solar panel deployment. Since the loads are resistive, these lines are unprotected. Moreover, they are not current-limited because they usually require large currents for a short time. OSs are still present and duplicated for redundancy. OSs commands are the PDU logical inputs, while their and CLs statuses are outputted.

With reference to battery utilisation, BDR regulates discharge voltage by means of VRU. OS is commanded by the computer. On the other hand, BCR regulates battery charge. The first OS is switched by the end-of-charge signal generators (EOCSG) and the computer. Whenever the battery is not fully charged the OS is always in the ON-status, which does not necessarily imply that the battery is being charged. The current monitoring unit (CMU) measures the available current and switches the second OS on when it is greater than the design charge current. Finally, the power regulation unit (PRU) supplies the battery with a constant current and boosts voltage when necessary. Since both BDR and BCR are critical components, they are duplicated for redundancy.

Logical inputs and outputs are managed by the data management unit (DMU). Besides voltage and current measurements and OSs and CLs statuses and commands, temperature measurements (TM), which are outputted to computer, are also envisaged for PCU critical components. TM devices and their positions have not yet been defined. Temperature measurements are also envisaged for the battery and the solar panels. These measurements are not managed by the DMU but they are directly delivered to the computer.

### 3 – SOLAR PANEL DEVELOPMENT AND TEST

#### 3.1 Components

The components which have been selected to integrate the solar panel are shown in Fig. 4. Even though microsatellites mainly use silicon (Si) solar cells, gallium arsenide (GaAs) solar cells have been selected. This choice has been driven by two considerations. The former is related to GaAs efficiency which allows to use a reduced area, whereas the latter is due to a procurement analysis. In fact, space-qualified GaAs solar cells are produced in Italy, while space-qualified Si solar cells must be acquired abroad. In particular, the selected GaAs solar cells are produced by the Enel S.p.A., Department of Materials and Diagnostics. Therefore, they can be bought at a very competitive price.

With reference to the other components for cell assembly, CMX cover glasses are produced by Pilkington (UK). Connectors and busbar are electro-formed from Ag metal sheets (20 $\mu$ m thickness).

Kapton RR is a radiation resistant product, manufactured by DuPont Company, and it is used as solar cell electrical insulated substrate. It will be bonded on the solar panel structures, which are sandwich structures designed at the Department [Frag 99]. It consists in aluminium core and CFRP skins for a total thickness of 6mm and mass of 0.7kg (per panel). The selected composite materials for the sandwich facings together with an aluminum honeycomb hexagonal core provide the panels with high stiffness, nearly zero in-plane thermal expansion, high in-plane and cross-plane thermal conductivity, low mass and thickness. Solar panels will be manufactured by a local small company. The possibility of integrating the Kapton substrate while manufacturing the panels is under study.

With reference to adhesives, they are produced by Norlabs (US). In particular, NORCAST RTV 817, which is used to bond solar cells and cover glass, is a two component, optically clear, silicon rubber compound. It has not yet been space-qualified but its temperature ranges (-65°C+204°C) are adequate for space applications. The adhesive must be handled in small quantities (~6 $\mu$ l) by means of micrometric dispenser (produced by Gilson). With reference to the connection between solar cells and connectors, adhesives have been preferred to soldering in order to limit technological problems. To this end, NORCAST 4913 adhesive, which is a low density silver filled conductive epoxy resin, has been identified. One of the test program's goals is to verify the effectiveness of connector bonding. NORCAST A-4000 is a two component solvent based silicon resin and it is used to bond the solar cells to the Kapton substrate. It is manufactured according to the MIL-A-47317 SPEC. NORCAST A-4000 is also used to bond the Kapton substrate and the sandwich panel.

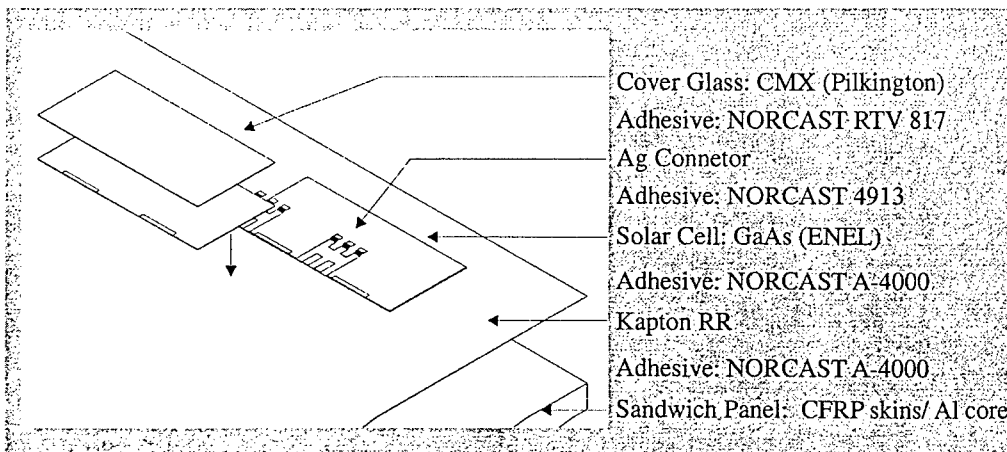


Fig. 4: Solar panel assembly scheme

### 3.2 Assembly procedures

Solar panel assembly consists in two main procedures. The former has been developed to integrate solar cells, cover glasses, and connectors. On the other hand, the latter is related to the integration of solar cell strings on panels.

With reference to the former, Fig. 5 shows the mechanical device which has been developed. In particular, it consists in four parts. Solar cells are firstly positioned on the rectangular base of Part A. Then, Part C is positioned over the cells in order to protect their active area from the adhesive drips which are distributed on the cells' metallized area. Afterwards, connectors are correctly positioned with the aid of the two guides on Part A and Part B is used to press the connectors until the adhesive bonds the components. After this step, Part B and C are removed and adhesive is dripped on the cell. Cover glass is, then, centred on the cell by means of the five pyramidal guides and pressed by Part D. Presently, the device design is being slightly modified in order to reduce its cost.

Solar panel assembly is realised by means of the equipment shown in Fig. 6, which is still under development. Firstly Kapton substrate is integrated on the panel structure and it is positioned on Part A, which gives a reference for position. Then, solar cells, which have been already integrated with the cover glasses and the connectors (bonded on their fronts), are positioned on a rectangular guide where their back contacts are bonded to form a string. Then, the string is taken by means of a system consisting in a pump and in several suction cups which are arranged on Part C of Fig. 6 (not shown in figure). Vacuum is also controlled to avoid cell damage. Finally, adhesive is distributed over the Kapton substrate, and the string is positioned on the panel. Weights are used to press the cells. Accurate positioning can be achieved by means of graduate scales on Part A and B. This device is being currently modified to include a worm screw to have a better positioning of the string along the panel.

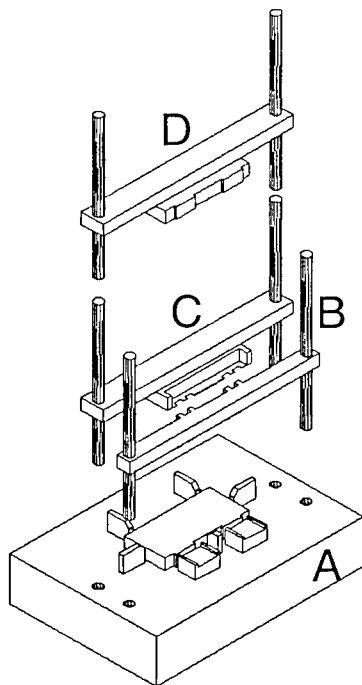


Fig. 5: System to integrate solar cell, cover glass, and connectors.

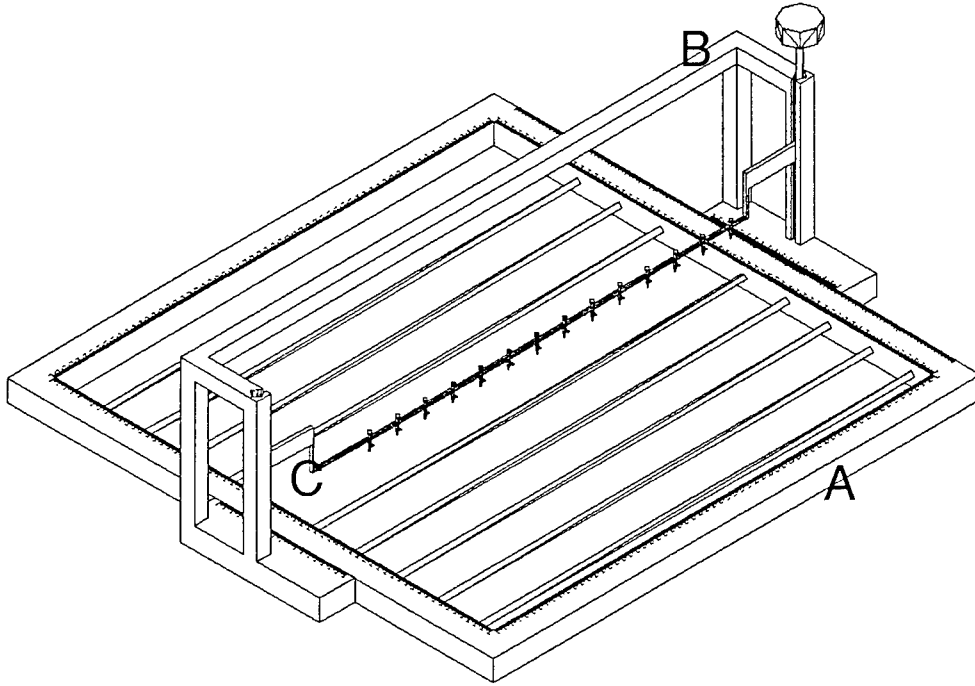


Fig. 6: System to integrate solar cells on the solar panel.

### 3.3 Tests

Test programme involves the different phases of solar panel assembly. In particular, with reference to the integration of solar cells, cover glasses, and connectors, the following steps are envisaged:

- 1) Characterisation of solar cells. It is performed to characterise solar cells and determine the cells which are going to be assembled in series (similar short circuit currents):
  - a) each cell is electrically characterised by determining the IV curve in both forward and backward polarisation.
- 2) Characterisation of connectors' bonding. It is performed to verify the bonding procedure as follows:
  - a) optical inspection to verify adhesive distribution (after connector bonding);
  - b) electrical characterisation to verify electrical performance;
  - c) pull tests to verify bonding strength
- 3) Characterisation of assembled cells. It is performed to verify the final result:
  - a) optical inspection (after connectors' bonding);
  - b) forward/backward electrical characterisation;
  - c) optical inspection (after cover glass' bonding);
  - d) forward/backward electrical characterisation.

In order to reduce panel cost, tests are firstly performed on second quality cells. When the procedure is assessed, first quality solar cells will be integrated and tested (without pull test).

Optical inspection is carried out by means of a Leica Microscope, model MZ6 (80x), with coaxial illumination by means of optical fibre. A pull tester is used to carry out pull tests.

The experimental equipment for solar cell electrical characterisation has been assembled at the Department. It consists in a 4-quadrant power supply (Keithley Instruments) and a 1kW solar simulator (Oriel Instruments). The equipment is PC-controlled by an ad-hoc LABVIEW software. Currently, data are acquired measuring temperature, but in the future solar cell temperature will be controlled by means of a cold plate.

Solar panels are larger than the solar simulator test area. Therefore, solar panel modules, which integrate a limited number of solar cells in both series and parallel connections (realised by using busbar), are tested:

- 4) Characterisation of cell strings. It is aimed at the test of series connection (8 cells, maximum) not already integrated on the panel, as follows:
  - a) optical inspection (after back contacts' bonding);
  - b) forward/backward electrical characterisation;
  - c) pull tests to verify bonding strength.
  
- 5) Characterisation of cell modules. It is aimed at the test of solar panel assembly procedure by means of the following steps:
  - a) optical inspection (after panel assembly);
  - b) forward/backward electrical characterisation;
  - c) optical inspection (after thermal cycling in vacuum conditions between  $-60^{\circ}\text{C}$ ÷ $100^{\circ}\text{C}$ );
  - d) forward/backward electrical characterisation.

Thermal vacuum cycling is performed by means of the Department's thermal vacuum chamber (Angelantoni S.p.A.). Tests # 5 will be improved in the near future by the integration of the solar simulator and the thermal vacuum chamber in order to perform electrical characterisation in operational temperature and pressure conditions.

Accelerated thermal cycling tests and thermal shock tests are also needed, but the relative equipment is not yet available at the Department. Therefore, agreements will be signed to perform these tests at factories. Due to the costs of solar cells, tests will not involve the operational solar panels but only test modules.

#### 4 – IMPACT ON EDUCATION

SMART and laboratory programmes have a great impact on university education in the field of Aerospace Engineering at three different levels:

- (1) degree courses
- (2) graduation dissertations
- (3) research activity of Ph. D. students

After recent laboratory completion, experimental activity is going to play an important role in different courses in the field of Aerospace Systems. In particular, besides some practical demonstrations of subsystems functioning, didactic activity will include design of experimental tests. Beginning with very simple ones, students are going to develop their skills managing experiments by computers and data acquisition software. Thanks to this approach, students are going to be early involved with practical problems in order to gain a better understanding of theoretical topics.

Students graduating in Aerospace Engineering have been involved in both projects since the



beginning. Some examples are the inertia and the Earth magnetic field simulators, which are currently important parts of the laboratory equipment. With reference to the EPS design, the work has been mainly addressed to the design of a solar simulator for solar panel electrical characterisation. This project was cut off due to the results in terms of cost and required supply power. A different approach was then decided which led to the acquisition of a solar simulator to test solar panel modules only. Some SMART components have been also designed in the framework of degree dissertations: magnetic coils, on-board computer, solar panel release mechanisms, etc.. The solar panel development also started with a dissertation. Students who carry out successful designs can also realise their project on the basis of a preliminary cost analysis.

Ph. D. students have participated in these projects too. The attitude determination and control subsystem is being developed in this framework, considering both simulation of control laws and hardware development. Inertia wheels (mechanics and electronics) have already be developed and sun sensors are under study. Electro mechanical devices based on shape memory wires are also being studied and tested. With reference to EPS, the solar panel sandwich structure has been designed by Ph. D. students.

As previously highlighted, students of all levels are involved with both design and development tasks. The main aim is indeed to force students to face up to practical problems. In this way, they have to take account of cost, procurement, and technological requirements. The main advantage of this approach is that they will be already experienced when working at industries.

## 5 – CONCLUSION

The authors outlined microsatellite and laboratory development at the Aerospace Engineering Department of the Second University of Naples. In particular, the activity regarding the electrical power subsystem has been highlighted.

SMART peak power requirement (46.1W) is fixed on the basis of the microsatellite engineering model and of the technological state of the art. In order to reduce solar array dimensioning, it has been decided to use the payload for 40% of the orbit and to transmit data for 5mins per orbit. This procedure leads to an average power requirement of 31.5W. Solar array consists in five solar panel which provides a peak power of 110.5W. They are able to supply the loads and the battery charge regulator with a 55.1W power. The 5Ah NiCd battery is charged at C/2.6 with a 20% DOD.

The power conditioning unit consists in different subsections which manage different functions. Panel functioning is monitored by an ad-hoc section which can also switch panels off. Moreover, voltage regulation (28.6V) is based on a shunt control logic. Battery switching is performed also in sunlight to account for peak power and battery voltage is regulated during both discharge and charge phases. Power distribution is based on switchable/maximum-current controlled/protected, unswitchable/maximum-current controlled/protected, and switchable/uncontrolled/unprotected supply lines. PCU functioning is monitored by voltage, current, and temperature measurements. These data and the commands and statuses are sent to the computer.

The authors also showed components, procedures, and tests which have been selected and developed to assemble the solar array. In particular, it is envisaged the use of components and techniques which have not yet been qualified. As an example the adhesive bonding of solar cell connectors is a critical procedure and a test programme to verify its effectiveness has been developed and it will be carried out in the next months. Other tests are designed to verify both solar cell strings and solar panel modules integration. They include thermal vacuum tests, which are carried out at the Department's laboratory.

Besides the research aims, SMART programme was started in order to involve students in design and development activities. This approach leads to a better understanding of aerospace topics. Moreover, it is also aimed at gaining a deeper exchange of experiences between the academicians and people working at industries, so that students can more easily approach the real world.

## 6 – REFERENCE

- [Baro 92] W.R. Baron, K. Leschly, and R.L. Thomson: "Mapping of Earth's Magnetic field with the ØRSTED Satellite", *Proceedings of the 6th Annual AIAA/USU Conference on Small Satellites*, Utah State University, Logan, Utah, September 1992.
- [Bean 88] N.P. Bean, J.M. Radbone, M.N. Sweeting, and J.W. Ward: "The UOSAT-C, D & E Technology Demonstrations Satellites", *Proceedings of the 2nd Annual AIAA/USU Conference on Small Satellites*, Utah State University, Logan, Utah, September 1988.
- [D'Er 98] M. D'Errico and M. Pastena: "Solar Array Design and Performance Evaluation for the SMART Microsatellite", *49th Congress of the International Astronautical Federation*, September-October 1998, Melbourne, Australia (IAF-98-R.1.06).
- [D'Er 99] M. D'Errico and M. Pastena: "Mission Analysis and Configuration Design for an Earth Observation Mission of the Naples Universities Microsatellite", submitted for publication on the *Journal of The Astronautical Sciences*, April 1999.
- [Frag 99] M. Fragnito and M. Pastena: "Design of SMART Microsatellite Deployable Solar Wings", *Acta Astronautica*, Vol. 46, No. 2-6, pp. 335-344, 2000.
- [Gina 90] Ginati A., G. Lehmann, H.J. Königsmann, H. Iglseder, and H.J. Rath: "BREM-SAT, A Small Scientific Satellite", *Proceedings of the 4th Annual AIAA/USU Conference on Small Satellites*, Utah State University, Logan, Utah, August 1990.
- [Jans 87] D. Jansson: "Spacecraft Technology Trends in the Amateur Satellite Service", *Proceedings of the 1st Annual AIAA/USU Conference on Small Satellites*, Utah State University, Logan, Utah, October 1987.
- [Kilg 89] C.C. Kilgus, E.J. Hoffman, W.E. Frain: "Monitoring the Ocean with NAVY Radar Altimeter Lightsats", *Proceedings of the 3rd Annual AIAA/USU Conference on Small Satellites*, Utah State University, Logan, Utah, September 1989.
- [Koni 94] H.J.Konigsmann, H.Oelze, and H.J.Rath: "BREMSAT-First flight Results", *Proceedings of the 8th Annual AIAA/USU Conference on Small Satellites*, Utah State University, Logan, Utah, 1994.
- [Miln 99] Milne Garth W. *et al.*: "SUNSAT - Launch and First Six Months' Orbital Performance" *Proceedings of the 13<sup>th</sup> Annual AIAA/USU Conference on Small Satellites*, Utah State University, Logan, Utah, September 1999.
- [Norb 95] O. Norberg *et al.*: "The Microsatellite Astrid", *Proceedings of the 12th ESA Symposium on European Rocket and Balloon Programmes and Related Research*, Lillehammer, Norway, 1995.
- [Past 98] M. Pastena and M. Grassi: "SMART Attitude Acquisition and Control", *Journal of the Astronautical Sciences*, Vol. 46, No. 4, pp. 379-393, October-December 1998.
- [Redd 90] F.J. Redd and T.A. Olsen: "Microspacecraft and Earth Observation: the Electrical Field (ELF) Measurement Project", *Proceedings of the 4th Annual AIAA/USU Conference on Small Satellites*, Utah State University, Logan, Utah, August 1990.
- [Save 93] L.K. Seversike: "Iowa Satellite Project", *Proceedings of the 7th Annual AIAA/USU Conference on Small Satellites*, Utah State University, Logan, Utah, September 1993.
- [Unde 91] C.I. Underwood, J.W. Ward, C.S. Dyer, A.J. Sims, J. Farren, and J. Stephen: "Space Science and Microsatellites - A Case Study: Observations of the Near-Earth Radiation Environment using the Cosmic-Ray Effects and Dosimetry (CREDO) Payload on-board UoSAT-3", *Proceedings of the 5th Annual AIAA/USU Conference on Small Satellites*, Utah State University, Logan, Utah, August 1991.
- [Wert 92] J.R. Wertz, and W.J. Larson: "Space Mission Analysis and Design", *Kluwer Academy Publishers*, 2<sup>nd</sup> Edition, Boston MA, pp. 811, 1992.

## SMART MICROSATELLITE STRUCTURE, MECHANISMS AND THERMAL DESIGN

Marino FRAGNITO

*Aerospace Engineering Department  
Second University of Naples  
Via Roma, 29 I-81031 - Aversa  
Ph: +39.081.5010.287, fax: +39.081.5010.264  
e-mail: marino.fragnito@unina2.it*

**ABSTRACT** - *This paper deals with the SMART microsatellite thermal-mechanical design. An integrated approach was used for the thermal-structural modeling. Numerical simulations were performed by Finite Element Models using MSC/NASTRAN, to validate both the structural and thermal design. A new concept, based on the properties of Shape Memory Alloy wires, was used to design the solar panels release/deployment system. To this purpose, an ad-hoc procedure was developed, in order to design the SMA wire actuated solar panel release mechanism strength to withstand the launch environment.*

### 1 – INTRODUCTION

The Scientific Microsatellite for Advanced Research and Technology, "SMART", is the result of a joint project between the Department of Aerospace Engineering of the Second University of Naples-Italy, and the Department of Space Science and Engineering "Luigi G. Napolitano" of the University of Naples "Federico II"-Italy. The project is being carried out with the financial support of the "Regione Campania", the Italian Ministry of University and Scientific Research and the Italian Space Agency (ASI). SMART is a multi-mission microsatellite aimed at carrying remote sensing payloads on sun-synchronous orbits with altitudes ranging from 400 to 1000 km.

In the stowed configuration SMART measures 450x450x360mm (see Tab.1), without the separation system, plus a 270 mm-long magnetometer located on the top plate. SMART frame structure is designed to good flexibility, in terms of subsystem locating, accessibility during assembly, and test of the spacecraft, prior to the final subsystem integration. In order to allow easy integration of a payload, the spacecraft is provided with a central cylindrical module (130-mm diameter, 360 mm long). The cylinder longitudinal axis is along the satellite yaw axis, to allow on board integration of both Earth and space viewing payloads. The on-board required electric power is provided by a solar array body-mounted on the top plate of the microsatellite and on four deployable solar wings. Fig.1 shows the engineering model of the SMART satellite in the deployed configuration, the solar panels are deployed in pairs at 16° and 90° respectively in order to maximize the electric power acquisition

Table 1 : SMART main characteristics.

Bus mass	33 kg
Bus size	450x450x360mm
Avg. electric power	64 W
Payload mass	up to 10 kg
Payload avg. Power	4 W
Orbits	Circular sun-synchronous
Time at the ascending node	10 pm –12 pm
TT&C	S-Band
Operating altitude	400 to 1000 km

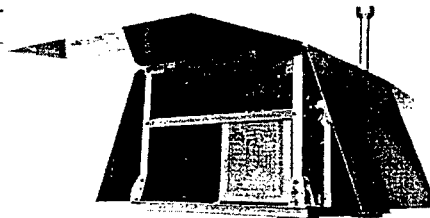


Fig.1: SMART engineering model.

along the orbit [Derr 98]. Each deployable wing (sandwich panel with Carbon Fiber Reinforced Plastic skins and Al-honeycomb core) is connected to the primary structure, next to the top panel, by a central hinge, preloaded by a clock spring to deploy the panel when released, and two side hinges to avoid undesirable vibration modes at launch. At its bottom, next to the satellite base plate, the solar panel is kept stowed at launch by an hold-down/release hook actuated by a shape memory wire. The release/deployment operation is described in section 4. The four solar wing release mechanisms were specifically designed to fly for the first time on the SMART satellite. An innovative concept was adopted for the design: they are actuated by Shape Memory wires, providing a synchronous and symmetrical release with no pyroshock [Frag 99].

The thermal control is totally passive, and it is based on an energy distribution concept, verified by finite element analysis. The along-the-orbit temperature excursion is limited by an optimized thermal modeling based on a parametric analysis taking into account the thermal finishing and the conduction paths within the spacecraft, in order to met the operation thermal requirements of the subsystems while maximizing the solar array efficiency by keeping its temperature as low as possible along the orbit [Frag 00a].

SMART thermal-structural verification was carried out by FEM models using MSC/NASTRAN™ to demonstrate compatibility with the Ariane 4 launcher and the achievement of the operating thermal requirements of the subsystems.

## 2 – STRUCTURAL DESIGN AND VERIFICATION

SMART primary structure consists of two 20 mm thick sandwich aluminum plates, respectively at the base and at the top of the body, 4 vertical L-shaped section aluminum beams, 8 horizontal L-shaped section beams (that also serve for subsystems attachments) and an aluminum cylinder to serve for payload module. The secondary structures, that is the deployable solar panels, are CFRP skins-aluminum core 4mm thick sandwich panels. A Finite Element Model of the assembled satellite was built using FEMAP™ and MSC/NASTRAN™. Table 2 summarizes the coordinates of the Center of Mass and the inertia about the Geometrical Center (G. C.) of the satellite, as resulted from the FEM model corresponding to the final subsystem configuration.

Table 2 : Satellite Mass Properties

Center of Mass (from G.C., m):	X=-0.015; Y=-0.014; Z=-0.023
Inertias about G.C.(kgm <sup>2</sup> ):	I <sub>xx</sub> = 0.817073 I <sub>xy</sub> = -0.0651003
	I <sub>yy</sub> = 0.804287 I <sub>yz</sub> = 0.0486787
	I <sub>zz</sub> = 0.949033 I <sub>zx</sub> = -0.0172644

The microsatellite total mass, without the payload, is about 33 kg. For the satellite design, a mass of 10 kg was allocated to the payload. The payload center of mass was considered to be coincident with the satellite G.C. . In fig. 2 the assembling of the satellite structure with all the subsystems, in the clean room of the Second University of Naples, is shown. The requirements taken into account for the design verification are those of the Ariane 4 A.S.A.P. [Aria 93], also assuming the ASAP Standard Separation System for the spacecraft deployment. According to this assumption, the satellite base plate was constrained in 12 nodes

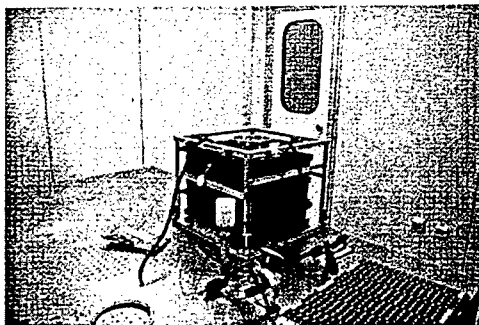
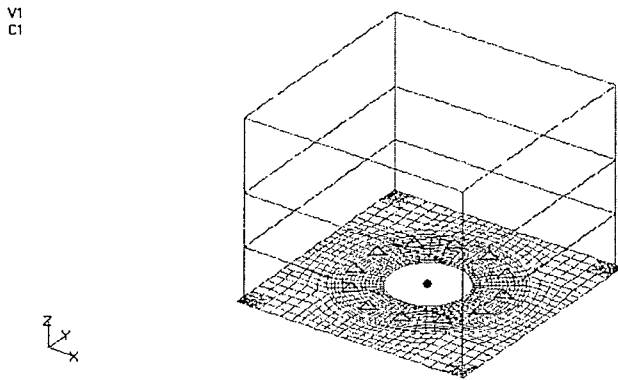
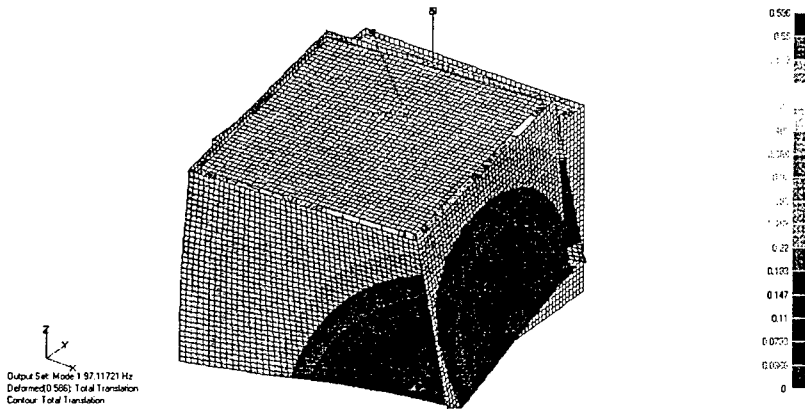


Fig. 2 : Assembling SMART in the clean room.

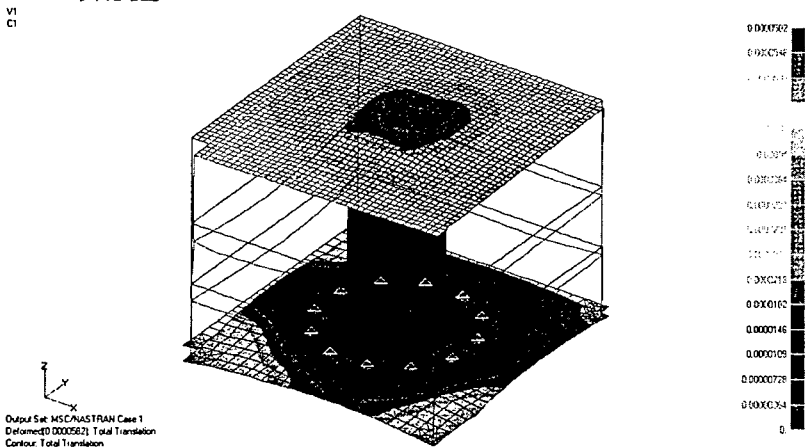
spaced of  $30^\circ$  on a 248 mm diameter, as visible in fig.3. The flexibility of the separation system was neglected for the calculation of the modal frequencies. The first mode shape, calculated by NASTRAN has a frequency of about 97 Hz, and as it is visible from fig. 4, it is a spacecraft lateral vibration mode, that means the ASAP frequency requirements are met. The maximum quasi-static



**Fig. 3 :** ASAP Standard Separation System constraint points on the satellite base plate.



**Fig. 4 :** Spacecraft (system assembled) first vibration mode: 97.1 Hz



**Fig. 5 :** Spacecraft structure total translation (detail) - under the design load of  $-66 \text{ m/s}^2$  along the thrust (z) axis.

load, assumed for the static verification of the FEM model, is that of the time instant just before thrust termination, as descending from a typical longitudinal acceleration profile of Ariane 4 [Aria 93]. A factor of safety of 1.5 was taken into account for the design, as prescribed by Ariane, yielding a total acceleration load of  $-66 \text{ m/s}^2$  along the thrust axis of the assembled spacecraft. Fig. 5 shows the total translation contour, of the spacecraft primary structure, output of the NASTRAN static analysis of the assembled satellite under the design load.

As it will be described in details in section 4, a random analysis was performed in order to derive the design loads for the SMA release mechanism design. This random analysis was based on the Power Spectral Density (PSD) corresponding to the acceptance levels for the random vibration tests prescribed by Ariane, and solved by a NASTRAN SEMFREQ solution using a RANDSP option. An overall structural damping coefficient of 0.0035 was assumed for this phase of the design [Demc 95]. As regards to the satellite dynamic envelope at launch, from the numerical random analysis it turned out that the maximum amplitude of a satellite structure nodal vibration is 0.4 mm. No excessive stress concentration resulted from the numerical simulations.

### 3 – THERMAL DESIGN AND VERIFICATION

For the thermal design and verification of the SMART satellite, an ad-hoc procedure was developed. The most challenging aspect of SMART thermal modeling was to keep the solar array temperature as low as possible, in order to maximize its efficiency, while satisfying the components thermal requirements. To this aim, a numerical model, consisting of a schematization of the satellite by 5 nodes (body plus 4 appendages), and of a simulation of the thermal environment which took into account the orbital geometry, was built in MATLAB<sup>TM</sup> code, and a parametric optimization was performed [Frag 00a]. The parameters assumed for this analysis were the thermal coatings of the solar wing back surfaces and the main conduction paths within the satellite, that is the conduction between the primary and the secondary structures. Fig. 6 shows the temperature excursions of the satellite body and the 4 appendages along one orbit, in the coldest day of the year, that is the most critical, calculated by the MATLAB

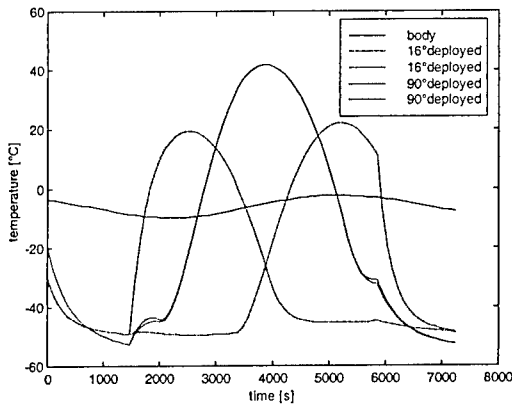


Fig. 6 : Temperature excursions along 1 orbit (5 nodes).

software with the thermal design values chosen by optimizing among the possible thermal control values.

From the preliminary thermal analysis and parametric optimization descended the choice of the thermal control coating ALZAC A5 for the solar wing back surfaces, the dimensioning of the wing-body conduction paths, which were designed in detail [Frag 00a], and the decision to cover the spacecraft main body with Multi Layer Insulation Blankets with specific surface thermal properties, to limit the onboard thermal excursion.

A FEM analysis was performed in order to verify the thermal optimization achievements, deriving the spatial temperature distribution on the panel surface. Two FEM models, one for the 16 degree deployed panel and one for the 90-degree, were built. The satellite body temperature variation was assumed to be the one derived from the preliminary analysis, the conduction paths and the panel structure were modeled by solid finite elements, the thermal loads applied were derived from the orbital propagator used for the preliminary analysis [Frag 00a].

Once the final configuration of the integrated satellite had been structurally verified by MSC/NASTRAN, a thermal analysis on the assembled FEM model was performed.

The fittings between the different subsystems and the primary structure, were chosen, in terms of number and position of the attachments points, in order to distribute the thermal energy among the satellite, taking into account the operating requirements of each subsystem. The detailed thermal modeling performed, based on the thermal distribution, allowed to achieve totally passive thermal control without adding mass, such as radiators and louvers. The solar wings themselves are used as radiators to dissipate the internally generated power. The internal heat generation loads, applied to the subsystems, are reported in table 3, while fig.7 shows a section cut of a temperature contour of the spacecraft at a specific time along the orbit.

Table 3 – Subsystems average power generation (internal heat)

SUBSYSTEM	POWER (W)
On Board Data Handling	5 W
Sun Sensor	0.8 W
Star tracker and Magnetometer	Neglected because they are external to the body
3 Reaction Wheels	1.8 W
2 Torquods	2.5 W
Satellite Attitude Control Electronics	1 W
Transceiver	0.4 W
Power Conditioning	5.5 W
Payload	4 W
Batteries	8.25 W

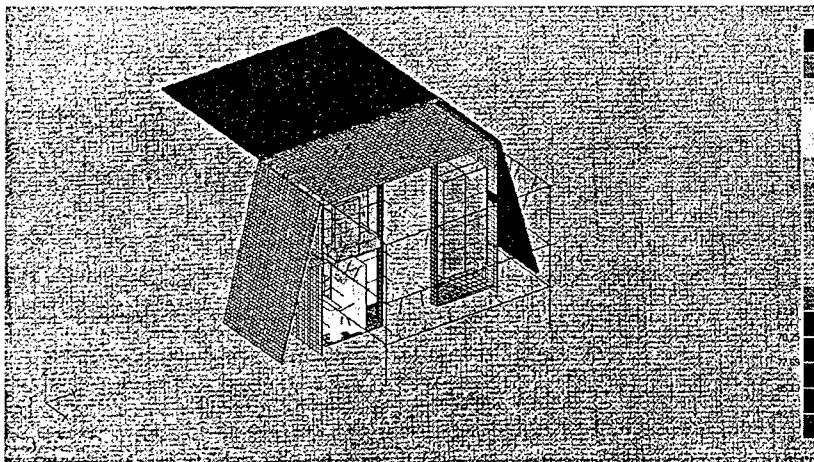


Fig. 7 : Satellite temperature contour (section view) at a time along the orbit.

#### 4 – SOLAR PANEL RELEASE MECHANISM DESIGN TO LAUNCH LOADS

A new concept, introduced by Fragnito and Vetrella [Frag 99], was adopted for the design of the solar panel hold-down/release system, with some changes. It is based on the use of a Shape Memory Alloy (SMA) wire as the active element of a release system: under an input supply current of 5A, the SMA wire simultaneously drives two mechanical assembly, corresponding to two symmetrical solar panels, and smoothly releases the panels, without pyroshock, in less than 300 milliseconds.

Then a clock spring deploys each panel to the desired angle while unidirectional bearings in the deployment hinges avoid the panel to return towards the stowed position. A prototype of the hold-down/release mechanism, its assembling scheme and its operation is shown in fig. 8 at the following page. The SMA wire used is a Flexinol™ with a 0.4 mm diameter and 210 mm length. According to the manufacturer, the wire maximum actuation force is about 20N. In order to design the mechanical assembly to sustain the launch loads an ad-hoc procedure was developed.

The mechanism cinematic pre-load torque was dimensioned to optimize the system performance, in terms of release time, smoothness of release and power consumption on the basis of the force exerted by the SMA wire on the mechanism [Frag 99; Frag 00b]. The geometry of the system was designed in a way that the panel being preloaded to deploy once released, the line of the deploy force, greatly increased by the peak acceleration due to random vibration at launch, is on a direction passing through the hold-down/release hook rotation axis. In this way, only the structural strength of the mechanism to the limit load has to be dimensioned.

The most critical loads taken into account for the design are those related to the random vibration at launch. The reference random environment is that of the payload acceptance tests prescribed by Ariane 4 A.S.A.P. [Aria 93], this environment is described by a PSD whose levels are reported in table 4.

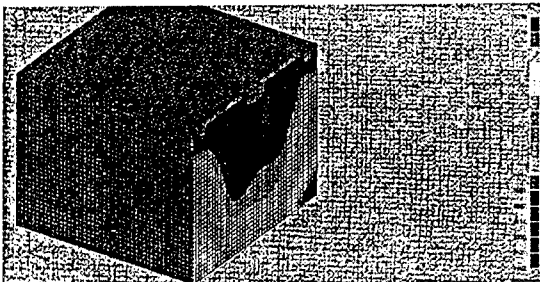
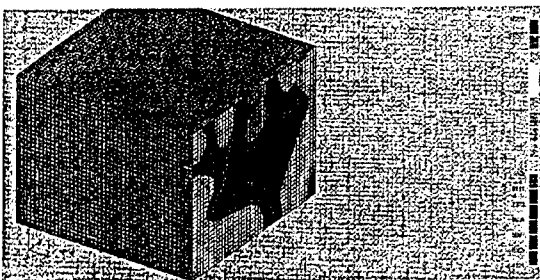
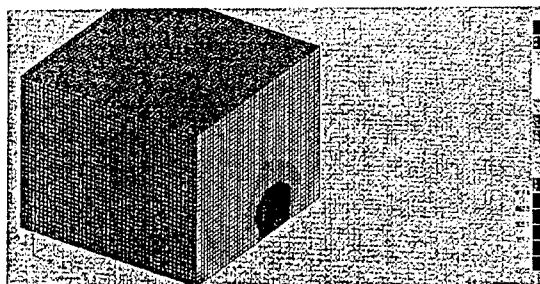


Fig. 9 : RMS acceleration response contour :  
a) along x, linear; b) rotational about y ; c) about z

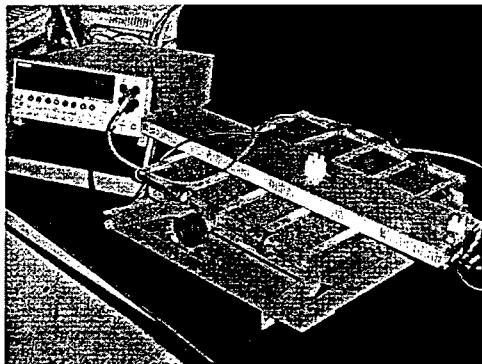
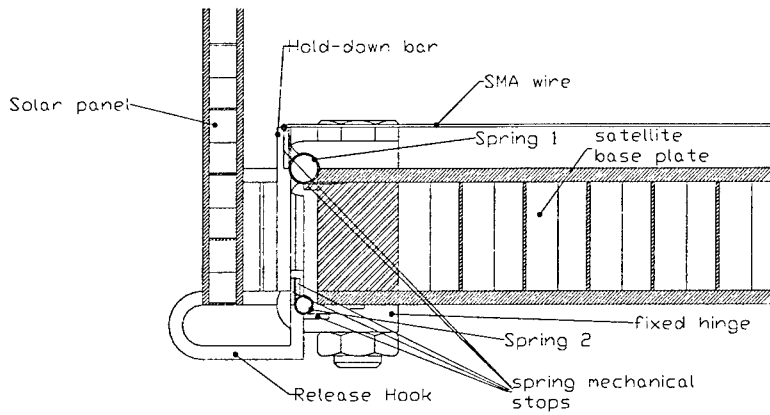
Table 4 – Ariane 4 - Random Vibration Tests  
– Acceptance levels.

FREQUENCY RANGE (Hz)	DENSITY ( $g^2/Hz$ )
30-100	+6dB/Octave ( $0.7210^{-2}g^2/Hz$ at 30 Hz)
100-500	0.08 $g^2/Hz$
500-2000	-3dB/Octave ( $2.010^{-2}g^2/Hz$ at 2000Hz)

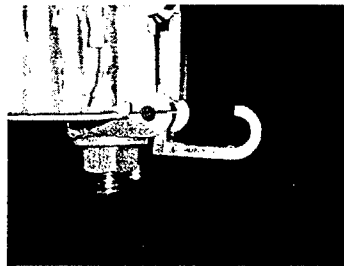
The RMS acceleration response of the solar panel points was derived, in the range 0-2000 Hz, from a NASTRAN random solution, with a forcing lateral acceleration perpendicular to the stowed solar panel surface. The acceleration components derived are: the linear component in the axis perpendicular to the solar panel surface and the rotational components around the other two orthogonal axes respectively. The three RMS acceleration contours are shown in fig. 9. Assuming the reference coordinate system of fig. 9, in the random analysis the x displacement of the solar panel points constrained by the mechanism, at the panel bottom line, was linked, through a master-slave connection, to the displacement of the satellite base plate adjacent points.

The peak displacements of the panel constrained points are shown in figs 10 and 11 against frequency, respectively for a random excitation in the solar panel in-plane

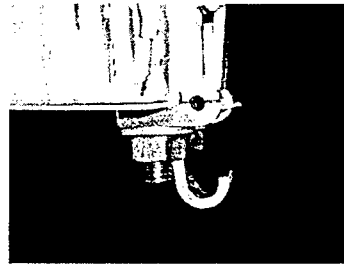




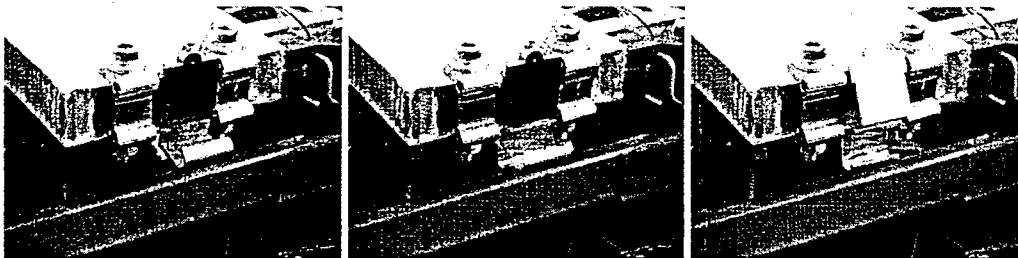
RELEASE MECHANISM OPERATION  
LABORATORY TEST SET-UP



HOOK IN STOWED  
POSITION



HOOK IN RELEASED  
POSITION

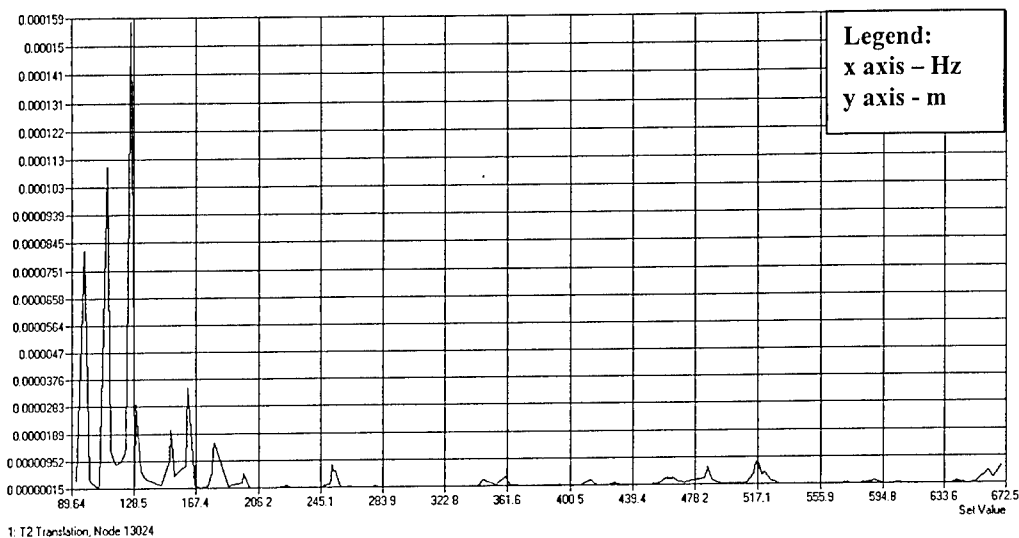


RELEASE OPERATION SEQUENCE

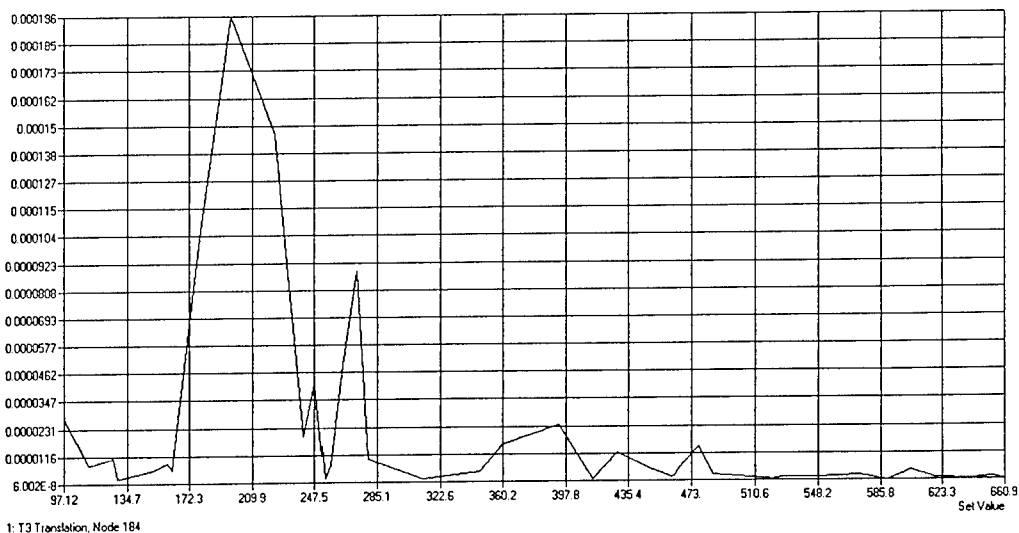
Fig. 8 : SMA actuated release mechanism.

direction and along the longitudinal axis (z). In both figures the displacement is in the same direction of the forcing function. It is evident that no accidental release of the panel can happen due to a deformation of the satellite structure under the random vibration environment.

Then, the derived RMS accelerations were transformed into peak forces, by an output transformation matrix [Sara 95a], on the panel nodes. The panel nodes corresponding to the points next to the release mechanism were statically constrained, as visible in fig. 12, and the reaction forces were calculated by a static FEM analysis. Fig. 12 shows the total translation contour of the



**Fig. 10 :** Dynamic response: peak translation of a panel point adjacent to the release hook surface; excitation (random) is in the same direction of the response translation, along the y (lateral) axis.



**Fig. 11 :** Dynamic response: peak translation of a panel point adjacent to the release hook surface; excitation (random) is in the same direction of the response translation – along the z (longitudinal) axis .

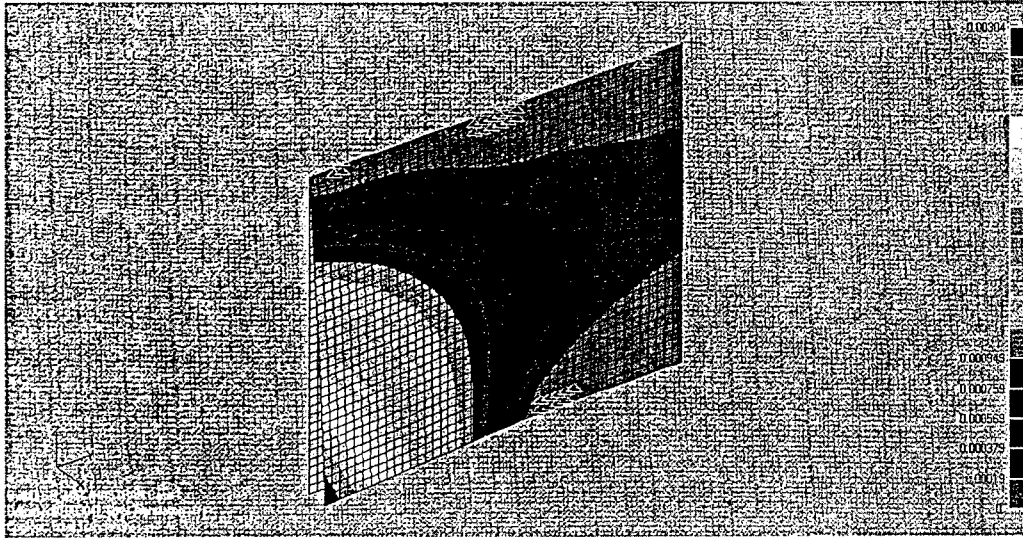


Fig. 12 : Total translation contour of the panel, under the statically applied load derived from the RMS response acceleration.

panel points under the statically applied load.

Since the random vibration levels for acceptance have to be applied for 60 seconds per axis, the number of loading cycles was estimated to be  $97 \text{ cycles/sec} \times 60 \text{ sec} = 5820$  cycles, since 97 Hz is the primary response frequency of the satellite. As a consequence, assuming the 99.87% Probability Extreme Value for design, we expect a peak response, of the panel points, 5.5 times the RMS response [Sara 95b]. Then, the reaction forces were multiplied by 5.5 and applied to the hook surface adjacent to the solar panel. A Factor of Safety 1.25 was assumed for this phase of the design. The material used for the mechanism structural assembly is Berillium S-200FH in HIP block form, which has a tensile Strength of 450 MPa and a tensile yield of 348 MPa at 25°C [Mard 98]; the stress margin of safety resulted to be higher than 1.25.

## 5 - CONCLUSION

SMART mechanical and thermal design was presented. From the structural design point of view, FEM simulations were performed, under the Ariane specifications, to achieve an optimal configuration in terms of stiffness. This should lead to a considerable reduction of time for the launcher acceptance tests. As regards to the thermal modeling, the energy distribution method adopted, together with the parametric optimization for the maximization of the solar array performance and the choice of the thermal design values (thermal finishing, conduction paths), permit the achieving of a totally passive thermal control without adding any mass (and cost), such as radiators or louvers, to the satellite configuration. Thermal modeling was performed in order to maximize the solar array performance by keeping its temperature as low as possible while in the components operating range. A new concept, no-pyroschock, solar panel release system, actuated by Shape Memory Wires, was specifically dimensioned for the mission to be integrated with the SMART satellite structure. Its main aspects are simplicity of operation and construction, low mass and cost.

## Acknowledgements

The author acknowledge the assistance of Pietro Trattino in carrying out the experiments on the SMA wire actuated release mechanism and of Dr M. Pastena in developing the thermal modeling and mechanism design procedures.

## REFERENCES:

- [Aria 93] Ariespace : A.S.A.P. - Ariane Structure for Auxiliary Payload - *Ariane 4 User's Manual*. Issue n.2 – Rev.1, Ariespace, Inc., Evry, France, 1993.
- [Demc 95] L. J. Demchack : "Estimating Structural Damping", In: *Spacecraft Structures and Mechanisms – From concept to launch* (Sarafin.(Ed)), Microcosm, Inc., USA, and Kluwer Academic Publishers, The Netherlands, 1995.
- [Derr 98] M. D'Errico, M. Pastena : "Solar Array Design and Performance Evaluation for the SMART Microsatellite", *49<sup>th</sup> International Astronautical Congress (paper IAF-98.R.1.06)*, Melbourne, Australia, 1998.
- [Frag 99] M. Fragnito, S. Vetrella : "A Space Release/Deployment System Actuated by Shape Memory Wires", *50<sup>th</sup> International Astronautical Congress (paper IAF-99.I.4.09)*, Amsterdam, The Netherlands, 1999.
- [Frag 00a] M. Fragnito, M. Pastena : "Design of Smart Microsatellite Deployable Solar Wings", *Acta Astronautica*, vol. 46, n.2-6, 2000, pp.335,344.
- [Frag 00b] M. Fragnito, M. Pastena : "A Smart Solar Panel Release System", to be included in: *Proceedings of the 1<sup>st</sup> IFAC Conference on Mechatronic Systems*, Darmstadt, 18-20 September, 2000.
- [Mard 98] J. Marder : "Beryllium and Its Alloys", *Space Vehicle Mechanisms: Elements of Successful Design*, Edited by Peter L. Conley, John Wiley & Sons, Inc, USA, 1998.
- [Sara 95a] T. P. Sarafin, R. E. Miliauskas : "Design Load Cycles", In: *Spacecraft Structures and Mechanisms – From concept to launch* (Sarafin.(Ed)), Microcosm, Inc., USA, and Kluwer Academic Publishers, The Netherlands, 1995.
- [Sara 95b] Sarafin, T., T. A. Harmel, R. W. Webb Jr.: "Verification Criteria", In: *Spacecraft Structures and Mechanisms – From concept to launch* (Sarafin.(Ed)), Microcosm, Inc., USA, and Kluwer Academic Publishers, The Netherlands, 1995.

THE EUROPEAN SPACECRAFT PLATFORM DATABASE  
(THE SITUATION OF RECURRENT SMALL PLATFORMS IN EUROPE)

Authors: Pierre LIONNET, Marcel TOUSSAINT, Eric DEBRUYNE  
Address: EUROSPACE, 16 Rue Hamelin, 75116 PARIS - France  
letterbox@eurospace.org

Eurospace (the association of European space industry) under contract with the European Space Agency, has been reviewing the current industrial capacities in terms of recurrent spacecraft platforms. Long extensive research was carried out in collaboration with the main European spacecraft platforms suppliers to elaborate a comprehensive database with technical and programmatic information on spacecraft platforms.

The database will serve two main purposes:

- 1) Assess the current situation of recurrent spacecraft platforms in Europe.
- 2) Review the opportunity and possibility of an ESA fast procurement process for spacecraft platforms.

The database provides a very in depth view of the platforms considered, with detailed technical and programmatic information at the level of system, subsystem and equipment.

This paper, working on the unique data collected between 1999 and 2000, will assess the European situation in terms of small spacecraft platforms (less than 500 kg) and will provide a first analysis of the extremely rich offering of the European smallsat scene.

The focus will be given to recurrent spacecraft platforms and series effects.

1. Methodology
2. Organisation of the data
3. Amount of data collected and programmes considered
4. Technological assessment, strengths and current needs in Europe
5. Recurrent platforms vs. one-shot programmes, a way towards standardisation?
6. Is there a small platform industry?
7. Conclusions

Smallsat programmes currently included in the database are:

- |                      |                  |                 |
|----------------------|------------------|-----------------|
| 1) Abrisax           | 18) Jason        | 35) SMOS        |
| 2) Astrid-1          | 19) KitSat-1     | 36) SNAP-1      |
| 3) Astrid-2          | 20) KitSat-2     | 37) STRVa&b     |
| 4) Cerise            | 21) MICROSCOPE   | 38) STRVc&d     |
| 5) Champ             | 22) Minisat-01   | 39) Thai-Phutt  |
| 6) Clementine        | 23) MITA         | 40) TiungSAT-1  |
| 7) Corot             | 24) Oersted      | 41) Tsingshua-1 |
| 8) Cosmo/Skymed      | 25) PARASOL      | 42) Tubsat-N    |
| 9) David             | 26) PICARD       | 43) Uosat-1     |
| 10) DEMETER          | 27) Picasso Cena | 44) UoSAT-12    |
| 11) ESAT             | 28) PicoSAT      | 45) Uosat-2     |
| 12) FASat-Alfa       | 29) PoSat-1      | 46) Uosat-3     |
| 13) FASat-Bravo      | 30) PROBA        | 47) Uosat-4     |
| 14) Fedsat           | 31) Radarsat     | 48) Uosat-5     |
| 15) FRANCO BRESILIEN | 32) Rocsat-2     | 49) BADB-R      |
| 16) Grace            | 33) S80/T        |                 |
| 17) HealthSat-2      | 34) SAFIR-2      |                 |

## SMALLSATS: FROM INFANCY TO ADULTHOOD?

Authors: Pierre LIONNET, Marcel TOUSSAINT, Eric DEBRUYNE  
Address: EUROSPACE, 16 Rue Hamelin, 75116 PARIS - France  
letterbox@eurospace.org

Smallsats are a big hype today, much talked of and highly visible in conferences and exhibitions worldwide. Initially the brand product of a very few players in Europe their offering is now supported by a brand new industrial segment where subsystem suppliers become system integrators and suppliers of turnkey space systems.

This new segment can be characterised by:

- 1 A new industrial setup: new players and new approaches to system design, development, manufacturing and integration
- 2 The existence of a wide range of low cost launch opportunities: as secondary payload on big launchers, but also as primary passenger to small alternative launchers.
- 3 A price tag below the 50 million Euro per mission (all included).
- 4 A heavy bias towards export: the bulk of the smallsat market is outside Europe.
- 5 A leading position of the European industry.

The evolution of smallsat technology and applications is now attracting the interest of the main Space Agencies and of the big players in the industry: national initiatives are supported by ad hoc programmes in France and the UK (respectively the CNES Microsat and the UK Sector Challenge programmes) and the four European big primes are catching up with programmes such as Leostar (MMS), Proteus (Alcatel), PRIMA (Alenia) or Flexbus (DASA Dornier).

But the new small system integrators may now be a few lengths ahead and they will be the first ones to reap the benefits of this new expanding market, especially if commercial applications for smallsats, such as affordable EO, communications, localisation etc., develop nicely.

The question is: to what extent will the smallsat market continue to grow? The present trend could be seriously affected by the reduction of cheap launch opportunities offerings (the major launch service providers are gradually acknowledging the smallsat market as such, and pricing policies will evolve) and by the fact that a big part of the smallsat market inherently creates its own competition.

**SPACE SCHOOL FOR TEENAGERS – NATIONAL INSTITUTE FOR SPACE RESEARCH,  
BRAZIL**

Tania Maria Sausen  
João Ávila  
Ministério da Ciência e Tecnologia  
Instituto Nacional de Pesquisas Espaciais  
Coordenadoria de Ensino, Documentação e Programs Especiais  
Av. dos Astronautas 1758, Cx.P. 515  
CEP 12201-970 São José dos Campos, SP, Brasil

The Space School was a pilot project developed by the National Institute of Space Research-INPE, in partnership with the Brazilian Space Agency-AEB and the Aerospace Technical Centre-CTA, in the period of November 16-19, 1999. The objective was to introduce the teenagers students to space activities and motivate them to choose professions related to space area. Twenty students (ten girls and ten boys), at age 15-17, from public and private schools, from São José dos Campos, took part in the Space School. The students have attended to several lectures and practical exercises on satellite building, satellite integration and test, remote sensing, meteorology, astronomy and astrophysics, launchers, Brazilian Space Program and a lecture with the Brazilian astronaut. The lectures and practical exercises were held at INPE and CTA laboratories. The students have also developed a radiometric data collecting fieldwork and launched small rocket under instructor supervision. The Space Schools instructors were the INPE, CTA and AEB researchers, responsible for the main projects developed for these institutions. It was developed an educational material, a brochure, prepared for each instructor, about the lectures and practical exercises. ESA has provided a videoconference, from ESA headquarter in Amsterdam, about its space program. Eight private companies, from São José dos Campos and Brasília, in partnership with INPE have funded the Space School. The success of this first experience motivated the Institute to keep it as a regular program, every year in July, taking advantage of the winter school vacations. The II Space School will be held in July 3-7, 2000 and will be open to teenagers students from 41 cities located in the Paraíba Valley, the region where INPE and CTA are located. INPE has offered to CONAE, from Argentina, a place for one Argentinian student. In 2001 the Space School will be open to teenagers students from the 26 Brazilian states.

## STATION FAIBLE COÛT POUR MICRO-SATELLITES

Frédéric LEMAGNER et Christian THOMAS - CNES Toulouse

Frederic.Lemagner@cnes.fr

Christian.Thomas@cnes.fr

### RÉSUMÉ

La multiplication des programmes satellitaires basés sur des micro-satellites tant dans les domaines scientifiques (science de la terre, connaissance de l'univers et physique fondamentale), technologiques et les radiocommunications, associée à l'émergence de projets applicatifs à faible coût (Demeter, Picard, Saphir,...), ont conduit le CNES à développer une station de réception des télémesures des Charges Utiles des MICROSAT optimisant le rapport performances/coût.

Quand des antennes de 9m de diamètre étaient nécessaires dans la décade précédente pour recevoir et démoduler les télémesure mission, maintenant il est devenu possible de concevoir des systèmes de réception avec des diamètres nettement inférieurs, d'une part, en utilisant l'avancée de la technologie que ce soit dans le domaine de l'amplification faible bruit ou de la démodulation haute cadence associée à des codages canal performants et d'autre part, en acceptant une limitation du domaine d'utilisation à partir d'angles d'élévation de 10° à 15°, pour les besoins de réception locale.

Le papier présente le concept d'une station automatique à faible coût, dans sa version déplaçable, et décrit les caractéristiques de l'antenne dotée d'une monture X/Y, de la démodulation 8PSK codée treillis, de la gestion globale et de la mise en oeuvre sur un site d'exploitation.

### ABSTRACT

*For Scientific or Technological missions, the necessary reduction in development costs for new programs (in particular for Microsatellites) leads, as a corollary, to the same tendency when designing ground segment receiving and processing stations, i.e. a reduction in overall development costs.*

*While during the previous decade, 9m antennae were needed to receive and demodulate mission telemetry, it is now possible to design receiving systems using much smaller diameter antennae on the one hand, by taking advantage of technological breakthroughs, whether in the field of low noise amplifying or high rate demodulation with decoding, or on the other hand, by accepting a working range constraint from elevation angles of 10° to 15°, for local receiving needs.*

*This paper introduces the concept of a portable automatic station and describes the antenna characteristics for automatic and ephemeris-programmed tracking modes, specific aspects of the X/Y mount, of 8PSK<sup>1</sup> demodulation with treillis decoding, of global management and of implementation of the station on an operational site. The main objective of the station concept is to reduce costs.*

---

<sup>1</sup> 8 Phase Shift Keying



## INTRODUCTION

La TET X (Telemetry Earth terminal in X band), développée par le CNES en version déplaçable, a été spécialement adaptée, à partir du produit SLS<sup>2</sup>, à la réception des satellites MICROSAT du CNES mais peut être facilement modifiable pour recevoir tout type de satellite

Elle dispose d'une antenne de 3,4 m de diamètre installée sur une monture X/Y, l'ensemble reposant sur un trépied, ce qui rend le système de réception opérationnel en moins de 5 jours sans nécessiter une infrastructure lourde.

La monture X/Y résulte d'une action de R&T du CNES menée avec la société SOTEREM en 1998, dont l'objectif principal était de minimiser le coût de réalisation pour des aériens allant de 2,5m à 3,4m de diamètre avec une précision de pointage de l'ordre de 0,1° pour des satellites défilant en orbite basse, de 500km à 1200 km.

## PERFORMANCES SYSTÈME

Les principales performances système dans la version développée sont les suivantes:

- Automatisation complète depuis la saisie des données de pointage et de réception jusqu'à l'enregistrement des données brutes,
- Acquisition dès 15° d'élévation sans perte de poursuite au zénith,
- Installation sur un site dans des délais courts vis à vis du type de mission envisagé, soit 5 jours au maximum,
- Repliement en moins de trois jours,
- Transport aisé mer, avion, route en containers normalisés
- Bande de fréquence RF : 8 à 8.4GHz

- Le facteur de mérite  $\geq 25$  dB/°K à 15° d'élévation,
- Faible dégradation de la démodulation  $\leq 1.5$  dB globale
- Taux d'ellipticité : 1.0 dB maximum
- Excellente disponibilité par utilisation d'équipements éprouvés, numérisation poussée, regroupement des fonctions de pilotage et de supervision dans un même calculateur,
- Poursuite soit en mode automatique en non-cohérent (précision  $\leq 0,1^\circ$ ), soit en mode programmé sur éphémérides (précision  $\leq 0,2^\circ$ ), dans des conditions de vent de 25 m/s.
- capacité de suivi et de stockage de 7 satellites de 5 missions différentes

## DESCRIPTION FONCTIONNELLE

### α Fonctions de la station Microsat

Les fonctions principales assurées par la station sont les suivantes :

- le suivi du satellite Microsat en mode désignation ou écartométrie,
- la réception du signal de télémesure mission MICROSAT,
- la démodulation et le décodage de la télémesure mission,
- l'enregistrement et le traitement de la télémesure mission,
- le test des fonctions principales de pointage et de démodulation.

### α Synoptique

La station est composée du sous-système antenne/RF, du sous-système bande de base et du sous-système supervision. L'annexe 1 présente le synoptique général de la station.

---

<sup>2</sup> Station Légère SPOT

## DESCRIPTION TECHNIQUE

✕ Sous-système Antenne/RF  
(voir photo annexe 2)

### Aérien :

Développé par RAYAN, l'aérien de géométrie Cassegrain comprend un réflecteur parabolique non conformé de 3,4m de diamètre, un réflecteur auxiliaire hyperboloïde, une source principale et 4 cornets pour l'écartométrie ainsi que les amplificateurs faible bruit associés.

La réception est assurée dans la bande 8025-8400 MHz en Polarisation Circulaire Droite.

### RF :

Cette partie assure les fonctions suivantes :

- génération du signal d'écartométrie par modulation du signal de la voie Somme reçu par les voies d'écartométrie Delta x et Delta y, suivant le principe du pseudo-monopulse,
- conversion de fréquence du signal image et du signal d'écartométrie.

### Positionneur :

(développé par SOTEREM)

Le mouvement suivant l'axe X est réalisé par une alidade semi-circulaire, elle-même montée sur un berceau assurant le mouvement suivant l'axe Y (guidage par galets). Le mouvement de chaque axe est assuré par un secteur denté entraîné par moto-réducteur.

Ce positionneur permet de pointer à partir de 10° d'élévation avec une dynamique de 3°/s sur chaque axe. Ce type de positionneur est particulièrement adapté au suivi des passages zénithaux. De plus la motorisation ne nécessite que des moteurs à faible consommation, 300 W par axe.

✕ Sous-système Bande de base :  
(développé par SMP)

Le sous-système bande de base assure les fonctions suivantes :

- réception et synchronisation par réception GPS et distribution du signal UTC sous forme IRIG-B et Top 1 Hz,
- démodulation 8 PSK codée treillis, décodages, et synchronisation jusqu'au niveau paquet du signal mission Microsat avec un démodulateur numérique SMP fonctionnant à 720 MHz,
- démodulation des signaux d'écartométrie avec un récepteur d'écartométrie numérique SMP,
- acquisition, traitement et stockage sous forme de fichiers de paquets classés par APID et par satellite de la télémessure mission,
- surveillance du signal reçu avec un analyseur de spectre.
- test du démodulateur en dehors des passages avec un modulateur de test /testeur de T.E.B.

✕ Sous-système Supervision :  
(développé par SMP)

Le sous-système supervision assure les fonctions suivantes :

- assistance à l'installation (position station et calage soleil),
- télégestion des équipements (commande et surveillance),
- gestion des séquences de test (test T.E.B en boucle courte et test du G/T sur le soleil),
- gestion automatique des passages satellite avec les étapes suivantes :
  - gestions des données d'orbitographie et des agendas des passages fournis par le Centre de Contrôle et élaboration des éphémérides antenne,
  - engagement automatique des poursuites

Pour chaque passage satellite, il gère une séquence type :

- sortie du mode survie et pointage sur le point d'attente à 15° d'élévation,
- commande synchronisée de l'antenne suivant les éphémérides calculées (mode désignation) ou en fonction des signaux d'écartométrie,
- mise à disposition des Centres de Mission des fichiers de paquets de télémesure sous FTP sécurisé.

Cette fonction est réalisée par un PC fonctionnant sous Windows NT.

Les sous-systèmes Bande de base et Supervision sont intégrés au niveau d'une baie de commande de 36U (voir photo à l'annexe 2) qui peut être installée dans un local à 50m de l'antenne.

### **TRANSPORT, INSTALLATION**

La station peut être facilement transportée par avion, au moyen de containers adaptés et réutilisables. Une fois sur site, la station est remontée et complètement re-validée en 5 jours.

L'installation du positionneur peut être soit de type permanent (interface béton) soit de type temporaire (sur trépied) pour des applications nécessitant une transportabilité de l'antenne.

### **EXPLOITATION**

Une fois l'antenne remontée, la mise à niveau du positionneur et la procédure automatique de calage sur le soleil permettent la mise en oeuvre opérationnelle rapide de la station.

L'exploitation de la station est automatique depuis le Centre de Contrôle.

### **RÉSULTATS D'ESSAIS**

Les essais de poursuite effectués ont montré qu'en mode de poursuite éphémérides la précision était meilleure que

0,2° quelles que soient les conditions extérieures.

La poursuite en écartométrie apporte un supplément de robustesse lorsque l'orbite est moins stable notamment après une manoeuvre ou bien si la station sur son trépied ou sa remorque s'est légèrement déplacée.

### **POTENTIEL D'ÉVOLUTION**

La station peut-être déclinée en plusieurs versions :

- fixe (installée sur un radier en béton),
- déplaçable (installée sur un trépied reposant sur un sol de type parking, le trépied étant repliable pour le transport),
- mobile (sur remorque).

Tout type de satellite dans la bande 8,025 GHz-8,4GHz peut-être reçu par changement des oscillateurs des convertisseurs de fréquence.

Cette station sera en mesure de recevoir des mini-satellites ou des satellites du type SPOT.

Pour améliorer les marges système, un aérien de 4,5 m peut-être installé, moyennant une évolution simple de la monture X/Y, permettant en plus une poursuite dès 5° d'élévation.

En 2000, une version avec une capacité de poursuite dès 5° d'élévation est développée pour les besoins de SPOT IMAGE, l'Opérateur Commercial du système SPOT.

De plus, le développement d'une version de 5.40 m, bâtie sur le même principe, a démarré pour une livraison prévue au début de 2001.

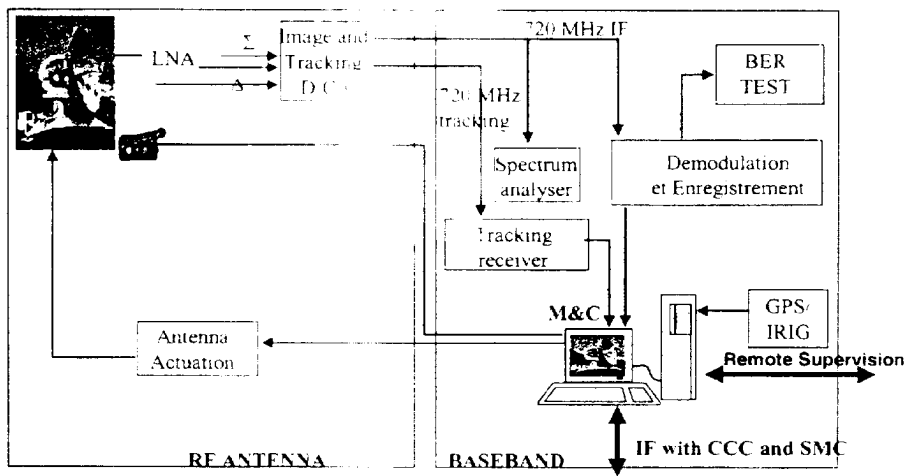
### **PRÉSENTATION DE L'ÉQUIPE DE DÉVELOPPEMENT**

Autour du CNES maître d'oeuvre du développement, trois industriels sont associés :

- SMP comme maître d'oeuvre de réalisation et fournisseur du sous ensemble bande de base.
- SOTEREM comme fournisseur de l'antenne et de la monture avec RAYAN comme sous-traitant pour la réalisation de la partie rayonnante



ANNEXE 1 SYNOPTIQUE STATION MICROSAT TET X

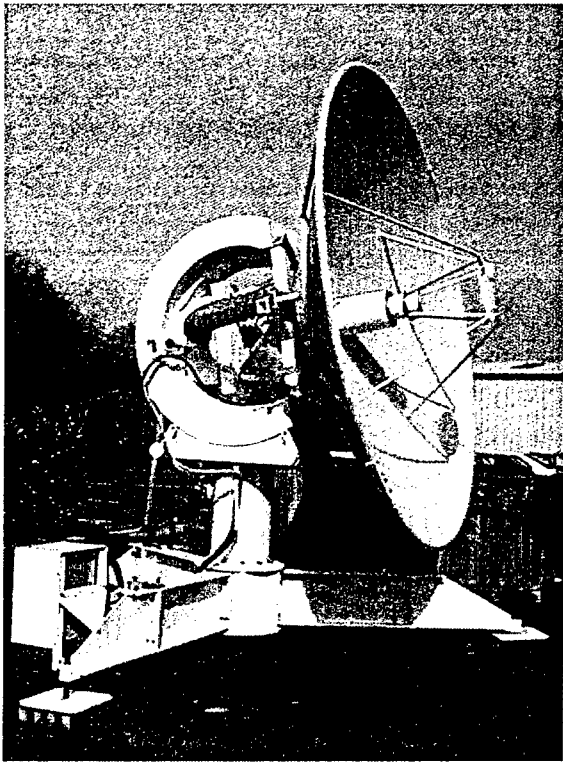


CCC = Control Command Center

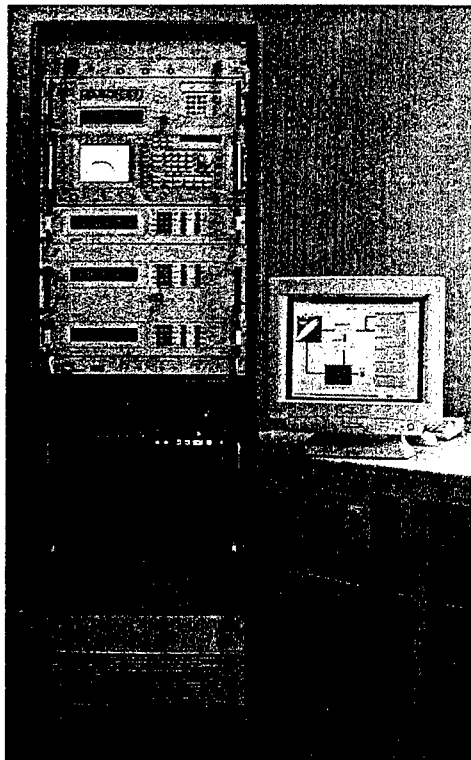
SMC = Scientific Mission Centers

ANNEXE 2

• Sous-système Antenne/RF



• Sous système Bande de Base et Supervision



## SWEDISH SMALL SATELLITES

Kaj LUNDAHL  
Fredrik von SCHÉELE

Swedish Space Corporation, P O Box 4207,  
S-171 04 SOLNA, SWEDEN  
kaj@ssc.se, fvs@ssc.se

*Abstract - In 1986 the first Swedish small satellite VIKING was launched on the Ariane 1 rocket together with the French remote sensing satellite SPOT. This paper describes the development of the Swedish Small Satellite Program. The satellites have delivered excellent scientific data to a low cost by using streamlined project organisations, competitive procurement programs and piggy-back launch opportunities.*

*The first micro satellite Astrid-1 was launched in January 1995 and was followed by the launch of Astrid-2 in December 1998. The capable Odin small satellite will be launched in September 1999. SSC has completed a design study for ESA's SMART-1 probe destined to the Moon - and possibly beyond. SMART-1, planned for launch in 2001, will be used for both research and as a technology demonstrator for future projects.*

*Future projects include micro and small satellites for ESA as Earth Explorer Opportunity Missions and for the Swedish National Space Board as galactic sky surveyors and atmospheric ozone depletion observers.*

### VIKING - THE FIRST SWEDISH SATELLITE

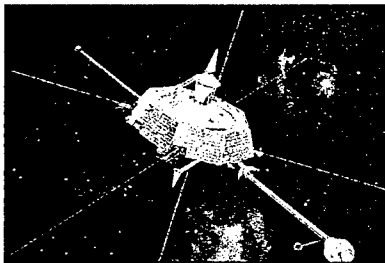
In recognition of the growing market for satellite services and the desirability of promoting Swedish industry's capabilities in this field the Swedish space budget was increased considerably in 1979. Given Sweden's long traditions in magnetospheric and ionospheric research it was only natural that the first national satellite should carry an advanced magnetospheric research payload into regions of space believed to hold many secrets of this scientific discipline.

VIKING carried into space a comprehensive selection of experiments put together by Swedish scientists in collaboration with colleagues from abroad and grouped into five main experiments i.e. electric field, magnetic field, particle, wave and UV imaging experiments.

VIKING was launched in 1986 on an Ariane 1 together with the French remote sensing satellite SPOT. Viking carried SPOT in a so called piggy-back arrangement.

After separation from Ariane VIKING's perigee boost motor burned its 230 kg of propellant to kick the satellite into a final 822 by 13700 km polar orbit with a 98,7 deg inclination.

VIKING was operated by SSC from the Esrange facility in northern Sweden. VIKING was designed for a nominal life time of eight months but lived for 444 days or almost 15 months. VIKING delivered excellent scientific data and performed a qualified "scientific first" space exploration.



THE FREJA SATELLITE

Fig. 1:  
Viking

### **The high Performance, Low-cost Space Research Platform**

FREJA was a joint Swedish-German project and its mission was research of the aurora. Other contributors to its scientific payload were Canada and the United States.

FREJA satellite development and manufacture, experiments, launch and operations cost was MSEK 160 (MUSD 20, ec.c. 1993). This low cost was partly due to the use of a piggyback launch opportunity, and partly because of a streamlined project organization and a competitive procurement programme.

Project start date was January 1988 and satellite system level testing was initiated in July 1991. Only one satellite was built; this "protoflight" model was first used for all qualification tests, and then for the actual flight.

The FREJA project was funded by Government grants via the Swedish National Space Board and donations from the Wallenberg Foundations (Sweden). The German Ministry for Science and Technology (BMFT) made contributions in cash, hardware and services. The Canadian Space Agency contributed to operations with data reception services from the Prince Albert Satellite Station, Saskatchewan, Canada.

The Swedish Space Corporation was selected as the prime contractor for FREJA by the Swedish National Space Board.

### **The Research Mission**

FREJA continued the upper ionosphere and lower magnetosphere research programmes that started in 1986 with the launch of VIKING, Sweden's first satellite.

Mission target was the auroral zone. FREJA carried detectors for high energy particles, magnetic and electric wave experiments as well as electric field sensors and a UV imager. FREJA had an almost ten times higher downlink data rate than VIKING. It used an S-band downlink with a maximum experiment data rate of 500 kbps.

### **Launch and Orbit**

FREJA was launched on 6 October 1992 "piggy-back" on a Long March 2C rocket from the Jiuquan Satellite Launch Centre in the People's Republic of China. FREJA orbited between 601-1756 km; its expected

operational lifetime was two years. The mass at launch was 256 kg and the in-orbit mass is 214 kg.

### **FREJA-C, THE COMPACT SATELLITE PLATFORM**

The FREJA-C compact satellite platform is a version of the successful FREJA satellite scaled down to 10 % of the mass while maintaining the basic design concept and detailed electronics design. The first FREJA-C has been manufactured for the ASTRID-1 mission (see below).

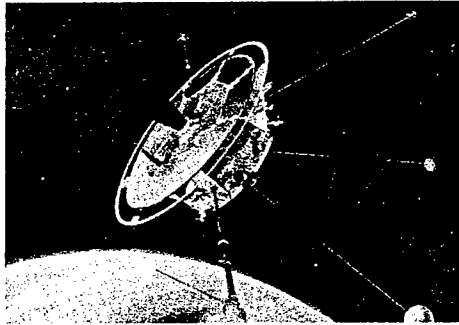


Fig. 2: Freja

### **ASTRID - THE FIRST SWEDISH MICRO-SATELLITE**

#### **Astrid-1**

The first Swedish micro-satellite Astrid was launched from the Russian launch site Plesetsk using a piggyback arrangement on a COSMOS launch vehicle in January 1995 and entered a circular orbit at 1000 km altitude inclined 83° to the equator. ASTRID was a spinning and sun pointing satellite with deployable solar panels. In stowed configuration the size was less than 0.5\*0.5\*0.5 m and the weight was 27 kg.

Astrid-1 carried scientific instruments designed to

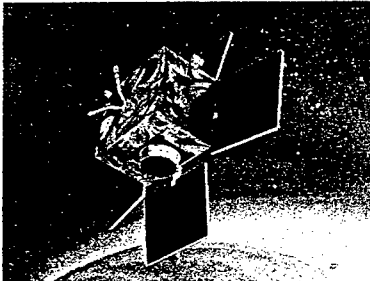


Fig. 3:  
Astrid-1

investigate near-space plasma with emphasis on neutral



particle phenomena. An electron spectrometer and two UV cameras were also aboard. The experiments were designed by the Swedish institute of Space Physics in Kiruna.

As from mid March the scientific experiments do not work but had at that time delivered data to the full satisfaction of the scientists. Communication and technical experiments were carried out from March to September when contact was lost.

#### Astrid-2

There is a continuous interest among the scientists for projects based on the Astrid-1 concept. Astrid-2 is designed for measuring of electrical and magnetic phenomenon in the upper part of the ionospheric plasma. Astrid-2 was successfully launched in December 1998, with the same launch arrangement as for Astrid-1.

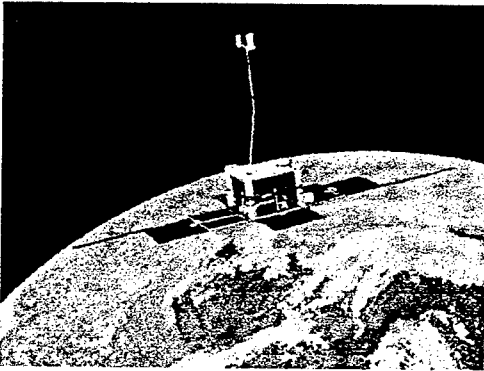


Fig. 4: Astrid-2

Astrid-3 not yet approved, will be equipped with instruments for measurement of wave propagation in layers locally disturbed by strong ground based radio transmitters. An orbit with a low perigee (200-250 km) above the ground station is required, which probably will require some kind of orbit control.

#### THE ODIN SATELLITE

##### Advanced Research on a small satellite

ODIN is a Swedish research spacecraft for both astronomical and atmospheric topics, like star formation in interstellar molecular clouds and the ozone layer depletion in the earth atmosphere. ODIN will search for important atoms and molecules using spectroscopy in previously unexplored wavelength bands, complemented by measurements at near optical wavelengths. Despite challenging goals and advanced

equipment ODIN will be a small, low-cost spacecraft, like the earlier Swedish research satellites VIKING and FREJA.

ODIN is 1.8 m high and 3.0 m wide and the mass is 250 kg. ODIN is 3-axis stabilized with a pointing accuracy of 15 arcsec. The design lifetime is 2 years and the orbit is 600 km, sun-synchronous. Assembly, Integration and Test of ODIN is ongoing and the launch onboard Start-1 is scheduled for September 2000.

#### The capable Odin platform

The spacecraft presently being manufactured for the Odin dual mission can also be adjusted to use for pure Earth observing missions. Absolute pointing accuracy (of entire spacecraft) for a nadir pointing mission would be better than 5 arcminutes - and possible to reconstruct to better than 0.5 arcminutes. The absolute pointing drift is estimated at 0.6 arcseconds/second.

Other features of this low-cost platform, derived from the successful Freja mission, are:

- Pegasus compatible dimensions
- Lightweight graphite composite structure
- On-board GPS for precise s/c location determination
- 720 kbps S-band telemetry (extendable to 1 Mbps)
- Allowable payload mass 75 kg (depending on launcher and orbit)
- Available payload power 160 W (after 2 years, depending on orbit).

An orbit control system can be incorporated to prolong the operational life time if needed.

The ODIN platform was used in a study for ESA of an Ice Topography Observing System (ITOS), one of the candidates for the Earth Observation Preparatory Programme.

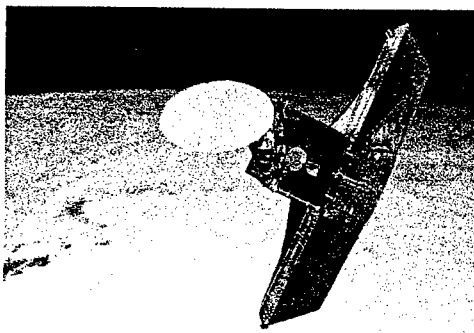


Fig. 5: Odin

SMART-1

SSC has completed a design study for ESA's SMART-1 probe destined to reach the Moon. SMART-1, planned for launch in 2002, will be used for both research and as a technology demonstrator for future projects.

SSC's project methods, as a supplier of small cost effective satellites to the Swedish national space science program, have been used as a model in the study. The primary aim of the study has been to provide a preliminary design and cost estimate of the space probe. SSC's design features navigation and a star-tracker based attitude control system, derived from Sweden's Odin satellite.

The main mission objective of SMART-1 is to demonstrate innovative and key technologies for scientific deep-space missions. One key technology is the solar electric propulsion used as primary propulsion. This will be used for orbit control in orbit around the Moon and for possible extended travel towards a comet or an Earth-crossing asteroid.

The spacecraft will arrive at the Moon by means of the electric propulsion system (accelerated ions) after injection into GTO (geostationary transfer orbit  $h_a=35781$  km,  $h_p=622$  km) by Ariane 5.

SSC submitted in July 1999 a proposal for the C/D phase to ESA and in December the contract was signed.

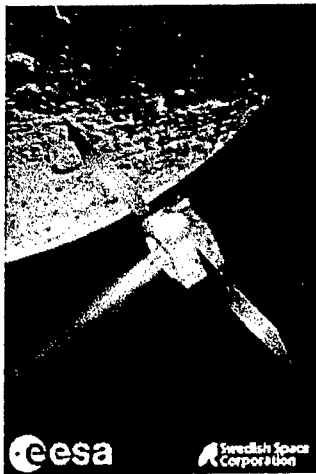


Fig. 6: Smart-1

### *Selma*

Selma is a proposed micro satellite with a small telescope for a sky survey in the 3.3 micron band. The project involves a number of technical challenges e.g. cooling of the detector and 3-axis attitude control of a maximum 50 kg micro satellite for a piggy-back launch.

### *Mats*

Mats is a proposed micro satellite with a spectrograph for investigation of dynamical processes in the Mesosphere and lower Thermosphere. Also this project involves a number of technical challenges as momentum-bias 3-axis control with one reaction wheel and earth sensors and magnetometers.

### *Earth Explorer opportunity missions*

ESA has during 1998 called for such missions and Sweden is involved in the Atmospheric Climate Experiment (ACE) in an ongoing phase A0 study for ESA.

ACE is a constellation of 6 small satellites in 2 different, polar orbits at 800 km for atmospheric profiling using GPS occultation techniques for determination of temperature and humidity. The ACE constellation gives high temporal and spatial resolution which makes it possible to study climate changes and calibrate atmospheric models for better weather forecast

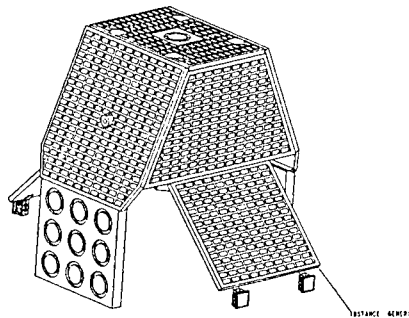


Fig. 7: ACE in flight configuration

### **Future small satellite projects**

**LET IT RUN**  
**AUTOMATION OF GROUND MISSION OPERATIONS**  
**AND SATELLITE TESTING ACTIVITIES**

**A Practical Application of a Common Checkout and Mission Control System**

**R. Aked\*, M. Ilzkovitz\*, F. Vlyminckx\*, I. Lobbrecht\***

*\*Space Applications Services (SAS) 325 Leuvensesteenweg, 1932 Zaventem, Belgium*

*Tel: +32-2-721.54.84 - Fax: +32-2-721.54.44 - Email: ra@sas.be, mi@sas.be, fv@sas.be, il@sas.be*

**ABSTRACT.** The paper describes the advanced features of the Ground Segment developed for the PROBA mission, a low-cost mission to demonstrate spacecraft autonomy. The Ground Segment uses a common system for performing integration, test and check-out activities and mission operations. It is designed to operate fully automatically during the mission and to require only minimal support for its maintenance. In case of anomaly, the Ground Segment notifies a remote standby operator and takes a few immediate actions to bring the mission to a safe state. This is the "Let it Run" concept and aims at having no operator in the control room for performing routine mission operations. The Operations Automation Environment (OAE) provides a framework to schedule, monitor, control and report on the execution of automated tasks. A subset of this framework, called the Test Preparation and Execution Environment (TPEE), supports the preparation, validation and execution of Automated Procedures (APs) to automate both the test activities during the satellite integration phase and the Ground Segment activities during mission operations.

**KEYWORDS:** Automation, Automated Procedure, Mission Control System, Electrical Ground Support Equipment, PROBA, SCOS, Operations Automation Environment, Test Procedure Execution Environment, Packet Utilisation Standards.

## 1. PROBA GROUND SEGMENT OVERVIEW

The PROBA Ground Segment is a highly capable low-cost system implemented on a mixture of Sparc-Solaris and PC-Linux/PC-NT/PC-vxWorks computers. The 'in-operations' configuration comprises:

- an EGSE/Mission Control System detailed further in this paper;
- a Mission Planning System (MPS) that computes the time and duration of the satellite passes over the ground station and plans the downlink of mission data dumps; (to demonstrate spacecraft autonomy, the planning of the payload requests can be performed on-board);
- a Mission Data System (MDS) that performs up to level 0 processing and local archiving of the mission data and that supports End Users and operators interactions with the Ground Segment through the internet. End Users access the MDS to request payload operations, to check their status and view quick look images or download the mission products;
- a performant LEO S-band ground station compliant with the CCSDS/ESA Standards for TM/TC packets and PUS Services comprising:
  - a TM/TC front end supporting COP-1 protocol in uplink and high rate (1 Mbps) TM with concatenated codes in downlink;
  - an RF equipment interfaced at 70 Mhz;
  - a Ground Station Controller (GSC);
  - an antenna and tracking system.

All these components are fully integrated into the Ground Segment and provide the necessary monitoring and control interfaces needed for automated operations.

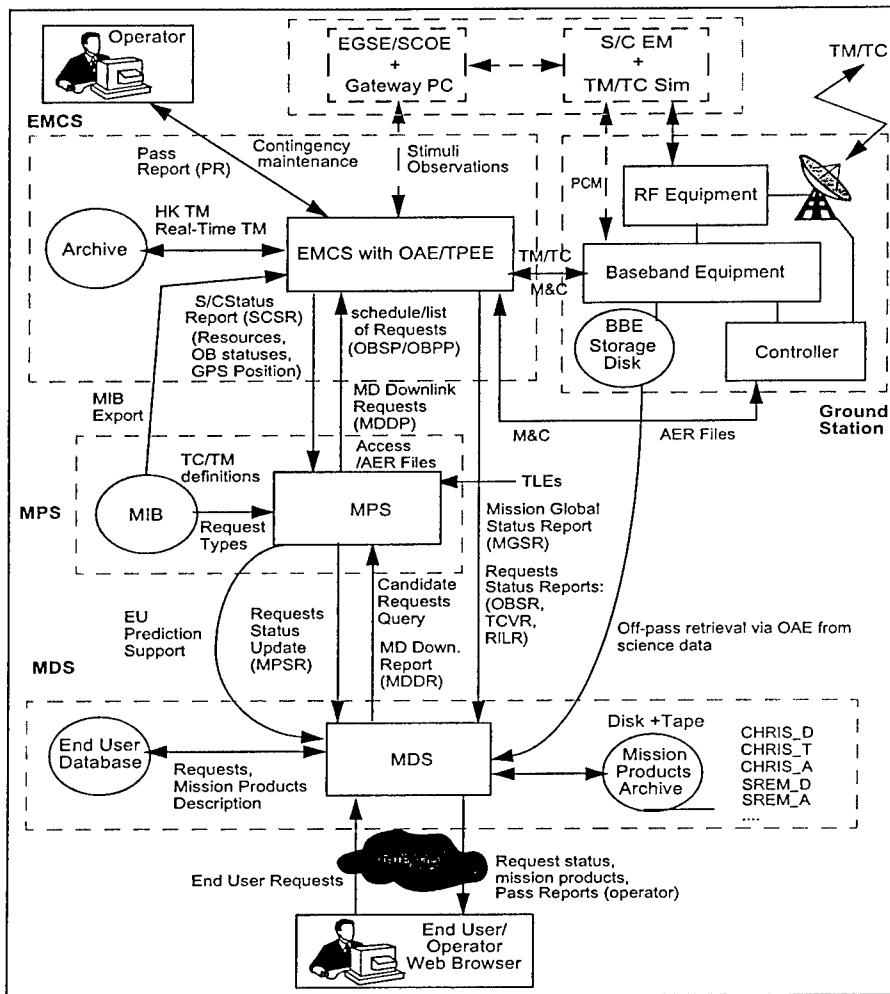


Fig 1: PROBA Ground Segment Overview

During the test, integration, validation and check-out activities, the EGSE/Mission Control System is interfaced to the following additional equipment:

- the Electrical Ground Support Equipment (EGSE), the Software Validation Facility (SVF) and the Special Check-out Equipment (SCOE) through an EGSE Gateway;
- a Spacecraft TM/TC simulator;
- an Engineering Model of the Spacecraft (S/C DHS EM).

## 2. EGSE/MISSION CONTROL SYSTEM (EMCS) FOR PROBA

### 2.1. EGSE/MCS COMMONALITY

It has been common practice to develop a separate Electrical Ground Support Equipment (EGSE) and Mission Control System (MCS) for each mission. As two systems have to be procured and maintained, this leads to a direct cost impact. In addition, it means that different and possibly incompatible tools are used for different parts of the spacecraft lifecycle. As a consequence, transfer of spacecraft databases and procedures from checkout to operations is usually not straightforward.

Using the same system to support EGSE and MCS is an obvious way to overcome this problem. The approach taken for PROBA is to use a generic control system for both EGSE and MCS.

For reason of availability at the time of development (late 98, early 99), the EGSE/Mission Control System (EMCS) is based on the SCOSII kernel system, the precursor of the SCOS-2000 system from ESOC.

The new EGSE system concept includes a gateway to interconnect any type of test equipment via TCP/IP with the EMCS. The test equipment includes the Software Validation Facility (SVF) for on-board software, Special Check-Out Equipment (SCOE) and TM/TC data compatibility tests equipment.

The Mission Information Base (MIB), the mission database schema and forms have been adapted to include EGSE data in addition to supporting the services of the Packet Utilisation Standard (PUS).

### 2.2. EGSE/MCS AUTOMATION

For a small mission with limited budget, it is critical to optimise the effort spent on tests during the development phase and to reduce the running costs during operations. The solutions promoted by PROBA are to place more autonomy on-board, to automate all the repetitive tasks on the ground and to limit the operator intervention to contingency situations.

The automation capabilities are provided by:

- the Test Preparation and Execution Environment (TPEE);
- the Operations Automation Environment (OAE);
- Real-time interfaces to the TM/TC data caches (PIF/CIF);
- Interface to archived TM (TMPP).

Although the EMCS can be used in automatic mode, without requiring operator intervention, all the functionality for operating the system manually is still available and control can be taken by the operator at any time.

### 2.3. EGSE/EMCS CUSTOMISATION

Dedicated ground station external interfaces (Uplinker, Receivers) have been developed to offer an interface at ESA/CCSDS packet level to the PROBA ground station, to support the COP-1 protocol and to perform central monitoring and control of the ground station equipment and the remaining systems of the Ground Segment from the EMCS.

### 3. TEST PREPARATION & EXECUTION ENVIRONMENT (TPEE)

#### 3.1. INTRODUCTION

The Test Preparation & Execution Environment (TPEE) is a configurable and scriptable environment accessible to the user from a dedicated shell (the tpeesh). The environment allows an operator to prepare, test and run Automated Procedures that send TCs, import TM Parameters as Tcl variables and combine these elements in steps, conditional statements or monitor constructs. This scriptable environment is based on the Tool Command Language (Tcl): TPEE extensions to Tcl have been implemented to augment the basic interpreter shell with commanding and monitoring capabilities.

The TPEE makes the following TC and TM paradigms possible:

- issuing EMCS telecommands (TC) is as simple as writing a function call;
- processing EMCS telemetry parameters (TM) is as simple as reading a procedure global variable.

Although Automated Procedures can be edited with any text editor and directly interpreted by sourcing and running them on the tpeesh, a tool with graphical interfaces is provided to simplify the editing and the control of the execution of the Automated Procedures.

#### 3.2. DESIGN OVERVIEW

The design of the TPEE is based on the Tcl environment enhanced with:

- two C++ TM/TC interface extensions, developed by ESOC:
  - the Parameter InterFace (PIF) server (TM server);
  - the Command InterFace (CIF) server (TC server);
- TPEE client API functions coded in C++;
- a set of language extensions mainly coded in Tcl;
- Tk extensions used for the GUI of the TPEE Preparation/Execution Support Tools;
- Expect extensions used to support procedure instrumentation and execution control;
- Oratcl extensions used to interface the TPEE to the Oracle DBMS maintaining the MIB.

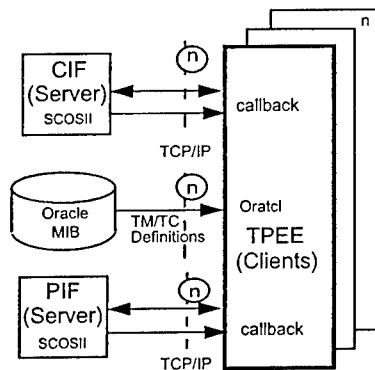


Fig 2: TPEE Client Server Architecture

When launched, a TPEE shell connects as a client to the TM and TC servers running on the EMCS kernel. When a TC is invoked from a TPEE procedure, the interpreter calls a TPEE client API to issue it. TM Parameter values are fed in the interpreter as Tcl global variables by calling another TPEE client API reporting by a mechanism of callback. This client-server architecture runs on top of the TCP/IP protocol and does not require the TPEE clients to run from the EMCS computer. Multiple clients can simultaneously connect to the TC and TM servers allowing concurrent control of multiple external systems (Spacecraft EM, SCOE, SVF) by running different TPEE instances.

The TM Parameters, TC Parameters and TCs are predefined in the tables of the MIB using the standard Oracle forms tool. TCs and TMs are made automatically processable at the shell level and their description and selection accessible from the TPEE editing support functions.

### 3.3. AUTOMATED PROCEDURES PREPARATION SUPPORT

The TPEE provides a dedicated editor to simplify the creation of Automated Procedures. This editor offers functions to browse a directory, load and save a procedure, to support the editing of the procedure itself (such as cut, copy and paste, find and replace, undo), the text formatting of the procedure (tabulation, commenting in and out, procedure keywords highlighting) and the verification of the non utilisation of reserved words. In addition, a TC toolbox supports the selection of a TC from a TC list, the specification of the TC parameters and the TC insertion in the edited procedure. A TM toolbox supports the selection of TMs from a TM list, the subscription or fetching of TMs and their insertion in the edited procedure. Finally a Monitor toolbox is provided to create the template for monitoring TM within the procedure.

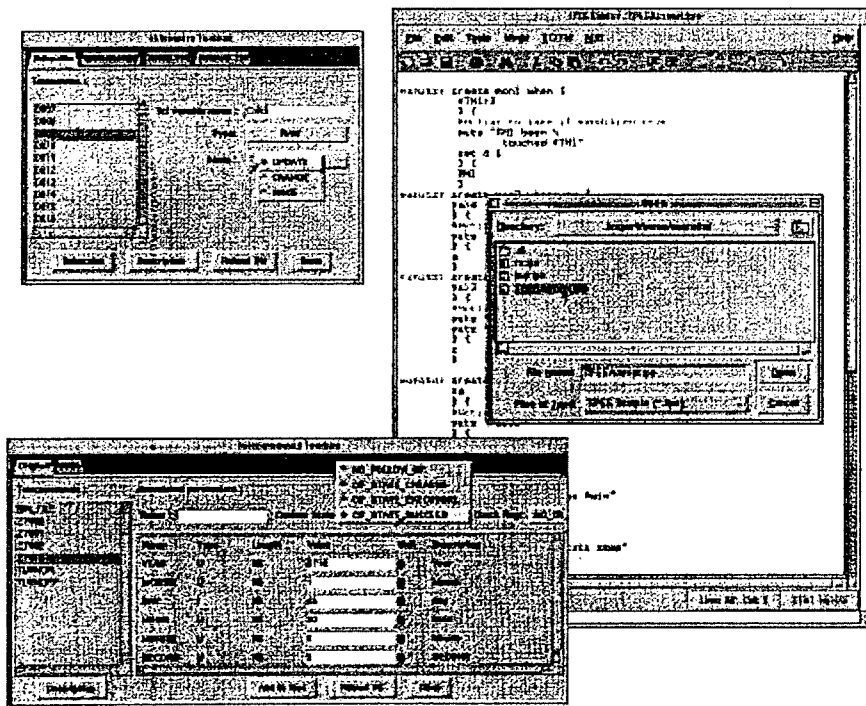


Fig 3: Automated Procedure Preparation Support

### 3.4. AUTOMATED PROCEDURE EXECUTION SUPPORT

The execution environment of the TPEE allows the monitoring and control of a procedure during its execution. A control dialogue box lets the operator configure the mode in which a procedure executes (No breakpoint, break on Step, break on TC, break on Statement), and buttons are provided to control the procedure execution (execute/resume, suspend and abort). Once loaded in the execution environment, the procedure contents is displayed. During execution, the display is refreshed to highlight each procedure statement before it executes. The execution environment provides also a trace function that records the sequence of statements having been executed during a test. The trace is displayed during execution and stored in a trace file. The result of a test procedure execution is recorded in the trace file. All messages output from the procedure are also redirected to the trace file. In this manner the test operator can instrument his procedure with specific trace messages.

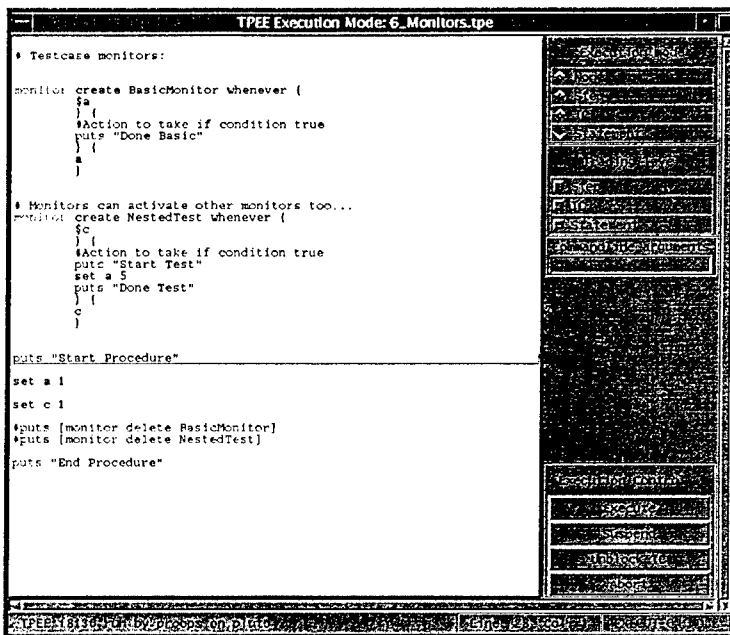


Fig 4: Automated Procedure Execution Support

### 3.5. TPEE LANGUAGE EXTENSIONS

The TPEE Language follows the powerful concept of language extensions promoted by Tcl and inherits all the power of the Tcl language. The following extensions are provided:

- Monitor extensions: **when** and **whenever**

These two constructs allow to monitor at any time during the execution of the main thread of a procedure when a monitored condition is verified and to asynchronously execute the thread associated to the body of this monitor. A monitor is thus comparable to a high level Event Handler suspending the main program flow to execute its event handler routine.



- Telemetry Parameter Acquisition extensions: **fetch** and **subscribe**

**fetch** offers a synchronous mode of telemetry acquisition. It takes as input the name of a TM parameter and returns its value as soon as this value becomes available. The procedure execution flow is suspended and resumed once the parameter value is acquired. However when the procedure is suspended waiting for a value to arrive, all other events can still be processed (e.g. the test conductor can interact with the TPEE and asynchronous TM acquisition remains active).

**subscribe** offers an asynchronous mode of telemetry acquisition. It is used to subscribe to a list of TM parameters and define the global variables where the values of these TM parameters have to be stored. The actions to be taken when values for these variables become available are specified by using the **when & whenever** monitor extensions. An **unsubscribe** extension is provided to terminate the subscribed service.

- Telecommand extension: **<CommandName>**

The telecommand extension is implemented like a function call. When the **<CommandName>** command is called from the procedure, this requests the environment to load the referenced telecommand and to pass the parameters that need to be specified or can be overridden at procedure execution time. If the command is successfully created, it is then placed by the TC server in a TC cache for uplink. The Telecommand extension comprises a follow-up mechanism that suspends the procedure execution until an error is returned or a requested level of confirmation (e.g. a PUS TC Verification Report value) is sent back by the TC server. The follow-up mechanism can be disabled in which case the procedure does not suspend on the telecommand but proceeds immediately with the execution on the next statement.

- **tcstatus** extension:

This extension is used to perform a deferred reading of the confirmation status of a telecommand for which the follow-up mechanism was disabled.

- **step** extension:

This extension provides a construct to structure the code of a procedure in steps. A step encapsulates a set of statements inside a code block that can be controlled and tested at procedure execution time. The usage of step is non mandatory in an Automated Procedure. When the AP Execution Support tool is configured into step execution mode, the execution of the procedure is suspended at the beginning of each step. The TPEE provides the `TPEE_step` global variable set with the name of the step currently in execution and that can be tested anywhere in the procedure. By testing this variable within a monitor, it is possible to implement a recovery mechanism at procedure level.

- **suspend** extension:

The **suspend** extension forces a suspension of the procedure execution on the **suspend** statement. The purpose of this extension is to provide a statement to explicitly specify when procedure control is to be given back to the test conductor.

- **tracing** extension:

The **tracing** extension allows to modify the level of tracing from within a procedure.

## 4. OPERATIONS AUTOMATION ENVIRONMENT (OAE)

### 4.1. INTRODUCTION

The Operations Automation Environment (OAE) is designed to automate the operator activities in nominal mission operations conditions. This covers:

- pass automation (monitoring and control of the ground station equipment and TM/TC front end equipment before and during a pass);
- spacecraft control (uplink of TCs, downlink of TM and Mission Data, monitoring of House-keeping TM data during a pass);
- Housekeeping TM Data post-processing (generation of report files for Standby Operator, MDS and MPS subsystems);
- Mission Data pre-processing (retrieval from ground station and filing).

Although mainly designed to be running unattended, the OAE provides a monitoring and control interface to assist an operator in analysing the current and planned operations of the Ground Segment at the time his intervention is required.

### 4.2. OAE OVERVIEW

The kernel of the OAE is a tasks scheduling tool primarily for the automation of mission operations activities but that is also suitable for automating the sequences of tests during the spacecraft integration and mission preparation phases.

The tool is general in the sense that it:

- can be used outside the scope of the PROBA mission;
- does not require any adaptation of the tasks scheduled by the OAE framework;
- can schedule tasks on the local workstation as well as on remote workstations.

The OAE is mainly implemented in Tcl/Tk and Expect.

### 4.3. OAE TASK PLAN

All the tasks scheduled by the OAE have to be planned by an operator who has to explicitly specify the planning constraints for each task in the Task Plan (TP), a script with a predefined layout that is simple to edit and modify. The planning constraints express the conditions to be satisfied for having the tasks launched and can be specified as the expiration of an absolute time or a relative time to an event and the verification of a set of logical expressions on the exit codes of previously launched tasks.

The OAE is best adapted to applications for which the scheduling of tasks can be planned from a set of predefined plans. Different Task Plan are then prepared and validated in advance. These are loaded for execution by an operator when required but they can also be automatically called for execution by one of the tasks scheduled in the Task Plan currently executed by the OAE.

### 4.4. OAE SCHEDULING FUNCTIONS

When the OAE executes a Task Plan, it schedules the time of execution for the planned tasks and verifies their planning constraints. This information is maintained by the Task Schedule (TS), the runtime instance of the Task Plan. If at a given time, a successor task is due for execution that depends on the completion result of preceding tasks, then the OAE will only start the successor task if the necessary preceding tasks have exited with the correct exit code. When the exit code of one or more predecessor tasks are not known at the start time of the successor task, the OAE keeps the successor task in standby awaiting the missing exit codes, for a specified time. If the time-out occurs, the successor task is skipped. The OAE is a stable tool that is not affected by malfunctioning tasks under its control.

#### 4.5. OAE MONITORING AND CONTROL FUNCTIONS

The OAE offers a graphical interface to visualize at any time the status of the tasks scheduled in the Task Schedule (TS). The OAE Task Schedule Control Panel presents coloured boxes, arrows and timelines. An arrow between two tasks represents a dependency between both tasks. Each task is represented by a coloured box. The current status of a task is indicated by the colour of the box. The table of fig 5 describes the states in which a task can be:

state	colour	description	Previous state
scheduled	purple	The task will be launched at the specified time. At that time the OAE will check whether the task depends on exitconditions from other tasks. The task will start running when the exitcodes meet the starting condition	none
cancelled	yellow	The task was cancelled before the OAE had launched it. Exitcode given to task = 10.	scheduled
running/stand-by	blue	The task is in execution or kept stand-by by the OAE. OAE keeps the task in standby mode until it knows whether the startcondition is met or not met or until a timeout occurs.	scheduled
skipped	orange	The task was dependant on other tasks and the exitcodes of those tasks did not meet the startcondition of the task or a timeout occurred before the exitcodes were known. When the OAE skips a task, it assigns exit-code 11 when the skip was due to a timeout, 12 when due to bad exit-codes.	standby
done	green	The task completed with exitcode zero.	running
failed	red	The task completed with an exitcode different from zero. (When a task cannot perform what it intends, it should quit with a non zero exitcode.)	running
crashed	pink	The task was aborted by the operating system due to malfunctioning. (A core dump might have been produced.) Typical reasons: programming error, division by zero,...	running
killed	black	The task was terminated or killed by the operator from the graphical interface or by another task.	running

Fig 5: OAE Task States

From the menu of the OAE Task Schedule Control Panel, it is possible to cancel all scheduled tasks. By specifying a Task Schedule identifier, it is possible to visualize the last known status of the tasks that were scheduled for that particular Task Schedule.

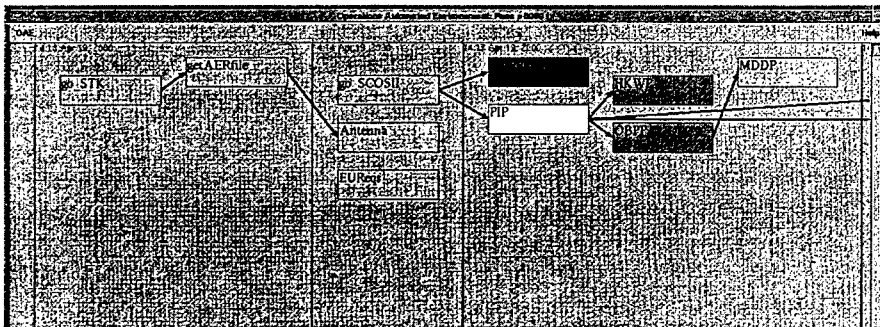


Fig 6: OAE Task Schedule Control Panel

Clicking on a task box in the OAE Task Schedule Control Panel opens a Task Description Panel from where it is possible to cancel a scheduled task or kill a running one, to display the output from the task (View log) and the code of the task (View task) itself in case the task is implemented as an Automated Procedure or a script.

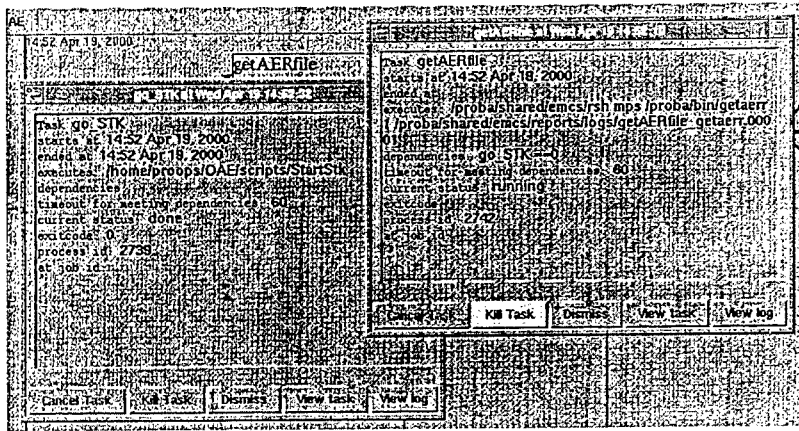


Fig 7: OAE Task Description Panel

#### 4.6. OAE REPORTING FUNCTIONS

The OAE builds a log file that stores the statuses of all tasks for a particular Task Schedule. All statuses that a task has been into are logged into this file. The file offers the textual equivalent of the information displayed by the OAE Task Schedule Control Panel and Task Description Panels.

The OAE logs all output (standard output as well as standard error) from each task for each Task Schedule in a specific logfile.

#### 4.7. OAE TASK PLAN FOR THE PROBA MISSION

The OAE Task Plan planning the PROBA Ground Segment mission operations is synchronised with the PROBA satellite pass times over the ground station. It comprises a task requesting the MPS to compute the time and duration of the satellite passes over the ground station for a number of coming passes. From this information, the task produces a Task Schedule skeleton for scheduling the tasks of the Ground Segment for the next pass. This task is planned into the Task Plan such as to be rescheduled again after each pass.

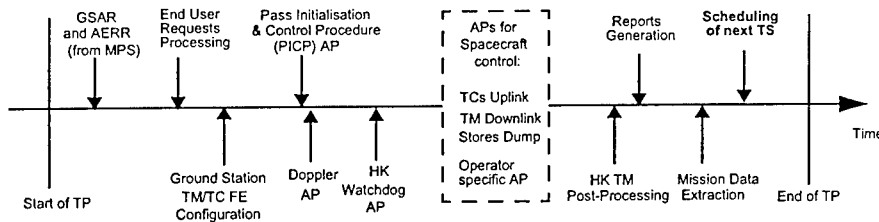


Fig 8: OAE Task Plan for the PROBA Mission

Prior to starting routine operations the operator specifies the Ground Segment tasks, their dependencies and their start times relative to the start or end of a pass in the TP. Some tasks are simple shell scripts or Expect scripts invoking the execution of programs locally or on another computer, some other tasks are programs called directly for execution while other tasks are implemented as Automated Procedures. The

control of the spacelink at initialisation and during the pass, the uplinking of End User Requests to the on-board planner, the insertion of TCs into the on-board scheduler or a data dump request are controlled by APs.

An operator can take manual or semi-automatic control of the Ground Segment operations at any time and decide for instance to replace a scheduled Automated Procedure task by another one, or to prepare a new procedure with the TPEE and run it in parallel to the tasks executing under the control of the OAE.

At the end of a Pass, the OAE produces a Pass Report that is sent by email to the standby operator. The Pass Report reports on the status history of all planned tasks, their start and end times and exit codes. The email contains also a list of logfiles from tasks that reported errors, warnings or failures.

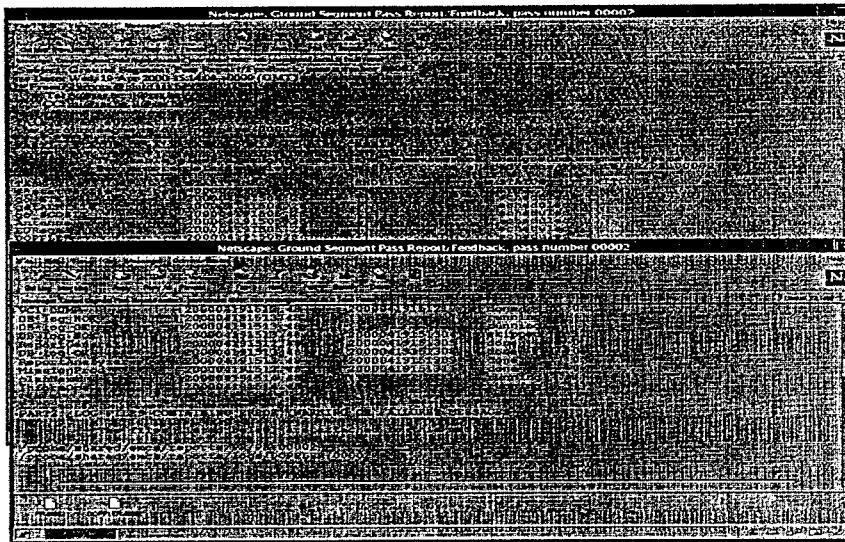


Fig 9: Pass Report

## 5. CONCLUSIONS AND STATUS

This paper presents a practical approach to reduce mission costs prior to launch and after launch. The Ground Segment is a solution for satellite system integration, testing and operations. It supports planning and scheduling and provides user data processing, communications and operations automation capabilities at low cost. The use of a common database for test and operations and that operations can be performed without manual intervention reduces the lifecycle cost significantly, compared to conventional systems. The Ground Segment simplifies and automates the repetitive tasks of test conductors and removes the need to have an operator in the control room during nominal mission operations.

The ground segment is suitable for small, medium and large satellites. It is compatible with a variety of ground stations and supports CCSDS telemetry and telecommand as well as ESA Packet Utilisation Standards.

The PROBA Ground Segment V1 is in use and supports the integration activities of the PROBA satellite. A preliminary configuration of the OAE for the PROBA mission has been demonstrated. Development and test of flight operations procedures will start in June 2000. The PROBA Ground Segment will be completed shortly thereafter. The PROBA mission is to be launched in 2001.

## DIAL-A-SAT: ACCESS LINKS FOR SMALL SATELLITES VIA COMMERCIAL MSS

E. Colzi\*, H. De Caunes\*\*, A. Ribes\*\*, A. Winton\*

\*European Space Agency (ESA), ESTEC, P.O. Box 299, 2200 AG Noordwijk, The Netherlands

\*\* Centre National d'Etudes Spatiales (CNES), 18 avenue Edouard Belin, Toulouse Cedex 31401, France

### Abstract

There is considerable interest at this time in the development of small, low cost satellite programmes for scientific and earth observation applications. An area that continues to challenge the mission planners is the communication links between small LEO satellites and control ground segment: the really limited visibility of the small spacecraft along its orbit and the scarce resources available on-board impose severe limitations on the communications possibilities and opportunities.

A typical small satellite mission often makes use of an omni-directional or wide-beam antenna on the satellite and a dedicated ground station for Tracking, Telemetry and Command (TT&C) support. Although dependant on the LEO satellite orbit altitude and inclination, as well as the latitude of the ground station, the contact time between the LEO satellite and the control ground station is generally quite short. Another important aspect to consider is the ever-increasing difficulty in obtaining a frequency assignment in a region of the frequency spectrum already overcrowded.

This article is based upon feasibility studies jointly financed by the European Space Agency (ESA) and the Centre National d'Etudes Spatiales (CNES). The paper describes a system where the mobile user terminal of a Mobile Satellite Service (MSS) system is used as the TT&C transceiver of a LEO spacecraft (called the user satellite).

The MSS system could be the operational Inmarsat III system or, in principle, one of the forthcoming Super-GEO systems currently under study or development. The MSS system is used to relay the TT&C data to the user satellite ground station. Such a system would offer a number of benefits to the user satellite operator such as:

- increased contact time to the user satellite by virtue of the MSS system global coverage, relative to a single control ground station,
- instant access to the user satellite
- a low cost communications payload,
- a low cost control ground station that may be as simple as a modem and personal computer,
- rapid mission deployment due to the use of an existing communications infrastructure.

Study activities were carried out to analyse the feasibility of the concept in terms of the orbital mechanic aspects (relative visibility, velocity, contact times, orbit altitudes and inclinations, etc.) and of the communications links aspects (mission scenario, achievable

Corresponding author:

Hélène De Caunes

Centre National d'Etudes Spatiales (CNES), 18 avenue Edouard Belin, Toulouse Cedex 31401, France;

Tel: +33-5-612.74138; Fax: +33-5-612.82399; e-mail: Helene.DeCaunes@cnes.fr

data rates, Doppler effects, interference and regulatory issues, technological constraints, etc.).

A driving element for the study was the design of a low-cost and fast-implementation mission, with the aim to maximise the reuse of the existing equipment developed in the framework of the MSS programme.

Emphasis was therefore put on reviewing existing equipment such as ground terminals, assessing the technological feasibility to modify this hardware - as well as its space qualification - and the cost implication of such activity.

The preliminary results of this study have been so encouraging that we are now ready to propose an integrated set of activities, aimed at an in-orbit demonstration of the Dial-A-Sat concept.