

**INSIDE A SOVIET ICBM SILO COMPLEX: THE SS-18
SILO DISMANTLEMENT PROGRAM AT DERZHAVINSK,
KAZAKHSTAN**

Approved for public release; distribution is unlimited.

August 2000



Prepared for:
Defense Threat Reduction Agency
45045 Aviation Drive
Dulles, VA 20166-7517

DNA IACRO-95-7026

John R. Matzko

Prepared by: U.S. Department of the Interior
U.S. Geological Survey National Center
12201 Sunrise Valley Drive
Reston, VA 20192

20010419 106

Technical Report

DESTRUCTION NOTICE:

Destroy this report when it is no longer needed. Do not return to sender.

PLEASE NOTIFY THE DEFENSE THREAT REDUC-
TION AGENCY, ATTN: ADM, 45045 AVIATION
DRIVE, DULLES, VA 20166-7517, IF YOUR ADDRESS
IS INCORRECT, IF YOU WISH IT DELETED FROM
THE DISTRIBUTION LIST, OR IF THE ADDRESSEE IS
NO LONGER EMPLOYED BY YOUR ORGANIZATION.

DISTRIBUTION LIST UPDATE

This mailer is provided to enable DTRA to maintain current distribution lists for reports. (We would appreciate you providing the requested information.)

- Add the individual listed to your distribution list.
- Delete the cited organization/individual.
- Change of address.

Note:
Please return the mailing label from the document so that any additions, changes, corrections or deletions can be made easily. For distribution cancellation or more information call DTRA/ADM (703) 325-1036.

NAME: _____

ORGANIZATION: _____

OLD ADDRESS

NEW ADDRESS

TELEPHONE NUMBER: () _____

DTRA PUBLICATION NUMBER/TITLE

CHANGES/DELETIONS/ADDITIONS, etc.)
(Attach Sheet if more Space is Required)

DTRA or other GOVERNMENT CONTRACT NUMBER: _____

CERTIFICATION of NEED-TO-KNOW BY GOVERNMENT SPONSOR (if other than DTRA):

SPONSORING ORGANIZATION: _____

CONTRACTING OFFICER or REPRESENTATIVE: _____

SIGNATURE: _____

CUT HERE AND RETURN

**DEFENSE THREAT REDUCTION AGENCY
ATTN: ADM
45045 AVIATION DRIVE
DULLES, VA 20156-7517**

**DEFENSE THREAT REDUCTION AGENCY
ATTN: ADM
6801 TELEGRAPH ROAD
ALEXANDRIA, VA 22310-3398**

REPORT DOCUMENTATION PAGE

Form Approved
OMB No. 0704-0188

Public reporting burden for this collection of information is estimated to average 1 hour per response, including the time for reviewing instructions, searching existing data sources, gathering and maintaining the data needed, and completing and reviewing the collection of information. Send comments regarding this burden estimate or any other aspect of this collection of information, including suggestions for reducing this burden, to Washington Headquarters Services, Directorate for Information Operations and Reports, 1215 Jefferson Davis Highway, Suite 1204, Arlington, VA 22202-4302, and to the Office of Management and Budget, Paperwork Reduction Project (0704-0188), Washington, DC 20503.

1. AGENCY USE ONLY (Leave blank)	2. REPORT DATE	3. REPORT TYPE AND DATES COVERED Technical 980529-980801	
4. TITLE AND SUBTITLE Inside a Soviet ICBM Silo Complex: The SS-18 Silo Dismantlement Program at Derzhavinsk, Kazakhstan		5. FUNDING NUMBERS DNA IACRO-95-7026	
6. AUTHOR(S) John R. Matzko		8. PERFORMING ORGANIZATION REPORT NUMBER	
7. PERFORMING ORGANIZATION NAME(S) AND ADDRESS(ES) U. S. Department of the Interior U.S. Geological Survey National Center 12201 Sunrise Valley Drive Reston, VA 20192			
9. SPONSORING/MONITORING AGENCY NAME(S) AND ADDRESS(ES) Defense Threat Reduction Agency 45045 Aviation Drive Dulles, VA 20166-7517 OSM/Kluchko		10. SPONSORING/MONITORING AGENCY REPORT NUMBER DTRA-TR-99-15	
11. SUPPLEMENTARY NOTES			
12a. DISTRIBUTION/AVAILABILITY STATEMENT Approved for public release; distribution is unlimited.		12b. DISTRIBUTION CODE	
13. ABSTRACT (Maximum 200 words) The SS-18 ICBM silos and associated structures in the Republic of Kazakhstan, at the Leninsk, Derzhavinsk, and Zhangiz Tobe missile bases, and the test silos at Balapan, were dismantled under the provisions of the START I Treaty of 1991. Upon abandoning the bases, the Russian military destroyed the silos with explosives. The blasts destroyed the headworks structure, and left craters 6 meters deep and up to 25 meters across at each silo. In dismantling the sites, the remaining above ground and near-surface structures were demolished, with the rubble pushed into the empty silo tubes or adjacent pits. A reinforced concrete cap was placed over the filled silo tube. Additional building rubble was then pushed into the crater, over the cap. The rubble was covered with clean earth and topsoil. Metal and concrete were salvaged for recycling or for use in the surrounding communities. Once a site was cleared of all structures, it was graded to match the topography of the surrounding countryside. The reclamation process was completed by the acceptance of a finished site by the local, regional and state authorities. These authorities may then sell or rent the land to the local community, who will use the land for farming or pasture.			
14. SUBJECT TERMS ICBM Missile Silo Dismantlement		15. NUMBER OF PAGES	
17. SECURITY CLASSIFICATION OF REPORT UNCLASSIFIED		16. PRICE CODE	
		20. LIMITATION OF ABSTRACT SAR	
18. SECURITY CLASSIFICATION OF THIS PAGE UNCLASSIFIED	19. SECURITY CLASSIFICATION OF ABSTRACT UNCLASSIFIED	20. LIMITATION OF ABSTRACT SAR	

UNCLASSIFIED
SECURITY CLASSIFICATION OF THIS PAGE

CLASSIFIED BY:

N/A since Unclassified

DECLASSIFY ON:

N/A since Unclassified

14. SUBJECT TERMS (Continued)

Cooperative Threat Reduction

Kazakstan

Derzhavinsk

SECURITY CLASSIFICATION OF THIS PAGE
UNCLASSIFIED

Preface

DTRA provided the funding and, along with the Government of the Republic of Kazakhstan, the opportunity to visit the Derzhavinsk ICBM base to observe and document the dismantlement process. All of the Brown & Root/ABB SUSA personnel in Almaty and at the Derzhavinsk camp were generous in providing invaluable support, data, advice, in sharing their expertise and insight on the layout of the silo sites, the construction materials used, and in explaining and demonstrating the dismantlement process. Specifically, William Suzuki, Project Manager for Brown & Root/ABB SUSA in Almaty, provided unlimited access to data files, and logistical support both at Almaty and Derzhavinsk. Without his assistance and support, this project would not have been possible. Deni Keeney, also of Brown & Root/ABB SUSA in Almaty, provided excellent descriptions of the layout of the silo sites and the dismantlement process. Office staff in Almaty, in particular Elie Ten and Pakiza Aitzhanova, graciously provided their time and energy in making copies of files, duplicating photographs, and ensuring that the administrative requirements of the author's extended stay in Kazakhstan were met. In addition, Bob Shropshire, site manager at the Derzhavinsk camp, was equally generous in providing support, guides and transportation to the various silo sites visited for this report. Such positive input from Brown & Root/ABB SUSA personnel both in Almaty and at Derzhavinsk ensured the success of this project. Their complete support is gratefully acknowledged and appreciated.

Table of Contents

Section		Page
	Preface.....	ii
	Figures.....	iv
1	Introduction.....	1
2	Site Description.....	4
	2.1 Location of the Base.....	4
	2.2 Layout of the Regiments.....	4
	2.3 Layout of the Silo Sites.....	4
	2.4 Site Structures.....	6
	2.4.1 Launch Silos and Launch Control Centers.....	6
	2.4.2 Support Buildings.....	9
	2.5 Vegetation.....	11
	2.6 Hydrologic Observations.....	11
	2.7 Geologic Observations.....	12
3	Silo Dismantlement.....	14
	3.1 Initial Destruction.....	14
	3.2 Site Reclamation.....	14
	3.2.1 Initial Site Assessment.....	15
	3.2.2 Site Demolition and Reclamation.....	17
	3.2.3 Administrative Acceptance of Completed Site.....	19
4	Conclusions.....	20
5	References.....	71
	Distribution List.....	DL-1

Figures

Figure		Page
1	Locations of the Derzhavinsk, Zhangiz-Tobe, Leninsk, and Balapan SS-18 sites in Kazakhstan.....	21
2	Location map of the Derzhavinsk ICBM base, Kazakhstan. Courtesy of Brown & Root/ABB SUSA.....	22
3	Plan drawing of a typical stand alone launch silo (LS) site. Derzhavinsk, Regiment 2, Silo 3.....	23
4	Plan drawing of a typical co-located launch silo and launch control center (LS/LCC) site. Derzhavinsk, Regiment 5, Silos 5/7.....	24
5	Helicopter overflight of a co-located LS/LCC silo site. Zhangiz Tobe. Courtesy of DTRA.....	25
6	Poured, reinforced concrete square outer retaining wall exposed in headworks crater. Derzhavinsk, Regiment 5, Silo 4.....	26
7	Plan and cross section drawings of the outer retaining wall, the inner "barbette" sectional wall, and the silo headworks area. The configuration and dimensions of the silo door, door pocket, and inner and outer headworks walls are estimated from the site photography. Derzhavinsk, Regiment 2, Silo 3. All measurements are in meters.....	27
8	Metal and concrete debris on the crater rim. The ribbed metal plate on the right may be part of the headworks wall. The transformer substation is in the right background. Derzhavinsk, Regiment 2, Silos 5/7.....	28
9	Detail of the silo door pocket and upper part of the silo tube, prior to demolition. The silo door is open. Note the elevator in the center. Derzhavinsk, Regiment 2, Silo 2. Courtesy of DTRA.	29
10	Destroyed silo door pocket standing on end. Note the individual for scale. Probably Zhangiz Tobe. Courtesy of DTRA.....	30
11	Detail of the top of the silo door pocket and door hinge assembly, prior to demolition. Derzhavinsk, Regiment 2, Silo 2. Courtesy of DTRA.....	31
12	Silo door in the open position, prior to demolition. Note the individual for scale. Derzhavinsk, Regiment 2, Silo 2. Courtesy of DTRA.....	32
13	Hinged door for a launch silo, resting on the crater wall. Zhangiz Tobe, Regiment 3, Silo 1. Courtesy of Brown & Root/ABB SUSA.....	33
14	Round silo door for the Launch Control Center (LCC) silo. Note the difference between this door and the door for a launch silo (compare to Figure 12). Derzhavinsk, Regiment 2, Silo 7.....	34

Figures

Figure		Page
15	Partially excavated shallow buried tunnel between the cooling system building (in background) and the Launch Control Center (LCC) silo. Derzhavinsk, Regiment 3, Silo 7.....	35
16	Underground tunnel entrance into the LCC silo headworks revealed in the crater. The round silo door rests on the crater rim. Derzhavinsk, Regiment 2, Silo 7.....	36
17	Fragment of a porphyritic igneous rock in the debris field around the crater. The rock has a dark matrix with white veins and crystals. The pen is six inches in length. Derzhavinsk, Regiment 2, Silos 5/7.....	37
18	Fragment of banded igneous rock in the debris field around the crater rim. The pinkish bands intruding into the fine-grained matrix give a “gneissic” appearance to the rock. The pen is six inches in length. Derzhavinsk, Regiment 2, Silos 5/7.....	38
19	Cross sectional drawing of the “Force Protection” guard house, and associated tunnel and entry structures. Derzhavinsk, Regiment 2, Silo 3. All measurements are in meters.....	39
20	Plan drawing of the “Force Protection” guard house, and associated tunnel and entry structures. Derzhavinsk, Regiment 2, Silo 3. All measurements are in meters.....	40
21	Trenching along side the “Force Protection” security building has exposed the subterranean level of the building and the associated shallow buried tunnel. The buried structures are lined with red clay brick. The excavation is about three meters deep in dry fine-grained silt and clay. Derzhavinsk, Regiment 2, Silo 2.....	41
22	The ventilated underground chamber for access to the launch silo and cables. The transformer substation is in the background. Derzhavinsk, Regiment 2, Silo 4.....	42
23	The “old” bermed control facility, marked by ventilation and exhaust shafts and hatches in the middle background of the photograph. The large building in the right background is the cooling system building; buried ventilated fuel tanks in the right foreground; hatches to storage tanks (?) in the middle foreground; broken lay-down mast antenna in the left background. Derzhavinsk, Regiment 2, Silos 5/7.....	43
24	Plan view drawing of the “old” bermed control facility, showing the internal layout of the rooms. Derzhavinsk, Regiment 5, Silos 5/7. All measurements are in meters.....	44

Figures

Figure		Page
25	Cross sectional drawing of the “old” bermed control facility. The floors of several rooms are floating, being mounted on shock absorbing devices. Derzhavinsk, Regiment 5, Silos 5/7. All measurements are in meters.....	45
26	Detail of the administration/barracks building, constructed of light gray bricks. Trees are planted in front of the tower section, which is about 8.4 meters in height. Derzhavinsk, Regiment 2, Silos 5/7.....	46
27	Plan and cross sectional drawings of the administration/barracks building. Derzhavinsk, Regiment 5, Silos 5/7. All measurements are in meters.....	47
28	Plan and cross sectional drawings of the cooling system building. Derzhavinsk, Regiment 5, Silos 5/7. All measurements are in meters.....	48
29	Plan and cross sectional drawings of the guest cottage. Derzhavinsk, Regiment 5, Silos 5/7. All measurements are in meters.....	49
30	The “Force Protection” security building. The green metal dome on top of the building houses a rotating gun position. Buried diesel fuel tanks in the foreground. Derzhavinsk, Regiment 2, Silos 5/7.....	50
31	Entrance to a co-located LS/LCC site. The major types of vegetation in the region are seen here: the short natural steppe grasses in the foreground; the planted deciduous trees on the site; and the extensive wheat fields on the horizon. At the time of this photograph (29 May 1998) the fields were being turned over by plow in preparation for planting. Derzhavinsk, Regiment 2, Silos 5/7.	51
32	Up-ended silo door pocket in flooded crater. The silo door is behind the door pocket, and higher on the crater rim. Derzhavinsk, Regiment 2, Silo 4.....	52
33	Bermed storage facility being exhumed for destruction and disposal. A black tar paper-like material covers the reinforced concrete. Derzhavinsk, Regiment 2, Silo 3.....	53
34	Crater resulting from the detonation of explosives, used to destroy the silo headworks. The craters are typically about six meters deep and about 25 meters across. The blast here exposed the silo tube and the reinforced concrete “barbette” sectional wall. Metal fragments from the headworks remain in the crater. Zhangiz Tobe, Regiment 6, Silo 3. Courtesy of Brown & Root/ABB SUSA.....	54
35	Abatement contractor crew removing PCB contaminated soil near the transformer building. Zhangiz Tobe. Courtesy of Brown & Root/ABB SUSA.....	55
36	Process flow chart for site dismantlement. Courtesy of Brown & Root/ABB SUSA.....	56

Figures

Figure		Page
37	Relatively intact LCC silo door pocket still attached to part of the headworks wall. Derzhavinsk, Regiment 2, Silo 7.....	57
38	Salvaged sections of the “barbette” reinforced concrete walls used to support a water tank on a local farm. Note the salvaged concrete pads on the ground surface. Derzhavinsk.....	58
39	Drilling dynamite emplacement holes in the two-meter thick reinforced concrete support blocks of the transporter loading ramp. Derzhavinsk, Regiment 2, Silo 2.....	59
40	Ramp partially dug down to the silo crater for removal of metal and concrete, and backfilling of the silo tube with debris. The silo door ocket is on end. Derzhavinsk, Regiment 2, Silo 4.....	60
41	Pouring the eight meter diameter reinforced concrete cap over the filled silo tube. Zhangiz Tobe, Regiment 3, Silo 4. Courtesy of Brown & Root/ABB SUSA.....	61
42	Poured reinforced concrete cap in place over the filled silo tube. Part of the “barbette” wall is exposed in the crater. Derzhavinsk, Regiment 3, Silos 5/7.....	62
43	After the silo tube has been capped, additional rubble is pushed into the crater over the cap. Zhangiz Tobe, Regiment 8, Silo 3. Courtesy of Brown & Root/ABB SUSA.....	63
44	The bottom of the heavily reinforced concrete foundation for the dish antenna located near the launch silo. The base is 6.8 to 8.8 meters across, and four meters thick. A cable conduit is seen in the center. Derzhavinsk, Regiment 5, Silo 4.....	64
45	Plan and cross section drawing of the antenna base. The upper two meters are lined with brick. Derzhavinsk, Regiment 2, Silo 3. All measurements are in meters.....	65
46	Excavating a pit along side a bermed storage bunker for the disposal of the bunker. The earth is brown fine-grained silt and clay; the gray-white material is poorly sorted sand, possibly dumped in place during construction. Derzhavinsk, Regiment 2, Silo 3.....	66
47	A pit has exposed the subterranean section of the “Force Protection” security building. The pit is partially filled with building rubble. Derzhavinsk, Regiment 2, Silo 2.....	67
48	Cable salvaging operations. Four cables are being retrieved from one trench. Zhangiz Tobe. Courtesy of Brown & Root/ABB SUSA.....	68

Figures

Figure		Page
49	Trench dug for cable salvaging, revealing medium to dark brown fine-grained silt with abundant rock fragments. This soil is probably backfill rather than in-place material. The box on the left is about 23 centimeters on a side. Derzhavinsk, Regiment 2, Silos 5/7.....	69
50	A completed, graded site ready to be turned over to the Kazakhstan State Land Commission. Derzhavinsk, Regiment 1, Silo 4.....	70

Section 1

Introduction

The Strategic Arms Reduction Treaty (START I), initially a bilateral US-USSR agreement signed in 1991 and entered into force in 1994, cut the SS-18 Intercontinental Ballistic Missile (ICBM) force of the former Soviet Strategic Rocket Forces by half, reducing it to 154 missiles. The protocol to the treaty requires that the silos be destroyed by excavation to a depth of eight meters, or by explosion to a depth of “no less than six meters”. The newly independent Republic of Kazakhstan agreed to eliminate most of the SS-18 ICBM silos on its territory. The U.S. Defense Threat Reduction Agency (DTRA¹) was in charge of overseeing this silo dismantlement program, which proceeded with funds from the Nunn-Lugar Cooperative Threat Reduction Program. The SS-18 ICBM bases located in Kazakhstan were: Zhangiz-Tobe, Leninsk, and Derzhavinsk; additional test silos were located at Balapan (see the location map in Figure 1). The dismantlement work was completed at all four locations by early November, 1998, with some follow-up work continuing at Derzhavinsk beyond that date. This report specifically documents the dismantlement process at Derzhavinsk, in western Kazakhstan, but because the different bases in Kazakhstan shared many similarities in layout and infrastructure, the dismantlement approach and techniques used were similar at all of the complexes.

The SS-18 ICBM is a fourth generation, two stage, liquid fueled, MIRV²-capable missile, replacing the older SS-9 ICBM. The SS-18's are housed in modified silos originally built for the SS-9. The initial construction of the silos must have been just prior to the first deployment of the SS-9 in about 1966. Modifications to the silos, to accommodate the larger SS-18, must have been made sometime prior to the initial deployment of the SS-18 in 1974 (Cochran, et.al., 1989, p. 127-128).

During the period from 29 May to 1 June 1998, fourteen ICBM silos in four regiments at Derzhavinsk were visited: eight stand-alone launch silos (LS), and an additional three launch silos that were co-located with a launch control center silo (LS/LCC). Photographic and video records

¹Formerly the Defense Special Weapons Agency (DSWA).

²Multiple Independently targeted Reentry Vehicles, or warheads. SS-18 Mods 4 and 5 carry 10 MIRV's, Mods 1, 3, and 6 carry a single warhead (US Department of Defense, 1990, p. 52).

of the dismantlement process were made, to document the sites as they were at the time Brown & Root/ABB SUSA³ initially came on location to start the reclamation; the various stages of dismantlement; and finally the appearance of the finished sites. The sites visited were: Regiment 1, silos 4 and 6; Regiment 2, silos 1, 2, 3, 4, 6, and co-located silos 5/7; Regiment 3, co-located silos 5/7; and Regiment 5, silo 4, and co-located silos 5/7 (see the layout of the Derzhavinsk base in Figure 2).

Brown & Root/ABB SUSA was the DTRA contractor charged with dismantling the ICBM sites in Kazakhstan, regrading the land surface and turning the completed sites over to the Kazakhstani authorities. The contractor maintained a 25-person capacity support camp near the missile base in each of the three regions worked (Balapan, Derzhavinsk, and Zhangiz-Tobe) until the dismantlement, regrading, and site turn-over was complete. Personnel at the Derzhavinsk camp included one to two U.S. expatriates in the capacity of site managers; about 10 local national support personnel such as construction supervisors, drivers, translators, camp maintenance, etc., and about 60 to 80 local subcontractor laborers who performed the demolition and regrading work using local equipment. In general a regiment, usually composed of 7 silos, could be dismantled in about two months, and two or three regiments could be worked simultaneously. The projected rate of silo dismantlement was 45 to 60 silos per year⁴, with a contract finish date of 30 September 1999 to complete the work at Derzhavinsk, Zhangiz-Tobe, and Balapan. However, Brown and Root/ABB SUSA exceeded the yearly target, and completed the work at all three locations by early November, 1998, with the exception of the follow-up work at Derzhavinsk, which continued beyond this date.

Brown & Root/ABB SUSA in Almaty maintains a documentation file for each of the silo sites dismantled. In perusing these files, it became obvious that many of the sites, particularly at Derzhavinsk, were nearly identical in the layout of their infrastructure and subsequently, in the method of their dismantlement. An Environmental Site Assessment Report (ESA Report) was produced for each site. These reports (see reference list) routinely consist of a brief overall description of the Derzhavinsk ICBM base, as well as a more detailed description of the individual silo site under consideration. Brief descriptions of 11 soil samples, collected for hazardous materials analysis, the site vegetation, the buildings and near-surface facilities directly associated

³Brown & Root, Civil/ABB SUSA, Inc. is a joint venture organized for the purposes of the dismantlement program in Kazakhstan. ABB SUSA is Asea Brown Boveri SUSA (SUSA was originally Sidelmi USA, which was acquired by ABB to establish a US presence).

⁴DTRA's Request for Proposal RFP DNA001-95-R-0026-0001, paragraph 2.3.

with the silo, and the condition of the silo itself, are included in each report. The reports indicate that attempts at collecting ground water samples from 5 meter-deep, augered holes were made at each site, but almost invariably these bore holes were dry. The bulk of these reports is concerned with the detection and identification of hazardous surface and near-surface material, through analysis of the collected soil samples, which could impact the health and safety of on-site personnel and, consequently, the clean up and reclamation efforts at that site. Included in the files are extensive site maps, which locate the silo(s) and associated structures. These maps often include a topographic survey made before the reclamation began. A separate map shows the site topography and the locations of rubble burial pits after reclamation. The files also contain plan and cross-section architectural drawings of all of the surface and subsurface structures at the site, including cross sections of the silo down to the six meter destruction level called for in the START protocol.

Section 2 Site Description

2.1 Location of the Base.

The Derzhavinsk ICBM base was located primarily in the Akmola (formerly Turgai) Oblast' of western Kazakhstan. The geographic coordinates of the center of the former base are roughly 51° 17' N x 66° 00' E. The base was located just to the west of the Ishim River, near the town of Derzhavinsk, on the flat to gently rolling steppes of the Turgai platform. The base stretched about 55 km east to west, and 85 km north to south (see Figure 2) and was situated in a region of extensive wheat fields.

2.2 Layout of the Regiments.

There were 61 individual silos at the Derzhavinsk base, grouped into 8 regiments. These included 52 "firing", or missile launch silos, 8 launch control centers located in silos, and one training silo (see the site map in Figure 2). Regiments 2 through 8 each contained seven silos, comprising five stand-alone launch silos (LS), and one LS co-located with a launch control center (LCC), which was within a silo. The LCC silo was configured as a command center for the particular regiment in which it was located. Regiment 1 consisted of 12 silos: ten launch silos, one launch control center, and one training silo. At the base, there were 45 stand-alone LS sites, which were smaller and less complicated in their infrastructure than the co-located LS/LCC sites. There were seven LS/LCC co-located sites (two silos per site), one stand-alone LCC site and one training silo site. The silos were located about 5 to 10 kilometers apart to avoid fratricide, with the exception of the LCCs, which were found within tens of meters of their co-located launch silos. Also, the single training silo was located closer to the town of Derzhavinsk than to the regiment.

2.3 Layout of the Silo Sites.

There were two different types of silo sites: a stand-alone launch silo (LS) site, and a co-located LS/LCC site. The Derzhavinsk base contained 45 stand-alone LS sites⁵, all of which were very similar in their layout. A plan of a typical LS site is given in Figure 3. These sites generally covered an area on the order of between 15 - 20 acres. The LS sites contained minimal support

⁵5 silos/regiment x 7 regiments; + 10 silos in Regiment 1 = 45

buildings as these were basically unmanned locations, apparently with only a small (one or two man) security force routinely in place. The infrastructure at the LS sites typically consisted of the launch silo; a dish antenna foundation; a bunkered storage building, sometimes with a guard position on top; a small perimeter security building referred to by the Russians as a "Force Protection" building; an above ground access hatch to a tunnel leading to the Force Protection building; a transformer substation; two buried water tanks; and a helicopter pad outside the perimeter. The perimeter was secured by four to five fences, which included motion sensing, barbed wire, and electrified fencing. Additional defenses apparently included some mined areas beyond the inner fence but within the outer perimeter fence. These mine fields were cleared by the Russians prior to Brown & Root/ABB SUSA's arrival on site.

During normal operations, electric power for the sites was tapped from the national grid. A line from this grid ran to the auxiliary power building at the regiment's co-located LS/LCC site. From there, power was run to the transformer substations located at the LS/LCC and at each of the LS sites. From the transformer substation power was distributed to the support buildings on site and to the silos. Generators were in place to supply power in case the supply from the national grid was interrupted.

The base contained eight LCCs, seven of which were co-located with an LS (the LCC for Regiment 1 was a stand-alone site). The co-located LS/LCC sites could cover an area of about 50 acres. The plan of a typical LS/LCC site is given in Figure 4; see also the low altitude overflight of a co-located site at Zhangiz Tobe in Figure 5. The LS/LCC sites contained more support buildings and tunnelling than the stand-alone LS sites, as these were the regimental headquarters and supported the regiment personnel. Above ground structures at the LS/LCC sites typically included:

- administration/barracks building
- a green house (occasionally)
- underground food storage facilities
- equipment storage building
- auxiliary power building
- maintenance building
- cooling system building (to cool personnel and equipment in the LCC)
- guest cottage
- farm buildings (some located outside the fences)
- grease storage building
 - transformer substation
- POL storage
- Force Protection building
- lay-down mast antenna
- 30 meter x 30 meter helicopter pad (which may be elevated about 1.5 meters), outside the gate

Subterranean structures typically included:

- launch silo (LS)
- launch control center silo (LCC)
- 10-14 buried diesel fuel tanks at each LS/LCC site for the standby generators
- “old style” antenna feeder structure
- “old” bermed control bunker
- various bermed food storage structures
- two buried water tanks for fire control
- dish antenna foundation near the LS
- tunnels linking various buildings and the LCC

In addition, some above ground buildings had subterranean levels for tunnel access, such as the cottage, cooling system building, and the Force Protection building. More detailed descriptions of some key buildings and the silo structures are given in the next section.

2.4 Site Structures.

2.4.1 Launch Silos and Launch Control Centers.

The LS and LCC silos appeared to be constructed largely in the same manner, with the exception of the headworks, door pocket and silo door. The bulk of the following description applies to both types of silo, with differences as noted.

At the Derzhavinsk base, the outermost structure surrounding the headworks was a square retaining wall formed of poured reinforced concrete (see Figures 6 and 7) (the LCC in Regiment 5, at least, does not appear to have had a retaining wall). The purpose of this wall was to hold back

the loose, unconsolidated clay and silt during construction of the silo and headworks.

Architectural drawings for silo 3, Regiment 2 (see Figure 7) indicate that this wall was 25 meters on a side, seven meters in height, and 0.3 meters thick (architectural drawings for the Zhangiz Tobe silo 5, Regiment 1, indicate that the retaining walls here, where they occurred, were 20 meters on a side and 0.5 meters thick). The wall appeared to be enclosed by framing material, four millimeters thick. Earth was backfilled against the outside of this wall. Inside the square retaining wall was a circular wall which was composed of individual, curved, reinforced concrete block segments called "barbettes," which interlocked and were bolted together. These segments were often seen in the crater wall of a blasted silo. The 4.5 meter wide space between the retaining and barrette walls was filled with earth. The barrette wall described at silo 3, Regiment 2, was 0.3 meters thick (but these walls were 0.5 meters thick on the Zhangiz-Tobe drawings). Each barrette section was one meter tall, 0.45 m thick, and 2.35 meters in length (as given for silo 5, Regiment 1 at Zhangiz-Tobe). The inside diameter of the barrette wall was 14.8 meters (10.5 meters at Zhangiz Tobe, silo 5, Regiment 1). The inside diameter of the silo tube (which remains in the ground after dismantlement) is 5.9 meters; the tube is over 30 meters in height. The headworks walls were located above the silo tube, and within the inner diameter of the barrette wall. The diameter of the headworks is not specifically known, although the diameter of the inner headworks wall must have been about the same as the silo tube, i.e., 6 meters. The outer headworks wall must have been less than the diameter of the barrette wall, or less than about 14 meters. Gross measurements based on site photography suggest the diameter of the outer headworks wall was about 12 meters: the center opening was 6 meters; each side off the opening was about 3 meters in width. Presumably, the space between the barrette wall and the outer headworks wall was also filled with earth. Large metal fragments in the crater rubble suggested that the headworks wall was formed of steel plates with hollow, metal, cement-filled ribs encircling the wall (see the interpretive reconstruction of the headworks in Figure 7, and presumed headworks debris in Figure 8).

The silo door pocket sat on top of the headworks walls, and was built to receive the larger part of the silo door when in the closed position (see Figure 7, and the detail in Figure 9). The top side of the door closed nearly flush with the ground surface. The door pocket was the large structure most often seen in the blast craters, as an upended, sometimes horseshoe-shaped chunk of metal (see Figure 10). Its exact dimensions are not specified, but site photography suggests it was on the order of 12 meters in diameter, and possibly 2 meters thick. On a launch silo, the silo door was hinged on one side of the door pocket (see the detail in Figure 11). The top of the LS door had a rectangular shape; the metal surface was covered with several layers of styrofoam-like blocks, as seen in Figure 12. The underside of the door had a hexagonal structure which fit into the door pocket to form a seal (see Figure 13). The door was formed of metal plates and ribs, and was

filled with concrete. The door for the LCC silo was different in that it was circular (see Figure 14) and does not appear to have been hinged. The configuration of the LCC door pocket was also different from the LS, to accept the circular door. The LCC door contained a layer of paraffin, which was used as a gamma blocker to protect the personnel inside the silo. The thickness of both the LS and LCC doors were on the order of one meter. The diameters of the doors were not specified; site photography suggests the diameter of the LS door was on the order of 7 meters. The weight of the doors was about 120 tons. Because of their weight and construction, the doors were rarely broken up by the initial blast; instead they were usually just separated from the door pocket and flung onto the crater rim.

At some point, the missile launch and control center was moved from the reinforced, bermed “old” control facility to the LCC. The LCC appeared to be either a launch silo converted to an LCC, or an LCC built for easy conversion to a launch silo, if necessary. The LCC did not contain a missile, and was presumably configured in several levels to house the personnel, equipment, and living facilities. Cooling was provided by the cooling system building on the surface. An access to the LCC was through a shallow buried tunnel between the LCC and the cooling system building (see Figure 15), which opened up into the headworks (Figure 16).

The debris that formed the crater rim around the headworks was composed mostly of silt, sand, clay and gravel. At co-located silos 5/7, Regiment 2, several large fragments of igneous and metamorphic rock were observed (Figures 17 and 18). The origin of these rocks is uncertain. The bedrock in the area of the Derzhavinsk base is composed of Paleozoic igneous rocks and Precambrian to Cambrian metamorphic rocks (see the section on Geology). It is possible that the fragments were excavated during the construction of the silo tube and added to the backfill, or the rocks may have been brought in from a quarry two or three kilometers east of the town of Derzhavinsk, and added to the backfill around the headworks. At least some silos appear to have been built up to about 1.5 m above the original ground surface and backfilled, possibly during modification of the original SS-9 silo to accommodate the larger SS-18 missile.

The tunnel systems on the co-located LS/LCC sites appear to have been designed to facilitate movement between the LCC and key buildings, probably during the initial minutes of an emergency. The tunnels were generally buried to depths of slightly less than one to about 1.5 meters. They were about 2.1 meters tall and 1.3 meters wide; the walls were 0.15 meters thick (see the drawings in Figures 19 and 20). Tunnel walls exposed in trenches showed that the outside was faced with red clay brick which overlay gray brick, probably composed of sand, which would be more porous and susceptible to groundwater infiltration (see Figure 21). The

black material appears to be a tar paper-like material, probably to reduce groundwater infiltration. As seen on the site plan in Figure 4, the tunnels typically ran between the cottage building to the cooling system building, then to the LCC. Depending on the site, the tunnel could also connect to the "old" control facility and the Force Protection guard building, or a separate, dedicated tunnel might have run between the control facility and the guard house. A tunnel also ran from the Force Protection building to an access hatchway on the other side of the fence line. There was also a short tunnel between the launch silo and a "ventilating" chamber (see Figure 22), which provided access to the tunnel and cables. At Zhangiz Tobe, the tunnels occasionally intersected fortified defense points, which were not present at the Derzhavinsk sites. On the stand-alone LS sites, the tunnelling was much less extensive (see the site plan in Figure 3). On these sites, only the short tunnel between the silo and the ventilating chamber was present, as was the tunnel between the Force Protection building and the access hatch beyond the fence.

2.4.2 Support Buildings.

The bermed "old" control facility was located near the LCC. The top of the berm was characterized by a forest of ventilation shafts, exhaust shafts, and entry hatches (see Figure 23). The facility specifically at silo 5/7, Regiment 5 at Derzhavinsk, was 35 meters in length and mostly 18 meters in width, with one section to 24 meters width. It was a little over 6.5 meters in total height (see the drawings in Figures 24 and 25). The top of the facility was covered by less than one meter to possibly about two meters of soil. Beneath the soil was a metal plate roof, four to six millimeters thick. This was underlain by 1.5 meters of concrete. The interior contained 14 rooms, according to the plan drawing (see Figure 24). The interior rooms were generally six by nine meters on a side and 5 meters in height. The drawing for the facility at silo 7, Regiment 1 at Zhangiz Tobe identifies the interior layout to contain vestibules, two sleeping quarters, one control and equipment room, an infirmary, a mess hall, a diesel generator and compressor room with exhaust ventilation shafts to the surface, a toilet with separate wash room, a warehouse, and an emergency exit. The sleeping quarters, instrument and control room, mess hall and infirmary had floating floors, which were spring- or shock-mounted to increase the survivability of the rooms and equipment. The facility was connected to the tunnel network on the site, and there was also an underground connection to the adjacent, old antenna feeder equipment. The volume of concrete and reinforced concrete in the structure (exclusive of the antenna feeder structure) was 2,200 cubic meters, and 164 tons of metal. In addition, about 13,650 cubic meters of soil were removed.

All of the permanent above-ground support buildings at both the LS and LCC sites appear to have been constructed of a light grayish colored brick, composed of very fine-grained and well sorted

sand (see Figure 26). The cooling system building also had sections that were constructed entirely of prefabricated, reinforced concrete slabs. Many buildings had concrete footings to help distribute the weight and support the buildings in weakly to poorly consolidated ground. The size and depth of the footings varied, depending on the size of the building.

The administrative/barracks building was a single level brick structure, about 56 meters long, mostly 13 meters wide, and 3.5 meters in height. A tower at the front of the building rose to 8.4 meters above ground surface (see Figure 26). Footings extended to about 2.1 meters below the ground surface, and were 0.6 meters wide with a base flaring to one meter wide. The interior contained up to two dozen rooms and open spaces, as shown on the architectural plan in Figure 27. The total volume of material dismantled (concrete, reinforced concrete, brick, and insulation) was 2,018 cubic meters, and 2.5 tons of metal.

The cooling system building, constructed of the gray sand brick and reinforced concrete slabs as mentioned above, was 44.5 meters long, generally 6.8 meters wide with a central extension adding another 5.2 meters, for a total width of 12 meters in this section. The building was 3.75 meters tall, with two “tower” sections, one at one end of the building and the other about two-thirds of the way to the other end. These tower sections rose to six meters above the ground surface. The interior of the building consisted mostly of open space to house machinery and equipment. Some office or storage space was built into the corners, as can be seen on the plan drawing in Figure 28. Footings for this building extended to about 4 meters depth, and were 0.6 meters wide. The base of the footings flared out to one meter width. The section that extends off the side of the building contained a subterranean level, which presumably was the entrance to the tunnel that ran to the headworks of the LCC. The floor of this section was about three meters below the ground surface. The total volume of brick, insulation, and reinforced concrete dismantled was about 930 cubic meters.

The guest cottage was a single level gray sand brick structure with a small subterranean section which allowed access to the site’s tunnel network. This building was 21.5 meters long, and about seven meters wide. There were two side extensions, one on either side of the building, increasing the width of the building to about 16 meters in this section. The above-ground portion of the building was a little more than three meters tall. The floor of the subterranean section was three meters below ground level. According to the plan drawing in Figure 29, the interior of the cottage contained 15 rooms and open areas. The footings of this building extended to about four meters depth, were 0.6 meters wide, and rested on a base that flared to one meter wide. The total volume of concrete, reinforced concrete, brick, and insulating material dismantled was 756 cubic meters.

A small guard house, referred to by the Russians as a "Force Protection" building, was located inside both the outer perimeter and inner perimeter fence lines (see the site plans in Figures 3 and 4, and the photograph of the building in Figure 30). The plan drawings for silo 3, Regiment 2 at Derzhavinsk (Figures 19 and 20), show the main portion of the two level guard house at this site was 6.4 by 6.8 meters on a side, with a 4.0 by 6.8 meter subterranean extension on one side. The above ground portion of the guard house was a little over three meters in height, with a metal-encased dome, housing a rotating gun position, which added another 2.5 meters to the height. The floor of the subterranean section was about 3.2 meters below ground level. Each level contained several rooms. As shown in the cross section drawing in Figure 19, the subterranean level opened into a tunnel about 20 meters long. This tunnel traveled under the inner perimeter fence, and lead to an access hatch and an associated vented structure. The volume of the reinforced concrete and monolithic concrete used in the construction of the tunnel totaled about 24 cubic meters. The upper level of the guard house totaled about 66 cubic meters of concrete and brick; the lower level totaled about 116 cubic meters.

2.5 Vegetation.

The base was located on the semi-arid steppes of the Turgai platform. Here, natural vegetation consists of short grasses and low shrubs, mostly less than 0.3 meters high. In spring and early summer, topographically low spots on the LS and LS/LCC sites and beyond them, could accumulate sufficient moisture to support marsh grasses. These small marshes, and the small ponds that could also form, are initially fed by snow melt, and tend to dry up over the course of the summer, leaving a saline residue on the ground surface. The entire region, including land almost up to the location of the perimeter fences, is cultivated in wheat. On the silo sites, particularly on the co-located LS/LCC sites, deciduous trees were planted for shade and ornamentation (see Figure 31). Most of the trees were probably birch, and were found mostly around living areas, such as the administration, barracks, and cottage buildings, but were also found elsewhere on site (for example, along side the bermed storage bunker near the site entrance). These trees were tall enough to mask the tower on the administration/barracks building, which was about 8.5 meters tall (see Figure 26).

2.6 Hydrologic Observations.

Small scale Soviet geohydrologic data (Dukhanin and Marinov, 1964) show the near-surface materials in the area of the former Derzhavinsk ICBM base to consist largely of Tertiary (Neogene)

deposits with poor water-bearing and transmission characteristics. Such properties are consistent with clay and loam, as described below in the section on *Geologic Observations*.

At the time of Brown & Root/ABB SUSA's initial entry to the sites, attempts were made to collect groundwater samples to evaluate the subsurface conditions for possible contamination. A total of 54 bore holes at Derzhavinsk⁶ were augered to five meters depth, in topographically low spots. A review of the Brown & Root/ABB SUSA file records show that no groundwater was encountered in any of these bore holes, therefore groundwater sampling was not performed. These records suggest that the depth to groundwater at the Derzhavinsk sites is greater than five meters.

The Derzhavinsk base was visited by the author in the late spring - early summer period (late May to early June, 1998), after the snow had melted and before the hotter summer weather set in. Some ephemeral rivers and lakes still contained water. On-site observations made by the author indicated that surface water had pooled in spots, that were probably underlain by soils with a higher clay content which prevented rapid downward percolation of the water. The surface water that was observed in these spots was most likely remnant snow melt or rain water or, on rare occasion, may have been placed by human activity during the dismantlement process. As noted in the section on *Vegetation*, some marshes were noted both on and off the silo sites. These marshes are of small areal extent and appeared to be mostly shallow. Some ponds and small lakes also exist in the region of the former ICBM base. Most of these apparently dry up over the course of the summer. Numerous poorly vegetated to unvegetated flats were observed which were characterized by a white powdery residue, probably saline deposits from shallow ponds which had already dried up. These marshes and ponds accumulate in low areas underlain by soil with a high clay content, typical for the region, and can form localized and temporary perched water tables.

On the LS and co-located LS/LCC sites, a few silo craters, which were about six meters deep, were observed to be flooded (see Figure 32, for an example). The source of the water in these craters was presumed to be primarily snow melt, rather than groundwater, as ice was still on the water surface in some cases. Also, the many excavations observed at the sites were dry, including trenches and pits dug to more than three or four meters depth. Groundwater was not observed seeping into the craters from the crater walls. Buried and bermed structures were observed to have a black tar paper - like layer covering the underlying brick or concrete (see Figure 33). This was probably to protect the structure from seepage of migrating groundwater after rains and the seasonally higher water table that may result from spring snow melt and saturated ground. Several

⁶ 65 LS & 1 LS/LCC sites/regiment x 7 regiments; + 10 LS & 1 LCC & 1 training silo at Regiment 1 = 54 individual bore holes.

of the Brown & Root/ABB SUSA Environmental Site Assessment Reports (see References) note that the foundations of many of the above ground structures, including road beds, were slightly elevated, probably to help increase drainage.

2.7 Geologic Observations.

Small scale Soviet geologic maps indicate that the surficial materials in the area of the former Derzhavinsk ICBM base consist of Quaternary and Tertiary unconsolidated continental deposits (Churinov, 1968; Nalivkin, 1965). These deposits are composed of clay, loam, sandy loam, sand, and occasional sandstone. The outcrops of intrusive igneous rocks to the east of the town of Derzhavinsk are variously mapped as granodiorite or plagiogranite (Nalivkin, 1965), or gabbro, diorite, and granodiorite (Kharkevich, 1968), of Paleozoic age.

Trenching for building demolition, to depths of about 4 meters or more (Figures 15, 21, 46, 47), and extensive shallow trenching by locals for cable salvaging (Figure 49), provided opportunities for observation of the near-surface geologic materials. At all of the sites visited, this consisted predominantly of fine grained unconsolidated to weakly consolidated material, generally light to medium brown silt and clay, with lesser amounts of sand. Gravel was locally abundant on the surface, but most of it was interpreted to have its origins in the road ballast commonly used at the sites. The remainder may have been stream or flood deposits. Debris on the crater rim and apron of one site visited included fragments of igneous and metamorphic rocks (see Figures 17 and 18), which may have been part of the material backfilled around the headworks during construction. It is surmised that these fragments were either derived on site, excavated during the construction of the silo tube, which is over 30 meters in height, or they were brought in to add to the backfill material around the headworks. Before leaving the region, a visit was made to a hard-rock quarry located about 2 or 3 kilometers east of the town of Derzhavinsk. This quarry has surface excavations which reveal the same types of rocks as seen in the debris fields at the silos.

Section 3 Silo Dismantlement

3.1 Initial Destruction.

Between 1990 and 1995, the Russian military removed the missiles from the silos and all equipment and supplies from the base, and the silos were destroyed by the detonation of explosives placed within the silo tube. These blasts resulted in the demolition of the silo door, headworks wall, and silo door pocket, and the creation of a crater to about 6 meters depth and up to about 25 meters across, centered over the silo tube (see Figure 34). The crater usually exposed the subterranean entrance into the LCC, as well as the “barbette” wall encircling the silo headworks. The blasts commonly upended the silo door pocket and flipped the one meter thick, 120 ton silo door onto the crater lip. At silo 1 in Regiment 1, the blast threw the silo door to a distance of 40 meters. On one occasion, a silo door was thrown into a nearby building, partially demolishing it. Other than to remove equipment and supplies, no further dismantlement appears to have been undertaken by the Russians. The sites and site structures were empty and mostly intact, except for the blasted silo headworks, by the time Brown & Root/ABB SUSA first entered the locations to initiate the reclamation process.

3.2 Site Reclamation.

The site reclamation process can be summarized in three major steps:

I. Initial site assessment

- Phase 1. Initial entry and preparation of site specific work plan.
- Phase 2. Environmental sampling and laboratory analysis.
- Phase 3. Preparation of the Environmental Site Assessment (ESA) report.
- Phase 4. Preparation of a plan for hazardous material disposal (HMDP).
- Pre-demolition site topographical and structural survey

II. Site demolition and reclamation

- additional demolition of silo door and headworks as necessary.
- above ground structure demolition.
- below ground structure demolition.
- salvage and transport of metal debris off-site.

- backfill silo and excavated trenches with debris.
- place concrete cap over filled silo tube.
- backfill silo crater with additional debris.
- grade site to match surrounding terrain and restore.
- post-demolition site topographical survey.

III. Administrative acceptance of completed site

- acceptance of site by local and regional authorities
- formal turn over of graded site to Kazakhstan Land Committee.

3.2.1 Initial Site Assessment ⁷.

At the initial entry onto a site, and before dismantlement work began, a physical inspection of the site was performed, which included screening for hazardous wastes and conditions that may be considered Immediately Dangerous to Life and Health (IDLH) (Brown & Root/ABB SUSA, 1996, p. 2). A work plan was prepared, tailored to the conditions of the specific site being worked. Air quality and radiological surveys were conducted, and soil and groundwater sampling points were identified in order to locate and characterize the nature of any surface or near-surface chemical or radiological contamination. Some of these sampling locations were picked in or near areas of visible surface contamination, in order to identify the contaminant and the severity of the contamination. Prior to their demolition, surface and some subsurface structures may have been entered to identify contamination or safety hazards that might have posed threats to the health and safety of the site demolition personnel. As of early June 1998, no sites were encountered with IDLH conditions, and only one minor radiation source- a part of a smoke detector left on the ground- was noted at Regiment 5, co-located silos 5/7. PCB contaminated soil was also noted in an area of this site. Recommendations were made to abate⁸ this hazard before dismantlement of the site began, and also for additional soil sampling for PCBs. It was recommended that formal Phase IV activities be carried out, along with the preparation of a Hazardous Material Disposal Plan (HMDP) for this site. PCB contamination was also noted in limited areas on several other silo sites, and these hazards were abated either prior to or during the dismantlement of the site (for

⁷Most of the data presented in this section are derived from the environmental site assessment reports of Brown & Root/ABB SUSA, 1996 and 1997.

⁸Environmental cleanup (remediation) of a site is not permitted under Nunn-Lugar, however, hazardous site conditions may be "abated" to protect worker health.

example, see Figure 35). If the abatement occurred during dismantlement, then the affected areas were roped off to prevent access by the work crews.

The soil surveys consisted of taking 10 soil samples per site, from depths of a few centimeters to less than half a meter, at previously identified locations. A single background soil sample was collected at each site beyond the perimeter fence, which was used as a reference sample against which the site samples were compared. Three additional samples and soil sampling equipment rinsate were collected for quality assurance and quality control (QA/QC). Soil and QA/QC samples were screened for radioactivity, and forwarded for analysis to the laboratory at the Institute for Chemical Sciences, in Almaty. The samples were analyzed for volatile organic compounds (VOCs), diesel range organics (DROs), polychlorinated biphenyls (PCBs), and priority pollutant metals such as antimony, arsenic, cadmium, chromium, copper, lead, mercury, nickel, selenium, silver, thallium, and zinc (Brown & Root/ABB SUSA, 1996, p. 6). The groundwater surveys consisted of digging by auger one groundwater sampling bore hole per site, to a depth of five meters, to determine if any contamination might have entered the groundwater. At Derzhavinsk, none of the 54 bore holes dug encountered water, consequently no groundwater sampling was done at the base.

After the site inspections, sample collections, and laboratory analyses were completed, an Environmental Site Assessment Report was prepared for each LS and LS/LCC site. The reports summarize the environmental observations made at the particular site in question, present the analyses of the soil samples collected for the site, and compare the site samples to the background sample collected for the site. The results were compared to cleanup guidelines for soil⁹, and formed the basis for recommendations for site abatement. If site abatement was recommended and approved by DTRA, a site-specific Hazardous Material Disposal Plan (HMDP) was drawn up, detailing the abatement procedures. On the basis of the inspections and sample analyses, sites were classified into one of three categories:

- Sites with IDLH conditions. Such sites required additional assessment and abatement of the IDLH condition before dismantlement began.
- Sites with contaminated soil or groundwater exceeding the risk-based cleanup criteria. Further characterization or abatement measures could be recommended.

⁹The guidelines used are composites derived from a review of standards from Kazakhstan, the former Soviet Union, the Netherlands, and the United States.

- Sites with no contamination, or contamination levels below the risk-based cleanup criteria. Dismantlement proceeded without further assessment.

Each site was mapped before the site dismantlement began. Structures on the sites, both above-ground and subsurface, were located and identified by purpose of the structure and construction material used - brick, reinforced concrete, monolithic concrete, or metal. Volumes of the various materials used in each building were calculated, so that the total amount of salvageable material or building rubble to be disposed of could be calculated. Occasionally, the topography of the site was mapped with a 0.5 meter contour interval.

3.2.2 Site Demolition and Reclamation.

After a site was physically inspected, sampled, evaluated, abated (if necessary), and mapped, the work to demolish the above-ground structures (and some buried structures) to reclaim the site began. The site reclamation process included building demolition, additional metal demolition as needed, metal and concrete salvaging or disposal, silo capping, trenching for cable salvaging, extraction of buried tanks, the final grading of a completed site, and a final topographic and mapping survey.

Contractual requirements were for a rubble-free zone on the site, extending from the ground surface to 1.5 meters below the surface, at Derzhavinsk, Leninsk, and Zhangiz Tobe (Balapan does not have recoverable farmland, so the requirement here was only for a 0.5 meter zone). Thus buried structures at depths greater than 1.5 meters could remain undisturbed. Structures that were mostly or entirely within the 1.5 meter zone, such as some storage tanks and concrete blocks, were extracted and salvaged or demolished. Structures, whose bulk was below the 1.5 meters zone but which had a protrusion into the zone (such as some buried tanks), could have the protrusion cut off at the 1.5 meter level and extracted, while the bulk of the structure remained buried. Shallow buried concrete structures, such as the reinforced concrete blocks used in the missile transporter loading ramp, were drilled for dynamite emplacement and blasted (see Figure 39).

The dismantlement process was tailored to the conditions and requirements of the specific site. There was no regular order of progression in the dismantlement; above ground and below ground structure destruction could occur nearly simultaneously, or one after the other. Similarly, destruction of the structures could proceed before the demolition of the silo door and headworks, and simultaneously with metal salvaging and cable trenching (see the Process Flow Plan in Figure 36).

Generally, the initial blasting by the Russians to destroy the silo left the silo door, silo door pocket, and headworks wall in large pieces. The heavy silo doors were only rarely broken up by the blasts (see Figures 13, 14, 16, 32, and the relatively intact door pocket/headworks wall in Figure 37). Because these pieces were commonly too large and heavy to handle with the available equipment, they were blasted again into smaller pieces by *Almatypromstroy*, a subcontractor to Brown & Root/ABB SUSA, using anti-tank mines. Some larger pieces were also cut up into fragments of about 1.5 x 2 meters (about 25 tons). The metal debris from the blasted headworks, antenna structures, and other metal from the site, was collected at a rail spur and shipped to a foundry for recycling.

The prefabricated concrete slabs used for surfacing roads and helicopter pads, and the concrete fence posts were salvaged for use by the local farming community, where requested (see Figure 38). All above ground structures were demolished, generally by bulldozer or wrecking ball, though on occasion some buildings were dynamited. Buried structures may have been completely demolished, partially demolished, or excavated, depending on their depth of burial.

A trench up to about 10 or 11 meters wide was excavated from the ground surface to the base of the headworks crater, to provide access to the headworks metal and the silo tube (see Figure 40). As much rubble and other non-salvageable debris as possible was pushed into the silo tube. When the 30 meter x 6 meter diameter silo tube was filled to capacity, it was then capped with a reinforced concrete shield, which is 0.5 meter thick and up to about eight meters in diameter (see Figures 41 and 42). (In one experiment to simultaneously dispose of and make use of the prefabricated concrete slabs, originally used for road surfacing, three layers of the slabs were placed over a silo tube to form the cap). After the cap was in place over the tube, the silo crater, which was about six meters deep, was filled with an additional 4.5 meters of rubble, such that the debris was about 1.5 meters below the level of the final ground surface (see Figure 43). The 1.5 meter space over the rubble was then backfilled with "clean" earth from the site, and included the placement of a layer of topsoil about 0.3 to 0.5 meters thick.

The 6.8 meter diameter by up to four meter thick reinforced concrete base for the dish antenna near the LS (see Figures 44 and 45) usually required additional blasting. For this purpose the base, at two meters depth, was rimmed with mines and detonated. Depending on its depth, the rubble was either buried in place or extracted for burial in a trench. Smaller concrete blocks, such as those which secured the tie-downs for the lay-down mast antenna, were small enough to be excavated by bulldozer or crane.

Trenches were also excavated alongside larger buildings and the shallow-buried tunnels, into which the rubble was dropped (see Figures 21, 46 and 47). The burial process of this debris was then the same as for the silo crater, in that the trench or pit was filled with debris to a level 1.5 meters below the level of the final ground surface; the remaining space was then backfilled with “clean” earth, then with 0.3 to 0.5 meters of topsoil. The prefabricated reinforced concrete slabs used for road surfaces, primarily in some areas at the co-located LS/LCC sites, were either collected and stored off site for use by the local community, or they were buried, if the communities did not want them. Similarly, loose gravel used for road ballast was also collected and stored off site, if requested by the local community. Brown & Root/ABB SUSA removed all available, designated cables within the sites. Often, however, people from the local community had already trenched and retrieved the main power cable for copper salvaging, both on the silo sites and off (see Figure 48), before Brown & Root/ABB SUSA arrived on site. The depths to the various cables ranged from about 0.7 meters to a little over 1.5 meters.

After all of the above ground structures had been demolished and the debris buried, the silos filled, capped, and buried, and all metal removed from the sites or buried, the sites were then graded by bulldozer to match the surrounding topography. Final topographic surveys of the sites were made, identifying the locations of the silos and debris burial pits. The original plans called for reseeded the sites with naturally-occurring vegetation, but at Derzhavinsk, the local farming community requested that no reseeded occur, since they intended to convert some of the reclaimed land to wheat farming. Land that was not suitable for farming was turned over to pasture.

The reclamation process eliminated all above ground traces of the silos and associated structures. A completed site ready to be turned over to the local land commission appeared to be no more than a patch of unvegetated farmland or pasture (see Figure 50).

3.2.3 Administrative Acceptance of Completed Site.

The final step in the reclamation process of a former LS or LS/LCC site was the acceptance of the site by the local and regional authorities, followed by the administrative turn-over of the site to the Kazakhstan State Land Committee. The land was then either sold or rented to local farmers, who cultivated the land in wheat or turned it into pasture.

Section 4 Conclusions

The dismantlement process at the Derzhavinsk ICBM base was streamlined in that the individual sites had largely the same layout, and the sites occurred in about the same type of geologic materials and under similar geohydrologic conditions. This similarity from site to site within the base, and to a lesser degree even between the different bases in Kazakhstan, allowed the same or similar methods to be applied repeatedly and refined over time. Using local labor and equipment as subcontractors, Brown & Root/ABB SUSA was able to complete the reclamation of a regiment in about two months, with two or three regiments being worked simultaneously. Thus it was possible to dismantle an average of about 10 silo sites per month.

Materials, equipment, and supplies were removed from the sites well before the dismantlement process began. For the most part, little to no site abatement for hazardous materials contamination was required; some minor PCB contamination was mitigated simply by the reclamation process, specifically burial and regrading of soils. The dismantlement process was straightforward: salvageable material was collected- metal sent to a foundry for recycling, and concrete structures that were of use to the local farming communities, such as prefabricated concrete road pads, some “barbette” blocks, gravel, etc. were collected and distributed. On occasion, even some buildings were saved for use by the farming community, at their request. All other buildings and structures were demolished and the rubble buried on site. The locations of the burial pits, including the filled and capped silo tubes, were marked on the final topographic survey map of the site.

The strategic importance of this program cannot be over emphasized. By assisting the Republic of Kazakhstan to become a non-nuclear weapons state and eliminating START-limited systems, the U.S. Department of Defense reduced the threat posed by the 148 silo systems located throughout the country, at a fraction of what it would cost to continue to counter them. Furthermore, this project strengthened the United States’ ability to respond to and defend against the proliferation of weapons of mass destruction.



Figure 1. Locations of the Zhangiz Tobe, Leninsk, Derzhavinsk, and Balapan SS-18 sites in Kazakhstan.

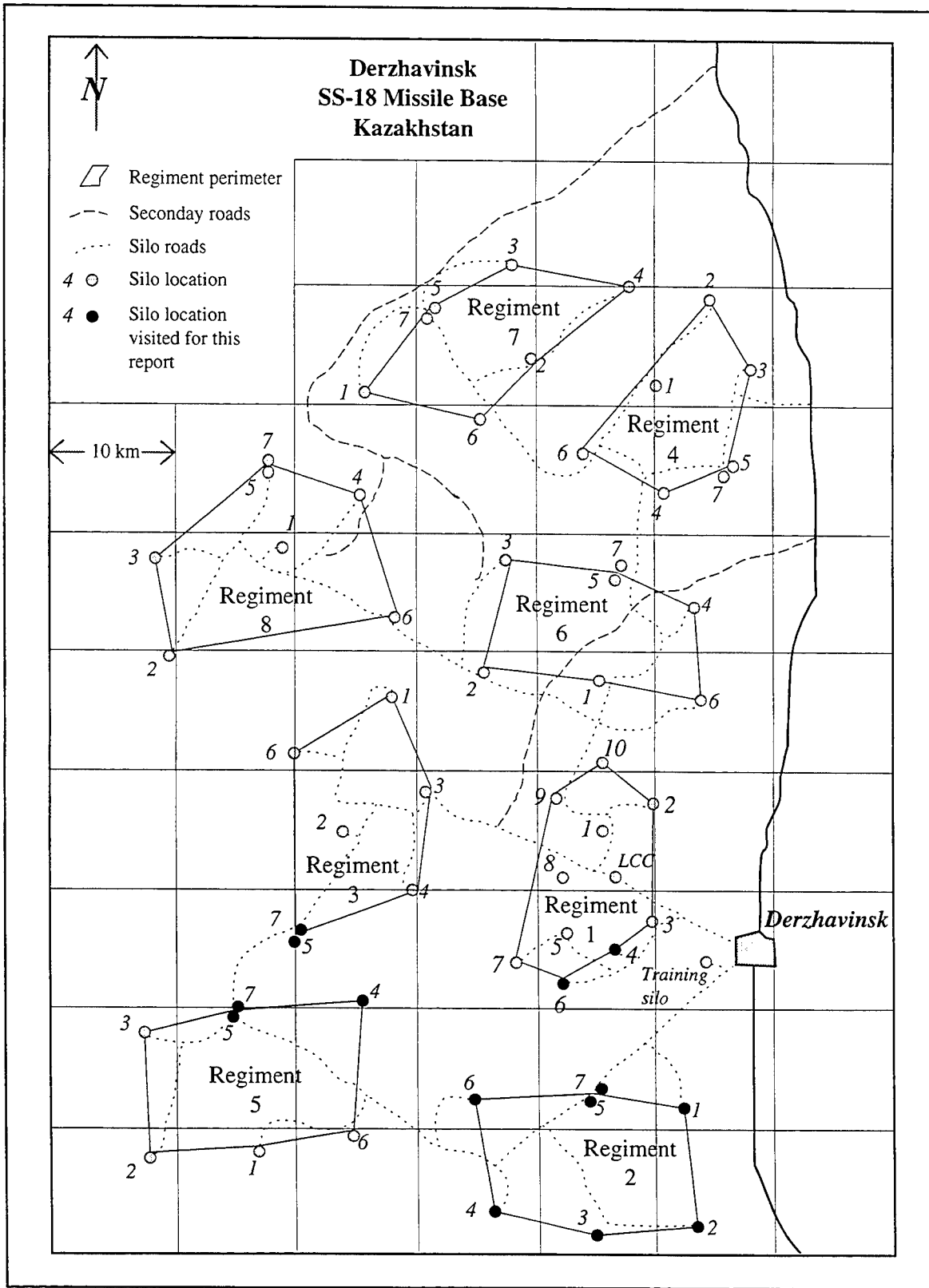

Figure 2. Location map of the Derzhavinsk ICBM base, Kazakhstan. Courtesy of Brown & Root/ABB SUSA.

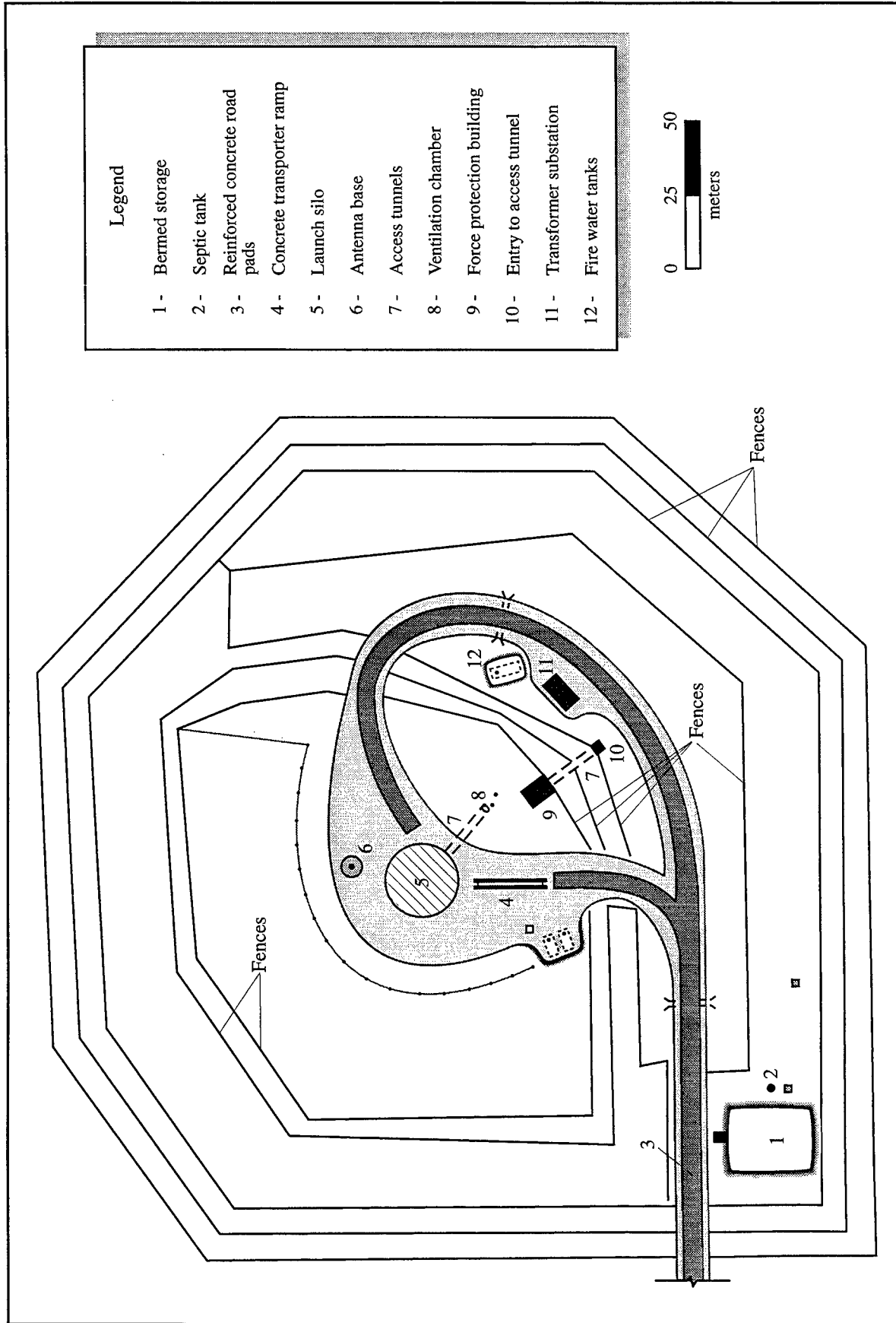

Figure 3. Plan drawing of a typical stand alone launch silo (LS) site. Derzhavinsk, Regiment 2, Silo 3.

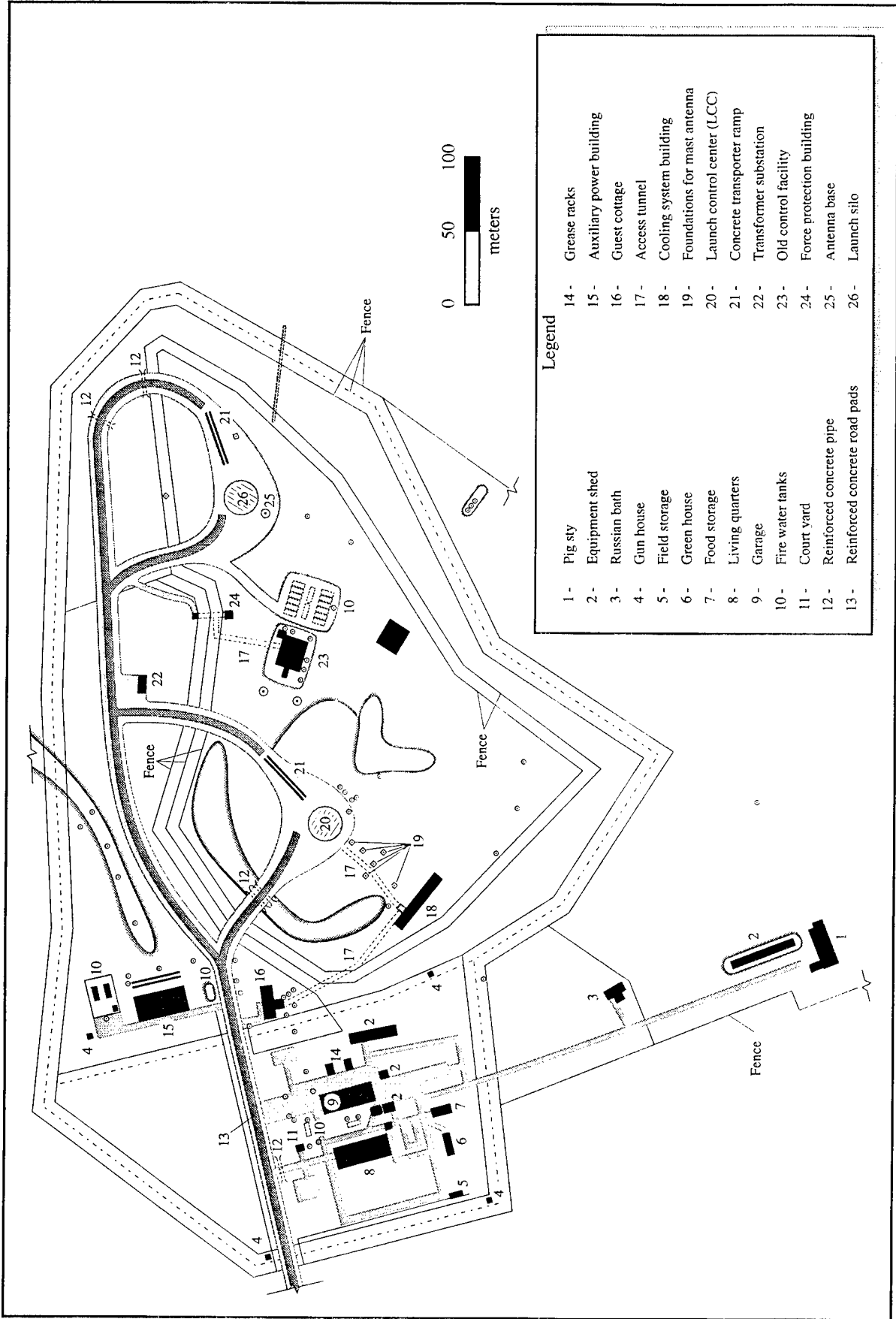

Figure 4. Plan drawing of a typical co-located launch silo and launch control center (LS/LCC) site. Derzhavinsk, Regiment 5 Silos 5/7.

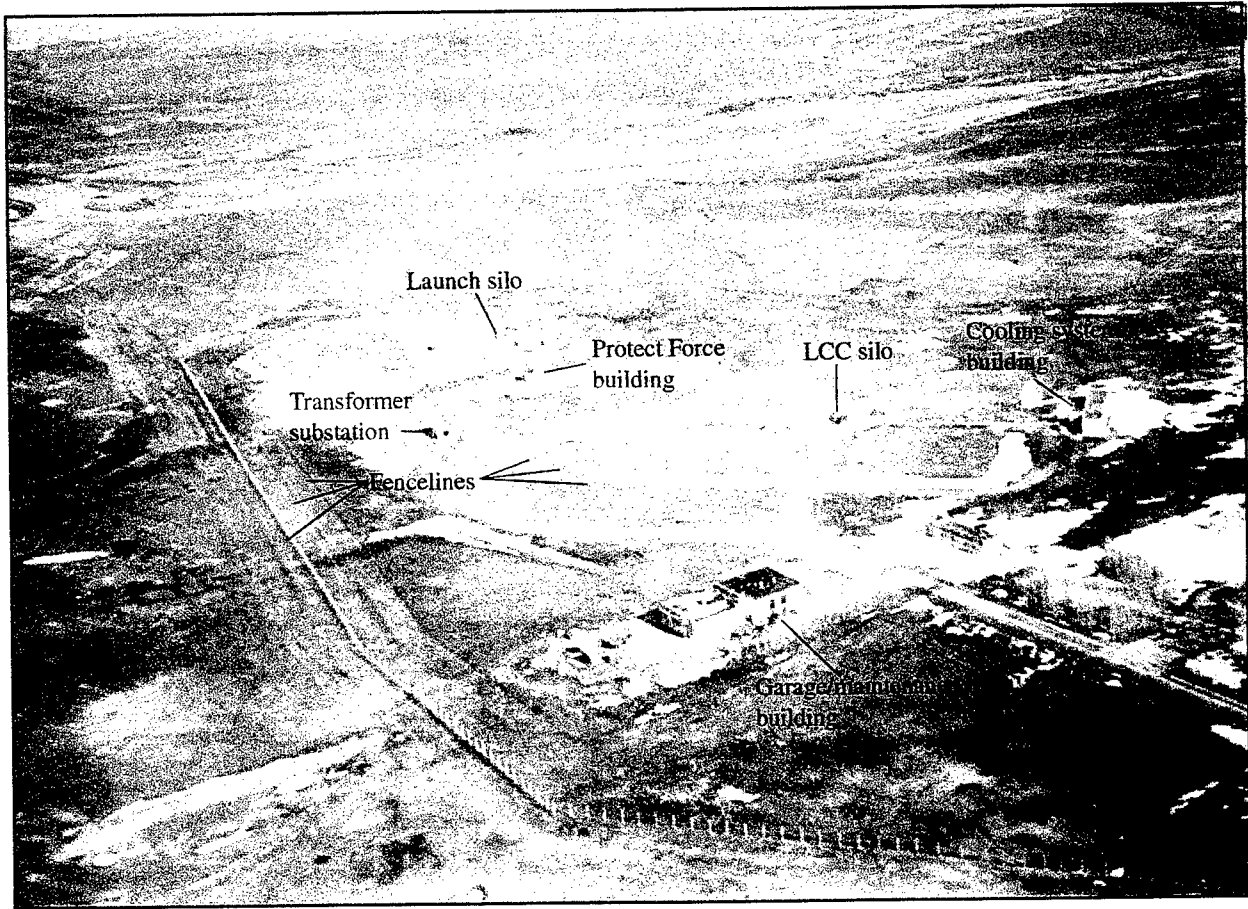

Figure 5. Helicopter overflight of a co-located LS/LCC silo site. Zhangiz Tobe. Courtesy of DTRA.

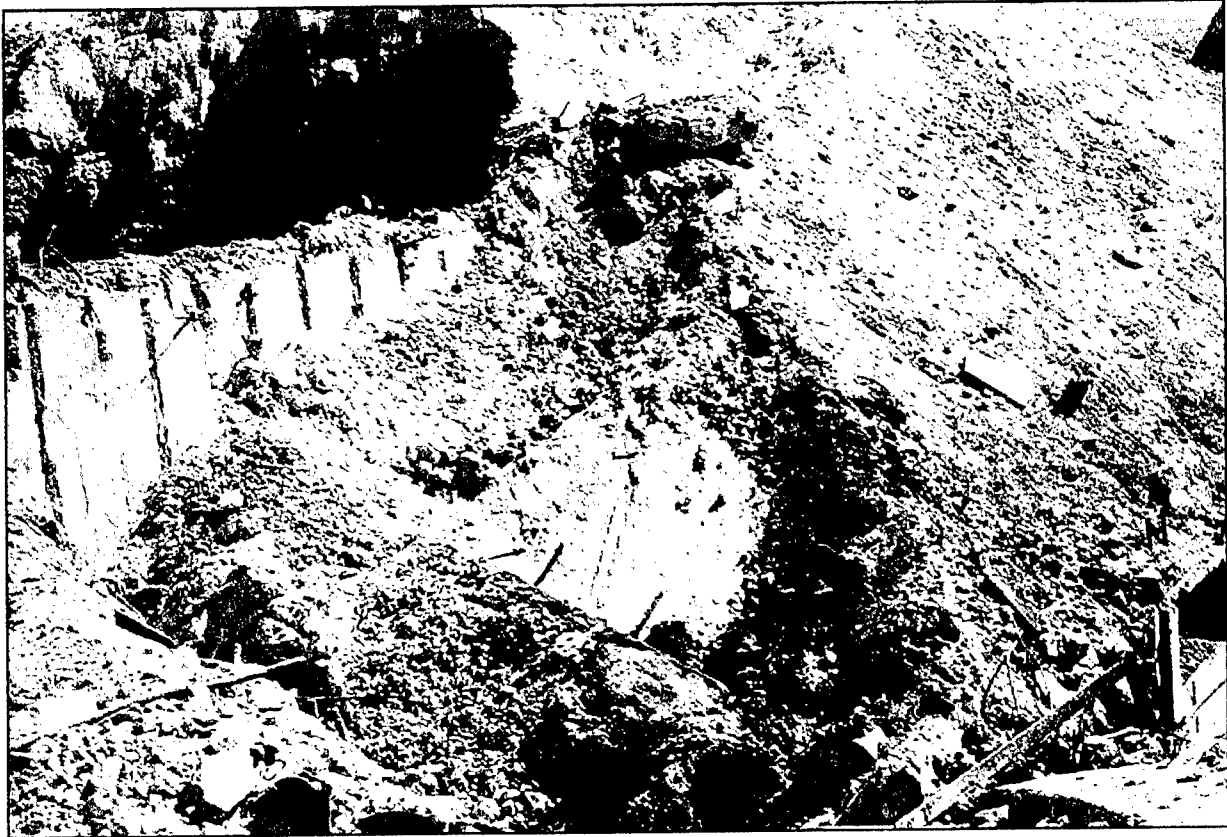

Figure 6. Poured, reinforced concrete square outer retaining wall exposed in silo crater. Derzhavinsk, Regiment 5, Silo 4.

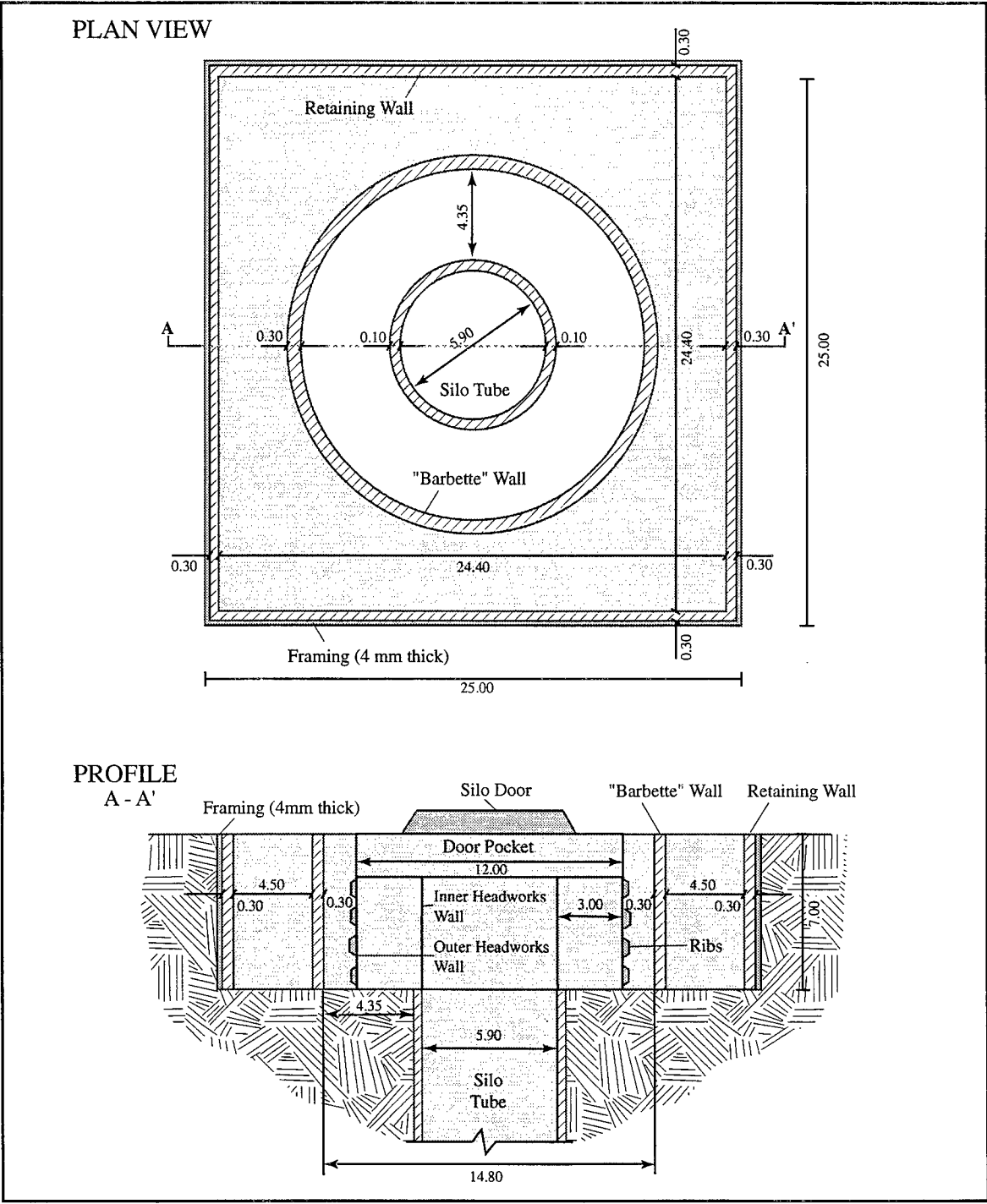

Figure 7. Plan and cross section drawings of the outer retaining wall, the inner "barbette" sectional wall, and the silo headworks area. The configuration and dimensions of the silo door, door pocket, and inner and outer headworks walls are estimated from the site photography. Derzhavinsk, Regiment 2, Silo 3. All measurements are in meters.



Figure 8. Metal and concrete debris on the crater rim. The ribbed metal plate on the right may be part of the headworks wall. The transformer substation is in the right background. Derzhavinsk, Regiment 2, Silos 5/7.

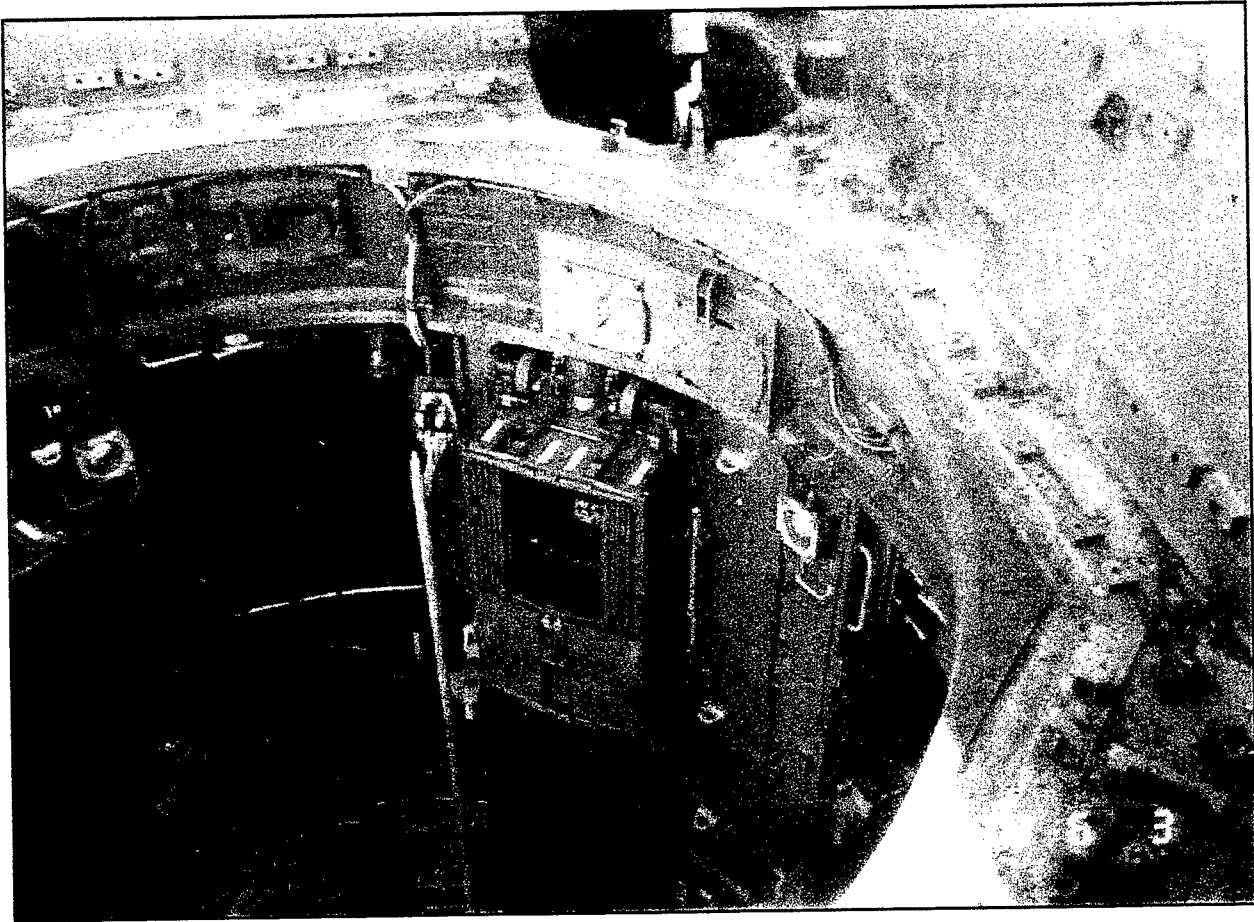

Figure 9. Detail of the silo door pocket and upper part of the silo tube, prior to demolition. The silo door is open. Note the elevator in the center. Derzhavinsk, Regiment 2, Silo 2. Courtesy of DTRA.

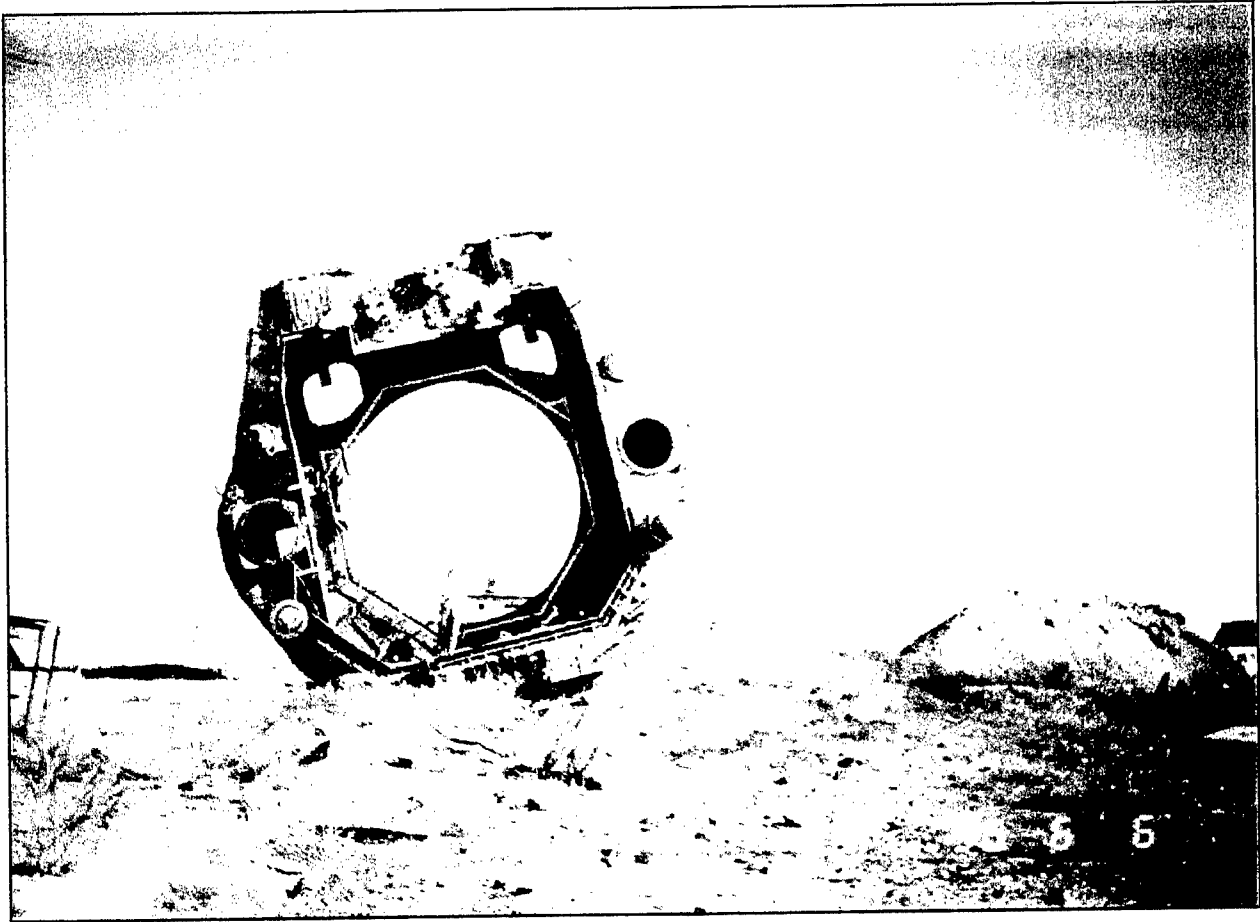

Figure10. Destroyed silo door pocket standing on end. Note the individual for scale.
Probably Zhangiz Tobe. Courtesy of DTRA.

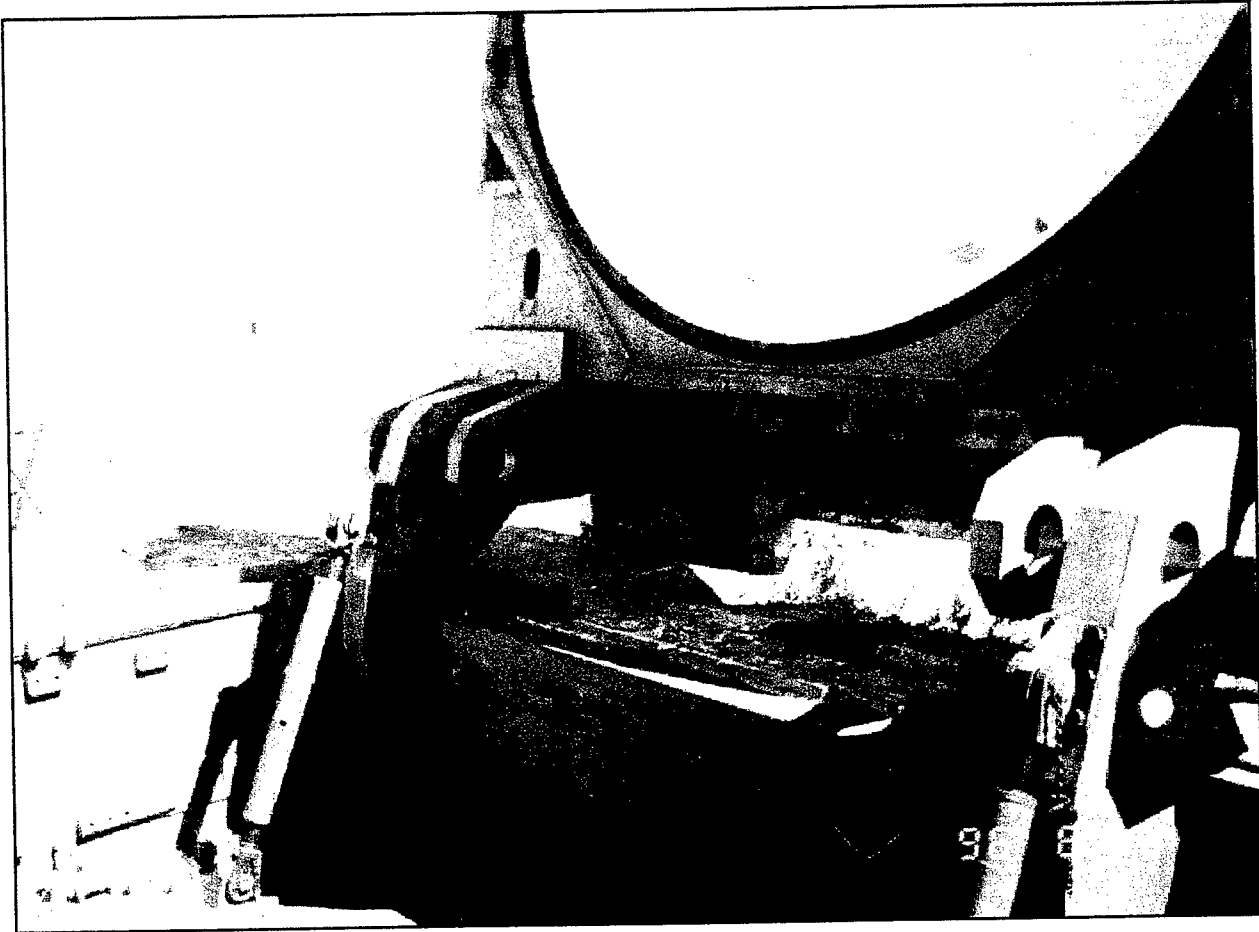

Figure 11. Detail of the top of the silo door pocket and door hinge assembly, prior to demolition. Derzhavinsk, Regiment 2, Silo 2. Courtesy of DTRA.

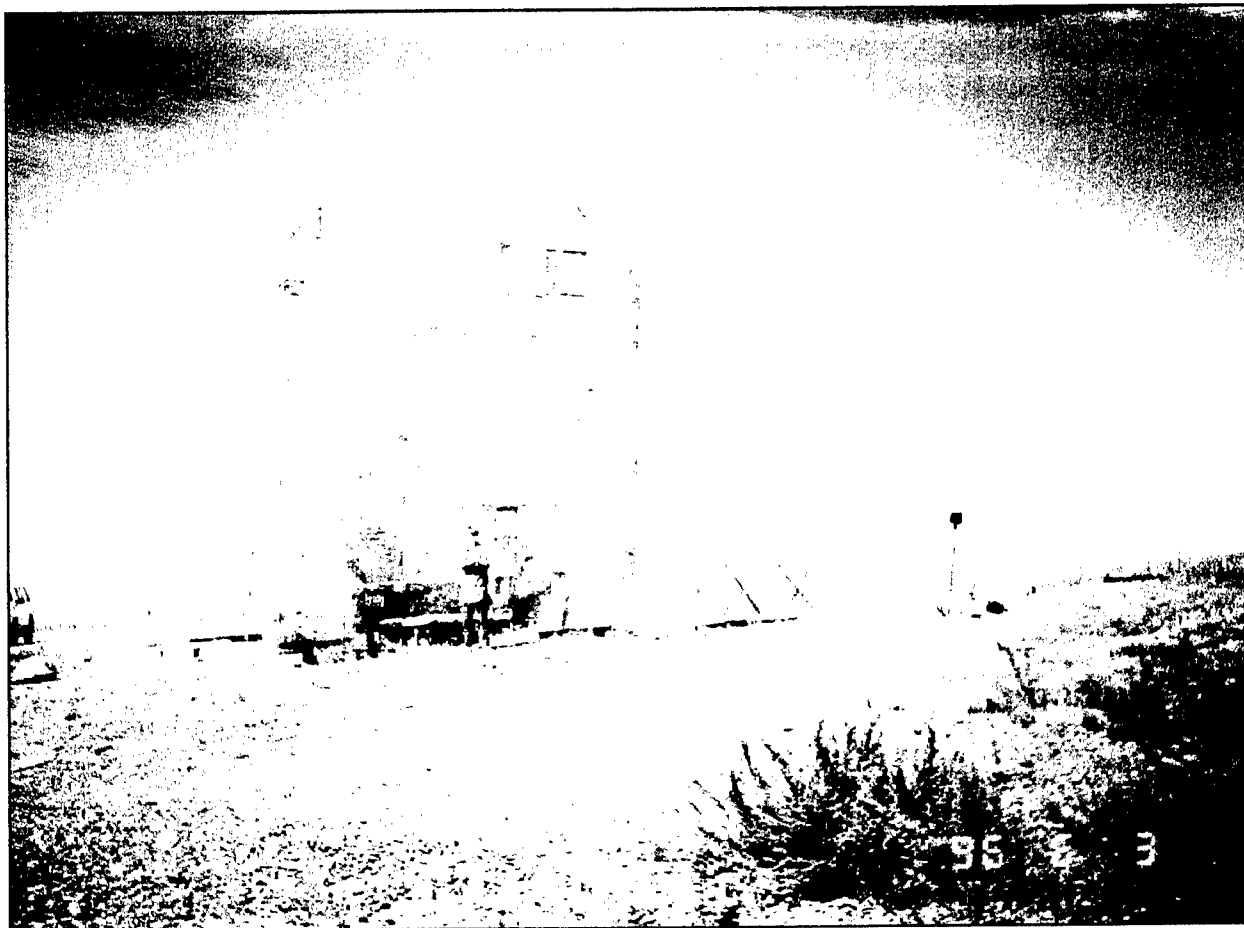

Figure 12. Silo door in the open position, prior to demolition. Note the individual for scale. Derzhavinsk, Regiment 2, Silo 2. Courtesy of DTRA.

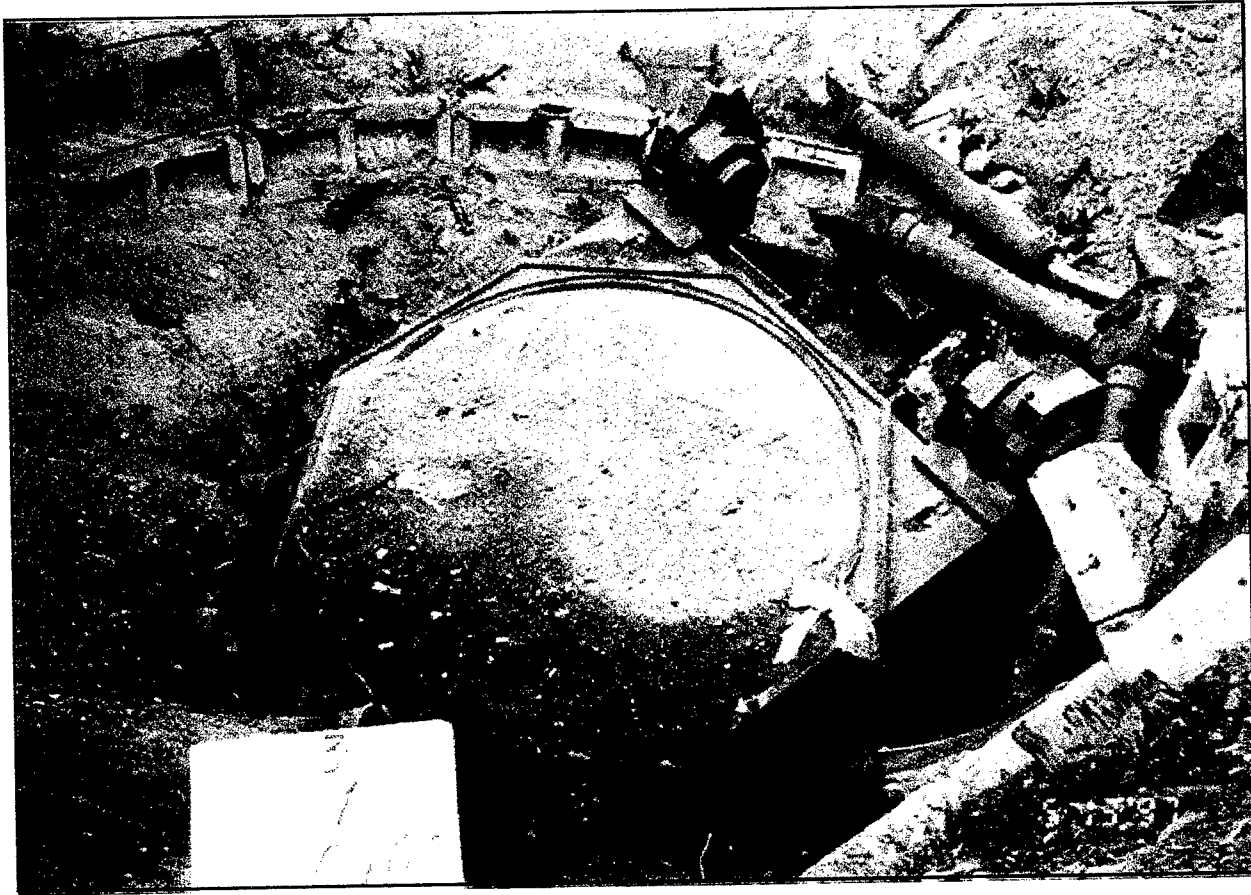

Figure 13. Hinged door for a launch silo, resting on the crater wall. Zhangiz Tobe, Regiment 3, Silo 1. Courtesy of Brown & Root/ABB SUSA.

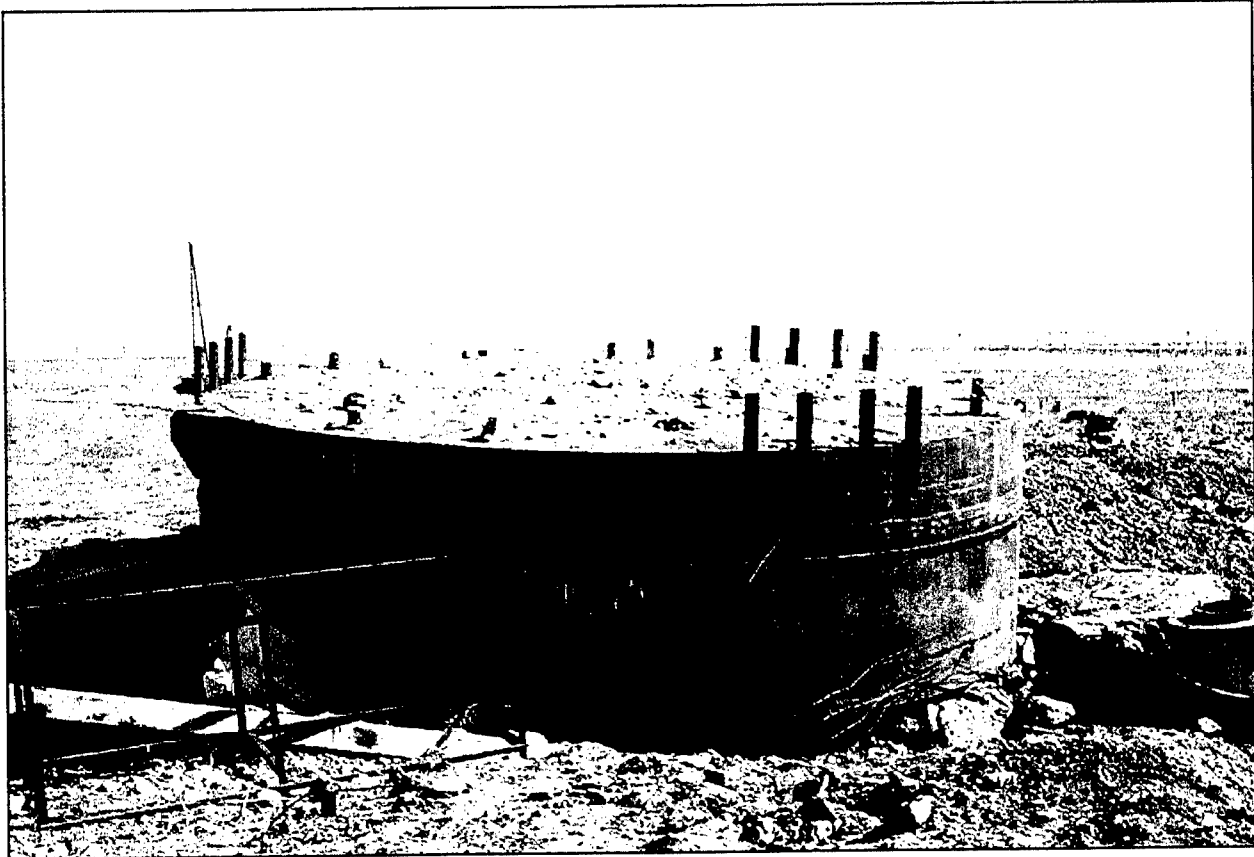

Figure 14. Round silo door for the Launch Control Center (LCC) silo. Note the difference between this door and the door for a launch silo (compare to Figure 12).
Derzhavinsk, Regiment 2, Silo 7.



Figure 15. Partially excavated shallow buried tunnel between the cooling system building (in background) and the Launch Control Center (LCC) silo. Derzhavinsk, Regiment 3, Silo 7.



Figure 16. Underground tunnel entrance into the LCC silo headworks revealed in the crater. The round silo door rests on the crater rim. Derzhavinsk, Regiment 2, Silo 7.



Figure 17. Fragment of a porphyritic igneous rock in the debris field around the crater. The rock has a dark matrix with white veins and crystals. The pen is six inches in length. Derzhavinsk, Regiment 2, Silos 5/7.



Figure 18. Fragment of banded igneous rock in the debris field around the crater rim. The pinkish bands intruding into the fine-grained matrix give a "gneissic" appearance to the rock. The pen is six inches in length. Derzhavinsk, Regiment 2, Silos 5/7.

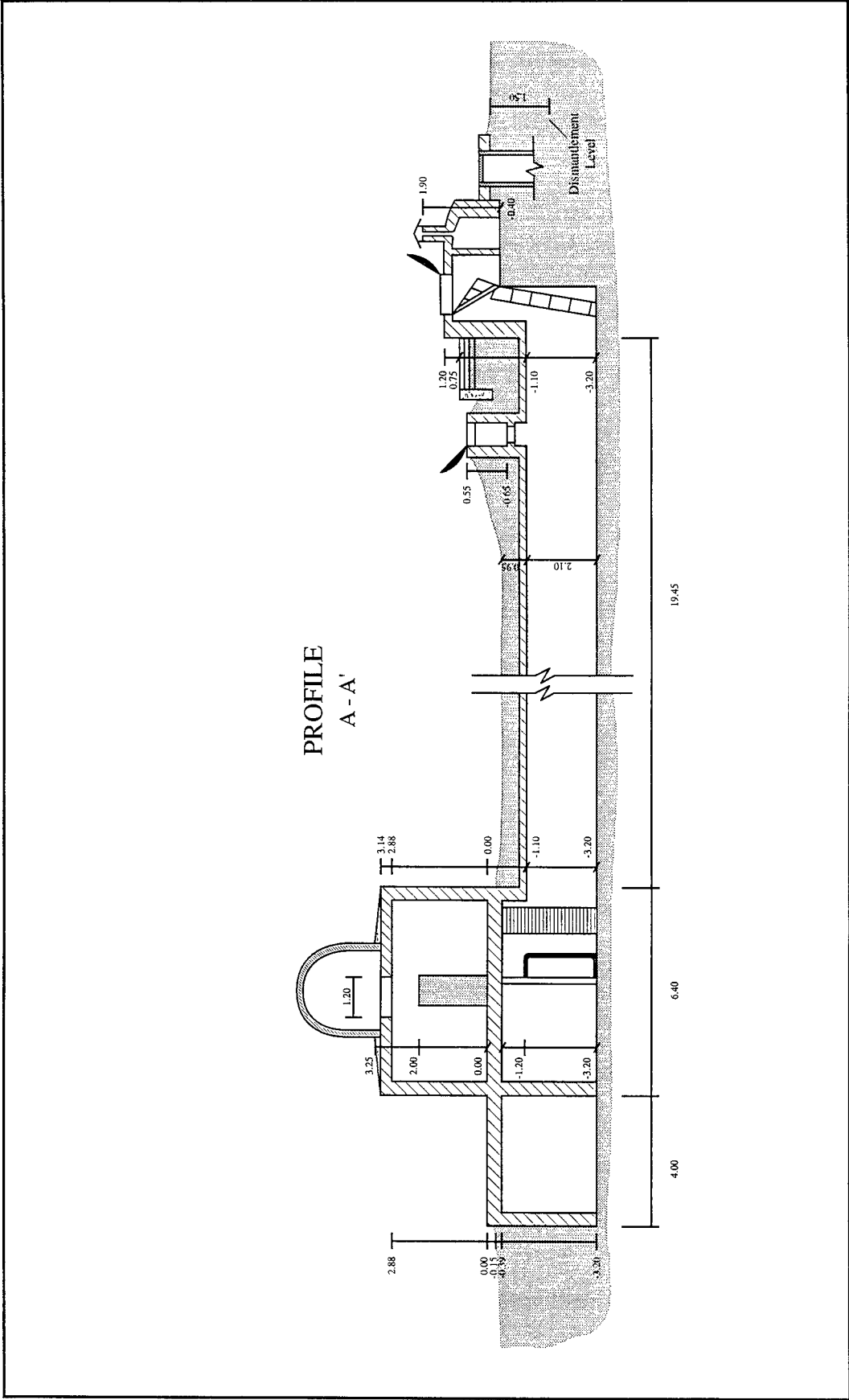

Figure 19. Cross sectional drawing of the "Force Protection" guard house, and associated tunnel and entry structures. Derzhavinsk, Regiment 2, Silo 3. All measurements are in meters.

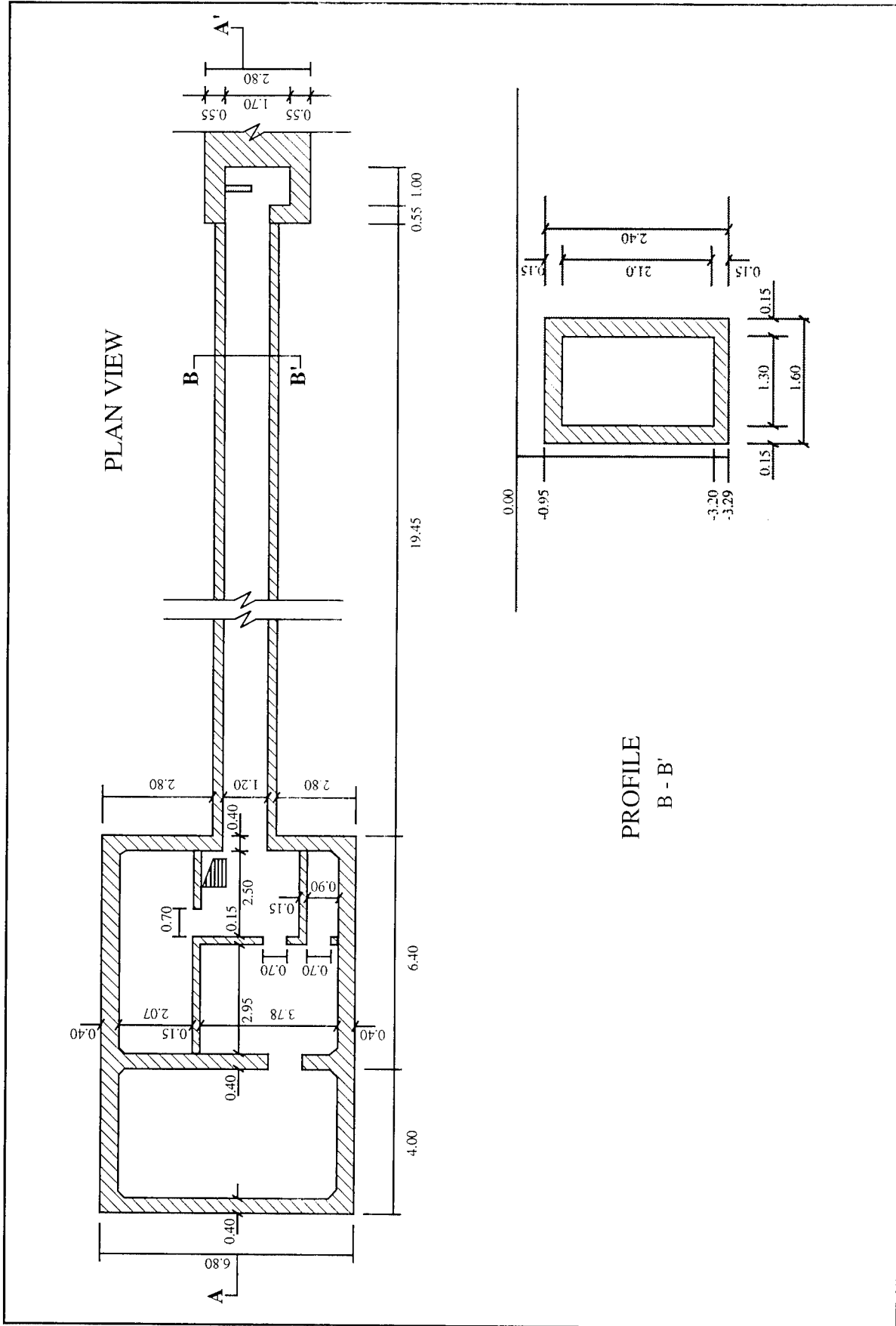

Figure 20. Plan drawing of the "Force Protection" guard house, and associated tunnel and entry structures. Derzhavinsk, Regiment 2, Silo 3. All measurements are in meters.



Figure 21. Trenching along side the "Force Protection" security building has exposed the subterranean level of the building and the associated shallow buried tunnel. The buried structures are lined with red clay brick. The excavation is about three meters deep in dry fine-grained silt and clay. Derzhavinsk, Regiment 2, Silo 2.

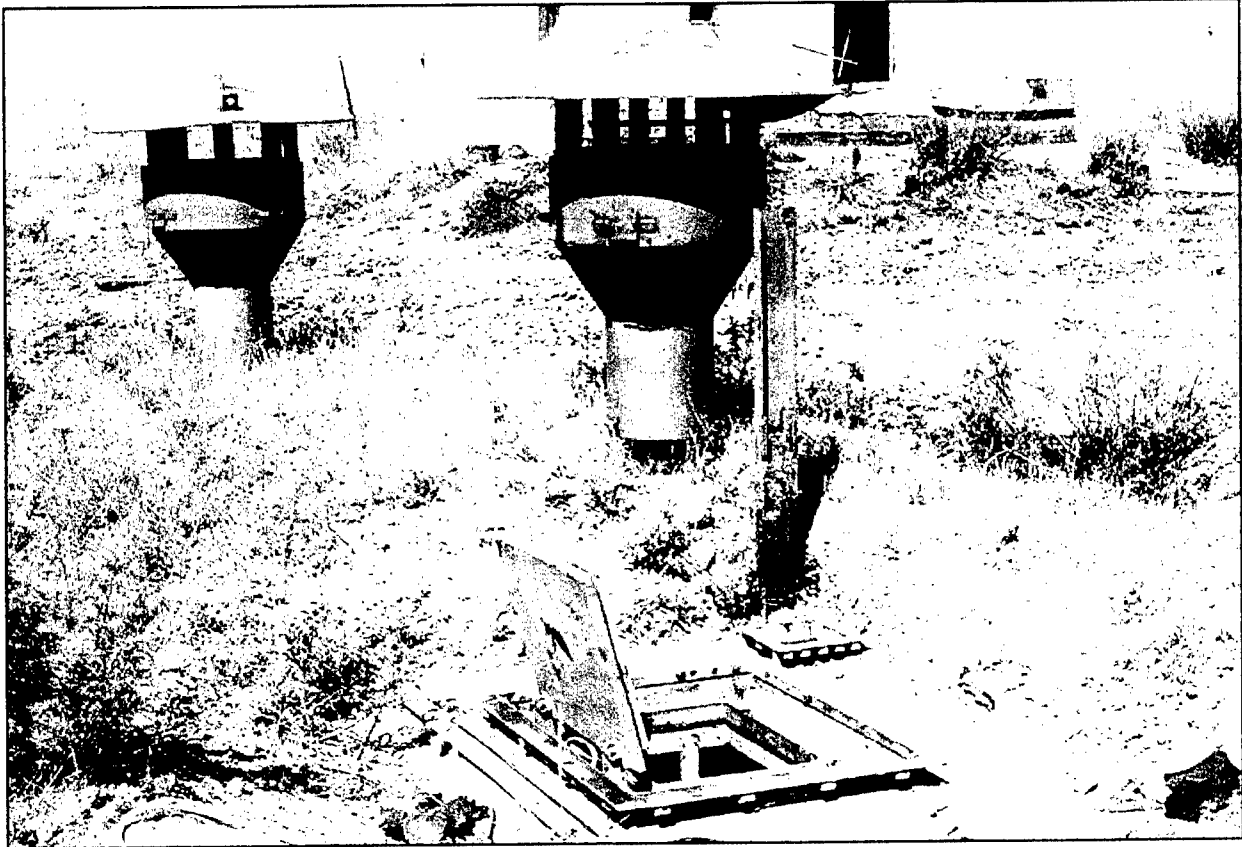

Figure 22. The ventilated underground chamber for access to the launch silo and cables. The transformer substation is in the background. Derzhavinsk, Regiment 2, Silo 4.

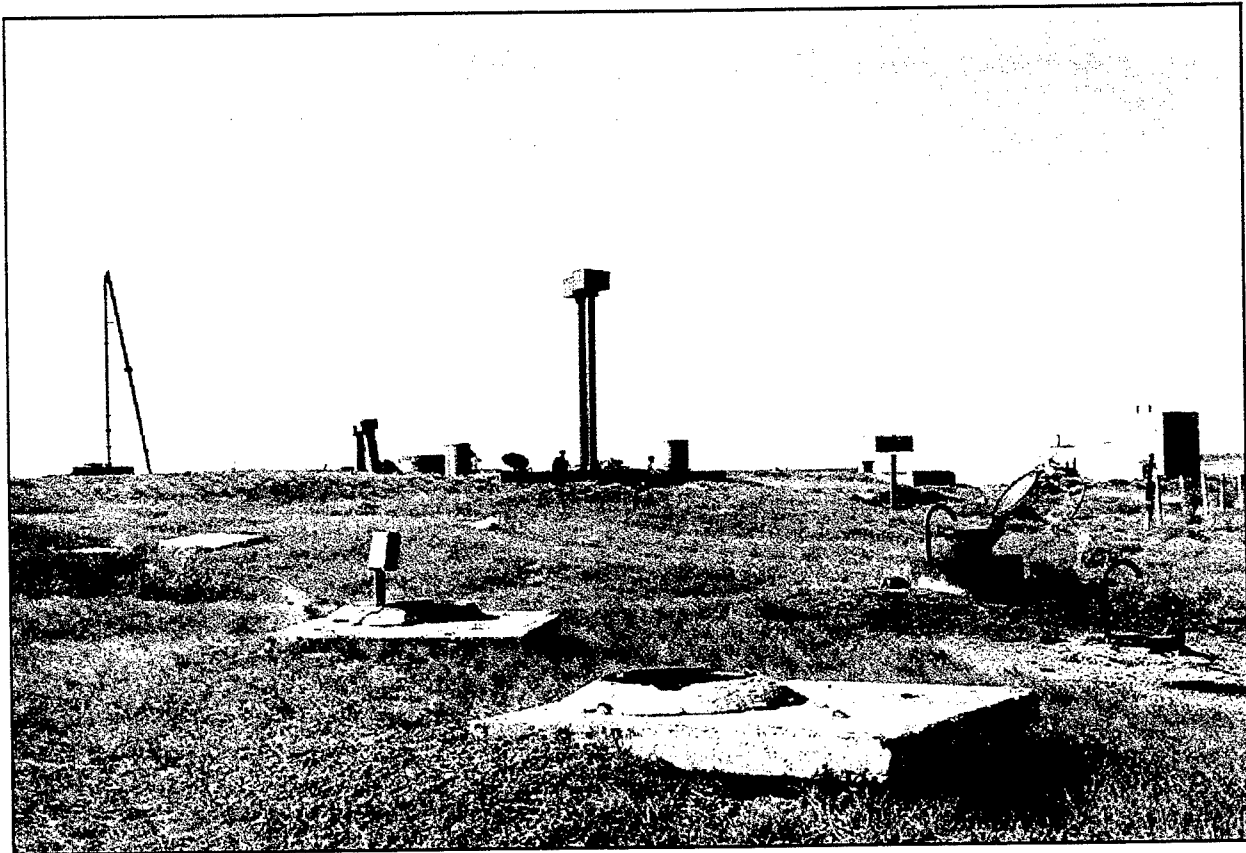

Figure 23. The "old" bermed control facility, marked by ventilation and exhaust shafts and hatches in the middle background of the photograph. The large building in the right background is the cooling system building; buried ventilated fuel tanks in the right foreground; hatches to storage tanks (?) in the middle foreground; broken lay-down mast antenna in the left background. Derzhavinsk, Regiment 2, Silos 5/7.

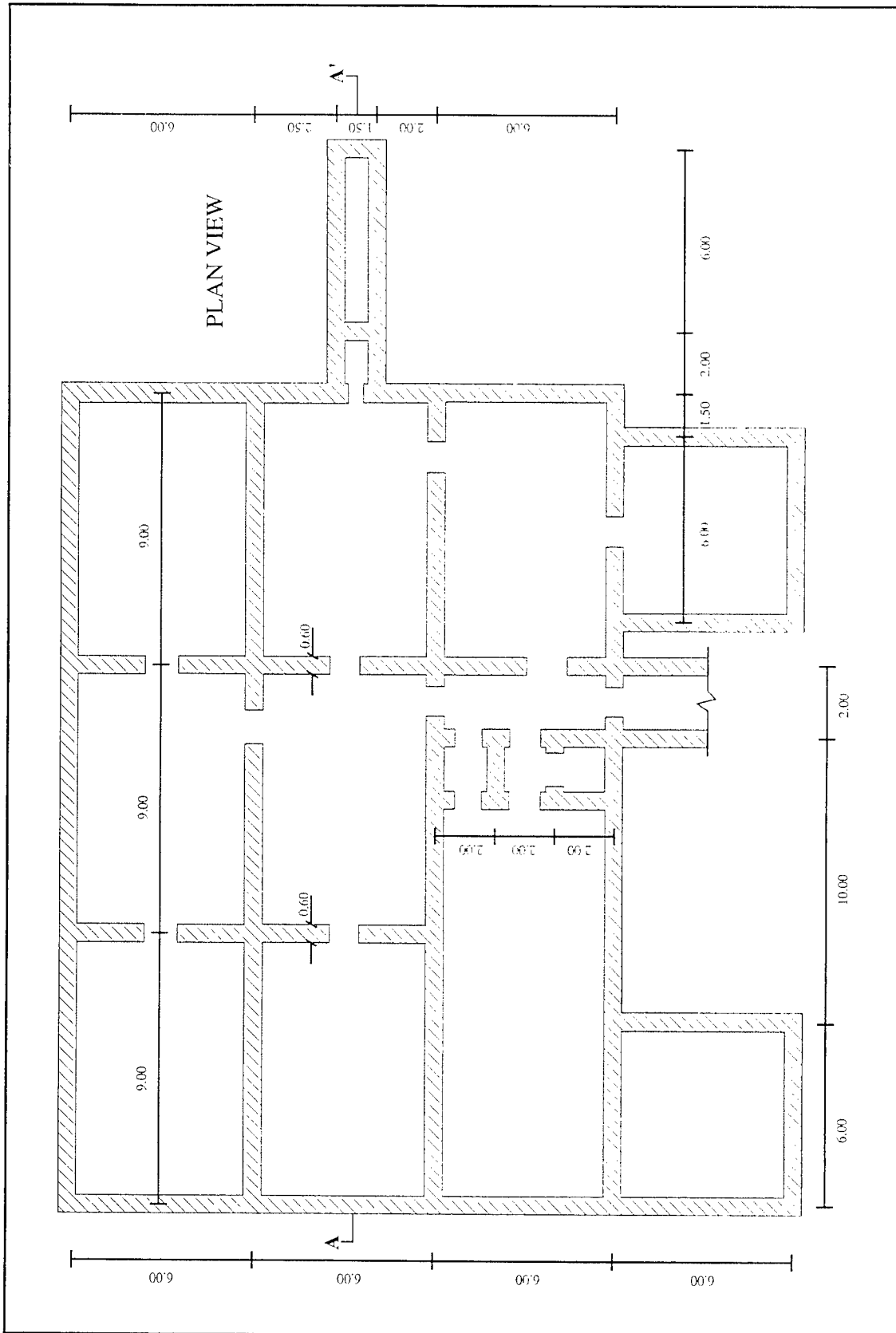

Figure 24. Plan view drawing of the "old" bermed control facility, showing the internal layout of the rooms. Derzhavinsk, Regiment 5, Silos 5/7. All measurements are in meters.

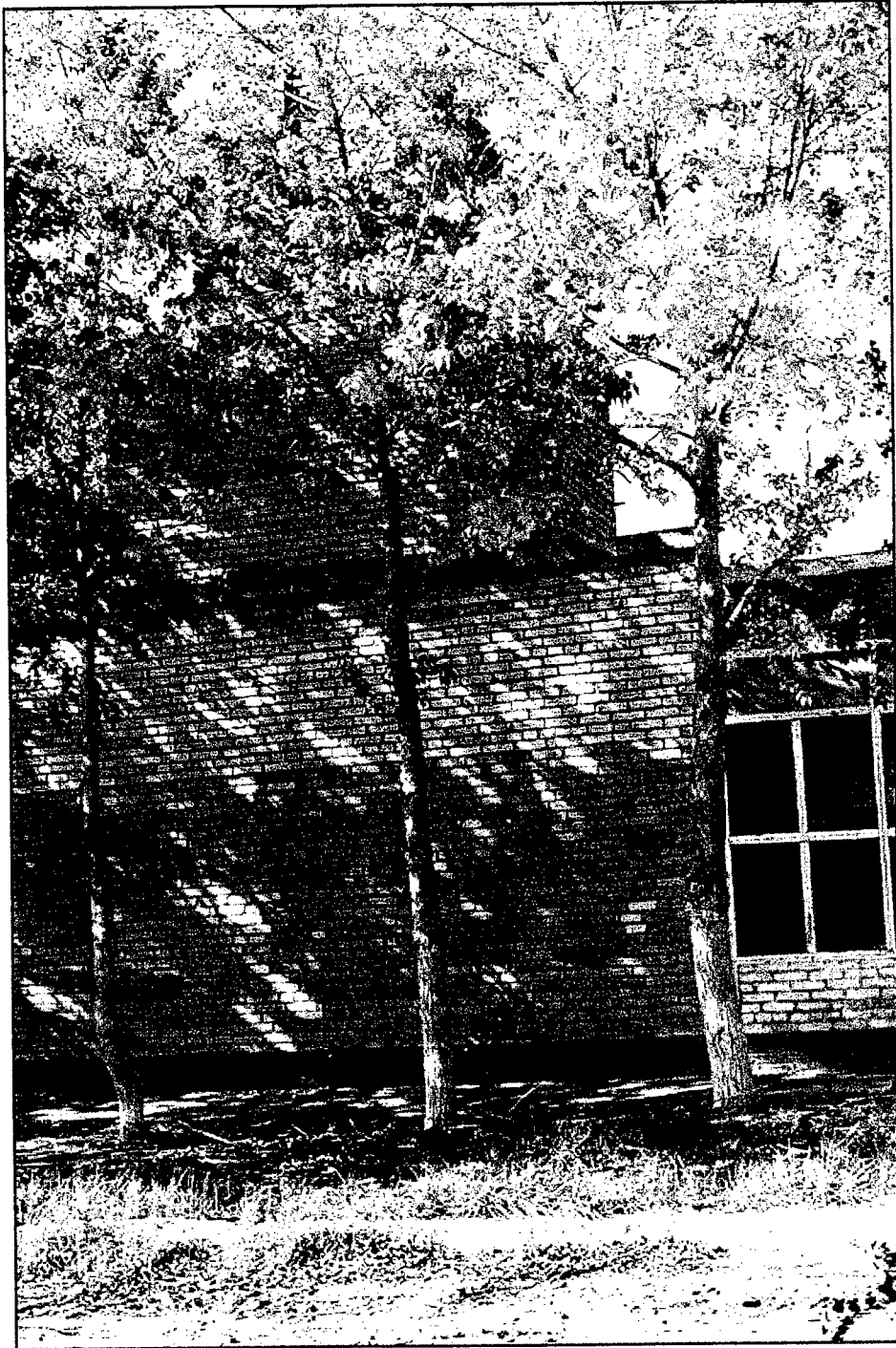

Figure 26. Detail of the administration/barracks building, constructed of light gray bricks. Trees are planted in front of the tower section, which is about 8.4 meters in height. Derzhavinsk, Regiment 2, Silos 5/7.

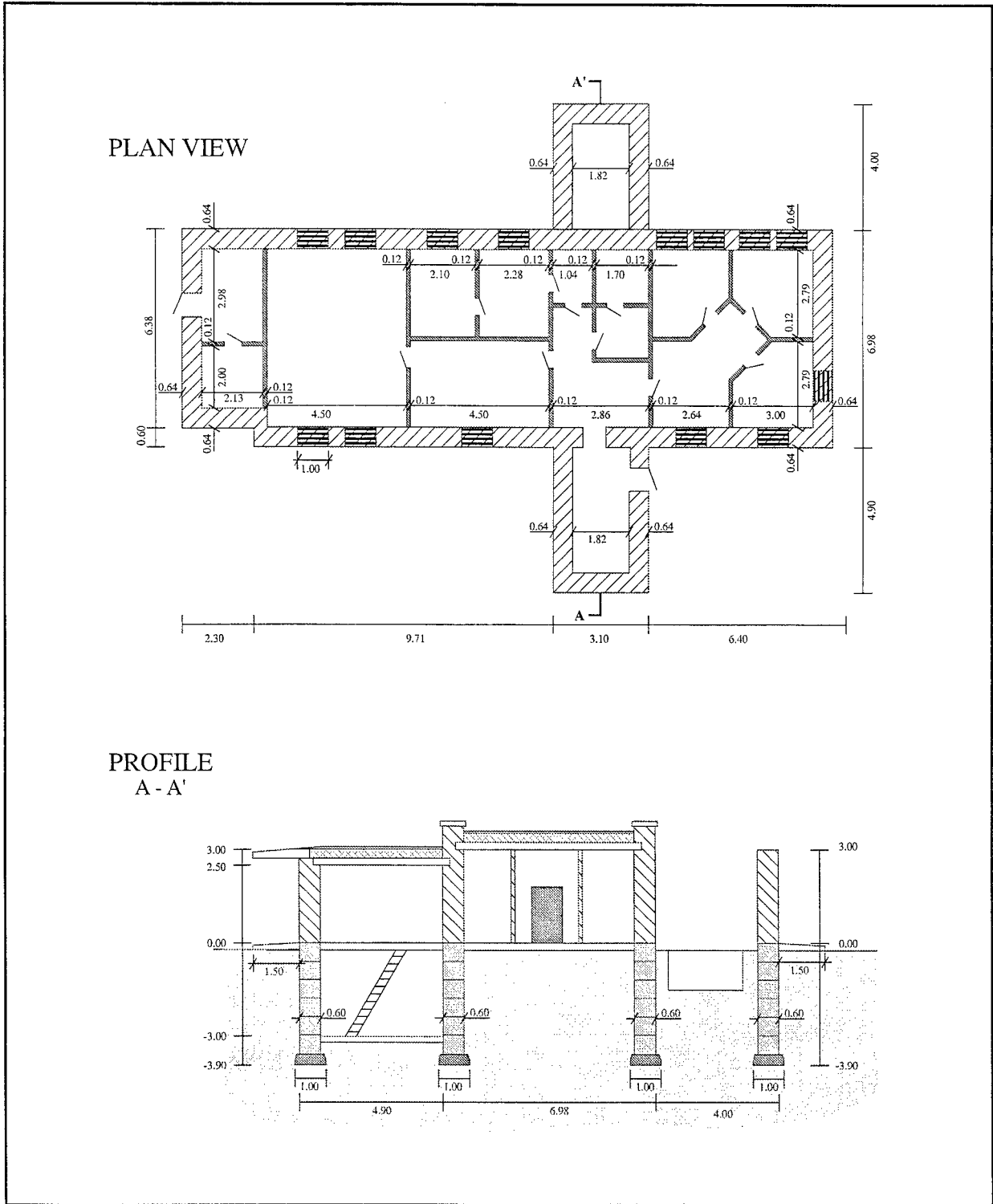

Figure 29. Plan and cross sectional drawings of the guest cottage. Derzhavinsk, Regiment 5, Silos 5/7. All measurements are in meters.

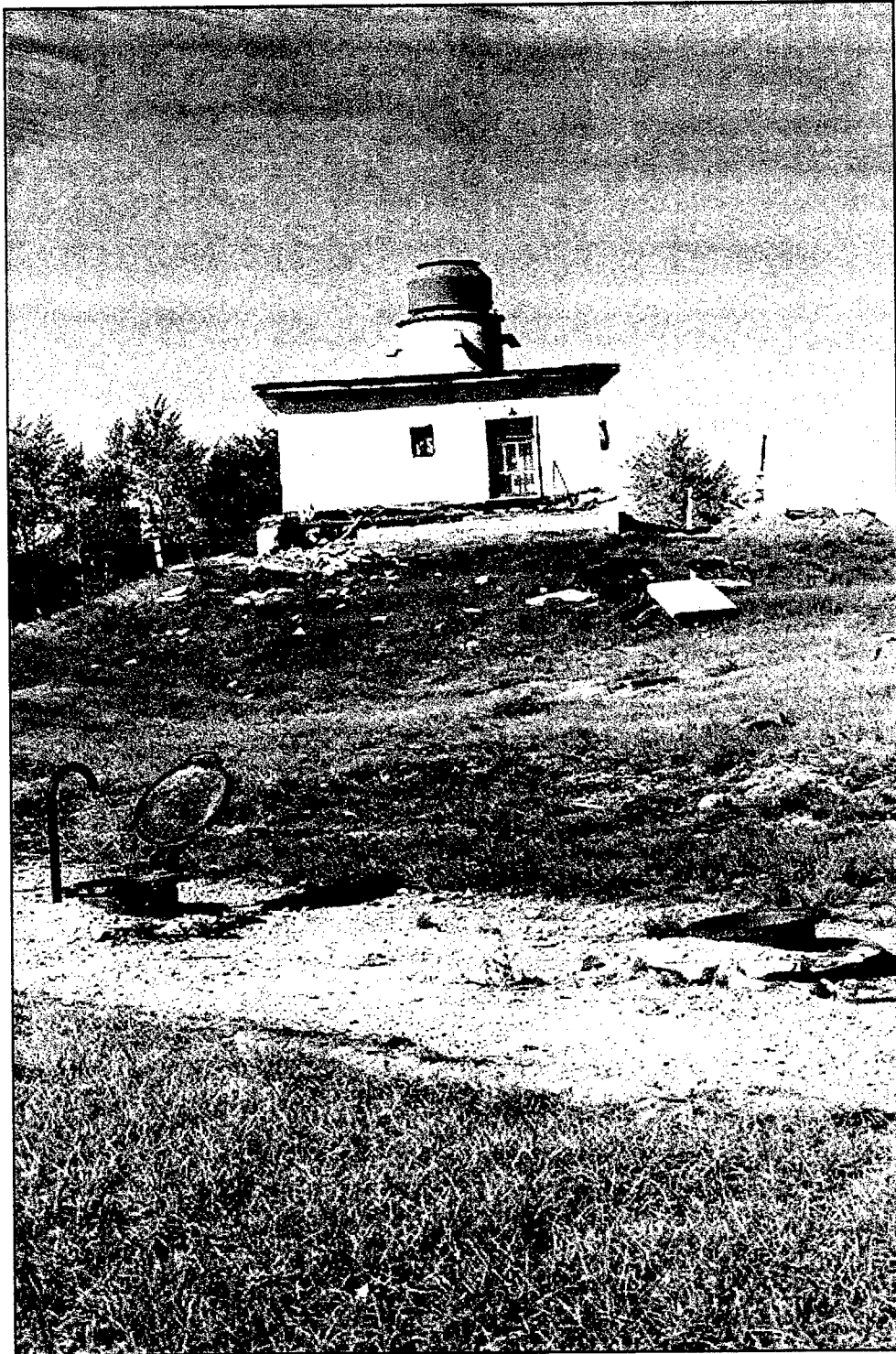

Figure 30. The "Force Protection" security building. The green metal dome on top of the building houses a rotating gun position. Buried diesel fuel tanks in the foreground. Derzhavinsk, Regiment 2, Silos 5/7.

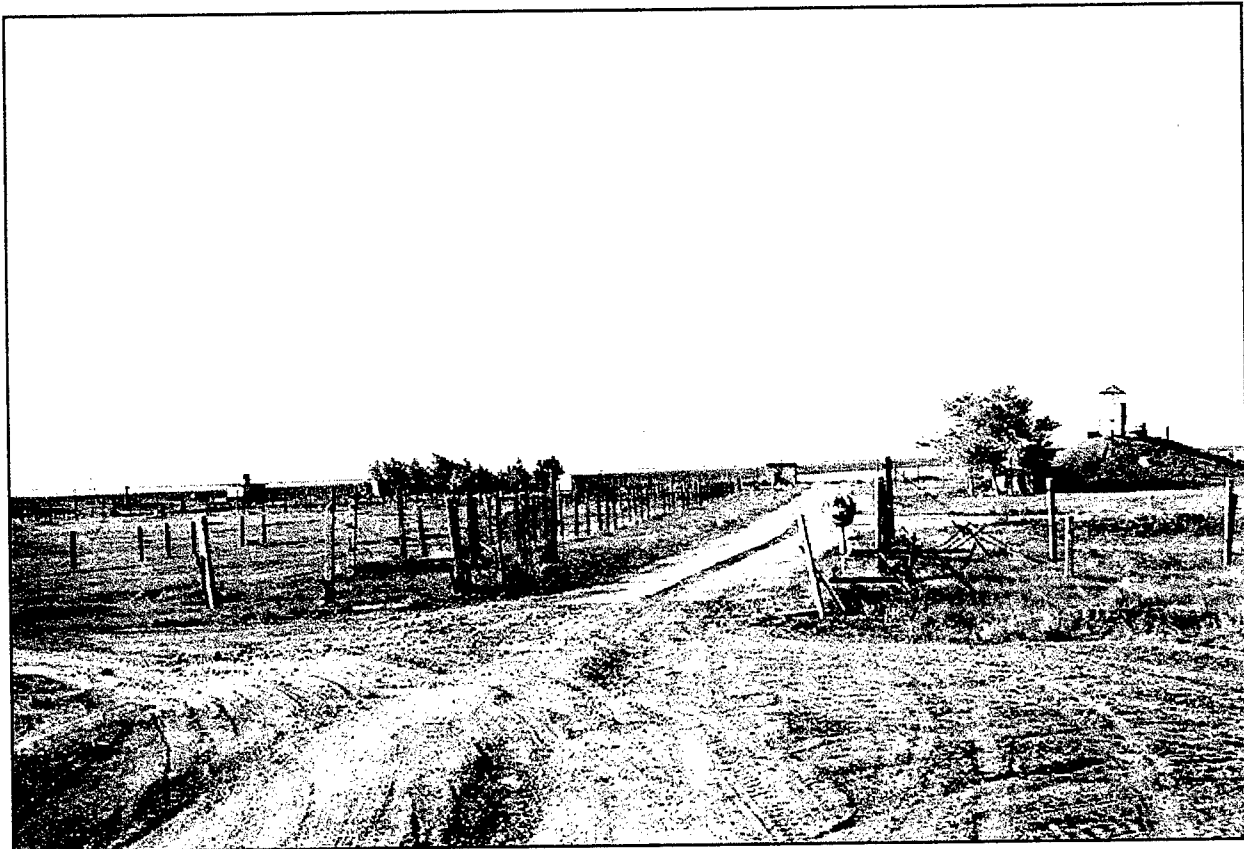

Figure 31. Entrance to a co-located LS/LCC site. The major types of vegetation in the region are seen here: the short natural steppe grasses in the foreground; the planted deciduous trees on the site; and the extensive wheat fields on the horizon. At the time of this photograph (29 May 1998) the fields were being turned over by plow in preparation for planting. Derzhavinsk, Regiment 2, Silos 5/7.

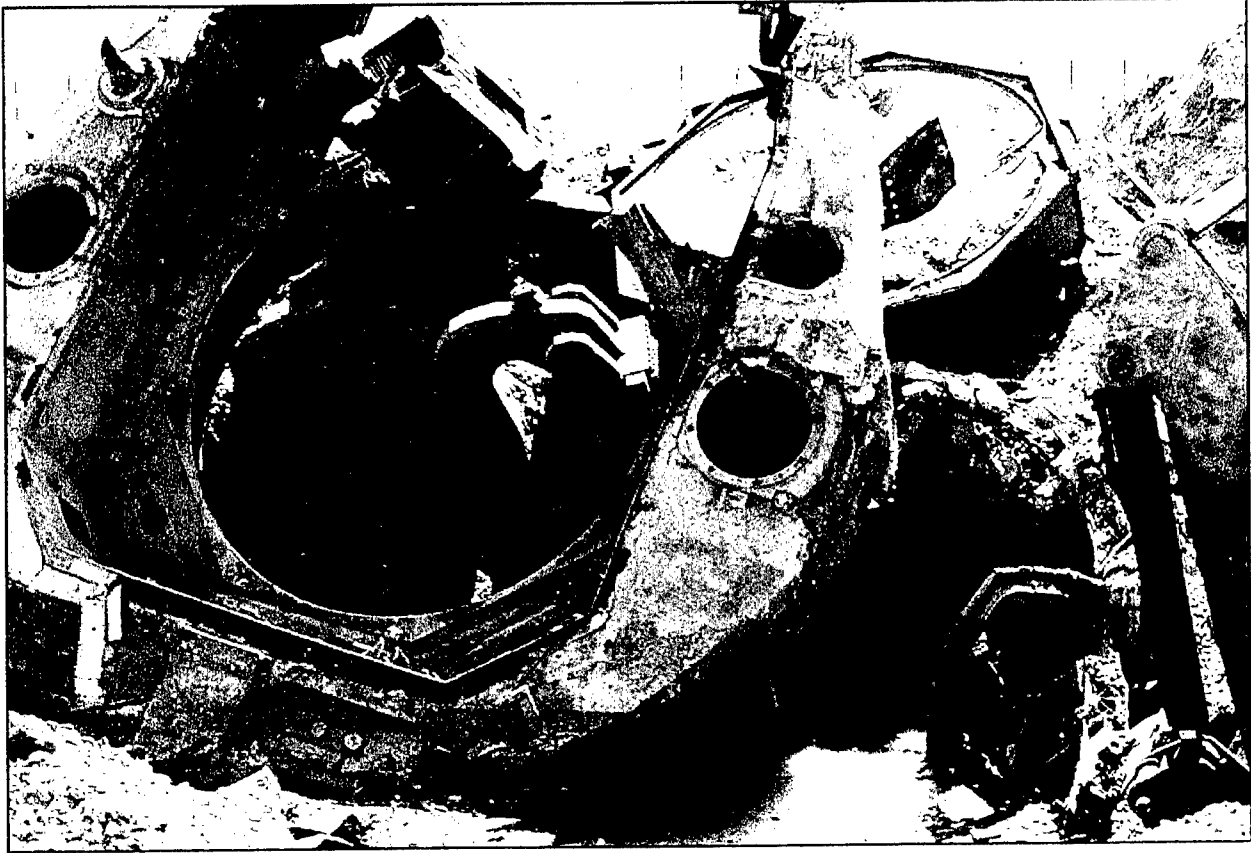

Figure 32. Up-ended silo door pocket in flooded crater. The silo door is behind the door pocket, and higher on the crater rim. Derzhavinsk, Regiment 2, Silo 4.



Figure 33. Bermed storage facility being exhumed for destruction and disposal. A black tar paper-like material covers the reinforced concrete. Derzhavinsk, Regiment 2, Silo 3.

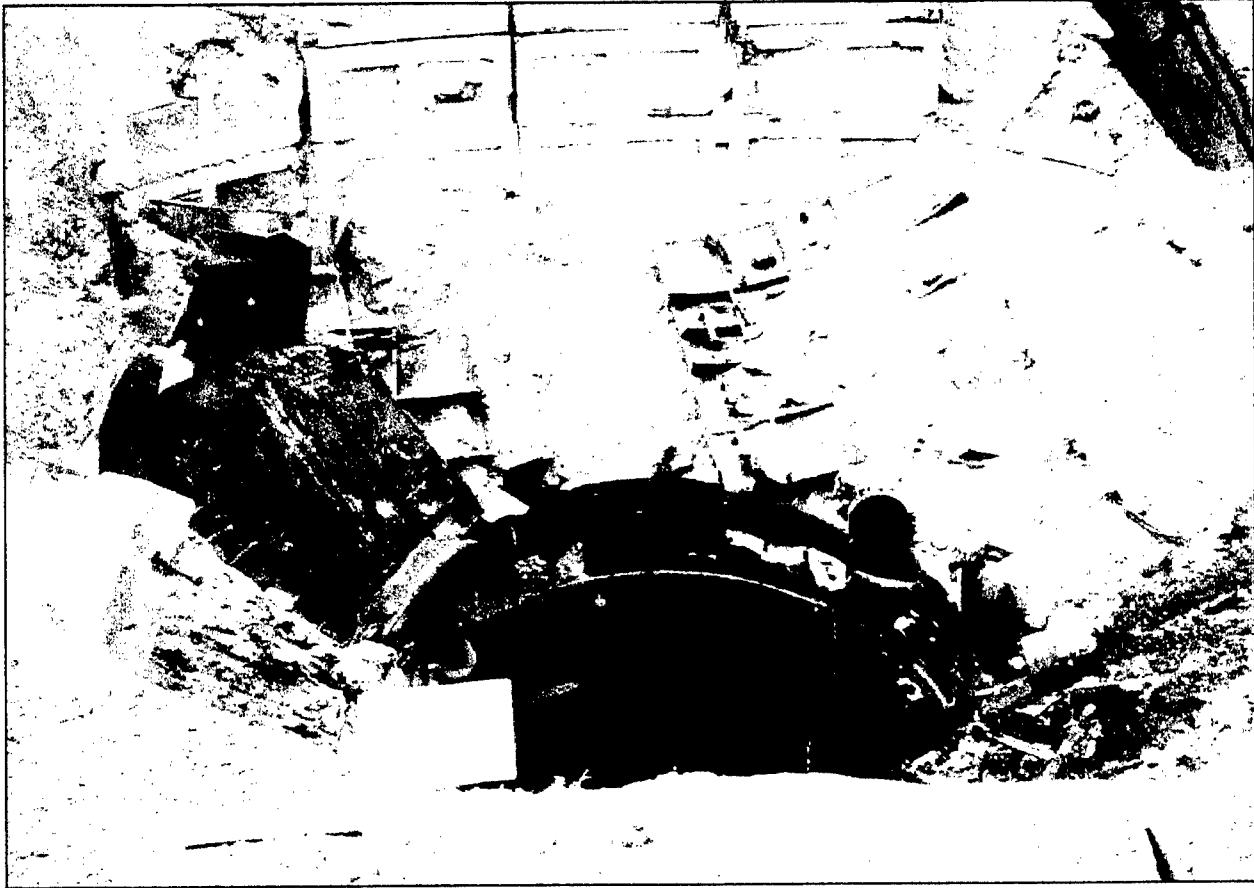

Figure 34. Crater resulting from the detonation of explosives, used to destroy the silo headworks. The craters are typically about six meters deep and up to 20 to 25 meters across. The blast here exposed the silo tube and the reinforced concrete "barbette" sectional wall. Metal fragments from the headworks remain in the crater. Zhangiz Tobe, Regiment 6, Silo 3. Courtesy of Brown & Root/ABB SUSA.



Figure 35. Abatement contractor crew removing PCB contaminated soil near a transformer building. Zhangiz Tobe. Photo courtesy of Brown & Root/ABB SUSA.

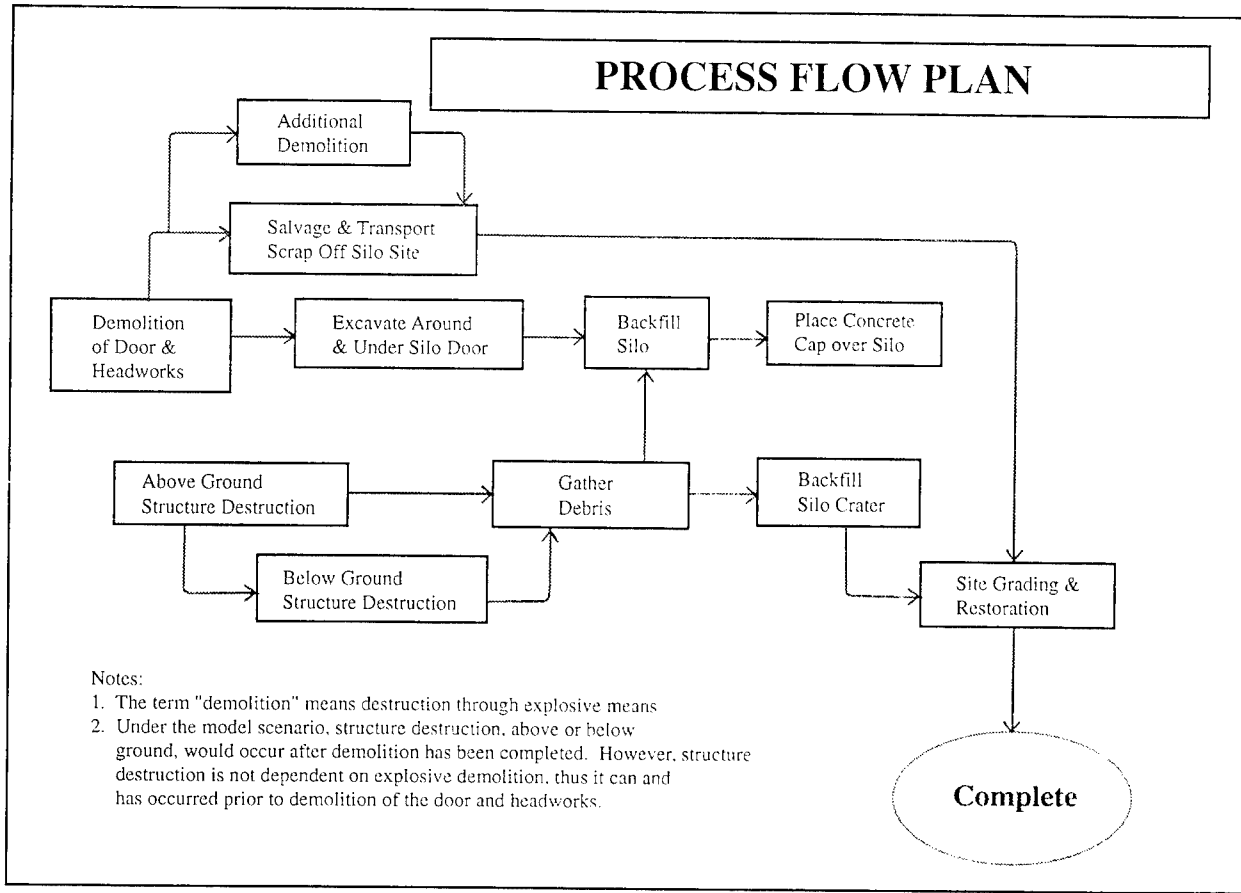

Figure 36. Process flow chart for site dismantlement. Courtesy of Brown & Root/ABB SUSA.



Figure 37. Relatively intact LCC silo door pocket still attached to part of the headworks wall.
Derzhavinsk, Regiment 2, Silo 7.

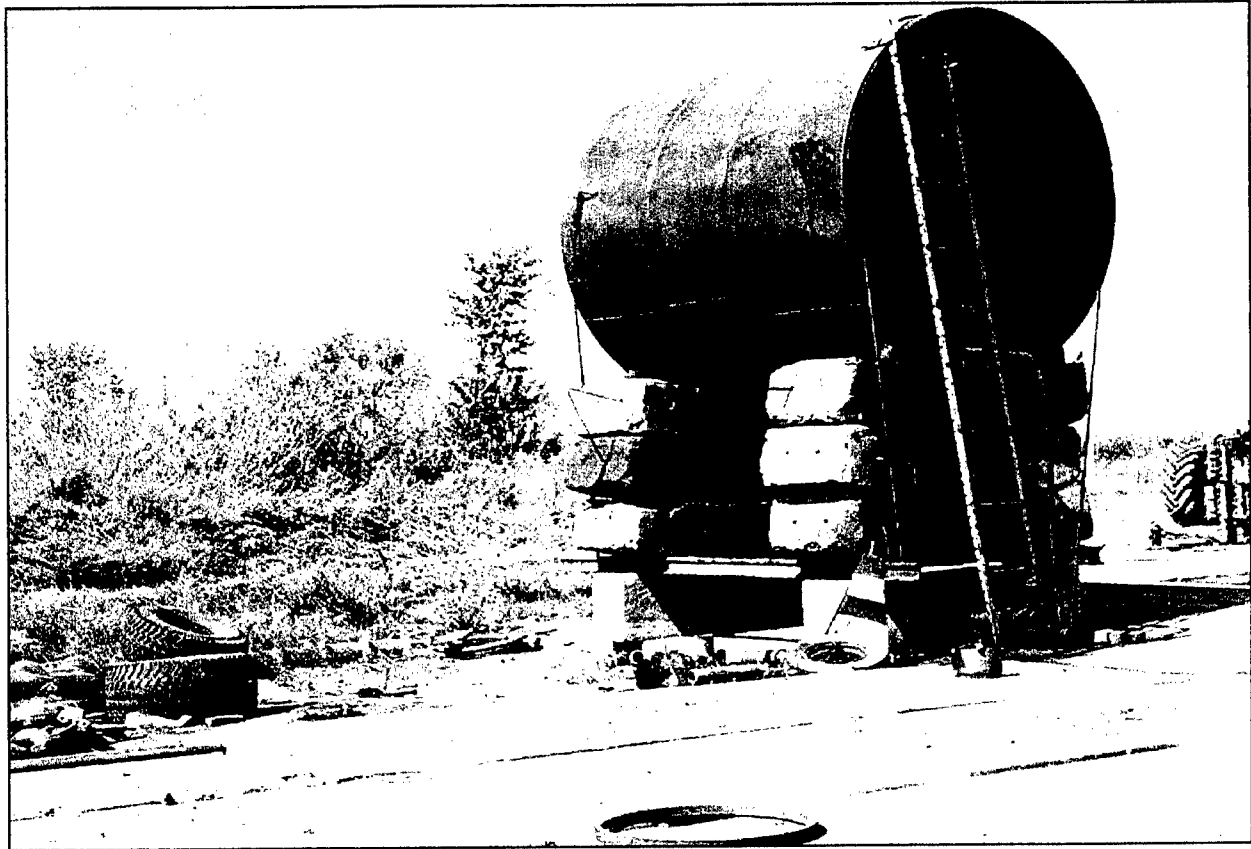

Figure 38. Salvaged sections of the "barbette" reinforced concrete walls used to support a water tank on a local farm. Note the salvaged concrete pads on the ground surface. Derzhavinsk.



Figure 39. Drilling dynamite emplacement holes in the two-meter thick reinforced concrete support blocks of the transporter loading ramp. Derzhavinsk, Regiment 2, Silo 2.



Figure 40. Ramp partially dug down to the silo crater for removal of metal and concrete, and backfilling of the silo tube with debris. The silo door pocket is on end. Derzhavinsk, Regiment 2, Silo 4.

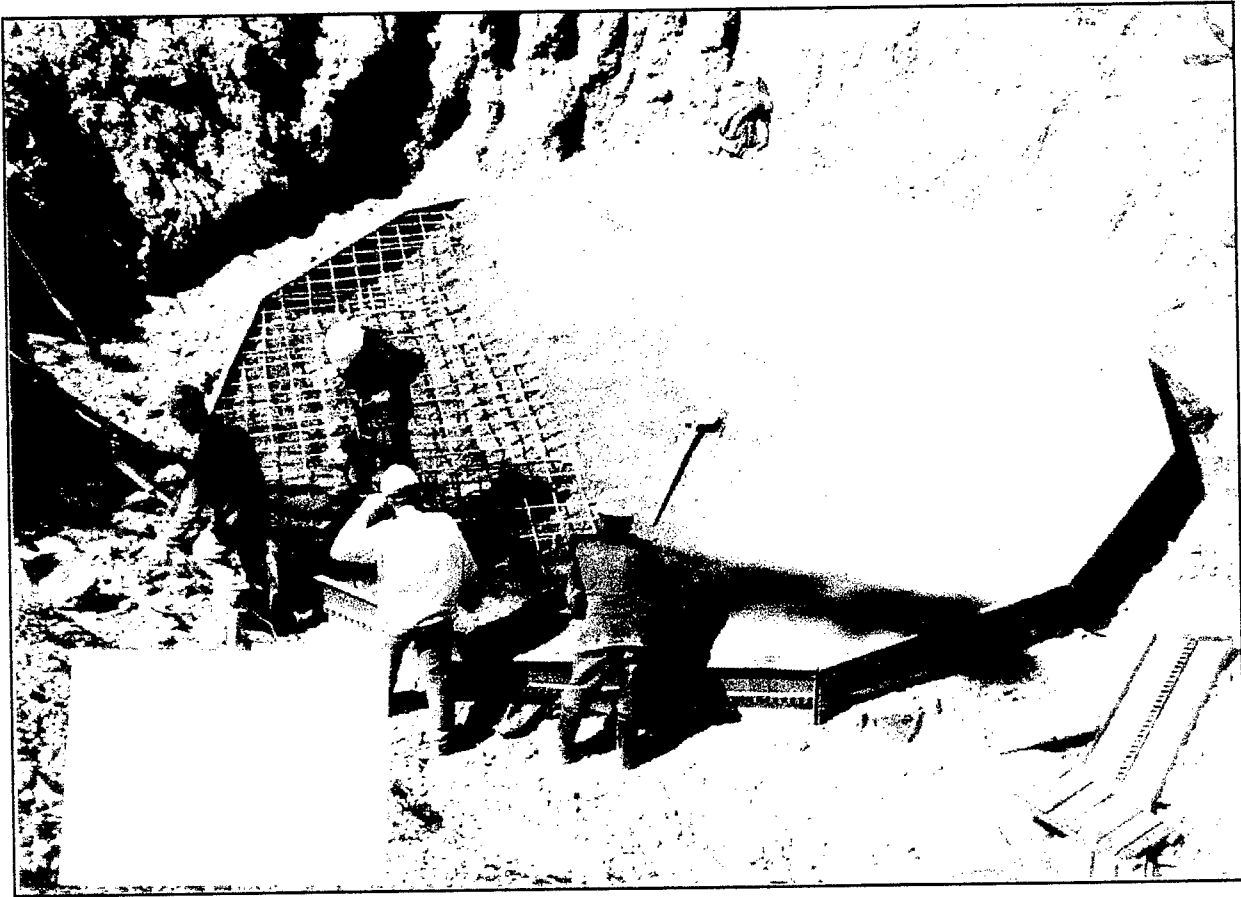

Figure 41. Pouring the eight meter diameter reinforced concrete cap over the filled silo tube.
Zhangiz Tobe, Regiment 3, Silo 4. Photo courtesy of Brown & Root/ABB SUSA.



Figure 42. Poured reinforced concrete cap in place over the filled silo tube. Part of the "barbette" wall is exposed in the crater. Derzhavinsk, Regiment 3, Silos 5/7.



Figure 43. After the silo tube has been capped, additional rubble is pushed into the crater over the cap. Zhangiz Tobe, Regiment 8, Silo 3. Courtesy of Brown & Root/ABB SUSA.

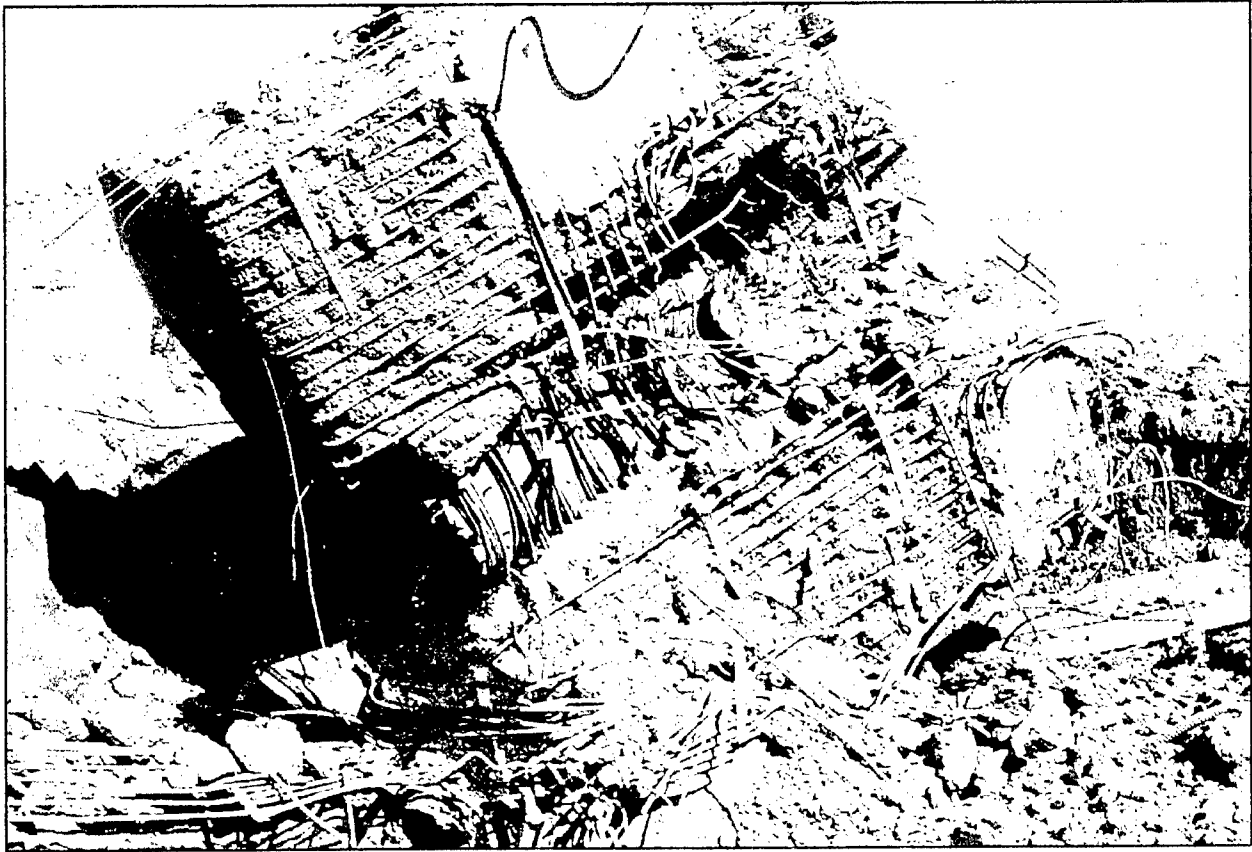

Figure 44. The bottom of the heavily reinforced concrete foundation for the dish antenna located near the launch silo. The base is 6.8 to 8.8 meters across, and 4 meters thick. A cable conduit is seen in the center. Derzhavinsk, Regiment 5, Silo 4.

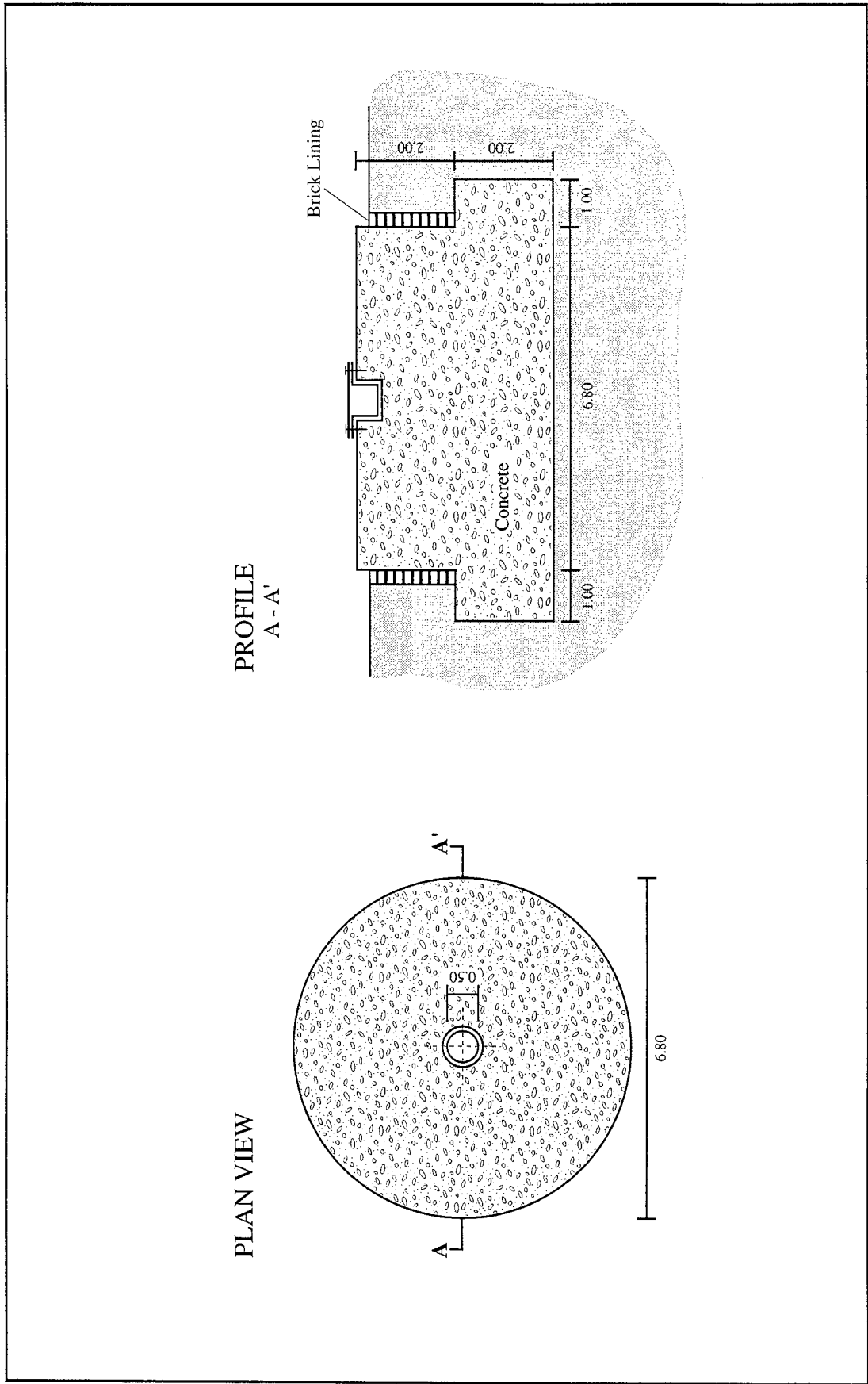

Figure 45. Plan and cross section drawing of the antenna base. The upper two meters are lined with brick. Derzhavinsk, Regiment 2, Silos 3. All measurements are in meters.



Figure 46. Excavating a pit along side a bermed storage bunker for the disposal of the bunker. The earth is brown, fine-grained silt and clay; the gray-white material is poorly sorted sand, possibly dumped in place during construction. Derzhavinsk, Regiment 2, Silo 3.



Figure 47. A pit has exposed the subterranean section of the "Force Protection" security building. The pit is partially filled with building rubble. Derzhavinsk, Regiment 2, Silo 2.



Figure 48. Cable salvaging operations. Four cables are being retrieved from one trench. Zhangiz Tobe. Courtesy of Brown & Root/ABB SUSA.

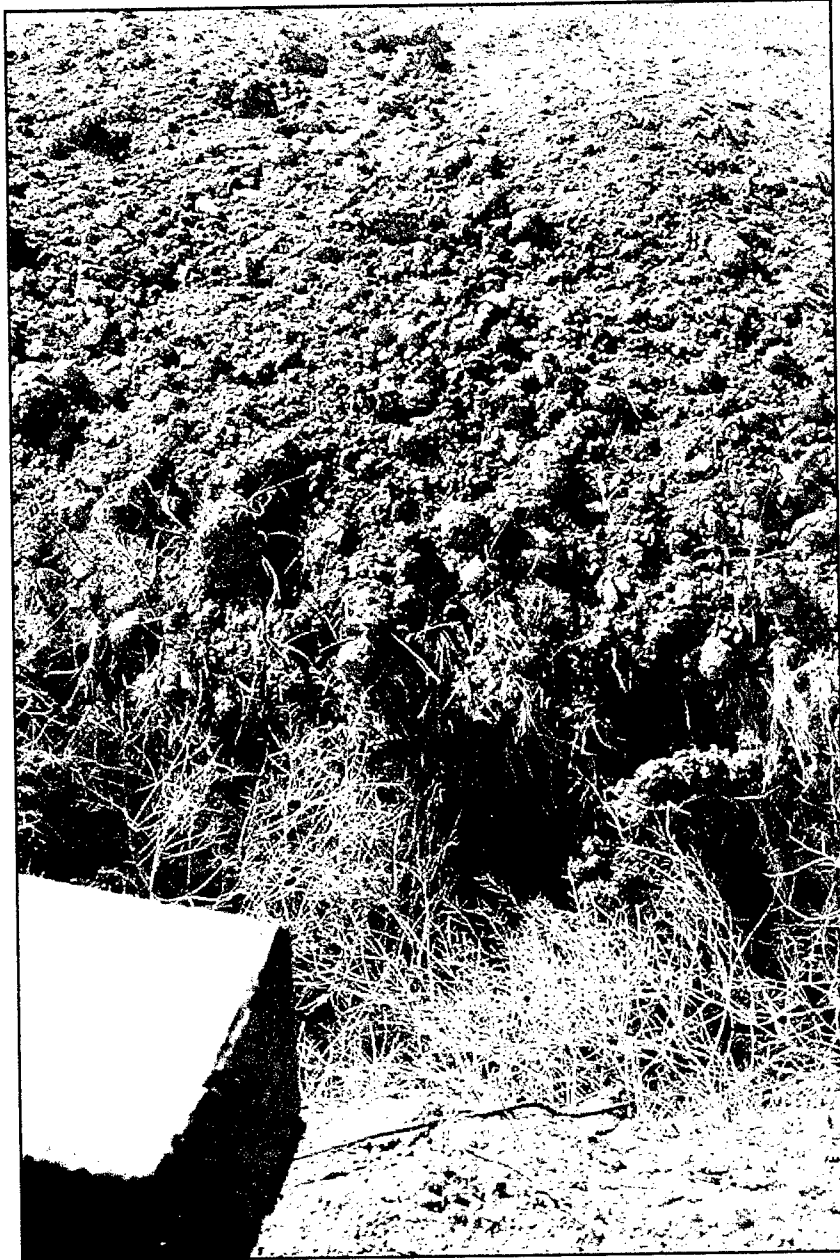

Figure 49. Trench dug for cable salvaging, revealing medium to dark brown fine-grained silt with abundant rock fragments. This soil is probably backfill rather than in-place material. The box on the left is about 23 centimeters on a side. Derzhavinsk, Regiment 2, Silos 5/7.



Figure 50. A completed, graded site ready to be turned over to the Kazakhstan State Land Commission. Derzhavinsk, Regiment 1, Silo 4.

Section 5
References

Brown & Root/ABB SUSA, Inc, 1996, Site-Specific Environmental Site Assessment Report, SS-18 ICBM Silo Dismantlement - Kazakhstan. Zhangiz-Tobe, Regiment 2, Silo Sites 5 and 7 (ZG205/7), (November), for: U.S. Defense Special Weapons Agency, contract no. DSWA 001-95-C-0216 (UNCLASSIFIED)

Brown & Root/ABB SUSA, Inc, 1997, Site-Specific Environmental Site Assessment Report, SS-18 ICBM Silo Dismantlement - Kazakhstan. Derzhavinsk, Regiment 5, Silo Site 5/7 (DZ505/7), (March), for: U.S. Defense Special Weapons Agency, contract no. DSWA 001-95-C-0216 (UNCLASSIFIED)

Brown & Root/ABB SUSA, Inc, 1997 (?), Environmental Site Assessment Report, SS-18 ICBM Silo Dismantlement - Kazakhstan. Derzhavinsk, Regiments 2,4,7,8, for: U.S. Defense Special Weapons Agency, contract no. DSWA 001-95-C-0216 (UNCLASSIFIED)

Churinov, M. V., (chief ed.), 1968, Inzhenerno-geologicheskaya karta SSSR (Engineering-geologic map of the USSR), Ministerstvo Geologii SSSR, VSEGINGEO, scale 1:2,500,000 (UNCLASSIFIED)

Cochran, T. B., Arkin, W. M., Norris, R. S., and Sands, J. I., 1989, Nuclear Weapons Databook, Volume IV, Soviet Nuclear Weapons, Harper & Row, New York, 433 p (UNCLASSIFIED)

Dukhanin, V. I., and Marinov, N. A., (eds.), 1964, Hidrogeologicheskaya karta SSSR (Geohydrologic map of the USSR), Ministerstvo Geologii SSSR, VSEGINGEO, scale 1:2,500,000 (UNCLASSIFIED)

Karkhevich, D. S., (Chief ed.), 1968, Karta magmaticheskikh formatsii SSSR (Map of the magmatic formations of the USSR), Ministerstvo Geologii SSSR, VSEGEI, scale 1:2,500,000 (UNCLASSIFIED)

Nalivkin, D. V., (Chief ed.), 1965, Geologicheskaya karta SSSR (Geologic map of the USSR), Ministerstvo Geologii SSSR, scale 1:2,500,000 (UNCLASSIFIED)

U.S. Department of Defense, 1990, Soviet Military Power, USGPO, Washington, D.C., 111 p (UNCLASSIFIED)

DISTRIBUTION LIST

DEPARTMENT OF DEFENSE

DEFENSE TECHNICAL INFORMATION CENTER
8725 JOHN J. KINGMAN ROAD, SUITE 0944
FORT BELVOIR, VA 22060-6218
ATTN: DTIC/OCP

HEADQUARTERS
DEFENSE THREAT REDUCTION AGENCY
45045 AVIATION DRIVE
DULLES, VA 20166-7517

ATTN: AMS
ATTN: AS
ATTN: ASA
ATTN: ASR
ATTN: AST
ATTN: CBC
ATTN: CBC
ATTN: CBP
ATTN: CI
ATTN: CIB
ATTN: CIC
ATTN: CICD
ATTN: CICN
ATTN: CIE
ATTN: CIF
ATTN: CII
ATTN: CIJ
ATTN: CIM
ATTN: CS
ATTN: CSD
ATTN: DDIR
ATTN: EO
ATTN: FM
ATTN: FMA
ATTN: FMAA
ATTN: FMB
ATTN: FMBD
ATTN: FMBP
ATTN: FMBT
ATTN: FMM
ATTN: GC
ATTN: HS
ATTN: IG
ATTN: IS
ATTN: ISO
ATTN: ISON
ATTN: ISOS
ATTN: ISP
ATTN: ISR
ATTN: ISRA
ATTN: ISRC
ATTN: ISS
ATTN: ISSB
ATTN: ISSD
ATTN: ISSM
ATTN: ISX

ATTN: LA
ATTN: OS
ATTN: OSA
ATTN: OSAC
ATTN: OSAE
ATTN: OSAN
ATTN: OSAO
ATTN: OSAS
ATTN: OSAU
ATTN: OSB
ATTN: OSC
ATTN: OSCH
ATTN: OSCT
ATTN: OST, C. OWENS
ATTN: OST, DR C. GALLAWAY
ATTN: OSTP, R. YOHO

DEFENSE THREAT REDUCTION AGENCY
6801 TELEGRAPH ROAD
ALEXANDRIA, VA 22310-3398

ATTN: CP
ATTN: CP, DR D. LINGER
ATTN: CPF
ATTN: CPF, R. JIH
ATTN: CPOD, S. DAINS
ATTN: CPOH, DR. P. CASTLEBERRY
ATTN: CPW
ATTN: CPW, C. MCFARLAND
ATTN: CPW, MAJ T. SMITH
ATTN: CPWE, DR L. WITTWER
ATTN: CPWPT
ATTN: NSNS, J. BRACKETT
ATTN: NSO
ATTN: NSOCS, G. BAIRD
ATTN: NSOM, R. D. ROSS
ATTN: NSP
ATTN: NSS
ATTN: NSSA
ATTN: NSSE, LCDR D. DEVANY
ATTN: NSSN, LCDR S. O'TOOLE
ATTN: NSSS, DR K. WARE

DEFENSE THREAT REDUCTION AGENCY
ALBUQUERQUE OPERATIONS
1680 TEXAS STREET, SE
KIRTLAND AFB, NM 87117-5669

ATTN: AORII
ATTN: AORP
ATTN: AORS
ATTN: AORSA
ATTN: AORSE, CPT D. RYNDERS
ATTN: AORSH
ATTN: AORSL
ATTN: AORSS
ATTN: AOS

DEFENSE THREAT REDUCTION AGENCY
ALBUQUERQUE OPERATIONS
1680 TEXAS STREET, SE
KIRTLAND AFB, NM 87117-5669
ATTN: AOS, K. WILLIAMS
ATTN: CPT
ATTN: CPT, P. THOMPSON
ATTN: CPTI
ATTN: CPTM
ATTN: CPTO, D. WALTERS
ATTN: CPTOE
ATTN: CPTOH
ATTN: CPTON
ATTN: CPTOT
ATTN: CPTP
ATTN: CPTP, DR B. RISTVET
ATTN: NSCO
ATTN: NSOCC
ATTN: NSOCM
ATTN: NSOCO
ATTN: NSOS
ATTN: NSOSS
ATTN: NSOW

DEFENSE THREAT REDUCTION AGENCY
NEVADA OPERATIONS
P. O. BOX 208
MERCURY, NV 89023-0208
ATTN: CPTON, E. SHANHOLTZ,
BUILDING #143
ATTN: CPTON, J. HOLZGRAFE,
BUILDING #143
ATTN: CPTON, L. J. GABRIEL,
BUILDING #143
ATTN: CPTON, R. CARNERO,
BUILDING #143

DEPARTMENT OF DEFENSE CONTRACTORS

ITT INDUSTRIES
ITT SYSTEMS CORPORATION
ATTN: AODTRA/DASIAC
1680 TEXAS STREET, SE
KIRTLAND AFB, NM 87117-5669
ATTN: DASIAC
ATTN: DASIAC/DARE

JAYCOR
1410 SPRING HILL RD., SUITE 300
MCLEAN, VA 22102
ATTN: DR. C. P. KNOWLES

LACHEL & ASSOCIATES INC.
P. O. BOX 5266
GOLDEN CO 80401
ATTN: D. LACHEL

LACHEL & ASSOCIATES, INC
17 CORN HILL DRIVE
MORRISTOWN, NJ 07960
ATTN: D. CHAPMEN

LACHEL & ASSOCIATES, INC.
301B COMMERCE STREET
P. O. BOX 406
OCCAQUAN, VA 22151
ATTN: MS L. BYKOWSKY

LACHEL & ASSOCIATES, INC.
3212 TITANIC DRIVE
STAFFORD, VA 22554
ATTN: C. R. LINAMEN

LOGICON R&D ASSOCIATES
6940 S. KINGS HIGHWAY, SUITE 202
ALEXANDRIA, VA 22310
ATTN: L. MILLS
ATTN: R. LEWIS
ATTN: T. SANDIN

SCIENCE & ENGINEERING ASSOCIATES,
INC.
7918 JONES BRANCH DRIVE, SUITE 500
MCLEAN, VA 22102
ATTN: R. BEATTY

DEPARTMENT OF ENERGY

DEPARTMENT OF ENERGY
1000 INDEPENDENCE AVENUE, SW
WASHINGTON, DC 20585-0420
ATTN: MS L. CASEY, DP-5.1

UNIVERSITY OF CALIFORNIA
LAWRENCE LIVERMORE NATIONAL
LABORATORY
P. O. BOX 808
LIVERMORE, CA 94551-9900
ATTN: L-200, L. GLENN

LOS ALAMOS NATIONAL LABORATORY
P. O. BOX 1663
LOS ALAMOS, NM 87545
ATTN: C. PEARSON, MS-C335, EE53,

OTHER GOVERNMENT

US DEPARTMENT OF THE INTERIOR
US GEOLOGICAL SURVEY
NATIONAL CENTER, MS 926-A
12201 SUNRISE VALLEY DRIVE
RESTON, VA 20192
ATTN: W. LEITH
ATTN: J. R. MATZKO