

NORTH ATLANTIC TREATY ORGANIZATION



RESEARCH AND TECHNOLOGY ORGANIZATION

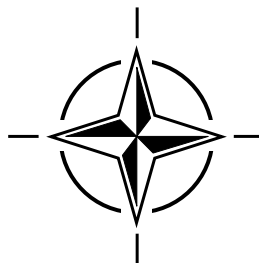
BP 25, 7 RUE ANCELLE, F-92201 NEUILLY-SUR-SEINE CEDEX, FRANCE

RTO TECHNICAL REPORT 29

# Flight Control Design – Best Practices

(la Conception des systèmes de commande de vol – Les meilleures pratiques)

*This report prepared by Task Group SCI-026 on Flight Control Law Design and has been sponsored by the former Flight Vehicle Integration Panel of AGARD, and the Systems, Concepts and Integration (SCI) Panel of RTO.*



## Form SF298 Citation Data

<b>Report Date</b> <i>("DD MON YYYY")</i> 01122000	<b>Report Type</b> N/A	<b>Dates Covered (from... to)</b> <i>("DD MON YYYY")</i>
<b>Title and Subtitle</b> Flight Control Design Best Practices		<b>Contract or Grant Number</b>
		<b>Program Element Number</b>
<b>Authors</b>		<b>Project Number</b>
		<b>Task Number</b>
		<b>Work Unit Number</b>
<b>Performing Organization Name(s) and Address(es)</b> Research and Technology Organization North Atlantic Treaty Organization BP 25, 7 rue Ancelle F92201 Neuilly-sur-Seine Cedex, France		<b>Performing Organization Number(s)</b>
<b>Sponsoring/Monitoring Agency Name(s) and Address(es)</b>		<b>Monitoring Agency Acronym</b>
		<b>Monitoring Agency Report Number(s)</b>
<b>Distribution/Availability Statement</b> Approved for public release, distribution unlimited		
<b>Supplementary Notes</b>		
<b>Abstract</b> Accidents due to adverse aircraft-pilot coupling phenomena in the latest technology aircraft occurred both in the US and in Europe, while other programs had less-well-publicized flight control development problems. These events showed that a robust and affordable solution to the development process of digital flight control systems was not universally available. This Technical Report begins with a review of some examples of flight control problems. They span the history of flight from the time when the practice of flying was preceding theoretical developments up to the recent events. There is a chapter detailing lessons learned from various programs with positive results. The review of problems and lessons learned leads into a chapter detailing a series of recommended design best practices. The best practices are laid out as a logical process with recommendations for avoiding the pitfalls that have led to problems in the past. The second part of the report continues with some theoretical aspects, such as flying qualities criteria and carefree handling, the latest results from analytical and research activities into PIOs, and modelling and system identification to support the design process. The report concludes with suggestions for required future research.		

**Subject Terms**

Flight control; Simulation; Lessons learned; Design; Aircraft; Best practices; Aviation safety; PIO (Pilot Induced; Handling qualities; Aviation accidents; Oscillations)

**Document Classification**

unclassified

**Classification of SF298**

unclassified

**Classification of Abstract**

unclassified

**Limitation of Abstract**

unlimited

**Number of Pages**

215

## REPORT DOCUMENTATION PAGE

<b>1. Recipient's Reference</b>	<b>2. Originator's References</b>  RTO-TR-029 AC/323(SCI)TP/23	<b>3. Further Reference</b>  ISBN 92-837-1047-9	<b>4. Security Classification of Document</b>  UNCLASSIFIED/ UNLIMITED
<b>5. Originator</b> Research and Technology Organization North Atlantic Treaty Organization BP 25, 7 rue Ancelle, F-92201 Neuilly-sur-Seine Cedex, France			
<b>6. Title</b>  Flight Control Design – Best Practices			
<b>7. Presented at/sponsored by</b>  the former Flight Vehicle Integration Panel of AGARD, and the Systems, Concepts and Integration (SCI) Panel of RTO.			
<b>8. Author(s)/Editor(s)</b>  Multiple			<b>9. Date</b>  December 2000
<b>10. Author's/Editor's Address</b>  Multiple			<b>11. Pages</b>  214
<b>12. Distribution Statement</b> There are no restrictions on the distribution of this document. Information about the availability of this and other RTO unclassified publications is given on the back cover.			
<b>13. Keywords/Descriptors</b>			
Flight control Design Aviation safety Aviation accidents	Simulation Aircraft PIO (Pilot Induced Oscillations)	Lessons learned Best practices Handling qualities	
<b>14. Abstract</b>			
<p>Accidents due to adverse aircraft-pilot coupling phenomena in the latest technology aircraft occurred both in the US and in Europe, while other programs had less-well-publicized flight control development problems. These events showed that a robust and affordable solution to the development process of digital flight control systems was not universally available. This Technical Report begins with a review of some examples of flight control problems. They span the history of flight from the time when the practice of flying was preceding theoretical developments up to the recent events. There is a chapter detailing lessons learned from various programs with positive results. The review of problems and lessons learned leads into a chapter detailing a series of recommended design best practices. The best practices are laid out as a logical process with recommendations for avoiding the pitfalls that have led to problems in the past. The second part of the report continues with some theoretical aspects, such as flying qualities criteria and “carefree handling”, the latest results from analytical and research activities into PIOs, and modelling and system identification to support the design process. The report concludes with suggestions for required future research.</p>			

**This page has been deliberately left blank**



**Page intentionnellement blanche**

**NORTH ATLANTIC TREATY ORGANIZATION**



**RESEARCH AND TECHNOLOGY ORGANIZATION**

BP 25, 7 RUE ANCELLE, F-92201 NEUILLY-SUR-SEINE CEDEX, FRANCE

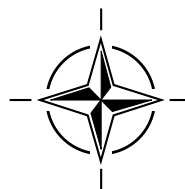
---

**RTO TECHNICAL REPORT 29**

## **Flight Control Design – Best Practices**

(la Conception des systèmes de commande de vol – Les meilleures pratiques)

*This report prepared by Task Group SCI-026 on Flight Control Law Design and has been sponsored by the former Flight Vehicle Integration Panel of AGARD, and the Systems, Concepts and Integration (SCI) Panel of RTO.*



# The Research and Technology Organization (RTO) of NATO

RTO is the single focus in NATO for Defence Research and Technology activities. Its mission is to conduct and promote cooperative research and information exchange. The objective is to support the development and effective use of national defence research and technology and to meet the military needs of the Alliance, to maintain a technological lead, and to provide advice to NATO and national decision makers. The RTO performs its mission with the support of an extensive network of national experts. It also ensures effective coordination with other NATO bodies involved in R&T activities.

RTO reports both to the Military Committee of NATO and to the Conference of National Armament Directors. It comprises a Research and Technology Board (RTB) as the highest level of national representation and the Research and Technology Agency (RTA), a dedicated staff with its headquarters in Neuilly, near Paris, France. In order to facilitate contacts with the military users and other NATO activities, a small part of the RTA staff is located in NATO Headquarters in Brussels. The Brussels staff also coordinates RTO's cooperation with nations in Middle and Eastern Europe, to which RTO attaches particular importance especially as working together in the field of research is one of the more promising areas of initial cooperation.

The total spectrum of R&T activities is covered by the following 7 bodies:

- AVT Applied Vehicle Technology Panel
- HFM Human Factors and Medicine Panel
- IST Information Systems Technology Panel
- NMSG Modelling and Simulation Group
- SAS Studies, Analysis and Simulation Panel
- SCI Systems Concepts and Integration Panel
- SET Sensors and Electronics Technology Panel

These bodies are made up of national representatives as well as generally recognised 'world class' scientists. They also provide a communication link to military users and other NATO bodies. RTO's scientific and technological work is carried out by Technical Teams, created for specific activities and with a specific duration. Such Technical Teams can organise workshops, symposia, field trials, lecture series and training courses. An important function of these Technical Teams is to ensure the continuity of the expert networks.

RTO builds upon earlier cooperation in defence research and technology as set-up under the Advisory Group for Aerospace Research and Development (AGARD) and the Defence Research Group (DRG). AGARD and the DRG share common roots in that they were both established at the initiative of Dr Theodore von Kármán, a leading aerospace scientist, who early on recognised the importance of scientific support for the Allied Armed Forces. RTO is capitalising on these common roots in order to provide the Alliance and the NATO nations with a strong scientific and technological basis that will guarantee a solid base for the future.

The content of this publication has been reproduced directly from material supplied by RTO or the authors.

Published December 2000

Copyright © RTO/NATO 2000  
All Rights Reserved

ISBN 92-837-1047-9



*Printed by Canada Communication Group Inc.  
(A St. Joseph Corporation Company)  
45 Sacré-Cœur Blvd., Hull (Québec), Canada K1A 0S7*

# **Flight Control Design – Best Practices**

**(RTO TR-029)**

## **Executive Summary**

This Task Group (formerly AGARD Working Group 23) was formally initiated in 1996, with the genesis and rationale contained in a pilot paper written in September 1994. The document cited applications of advanced Flight Control Systems (FCS) in the 1980s and early '90s. Despite numerous significant successes having been achieved, as demonstrated by the number of experimental and production aircraft based on digital flight controls that flew successfully, major programmes of primary importance to NATO had suffered from troubled FCS developments. Well-publicized and highly visible accidents due to adverse oscillatory aircraft-pilot coupling phenomena in the latest technology aircraft occurred both in the US and in Europe. Other programs had less-well-publicized FCS development problems, with time and cost overruns more the rule than the exception. These events show that notwithstanding the successes, a robust and affordable solution to the development process of digital flight control systems that are proven to be safe from a flying qualities point of view was not universally available.

The first part of the report begins with a review of some examples of flight control problems. They span the history of flight from the time when the practice of flying was preceding theoretical developments up to more recent time when it might be thought that flight control designers “should know better”. Much of the information is incomplete, but the chapter finishes with an example of a problem and the solution being published together. Then there is a chapter detailing lessons learned from various programs with positive results, which leads into a section detailing a series of recommended best practices. The best practices are laid out as a logical process with recommendations for avoiding the pitfalls that have led to problems in the past. It is NOT, however, a “cookbook” process that can be followed blindly. Using (good) engineering analysis and judgement, and following the defined process, will ensure a successful design.

The second part of the report continues with some theoretical aspects. First, there is a discussion of flying qualities criteria, especially the US military specifications. This brief discussion covers the evolution of the specifications covering both good and bad points, together with the common misinterpretations. The current state of the art of “carefree handling” is presented, defined as flying qualities that allow pilot commanded maneuvering without adverse characteristics, such as departures, requiring the pilot’s attention. Then, there is a discussion of demonstration maneuvers as a flying qualities evaluation tool. It is emphasized that these maneuvers should be used aggressively during the early development phase to uncover possible problem areas and to feed data back into the analytical design process. Next there is an extensive discussion of the latest results from analytical and research activities into PIOs. The section is aimed at presenting and assessing a number of PIO criteria to augment the design process defined under the best practices. A discussion of modelling and system identification is then included to present the current state of the art in this important area, which is evolving very rapidly because of the continuous improvements in both hardware and software. The Task Group members originally laid out this report to present an assessment of design methods, but no correlation has been found between the method used and the problems of the past, or the successes. The benefits of advanced methods are primarily in terms of greater efficiency, with a shorter design cycle translating into cost savings. No method will guarantee success by itself, since it still needs the correct design criteria and the other components of the best practices process as defined in this report.

The report concludes with suggestions for required future research.



# la Conception des systèmes de commande de vol – Les meilleures pratiques

(RTO TR-029)

## Synthèse

Les origines et la mission de ce groupe de travail (anciennement WG 23 de l'AGARD), créé en 1996, se trouvent dans un document d'orientation édité en 1994. Ce document faisait état des applications de systèmes de commande de vol avancés (FCS) réalisées dans les années 1980 et au début des années 1990. Malgré les nombreux et importants résultats obtenus pendant cette période, comme en témoigne le nombre de vols réussis par des aéronefs expérimentaux et de série équipés de commandes de vol numériques, certains grands programmes, d'une importance primordiale pour l'OTAN, ont connu des perturbations lors du développement de leurs FCS. Des accidents spectaculaires, dont les comptes rendus ont été publiés dans la presse, occasionnés par des phénomènes oscillatoires générés par un déphasage entre les actions du pilote et les mouvements des commandes de vol ont impliqué les aéronefs de la dernière génération aux Etats-Unis et en Europe. D'autres programmes ont souffert de problèmes de développement FCS moins relayés par les médias, à savoir des dépassements de délais et de coûts devenant la règle plutôt que l'exception. Ces événements fournissent la preuve que, malgré les réussites enregistrées, une solution durable à coût abordable du problème du développement de systèmes de commande de vol numériques, acceptables du point de vue des qualités de vol, n'était pas universellement disponible à l'époque.

La première partie du rapport donne quelques exemples de problèmes de commandes de vol. Ils couvrent toute l'histoire du vol, depuis l'époque où la pratique du vol était en avance sur les développements théoriques jusqu'à une époque plus récente, où, selon certains, les concepteurs des commandes de vol « auraient dû être plus avisés dans leurs choix ». Bon nombre de ces informations sont incomplètes, mais le chapitre se termine par l'exemple d'un problème et sa solution. Le chapitre qui suit présente les enseignements tirés des différents programmes ayant donné des résultats positifs, suivis d'une section qui propose une série de meilleures pratiques recommandées. Celles-ci sont présentées comme un procédé logique et sont accompagnées de recommandations pour éviter les pièges à l'origine de problèmes rencontrés dans le passé. Il ne s'agit pourtant pas, d'une « recette » à suivre aveuglément. La garantie d'une conception réussie passe par la conformité avec un procédé bien défini et par l'exercice d'un bon jugement et d'une bonne analyse technique.

La deuxième partie du rapport traite de certains aspects théoriques. Vient d'abord un débat sur les critères de qualités de vol, en particulier sur les spécifications militaires américaines. Ce court débat porte sur l'évolution des spécifications et souligne les points forts et les points faibles, ainsi que les fausses interprétations courantes. L'état actuel des connaissances dans le domaine du « pilotage sans-souci » est présenté et défini comme les qualités de vol permettant au pilote de manoeuvrer sans avoir à se soucier de réactions incontrôlées, telles que les déclenchements. Cette présentation est suivie d'une discussion sur l'intérêt des manoeuvres de démonstration en tant qu'outil d'évaluation des qualités de vol. Il est souligné que ces manoeuvres doivent être exécutées aux limites lors des premières phases du développement pour révéler d'éventuels problèmes et pour ensuite apporter des données au processus de conception analytique. Cette discussion est suivie d'une autre, très approfondie, sur les derniers résultats des activités analytiques et de recherche sur le pompage piloté (PIO). Aux yeux de certains, cette discussion peut paraître plutôt destinée à ceux qui font abstraction des meilleures pratiques, ainsi que du reste du rapport. Une discussion sur la modélisation et l'identification des systèmes vient ensuite, afin de présenter l'état actuel des connaissances dans ce domaine important, qui évolue très rapidement sous l'effet des améliorations constantes du matériel et des logiciels.

A l'origine, les membres du groupe de travail avaient envisagé ce rapport comme une évaluation des méthodes de conception, mais aucune corrélation n'a été trouvée entre méthode utilisée et réussites connues et les problèmes rencontrés dans le passé. Les avantages des méthodes avancées consistent principalement en une plus grande efficacité, avec un cycle de conception réduit, conduisant à des économies de coûts. Aucune méthode en soi ne peut garantir la réussite, puisque, pour bien fonctionner elle a toujours besoin de critères de conception appropriés et des autres éléments du processus des meilleures pratiques tels que définis dans ce rapport.

Le rapport se termine par des suggestions concernant de nécessaires futurs travaux de recherche.

# Contents

	<b>Page</b>
<b>Executive Summary</b>	<b>iii</b>
<b>Synthèse</b>	<b>iv</b>
<b>List of Figures and Tables</b>	<b>vii</b>
<b>Acknowledgements</b>	<b>x</b>
<b>CHAPTER 1 INTRODUCTION</b>	<b>1</b>
<b>CHAPTER 2 BACKGROUND SURVEY OF FCS PROBLEMS</b>	<b>5</b>
2.1 Historical Perspective	5
2.1.1 The Wright Brother's Flyer	5
2.1.2 Bell X-2	6
2.1.3 North American F-100A	6
2.1.4 Hawker-Siddeley AV-8 Harrier	7
2.1.5 McDonnell Douglas F4H-1	7
2.1.6 M2F2 Lifting Body	8
2.1.7 Space Shuttle Orbiter	9
2.1.8 General Dynamics YF-16A	9
2.1.9 Rockwell B-1A	10
2.1.10 Wills Wing Hang Glider	11
2.1.11 Summary	12
2.2 SAAB Gripen Experience	12
2.2.1 The First PIO Accident (February 1989)	12
2.2.2 The Second PIO Accident (April 1990)	14
2.3 YF-22 Experience	15
<b>CHAPTER 3 LESSONS LEARNED</b>	<b>19</b>
3.1 Tornado Spin Prevention and Incidence Limiting System	19
3.2 Fly-By-Wire Jaguar	21
3.3 The Experimental Aircraft Programme	22
3.3.1 Flying Qualities Design	23
3.4 Control Laws Design for VAAC Harrier	24
3.5 STOL & Manoeuvre Technology Demonstrator Program	25
3.5.1 Flying Qualities Requirements	26
3.5.2 Design Methodology	29
3.5.3 Atmospheric Disturbance Models	31
3.5.4 Management of FCS Development Tasks	31
3.6 F-22 Re-design Experience	32
3.6.1 Flying Qualities	32
3.6.2 Use of Piloted Simulation	36
3.6.3 Effects of Non-Linearities	36
3.6.4 Summary	37
3.7 X-31 Experience	38
3.8 Transports and Large Aircraft	39

<b>CHAPTER 4 BEST DESIGN PRACTICES</b>	<b>41</b>
4.1 Establishing the Aerodynamic Design and System Performance Requirements	43
4.2 Modelling and Analysis of the Unaugmented Vehicle	44
4.3 Design Criteria and Flying Qualities Specifications	45
4.4 Control Laws Design and Development	46
4.5 Control Laws Functional Specification, Implementation and Verification	47
4.6 Piloted Simulation and Handling Qualities	48
4.7 Aeroservoelasticity and Structural Mode Filter Design	49
4.8 Design Robustness and Flight Clearance	50
4.9 Developments During Flight Testing	50
4.10 Management Aspects	52
4.11 Design Considerations for PIO Prevention	53
4.11.1 An Overview of PIO	53
4.11.2 Type 1 PIO Prevention	54
4.11.3 Type 2 PIO Prevention	54
4.11.4 Type 3 PIO Prevention	55
4.11.5 Actuation System Considerations	55
4.11.6 Control Law Considerations	56
4.11.7 Summary	56
<b>CHAPTER 5 THEORETICAL ASPECTS</b>	<b>57</b>
5.1 Flying Qualities	57
5.1.1 Flying Qualities Criteria	57
5.1.2 Carefree Handling	57
5.1.3 Flying Quality Demonstration Manoeuvres	71
5.2 Discussion of PIO Criteria	75
5.2.1 Category I PIO	77
5.2.2 Category II PIO	101
5.2.3 Category III PIO	127
5.3 Modelling and System Identification	128
5.3.1 Introduction	128
5.3.2 Modelling for Control System Design	130
5.3.3 Physical Model-Building Leading to Automatic Code Generation	140
5.3.4 System Identification and Model Validation	145
<b>CHAPTER 6 CONCLUSIONS &amp; RECOMMENDATIONS</b>	<b>163</b>
6.1 What are the true problems associated with flight control law design?	163
6.2 Why has the design task become so complicated?	164
6.3 What are the real design requirements?	164
6.4 What are the best design practices?	165
6.5 What is the best way to handle uncertainty?	166
6.6 What do the modern/advanced design techniques really offer?	166
6.7 What can be done to support current and future projects?	167
<b>CHAPTER 7 REFERENCES</b>	<b>169</b>
<b>ANNEX A Glossary of Terms</b>	<b>183</b>
<b>ANNEX B Acronyms</b>	<b>193</b>

# List of Figures and Tables

<b>Figures</b>	<b>Page</b>
Figure 2.3.1 YF-22 PIO Time History	16
Figure 2.3.2 Smith-Geddes Criteria Results for the YF-22	17
Figure 2.3.3 Gibson Phase Rate Criteria Results for the YF-22	17
Figure 2.3.4 Bandwidth Criteria Results for the YF-22	17
Figure 3.1.1 Tornado Time Histories	20
Figure 3.5.1 The STOL & Manoeuvre Technology Demonstrator	25
Figure 3.5.2 Choice of Design Approach	29
Figure 3.5.3 Convergence of Design Approaches	30
Figure 3.6.1 YF-22 Pitch Command Gradients	34
Figure 3.6.2 Smith-Geddes Criteria Results for the F-22	35
Figure 3.6.3 Gibson Phase Rate Criteria Results for the F-22	35
Figure 3.6.4 Bandwidth Criteria Results for the F-22	35
Figure 4.1 Flight Control System Design Process	41
Figure 5.1.1 Reduction of Pedal Authority	60
Figure 5.1.2 Warning Curves	61
Figure 5.1.3 Simulation of deceleration flights with digital flight controller (full back stick)	61
Figure 5.1.4 Carefree Design Process	62
Figure 5.1.5 Time Responses	63
Figure 5.1.6 Simplified Control Law Structure for Carefree Manoeuvring	63
Figure 5.1.7 Example Limitation for the Prototype	64
Figure 5.1.8 Pilot Activated Recovery Regions	65
Figure 5.1.9 Time Available Determination for Nuisance Criteria	66
Figure 5.1.10 Nuisance Criteria Results	67
Figure 5.1.11 Algorithm Architecture	68
Figure 5.1.12 Auto GCAS Display	68
Figure 5.1.13 Scan Pattern Variations with Turn Rate	69
Figure 5.1.14 New Scan Pattern Variations	69
Figure 5.2.1 Understanding PIO (the flying qualities cliff)	76
Figure 5.2.2 Influence of the high frequency phase roll-off on the pilot rating (Neal-Smith database)	77
Figure 5.2.3 Application of the Neal-Smith criterion to the landing databases LAHOS, HAVE PIO, HAVE CONTROL	80
Figure 5.2.4 Application of the bandwidth/phase delay criterion to the landing databases LAHOS, HAVE PIO, HAVE CONTROL	81
Figure 5.2.5 Application of the Smith-Geddes criterion to the landing databases LAHOS, HAVE PIO, HAVE CONTROL	83
Figure 5.2.6 Application of the phase rate criterion to the landing databases LAHOS, HAVE PIO, HAVE CONTROL	84
Figure 5.2.7 The gain phase template part of the Average Phase Rate criterion, with the evaluation of configuration LAHOS 5_1	85
Figure 5.2.8 Evaluation of the LAHOS configuration 5_1 by the Gibson gain-phase criterion	86
Figure 5.2.9 Definition of vector margin VM	87
Figure 5.2.10 Application of the Vector Margin criterion to the landing databases LAHOS, HAVE PIO, HAVE CONTROL	87
Figure 5.2.11 Selection of a VM bound for PIO proneness	88
Figure 5.2.12 Pitch rate box-car input used in the definition of Dropback	89

Figure 5.2.13	Definition of Dropback parameter by Gibson	89
Figure 5.2.14	Application of Gibson Dropback criterion to the landing databases LAHOS, HAVE PIO, HAVE CONTROL	90
Figure 5.2.15	Definition of the new dropback parameter	91
Figure 5.2.16	Application of the new dropback criterion to the landing databases LAHOS, HAVE PIO, HAVE CONTROL	91
Figure 5.2.17	Application of the Hess-Kalteis criterion to the landing databases LAHOS, HAVE PIO, HAVE CONTROL	93
Figure 5.2.18	Pilot-Vehicle System for Hess Criterion	94
Figure 5.2.19	Hess criterion mappings for selected LAHOS configurations, Handling Qualities Sensitivity Functions	97
Figure 5.2.20	Hess criterion mappings for selected LAHOS configurations, PSD of scaled proprioceptive feedback signals	98
Figure 5.2.21	Time delay induced by rate limiting	101
Figure 5.2.22	Application of Bandwidth/Phase Delay criterion to X-15 non-linear data	102
Figure 5.2.23	Analysis model of the X-15 Landing flare PIO	103
Figure 5.2.24	Rate limited actuator with first-order linear dynamics	104
Figure 5.2.25	X-15 Describing function analysis	104
Figure 5.2.26	X-15 Describing function analysis, zoom on critical point area	105
Figure 5.2.27	Jump phenomenon after rate limiting onset	106
Figure 5.2.28	Physical significance of the OLOP parameter	106
Figure 5.2.29	Verification of the PIO boundary by off-line simulations (OLOP criterion)	108
Figure 5.2.30	YF-16 first flight PIO analysis	109
Figure 5.2.31	Typical time histories of two simulator runs with a Category II PIO prone configuration	110
Figure 5.2.32	Validation of the OLOP criterion with experimental data	111
Figure 5.2.33	Closed loop diagram for Category II PIO analysis	111
Figure 5.2.34	Saturation non-linear characteristic	112
Figure 5.2.35	Robust stability analysis block diagram	112
Figure 5.2.36	Describing Function analysis block diagram	113
Figure 5.2.37	Robust stability of uncertain linear system	114
Figure 5.2.38	Equivalent linear model of the rate limited actuator	115
Figure 5.2.39	X-15. Robust stability analysis with respect to pilot gain $K_p$ and actuator parameter $L$	116
Figure 5.2.40	X-15 Root locus for varying actuator parameter $L$	117
Figure 5.2.41	X-15 PIO Analysis with the Popov approach	118
Figure 5.2.42	X-15. Comparison of limit cycle frequency predicted by: 1) DF analysis, 2) RSA, 3) time simulations (TS) of the Simulink non-linear model	119
Figure 5.2.43	Hess non-linear criterion application results for selected configurations	120
Figure 5.2.44	Pilot-Vehicle System definition for Application of Time Domain Neal-Smith Criterion	121
Figure 5.2.45	Pitch Response in a Step Target Acquisition Task	122
Figure 5.2.46	Simulink Model used for Time Domain Neal-Smith criterion application	123
Figure 5.2.47	Time domain Neal-Smith criterion application results for selected linear configurations	124
Figure 5.2.48	Time domain Neal-Smith response for Category II PIO prone configuration	125
Figure 5.2.49	Time domain Neal-Smith response for PIO-free configuration	125
Figure 5.3.1	Aircraft simulation model	131
Figure 5.3.2	Unloaded Actuator Bandwidth vs. Input Amplitude, Experimental Results	136
Figure 5.3.3	Loaded Actuator Frequency Response	136
Figure 5.3.4	Actuator Model with and without Control Module Dynamics	137
Figure 5.3.5	Object diagram of HIRM	141

Figure 5.3.6	Aircraft model library	142
Figure 5.3.7	Structure of aircraft physical model	144
Figure 5.3.8	From system configuration to simulation/analysis model	145
Figure 5.3.9	The Quad-M basics of flight vehicle system identification	146
Figure 5.3.10	Frequency domain comparison of input signals	147
Figure 5.3.11	Estimates of canard control effectiveness from X-31A flight data	148
Figure 5.3.12	Schematic of output error method	150
Figure 5.3.13	Schematic of filter error method	151
Figure 5.3.14	Flight estimates of weathercock stability	154
Figure 5.3.15	Example of X-31A database update	156
Figure 5.3.16	Proof-of-match for short period dynamics	157
Figure 5.3.17	Proof-of-match in the frequency domain for pitch rate (short period dynamics)	158
Figure 5.3.18	Principle of <i>Explicit Model Following Control</i>	158
Figure 5.3.19	Principle of <i>Inverse Simulation</i>	159
Figure 5.3.20	Principle of <i>Simplified Inverse Simulation</i>	159
Figure 5.3.21	Advanced Technologies Testing Aircraft System (ATTAS)	159
Figure 5.3.22	Flight test data and model results (model without ground effect)	160
Figure 5.3.23	Flight test data and model results using the <i>Simplified Inverse Simulation</i> (model without ground effect)	161
Figure 5.3.24	Flight test data and model results using the <i>Simplified Inverse Simulation</i> (improved model with ground effect)	161

## Tables

Table 5.2.1	PIO categories	76
Table 5.2.2	Landing Databases (NT-33 flight test programs)	77
Table 5.2.3	Evaluation of PIO prediction	78
Table 5.2.4	PIO prediction with the Neal-Smith criterion	80
Table 5.2.5	PIO prediction with the bandwidth-phase delay criterion	82
Table 5.2.6	PIO prediction with the Smith-Geddes criterion	83
Table 5.2.7	PIO prediction with the Average Phase Rate plus gain-phase template criterion	85
Table 5.2.8	PIO prediction with the Gibson gain-phase template	86
Table 5.2.9	PIO prediction with the Vector Stability Margin	88
Table 5.2.10	PIO prediction with the Gibson dropback criterion	90
Table 5.2.11	PIO prediction with the new dropback criterion	92
Table 5.2.12	PIO prediction with the Bode gain template criterion by Hess and Kalteis	93
Table 5.2.13	CHR prediction with the Hess criterion	97
Table 5.2.14	PIO prediction with the Hess criterion	97
Table 5.2.15	Performance Indices of Category I PIO prediction criteria	98
Table 5.2.16	Summary of PIO criteria assessment	100
Table 5.2.17	Lateral databases for PIO research	107

# Acknowledgements

The members of Task Group SCI-026 were:

Dr. David J. Moorhouse (Chairman)	AFRL	USA
Mr. Wim de Boer	NLR	Netherlands
Mr. Chris Fielding	BAe	U.K.
Dr. Klaus-Uwe Hahn	DLR	Germany
Mr. Georg Hofinger	DASA	Germany
Dr. Jean-Francois Magni	ONERA	France (part time)
Dr. Leopoldo Verde	CIRA	Italy

Additional contributions to this report were made by (in alphabetical order):

Prof. Francesco Amato	U. of Naples	Italy
Mr. Moshe Attar	IAI	Israel
Mr. Thomas Black	USAF	USA
Mr. Finley Barfield	AFRL	USA
Mr. Thomas Cord	AFRL	USA
Mr. Pierluigi Capone	Aermacchi	Italy
Dr. Michael Dinkelmann	DASA	Germany
Dr. Holger Duda	DLR	Germany
Dr. John Gibson	Consultant	UK
Mr. Raffaele Iervolino	U. of Naples	Italy
Dr. Javindra Jategaonkar	DLR	Germany
Mr. Dieter Moormann	DLR	Germany
Dr. Stefano Scala	CIRA	Italy
Mr. Rogier van der Weerd	U. of Delft	Netherlands

## 1.0 INTRODUCTION

This Working Group (originally AGARD WG23) was formally initiated in 1996, with the genesis and rationale contained in a Pilot Paper written in September 1994. It is appropriate, therefore, to start with some thoughts from that document. The document cited applications of advanced Flight Control Systems (FCS) in the 1980's and early 90's. Despite numerous significant successes having been achieved, as demonstrated by the number of experimental and production aircraft based on Digital Flight Controls successfully flown, major programmes of primary importance to NATO had suffered from troubled FCS developments. Well-publicised and highly visible accidents due to adverse oscillatory aircraft-pilot coupling (synonymous with PIO, which is used in this report) phenomena in the latest technology aircraft occurred both in the US [Dornheim, 1992] and in Europe [Kullberg and Elcrona]. Other programs had less-well-publicised problems [e.g. Iloputaife] and FCS development problems causing time and cost overruns seemed to be more the rule than the exception. These events showed that, notwithstanding the successes, a robust and affordable development process for Digital Flight Control Systems that are proven to be safe from a Flying Qualities point of view was not universally available. In consideration of the criticality of these occurrences, in 1992 the USAF initiated an Aircraft Digital Flight Control System Technical Review to analyse the design process. One result of that study was that FCS problems were not unique to digital systems, there have been problems with every form of FCS design and therefore there are generic lessons to be learned. PIOs can be encountered in some light aircraft which feature too much elevator authority at low speed combined with too-light stick forces, which is a generic and common problem. While they can be delightful airplanes to fly with one's fingertips they demand to not be flown with heavy hands (the way student pilots usually fly airplanes!). There are, however, unique aspects of fly-by-wire (FBW) control systems that are discussed in this report. The most obvious, and frequently the most important, is that the direct connection between the pilot and the control surfaces is not there. Special attention is required to provide appropriate connectivity through the design of the FBW system. In addition, the very flexibility of the digital FBW technology has also given designers more flexibility for error in new ways. A particular example is the introduction of time delays and phase lags. These delays and/or lags, in combination with pilot command gains that are too high, are the basic design problem that is the cause of every recent FCS problem. There are, however, often additional factors that need to be addressed as discussed in this report.

The Pilot Paper also stated an additional element of concern in that the vast amount of experience gained so far is under risk of being lost because of the limited number of new programmes and the time elapsing between them. The Working Group has also found that many times the experience to avoid a particular problem had already existed, but was not available in a useful form or was just ignored as being "not applicable" (until later analyses of the problem). The skill required to design an advanced Flight Control System is not easily transferred and very little material exists in the open literature to be used as a reference handbook by designers. That was the intent of military specifications, i.e. to contain a repository of knowledge. They were often criticised by designers, and frequently not used or else used incorrectly. There is an almost universal misperception that the US Military Flying Qualities Specifications applied only to linear characteristics. This was never true and is discussed throughout this report. In addition, although the use of these specifications is currently out of favour, it will also be made clear that most FCS problems come from characteristics that violate the specification requirements as written.

Lessons learned do exist but are scattered throughout numerous references, such as Tischler, 1996. The working group was established to review the FCS development process with the task of issuing recommendations on improvements to the design and test procedures in order to minimise the probability of occurrence of in-flight accidents due to design errors, e.g. adverse pilot-vehicle coupling phenomena. The authors of this Technical Report decided, however, that designing for good flying qualities is the best approach, not designing for PIO avoidance. The product of this Working Group is intended to be design guidance that will be useful to designers, chief engineers and program managers.



In order to focus the activities of the effort, the above stated objectives were re-stated in the form of seven basic questions:

**1) What are the true problems associated with Flight Control Law design?**

In general, flight control is viewed as a difficult and problematic area of aerospace engineering, primarily since it has a track record associated with program delays, and aircraft incidents and accidents. If the development is done right, however, it does not need to be a cause of delays. The F-22 FCS, validated by a successful in-flight simulation and later by flight test, was ready to fly a year before first flight was scheduled. They also eliminated some testing not deemed necessary (e.g. a drop model made unnecessary by advances in wind tunnel test and simulation technology; and a second in-flight simulation after the successful first session) to control costs, but they held the line on testing that was felt to be necessary -- the F-22 Flying Qualities Working Group (FQWG) being responsible for these decisions. The reasons for the difficulties are sometimes (quite rightly) not made fully public, due to commercial or program pressures. Too often, the reasons given are not entirely technically correct and it seems that 'aircraft-pilot coupling' or 'software fault' is given as the cause, irrespective of the deeper underlying technical reasons. The true problems need to be identified to enable future research efforts to become more focussed.

**2) Why has the design task become so complicated?**

It sometimes seems that the flight control law design task is becoming unmanageable due to the wide technical knowledge needed to carry out the design, the significant number of interfaces involved, and the volume of data and software that can be generated by the design and clearance process. At the same time, aircraft flight envelopes continue to expand and more and more functions are integrated with the basic flight control. Sometimes the designers make things more complicated than they need to be. The reasons behind design complexity need to be established, in order to propose some best practices, to control the design task, and to obtain visibility of both the design and the design process.

**3) What are the real design requirements?**

The available official design documentation comprises the U.S. military specifications and standards, which are usually supplemented by national government standards in other countries. In practice, these are criticised for being both too restrictive and not providing sufficient guidance. They have also been viewed as only linear requirements, which has never been true. Other relevant documentation is available, particularly for commercial aircraft, in the form of the aircraft airworthiness requirements. The generation of specific design criteria for any particular project has been an ad hoc process across the total aerospace community. The flight control law design has to meet these requirements and those associated with a significant number of technical interfaces. It is considered that a review of the overall design requirements will help the flight control community and act as a checklist for planning purposes.

**4) What are the best design practices?**

On each program, new lessons are learned which result in a better product and should provide an improved means of designing the next aircraft (conversely, it could be something to be avoided). Sometimes lessons are re-learned on the later projects, resulting in unnecessary cost and program difficulties. It is important that the significant lessons are captured, analysed and clearly understood, in order to avoid repeating the mistakes of the past and to ensure that best practice is applied in the future.

**5) What is the best way to handle uncertainty?**

One fundamental reason for using feedback is to correct for uncertainty in the vehicle's dynamics. Traditionally, the robustness of a design is dealt with by measuring the system stability margins of the individual control loops, and by assessing the effects of design tolerances. With the development of robust control theory over the last two decades and with the experience gained in applying the new techniques, there are alternative (and/or complementary) means of handling the robustness issue and for dealing with parameter uncertainty. It is worth reviewing the options available, and to seek out process improvements.

## 6) What do the modern/advanced design techniques really offer?

In promoting their research activities on the advanced control methods, organisations state the benefits offered by the emerging techniques. Whilst not doubting these benefits, it is important for flight control law designers to determine which methods offer the greatest benefits to the flight control design task, and in which parts of the design process (or for what flight control modes) the methods should be applied.

## 7) What can we do to help on current and future projects?

In answering the previous six questions and by reviewing the lessons learned from aircraft projects, the Working Group should be in a good position to provide recommendations for the next generation of flight control engineers and researchers, resulting in satisfactory system designs and relevant, well-directed research.

The remainder of this report attempts to address and answer each one of these questions. The report is organised, first, to review some examples of flight control problems. They span the history of flight from the time when the practice of flying was preceding theoretical developments up to more recent time when it might be thought that flight control designers “should know better”. Much of the information is incomplete, but the chapter finishes with an example of a problem and the solution being published together. Then there is a chapter detailing lessons learned from various programs with positive results, which leads into a section detailing a series of best practices. The best practices are laid out as a logical process with recommendations for avoiding pitfalls that have led to problems in the past. It is NOT, however, a “cookbook” process that can be followed blindly. Using (good) engineering analysis and judgement, and following the defined process, will ensure a successful design. This may be considered to be Part 1 of the report.

The effective Part 2 of the report continues with a chapter on theoretical aspects. The primary purpose of a flight control system is to provide the appropriate interface between a pilot and the aircraft responses. Although stabilisation is also a requirement of a typical modern FCS, it is stabilisation with a pilot in the loop, or flying qualities, that is the design challenge and has caused most problems. Flying qualities is thus the subject of the first sub-chapter. First, there is a discussion of flying qualities criteria, especially the US military specifications. This brief discussion covers the evolution with the good and bad points, together with the common misinterpretations. The most common of these is the question of application to linear or non-linear characteristics. Next, the current state of the art of “carefree handling” is presented, defined as flying qualities that allow pilot commanded manoeuvring without adverse characteristics, such as departures, requiring the pilot’s attention. Then, there is a discussion of demonstration manoeuvres as a flying qualities evaluation tool. It will be emphasised that these manoeuvres should be used aggressively during the early development phase to uncover possible problem areas and feed data back into the analytical design process. They can then be used during flight test to correlate with simulation and analytical data. This list of manoeuvres could probably be flown by a skilled pilot with a very bad configuration if used only as a checklist. Next there is an extensive discussion of the latest results from analytical and research activities into PIOs. While it is tempting to assert that this is for the benefit of those who ignore the best practices and the rest of the report, the section is aimed at presenting and assessing a number of PIO criteria to augment the design process defined under the best practices. It also highlights open questions and lines along which further research is needed. A discussion of modelling and system identification is to present the current state of the art in this important area. It is also evolving very rapidly because of the continuous improvements in both hardware and software.

The working group members originally laid out this report to present an assessment of design methods (i.e. question 6), but no correlation has been found between the method used and the problems of the past, or the successes, see chapter 3.5.2. The benefits of advanced methods are primarily in terms of more efficiency, and a shorter design cycle translates into cost savings. No method will guarantee success by itself, it still needs the correct design criteria and the other components of the process as in Chapter 4.

Finally, the report concludes with answers to, and further discussion of, the above seven questions. It is summarised with a suggestion of required future research.

**This page has been deliberately left blank**



**Page intentionnellement blanche**

## 2.0 BACKGROUND SURVEY OF FLIGHT CONTROL PROBLEMS

The purpose of this section is to discuss some specific flight control problems that have occurred in the past. The examples in the first sub-section span the history of flight from the time when flying was the sole task and the practice was leading theoretical developments. Much of the information had to be assembled from incomplete sources, so that it was difficult to find general guidance. The section finishes with a discussion of the two highly publicised events that were a large part of the instigation for this Working Group.

Any discussion of aircraft flight control development or problems must have a genesis in the crash of Otto Lillienthal's glider and the comment by Wilbur Wright from a paper presented to the American Western Society of Civil Engineers in Chicago on 18 September 1901, as follows: "The difficulties which obstruct the pathway to success in flying machine construction are of three general classes: (1) those which relate to the construction of the sustaining wings, (2) those which relate to the generation and application of the power required to drive the machine through the air, (3) those relating to the balancing and steering of the machine after it is actually in flight. This inability to balance and steer still confronts students of the flying problem. When this one feature has been worked out, the age of flying machines will have arrived, for all other difficulties are of minor importance".

The Wright Brothers' initial flights were made with an unstable configuration requiring full time pilot attention for control. Relating their choice to a modern analytical understanding of aerodynamic stability and control is difficult at this point in time. It has been suggested that they thought the crash was caused by the effect of the stalled wing on the tail, so put it in front. Another story is that the brothers used this approach after deciding that Lillienthal was killed when his stable glider (too stable?) was upset by a gust. Although the story may be apocryphal, it could also be the first application of a lesson learned from another's previous experiences. The first example below may also indicate that the lesson to be learned is not always straightforward.

### 2.1 HISTORICAL PERSPECTIVE

An excellent review of some historical aspects was presented by Anderson, 1993. This section presents some abstracts from that reference, with applicability to FCS design problems, plus the author's view of the lesson to be learned. Some additional comment has also been added in the form of a differing interpretation or additional information.

#### 2.1.1 The Wright Brothers' Flyer

Starting with the first human flight in a powered aircraft, many accidents occurred because the control limitations of the aircraft were not understood, *or it may be stated that the control limitations, etc., were being learned in flight test, which continues today.* Although the Wright Brothers appreciated the importance of adequate flight path control, they initially never achieved it; in part because the aircraft was statically unstable and the canard pitch control had limited authority.

As noted in accounts of their first flights, their configuration was very challenging to fly because overcontrol in pitch attitude occurred continuously during most of the flights. Because of these stability and control problems, frequent inadvertent upsets occurred in low-speed flight. Accidents occurred so frequently that in 1908, 80 percent of the licensed pilots were killed. Subsequently the "Flyer" was modified to use trailing edge ailerons to reduce adverse yaw, and the canard was replaced with an aft tail to improve stability and stall control. The canard-configured Wright Flyers also had overbalanced elevators, so that when the pilot moved the elevators past the streamlined position a strong and sudden stick-force reversal occurred as the elevators immediately tried to deflect to the full command position.

The main lesson learned was to recognise the need to improve the poor handling qualities which severely compromised flight safety. Learning to control the pitch instability did not ensure safe operation in low speed flight because the poor stall behaviour left little margin for error when manoeuvring in turbulence. *{Comment: The trade-off between stability and manoeuvrability continues to the present time, because it is*

usually in the context of limited control power available. In addition, with FBW technology, designers must consider the question of priority for control surfaces that are used for both functions. There is also the aspect of defining the task which, for the Wright Brothers, was solely to fly and which they definitely achieved. In the words of an early US army airman, however: “We wanted to develop the airplane into a stable platform for air reconnaissance work. Old Number One was the last of the Kitty Hawk models, and with its two elevators out in front it was about as stable as a bucking bronco. We continued experimenting there while the Wright Brothers made modifications back at Dayton, Ohio. When one of the elevators up front was moved around to the back, stability improved somewhat but not enough. I later found out that by using just one elevator, the rear one, I had a platform that worked very well. I could let go of the levers and make sketches. It got to be an airplane that could be used for real military reconnaissance”}.

### 2.1.2 Bell X-2

The X-2 flown in the early 1950s was one of a series of high-speed research aircraft having performance capabilities exceeding Mach 3 and an altitude of 126,000 ft. Powered by a rocket engine of 15,000 lb (7,000 kg) thrust, its wings were swept 40 deg and constructed of stainless steel. A fatal accident in the X-2 is a classic example of the human limitations in controlling a vehicle with excessive or adverse roll-pitch-yaw (inertial) coupling. The resulting oscillation involved interactions among the airframe aerodynamics, the inertia characteristics about all axes, and the kinematics (gyroscopic torque) created by the rolling motion.

The X-2 had to be flown quite cautiously on a wings-level ballistic trajectory at high Mach numbers because of a known deterioration in directional stability at moderate angles of attack (AOA). A USAF pilot, flying the aircraft for the first time, attempted to set a new speed record before turning the aircraft over to NACA for further research. After rocket burnout, control motions were initiated to start a left turn. As the turn progressed, AOA was increased and directional stability decreased. When aileron deflection was applied to limit the left banking tendency caused by dihedral effect, the adverse yawing moment due to aileron exceeded the directional restoring moment due to sideslip. Yaw/roll coupling motions increased in intensity until critical roll velocity for inertial coupling was exceeded. Violent, uncontrollable motions occurred about all axes. High positive and negative accelerations were imposed on the aircraft, which finally entered an inverted spin. After two recovery attempts, the pilot jettisoned the nose escape capsule at an altitude of 40,000 ft. The separation was successful; however, the capsule was violently unstable before the drogue chute was deployed. The pilot was incapacitated by the severe capsule motion and did not effect a separation from the capsule.

This accident occurred in part because the pilot initiated a turn (for reasons unknown) at too high a Mach No. (2.8) where stability and control deteriorated irrevocably. The lessons learned were threefold: (1) do not expect a new pilot to acquire the necessary skills on a first flight to maintain the necessary precise control of the high altitude trajectory; (2) ensure that the test pilot understands the logic and importance of correctly following the established emergency procedure, which in this case was to remain with the aircraft to low altitude where increased angular rate damping would not only aid recovery from the inverted spin, but would also reduce accelerations so that the pilot could deploy the stabilising capsule drogue chute; (3) finally, and most important, is the need to have a clearer understanding of the consequences of inherent stability and control deficiencies in an environment that was extremely hazardous. *{Comment: Application of the first two lessons should be standard today through the rigorous training and standard procedures. The third should be covered by knowledge and understanding that have been acquired since the 1950's, provided the available lessons are studied and applied.}*

### 2.1.3 North American F-100A

The F-100A single engine aircraft was introduced in the 1950s as the first USAF supersonic fighter employing 45 degrees wing sweep. Typical of swept wing aircraft in general, pitch-up occurs at high AOA and lateral-directional stability and control deteriorate.

The potential danger of this situation occurred during operational test of an F-100A aircraft at Edwards Air Force Base, California. The pilot was attempting to land on a portion of the runway which had been surfaced with fire extinguisher foam to alleviate the effect of a misaligned nose wheel on touchdown.

Because the pilot was unable to position the aircraft accurately over the foamed area, power was applied for another approach. Unfortunately, in the desire to land as slowly as possible, the aircraft was operated too far on the backside of the power-required curve, such that level flight could not be achieved even with full afterburner power. At this high AOA condition, a pitch instability was encountered and both longitudinal and lateral directional aircraft response deteriorated until the aircraft became uncontrollable.

The F-100 was an aircraft which was noticeably underpowered even by the standards of the day, and had very pronounced “backside” tendencies if airspeed was allowed to decay too much. It is unlikely that the F-100 had pitch up tendencies (with a low-set horizontal tail), but it did have strong dihedral effect and pronounced adverse yaw at higher angles of attack to the extent that, below 250 KIAS, the procedure was to centre the stick laterally and rudder roll the aircraft. Other information indicates that the aircraft which suffered the accident had departed the Los Angeles factory earlier in the day as part of a multi-ship delivery flight (thus it was heavy, with full internal fuel and 2 full external tanks). The aircraft suffered some type of problem, and the pilot elected to divert to Edwards AFB to take advantage of the facilities there. The pilot was receiving a constant stream of conflicting advice and instructions over the radio. The pilot neither burned off nor jettisoned fuel, so the landing attempts (there were several, each getting progressively worse) were at a heavy weight. In the final attempt, the pilot allowed the aircraft to get too slow on an attempted go-around, resulting in a rapidly deteriorating and ultimately unrecoverable situation.

Anderson states that this accident happened because the pilot *inadvertently* allowed AOA to increase into the pitch-up region. From the lessons learned standpoint, two points can be made. First, a contingency plan for the unexpected would have been helpful. The pilot should have been warned beforehand that below a certain approach speed, a landing was mandatory. The second point, closely related, was that the pilot did not really understand the limitations of the aircraft when operating in the high AOA region where marked degradation in lateral-directional behaviour and climb performance was certain to occur. *{Comment: It would seem that this accident should not happen today with the pilot training and standard procedures, together with an understanding of handling qualities impacts on minimum control speeds? It may also be considered as leading to the modern emphasis on carefree handling, discussed later.}*

#### **2.1.4 Hawker-Siddeley AV-8 Harrier**

Several problems showed up early in low-speed, low-altitude operation of this single engine VTOL fighter. This aircraft along with several other VTOL concepts shared a strong requirement for relatively large roll control power needed to trim in sideward/sideslip flight and yawing manoeuvres. The positive dihedral effect (rolling moment due to sideslip) introduced from a combination of aerodynamic-induced and engine-induced flow was large enough to cause several accidents. For example, a fatal accident occurred in the late 1960s involving a first Harrier flight by a USAF pilot. In this case, a skidding right turn was made at 90 knots to avoid flying over a photographer shortly after takeoff. Because of excessive left sideslip, the aircraft rolled abruptly in spite of full opposite aileron input. The aircraft banked beyond 90deg before the pilot ejected.

The lessons learned from this accident are straightforward. The pilot did not appreciate or understand the need to minimise sideslip in an airspeed regime where inherent directional stability was low, allowing directional/roll divergence to occur. Dealing with this particular departure requires mandatory use of rudder to reduce sideslip to recover from the roll-off. Instinctive use of aileron to reduce bank angle divergence will aggravate the situation because of adverse yaw generated by aileron deflection. *{Comment: Can we assume we have passed by this kind of a problem? Will this problem of roll/yaw coupling return in a different form as we consider tailless configurations with marginal directional stability? Are there new lessons to be learned (or old ones re-learned) about roll/yaw coupling? Lastly, was this a training lesson?}*

#### **2.1.5 McDonnell Douglas F4H-1**

A classic and fatal PIO accident occurred when an F4H attempted a speed record run at low altitude on May 18, 1961. The aircraft had attained a speed of Mach 1.1, 200 ft above ground level, when the PIO resulted in a structural break-up of the aircraft. In less than 2 sec, the aircraft reached -4 to +14 g after three oscillations.

Although the accident was investigated quite thoroughly, the question of why the pilot encountered PIO was never completely answered. In a piloted motion-simulator study conducted after the accident, it was determined that a tendency toward PIO was markedly increased if stick forces were not completely trimmed. In addition, the oscillations would damp out if the pilot relaxed his hold on the stick. In this regard, it was known that the Navy pilot held approximately 20 lb (9kg) push force in practice high-speed, low-altitude, runs to provide a nose-up safety margin in the event he was distracted and relaxed pressure on the control stick.

Anderson's lesson learned was to recognise that the aircraft had inherent PIO tendencies which should have been eliminated before attempting a record-setting flight. In addition, the pilot should have been warned that it was necessary to continuously keep the aircraft trimmed during high-speed operation. *{Comment: It has also been stated that the team and the pilot were well aware of the PIO tendencies at that extreme flight condition. The "contingency plan" was to use the nose-up trim to recover from any incident by the pilot releasing the stick. A real lesson learned is that pilots do not, and should not be relied upon to, recognise a PIO in time to prevent the incident from becoming worse. In addition, we now assert that an aircraft can be designed to be free from PIO tendencies, even at the extremes of the flight envelope, i.e. again – carefree handling.}*

### 2.1.6 M2F2 Lifting Body

The M2F2 was a small, lightweight (6,000 lb) research vehicle designed to demonstrate the feasibility of unpowered horizontal landings with very low lift/drag (L/D) ratios, typical of a Space Shuttle configuration. The M2F2 was air launched from a B-52 mother ship at an altitude of 45,000 feet and a Mach number of 0.8. The launch altitude was chosen to give the pilot the maximum time (4-5 minutes) to evaluate the stability and flight path control prior to a committed landing. Because the vehicle was unpowered and had an inherent high sink rate (low L/D), proper selection of flight path angle and pre-flare approach speed, was essential for safe operation. Shallow, low speed, approaches make flare initiation easier to judge; however, the post-flare float time needed to adjust rate of descent for touchdown becomes critically short. Steep, high speed (high energy) approaches provide a longer float time, but make the flare procedure more demanding.

The first flight was made 12 July 1966. Sixteen flights were conducted before the vehicle was damaged in landing 10 May 1969. The accident occurred because the pilot misjudged the correct flare height. The flight scenario starts with the pilot's description of a lateral/directional PIO in the initial portion of the approach. "I was well-established in my glide, very low angle of attack, picking up my airspeed, and had the feeling that I would land just slightly short of the 2-mile point, angling across the runway. Everything was going normally with no problems, then suddenly at 5,000 to 7,000 ft, with no warning at all, I experienced very high roll accelerations as a divergent Dutch-roll-type of manoeuvre developed. This manoeuvre was disorienting, and I pulled back on the stick to increase angle-of-attack, trying to damp it out".

The PIO activity undoubtedly affected the pilot's judgement in flare initiation and accuracy of touchdown. Another was the presence of a chase helicopter in the landing area. As a consequence, the vehicle overshot the "bull's eye" target area on the lakebed, depriving the pilot of good visual reference points for height estimates. As a result, post-flare float time was inadequate to completely extend and lock the landing gear before inadvertent ground contact occurred ending in a tumbling "ground roll".

Finally, there are several lessons learned. First, even a test vehicle of this class must have a satisfactory stability augmentation system (SAS) to improve low stability and poor damping and to reduce adverse cross-coupling characteristics inherent in this short-coupled configuration. Second, adequate simulation facilities are needed to allow the pilot to gain experience in handling the unusual approach and touchdown requirements for low L/D configurations. Third, deviation from the standard approach may leave little margin for error in a power-off landing. *{Comment: Note the pilot's description of his problem, i.e. the PIO appeared suddenly, which is characteristic of PIOs, and that it appeared as a divergent Dutch-roll, which is unlikely. This is definitely a design problem.}*

### 2.1.7 Space Shuttle Orbiter

Flare and landing the Orbiter delta-wing concept were anticipated to be the most critical and demanding pilot tasks in flying the Space Shuttle. This is due to the vehicle's unusual aerodynamic/control characteristics. The low lift/drag, large induced drag, lack of engine power to make flight path adjustments, and the requirement to master new piloting techniques to achieve low sink rate and point of touchdown accuracy complicate the piloting task. Flight path control is further complicated because the centre of rotation of the pitch axis is ahead of the pilot's position in the cockpit which means the pilot does not perceive any change in flight path for almost a full second after control input. *{Comment: It might, however, have been thought that lessons would have been learned from the preceding example of the M2F2.}*

On STS-3 (March, 1982) Columbia was in an incipient PIO at touchdown. A high crosswind caused an overshoot of the final approach course coming off of the Heading Alignment Circle (the final alignment turn the shuttle makes). By the time the vehicle was re-established on course it was late in the final approach and the vehicle was significantly fast. The landing gear will not deploy until the vehicle is below the gear limit speed, so the crew were further distracted by that. The result was a high-gain situation on short final, with the vehicle being in the beginning phases of a PIO just as it touched down. There was also about a 1 ½-cycle oscillation as the nose was lowered, resulting in a pronounced "slam-down" of the nose.

The fifth landing made on the Edwards AFB 15,000-ft concrete runway, ALT-5, was more spectacular in that a PIO resulted in less than desired touchdown performance and showmanship. The pilot's touchdown aim point was about 5,000 ft beyond the runway threshold where most newspeople and spectators were assembled. The pilot perceived that he would overshoot the intended touchdown point and attempted to spike it on, setting the stage for a skip and balloon behaviour and ensuing PIO motions. Records indicate almost continuous elevon rate limiting with a pitch PIO started seven seconds prior to first touchdown and a lateral PIO five seconds before touchdown. After the first touchdown and bounce, a more pronounced lateral PIO occurred, followed by a series of overcontrolled skip and hop motions.

There are at least two human limitations illustrated in this incident. First, pilot skill is very demanding, as the pilot must learn new control techniques to avoid exciting the inherently poor flightpath response characteristics. In essence, the landing approach must be set up to require minimum control inputs and to anticipate the effect of response delay. It follows that the pilot needs help to reduce judgement errors. This help could be from the FCS in the form of better flightpath command logic, or from the display logic.

There are a few lessons learned in this example. First, the pilot would have benefited from improved guidance for touchdown accuracy. Second, it is necessary to eliminate adverse control system characteristics (excessive lag) which are known to cause PIO under high stress conditions. Finally, improve the SAS to help reduce pilot workload. *{Comment: This PIO was predicted before it occurred by means of the Smith-Geddes criterion. After the PIO occurred, the final solution was a frequency-dependent filter that reduced pilot command gain as the frequency of input increased [see Smith and Edwards]. The implementation of this filter has been successful (presumably) since there has not been another PIO occurrence. As another lesson learned: such a gain reduction filter could be a design option to consider in the beginning if it is decided that there is no better way to eliminate a PIO tendency that is analytically predicted, i.e. before one occurs in flight. It is also possible to state this principle as a design requirement, as in BP 4.4.}*

### 2.1.8 General Dynamics YF-16A

Another example of an incident where PIO was involved occurred with the YF-16 single engine aircraft during initial trials in January 1974. This aircraft had novel features including being the first USAF operational fighter equipped with a fly-by-wire control system and a sidestick controller where pitch and roll commands were signalled by force instead of displacement inputs. Response gains for initial flight tests of this "force-feel" control system were finalised by extensive ground based piloted simulator studies.

Prior to the first scheduled flight, high-speed taxi tests were conducted. The test plan was to acquire a preliminary "feel" for control response by accelerating to approximately 120 knots, reduce power and then



raise the nose to a moderate pitch attitude. Unnoticed by the pilot, the aircraft gained excessive airspeed and upon rotating to about 10 deg at 130 knots, the aircraft lifted off while rolling to the left. In correcting with a right-wing-down command, a series of PIO oscillations occurred primarily in roll for approximately 15 sec at a frequency less than 1Hz. Relatively high roll rates were being commanded (approximately 50 deg/sec) resulting in both position and rate limiting of the control surfaces. Due to the combination of very high pilot gain and the control system lag at the high input frequencies, the pilot's input commands were out of phase with the aircraft response.

Because of a heading deviation which occurred during the run, the pilot elected to add intermediate power and go around rather than try to steer the aircraft back to the runway. Once away from the ground, pilot gain decreased and the PIO stopped. A safe landing was made.

Anderson states that this case illustrates both an *inadvertent* and *judgement* error. It is obvious, however, that the predicted aircraft flying speed was incorrect or else the pilot exceeded it before the power reduction. In addition, since the pilot did not expect to lift off the runway, a high stress situation quickly developed. In the more relaxed setting during the simulator tests of lift-offs, no PIO tendencies were noted.

From the lessons learned aspect, two points are of interest. First, the pilot did carry out a contingency plan to handle the unexpected directional deviation from the runway, *although it may have been an instinctive reaction*. Second, too much reliance was placed on using simulator tests to set optimum control gains for a novel force feel control system. It might have been wiser to use more conservative (sluggish) response gains for first flight. *{Comment: Note that this lesson, about use of the simulator to design control law gains, was "relearned" by the same organisation with the crash of the YF-22, as described in Section 2.3. We might also claim that the lesson concerning the sidestick had already been learned and published in Graves 1962. Quoting from that reference: "Every pilot who first flew both the rigid stick and the moving stick on the ground simulator preferred the rigid stick over the moving stick, both for manoeuvring and trimmed flight. However, after actually flying both stick types, every pilot reversed his opinion preferring the moving stick for manoeuvring flight. Some pilots enjoyed flying the rigid stick in low-demand flying, slow manoeuvring, or trimmed flight; but all pilots rejected it for the more demanding tracking problems". The best practice, defined later (BP 4.6), is to never use a simulator to design the gains or any other aspect of the flight control system. The simulator should only be used for assessment.}*

### 2.1.9 Rockwell B-1A

The B-1A is a supersonic, variable-geometry, strategic bomber designed to operate at treetop heights at near sonic speeds and at Mach 2 in high altitude dash operations. To achieve this performance, variable geometry outer wing panels are used - 15 deg of leading edge sweep when fully forward for take-off and landing and 67.5 deg when fully swept for high speed operation. A computerised fuel transfer system with manual backup is used to optimise performance by selecting fuel from eight integral tanks located in the fuselage in order to control the centre of gravity.

A B-1A was conducting low speed flight tests on August 29, 1984, when the aircraft departed from controlled flight from an altitude of about 4,000 feet AGL and was destroyed. The mechanics of the accident are straightforward, involving the need to maintain the correct C.G. location as a function of wing sweep. When the wings are swept forward, the fuel must be transferred forward to stay within the available pitch trim capability. As with most swept plan forms, a non-linear (unstable) pitching moment with AOA can occur if excursions to high AOA are allowed to develop.

A US Air Force Investigation Team concluded that "human error" caused the crash. Investigators stated that the crew failed to move the control knob that transfers fuel forward as required to maintain pitch trim when the wings were swept forward. As a result, the aircraft pitched up to about 70 degrees AoA, lateral directional wallowing occurred, and the aircraft began to lose altitude. The pilot added full throttle, but the aircraft had penetrated too far on the backside of the power required curve, rolled, and plummeted to the desert floor.

Examining human factors aspects, this “human error” falls in the inadvertent category involving forgetfulness, indecision, and confusion among the crew. Although the pilot-in-command had only two flights in the aircraft, the co-pilot was regarded as the most experienced pilot in the B-1A test program, having made the maiden flight and participated in the entire test program. The pilot, who survived, stated that he did not remember being concerned about C.G. location and did not recall seeing the warning lights.

Several behavioural factors might explain why fuel transfer was overlooked, prior to wing sweep change. First, the pilot may have been too complacent and assumed that the seasoned co-pilot would not allow such a gross error in C.G. management to occur. Correspondingly, the co-pilot may have assumed that C.G. management was being handled by the computerised fuel transfer system and, in addition, rationalised that since he was not flying the aircraft, he had less responsibility and relied on the ground test team to alert the crew of potential abnormalities. However, because the aircraft was between test conditions, the ground staff was not paying attention. It is interesting to note also that the third crewmember, the flight engineer, did not alert the pilot to the potential out-of-trim condition. *{Comment: It is also interesting to note that many test aircraft crash during portions of a flight which is not a part of the actual test program. Some examples are the XV-4B, JAS-39, YF-22, X-31 and there are probably many more.}*

Finally, from the lessons learned standpoint, since the accident would not have occurred had normal test procedures been followed, a contingency plan for the unexpected should have been rehearsed. In addition, a better method of warning for the pending out-of-trim condition should have been provided. Tests have indicated that warning lights are not “forceful” enough to invoke response in a high stress situation. The bottom line is: “little” management decisions can ruin “big” aircraft even with three cockpit crewmembers. *{Comment: As a design lesson learned, we could assert that it is a design requirement to prevent ambiguous signals to the crew. Also, where possible and reasonable, the flight control system should be designed to prevent such human errors. With digital FBW technology, such logic should be straightforward, and also reasonable cost. It is difficult to justify leaving such responsibilities to the crew, when that action may be considered to be a primary flight control function. This also may be considered as leading to requirements for carefree handling.}*

### **2.1.10 Wills Wing Hang Glider**

Modern hang gliders have aerodynamic design features similar to flying wing aircraft. Aerodynamic characteristics associated with the mild sweep and lack of tail surfaces include inherent pitch up at high AOA, low directional stability, inadequate Dutch roll damping at low AOA, and less-than-desired directional and roll control power. Compared to an aircraft, it is more difficult to touch down at a prescribed spot because of limited variation of L/D (no flaps, power adjustments, etc.). Similar to aircraft, a good approach helps ensure a safe landing.

In the reference, Anderson relates a personal experience landing a hang glider: “I noted low frequency oscillatory heading deviations which coupled into bank angle excursion of increasing magnitude. Initially, I thought turbulence had increased near the ground. Observers on the ground stated that the bank angles were approaching 45° about 50 feet AGL. As I was slipping downward in a left bank, I recognised that I was in a PIO and that an uncontrolled serious injury ground impact was only seconds away. When the glider was about wings level through the next cycle, the ground observers noted that I released my grip on the control bar, the nose pitched up and immediately the roll oscillation terminated. A successful landing was made albeit only 10 feet in front of some 200-ft tall pine trees.

There are several important lessons learned in this example of PIO which may have broad applications. First, and most important is that I recognised a PIO had developed and that I needed to get out of the control loop. This is very difficult to do when you are approaching the ground. The normal tendency to think that you will reduce the bank angle magnitude in the next control cycle must be ignored. The second point is that I knew beforehand the glider had inherent PIO tendencies at high airspeeds and understood that damping would increase at high AOA”. *{Comment: It is recommended that the experience of this particular individual in recognising that he was in a PIO should not be used as a lesson learned. There have been many examples of incidents and accidents where PIO tendencies were known, or suspected, but an*

*assumption was made that “the pilot will not do that”. It is definitely not valid to fly an aircraft with predicted PIO tendencies.}*

### **2.1.11 Summary**

The preceding section is a very brief indication of problems that have occurred either with the flight control design or that could have been eliminated with modern control design capabilities. The causes of accidents and incidents are seldom available in an explicit form to help other designers. It is often by inference or by adding separate pieces of information together that some assessment can be made. This began to change when John Gibson, 1978, documented an example of a flight control problem together with the solution. In that case, a PIO was encountered on a landing of a Panavia Aerospace Tornado after many flights. The event led to a detailed analysis of the cause, which was also the precursor to additional work that is discussed later in this report. It is, however, the first reference that has been found, which discusses both a problem with a production aircraft and the solution in the form of revised control laws. More recently, Kullberg and Elcrona presented problems and the solution implemented on the SAAB Gripen. In addition, the paper by Harris and Black is an outstanding account of the development of the FCS for the YF-22, which crashed because of PIO, and the different approach that was used in the design of the F-22 control system. Both of these are summarised and discussed in more detail in this report.

## **2.2 SAAB GRIPEN EXPERIENCE**

This discussion is from Kullberg and Elcrona, with additional comment.

Prior to commencing on the JAS-39 project, SAAB’s experience of the PIO phenomenon had commenced with the J-35 Draken aircraft. This aircraft had high stick sensitivity combined with a linear gearing of the stick to elevon. Following the PIO, the solution devised was to add a non-linear gearing and improve the stability augmentation of the system.

For the next aircraft project, the AJ-37 Viggen, significant work was performed on the handling qualities and resistance to PIO, based upon new information received during the 1960s from Ashkenas, McRuer and A’Harrah. By 1963, Sweden had developed its own specification for flight control system design and for handling qualities. The latest versions of this AJ-37 aircraft have a digital flight control system. The AJ-37 Viggen has never experienced a problem with PIO in its service to date.

The JAS-39 flight control system originated from demonstration work performed by SAAB on a FBW AJ-37 Viggen aircraft. This aircraft had been flown with instability levels of up to 4% chord at low Mach Number. This was the limit for this aircraft. Although this aircraft was reported to have experienced Level 2 or 3 handling, due to excessive time delays within the flight control system, it never experienced rate limiting or PIO. On this basis, it was deemed that there was sufficient knowledge and confidence to proceed with the JAS-39 aircraft project, and the JAS-39 specification was written around this experience, with a demanding handling qualities requirement. *{Comment: At this point, the process as stated seems like the ideal way to develop a flight control system design specification, i.e. using results from a technology demonstrator and rigorous analysis}.*

Examination of the time delay requirements in the fly-by-wire experiments resulted in the requirement to achieve Level 1 handling qualities, with a time delay of less than 100 milliseconds. The measured time delay, from flight test, was actually around 70 to 90 milliseconds in both roll and pitch axes. It was noted that this requirement resembles the recommendations of both MIL-F-8785C and MIL-STD-1797.

### **2.2.1 The First PIO Accident (February 1989)**

The design criteria used relate to the total time delay in the system. Whilst under ordinary linear circumstances, this can be achieved with comparative ease, once the actuator exhibits rate limiting, the effective time delay increases rapidly beyond 100 milliseconds. *{Comment: It will be discussed later that the military specification requirements were never intended to apply only to the linear small-amplitude responses, the wording in MIL-F-8785C specifically requires that all non-linearities be included in*

*calculating the equivalent system time delay. The total non-linear response was also intended to satisfy the gain and phase margin requirements in MIL-F-9490.*

Actuator rate limiting played a very significant part in both accidents to the JAS-39 Gripen. The first accident was described as a design error, in that the design was known to be sensitive prior to flight. However, the design process did not catch up with the evidence and required modification before flight. Following the accident, the whole process was reviewed and scrutinised with regard to the design of the flight control system.

The first accident started as a response to lateral turbulence with a control system which augmented the dihedral effect, making the aircraft very sensitive in roll. More than one presenter, who had been involved with SAAB in the subsequent work, commented that the JAS-39 “mini-stick” probably had a very significant effect, as it requires only very small movements to demand full control and had a skewed axis. Once the rate limits were reached, the PIO developed initially in roll, then in pitch.

*{Comment: the question must be asked “why did a classical roll PIO couple into the pitch axis?”}. On the JAS-39, the controls are used for both stabilisation and control, {and the tail surface provides both pitch and roll, as with almost every other fighter aircraft of this conventional configuration}. There is thus competition between the requirements for the control capability. Clearly, if the pilot demand uses all the capability that is present, then there is no capability left for the stabilisation of the aircraft. The effect can be likened to approaching an invisible cliff edge, all is acceptable until there is a sudden loss of control and the aircraft departs from controlled flight. {Comment: the pilot command inputs in roll saturated the pitch axis. We can infer a lesson learned in the form of design guidance for control allocation or priority. Rigorous analysis is required to define which axis of control has priority and also stabilisation should not be sacrificed to pilot control in an appropriate frequency range. The general overriding, but subjective, requirement is to prevent all adverse effects of control saturation.}*

### **The Development of the “Fix”**

Modifications to reduce the pilot command gain, which also reduced the manoeuvrability and agility at low speeds, were introduced and the aircraft was assessed using a HQDT test. Detailed assessment enabled the establishment of a “footprint”, from parametric variation of stick inputs in both pitch and roll, taking into account the effects of atmospheric disturbances such as gusts and turbulence, where rate limiting effects could be encountered, and hence these regions could be avoided. Using results of this, a criterion was developed which allowed the margins from rate limit, or the distance from the cliff edge, to be established. Within these bounds, the aircraft can be safely operated without any particular concern.

Typically, for a given system evaluation, the results of around a thousand simulated landings would be examined for the effects and the presence of rate limiting. In this way, different control system designs could be evaluated. The more control activity a system showed, then the closer the system would be to the adverse effects of rate limiting and the consequent significant increase in the time delays which result.

As development progressed as planned through the flight test program, there was a desire to boost agility at lower speeds and modifications were introduced. Assessment showed that under extreme conditions, using full roll and pitch stick, rate saturation and departure from stabilised flight could be reached. It was understood that it was vital not to reach rate saturation for any length of time as the effects of the reduced gain and additional phase lag would cause the aircraft to become unstable. *{Again, this can be expressed better as a design requirement at the beginning of the design process}*. The possibility of the “cliff edge” was found and action was taken, but unfortunately the wrong conclusions had been drawn.

The decision was taken to continue flying, as there were only a small number of aircraft involved in the test program and all flying was to take place under very controlled circumstances which would minimise the possibility of any problems developing. It was known that for production, the problem had to be solved and the solution was defined some months before the second accident.

## 2.2.2 The Second Accident (April 1990)

A time history of the second accident, which occurred during the public demonstration at the Stockholm Water Festival, was shown. The second accident featured a roll PIO consequent upon the pilot aggressively rolling to wings level to accelerate in front of the crowd watching the aircraft. The roll input was sufficient to drive the actuation to the deflection limit and shortly after the rate limit was reached. This caused the aircraft to roll more than expected, so the stick was reversed, driving well into the rate limiting since the stick was demanding the limit of both deflection and rate. With the rate limiting in effect, the inner stabilisation loops were ineffective. Analysis has shown that the effective time delay between pitch stick and pitch acceleration response increased from less than 100 milliseconds to around 800 milliseconds. The subsequent response and pitch up to high AoA caused the pilot to eject after 5.9 seconds, fortunately without causing any harm to the crowds on the ground or the pilot.

### The Chosen Solution

In Kullberg and Elcrona, it was reported that the long-term solution was designed around the concept of making the actuator reverse when the stick is reversed. The solution being implemented on the JAS-39 is similar to that proposed by Ralph A'Harrah and tested in the Scarlet experiment at DLR and also on the Calspan Lear Jet [see papers in McKay]. This works well to reduce the phase loss due to the actuator, but needs careful blending of the signals to avoid further problems due to the actuator not being at the demanded position. In addition, the effects of noise at around 10 Hz needs to be considered.

The revised control strategy is effective in controlling the response during stick pumping and when the stick is let go. However, one result is that the response to a step input is reduced, which tends to reduce the aircraft agility. This would appear to be an essential compromise, if aircraft safety and freedom from PIO is to be ensured.

### Conclusions Regarding PIO

Kullberg and Elcrona list their conclusions from the experience discussed above:

- 1) That PIO susceptibility is independent of the type of flight control mechanisation, i.e. whether or not the aircraft is FBW or conventional. *There are, however, the additional factors discussed in Chapter 1 of this report.*
- 2) PIO is the result of “disharmony” between the pilot’s action and the aircraft’s reaction, i.e. there is an excessive time delay between the input and subsequent response. *More precisely, it is any characteristic that causes the pilot input to be 180 degrees out of phase with the response where the command to the control surfaces has sufficient gain to sustain the oscillations.*
- 3) The causes of PIO are now known to be associated with a susceptible aircraft, a demanding pilot task and a trigger event. *A demanding pilot task is not required because a pilot will increase his gain as a reaction to anything considered as not the response to his or her input. “Trigger events” will happen, and those last two items only detract from addressing the real cause of PIOs, a deficient FCS design, as implied by the next comment.*
- 4) Within these factors, the aircraft susceptibility is the only one over which the designer has any consistent control. The other factors are associated with “chance”.
- 5) A susceptible aircraft, e.g. a vehicle with either high stick sensitivity or excessive time delay or phase lag, or any combination of those factors. *Note that this implies characteristics that violate the Military Flying Qualities Specification and also additional known criteria such as Gibson, Smith-Geddes, etc.*
- 6) System non-linearities, e.g. unblended changes in gain which are not controlled by the pilot, rate limiting of the control surfaces and excessive deadband in the stick sensor system.

## 2.3 YF-22 EXPERIENCE

The data and some of the discussion of this section are from Harris and Black, who presented a detailed before and after discussion of the flight control process used in the YF-22 and the changes that were made for the F-22. The YF-22 control laws started with a very conventional inner-loop design and the basic command architecture was very similar to that used on the F-16. What were considered to be enhanced capabilities were added to the YF-22 control laws as the prototype program matured, as aerodynamic and propulsion models matured and as flight test approached. Use of the thrust vectoring nozzles to augment the aerodynamic pitch control power of the aircraft was incorporated into the control laws and the high angle of attack control laws were also added to the basic structure. For flight test purposes, a switch was provided in the cockpit to engage/disengage thrust vectoring. In addition to the incorporation of thrust vectoring, other program objectives, such as the requirement to provide very high pitch rate capability in certain parts of the envelope, were added to the YF-22 control laws. Many of these features were designed to demonstrate capabilities at a specific point in the envelope and, due to schedule constraints, did not represent a full envelope production aircraft design.

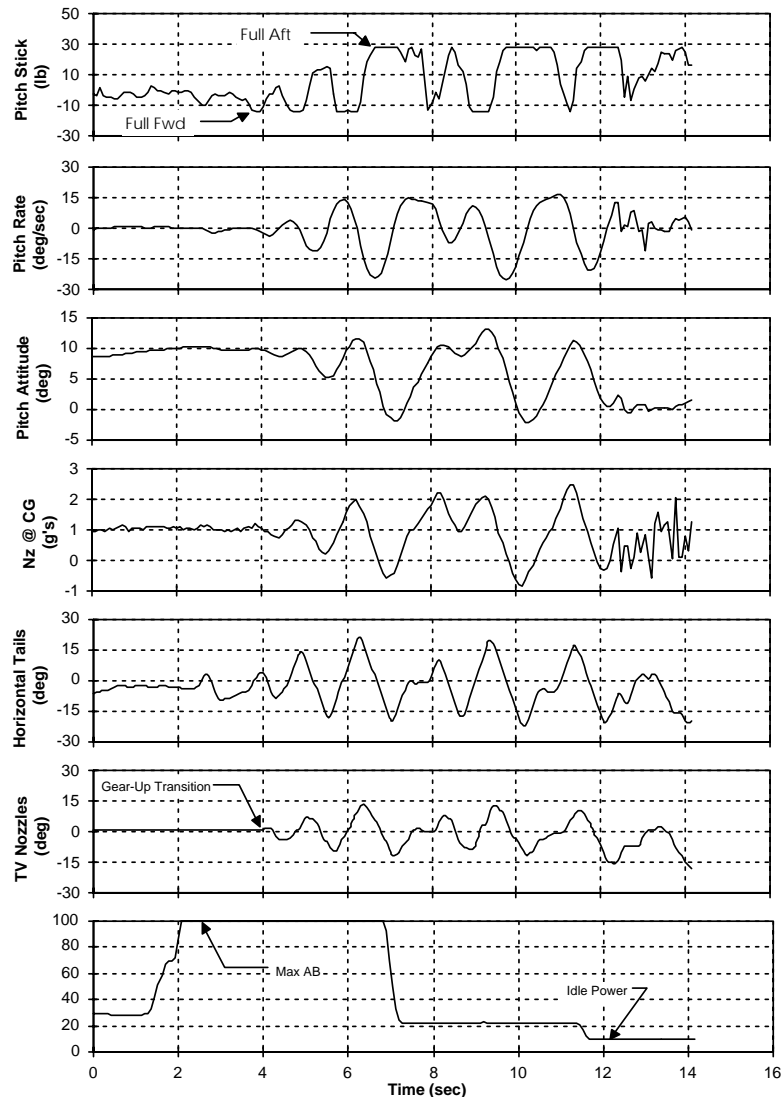
The YF-22 control law feedback and feedforward gains were designed using fairly conventional tools. Design goals were based on accepted short period mode, roll mode and Dutch-roll mode frequencies, damping ratios and mode shapes. An eigenstructure assignment algorithm was used to calculate the initial feedback gains for the longitudinal axis. However, by combining the pitching moment control power of the horizontal tails and thrust vectoring nozzles into a single, generalised controller this technique essentially reduced to a pole placement algorithm. The initial short period mode design goals were fairly conventional, i.e. Control Anticipation Parameter = 1.0, and damping ratio = 0.8. Further refinements to the control law gains were developed from analysis of off-line simulation time histories (step/doublet pitch stick inputs) and comments from piloted evaluations using the fixed-base, YF-22 Handling Qualities Simulator (HQS). Some of the final control law changes that were made to the YF-22 prior to flight test included increases to the forward path gains because pilots had commented on a sluggish initial pitch response in the HQS.

Due to the time constraints of the prototype program, much of the analysis of the handling qualities of the YF-22 was performed after **the control laws were designed in the simulator**. That analysis generally consisted of stability margin predictions, time history analyses and comparisons with MIL-F-8785C boundaries that were incorporated into the Flying Qualities Substantiation report and used to support safety and flight readiness reviews. Category A flying qualities were all predicted to be Level 2 or 3 but the “acceptability” was based on the piloted simulation comments, while Category C was mostly Level 1. For all of the manoeuvres flown during the initial flight test program the aircraft was judged to be well behaved with predictable flying qualities. Harris and Black state that: “The aircraft generally received Level 1 Cooper-Harper ratings for both Up & Away (UA) and Power Approach (PA) handling qualities tasks.” This assessment was related to the flying of the demonstration program, not to any formal handling qualities testing.

In April of 1991 the Lockheed team was awarded the contract for the F-22 program and a follow-on flight test program with the YF-22 began shortly thereafter. The primary objective of the follow-on test program was to expand the flutter and flying qualities envelopes of the aircraft. On April 25, 1992, the YF-22 test aircraft took off from Edwards AFB on a Flutter Excitation System test mission. Upon returning to the terminal area, the pilot performed an uneventful low approach, low pass over the runway, selected military power, raised the landing gear and went around. During a second low approach and pass over the runway, the pilot selected afterburners and raised the landing gear to go around again. The aircraft began a series of pitch oscillations at a height above the runway of approximately 40 feet. After 4 to 5 oscillations, the aircraft impacted the runway, see Figure 2.3.1.

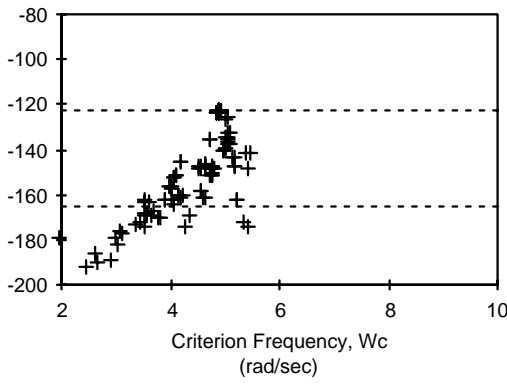
A detailed post-crash analysis of the site and aircraft components was conducted and revealed that no aircraft malfunction had occurred. As with many PIO incidents, the pilot initially thought that an aircraft failure had occurred. Up until that point in the test program, all of the pilots were very impressed with the YF-22 in the approach and landing pattern and had commented that the aircraft response was very predictable, which agrees with the Category C flying qualities prediction. The review team analysed the flight data from the accident, shown in Figure 2.3.1, and concentrated on the YF-22 control laws including sensitivity changes across the gear-down to gear-up mode transition, the effect of transient suppression

filters (sumps) and effective time delay in the flight control system [see Dornheim, 1992]. Fast Fourier Transform (FFT) analysis was performed on the flight data of both approaches and go-arounds as well as the PIO in order to develop the pitch attitude to pitch stick force frequency response.

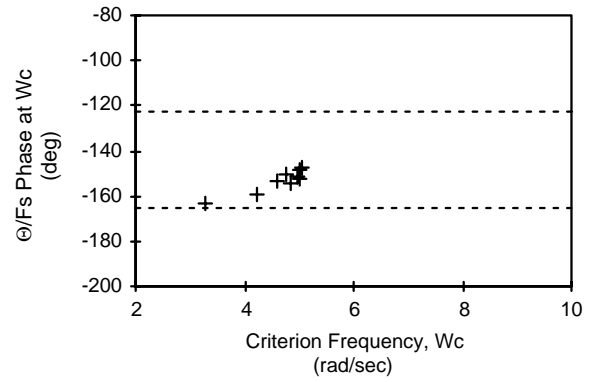


**Figure 2.3.1: YF-22 PIO Time History**

That data was then used to analyse the YF-22 performance against the Smith-Geddes handling qualities/PIO metrics. The analysis (Figure 2.3.2) indicated that the YF-22 was absolutely PIO prone in the flight regime in which the accident occurred, i.e. flaps up, with up-and-away control laws at low speed. This also means that the aircraft was just as PIO-prone on the first pass as on the second. The analysis did show that selection of afterburner was not relevant, but that was the only difference that the pilot knew, which gave the appearance of a failure when the aircraft pitched up unexpectedly.



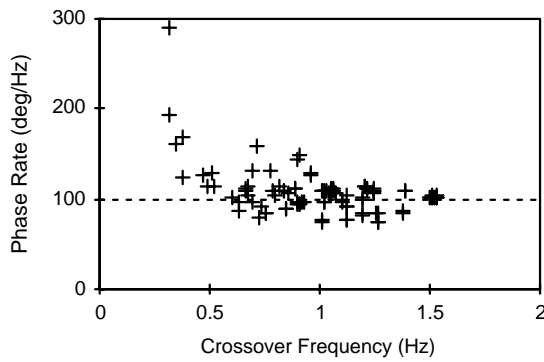
(a) Category A



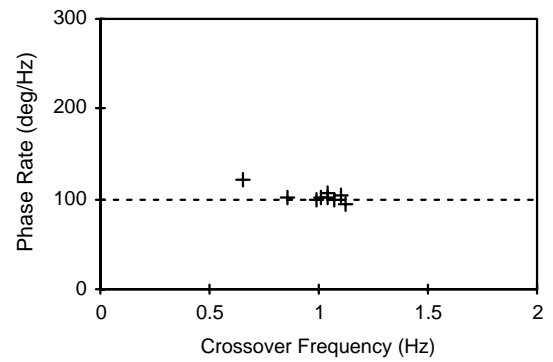
(b) Category C

**Figure 2.3.2: Smith-Geddes Criteria Results for the YF-22**

The review team and the contractor did not reach agreement on every detail, such as the influence of the transient suppression filters or sumps. There was, however, complete agreement on the flying qualities. Figures 2.3.3 & 2.3.4 show that analyses using second tier criteria were consistent with the results using MIL-F-8785C – even the linear characteristics required significant improvement.

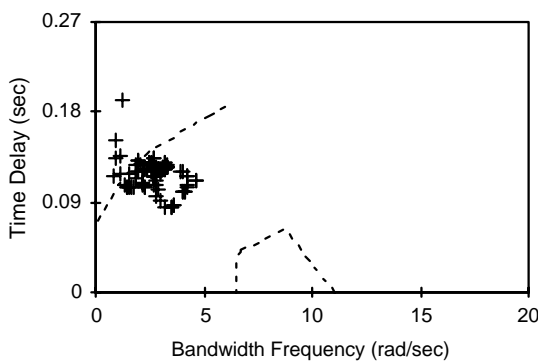


(a) Category A

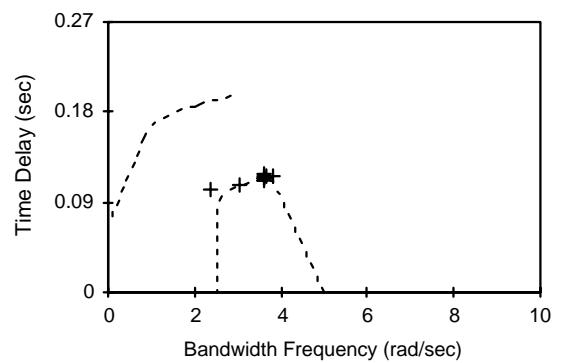


(b) Category C

**Figure 2.3.3: Gibson Phase Rate Criteria Results for the YF-22**



(a) Category A



(b) Category C

**Figure 2.3.4: Bandwidth Criteria Results for YF-22**



Simulator fidelity and the tasks used to evaluate flying qualities/PIO susceptibility during the YF-22 development were also investigated. Although some refinements to the off-line and HQS models had to be made to better represent both the effective time delay and bus communications between the FCS and digital engine controller, the team was able to successfully match the time history of the PIO incident using the off-line simulation. Attempts to recreate the PIO flight scenario using the pilot-in-the-loop HQS were only successful one time, because of the precise timing of events that were needed to produce the actual incident. It was also possible to get the simulator to PIO at the same flight condition, but the pilot had to work at exciting the system knowing the control inputs to try. *The point is, however, that the simulator fidelity was not a problem. It was the misuse of the simulator to set control law gains, and the lack of high-gain tasks to evaluate the system rigorously.* The preceding discussion documents the mistakes that were made in the pressure of a competitive program, but caused a different approach to be used for the F-22 program as presented in Chapter 3.6 of this report.

### 3.0 LESSONS LEARNED

Lessons may certainly be inferred from the problems cited in the preceding section. Inference is not a reliable design process, however, and the purpose of this section is to present a compilation of explicit lessons learned from as many programs as possible. The lessons are presented in the form of successful approaches either in response to a problem or as a design effort. It is intended to cover all aspects of flight control system design and to lead into the definition of best practices. One problem to be addressed is also the question of lessons that are not learned, even though they were available. Thus history shows the same lessons “re-learned or not learned” over and over again, in flight control design as in everything else.

#### 3.1 TORNADO SPIN PREVENTION AND INCIDENCE LIMITING SYSTEM

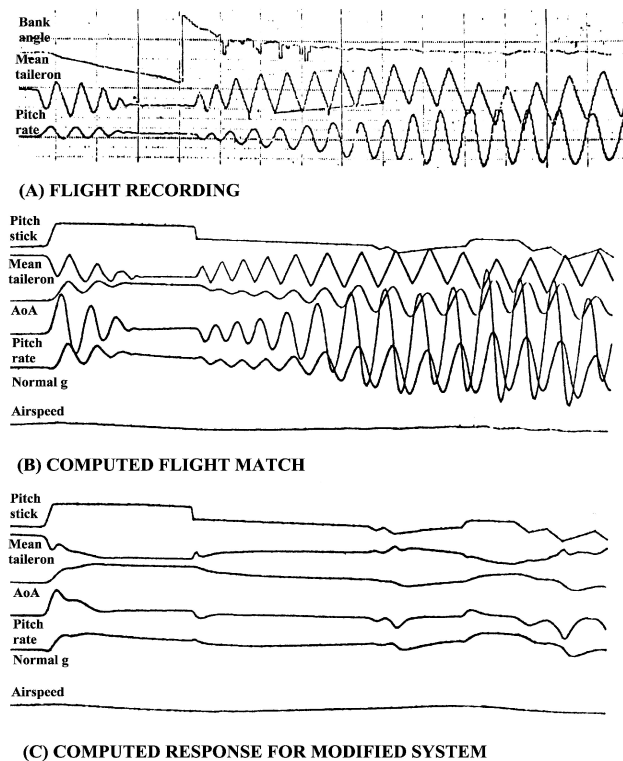
A problem occurred in 1981 during the development of the Tornado aircraft’s Spin Prevention and Incidence Limiting System (SPILS). In early flights some rate-limited oscillations had been encountered, which exhibited adequate damping characteristics. These were only seen when the pilot pulled rapidly to fully back stick to test the incidence limiting capability of the system, and then only at specific flight conditions. Comparisons with the simulation model, which included actuator rate limiting, showed the in-flight oscillations to be somewhat worse, with slightly lower damping. However, the test pilots considered the aircraft response to be acceptable and flight testing was therefore allowed to continue to further investigate the system.

A severe large amplitude rate limited oscillation was encountered [see Fielding] during the 42nd flight with this system and was despite the system having (apparently) acceptable stability margins. Following a detailed analysis of the flight incident, the aircraft’s instability was found to be associated with a combination of specific conditions and non-linear behaviour. To provoke the oscillation, it was necessary:

- to drive the taileron actuators hard into rate and acceleration limiting,
- to have the aircraft in the speed range where the aircraft / FCS loop gain was highest,
- to be in a dive,
- to hold the airspeed constant (and hence maintain the highest loop gain),
- to have the pitch stick positioned about 50% aft of centre to maximise the combined feedback through the Command and Stability Augmentation System (CSAS) and SPILS.

Such a combination had not been encountered in previous flights, hence the number of flights without any problems.

Some difficulties in simulating the oscillation were encountered. However, following a detailed taileron actuation system modelling exercise, which included the effects of acceleration limiting due to current limiting in the servo amplifier driving the first stage actuator, a good simulated match of the incident was obtained, as indicated by Figures 3.1.1 (A) and (B). This actuation system model played a significant part in evaluating the design modifications. The solution to the stability problem involved an actuation system outer loop modification and control law non-linear compensation. This compensation, which was tested in 1981-82, is identical in purpose to the rate limiting algorithms promoted in the mid-1990s. These modifications led to a dramatic increase in augmented aircraft stability (effectively recovering the linear behaviour), as shown by Figures 3.1.1 (B) and (C). The resulting design was thoroughly validated by flight testing and has been successfully flown in the Tornado aircraft since 1982.



**Figure 3.1.1: Tornado Time Histories**

The lessons learned from the Tornado SPILS experience were mainly associated with flight control system non-linearities, as follows:

- The SPILS was designed as an ‘add-on’ system to the existing CSAS, with the dictate that no significant changes should be made to the CSAS in the interests of minimising the costs and impact of the change. This compromised the design of the SPILS and the subsequent modifications to correct the problem found. A more integrated approach would have allowed a better design to be achieved.
- Even the accurate modelling of rate limiting, including actuation loading effects, may not provide an adequate representation for design and simulation, since an additional effective time delay is introduced as a rate limited actuator changes its direction. Acceleration limits should be accurately modelled and actuation system specifications should include adequate acceleration capability, to avoid jump resonance type of characteristics.
- Ensure that the system stability analyses and simulations have identified the worst cases, including the combined effects of several non-linearities and maximum loop gains. Fully understand the system non-linearities and be aware that for a highly non-linear system, any sign of low damping for large amplitude responses is a potential warning sign for a cliff-edge instability.
- The main area of concern was that the pilots would ‘beat the system’. In this respect, the rapid fully aft stick pull had been assumed to be the worst case in the pitch axis, in that it induced significant pitch momentum and rate limiting behaviour as the incidence limit was being approached. In terms of overall system stability this was not the worst case, since CSAS error authority limiting was occurring for the extreme stick commands, and this effectively reduced the feedback through the system. This effect, although known, was not fully appreciated when in combination with the non-linear actuation system behaviour described above.

In addition, the early flights provided an indication that flight results were not matching predictions. As noted, “the test pilots considered the aircraft response to be acceptable”, but this provides no indication of characteristics yet to be tested; all anomalies should be analysed. A number of other lessons are also available from Tornado experience. Although integral controllers were not used and the handling

characteristics were partially classical in form, valuable lessons were learned for the manoeuvre demand systems in later aircraft designs:

- The feedback structure of the CSAS has remained unchanged from 1974 up to date apart from an initial, minor low speed modification. Early handling problems with high-order landing PIO were associated with excessive command path gains and phase lags in the command path pre-filter.
- The original pitch control forward path structure resulted in easy saturation both of rate and position limits in particular circumstances. The structure was modified, virtually eliminating position saturation within the stick travel limits. However, the gain was still slightly higher than necessary in the mid-speed range in which the SPILS rate limit problem was encountered.
- Further handling improvements were incorporated by changes to the pre-filter design with scheduling of the lag-lead time constants. Principal development areas were the landing approach and pitch tracking at high speeds. This experience led to an understanding of high order PIO and the means to prevent it by design.
- The ability to tune the handling through pre-filters without affecting the feedback system was proven as a powerful means for optimising handling qualities. This is also corroborated by the F-22 control law designers.

The overall lessons learned were the need to prevent non-linear actuation behaviour, to match the forward path gains to both static and dynamic needs, to avoid rate saturation and surface position saturation while within the stick travel limits, and to maintain sufficient direct unlagged connection between the stick and actuation, to provide immediate responsiveness to pilot commands (i.e. angular acceleration cues).

### 3.2 FLY-BY-WIRE JAGUAR

The Jaguar Fly-By-Wire Programme [Nelson and Smith] spanned the period 1977-84 and built upon the experience gained by British Aerospace from the fly-by-wire systems of the TSR2 (1963-65) and Tornado aircraft, and airborne digital control from the Concorde intake control system. The prime objective was to identify the design methodology and airworthiness criteria necessary for flight certification of a full-time, digital fly-by-wire flight control system. Throughout the programme the control system was treated as though intended for production, leading to the design and flight demonstration of a quadruplex digital control system, without an analogue or mechanical back-up.

As part of the programme, the aircraft's longitudinal stability was progressively reduced by adding ballast and fitting strakes, with the consequent demonstration of aircraft performance improvements. The flight test programme (first flight 1981) of 96 flights, successfully demonstrated an angle-of attack control and spin prevention system, and the ability to control an airframe with significant relaxed static stability: a minimum time to double amplitude of 250 msec. was controlled in flight. From this programme, the lessons learned with respect to flight control laws were mainly associated with the introduction of digital flight control, and the control of an unstable airframe:

- It was found that provided that the airborne computer iteration rate was fast enough (e.g. 50 Hertz, giving acceptable accuracy up to 5 Hertz), all significant aspects of control laws design could be covered by using analogue approximations to allow for the effects of digital computation. This permitted the use of the Laplace s-domain techniques for the basic design of the sampled data system. The higher frequency structural mode filters (e.g. notch filters) and anti-aliasing filters required special consideration.
- A major consequence of destabilisation of the airframe was found to be a progressive reduction in the capacity for absorption of off-design characteristics; i.e. it is more difficult to design in robustness. This has a significant implication on the data quality requirements for any highly unstable aircraft.
- For accurate aircraft simulation it was found to be necessary to model the sampling and computer delay effects within the digital simulation of the combined aircraft / FCS dynamic model. Whilst simplification of certain elements such as notch filters could be used without degradation of the model, computation of control law filters using algorithms corresponding to, or equivalent to those of the

airborne software, was essential to ensure an exact end-to-end match of the dynamics in order to fully represent the handling qualities characteristics.

- Visibility was found to be essential in the definition of control laws for translation into code, for simulation and for hardware/software definition. A formal means of control laws functional specification was recommended, in order to provide unambiguous information.
- The development and application of handling qualities criteria which included the effects of the ‘high-order FCS’, proved to be very successful in achieving good handling qualities and avoiding pilot induced oscillation tendencies.
- In the absence of proven high order FCS handling design criteria for initial design, fixed base simulation was very successfully used before flight to identify deficiencies in flight path response that are characteristic of a basic proportional + integral pitch rate demand control system. The forward path command structure was modified to produce crisp and precise pitch and path control, and this was confirmed in flight.
- PIO prevention criteria developed as a result of the Tornado experience were applied to the initial design. As expected, no PIO occurred during the whole flight program.
- A number of in-house frequency and time response handling qualities design criteria (the “Gibson Criteria”, [Gibson 1982]) co-evolved with further control law development. These criteria made no specific connection with conventional modal parameters but were based on graphical representations of desirable response characteristics. Very good handling was achieved, with excellent in-flight refuelling and pitch tracking qualities.
- Mild roll ratchet was experienced by a single pilot. This was eliminated by simple control law changes based on the principle of the stability of the lateral acceleration bob weight loop, and by the addition of a viscous damper to the stick.
- Simulation played a major confidence building role in pre-flight clearance. Its use was essential for clearance of the carefree manoeuvre envelope. With the advantage of having the normal Jaguar experience for direct comparison, much was also learned about its limitations. However, apart from the initial flight path control improvement, all handling qualities design was based on analysis.

### 3.3 THE EXPERIMENTAL AIRCRAFT PROGRAMME

The FCS technology demonstrated by the FBW Jaguar was further developed in the Experimental Aircraft Programme (EAP) technology demonstrator aircraft, which first flew in 1986 [see McCuish and Caldwell]. The objective of this programme was to provide flight demonstration of various technologies for a future European combat aircraft (which became Eurofighter 2000) and included: modern cockpit displays, avionics systems integration, advanced aerodynamics, advanced material construction and active control.

The performance requirements for the EAP aircraft resulted in a closely coupled canard-delta configuration with a high level of longitudinal instability: a minimum time to double amplitude of 180 msec. was controlled in flight. This instability dictated the need for a full-time full-authority quadruplex digital fly-by-wire system, which did not have any analogue or mechanical backup. The system was successfully demonstrated in a flight test programme of 259 flights, which included carefree manoeuvring: automatic protection against stalling, spinning and over-stressing of the airframe.

The lessons learned from the development of the EAP flight control laws were mainly associated with the development of the architecture and functionality of the control laws:

- The ‘normalisation’ of control surface effectiveness within the control laws, to compensate for the effects of dynamic pressure, Mach number and control surface deflection, resulted in simplified controller gain scheduling. The normalisation was achieved by non-linear control demand functions, just upstream of the actuation system commands, which provided a linear pitching moment command point within the control laws, which was independent of aircraft operating point.
- The introduction of mixed airstream direction data and inertially derived incidence (using complementary filtering) for pitch stiffness augmentation was shown to markedly improve the response

to wake penetrations or large gusts, resulting in little aircraft motion or surface activity. This followed an incident whereby the aircraft had passed through the wake of a target aircraft and experienced unacceptable control surface and aircraft transients due to an airstream direction signal being fed directly to the control surfaces.

- Automatic trim functions which were part of the baseline FCS (i.e. not part of an autopilot) were introduced. In particular, an automatic wings-levelling function which was engaged when the aircraft was close to level flight, was integrated into the system and reduced pilot workload.
- A pseudo-static stability function was introduced at low speeds in the form of an airspeed-scheduled pitch stick offset. This required the pilot to move the stick progressively aft as speed reduced, effectively providing the static stability tactile cue on landing approach characteristic of a stable airframe. A series trim was provided with a constant trimmed stick position. Although the pilots would have preferred a parallel trim with a moving stick trim position, there was no trimming function except at low speed and the mechanical complexity was not considered to be justified.
- With the initial reversionary control laws, the roll acceleration was satisfactory in flight. From flight experience, the pilots thought that increased acceleration would be desirable in the second control law set with full manoeuvre limiting, and this followed in proportion to the 25% higher maximum roll rate provided in this set. In flight, the pilots enjoyed the “spectacular” acceleration, but found that the lateral acceleration at head level for maximum input rolls was excessive, preventing absolute precision in very rapid bank angle capture. Naturally this particular problem was not identified in fixed base simulation. However, simulation was not employed to design the roll sensitivity, which in general was excellent. In combat chase manoeuvres the transition from hard manoeuvring to settling into precision tracking was easy and precise. The design methodology successfully prevented roll ratchet despite the high acceleration. Close formation flying was also easy and precise.

### 3.3.1 Flying Qualities Design

The lessons learned also included invaluable experience in the further development and application of improved in-house high order handling qualities design and PIO prevention criteria. The handling qualities were generally excellent, again resulting in a design which avoided any PIO tendencies, but which had one or two minor deficiencies that were left uncorrected due to program time limitations. The design methods to achieve this are discussed in detail in Gibson [1999].

There were several basic strands to the achievement of these results. Conventional mode parameters and LOES methods were not employed to define handling. The pitch and roll response characteristics in both the time domain and frequency domain were described by a highly visible graphical method meaningful both to pilots and engineers. In pitch, the basic mode was pitch rate demand, with dynamics tuned to represent a conventional angle of attack demand response in the short period frequency region. With increasing stick demand, the mode was blended progressively into a normal acceleration demand or an angle of attack demand above and below the corner point respectively. All modes had similar “short period” dynamics with seamlessly transparent mode transitions, and there was no essential difference between wheels-up and wheels-down handling.

Response optimisation was completed by a tracking filter in the pitch command path to provide precision K/s-like attitude control up to the crossover frequency for fine tracking, with CAP values typically less than 0.4 rad/sec<sup>2</sup>/g. This filter was dynamically modulated as a function of the amplitude and rapidity of the stick input to optimise the flight path response with increased CAP for aggressive manoeuvring, the transition appearing seamless to the pilot.

Adverse high order effects were prevented by design in a number of ways. Regardless of the overall control law structure, extremely direct paths between the stick and the control surface actuators were maintained to ensure an immediate response to any stick input, keeping the pilot feeling closely in touch with the aircraft. With the command path filter optimisation, this ensured the absence of conventional PIO problems such as bobble and tracking oscillations. Type 1 high order locked-in PIO was prevented by the small phase delays and the provision of response attenuation without phase penalty at the 180 degree phase lag PIO frequency. Large amplitude PIO was prevented by actuator rates sufficient to avoid significant exceedance even with

maximum stick inputs at the PIO frequency, where only small oscillations could be excited. The resulting response degradation with increasing amplitude was minor and progressive, and both Type 2 and Type 3 PIO were accordingly impossible.

As with the FBW Jaguar, fixed base simulation played a major role in pre-flight clearance of carefree handling, since pilots could use combinations of inputs undreamed of by engineers and were very good at finding the exact input to trip up the system. It was also significant in developing the take-off ground-to-air fading of the control laws, which could not be done by analysis alone.

### 3.4 CONTROL LAWS DESIGN FOR VAAC HARRIER

‘Vectored thrust Aircraft Advanced flight Control’ (VAAC) is a UK project, which is managed by the Defence Evaluation and Research Agency. The project [Shanks, et al] is investigating the low speed flight control, handling and cockpit display concepts applicable to an aircraft to replace the Harrier. As part of the project, British Aerospace have designed a ‘two inceptor’ pitch control law which has been successfully demonstrated in a series of flight trials in the VAAC Harrier experimental research aircraft. With the two inceptor control strategy, the aircraft’s pitch stick, throttle lever and nozzle lever (for thrust vectoring) are replaced with right hand and left hand inceptors for controlling the aircraft in pitch. Such an arrangement involves a high degree of automatic control of the thrust vector.

Through involvement in this programme, the lessons learned with regard to pitch flight control laws are mainly associated with the handling of the aircraft during the transition between wing-borne and jet-borne flight (and vice-versa), and at low speed and in the hover:

- There was a clear lack of design aims and design criteria for the type of control laws being designed. Criteria therefore need to be further developed and validated, to provide a guide for the design aims of STOVL flight control systems: to define handling qualities criteria and the requirements for carefree handling at low speed and in the hover. Existing specifications and criteria have become obsolete, i.e. MIL-F-83300 (1970) and AGARD-R-577 (1973).
- The early standard of the control law used an airspeed-triggered switch to transfer from pitch rate to height rate demand modes, with associated signal equalisation. This proved to be unnecessarily complicated and introduced a discrete, and undesirable, change in handling qualities. The control law was developed to include airspeed blending between the modes, leading to a significantly easier implementation and providing continuity of handling characteristics.
- Unlike a conventional aircraft, where full primary control surface deflections are rarely (if ever) used, the nozzle and throttle controls of a VSTOL aircraft are often operated on their limits, for example: to achieve maximum acceleration or deceleration performance, and when operating close to the hover with a low thrust margin. Since the thrust vector became part of a closed-loop system which involved integral control, appropriate integrator conditioning logic was required.
- Flight testing showed that the two-inceptor control strategy resulted in a large reduction in pilot workload, when compared with a three-inceptor arrangement, during the transition from wing-borne to jet-borne flight and hover. The demonstrated reduction in pilot workload was mainly due to the automatic axis transformations inherent in the control law, whereby the pilot’s thrust vector commands were in inertial axis rectangular coordinates (where appropriate) rather than body axis polar coordinates.

Subsequent to the development of the pitch laws, BAe have designed lateral/directional control laws for the VAAC Harrier [see Lodge and Runham], resulting in some further lessons learned:

- Care must be taken during pilot-in-the-loop simulation assessments. The lack of roll acceleration cues can result in a request for an increase in roll bandwidth, which when subsequently flown on the aircraft may result in an over-active response.
- Modelling fidelity is important for development testing; problems showed up in the flight test phase that previously had not been apparent, due to the lack of sensor noise modelling in the simulation model.

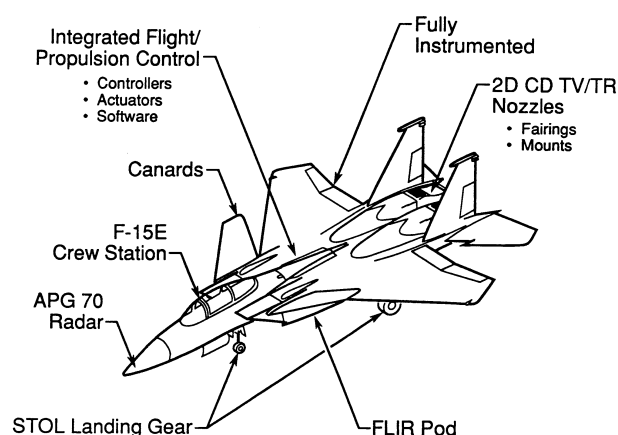
- The use of auto-coding for generation of the aircraft's embedded flight control laws enabled rapid progress to be made, once flight testing had commenced. Once deficiencies had been identified in the control laws, changes could be identified, tested, implemented, and flown on the aircraft, on the same day.
- Once the pilots had become familiar with the response produced by translational rate control (TRC), it was found that they wanted more authority than was initially provided. Currently a full authority TRC input will produce a ground-referenced lateral velocity of 20 knots.
- Although two-axis (pitch and bank) TRC in the hover has shown that a significant decrease in workload is achievable, questions have been raised as how best to implement the TRC pilot interface. Of the various control options tried (centre stick, left and right hand mini-stick tops), the left-hand mini-stick top mounted on the throttle has met with the best response from pilots. In this set up, the pilot controls his 'plan' position using his left hand (the left hand already controls speed/ acceleration) and height rate is controlled on the longitudinal axis of the centre stick. This proved to be better than controlling all three axes on one hand, using a two-axis mini-stick top on the centre stick, which was found to increase pilot workload.
- By ensuring that the pitch and lateral/ directional blending regions were common, the number of control modes and hence blending regions were kept to a minimum. This helped to reduce the potential for pilot confusion during the transition.

### 3.5 STOL & MANOEUVRE TECHNOLOGY DEMONSTRATION PROGRAM

The S/MTD program was a technology demonstration program to validate four specific technologies related to providing high performance fighters with both STOL capability and enhanced combat mission performance:

- Two-dimensional thrust vectoring and reversing exhaust nozzle.
- Integrated Flight & Propulsion Control (IFPC).
- Advanced Pilot Vehicle Interface (PVI).
- Rough/soft field landing gear.

These technologies were incorporated into a YF-15B together with all-moving canard surfaces (see Figure 3.5.1), starting in October 1984 with a last flight in August 1991.



**Figure 3.5.1: The STOL & Manoeuvre Technology Demonstrator**

For the purposes of this report, the lessons learned are concerned with removing the original mechanical control system and replacing it with a new digital control system including propulsive control. Various references are summarised to discuss lessons learned in the areas of flying qualities requirements; design methodology; disturbance inputs for use in the design process and management issues. Throughout this Technical Report there are frequent comments concerning whether lessons are learned and applied or



ignored and re-learned, and also about the experience level of the design team. For the S/MTD program, many of the team had recently experienced the design of the F/A-18A and applied the lessons learned successfully [see Walker and LaManna].

### 3.5.1 Flying Qualities Requirements

As a technology demonstrator program, the design requirements were quite explicit. The IFPC system was required to provide “good inner-loop stability and positive manual control in all axes of the air vehicle throughout its intended operating envelope both in flight and on the ground (satisfying the intent of MIL-F-8785C)”. The S/MTD program was an opportunity to assess the military specification requirements for flying qualities, MIL-F-8785C, that had been published in 1980. One flying qualities requirement that was explicitly called out in the Statement of Work was to minimise time delay, or lag in aircraft response to pilot control input. This was expressed as the (new in 1980) equivalent system time delay requirement to be less than 100 msec for Level 1. Although the importance of time delay is more widely accepted now, it still should be an explicit, hard requirement in any control system to be designed for any precise task, regardless of the method of design or implementation.

Immediately after contract award, a joint effort was made to refine the specification requirements to a more explicit set of design goals. This amounted to a more restrictive set of parameter boundaries within those of MIL-F-8785C, as documented and discussed in Moorhouse and Moran. A group of “second tier” flying qualities criteria was used during the development of the control laws to improve the tactical capability [see Bland et al]. While none of the requirements of the primary specifications were violated by the final results, the concept of keeping each of the parameters in the middle of the chosen envelope was abandoned in favour of obtaining pilot acceptance of the overall results. Lessons relative to application of the military flying qualities specification Moorhouse, 1990) are summarised here together with additional comment.

Equivalent System Formulation: The equivalent system concept was introduced into the MIL-F-8785C version of the specification, whereby quantitative requirements apply to the parameters of the equivalent, conventional-order transfer function which approximates the actual dynamics most closely. A primary motivation was to facilitate the use of the large flying qualities database to evaluate highly augmented configurations, but it was also believed that the essential characteristics of the “old fashioned requirements” still had validity. Further, it was suggested that the “best” type of response would be classical second-order, minimising artefacts of the digital FBW. The equivalent system captures the essential characteristics of the actual response that are important to a pilot, independent of the order or any of the discrete modes. The design task is then the reverse process, i.e., definition of the FCS augmentation, compensation, etc. to produce an aircraft response with the appropriate parameters.

The S/MTD control laws were also designed using both classical and multivariable methods. An interesting comparison became possible between the final CONVENTIONAL and COMBAT modes that were designed to the identical pitch rate to stick deflection second-order equivalent system transfer function. The Cooper-Harper ratings for tracking were both Level 1, a confirmation of the equivalent system approach, not just as an evaluation tool but as a design requirement to achieve a pure second-order response.

It is important that this result is interpreted correctly. MIL-F-8785C requirements are to be applied to “equivalent system” representations of the actual aircraft dynamics, expressed in terms of classical second-order modal responses. What is defined, however, is a family of response characteristics. Initial piloted simulation yielded Level 2 ratings for target tracking in the CONVENTIONAL and COMBAT modes, and Bland et al document how the second-tier criteria were used to reformulate a different second-order pitch rate response that received Level 1 ratings. In the final implementation, however, there were slight differences between the two modes with the COMBAT mode showing slightly more deviation from a pure second-order response. This difference proved to be noticeable to the pilots, average Cooper-Harper ratings for fine target tracking were 2 for the CONVENTIONAL mode and 3 for COMBAT mode.

Short Period Requirements (Category A): The initial interpretations of MIL-F-8785C [see Moorhouse and Moran] were a damping ratio of 0.7 - 0.8 and CAP of 0.35 - 1.2. Pilot evaluations in the simulation was satisfactory for everything except fine tracking, for which the configuration received definite Level 2 ratings and comments. The relatively low wing loading of the F-15 (to satisfy turn rate and manoeuvre

requirements) gives a low value of numerator time constant and with a value of CAP of approximately 0.4, all second-tier criteria predicted Level 2 tracking characteristics. Then the question became a choice of the best way to increase the bandwidth to the recommended 6.5 rad/sec. First, we could retain the airframe-defined numerator time constant. Augmenting the short period frequency sufficiently then also requires augmenting the damping to values around the maximum allowable specification values. The second option is to retain the same values of damping ratio and CAP and use the augmentation to produce a higher equivalent numerator time constant. Bland et al documents the reasons for choosing the second option and the consistency that then exists between different criteria. The S/MTD program used this approach in the CONVENTIONAL and COMBAT modes to produce excellent tracking characteristics at the expense of the long-term flight path response, i.e., g creep. The CRUISE mode, however, retained the original design which preserved the correct flight path response to pitch input at the expense of the degraded tracking characteristics.

The flight test results for the HQDT tests of both the CONVENTIONAL and COMBAT modes were Level 1 and pilot comments reflect excellent tracking characteristics. The CRUISE mode ratings for HQDT were Level 2 as expected, reflecting a loss of precision in the pitch response. For a flight path control task, the CRUISE mode was Level 1 and pilot comments reflected the precision with which flight path vector changes could be commanded. At the same time, one pilot commented on the strangeness of not having to apply additional compensation! In addition, there was an overall preference for CONVENTIONAL & COMBAT mode flying quality characteristics over CRUISE mode. There is the possibility, however, that a CRUISE/flight path control type of characteristic would be required for a task such as certain bomb delivery manoeuvres.

The lesson learned from this development is that it is definitely not necessary to retain the classical long-term load factor to pitch attitude response for tasks involving pitch pointing. It also does not mean that other solutions could not be found, depending on the configuration, only that this approach gave satisfactory flying qualities for all tasks tested. But the danger for any similar configuration with a low value of numerator time constant is the tendency toward producing a sensitive, overly damped characteristics (see also discussion of the YF-22 and F-22 in Chapters 2.3 and 3.6 of this report).

Short Period Requirements (Category C): 1500-ft landing distance on a wet runway in a 30kt crosswind formed a very stringent design requirement. The S/MTD landing task was to touchdown in a “box” 60 ft long by 20 ft wide at the start of the 1500 ft x 50 ft operating strip. A qualitative requirement to minimise touchdown dispersion was supplemented by defining precise landing as a Category A tracking task rather than Category C for application of the MIL-F-8785C short period pitch requirements. The indirect effect is an increase in the required pitch bandwidth. This change was more heuristic than analytical, since there is no suggestion of any particular touchdown precision associated with the Category C landing requirements of the military flying qualities specifications.

A complete documentation of the development of the S/MTD landing control laws featuring decoupled speed and flight path control is available [Moorhouse, Leggett and Feeser]. With speed hold there is reasonable consistency with the requirements. This pitch attitude bandwidth requirement is not, of course, directly related to any requirement on speed stability. Without speed hold, it would appear that the bandwidth requirements should be more stringent. The results show that the effect of speed stability on the pitch axis requirements needs further research.

MIL-STD-1797 contains the MIL-F-8785C requirements unchanged. There is also a bandwidth requirement as an alternate criterion, although the same one is used for both conventional and STOL configurations. The following lessons learned are suggested for MIL-STD-1797. First, there is a critical need for guidance on how the requirements are affected by the touchdown precision that the aircraft is expected to achieve. The Category C requirements from MIL-F-8785C will provide satisfactory flying qualities only if normal touchdown precision is acceptable, while the Category A requirements will provide more precision for conventional landings. If “some degree of touchdown precision” is required, then a pitch attitude bandwidth requirement with a minimum value of 2.5 rad/sec should be specified. If a true requirement for precise landing exists, e.g. the S/MTD program, then a minimum bandwidth of 3.5 rad/sec is required. Lastly, for additional guidance, the requirements can be relaxed if a high degree of speed stability is incorporated as discussed above.

Stick Force Characteristics: The S/MTD control system was digital fly-by-wire with no mechanical backup. Flight testing was started without a stick damper, even though it had been planned for installation. During envelope expansion testing, a flight condition was reached where the mass of the centre stick coupled with the aircraft short period response and the damping became unacceptably low. The stick damper had to be installed to continue expanding the envelope. A nominal damping ratio of 0.7 was satisfactory for all S/MTD testing, but no effort was made to determine the effect of any different values. It is also of interest to note that this lesson was independently learned on the Fly-By-Wire Jaguar program, [see Smith, Yeo and Marshall], although no suggestion for damping ratio is given. In spite of a trend towards various forms of mini-stick, this remains as a lesson learned for centre sticks or any device with appreciable mass.

The wording of MIL-F-8785C indicated that feel system characteristics should be included in the equivalent system definition. The S/MTD implementation used stick deflection as the command input and the decision was made to define all equivalent systems as response to stick deflection and not include the feel characteristics. This approach was used throughout the program with success. In addition, the stick damper added significant phase lag to the feel system. The pilots had no adverse comments on this aspect of the flying qualities, further supporting the approach used. Moorhouse 1994 contains further discussion and suggested criteria for when to include stick characteristics in equivalent system formulation.

A complete treatment of stick force characteristics is contained in Gibson and Hess, where the question of damping is discussed. In the past, though some conventional aircraft did require the use of stick damping, many others had satisfactory characteristics without it, a sufficient effect being provided by the mechanical control system. In fly by wire aircraft, stick damping seems always to have been found necessary for the best handling. In Gibson [1999], a damping level of 50% to 70% of critical is proposed from experience to be adequate but not excessively over-damped. At present there is no explicit requirement, which suggests an area of required future research.

Equivalent System Time Delay: Although the overall S/MTD design requirement was the 'intent' of MIL-F-8785C, one particular requirement was stated explicitly and not considered as open to negotiation - equivalent system time delay less than 100 msec for Level 1. The contractor established a design goal of 70 msec based on the development of the F/A-18A [Walker and LaManna], so that time delays were not a factor in S/MTD handling qualities. One exception provided inadvertent validation of the requirement. During initial envelope expansion, pilots complained of a loss in directional damping at high dynamic pressure. The problem was traced to a software error in the yaw axis causing an additional time delay putting the total over the 100-msec limit. A software change was made before flight testing continued to higher speeds. The overall S/MTD development validated the requirement that equivalent system time delay should be less than 100 msec in all axes for Class IV aircraft - the requirement for precise control can be taken as a given.

Lateral/Directional Tracking: The initial lateral/ directional design goals were conventional, i.e. Dutch roll damping of 0.7 and frequency the same as the basic F-15, and roll mode time constant of 0.3 sec. Roll coordination was achieved with straight forward interconnects from the lateral control commands to the directional controls. All the primary mode characteristics plus secondary ones such as sideslip excursion, roll oscillation, etc. met the Level 1 requirements in MIL-F-8785C. Both fixed-base and motion-base simulations gave Level 1 ratings for all tasks except target tracking. During the tracking tests, the pilot could not move the pipper laterally without first a lag and then an overshoot in the response, leading to Level 2 pilot ratings. Further analysis showed that the response of the pipper aim point did indeed agree with the pilot comments. In addition, yaw rate response to lateral stick input was the parameter most nearly correlated with pipper aim point. Modified lateral/directional interconnects were implemented which reduced the lags in both yaw rate response and pipper aim point response. These modified interconnects produced Level 1 ratings and comments in further piloted simulation.

Based on this experience, it was proposed that a specific lateral tracking criterion was required [Moorhouse 1990]. One candidate would be aircraft yaw rate response to lateral stick input. It is reasonable to expect that the equivalent time delay in this response should meet the same requirements as all other axes. It would also be expected that bandwidth criteria could be developed, analogous to the ones being applied in the pitch axis. The S/MTD development supported this proposal in principle, but further research is needed to quantify such requirements. It would also be necessary to consider whether aircraft yaw rate or pipper aim point is the correct parameter to specify. The correlation between the two may not apply at high angles of attack.

In summary, the flight control system of the S/MTD program was developed with design requirements that were a restricted set within the Level 1 boundaries of the new MIL-F-8785C. As the development progressed through simulation and flight test, the refinements were to improve Level 2 pilot ratings. There was never any explicit consideration of PIO, but neither was any existing boundary violated. The overall lesson learned was in support of using the specifications, with refinements made by analysis and validated by rigorous evaluations in a piloted simulation, including use of high-gain tasks to search for problems.

### 3.5.2 Design Methodology

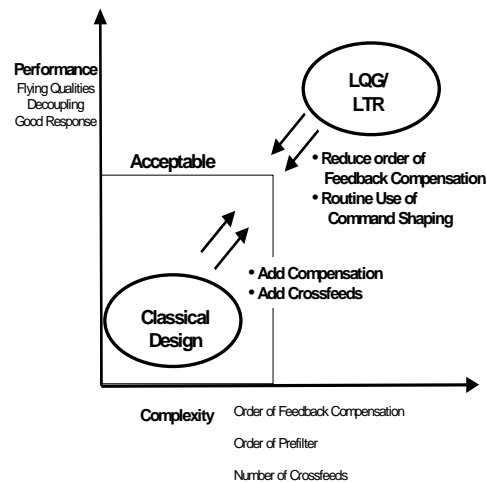
There is a continuing debate about the use of modern design methods and some of the S/MTD experience is still valuable to this day. Part of the answer lies in an implied trade-off of design complexity for performance. Design complexity (sensor complement, additional computation, etc.) is often more apparent than gains in control system performance. A conventional aircraft with conventional control architecture may not show any benefit due to multivariable control design methodologies. This assertion, however, assumes an experienced design team. All the bidders on the S/MTD contract were strongly encouraged to use multivariable control theory, although it was not expressed as an absolute requirement. With integration as a program objective, there was some uncertainty that a classical approach would optimise use of all the available effectors, totalling twenty-two and covering all six degrees of freedom. In the actual program, a combined approach was used, and a choice was then made as to which one to implement in the control laws for flight. The choices by mode and axis are shown in Figure 3.5.2. This allowed a unique comparison of the methods [see Moorhouse and Citurs].

Axis/Mode	LQG/LTR	Classical
Longitudinal		
CONV		x
COMBAT	x	
CRUISE	x	
STOL-Land	x	
STOL-Takeoff	x	
STOL-Ground	x	
Lateral/Directional		
CONV		x
COMBAT/CRUISE		x
STOL-Land		x
STOL-Takeoff		x
STOL-Ground		x
Thrust		
CONV		x
COMBAT/CRUISE		x
STOL-Land	x	
STOL-Takeoff		x
STOL-Ground		x

**Figure 3.5.2: Choice of Design Approach**

The first result was not really a surprise. For the modes or axes that had only conventional controls/requirements, the multivariable design technique was not judged to offer any benefit. An aspect of the development that gave totally unexpected benefits was the synergism of the parallel design process for the unconventional modes. One of the critical areas of multivariable control theory is to establish all the design requirements as the starting point. A full performance design is then synthesised to satisfy them. The classical approach addresses the requirements individually, in principle, although an experienced designer uses his past experience to approach the final solution efficiently. Both McDonnell Aircraft and Honeywell used experienced control system designers. Even so, the classical design benefited from knowledge of the performance attainable by the multivariable design. Simultaneously, the Honeywell design simplified the high-order compensator of the full-performance design aided by the knowledge of the performance attainable with the simpler formulations of the classical design. The result from the management perspective, was convergence on an optimum balance of performance and complexity (depicted in Figure 3.5.3). The consensus was that both the speed and accuracy of this evolutionary process, regardless of the method being used, depended more on the capability of the individual doing the work than on the

process itself. In addition, the combined approach was more efficient than either method by itself for the modes or axes with more than conventional requirements.



**Figure 3.5.3: Convergence of Design Approaches**

One of the comparisons to be made when assessing two methodologies is the ease of modifying the results or, if necessary, the ease of correcting deficiencies. In this respect, the insight into the design process provided by the classical method of control law development/analysis has a distinct advantage over the multivariable techniques. For example, during the early flight testing of CONVENTIONAL mode, it was discovered that the system damping was lower than desirable at low altitude, high-speed flight conditions. While the causes and fixes for the condition were being investigated, a simple patch to the software was installed, changing the feedback gains and providing sufficient damping to continue the flight test program. Had those particular control laws been developed using the modern method, a complete analysis of the system would have been required to define the changes required to improve the flying qualities. This is further support for the conclusion that multivariable theory is not warranted for a conventional design problem. The converse is probably also true - such a problem in one of the complex modes might not be so amenable to a simple fix.

The system was also required to be designed to meet the intent of MIL-F-9490D with the stability margins of MIL-F-9490D as design goals, followed by: "Single-input/single-output parameters may be too restrictive or too lenient for different aspects of the IFPC system in achieving the desired compromise between stability and performance. The contractor shall analyse and document deviations from the MIL-F-9490D requirements". This was therefore a requirement to validate or correct the 6db gain margin and 45 deg. phase margin for such a complex system. A flight test problem was manifested first by the pilots complaining about the pitch axis "ringing". In other words, aircraft response to the normal flight test stick inputs did not damp out as expected. Analysis of the flight test data revealed that the gain margin had decreased to approximately 3 db, the cause being a design error in use of the aerodynamic data. The fix that restored damping also restored gain margin to 6 db and gave flying qualities satisfactory for completion of the flight test. The S/MTD project considered that the experience validated MIL-F-9490D requirements for overall loop gain and phase margin.

Part of the difference in pilot ratings for the CONVENTIONAL and COMBAT modes came from the implementation of structural filters. The aeroservoelastic analysis was being done by McAir simultaneously with the control law development. Addition of the effect of the structural filters to the control laws developed by multi-variable design was much more difficult to perform than the similar effort being done on the conventional design, since the inclusion of those effects impacted the design of the prefilters used to shape the response to the pilot commands. A late change in filter characteristics was thought to be a small impact, but may have contributed to the above COMBAT mode-tracking characteristic. Another possible cause has also been discussed - compensator order reduction which, in this case, gave a second-order compensator. A more complex regulated variable would also have been an option to improve the responses, or more iterations could have been performed with the multivariable synthesis to improve the flying qualities. In reality, a production development program may or may not pay for an improvement in a flying qualities range predicted to be Level 1 (i.e., 'satisfactory without improvement' by definition). For the S/MTD program, time constraints precluded this further development.

### 3.5.3 Atmospheric Disturbance Models

The atmospheric disturbance model included in the flying qualities specification was revised extensively for the MIL-F-8785C version, with particular emphasis on the low-altitude region. There was much discussion and explanation of the components but guidance for use of the model was not very explicit. The MODERATE intensities of this model were explicitly required for use in the S/MTD development. Considerable effort was expended in simulating turbulence, crosswinds and wind shear, in order to develop the control laws to facilitate precise landing in those conditions. The occurrence of control rate limiting during a landing approach in gusty conditions at Edwards AFB was a surprise. A return to the piloted simulation was made to replicate the problem and develop a solution. The lesson learned was that crosswinds and wind shear are an essential part of the overall landing task but do not provide enough dynamic input to assess handling qualities. Turbulence is required in addition to winds, but simulation of continuous turbulence is only realistic to the LIGHT intensity level when we use Gaussian models. Above that, the pilots did not accept purely continuous disturbances and tended to ignore it. It was found that a combination of discrete gusts and turbulence was required for both pilot acceptance and to provide sufficient dynamic input into the aircraft responses. Proposed explicit guidance on application of the model is presented in Leggett, Moorhouse and Zeh.

MIL-F-8785C also introduced a means of recognising the degradation in pilot workload, i.e., pilot rating, that is to be expected as disturbance intensity increases. The designation “Level 1, 2 and 3” was applied only to system parameters, i.e., quantitative requirements. The term “qualitative degrees of suitability” was devised to represent different Levels when applied to pilot rating, with essentially identical descriptors. In spite of the semantic distinction in the specification language, the practical application would reflect that an aircraft with Level 1 characteristics would receive Level 1 ratings in LIGHT disturbances, Level 2 ratings in MODERATE and Level 3 ratings in SEVERE, provided that the pilot just rates actual task performance and does not make mental adjustments. Overall, the S/MTD development was considered to validate the requirements for recognising but limiting the degrading influence of disturbances.

### 3.5.4 Management of FCS Development Tasks

The following discussion represents a “case study” of the development of a new (starting on 1 October 1984) Integrated Flight/Propulsion Control (IFPC) system with many unusual features. There appears to be an accepted truism that: “There is never time to stop and plan a job, but there is always enough time to do it over again”. In this program, there was a conscious effort to defeat that truism. An “integrated design team” was discussed and agreed to even before contract award. In practice, interpretations of what that meant varied from lip service to total commitment, as should be expected from any large group of human beings. To foster or force and to monitor the integrated design, a Control System Integrated Board (CSIB) was implemented, with government and contractor co-chairmen. The first meeting was held less than four months into the contract. The contractor hosted the meetings, with an agenda of reviewing all the various components that were being integrated into the IFPC system. Attendees represented different contractor functional areas, all the major subcontractors and different government agencies. The Interface Control Sheets were defined in one-on-one meetings between the contractor and the various suppliers. In any complex system, there are likely to be indirect effects of one component on some other, apparently unrelated component or function. The rationale behind the CSIB was to anticipate and address integration questions as early as possible, and also to involve all the subcontractors and subsystem managers in the discussions, so as to uncover any possible indirect effects. Government participation was also an integral part of the meeting. The Program Office engineers frequently provided timely interpretation of Statement of Work requirements. The acquisition engineering representatives gained a familiarity with the system that they would later be responsible for clearing for flight. Similarly, the AF Flight Test Center personnel became knowledgeable on the system they would be testing, as well as ensuring that the test requirements were understood during the design process.

There was an initial resistance to “yet another meeting when everyone is so busy”. (Notice the similarity to the TRUISM). One Subsystem Manager instructed his Subcontractor to sanitise his briefing, because “there is too much technical detail for a government meeting”. The government and contractor co-chairmen were committed to making the CSIB a true working group, and time was spent reiterating this philosophy at more than the first meeting. The agendas and the time between the meetings were driven by purely technical considerations. After the initial teething problems, CSIB meetings were fully supported from the initial design questions through to preparation for flight clearance. The IFPC system that was developed was an all-new quadruplex digital fly-by-wire system with no dissimilar backup. Operation was almost perfect

throughout the flight test program of 145 flights. Did the CSIB meetings contribute to the successful development? Both of the CSIB co-chairmen [see Kisslinger and Moorhouse] unequivocally believe that it did, although it is never possible to quantify problems avoided.

On the other hand, it is possible to provide a lesson learned from not following the above procedure. A digital skid controller was provided by the supplier without charge to the program as a “simple” upgrade from the previous analogue component. Interface Control Sheets were defined, but neither the subsystem manager nor the supplier felt that there would be an integration problem, and they did not fully participate in the CSIB process. Stable, but not optimum, braking was finally achieved after nineteen software versions. Many of the problems were interface or integration problems that (with hindsight) were items for CSIB consideration.

After the effectiveness of the CSIB was evident a similar group was started, known as the Propulsion System Integration Board. Prior to this, the nozzle development operated under standard, “business as usual”, propulsion system ground rules, which view the propulsion system as an entity separate from the aircraft. The need for a different approach became apparent after a required weight redesign (with an attendant six-month delay in nozzle development and a major cost overrun) had been identified. The new board was chartered to address engine/airframe nozzle integration issues, i.e. other than control issues, in an analogous working group arrangement.

### 3.6 F-22 RE-DESIGN EXPERIENCE

The primary goals of the F-22 control law design team, [Wilson et al], were to insure that the lessons learned from the YF-22 would be incorporated into the design to provide safe and predictable flying qualities throughout the flight envelope, and that the aircraft would have exceptional flying qualities designed into the aircraft from the start of the program.

In order to achieve these goals a very structured design/analysis philosophy and development process was established. It is an iterative process that incorporates the following key features:

- specific design goals are established at the start of the design cycle,
- a control law structure is defined that allows those goals to be achieved,
- validated linear and non-linear analysis tools, including simulation (HQS), are used to verify that the design goals are satisfied,
- open and closed-loop evaluation tasks for the HQS are defined and used to validate the design.

The F-22 team also formed a Flying Qualities Working Group (FQWG) which functioned exactly as the CSIB had for the S/MTD, enjoyed the same level of commitment, and eventually partially incorporated some of the propulsion (PSIB) functions due to the highly integrated nature of the F-22. The benefits of the FQWG can be inferred from 600+ hours of flight testing to date (9/99) covering SL-50,000 ft, Mach 1.5 to 90 KIAS (60 deg AoA), and  $-1$  to 7 g. There has only been one occurrence of any pilot ratings less than Level 1 (and that was a single occurrence of a CH4); customer pilots consider the F-22 to be the “benchmark” for refuelling flying qualities. An independent assessment of the flying qualities for the first flight review team indicated that the teamwork exhibited by the FQWG impressed him even more than the airplane, and was considered to be a large part of the reason the aircraft flew as well as it did.

#### 3.6.1 Flying Qualities

Design Goals: The first step in the design process was to choose the control law design goals for the F-22. These goals were derived from a number of sources including specification requirements, industry and government research, and specific mission requirements (i.e. performance, aircraft loads). For the F-22, it was decided that the specification requirements for the short-term pitch response of the aircraft were far too vague to provide adequate guidance on setting the CAP and short period damping ratio. In particular, the Category A Level 1 CAP boundaries of  $.28$  to  $3.6$  rad/sec<sup>2</sup>/g are too large to define good flying qualities for most current generation fighters. As a result, the F-22 designers relied on alternate handling qualities criteria, such as Gibson, Neal-Smith, Bandwidth and Smith-Geddes, to shape the design goals for the aircraft. The performance of the YF-22 against these metrics was already known.

Control Law Architecture/Design Goals: The initial F-22 control law development effort concentrated on identifying the features of the architecture that would impact the designer's ability to satisfy the chosen design goals. It was determined that the pitch integrator played a pivotal role in the control law design process. It is fairly typical in modern day fighters to have an integrator in the pitch axis to provide set point control and minimise the need for the pilot to trim the aircraft as flight conditions change. However, the added dynamics of the integrator pole and zero on the longitudinal response can limit the effective bandwidth of the closed-loop system and has a significant impact on the performance relative to all of the linear metrics. For the YF-22, the integrator pole, and not the short period mode, was the dominant mode of the load factor and pitch rate response. In order to satisfy the linear metrics for the longitudinal axis, as well as many of the specification requirements, it was necessary to structure the control laws so that the integrator dynamics were not observed in the short term, closed-loop response of the aircraft. In other words, the F-22 had to be designed to have a low second-order equivalent response. Integrator dynamics were removed from the closed-loop response by using the integrator zero to cancel the integrator pole through proper selection of the proportional and integral stick path gains.

With the control law structure defined, the control law designer was free to iterate on the required short period frequency and damping ratio in order to optimise the performance against the various design goals. For the F-22, it was discovered that fairly non-traditional values of CAP and damping ratio were required to satisfy these metrics. CAP values of  $0.35 \text{ rad/sec}^2/g$  were chosen for flight conditions with relatively high values of  $N_z/\alpha$  [Moorhouse and Moran]. At lower airspeeds, the CAP value was allowed to rise to a value of  $1.0 \text{ rad/sec}^2/g$  to provide adequate closed-loop bandwidth. Short period damping was typically a value of 1.1 - 1.2 for most flight conditions in order to satisfy Gibson's Dropback Time criteria.

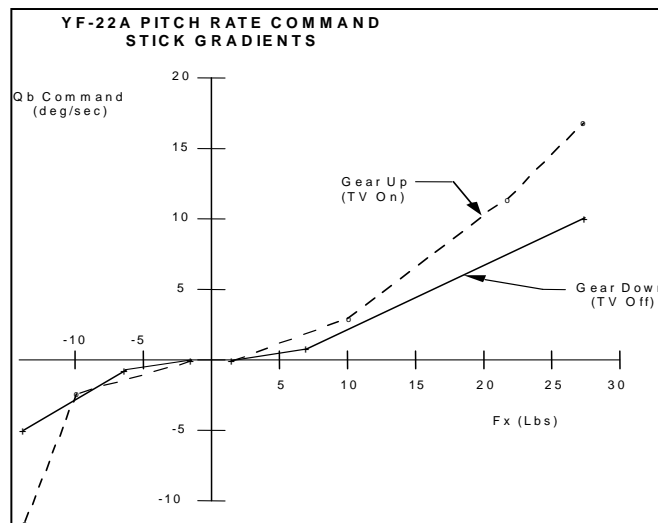
The control law designers also found that, due to the natural  $L_\alpha$  of the airframe at certain flight conditions, it was not possible to satisfy the design goals with a classical, second-order closed-loop response and still remain within the specification boundaries for CAP and short period damping. For the flight conditions in question, the design satisfied the goal metrics by masking the effects of  $L_\alpha$  in the pitch rate to pitch stick transfer function [see Bland et al]. Through the use of a first-order prefilter in the pitch stick path, the numerator term in the pitch rate transfer function was augmented to shape the pitch rate response of the aircraft and allowed the designer to satisfy the alternate handling qualities metrics. This technique results in a higher order load factor response (first / third order). The amount of "g-creep" observed in the response of the aircraft is a function of the short period mode frequency and damping and the level of augmentation to the pitch rate zero. The practical trade-off is the potential impact on tasks such as formation flying or aerial refuelling that require precise control of flight path angle.

This trade-off between pitch attitude and flight path angle bandwidth presents itself to the control law designer regardless of whether a classical or non-classical design is being considered. All of the existing alternate handling qualities metrics describe the pitch attitude performance of the aircraft for fine tracking tasks. In order to achieve a balance between pitch tracking requirements and precise flight path control, the control law designers have had to adjust the design goals to achieve a balance between these conflicting requirements within the achievable performance of the F-22. There was also an attempt to explicitly balance pitch attitude and flight path response by establishing (in addition to the pitch attitude design requirements) a set of flight path design requirements, primarily based on flight path bandwidth work performed by Hoh.

F-22 Flying Qualities/PIO Risk Minimisation: A very structured design and evaluation process was used to govern the development of the F-22 control laws. In addition, a number of specific design changes were incorporated into the F-22 control laws to minimise PIO susceptibility and address the items of the YF-22 mishap closure plan.

Maintaining consistent and well matched design goals between the gear-up and gear-down modes of the control laws and eliminating the steep command gradient changes between the modes has eliminated the triggering mechanisms that led to the YF-22 PIO (see Figure 3.6.1). For the F-22, Power Approach and Up & Away design goals of short period mode frequency, CAP and damping ratio are nearly identical and manoeuvring stick force gradients are identical so that the aircraft's handling qualities appear natural and consistent across the modes. Also, the use of vectoring with the gear down eliminates the configuration change present in the YF-22 at gear transition.





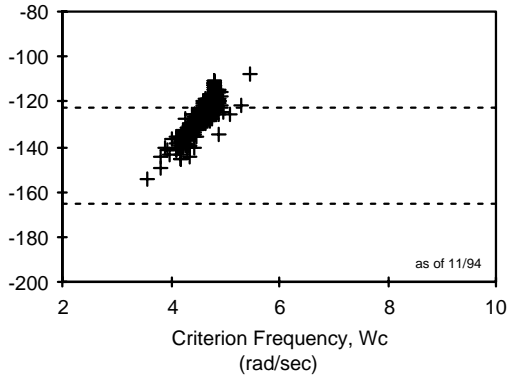
**Figure 3.6.1: YF-22 Pitch Command Gradients**

One of the major causes of the YF-22 PIO was the large command gradient change between the gear-up and gear-down control laws. The F-22 control law designers recognised the potential for steep gradients that can result from trying to blend the requirements for good handling qualities with specification requirements for high pitch rate/g-onset manoeuvring and recoveries from post-stall angles of attack. The F-22 team performed an extensive study into the optimum mechanisation to achieve this blend. Evaluations in the HQS included pitch/angle of attack captures and large angle-off gross acquisitions/transitions to a fine track of a manoeuvring target. The results of that study showed that an extended motion stick mechanisation provided the best design for satisfying the high rate requirements of the F-22 while maintaining exceptional flying qualities for normal manoeuvring.

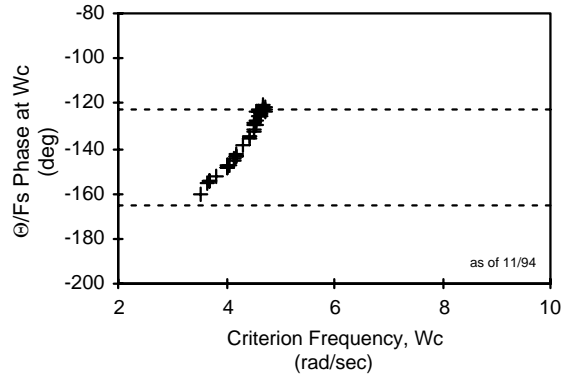
This philosophy for identifying and eliminating triggering mechanisms in the design of the F-22 extends to all control law mode or aircraft configuration transitions, not just to landing gear transitions. In addition, specific tasks were developed for the HQS to evaluate the handling qualities of the aircraft across mode transitions to validate the design. These mode transitions could also be triggered manually from the control console of the HQS during high-gain tasks. This was typically the final evaluation performed during a set of runs. When we did this (blindly) and asked the pilot later if he noticed the Mode Transitions, he typically replied “what mode transitions?”.

Summary of F-22 Flying Qualities: The F-22 control law design was based on goals derived from the guidelines provided by existing alternate handling qualities/PIO metrics, with specific control law architecture changes made to satisfy these goals. In particular, the F-22 was designed to have a low order, classical aircraft response. Elimination of integrator dynamics from the closed-loop response of the aircraft allowed the designer to increase the bandwidth of the system, lower equivalent system time delay and achieve satisfactory performance trends with respect to these handling qualities/PIO metrics.

The performance of the F-22 relative to the Smith-Geddes Gibson Phase Rate and Bandwidth criteria is shown in Figures 3.6.2 - 3.6.4. Compared against Figures 2.3.2 - 2.3.4, the improvement over the YF-22 is obvious. Although the data is not shown in this report, comparable improvements in the performance of the F-22 with respect to the Neal-Smith, Gibson Attitude Boundaries and Dropback Time design goals were also achieved. Even though there are questions about the flying qualities levels assigned for these metrics (especially when extending these metrics to current generation fighters), the trends in the data indicate the soundness of the basic design, even against the original boundaries for these metrics. The design goals, as well as the control law design philosophy, have been validated through ~800 hours of piloted evaluation in the HQS and two very successful in-flight simulation sessions.

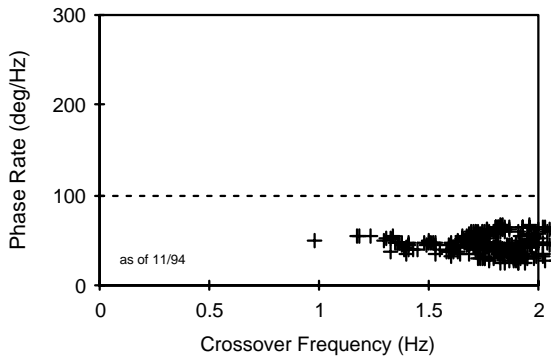


(a) Category A

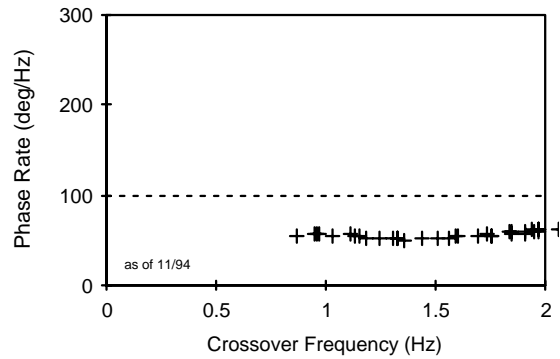


(b) Category C

**Figure 3.6.2: Smith-Geddes Criteria Results for the F-22**

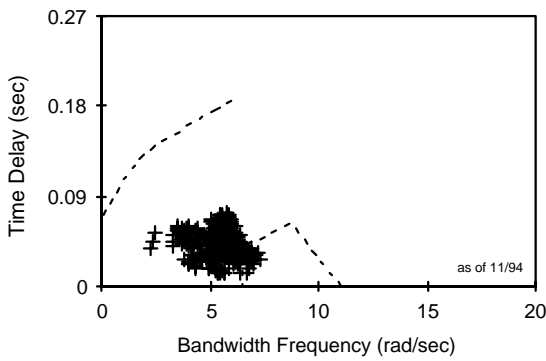


(a) Category A

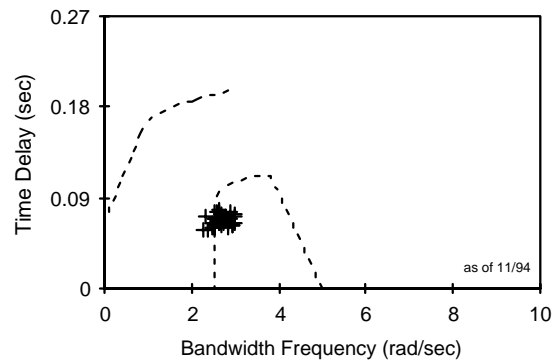


(b) Category C

**Figure 3.6.3: Gibson Phase Rate Criteria Results for the F-22**



(a) Category A



(b) Category C

**Figure 3.6.4: Bandwidth Criteria Results for the F-22**

F-22 flight experience has completely validated the approaches discussed above. Harris and Black further state that the level of performance achieved in the F-22 design seems to support recent modifications in the proposed boundaries for some of the metrics [see Mitchell et al]. The F-22 team would recommend that further research be directed at defining suitable boundaries for current generation fighters; including the extension of these criteria to the post-stall flight regime.

### 3.6.2 Use of Piloted Simulation

Handling Qualities Simulator (HQS): An integral part of the design process was the development of a disciplined, well-defined evaluation philosophy. Once a design was developed that was predicted (through the use of linear analysis tools and off-line simulation) to satisfy all of the goals chosen by the designer, piloted evaluations were performed to validate the design. The key to this philosophy is that the simulator is an evaluation tool not a design tool. If pilot ratings/comments for a particular task did not match predicted performance, then the evaluation task and/or the design goals were reviewed.

Prior to the start of piloted evaluations, a simulation test plan was developed that governed a number of key aspects of pilot-in-the-loop testing, and contained:

- definition of test manoeuvres, including measurable criteria for desired/adequate pilot performance for closed-loop tasks.
- flight envelope expansion process.
- aircraft configurations/test points.
- pilot/engineer team responsibilities.

An important aspect of the HQS evaluations is the test manoeuvres that are flown in order to validate the control laws and assess the handling qualities/PIO susceptibility of the aircraft. A complete set of manoeuvres was defined and documented to govern both open-loop and closed-loop tasks. The end result was that simulator evaluations were conducted in a fashion very much like actual aircraft envelope expansion and flying qualities evaluations, using test plans, Test Information Sheets, and test cards, and formal team briefings and debriefings, albeit the process taking orders of magnitude less time than actual flight testing.

Simulation Task Development: A very complete series of open- and closed-loop tasks was developed and used in the HQS to validate the F-22 control law design. The use of high gain tracking tasks, such as air-to-air tracking of a manoeuvring target, aerial refuelling and pitch/roll/flight path angle tracking using special HUD command symbology, enhanced the designer's ability to drive the pilot's gain up under operationally significant scenarios. Atmospheric disturbances and system failures, injected randomly by the test conductor, also help to force the pilot to increase his gain to complete the chosen task. The pilot ratings for these closed-loop tasks have consistently matched the ratings that were predicted from off-line analyses, supporting the choice of design goals for the F-22 and the design/evaluation process.

These high gain tasks were also used to explore the F-22's susceptibility to PIO. Examining the effects of mode transitions on handling qualities during high gain tasks allowed the designer to evaluate the potential impact of triggering mechanisms on PIO susceptibility. Other tasks, such as stick sweeps and large amplitude command reversals, have helped the designer extend the results of the linear analyses to the full-order, non-linear simulation environment.

### 3.6.3 Effects of Non-Linearities

Based on a thorough understanding of the existing alternate handling qualities metrics, the F-22 design team defined a control law architecture and chose appropriate design goals to minimise the susceptibility of the F-22 to Category 1 (linear) PIO. The team also eliminated triggering mechanisms within the control laws that may lead to the bang-bang control input strategy that is so prevalent in analysed PIO incidents.

However, the team also recognised that non-linear effects, such as rate and position limiting of the control surfaces, stick/feel system dynamics and non-linear airframe characteristics, play a crucial role to the overall performance of the aircraft and susceptibility to Category II PIO. No current criteria directly addresses the effects that these non-linearities have on handling qualities. As a result, the team has explored additional analyses to quantify the effect of these non-linearities.

The use of high gain tracking tasks in the HQS has been an excellent tool to identify control law sensitivities resulting from basic deficiencies in the design, as well as non-linear effects. These tasks have been useful in understanding that the time a control surface spends on a rate limit, and not just the occurrence of rate limiting by itself, is critical to the pilot's perception of the aircraft's handling qualities as a result of the non-linearity.

PIO criteria that have been proposed based on Limit Cycle Oscillation (LCO) analysis have been analysed by the F-22 team. The Ralph Smith degenerative pilot model and a pilot model proposed by C. R. Chalk have been used to assess F-22 performance. While the Chalk pilot model and criteria is more intuitive, neither approach has been validated as a PIO metric. However, the Chalk analysis has been extremely helpful in identifying regions in the flight envelope where system stability may be significantly effected by non-linearities. It has also been useful by showing the flying qualities community that "good" airplanes will rate limit their control surfaces at surprisingly small stick input levels. Prior to performing this analysis, it was thought that "good" aircraft rarely, if ever, rate limit their control. It also gives you an idea of what type of aircraft response is "good" if an LCO occurs – "good" airplanes exhibit very low amplitude, high frequency oscillations. In other words, if a PIO could be forced at all it would only appear to be a steady self-limiting "bobble" even under sustained high frequency large amplitude control inputs at the critical LCO frequency.

One of the limitations of LCO analysis is that it may tell you how bad a sustained oscillation may get if the pilot adopts a bang-bang control strategy, but it is not a measure of the susceptibility of the aircraft to PIO. As such it is not a predictor of PIO susceptibility; an essential quality for any validated PIO criteria.

The F-22 team also explored a variety of techniques to minimise the system phase loss due to rate limiting of the control surface command. These "alternate control schemes" have shown some merit in improving system stability when rate limiting occurs. However, the F-22 team views these measures as a band-aid, and has always opted to correct any basic deficiencies in the system that led to the instability in the first place! This would usually involve modifying design goals to insure that desired system performance was within the control power capability of the actuators.

Another benefit of the method using design goals is that the aircraft can exhibit large changes in characteristics between control law releases but the flying qualities remain constant following redesigns to the same design goals. Over a period of 18 months following CDR, there were major changes in the sensor models, structural filters, and aerodynamic database, but following control law redesigns the flying qualities were indistinguishable from the previous iteration.

### **3.6.4 Summary**

A primary objective of the F-22 control law designers was to fully understand the cause of the PIO that prematurely ended the flight test program of the YF-22. A thorough analysis of the YF-22 revealed that basic deficiencies in the handling qualities of the YF-22 would be predicted using existing handling qualities/PIO metrics such as Gibson, Neal-Smith, Bandwidth and Smith-Geddes. In addition, severe triggering mechanisms existed within the YF-22 due to large changes in the command gradient at the gear-down to gear-up mode transition. As a result of the accident, a closure plan was established that would shape the development of the F-22.

A very structured design and evaluation process is in place to govern the development of the F-22 control laws. This process involves the definition of very specific design goals, the definition of a control law architecture that will allow the designer to satisfy those design goals and an evaluation philosophy that makes extensive use of both off-line and piloted simulations. The development and use of high gain,

closed-loop tasks has made the HQS an invaluable tool for analysing the F-22 handling qualities and PIO susceptibility.

The existing handling qualities/PIO metrics have played a major role in the development of the F-22 control laws. Many of these metrics were developed from straight-wing aircraft, such as the NT-33. However, the team has demonstrated that the trends in these metrics, and not necessarily the absolute flying qualities boundaries, are still useful in assessing the performance of current generation fighters. These metrics tend to provide a better measure of “goodness” of an aircraft’s handling qualities than the guidance on short period frequency and damping contained in the flying qualities specification (MIL-STD-1797, MIL-F-8785).

A fundamental limitation of the existing metrics is that they do not directly address the effects of control system, actuator and airframe non-linearities. These non-linearities can have a significant impact on flying qualities and PIO susceptibility. The F-22 team has begun extending the existing linear metrics to include the effects of a rate limited actuator. Specific tasks have been developed for the HQS to evaluate the handling qualities of the F-22, susceptibility to PIO and to identify potential PIO triggering mechanisms. Research programs, such as the Unified PIO Theory contracts, are crucial to the development of a validated metric that accounts for both linear and non-linear effects.

### **3.7 X-31 EXPERIENCE**

The X-31A post-stall experimental aircraft was developed to demonstrate enhanced fighter manoeuvrability by using thrust vectoring to fly beyond the stall limit. The goal of the programme was to demonstrate the tactical advantage of a fighter aircraft being capable of manoeuvring and maintaining controlled flight in the post-stall regime up to 70° AoA.

The aircraft is a longitudinally unstable delta-canard configuration with a time to double amplitude as low as 200 msec. A full authority digital fly-by-wire flight control system is used for stabilisation and control, where the safety critical components are essentially quadruplex.

The lessons learned from the development of the X-31A control laws were mainly associated with definition of the structure (block diagram) of the control laws and the assessment of the linear stability and handling qualities as well as a thorough usage of non-linear real-time and non-real-time simulation.

- The definition of the structure of the flight control system in the very beginning of the design work is one of the most important processes of the whole design cycle. Usually the control laws become more and more complicated (in terms of complexity) during the design. They consist not only of the basic (primary) but also the reversionary control laws and command of secondary surfaces and systems such as speedbrakes, engine intake or nose wheel steering. Compensation loops are included, e.g. pitching moment compensation due to speedbrake. Putting all these systems together has to be done very carefully, to avoid coupling or even fighting between different subsystems. “Keep the control laws as simple as possible”, is the main goal from the beginning till the end of the design. This will ease your work, avoid errors and save time. In addition it makes it easier for every designer in the team to know and understand the whole structure of the control laws with all its bits and pieces.
- A lot of different tools exist and many methods have been established for the design of gains, time constants or other control law elements. Basically all of these can be used. The important thing is the full linear and non-linear assessment of the resulting control laws. In the X-31A programme all gains and filters were designed using linear tools (LQG, Nyquist, etc).
- The system stability was assessed using the 6dB and 45 degree gain and phase margin requirement with the system broken at every feedback input and actuator command.
- In addition to the MIL-F-8785C handling quality requirements, which had to be used due to contractual reasons, the Gibson, Roeger and Bandwidth criterion were also assessed.
- A thorough sensitivity analysis, with tolerances on the stability, damping and control derivatives was performed. Extensive tolerances of –100% (no control at all) and +50% have been used on the thrust vectoring control derivatives below 30° AoA, due to the uncertainty in tracking the plume with the

paddles. After initial flight tests with the “thrust vector on” control laws and confirmation respectively update of the TV control power, these tolerances were reduced for clearance at high AoA.

- Effects of actuator rate limitation and other non-linear effects were assessed with offline simulation. If a change of linear control law elements was necessary, the control laws were corrected using the linear design tools. Gains or filter time constants should never be designed or changed with simulation results only.
- A change of linear control elements, such as gains or filters or an update of the linear a/c model (e.g. aerodynamics) always required a reassessment of the control laws (linear and non-linear).
- Handling qualities in the poststall regime were a top issue during the whole program. As there were no settled baseline requirements or experience available in this area the design team set up three main guidelines:
  - a) keep flying qualities consistent over the whole angle of attack range for a specific dynamic pressure (Bandwidth, Short Period, Dutch Roll, roll mode time constant),
  - b) roll around the wind vector, and
  - c) no sideslip command authority above 40° AoA.

The latter two should minimise sideslip, because of the strong non-linear lateral aerodynamic data with larger sideslip. These guidelines have been verified during manned simulation and finally in flight test the pilots felt very comfortable with the handling qualities at high angle of attack.

During the X31-A flight test this control law design approach was confirmed. The simple control laws make it easy to introduce any necessary update. There was only one control law related incidence, where we encountered a severe “wing drop” at around 40° AoA followed by an uncommanded 360° roll. The parameter identification of the flight test traces showed a large aerodynamic lateral asymmetry, which required a change of the aerodynamic data set and consequently of the control laws.

### **3.8 TRANSPORTS AND LARGE AIRCRAFT**

Throughout this report, there may be an implication that high-performance aircraft are the focus. That is not the intent, but it is suggested that it is only the consequence of such aircraft typically leading the expansion of flight envelopes and the use of new technologies. Thus, fly-by-wire flight control technology was demonstrated and then implemented in fighter aircraft first. Recent large aircraft have also shown development problems using FBW technology, both military and commercial.

Iloputaife discusses the changes that were made to the control system of the C-17 to cure PIO tendencies experienced during development flight testing. One of the factors that caused the problem was a programmatic change in design philosophy during the development process to go from a conventional mechanical to a digital fly-by-wire system. With such a major change, the use of a rigorous design process was probably even more critical. In fact, some of the discussion by Iloputaife reflects such an approach being used to correct the deficiencies in the flight control system found in flight test. In that context, i.e. the analytical approach to design changes, the process is similar to that used for the F-22 [see Harris and Black and Chapter 3.6] and could be used as guidance for any flight control development. It is the detailed application of the criteria that is different. The same conclusion is obtained from the B-2 flight control system changes during development flight testing [see Jacobson, et al].

Recent commercial aircraft have also experienced PIOs during development [see McRuer et al, 1997] and many of the recommendations are consistent with the best practices in the next chapter. One significant difference, however, is the influence of the autopilot in commercial operations. Although not explicitly addressed in this report, autopilot design may be expected to benefit from many of the same general principles as a good FCS design process. In addition, Branch suggests a set of rules and guidelines explicitly for autopilot design. One critical interface area can be stressed here, i.e. it has frequently been demonstrated that pilots have great difficulty taking over control when the autopilot disconnects with the aircraft in a dynamic state. Failures and disconnects must be analysed very thoroughly.

In any future aircraft development, therefore, we suggest following the best practices defined in the next chapter. The difference would only be in the details, such as the definition of appropriate design criteria. The military flying qualities specifications differentiate by class of aircraft, with further discussion in Chapter 5.1.

## 4.0 BEST DESIGN PRACTICES

The design, implementation and certification of a flight control system is an integral part of the overall aircraft design process, which starts with concept feasibility studies to shape the vehicle's airframe and systems in order to meet its operational requirements, and ends with release to service and in-service support. Throughout this life cycle there are many good (and bad) practices which are pertinent to the flight control system. It is therefore considered appropriate to establish a set of the best practices, in order to expedite the development of flight control laws for future aircraft.

The flight control system design process is expressed in graphical form in Figure 4.1. This is similar to the process suggested by Harris and Black as the correct way to design a flight control system (excluding the systems engineering aspects such as redundancy management). It shows a logical process, starting with consideration of the various requirements, to establish a well-defined set of FCS design criteria. These allow definition of the control laws architecture and an initial design to be established. This is also the point at which consideration of non-linearities should start, such as those associated with actuation system specifications.

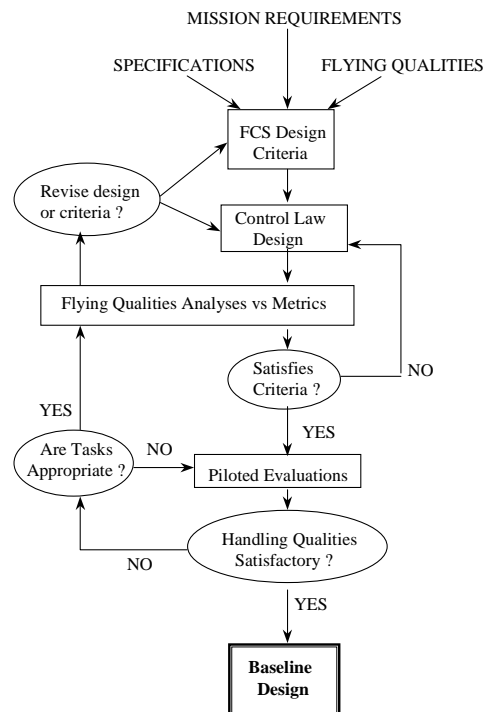


Figure 4.1: Flight Control System Design Process

There is then a loop of analyses to ensure that the control law design meets the criteria that were established. These analyses should be a package of methods that are complementary, documented and can initially be informal, but must be thorough. The recommended approach to achieving satisfactory flying qualities is to assess the predicted responses to cover all flight conditions, including all non-linearities and pilot input amplitudes, to show that they satisfy Gibson 1999, and do not violate any Level 1 boundaries of MIL-F-8785C. This first assessment of the predicted non-linearities might indicate the need for special measures, such as gain attenuation filters, and will form a sound basis with which to commence piloted simulation.

During the piloted evaluations, if unsatisfactory handling is discovered, then it is necessary to analyse the problem to determine whether it is due to a valid control law problem, or whether it is a characteristic of the simulation set-up. It is possible that the poor handling is due to an inappropriate task, whereby a revision will be necessary. If the tasks are satisfactory, then it is likely that the design criteria are inadequate. A comparison of the simulation results with the criteria should highlight the deficiencies and allow an



appropriate update to be made. It is also possible that the criteria are satisfactory but the initial analyses are not sufficiently thorough and some re-design will become necessary.

If it is decided that the control laws need to be revised, then the change must be done analytically. The history of lessons learned contains many examples of control law changes made in response to simulation comments that were found to be invalid in flight test.

This process forms a rigorous procedure that can be followed and audited to produce a good flight control system design, once all the analytical design criteria have been met and satisfactory handling qualities demonstrated. There should be no short cuts through this process to arrive at a satisfactory design. Further information on the design process is described by Irving, and by Moorhouse and Kisslinger.

The application of a robust and reliable design process on its own, is not enough to achieve a satisfactory design within acceptable time-scales, and the success of current and past flight control systems owes much to the skills and experience of their designers. The development of the required design skills is not easily acquired and as noted by Shmul et al, knowledge is required in many engineering areas:

- control theory,
- control system architecture,
- aerodynamics,
- aircraft dynamics,
- aero- (and aero-servo-) elasticity,
- aircraft loads,
- weight and balance,
- simulation and modelling methods.

Further knowledge will be required for a digital flight control system:

- digital signal processing,
- software engineering .

Flight control design experience is even harder to gain and takes many years, with most of the available experience resting with the more senior design engineers within each organisation. It is important that such experience is captured, recorded and made available for the next generation of designers, and that significant lessons learned from aircraft projects are recorded.

Some of the lessons learned in the development of advanced system implementations have already been recorded in Section 3. These lessons are now collated and expanded, to give a set of design guidelines, in terms of desirable practices. The aim of these is to help to minimise the costs and risks associated with development of flight control laws.

In order to organise the material for easy reference, it is presented in terms of flight control law design sub-processes under the following headings:

1. Establishing the aerodynamic design and system performance requirements.
2. Modelling and analysis of the unaugmented vehicle.
3. Design criteria and flying qualities specifications.
4. Control laws design and development.
5. Control laws functional specification, implementation and verification.
6. Piloted simulation and handling qualities.
7. Aeroservoelasticity and structural mode filter design.

8. Design robustness and flight clearance.
9. Developments during flight testing.
10. Management aspects.

An overview of each part of the process is given, prior to listing the best practices for each sub-process. Although these sub-processes are presented sequentially, some of the activities are usually carried out in parallel and tend to involve iterations. Each best practice is numbered according to its association with the sub-process and given the prefix 'BP'.

This chapter is concluded with a section on design considerations for PIO prevention, which serves as a link between the listed best practices and the theoretical methods that are described and reviewed in Chapter 5.

#### 4.1 ESTABLISHING THE AERODYNAMIC DESIGN AND SYSTEM PERFORMANCE REQUIREMENTS

Some of the difficulties associated with flight control laws design can be created very early in an aircraft's life-cycle by the design of the airframe and the related performance specifications used for its FCS hardware. It is important that the control law designer is involved in the definition of the aerodynamic characteristics and the associated FCS equipment performance, at an early stage. If these are not satisfactory, he may be tasked with compensating for undesirable physical behaviour by including appropriate functionality within the flight control algorithms. Whilst it is accepted practice to provide stability augmentation and even artificial stabilisation, there are bounds on what can be safely achieved, simply due to the laws of physics. Even before the physical limit is reached, the financial cost of providing artificial stability may be very high, owing to the required performance of the FCS hardware.

Many of the problems experienced by aircraft with their flight control systems are due to aerodynamic or system non-linearities, and a possible lack of appreciation of their significance by the FCS community. If we minimise the non-linearities, the FCS design, implementation and flight clearance tasks become greatly simplified, as the number of design cases to be assessed is reduced.

It is therefore prudent to alleviate the workload and risk associated with the physical design problem:

**BP1.1** Design the airframe to have aerodynamic characteristics which are as linear as possible across the operating envelope, particularly with respect to angles of attack and sideslip, and Mach number. This goal is frequently in contradiction with a desire to increase aircraft performance and capabilities, e.g. by expanding flight envelopes (sometimes to the extremities), carriage and release of new stores, and stealthy shaping of the airframe.

**BP1.2** Ensuring that the vehicle's control surfaces are sized and positioned to provide sufficient control power for trimming, stability augmentation, manoeuvring and disturbance rejection.

**BP1.3** Ensuring that each of the vehicle's motion sensors and air data system are specified to provide a sufficient range of measurement, good linearity, acceptable signal/noise characteristics and an adequate bandwidth. Do not underestimate the air data system's functional complexity – it can be of a similar order of magnitude to that of the control laws.

**BP1.4** Ensure that the actuation system specifications include sufficient displacement, rate and acceleration capability, with a performance that is not adversely affected under the predicted loading conditions. These specifications must include satisfactory bandwidth for aircraft stabilisation and control. It must also be ensured that the electrical and hydraulic systems have sufficient capability to maintain the actuation system performance for all potential operating conditions.

**BP1.5** For aircraft with relaxed static stability, it is necessary to ensure that the maximum airframe instability is consistent with the specified FCS hardware performance and the design requirements for aircraft handling and stability. The possible centre of gravity variations should take into account all fuel and

store states, including all significant failures of the fuel and stores management systems. The integrity of these systems needs to be consistent with the aircraft's performance requirements.

**BP1.6** Have good early estimates of control law data storage and throughput, to help to establish flight control computing requirements. Aim to minimise the inherent phase lag due to digital computing, i.e. the compute delay and the anti-aliasing filtering. This is particularly important on the angular rate feedback and pilot command paths.

**BP1.7** Avoid excessive delays on air data scheduling information. Air data complemented with inertial mixing should be used, to give signals that are less prone to atmospheric disturbances. Ensure that the signals used by the control laws are robust against local atmospheric disturbances, such as when flying through the wake of another aircraft.

**BP1.8** Ensure that pilot inceptor characteristics are acceptable in terms of force, displacement and damping, and that potential coupling with the aircraft motion and pilot are considered.

**BP1.9** If the powerplant is to be integrated into the FCS, then the above guidelines for actuation systems are equally applicable to the thrust magnitude and directional control response characteristics.

**BP1.10** Ensure a clear definition of failure probabilities and the redundancy management system. There should be an 'audit trail' to justify the probabilities defined and where possible, these should be based on in-service statistics.

**BP1.11** When designing a system for carefree handling, ensure that there is a clear and agreed definition of what this means. Ensure that the sensors available have sufficient accuracy and provide the required integrity to safely keep the aircraft within the carefree envelope boundaries.

## 4.2 MODELLING AND ANALYSIS OF THE UNAUGMENTED VEHICLE

Before beginning any control law design, it is important to study and fully understand the dynamics and the non-linearities of the unaugmented vehicle, including those of the FCS hardware, the air data system and the powerplant. It is also important to understand how these are likely to affect the aircraft's control characteristics as its operating condition varies. If this is not done then there are likely to be some nasty surprises later in the design process, which will require re-work. Some key points for modelling and analysis are now described:

**BP2.1** All models must be sufficiently representative and have an appropriate level of complexity. Avoid 'gold-plating' of sub-models. Models should be modular, portable and be configuration controlled, with an adequate documentation set. Any control law design is only as good as its aerodynamic dataset, since the design is in many ways, a 'mirror image' of this dataset.

**BP2.2** Model and understand the aerodynamic and inertial data characteristics, including the effects of the aerodynamic non-linearities and the flight envelope to be covered in terms of Mach, altitude, airspeed, AoA, etc.

**BP2.3** Aim to match the model components to test data, in order to minimise some of the uncertainties. Define a set of model uncertainties that can be used as design tolerances.

**BP2.4** Analogue approximations may be adequate for modelling digital effects at rigid airframe frequencies. At higher frequencies, such as when designing digital notch filters for the flexible airframe dynamics, the effects of frequency warping and aliasing will need special attention.

**BP2.5** At an early stage of the design, explicitly model or introduce approximations for structural mode filters, anti-aliasing filters and computer transport delays, to avoid misleading design results and potential re-work. Be aware of the validity of any approximations, in terms of the errors introduced.

**BP2.6** Beware of aerodynamic approximations, especially when operating at high angles of attack and when approaching zero speed. Many of the traditional equations assume flight at low incidence and do not adequately cover post-stall or hovering flight conditions. Ensure that equations of motion have adequate protection for the singularities at zero speed, 180 degrees angle of attack, etc.

**BP2.7** Careful use of aerodynamic data extrapolation is required, to avoid unexpected or incorrect results. A set of ‘ground-rules’ needs to be established for dealing with this situation. If data tables are used in control law gain schedules then it is recommended that extrapolation is avoided, i.e. the data table points cover all possible scheduling parameter variations.

**BP2.8** Prior to commencing the linear design, verification of the linearised models used for the design is desirable, to ensure that when the control laws are implemented in the non-linear environment (simulated or actual), the stability characteristics are as intended. This avoids unnecessary modelling errors due to the linearisation process. Over-plotting of linear and non-linear responses (for small inputs at the same trimmed operating condition) provides a good visual check on the quality of the linear model.

### 4.3 DESIGN CRITERIA AND FLYING QUALITIES SPECIFICATIONS

The military flying qualities specifications may have been misused as often as they have been used correctly. A very common statement is that they apply only to the linear small-amplitude responses. The US military specifications have never stated this, they actually defined flight envelopes over which the required criteria were to apply. Because of the practical problem of the unavailability of non-linear theories, the non-linear effects have frequently been neglected, or even ignored, in the past.

The introduction of Equivalent Systems into MIL-F-8785C provided a means to characterise the actual aircraft response, whether it was linear or non-linear. The characterisation was in terms of a conventional linear response model, and was therefore, mathematically not exact. Such an approach would be a better start than nothing. Since the introduction of MIL-F-8785C, other methodologies have been developed which apply equally to non-linear responses as well as the linear, e.g. Gibson, 1999.

Some of the best practices in relation to design criteria are:

**BP3.1** Use the Military Specifications and other design standards to establish both design requirements and design aims for the aircraft, and use supplementary criteria wherever it is considered to be necessary. For example, Gain and Phase Margins are usually good indicators of a control loop’s robustness but must be supported with other criteria.

**BP3.2** Exploit handling qualities criteria to achieve good handling and avoid PIO by design (see Section 4.10). As a best practice, the designer should establish a set of flying qualities design criteria. These must be based on the established criteria – and a starting point for high performance aircraft could be to aim to meet all criteria in Gibson, 1999, and not violate any MIL-F-8785C Level 1 boundary.

**BP3.3** Any non-linearity caused by the flight control system, including maximum pilot inputs and all hardware and software effects, should not occur at any frequency below the value for 180 degrees of phase angle. If this (and BP3.2) can be achieved by the design, then we could almost guarantee satisfactory flying qualities (recognising that this ideal may not be possible under all conditions, such as failures or other limitations).

**BP3.4** Ban designers from randomly quoting “mil-spec”. If they cannot identify the source of their design assumptions they should be told to go and find out. Blind adherence to popular criteria can result in incorrect application. It is important, not just to have a set of numbers, but to understand the background and intent of such criteria.

## 4.4 CONTROL LAWS DESIGN AND DEVELOPMENT

Having established the capability to produce linearised models of the aircraft, its powerplant and FCS hardware, in a classical design sense, a grid of design points are selected to cover the required flight envelope. A series of localised controllers are then designed and implemented using gain schedules to cover the flight envelope. At this stage, additional non-linear functionality is added, for example rate limiting functions and authority limits. There then follows a comprehensive assessment of the design, leading through to flight clearance.

In order to minimise the costs and risks associated with poor designs, design iterations and re-work, the following best practices are identified:

**BP4.1** Understand the operational requirements and the piloting task in each phase of the mission and aim to use a control strategy that works for all tasks, at all flight conditions. Ensure good communications with pilots is maintained in order to be fully aware of operational conditions.

**BP4.2** Take advantage of any physical knowledge when choosing the control laws architecture, in order to simplify the design and its gain scheduling. Avoid over-complexity and aim to keep the design as simple and as visible as possible. Avoid any unnecessary duplication of functional elements.

**BP4.3** To maximise visibility, work with functional ‘control engineering’ block diagrams of the control laws and the flight control system. These need to include physical units, all feedback signs, be kept up-to-date and made available to all team members.

**BP4.4** With caution, use functional non-linearities to their advantage, to compensate for non-linear behaviour or to provide known desirable effects that cannot be achieved by linear functions. Be aware of the effects of these functions on aircraft and pilot-in-the-loop stability.

**BP4.5** Use the most appropriate axis system for control and provide de-coupled control wherever appropriate, in order to reduce pilot workload.

**BP4.6** Verify that all integrator functions used are not subject to open-loop wind-up under any circumstances and include appropriate management logic.

**BP4.7** Automatic trim functions are highly desirable in all axes to minimise pilot workload, but be aware of possible conflicts between roll and yaw trim.

**BP4.8** Try to ensure that any reduction in control authority resulting from the auto-trim is apparent to the pilot, for example, by movement of the control inceptor during trimming.

**BP4.9** In general, aim to avoid commanding from the actuators what they are unable to perform. If this is occurring, aim to reduce the control law gains, improve the actuators or incorporate ‘smart’ rate limiters.

**BP4.10** Take special care in the cases where control surfaces are used for both pitch and roll control (e.g. elevons on delta-winged aircraft), where the roll loop can have an adverse interaction with the pitch loop and vice-versa.

**BP4.11** There is no substitute for a good robust inner loop design, which should not be compromised by the design of the command path or the outer loops. The inner loops should be designed first, to provide good disturbance rejection by tight tracking of error signals.

**BP4.12** Beware of control systems which appear to achieve excellent performance, mainly by open-loop compensation of the nominal model. Such performance can deteriorate very rapidly when modelling tolerances are introduced or when external disturbances are applied. Such effects can be corrected by improving the closed-loop performance of the system, usually by increasing the feedback gains – although this is not always possible.

**BP4.13** Keep any moding simple and to a minimum, to avoid confusing the pilot. Beware of changes in handling qualities on changing modes and aim for continuity, for normal mode changes and for mode changes as a result of failures. Avoid transients on changing modes by using continuous blending or appropriate faders. Minimise the chance that the pilot will modify his behaviour to compensate for system response characteristics. When designing for carefree handling, make sure that the aircraft's agility is not unduly reduced as the carefree envelope boundaries are approached.

**BP4.14** Where significant transients can occur due to a mode change, it is often advantageous to arrange for the mode change to be initiated by the pilot. The transient might then be regarded as a useful motion cue, indicative of a successful mode change, rather than appearing as an unexpected disturbance.

**BP4.15** Beware of possible aircraft transients or implicit feedback loops due to gain scheduling. Aim to minimise the effects of gain schedules on stability and include all closed-loop effects in stability analyses.

**BP4.16** Ensure that for autopilot designs, the fundamental design rules and guidelines (as suggested by Branch) are taken into account, to provide a basis for safe operation, avoiding known problems that were encountered on earlier designs.

**BP4.17** Consider the effects of gusts and turbulence in terms of system performance and pilot acceptability. The FCS should always have a beneficial (might be small) effect on the gust response. The design of the FCS and its sub-systems should also allow for the extreme ranges of atmospheric pressure and temperature that the aircraft might meet in service across the globe.

**BP4.18** Carry out a limited sensitivity analysis of the control laws at the design stage, to identify any robustness issues associated with parameter tolerances. This will help to avoid undue difficulties during the aircraft's flight clearance phase.

**BP4.19** Fully consider the effects of all possible failures on the design. This should include partial or total loss of air data, and electrical and hydraulic failures. Mathematical modelling should be carried out to assess the failure transients and the effects of the failures on aircraft stability and handling.

**BP4.20** There is also the promise that future developments of modern control, such as robust control theory, will change the emphasis of the above list. There should always, however, be the judgement and insight that comes from some application of the above. The physics of flight remain the same, irrespective of the design methodology.

## **4.5 CONTROL LAWS FUNCTIONAL SPECIFICATION, IMPLEMENTATION AND VERIFICATION**

Whether the flight control laws are to be implemented in an analogue or, more usually these days, a digital flight control computer, some means of functional specification is needed to enable the laws to be implemented. For digital flight control, the functional specification will enable coding into the target machine's language and allow the implementation to be verified against the intentions of the designer.

In terms of expediting this process, the following best practices are identified:

**BP5.1** An unambiguous control law functional specification including moding and logic is essential. This functional specification should be configuration controlled, portable and executable, and include the timing and framing requirements for the control law elements and the allowable overall lag/delay on each of the control law paths, for implementation in the flight control computer.

**BP5.2** The control laws should be broken down into testable elements as small as is practicable. A formal naming scheme with unambiguous mnemonics is required for uniquely identifying each of the elements. Such a scheme is also necessary for identifying all of the signals passing through the control laws. Correct connectivity of the control law elements must be demonstrated.

**BP5.3** A high degree of visibility of the control laws and good liaison with the FCC implementer is essential, to aid FCC implementation and verification. Ensure that functional ‘control engineering’ block diagrams are provided, with supporting technical descriptions. Diagrams should include physical units where appropriate and show the polarity of all feedback signals.

**BP5.4** Provision of satisfactory test cases is essential for the control laws software verification, at unit, box and system levels. In integration testing, real hardware and software should be used as much as possible, and as early as possible. The control laws testing should be part of a well-planned test programme that includes the use of well-developed automatic testing tools.

**BP5.5** The flight control computer software engineers should be included as part of the design team at an early stage, to ensure that they understand what they are coding and why.

## 4.6 PILOTED SIMULATION AND HANDLING QUALITIES

The control laws are thoroughly evaluated by piloted simulation. The initial task is to set up the control laws within the simulator’s real-time environment and to establish the interface between the control laws and the pilot’s controls and displays. The implementation must then be verified, prior to exposing the simulation to pilots. A series of piloted evaluations then take place, during which the handling qualities and mission effectiveness of the augmented aircraft are assessed. This usually results in further developments of the control laws, as handling deficiencies are identified.

In order to simplify the installation, verification and testing of the flight control laws on the piloted simulator, the following best practices are recommended:

**BP6.1** Plan for an integrated simulation programme and ensure that all IPT members (especially pilots and managers) are clear that the various simulators are for evaluation purposes, to feed data back into the analytical design process.

**BP6.2** Identify the limitations of the simulation, including consideration of providing motion cues. Be aware that although simulators are of great value if used correctly, they can give misleading results if the assessments are not rigorously controlled. Simulation validation is highly desirable, if not essential.

**BP6.3** Use the piloted simulator to complement the off-line design and development tools, and to intercept any design deficiencies at an early stage. The earlier that problems are detected, the less it costs to fix them.

**BP6.4** Use common code and data for off-line and piloted simulation to avoid unnecessary software maintenance or translation (time and cost) and the possible introduction of errors in control law functionality. Provide adequate off-line check cases to verify the control law implementation on the simulator.

**BP6.5** Simulation displays and controls need to be representative, in order to avoid colouring pilot opinion of the control laws. Second order effects can become major problems for precision tasks.

**BP6.6** Ensure that assessment pilots are briefed adequately and understand the control strategy, the rationale of the assessment and the limitations of the simulation. It is desirable that pilots are ‘calibrated’ in the use of development simulators, to aid their judgement of the simulated aircraft’s handling characteristics. One way of achieving such calibration is to allow them to familiarise themselves with the simulator, by flying an aircraft with which they have flying experience.

**BP6.7** Deliberately search for handling problems, including the effects of design tolerances (parameter uncertainties) and failures. Identify the worst cases and any hidden weaknesses in the design, and fully explain any unexpected simulation results.

**BP6.8** If a non-linear stability problem is found, restricting the pilot's commands may help but is unlikely to provide a full solution. For example, a stability problem might still be provoked by an external disturbance, such as a large gust.

**BP6.9** Ensure that Cooper-Harper ratings are fully supported with relevant pilot comments and aim to establish links between the pilot comments and the control law parameters, such that any handling change requirements can be addressed quickly.

**BP6.10** Evaluate the ability of the pilot to enter the control loop, to help out the automatic functions. Show that there is no tendency for divergence between the automatic and manual control functions.

**BP6.11** Ensure that adequate handling qualities are provided and that PIO is avoided under all circumstances, including failure conditions such as single hydraulics operation or loss of air data functionality. Design considerations for PIO prevention are specifically addressed in Section 4.10.

## 4.7 AEROSERVOELASTICITY AND STRUCTURAL MODE FILTER DESIGN

The primary function of the flight control laws is to provide the aircraft with good handling qualities by using feedback of the 'rigid aircraft' motion to the flying control surfaces. However, the airframe is not rigid and has many structural modes of vibration that will be excited by the control surface movements. The response of these lightly damped modes is usually detected by the motion sensors and fed back to the control surfaces, with the potential for closed-loop instability at the structural mode frequencies.

The application of modern high bandwidth flight control systems and advanced aerodynamic configurations has led to an increase in the levels of interaction between the airframe and its FCS (see Caldwell). The aeroservoelasticity specialist has the task of defining a set of structural mode filters that provide sufficient attenuation of the structural mode content of motion feedback signals.

For this aspect of the flight control law design process, the following best practices are identified:

**BP7.1** Sensors should be located to minimise structural mode pick-up and the sensor installation must follow good mechanical practice, with the sensors being rigidly mounted to the primary structure. Anti-vibration mountings should only be used if justified and proven.

**BP7.2** Good quality flexible aircraft models are required, supported by ground vibration testing and airframe/FCS 'structural coupling' ground testing. In-flight validation of the models is desirable if phase stabilisation of structural modes is necessary. Frequency sweep or similar methods, with high fidelity response measurement and recording facilities, are beneficial for identification during ground and flight testing. Highly automated test and analysis facilities are essential.

**BP7.3** Establish understandable guidelines and requirements for airframe/FCS structural mode attenuation. These must be agreed with the whole IPT, including the customer.

**BP7.4** A balanced design of structural mode and rigid body control filters is needed, in order to optimise aircraft stability margins. This needs to take into account the conflicting requirements of controlling the aircraft's rigid modes (a requirement to minimise the low frequency phase lag due to the structural mode filtering) and flexible modes (a requirement to provide sufficient attenuation at higher frequencies). The structural mode filtering needs to provide satisfactory attenuation for all fuel states, stores configurations and failure states, across the flight envelope and during ground operations. The definition of the maximum allowable end-to-end gains for the different control law feedback paths, from a structural coupling point of view, gives an early indication of problematic areas and allows the control law designer to include this as a constraint from the very beginning.

**BP7.5** Digital effects such as the frequency warping of notch filters and fold-back due to aliasing, need careful attention. A detailed understanding of the digital FCS is essential and knowledge of its interfaces



with flight test instrumentation processing is required, where flight test evidence is needed for model validation.

## 4.8 DESIGN ROBUSTNESS AND FLIGHT CLEARANCE

The certification or flight clearance process is essentially aimed at providing the evidence in order to certify that the aircraft is safe to fly. The qualification (validation) process is aimed at demonstrating that the design qualifies in meeting its design specification. If a satisfactory design has been achieved in accordance with the design requirements and guidelines, and the functionality is clearly defined, then these tasks should be relatively straightforward. However, the task is usually large and detailed, since there are very many cases which need to be assessed, covering a wide range of aircraft configurations and states, including parameter uncertainties, which have to be evaluated against a range of criteria to assess different aspects associated with safety and performance. For this to be achieved in an efficient manner, the following guidelines are recommended:

**BP8.1** Agree a set of design requirements and guidelines with the IPT and the customer. Ensure that sufficient flexibility is retained for modifying the requirements of clearing non-compliant cases, subject to demonstration of acceptable aircraft handling.

**BP8.2** A large number of flight cases usually have to be assessed, leading to a significant engineering workload. Good automation and planning of the clearance process is therefore essential, to ensure that all configurations and conditions have been adequately addressed.

**BP8.3** The size of the clearance task is related to control law complexity. We therefore re-iterate the need to keep control laws simple at the design stage.

**BP8.4** Relaxed static stability of the airframe will increase a design's sensitivity to uncertainties in the parameters that affect loop stability. Good quality data is therefore required to minimise the design tolerances and ease the clearance process.

**BP8.5** There is considerable onus on the designer to identify problems and prove that the design is robust. He must therefore deliberately search for problems, identify the worst cases and analyse the system behaviour in great detail, to understand the effects of non-linearities in the design. It is recommended that the final assessment and clearance of the design is carried out by an independent group.

**BP8.6** Check that the probability of actuator position limiting is extremely remote under all circumstances, including maximum manoeuvring rates and severe turbulence conditions. Check that any rate limiting behaviour is only transient and does not adversely affect stability.

**BP8.7** Good use of the piloted simulator should be made, to complement the off-line analysis and in particular, to carry out more detailed investigations for regions of low stability or unusual handling. Transients due to gusts, failures and mode changes should also be considered. Assessment of carefree handling functions needs to be very thorough, in order to demonstrate that the system is fully effective.

**BP8.8** The limitations of the aerodynamic, structural and FCS modelling, must be taken into account when generating the flight clearance for airframe/FCS structural coupling. Variations in flight condition, fuel state and stores carriage all need to be adequately covered.

**BP8.9** Define air data system tolerances at levels which provide sufficient accuracy for aircraft controllability, but which are sufficiently wide to allow flight envelope expansion and air data system calibration to proceed without undue difficulty.

## 4.9 DEVELOPMENTS DURING FLIGHT TESTING

A safe and well-planned programme for the flight testing of the aircraft and its flight control system is essential (Webster). Flight testing of a flight control system usually involves some risk due to the

uncertainties in the models used to establish the design, although this can be minimised by some of the best practices already covered. Once the flight test programme has commenced, parameter identification is usually carried out, in order to validate the aircraft model. This leads to further flight clearances and increased confidence, enabling flight envelope expansion to continue in a safe and progressive manner.

If the aircraft behaviour is significantly different from that predicted and deemed to be unacceptable, then control law changes will need to be introduced during the flight test programme. Clearly, this needs to be done efficiently and safely in order to meet overall programme timescales. Such differences in predicted behaviour should always be investigated and fully explained.

The following best practices are identified for this phase of the flight control system development programme. These are partly based on the lessons learned from the B-2 programme (Jacobson et al):

**BP9.1** Aim to have a mature design before entering the flight testing phase. This will allow a rapid envelope expansion by minimising the anomalies and any possible re-work during the testing.

**BP9.2** Detailed safety planning, flight operation limits, and mission briefings are necessary to ensure proper dissemination of information amongst the flight test team. The testing needs to be under tight configuration control, as part of ensuring that what is being tested at any given time is fully understood. This needs to include the flight control system and control laws.

**BP9.3** The flight test planning should allow some contingency for dealing with anomalies and software updates. Independent high and low technical risk paths should be identified, to allow testing to continue when an anomaly is encountered.

**BP9.4** Fully define what needs to be measured by flight test instrumentation and understand exactly what is being measured. Ensure that in-flight excitation and data gathering manoeuvres are safe and are sufficient to produce the required information.

**BP9.5** Time must be allocated in the programme for general qualitative pilot assessment, which is in addition to the quantitative (data gathering) testing.

**BP9.6** Pilots should have up-front training on the simulator and be fully briefed on what to expect in flight.

**BP9.7** Use a progressive approach to the testing in order to minimise risk. Fixed gains might be acceptable for early flying, while the air data system is being calibrated. Increased complexity via scheduled gains and more advanced moding can be introduced later, once the basic system has been proved. The proven basic system can then serve as a safe backup mode for dealing with hardware failures.

**BP9.8** Early flight testing needs to validate the models used to design the flight control system and generate the flight clearance. This should include air data (incidence, sideslip and pitot/static pressures), the aerodynamics model and the loads model.

**BP9.9** The envelope expansion process must be carefully controlled to ensure that each expansion step is made only when flutter, handling (aerodynamics model), loads and air data characteristics have been adequately assessed up to the previous limit. All these areas interface with the flight control system.

**BP9.10** The FCS must be exposed (in a progressive fashion) to ‘high gain’ manoeuvres, to ensure freedom from over-control/PIO. This should be done as early in the programme as possible, consistent with the maturity of the control laws. Such manoeuvres will include air-to-air tracking, air-to-air re-fuelling, formation flying, etc.

**BP9.11** It is essential that any unexpected or abnormal behaviour, however trivial, is fed back to the design team. The information should be fully analysed and explained before further flight envelope expansion is undertaken and in extreme cases, before the test is repeated.

**BP9.12** Rapid changes to the aircraft/FCS simulation and analysis models are required to enable timely flight control software updates. Beyond this, an efficient and responsive software change process is required to avoid programme delays. A ‘limited change capability’ is needed to enable the flight control software to be changed quickly, and without compromising aircraft safety. The FCS design should be such that it facilitates rapid changes.

#### **4.10 MANAGEMENT ASPECTS**

All good management practices are applicable to the development of the flight control system, and it is not intended here to write about what constitutes good management. However, there are some practices that are worth highlighting in order to emphasise their importance. The best overall management practice is to ensure that the detailed recommendations in this section are applied in any flight control system development:

**BP10.1** Plan carefully and don’t underestimate the size of the job or the resources required. From collective experience of earlier projects, it must be assumed that there will be some surprises at some stage during the flight control system development, and some contingency planning might be necessary, including provision for software updates.

**BP10.2** An Integrated Product Team (IPT) for flight controls/flying qualities should be formed, covering all the skill areas required to develop a flight control system. This team should be responsible for tracking the design, development and test of each component, and the implementation and verification of each interface.

**BP10.3** Perform the work in a structured and properly phased manner, starting each design with a thorough requirements analysis. Make sure that everybody involved understands and agrees with the requirements.

**BP10.4** Design specifications should be based on the required system performance. System requirements should not be changed from the top, and only changes to the required system performance should be allowed to modify requirements. If this recommendation is not followed then a formal process is essential, to track the effects of changing requirements. The “intent” of a specification may allow a more optimum development.

**BP10.5** The route to certification and qualification, and the required documentation, should be established early on, and the evidence collected and recorded as soon as available, rather than in a rush at the end.

**BP10.6** In general, documentation should be the “minimum necessary to satisfy the requirements”, but it is absolutely necessary to record decisions and substantiating data. The earliest possible definition of interface control documentation is critical to avoiding later development problems.

**BP10.7** The team must be allowed to select and agree the processes and tools to be used for the control laws development. If the designers have been involved in the development of the processes and tools (e.g. the functional specification and acceptance testing), then this should be a formality.

**BP10.8** Automate the work where it is appropriate to do so, but never lose sight or control of the design. Use computer optimisation with numerical criteria and ensure that designers are free to concentrate on design decisions, rather than wasting their time on routine work.

**BP10.9** Throughout the design period, working level integration meetings should be held regularly, to ensure good team communications and an integrated design. These should be detailed technical working meetings (not committee meetings) with the agenda and frequency driven by addressing specific and current integration questions. Conversely, any suggestion of unwilling participation or “too busy to attend” should raise a red flag to the managers responsible for the integration process.

Deliberations should be encouraged, to bring into public view any problem or area of concern, so that all attendees can assess possible interactions with their area of responsibility, or where appropriate, potential solutions to “system” problems which may involve components other than those which encountered the anomaly. Stress should be placed on including all components and interfaces in the discussions, since a system problem can be generated by a component that is performing well within the performance boundaries specified for it as a unit.

**BP10.10** The design should be frozen as late as is reasonably possible. Once frozen, it should be placed under tight configuration control, and only cost-effective and/or essential changes should be allowed.

**BP10.11** Ensure that all sub-processes include a ‘limited change’ capability. Aim for local solutions to local problems, and avoid major re-design where it is not necessary.

**BP10.12** Be honest and let your customer and team know about your genuine problems – they may be able to help.

**BP10.13** Finally - encourage the team to keep a log of their lessons learned and best practices for application to future projects.

## **4.11 DESIGN CONSIDERATIONS FOR PIO PREVENTION**

Although the application of the above best practices will help to avoid pilot involved oscillations, it is considered that this topic warrants further comment, due to the problems it has caused the flight controls community in general. Much research has been carried out on this subject in recent years and the many results available can be quite daunting for a budding flight control engineer. In this section, we therefore aim to distil the main factors, in order to clearly identify what really matters in terms of best practices. The background research and analysis methods are reviewed in detail in Chapter 5.

### **4.11.1 An Overview of PIO**

It is a simple fact that PIO occurs because the aircraft dynamics permit it. There should no longer be much mystery about the general characteristics of PIO-prone dynamics, even if the satisfactory PIO-free boundaries are defined somewhat empirically. In fly-by-wire aircraft, these dynamics are almost entirely an artefact of the control designer. A careful and structured approach to the design of the control laws and hardware, with PIO prevention given equal status to handling qualities, can result in strong assurance of PIO-free dynamics. While a growing array of analysis methods can then give theoretical confidence in this assurance, the practical design steps towards this goal must come first [see Gibson 1999].

There are two basic types of PIO problem. Classical PIO is typified by oscillations caused by over-sensitivity, excessive bobble or dropback, tracking resonance caused by a too-wide or flat “attitude shelf”, excessively low natural frequency, low damping and so on, resulting from the dynamics possible with natural aerodynamics. Angular acceleration responses are immediate and directly coupled to the stick inputs, and usually the pilot can stop the PIO by reducing his gain or backing out of the closed loop altogether. The Classical PIO is associated with PIO ratings of 1 to 4.

High order PIO is mostly associated with control system effects, including additional phase lags due to inappropriate filters and (to a limited extent) digital effect time delays, excessive command path gains, and actuation system saturation, categorised into Types 1, 2 and 3. The angular acceleration responses are lagged or delayed, and typically, the pilot feels unable to stop the PIO, with ratings of 5 or 6. Their essence is an oscillation at a frequency where the attitude response lags the stick inputs by approximately 180 degrees, the high order PIO frequency, sometimes known as the instability frequency.

### 4.11.2 Type 1 PIO Prevention

By meticulous attention to detail in the control law design, prevention of both conventional and the linear high order Type 1 PIO is a relatively straightforward matter. Such details include:

- Proper shaping of both the feedback and feedforward paths to provide good short-term response, irrespective of the long-term manoeuvre demand type, with a suitable compromise between K/s-like attitude control and satisfactory flight path control properties, depending on flight condition and task phase.
- Absolute minimisation of high order phase delay, which is very strongly, though not exclusively, dominated by the feed-forward path from stick to control actuator and which determines how well connected with the aircraft the pilot feels, through the angular acceleration response. This is coupled with maximising the attitude response frequency and minimising its gain at the 180-degree lag frequency.
- Proper manipulation of the command path gain to counter high gain feedback in manoeuvres at lower frequencies, to prevent excessive control deflections at higher frequencies where there is little or no feedback signal and particularly at the 180 degrees attitude phase lag frequency, and to ensure satisfactory response sensitivity.
- Ensuring that significant response dynamics or trim changes occur only upon pilot-selected configuration changes, and are faded in or preferably avoided altogether.

The resulting linear regime handling qualities will be consistent and homogeneous throughout the flight envelope, presenting no unexpected surprises to the pilot. They will be easy to analyse by simple linear methods. As control input amplitudes increase, the characteristics will begin to change as a result of approaching limitations in control actuation systems and probably also due to non-linear aerodynamics. As noted in Chapter 3, the latter can be partially addressed by control demand linearisation functions.

### 4.11.3 Type 2 PIO Prevention

Severe rate-limited Type 2 PIO has usually displayed one of two onset characteristics. Some have commenced from a small but divergent linear PIO that merged progressively into increasingly rate-saturated characteristics, with a rapid growth in amplitude and a reduction in frequency. Clearly this onset type is prevented if the above linear design practices are followed.

Very often, the onset has been sudden, with instant immersion in the fully saturated dynamics. The initiation ranges typically from a moderate control input to check a disturbance, followed by control reversal, forming the half-cycle input oscillation with a control surface demand large enough to rate saturate the actuator that inevitably leads straight into the PIO, to a full opposite stick input in reaction to a rate saturated response that continues well beyond the expected. In the majority of examples the stick inputs go immediately from stop to stop in the ensuing PIO. As can be seen in all available Type 2 PIO records, the pilot instantly abandons any previous compensation strategy and adopts a synchronous behaviour in which the timing of the stick reversal is tied to the zero crossings of the attitude response rate. The form of stick input varies between a sinusoid in anti-phase with the attitude response, to a relay-like square wave, apparently in anti-phase with the attitude rate response, depending on the size of the stick and the range of movement [see Gibson 1999].

Significant actuator rate saturation within the stabilisation closed loop will reduce stability margins and can cause loss of control in an unstable aircraft. System instability may also be encountered in a stable aircraft with stability augmentation, as was the case in the early Tornado development (Chapter 3). Even where instability does not occur, the changes in controlled response dynamics have frequently been severe, with sudden increases in phase lag and possibly in amplitude ratio as well, precipitating a major PIO that is likely to be unstoppable.

The difference in saturation effects between mechanically and electrically signalled actuation is profoundly significant, and historical values of rate capability are an unreliable guide for fly-by-wire design. In the former, the stick cannot be moved more than the equivalent of a couple of degrees away from the actual surface angle, and the stick rate is physically constrained by this. In a stable airframe, the result may be noticeable but it is not inherently destabilising. With electrical signalling there is no constraint on the stick

and it can be in the opposite sectors of the travel range from the control surface, when deep in rate saturation. Stability or command augmentation is not a prerequisite for Type 2 PIO, as evidenced by the first flight landing PIO of the X-14 [Klyde 1995] and by roll PIO occasionally experienced in the landing phase on airliners with electrically signalled spoilers.

The basic guidelines for control system design to prevent this PIO type are clear:

- It is essential to investigate the response in the region of 180 degrees attitude phase lag, with the maximum possible stick inputs, however unrealistic this may seem.
- The more the command path gain is attenuated at potential PIO frequencies, the less is the risk of control rate saturation. The control angles that can be demanded here should not exceed those typical of a normal mechanical control system, for example, and should be considerably less in many flight conditions.
- If large amplitude dynamic response changes are unavoidable, they should be limited as far as possible and should blend smoothly and gradually from the linear response.
- The provision of sufficient actuator rate capability to postpone rate saturation onset, up to or beyond the frequency for 180 degrees phase lag in the linear attitude response with cyclic stop-to-stop stick inputs, will essentially prevent Type 2 PIO altogether.

The last guideline provides an extra margin over the PIO-free boundary of Duda's non-linear OLOP PIO criterion, discussed in Chapter 5.2.2.1 (2). It suggests that even with the maximum likely pilot gain in a closed loop task using maximum stick input amplitudes, rate limiting will not occur and the response remains essentially as analysed by linear methods. If it is truly impossible to achieve it, then at least the Duda limit must be aimed for, to ensure that there is no rate limiting before the 160° attitude phase lag frequency is reached.

#### 4.11.4 Type 3 PIO Prevention

It is considered that by eliminating Types 1 and 2, that Type 3 will not occur. This statement holds true for all known examples of PIO to date.

#### 4.11.5 Actuation System Considerations

The applicable control surface angular range is at least that generated by the full stick inputs at the specified frequency. This is not necessarily the full available surface range in the pitch axis, since it should correspond to the pitch acceleration required and some of the surface range may be there to provide trim, but in most aircraft it is probably legitimate to require the maximum roll acceleration at the lower speeds and therefore also the maximum roll control angles.

Unfortunately, actuator rates for a new design will need to be chosen before the control laws are sufficiently developed to determine the values on this basis. A rate sufficient to reach full surface deflection from neutral in 0.2 seconds, provides a fast transient response and permits a full cycle of maximum amplitude oscillatory surface travel at about 5 rad/sec at the onset of rate saturation up to about 8 rad/sec, while fully rate saturated, if acceleration limiting is negligible. This may typically require maximum rates of about 100°/second as were used in the EAP (Chapter 3) and the Eurofighter, which with severe pitch instability and very high agility were unable to tolerate significant rate limiting.

The numerical values of such an angular rate need to be put into context. As a past example, the English Electric Lightning had aileron rates of 160°/sec. and used only ±8 degrees with wheels up. The important parameter is how long it takes for a maximum control surface angle to be applied. For a time of 0.2 seconds, the corresponding rate for roll control by a differential tailplane with ±5 degrees authority is only 25°/sec, although this might be inadequate for its symmetrical pitch control function. Ailerons with a travel of ±20 degrees would need 100°/sec. For the same effective rate with 50-degree spoilers, the equivalent rate is 250°/sec.

High rate capability does not mean that pilots will sit there 'thrashing the controls' at maximum rate for long periods, therefore requiring large hydraulic power and flows. It is lack of transient rate capability that can lead a pilot into a saturated full amplitude PIO. Sufficient accumulator capacity can allow a large out-

and-return rapid transient input followed by a short dwell, in which time, a lower rate pump can recharge the accumulator. This capability removes one of the principal trigger causes of Type 2 PIO. In discussions of actuation rates, it should of course be remembered that the hydraulic pump flow delivery capability is a direct function of engine rpm.

Prevention of Type 2 PIO requires more than just high actuation rates, as evidenced by the early F/A-18 problems of rate saturated lateral PIO, despite 100°/sec aileron rates. This was “*plagued with bobbles, overcontrol tendencies and PIO, especially if the pilot used a high gain in tightly controlled tasks*” [Walker, 1982], a result of an attempt to provide extreme responsiveness. The C-17 military transport actuation hardware, designed originally for conventional mechanical control, was unable to cope with attempts to provide fighter-like responsiveness, after the change to a fly-by-wire system. This resulted in many rate saturated lateral and pitch PIOs [Iloputaife], exacerbated by very low elevator rates and moderate aileron rates (about 11 and 40°/sec in published data). In both cases an essential part of the solution was to reduce the excessive high frequency demands that had been made on the flight controls, respecting the physically practical limits on responsiveness. Similarly, in new design, all practical limits must be carefully assessed and sensible decisions taken on the responsiveness that is actually needed.

#### 4.11.6 Control Law Considerations

A necessary further protection is the provision of inner and outer loop electronic rate limiters in specific strategic locations. One is at the actuator drive inputs to prevent hardware rate limiting - always highly desirable, regardless of actuation rates. Saturation of this rate limiter can cause changes in augmented closed-loop behaviour with potentially serious effects on handling, and it should not be seen as an easy solution to inadequate actuator rate capability.

A second outer loop limiter should be located in the stick command path, and this must be set to prevent inner loop rate saturation. This outer loop limiter is crucial in preventing Type 2 PIO, and is especially important when actuation rates cannot be made as high as is desired. This was a feature of the solution to the C-17 PIO problem. The effect of such a limiter is detectable to the pilot, but it seems not to degrade the handling to a serious extent, as experienced up to the present [see Duda 1997; van der Weerd 1999], provided that it is not too extreme. Placed downstream of a command path non-linear shaping function, typical of many roll command and some pitch command systems, it can allow crisp and responsive control at moderate stick amplitudes, while preventing excessive rate demands at large inputs.

Phase compensation rate limiters are now well known [Rundqwist], and should be used as a matter of course. Though the gain attenuation remains, these effectively remove most of the phase loss caused by rate saturation, which is a principal cause of PIO. They are well suited for use in stick rate limiters, having the effect of an automatic gain reduction device at PIO frequencies, without the delayed gain recovery associated with the PIO suppression filter in the Shuttle Orbiter. The best limiters seem to be the feedback type, such as the Rundquist limiter for the Gripen and that for the Tornado SPILS (Chapter 3). In all cases, the parameters of the limiter design need to be carefully chosen for the particular circumstances [van der Weerd 1999].

#### 4.11.7 Summary

The prevention of high order PIO can be summarised by the following: the PIO frequency cannot be too high, the PIO gain cannot be too low, the phase delay cannot be too small, and the large amplitude response cannot be linearised too much. These replicate the ideal characteristics of the classical conventional aircraft of the past, which rarely suffered from the PIO problems all too often demonstrated in fly-by-wire aircraft. Clearly, if the application of stop-to-stop stick inputs at the PIO frequency, results only in small oscillations of a couple of degrees or so, a genuine high order PIO is impossible. Given the achievement of these aims, satisfactory assessment of the dynamics by the available linear and non-linear PIO criteria is assured.

As a result of the significant research carried out into PIOs during the last three decades, there exists a range of PIO evaluation methods, underpinned by an abundance of results and technical papers. This information will now be reviewed and summarised in Chapter 5, as part of the theoretical aspects of flying qualities.

## 5.0 THEORETICAL ASPECTS

### 5.1 FLYING QUALITIES

Flying qualities represent the most important design requirement for a flight control system. Although system stabilization is also a primary requirement for most modern aircraft, most past problems have been typified by consideration of performance and stability with a pilot in the loop, which we term flying qualities.

#### 5.1.1 Flying Qualities Criteria

The first “flying qualities specification” can be inferred from the US Signal Corps Specification for the Wright Model A. Flying qualities were defined by: “...maintain perfect control and equilibrium at all times...” together with a caveat on the pilot interface as: “...able to be operated by an intelligent man...”. This form of specification was continued through the 1940s, with definitions of required tasks that the aircraft had to be able to accomplish, up through the first of the MIL-F-8785 series of military flying qualities specifications. The perceived “benefit” of this philosophy is that it does not tell designers how to design the aircraft; whereas the disadvantage was that problems might not be found until during flight test.

In the USA, this philosophy changed with the publication of MIL-F-8785B in 1969. This version formulated the requirements in terms of ranges of design parameters that had been correlated from past experience to give satisfactory levels of flying qualities. This series of specifications was always supposed to be tailored for each specific application, but seldom was. In addition, they were not intended to be “how-to-design manuals”, and each version was supported by a back-up report providing the supporting data and substantiation for each requirement [i.e. Chalk, et al, and Moorhouse and Woodcock].

That informal philosophy was next formalized into the Mil-Standard format - which was a specification framework containing blanks for requirements together with a Design Handbook which was intended to be used to fill in those blanks for a particular system acquisition.

As long as the specifications were a list of required manoeuvres for test, they were not perceived as “telling the designers how to design the aircraft” and thus were not threatening. After they became a list of good characteristics, they were perceived as “how to” specifications and therefore threatening. From that time they may have been misused as often as they have been used correctly. The formulation of requirements in terms of linear parameters was both a convenience and also consistent with the analytical tools. On the other hand the specification always applied to the full range of manoeuvres across the flight envelopes, i.e. the full non-linear problem. It was left up to designers to resolve that difference. As has already been stated, when the equivalent systems concept was introduced into MIL-F-8785C, all non-linearities were required to be included in formulating the approximate linear transfer function. Just the rigorous application of this specification requirement would have prevented most of the problems documented in Chapter 2. The intent of the equivalent system approach was to guide the designer to produce essentially linear response characteristics, which met the linear requirements based on previous experiences. In principle, this is still a good practice and entirely consistent with the recommendations presented in Chapter 4.11. In the next two sections, we discuss the application of handling qualities to protect the pilot at the limits of the envelopes, and then, tasks which can be used to search for control problems from early in the development phase through the flight testing.

#### 5.1.2 Carefree Handling

The expression “carefree handling” can have different definitions and is often a cause of misunderstanding. For the purposes of this document it is taken to mean the reliable limitation of commands from a trained pilot in order to keep the aircraft always inside the allowed envelope, to avoid departure, and to prevent overloading of the aircraft and unconsciousness of the pilot. The technology has progressed from simple autopilots, through stick shakers/pushers, to provide fully automatic control of recovery from dangerous situations. Often an aircraft is only carefree with respect to some critical parameters. Military high



performance aircraft not only need the carefree handling technology more than other aircraft, but are also leading the implementation and development.

Furthermore, carefree handling means the safe manoeuvring of the aircraft under failure-free conditions for all movements around the centre of gravity (c.g.). At the end of this section, the concept of carefree handling is taken a stage further, by considering the motion of the flight path of the c.g., e.g. collision avoidance (ground or other aircraft).

Two military combat aircraft are described to show the historical development and the actual status of carefree handling, with the necessary steps in the development and testing process:

- An aircraft which has been in service for nearly 20 years, as an example of the status of carefree handling for aircraft which are still in service today, to show how even a good basic design can be improved by continuous development.
- A modern aircraft, as an example of the status of carefree handling for the next generation of combat aircraft, to show what is possible with respect to carefree handling for aircraft which are entering service in the near future.

### 5.1.2.1 History

Early in the history of flight, automatic flying by autopilot was possible although this was by no means adequate to provide carefree handling. The pilot has only limited command authority in autopilot mode (“the computer flies the aircraft”), whereas in the carefree mode, the computer is only monitoring and limiting (“the pilot flies the aircraft”).

The carefree function became necessary with the development of the jet aircraft and increasing flight envelopes, which introduced new problems for the pilot, due to the aircraft’s performance potential. At first, only the most critical parts of the envelope were monitored, e.g. the maximum angle-of-attack (AoA) to prevent stall. The maximum controllable AoA of a combat aircraft is highly dependent on flight condition and configuration (stores, c.g., wing sweep etc.). Therefore, many more input parameters are needed than just the AoA measurement, otherwise a reliable limitation can only be guaranteed for one single configuration. This example shows how complicated the limitation of one single parameter can be.

The AoA control can be done by two different ways:

- Passive, with no control law change: a pure warning system (most are acoustic) giving information about the distance to the actual boundaries of the flight envelope, in order to allow the pilot to control the aircraft nearer and safer along these boundaries.
- Active, with control law changes: an active limitation system is more complex and therefore considered to be more risky, but is gaining acceptance as it offers better performance and increased safety.

Although even passive systems can support the pilot very effectively, carefree handling always requires active systems. Nevertheless, the passive systems were easier to realise and therefore came into service earlier than active ones. Unfortunately, there have been many accidents where the warnings were just ignored.

Military aircraft are often in service for an extremely long time (e.g. planning for B-52 now spans 80 years). During this time, not only the mission type can change, but there will also be technologies which were not available during the design phase of the aircraft. When upgrading the aircraft, a modern technology can be implemented, if this can be done with moderate (financial) effort. By doing so, even an aircraft which was originally difficult to handle can reach a more satisfactory level of handling.

### 5.1.2.2 Advantage/Disadvantage of Carefree Handling

Unlike other types of aircraft, a high performance combat aircraft is often designed at the leading edge of the technology, and where even mission performance can be endangered by deficiencies. Therefore, during the design process, everything which is possible has to be done to get an optimal configuration. The current state of the art means that this will often be a single-seat configuration.

The pilot's workload in a single-seat aircraft can be extremely high, especially in combat situations with rapidly changing flight conditions. Therefore, he might not be able to monitor the boundaries of the flight envelope fast enough - even with modern head-up displays. This will be critical in terms of:

- Risk for man and machine, when exceeding the limits of the flight envelope.
- Disadvantage in combat, when the available flight performance may not be fully used.

To reduce the resulting risk as far as possible, some limitations can be monitored by computer.

Advantages of Carefree Handling: There are some good reasons to implement effective carefree handling characteristics:

- Increased mission success:
  - Full concentration of the pilot on the target.
  - Command inputs can be applied in a more aggressive manner, while using the full flight performance.
  - Reduced risk for man and machine.
- Reduced weight, hence better flight performance:
  - Reduction of the structural load factor margin, since a violation of the limits by the pilot may no longer have to be considered.
  - Less crew (single seater).

Disadvantages of Carefree Handling: There are only a few disadvantages:

- Expensive during development, clearance and flight test; cost of additional hardware.
- Acceptance, since some pilots always want to have full control.
- Reduced agility - but the pilot can now make more aggressive inputs.

All in all, there are enough advantages to justify the implementation of carefree handling characteristics in nearly every new combat aircraft.

### **5.1.2.3 Control for Carefree Handling**

When implementing carefree handling characteristics we use sensor information to provide the flight controller with the flight conditions, and to enable monitoring (observing) of the limitations of the envelope. The flight control computer is co-ordinating the demands of the control surfaces statically and dynamically, to feed forward the pilot commands under consideration of given requirements:

- Stabilisation
- Handling characteristics
- Manoeuvre characteristics
- Loading constraints
- Controllability reserves
- Minimum drag

These must be satisfactory in a region as wide as possible. Additional limitations must be monitored by the pilot. To do this by the computer, the scope of the flight controller has to be extended.

If there is, for example, a tendency to violate a certain limit, the flight controller must have the authority to reduce the pilot's command. A lot of pilots have an acceptance problem with this computer authority. Therefore there will always be a discussion: "what does carefree mean" and "what does it not mean".

Design and Implementation: The following steps have to be done:

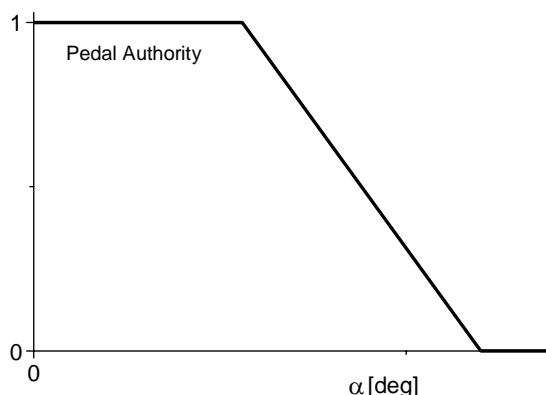
- Define the envelope of the augmented aircraft in terms of where it can and should fly without stability or loading problems.
- Identify which part of the flight condition vector is the cause of the problem, i.e. which part has the highest efficiency in providing the necessary limiting, e.g. to avoid a load factor violation we have to limit the AoA.
- Determine how to measure violations of the boundaries with the existing sensor signals.
- Implementation into the control laws should be simple, with no change of the basic functions.
- Demonstration of carefree handling by simulation and flight test.

1970s Aircraft: The primary design of the aircraft, in the first example, was done in 1970-75. The aircraft is stable in the longitudinal axis and statically unstable in the lateral axis with heavy stores at high AoAs. The analogue flight controller made it more difficult to improve the FCS in terms of introducing a complex (multi-dimensional) design. During the development phase, the reliability of AoA and AoS sensors was considered to be insufficient. Therefore a feedback of these signals was not used for the primary control law design, although AoA sensors were used for the cockpit displays (AoA and AoS sensor signals were implemented in primary flight controllers for the first time in the early 80s). The damping of the aircraft motion was achieved by a feedback of the pitch, roll and yaw rates.

One of the main design tasks was to achieve good handling characteristics at low and medium AoAs. For example, this was done successfully by feeding the roll input to the rudder to achieve co-ordinated manoeuvring at low AoS (and to avoid autorotation). The augmented aircraft was then carefree with respect to autorotation.

After entering service, the aircraft exhibited good handling characteristics at low and medium AoAs, but showed problems at high AoAs with heavy stores. To solve these problems the FCS was upgraded with a supplementary high incidence system in the early 80s, which is based on AoA feedback measured by the existing sensors. This system drastically reduces the pilot's command authority in all axes at high AoAs and also avoids extreme AoAs. It can be switched off manually, and considering the acceptance problem of a reduced pilot's authority, many accidents happened because this system was not activated - but no accident happened due to handling problems with the system engaged.

In Figure 5.1.1 this is shown for a pedal input from the pilot. While at low AoA the full command can pass through the system, the command will be reduced with increasing AoA. At high AoAs the controller "ignores" the command input. On one hand, this may be considered as reducing the agility of the aircraft at high AoAs. On the other hand, the clean aircraft is now carefree with respect to departure, and all other configurations are at least much better, than without the system. This can be done without any additional store information.



**Figure 5.1.1: Reduction of Pedal Authority**

The remaining critical regions are handled with relatively complex AoA limitations, which the pilot has to respect manually. An example is shown in Figure 5.1.2. The maximum allowed AoA (depending on manoeuvre type and configuration) is defined as a function of roll and pedal commands. The pilot's workload can be clearly reduced by a passive warning system which is informing the pilot about the distance to the boundary, with an acoustic signal of increasing loudness and frequency. An optical display ("Indicator" in Figure 5.1.2) can give the pilot additional information.

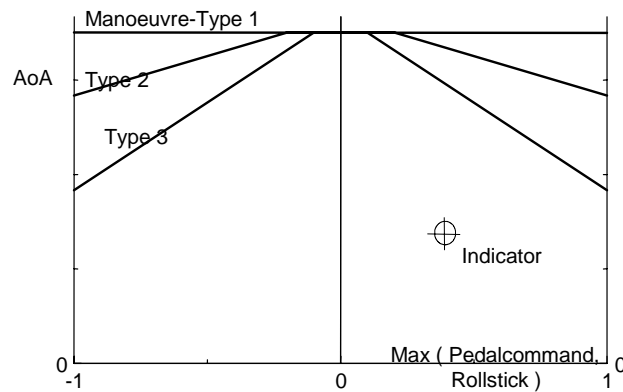


Figure 5.1.2: Warning Curves

One of the main problems, the acceptance problem, cannot be solved with such a system. The pilot can ignore the warning tone, e.g. because he sometimes exceeded a limitation and nothing happened (possibly with no safety margin!). Therefore he might think "it's good for most of the pilots, but I don't need it!" or "I can do better than the automatic system".

Additional improvements can be achieved for this aircraft, only by implementing a digital flight controller. Pre-investigations showed that with such a system (using AoA and AoS feedback) the aircraft would be carefree with respect to departure, not only in the whole (extended) envelope, but also for every (symmetrical) configuration. Even with asymmetric stores the aircraft reacts in a well controlled way.

With digital flight control, the pilot's workload can be reduced also, e.g. the computer can monitor a certain AoA limit (Figure 5.1.3). This figure shows two deceleration manoeuvres for different configurations. The AoA can be limited very well, even if the maximum AoA cannot be currently achieved, because only a preliminary control law design was used. Attainment of the maximum AoA is possible with more complex control laws with AoA and AoS feedback, but even this system cannot prevent high load factors – for this to be automatically controlled there must be reliable information about fuel mass, c.g. and stores, which are likely to be available for modern aircraft.

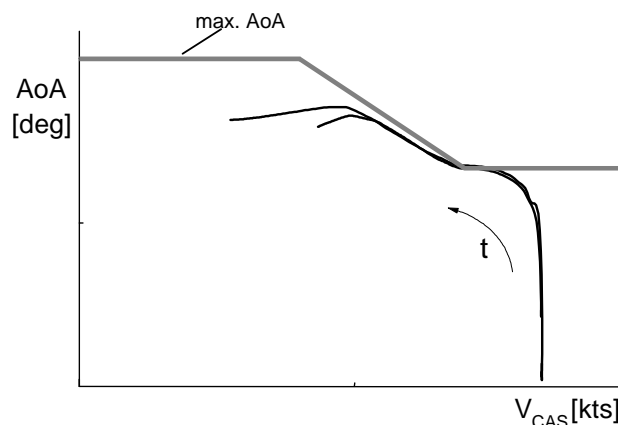


Figure 5.1.3: Simulation of deceleration flights with digital flight controller (full back stick)

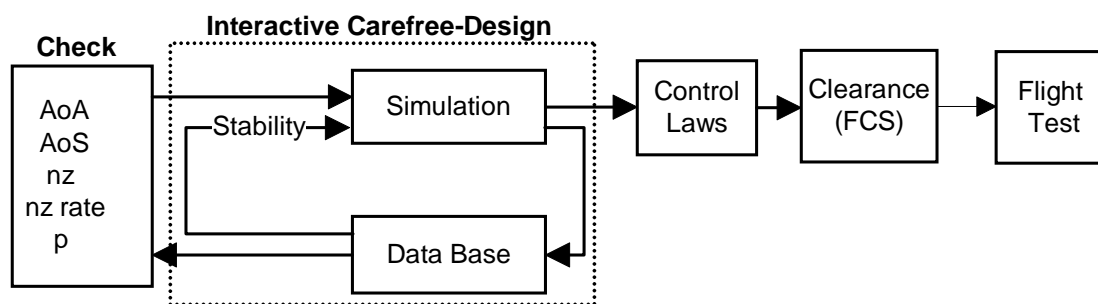
This aircraft is not only a good example of the status of carefree handling in aircraft which are in service today, but also how a good basic design can be improved by continuous upgrades – and how a good aircraft can become even more successful and safe.

1990s Aircraft: For this example, the primary design was done in the 1990s (about 20 years later than for the previous example). Modern carefree handling characteristics are implemented in a quadruplex digital flight controller, without mechanical backup. Many modern combat aircraft, like the one discussed here, are unstable in the longitudinal axis to minimize the drag in trimmed flight and to increase the agility. It can only be controlled with a digital flight controller with full authority of all control surfaces. Such a controller with its multiple sensor system is the perfect basis for providing carefree handling characteristics, which is new for Europe – not only considering the design and implementation, but also the clearance and test process. This aircraft will be carefree for any configuration with respect to:

- Departure.
- Violation of the boundaries of:
  - Angle of Attack,
  - Angle of sideslip,
  - Load factor (+ load factor rate),
  - Roll rate and roll acceleration.

Whilst the aircraft can be made carefree with respect to departure by co-ordinated manoeuvring at low AoS, the other parameters are handled by limitations (e.g. the load factor limitation as a function of Mach number, dynamic pressure, mass and stores).

The design process is shown in Figure 5.1.4. The basic design of the carefree handling characteristics in the flight controller is made by limiting the pilot's commands in such a way that no violation of the boundaries occurs (see Figure 5.1.5). Numerical simulations of the aircraft and its motions are performed to check that the parameters of interest stay inside the envelope. If there are no critical violations, the control laws can be frozen (from the carefree point of view). Figure 5.1.6 shows a part of the simplified control laws. A pilot input will be limited first before it is fed into the flight controller.



**Figure 5.1.4: Carefree Design Process**

To preserve the agility of the aircraft, we want to have good response behaviour (steep response gradient after a pilot's input, see Figure 5.1.5, types 2 and 3). Whilst inside the envelope, a characteristic similar to type 3 can be tolerated, but the characteristic at the boundaries should be more like type 1. The eigenvalues should be well damped for all types. To solve the conflicting response requirements, a compromise is needed.

Before giving a clearance for carefree handling flight tests, there must be numerical simulations to show that the violations (see Figure 5.1.5) stay inside the allowed safety margin, even for the worst case configurations. One of the main problems is that it is a multi-dimensional problem, where some parameters can augment each other. Moreover, we have to look at a wide c.g. range, and during the prototype tests there are big tolerances on the aerodynamic modelling (see Chapter 5.3) and the sensor system.

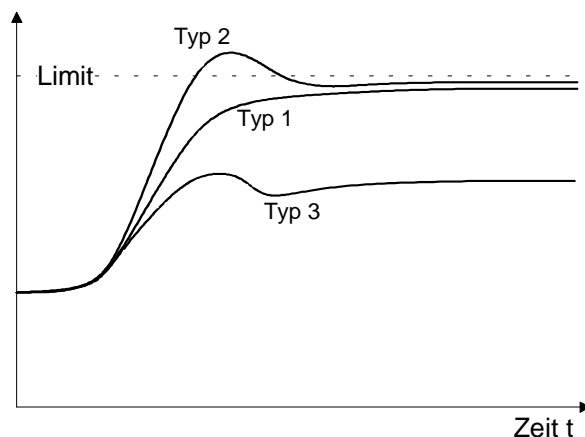


Figure 5.1.5: Time Responses

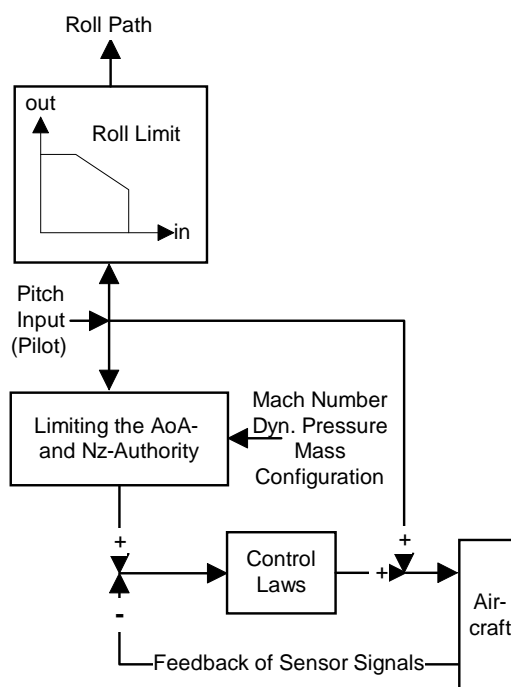
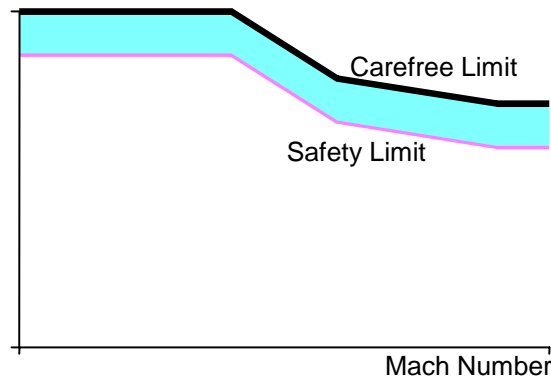


Figure 5.1.6: Simplified Control Law Structure for Carefree Manoeuvring

Rate limitation has the risk of PIO, so investigations and simulations of possible PIO sensitivity are necessary. Additional emergency precautions were done for one prototype, e.g. spin tests in the wind tunnel; a spin chute was fitted to that prototype; automatic start of the APU if the main engines stop due to spinning; an extended emergency limit for the actuator rate; an emergency recovery mode of the flight controller with increased pilot's authority etc. Only this one prototype was allowed to fly in those regions which were restricted for all others (Figure 5.1.7). The pilot was supported in his decisions during flight test by a safety pilot in the ground station, who was supported by different specialists.

The flight tests showed more or less the same characteristics as the simulations, and few additional design iterations were necessary. Finally, due to the success of the carefree handling flight demonstration, all prototypes were given the clearance to fly in this region.



**Figure 5.1.7: Example Limitation for the Prototype**

From then on, the flight display flown at air shows included carefree manoeuvring. Nevertheless, some work has still to be done to ensure that all the demands of the customer are fulfilled:

- Carefree handling at low dynamic pressure (which could include automatic throttle).
- Carefree handling for various stores.

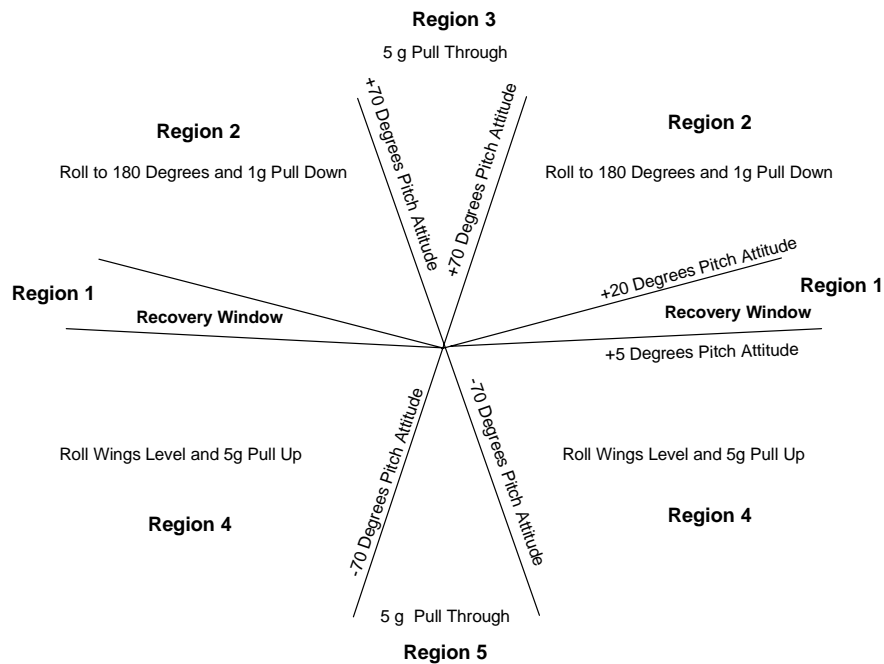
Future Systems: The future will bring aircraft where also the motion of the c.g. will be co-ordinated (not only the motion around the c.g.):

- A “Disorientation Recovery Function” (DRF). If the pilot does not know exactly his position and attitude (in bad weather conditions, or above difficult terrain such as desert or sea), the aircraft can return autonomously to a safe flight with predefined conditions. The computer will also control the velocity in this case.
- A combination with collision warning systems can avoid ground contact (it can be integrated in the digital map as “Ground Proximity Warning System”) and collision with other aircraft.

#### 5.1.2.4 Control for Recovery Function

An example of a Disorientation Recovery Function was designed and flight tested by the USAF on a highly modified single seat fighter. It was installed as a safety system to support low level night flight testing. The system called the “Pilot Activated Recovery System” or PARS, provided a pilot initiated automated manoeuvre capable of aircraft recoveries in situations of unusual attitudes and spatial disorientation. It was developed to provide an alternative to manual recoveries using an Attitude Direction Indicator (ADI). The system mimicked the standard unusual attitude recoveries taught to pilots. Once activated by the pilot, the system automatically manoeuvred the aircraft to a slightly nose high, wings level recovery attitude. A recovery window was reached, aircraft rates were nulled and control of the aircraft was returned to the pilot. The aircraft on which the system was installed had an angle-of-attack limiter in the pitch command system. The system commanded the g for recovery as shown in Figure 5.1.8 or the “available g” if the aircraft was operating on the alpha limiter.

A range of pitch attitudes and aircraft responses, as shown in the figure defines five regions. In region one, the recovery window, an automatic manoeuvre is only commanded to reach a wings level condition. In region two, when pitch attitude is greater than 20 degrees but less than 70 degrees, the manoeuvre is to roll the aircraft inverted and initiate a gentle (1g) pull down. In region 3, pitch attitude greater than +70 degrees, the aircraft is commanded to a 5g pull through. No roll command is issued since bank angle is ill defined. Once into region 2, bank angle is commanded to 180 and the pull down is reduced to 1g. Upon entering region 1, a 180 deg/sec roll rate is commanded to return to 1g wings level flight. In region 4, the aircraft is commanded to roll wings level and pull 5g until region 1 is reached. Region 5 is similar to region 3 in that a pull through is initiated, without a roll command, until region 4 is reached. At that time the aircraft is rolled wings level and continues the pull up until into region 1.



**Figure 5.1.8: Pilot Activated Recovery Regions**

The pilot could always disengage the system by an on-stick switch or with 90 percent aft or 60 percent forward stick command. If he applied stick commands during the recovery, they were blended with the automatic recovery commands. The system was automatically inhibited if the aircraft was placed in the landing configuration, the air-refueling configuration, or if the flight control system had experience failures. The system was designed such that a failure could not result in an unsafe recovery.

The system is credited with saving the test aircraft during the evaluation of a new night vision system. During this test a steerable FLIR, synchronized with the pilots head position, was used to provide an infrared image to a helmet-mounted display. The system sustained a failure during a low-level night test mission. The failure resulted in the FLIR locking in a position looking to the side of the aircraft and continuously presenting that image as the pilot's head was turned in flight. This resulted in a severe case of disorientation. The pilot believed he was flying inverted. He activated the system numerous times during the period of disorientation to verify that the aircraft was in a safe wings level, nose-high condition until he could re-established his proper orientation. Since the aircraft was being operated in the recovery window, the system did not manoeuvre the aircraft at all during these activations.

### 5.1.2.5 Control for Collision Avoidance

#### Automatic Ground Collision Avoidance:

Controlled flight into terrain due to spatial disorientation or lack of situation awareness has plagued aircraft pilots for many years (see Swihart and Barfield). This condition has been compounded by the increase of information via cockpit sensors to the operator. Many kinds of ground collision warning systems have been developed over the years, and even though they provide a considerable warning capability, a large number of aircraft are still being lost due to controlled flight into terrain accidents. Part of the problem is due to a system design that forces the pilot to correct the situation. All of these designs contain a warning that must be given a second or two early in an attempt to account for the pilot's reaction time in recognizing the problem and correcting it. This reaction time, in many instances, causes the systems to issue a warning when the aircraft is not in danger. These early warnings are nuisances to the pilot and are either ignored or turned off. The only method to prevent nuisance warnings is to eliminate the pilot reaction time. In other words, the system has to be designed to always be in the background, allowing the pilot to manoeuvre to all attitudes and altitudes without causing a warning unless the aircraft is in danger of striking the ground.

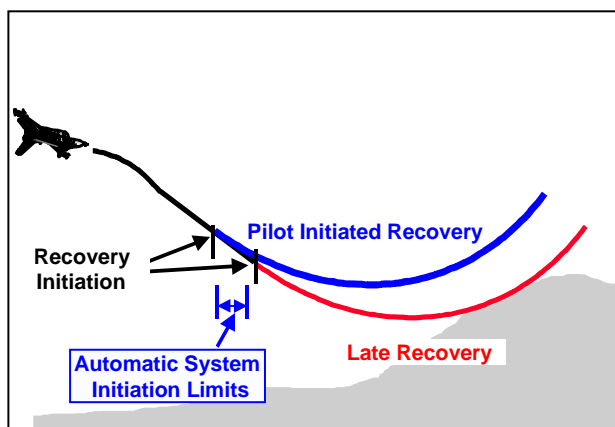


The advent of digital fly-by-wire flight controls has allowed integration of various avionics systems with flight controls. The integration of avionics and flight controls to provide an automated means for aircraft recovery will prevent virtually all controlled flight into terrain mishaps. The system can be designed to operate without a pilot reaction time, thus preventing nuisance warnings. An automatic system also has the added advantage of providing a recovery for G-induced loss of consciousness mishaps. However, extreme care must be taken to prevent nuisance automatic activations.

#### Ground Collision Avoidance Nuisance Criteria:

An independent flight test programme was established in 1996 to develop a nuisance criteria for ground collision avoidance systems that could be used to design a nuisance-free system (see Huffman, et al, 1997 and 1998). In this effort, pilots determined the point, during manoeuvring approaches to terrain obstacles, at which they would manually pull away from the terrain. For a collision avoidance system to be nuisance free, it must not interfere with normal manoeuvring. Any automatic recovery must occur after the point at which the pilot would recover the aircraft. The test data indicate that the pilot's opinion of where that point is, can best be correlated with an apparent "time available to avoid ground impact" that includes the effects of airspeed, altitude, dive angle, as well as velocities and accelerations.

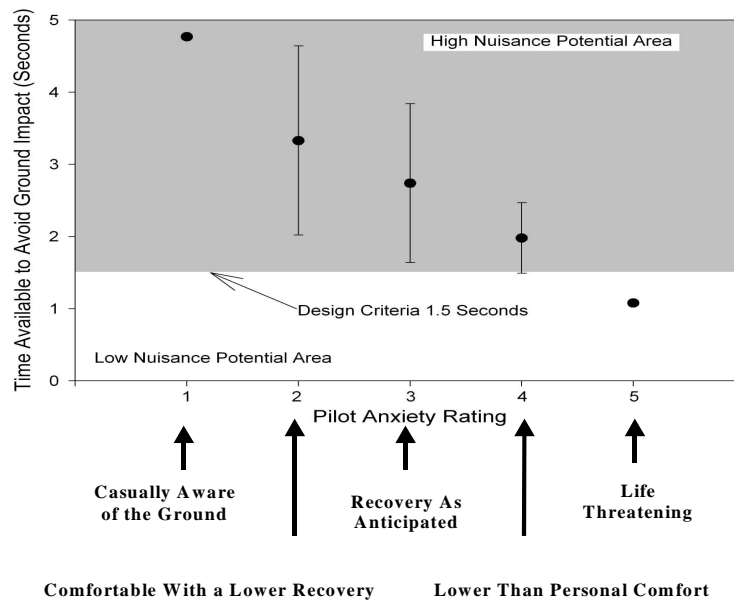
Consider a pilot initiating a recovery that comes as close to the terrain, during the pull out, as is felt to be safe by the pilot. This would be the pilot initiated recovery (top trajectory) in Figure 5.1.9. The point of the initiation is marked. Next consider this same recovery projected in time until it will just touch the ground. This is the lower limit of time available to the pilot to recover the aircraft. It is called the zero-time-available recovery. The initiation point of this recovery is also marked. To be nuisance free, the automatic system must initiate a recovery between these points. It must be a recovery that occurs after the time when the pilot would recover the aircraft, but it must be before the zero-time-available initiation.



**Figure 5.1.9: Time Available determination for Nuisance Criteria**

Pilots demonstrated the ability to consistently recover the aircraft when the time available was between 2.0 to 2.7 seconds. A lower limit on this time available that includes all pilots tested would be approximately 1.5 seconds as shown in Figure 5.1.10. The times were consistent for all pilots with no change for different training, different experience or the amount of time spent in low level operations. This criterion, although still being verified and refined, was used to develop the enhanced automatic ground collision avoidance system discussed below.

Through this implementation, minimum disruption occurs in the pilot's ability to complete his task. Intervention takes place only when a collision is imminent. Further, as soon as the danger is past, system control inputs are removed. The 12 Hz update rate used kept the resulting excursions fairly small even in dynamic rolling situations. The key is that large amplitude deviations were not allowed to develop. Since the recovery inputs are patterned after the pilot's natural actions, the trajectory tends to follow a minimum clearance path.



**Figure 5.1.10: Nuisance Criteria Results**

### Demonstration System Design

A demonstration automatic ground collision avoidance system was developed and flight tested in the 1991-1997 time period on the AFTI/F-16 aircraft. At the time, technologies were being evaluated for low-level night attack in a single-seat fighter. The potential for momentary task overload and loss of situation awareness was extremely high. The consequences are aircraft and pilot loss due to controlled flight into the terrain. This demonstration system proved the viability of an automatic recovery to provide protection during low level close air support and battle air interdiction missions.

The design utilizes a digital terrain system with a terrain-referenced navigation algorithm to locate the aircraft spatially with respect to the terrain. The terrain database around the aircraft is scanned, and a terrain profile is created. An aircraft response model is used to continuously predict the aircraft's future recovery trajectory. A recovery is automatically performed whenever the trajectory penetrates a preset distance from the terrain profile.

Due to time and money constraints, limitations were imposed on the system. The design was completed for one store loading. System operation was enabled for dive angles less than 60 degrees, altitudes less than 20,000 feet and airspeed between 250 knots and 0.95 Mach number. These were the expected conditions for the close air support and low level interdiction missions. The enhanced design (discussed next) removes these limitations. This new system provides protection at all attitudes, all airspeeds, all altitudes, in all mission phases with gear up, and for a large combination of store loadings.

### Enhanced System Design

An enhanced Automatic Ground Collision Avoidance System (Auto GCAS) was development in a joint United States and Sweden effort in 1997 to 1999. Auto GCAS technology is being considered for application on the F-16 and JAS39 aircraft. Both designs share a common architecture as shown in Figure 5.1.11. The system continuously predicts the flight path of the aircraft, assuming a recovery is needed, 10 to 15 seconds in the future. This prediction is accomplished using a high-fidelity aircraft response model. At the same time, the terrain database around and in front of the aircraft's position is scanned to determine all terrain features that may be dangerous to the aircraft's flight. The scanned terrain points are collapsed onto a recovery profile and sorted by range into bins. The highest point in each bin determines the height of the bin.

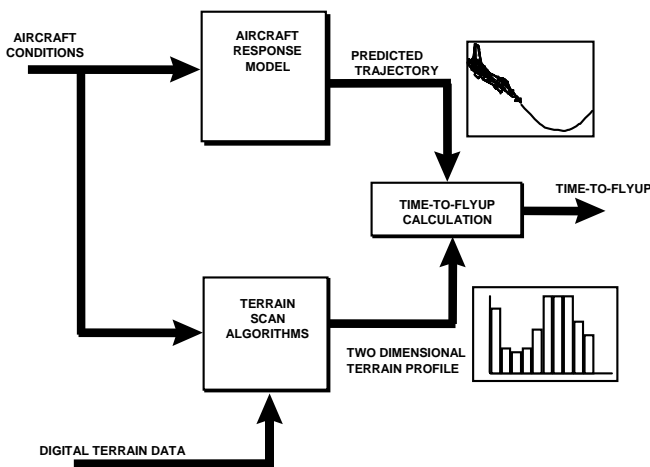


Figure 5.1.11: Algorithm Architecture

Bin width is selected based on navigation uncertainty. The terrain is represented by the tops of the bins. A comparison of the future recovery flight path and the terrain profile along the path (represented by bin tops) is made. From this comparison, a time-to-fly-up is generated. At a time-to-fly-up of 5 seconds, chevrons appear on the HUD as shown in Figure 5.1.12. When the time-to-fly-up reaches zero, a coupler or auto-pilot in the flight control system commands an automatic recovery. The recovery is a roll to wings level, 5g pull up. If inverted at the fly-up initiation, the system unloads the aircraft and counters gravity during the initial roll. The 5g pull is commanded as soon as the bank angle is less than 90 degrees. This recovery is continued until the projected flight path has cleared the terrain feature of concern. Changes to enable the system to provide expanded coverage were made to the scan pattern computations, the aircraft response model, the safety monitors, and the flight control couplers.

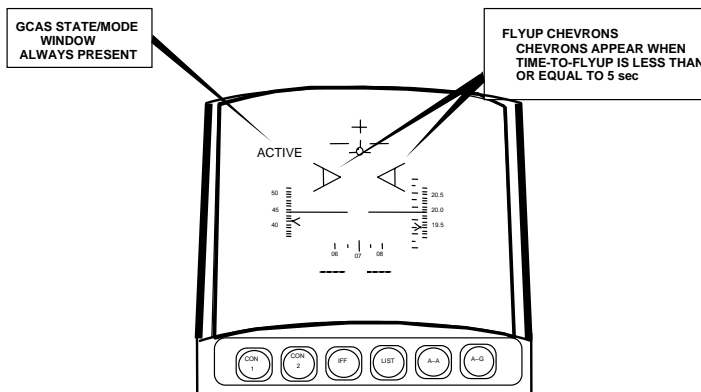


Figure 5.1.12: Auto GCAS Display

Figures 5.1.13 shows the scan pattern variations for turning flight that were retained from the demonstration design. Changes made to the digital terrain scanning shapes in the enhanced design for inverted flight and steep dive angles are illustrated in Figure 5.1.14. The hexagon pattern is used to represent a circular scan shape.

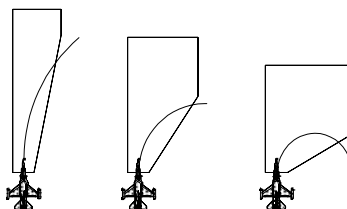
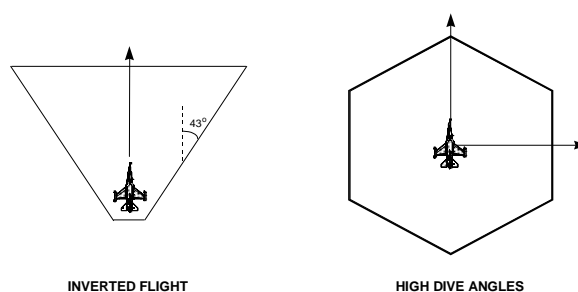


Figure 5.1.13: Scan Pattern Variations with Turn Rate



**Figure 5.1.14: New Scan Pattern Variations**

The flight control coupler was altered to allow the control system to execute a recovery at slow speeds and while carrying a heavy store configuration. In the pitch axis, load limits for pitch command at low speed were added to Auto GCAS to allow for the full aircraft envelope and all store configurations. The final pitch command limits were increased on the positive side to allow for quicker onset rates. At the end of the recovery, the pitch rate is reduced to prevent the aircraft from coasting beyond the flyup termination angle. In the roll axis, damped proportional and integral feedback has been added to handle asymmetric loads. The roll rate limit was reduced to avoid ringing with heavy stores. Roll-to-wings level latching was added to improve the fly-up performance.

Pilot override of the system is by using a paddle switch on the stick. Thus, the pilot can always prevent an automatic recovery from occurring. In the demonstration system, the pilot could blend with the recovery by applying commands to the stick during the fly-up. Flight test experience showed this could be dangerous. A stick command of a few milliseconds in opposition to a fly-up resulted in the loss of several hundred feet in altitude during the recovery. Thus, for the enhanced design, pilot blending was modified to prevent stick commands until the aircraft's bank angle was close to wings level during a flyup.

The design envelope includes all attitudes, and all airspeeds with gear up from minimum controllable to Mach 1.2. It also covers store configurations up to a 25,000 ft-lbs asymmetry.

A safety function called System Wide Integrity Management (SWIM) was designed into the Auto GCAS specifically to provide a means to safely integrate flight control with other avionics. The SWIM function is like a built-in test for a system. It is a method to ensure that signals received from non-redundant portions of the Auto GCAS will not cause unsafe conditions. Most of the Auto GCAS is non-redundant with the exception of the flyup command which is in the quad redundant flight control computer. SWIM provides monitors that test and compare the signals from non-redundant systems utilizing the flight control system to accomplish these tasks. An example is aircraft attitude which is one of the most important parameters required for safe Auto GCAS operation. The attitude is compared with the integrated roll rate from the redundant flight control system. Should a failure of the aircraft attitude be detected during a recovery, the flight control system has enough information to complete the recovery.

### Flight Test

The flight test programme began in May of 1998. Testing was conducted using a two seat F-16 at Edwards Air Force Base in California. Pilots from the US and Sweden evaluated the system against a variety of terrain from flat Mojave desert dry lake beds to rugged Sierra Nevada mountains. Various dive angles and bank angles were tested, as well as several store configurations. The flight testing included flying representative operational mission phases to evaluate the system's acceptability during these missions. To show the ability of the system to prevent controlled flight into terrain, several accident profiles were recreated in-flight. In all cases the Auto GCAS protected the aircraft.

### Transition To Other Aircraft

The design was partitioned to fit in any aircraft. The Auto GCAS is transitioned into another host aircraft by substituting new aircraft characteristics into the coupler, aircraft response model, and scanning algorithms. A different terrain database can be substituted as well. The primary objective on the host aircraft is the same -- to save the pilot/aircraft but not annoy the pilot with nuisance recovery warnings.

The current design is estimated to allow nuisance free operation as low as 150 ft over all types of terrain. Changing the system for extreme low altitude operations will mean refinements to the aircraft response model, the terrain scanning algorithm, and the flyup coupler.

The target aircraft would require a digital flight control system and preferably be fly-by-wire. An aircraft model of the specific aircraft would be integrated into the GCAS algorithm. The model would provide the necessary parameters to predict a future aircraft trajectory. The digital terrain scanning would be modified to allow for the response of a new aircraft.

The pilot always has the option to inhibit or override any automated manoeuvre. These nuisance conditions should be near zero if the system is designed properly. An automatic GCAS has the advantage over a manual GCAS in that it does not have to compensate for the pilot's reaction time. This fact alone should eliminate most nuisance activation. There are still database errors that can cause nuisance cases. As the database gets more accurate over time, these also will be eliminated.

#### **5.1.2.6 Summary**

The objective of this sub-chapter was to discuss the extension of flight control design beyond stabilization and control, sometimes referred to as Active Control Technology. The term "carefree handling" is used in this report to designate the design of the control laws to prevent pilot inputs that would cause departures, exceeding limit loads, etc. Then we can consider a progression to recovery directions for the pilot to follow, through to complete intervention of the control system.

First, two aircraft with different technology status of "carefree" handling have been discussed. It was shown not only how an aircraft can be upgraded during its lifetime with the actual technical development, but also what is possible today for a combat aircraft of the newest generation. The principle is the same for both, only a reliable control system with a good sensor system for measuring the flight condition enables the function "carefree handling".

A Pilot Activated Recovery System has been shown to be effective. This system was pilot selected and provided guidance which mimicked recovery procedures that are taught to the pilots. As such, it was very acceptable to the pilots.

The above approaches are oriented towards helping the pilot to the maximum extent. There still exist possibilities where the pilot does not realize the situation or is temporarily incapacitated. In addition, there have been many accidents where warnings were not sufficient. This leads to consideration of fully automatic systems to take over control. The flight test results from an Auto Ground Collision Avoidance System programme show the benefits of an automated system. It shows that nuisance warnings are almost zero and that interference to the pilot is basically non-existent. Pilot acceptance of automated systems has been a problem in the past. This reluctance was based on insufficient knowledge of automated system operation or experience with inadequate manual systems. Future aircraft will be more complex both in pilot workload and in display technology. These facts alone will make the need for more automation imperative. It is not the intent of this programme to provide data to help eliminate the pilot, but it was the intent to assist the pilot, so that he/she can accomplish the mission safely and effectively. This level of automation could be of great benefit for unmanned aircraft where pilot acceptance will not be a problem; it might even be considered that such a system is a requirement for unmanned aircraft.

All the design aspects of Active Control Technology and carefree handling are subject to the Best Practices given in Chapter 4. An early programme decision is mandatory to define the extent of the technology. It does increase the design effort and therefore must be justified. Even in the simulation and especially in flight test a higher effort is needed to clear the aircraft for "carefree" manoeuvring. Nevertheless the advantages are so big that every modern combat aircraft should have it. When designing the control laws, the pilot inputs are reduced to avoid violation of all given stability and controllability margins and additional limitations (e.g. load factor). The agility of the aircraft must not be reduced "too much", which is a subjective evaluation when the pilots think that the control laws are preventing them from achieving some realizable performance objective. Part of the solution to this problem of acceptance is to design for

minimum intervention, as discussed above in all three areas. Finally, it is mandatory that pilot selectable features should not be “dormant”, i.e. it must be clear to every pilot exactly what the selected configuration is doing.

### 5.1.3 Flying Quality Demonstration Manoeuvres

#### 5.1.3.1 Background

As a result of the current (as of the date of this report) acquisition reform, the air vehicle specification process in the U.S. has undergone a considerable change. Detailed design criteria still exist but are now only guidelines. Requirements are defined only at a top level and are derived directly from the designated operational needs. The emphasis is to tell the aircraft developer what the product should do, as opposed to how to design the system. This will result in significant freedom to the contractor in finding design solutions, but confidence in the predicted capability will suffer when those detailed criteria are violated. This is especially true for flying qualities.

As aircraft flight envelopes are expanded and increases in information and weapon capability of the system change the pilot tasks, the interfaces among technologies are no longer clearly separate. Many of the individual criteria, which previously came close to guaranteeing success, may no longer do so. Since design criteria are based on experience, they are destined to lag behind advances such as we are seeing now. Some deficiencies in flying qualities still may not be exposed by accepted criteria under all conditions. Also, current criteria are written to be applied to one axis at a time and there are no catch-all criteria that assure acceptable multiple-axis operation. In order to address the above problems, the demonstration manoeuvre concept is being revived. The same manoeuvres can be used early in the design process in conjunction with existing criteria, to establish control power and to perform preliminary flying quality checks as simulation becomes available. Final verification of an aircraft’s flying qualities can be shown directly by conducting this series of operationally-relevant flight tasks and demonstrating acceptable performance and workload. The flying-qualities specifications from MIL-F-8785 onwards, did not require closed-loop testing, it has been argued that it should not be performed. This has often resulted in an almost confrontational atmosphere between the procuring activity and the industry.

The U.S. Army adopted a specification for rotorcraft flying qualities, Airworthiness Design Standard ADS-33D [Anon, 1996] which consists of both quantitative criteria and qualitative flight test manoeuvres. The following is an adaptation of the introductory wording from that document. Whatever the final form of these manoeuvres, wording such as this must be included:

“The manoeuvres proposed here are intended to provide an overall assessment of the aircraft’s ability to perform certain critical tasks. The specific manoeuvres required for any aircraft will be designated by the procuring activity. They should be performed with all combinations of manual flight control modes and displays available to the pilot and used as they would normally be used in the conduct of the actual mission”.

There should be guidance on *Conduct of Tests*:

“Pilots shall assign subjective ratings using the Cooper-Harper Handling Qualities Rating scale. The manoeuvres should be performed at the Normal States within the Operational Flight Envelope that are most critical from the standpoint of flying qualities. It is emphasised that the performance capability of the aircraft is not an issue in these tests, and that the flight conditions should be selected accordingly”.

Also guidance on *Performance Standards*:

“These performance limits are set primarily to drive the level of aggressiveness and precision to which the manoeuvre is to be performed. In cases where the performance does not meet the specified limits, it is acceptable for the evaluation pilot to make as many repeat runs as necessary to insure that this is a consistent result. Repeat runs to improve performance may expose handling qualities deficiencies. Such deficiencies should be an important factor in the assigned pilot rating”.

Experience to date with both procuring agencies and the rotorcraft industry has proven that demonstration manoeuvres can enhance both the design and the evaluation process.

### 5.1.3.2 Current Fixed-Wing Demonstration Manoeuvres

The investigation of the YF-22 incident led to a Best Practices review of aircraft design and evaluation. One element of the findings dealt with the evaluation process, which was characterised as not including high-gain, closed-loop tasks of the sort that would most likely uncover the PIO sensitivity of that configuration. The reason for the lack of such a test was that no requirement existed for it. As a result, the following set of demonstration manoeuvres has been incorporated into the Notice of Change to MIL-STD-1797A [Anon, 1995]:

- Air-to-Air Tracking;
- Offset, Precision Landing;
- Aerial Refueling;
- Air-to-Ground Tracking;
- Capture Tasks; and
- Take-off.

Although MIL-STD-1797 has since been eliminated as a binding requirement, the set of manoeuvres is seen as an excellent start on a standardised evaluation methodology. One conclusion of that effort is that in order for pilot-in-the-loop testing to be performed to a consistent standard of judgement, the manoeuvres and their definitions must be specified prior to procurement and that the following should be met:

*Coverage of all levels of manoeuvre amplitude.* Most of the requirements of MIL-STD-1797A, and most of the flying qualities tasks in use today, are written in terms of linear characteristics and have been taken to imply small-amplitude control. Many basic problems endemic to modern aircraft will typically be exposed by such tasks. There is, however, a need to assure that the moderate- and large-amplitude characteristics of current and future aircraft are also satisfactory. While there are some such requirements (dealing with, for example, control force per g, time to roll through a specified bank angle, etc.), there is a shortage of tasks that emphasise manoeuvring at elevated load factors or that involve g capture or large rolling manoeuvres. These types of tasks will be especially challenging in defining performance criteria that are both meaningful and measurable.

*Adaptability to all aircraft classes, response-types, and levels of visual cues.* A common criticism of the current MIL-STD-1797A is that it has a “fighter bias” since almost all of the quantitative criteria were developed for, and apply primarily to, fighters. It is also true that most flying qualities research is oriented towards high-performance aircraft. There have been steps taken to remedy this situation, including development of pitch attitude and flight-path response requirements for transports. The demonstration manoeuvres must also reflect all classes of aircraft. In some cases, of course, the specific mission task element relates to a specific class of aircraft; for example, tracking a manoeuvring target would not be expected to apply to transports. On the other hand, some tasks may apply to all classes, including not only the obvious, such as landing, but also the less apparent, such as in-flight refueling as the receiver.

### 5.1.3.3 Use as a Design Tool

There is an ongoing debate concerning the best method for specifying demonstration manoeuvres, either in the flying qualities design guidelines, the Air Vehicle Guide Spec or in a separate flight test document. On one hand, they can take on a life of their own, and some may assume (incorrectly) that the flight test manoeuvres are *always* the final answer, no matter what the analytical criteria may say. They also may be ignored. The manoeuvres should be on a par with the analytical requirements. Current applications identify a complete demonstration manoeuvre set in the design guidelines and a reduced set in the Guide Spec.

The following recommendations are for use within the design group in order to assess early versions of control laws and search out problem areas as the development proceeds. First, batch manoeuvres should be

used to stress the initial flight control system design well before the simulation is available [see, e.g. Onstott and Faulkner]. It is also suggested that the recommended manoeuvres should be exercised before a customer flies the simulation, and is based on a strong recommendation that it is wise to be aggressive in looking for problems with each version throughout the development process.

Demonstration manoeuvres have a place in every phase of aircraft development. In the conceptual stages, they can be used to check control power requirements and flight envelope definitions. They can be used in design trades involving performance levels, weights and inertias, actuation performance requirements, and control surface sizing and placement. Early simulations of the flight control system can be evaluated using these manoeuvres. Of course, the final evaluation in flight test must include demonstration manoeuvres. This last set of manoeuvres is suggested in the Mil-Standard for Flying Qualities, Mil-Std 1797A, and includes a full range of tasks and conditions to be tested. What is needed for the early stages of development is a necessary and sufficient subset of these manoeuvres that can identify problem areas and give confidence in the ability to achieve Level 1 flying qualities. While a universal set of manoeuvres is not apparent, a process can be suggested by which each programme can define those manoeuvres needed for its particular missions. This process should be implemented by the full design working group {BP10.2}, including the procuring agency, the user, the prime designers and all subcontractors, with the intent to uncover problems early in order to avoid costly and inefficient fixes later in the programme {BP6.3}.

The first set of manoeuvres is considered to be required of all flight vehicles as they examine the basic closed-loop tasks common to all missions. The main purpose is to find representative stressing manoeuvres and conditions that are appropriate for the vehicle being procured. The manoeuvres should represent the types of tasks expected of the vehicle, such as tight air-to-air tracking, flight path control or disturbance rejection. The conditions should be extreme for the mission of the aircraft. The urgency of the task as expected in operational use should be reflected in the definition of adequate and desired performance. Since these are manoeuvres to give confidence in the flying qualities of the vehicle, designing them beyond the expected limits to show some margin is not unreasonable. The thought is that if pilots can do these tasks, all other tasks can be done with equal or better performance and equal or less workload. Suggested manoeuvres are:

Gross acquisition – large amplitude manoeuvres that are highly dynamic and may produce coupling among the various axes and subsystems. Calls for aggressive initiation and checking of the manoeuvre. Use for each axis individually and in multi-axis tasks to look for problems with, or even loss of, control or conditions which may exceed aircraft limits. Success is being able to complete the task with satisfactory performance and acceptable workload. Once the acquisition tasks can be completed, they should be used as a lead into the following manoeuvres.

Fine tracking – Target tracking techniques are appropriate as a stress test for most aircraft. Tracking a manoeuvring target [see Twisdale and Franklin] emphasizes the pointing and attitude control aspects of the FCS. An alternative is a random variation of fixed targets [see Shafer et al] which puts more emphasis on flightpath control and may be used for configurations which have a ground-attack mission. The performance criteria must be established to require overly aggressive pilot inputs to uncover problem areas. Success is tracking with satisfactory performance and acceptable workload.

Offset landings – at least a 150-foot offset laterally and 50-foot vertically, corrected at 150 feet AGL. Perform in calm conditions and atmospheric conditions representative of the worst imaginable case. Success is being able to land within desired performance and minimal workload in calm air. In the extreme atmospheric conditions, success is redefined as being able to control flight path with pilot ratings and comments in accordance with the allowable degradations for atmospheric disturbances of MIL-F-8785C and MIL-STD-1979A.

Close formation or in-flight refueling – a pure flight path control test. Success is being able to complete the task with satisfactory performance and acceptable workload.

For the STOL/Maneuver Technology Demonstration programme development of up and away control laws, a very aggressive fine tracking was chosen as the stressing manoeuvre, much like the traditional



interpretation of Handling Qualities During Tracking [Twisdale and Franklin]. It was appropriate because the decision was made to design the control laws for air combat use. It is of interest to note that the initial HQDT simulation indicated pitch axis deficiencies that were corrected as discussed in Chapter 3.5.1. The next simulation, however, now received adverse pilot comments about the lateral/directional axes. The lateral/directional modifications are also presented in Chapter 3.5.1. A third simulation verified the control law design was satisfactory, and the design was finally validated in flight test as Level 1. This tracking technique also worked well when evaluating changes in the landing configuration. This was appropriate because of the high level of landing precision called for by the programme requirements. Other vehicles have had similar single manoeuvres that exposed problems well.

Since problems are not known *a priori*, however, it is difficult if not impossible to guarantee that one or two manoeuvres per programme are sufficient. A second set of manoeuvres is suggested to assure that the combination of vehicle, control system and pilot do not include regions of unsafe flight. The following tasks are suggested in order to demonstrate freedom from loss of control. The manoeuvres should be performed at the most stressing points in the envelope for each axis and parameter of interest. Again, the intent of this set of manoeuvres is satisfied only by actively looking for problem areas.

Aggravated Departure Control Inputs – evaluates departure resistance. Sustained cross-coupled inputs are a must. For aircraft with carefree manoeuvring, this type of task is mandatory to validate the limits and success is the maintenance of control. For aircraft not designed for carefree manoeuvring, success is finding a consistent departure characteristic and a reliable, straightforward recovery method.

Take-off – brake release to stabilized positive flight path. Success is clearance of a fifty-foot obstacle with various combinations of wind, turbulence and gusts and appropriate pilot ratings and comments.

Special Modes – any special modes such as automatic ground collision avoidance should be represented in the manoeuvre set. Success is showing the special modes do not interfere with the other manoeuvres while satisfying their own intent.

Since the demonstration manoeuvres are a primary means of communication among the various aircraft design disciplines, it is imperative that they be described in clear terms. The following format from is suggested [see Klyde] as an efficient way to achieve that communication.

#### **5.1.3.4 Example Demonstration Manoeuvre Format**

Simulated Aerial Refueling. This description is based on the task using a T-39 (or any appropriate aircraft) as the simulated tanker aircraft [see Skeen]. A reference box was drawn on the underside of the T-39 to give the evaluation pilot a reference for his placement with respect to proper refueling position. The important part of this example comes not from the specific details of the manoeuvre, but rather from the level of detail which is presented.

##### Objectives

Check ability to precisely control flightpath and airspeed. Check control sensitivity for small inputs.

##### Description

Level Flight Test Trail: The target stabilises at  $20,000 \pm 1,000$  feet pressure altitude and  $300 \pm 20$  KCAS with the test aircraft in the test trail position (i.e., 10 feet aft and 10 feet below the target aircraft). Attempt to track the target using operationally representative control inputs. Continue the manoeuvre until you are confident in providing a handling qualities rating (HQR) using the desired and adequate performance criteria defined below.

##### Desired Performance

Maintain tip of ventral antenna of the T-39 inside the 1.0 by 6.5-inch inner reference box. If run with a 10-foot lateral offset, obtain the test trail desired criteria with no more than one overshoot. Magnitude of the overshoot remains within the desired region.

### Adequate Performance

Maintain tip of ventral antenna of the T-39 inside the 3.0 by 9.0-inch outer reference box. If run with a 10-foot lateral offset, obtain the test trail adequate criteria with no more than one overshoot. Magnitude of the overshoot remains within the adequate region.

### Variations

30° Bank Angle Test Trail: The target stabilises in a 30° bank at  $20,000 \pm 1,000$  feet pressure altitude and  $300 \pm 20$  KCAS with the test aircraft in the test trail position (i.e., 10-feet aft and 10-feet below the target aircraft). Attempt to track the target using operationally representative control inputs. Continue the manoeuvre until you are confident in providing a handling qualities rating (HQR) using the desired and adequate performance criteria.

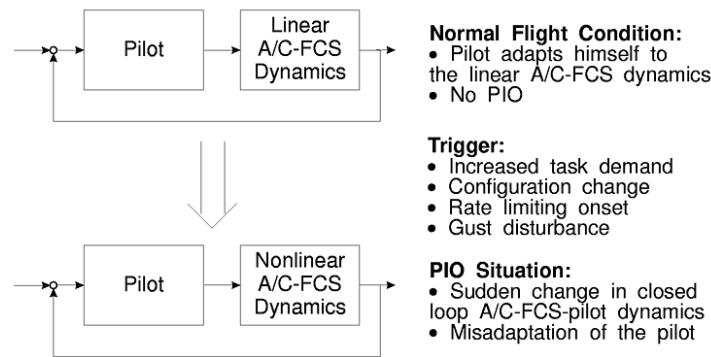
Lateral Offset to Level Flight Test Trail: The target stabilises at  $20,000 \pm 1,000$  feet pressure altitude and  $300 \pm 20$  KCAS with the test aircraft in the test trail position (i.e., 10-feet aft and 10-feet below the target aircraft). Offset 10 foot laterally and attempt to re-acquire the test trail position. Then attempt to track the target using operationally representative control inputs. Continue the manoeuvre until you are confident in providing a handling qualities rating (HQR) using the desired and adequate performance criteria.

## **5.2 DISCUSSION OF PIO CRITERIA**

The introduction of digital fly-by-wire flight control systems has increased the potential for adverse interactions between the human pilot and the aircraft dynamics. In the past, these phenomena have been called *Pilot-Induced Oscillations* (PIO). But this expression by implication blames the pilot, while it is generally accepted that such oscillations are not due to pilot failure. Therefore, it was recommended to use the term *Aircraft-Pilot Coupling* (APC) [McKay, 1994]. Recently a new classification was introduced considering PIO to be a certain subclass of APC. PIO (now called Pilot-In-the-Loop Oscillations or Pilot Involved Oscillations to avoid the implication above) are defined as oscillatory APC events [McRuer, 1997]. This classification is consistent with the definitions from MIL-F-8785C [Anon., 1980] and MIL-STD-1797 [Anon., 1990]:

*PIOs are sustained or uncontrollable oscillations resulting from the efforts of the pilot to control the aircraft.*

A review of historical incidents/accidents clarified that severe PIO are sudden and unexpected [McKay, 1994]. Just moments before the sudden onset of severe PIO, the aircraft is docile and easily controllable, which is commonly described by the *flying qualities cliff* metaphor, see Figure 5.2.1. The main three elements of a PIO have been identified to be the aircraft, the pilot and the trigger. In this context the aircraft is represented by the dynamics of the complete system including the bare aircraft, flight control system, actuators, sensors, hardware filters, etc. It is assumed that the pilot adapts/optimises his behaviour with respect to the effective aircraft dynamics during a closed-loop task, such as landing in severe turbulence or aerial refuelling. The trigger can have different forms, for example a non-linear effect in the flight control system, a transition in the pilot behavioural pattern, or atmospheric turbulence, but it always causes a sudden change in the closed-loop dynamics of the aircraft-pilot system. It is assumed that the human pilot is not able to adapt his control behaviour (e.g. pilot gain) to the new dynamic characteristics (e.g. non-linear aircraft) immediately, therefore, the sudden change in the effective system dynamics leads to a misadaptation of the human pilot. However, PIO is not considered to be a pilot failure!



**Figure 5.2.1: Understanding PIO (the flying qualities cliff)**

This discussion indicates that the cause for PIO is characterised by a rich variety of highly diverse phenomena in terms of effective aircraft dynamics and pilot behavioral modes. To facilitate a clearer understanding of PIO through a systematic study, a classification was recently introduced [Klyde, et al, 1995]:

Category I PIO is the well known linear phenomenon characterised by excessive lags and delays. The other two categories involve non-linear behaviour. The distinction between Category II and III PIO is due to the experience that rate limiting is the dominating non-linear effect in modern flight control systems triggering PIO, and therefore a separate study of this kind of non-linear behaviour is called for. Further, by isolating this very specific behaviour it can be possible to obtain criteria for PIO prediction more easily.

Flying qualities criteria have been developed over a long period of time using ground-based and in-flight simulators and experimental, prototype and operational aircraft. Some of these criteria are also suitable to address PIO. The criteria have been validated by means of special flying qualities research programs, in which different effective aircraft dynamics have been evaluated by piloted simulations with flying and ground-based experimental facilities. But, the vast majority of the available experiments deals with linear effects in the flight control system, such as the Neal-Smith database [Neal and Smith, 1970], LAHOS [Smith, 1978], HAVE PIO [Bjorkman, 1986], HAVE CONTROL [Lindsey, 1989], etc. Recently new test programs were conducted dealing with rate limiting effects in flight control systems, such as SCARLET [Martin and Buchholz, 1995] the HAVE LIMIT [Kish, et al, 1997] research flight test programs and a Boeing study on APC [Nelson and Landes, 1996] and the flight simulator experiments on PIO due to rate saturation [Duda and Duus, 1997].

The discussion of PIO criteria and analysis techniques presented below is separated with respect to the three PIO categories according to Table 5.2.1.

**Table 5.2.1: PIO categories**

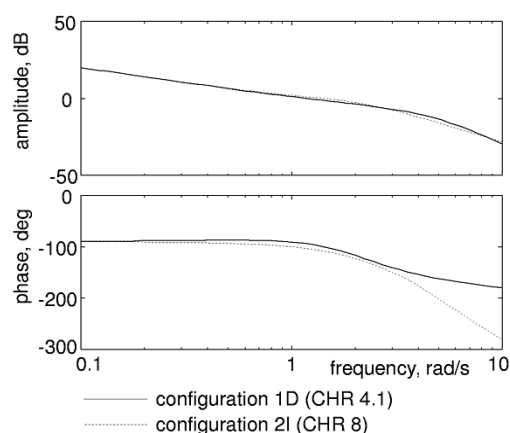
Category I:	Essential linear pilot-vehicle system oscillations.
Category II:	Quasi-linear pilot-vehicle system oscillations with rate or position limiting.
Category III:	Essential non-linear pilot-vehicle system oscillations, such as multiple non-linearities, transitions in pilot behaviour, etc.

One important thing should be mentioned here on the *objective these criteria should be used for*: the following criteria should be *used during the design process* in order to predict and thus prevent the possibility of occurrence of PIO in flight. They should *not to be intended as a post-PIO analysis tool*, to be used to understand why a PIO occurred. Indeed the occurrence of a PIO in flight would imply that the criteria have already failed in their objective to prevent such a problem.

## 5.2.1 Category I PIO

These kinds of oscillations are characterised by essentially linear aircraft-pilot interactions. The dynamics of the augmented linear aircraft have been found to be the key factor for these problems. This finding might at first seem astonishing, since the introduction of full-authority fly-by-wire systems allows the designers to provide reasonable short period characteristics, such as frequency and damping. But, the problem area has moved towards another direction, which can be characterised by the effective aircraft time delay. The effective time delay results from the latency within the electronic flight control system due to computer frame time, sampling rate, filters, actuators (not rate limiting) and sensors. All these effects lead to a *high-frequency phase roll-off* of the attitude frequency response, which can be regarded as the key cause of Category I PIO. In this context, *high frequency* refers to the region around neutral stability  $w_{180}$ , the frequency corresponding to 180° phase lag.

Figure 5.2.2 presents the effects of the high frequency phase roll-off by means of two configurations from the Neal-Smith database [Neal and Smith, 1970]. The configurations have very similar characteristics in the low frequency range, but configuration 2I is characterised by a significantly higher phase gradient in the higher frequency range (in this case, above 3 rad/sec). Hence, it was rated significantly worse by the pilots.



**Figure 5.2.2: Influence of the high frequency phase roll-off on the pilot rating (Neal-Smith database)**

It is obvious that a successful Category I PIO criterion must address the high-frequency phase roll-off. In the following, several PIO criteria are reviewed. The statements given in that review are clarified by means of evaluating three of the well-known PIO databases for the landing task presented in Table 5.2.2.

**Table 5.2.2: Landing databases (NT-33 flight test programs)**

LAHOS	Landing Approach High Order System: Influence of high order effects on landing and approach flying qualities, 49 configurations, 1978 [Smith, R.E., 1978]
HAVE PIO	PIO investigations during landing, 18 configurations, 1986 [Bjorkman, 1986]
HAVE CONTROL	PIO investigations during landing, 12 configurations, 1989 [Lindsey, 1989]

Finally, the criteria are discussed regarding their effectiveness of Category I PIO prediction, the gaps in the criteria are identified, and their applicability to the roll axis is discussed.

### 5.2.1.1 Description of PIO Criteria

Within the *jungle* of flying qualities criteria, a group of frequency domain PIO criteria has been established. The most prominent Category I PIO prediction criteria are the following:

- 1) Neal-Smith [Neal and Smith, 1971]
- 2) Bandwidth/phase delay [Hoh, et al, 1994]
- 3) Smith-Geddes [Smith, 1977 and 1994]; [Smith and Geddes, 1978]

- 4) Phase Rate Criterion and Gain Phase Template [Gibson, 1982, 1990 and 1994]
- 5) Gibson frequency domain Criterion [Gibson, 1982]
- 6) Robust Stability Analysis [Anderson and Page, 1994]
- 7) Gibson Time Domain Dropback [Gibson, 1982] and [Mooij, 1988]
- 8) Updated Dropback criterion by Mitchell and Hoh [Mitchell, et al., 1994<sup>a</sup>]
- 9) Bode Gain Template by Hess and Kalteis [Hess and Kalteis, 1991]
- 10) Power Spectral Density Analysis of the Pilot Structural Model [Hess, 1997<sup>a,b,c</sup>]

All these criteria address stability aspects of closed-loop aircraft-pilot systems. Some criteria define a pilot model and use it for the analysis of the closed-loop system; the Neal-Smith, Smith-Geddes, Robust Stability Analysis, and the two Hess criteria are of this kind. The other criteria only use the open-loop aircraft with no direct model of the pilot. Implicit inclusion of the pilot is obtained by plotting some parameters of the aircraft model onto plots where boundaries of PIO proneness/safety have been derived from the analysis of the parameters of configurations whose PIO properties were known from piloted tests. The bandwidth/phase delay, phase rate, dropback and Phase Gain template criteria do not use an explicit pilot model.

All the “Gibson criteria” discussed were developed as design guidelines for good handling and to ensure freedom from PIO. They are not primarily intended to be general tools for analysing PIO events, but to draw attention to those features of the response dynamics that must be avoided in design, so that designers can specifically shape the piloted response into ideal areas that will ensure the absence of PIO [Gibson, 1999].

In the past, a great number of research programs have been carried out in order to derive and evaluate these criteria. Therefore, it can be stated that a great knowledge base is available. The major research effort in the past has been on deriving criteria for the pitch axis, due to the maximum importance of stability and control in this axis for the safe operation of the aircraft. Open questions are mainly concerning the applicability to the roll axis (the criteria were originally developed for the pitch axis) and validated boundaries for the steady state gain of the transfer functions from stick force to roll or pitch attitude. Also the applicability of the criteria to fly-by-wire transport aircraft has recently been discussed, [Nelson and Landes, 1996].

For the application of these criteria, the pitch attitude frequency response is required. The criteria can be considered as design guidelines, but they are applicable to flight test data as well. In the following pages a quantitative evaluation of the different PIO prediction criteria is presented, to complement the description of the methods. The evaluation is based on the use of the following table, where the number of cases predicted to be PIO prone/free is compared to the actual number of flight test PIO, and PIOR is the PIO rating provided by the pilot. The three pitch axis PIO databases of Table 5.2.2 will be used.

**Table 5.2.3: Evaluation of PIO prediction**

Number of cases		Flight test PIO (Mean PIOR>2)	
		NO PIO	PIO
PIO prediction by the analysed criterion	NO PIO	(B)	(A)
	PIO	(C)	(D)

From the numbers in the table it is possible to evaluate the effectiveness of the PIO criteria in predicting PIO, according to different effectiveness measures. Two indices of effectiveness proposed in [Mitchell, et al., 1994<sup>a</sup>] are the global success rate, i.e. the percentage of cases which are correctly predicted to be PIO free or prone, and an index of non-conservatism, i.e. the percentage of cases predicted PIO prone which have actually undergone PIO in reality with respect to the total number of predicted PIO prone cases:

$$I1) \text{ Global success rate} = (B+D)/(A+B+C+D)$$

$$I2) \text{ Non-conservatism index} = D/(C+D)$$

A further significant index of effectiveness, introduced in [Scala, et al., 1999], is the percentage of flight test PIO which are predicted by the criterion with respect to the total number of flight test PIO cases.

I3) Safety index =  $D/(A+D)$

The aim is to maximise this measure, since failing to identify cases which can produce PIO can lead to very dangerous situations.

It is interesting to note that index I2 highlights the conservatism of the method (the higher the index the less conservative is the method), i.e. what is the probability that a configuration which has been identified as PIO prone by this method will actually develop a PIO in flight, while index I3 highlights how safe is the use of the method, i.e. what is the probability that PIO prone configurations are identified by the method.

### 1) Neal-Smith Criterion

The Neal-Smith closed-loop criterion was originally developed for highly augmented fighter aircraft performing precision pitch attitude tracking tasks [Neal and Smith, 1971]. It includes a simple pilot model containing a gain, lead/lag compensation and a time delay. The pilot model is defined using a certain performance standard or degree of aggressiveness of the pilot, which is characterised by the bandwidth frequency  $\omega_{bw}$ . The parameters of the pilot model must be adjusted so that the closed-loop frequency response satisfies the following requirements:

- the aircraft-pilot phase angle at the bandwidth frequency must be -90 deg.
- the low frequency amplitude droop must be less than -3 dB.

The application of the criterion consists of the following steps:

1. Specify the bandwidth appropriate for the task:

$$\text{Category A flight phases:} \quad \omega_{bw} = 3.5 \frac{\text{rad}}{\text{sec}}$$

$$\text{Category B and C flight phases:} \quad \omega_{bw} = 1.5 \frac{\text{rad}}{\text{sec}}$$

$$\text{Category C - Landing:} \quad \omega_{bw} = 2.5 \frac{\text{rad}}{\text{sec}}$$

2. Adjust the pilot model parameters to meet the performance standard defined by the bandwidth frequency  $\omega_{bw}$  using a fixed pilot model time delay (0.3 sec).
3. Determine the pilot phase compensation and closed-loop resonance and compare to the proposed flying qualities boundaries.

The bandwidth  $\omega_{bw}$  influences the criterion results tremendously. Increasing the required bandwidth  $\omega_{bw}$  causes a higher pilot phase compensation and a higher closed-loop resonance. It has been shown that the required value of  $\omega_{bw} = 3.5$  rad/s for Category A flight phases seems to be too demanding, therefore, it is often difficult to reach the Level 1 area [Koehler, 1996]. This high bandwidth requirement leads to some conservatism of the Neal-Smith criterion.

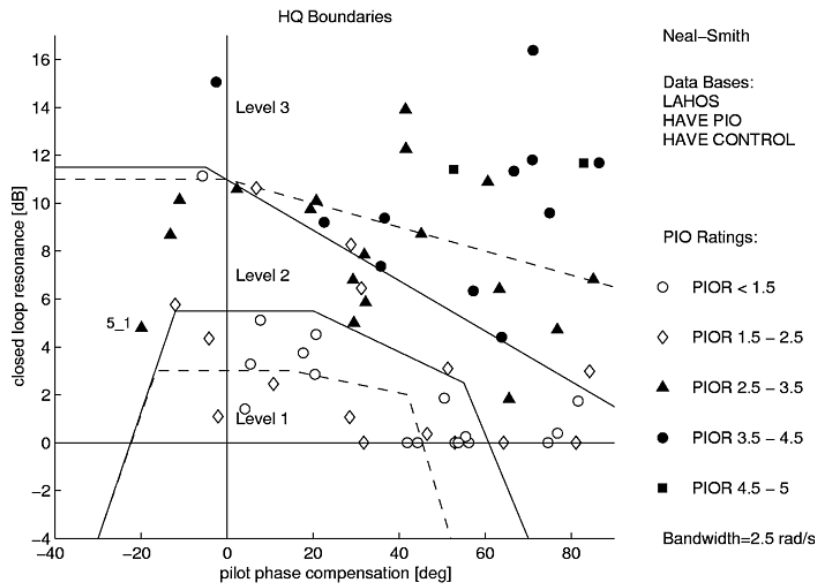
The Neal-Smith criterion was extended to the approach and landing task using the databases presented in Table 5.2.2. New flying qualities boundaries have been proposed, providing an impressive correlation between the predictions by the criterion and the Cooper Harper ratings (CHRs) of about 90% [Höhne, 1997].

Figure 5.2.3 presents the evaluation of the Neal-Smith criterion with the three databases presented in Table 5.2.2 clarifying the correlation between the criterion parameters and PIO ratings obtained within the experiments. It appears that the modified Neal-Smith boundaries are well suited to predict PIO during landing. The PIO rating of a configuration is very likely to be less than 2.5 if the criterion parameters are located within the Level 1 area. One specific configuration is considered more in detail in order to show the

capability to predict bobble tendencies, too: LAHOS configuration 5\_1, which is marked in the figure. This configuration was rated with PIOR 3 after two runs with the following typical pilot comments:

*Tendency to bobble, low frequency PIO during landing.*

The Neal-Smith criterion correctly poses this configuration in the Level 2 area.



**Figure 5.2.3: Application of the Neal-Smith criterion to the landing databases LAHOS, HAVE PIO, HAVE CONTROL. Dashed: original boundaries cat. A; solid: new boundaries for landing.**

**Table 5.2.4: PIO prediction with the Neal-Smith criterion**

Number of cases		Flight test PIO (Mean PIOR>2)	
		NO PIO	PIO
PIO prediction by Neal Smith	NO PIO	6 (B)	1 (A)
	PIO	24 (C)	36 (D)

From the numbers in the table it is possible to evaluate the values of the three effectiveness indices introduced above:

- I1) Global success rate  $((B+D)/(A+B+C+D)) = 42/67 = 63\%$
- I2) Non-conservatism index  $(D/(C+D)) = 36/60 = 60\%$
- I3) Safety index  $(D/(A+D)) = 36/37 = 97\%$

**2) Bandwidth/Phase Delay Criterion**

The bandwidth/phase delay criterion was developed using the Neal-Smith database for Category A flight phases and the LAHOS database for Category C flight phase [Hoh and Hodgkinson, 1982]. Bandwidth is indicative of the highest frequency at which the aircraft-pilot loop can be closed without threatening stability. Physically, the bandwidth is a measure of the frequency below which the aircraft can follow all pilot commands, and above which it cannot. For the determination of the bandwidth  $\omega_{bw}$  a frequency domain metric based on the aircraft attitude transfer function was defined: the bandwidth  $\omega_{bw}$  is the frequency at which the phase margin is  $45^\circ$  or the gain margin is 6 dB, whichever frequency is lower [Hoh and Hodgkinson, 1982]. The second criterion parameter is the phase delay  $\tau_p$ , which represents a measure

of the phase angle shape at frequencies above the bandwidth. For its calculation the following equation is used:

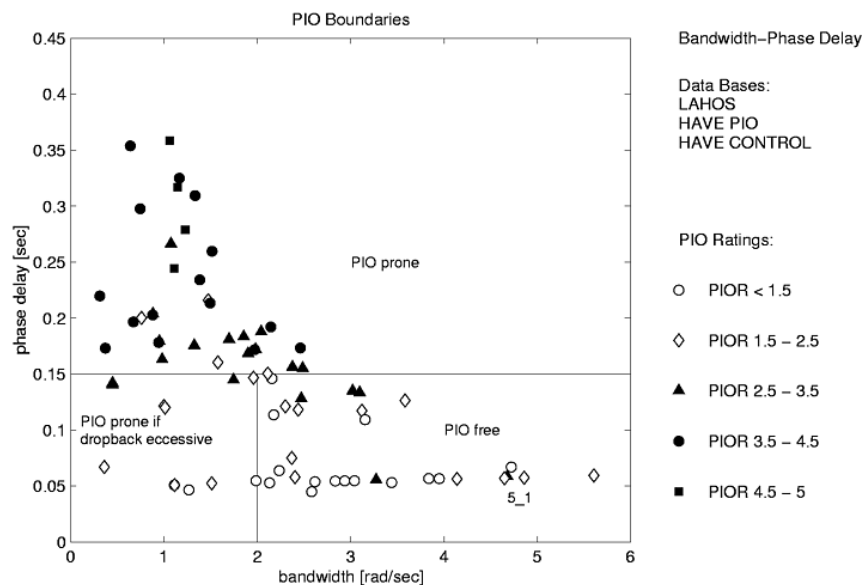
$$\tau_p = -\frac{\Phi(2\omega_{180}) - \Phi(\omega_{180})}{2\omega_{180}} \frac{\pi}{180} \text{ [s]}$$

Physically, the phase delay parameter  $\tau_p$  can be considered as an equivalent time delay of a highly augmented aircraft.

The bandwidth/phase delay criterion was updated recently with respect to the effects of flight path bandwidth and pitch rate overshoot, based on the dropback parameter [Mitchell, et al, 1994<sup>a</sup>]. However, the phase delay parameter  $\tau_p$  is the dominating indicator in view of PIO prediction. The following metric was defined:

1. The aircraft is PIO prone, if the phase delay parameter  $\tau_p \geq 0.12$  sec for up-and-away flight or  $\tau_p \geq 0.15$  sec for landing.
2. There is a possibility for PIO, if dropback is excessive (no numbers available) and bandwidth  $\omega_{bw} \leq 2$  rad/sec.
3. When  $\omega_{bw} \geq 2$  rad/s and  $\tau_p \leq 0.12$  sec, excessive dropback will result in pitch bobble, but not in a severe PIO.

Figure 5.2.4 presents the evaluation of the bandwidth/phase delay criterion with the three databases presented in Table 5.2.2. An additional point to note is that almost all configurations with bad PIOR below the 0.15 s line are characterised by excessive dropback.



**Figure 5.2.4: Application of the bandwidth/phase delay criterion to the landing databases LAHOS, HAVE PIO, HAVE CONTROL**

The bandwidth/phase delay criterion has also been successfully applied to fly-by-wire helicopters [Hamel, 1996].

In the following table a summary of the results of the application of the criterion to the three landing databases is presented.



**Table 5.2.5: PIO prediction with the bandwidth-phase delay criterion**

Number of cases		Flight test PIO (Mean PIOR>2)	
		NO PIO	PIO
PIO prediction by Bandwidth-Phase Delay	NO PIO	28 (B)	10 (A)
	PIO	4 (C)	34 (D)

The three effectiveness indices are:

- I1) Global success rate  $((B+D)/(A+B+C+D)) = 62/76 = 82\%$   
 I2) Non-conservatism index  $(D/(C+D)) = 34/38 = 89\%$   
 I3) Safety index  $(D/(A+D)) = 34/44 = 77\%$

### 3) Smith-Geddes Criterion

The Smith-Geddes criterion is based on investigations by Ralph Smith and is sometimes referred to as the *Ralph-Smith Criterion* [Smith, 1977]. Within the theory of Ralph Smith, three types of PIO are considered:

- Type I Initiated by resonance of the closed-loop aircraft-pilot system during attitude tracking. PIO triggered by switching from attitude to normal acceleration control.  
 Type II Initiated by resonant open-loop dynamics, e.g. due to low damping.  
 Type III Initiated by resonance of the closed-loop aircraft-pilot system during attitude tracking, regardless of acceleration dynamics without any switching.

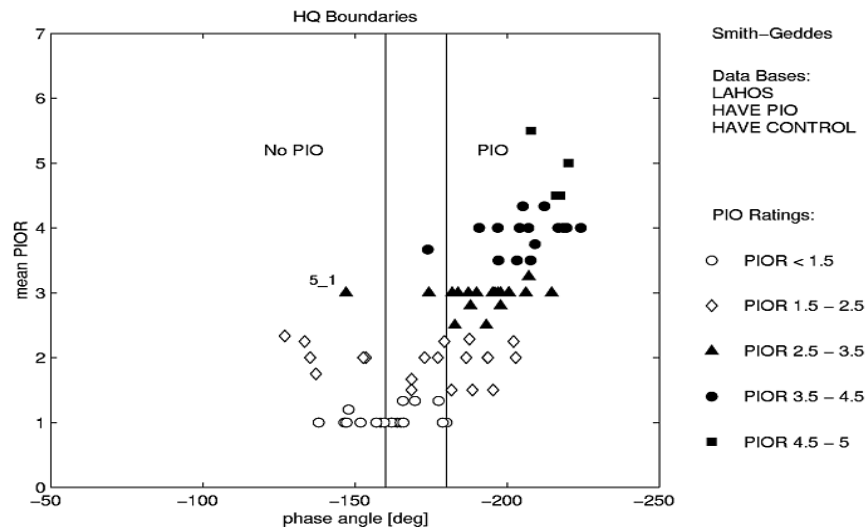
For the application of attitude-dominant type III PIO criteria a very simple formula for the aircraft-pilot crossover frequency  $\omega_c$  has been developed, based on the crossover frequency data of single axis tracking tasks [McRuer, et al, 1965]. It appeared that the crossover frequency is almost completely defined by the amplitude slope of the pitch attitude frequency response, while the phase angle appeared to be a secondary consideration. The crossover criterion frequency  $\omega_{cr}$  is depending on the average slope  $S$  of the aircraft amplitude response in the crossover region:

$$\omega_{cr} = 6.0 + 0.24 S$$

For the application of the attitude dominant Smith-Geddes criterion to the pitch axis, the following steps have to be performed:

1. Determine the slope of pitch attitude to stick force amplitude response  $S$  over the frequency range 1 to 6 rad/s.
2. Calculate the crossover criterion frequency  $\omega_{cr}$  and the criterion phase angle of pitch attitude to stick force frequency response  $\Phi_{cr}$ .
3. The aircraft is type III PIO sensitive if  $\Phi_{cr} < -160^\circ$  and PIO prone if  $\Phi_{cr} < -180^\circ$ .

The Smith-Geddes criterion was validated in the pitch axis using the Neal-Smith database for up-and-away flight [Smith and Geddes, 1978]. Figure 5.2.5 presents the evaluation of the Smith-Geddes criterion with the three databases presented in Table 5.2.2. The criterion can be considered to be effective in detecting PIO prone configurations, since all configurations with a PIOR higher than three are predicted to be PIO prone. But, a large scattering is found in the data, such as some very good configurations (PIOR 1.5) are predicted to be PIO prone. Thus it appears that the Smith-Geddes criterion parameter  $\Phi_{cr}$  alone is not sufficient as a PIO indicator. This is confirmed by the fact that the important influence of the high frequency phase rolloff is not addressed by this criterion.



**Figure 5.2.5: Application of the Smith-Geddes criterion to the landing databases LAHOS, HAVE PIO, HAVE CONTROL**

Investigations based on the HAVE PIO database have shown that the crossover frequency  $\omega_{cr}$  is highly correlated with the frequency of PIO cases that have occurred [McRuer, 1997].

**Table 5.2.6: PIO prediction with the Smith-Geddes criterion**

Number of cases		Flight test PIO (Mean PIOR>2)	
		NO PIO	PIO
PIO prediction by Smith Geddes	NO PIO	24 (B)	7 (A)
	PIO	8 (C)	37 (D)

From the numbers in the table it is possible to evaluate the value of the three effectiveness indices introduced above:

- I1) Global success rate  $((B+D)/(A+B+C+D)) = 61/76 = 80\%$
- I2) Non-conservatism index  $(D/(C+D)) = 37/45 = 82\%$
- I3) Safety index  $(D/(A+D)) = 37/44 = 84\%$

#### 4) Phase Rate Criterion and Gain Phase Template

The phase rate criterion was introduced as a simple design criterion to predict PIO due to high order effects in modern flight control systems [Gibson, 1990]. The phase rate parameter is defined as the gradient of the phase angle with respect to the frequency in the neutral stability region, which means  $180^\circ$  phase delay. Therefore, it is a direct measure of the high frequency phase rolloff. The phase rate parameter has been found empirically to have a strong relationship with the features which tend to promote PIO. A high phase rate appears to negate the efforts by the pilot to break out of a PIO, since any increase in crossover frequency results in a severe loss of phase margin.

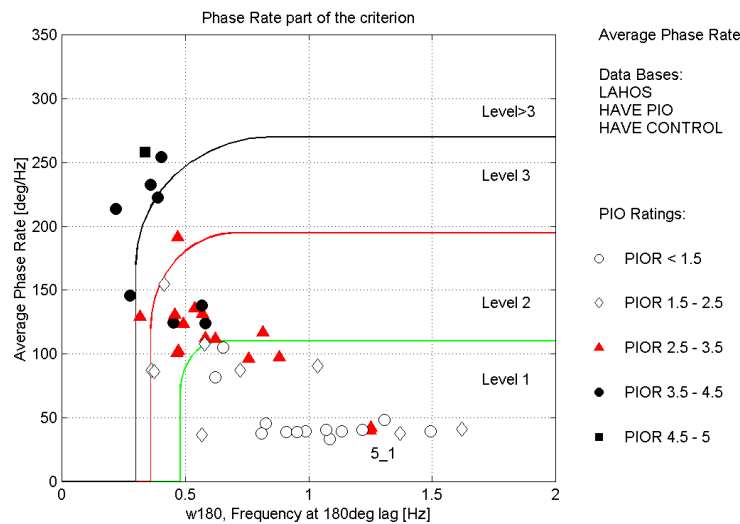
Originally, the phase rate parameter was defined as the local slope of the phase angle around  $180^\circ$  phase delay:

$$PR_{180} = \left. \frac{-d\Phi(\omega)}{d\omega} \right|_{\Phi(\omega)=-180^\circ}$$

More recently the average phase rate is used [Gibson, 1994], where the phase angle slope is determined within a wider frequency range:  $\Delta\omega = 2\omega_{180} - \omega_{180}$ . It is obvious that the average phase rate parameter is directly proportional to the phase delay parameter  $\tau_p$  of the bandwidth criterion (see above). Hence, in this context, the local phase rate is considered in the following discussion. Minor differences exist between the criterion boundaries for local and average phase rate.

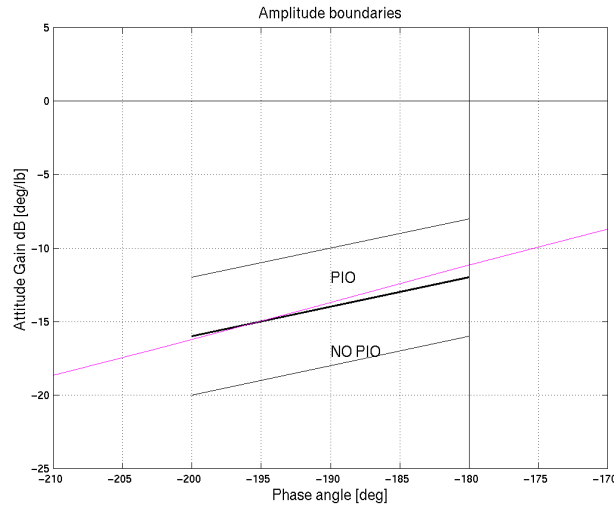
For the evaluation of the criterion, the phase rate parameter  $PR_{180}$  in deg/Hz and the neutral stability frequency  $f_{180}$  in Hz have to be determined from the pitch attitude frequency response.

Figure 5.2.6 presents the evaluation of the phase rate criterion with the three databases presented in Table 5.2.2. The figure indicates that the PIO rating of a configuration is very likely to be less than 2.5 if the criterion parameters are located within the Level 1 area.



**Figure 5.2.6: Application of the phase rate criterion to the landing databases LAHOS, HAVE PIO, HAVE CONTROL**

The first part of the Average Phase Rate (APR) criterion just described is very similar to the Bandwidth/Phase Delay criterion. A second part of the criterion has been proposed [Gibson, 1994<sup>a</sup>] in order to include evaluation of the effect of the actual gain of the aircraft dynamics. This part of the criterion plots the pitch attitude transfer function on a Nichols (gain-phase) diagram with a focus on the “PIO region”, i.e. the area with phases ranging in  $[-200^\circ, -180^\circ]$ . In this area bounds are given both for the gain at  $-180^\circ$  phase and for the slope of the transfer function in the phase range  $[-200^\circ, -180^\circ]$ . Figure 5.2.7 presents the gain-phase template with the prescribed boundaries, including the evaluation of LAHOS configuration 5\_1. It is evident that, contrary to the APR part of the criterion, the gain phase part of the criterion successfully predicts this configuration to be PIO prone. It is worth noting again that the added value of the gain-phase part of the criterion is in the inclusion of a gain driven evaluation criterion.



**Figure 5.2.7: The gain phase template part of the Average Phase Rate criterion, with the evaluation of configuration LAHOS 5\_1**

The results for this criterion are summarised in the following table.

**Table 5.2.7: PIO prediction with Average Phase Rate plus gain-phase template criterion**

Number of cases		Flight test PIO (Mean PIOR>2)	
		NO PIO	PIO
PIO prediction by Phase Rate + gain-phase template	NO PIO	12 (B)	1 (A)
	PIO	20 (C)	43 (D)

The three effectiveness indices are:

I1) Global success rate  $((B+D)/(A+B+C+D)) = 55/76 = 72\%$

I2) Non-conservatism index  $(D/(C+D)) = 43/63 = 68\%$

I3) Safety index  $(D/(A+D)) = 43/44 = 98\%$

It is evident that this criterion is highly effective with respect to the safety point of view (index I3).

### 5) Gibson frequency domain template Criterion

This is a further criterion [Gibson, 1982] for handling qualities evaluation. The analysis is performed by plotting the pitch attitude fixed speed transfer function in the Nichols plane (phase-gain plane) against boundaries derived from a database of configurations with known handling qualities. A relative gain transfer function is plotted, where the attitude gain is scaled so that the  $-120^\circ$  phase angle point lies on the 0dB line. Areas of particular interest for handling qualities behaviour are labelled in the plot. Other than a satisfactory area, also a PIO area and a “pitch bobble” one are indicated on the template. The satisfactory area is centred on a K/s behaviour of the response, by assuming that this kind of response is particularly well behaved.

Since the criterion parameter is the transfer function itself and not some global parameters, this criterion is not suitable to plot a whole set of configurations, because the spread of the graphs on the plot could hide the peculiarities of the singles one. On the other hand looking at the whole transfer function can give more indications than just looking at some global parameters.

In the following table a summary of the results of the application of the Gibson gain-phase template criterion to the three landing databases is presented.

**Table 5.2.8: PIO prediction with Gibson gain-phase template**

Number of cases		Flight test PIO (Mean PIOR>2)	
		NO PIO	PIO
PIO prediction by Gibson freq. domain template	NO PIO	13 (B)	1 (A)
	PIO	19 (C)	43 (D)

From the numbers in the table it is possible to evaluate the value of the three effectiveness indices introduced above:

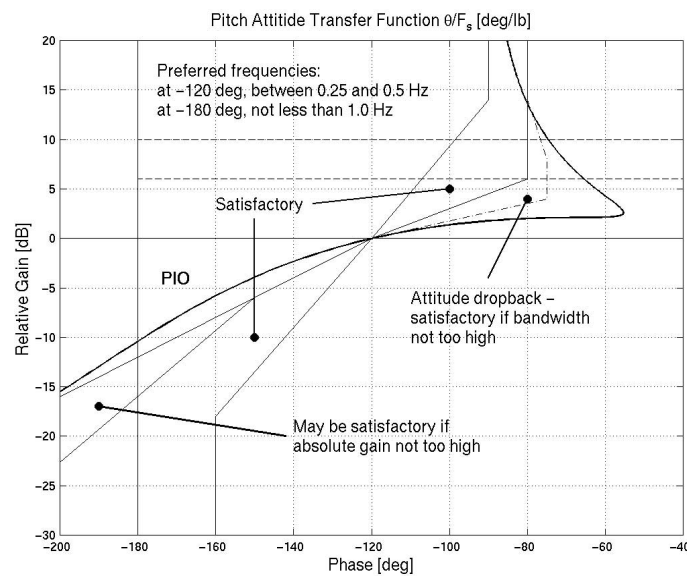
I1) Global success rate  $((B+D)/(A+B+C+D)) = 56/76 = 74\%$

I2) Non-conservatism index  $(D/(C+D)) = 43/62 = 69\%$

I3) Safety index  $(D/(A+D)) = 43/44 = 98\%$

It is evident that also this criterion is highly effective with respect to the safety point of view (index I3).

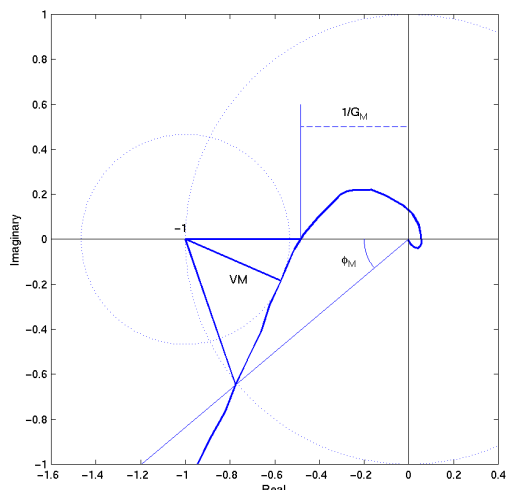
Figure 5.2.8 presents the evaluation of LAHOS configuration 5\_1. The Gibson frequency domain criterion correctly predicts the PIO proneness of this configuration. The transfer functions exits from the prescribed bounds both in the low frequencies region (above 0dB of relative gain), where attitude dropback is predicted, and in the higher frequency region (below 0dB of relative gain), where the PIO region is crossed.

**Figure 5.2.8: Evaluation of the LAHOS configuration 5\_1 by the Gibson gain-phase criterion**

## 6) Robust Stability Analysis

Robust Stability Analysis (RSA) has been first used for PIO prediction in [Anderson and Page, 1995], both with respect to Category I PIO and to Category II PIO. The method basically analyses the robustness of the stability of the pilot-vehicle system, with respect to one or more parameters. The Synchronous Pilot (SP) model (i.e. a simple gain pilot model) and the Modified Optimal Control Model (MOCM) [Davidson, 1992] have been used for investigation. This second model has been proven to best fit the prediction of Category I PIO.

In the case of Category I PIO a Pass/Fail criterion has been proposed, which uses the MOCM and is based on the definition of the vector stability margin. The Vector Margin (VM) is defined in Figure 5.2.9 as the minimum distance of the open loop pilot-vehicle transfer function from the critical point,  $-1+j0$ , in the Nyquist plane.



**Figure 5.2.9: Definition of vector margin VM**

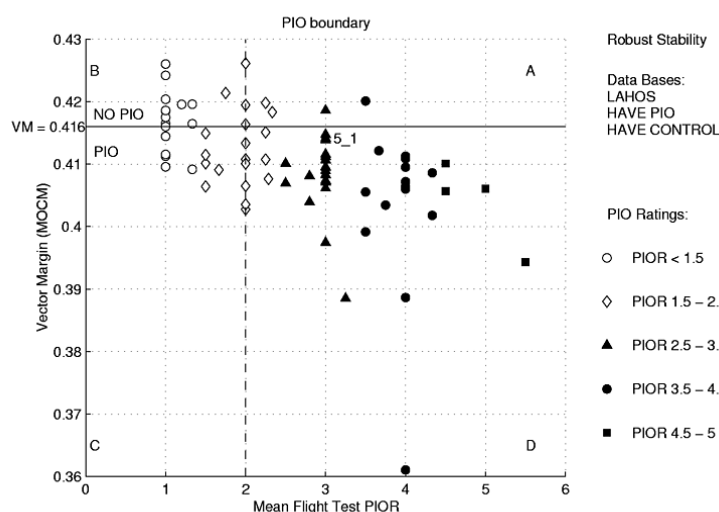
A physical explanation has been given in [Anderson and Page, 1995], which establishes a link between bounds on the Vector Margin and handling qualities levels as predicted by the closed loop resonance peak of the Neal Smith criterion.

The application of the criterion consists of the following steps:

1. Compute the open-loop transfer function between the pilot command and the pitch attitude;
2. Derive a pilot model in the form of MOCM, which is essentially a Kalman filter minimising the pitch attitude error caused by a noise disturbance input;
3. Compute the vector stability margin of the open loop interconnection of the pilot and aircraft models;
4. Check the resulting VM with respect to the prescribed bound.

A bound [Anderson and Page, 1995] for VM is derived from an analysis performed on the HAVE PIO database. For the validation of the criterion, a configuration is *defined* as PIO prone if the mean flight test PIO Rating is greater than 2. The configuration is *predicted* to be PIO prone by the criterion if the VM is less than 0.415, and PIO free if the VM is greater than this value.

The VM criterion has been validated [Scala, et al., 1999] with respect to the other PIO databases, LAHOS and HAVE CONTROL. Figure 5.2.10 presents the result of the VM criterion evaluation for all of the three landing databases.



**Figure 5.2.10: Application of the Vector Margin criterion to the landing databases LAHOS HAVE PIO, HAVE CONTROL**

In the following table the number of cases belonging to each one of the four quadrants A to D of Figure 5.2.10 is reported.

**Table 5.2.9: PIO prediction with Vector Stability Margin**

Number of cases		Flight test PIO (Mean PIOR>2)	
		NO PIO	PIO
PIO prediction by VM:	NO PIO	15 (B)	4 (A)
PIO free for VM>0.416	PIO	17 (C)	40 (D)

The three effectiveness indices are:

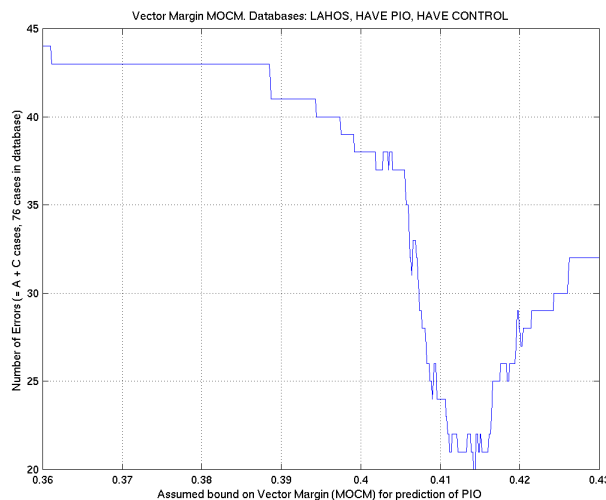
I1) Global success rate  $((B+D)/(A+B+C+D)) = 55/76 = 72\%$

I2) Non-conservatism index  $(D/(C+D)) = 40/57 = 70\%$

I3) Safety index  $(D/(A+D)) = 40/44 = 91\%$

Although the bound proposed in [Anderson and Page, 1995] is practically confirmed also for the LAHOS and HAVE CONTROL databases, in the above calculations a refined bound,  $VM=0.416$ , has been used as the minimum VM for a PIO free configuration. The refinement is suggested by the analysis of Figure 5.2.11. This figure presents the number of errors in predicting PIO (the complement of the global success rate) as a function of the value assumed for the PIO bound on VM. It is evident that the minimum of this error is attained in the range  $VM \in [0.411, 0.416]$ . In this range the number of errors is substantially invariant ( $=21 \pm 1$ ), therefore all the values in the range are equivalent from the point of view of this index, and the upper bound of this range is assumed as the PIO free bound for the VM, since this maximises the safety index I3.

The VM criterion indicates successfully the PIO proneness of LAHOS configuration 5\_1.



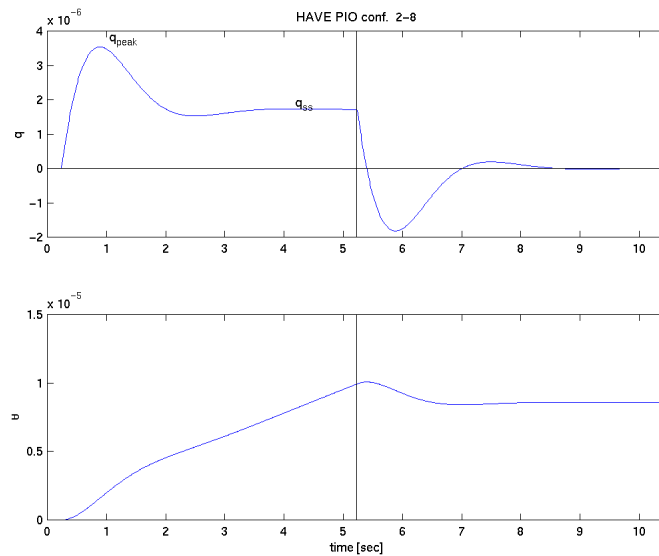
**Figure 5.2.11: Selection of a VM bound for PIO proneness**

### 7) Gibson Time Domain Dropback

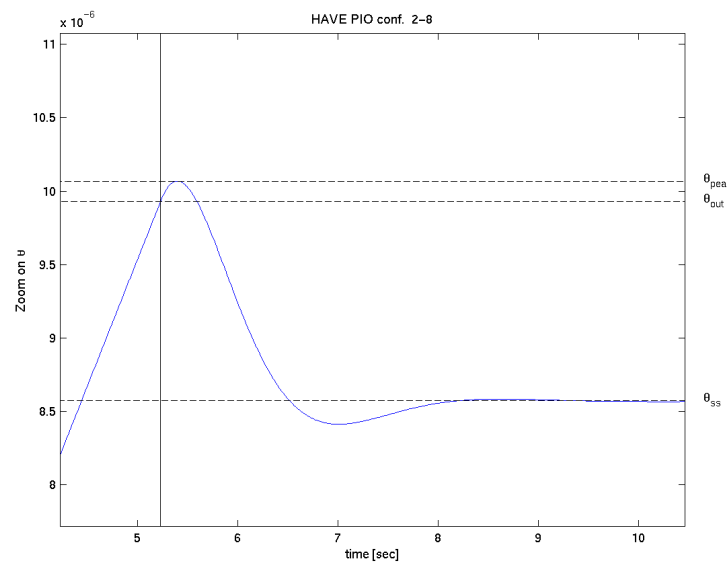
The dropback criterion in its original form was developed as one of a set of design guidelines for highly augmented fighter aircraft [Gibson, 1982]. A subsequent analysis for transport aircraft is reported in [Mooij, 1988].

While excessive dropback can cause so-called “bobble PIO”, this is not a Cat. I PIO as defined earlier with additional phase delay. It is not known ever to have caused worse than Level 2 handling on its own.

The criterion is based on the analysis of the open-loop fixed speed response to a pilot box-car input (i.e. a corrective pilot command on pitch attitude). The parameters involved in the criterion are the peak pitch rate,  $q_{max}$ , and the attitude dropback,  $db$ , normalised to the steady state pitch rate,  $q_{ss}$ , as defined in Figure 5.2.12 and Figure 5.2.13, where the results for the HAVE PIO configuration 2-8 are plotted. Dropback,  $db$ , is computed as the difference between the pitch attitude at the time the stick is released and the steady state attitude after the stick is released,  $db = \theta_{out} - \theta_{ss}$ . A positive value of this difference, as in Figure 5.2.13, is termed dropback, while a negative value, as in Figure 5.2.15, is named overshoot.



**Figure 5.2.12: Pitch rate box-car input used in the definition of Dropback**



**Figure 5.2.13: Definition of Dropback parameter by Gibson**

The criterion is applicable to pitch rate, normal acceleration and angle of attack demand systems, or to any other that results in a steady state pitch rate with the fixed speed assumption.

Regions of typical pilot comments are defined in the criterion plane ( $db/q_{ss}$ ,  $q_{max}/q_{ss}$ ), relating the criterion parameters to response abruptness, sluggishness, bobbling. Negative dropback (also known as overshoot) is an indication of sluggishness, while large positive values of dropback indicate abrupt and bobbling tendencies. Low values of dropback, between 0 and 0.1s, are usually considered good. The



physical explanation of the criterion is that the satisfactory region is associated with predictability of the open-loop attitude response after a corrective pilot command. This region is assumed as the PIO free region.

Figure 5.2.14 presents the evaluation of the Gibson dropback criterion with the three databases presented in Table 5.2.2.

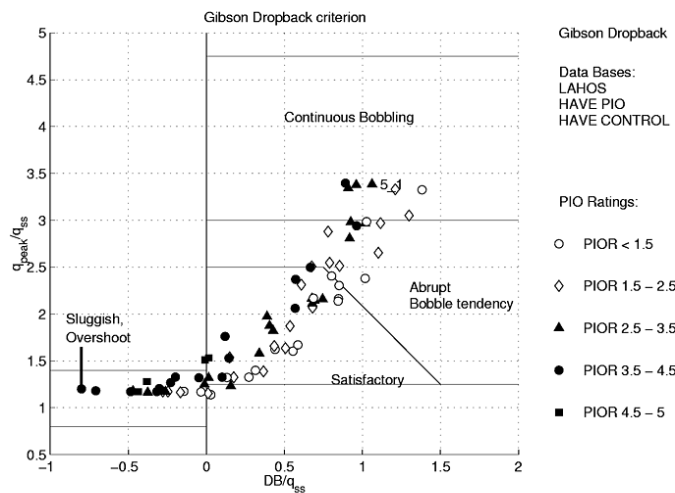


Figure 5.2.14: Application of Gibson Dropback criterion to the landing databases LAHOS, HAVE PIO, HAVE CONTROL

In the following table a summary of the results of the application of the Dropback criterion introduced by Gibson to the three landing databases is presented.

Table 5.2.10: PIO prediction with Gibson dropback criterion

Number of cases		Flight test PIO (Mean PIOR>2)	
		NO PIO	PIO
PIO prediction by	NO PIO	19 (B)	16 (A)
	PIO	13 (C)	28 (D)

The three effectiveness indices are:

I1) Global success rate  $((B+D)/(A+B+C+D)) = 47/76 = 62\%$

I2) Non-conservatism index  $(D/(C+D)) = 28/41 = 68\%$

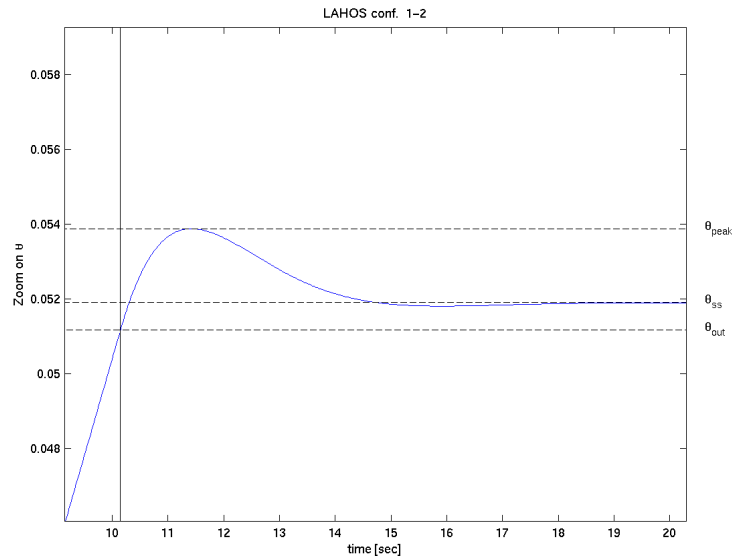
I3) Safety index  $(D/(A+D)) = 28/44 = 64\%$

Note that the majority of the three database PIOs are high order examples to which this criterion is inapplicable.

8) Updated Dropback criterion

This further dropback criterion has been defined [Mitchell, et al. 1994<sup>a</sup>], in order to improve on some shortcomings of the Gibson dropback. In particular it is noted that dropback as defined by Gibson is influenced by time delay, which is separately taken into account in other handling qualities requirements. Therefore the new form of dropback defined in Figure 5.2.15 has been proposed, which is more focused on the mid-frequency range of the attitude response. Pitch attitude dropback,  $db$ , is defined here as the difference between the peak pitch attitude,  $\theta_{peak}$ , and the steady state pitch attitude,  $\theta_{ss}$ , after the stick is released,  $db = \theta_{peak} - \theta_{ss}$ . This eliminates from the dropback parameter the effect of the time delay on the

response. Note also that the newly defined dropback cannot be negative, whereas the Gibson dropback can be negative, as shown for the LAHOS configuration 1-2 in Figure 5.2.15.

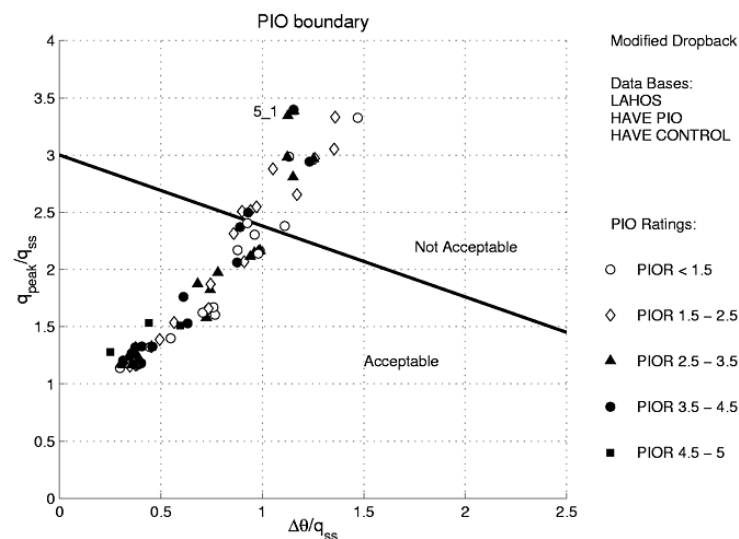


**Figure 5.2.15: Definition of the new dropback parameter [Mitchell, et al., 1994<sup>a</sup>]**

A single boundary is defined in the criterion plane, dividing it into the two regions of *Acceptable dropback* and *Unacceptable dropback*.

According to [Mitchell, et al. 1994<sup>a</sup>] this version of dropback is not to be used as a stand-alone PIO criterion. Instead it must be used to complement the bandwidth criterion, in order to highlight a PIO tendency of configurations with low phase delay and bandwidth.

Figure 5.2.16 presents the evaluation of the new dropback criterion with the three landing databases.



**Figure 5.2.16: Application of the new dropback criterion to the landing databases LAHOS, HAVE PIO, HAVE CONTROL**

The summary of the results is presented in the following table.

**Table 5.2.11: PIO prediction with new dropback criterion**

Number of cases		Flight test PIO (Mean PIOR>2)	
		NO PIO	PIO
PIO prediction with new drop-back by Mitchell	NO PIO	26 (B)	30 (A)
	PIO	6 (C)	14 (D)

The three effectiveness indices are:

I1) Global success rate  $((B+D)/(A+B+C+D)) = 47/76 = 53\%$

I2) Non-conservatism index  $(D/(C+D)) = 14/20 = 70\%$

I3) Safety index  $(D/(A+D)) = 14/44 = 32\%$

### 9) Bode Gain Template

This criterion was proposed [Hess and Kalteis, 1991] as a technique for predicting longitudinal PIO; the HAVE PIO database plus seven of the LAHOS configurations and three further configurations of a high performance aircraft were used for demonstration. The method employs the Optimal Control Model (OCM) of the human pilot for pitch attitude command tracking tasks. In these tasks the pilot is assumed to generate a control input  $\delta(t)$  minimising a weighted sum of mean square tracking error and control rate given by the performance index

$$J = E \left\{ \lim_{\chi \rightarrow \infty} \int_{-\chi}^{\chi} \left[ \theta_e^2(t) / \theta_M^2 + \dot{\delta}^2 / \dot{\delta}_M^2 \right] dt \right\}$$

The analysis is performed by plotting the resulting open-loop pilot-vehicle system (PVS) transfer function in the Bode diagram for amplitudes. A PIO boundary is drawn in this diagram, thus PIO proneness (a PIOR greater than 2.0) is predicted when the PVS transfer function touches or crosses the PIO boundary. The aircraft is PIO free if the PVS transfer function stays above the given boundary.

The PIO boundary is derived from simple considerations on the shape of the closed loop amplitude characteristics of a crossover pilot model, i.e. a model approximating the open loop PVS as

$$Y_P Y_C = \frac{\omega C}{s} e^{-\tau_e s}$$

This model is supposed to be a valid approximation of the true PVS around the crossover frequency.

The core of the method relies on obtaining the appropriate OCM of the pilot. In [Hess and Kalteis, 1991] a technique for choosing the free parameters of the OCM is presented. This technique is based on the results of the analysis of single-axis manual control tasks of simple (low order) dynamic systems. To be applicable also to cases where high order dynamics exist in the augmented aircraft, the authors use a Low Order Equivalent System (2<sup>nd</sup> order LOES, i.e. short period approximation) representation of the vehicle dynamics, so that the higher order high frequency dynamics are taken into account by an equivalent time delay.

The application of the criterion consists of the following steps [Hess and Kalteis, 1991]:

1. Obtain a model of the pitch attitude dynamics of the vehicle at the flight condition of interest. This model should include all control and display system dynamics.

$$\frac{\theta}{\delta}(s) = K \frac{s^{n-1} + a_{n-2}s^{n-2} + \dots + a_1s + a_0}{s^n + b_{n-1}s^{n-1} + \dots + b_1s + b_0}.$$

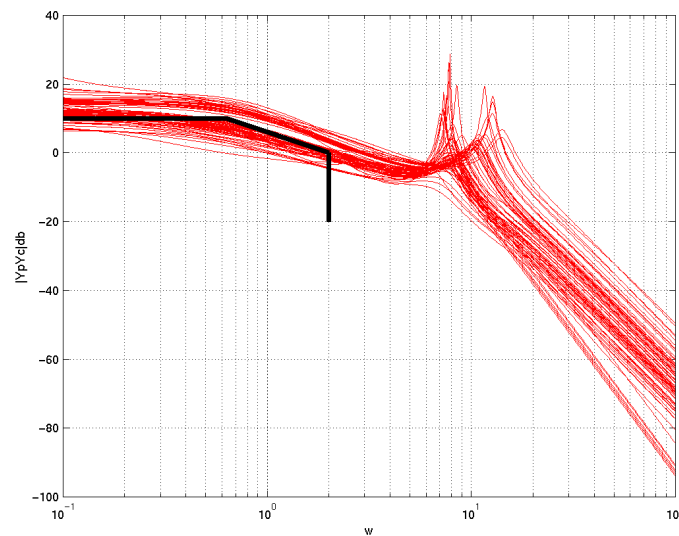
2. Fit this model to the LOES transfer function.
3. Compute the effective time constant  $T=0.65(\tau_p+\tau_D)$ , with pilot delay  $\tau_p=0.2$  s and  $\tau_D$  from the LOES fit.
4. Select an arbitrary  $\dot{\theta}_M$  and compute  $\theta_M$  and  $\delta_M$  according to the following formulae

$$\theta_M = \dot{\theta}_M T$$

$$\delta_M = \frac{1/T^{n-1} + |b_{n-1}|/T^{n-1} + \dots + |b_1| + |b_0|T}{K(1/T^{n-2} + |a_{n-2}|/T^{n-2} + \dots + |a_1| + |a_0|T)} \dot{\theta}_M$$

5. Set up the OCM so that attitude error and error rate are the perceived variables. Set the observation noise-signal ratios to -20dB for each of these. Use -40dB for the motor noise signal ratio. Use a command attitude signal as white noise passed through a second order filter  $1/(s+1)^2$ . The intensity of this noise is arbitrary.
6. Plot the  $Y_P Y_C$  transfer function generated by the OCM and determine if the PIO boundary of Figure 5.2.17 has been violated. If it has not, assume the vehicle is not PIO prone.

Figure 5.2.17 presents the evaluation of the criterion with the three landing databases. The open loop pilot vehicle transfer functions are plotted against the criterion boundary.



**Figure 5.2.17: Application of the Hess-Kalteis criterion to the landing databases LAHOS, HAVE PIO, HAVE CONTROL**

The following table presents the summary of the results.

**Table 5.2.12: PIO prediction with Bode gain template criterion by Hess and Kalteis**

Number of cases		Flight test PIO (Mean PIOR>2)	
		NO PIO	PIO
PIO prediction by Hess-Kalteis	NO PIO	20 (B)	5 (A)
	PIO	12 (C)	39 (D)

The three effectiveness indices are:

- I1) Global success rate  $((B+D)/(A+B+C+D)) = 59/76 = 78\%$
- I2) Non-conservatism index  $(D/(C+D)) = 39/51 = 76\%$
- I3) Safety index  $(D/(A+D)) = 39/44 = 89\%$

### 10) Power Spectral Density Criterion

In a number of recent papers a method to predict handling qualities levels by using a ‘structural’ model of the human pilot [Hess, 1997<sup>a,b,c</sup>]. A PIO rating prediction was added to the method. By defining bounds, this Power Spectral Density (PSD) analysis using pilot structural model can be used as a criterion, to complement the previously described criteria.

Bounds were extracted using LAHOS [Smith, 1978] and TIFS [Berthe, 1984] data and the results appear to be promising. Both databases contain the results of experiments conducted in variable-stability aircraft intended for criterion development for the approach and landing task. However, an argument can be made that the Hess method is applicable to a wide range of aircraft types in up-and-away pitch attitude tracking task as well. This may seem questionable as the underlying data was for landing tasks. It will be shown, however, that one of the key elements in the method is evaluation of the pilot’s control activity. This metric should be within certain limits for any particular flying task for any airplane. Therefore it would seem appropriate to apply this method, although the specific proposed boundaries may not be valid.

#### a) Criterion description

The Hess method makes use of a revised (simplified) structural model of the human pilot as shown in Figure 5.2.18. The distinction between structural models and functional models of human behaviour is common in man-machine engineering [van der Vaart, 1992]. A structural model lays out an explicit, causal mechanism consisting of human perception, decision making and output generation. Functional models relate input and output directly without describing the underlying processes. A well known example of a functional model is the crossover model [McRuer, 1995].

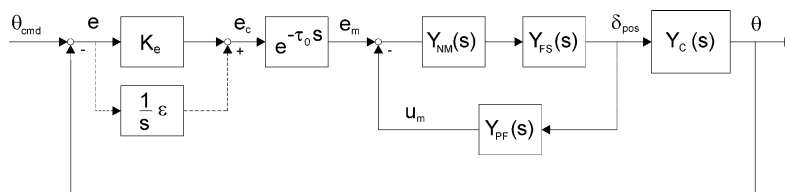


Figure 5.2.18: Pilot-Vehicle System for Hess criterion [Hess, 1997<sup>b</sup>]

The structural model describes compensatory pilot behaviour, i.e. behaviour involving closed-loop tracking in which the visual input is system error. It has been successfully used to explain a number of phenomena in Pilot-Vehicle Systems such as roll ratcheting [Hess, 1997<sup>c</sup>] and the effect of motion cues in vehicular control [Hess, 1989]. A principal assumption is that the resulting Pilot-Vehicle System mimics the crossover model, i.e. (see Figure 5.2.18):

$$Y_p Y_C(j\omega) = \frac{\delta_{pos}}{e}(j\omega) \cdot Y_C(j\omega) \approx \frac{\omega_c}{j\omega} e^{-\tau_e s} \text{ for } \omega \approx \omega_c \quad (5.2.1)$$

In order to achieve this, the pilot is assumed to perform a number of operations on a perceived error signal. The attitude error signal  $e(t)$  is the difference between the commanded attitude and the actual attitude, and passes through normal error sensing and gain compensation  $K_e$ , including the possibility of accomplishing low-frequency trim (or integral) compensation via  $\varepsilon/s$ . In the criterion  $\varepsilon$  is assumed to be zero except under special conditions.

Next, a pure time delay  $\tau_0$  is encountered, representing a central processing delay. The signal then passes through an inner, proprioceptive feedback loop. In the forward path of this loop, the elements  $Y_{NM}(s)$  and  $Y_{FS}(s)$  represent, respectively, the open-loop dynamics of the neuromuscular system driving the cockpit inceptor, and the dynamics of the force-feel system. The feedback portion of this loop contains the element  $Y_{PF}(s)$ , which acts on the sensed inceptor position  $\delta_{pos}(t)$ .

The element  $Y_{PF}$  and its location in the model is essential to the functionality of the structural model. This operation upon a proprioceptively sensed variable is assumed to enable the human pilot to generate

equalization necessary to make the Pilot-Vehicle System behave like the crossover model. This is in contrast to other pilot models (for instance, the model used in the Neal-Smith criterion) that assume this equalization to result from filtering action upon visually sensed information. It is noted that for application in the criterion, an outer vestibular feedback loop that is part of the original structural model is omitted.

Essential in the criterion developed by Hess is the parameter selection for the pilot model. A number of parameters are considered to be invariant across different vehicles and tasks. These include:

$$\begin{aligned}\tau_0 &= 0.2 \text{ s} \\ \omega_c &= 2.0 \text{ rad/s} \\ Y_{NM} &= \frac{\omega_{NM}^2}{s^2 + 2\zeta_{NM}\omega_{NM}s + \omega_{NM}^2} \\ &\text{with } \zeta_{NM} = 0.7, \omega_{NM} = 10 \text{ rad/s}\end{aligned}$$

The choice of this crossover frequency and the fact that it is assumed to be fixed (except under special conditions) is a very important issue. Fixing its value makes it possible to compare different models by ensuring similar operating conditions. Choosing the value of 2.0 radians per second stems from results described in [Hess, 1989].

Other variables are dependent on the specific vehicle dynamics around the crossover frequency. Adjusting  $Y_{PF}$  is thought to be the manner in which the pilot uses an internal model of the vehicle in tracking and regulating tasks to create compensation that leads to the crossover model. In the modeling procedure, one of the following forms of proprioceptive feedback is chosen:

$$Y_{PF}(s) = \begin{cases} K(s+a) & \text{or,} \\ \frac{K}{K} & \text{or,} \\ \frac{K}{(s+a)} & \end{cases} \quad (5.2.2)$$

The three forms can be interpreted as the pilot's 'internal' model of the vehicle dynamics. In the range of crossover,  $Y_{PF}(s)$  shall be proportional to  $s \cdot Y_C(s)$ . This will then result in an open loop transfer function that shows a crossover model characteristic of (5.2.1):

To accomplish this, the right hand side of Equation (5.2.2) is chosen such that

$$\left| \frac{Y_c(j\omega)}{Y_{PF}(j\omega)} \right| \approx \left| \frac{K_1}{j\omega} \right| \text{ for } \begin{cases} \omega \approx \omega_c \\ K_1 \text{ arbitrary} \end{cases} \quad (5.2.3)$$

The gain  $K_1$  appearing in Equation (5.2.3) is then chosen such that, with all other loops open, the minimum damping ratio of any quadratic closed-loop system poles of  $\frac{\delta_{pos}}{e_m}(s)$  is  $\zeta_{min}=0.15$ . This will ensure that the pilot vehicle system will show neuromuscular amplitude peaking that is characteristically present [Hess, 1989]. Finally,  $K_c$  is selected so that the crossover frequency of 2.0 radians per second is obtained.

### ***b) Analysis of handling qualities***

It has been suggested by [Smith, R.H, 1976] that, in any closed loop tracking task, rate control activity by the pilot is of fundamental importance to perceived handling qualities. For example, if the control task is pitch-attitude regulation in turbulence, pitch-rate control is the rate control activity in question. A physiological measure for pilot opinion ratings is the rate at which nerve impulses (or an equivalent measure) arrive at the point within the central nervous system where all signals due to rate control are summed and processed.

This assumption was interpreted in terms of the structural model of Figure 5.2.18 by showing that the signal  $u_m$  is proportional to vehicle output rate due to control activity. He showed that the mean square value of

$u_m$ ,  $\sigma_{u_m}^2$ , which represents the average power of  $u_m$ , correlated well with Cooper-Harper Ratings (CHR). The larger the value of  $\sigma_{u_m}^2$ , the higher the CHR (the poorer the handling qualities). Parseval's theorem shows that  $\sigma_{u_m}^2$  can be expressed as

$$\sigma_{u_m}^2 = \frac{1}{2\pi} \int_{-\infty}^{\infty} \Phi_{u_m u_m}(\omega) d\omega = \frac{1}{\pi} \int_0^{\infty} \left| \frac{u_m}{\theta_{cmd}}(j\omega) \right|^2 \Phi_{cc}(\omega) d\omega \quad (5.2.4)$$

The handling qualities assessment technique discussed in [Hess, 1997<sup>a</sup>] defines a Handling Qualities Sensitivity Function (HQSF) as

$$HQSF(\omega) = \left| \frac{u_m}{\theta_{cmd}}(j\omega) \right|$$

Thus, in Equation (5.2.4), the HQSF can be thought of as a weighting function, determining how input power  $\Phi_{cc}$  is transformed into rate-control power  $\sigma_{u_m}^2$  by the pilot in the task at hand.

To be able to compare different Pilot-Vehicle Systems using the HQSF the effects of control sensitivity must be removed. This is accomplished by defining it as (see Figure 5.2.18):

$$HQSF(\omega) = \left| \frac{\theta}{\theta_{cmd}}(j\omega) \cdot \frac{1}{K_e} \cdot \frac{1}{Y_C(j\omega)} \cdot Y_{PF}(j\omega) \right| \quad (5.2.5)$$

Note that this can only be done when the PVS is fully linear. It will be shown later how non-linearities in the vehicle description can be taken into account. Hess has defined boundaries for the HQSF that can be used to discriminate between handling qualities levels 1 to 3.

The PIO assessment technique discussed in [Hess, 1997<sup>a</sup>] uses the power spectral density of the signal  $u_m$ ,

$$\Phi_{u_m u_m} = \left| \frac{u_m}{\theta_{cmd}}(j\omega) \right|^2 \cdot \Phi_{cc} = |HQSF|^2 \cdot \Phi_{cc}$$

when the PSD of the command signal  $c(t)$  has the particular form of:

$$\Phi_{cc}(\omega) = \frac{4^2}{\omega^4 + 4^2}$$

For simulation purposes, this signal can be generated by passing white noise through a forming filter with a transfer function:

$$H(s) = \frac{4}{s^2 + \sqrt{8}s + 4}$$

This command signal has a break frequency of 2 radians per second, identical to the crossover frequency enforced in the pilot-vehicle analysis. Plots of  $\Phi_{u_m u_m}$  can be used to delineate levels of Pilot-Induced Oscillation Ratings (PIORs).

When only dealing with linear PVS the particular value of the root mean square of  $c(t)$  is not important, other than it was held constant at the value implied by Equation (5.2.5). It will be shown that when non-linearities in the vehicle description are included, scaling of the command signal is needed in order to achieve a response that is within real-life limits.

### c) Criterion application

The Hess criterion was applied to the three databases described in Table 5.2.2 and the results are presented in Table 5.2.13 and Table 5.2.14. Note that the Hess criterion predicts both flying qualities levels and PIO levels as defined in the tables so performance indicators can be determined for both predictions.

**Table 5.2.13: CHR prediction with Hess criterion**

Number of cases		Flight test CHR		
		L1 CHR≤3	L2 CHR≤6	L3 CHR>6
CHR Prediction by Hess	L1	12 (B)	6 (A)	0 (A)
	L2	2 (C)	24 (D)	1 (A)
	L3	0 (C)	7 (C)	17 (D)

From Table 5.2.13 the values of the three effectiveness indices in terms of flying qualities level prediction turn out to be:

- I1) Global success rate  $((B+D)/(A+B+C+D)) = 53/69 = 77 \%$
- I2) Non-conservatism index  $(D/(C+D)) = 41/50 = 82 \%$
- I3) Safety index  $(D/(A+D)) = 41/48 = 85 \%$

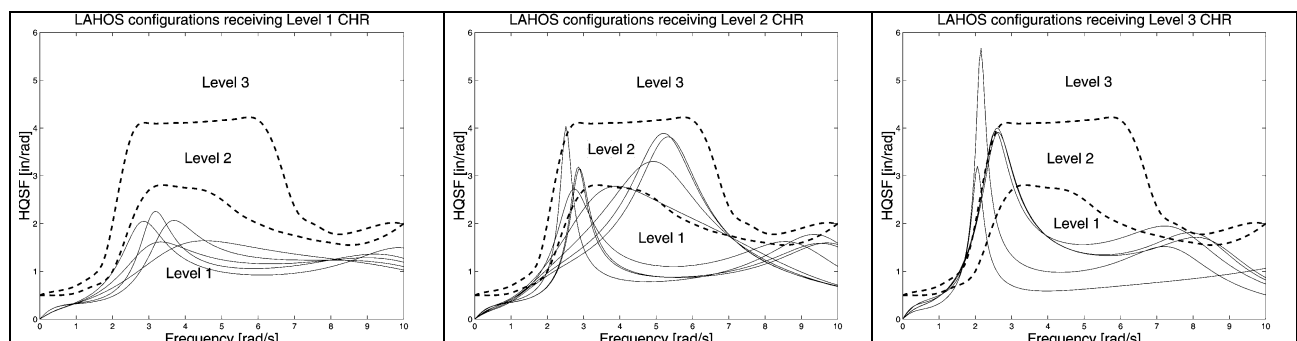
**Table 5.2.14: PIO prediction with Hess criterion**

Number of cases		Flight test PIO (Mean PIOR>2)	
		NO PIO	PIO
PIO prediction by Hess	NO PIO	20 (B)	5 (A)
	PIO	10 (C)	34 (D)

The three effectiveness indices in terms of PIO prediction are:

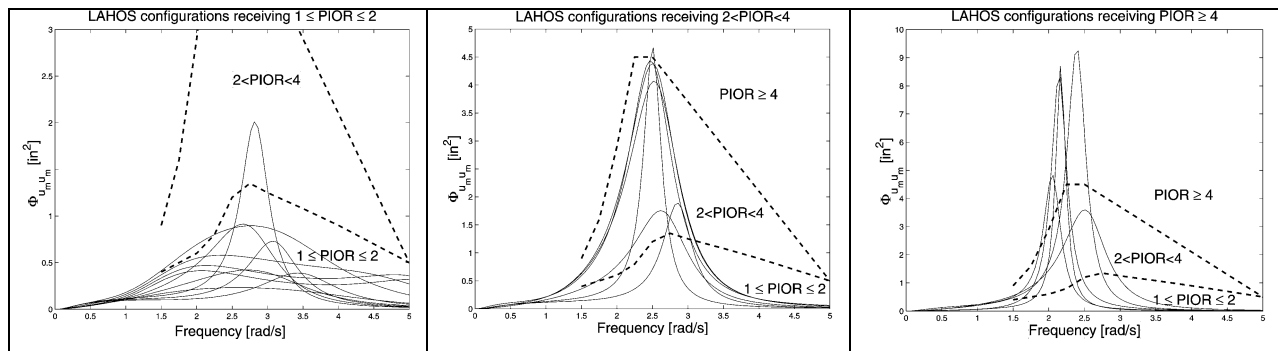
- I1) Global success rate  $((B+D)/(A+B+C+D)) = 54/69 = 78 \%$
- I2) Non-conservatism index  $(D/(C+D)) = 34/44 = 77 \%$
- I3) Safety index  $(D/(A+D)) = 34/39 = 87 \%$

Although generally the methodology to determine the pilot model parameters as described above will be straightforward and can even be automated quite easily, there are some cases where compliance to Equation (5.2.3) results in possible ambiguity in the selection of  $Y_{PF}(s)$  and the parameter  $a$  in Equation (5.2.2). For the databases evaluated, difficulties arise for LAHOS configurations 3-C through 3-7. For all these seven configurations, the gain slope of  $Y_C(s)$  at the crossover frequency  $\omega_c=2.0$  rad/s is greater than zero, which makes it impossible to comply with (5.2.3). It is left to the user's engineering judgement to make a correct choice and unfortunately this makes criterion results non-unique. For this reason, these cases have been excluded from the evaluation presented here.



**Figure 5.2.19: Hess criterion mappings for selected LAHOS configurations; Handling Qualities Sensitivity Functions**





**Figure 5.2.20: Hess criterion mappings for selected LAHOS configurations; PSD of scaled proprioceptive feedback signals**

**5.2.1.2 Discussion**

The criteria presented above are discussed with respect to the following topics:

- a) Effectiveness of PIO prediction,
- b) Gaps in the criteria and possible extensions,
- c) Applicability to the roll axis.

In general it can be stated that

*Category I PIO can be considered to be well understood.*

Really good configurations are rated good by all criteria and vice versa. But there are significant differences between the criteria and *open questions* to be discussed.

**a) Effectiveness:**

In Table 5.2.15 a summary of the performance indices of the Cat. I PIO prediction criteria is presented.

**Table 5.2.15: Performance Indices of Category I PIO prediction criteria**

PIO criterion	Global success rate [%]	Non conservatism index [%]	Safety index [%]
1. Neal Smith	63	60	97
2. Bandwidth / Phase delay	82	89	77
3. Smith Geddes	80	82	84
4. Phase Rate / Gain Phase	72	68	98
5. Gibson template	74	69	98
6. Vector Margin	72	70	91
7. Gibson Dropback	62	68	64
8. Mitchell Dropback	53	70	22
9. Hess-Kalteis	78	76	89
10. Hess PVS model	78	77	87

Almost all of the criteria presented above are suitable for predicting Category I PIO problems, but each with different effectiveness w.r.t. the three indices. The Bandwidth-Phase Delay and Smith-Geddes criteria have the highest global success rate, about 81% success cases. The Bandwidth-Phase Delay is also the less conservative criterion, with 89%.

The Hess criterion has a slightly lower global success rate, about 78%, and may be a valuable new addition to other well-established criteria such as bandwidth and Neal-Smith. Its application is straightforward, but in some cases, pilot model parameter selection can be problematic. In those cases, good understanding of the theory behind the criterion is essential in order to make sensible choices in the parameterisation process.

With a reasonable success rate, between 72-74% success cases, follow the Phase Rate, the Gibson Frequency Domain template and the Robust Stability criterion. These three criteria are all characterised by a high value of the safety index, above 90%. The two Gibson criteria, that are the only ones that include a bound for the gain of the transfer function, share an almost complete success in the safety index with a value of 98%, and therefore it is suggested to include these criteria in a PIO analysis.

The Neal Smith criterion, although with a lower global success, 63%, also has a very high safety index, 97%. Further, as explained below, it predicts bobbling tendencies, which although not really considered as PIO, can be annoying for the pilot. The weak point of this criterion, as already said before, is its conservatism with a value of 60% of the related index.

The two dropback criteria have the lowest effectiveness for PIO prediction. On the other hand they are able to predict bobbling tendencies, too. In order to show this capability, one specific configuration is considered more in detail: LAHOS configuration 5\_1, which is marked in the figures above. This configuration was rated with PIOR 3 after two runs with the following typical pilot comments:

*Tendency to bobble, low frequency PIO during landing.*

The Smith-Geddes criterion does not represent these pilot ratings, since the configuration is predicted to be PIO free. The bandwidth/phase delay also does not predict the PIO potential of this configuration, but the bobbling is indicated due to the excessive dropback, which has been suggested as a complementary criterion. The phase rate criterion predicts the PIO potential since the gain-phase template requirement is not satisfied. The Gibson frequency domain criterion also predicts unsatisfactory behaviour from both the low gain margin and the high attitude dropback. The Robust Stability criterion predicts configuration 5\_1 to be PIO prone. The Neal-Smith criterion also indicates the bobbling tendency, since the pilot phase compensation is negative. But, it also has some potential to explain the PIO during landing, since this configuration is extremely sensitive to bandwidth, which means aggressiveness of the pilot. By increasing the bandwidth from 2.5 to 3.0 rad/s the closed-loop amplitude is increased from 4.8 to 11.3 dB (Level 3), which means a significant PIO potential is predicted. This means that

*Besides the high frequency gain and phase roll-off other linear effects can also cause Category I PIO!*

#### **b) Gaps/Extensions**

Only attitude control is considered in the prominent criteria presented above, while it is generally accepted that acceleration cues are also important for the pilot. These effects were considered within the type I PIO criterion by R. Smith. In that theory the PIO is triggered by switching from attitude to acceleration control. However, the computations required for application of this criterion are much more complex than those of the very simple type III PIO criterion presented here. Further more, the PIO criteria discussed above are highly successful in PIO prediction based on the attitude transfer function.

The original structural model of the human pilot used by Hess featured vestibular feedback as an extra outer feedback loop complementing the visual feedback loop. Including this loop for the criterion for purposes of the criterion is of course possible, but makes the application more complicated. Since it was left out of the criterion definition by Hess, it appears that including it doesn't improve the criterion success significantly.

Only a few of the above criteria address the steady-state gain of the attitude transfer function. This is done either directly as a bound for the gain at the  $-180^\circ$  frequency, as in the two Gibson criteria in the frequency domain, or by including a pilot model whose gain is optimised to fit the aircraft transfer function, as with the Neal-Smith and Robust Stability criteria and with the two Hess criteria. It is worth noting that these criteria are also those with the highest values of the safety index, about 90% or higher. With respect to a validation of the absolute amplitude criteria, the problem arises that it is generally difficult to reproduce the steady-state gain from the available databases (Neal-Smith, LAHOS, HAVE PIO, HAVE CONTROL).

The other criteria discussed above do not address the steady state gain of the attitude transfer function. The background for this gain independence is the assumption that the steady state gain is compensated by the pilot gain.

Regarding practical applications of the bandwidth/phase delay criterion to flight test data, problems can arise, since the measured frequency response data might be doubtful in the high frequency range of  $2\omega_{180}$  [Koehler, 1996]. The computation of the average magnitude slope for the Smith-Geddes criterion can be no longer meaningful for configurations with low damped modes, such as flexible modes, within the frequency range of interest, 1 to 6 rad/sec. Indeed these cases can show a significant variation of the magnitude slope with respect to the average value, in the range of the low damped modes.

### *c) Applicability to the roll axis*

A similar application of the PIO criteria to the roll axis is conceivable, using the roll attitude transfer function instead of pitch attitude. This approach was investigated in [DeMatthew, 1991] using the Neal-Smith criterion, while the droop parameter has been set to zero dB. It appeared that the Neal-Smith criterion seems to have some potential for PIO prediction in the lateral axis as well. The Smith-Geddes criterion has also been suggested to be applied in the roll axis [Smith, R.H., 1982]. For the data analysed in that study it appeared that the consideration of the lateral acceleration dynamics adds nothing to understanding the problem. Therefore, the bank angle dynamics are sufficient for PIO analysis in the roll axis. The most detailed investigation on the applicability of the longitudinal PIO criteria to the roll axis is summarized in [Duda, 1995]. Within that study more than 150 configurations from three roll axis databases were evaluated providing the following main results:

- The Smith-Geddes criterion showed a large scattering between the criterion phase angle and the pilot ratings.
- The phase rate criterion appears to be a very effective PIO predictor in the roll axis. The handling qualities boundaries of the pitch axis are valid for the roll axis as well.

The structural model of the human pilot is applicable to the roll axis, e.g. [Hess, 1989] describes the results of a study into the human use of motion cues in a roll-attitude tracking task. No investigation has been undertaken so far to extend the Hess criterion to the roll axis but this may be an interesting issue to pursue in the future.

### **5.2.1.3 Summary**

The main results of the Category I PIO criteria assessment discussed above is summarised in Table 5.2.16.

**Table 5.2.16: Summary of PIO criteria assessment**

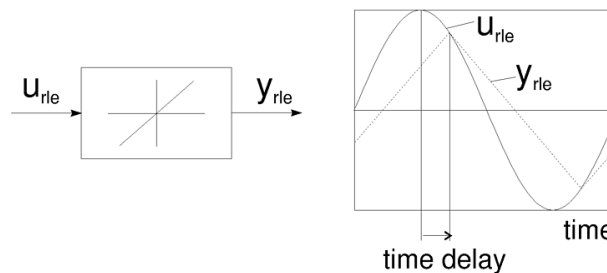
Neal-Smith	<ul style="list-style-type: none"> <li>• Effective PIO indicator, bandwidth sensitivity important</li> <li>• Modified criterion available in the roll axis.</li> </ul>
Bandwidth/Phase Delay	<ul style="list-style-type: none"> <li>• Effective PIO indicator (high frequency phase rolloff).</li> <li>• Problems when applied to flight test data.</li> </ul>
Smith-Geddes	<ul style="list-style-type: none"> <li>• High frequency phase roll off is not addressed</li> <li>• Crossover frequency correlated to PIO frequency</li> <li>• Available in the roll axis.</li> </ul>
Phase Rate/ Gain-Phase	<ul style="list-style-type: none"> <li>• Effective PIO indicator (high frequency phase rolloff).</li> <li>• Steady-state gain considered</li> <li>• Applicable to the roll axis as well.</li> </ul>
Gibson frequency domain template	<ul style="list-style-type: none"> <li>• Effective PIO indicator, especially for safety index</li> <li>• Steady-state gain considered</li> </ul>
Robust Stability Analysis	<ul style="list-style-type: none"> <li>• Effective PIO indicator, especially for safety index</li> </ul>
Gibson Dropback	<ul style="list-style-type: none"> <li>• Not relevant to high order phase delay PIO problems</li> <li>• Predicts bobbling tendencies</li> </ul>
Mitchell Dropback	<ul style="list-style-type: none"> <li>• Low effectiveness as a stand-alone criterion</li> </ul>
Hess-Kalteis Bode Gain Template	<ul style="list-style-type: none"> <li>• Effective PIO indicator</li> <li>• Steady-state gain considered</li> </ul>
Power Spectral Analysis	<ul style="list-style-type: none"> <li>• Effective PIO indicator</li> <li>• Determination of the pilot model parameters can be problematic</li> </ul>

## 5.2.2 Category II PIO

Category II PIO events are characterised by quasi-linear pilot-vehicle system oscillations, but with rate and/or position limiting as well defined non-linear effect.

This kind of non-linearity is unavoidably present in every aircraft, because of physical constraints of elements such as stick/column deflections, actuators position and rate limiters, limiters in the controller software and so on. In particular, actuator rate limiters have been indicated as the concurring cause to various high dramatic PIO incidents/accidents in the last years (YF22, Gripen).

The non-linearity can be particularly dangerous because it exposes the pilot to a sudden change of the dynamics of the augmented aircraft (flying qualities cliff). Indeed, due to the rate limitation, the pilot sees a slower response of the aircraft and may try to boost it by raising his gain thus initiating the PIO. The activation of the rate limiting introduces an additional time delay which may have catastrophic influence on the flying qualities of the aircraft, Figure 5.2.21.

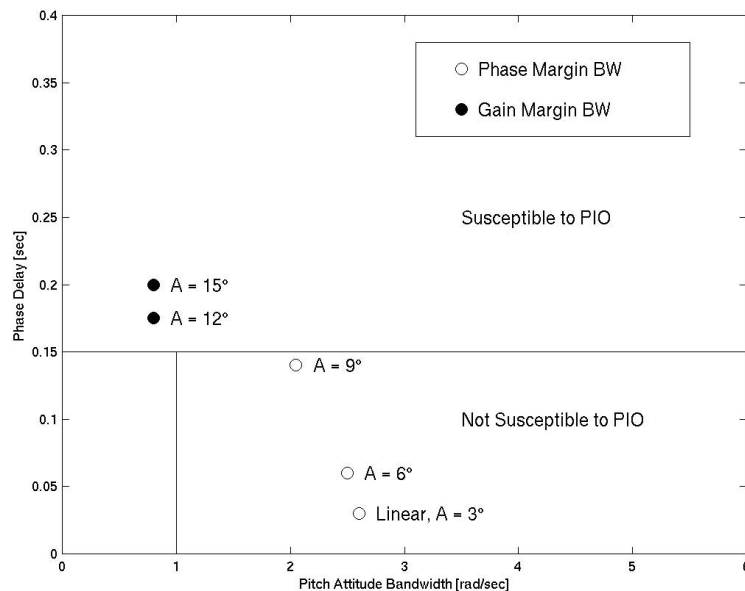


**Figure 5.2.21: Time delay induced by rate limiting**

For this purpose, several attempts have been made to provide methods to predict the tendency to Category II PIO. Many of these methods are currently under development. A quite complete list of them is the following:

1. Describing Function Analysis of Limit Cycles
2. Open Loop Onset Point Criterion (OLOP)
3. Robust Stability Analysis Methods
4. Power Spectral Density of the Pilot Structural Model
5. Time Domain Neal Smith Criterion (TDNS)

Furthermore, several attempts to use the Category I PIO criteria to predict Category II PIO have been made. In these tests the criteria have been used on frequency domain data generated for several values of the amplitudes of the relevant input signals. The data obtained define a locus, in the plane of the parameters of the criterion, that is a function of the input amplitude. The locus is overlaid on the linear requirements to define PIO prone regions. An example of these tests is the application of the Bandwidth-Phase Delay criterion to the X-15 aircraft, see Figure 5.2.22, extracted from [Klyde, et al, 1995<sup>b</sup>]. In figure a sensitivity analysis of the criterion parameters w.r.t. the value of the input amplitude is presented. The analysis shows that the X-15 data move from the PIO free region to the PIO prone region when the input amplitude increases from  $A=3^\circ$  (small amplitude, linear behaviour) to  $A=15^\circ$  (large amplitude, non-linear behaviour).



**Figure 5.2.22: Application of Bandwidth-Phase Delay criterion to X-15 non-linear data**

The analysis of non-linear data through one of the Category I PIO criteria usually involves a simulation of the non-linear system and the computation of the criteria parameters after a suitable transfer function has been obtained from FFT. This requires a systematic approach to specify the pilot input amplitude for the frequency sweeps. A reduction of the describing function coherence in the neighbourhood of the rate saturation frequency is reported in [McRuer, et al., 1998], based on the analysis of a limited set of data. A further comment on the use of Category I PIO criteria for the analysis of rate limited aircraft configurations is given in [Gibson, 1999]:

*The author at one time considered applying his linear phase rate measures to non-linear responses. This proved difficult, requiring much non-linear time response simulation etc., and it was eventually realised that the idea was actually inappropriate. Phase rate or phase delay is a valid measure as a symptom of adverse dynamics in normal linear control. Severely rate saturated dynamics do not affect the handling in normal circumstances and are not involved in control tasks. These dynamics are themselves the root cause of severe PIO and appear “out of the blue”.*

Gibson also comments that the attitude gain limits of the Average Phase Rate criterion (see Figure 5.2.7) are fully applicable to non-linear Category II PIO. Their use prohibits the large response gain typical of rate-saturated PIO and forces a design solution to satisfy this.

In the following we are going to describe in some detail the five methods listed above, since they have specific peculiarities to the non-linear Category II PIO.

The first four criteria are based on frequency domain analysis, while the last one is a time domain based method. Similar to the Category I PIO criteria, the above criteria address stability aspects of the closed-loop aircraft pilot system, focusing on the non-linear behaviour induced by rate limiters. In fact, although the research so far has dealt with the influence of rate limit non-linearities, the TDNS could equally be applied to deal with more general non-linearities. All of the criteria make explicit use of pilot models, although of different complexity.

### 5.2.2.1 Description of PIO Criteria

#### 1) Describing Function Analysis of Limit Cycles

The non-linear effects of rate saturation can be analysed in the frequency domain by using the describing function technique. The motivation is that the resulting PIO has the form of a limit cycle of the non-linear system. Thus limit cycle analysis is a sensible way to analyse the aircraft in order to predict this kind of

PIO. This technique has already been applied within the early work of Ashkenas [Ashkenas, et al, 1964] for the analysis of the X-15 PIO incident. Using the describing function technique, the possibility of limit cycles can be investigated by plotting the frequency responses of the linear part of the control loop and the negative inverse describing function on a Nichols chart. Any intersection of the two curves provides the frequency and amplitude of the limit cycle. In the case of the X-15 PIO analysis, very good agreement was reached between the limit cycle frequency and amplitude predicted by the analysis and experienced in flight [Ashkenas, et al, 1964].

A further analysis of the X-15 PIO, via describing function methods is described in [Klyde, et al, 1997]; it gives more insight into the behaviour of the rate limited actuator and the consequences in terms of PIO occurrence. In [Anderson and Page, 1995] and [Anderson, 1998] the describing function approach is proposed in combination with numerical techniques, to deal with the case of multiple non-linearities.

Some drawbacks exist for the describing function method. First, the graphical nature of the classical procedure limits the extension of its applicability to a single non-linearity. Second, the numerical approach, which has been recently proposed to make full use of the computing power of modern computers, requires an a priori estimate of possible limit cycles, because it is based on the numerical solution of a non-linear equation for which good tentative solutions are preferable in order to reduce the computational effort; moreover a basic assumption to simplify the analysis is that the non-linear elements are independent from each other, i.e. their describing functions are those obtained in the case of a single non-linearity. Finally, if the actuator presents significant acceleration limiting then the rate-limit describing function may not represent the dynamics of the real actuator with sufficient accuracy, and only a full simulation of the actuator can genuinely model the response.

#### a) Test case of Category II PIO analysis. The X-15 landing flare PIO

In this section we present a test case to demonstrate the use of describing function analysis for prediction of limit cycles arising in Category II PIO.

In [McRuer, 1995], [Klyde, et al., 1997], [Klyde, et al., 1995], the problem of analysis and prediction of PIO in aircraft with actuator rate limiting is studied through DF analysis, and it is shown that this technique can be used to provide a prediction of the limit cycle or PIO frequency. The test case illustrated below has been presented in [Klyde, et al., 1997], and is based on the X-15 PIO that occurred during a landing flare on June 8, 1959, as reported in [Matranga, 1961].

The model of the aircraft with rate limited actuator is shown in Figure 5.2.23.

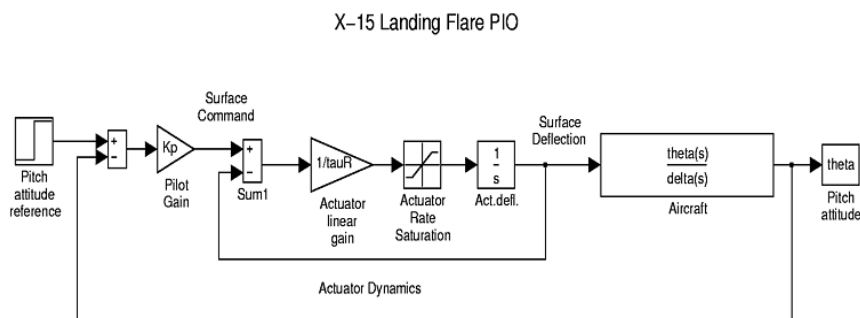


Figure 5.2.23: Analysis model of the X-15 Landing flare PIO

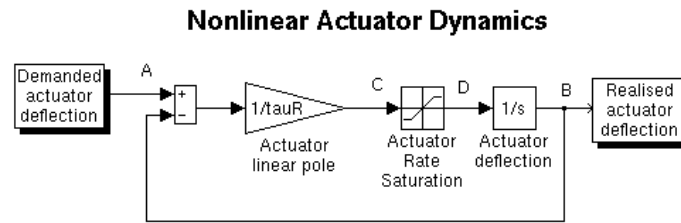
The numerical values of the elements in the block diagram are:

$$\frac{\theta}{\delta} = \frac{3.476(0.0292)(0.883)}{[0.19, 0.1][0.366, 2.3]}, \begin{cases} \text{1st order term } (\lambda) \\ \text{2nd order term } [\zeta, \omega_n] \end{cases}$$

$$\tau_R = 0.04 \text{ s}$$

$$\dot{\delta}_{MAX} = 15^\circ/\text{s}$$

The non-linear dynamics of the rate limited actuator are highlighted in Figure 5.2.24.

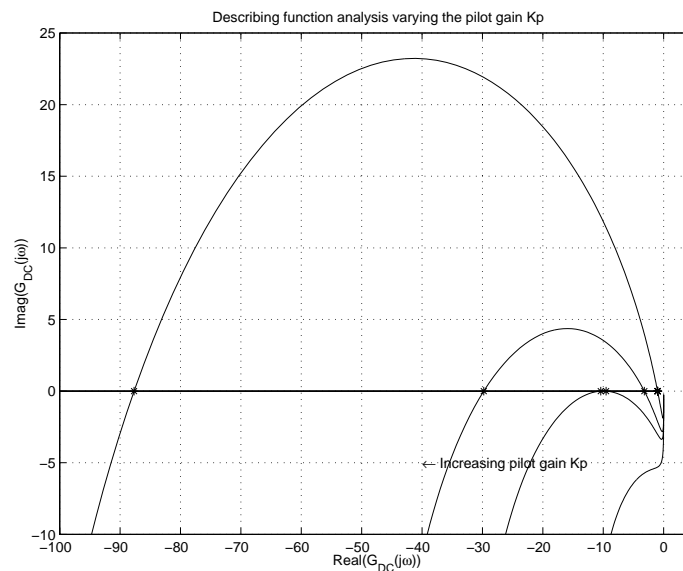


**Figure 5.2.24: Rate limited actuator with first order linear dynamics**

In Figure 5.2.25 and Figure 5.2.26 the Nyquist plot of the transfer function  $G_{DC}(j\omega)$  is plotted against the negative inverse of the describing function of the saturation, to find the limit cycles. The DF analysis predicts the following limit cycles:

- for  $K_p < 2.04$ , no limit cycles exist;
- for  $K_p = 2.04$  one limit cycle exist of frequency  $\omega_n = 2.74$  rad/s
- for  $K_p \in [2.04, 7.1]$  two limit cycles exist, an unstable one, whose frequency increases with  $K_p$ , and a stable limit cycle of decreasing frequency w.r.t.  $K_p$ ;
- for  $K_p = 7.1$  two limit cycles exist, one of them, with frequency  $\omega_n = 5.28$  rad/s is an unstable “linear” limit cycle, i.e. it consists of non vanishing linear oscillations of the closed loop system, which for this value of  $K_p$  is only marginally stable;
- for  $K_p > 7.1$  there is only one stable limit cycle, of decreasing frequency w.r.t.  $K_p$ .

Note that the PIO frequency in flight was about 3.3 rad/s [Klyde, et al., 1997].



**Figure 5.2.25: X-15. Describing function analysis**

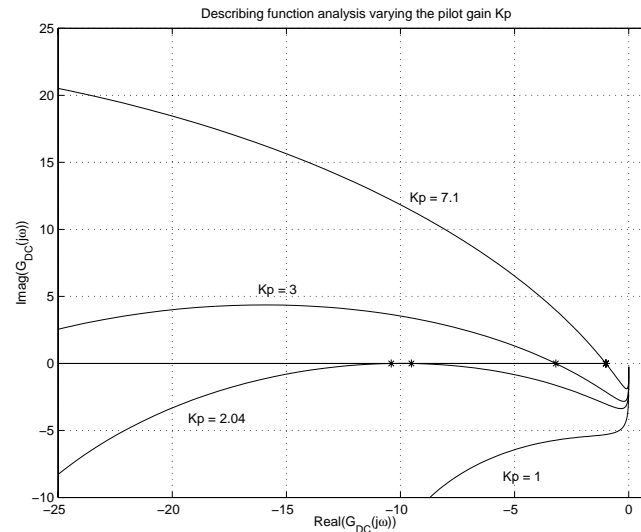


Figure 5.2.26: X-15. Describing function analysis, zoom on critical point area

The stability of the limit cycles can be inferred using the method presented in [Gelb and van der Velde, 1968].

## 2) Open Loop Onset Point (OLOP)

The describing function technique has been shown to be a suitable technique for non-linear PIO prediction and was the basis for a new Category II PIO prediction criterion developed at DLR: the OLOP criterion [Duda, 1994, 1995 and 1997], [Duda et al, 1997]. OLOP means the *open-loop onset point* of the rate limiting element in a Nichols chart.

### a) Background

The development of the OLOP criterion is based on the describing function technique. The describing function of an isolated rate limiting element has been developed using a Fourier series for the fully developed rate limiting situation (pure triangle output function) [Duda, 1997]. The describing function is dependent on frequency and input amplitude  $u_{rle}$ , while the amplitude dependence is included in the onset frequency  $\omega_{onset} = R / u_{rle}$ . The latter is defined as the frequency at which the rate limiter, of value  $R$ , is activated for the first time [Hanke, 1993, 1994].

For Category II PIO prediction the rate limiting effects in a closed control loop have to be analysed. Therefore, a method has been developed to calculate the describing function of a rate limited closed-loop system. The application of this method to a highly augmented aircraft with a rate limiter in the feedback loop is presented in Figure 5.2.27. The closed-loop system describing function is characterised by a discontinuous phase after rate limiting onset, which can be recognised in a Nichols chart as a change in gradient. In the presented example, the phase jump leads to a dramatic loss of phase and amplitude margins, indicating the potential for an instability of the closed-loop system. This instability was verified by a non-linear simulation in the time domain [Duda, 1995].

In that Nichols chart, the open-loop onset point (OLOP) can be identified as the point where the phase jump starts. In further studies, the OLOP parameters of a great number of aircraft systems have been determined, indicating that the severity of the jump phenomena in the frequency domain and the corresponding destabilisation observed in the time domain, are highly correlated with the OLOP location in a Nichols chart.



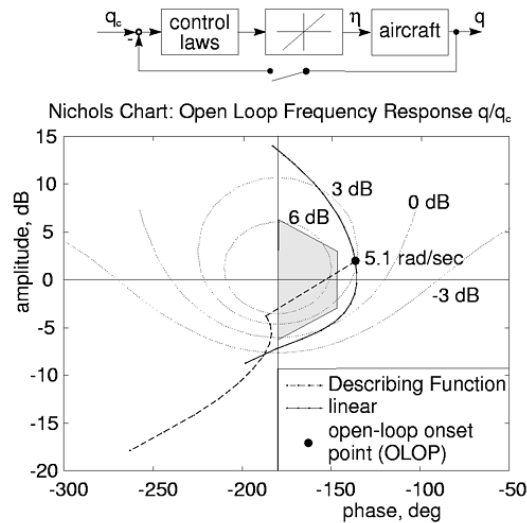


Figure 5.2.27: Jump phenomenon after rate limiting onset

**b) Physical Significance**

The OLOP location in a Nichols chart is an indicator of the magnitude of the additional time delay due to rate limiting onset. It has been shown by the describing function analysis that the primary effect caused by the activation of a rate limiter is a strong increase in phase lag and a slight decrease in amplitude [Duda, 1997]. If the OLOP is located at high amplitudes, the additional phase delay causes an increase in the closed-loop amplitude as demonstrated in the Nichols chart, Figure 5.2.28. This increase in closed-loop amplitude provokes a stronger rate saturation and, therefore, a further increasing phase delay. This mechanism can lead to a closed-loop instability. For an OLOP located clearly below 0 dB the increasing phase delay causes only little or no increase in closed-loop amplitude, so the rate limiting effects are less dramatic.

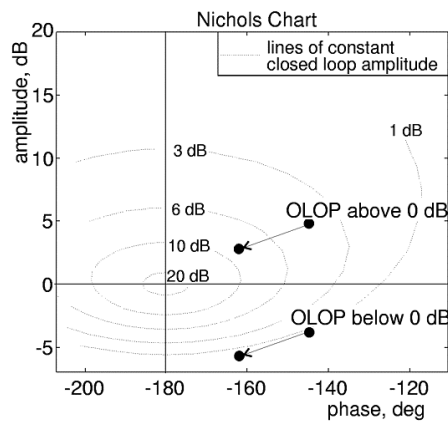


Figure 5.2.28: Physical significance of the OLOP parameter

**c) Evaluation Procedure**

For the application of the OLOP criterion, the use of the describing function technique is not required. A linear model of the aircraft including the flight control system, the position of the relevant rate limiter, and the information about maximum stick deflections and maximum rates must be available. The procedure for the evaluation of the OLOP criterion is summarised below [Duda, 1997].

1. Definition of a simple (high) gain pilot model based on the linear aircraft dynamics.
2. Calculation of the linear closed-loop frequency response from the stick input to the input of the rate limiter.

3. Determination of the closed-loop onset frequency  $\hat{\omega}_{onset}$  considering stick and control surface deflection limits.
4. Calculation of the linear open-loop frequency response  $F_{OLOP}(j\omega)$  and separation into amplitude  $A_0(\omega)$  and phase angle  $\Phi_0(\omega)$ .
5.  $OLOP = [ \Phi_0(\hat{\omega}_{onset}), A_0(\hat{\omega}_{onset}) ]$

The pilot model has to be adjusted to the linear aircraft model, which means that the pilot has adapted himself to an aircraft behaviour without rate saturation. It is assumed that in a time period after rate limiting onset, the pilot dynamics remain those adapted to the linear aircraft behaviour (*post-transition retention*) [McRuer, 1995]. The sudden change in closed-loop aircraft behaviour may lead to a strong misadaptation of the pilot, which can cause an instability of the closed-loop aircraft-pilot system (= PIO).

It is recommended that simple gain pilot models be used since the pilot usually reacts as a simple gain during a fully developed PIO (*synchronous precognitive behaviour*) [McRuer, 1995]. The pilot gain  $K_{pil}(\Phi_{cr})$  has to be adjusted based upon the linear crossover phase angle of the open-loop aircraft-pilot system  $\Phi_{cr}$ . It is recommended that a gain spectrum from  $\Phi_{cr} = -120^\circ$  (low pilot gain) up to  $\Phi_{cr} = -160^\circ$  (high pilot gain) should be applied. This gain spectrum should be used to assess the sensitivity of the aircraft to the pilot model gain.

The linear open-loop frequency response  $F_{OLOP}(j\omega)$  is determined by cutting the system at the rate limiter and treating the system with rate limiter removed: the output of the rate limiter is defined as the input of the open-loop system  $u_{OLOP}$ ; the input of the rate limiter is defined as the output of the open-loop system  $y_{OLOP}$ . More details on the application of the OLOP criterion are available in [Duda, 1995 and 1997; Duda, et al, 1997].

The procedure introduced here is applicable to both the pitch and roll axes.

#### d) PIO Boundary

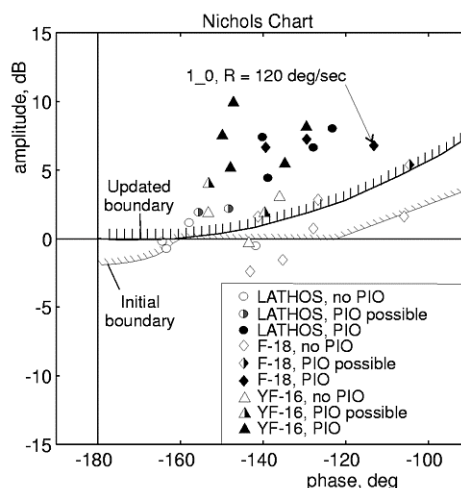
For the verification of the PIO boundary a large number of aircraft models has been investigated based on the three lateral databases, Table 5.2.17. Based on the results of a linear PIO analysis a set of 17 representative configurations has been selected from the three databases to be analysed using the OLOP criterion [Duda, 1997].

**Table 5.2.17: Lateral databases for PIO research**

LATHOS	(LATeral High Order System): In-flight simulation program on the NT-33 to study the effects of time delay and prefilter lag in the lateral flight control system [Monagan, et al, 1982].
F-18A	In-flight simulation program on the NT-33 to identify flying qualities problems of the F-18A prior to its first flight [Smith, R.E., 1979].
YF-16	The famous first flight PIO incident of the YF-16 aircraft including the flight control system modifications [Smith, J.W., 1979].

Figure 5.2.29 presents the verification of the OLOP boundary by means of evaluating the configurations from the three databases. Their Category II PIO potential is based upon non-linear simulations in the time domain with pilot models. It is important to note that in this Nichols chart, configurations with forward path and feedback loop rate limiters are evaluated, while a high correlation has been found between the OLOP location and the PIO susceptibility. This indicates that the OLOP criterion is applicable to both forward path and feedback loop rate limiters, using the same PIO boundary. Two boundaries are presented: the

initial boundary has been proposed in 1995 [Duda, 1995] and has been updated in 1997 [Duda, 1997]. This new boundary has a deeper theoretical background and it provides a higher correlation with the results from the non-linear simulations.



**Figure 5.2.29: Verification of the PIO boundary by off-line simulations (OLOP criterion)**

It has been shown that the activation of rate limiters in the feedback loop provides a very strong Category II PIO potential, especially for high flight control system feedback loop gains. In order to stress and illustrate this statement the analysis of the F-18 configuration 1\_0 is indicated in Figure 5.2.29. The OLOP parameter of this configuration with a maximum rate of  $R = 120^\circ/s$  and a low pilot model gain ( $\Phi_{cr} = -120^\circ$ ) is located in the PIO prone area. But the F-18 configuration 1\_0 has been predicted to have Level 1 flying qualities by the phase rate criterion for small amplitude signals (i.e. for Category I PIO). Further investigations have shown that Category I and II PIO are not correlated, which means the OLOP criterion is not correlated with the linear PIO criteria [Duda, 1997].

### e) Validation

For the validation of the OLOP criterion, the available aircraft (flight control system) models of PIO prone configurations with rate limiting have been evaluated. Second, the available experimental data with respect to PIO due to rate limiting were used. Finally, new flight simulator experiments have been conducted in order to get a wider OLOP spectrum.

The following aircraft flight control system models have been analysed:

- X-15: PIO during landing, rate saturated actuator (pitch damper inactive), considered as rate limiter in the forward path, 1959 [Matranga, 1961].
- YF-16: PIO during unintended first flight, rate limiter in the feedback loop, 1974 [Smith, J.W., 1979].
- YF-12: PIO during aerial refueling, rate saturated pitch damper, 1975 [Smith, J.W., 1975].

The analyses of these configurations have been discussed extensively in [Duda, 1997]. In all cases, a very high effectiveness of the OLOP criterion in view of Category II PIO prediction has been found. As an example a brief summary of the YF-16 analysis is presented [Duda, 1997].

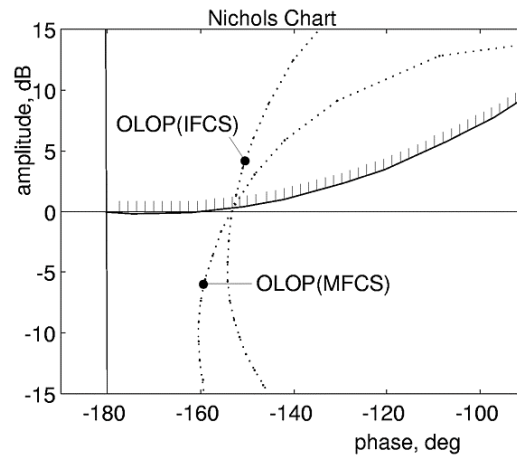
During a high speed taxi run, scheduled as part of the build-up prior to the first flight, the YF-16 aircraft inadvertently became completely airborne and a severe PIO occurred. The magnitude and rate of the pilot control inputs were sufficient to position and rate saturate the roll axis flight control system. Following that PIO incident, the YF-16 aircraft's Initial roll Flight Control System (IFCS) was modified by reducing the forward path and feedback loop gains, the roll command force gradient and by lowering the maximum commanded roll rate (MFCS is the Modified Flight Control System).

The linear analysis of these two configurations has shown that the modifications even had adverse effects on the handling qualities of the aircraft, e.g. the local phase rate parameter became worse:

IFCS:  $PR_{180} = 115^\circ/Hz$  Level 2 (boundary to Level 1)

MFCS:  $PR_{180} = 133^\circ/Hz$  Level 2

Nevertheless, it has been proven by application of the OLOP criterion that the aircraft was less Category II PIO prone, due to the gain reduction in the flight control system, as shown in Figure 5.2.30.



**Figure 5.2.30: YF-16 first flight PIO analysis**

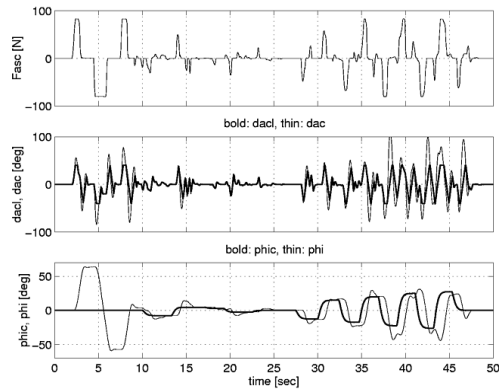
The following experimental data on PIO due to rate limiting were evaluated [Duda, 1997]:

- Space Shuttle ground-based simulation experiments from Systems Technology Inc. (STI) [Teper, et al, 1981].
- In-flight simulation experiments from Saab Military Aircraft (SMA) on Calspan LearJet, in order to test phase compensating rate limiters [Rundqwist and Hillgren, 1996].

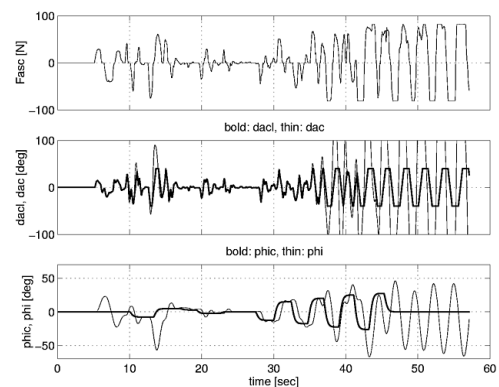
For both databases a high correlation between the predictions of the OLOP criterion and the experimental results was obtained. The STI experiments proved that configurations with Level 1 flying qualities based on the linear criteria were rated very good during the runs without rate limiting, but during the runs with rate limiting, significant flying qualities cliffs occurred. These results have been predicted by the OLOP criterion [Duda, 1997]. The well-defined tracking tasks of the SMA experiments were used to check the simple pilot models, indicating that a pure gain pilot model is suitable for this purpose.

For the final validation of the OLOP criterion new experiments utilising a three degree-of-freedom motion-base flight research simulator have been conducted within the scope of a German/Swedish cooperation on non-linear effects in modern flight control systems [Duda and Duus, 1997]. This new Category II PIO database has been analysed using the OLOP criterion.

Figure 5.2.31 presents typical time histories of two simulation runs with a Category II PIO prone configuration (based on OLOP analysis). In both runs, exactly the same conditions existed, while two completely different situations appeared. During one run, the pilot did not detect the PIO susceptibility of the F-18A 1\_0 configuration although the flight control system was significantly rate saturated (Figure 5.2.31a). During another run, a fully developed PIO occurred with the same pilot, the same task, and the same configuration (Figure 5.2.31b). These extreme differences can be considered as a demonstration of a flying qualities cliff. Furthermore, this example confirms the importance of a reliable PIO criterion for the detection of such phenomena. If a potential PIO tendency exists, it might not be discovered by pilot-in-the-loop simulations since the PIO will not develop in any case. But the OLOP criterion indicates the latent danger very clear as illustrated in Figure 5.2.29.



a) No PIO, PIOR 2



b) Fully developed PIO, PIOR 4.5

**Figure 5.2.31: Typical time histories of two simulator runs with a Category II PIO prone configuration (F-18A 1\_0,  $R = 140^\circ/\text{sec}$ )**

The differences between the PIO ratings of non-linear and linear runs have been considered for the validation of the OLOP criterion, since the criterion only addresses the decrease in the flying qualities due to rate saturation:

$$DPIOR = PIOR_{non-linear} - PIOR_{linear}$$

Figure 5.2.32 presents the OLOP diagram with all the evaluated configurations. A significant correlation between the experimental results and the OLOP criterion was found. But also some discrepancies occurred, which means the OLOP criterion seems to fail with respect to the PIO ratings. Significant examples for this are the cases, for which the OLOP criterion predicts a Category II PIO potential, but without any decrease in the pilot ratings - the bright filled symbols above the boundary in Figure 5.2.32. But these cases are not considered as criterion failures, since the OLOP criterion represents a type of worst case scenario and it predicts a potential PIO problem, but it does not predict that a PIO will definitely occur, see Figure 5.2.31. The more critical cases are those with a significant decrease in the pilot ratings, but predicted to be PIO free by the OLOP criterion, such as some dark filled F-18 symbols below the boundary. One peculiarity is the F-18 configuration, which is located clearly in the safe area, but a DPIOR 2 (linear PIOR 3, non-linear PIOR 5) was given. Looking at the measured data nearly no difference was found between the corresponding linear and non-linear runs [Duda, Duus, 1997]. Therefore, the PIOR 5 of the non-linear run has to be considered as questionable and this point can be ignored. In most flight test programs there are questionable cases.

The main finding from the experiments and analysis was that the PIO potential due to rate saturation in the feedback loop is even higher than expected. It was discovered that, for some configurations with rate limiting in the feedback loop, clear PIO cases occurred in the experiments, but the OLOP criterion did not predict PIO problems that clearly - the black filled symbols around the boundary. Furthermore, it appeared that rate saturation in the forward path is less critical than in the feedback loop, even for similar OLOP locations. In that case, the change in the system dynamics is much better understandable (predictable) by

the pilot than for rate limiters in the feedback loop. These results indicate that two different OLOP boundaries are required, depending on the location of the rate limiter (forward path or feedback loop). However, it is proposed to retain only one boundary at the moment, but with a relaxation for the rate limiting in the forward path and with the recommendation to keep a safety distance to the OLOP boundary for systems with rate limiters in the feedback loop.

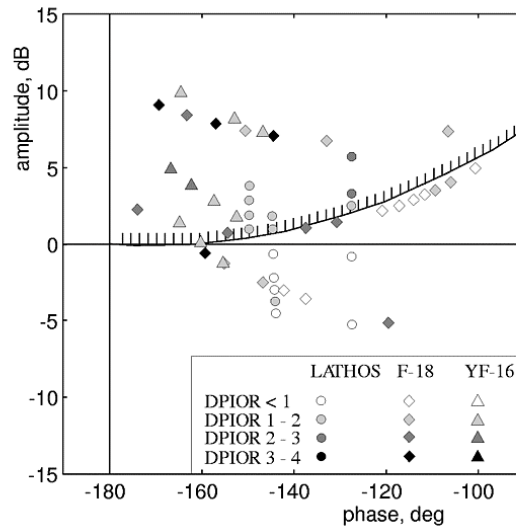


Figure 5.2.32: Validation of the OLOP criterion with experimental data [Duda and Duus, 1997]

The evaluation of the results from the German/ Swedish cooperation showed clearly that the Category I PIO criteria are not sufficient to predict the occurrence of Category II phenomena. The importance of a reliable indication of such PIO tendencies is undisputed. The OLOP criterion can be considered as a powerful design and analysis tool for Category II PIO prediction.

3) Robust Stability Analysis methods

Robust Stability Analysis (RSA) has been first used in [Anderson and Page, 1995] to analyse the robustness of the stability properties of the closed loop pilot vehicle system with rate limited actuators. In this context it has the capability of emphasising if the actuator rate limiting is potentially dangerous for the system stability, and can therefore be used to establish Category II PIO proneness of a given aircraft. Several RSA techniques have been investigated to this aim in [Scala, et al, 1999], and [Amato, et al, 1999<sup>a,b,c</sup>]. [Amato, et al, 1999<sup>a,b</sup>] compare two methods based respectively on the Robust Stability analysis of a system subject to constant uncertain parameters and on the Quadratic Stability analysis of a system subject to time-varying uncertain parameters. [Scala, et al, 1999] and [Amato, et al, 1999<sup>c</sup>] compare two methods based respectively on the Robust Stability analysis of a system subject to constant uncertain parameters and on the Popov criterion for the absolute stability analysis of a non linear system. In the following the methods based respectively on the Robust Stability analysis of a system subject to constant uncertain parameters and on the Popov criterion for the absolute stability analysis of a non linear system, are presented.

In the block diagram of Figure 5.2.33 a classical closed loop scheme for the study of Category II PIO occurrence in the pitch axis is considered.

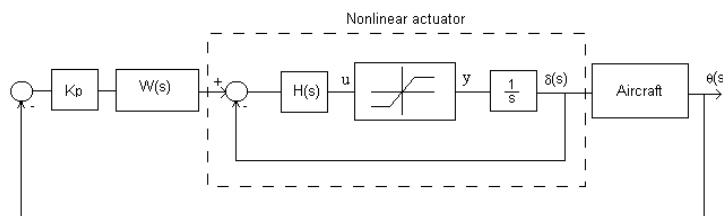
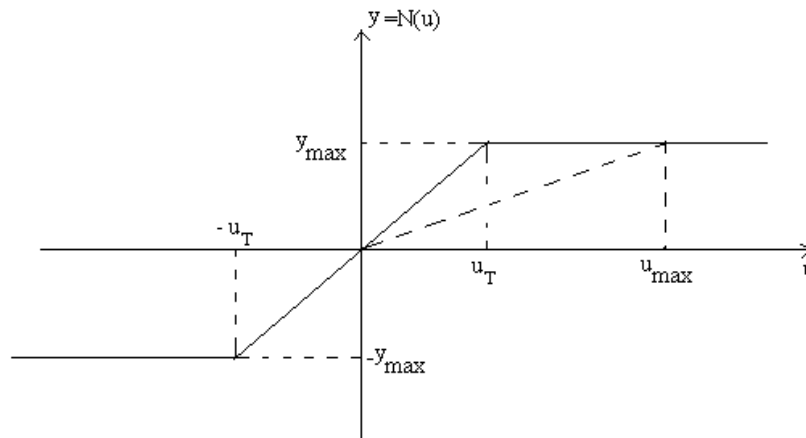


Figure 5.2.33: Closed loop diagram for Category II PIO analysis

The main blocks in Figure 5.2.33 are: the pilot transfer function, given by the series of the gain  $K_p$  and the normalised filter  $W(s)$ , the non-linear actuator, whose rate limiting is provided by the saturation non-linearity (normalised to be symmetric with unitary slope) which precedes the position integrator, and the aircraft dynamics transfer function  $\theta(s)/\delta(s)$  from the control surface position to the variable controlled by the pilot.

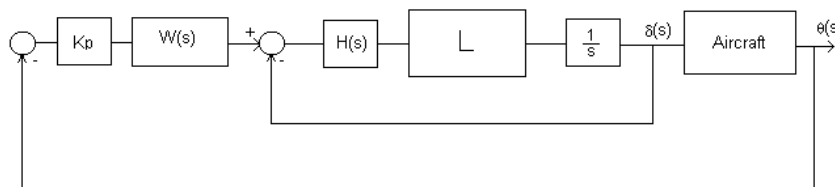
The notation for the normalized non-linearity with equation  $y=N(u)$  is given in Figure 5.2.34.



**Figure 5.2.34: Saturation non-linear characteristic**

Here  $R$  is the maximum output amplitude, i.e. the maximum actuator rate, while  $u_{max}$  denotes the maximum input amplitude.

Two techniques for PIO analysis based on robust stability methods are presented below. To this end consider the scheme depicted in Figure 5.2.35, where the non-linear element has been replaced by the linear gain  $L$ .  $L$  is the first parameter of the RSA.



**Figure 5.2.35: Robust stability analysis block diagram**

It is clear that, when the actuator is not saturated,  $L=1$  (because the non-linearity has been normalised to have unitary slope); in the same way the minimum value attained by  $L$  is

$$L_{min} = \begin{cases} R/u_{max} & \text{if } u_{max} > R \\ 1 & \text{if } u_{max} \leq R \end{cases}$$

therefore we can conclude that  $L \in [L_{min}, 1]$ .

A second parameter which is considered in the stability analysis is the pilot gain  $K_p$ ; indeed it is well known that critical full attention manoeuvres, like tracking, aerial refueling, etc., may require a high pilot gain which can trigger the PIO occurrence.

The first method, which assumes the parameter  $L$  to be *time-invariant*, will be shown to be equivalent to the DF analysis method in the prediction of Category II PIO. However, the robust stability analysis is easier to perform and can give more comprehensive results.

The second method takes directly into account the non-linear element and the stability analysis is performed by means of the so-called Lur'e Lyapunov functions which are used in the Popov criterion.

Since the first method may be optimistic and the second one conservative, by the use of both methods a complete analysis of the non-linear system can be performed.

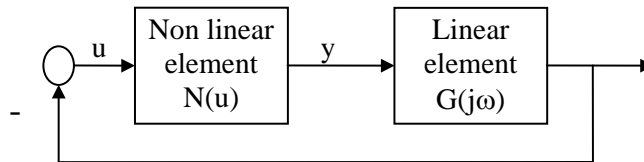
**a) Equivalence of Describing Function Analysis and Robust Stability Analysis with a Time-Invariant Gain**

The approach of this section can be used to obtain some of the results given by describing function analysis and can therefore be proposed as an alternative to it.

This alternative analysis method is based on a methodology for sensitivity analysis of poles domain location of linear systems subject to time-invariant parameters, (see [Verde, 1992]). The methodology is implemented in the software tool ROBAN, developed at CIRA.

The methodology has been applied in the past with a good success to perform sensitivity analysis of flying qualities with respect to uncertain physical parameters of the augmented aircraft, such as robustness to variation in the flight envelopes [Cavallo, et al, 1990<sup>a,b</sup>], to sensor failures [Cavallo, et al, 1990<sup>c</sup>], [Cavallo, et al, 1991], and [Cavallo, et al, 1992<sup>b</sup>], and to aerodynamic uncertainties [Cavallo, et al, 1992<sup>a</sup>].

By block diagram algebra, the system in Figure 5.2.33 can be transformed into the equivalent one in Figure 5.2.36 where  $G(s)$  denotes the transfer function of the linear part of the system.



**Figure 5.2.36: Describing Function analysis block diagram**

Consider the following problem.

**Problem NL.** *Limit cycle existence.*

*Consider the system in Figure 5.2.16. Find, if existing, the limit cycles of the closed loop system, i.e. the persistent sinusoidal oscillations of the system. Find also the frequency of each limit cycle.*

By definition limit cycles are the solutions of

$$N(u)G(j\omega) = -1 \quad , \quad N(u) \in [L_{\min}, 1] \quad (5.2.6)$$

where  $N(u)$  is the DF of the non-linearity in Figure 5.2.36; note that, in the case of saturation,  $N(u)$  is real, positive and does not depend on the frequency  $\omega$ .

If the above system of equations admits a solution, this gives the frequency  $\omega$  of the limit cycle and the amplitude  $u$  at the input of the non-linear element. Next consider the following.

**Problem LIN<sub>[L<sub>min</sub>,1]</sub>.** *Robust stability of uncertain linear system.*

*Consider the system in Figure 5.2.37, where the uncertain gain  $L$  takes values in  $[L_{\min}, 1]$ . Determine the range of values of  $L$  for which the closed loop system is asymptotically stable and that for which it is not. For the limit values of  $L$  determine also the neutral stability frequency, i.e. the natural frequency of the closed loop poles which are at the limit of stability.*



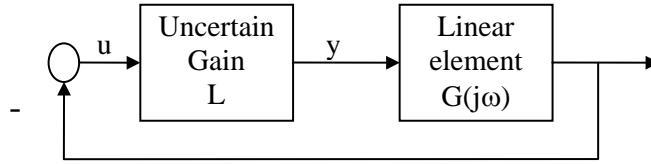


Figure 5.2.37: Robust stability of uncertain linear system

By a modification of the standard Nyquist stability theorem the search for the stability limits can be done by inspecting the stability of the system with open loop transfer function  $G(j\omega)$  with respect to critical point varying on the real axis of the Nyquist diagram within the range  $[-1/L_{\min}, -1]$ . particular this means that the limit values  $L^*$  of  $L$  and the respective neutral stability frequency are the solutions of the following

**System of Equations  $LIN_{[L_{\min}, 1]}$**

$$LG(j\omega) = -1 \quad , \quad L \in [L_{\min}, 1] \tag{5.2.7}$$

By the analogy between (5.2.6) and (5.2.7), it is evident that problem NL is equivalent to problem  $LIN_{[L_{\min}, 1]}$ .

Therefore the search for limit cycles by DF analysis and by RSA are equivalent. One of the advantages of the last approach is that the robust stability analysis is easier to perform and can give more comprehensive results.

**b) Robust Stability Analysis Using the Popov Approach**

It is important to recall that if we try to evaluate the stability of the non linear system in Figure 5.2.36 from the analysis of the linear scheme in Figure 5.2.37, the result can be fallacious; indeed the input-output gain of the non linear element in Figure 5.2.36 is time-varying, while the stability analysis performed in the previous section assumes that the gain  $L$  is time-invariant. Since stability versus a time-invariant parameter *does not guarantee* stability versus a time-varying parameter, the approaches based on both DF and RS analysis may be “optimistic” in determining PIO proneness of an aircraft. A different approach, in which the non-linear element is directly taken into account in the stability analysis and which provides a stability test guaranteeing asymptotic stability of the original non-linear system, is presented in this section.

Also this approach will provide a useful tool to estimate how optimistic the approach of the previous section is.

To this end refer to Figure 5.2.36 and denote by (A,B,C) a state space realisation of the transfer function  $G(s)$ ;

$$\dot{x} = Ax + By \tag{5.2.8a}$$

$$u = -Cx \tag{5.2.8b}$$

$$y = N(u) \tag{5.2.8c}$$

where the non-linearity satisfies the sector condition

$$L_{\min} u^2 \leq uN(u) \leq u^2 \tag{5.2.9}$$

A sufficient condition for the stability of the non-linear system (5.2.8)-(5.2.9) can be found by using the Lyapunov function [Khalil, 1992]

$$V(x) = x^T Px + 2\lambda \int_0^{Cx} N(u) du$$

where  $P$  is positive definite and  $\lambda$  is a nonnegative scalar. The application of this method is summarised in the following.

### Theorem 1

System(5.2.8)-(5.2.9) is asymptotically stable if there exists a matrix  $P > 0$  and scalars  $\lambda \geq 0$ ,  $\tau \geq 0$  such that the following Linear Matrix Inequality (LMI) is satisfied:

$$\begin{pmatrix} A^T P + PA & PB + A^T C^T \lambda + C^T \tau \\ B^T P + \lambda CA + \tau C & \lambda CB + B^T C^T \lambda - 2\tau \end{pmatrix} < 0$$

Note that the result contained in Theorem 1 is a conservative condition for asymptotic stability of the non-linear system (5.2.8) because it guarantees stability for *all* non-linearities within the sector (5.2.9) while the actual non-linear system contains a single non-linearity (the one considered in Figure 5.2.36).

### c) Test case of Category II PIO analysis

In this section we will take advantage of the equivalence between DF analysis and RSA of linear systems subject to a time-invariant parameter to predict the existence of Category II PIO in an aircraft with a rate limited actuator. Moreover, a stability analysis, using the Popov criterion, will be performed. The proposed example is the X-15 PIO case used to present the Describing Function analysis.

In order to verify the method, a comparison of the results of different approaches is presented:

1. DF analysis (presented at the beginning of section 5.2.2.1)
2. RSA of the equivalent linear system via ROBAN
3. RSA of the non-linear system via Popov criterion
4. Time simulation of the non-linear model in Simulink

The equivalent linear model of the rate limited actuator, shown in Figure 5.2.38, can be used within the RSA method to derive PIO predictions.

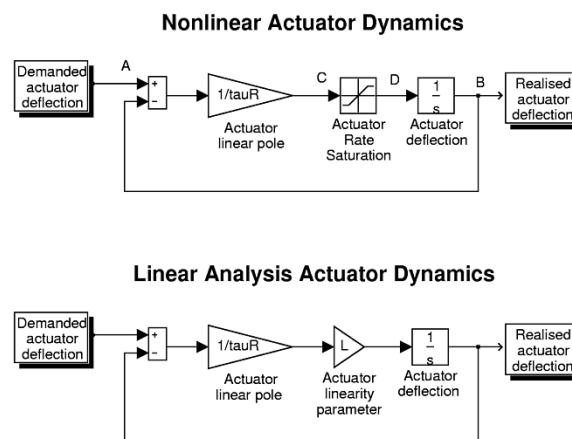
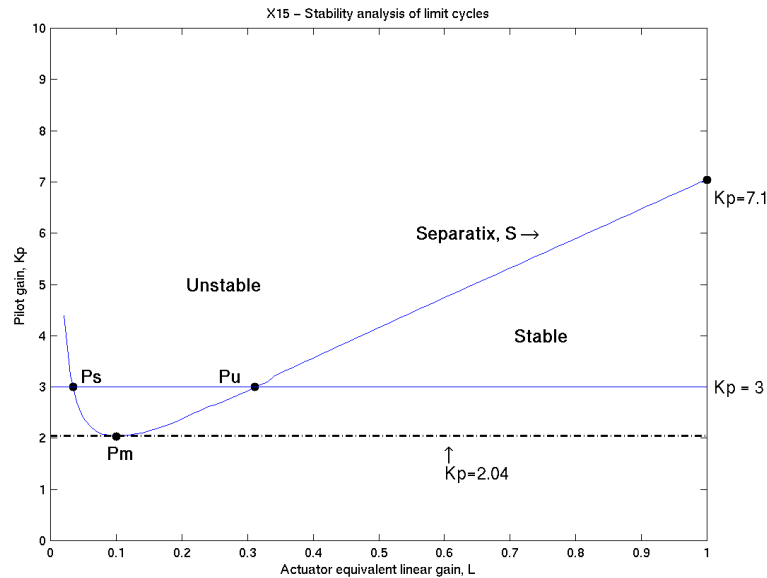


Figure 5.2.38: Equivalent linear model of the rate limited actuator

### RSA versus a time-invariant gain

In Figure 5.2.39 we present the results of the RSA. The stability boundary curve  $S$  gives the couples  $(L, K_p)$  for which the closed loop linear system of Figure 5.2.35 is neutrally stable, i.e. a couple of poles with zero real part exists, and divides the parameter plane into the stable and unstable regions, i.e. the couples of parameters  $(L, K_p)$  for which the closed loop system is respectively asymptotically stable or unstable.

By the equivalence between problem NL and problem  $LIN_{[L_{min}, 1]}$  above, the imaginary part of the neutrally stable poles is the neutral stability frequency and also the frequency of the limit cycle of the non-linear system for the given  $K_p$ . This is confirmed by the numerical analysis, as it is shown in Figure 5.2.42.



**Figure 5.2.39: X-15. Robust stability analysis with respect to pilot gain  $K_p$  and actuator parameter  $L$**

From Figure 5.2.39 it is evident the power of the Robust Stability method in the prediction of limit cycles; *from a single plot one can directly derive the existence of limit cycles for a whole set of values of the pilot gain  $K_p$ .*

In particular it is immediate to find the minimum  $K_p$  for the existence of limit cycles,  $K_p=2.04$ , the  $K_p$  for “linear” limit cycles,  $K_p=7.1$ , (which is the one for which the stability boundary  $S$  crosses the linear behaviour curve, i.e. the vertical line with  $L=1$ ) and the number of limit cycles for each value of  $K_p$ , which equals the number of intersections of the stability boundary  $S$  with a horizontal straight line of given  $K_p$ . The tangent intersection corresponds to the lower value of  $K_p$ ,  $K_p=2.04$ , for which a limit cycle with frequency  $\omega_{LC}=2.74$  rad/s is detected. The analysis on the Nichols plot of the linear system without rate saturation, previously performed, predicts the neutral stability frequency to be  $\omega=5.31$  rad/s, and the gain margin  $17\text{dB} = 7.1$ , which is also in agreement with the RSA results.

#### *Stability of limit cycles and their practical occurrence*

By use of informal, not rigorous, arguments it is possible to predict if the limit cycles found by the previous analysis can develop in a real situation.

To answer the question we analyse more deeply Figure 5.2.39 to extract further information from it.

In the following it is assumed that in the real situation to be analysed the pilot gain  $K_p$  is constant, i.e. it is held fixed to some particular value during the manoeuvre, the actual value maybe depending on the flight phase and the particular pilot himself.

The other parameter in the figure,  $L$ , is on the other hand varying during the manoeuvre, if the actuator rate saturates.

The above assumptions on  $K_p$  and  $L$  restricts the analysis to a horizontal line of given  $K_p$ .

From simple considerations it is possible to establish that the point on the left side of the stability boundary  $S$ , up to the minimum point  $(L, K_p) \approx (0.15, 2.04)$ , are points of stable limit cycles. On the other hand the points on the right side of the stability boundary  $S$  represent unstable limit cycles. A simple, intuitive explanation for this is given by the analysis of Figure 5.2.40, where the root locus of the system in Figure 5.2.35, for  $K_p=3$ , and  $L \in [0, 1]$  is presented. The “x” mark corresponds to  $L=0$ , and the circle to  $L=1$ . One branch of the root locus presents two crossings of the vertical axis, indicating the cases of marginal

stability. Considering that increasing of  $L$  is associated to decreasing of the input to  $L$ , it can be concluded that the limit cycle with higher frequency (i.e. the one closest to  $L=1$ ) is unstable and the other is stable.

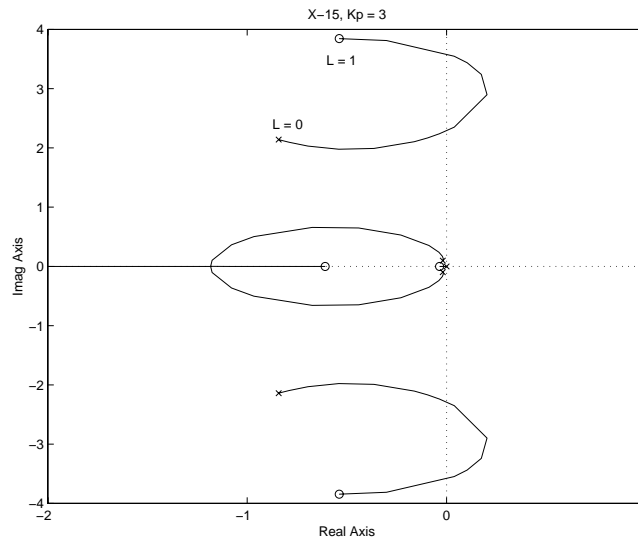


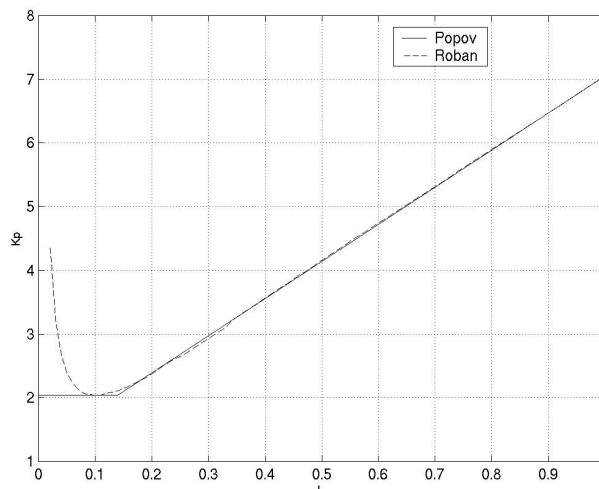
Figure 5.2.40: X-15. Root locus for varying actuator parameter  $L$

From this the following behaviour of the complete system is predicted:

- for  $K_p < 2.04$  the linear system ( $L=1$ ) is stable and no intersection with the stability boundary  $S$  (no limit cycle) is detected. Therefore in this case no limit cycles will occur and the origin of the system state space is asymptotically stable. This means that, even if rate saturation occurs during the manoeuvre, it will not develop in a limit cycle, but the actuator will exit from the rate limiting situation and the system will settle to its linear equilibrium point.
- for  $K_p \in [2.04, 7.1]$  the linear system is asymptotically stable and moving on the horizontal line at constant  $K_p$  two limit cycles are met, first an unstable limit cycle, then a stable limit cycle. We now remind that decreasing  $L$  imply that the input to the saturation element between  $C$  and  $D$  of Figure 5.2.38 is increasing, and in our case the input to the saturation is the demanded rate of the actuator deflection. Therefore it can be concluded that two behaviours are possible, depending on the amplitude of the rate demand to the actuator:
  - first as far as the system will demand a low actuation rate, the system is stable and the equilibrium point is the linear one. Therefore no limit cycle develops if the demanded rate is low.
  - when the demanded rate increases, then an unstable behaviour develops, which leads the system to the working point on the second limit cycle, the one on the left side of the stability boundary, which is a stable limit cycle. Therefore the system will settle to this limit cycle for a high demanded rate.
- for  $K_p > 7.1$  the linear system is unstable and there exists only one limit cycle, which is a stable one. Therefore in this case the steady state behaviour of the system is always a limit cycle on the left side of the stability boundary.

#### *RSA using the Popov approach*

The Popov approach has been applied to the X15 data to estimate the maximum value of  $K_p$  which does not destabilise the system for non-linearities in the sector  $[L_{\min}, 1]$ , for several values of  $L_{\min}$  between 0 and 1, say  $K_p^m(L_{\min})$ . The Popov stability boundary, shown in Figure 5.2.41 with a continuous line is obtained by joining the values  $K_p^m(L_{\min})$ . In the same figure the stability boundary evaluated by ROBAN is also shown with a dashed line.



**Figure 5.2.41: X-15 PIO analysis with the Popov approach**

As said before, the ROBAN approach may be optimistic, while the Popov approach may be conservative; in the X-15 case considered here, however, the right side of the stability boundary obtained by the Popov approach is practically coincident with the one obtained via the ROBAN approach. This validates (at least for the case considered here) both approaches.

#### *Time simulations*

A set of time simulations of the non-linear model (i.e. with the actual saturation block instead of the equivalent linear gain  $L$ ) have been run. The set of simulations includes both step responses with different step amplitudes, and initial conditions responses with different values of initial conditions of the actuator deflection and the aircraft pitch attitude angle. For each time simulation different values of the pilot gain  $K_p$  have been used and the frequency of the resulting limit cycle has been recorded.

The frequency of the occurred limit cycles is independent from the amplitude of the step input and from the given initial condition, and only depends on the value of the pilot gain. In other words the same limit cycle frequency results in all the simulations having the same value of the pilot gain.

In Figure 5.2.42 the values of the limit cycle frequencies obtained by the use of the three different methods are shown. From Figure 5.2.42 it can be derived that the same limit cycle frequency is obtained from DF and RSA for the same pilot gain  $K_p$ , while a different, higher frequency, is obtained from the time simulations. It should not be a surprise that the frequency from the non-linear simulation is different. Indeed both the describing function analysis and the robust stability analysis approximate the real non-linear system by an equivalent system in which only the first harmonic of the real non-linear oscillation is considered.

The exclusion of higher order harmonics brings this difference into the final result, as it is explained for instance in [Vidyasagar, 1992]. It is also worth to note here that the prediction of the existence of a limit cycle is already a valuable information, and that the predicted frequency is anyway close to the real frequency. Moreover RSA predicts that no limit cycles at all can be developed for pilot gain less than 2.04, and this is confirmed by time simulation, where the lower pilot gain for the generation of PIO is 2.6.

A further comment can be derived from Figure 5.2.42. The curve of the limit cycle frequencies from time simulations does have only a decreasing part in the left side of the plot, whereas the curve from DF and RSA have both a decreasing part and an increasing part at the right of a frequency of about 2.74 rad/sec. The two branches correspond respectively to the stable limit cycles and the unstable limit cycles which are predicted for the range of pilot gain  $K_p=[2.04,7.1]$ . It is therefore clear why the time simulation analysis does not have the increasing branch on the right side, they are representative of unstable limit cycles which cannot be detected in a “real world” non-linear simulation environment.

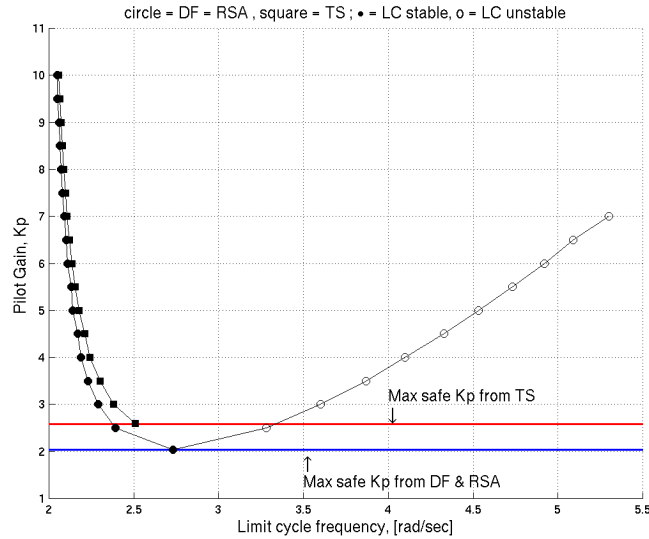


Figure 5.2.42: X-15. Comparison of limit cycle frequency predicted by: 1) DF analysis, 2) RSA, 3) time simulations (TS) of the Simulink non-linear model.

#### d) Concluding remarks

In conclusion the test case has shown that RSA is a very promising tool to be used in the Category II PIO prediction in alternative/complement to DF analysis. In order to validate the method as a PIO criterion further research is suggested, in particular on the following issues:

- pilot model(s) to be used for the analysis;
- testing other structural properties to be used as PIO indicators in alternative to system stability;
- extension to multiple non-linearities / multiaxis PIO
- quantitative correlation between parameters of the method and PIO rates.

#### 4) Hess Method With Non-linear Dynamics

The Hess method to predict handling qualities levels and PIO ratings as described in section 5.2.1 addressed Category I events only. Hess extended his method to account for the effects of actuator and software rate limiting [Hess, 1997<sup>b</sup>]. The extension is rather straightforward and this is basically because the fundamental metric used to determine PIO susceptibility is the power spectral density of the proprioceptive feedback signal  $u_m(t)$ . The assumption made is that the pilot model can be based on the linear model and can be found using the techniques presented earlier. An off-line simulation can then be performed with rate limiters in place. The interpretation of the spectral characteristics of  $u_m(t)$  as being an indication of perceived handling qualities is not confined to linearity assumptions. However, the magnitude of the commanded signal  $\theta_{cmd}(t)$  becomes important since it will influence the amount of rate limiting that will occur during the simulation. The approach taken is to scale the PSD of  $\theta_{cmd}(t)$  such that when rate limiting is removed, the root mean square value of the resulting stick displacement is 0.7 times the maximum physical stick displacement. Thus,

$$\Phi_{cc}(\omega)|_{scaled} = \Phi_{cc}(\omega) \cdot \left[ \frac{0.7 \cdot \delta_{pos}|_{max}}{\sigma_{\delta_{pos}}} \right]^2 \quad (5.2.10)$$

In which

- $\Phi_{cc}(\omega)$  =  $16/(\omega^4+16)$ , the original defined PSD
- $\delta_{pos|max}$  = maximum physical stick displacement
- $\sigma_{\delta_{pos}}$  = rms of stick displacement when using linear simulation and  $\Phi_{cc}(\omega)$

The bracketed expression in Equation (5.2.10) represents the scaling factor applied to the command signal. The amount of scaling chosen is such that the stick activity is considerable and the aircraft is excited aggressively. The choice of a factor of 0.7 was made by Hess and is based on observations of actual PIO incidents involving rate limiting that typically show very large cockpit control displacements. Once the scaling factor is found, the simulation can be run again but now with the rate limiters in place and the PSD of  $u_m(t)$  is obtained as

$$\Phi_{u_m u_m}(\omega) = \left[ \Phi_{u_m u_m}(\omega) \Big|_{sim} \right] \cdot \frac{1}{K_e^2} \cdot \left[ \frac{\sigma_{\delta_{pos}}}{0.7 \cdot \delta_{pos}|_{max}} \right]^2 \quad (5.2.11)$$

The term  $\left[ \Phi_{u_m u_m}(\omega) \Big|_{sim} \right]$  represents the PSD obtained directly from the non-linear simulation. Just as in the linear case, the  $K_e$  term removes control sensitivity effects from the PSD calculation. The final term on the right hand side of Equation (5.2.11) is the reciprocal of the final term on the right hand side of Equation (5.2.10) and removes scaling effects, thus allowing the use of the same boundaries as defined in the linear version of the criterion. The advantage of this approach is that multiple rate and position limits can be included without any difficulty, the application of the criterion just involves finding correct scaling for the command signal, running the non-linear simulation and calculating the PSD of  $u_m(t)$ .

The method has been applied only to a very limited number of cases, mainly because there are few data involving PIOs caused by rate limiting available in the open literature. [Hess, 1997<sup>b</sup>] applied the method to the HAVE LIMITS tests conducted using the Air Force/Calspan variable stability NT-33A aircraft [Kish et al, 1997]. The results obtained by applying the Hess method corresponded to the results of the flight tests. In [van der Weerd, 1999], the criterion was applied to a large fly-by-wire transport aircraft and it was successful in differentiating bad configurations that experienced Category II PIOs in-flight from the improved configuration that did not show any PIO tendencies. As an illustrative example, three typical cases are taken from this study and the results of the Hess criterion are presented in Figure 5.2.43. The details of the particular configurations are not explained here, other than that they represent Level 1 through Level 3-type configurations with varying PIO susceptibility. The mappings using the linear Hess criterion are plotted, as well as the mappings for the non-linear case. The effect of rate limiters, positioned before the elevator actuators is seen in the figure; the curves shift towards lower frequencies and the peaks become wider. The L1 configuration remains in the PIO free region, while the other two configurations both enter regions that indicate some level of PIO susceptibility. This corresponds to results that were found in flight tests.

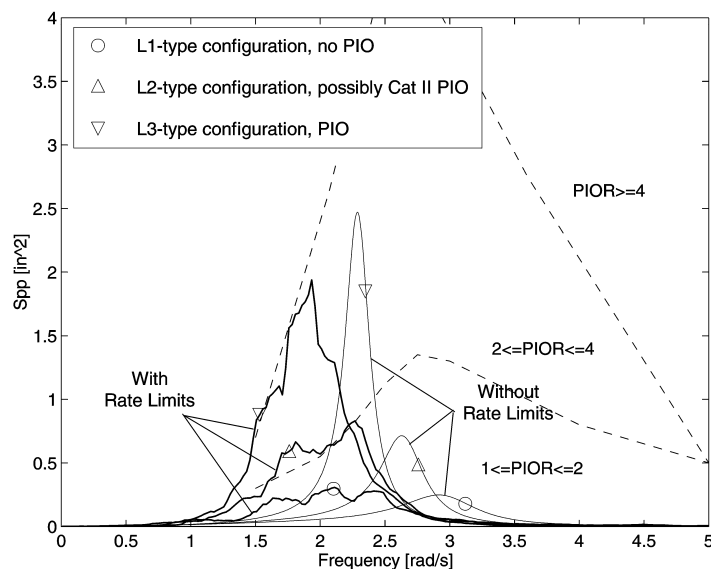


Figure 5.2.43: Hess non-linear criterion application results for selected configurations

Also noticeable is that the loci that result from the non-linear analysis are less smooth and contain spikes. This stems from the fact that in order to obtain the PSD, a Fast Fourier Transform is applied to time history data.

As explained, some strong assumptions are made in order to extend the Hess criterion to non-linear vehicle dynamics. First, it is assumed that an identical pilot model is applicable for linear and non-linear cases. This may be explained by the fact that in the short period that the non-linearity becomes active, the pilot is unaware of it and cannot adapt to unexpected changes in vehicle dynamics to compensate for them.

However, when considering the simulation using a commanded signal characterised by Equation (5.2.10), the pitch attitude motion can be extremely oscillatory, and this behaviour can be persistent. It remains questionable whether the assumption that the pilot remains to mimic the crossover model is valid. In fact, some studies indicate that during a full developed PIO, the pilot acts as a pure gain [Duda, 1997]. Gibson reports in [Gibson, 1999] that in all the PIO cases observed, whether of linear Cat. I or saturated Cat. II PIO, the pilot always drops instantly into the “synchronous” stick activity controlled by the attitude rate zero crossings. The criterion needs further validation using reliable data in order to prove its effectiveness.

### 5) Time Domain Neal-Smith

A recent effort by [Bailey et al, 1995, 1996] involved an investigation into an equivalent definition of the Neal-Smith criterion in the time domain. The rationale is that the same principles and theories used in the frequency domain Neal-Smith criterion can be used but that, because of the time domain definition, non-linearities in the vehicle description can be dealt with more easily. Covering non-linear behavior in the frequency domain requires the use of describing functions, a technique that can be complex and requires assumptions to be made of the magnitude of pilot command signals, information that is not available until an actual PIO has occurred in-flight.

#### a) Criterion description

The time domain criterion concentrates solely on the pitch attitude response and is based on a combination of the original Neal-Smith criterion and work performed by [Onstott et al, 1978]. A commanded pitch attitude step is imposed on the Pilot-Vehicle System, see Figure 5.2.44. Using the same pilot model as the original Neal-Smith criterion, the overall piloting goal (‘To acquire a target quickly and predictably, with a minimum of overshoot and oscillation.’) was translated to a set of performance requirements and constraints on the response to the commanded step input.

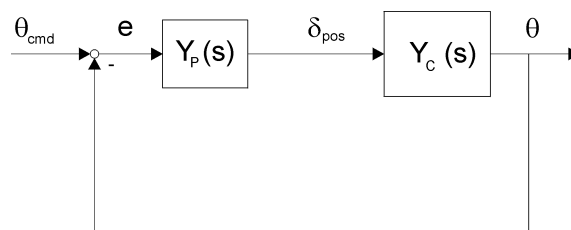
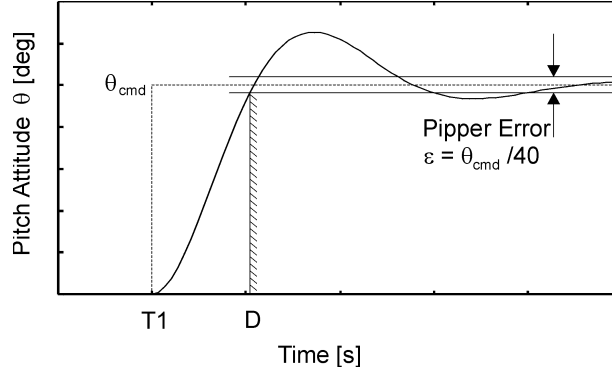


Figure 5.2.44: Pilot-Vehicle System definition for Application of the Time Domain Neal-Smith Criterion

The required acquisition time  $D$  is defined as the time at which the actual aircraft attitude is first within a region close to the commanded attitude, bounded by the pipper error, see Figure 5.2.45. By selecting  $D$ , a required task performance (or aggressiveness) is imposed to the pilot for the tracking task. The pilot model parameters are now chosen such that the acquisition time  $D$  is reached and the root mean square (rms) of the attitude error  $e = \theta_{cmd} - \theta$  after acquisition is minimized. This definition of the problem makes it an optimization problem in which the acquisition time  $D$  is a limiting constraint, the pilot model parameters are the ‘free’ variables and the cost function is the  $rms(e)$ .





**Figure 5.2.45: Pitch Response in a Step Target Acquisition Task**

The pilot variables that are varied are the pilot gain  $K_{pil}$  and the pilot compensation time constant,  $T_L$ . In the optimisation, positive values of  $T_L$  correspond to pilot lead compensation using the model:

$$Y_P(s) = \frac{\delta_{pos}}{e}(s) = e^{-0.3s} \cdot K_{pil}(T_L s + 1)$$

Negative values of  $T_L$  correspond to pilot lag compensation using the model:

$$\frac{\delta_{pos}}{e}(s) = e^{-0.3s} \cdot K_{pil} \left( \frac{\tau_{p1}s + 1}{\tau_{p2}s + 1} \right) \quad (5.2.12)$$

These two models are the same as those used in the frequency domain Neal-Smith criterion definition. For both models the equalisation rules from the Neal-Smith criterion are adopted to determine the optimal compensation. To do this, an equivalent bandwidth frequency must be defined. The acquisition time  $D$  was a measure of task aggressiveness and when assuming a perfect compensator,  $D$  can be related to an equivalent bandwidth through:

$$\omega_{BW,NS} = -\frac{1}{(D - T1)} \ln\left(\frac{\varepsilon}{\theta_{cmd}}\right) \quad (5.2.13)$$

Lead and lag terms in Equation (5.2.12) can now be computed using:

$$\tau_{p2} = \left( \frac{1}{\omega_{BW,NS}} - T_L \right), \quad \tau_{p1} = \left( \frac{1}{(\tau_{p2} \cdot \omega_{BW,NS}^2)} \right)$$

The optimisation of the model parameters is done in the time domain and that makes it sensitive to the exact definition of the step input, the time delay etc. Conventions for these parameters were suggested by [Bailey, 1995]. For a given value of the acquisition time  $D$ , the procedure outlined above will result in an optimal pilot model characterised by a pilot compensation angle and pilot gain, a Pilot-Vehicle System characterised by the closed-loop response and resulting root mean square of the error signal  $rms(e)$ . The pilot compensation angle in degrees is defined as:

$$\begin{aligned} \angle_{pc} &= 57.3 \tan^{-1}(T_L \omega_{BW,NS}), \text{ for } T_L > 0 \\ \angle_{pc} &= 57.3 \left[ \tan^{-1}(\tau_{p1} \omega_{BW,NS}) - \tan^{-1}(\tau_{p2} \omega_{BW,NS}) \right] \\ &\text{for } T_L < 0 \end{aligned} \quad (5.2.14)$$

Variations of the acquisition time corresponds to changes in the aggressiveness of the task performance and the speed of the closed-loop response. These changes produce variations in the closed-loop time history responses and the criterion relates the manner in which specific parameters change with increasing performance requirements to handling qualities and PIO potential.

A good configuration – one with good flying qualities and without PIO tendencies should not show significant variation in closed-loop response character as the task demands increase. A poor configuration – one with bad flying qualities and PIO tendencies- should show significant variation with increasing task demands. Typically, as the task demand increases and more pilot lead is used, oscillatory closed-loop behaviour occurs. By looking at the appropriate variables and evaluating different configurations whose Cooper-Harper Ratings are known, a criterion boundary could be determined. The proposed variables that are indicative of PIO potential are the  $rms(e)$  value (which has become the time domain equivalent of the resonance peak) and the pilot compensation angle (the indicator of pilot workload). By comparing the configurations of the Neal-Smith, LAHOS and TIFS (‘Pitch Rate’) data, the time domain criterion was shown to be analogous to the frequency domain Neal-Smith criterion in case the vehicle description is fully linear.

A specific metric for PIO analysis was proposed and involved the behaviour of the  $rms(e)$  values for increasing task demands. By taking the second derivative of  $rms(e)$  with respect to  $D$ , the ‘severity’ of closed-loop stability deterioration with decreasing  $D$  was thought to be revealed. Finally, the effect that rate limiting can have on the closed-loop stability was examined using several hypothetical configurations. It was shown that rate limiting elements can have an ‘explosive’ effect on closed-loop stability with increasing task demand.

### b) Criterion application

To obtain the Time Domain Neal-Smith criterion results, an optimisation is performed in the time domain, following the ‘rules’ that were just described. Use can be made of the Non-linear Control Design Toolbox for Matlab [Potvin, 1993]. The optimisation algorithm makes use of the sequential quadratic programming method, the details of which are described in this reference. An example Simulink system that interfaces with the toolbox is shown in Figure 5.2.46. Basically, the system shown represents the simple closed loop system used in the Neal-Smith criterion definition. The error signal between the commanded pitch attitude and the actual pitch attitude is fed through the Neal-Smith pilot model that consists of the lead or lag compensation including the pilot gain  $K_{pil}$  and a time delay.

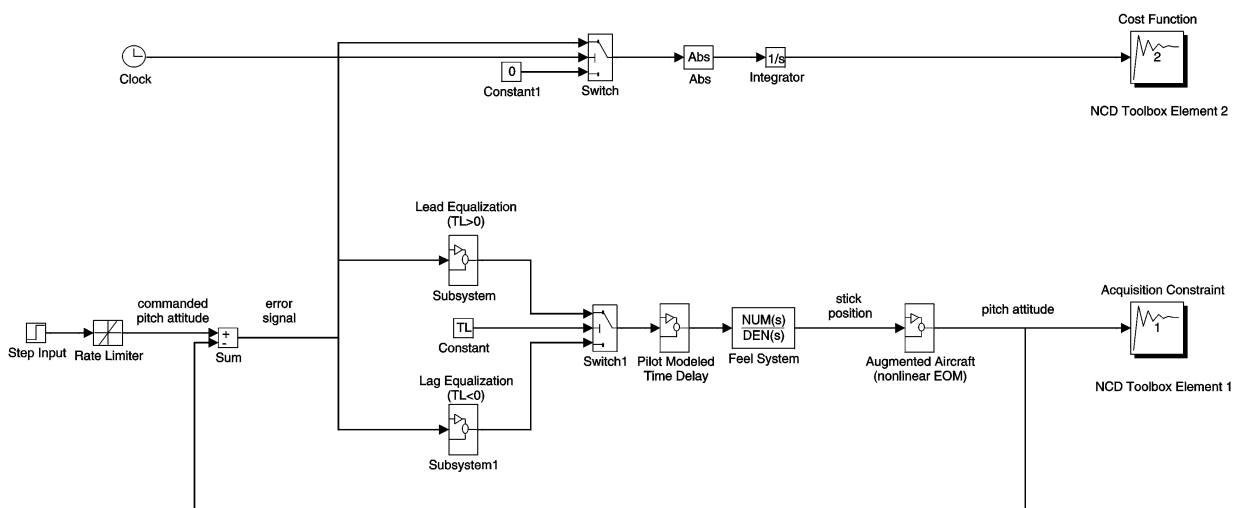


Figure 5.2.46: Simulink model used for Time Domain Neal-Smith criterion application

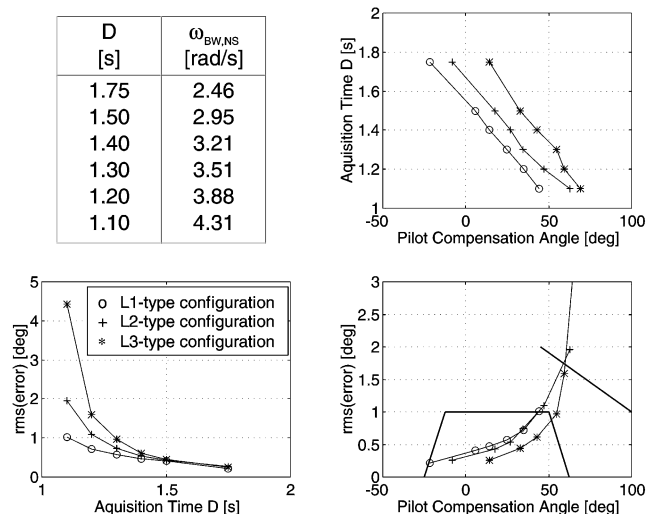
The resulting control force passes through the modelled feel system and the augmented aircraft block (typically non-linear because of rate limits). Two constraint elements are used in the optimisation. The first element, denoted Acquisition Constraint is used to impose the acquisition time  $D$  on the closed-loop step response.

The second element is used to minimise the cost function; this function is defined as the integral of the absolute value of the error signal after the target attitude is acquired. This is equivalent to the criterion

requirement that the root mean square value of the tracking error signal be minimised. The variables that can be adjusted in the optimisation are the pilot gain  $K_{pil}$  and the pilot compensation constant,  $T_L$ .

For a specific configuration, the optimisation can be run for several values of the acquisition time  $D$ . For each run, this will result in values for the pilot compensation angle as defined by Equation (5.2.14) and the minimised value of the root mean square value of the error signal. [Bailey, 1995] defined a plotting format in which all these parameters are presented. The procedure described above can be performed on fully linear models. A typical selection of linear configurations was evaluated so that a comparison could be made with the classical Neal-Smith criterion. The results are presented in Figure 5.2.47.

For each configuration, the constraint time  $D$  was varied from 1.75 to 1.1 seconds. The general effect a decrease in  $D$  has on the parameters is an increase in the root mean square value of the error signal and more positive values of the pilot compensation angles (i.e. more lead is required as the task demand increases). The poorer configurations (L2-type and L3-type) result in larger pilot compensation angles and greater root mean square values of the error signal. The lower right plot (Figure 5.2.47) can be compared to the frequency domain Neal-Smith criterion results. It follows that the loci are equivalent to those that result from the classical Neal-Smith criterion application. In [Bailey, 1995], the boundaries from the frequency domain criterion were redefined for the time domain criterion and these are plotted in Figure 5.2.47 as well.



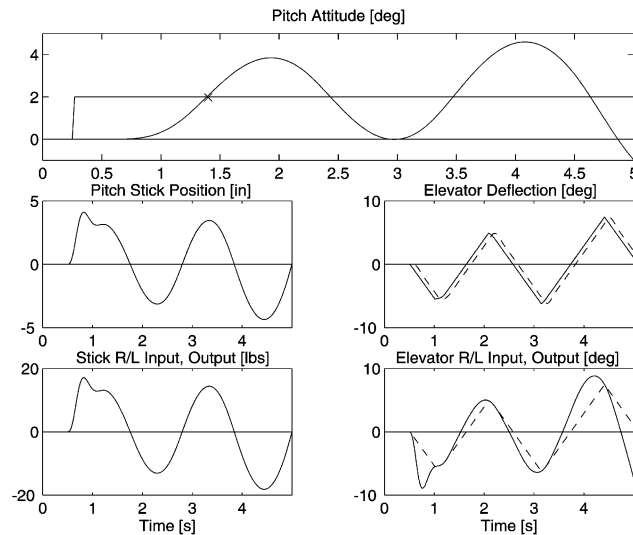
**Figure 5.2.47: Time domain Neal-Smith criterion application results for selected linear configurations**

The sensitivity of the parameters to variations in  $D$  (or, bandwidth) is comparable to the frequency domain results. The equivalent bandwidth frequencies, computed using Equation (5.2.13) turn out higher than expected. The emphasis should not be on the absolute values of equivalent bandwidth frequencies but rather on the variation of the different parameters as a result of increasing bandwidth and when this is done, the correspondence between the time domain and the frequency domain Neal-Smith criteria is evident.

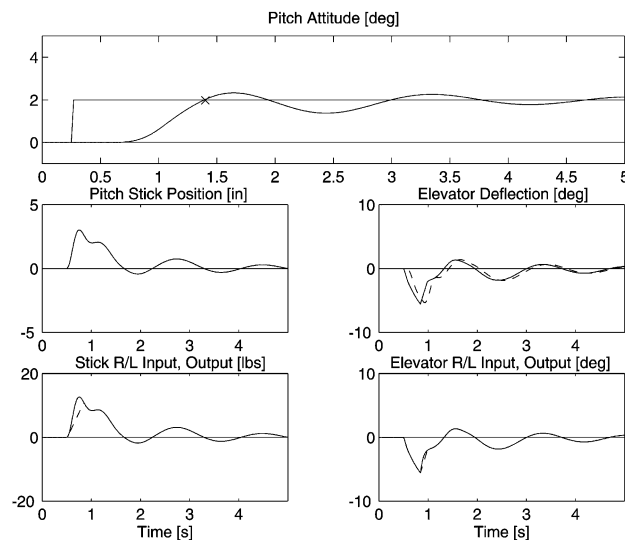
In order to show the effect of rate limiting on the criterion results, the results of an evaluation performed in [Van Der Weerd 1999] is presented here. Two typical configurations are examined; one that showed Category II PIO in-flight, and a similar configuration whose FCS was improved and did not show any PIO tendencies. The parameters resulting from the non-linear criterion application will be the same as the linear case, as long as no rate limiting is encountered. Once a rate limit is encountered an effect identified by [Bailey, 1995] was an asymptotic barrier where the value of  $rms(e)$  explodes with very small decreases in required task acquisition time  $D$ . The pilot compensation angle does not change considerably at this cliff but the closed-loop performance deteriorates rapidly. Task performance standards more stringent than the rate limit-imposed cliff (i.e. shorter acquisition times) simply cannot be attained. The optimisation performed in the criterion makes the pilot gain higher which will result in an unstable closed loop system.

This explosive effect is demonstrated in Figure 5.2.48 and Figure 5.2.49. The step responses for an acquisition time of  $D=1.4$  seconds is shown for both configurations. The solution for the PIO prone case

results in an unstable response as it is shown in the figure. For the PIO free case, the response is still reasonable for the selected acquisition time. However, as  $D$  is reduced further, a similar barrier will be encountered and eventually the resulting system will become unstable as well. This value of  $D$  was found to be around 1.2 seconds. The fact that the ‘performance barrier’ is reached at lower values of  $D$  was recognised by [Bailey, 1995] as an indication of less susceptibility to PIO. Unfortunately, no clear quantitative regions of  $D$  that define good or bad configurations were identified, mainly because of the lack of good comparative data.



**Figure 5.248: Time domain Neal-Smith response for Category II PIO prone configuration, Acquisition time  $D=1.4$  seconds**



**Figure 5.249: Time domain Neal-Smith response for PIO-free configuration, same conditions**

### *c) Practical aspects*

Some practical difficulties can arise when applying this criterion to non-linear systems. Firstly, the optimisation problem is non-convex and the risk of finding local minima over the global minimum can distort the results. Fixing this problem can be quite time consuming.

Also, around the critical acquisition time  $D$ , the  $rms(e)$  against  $D$  locus tends to become rather spiky, and determining the second derivative can give scattered results, potentially making it impossible to impose bounds to determine PIO susceptibility.

### 5.2.2.2 Summary

The criteria presented above will be discussed with respect to the following topics:

- a) Effectiveness of PIO prediction
- b) Gaps in the criteria and possible extensions
- c) Applicability to the roll axis

In general it can be stated that the lack of an extended collection of data on Category II PIO from simulator or flight test experiments makes it difficult to assess the real effectiveness of the presented methods in predicting PIO. The existing database suffer from some aspects, such as for example:

- for the HAVE LIMITS database, some time histories have not been collected correctly, which makes difficult to reproduce the data;
- for the FOSIM database, pilot ratings are not completely consistent and in some cases do not differentiate significantly between aircraft configurations.

Thus the most important comment regarding Category II PIO prediction is that research activities aimed at collecting more data on this kind of PIO is most needed.

#### *a) Effectiveness*

The comparison of the presented criteria in a way similar to Category I PIO criteria is difficult, because of the lack of an extended database for Category II PIO. Therefore their effectiveness will be described here on the basis of the results presented in the references. It is considered that further validation is in general needed, using more and reliable data, in order to validate the methods as PIO prediction criteria.

The Describing Function analysis is very effective in predicting limit cycles; its basic limit is the assumption that the oscillations are quasi-linear, i.e. that higher order harmonics have a small effect. A further limit are the computational difficulties in finding all the solutions of a non-linear equation.

In [Duda and Duus, 1997] it is shown that the OLOP prediction matches satisfactorily the experimental results. On the other hand, the OLOP cannot predict pilot ratings, but only says if the rate limit will induce a degradation of the pilot rating from the linear case. Further the boundary should not be considered as a precise limit, a fuzzy boundary seems to be more appropriate, with margins on both sides of the current boundary, to take into account the different cases of rate limiters in the feed-forward path or in the feedback loop.

The Robust Stability analysis can predict the loss of stability and the limit cycles in a rate limited situation. A quantitative PIO boundary is still not available, due to the lack of data to correlate.

The Power Spectral Density approach of Hess has been successfully applied to the HAVE LIMITS data and to a large Fly-by-Wire transport aircraft [van der Weerd, 1999].

The Time Domain Neal Smith Criterion has been evaluated on several configurations (3) of the HAVE LIMITS database. The results show that the method can qualitatively predict PIO phenomena, but no quantitative bound for PIO has been proposed yet. Known computational problems exist for the solution of the optimisation problem and for the computation of the criterion parameter, which requires a second order numerical derivative of potentially spiky data.

#### *b) Gaps/Extensions*

The main gap of the analysis methods proposed for Category II PIO prediction is the lack of rigorous quantitative bounds to correlate the criteria parameters to PIO ratings. The Power Spectral Density is an exception, since it assumes that the same bounds derived for Category I PIO are still applicable for Category II. The OLOP criterion does not correlate directly with PIO ratings, but with the degradation from the rating of the linear configuration, due to the introduction of the non-linear element. This seems a sensible approach, since a linear analysis would be performed anyway before considering non-linear elements, and those configurations that do not fulfil linear requirements would be discarded.

The application of Category II PIO criteria requires manipulating data of higher complexity than those involved in Category I. Therefore software tools that make the analysis easier are desirable. While developing these tools one should take advantage of the existing aircraft simulation models used for flight control system design, which are usually developed in software environments such as MATRIX<sub>x</sub>/System Build, or MATLAB/Simulink. The block diagram interface of these environments provides the versatility to define the location and type of non-linearities and the system structure interconnection. A MATLAB/Simulink implementation of the Power Spectral Density method is presented in [Hess and Stout, 1998].

### *c) Applicability to the roll axis*

Category II PIO can in principle be extended to the roll axis, as said for Category I PIO criteria, by changing the pitch attitude transfer function with the roll attitude. Since the principles behind the presented criteria are valid for the roll axis too, it can be expected that the application be successful. An open point would be if the same PIO boundaries of the pitch axis remain valid for roll.

The describing function method [Anderson and Page, 19xx] has been applied to the lateral-directional axis analysis, on the M2F2 test case, where it has been able to find limit cycles similar to those experienced in flight. The OLOP criterion has recently been validated in a flight simulator experiment [Duda and Duus, 1997] based on the three lateral databases of Table 5.2.3. The results show that the same OLOP boundary can be applied in pitch and roll axis which is not surprising, considering its significance. The Robust Stability method and the Power Spectral Density can also be applied to the roll axis, and it is expected that similar results will be obtained. The TDNS has initially been proposed only for extending the pitch axis frequency domain Neal Smith criterion to the analysis of non-linear configurations by using a time domain approach. No proposal to extend it to the roll axis has been made yet, and it is the opinion of the authors that the computational difficulties discussed above should be addressed first.

### *d) Conclusions*

All of the methods presented above have some potentialities in predicting Category II PIO.

The lack of an extended and reliable set of data for rate limited cases makes it impossible to fully evaluate the criteria.

It is considered that further research on analytical methods for Category II PIO prediction has to be conducted. This is further supported by one of the lessons learned from a Boeing project on APC assessment for B777 [Nelson and Landes, 1996], which remarks that the effect of the surface rate and travel limits and of non-linearities still remain among the unresolved technical issues.

## **5.2.3 Category III PIO**

Category III PIO is characterised by highly non-linear pilot-vehicle interactions including multiple dominant non-linearities, transitions in the pilot and aircraft behaviour, such as mode changes, and modification in cues (e.g. from attitude to load factor). That is, the pilot might be confronted with a variety of different effective aircraft dynamics within the oscillation. Modern aircraft systems contain several non-linear effects, which are summarised below:

- Basic aircraft:
  - Kinematics
  - Aerodynamics: Mach number, AOA, AOS, control power
- Flight control system (hardware):
  - Hysteresis
  - Acceleration, rate and deflection limits
  - Friction

- Flight control laws (functional):
  - Non-linear filters/functions
  - Data tables
  - Limitations
  - Mode changes
  - Gain scheduling
  - Protections

Besides this (incomplete) list of non-linear effects, the pilot behaviour is also highly non-linear and time varying [McRuer, 1995].

One well-defined non-linear effect - the rate saturation - has been covered above, since it has been shown to be the dominating non-linear effect (category II PIO). The rate limiting problem is readily parameterised by a relative small set of quantities, such as input amplitude and maximum rate. Describing functions have been shown to be suitable tools to address these kinds of non-linearities, but it will be hard to provide general applicable tools for the analysis of the remaining non-linear effects listed above.

A further aspect to be considered is the case when there are multiple control effectors (canards, elevons, thrust vectoring). That case leads to a multiple axis problem, which complicates the situation tremendously. For configurations with multiple axis control surfaces (elevons), combinations of roll and pitch inputs might cause severe problems, while looking separately at the two axis does not reveal any problems. The second JAS39 crash occurred due to these kinds of problems. Therefore, a method is required to find the worst pilot input signals, such as the worst combination of roll and pitch control inputs for elevon configurations.

For at least some of the Category III PIO cases that have been encountered, it appears that the aircraft were susceptible to Category I PIO. Hence, the suggestion has been made that those PIO were initially Category I, then diverged to rate limiting and then finally became Category III. This suggestion brings up the question whether Category III PIO is relevant to the flight control system designer, if he considers the Category I and II PIO criteria.

A general rule is to avoid triggers. One significant trigger is the automatic change of the flight control system due to configuration changes, e.g. gear transitions. The term *avoid triggers* also means to be careful with non-linear functions in the flight control laws. The designer has a lot of freedom today, but the goal should be to keep the system as linear as possible. Non-linear effects in modern flight control systems provide a large potential for *unexpected effects*. It is extremely hard to consider all possible adverse impacts of non-linear elements in flight control system.

## 5.3 MODELLING AND SYSTEM IDENTIFICATION

### 5.3.1 Introduction

The availability of a model describing the flight vehicle is the prerequisite for any synthesis and analysis of FCL. By means of a reliable model parameter and sensitivity studies can be performed to improve the system knowledge to detect, avoid and fix design problems already in the early design phase. The later the potential deficiencies of the augmented aircraft are detected, the more expensive it is to put them right. Therefore, from the beginning the modelling of the aircraft including all subsystems plays an important role for the overall design process. The accuracy of the used flight vehicle model affects the number of repetitions in the later design phases and thus influences the costs of the entire design process.

Recent approaches aim at performing the first design phase only once. This objective has been illustrated by phrases like “first time right” or “one shot approach”. These terms mean that iterations are allowed within computer simulations, but the results that come out of the computers (to be implemented on the flight simulator and the real FCS) have to satisfy the defined requirements. This will only be possible by using high quality models with defined (limited) uncertainties. From this point of view it can be expected that the

modelling process will gain even more importance in future taking also advantage from object-oriented model-building and automatic code generation (see section 5.3.3).

The full authority FBW systems of modern aircraft enable the FCL designer to tailor the aircraft dynamics to a wide range of desired performance characteristics and handling qualities. The quality and accuracy of the mathematical models describing the basic flight vehicle and its subsystems used for the FCL design have a tremendous impact on the quality of the FCL and the achievable control bandwidth [Padfield, 1988].

Uncertainties in the models can lead to sub-optimal controller operations, reduced flight performance, and very often result in additional costs. Therefore, it is obvious that for the FCL design reliable high quality models are required. This is true not only for the synthesis of FCL but also for real-time applications in manned simulators used for the FCL validation (see section 4.6).

For the mathematical modelling of atmospheric flight combinations of various interacting processes based on different physical effects have to be taken into account. The knowledge of aerodynamics and fluid mechanics is required to model the aerodynamic forces and moments. The propulsion experts (fluid dynamics and thermodynamics) have to supply their inputs in terms of mathematical relations. The structure people must specify the mass distribution, inertia, and the aeroelastic behaviour of the aircraft. The system engineers have to model the relevant aircraft's subsystems (e.g. actuators, gear, flaps). Meteorological models are needed to describe the atmospheric conditions. Weapon specialists have to define the effects of weapon or missile operation, drop, and delivery on the flight vehicle. The flight mechanics will connect all the forces and moments acting on the aircraft to provide the rigid body dynamics. Hence different disciplines of science and applied engineering have to work closely together to develop a reliable mathematical description of the entire process.

To produce realistic inputs into the modelled aircraft, guidance and control information have to be expressed by mathematical equations. Depending on the respective task the exactness of the modelling might require many more additional contributions from other disciplines. For example the electronic sciences may help to model sensors, signal chains, and display characteristics. Even contributions from medicine and anthropology can be required if specific human behaviour is a matter of concern.

Obviously it is impossible to model the complexity of the real atmospheric flight and its physical effects in detail with an acceptable effort. Especially in the beginning of a new aircraft design a relatively poor knowledge about the vehicle is available concerning the aerodynamic database, mass and inertia, the FCS hardware (actuators, sensors), computing time delays, elasticity, etc. But experience is commonly available to define probable uncertainties in the aircraft and subsystems, which can be specified for a certain model (model uncertainties) and hence consequently can act as design tolerances in the FCL design phase. But if the uncertainties defined are too big this will result in a loss of control performance. For that reason all known relevant real-world effects should be considered for modelling, at least by the introduction of suitable approximations.

The model requirements (see section 5.3.2) are directly defined by the expected results. Regarding the respective task and application the entire process of the atmospheric flight can be simplified or even reduced to sub-processes representing the relevant sub-dynamics [Brockhaus, 1994]. But the user of such simplified dedicated mathematical models has always to check that the chosen model is valid for the respective application and that the results are not badly affected by unmodelled effects. The designer must have understood the models of all subsystems, especially concerning their non-linear effects. Simplified linear models should be matched against the non-linear models by comparing the corresponding time responses. The limits of their validity have to be established.

The ultimate test for model validation is the comparison with flight test data. Model deficiencies (parameter deviations as well as unmodelled physical effects) can be discovered by using modern system identification methods (see section 5.3.4) [Hamel, 1994]. Therefore, comprehensive flight tests in a variety of conditions and with dedicated manoeuvres are required in order to get maximum reliability of the used models. This might result into necessary model adaptations and updates to meet the desired model quality. The interplay between simulation and system identification helps to reduce the risk for flight envelope expansion during



flight testing of new FCS. For the development of FCL based on mathematical models a set of design criteria is required. From sections 4.1 and 4.2 it can be gathered that the majority of the design criteria for FCL development has been developed and validated for linear aircraft models. But the mathematical description of a real flight vehicle covering its whole flight envelope is non-linear. In contrast to linear systems, where a complete system theory is available, non-linear systems can be analysed only for special cases. In addition the effort for the non-linear system analysis is much higher than for linear systems, even for special cases. By careful utilisation of linear models in combination with the available set of linear criteria in the early design phase it should be possible to develop linear FCL, which provide good flying qualities. But many of the difficulties with flight control systems are due to aerodynamic or system non-linearities and a possible lack of appreciation of their significance by the designer (see section 4.2). For this reason it is an absolute must to check the linear FCL in the more complex non-linear model environment.

The availability of high computing power provides the opportunity for the model developer to introduce more and more highly complex non-linear elements into the model which help to make the models more and more realistic. Keep in mind that it is very easy to implement lots of additional non-linear functions into a model, but it is much harder to check and verify their correctness and faultless operation within the entire range of the required model validity. The real art of modelling is the balance between model realism, complexity, transparency, necessary efforts, and costs (see B2.1).

### 5.3.2 Modelling for Control System Design

As one might expect, the modelling requirements for Control Laws (CL) design and verification embody requirements for other aspects of FCS and aircraft design.

Analyses and investigations to be conducted during the different phases of the design require different levels of detail, while the maximum level of accuracy is used throughout the process of verification. Additionally, development and verification need some sub-modules to be exported from the simulation model to other simulation/analysis tools (such as real-time simulators, specific design tools, etc.) and vice-versa. The need to fulfil such tasks by the same tool leads to the creation of highly versatile simulation models. It is evident, from this point of view, that the term “model requirements” is no longer addressed only to mathematical modelling, but also to the structure and the flexibility of the simulation model.

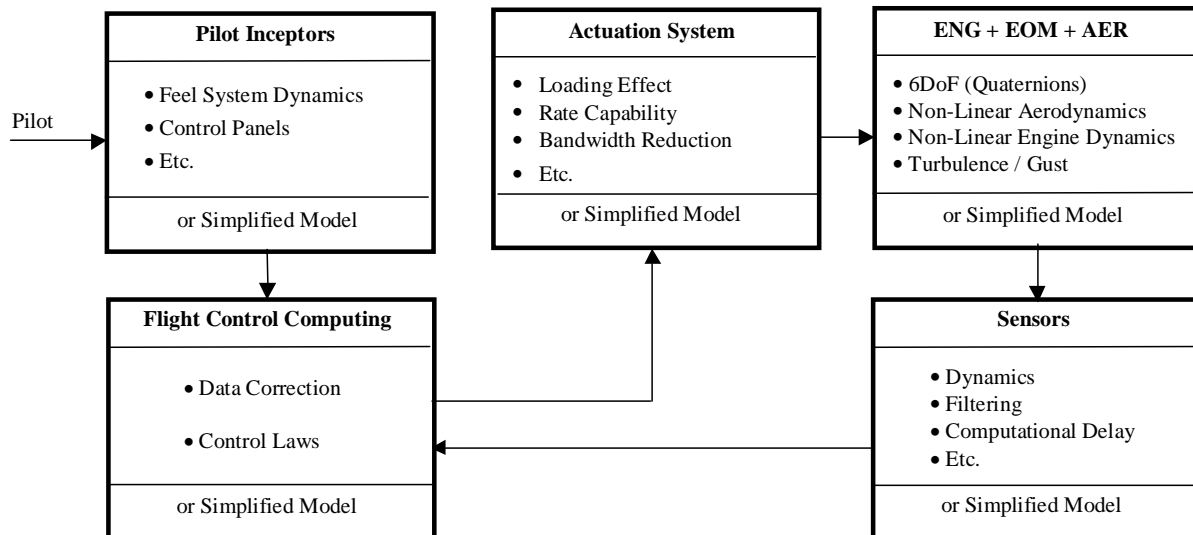
The issue of the requirements for the development of the aircraft simulation model will be shortly discussed in paragraph 5.3.2.1. The available simulation environment will strongly drive the FCL design process and affect the timetable and the costs. Therefore, a brief overview of the modelling environment requirements will be given in paragraph 5.3.2.2, while, in paragraphs 5.3.2.3-5.3.2.11 the modelling of the various items that form a modern augmented aircraft will be introduced and briefly discussed, taking care of the implications of some approximations.

#### 5.3.2.1 Model Development

The development process for a complex aircraft simulation model starts with the collection of all relevant modelling elements with respect to the final application(s). The system/aircraft to be modelled needs to be broken down to the required level of detail, e.g.

- System
  - Sub-systems
    - Components
      - Functions
        - Sub-functions

Each developed model element has to be verified and validated before it is integrated into the next higher level. At least for higher levels the verification and validation should involve all persons concerned. These are the experts / engineers (designers of the real world system), the end users, and of course the model developers.



**Figure 5.3.1: Aircraft simulation model**

The complete simulation model is synthesised from the approved modules. Some modules might come from other (already existing) sources. The exchange of modules between different simulation set-ups / analysis tools has the advantage of a common and efficient use of identical models.

A requirement for the exchange of modules is the definition of model interfaces and data formats respecting the different simulation set-ups and also considering the analysis tools. The model development has to be accompanied by a documentation procedure for all model levels providing information on:

- Model description
- Functions
- Assumptions and constraints
- Limitations
- Interrelations

An important but sometimes underestimated requirement is a clear and consistent model version management filing all changes and revisions. This version management should be completed by a notification concept / service keeping all affected persons informed about the current status of modelling / simulation.

### 5.3.2.2 Modelling Environment

The design of control laws is strictly related to the availability of a simulation/design environment which provides a high level of detail for the aircraft model and the possibility of running control system design & analysis tools.

With regard to control laws design, the main difficulties arise from the significant tasks to be faced such as:

1. aerodynamic data analysis & validation (unaugmented aircraft stability and controllability analysis, aerodynamic tables and build-up implementation, parameter identification, etc.)
2. FCS architecture design (sensors, actuators, data filtering and processing)
3. mathematical modelling of: aircraft motion, aerodynamics data set, servos, sensors, engine, hydraulic system, etc.
4. validation of the linear models through comparison with the non-linear/flight test estimated models
5. control laws design techniques (classical and modern)
6. linear/non-linear simulations

In the past, control law functionality has been captured by using hand made code (such as Fortran or C). This code did not allow an easy check of its consistency and usually required large amount of work for any modification. Furthermore, the inherent incapability of an easy and flexible production of plotting, documentation and database called for more comprehensive and adaptable code.

The efforts spent in this direction in the past decade have led to a large number of *Visual Modelling Oriented Software* (VMOS) packages. This kind of software allows the user to define his aircraft model by means of a visual modelling environment and his routines (toolboxes) by means of powerful mathematical engines.

The increased computational load connected with the complexity and the “interpreting” nature of these programs has been overcome by the increased power of new computers and the capability of automatically generating code (Fortran, C, ADA, etc.) from the block diagram of the system. Among this type of software, Matlab/Simulink, MATRIXx/SystemBuild, EASY5 and DYMOLA are notable examples. Moreover, some of these programs offer what could be called “Physical Block Diagram Representation”; i.e. the appearance of the modelled system reflects that of the actual implementation schemes.

By means of such tools it is now possible to generate comprehensive non-linear aircraft simulation models inclusive of systems such as sensors, actuators, air data correction and so on (Figure 5.3.1). The idea behind these Flexible<sup>1</sup> Simulation Models (FSM) is that a unique, fast and compact simulation model can be used to generate accurate non linear simulations as well as simplified models where the simplifications can be chosen by the designer according to the case.

Another point to be made is that the multidisciplinary aspect of the FSM allows users from different departments such as Stress, Aerodynamics, Flight Test, Systems, etc. to use the same model (and the same data-base) for their computation and in so doing, contributing to the better matching of the real system.

The capability of the FSM of generating code from graphical block-diagrams representations could give the ability to reduce or even fill the gap between the simulation models used for off-line and pilot-in-the-loop simulations [Cavalcanti, 1998].

The Aermacchi (AEM) experience on this subject starts from the late 80s. The flexibility of the FSM has made it the most used tool in the Flight Mechanics and Control System Design departments. It has been used for the widely differing purposes such as aerodynamic data validation, loads computation, flight accidents reconstruction, fidelity of real time simulators, design of Yaw-damper / flight director / trimming devices / control laws, and so on.

### 5.3.2.3 Equations of Motion (EOM)

#### a) Writing the E.O.M.

The implementation of the rigid body equations of motion does not represent a complex task, bearing in mind some basic principles related both to the physics of the problem and to the way in which a computer works. In the following, some issues, which are considered of paramount importance in relation to EOM simulation / analysis, will be presented.

The Euler angles can be computed through quaternions [Robinson, 1958; Mitchell, Rogers, 1965], which allow the model to be in any possible orientation with respect to the earth-based inertial reference frame without having the simulation problems (trigonometrical discontinuities) related to unusual attitudes such as those of vertical climbs or dives. A general rule, especially true for equations of motion, is to protect the model with regard to singularities (see BP2.6). In the case of EOM, these singularities could be represented by zero speed, 90° of angle of sideslip, etc.

The equations of motions shall be written in their explicit form [Brumbaugh, 1994]. There are several good reasons for this: lower computational load, reliable linearisation and efficient use of memory.

---

<sup>1</sup> Flexible here implies versatility and not airframe structural characteristics, although these could form part of the model.

One of the problems to be faced when running an aircraft simulation is that some aerodynamic data are related to the derivatives of the aerodynamic angles, and if the actual value of these derivatives is fed into the aerodynamic data set, a loop will be created in which the derivatives of the states generate forces and, thus, the derivatives themselves. This situation is often called an “algebraic loop” [MATRIXx/ SystemBuild User’s Guide; Matlab/Simulink User’s Guide] and is well known by people writing simulation code. The VMOS will usually solve the loop iteratively during simulation, resulting in longer simulation times. This situation is usually by-passed either by inserting high frequency filters or by using a “sample and hold” block. In this way, the implicit loop will be broken and the system responses will not be significantly modified if the time constant used for the filter or for the “sample and hold” block is sufficiently small (but not so small to slow down simulation by necessitating a small integration step size). An alternative approach could be to solve the EOM with respect to the derivatives if the forces/moments dependence from  $\dot{\alpha}$  and  $\dot{\beta}$  is simple (e.g.  $F_{\dot{\alpha}} = K \cdot \dot{\alpha}$ ); this approach could also be used when the EOM are written in body axes, by noticing that:

$$\alpha = \angle \tan\left(\frac{w}{u}\right) \Rightarrow \dot{\alpha} = \frac{\dot{w}u - u\dot{w}}{u^2 + w^2}$$

$$\beta = \angle \sin\left(\frac{v}{V}\right) \Rightarrow \dot{\beta} = \frac{V\dot{v} - \dot{V}v}{V^2 \cos \beta}$$

It shall be possible to use the same simulation model to perform simulations by replacing the equations of motion with simplified models of them. For instance, a longitudinal stick step simulation could be performed with the complete 6DoF model, the longitudinal 3DoF model, the 2DoF model obtained by freezing the speed and the 6/3/2DoF models obtained by linearisation of the equation of motions and selection of the appropriate states.

The equations of motions shall be written in their explicit form [Brumbaugh, 1994]. There are several good reasons for this: lower computational load, reliable linearisation and efficient use of memory.

#### *b) Simplification of the E.O.M.*

Analyses and investigations often require a simplification of the EOM. These simplifications, to be used for replacing the complete EOM, could be divided into two main groups:

1. Non-Linear Models; in this case the equations of motion are replaced by an approximation in which some simplifications have been introduced such as: frozen flight path speed, longitudinal / lateral-directional decoupling, etc.
2. Linear Models; in this case the equations of motion are linearised together with the aerodynamic tables and probably the engine and flight control system too.

The first class of models is usually used to perform simulations with approximations that allows the user to specify either particular piloting actions or conditions. For example, let us take into consideration a manoeuvre such as a “windup turn” in which the pilot, in the attempt to keep both load factor and speed constant, loses altitude. In this case the aircraft response is generally well approximated by a simplified non-linear 2DoF longitudinal model in which the effects of attitude and speed are frozen.

The linear model class is generally employed for control laws design, robustness assessment and flying qualities assessment. In this case, the response of the linear system shall be matched with that of the non-linear one [Marchand, et al, 1993; Anon., 1980] (see BP2.8). To do so, it shall be possible to specify the input/state perturbations to be used for linearisation.

#### *c) Remarks on the solution of the trim problem*

Control laws design and verification by means of off-line simulations require the FSM to be trimmed in different conditions such as:

- Straight and Level flight (S&L)
- Steady Turn (S-T)

- Pull-up / Push-over (P-U)
- Steady Heading Steady Sideslip (SHSS)
- Other manoeuvres

For each of this group, many options are usually needed because of the different parameters the designer will need to fix depending on the case.

A correct trim condition is essential for both simulation and linearisation. From this point of view it is very important to:

- specify the exact number of constraints by freezing states, outputs and state derivatives
- verify that the number of unknowns is equal to the number of constraints
- monitor the rank of the problem during the trim process

Basically, any numerical method relevant to the solution of a constrained optimisation problem [Luenberger, 1987; Gill et al., 1981] is suitable for the trim process. From a practical point of view the big difference is whether or not all the states of the system are accessible by the trim routine. If the whole state vector is accessible, in spite of the complexity of the model a simple Newton-Rapson [Press et al., 1989] method has been found to be very efficient and reliable. If not all the states are available, the trim condition could be found iteratively by simulations performed with fixed inputs, changed at each step to obtain steady-state outputs response.

#### 5.3.2.4 Aerodynamics

Even the best modelling of aircraft systems and EOM will not help if the Aerodynamic Data Set (ADS) is not reliable. The amount of data, the complexity of the mathematical model to be used and the quality of the ADS depend on the type of aircraft and the task to be fulfilled. In this section no consideration with regard to the validity of the data will be made, but only some general considerations with regard to ADS modelling.

It shall be possible to limit (saturate) or not limit the maximum and minimum values of the ADS inputs such as angle of attack. The AEM experience is that combinations of input variables in which some are outside their range usually ends up in erroneous extrapolations. Unfortunately, such conditions are often encountered (usually in loads survey analyses). In this case, different approaches have been used with regard to different input variables and conditions. In general, a very good feature is that of generating warnings where an extrapolation is made in the ADS. In the case of the AEM FSM the simulation is even stopped if a variable like angle-of-attack or Mach goes outside its range of validity (see BP2.6, BP2.7, BP6.2).

Another point to be considered in relation to variable saturation is the trim process. In general, the trim procedure requires several linearisations of the aircraft model for gradient-based method. These linearisations are performed by using generic values for states and input perturbations. Where saturations of variables exist, the results of the linearisation could prevent the trim routine from convergence. Irrespective of which trimming method is used, there needs to be a clear strategy for dealing with this situation. For example, in the AEM FSM, almost every saturation block could be disabled during linearisation.

The longitudinal wind tunnel coefficients could be available either in body or in stability axes. On the other hand, the lateral-directional wind tunnel coefficients are, in general, available in body axes. Several possibilities have been discussed at AEM with regard to the axes to be used to express the aerodynamic coefficients. Stability axes are useful for wind tunnel/simulation data comparison, while body axes seem to be better for analysis and control system design needs. For example, the maximum load factor for the specified flight condition and aircraft configuration would be evident if body axes were used to express longitudinal forces.

In general, aerodynamicists try not to modify wind tunnel data in order to represent the aerodynamic phenomenon better. This could result in coefficients that, once derived, originate extremely scattered derivatives curves. In this case, reasonable derivatives can usually be obtained by selecting the appropriate perturbations for the input variables to be used during linearisation. If this approach is not sufficient the ADS could be linearised separately for the selected flight condition and then used for the linearisation of the whole aircraft model. A good rule is to use wind tunnel data as much as possible as they are. The data collected in wind tunnel usually contains more information than expected (see BP2.2). The blending of data from different wind tunnels should be avoided. Where this is impossible, like most of the cases, the combination of data coming from different sources shall be carefully performed, taking care of all the possible differences (measurement equipment, aircraft model, etc.).

### 5.3.2.5 Engine

Accurate modelling of the engine(s) dynamics plays an important role when manoeuvres that involve large thrust setting changes shall be investigated, for auto-throttle design, or for control laws design of STOVL aircraft. In the simplest case, a first order model could be used if the time constant is a function of the engine and flight conditions (RPM, altitude, etc.) [Gilbert et al. 1976]. This approach can be improved by considering thrust rate limitations being a function of the thrust level [Schänzer]. On the other hand, if the propulsion system dynamics is of primary concern for CL design, accurate engine models should be used.

Usually, the engine model used for FCL design represents a simplification of that employed in pilot-in-the-loop simulations. On the other hand, the philosophy of the FSM and the possibility to generate code from the VMOS, leads to the use of the same engine model for both off-line and pilot-in-the-loop simulations.

The use of the FSM for point-performance (PERF) calculation is, obviously, beyond its scope. However, it is good practice to share the same engine tables between the FSM and PERF models [Hoffren et al. 1998]. In general, the availability of the correct engine deck in the FSM will greatly help the CL and FCS designer in selecting the most appropriate flight conditions for the design.

Moreover, the modelling of the engine is also important for the modelling of the actuation system if the effects of pressure/hydraulic flow are taken into account by introducing pump characteristics.

### 5.3.2.6 Actuation System

As discussed in section 5.2, an accurate model of the actuation system is crucial for the design of effective and PIO free CL. For this reason, all the relevant effects on the actuator shall be carefully introduced.

Even if a generic model for an actuator does not exist, some basic items can be identified:

- Rate Capability (*RC*): maximum no-load rate
- Nominal Bandwidth (*NBW*): no-load bandwidth
- Stall Load (*SL*): maximum actuator output force (stalled load occurs at zero velocity with the valve open [SAE, 1993])
- Control Module Characteristics: direct-drive valve / electro-hydraulic, bandwidth, damping ratio, spool stroke, etc.

Beside these, other characteristics should be known during the design phase, such as:

- Hysteresis
- Threshold (lowest level of input which will produce a perceptible and measurable output [SAE, 1993])
- Free play
- Failure transients
- Actuator characteristics in failure states

From the above characteristics, a large series of effects affecting either stability or manoeuvrability could be derived.

The *NBW* represents the bandwidth of the actuator for small-medium amplitude inputs. Since the aircraft will be designed to operate in such conditions for most of its life, it is of paramount importance to use the correct bandwidth for the actuator model.

When the input amplitude is such that the rate required for the actuator to reproduce the commanded input is bigger than its *RC*, the bandwidth of the actuator drastically decreases [Klyde et al., 1996]. Moreover, this reduction is accompanied by an increase of the negative slope of the gain and phase plots. This higher phase and gain rate means that a small increase in frequency will be accompanied by a significant decrease of phase and gain. The modelling of such effects is relatively easy for non-linear simulation. In the case of the linearised model, these effects could be introduced with different degrees of accuracy. At first, only the reduction of bandwidth due to input amplitude might be considered. Thus, the phase and gain rate variations due to the saturation are neglected. Better results will be obtained if the frequency response of the saturated actuator is matched with the transfer function of an equivalent linear system to be used in place of the actuator model for linear analysis. Figure 5.3.2 shows the experimentally determined bandwidth of an actuator with respect to input amplitude. The reduction of bandwidth due to rate saturation is evident.

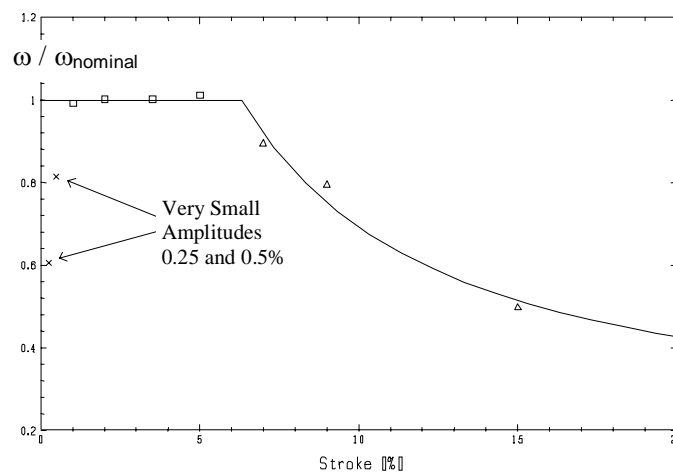


Figure 5.3.2: Unloaded Actuator Bandwidth vs. Input Amplitude, Experimental Results

The rate of the actuator does not depend uniquely on its *RC* but also on the load *L* acting on the actuator. For instance, an unloaded actuator will move with a rate equal to its *RC*, while a loaded actuator will move with a rate *RC<sub>L</sub>* smaller (or bigger) than *RC* for an opposing (or aiding) load.

It should be noted that, depending on the type of load acting on the actuator, different results could be obtained for its frequency response. Figure 5.3.3 shows the frequency responses for a load proportional to rate (i.e.  $L = K \dot{\delta}$ ).

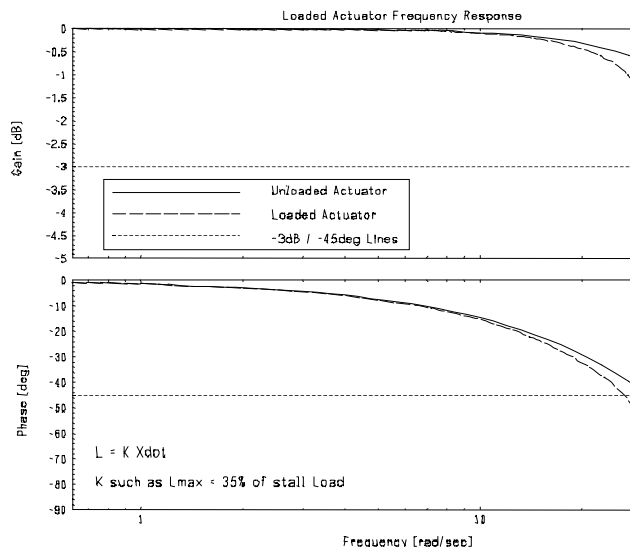
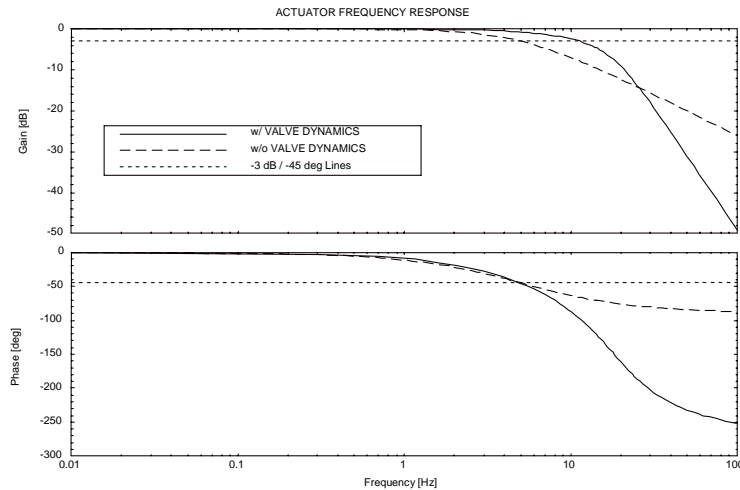


Figure 5.3.3: Loaded Actuator Frequency Response

A model of the control module shall be introduced, especially for PIO analyses. While a simple actuator can be modelled by a first order system the introduction of the control module, that is usually represented by a second-order model, makes the whole system a third-order one. Figure 5.3.5 compares the responses of two actuator models having the same bandwidth (defined at  $-45^\circ$  and  $-3\text{dB}$ ) but of different order (first and third order respectively). From Figure 5.3.4, it is evident that the control module dynamics plays a significant role where medium-high frequency phenomena are investigated.



**Figure 5.3.4: Actuator Model with (w/) and without (w/o) Control Module Dynamics**

The effect of hysteresis and threshold influences the very small amplitudes responses like that encountered at high speed where high control effectiveness exists due to high dynamic pressure. Furthermore, hysteresis could be considered mainly responsible for the bandwidth reduction that occurs at very small amplitudes also shown in Figure 5.3.2. As an example, for an unstable aircraft, the modelling of hysteresis in such conditions will determine the amplitude and frequency of the limit cycle oscillations.

In presence of failures resulting in operational states that require level 3 flying qualities, such as reduced operating pressure or hydraulic flow rate, depending on failure probability controllability shall be guaranteed in spite of the degraded performance of the actuation system. For this reason, during the HQ assessment for such aircraft failure states, the characteristics of the degraded actuator model shall match those of the real one (see BP2.3).

### 5.3.2.7 Sensors

For augmented aircraft the strong dependence of stability and controllability from sensors information calls for an accurate modelling of these elements' characteristics.

The variety of sensors used on an aircraft show different dynamics, noise levels, ranges and accuracy. Within the scope of realistic sensor modelling all these specific aspects have to be carefully combined. For example, the computation of the angle of attack for highly manoeuvrable aircraft might require the use of both the flow angle measures and the data coming from the motion sensors (inertial sensors). These inertial and air data are characterised by different physical effects and hardware resulting in different dynamics, accuracy and refresh rates.

For certain sensors like pressure probes, the sensors' dynamics could significantly depend on flight parameters like airspeed. In this case, the sensors can be approximated by a first or second order transfer function defined by a time constant or by an eigen-frequency and a damping, that are functions of the dynamic pressure.



In general, the basic sensor characteristics to be considered for modelling are:

- Sensors dynamics
- Data filtering (averaging, anti-aliasing, structural mode filters, etc.)
- Computational delay/latency
- D/A and A/D conversion
- Operating range
- Linearity
- Accuracy

Another point for sensor modelling is whether or not the sensed signals are sensitive to changes of configuration parameters, e.g. external loads or sensor location with respect to the centre of gravity position. Even if no adaptation to those effects is considered in the FCC, these uncertainties should be quantified *and analysed* to some extent, during the design phase.

### 5.3.2.8 Control Laws

A suitable model is the prerequisite for control law design (BP2.1). The availability of powerful modelling capabilities (e.g. VMOS based FSM) and the possibility of using hybrid systems for the digital simulation make it easier for the FCL designer to implement, check and tune complicate functions and logic during the design phase.

From this point of view all the characteristics of the control laws shall be incorporated into the simulation model. The main aspects to be considered are:

- Logic (configuration, flight conditions, carefree handling, etc.)
- High order dynamics (notch filters, anti-aliasing filters, etc.)
- Effects of digitalisation (transfer function approximation, transport delay, etc.)
- Non-linearities (saturation, dead bands, etc.)

Some lessons learned (see 3.2) indicate that a discrete modelling and design of the control laws is not always needed for modern FCS characterised by high computing rates (80Hz and more). On the other hand, some of the modern VMOS provide a nice feature: the designer can model a system as continuous (or discrete) and then automatically transform it to a discrete (or continuous) version and vice-versa (see BP2.4).

Another subject that will be discussed and gain importance in the future is the possibility of generating safety-critical software by means of automatic code generators [Hreha, 1999]. Although the automatic code generation will be treated in section 5.3.3, with regard to modelling requirements it should be noted that the use of the FSM FCL model for safety-critical code generation leads to even more stringent modelling requirements. One of the reasons for this is that the VMOS auto-coders are in general not designed for safety-critical software development. For this purpose, it would be better to use specific code generator tools which can handle the particular requirements of design, development, and test of safety-critical applications [Kröger, 1994]. On the other hand, an integration of such specific code generators into VMOS is possible [AW&ST, 1999] and certainly, the implications in terms of modelling requirements will be the subject of further investigations.

### 5.3.2.9 Elasticity

Even if the aircraft elastic characteristics are important during the FCS design process for the correct positioning of the sensors and for the design of the structural filters, these tasks do not require explicit modelling of aircraft elasticity in the FSM.

In general, some effects of elasticity are considered in the ADS by introducing static aeroelastic coefficients. This is applied for control effectiveness reduction or aerodynamic centre displacement. This static approach is not sufficient for the case where the coupling of elastic and rigid modes needs to be examined in detail.

One of the assumptions usually adopted for fighter aircraft is that the frequencies of the elastic modes are well separated from the ‘rigid body’ models of the aircraft motion, such as the short period. When the frequencies of the elastic modes become low and approach those of the rigid-body modes, their effect can significantly alter the vehicle’s Handling Qualities [Waszak et al., 1987].

The modelling of the flexible aircraft can be done with relatively moderate effort, simply by adding the elastic degrees of freedom to the rigid ones [Schmidt et Raney, 1998]. Beside the data needed to model the rigid-body motion, the following information are needed:

- Aerodynamic influence coefficients
- Elastic mode shapes and the respective associated eigenvalues
- Generalised masses

These data are usually available from structural and aerodynamic analyses.

The selection of the modes to be used is crucial and should be based on the result of an accurate modal analysis. In principle, the selected modes should be those that can be excited by the rigid-aircraft / FCS / engine motion and that correspond to important displacements of relevant sections of aircraft structure such as the cockpit [Schmidt et Raney, 1998].

The effects of flexible structures are in general significant for large transport aircraft. For small / medium sized aircraft this has to be evaluated for the individual case. The delicate task of introducing elasticity into the FSM consequently leads to an increased complexity of the model and an additional effort for modelling and CL design. The benefits of such modelling should be carefully weighted against the connected costs and required extra manpower (see BP2.1).

#### **5.3.2.10 Feel System**

The feel system is the primary interface between the aircraft and the pilot. It provides immediate feedback on pilot’s input. The complexity of such a model depends on the type of flight control: The modelling of direct mechanical controls or power boosted controls greatly differs from that of modern irreversible FBW control systems.

Since the pilot accesses both position and force information, the impact on handling qualities of delays resulting from the feel system dynamics can be less significant with respect to effects of delays produced by the flight control system itself [Anon., 1991; Smith et Sarrafian, 1986]. From this point of view, the modelling and the inclusion of the feel system model in the aircraft simulation model for control laws design and/or flying-qualities evaluations [Mitchell et Aponso, 1995] is an open issue (see Chapter 3.5 and 3.6).

Although the modelling of reversible flight controls usually can become very complex [Weiss, et al. 1998], irreversible force-feel systems can often be adequately described by a second-order system [Gibson et Hess, 1997].

In general, the basic items to be considered for the feel system modelling are:

- Natural frequency and damping
- Static force displacement characteristics
- Non-linearities (in force gradients, break-out, hysteresis, friction, etc.)

Analyses of phenomena such as roll ratcheting require the additional introduction of a pilot model. It is evident that for this interaction between the physical coupling of aircraft response and motion of the pilots body the modelling of the stick dynamics is essential [Johnston et McRuer, 1987; Smith et Montgomery, 1996; Höhne, 1999; Koehler, 1999].

### 5.3.2.11 General Remarks

The modelling of an aircraft requires a background not only related to the “flying machine” (flight mechanics, aerodynamics, control system architecture, etc.) but also to the knowledge of other subjects relevant to simulation such as:

- Computer science
- Numerical analysis
- Programming

The required accuracy and complexity of the complete aircraft model defines the degree of detail of the sub-models. It is of no use to implement highly sophisticated sub-models if the basic inputs such as the ADS are not reliable (see BP2.1).

A configuration control of the aircraft simulation model is a must, especially for shared models. If this configuration management is not automated a formally revision process should be established.

The modelling environment has been discussed and some of the advantages of modern VMOS have been highlighted. They provide a common and versatile framework to different groups (such as Stress or Aerodynamics Dept.). Also the model / sub-models benefit from the demands, the knowledge, and the contributions of all the different users. This interaction can significantly improve the quality of modelling. As pointed out in [Robins et al., 1998], some disadvantages of using VMOS still exist. For example, VMOS software is not faultless. Where a bug is present, the user is at the mercy of the vendor for prompt support and fixes. Furthermore, an automatic code generator add-on is often expensive.

The availability of a Flexible Simulation Model helps the FCL engineer throughout design and analysis. FSM is a VMOS-based detailed and compact aircraft simulation model that is extremely flexible with regard to modifications (addition / elimination / modification of its components). Simplifications, approximations and changes required for analysis and design of FBW aircraft can be chosen by the user according to the respective application.

An important issue, in relation to modelling, is the availability of specific documentation. While the modelling of elements such as rigid body equations has been widely discussed in literature, it is hard to find a detailed model of a sensor. Moreover, those who have spent their time and energy in making such models tend to be protective towards their work. Nevertheless, some documentation is available for the basic [Ralfe et Staples, 1986] and more detailed model [Messina et al., 1996; Anon., 1997].

A crucial remark is to be made on the portability / compatibility of the simulation models. VMOS have both the possibility of incorporation of legacy code and the capability of automatic code generation. Therefore, it can be stated that they favour the exchange and reuse of simulation code. But a far-reaching real portability and/or compatibility does not exist yet. More efforts should be spent on standardisation, not only for the basics of the modelling data [Hildreth, 1998] but also for the simulation models themselves.

### 5.3.3 Physical Model-Building Leading to Automatic Code Generation

The task of the model-building and code generation process is to put all required aircraft data into a computer readable format and make the (non-linear) model available to synthesis and analysis tools for design and assessment of flight control systems.

The model-building and code generation process from a physically set-up flight dynamics library is described here for the High Incidence Research Model (HIRM)\*, which was one of the benchmarks solved within the GARTEUR† Design Challenge on Robust Flight Control (1995-1997), where 18 teams from 7 European countries investigated the applicability of modern control concepts for developing robust flight control systems.

A unique simulation model for HIRM has been made available by this technique to all design teams either as Matlab/Simulink simulation code or as Fortran/C codes. The different codes describing the same aircraft dynamics model were built automatically from a ‘generic’ physical aircraft description, using the object oriented modelling and simulation code generation environment Dymola [Elmqvist, 1993]. This procedure guaranteed that groups working with different simulation environments still used the same aircraft model.

### 5.3.3.1 Object Modelling

Models of aircraft dynamics should be described in a notation close to the aircraft physics. The most natural way of modelling physical systems is as physical objects and phenomena, which are connected according to their physical energy flow interaction. This is different from modelling via signal flows or input-output block diagrams as traditionally used for controller modelling.

An aircraft consists of a variety of different systems, which represent the interacting disciplines involved in aircraft engineering (e.g. flight mechanics, aerodynamics, propulsion).

As displayed in Figure 5.3.5, an aircraft consists of a *body* (airframe), which is powered by one or more *engines* and which has *gravity* acting on it. The *aerodynamics* describes the effects of the airflow over the aircraft, which is influenced by the surrounding *atmosphere* and additional *winds*.

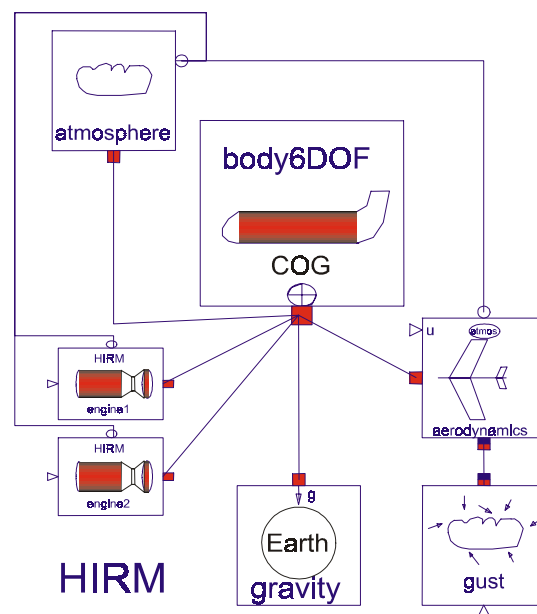


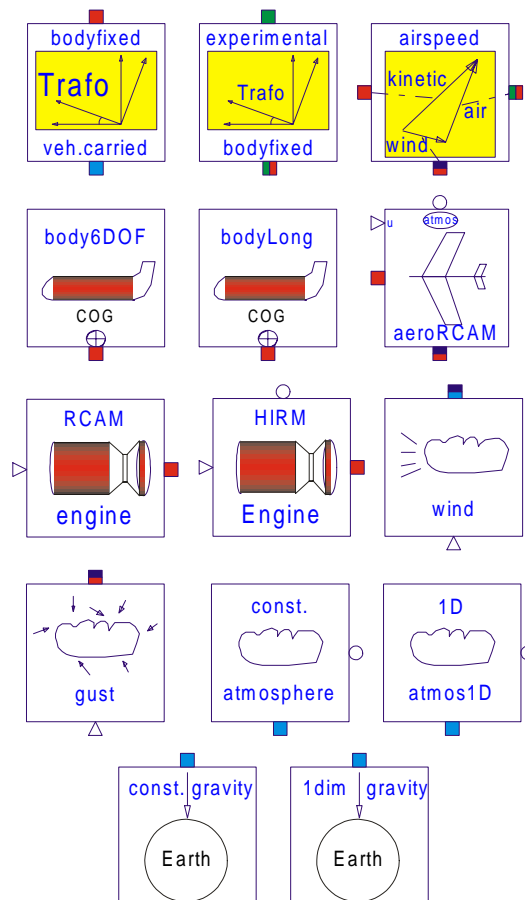
Figure 5.3.5: Object diagram of HIRM

Each of these phenomena is most conveniently described as one physical object. All objects are connected according to Figure 5.3.5 to represent the interactions within an aircraft. No connections between engine and aerodynamics have been considered for HIRM, but it should be noted that especially for fighters and for prop aircraft such effects might have strong influence and cannot be neglected.

\* HIRM data provided from DERA, Bedford, UK.

† GARTEUR = Group of Aeronautical Research and Technology in EUROpe.

In order to make the understanding of the objects easy, each component is described in its own coordinate system. Gravity, wind, and atmosphere are conveniently described in the aircraft-carried normal earth system, aerodynamics in the air-path axis system, and engines in a system which is related to the body axis system. Hence coordinate transformations and an object to describe the relationship between velocity, wind, and airspeed are needed in between all of these sub-systems when they are connected. Therefore, in addition to the basic aircraft components, coordinate transformations are also detailed and handled as objects in the aircraft library (see Figure 5.3.6).



**Figure 5.3.6: Aircraft model library**

In the physical aircraft library different representations of one component can be found. There is a class Body with six degrees of freedom (Body6DOF) and a class with three degrees of freedom (BodyLong), which can be used to generate a non-linear simulation model for the longitudinal axis only. There are also engine, atmospheric and gravity models of different complexity.

In a graphical view Figure 5.3.5, the interconnection structure of an aircraft can be most easily understood. If a more complex gravity model acts on the aircraft, this object can simply be taken from the aircraft library to replace the simple gravity object. In the same way one or more engines can be added or removed from the aircraft or can be modified. This is the most transparent user layer with no need to think about the structure of any specific simulation code.

The objects which form the physical model contain equations (and not assignments as common in programming or simulation languages). This makes the understanding and the reuse much easier than looking at low level code, whose purpose is to be understood by a computer. Once the objects are available in computer readable form the object equations can be sorted automatically by a symbolic equation handler. This is a main feature of Dymola.

Objects, formulated in that way do not necessarily have to represent causalities. This allows one object to fulfil different tasks. For example, the object which does the transformations between the body axis and the air-path axis system, is used for the transformation of the body-fixed velocities to the air-path axis system, as they are required within the aerodynamics. The same object is used for the transformation of the forces and moments from the aerodynamic to the body axis system. When connecting components as objects, only the relation between them is defined and not the order, in which those equations are finally solved.

In *Dymola*, graphical syntax components are coupled by drawing a line between the defined ‘coupling’ points of the objects, which are called ‘cuts’. These couplings represent either energy or signal flow. For example, the cut *bssystem* (body axis system) has the following structure:

$$\begin{aligned} & \text{terminal } {}^vT^b[3,3], r[3], v_b[3], w_b[3], a_b[3], z_b[3], F_b[3], M_b[3] \\ & \text{cutssystem } ({}^vT^b, r, v_b, w_b, a_b, z_b / F_b, M_b) \end{aligned}$$

The matrix  ${}^vT^b$  defines the orientation of the body axis system with respect to the aircraft-carried normal earth system. The vector  $r$  is the aircraft’s inertial position in the aircraft-carried normal earth system; the vectors  $v_b$  and  $a_b$  are the velocity and acceleration in the body axis system and the vectors  $F_b$  and  $M_b$  are the forces and moments, also formulated in the body axis system. In the same way there are cuts defined for the aircraft-carried normal earth system (*vssystem*) and for the air-path axis system (*asystem*).

This cut structure represents physical connections. When objects are connected, *Dymola* adds equations for the cut variables. All quantities of the cut before the slash operator (Across variables) are set equal when connected, as it is reasonable for positions, velocities and accelerations, quantities after the slash operator (Through variables) are summed up to zero, as it is reasonable for forces and moments. This principle is used for connecting engines to the aircraft body for example. The engines have the same position, airspeed, and accelerations than the aircraft’s body, their forces and moments sum up with all the other forces and moments acting on the aircraft. Because of that formulation it is easy to add more engines to the aircraft just by adding another engine object to Figure 5.3.5 and connecting it to the aircraft’s body.

This object-oriented equation-based form of describing physical systems helps to understand the physical system and enables the user to modify the model most conveniently.

### 5.3.3.2 Hierarchical Object Structure

An important aspect in object oriented modelling of physical systems is the encapsulation of objects. The internal implementation of details, e.g. of the aerodynamics, are not visible, when viewing the HIRM object model as depicted in Figure 5.3.5. By encapsulation, the implementation of an object can be changed without affecting the functionality of the whole model.

Figure 5.3.7 demonstrates, how the HIRM model is structured. Here only the aerodynamics model is extracted. In the same way details of the engine, gravity, wind, and atmospheric models can be displayed.

Extracting the *aerodynamics* results in the aerodynamics sub-model, which consists of the aerodynamic equations *aero equations* and the object *airspeed*. The latter object describes the kinematics between the inertial motion (flight-path velocity), the wind velocity, and the aircraft’s movement relative to the air (aircraft velocity).

Using the graphical interface, ‘double clicking’ on *aerodynamics* displays the parameter window of this object. This window allows the parameters to be modified. In the same way, all of the other objects (body, engines) can be instantiated with their parameters.

The objects of HIRM model will be detailed in the following sections. Boxes in the following sub-sections contain *Dymola* code in the form of real equations.

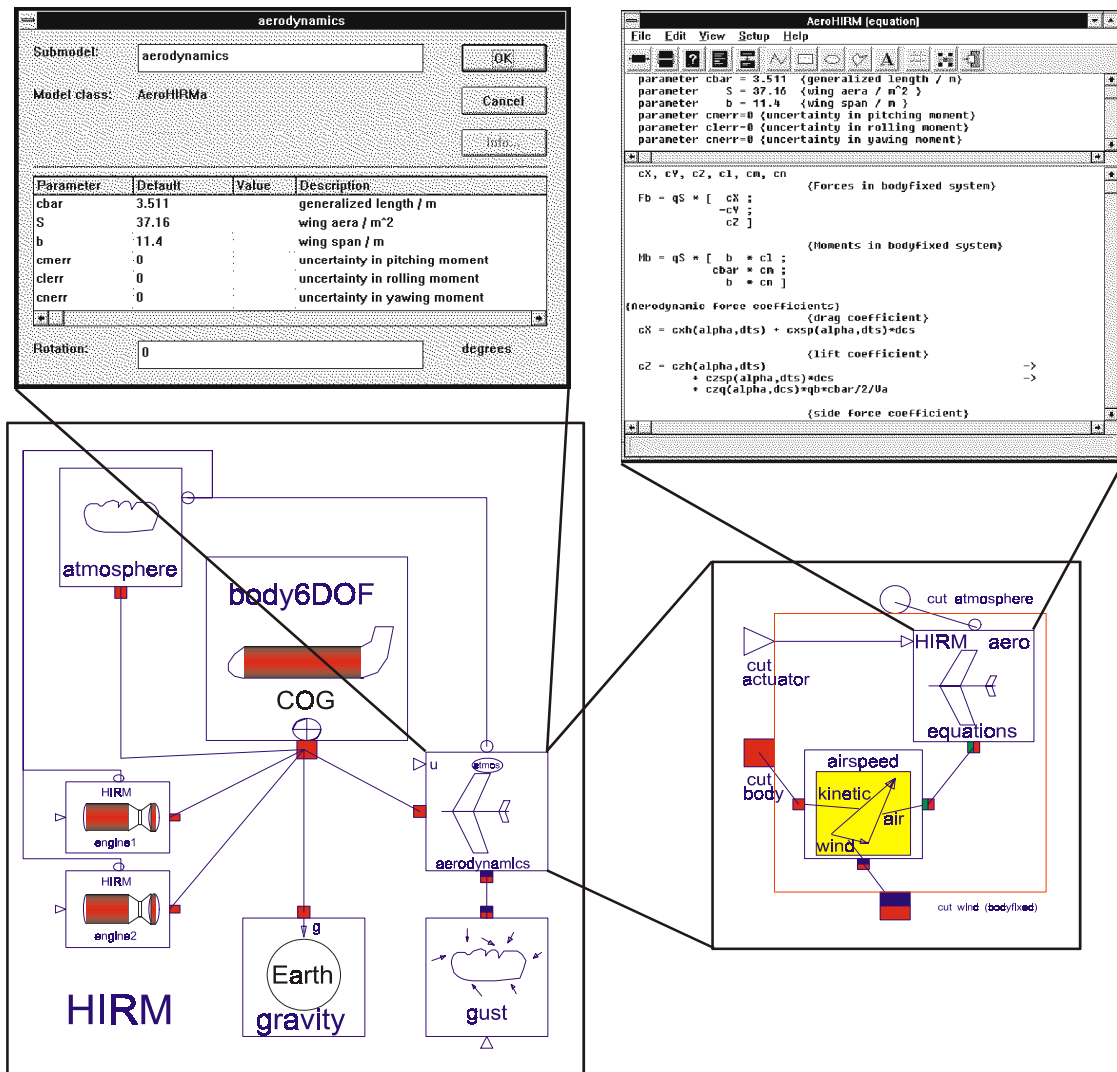


Figure 5.3.7: Structure of aircraft physical model

### 5.3.3.3 Code Generation

From the graphical and textual model description *Dymola* generates efficient code for different simulation environments (see Figure 5.3.8).

Its symbolic equation handler generates a state space model from the parameter instantiated equations of each object and from the equations derived from the interconnection structure. The equations are sorted and solved according to the specified inputs and outputs. Equations which are formulated in an object but not needed for the specified configuration are removed automatically. The result is a mathematical model with a minimum number of equations for the specified task.

As a next step, simulation code for different simulation environments (e.g. Simulink, ACSL, ANDECS\_DSSIM) is generated automatically. The code for Simulink can be a m-file or a cmex-file. Fortran or C code can be exported in the DSblock neutral simulation-model format [Otter, 1992], to be used in any other simulation run-time environment capable of importing Fortran or C models. This is targeted in particular at the ANDECS design environment for control engineering [Grübel, et al, 1993].

### 5.3.3.4 General Remarks

It is most natural to model physical systems on a physical level in the form of equations. For simulation purposes, simulation code can be generated automatically from physical equations provided that a suitable software tool like *Dymola* is available. It has been shown that aircraft dynamics code for Simulink is generated for common use in the Robust Control Design Challenge. This is achieved by using a generic *Dymola* flight dynamics object library.

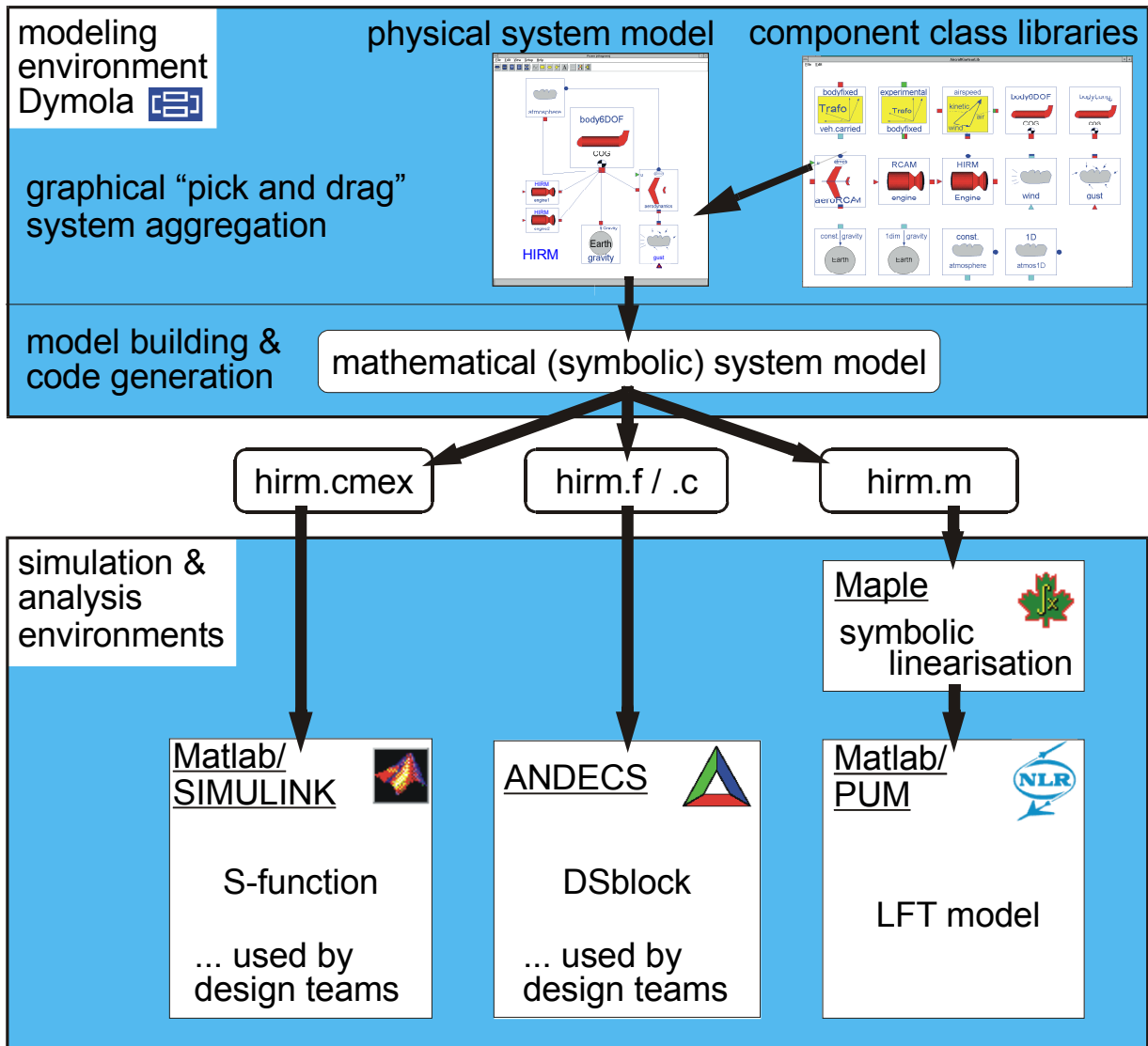


Figure 5.3.8: From system configuration to simulation/analysis model

This approach to automatic code generation has the further advantage that not only can efficient parameterised simulation code be obtained for different simulation and analysis environments but a parameterised symbolic code can be produced as well. This can be used as input for symbolic analysis tools such as PUM (Matlab Toolbox for Parametric Uncertainty Modelling) [Lambrechts, Terlouw, 1992] or PARADISE (PARAmetric Robustness Analysis and Design Interactive Software Environment) [Sienel, Ackermann, 1996].

### 5.3.4 System Identification and Model Validation

System identification is an inverse problem of obtaining model description in some suitable form for a system, given its behavior as a set of observations. The highly successful application of system identification to flight vehicle is possible partly due to the advances in measurement techniques and data processing capabilities provided by digital computers, partly due to the ingenuity of the engineers in advantageously using the developments in other fields like estimation and control theory, and partly due to the fairly well-understood basic physical principles underlying flight vehicles enabling adequate modeling and the possibility of carrying out proper flight tests.



### 5.3.4.1 Principles of System Identification

The general approach to aircraft system identification is shown in Figure 5.3.9. During the flight tests, specifically designed control inputs are applied to excite the characteristic aircraft motions. The applied control inputs and aircraft responses are measured and recorded. A suitable model is postulated for the phenomenon being investigated and the unknown parameters within the model are so determined as to match the model response with the flight measured aircraft response.

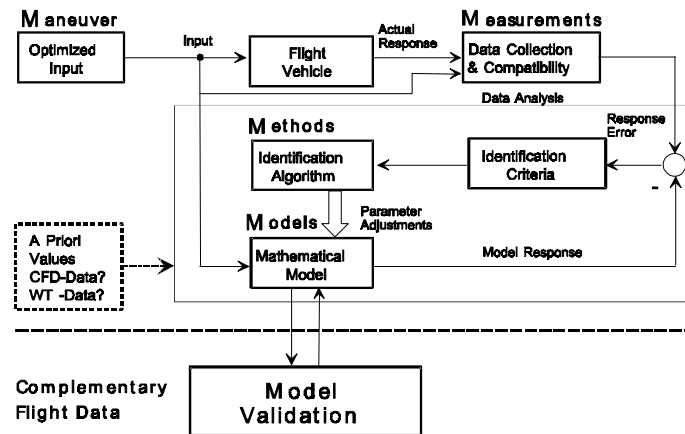


Figure 5.3.9: The Quad-M basics of flight vehicle system identification

A coordinated approach to flight vehicle system identification can be divided into three major parts [Hamel; Jategaonkar, 1996 and 1998]:

- **Instrumentation and Filters** which cover the entire flight data acquisition process including adequate instrumentation and airborne or ground-based digital recording equipment. Effects of all kinds of data quality have to be accounted for.
- **Flight Test Techniques** which are related to the selected flight vehicle maneuvering procedures. The input signals have to be optimised in their spectral composition in order to excite all response modes from which parameters are to be estimated.
- **Analysis of Flight Data** which includes the mathematical model of the flight vehicle and an estimation criterion which devises some suitable computational algorithm to adjust some kind of starting values or a priori estimates of the unknown parameters until a set of best parameter estimates is obtained which minimises the response error.

Corresponding to these strongly interdependent topics, four important aspects of the art and science of system identification have to be carefully treated (see Figure 5.3.9).

- Design of the control input shape/amplitude in order to excite all modes of the vehicle dynamic **motion**.
- Selection of instrumentation and filters for high accuracy **measurements**.
- Type of flight vehicle under investigation in order to define the structure of a possible mathematical **model**.
- Quality of data analysis by selecting the most suitable time or frequency domain identification **method**.

These “**Quad-M**” requirements must be carefully investigated for each flight vehicle from a physical standpoint, and are the key to the successful flight vehicle system identification. A systematic treatment of these key-issues has been provided by Maine and Iliff [1985 and 1986], and Klein [1989], Hamel [1979], and Mulder et al [1979]. A survey of contributions to flight vehicle system identification up to 1980 has been provided by Iliff [1989] and more recently by Hamel and Jategaonkar [1996]. The role of system identification for flight vehicle applications has been highlighted by Hamel and Jategaonkar [1998].

### 5.3.4.2 Optimal Inputs for Dynamic Motion

The accuracy and reliability of parameter estimates depend heavily on the amount of information available in the vehicle response. Hence, a proper experiment design is important. In general, an optimal input is that which best excites the frequency range of interest. Purely from this view point, the direct choice may appear to be a frequency sweep input. However, it leads to relatively long maneuver times, is mostly restricted to single axis excitation and has a tendency to depart from the nominal trim. Based on these practical considerations, several signals have been designed in the past, for example 1) doublet, 2) multistep 3211, 3) Mehra, 4) Schulz, 5) DUT, and 6) Langley input [Mehra, 1972; Stepner, Mehra, 1973; Gupta, Hall, 1975; Koehler, Wilhelm, 1977; Plaetschke, Schulz, 1979; Morelli, Klein, 1990]. Although the 3211, Mehra, DUT, and Langley inputs are more efficient, the doublet input is often used due to its simplicity. Amongst the above indicated inputs signals, the multistep 3211 signal is easily realizable and relatively easy to fly manually by pilots [Koehler, Wilhelm, 1977]. It is for this reason that the 3211 signal remains as the one most accepted by the flight test community. Figure 5.3.10 shows the 3211 input and its spectrum in comparison to step and doublet input signals.

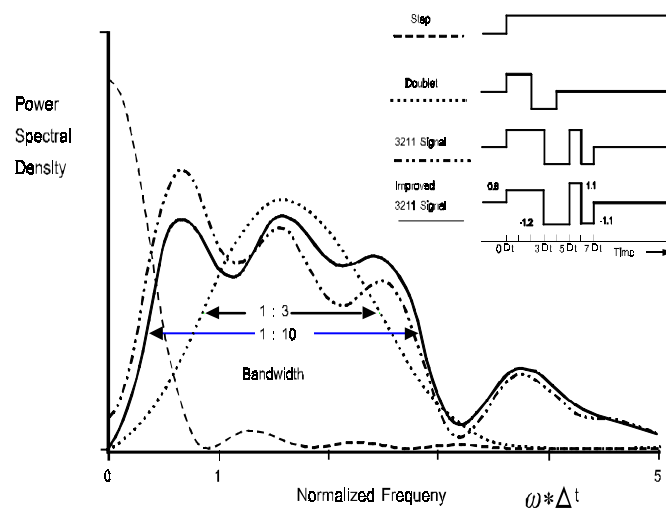
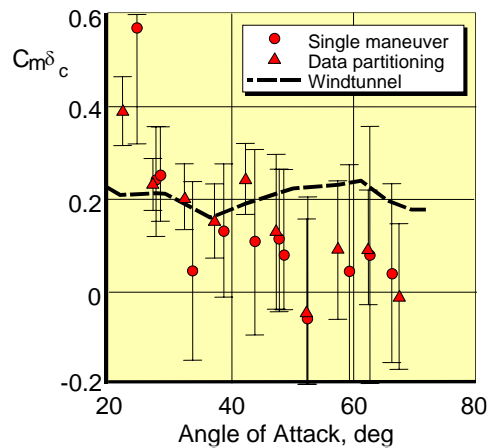


Figure 5.3.10: Frequency domain comparison of input signals

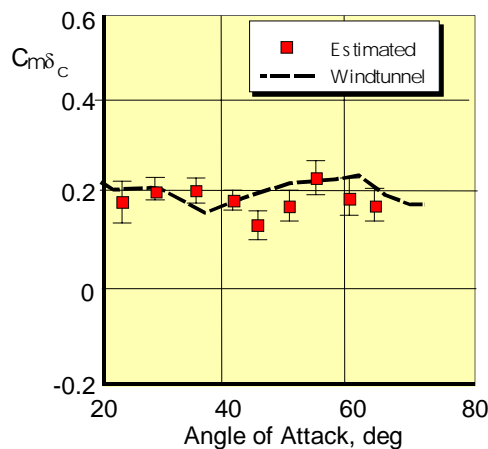
More recently the emphasis has been on improving the hitherto designed input signals and on expanding the design techniques based on additional practical considerations. For example, Figure 5.3.10 shows an improved 3211 signal, which has different amplitude levels for each step, resulting in a better spread of the frequency spectrum compared to the conventional 3211 signal, and also having zero energy content in the low frequency range which alleviates the tendency to depart from the nominal trim [Friedmelt, et al, 1995]. A derivative of the Mehra's signal has also been designed by minimizing the number of elementary sine functions used to optimise the signal [van der Linden, et al, 1994]. In yet another application, dynamic programming technique has been used to generate an input signal by optimally combining square waves only [Morelli, 1997]. This approach is applicable to non-linear models and also enables to account for feedback control and actuator dynamics in the optimization. These recent designs have improved properties and have been applied in a few practical cases; however, they are difficult to fly manually and can be best realised through onboard computer implementation. Thus, although it may appear that the current trend is towards more complex computerised control inputs, the simpler input signals like doublet or 3211 will continue to be accepted in the future as in the past.

Although the dynamic programming technique allows an input design accounting for the feedback control, it does not overcome the control-surface correlation, which may be dominant in highly augmented aircraft. In such cases the separate surface excitation (SSE) yields the best parameter estimates [Hamel; Jategaonkar, 1996; Weiss, et al, 1996; Gates, et al, 1996]. In this approach the standard doublet or 3211 inputs are fed after the controller to directly deflect the control surfaces. As a typical example, Figure 5.3.11 shows the estimates of the canard control effectiveness obtained from the X-31A flight test data for two cases, namely the pilot

input maneuvers and the separate surface excitation. As evident from Figure 5.3.11a, the pilot input maneuvers yield estimates with large standard deviations and moreover the scatter is also large. This is definitely attributed to insufficient information content and of correlated variables. On the other hand, the separate surface excitation maneuvers yield well identifiable estimates (see Figure 5.3.11b).



a) Pilot input maneuvers



b) Separate surface excitation maneuver

**Figure 5.3.11: Estimates of canard control effectiveness from X-31A flight data**

For rotorcraft system identification, frequency sweep test techniques and multistep signals like doublet or 3211 are popular. Both these test techniques are found to provide comparable results. Frequency sweep testing is better suited for identification of transfer function models and is necessary when the estimation algorithm is based on frequency domain techniques [Tischler, et al, 1987 and 1992]. In several of the cases it has been observed that the pilot flown sweeps, which tend to contain sharp superimposed inputs, yield better estimates compared to those from the pure sweep inputs applied from an onboard computer. Care needs to be exercised during the sweep testing to avoid critical flight incidence resulting from aeroservoelastic interactions or due to exceeding the permissible loads.

### 5.3.4.3 Methods of Data Analysis

The various parameter estimation methods can be broadly classified into three categories: i) equation error methods, ii) output error methods, and iii) filter error methods. Choice of a particular method is generally dictated by the model formulation and assumptions made regarding the measurement and process noise, both of which are unavoidable in practical cases. The above three methods belong to a class called the “direct approach”. The other approach to aircraft parameter estimation is called the “indirect approach” in which a non-linear filter provides estimates of the unknown parameters which are artificially defined as additional state variables. The equation error methods represent a linear estimation problem whereas the

remaining methods belong to a class of non-linear estimation problems. The equation error and the output error methods are deterministic methods whereas the other two (the filter error and the indirect approach) are statistical. More recently the neural network approach to aircraft parameter estimation has also been investigated.

#### a) Equation Error Method

Synthesis of aerodynamic forces and moments acting on a flight vehicle through Taylor series expansion invariably leads to a model that is linear in parameters. To this class of problems, the classical regression techniques can be conveniently applied [Klein, 1979 and 1989; Milder, et al; 1979]. Application of the regression technique requires measurements of the dependent variables, for flight vehicles these are the aerodynamic forces and moments. Though these variables are not directly measurable, they can be computed with relative ease from measurements of linear and angular accelerations.

At any instant of the time  $t_k$ , the dependent variables, in this case the aerodynamic forces and moments,  $y(t)$ , can be expressed in terms of the independent variables,  $x(t)$ , for example the angular rates, flow variables etc., as:

$$y_i(k) = \theta_{i1}x_1(k) + \dots + \theta_{ir}x_r(k) + e_i(k) \quad (5.3.1)$$

where  $e_i$  denotes the stochastic equation-error, and hence the synonymously used name “equation error method”. From  $N$  discrete measurements of the dependent and independent variables, for  $N > r$  the unknown parameters can be estimated applying the least-squares method.

$$\hat{\theta} = (X^T X)^{-1} X^T Y \quad (5.3.2)$$

where  $\theta$  is the  $r$  dimensional vector of parameters,  $Y$  is the  $N$  dimensional vector of measured values of  $y_i$ , and  $X$  is the  $N \times r$  matrix of independent variables. Considering one dependent variable at a time, the parameters of the three aerodynamic forces and three aerodynamic moments acting on the aircraft are estimated separately.

The main advantage of the regression technique is its simplicity. For a given model structure, the least-squares estimates are obtained with minimal computation in one shot. One of the regression techniques is the stepwise regression. This method, including statistical evaluation of the residuals, is particularly helpful in efficiently arriving at unknown aerodynamic model structure through successive augmentation of the postulated mode [Klein, et al, 1981]. Furthermore, since the method does not rely on the temporal relation between the data points, several separate maneuvers can easily be concatenated to estimate a single set of derivatives common to all the time segments. Based on this property, the ‘Data Partitioning’ approach can be applied to analyse large amplitude maneuvers by dividing the maneuver into several smaller portions to which a simplified model can be fitted [Klein, 1989; Batterson, Klain, 1989; Weiss, et al, 1995].

The main disadvantage of the regression method, however, is that due to the presence of measurement errors in the independent variables, the leastsquares estimates are asymptotically biased, inconsistent and inefficient [Klein, 1979] Nevertheless this method has found several applications to aircraft parameter estimation, providing acceptable results compared to the more complex methods. It is mainly because of two reasons. First, the high quality sensors and instrumentation system minimise these errors. Secondly, prior to applying the regression method, more reliable signals can be generated through a data preprocessing step. The well defined kinematic equations of aircraft motion provide a sound basis for this step, which is often called as flightpathreconstruction or aircraft state estimation [Klein, Schiess, 1977; Keskar, Klein, 1980; Evans, et al, 1985] The separation of the state estimation and aerodynamic modeling is called in the literature as TwoStep method or Estimation Before Modeling, EBM [Stalford, 1981; SriJayantha, Stengel, 1988].

#### b) Output Error Method

The output error method requiring non-linear optimization is the most widely used method for aircraft parameter estimation [Hamel, Jategaonkar, 1996; Maine, Iliff, 1986]. Figure 5.3.12 provides a schematic of

the output error method that accounts for measurement noise only. The equations of aircraft motion are formulated in state space as:

$$\dot{x}(t) = f[x(t), u(t), \beta] \quad x(t_0) = x_0 \quad (5.3.3a)$$

$$y(t) = g[x(t), u(t), \beta] \quad (5.3.3b)$$

$$z(t_k) = y(t_k) + v(t_k) \quad (5.3.3c)$$

where  $x$  is the state vector,  $y$  the observation vector, and  $u$  the control input vector. The system functions  $f$  and  $g$  are general non-linear real valued vector functions, containing the unknown parameters  $\beta$  representing the stability and control parameters. The measurement noise  $v$  is assumed to be characterized by zero-mean Gaussian noise with covariance matrix  $R$ . In addition to the unknown system parameters  $\beta$ , the initial conditions  $x_0$  are also usually unknown. Furthermore, the measurements of  $z$  and  $u$  are likely to contain systematic errors  $\Delta z$  and  $\Delta u$  respectively.

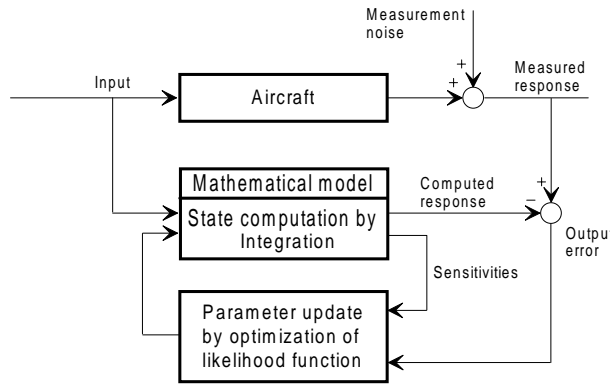


Figure 5.3.12: Schematic of output error method

The estimates of parameter vector  $\Theta^T = [\beta^T, x_0^T, \Delta z^T, \Delta u^T]$  are obtained by minimizing the cost function:

$$J(\Theta, R) = \frac{1}{2} \sum_{k=1}^N [z(t_k) - y(t_k)]^T R^{-1} [z(t_k) - y(t_k)] + \frac{N}{2} \ln |R| \quad (5.3.4)$$

where  $R$  is the measurement noise covariance matrix. Eq. (5.3.4) is the negative logarithm of the likelihood function (probability density of the measurement vector) which, for a given  $R$ , reduces to the output error cost function. Starting from suitably specified initial values of parameter vector, the new updated estimates are obtained applying the Gauss-Newton method [Maine, Iliff, 1985].

$$\Theta_{i+1} = \Theta_i + \Delta\Theta \quad (5.3.5)$$

$$\Delta\Theta = \left\{ \sum_{k=1}^N \left[ \frac{\partial y(t_k)}{\partial \Theta} \right]^T R^{-1} \frac{\partial y(t_k)}{\partial \Theta} \right\}^{-1} \left\{ \sum_{k=1}^N \left[ \frac{\partial y(t_k)}{\partial \Theta} \right]^T R^{-1} [z(t_k) - y(t_k)] \right\} \quad (5.3.6)$$

where the subscript  $i$  indicates the  $i$ -th iteration. The first term in braces on the right-hand side of Eq. (5.3.6) is an approximation of the second gradient  $\partial^2 J / \partial \Theta^2$ , which helps to reduce the computational costs without significantly affecting the convergence [Taylor, Iliff, 1972].

The maximum likelihood estimation is asymptotically bias free. The Fisher information matrix, which is the first term on right hand of Eq. (5.3.6), provides a good approximation to the parameter error covariance matrix  $P$ . The diagonal elements of  $P$ , which are the variances of the estimates, are indicators of the accuracy of the estimates and are called the Cramer-Rao bounds. In addition, the correlation coefficients,

which are a measure of statistical dependence between the parameters, can also be obtained from the off-diagonal elements of  $P$ .

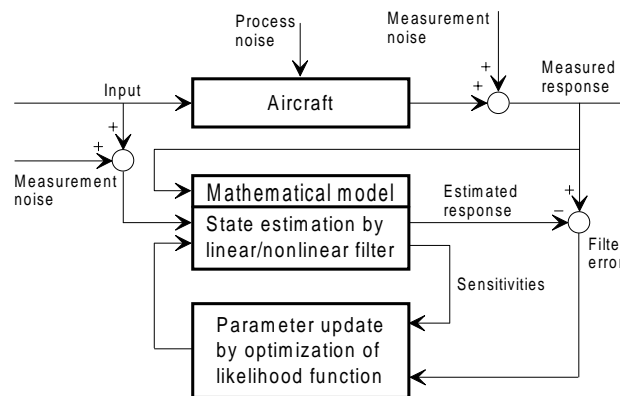
Implementation of the output error method requires computation of the state variables,  $x$ , of the response variables,  $y$ , and of the response gradients  $\partial y/\partial\Theta$  based on the postulated model of Eq. (5.3.3). Numerical integration methods, for example a fourth order Runge-Kutta, are used to compute the state variables. Computation of the response variables is then a simple matter of plugging the right quantities into Eq. (5.3.3b). The response gradients are approximated by finite-differences [Trankle, et al, 1982, Jategaonkar, Plaetschke, 1983]. The procedure is fairly straightforward. Perturbing one parameter at a time, and each time solving the perturbed state equations by numerical integration, the perturbed response variables  $y_p(\Theta_j)$  are computed. The response gradient for this parameter can be approximated as:

$$\left[ \frac{\partial y(t_k)}{\partial \Theta} \right]_{ij} \approx \frac{y_{pi}(t_k) - y_i(t_k)}{\delta \Theta_j} \quad (5.3.7)$$

Concatenation of these response gradients yields the sensitivity matrix. Several estimation packages catering to general non-linear systems have been developed based on the aforesaid approach of numerical-approximation of the sensitivities [Jategaonkar, 1995; Murray, Maine, 1987; Blackwell, 1988]. An alternative approach based on surface fitting is also possible to approximate the sensitivities [Murphy, 1984]. The modified Newton-Raphson method with numerical approximation of the sensitivities is found to be far more efficient than the derivative free, so-called, direct search methods [Jategaonkar, Plaetschke, 1983; Murphy, 1986]. The finite difference approach overcomes the need for tedious and laborious algebraic derivation software implementation of sensitivity equations, any time the structure of the postulated non-linear model is changed, and thus leads to a flexible software which caters to general non-linear systems.

### c) Filter Error Method

The filter error method is the most general stochastic approach to aircraft parameter estimation, which accounts for both process and measurement noise [Maine, Iliff, 1981; Jategaonkar, Plaetschke, 1981]. These techniques provide capabilities to estimate aircraft parameters from flight data in a turbulent atmosphere (Figure 5.3.13).



**Figure 5.3.13: Schematic of filter error method**

The dynamic system is assumed to be described by the following stochastic equations:

$$\dot{x}(t) = f[x(t), u(t), \beta] + Fw(t) \quad x(t_0) = x_0 \quad (5.3.8a)$$

$$y(t) = g[x(t), u(t), \beta] \quad (5.3.8b)$$

$$z(t_k) = y(t_k) + Gv(t_k) \quad (5.3.8c)$$

where  $w$  and  $v$  represent the process and measurement noise respectively and  $F$  and  $G$  the corresponding distribution matrices.

In such a case, the cost function of Eq. (5.3.4) gets modified to:

$$J(\Theta, \tilde{R}) = \frac{1}{2} \sum_{k=1}^N [z(t_k) - \tilde{y}(t_k)]^T \tilde{R}^{-1} [z(t_k) - \tilde{y}(t_k)] + \frac{N}{2} \ln |\tilde{R}| \quad (5.3.9)$$

where  $\tilde{y}$  is the filter predicted observation vector and  $\tilde{R}$  is the covariance matrix of the innovations. Computation of  $\tilde{y}$  requires the predicted state vector  $\tilde{x}$ . The Kalman filter is an optimal state estimator for linear systems. However, since the complex aerodynamic models are more often non-linear, some difficulties are encountered in deriving proper state estimator. Optimal filters for non-linear systems are practically unrealizable, but an extended Kalman filter based on a first-order approximation of the state and measurement equations can be used for non-linear filtering. Furthermore, in many applications, particularly when the system under investigation is time-invariant, it is often adequate to use a steady-state filter for state estimation. Such a non-linear constant-gain filter can be represented as:

$$\tilde{x}(t_k) = \hat{x}(t_{k-1}) + \int_{t_{k-1}}^{t_k} f[x(t), u(t), \beta] dt \quad (5.3.10)$$

$$\tilde{y}(t_k) = g[\tilde{x}(t_k), u(t_k), \beta] \quad (5.3.11)$$

$$\hat{x}(t_k) = \tilde{x}(t_k) + K[z(t_k) - \tilde{y}(t_k)] \quad (5.3.12)$$

where  $\tilde{x}$  and  $\hat{x}$  denote the predicted and corrected state vectors respectively,  $K$  denotes the Kalman filter gain matrix, and  $[z(t_k) - y(t_k)]$  is the residual (innovation). The gain matrix  $K$  is obtained by solving the Riccati equation. Optimization of the cost function requires gradients of response variable which necessarily needs gradients of the state variables, which in turns demands gradients of the state prediction covariance matrix. The assumption of steady-state filter results in significant reduction of computational burden. Even under this assumption, computation of the gain matrix  $K$  and the various gradients is the most complex part of the filter error method. The algorithmic details are found in references [Jategaonkar, Plaetschke, 1989], and are omitted here for the sake of brevity. It is, however, worth pointing out that the above non-linear filter is based on the prediction step incorporating the integration of the non-linear equation; the linearized system is used only in the correction step. In practice it is found that this approach works very well.

#### d) Estimation in Frequency Domain

Although since last three decades the time domain methods have dominated the field of aircraft parameter estimation, there are a few cases, for example rotorcraft identification, in which the frequency domain may be preferable [Klein, 1978].

Applying the Fourier transformation, the system equations get transformed into:

$$j\omega x(\omega) = A(\beta)x(\omega) + B(\beta)u(\omega) \quad (5.3.11)$$

$$y(\omega) = C(\beta)x(\omega) + D(\beta)u(\omega) \quad (5.3.12)$$

$$z(\omega_\ell) = y(\omega_\ell) + v(\omega_\ell) \quad (5.3.13)$$

The cost function to be minimized is then given by:

$$J_{FR} = \sum_{\ell=1}^M [z(\omega_\ell) - y(\omega_\ell)]^T S_{vv}^{-1} [z(\omega_\ell) - y(\omega_\ell)] + \log |S_{vv}| \quad (5.3.14)$$

where  $\omega_l = 2\pi l/T$  is the  $l$ -th discrete frequency,  $M$  is the number of frequencies to be evaluated, and  $S_{vv}$  is the spectral density matrix of the measurement noise. Minimization of Eq. (5.3.14) by the Gauss-Newton method yields the maximum likelihood estimates of the parameters. The scope of the frequency domain method has been extended to include non-periodic signals and to enable multi-run evaluations [Fu, Marchand, 1983; Marchand, Fu, 1985].

The transformation of system equations to the frequency domain leads to a set of algebraic equations, i.e. no integration is involved in the frequency-domain. This makes the method suitable for unstable systems for which numerical integration in the time-domain can lead to numerical divergence problems. Furthermore, without affecting the estimation results the ‘zero-frequency’ can be neglected in the evaluation, which can be advantageous not only in eliminating the need to account for a large number of bias parameters and thereby drastically reducing the total number of parameters to be estimated but also to overcome the problems of correlation between the bias parameters and the aerodynamic bias terms. For multi-run evaluations, bias parameters often far exceed the number of aerodynamic derivatives. The aforementioned advantages of the frequency-domain method are, however, associated with a substantial disadvantage of the method being applicable to only linear systems.

More recently, Tischler and Cauffmann have demonstrated yet another frequency-domain approach to state-space model identification [Tischler, Cauffman, 1992]. In this approach based on transfer functions, a cost function in terms of frequency-response error, rather than in terms of output error of Eq. (5.3.14), is minimized:

$$J_{FR} = \sum_{\ell=1}^M \varepsilon^T(\omega_{\ell}, \Theta) W \varepsilon(\omega_{\ell}, \Theta) \quad (5.3.15)$$

where  $W$  the weighting matrix based on the values of coherence at each frequency point and  $\varepsilon$  is the error between the frequency response  $T$  extracted from the flight data and the model response  $T_m$ :

$$T_m(j\omega) = \{C[j\omega I - A]^{-1} B + D\} e^{-j\omega\tau} \quad (5.3.16)$$

where the subscript  $m$  refers to the postulated state-space model and  $\tau$  is the matrix of time delays.

The frequency-response error formulation may have some advantages over the output-error formulation such as: i) eliminating the effects of uncorrelated process and measurement noise, ii) emphasizing on the most accurate data through multiple coherence functions, and iii) selectively accounting for the frequency ranges of good coherence. However, as in the other case, the approach requires pre-processing of data and is restricted to linear models.

#### e) Parameter Estimation by Filtering Approach

In this indirect approach the parameter estimation problem is transformed into a state estimation problem by artificially defining the unknown parameters as additional state variables. Considering the constant system parameter vector  $\Theta$  as output of an auxiliary dynamic system:

$$\dot{\Theta} = 0 \quad (5.3.16)$$

and by defining an augmented state vector  $x_a^T = [x^T, \Theta^T]$ , the extended system can be represented as:

$$\dot{x}_a(t) = \left\{ \begin{array}{c} f[x_a(t), u(t)] \\ 0 \end{array} \right\} + \left[ \begin{array}{c|c} F & 0 \\ \hline 0 & 0 \end{array} \right] \left[ \begin{array}{c} w(t) \\ 0 \end{array} \right] \quad (5.3.17)$$

$$y(t) = g[x_a(t), u(t)] \quad (5.3.18)$$

$$z(t_k) = y(t_k) + v(t_k) \quad (5.3.19)$$

The Extended Kalman Filter yields the solution to this combined state and parameter estimation problem. As in the case of filter error methods for non-linear systems, a numerical approach to compute the first order system matrices leads to a flexible software which can be easily applied to general non-linear systems [Jategaonkar, Plaetschke, 1989].

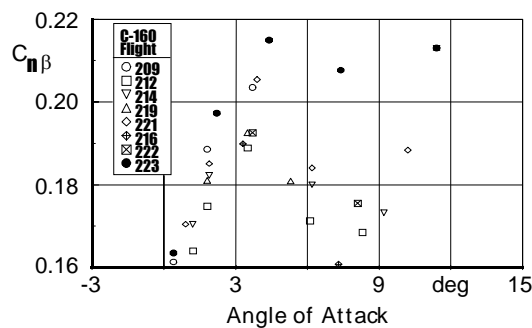
The filtering approach to identification of aerodynamic derivatives is seldom used, mainly because the performance strongly depends upon the statistics of the measurement and process noise, i.e. on the covariance matrices, which are in general unknown. The approach is, however, well suited for on-line application and applicable to unstable systems as well. It has found some application with renewed interest in the very recent.



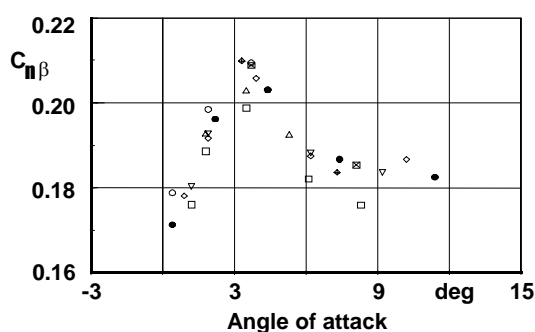
### 5.3.4.4 Practical Utility of Filter Error Methods

For flight data gathered in turbulence the filter error methods are inevitable, since the output error method is known to yield biased estimates in the presence of atmospheric turbulence. Even in the case of flight maneuvers in smooth air, the filter error method could lead to better estimation results, since some of the unavoidable modeling errors are then treated as process noise characterized by low frequency contents rather than as measurement noise [Maine, Iliff, 1981]. Moreover, although it is generally argued that the flight tests for aircraft parameter estimation could be carried out in calm air, in any practical exercise one has no control over the prevailing atmospheric conditions or due to very tight time schedules and due to cost factors involved in a time-bound project very little choice of waiting for steady atmospheric conditions.

As a typical example, the estimates of the weathercock stability, derivative  $C_{n\beta}$ , obtained by applying the output error and the filter error method to the same set of flight data are provided in Figure 5.3.14 [Jategaonkar, 1993]. The C-160 data analyzed here was gathered from eight flights carried out during a span of less than two weeks, seven of them being in a seemingly steady atmosphere whereas one encountered moderate amount of turbulence. It is clearly visible that the estimates provided by the output error method, particularly those for the flight 223 during which moderate turbulence was encountered, differ much from those of other flights at the same nominal flight conditions. Moreover, a fair amount of scatter is observed in the estimates from other flights in a seemingly steady atmosphere, making a final conclusion regarding the nature of the non-linearity or fairing of data difficult. On the other hand, the filter error method yields clearly grouped estimates with much less scatter and the estimates from the flight 223 match well with the other estimates. The non-linear dependency of the weathercock stability on the angle of attack is now to be observed much better.



a) Output error method



b) Filter error method

**Figure 5.3.14: Flight estimates of weathercock stability**

Another example for which the estimation methods accounting for process noise are essential pertains to X-1A identification. At high angles of attack, the forebody vortices, which are shed stochastically from the aircraft nose, act as process noise exciting randomly the lateral-directional motion. The results presented later in this paper demonstrate that the filter error method was well suited for this application, whereas the output error method provided estimation results which could not be completely resolved.

The filter error method, due to its formulation, contains a feedback proportional to the fit error. This feedback stabilizes numerically the filter error algorithm and also helps to improve the convergence

properties. The stabilizing property of the filter error algorithm makes it suitable for open-loop identification of unstable aircraft.

These few selected typical examples provide an answer to the question often raised regarding the practical utility of the filter error method. It can be pragmatically concluded that these methods can yield better estimates, are no more limited to linear systems, and are indispensable for many future applications such as identification at high angles of attack or of unstable aircraft. These advantages outweigh the disadvantage of higher computational overheads. Even in such a case it needs to be remembered that in any exercise on parameter estimation the actual cpu-time is only a minor part of the total time, the major part being consumed by mundane tasks such as checking flight data, collecting and analyzing the results, and generating plots et cetera.

#### 5.3.4.5 Unstable Aircraft Identification

The demands of high performance characteristics have led to aerodynamically unstable aircraft configurations. Although unstable aircraft can be flown only with the aid of a flight controller, i.e., in closed loop, the determination of aerodynamic characteristics of the basic unstable aircraft, i.e., of the open-loop plant, is of primary interest in several instances.

The simplest approach to identification of unstable aircraft is to use linear regression in the time domain or as already mentioned, the maximum-likelihood method in the frequency domain. Application of the other time-domain methods to such cases, however, needs some consideration. The most widely used output error method in this case encounters numerical difficulties of diverging solution. Some special techniques and modifications are, hence, necessary to prevent the growth of errors introduced by poor initial values, round-off or discretization and propagated by inherent instabilities of the system equations. Several solutions such as: i) S-plane transformation, ii) output error method with artificial stabilization, iii) equation decoupling, iv) a relatively new approach called multiple-shooting based on efficient techniques for the solution of two-point boundary value problems, and v) parameter estimation by filtering approach using extended Kalman filter are possible [Hamel, Jategaonkar, 1996, Maine, Murray, 1988; Jategaonkar, Thielecke, 1994]. These approaches, although provided solutions in particular cases, were either found to involve engineering judgement, or require considerable effort or the results could not be completely resolved. On the other hand, the filter error method and the regression method appear to be more readily applicable to unstable aircraft. The filter error method may have some advantages, particularly in the presence of considerable measurement noise in which case the regression analysis yields biased estimates. In any case, a method which accounts for process noise is preferable, since the controller feeds back the measured variables containing measurement noise, and thereby introduces a component of stochastic input.

Apart from the choice of a suitable method, yet another serious difficulty encountered in the unstable aircraft identification is that of parameter identifiability. The controller tends to suppress the oscillatory and transient motion. This is what the controller is anyway designed for. It is, however, detrimental to the identifiability and accuracy of the parameter-estimates, since the information contained in the data is drastically reduced. Furthermore, the feedback results in correlated inputs and also correlated motion variables. The combined solution to both these problems is to introduce controlled inputs directly deflecting the control surfaces. This is often called in the literature as Separate Surface Excitation.

As demonstrated in Figure 5.3.11, the separate surface excitation eliminates the problems due to the correlated inputs and correlated motion variables. The separate surface excitation is, however, a complex procedure requiring hardware modifications and often flight certification. Otherwise, the alternative approach would be to attempt parameter-estimation based on data-collinearity and mixed estimation. In such cases, however, it may be possible to obtain unbiased estimates of only a subset of parameters. Moreover, the basic problem of insufficient excitation still persists.

Although the aspects of parameter identifiability and data-collinearity have been discussed in the context of unstable aircraft, these issues are equally applicable to stable aircraft as well.

Identification of open-loop unstable aircraft via closed-loop identification, although feasible, is rather impractical. From such an attempt, to obtain the open-loop parameters of the basic aircraft, it would require incorporating the models for the controller and actuator dynamics in the estimation procedure. The overall system being stable, any standard parameter estimation method can be applied without encountering any serious difficulty. With the current state of the art, even the increased model size should not be a serious

problem. The primary difficulty is to obtain the exact models for the complex control laws containing discrete non-linearities, and that the actuator performance and controller gains may be flight condition dependent. Moreover, this approach may result in open-loop parameter estimates with low accuracy.

#### 5.3.4.6 Database Generation and Validation

To generate high fidelity databases there are two viable approaches. The first approach is to update the wind-tunnel predictions through incremental coefficients obtained from flight data analysis [Neville, Stephens, 1993; Trankle, Bachner, 1995; Rohlf, 1998]. The second approach is to generate a new database from flight data through a systematic procedure starting from a basic model for symmetric flight and extending it to include special effects like landing gear, high angle of attack regime, unsteady aerodynamics, ground effects, engine-out effects [Jategaonkar, et al, 1994; Jategaonkar, Mönnich, 1997]. In both the approaches the task is formidable, the process iterative, requiring model structure determination, and the two methods can be equally complex. In general, the primary aerodynamic derivatives can be extracted well; determination of aerodynamic effects of secondary order requires some considerations [Hamel, Jategaonkar, 1998].

In several instances the system identification results are used to validate the wind tunnel predictions, and to update the database if necessary. As a typical example, Figure 5.3.15 shows the flight estimates of X-31A dihedral effect, which did not confirm the wind-tunnel-predicted large value between 30°-45° of angle of attack. Based on the flight estimates this derivative as well as several others was updated.

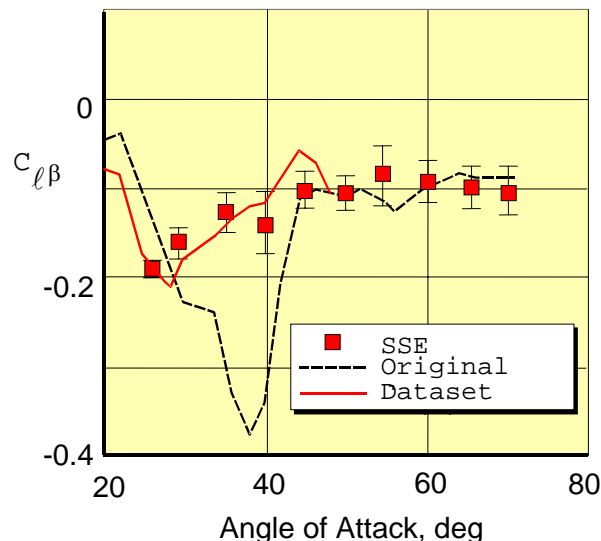


Figure 5.3.15: Example of X-31A database update

#### 5.3.4.7 Model Validation

As depicted in Figure 5.3.9, the parameter estimation and the model validation are an integral part of system identification. The parameter estimation methods provide an answer to the question:

*“Given the system responses, what is the model?”*

whereas model validation tries to provide an answer to the related question:

*“How do you know that you got the right answer?”.*

Several criteria, to be used in conjunction with each other, help to validate the model: i) standard deviations of the estimates (i.e. estimation uncertainties in terms of Cramer-Rao bounds), ii) goodness of fit (i.e. value of the cost function being minimized, for example, the determinant of the covariance matrix of the residuals), iii) correlation coefficients among the estimates, iv) plausibility of the estimates from physical understanding of the system under investigation or by comparison with other predictions such as wind-tunnel or analytical methods, and v) model predictive capability.

### a) Model Predictive Capability

The predictive capability of the identified model is determined by comparing the flight measured aircraft responses with those predicted by the model for the same control inputs. In this proof-of-match process, the aerodynamic model is kept fixed. The initial conditions have to be suitably adjusted to match the flight conditions being tested. The flight maneuvers used for model validation are, as a general rule, not used in estimating the aerodynamic model. The complementary flight data, often called as validation test data, for which the model predictive capability has to be demonstrated is an important part of flight simulator certification and acceptance. To eliminate subjective evaluation, the FAA (Federal Aviation Administration) has specified guidelines in terms of tolerances for each variable depending upon the nature of the validation test [Anon. 1991 and 1995]. For example, in the case of short period dynamics, the tolerances are  $\pm 2^\circ/s$  for the pitch rate,  $\pm 1.5^\circ$  for the pitch attitude, and  $\pm 1g$  for the vertical acceleration. For the roll response the tolerances are  $\pm 2^\circ/s$  for roll rate and  $\pm 2^\circ$  for bank angle. The flight measurements with these tolerances define a band within which the model predicted response must lie to meet the specified accuracy requirements. Although majority of the validation tests are verified in time domain either through time histories or in terms of period and damping ratios of the oscillatory modes such as phugoid or dutch roll, it is also possible to extend the verification to the frequency domain, which may bring out more clearly the range of applicability of the identified model [Hamel, Jategaonkar, 1996; Tischler, 1995]. This is particularly important for high authority flight control systems or in cases where aeroservoelastic effects may be dominant.

As a typical example, Figure 5.3.16 demonstrates the fidelity of the C-160 flight database identified from flight data applying system identification methodology [Jategaonkar, et al, 1994]. The model predicted responses shown by solid lines are well within the specified band obtained from the flight measurement plus/minus the tolerances defined by the FAA for the highest fidelity training simulators. For the same maneuver the validation in frequency domain is shown in Figure 5.3.17. The boundaries of the so-called unnoticeable dynamics, shown in terms of magnitude and phase angle in this figure, can be interpreted as equivalent to the FAA Level D fidelity. Within these limits the pilot will not notice simulation deficiencies.

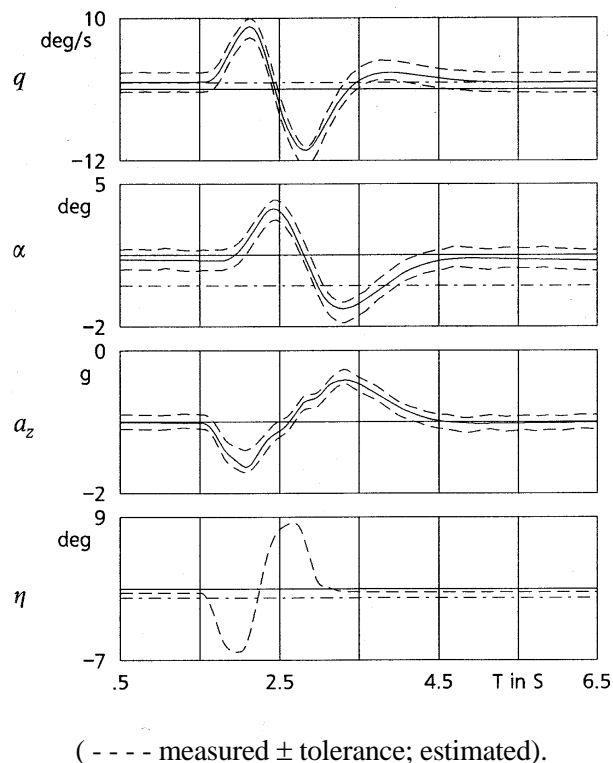
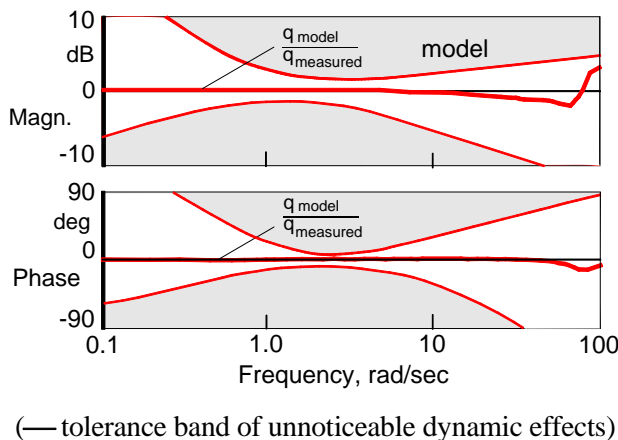


Figure 5.3.16: Proof-of-match for short period dynamics

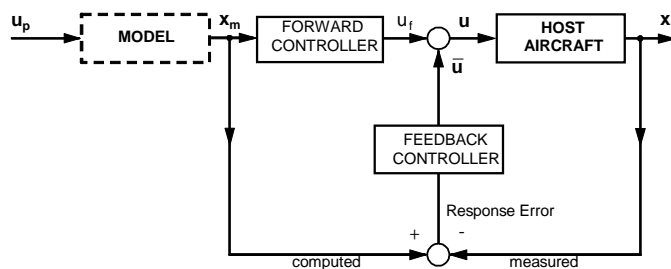


**Figure 5.3.17: Proof-of-match in the frequency domain for pitch rate (short period dynamics)**

*b) Inverse Simulation*

The assessment of model fidelity described in the foregoing section is based on the classical approach of simulation which is also an integral part of system identification, and uses the flight measured control inputs to compute the flight vehicle response. An alternative approach, called inverse simulation, would be to compute the desired inputs necessary to reconstruct the measured flight path given a model database. This approach is mainly used in conjunction with the model following control strategy and to verify simulation implementation of the databases. In an ideal case the computed control inputs should match the flight measured controls very well, the required ‘residual’ controller output being zero. Any deviation beyond certain acceptable limits is an indicator of model deficiencies or errors in the simulator implementations. In this broad sense inverse simulation is a validation tool.

As a typical example, the inverse simulation technique is applied to assess the model following control system (MFCS) designed for the helicopter in-flight simulator BO-105-S3. The basic principle of explicit model following is shown in Figure 5.3.18. The pilot inputs  $u_p$  are fed into a mathematical model which describes the desired flight vehicle characteristics. The model response  $x_m$  drives the feedforward controller, which in turn drives the host aircraft. The feedforward controller is the exact inverse of the host flight vehicle. The feedback controller driven through the response error ( $x_m-x$ ) is used to suppress errors caused by non-linearities, model inaccuracies and outer disturbances.



**Figure 5.3.18: Principle of *Explicit Model Following Control***

The same approach can be applied to the inverse simulation by exchanging the blocks MODEL and HOST AIRCRAFT in Figure 5.3.18 through FLIGHT VEHICLE and NON-LINEAR SIMULATION respectively (see Figure 5.3.19). The pilot inputs  $u_p$  excite the flight vehicle, leading to the measured response  $x_m$ . Since forward controller is an exact inverse of the host aircraft, the output of the feedforward controller  $u_f$  will be the same as  $u_p$ , subject to the model deficiencies. The feedback controller driven through the response error suppresses the errors due to the model inaccuracies or errors in the simulation software. Detailed explanation and typical test cases are found in Ref. [Thomson, Bradley, 1990; von Grünhagen, 1993].

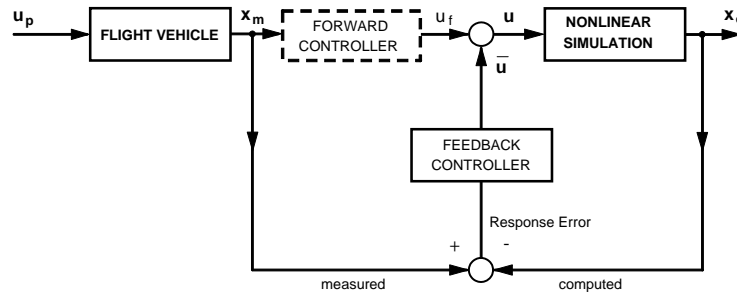


Figure 5.3.19: Principle of *Inverse Simulation*

Concerning model validation an improvement by simplification can be made, removing the feedforward controller [Hamel, 1994]. This has got the advantage that the requirement for an exact inversion of the host flight vehicle, which often is not simple at all and only possible for a linear system, no longer applies. Without the feedforward controller the measured pilot inputs  $u_p$  are directly fed into the simulation to excite the modelled system. The response error between computed model output  $y_{\text{model}}$  and measured data  $y_m$  drive the feedback controller as explained above. The required residual controller outputs can be regarded as a quality criterion for the fidelity of the simulation model. For a perfect model these outputs should be equal zero. The principle of the *simplified inverse simulation* is shown in Figure 5.3.20. The method is a practicable and helpful tool for model structure determination and model assessment. It can be used for modelling improvements by reducing systematically the output of the feedback controller to match measurement and simulation.

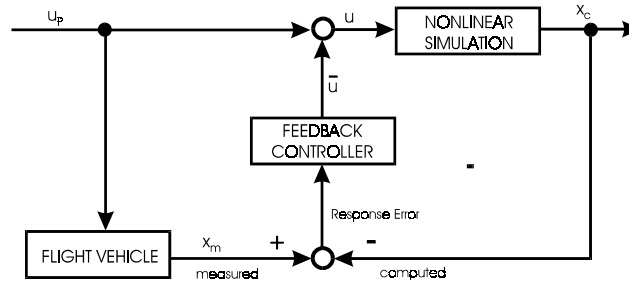


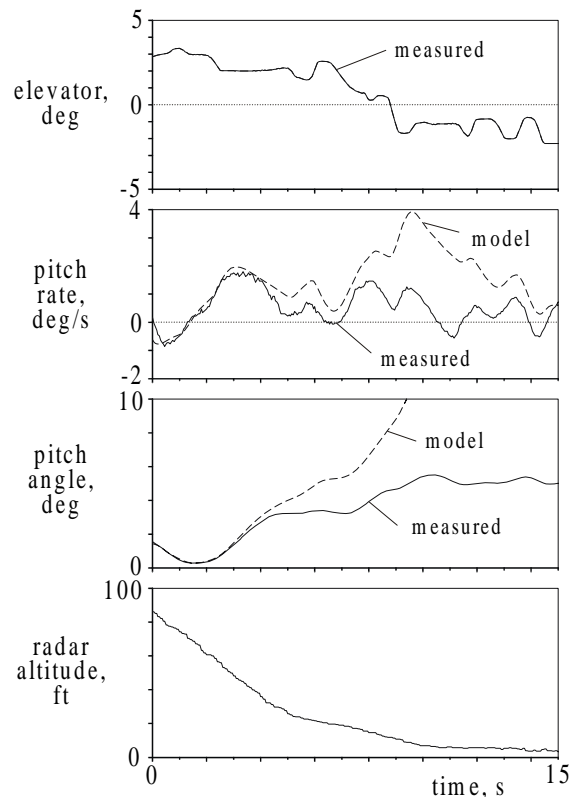
Figure 5.3.20: Principle of *Simplified Inverse Simulation*

The application of the *simplified inverse simulation* will be illustrated by an example [Fischenberg, 1999] using data from the DLR's flying testbed ATTAS. This test vehicle is based on a VFW614, twin-turbofan, short-haul 44-passengers a/c (Figure 5.3.21) and it is ideally suited as a general purpose testbed due to the size, cabin space, loading capacity and flight performance. The aircraft is equipped with complete experimental fly-by-wire fly-by-light system and comprehensive flight test instrumentation [Hanke, Lange, 1988, Hanke, et al, 1990]. This allowed a highly accurate system identification and modelling of the aircraft.



Figure 5.3.21: Advanced Technologies Testing Aircraft System (ATTAS)

Figure 5.3.22 shows the elevator deflection, pitch rate, pitch angle, and altitude for a landing approach and succeeding flare. The solid lines represent the measured flight test data while the dashed lines give the simulation results from a model identified for flight condition far off the ground. The model dynamics are stimulated by the measured elevator inputs and the simulation altitude is set to the measured values. Starting from the correct trim point, considerable differences between real aircraft and model pitch response already occur after a few seconds. The strong divergence from the measured data is caused by the unmodelled ground effect. Obviously the neglected ground effect induces a wrong pitching moment resulting in a rapid runaway from the trim point. From Figure 5.3.22 it is easy to understand that the model does not fit the real aircraft but it is hard to determine the degree of model deficiencies.



**Figure 5.3.22: Flight test data and model results (model without ground effect)**

For the final model check again the *simplified inverse simulation* is used (Figures 5.3.23-24). Figure 5.3.24 shows the results of the model now considering the ground effect. The maximum controller activity in terms of additional elevator deflection is less than 1 deg. Compared to the initial model which produces a demand of extra elevator deflection of more than 4 deg maximum, this is an improvement of 75% for the peak values. Regarding the average of additional elevator deflection the improvement is even much better. The comparison of the residual controller outputs allows a quantified assessment of model improvement and the detection of model structure deficiencies for further development.

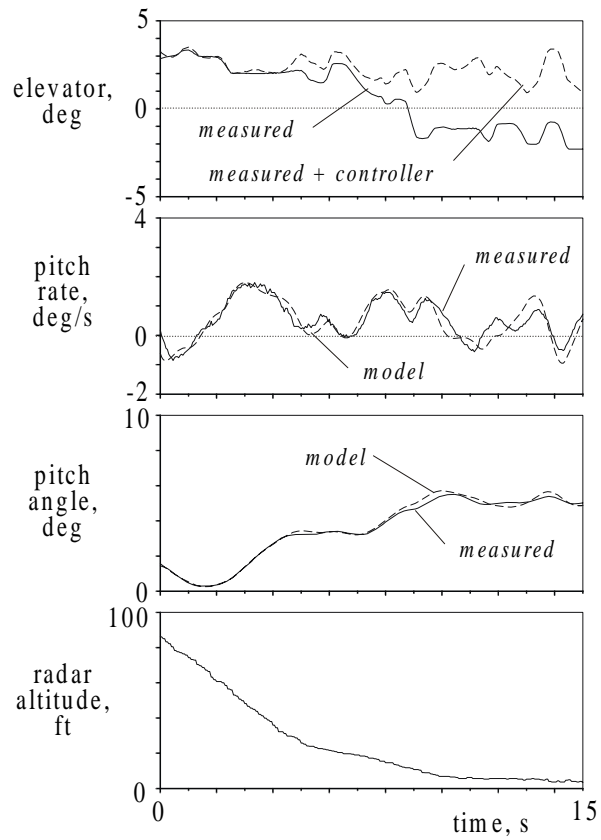


Figure 5.3.23: Flight test data and model results using the *Simplified Inverse Simulation* (model without ground effect)

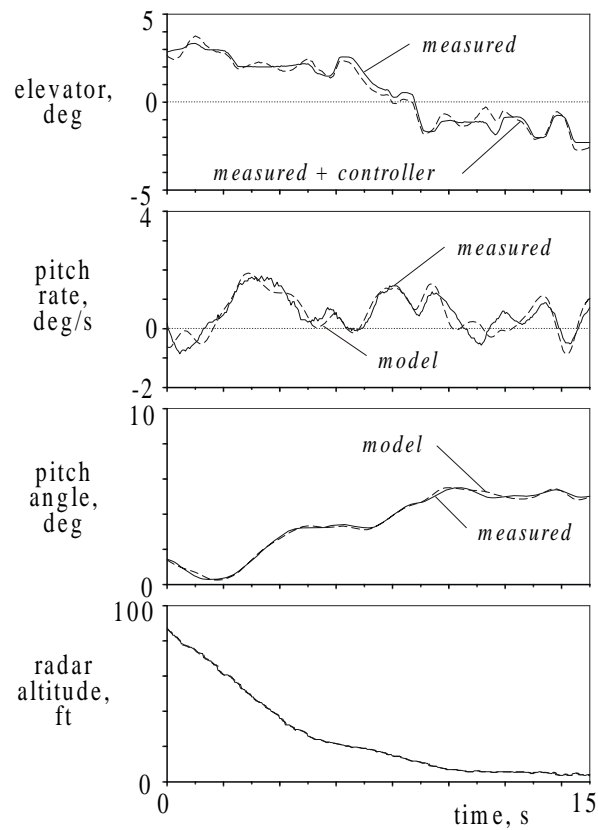


Figure 5.3.24: Flight test data and model results using the *Simplified Inverse Simulation* (improved model with ground effect)



**This page has been deliberately left blank**



**Page intentionnellement blanche**

## 6.0 CONCLUSIONS AND RECOMMENDATIONS

The work of SCI Task Group 26 is now complete and has been described in detail in the previous chapters. The emphasis of the work has been to collect and correlate both good and bad experiences in flight control design. During a series of technical meetings, involving flight control related presentations, the Group identified important lessons learned and best practices. Lessons learned from a selection of problems that occurred during the history of flight, ranging from the Wright Brothers' Flyer to the YF22, have been described and discussed. Another chapter presents a discussion of the positive processes and experiences from programs that were successful or that cured flight control problems that occurred during flight testing in the past.

To summarise, the most important lessons learned are considered to be in relation to the pilot and the handling qualities of the aircraft:

- Poor handling qualities can severely compromise flight safety.
- Controlling a vehicle with excessive or adverse roll-pitch-yaw (inertial) coupling is beyond human capabilities.
- Do not expect a new pilot to acquire the necessary skills on a first flight. Ensure that he understands the logic and importance of correctly following the established emergency procedures.
- A clear understanding of the consequences of inherent stability and control deficiencies is very important.
- The pilot must have a full understanding of the limitations of the aircraft, e.g. when operating in the high angle-of-attack region, where longitudinal and lateral-directional stability and control problems often occur.
- Pilots should gain experience in unfamiliar situations from adequate simulation facilities.
- Aircraft with inherent PIO-tendencies should not be (further) flight tested. PIOs can occur and have occurred, both in conventional and FBW-controlled aircraft. These tendencies should be eliminated with the highest priority.
- Pilots do not, and should not be relied upon, to recognise a PIO in time to prevent the incident from becoming worse.
- PIOs can be predicted to happen in flight by applying certain criteria. Immediate corrective actions need to be taken before the real flight takes place.
- Finally, a better approach is to prevent the occurrence of PIOs by design.

With respect to flight control design, there are many underlying causes for the above, which usually are the result of a poor design. In order to extract the design process related problems, it was stated in the introduction to this document, that we would attempt to give answers to seven basic questions. We now review those questions and answer them, based on our findings:

### 6.1 WHAT ARE THE TRUE PROBLEMS ASSOCIATED WITH FLIGHT CONTROL LAW DESIGN?

The flight control law engineer needs to have knowledge in many areas, such as control theory, control system architecture, aerodynamics, aircraft dynamics, aero- and aero-servo-elasticity, aircraft loads, weight and balance, and simulation and modelling methods. Since it is difficult to have detailed knowledge in all of these areas, a design team consisting of all the expertises mentioned above should be constituted early in the programme. However, the control law designers still need to have a basic understanding of all the above items. One of the true problems is that of easily and quickly gaining this understanding, due to modern flight control system complexity. Even when the design teams are established, there is no reference handbook for the designer, and appropriate and meaningful design guidelines are lacking. The skill required is mainly obtained in practice, and with only a limited number of new programmes and with time elapsing between them, there exists the real concern of losing the built-up experience.

Good communication and exchange of information between all parties involved is essential, covering both documented and verbal communications. This is particularly true for the design phase during which people from different disciplines have to collaborate intensively. Problems can occur because of incorrect, incomplete, insufficient and sometimes misleading customer or design requirements, with misinterpretation of these requirements by the designer contributing to the problems. Documentation is often excessive and subject to change as the programme develops. In this context good “configuration management” is of the utmost importance.

A lack of understanding of the pilot’s requirements and poor communication between pilots and designers are related factors, with designers often not being fully aware of the actual operational conditions. When applying flying qualities requirements for the assurance of satisfactory stability margins of the FCS design, it is of great importance that all dynamic models, like sensor noise and dynamics, anti-aliasing filters, stick dynamics and structural mode filters, sampling and computer delay effects, are incorporated as early as possible. If these models do not exist, approximations should be used. A problem in this area is related to the level of modelling complexity - knowing when the model is suitable for its intended purpose.

A complete aerodynamic, aeroelastic and aero-servo-elastic data package needs to be available as soon as possible. In general, there is a lack of reliable data required at the beginning of the design phase, resulting in incorrect modelling of the overall system, which can result in problems appearing only during the flight test phase. System non-linearities form a significant problem, as they are often ignored or not well understood.

## **6.2 WHY HAS THE DESIGN TASK BECOME SO COMPLICATED?**

Due to historic reasons, designs are generally not made from scratch, but are based on existing designs. This means that some designs inherit the weaknesses of their predecessors, with many subsequent additions, bug-fixes, and ad-hoc solutions to any significant problems. These systems, and others in general, may grow to a point of complexity, so that nobody entirely oversees all the functions of the system.

Performance requirements, such as high angle-of-attack capability and requirements for low observability have increased the complexity of aerodynamic designs. This has led to configurations with a high level of inherent instability, to low control power situations and to limited air data information. An important complicating factor is that a diverse range of aircraft external stores need to be covered. The capabilities of digital fly-by-wire systems are well-known and expectations from customers is high, both in terms of the aircraft’s performance and its handling qualities: second best is not acceptable. The aircraft’s flight controls are of high-order, are non-linear and of a multivariable nature, with mode (switching) logic and failure modes with their inherent complexity. For STOVL aircraft with complex powerplant arrangements, which lead to a high level of flight and propulsion control integration, additional complexity is introduced.

The digital revolution has increased the flexibility enormously. “If-then-else” statements are very easily implemented, but chains of these statements can make digital systems very complex. For human beings it is virtually impossible to overview all possible combinations of these structures, potentially leading to unexpected mode logic behaviour and failure modes. In fact, many systems have been made complex because it was too easy to do so.

For economical reasons, shorter development phases are required. This has to lead to a shorter and more efficient design process. As a result, work on strongly related disciplines has to be performed in a parallel fashion, applying the latest concurrent engineering techniques.

## **6.3 WHAT ARE THE REAL DESIGN REQUIREMENTS?**

A substantial source of problems with FCS design is the design requirements specification. In many cases, requirements are incomplete, ambiguous, sometimes contradictory, and in many cases, not fully quantified and prone to misinterpretation by the designer. Substantial improvement was made in this context, by the introduction of MIL-STD-1797 for military aircraft, although it is still no guaranteed roadway to success.

In cases where the design requirements are not well specified quantitatively, the particular success of an FCS design depends heavily on the incidental and individual experience and skill of the control law designers and their ability to overview the flight control laws design, as an integral part of the flight control system, with its inherent hardware and software constraints. Therefore, the real design requirements probably only exist in the minds of experienced designers, Who can correctly interpret the available information and make sound judgements about what might be missing.

The best handling qualities design requirements are those that reflect the real needs of the pilot-vehicle interface, are well understood by the flight control law designer and are preferably, based on flight test results. The requirements that have proven to be successful, meaning that Level 1 flying qualities have been achieved, are the requirements that should be applied.

Experience from the S/MTD program has shown that, using a restricted set within the Level 1 boundaries of MIL-F-8785C specifications as design requirements for the FCS, will result in a satisfactory system. These requirements should be supplemented with refinements made by analysis and validated by rigorous evaluations in a piloted simulation. No special consideration of PIO is required, but taking special care that none of the existing specification boundaries is being violated.

Existing handling qualities/PIO metrics have played a major role in the development of the F-22 control laws. Although many of these metrics were developed from earlier generation aircraft, it has been demonstrated that the trends, and not necessarily the absolute boundaries, are still useful in assessing the handling qualities of current generation fighters. These metrics tend to provide a better measure of “goodness” of an aircraft’s handling qualities than the guidance on short period frequency and damping contained in the flying qualities standard MIL-STD-1797 and specification MIL-F-8785.

Control system, actuator and airframe non-linearities can have a significant impact on flying qualities and PIO susceptibility. Existing handling qualities/PIO metrics do not directly address these effects, but this does not preclude consideration of non-linearities. The F-22 team has begun extending the existing metrics to include the effects of actuator rate limiting. Research programmes, such as the Unified PIO Theory programme, are crucial to the development of validated metrics, that account for both linear and non-linear effects.

## **6.4 WHAT ARE THE BEST DESIGN PRACTICES?**

From the collective experience gained during the development of flight control systems, there are many best practices that have been established from demonstrator and production development flight programmes. These practices have been developed through the challenges that have emerged, particularly for the flight control law designers, and from the more general lessons learned, quite often as a result of things that have not gone as planned. Such best practices are vested in each organisation, with some being well documented, thoroughly understood and strictly adhered to. There are others that are less obvious and perhaps not adequately recorded.

In Chapter 4, an initial open collection of the best practices for flight control systems has been assembled and organised for easy reference, within the framework of the flight control system development process. Many of these practices are not particular to the flight control system and are simply ‘good engineering practices’, which could easily be applied elsewhere.

Flight control system design is a multidisciplinary activity, where a successful design and development programme is most likely to be achieved by having satisfactory procedures, sufficiently experienced and well-trained engineers, and adherence to the best practices that have been proposed in Chapter 4.

All flight control law developers should read Chapter 4 and at least be aware of the points that are made. They should then study in detail, the best practices that are directly applicable to their responsibilities within the design process, and ensure that they fully understand what is being proposed. This might require seeking the advice of their senior colleagues and specialists within their organisation, or by attending appropriate technical training courses. The best practices in Chapter 4 should also be read by the flight

control managers, to help with their planning and to maximise the probability of their team's adherence to their programmes.

In the longer term, each organisation should begin to assemble a database of their best practices for flight control, with a view to producing an update to Chapter 4 in the future. Ideally, each best practice would be demonstrated by an example, to show what can go wrong in practice and what solutions are available to solve any problems that are encountered.

## **6.5 WHAT IS THE BEST WAY TO HANDLE UNCERTAINTY?**

Minimise uncertainties as much and as soon as possible, by applying CFD and using wind tunnels and simulators, and by building prototypes. Perform testing to obtain accurate measurements for modelling and clearance, before flight testing. Aim to obtain further information during flight to further reduce uncertainties and to validate the models of the aircraft's characteristics.

Know where and why all the uncertainties arise, have good estimates of their expected ranges and understand how uncertainties affect the system's behaviour. Uncertainty modelling can be helpful in this respect, as it will provide the designer with a model which can be used to systematically investigate the system's responses. This modelling should address possible variations in aerodynamic data, centre of gravity, mass/inertia, actuation dynamics and the airdata system.

Identify and list the uncertainties and take them into account from the beginning, selecting a representative set of uncertainties to be used for the design. Design for a specified level of robustness against the uncertainties in the system. Take into account the trade-off between performance and robustness, and be aware that the right balance between these differs from design to design.

Perform the initial design with relatively large stability margins to allow for the higher levels of uncertainty to be expected at this stage. Evaluate the design for several sets of uncertainties to make the robustness characteristics visible, in an understandable manner. Aim to reduce uncertainties as test information becomes available, since large uncertainties can compromise performance and restrict the aircraft's flight envelope through flight clearance limitations.

## **6.6 WHAT DO THE MODERN / ADVANCED DESIGN TECHNIQUES REALLY OFFER?**

The 'robust control' techniques offer methods for handling uncertainties by incorporating robustness from the start of a design. Certain techniques, such as "mu-analysis", can be useful to find the worst case conditions and to aid in finding the effects that uncertainties can have.

Advanced design techniques also offer the possibility for a more systematic, well-structured, more efficient, automatic design process, making quick iterations possible due to rapid prototyping. Automation of the design process, for example, by systematically exploring different controller architectures and by introducing automatic tuning of design parameters, allows the designer to concentrate more on important matters than on routine activities.

These techniques offer methods to aid in the design and development of high-order multi-input/multi-output systems, and some 'artificial intelligence' techniques, such as neural networks, have potential for dealing with failure cases and for correcting for battle damage.

However, all techniques by no means, offer a substitute for experience, and do not offer a solution to non-linear system design. The modern methods do not provide a better insight into the physics of the design and flight mechanics knowledge is essential to enable interpretation of the results.

## 6.7 WHAT CAN BE DONE TO SUPPORT CURRENT AND FUTURE PROJECTS?

Learning the right lessons from the past can support future projects, by aiming to understand the real reasons for past problems and successes. Exchange of experience, thereby being as open as possible, is strongly recommended. Design cycles are these days, very long, and any designer is faced only with a few designs during his career and therefore, experience can only partly be gained by learning from the experience of others.

To bridge the gaps between projects, an environment has to be established that allows young engineers to acquire rapidly and reliably, past experience. The establishment of databases is recommended that contain bad and good examples of projects from the past. It is important to also consider the establishment of education methods, curricula and training environments in this context.

The flight control design problem has to be understood as a multidimensional multidisciplinary problem that can only be solved with proper co-operation and mutual understanding between different disciplines.

It is therefore important to spend sufficient time at an early stage, to talk to everybody who is involved in the design process, and to consider whether the group has the right constitution.

Modern communication and information technology may help to improve the design process, but the question is how might the flight control research community contribute in this area? New design techniques have been and are being developed, which may aid the designers. An important contribution of the research community could be to make these methods more accessible for the wider design, implementation and testing communities. The gap between science and practical application needs to be narrowed. Modern information and communication technologies could be very helpful in this respect.

As a proven design process represents a critical capital for industry, new methods will be adopted only if they are mature. Therefore, it is desirable that any modern design method is demonstrated by application to a benchmark problem, which is representative of an industrial situation (no academic benchmarks!). The future work should focus on the design process and its risks, in terms of cost and time overruns; i.e. cheaper, faster, better.

Existing requirements for flight control systems, handling qualities, structural design, air data system design, actuation system design, should be re-visited and where possible, harmonised towards common goals. There is a need to continue with the formulation and validation of handling qualities criteria, including PIO/APC, that are valid for modern pilot interfaces, that reduce flight simulator testing and that can be used in an automated computer-based design process. It is recommended to continue the collection and summing-up of handling qualities criteria, and where possible, to expand and develop their application civil aircraft.

We should continue to address the problem of accidents due to oscillatory aircraft-pilot coupling, by using (modular) research flight simulation facilities, in combination with computational analysis tests, e.g. with pilot models and fast pre-design, using mock-ups or using very simple facilities like PCs with a joy-stick.

A better integration of the research community's flight research facilities is recommended.

Aim to dispel the "myths and misconceptions" about flight control and give the research community some positive directions, so that their work will be more relevant to the real current, and possible future, flight control problems. Define the "demand for future research". Stimulate the cooperation between industry and the research community on actual current and future design cases.

As mentioned in the introduction of this report, the second part of the report has addressed the theoretical aspects of flight control design, as described in Chapter 5. It starts with a discussion of the history and development of the (US) Flying Qualities Criteria. An important observation made here, is that the

specification should always be applied to the full range of manoeuvres across the total flight envelope, which means the incorporation of all non-linearities.

The subject of “carefree handling” has subsequently been dealt with, discussing advantages and disadvantages, design and implementation considerations, concluding with a summary of lessons learned. A subchapter on Flying Quality Demonstration Manoeuvres for the evaluation of flying qualities has been included, as this concept is being revived under the changed (US) acquisition circumstances and air vehicle specification process. Current and proposed demonstration manoeuvres have been discussed.

PIO phenomena can have various different causes. To facilitate a better understanding of the occurrence of PIOs, a classification into three categories has been introduced:

- Category I: essential linear pilot-vehicle system oscillations.
- Category II: quasi-linear pilot-vehicle system oscillations with rate or position limiting.
- Category III: essential non-linear pilot-vehicle system oscillations, such as multiple non-linearities, transitions in pilot behaviour, etc.

In Chapter 5.2 of this report, an overview of most of the methods and criteria, proposed by the flying qualities research community to predict PIO, has been presented. The overview has followed the above classification. For Category I PIO it has been shown that several very effective indicators of PIO exist. The presented criteria deal with attitude control pilot-vehicle systems. It is considered that by using a combination of some of the presented criteria during the flight control design process, the probability that PIO will occur can be greatly reduced. Some extensions to the presented methods have been suggested.

For Category II PIO some promising methods have been presented, all of them showing potential to predict this type of PIO. Although it is considered that using the presented criteria can also reduce the risk of experiencing PIO in flight, more data are needed from flight and/or simulator experiments, in order to refine and validate the boundaries which discriminate between PIO-prone and PIO-free behaviour. It is therefore recommended that further research is to be done in this area, with a twofold objective, firstly, to collect more data, and secondly, to use these data to validate and refine the proposed methods and to derive new ones where necessary.

Category III PIO is still a problem area, but eliminating Categories I and II PIOs will help to avoid Category III. The wide variety of phenomena included under this category makes it more difficult to develop PIO prediction methods, than for Categories I and II. At the same time, developing methods for predicting more than simple linear or quasi-linear PIOs, is crucial for future aircraft. It is recommended to increase research on this subject, which is part of the wider topic of non-linear control.

It can be concluded from the answers given to a number of the seven basic questions presented above, that modelling and simulation play a very significant part in the flight control design process. The availability of good models, reliable data and a good understanding and strategy for how to deal with uncertainties, are of great importance in this respect. Therefore, special attention has been paid to this subject in the concluding part of Chapter 5 and more emphasis needs to be placed in this area in the future.

## 7.0 REFERENCES

- <sup>a</sup>Amato, F., Iervolino, R., Scala, S., and Verde, L., “A Robust Stability Analysis approach for prediction of Pilot in the loop Oscillations”, ECC’99, European Control Conference, Karlsruhe (DE), August 1999.
- <sup>b</sup>Amato, F., Iervolino, R., Scala, S., and Verde, L., “Actuator Design for Aircraft Robustness Versus Category II PIO”, MED’99, Mediterranean Conference on Control and Automation, Haifa (IL), June 1999.
- <sup>c</sup>Amato, F., Iervolino, R., Scala, S., and Verde, L., “New Criteria for Prediction of PIO based on Robust Stability Methods: Application to the Design of Rate Limited Actuators”, AIAA Atmospheric Flight Mechanics Conference, Portland (OR), August 1999.
- Anderson, M.R., and Page, A.B., “Unified Pilot-Induced Oscillation Theory, Volume III: PIO Analysis using Multivariable Methods”, WL-TR-96-3030, Wright Laboratory, Wright-Patterson Air Force Base, Ohio, 1995.
- Anderson, M.R., “Pilot-Induced Oscillations Involving Multiple Non-linearities”, Journal of Guidance, Control, and Dynamics, Vol. 21, No. 5, p.786-791, 1998.
- Anderson, S.B., “Some Lessons Learned from An Historical Review of Aircraft Operations”, in Aircraft Flight Safety, International Conference Proceedings, Zhukovsky, Russia, Aug/Sept 1993.
- Anon, Military Specification, “Flying Qualities of Piloted Airplanes”, MIL-F-8785B (ASG), Aug. 1969.
- Anon, Military Specification, “Flying Qualities of Piloted Airplanes”, MIL-F-8785C, Nov. 1980.
- Anon, “Military Standard: Flying Qualities of Piloted Aircraft”, MIL-STD-1797A, Wright-Patterson AFB, 1990
- Anon, “MATRIXx/System Build User’s Guide”, Integrated System Inc.
- Anon, “Matalb/Simulink User’s Guide”, The Matworks Inc.
- Anon, “Airplane Simulator Qualification”, FAA Advisory Circular, AC 120-40B, Interim Version, Feb. 1991.
- Anon, “Handling Qualities of Unstable Highly Augmented Aircraft”, AGARD-AR-279, 1991.
- Anon, “Airplane Flight Simulator Evaluation Handbook”, The Royal Aeronautical Society, London, Feb. 1995.
- Anon, Notice of Change to MIL-STD-1797A, Notice 1, Department of Defense Interface Standard, 28 June 1995.
- Anon, “Handling Qualities Requirements for Military Rotorcraft”, Aeronautical Design Standard, ADS-33D-PRF, May 1996.
- Anon, “Simulink Linked with Beacon Autocoder”, Aviation Week & Space Technology, June 28, 1999
- Ashkenas, I.L., Jex, H.R., and McRuer, D.T., “Pilot-Induced Coupling Oscillations: Their Cause and Analysis”, NORAIR Report NOR-64-143, 1964.
- Bailey, R.E., and Bidlack, T.J., “Unified Pilot-Induced Oscillation Theory Volume IV: Time-Domain Neal-Smith Criterion”, Wright Laboratory Report WL-TR-96-3031, December 1995.
- Bailey, R.E., and Bidlack, T.J., “A Quantitative Criterion for Pilot-Induced Oscillations: Time Domain Neal-Smith Criterion”, AIAA-96-3434-CP, August 1996.



Batterson, J.G., and Klein, V., "Partitioning of Flight Data for Aerodynamic Modeling of Aircraft at High Angles of Attack", *Journal of Aircraft*, Vol. 26, No. 4, April 1989, pp. 334-339.

Benjes, CDR Christopher, USN, and MAJ John Rader, USMC, "F/A-18 Night Attack Development and Flight Testing," *Thirty-Third Symposium Proceedings, Society of Experimental Test Pilots*, Sept. 1989.

Berthe, C.J., Chalk, C.R., and Sarrafian, S.K., "Pitch Rate Flight Control Systems in the Flared Landing Task and Design Criteria Development"; NASA CR-172491, 1984.

Bjorkman, E.A., "Flight Test Evaluation of Techniques to Predict Longitudinal Pilot- Induced Oscillations", AFIT-GAE-AA-86J-1, USAF Institute of Technology, Wright-Patterson AFB, 1986.

Blackwell, J., "A Maximum Likelihood Parameter Estimation Program for General Non-Linear Systems", ARL-AERO-TM-392, Jan. 1988.

Bland, M., et al, "Alternative Design Guidelines for Pitch Tracking", AIAA Paper 87-2289, August 1987.

Branch, W., "Autopilot Design Rules and Guidelines", Paper No. AIAA-98-4425, August 1998.

Brickner, Michael S., "Helicopter Flights with Night-Vision Goggles – Human Factors Aspects", NASA TM 101039, March 1989.

Brockhaus, R., "Flugregelung", Springer-Verlag, Berlin/Heidelberg/New York, 1994.

Brumbaugh, R.W., "Aircraft Model for the AIAA Controls Design Challenge", *Journal of Guidance, Control and Dynamics*, July-August 1994.

Buchacker, E., Galleithner, H., Koehler, R., and Marchand, M., "Development of MIL-8785C Into a Handling Qualities Specification for a New European Fighter Aircraft", AGARD-CP-508, Paper 10, October 1990.

Caldwell, B.D., "The FCS Structural Coupling Problem and its Solution", AGARD-CP-556, 1994.

Cavalcanti, S., "The Integration of MATRIXx Simulation Models into the Aircraft Design Process", MATRIXx & Betterstate User's Conference, Dorval, October 15, 1998.

Cavallo, A., De Maria, G., and Verde, L., "Robustness Against Aerodynamic Parameter Uncertainties in Flight Control Systems", in *Mathematics of Analysis and Design of Process Control*, edited by Borne, P., and Tzafestas, S.G., March 1992.

Cavallo, A., De Maria, G., and Verde, L., "Robust Flight Control Systems: a Parameter Space Design", *Journal of Guidance Control and Dynamics*, Vol. 15, No. 5, September 1992.

Cavallo, A., De Maria, G., and Verde, L., "Robust Analysis of Handling Qualities in Aerospace Systems", *Proc. of the 11<sup>th</sup> IFAC World Congress*, Vol. 5, edited by Utken, V., and Jaaksoo, U., Pergamon, Oxford, Tallinn URSS, 1990.

Cavallo, A., De Maria, G., and Verde, L., "Robust Parameter Design of Flight Control Systems", *Proc. of the 4<sup>th</sup> AMST 90*, Bradford, UK, 1990.

Cavallo, A., De Maria, G., and Verde, L., "Parameter Space Design of Robust Flight Control Systems", AGARD 50<sup>th</sup> Symp. of the Guidance and Control Panel, Turkey, 1990.

Cavallo, A., De Maria, G., and Verde, L., "Robust Flight Control System Design with Fault Tolerance against Sensor Failure", *Proc. of 13<sup>th</sup> IMACS World Congress*, Dublin 1991.

- Chalk, C.R., Neal, T.P., Harris, T.M., Pritchard, F.E., and Woodcock, R.J., "Background Information and User Guide for MIL-F-8785B(ASG), Military Specification – Flying Qualities of Piloted Airplanes", AFFDL-TR-69-72, August 1969.
- Cooper, G.E., and Harper, R.P. Jr., "The Use of Pilot Rating in the Evaluation of Aircraft Handling Qualities", NASA TN D-5153, April 1969.
- DeMatthew, D.A., "Modification of the Neal-Smith Criterion for the Lateral Axis", AIAA-Paper 91-2884, 1991.
- Dornheim, M.A., "Report Pinpoints Factors Leading to YF-22 Crash", Aviation Week and Space Technology, 9 November 1992.
- Dornheim, M.A., "USAF NVGs: Daytime Tactics for Night Fighters," Aviation Week & Space Technology, 16 June 1997, pp. 172 to 179.
- Duda, H., "Frequency Domain Analysis of Rate Limiting Elements in Flight Control Systems", DLR-FB-94-16, Braunschweig, 1994 (in German).
- Duda, H., "Frequency Domain Analysis of Rate Limiting Elements in Flight Control Systems", DLR-FB 94-16, Braunschweig, 1994 (in German).
- Duda, H., "Effects of Rate Limiting Elements in Flight Control Systems - A New PIO Criterion", AIAA-Paper-95-3304, August 1995.
- Duda, H., "Analysis of Adverse Aircraft- Pilot Coupling in the Roll Axis Using Frequency Domain Criteria", DLR-IB 111-95/24, Braunschweig, 1995.
- Duda, H., "Prediction of Adverse Aircraft Pilot Coupling in the Roll Axis due to Rate Limiting in Flight Control Systems", DLR-IB 111-96/13, Braunschweig, 1996.
- Duda, H., "Prediction of Pilot-in-the-Loop Oscillations due to Rate Saturation", Journal of Guidance, Navigation, and Control, Vol. 20, No. 3, May-June 1997.
- Duda, H., "Flying Qualities Criteria Considering Rate Limiting", DLR-FB 97-15, Braunschweig, 1997 (in German).
- Duda, H., "Minutes of a Workshop on Pilot-in-the-Loop Oscillations held at DLR, Braunschweig on June 12-13<sup>th</sup>, 1997", DLR IB 111-97/25, Braunschweig, 1997.
- Duda, H., and Duus, G., "New Handling Qualities Database on PIO due to Rate Saturation", DLR-FB 97/53, Braunschweig, 1997.
- Duda, H., Hovmark, G., and Forssell, L., "Prediction of Category II Aircraft-Pilot Couplings – New Experimental Results", AIAA-Paper 97-3499, August 1997.
- Elmqvist, H., "Dymola-Dynamic Modeling Language User's Manual", Dynasim AB, S-22370 Lund, Sweden, 1993.
- Elmqvist, H., "Object-Oriented Modeling and Automatic Formula Manipulation in Dymola", Scandinavian Simulation Society SIMS'93, Kongsberg, Norway, June 1993.
- Evans, R.J., Goodwin, G.C., Feik, R.A., Martin, C., and Lozano-Leal, R., "Aircraft Flight Data Compatibility Checking Using Maximum Likelihood and Extended Kalman Filter Estimation", Proc. of the 7<sup>th</sup> IFAC Symposium on Identification and System Parameter Estimation, York, UK, July 3-7, 1985.

- Fielding, C., "Non-linear analysis and modelling during the development of an aircraft Incidence Limiting System" in Non-linear System Design, IEE (Peter Peregrinus, 1984).
- Fischenberg, D., "Ground Effect Modeling Using a Hybrid Approach of Inverse Simulation and System Identification", AIAA Modeling & Simulation Technologies Conference, Portland, Oregon, 1999.
- Friehmelt, H., Weiss, S., Rohlf, D., and Plaetschke, E., "Using Single Surface Excitation for X-31 System Identification at High AoA", Proceedings of the 26th Annual Symposium of the Society of Flight Test Engineers, Berlin, June 19-23, 1995.
- Fu, K-H., and Marchand, M., "Helicopter System Identification in the Frequency Domain", 9<sup>th</sup> European Rotorcraft Forum, Sept. 13-15, 1983, Stresa, Italy, Paper 96.
- Gates, R.J., Bowers, A.H., and Howard, R.M., "A Comparison of Flight Input Techniques for Parameter Estimation of Highly Augmented Aircraft", AIAA Atmospheric Flight Mechanics Conference, Paper 96-3363, San Diego, CA, Aug. 11-13, 1996.
- Gelb, A., and van der Velde, W.E., "Multiple Input Describing Functions and Nonlinear System Design", McGraw Hill Book Co., 1968.
- Gibson, J.C., "Flying Qualities and the Fly-by-Wire Aeroplane", AGARD-CP-260, Stability and Control, 1978.
- Gibson, J.C., "Piloted Handling Qualities Design Criteria for High Order Flight Control Systems", AGARD-CP-333, Paper 4, April 1982.
- Gibson, J.C., "Evaluation of Alternate Criteria for FBW Handling Qualities", AGARD-CP-508, Flying Qualities, October 1990.
- Gibson, J.C., "The Prevention of PIO by Design", AGARD-CP-560, Active Control Technology, 1994.
- Gibson, J.C., "Looking for a Simple PIO Model", AGARD-AR-335, Flight Vehicle Integration Panel Workshop on Pilot Induced Oscillations, 1994.
- Gibson, J.C., and Hess, R.A., "Stick and Feel System Design", AGARD-AG-332, March 1997.
- Gibson, J.C., "Development of a Methodology for Excellence in Handling Qualities Design for Fly By Wire Aircraft", Delft University Press, Series 03: Control and Simulation 06, ISBN 90-407-1842-3, 1999.
- Gilbert, W.P., Nguyen, L.T., and Van Gunst, R.W., "Simulator Study of the Effectiveness of an Automatic Control System Designed to Improve the High-Angle-of-Attack Characteristics of a Fighter Airplane", NASA TN D-8176, 1976.
- Gill, P.E., Murray, W., and Wright, M.H., "Practical Optimization", Academic Press, 1981.
- Graves, H.C., et al, "Study and Development of an Electric Sidestick Controller for Aerospace Vehicles", ASD-TR-61-603, May 1962.
- Grübel, G., Joos, H-D., Otter, M., and Finsterwalder, R., "The ANDECS Design Environment for Control Engineering", 12th IFAC World Congress, Sydney, Australia, Vol. 6, July 19-23 1993.
- Gupta, N.K., and Hall, W.E. Jr., "Input Design for Identification of Aircraft Stability and Control Derivatives", NASA CR-2493, Feb. 1975.
- Hamel, P.I., "Rotorcraft-Pilot Coupling, A Critical Issue for Highly Augmented Helicopters?", AGARD-FVP Symposium Advances in Rotorcraft Technology, CP-592, 1996.

- Hamel, P., "Aerospace Vehicle Modelling Requirements for High Bandwidth Flight Control", in: Aerospace Vehicle Dynamics and Control, edited by M.V. Cook and M.J. Rycroft, Clarendon Press, Oxford, 1994.
- Hamel P.G., and Jategaonkar, R.V., "Evolution of Flight Vehicle System Identification", *Journal of Aircraft*, Vol. 23, No. 1, Jan.-Feb. 1996.
- Hamel, P.G., and Jategaonkar, R.V., "The Role of System Identification for Flight Vehicle Applications – Revisited", RTO-MP-11, Symposium on System Identification for Integrated Aircraft Development and Flight Testing, May 1998.
- Hamel, P.G., "Aircraft Parameter Identification Methods and Their Applications – Survey and Future Aspects", AGARD-LS-104, Nov. 1979.
- Hanke, D., "The influence of Rate Limiting Elements in Flight Control Systems on Handling Qualities", DLR-IB 111-93-61, Braunschweig, 1993.
- Hanke, D., "Handling Qualities Analysis of Rate Limiting Elements in Flight Control Systems", AGARD Advisory Report AR-335, Paper 11, 1995.
- Hanke, D., and Lange, H., "Flight Evaluation of the ATTAS Digital Fly-by-Wire/Light Flight Control System", ICAS-88-3.6.1, Jerusalem, 1988.
- Hanke, D., Bauschat, J-M., Lange, H-H., and Heutger, H., "In-Flight Simulator ATTAS-System Design and Capabilities", In-Flight Simulation for the 90's, DGLR Conference Proceedings 91-05, Braunschweig, 1990.
- Harris, J.J., and Black, G.T., "F-22 Control Law Development and Flying Qualities", AIAA Paper 96-3379-CP, August 1996.
- Hess, R.A., "Model for Human Use of Motion Cues in Vehicular Control"; *Journal of Guidance, Control and Dynamics*, Vol.13, No. 3, 1989.
- <sup>a</sup>Hess, R.A., "Unified Theory for Aircraft Handling Qualities and Adverse Aircraft-Pilot Coupling", *Journal of Guidance, Control, and Dynamics*, Vol. 20, No. 6, p.1141-1148, 1997.
- <sup>b</sup>Hess, R.A., "Assessing Aircraft Susceptibility to Nonlinear Aircraft-Pilot Coupling/Pilot Induced Oscillations", AIAA-97-3496, August 1997.
- <sup>c</sup>Hess, R.A., "A theory for the Roll-Ratchet Phenomenon in High Performance Aircraft"; AIAA-97-3498, August 1997.
- Hess, R.A., and Kalteis, R.M., "Technique for Predicting Longitudinal Pilot-Induced Oscillations", *Journal of Guidance, Control, and Dynamics*, Vol. 14, No. 1, 1991.
- Hess, R.A., and Stout, P.W., "Predicting Handling Qualities Levels for Vehicles with Nonlinear Dynamics", AIAA-98-0494, 1998.
- Hildreth, B.L., "The Draft AIAA Flight Mechanics Modelling Standard: an Opportunity for Industry Feedback", Paper No. AIAA-98-4576-CP, 1998.
- Hoffren, J., and Vilenius, J., "Sensitivity of Air Combat Maneuvers to Aircraft-Modeling Uncertainties", AIAA-98-4165, 1998.
- Hoh, R.E., and Hodgkinson, J., "Bandwidth – A Criterion for Highly Augmented Airplanes", AGARD-CP-333, Paper 9, April 1982.

Hohne, G., "Longitudinal Flying Qualities Investigations of Highly Augmented Aircraft during Landing", DLR-IB 111-97/20 Braunschweig, 1997 (in German).

Höhne, G., "A Biomechanical Pilot Model for Prediction of Roll Ratcheting", Paper No. AIAA-99-4092-CP, Portland, 1999.

Hreha, M., "F-15 ACTIVE Control Law Development & Testing", MATRIXx User's Conference, Long Beach, California, April 8, 1999.

Huffman, R.E., Cawood, M.D., Ferm, M., and Skoog, M.A., "Determination of Nuisance Criteria for Ground Collision Avoidance Systems", presented at the 4<sup>th</sup> Saint Petersburg International Conference on Integrated Navigation Systems, May 26-28, 1997.

Huffman, R.E., Skoog, M.A., Pinerio, L., and Ferm, M., "Application of Ground Collision Avoidance System Nuisance Criteria", presented at the 21<sup>st</sup> Congress of the International Council of the Aeronautical Sciences, (ICAS 98), September 1998, Melbourne, Australia.

Iiliff, K.W., "Parameter Estimation for Flight Vehicles", *Journal of Guidance, Control, and Dynamics*, Vol. 12, No. 5, Sept.-Oct. 1989.

Iloputaife, O., "Minimizing Pilot-Induced-Oscillation Susceptibility During C-17 Development", AIAA-97-3497-CP, August 1997.

Irving, J.P., "Flight Control Law Process Model", GARTEUR FM(AG08)/TP-088-2, 22 May 1995.

Jacobson, S.B., Colangelo, T.D., Harwood, K.E., and Hobbs, B.L., "B-2 Flight Control System Development Flight Test Lessons Learned", Flight Test News, Vol. 30, number 3, Society of Flight Test Engineers, March 1999.

Jategaonkar, R.V., and Plaetschke, E., "Maximum Likelihood Parameter Estimation from Flight Test Data for General Nonlinear Systems", DFVLR-FB 83-14, March 1983.

Jategaonkar, R.V., "User's Manual for NLMLKL, a General FORTRAN Program for Parameter Estimation in Time Domain", DLR IB 111-95/03, March 1995.

Jategaonkar, R.V., and Plaetschke, E., "Non-Linear Parameter Estimation from Flight Data Using Minimum Search Methods", DFVLR-FB 83-15, March 1983.

Jategaonkar, R.V., and Plaetschke, E., "Algorithms for Aircraft Parameter Estimation Accounting for Process and Measurement Noise", *Journal of Aircraft*, Vol. 26, No. 4, April 1989.

Jategaonkar, R.V., "A Comparison of Output Error and Filter Error Methods from Aircraft Parameter Estimation Results", In: DLR-Mitt. 93-14, Dec. 1993.

Jategaonkar, R.V., and Thielecke, F., "Parameter Estimation Methods for Unstable Aircraft", *Journal of Aircraft*, Vol. 31, No. 3, May-June 1994.

Jategaonkar, R.V., Mönnich, W., Fischenberg, D., and Krag, B., "Identification of C-160 Simulator Data Base from Flight Data", *Proceedings of the 10<sup>th</sup> IFAC Symposium on System Identification*, Copenhagen, Denmark, July 1994.

Jategaonkar, R.V., and Mönnich, W., "Identification of DO-328 Aerodynamic Database for a Level D Flight Simulator", AIAA Atmospheric Flight Mechanics Conference, Paper 97-3729, New Orleans, LA, August 1997.

- Johnston, D.E., and McRuer, D.T., "Investigation of Limb/Side Stick Dynamic Interaction with Roll Control", *Journal of Guidance, Control and Dynamics*, Vol. 10, No. 2, 1987.
- Keskar, D.A., and Klein, V., "Determination of Instrumentation Errors from Measured Data Using Maximum Likelihood Method", AIAA 80-1602, 1980.
- Khalil H.K., "Nonlinear Systems", Macmillan Publishing Company, 1992.
- Kish, B.A., Mosle, W.B., and Remaly, A.S., "A Limited Flight Test Investigation of Pilot-Induced Oscillation Due to Rate Limiting", AIAA-97-3703, August 1997.
- Kisslinger, R.L., and Moorhouse, D.J., "Lessons Learned in Control System Integration & Management from the S/MTD Program", SAE Paper 901849, SAE Aerotech '90, October 1990.
- Klein, V., "Estimation of Aircraft Aerodynamic Parameters from Flight Data", *Progress in Aerospace Sciences*, Vol. 26, Pergamon Press, Oxford, UK, 1989.
- Klein, V., "Identification Evaluation Methods", AGARD-LS-104, 1979.
- Klein, V., Batterson, J.G., and Murphy, P.C., "Determination of Airplane Model Structure from Flight Data by Using Modified Stepwise Regression", NASA TP-1916, Oct. 1981.
- Klein, V., and Schiess, J.R., "Compatibility Check of Measured Aircraft Responses Using Kinematic Equations and Extended Kalman Filter", NASA TN D-8514, Aug. 1977.
- Klein, V., "Aircraft Parameter Estimation in the Frequency Domain", AIAA 78-1344, 1978.
- Klyde, D.H., McRuer, D.T., and Myers, T.T., "Unified Pilot-Induced Oscillation Theory, Volume I: PIO Analysis with Linear and Nonlinear Effective Vehicle Characteristics, including Rate Limiting", WL-TR-96-3028, Wright-Patterson Air Force Base, Ohio, {also TR-1313-1, Systems Technology Inc., Hawthorne}, 1995.
- Klyde, D.H., McRuer, D.T., and Myers, T.T., "PIO Analysis with Actuator Rate Limiting", AIAA-96-3432-CP, 1996
- Klyde, D.H., McRuer, D.T., and Myers, T.T., "Pilot-Induced Oscillation Analysis and Prediction with Actuator Rate Limiting", *Journal of Guidance, Navigation and Control*, Vol. 20, No.1, January-February 1997.
- Koehler, R., "X-31A Flying Qualities Results using Frequency Response Flight Test Evaluation Techniques", DLR-IB 111-96/11, Braunschweig, 1996.
- Koehler, R., Buchacker, E., and Biezd, D.J., "GRATE – A New Flight Test Tool for Flying Qualities Evaluations", AGARD-CP-452, 1988.
- Koehler, R., and Wilhelm, K., "Auslegung von Eingangssignalen für die Kennwertermittlung", DFVLR-IB 154-77/40, Dec. 1977.
- Koehler, R., "Unified Approach for Roll Ratcheting Analysis", AIAA, *Journal of Guidance, Control, and Dynamics*, Volume 22, Number 5, 1999.
- Kröger, A., "Data-Flow-Oriented Control Law Design with Graphical Language HOSTESS", Conference Proceedings, International Conference and Exhibition, 8th international event on Civil and Military Avionics, Heathrow, 1994.
- Kullberg, E., and Elcrona, P.-O., "SAAB Experience with PIO", Paper 9, AGARD-AR-335 (Flight Vehicle Integration Panel Workshop on Pilot Induced Oscillations), February 1995.

Lambrechts, P.F., and Terlouw, J.C., "A Matlab Toolbox for Parametric Uncertainty Modeling", Philips Research Eindhoven and NLR Amsterdam, 1992.

Leggett, D.B., Moorhouse, D.J., and Zeh, J.M., "Simulating Turbulence and Gusts for Handling Qualities Evaluation", AIAA Paper 90-2845, August 1990.

Lindsey, S.W., "Prediction of Longitudinal Pilot Induced Oscillations Using the Optimal Control Model", AFIT-GAE-ENY/90M-1, USAF Institute of Technology, Wright-Patterson AFB, 1989.

Lodge, P.M., and Runham, S.I., "Design and Flight Demonstration of an Advanced Flight Control Law in the VAAC Harrier", International Powered Lift Conference Proceedings, The Royal Aeronautical Society, 1998.

Luenberger, D.G., "Linear and Non-Linear Programming", Addison and Wesley Publishing Co., 1987

Maine, R.E., and Iliff, K.W., "Identification of Dynamic Systems – Applications to Aircraft. Part I; The Output Error Approach", AGARD-AG-300, Vol. 3, Part 1, Dec. 1986.

Maine, R.E., and Iliff, K.W., "Identification of Dynamic Systems", AGARD-AG-300, Vol. 2, Jan. 1985.

Maine, R.E., and Iliff, K.W., "Formulation and Implementation of a Practical Algorithm for Parameter Estimation with Process and Measurement Noise", SIAM Journal of Applied Mathematics, Vol. 41, Dec. 1981.

Maine, R.E., and Murray, J.E., "Application of Parameter Estimation to Highly Unstable Aircraft", Journal of Guidance, Control, and Dynamics, Vol. 11, No. 3, May-June 1988.

Marchand, M., Koehler, R., Duda, H., Buchacker, E., and Elbel, K., "EFA Flying Qualities Specification and Its Utilisation", AGARD-CP-548, Technologies for Highly Manoeuvrable Aircraft, Oct. 1993.

Marchand, M., and Fu, K-H., "Frequency Domain Parameter Estimation of Aeronautical Systems without and with Time Delay", Proceedings of the 7<sup>th</sup> IFAC Symposium on Identification and System Parameter Estimation, York, UK, July 3-7, 1985.

Martin, J., and Buchholz, J.J., "SCARLET: DLR Rate Saturation Flight Experiment", AGARD Advisory Report AR-335, Paper 8, 1995.

Matranga, G.J., "Analysis of X-15 Landing Approach and Flare Characteristics Determined from the first 30 Flights, NASA TN D-1057, 1961.

McCuish, A., and Caldwell, B.D., "Development and Flight Experience of the Control Laws and the Aeroservoelastic solution in the Experimental Aircraft Programme", in *Tischler*.

McKay, K., ed., "Flight Vehicle Integration Panel Workshop on Pilot-Induced Oscillations", AGARD-AR-335, February 1995.

McRuer, D., Graham, D., Krendel, E., and Reisener, W., "Human Pilot Dynamics in Compensatory Systems", AFFDL-TR-65-15, Wright-Patterson AFB, 1965.

McRuer, D., "Pilot-Induced Oscillations and Human Dynamic Behaviour", NASA CR 4683, 1995.

McRuer, D., et al "AVIATION AND PILOT CONTROL. Understanding and Preventing Unfavorable Pilot-Vehicle Interactions", ASEP National Research Council National Academy Press, Washington D.C., 1997.

McRuer, D.T., Klyde, D.H., Parrag, M., A'Harrah, R., and Bailey, R., "Pilot-Induced Oscillations: Theory, Analysis and Flight Research", AIAA Professional Development Tutorial Short Course, Boston, August 1998.

Mehra, R.K., "Optimal Inputs for Linear System Identification", Preprints, JACC, Stanford, California, 1972.

Messina, M.D., Strickland, M.E., Hoffler, K.D., Carzoo, S.W., Bundick, W.T., Yeager, J.C., and Beissner, F.L. Jr., "Simulation Model of the F/A-18 High Angle-of-Attack Research Vehicle Utilized for the Design of Advanced Control Laws", NASA TM-110216, May 1996.

<sup>a</sup>Mitchell, D.G., and Hoh, R.H., Aponso, B.L., and Klyde, D.H., "Proposed Incorporation of Mission-Oriented Flying Qualities into MIL-STD-1797A", WL-TR-94-3162, October 1994.

<sup>b</sup>Mitchell, D.G., Hoh, R.H., Aponso, B.L., and Klyde, D.H., "The Measurement and Prediction of Pilot-In-The-Loop Oscillations", AIAA-Paper 94-3670, August 1994.

Mitchell, D.G., and Aponso, B.L., "Feel System and Flying Qualities", paper no. AIAA-95-3425-CP, 1995.

Mitchell, E.E., and Rogers, A.E., "Quaternions Parameters in the Simulation of a Spinning Body", Simulation, June 1965.

Monagan, S.J., Smith, R.E., and Randall, E.B., "Lateral Flying Qualities of Highly Augmented Fighter Aircraft", AFWAL-TR-81-3171, Vol. I & II, 1982.

Mooij, H.A., "Low-Speed Longitudinal Flying Qualities of Motion Transport Aircraft", in Advances in Flying Qualities, AGARD-LS-157, 1988.

Moorhouse, D.J., "STOL Flying Qualities and the Impact of Control Integration", Proceedings of IEEE NAECON, May 1983.

Moorhouse, D.J., "Lessons Learned from the S/MTD Program for the Flying Qualities Specification", AIAA Paper 90-2849, August 1990.

Moorhouse, D.J., "Experience with the R. Smith PIO Criterion in the STOL & Maneuver Technology Demonstrator", AIAA Paper 94-3671, August 1994.

Moorhouse, D.J. and Kisslinger, R.L., "Lessons Learned in the Development of a Multivariable Control System", Proceedings of IEEE NAECON '89, May 1989.

Moorhouse, D.J., Leggett, D.B., and Feeser, K.A., "Flying Qualities Criteria for Precise Landing of a STOL Fighter", AIAA Paper 89-3390, August 1989.

Moorhouse, D.J., and Moran, W.A., "Flying Qualities Design Criteria for Highly Augmented Systems", Proceedings of IEEE NAECON '85, May 1985.

Moorhouse, D.J., and Woodcock, R.J., "Background Information and User Guide for MIL-F-8785C, Military Specification – Flying Qualities of Piloted Airplanes", AFWAL-TR-81-3109, July 1982.

Morelli, E.A., and Klein, V., "Optimal Input Design for Aircraft Parameter Estimation Using Dynamic Programming", AIAA Atmospheric Flight Mechanics Conference, Paper 90-2801, August, 1990.

Morelli, E.A., "Flight Test Validation of Optimal Input Design and Comparison to Conventional Inputs", AIAA Atmospheric Flight Mechanics Conference, August, 1997.

Mulder, J.A., Jonkers, H.L., Horsten, J.J., Breeman, J.H., and Simon, J.L., "Analysis of Aircraft Performance, Stability and Control Measurements", AGARD-LS-104, Nov. 1979.



Murphy, P.C., "An Algorithm for Maximum Likelihood Estimation Using an Efficient Method for Approximating Sensitivities", NASA TP 2311, June 1984.

Murphy, P.C., "A Methodology for Airplane Parameter Estimation and Confidence Interval Determination of Nonlinear Estimation Problems", NASA CP 1153, April 1986.

Murray, J.E., and Maine, R.E., "pEst Version 2.1 User's Manual", NASA TM 88280, Sept. 1987

Neal, T.P., and Smith, R.E., "An In-Flight Investigation to Develop Control System Design Criteria for Fighter Airplanes", AFFDL-TR-70-74, Vol. I & II, Wright-Patterson AFB, 1970.

Neal, T.P., and Smith, R.E., "A Flying Qualities Criterion for the Design of Fighter Flight Control Systems", Journal of Aircraft, Volume 8, Number 10, 1971.

Nelson, J.R., and Smith, T.D., "Improved Combat Performance Using Relaxed Static Stability and a Spin Prevention System". AGARD Conference Proceedings CP-409, 1984.

Nelson, T.A., and Landes, R.A., "Boeing 777 Development and APC Assessment", SAE Control & Guidance Systems Conference, March 1996.

Neville, K.W., and Stephens, A.T., "Flight Update of Aerodynamic Math Model", AIAA Flight Simulation Technologies Conference, Paper 93-3596, Monterey, CA, August, 1993.

Onstott, E.D., and Faulkner, W.H., "Prediction, Evaluation, and Specification of Closed-Loop and Multiaxis Flying Qualities", Flight Dynamics Laboratory Report AFFDL-TR-78-3, February 1978.

Otter, M., "Dsblock 'A neutral description of dynamic systems', Version 3.2", Technical Report TR R81-92, DLR, Institute of Robotics and System Dynamics, Oberpfaffenhofen, D-82234 Wessling, Germany, May 1992.

Padfield, G.D., "Helicopters Handling Qualities and Control", Proceedings and Companion Volume of the RAeS, AAAF, DGLR, AHS, International Conference, London, 1988.

Plaetschke, E., and Schulz, G., "Practical Input Signal Design", AGARD-LS-104, Nov. 1979, Paper 3.

Potvin, A.F., "Nonlinear Control Design Toolbox For Use With Matlab", the MathWorks, Inc., 1993.

Press, W.H., Flamery, B.P., Teukolsky, S.A., and Vetterling, W.T., "Numerical Recipes", The Art of Scientific Computing, 1989.

Ralfe, J.M., and Staples, K.J., "Flight Simulation", Cambridge Aerospace Series, 1986.

Robins, A., Philbrick, D., Bowen, P., and Klebunde, R., "Commercial Visual Programming Environments: One Step Closer to Real Simulation Re-use", Paper No. AIAA-98-4528, 1998.

Robinson, A.C., "On the Use of Quaternions in the Simulation of Rigid Body Motion", WADC (Wright Air Development Center), Technical Report 58-17, Dec. 1958.

Rohlf, D., "Direct Update of a Global Simulator Model with Increments via System Identification", RTO SCI Symposium on System Identification for Integrated Aircraft Development and Flight Testing, May 1998, Madrid, Spain.

Rundqwist, L., and Hillgren, R., "Phase Compensation of Rate Limiters in JAS 39 GRIPEN", AIAA-Paper-96-3435, 1996.

SAE, "Actuators: Aircraft Flight Controls, Power Operated, Hydraulic, General Specification for", Aerospace Recommended Practice, ARP 1281, Rev. B, Society of Automotive Engineering, 1993.

Scala, S., Verde, L., Amato, F., and Iervolino, R., "Analysis and Synthesis of PIO Prediction Criteria", CIRA-TR-SIV-99-075, April 1999.

Schänzer, G., and Krauspe, P., "Einfaches Triebwerksmodell zur Simulation nichtlinearer Schubantworten", Zeitschrift für Flugwissenschaften und Weltraumforschung, Band 2, Heft 3, Köln, 1978.

Schmidt D.K., and Raney, D.L., "Modeling and Simulation of Flexible Flight Vehicles", Paper No. AIAA-98-37315, August, 1998.

Scott, W.B., "F/A-18D Night Attack Features Boost Marine Air Effectiveness," Aviation Week & Space Technology, 3 Feb. 1992.

Scott, W.B., "Lantirn Gives Tomcat Night Attack Role," Aviation Week & Space Technology, 10 June 1996.

Shafer, M.F., Koehler, R., Wilson, E.M., and Levy, D.R., "Initial Flight Test of a Ground Deployed System for Flying Qualities Assessment", AIAA Paper No. 89-3359-CP, August 1989.

Shanks, G.T., Gale, S.L., Fielding, C. and Griffith, D.V., 'Flight Control and Handling Research with the VAAC Harrier Aircraft', in *Tischler*.

Shmul, M., Erenthal, E. and Attar, M., "Lavi Flight Control System", in *Tischler*.

Sienel, W., Bünte, T., and Ackermann, J., "Paradise - a Matlab-based robust control toolbox", Proc. IEEE Symposium on Computer-Aided Control System Design, Dearborn, MI, 1996.

Skeen, M.E., "Limited Investigation of the Pitch and Flightpath Handling Qualities During Aerial Refueling and Air-to-Air Tracking Tasks", US Air Force Flight Test Center, AFFTC-TLR-96-12, July 1996.

Smith, J.W., and Berry, D.T., "Analysis of Longitudinal Pilot-Induced Oscillation Tendencies of the YF-12 Aircraft", NASA-TND-7900, 1975.

Smith, J.W., "Analysis of a Lateral Pilot-Induced Oscillation Experienced on the First Flight of the YF-16 Aircraft", NASA-TM-72867, 1979.

Smith, J.W., and Edwards, J., "Design of a Non-linear Adaptive Filter for Suppression of Pilot-Induced-Oscillation Tendencies", NASA-TM-81349, April 1980.

Smith, J.W., and Montgomery, T., "Biomechanically Induced and Controller coupled Oscillations Experienced on the F-16XL Aircraft During Rolling Maneuvers", NASA TM-4752, July 1996.

Smith, R.E., "Effects of Control System Dynamics on Fighter Approach and Landing Longitudinal Flying Qualities", AFFDL-TR-87-122, 1978.

Smith, R.E., "Evaluation of F-18 Approach and Landing Flying Qualities Using an In-Flight Simulator", Calspan Report No. 6241-F-1, 1979.

Smith, R.E., and Sarrafian, S.K., "Effect of Time Delay on Flying Qualities: An Update", Journal of Guidance and Control and Dynamics, Vol. 9, October 1986.

Smith, R.H., "A Unifying Theory for Pilot Opinion Rating", Proceedings of the 12th Annual Conference on Manual Control, NASA TM X-73, 170, May 1976.

Smith, R.H., "A Theory for Longitudinal, Short-Period Pilot-Induced Oscillation", AFFDL-TR-77-57, June 1977.

Smith, R.H., "Notes on Lateral-Directional Pilot-Induced Oscillations", AFWAL-TR-81-3090, 1982.

Smith, R.H., "The Smith-Geddes Handling Qualities Criteria", 1994 SAE Aerospace Atlantic Conference, Dayton, 1994.

Smith, R.H., "Observations on PIO", AGARD-AR-335, Paper 3, May 1994.

Smith, R.H., and Geddes, N.D., "Handling Quality Requirements for Advanced Aircraft Design: Longitudinal Mode", AFFDL-TR-78-154, 1978.

Smith, T.D., Yeo, C.Y. and Marshall, R.E.W., "Ground and Flight Testing on the Fly-By-Wire Jaguar Equipped with a Full Time Quadruplex Digital Integrated Flight Control System", in AGARD Symposium Proceedings, Advances in Guidance and Control Systems, Portugal, 1982.

Sri-Jayantha, M., and Stengel, R.F., "Determination of Nonlinear Aerodynamic Coefficients Using the Estimation-Before-Modeling Method", Journal of Aircraft, Vol. 25, No. 9, Sept. 1988.

Stalford, H.L., "High-Alpha Aerodynamic Model Identification of T-2C Aircraft Using the EBM Method", Journal of Aircraft, Vol. 18, No. 10, Oct. 1981.

Stepner, D.E., and Mehra, R.K., "Maximum Likelihood Identification and Optimal Input Design for Identifying Aircraft Stability and Control Derivatives", NASA CR-2200, March 1973.

Swihart, D., and Barfield, F., "An Advanced Automatic Ground Collision Avoidance System for Fighter Aircraft", presented at the RTO Symposium, Flight in a Hostile Environment, October 1999, Solomons Island, Maryland, USA.

Taylor, L.W. Jr., and Iliff, K.W., "System Identification Using a Modified Newton-Raphson Method – A FORTRAN Program", NASA TN D-6734, May 1972.

Teper, G.L., DiMarco, R.J., Ashkenas, I.L., and Hoh, R.H., "Analysis of Shuttle Orbiter Approach and Landing Conditions", NASA CR 163108, 1981.

Thomson, D.G., and Bradley, R., "The Use of Inverse Simulation for Conceptual Design", 16<sup>th</sup> European Rotorcraft Forum, Glasgow, Sept. 1990.

Tischler, M. ed, "Advances in Aircraft Flight Control", published by Taylor and Francis, 1996.

Tischler, M.B., "System Identification Methods for Aircraft Flight Control Development and Validation", NASA TM 110369, Oct. 1995.

Tischler, M.B., Fletcher, J.W., Diekmann, V.L., Williams, R.A., and Cason, R.W., "Demonstration of Frequency-Sweep Testing Techniques Using a Bell 214-ST Helicopter", NASA TM-89422, April 1987.

Tischler, M.B., and Cauffman, M.G., "Frequency-Response Method for Rotorcraft System Identification: Flight Applications to BO 105 Coupled Rotor/Fuselage Dynamics", Journal of the American Helicopter Society, Vol. 37, No. 3, July 1992.

Tischler, M.B., Colbourne, J.D., Morel, M.R., Biezd, D.J., Levine, W.S., and Moldoveanu, V., "CONDUIT – A new multidisciplinary integration environment for flight control development", NASA TM 112203, 1997.

- Trankle, T.L., Vincent, J.H., and Franklin, S.N., "System Identification of Non-linear Aerodynamic Models", AGARD-AG-256, March 1982.
- Trankle, T.L., and Bachner, S.D., "Identification of a Nonlinear Aerodynamic Model of the F-14 Aircraft", *Journal of Guidance, Control, and Dynamics*, Vol. 18, No. 6, Nov.-Dec. 1995.
- Twisdale, T.R., and D.L. Franklin, "Tracking Test Techniques for Handling Qualities Evaluation", AFFTC-TR-75-1, May 1975.
- van der Linden, C.A.A.M., Mulder J.A., and Sridhar, J.K., "Recent Developments in Aircraft Parameter Identification at Delft University of Technology - Optimal Input Design", in Cook, M.V., and Rycroft, M.J. (Eds), *Aerospace Vehicle Dynamics and Control*, Clarendon Press, Oxford, 1994.
- Van Der Vaart, J.C., "Modeling of Perception and Action in Compensatory Manual Control Tasks", PhD. Thesis, Delft University of Technology, Delft 1992.
- Van Der Weerd, R., "Pilot-Induced Oscillation Suppression Methods and Their Effects on Large Transport Aircraft Handling Qualities", Series 03: Control and Simulation, Delft University Press, Delft, 1999.
- Varga, A., Looye, G., Moorman, D., and Grübel, G., "Automated Generation of LFT-Based Parametric Uncertainty Descriptions from Generic Aircraft Models". GARTEUR FM(AG08), TP-088-36, January 1997.
- Verde, L., "Controllo Robusto di Aeromobili: Metodi Parametrici per l'analisi e la sintesi", PhD Thesis Università degli Studi di Napoli, February 1992.
- Vidyasagar, "Non-linear Systems Analysis", Prentice Hall, 1992.
- von Grünhagen, W., "Inverse Simulation: a Tool for the Validation of Simulation Programs – First Results", *ZFW*, Vol. 17, 1993.
- Walker, L.A. and LaManna, W.J., "Development of the F/A-18A Handling Qualities Using Digital Flight Control Technology", *Proceedings of the 26<sup>th</sup> Annual Symposium of the Society of Experimental Test Pilots*, September 1982.
- Waszak, M.R., Davidson, J.D., and Schimdt, D.K., "A Simulation Study of the Flight Dynamics of Elastic Aircraft", NASA CR 4102, Vols. I and II, December, 1987.
- Webster F., "Flying Qualities Flight Testing of Digital Flight Control Systems", AGARDograph Series 300, *Flight Test Techniques*, Volume B, 1999 (Draft).
- Weiss, S., Frihmelt, H., Plaetschke, E., and Rohlf, D., "X-31A System Identification Using Single-Surface Excitation at High Angles of Attack", *Journal of Aircraft*, Vol. 33, No. 3, May-June 1996.
- Weiss, S., Gockel, W., Mönnich, W., Rohlf, D., "Identification of DORNIER-328 Reversible Control System", AIAA-98-4163, Boston, 1998.

**This page has been deliberately left blank**



**Page intentionnellement blanche**

## ANNEX A: GLOSSARY OF TERMS

**ACCIDENT (AIRCRAFT):** An unintended event that causes death, injury, environmental or material damage.

**ACTIVE CONTROL TECHNOLOGY (ACT):** The use of feedback control to enhance the performance or controllability and handling of a vehicle.

**ACTUATOR:** Physical device for producing motion and/or force.

**ADAPTIVE CONTROL:** Real-time adaptation of a controller, usually following some form of parameter identification or by using a model reference.

**AERODYNAMIC DERIVATIVE:** Partial derivative defining changes in vehicle force or moment due to changes in control or motion parameters.

**AIR DATA SYSTEM:** Provides flight condition and velocity vector information from external aircraft measurements.

**ALIASING:** Sampling phenomenon in which input signal frequencies above half the sampling frequency appear at lower frequencies on the output signal.

**ANALOGUE (COMPUTER):** Using electrical signals that are directly proportional (i.e. analogous) to a continuous physical parameter.

**ANGLE-OF-ATTACK (AoA):** Angle formed by vector addition of an aircraft's body axis normal and longitudinal velocity components, measured from the longitudinal axis (i.e.  $\arctan(w/u)$ ).

**ANTI-ALIASING FILTER:** Function for reducing aliasing by restricting the bandwidth of the signal to be sampled - usually an analogue filter with a natural frequency set to less than half the sampling frequency.

**AUTHORITY LIMIT:** Permissible amplitude of a signal or physical parameter.

**AUTOPILOT:** Outer-loop automatic system for reducing pilot workload and/or augmenting weapon system performance.

**AUTOSTABILISER:** Simple stability augmentation system, usually to provide increased damping and often with limited authority.

**AVERAGING (ROLLING AVERAGE):** Digital process that is used to provide a smoothing and anti-aliasing function.

**BACKLASH:** A form of hysteresis found in mechanical systems.

**BAND STOP FILTER:** see notch filter.

**BANDWIDTH:** Range of frequencies over which the amplitude of the frequency response of a device remains essentially constant (numerical definitions vary). Usually defined as a maximum frequency for flight control applications.

**BODE DIAGRAM:** Frequency response plots covering gain (usually in dB) against frequency and phase against frequency.

**BREAK POINT:** Frequency at which attenuation (or amplification) appears to occur, for the frequency response of a real pole or zero term.

**CAREFREE HANDLING:** Use of FCS functionality to provide protection of aircraft from departure and from exceeding structural loading limits, regardless of pilot input demands.

**CERTIFICATION:** Process for demonstrating that system safety is satisfactory for flight operation.

**CHARACTERISTIC EQUATION:** Polynomial defining the linear stability characteristics of the system (defined by setting the denominator of a transfer function equal to zero).

**CLASSICAL CONTROL:** Range of design and analysis techniques that were mainly developed early in the 20<sup>th</sup> century (e.g. Bode, Nyquist, Nichols, Root-Locus) and associated with Single-Input, Single-Output (SISO) systems.

**CLEARANCE:** A process to prove the integrity and / or safety of a system, as a step towards certification.

**CLOSED-LOOP CONTROL:** Outputs are measured and fed back, to provide corrective action.

**COMMAND PATH:** Part of control system between its physical input (e.g. pilot's stick) and the point where feedback is applied.

**CONDITIONALLY STABLE:** A system that is stable only for a range of values of a particular gain; the system can be made unstable by either increasing or decreasing the nominal gain value by a sufficient amount.

**CONTROL-CONFIGURED VEHICLE (CCV):** One which incorporates the control system capabilities and limitations at the onset of the project design; in particular, to use automatic control to compensate for aerodynamic instability, in order to achieve aircraft performance improvements.

**CONTROL LAW:** An integrated set of algorithms, containing controllers, non-linear functions, moding logic and gain scheduling.

**CONTROLLER:** An algorithm or filter (usually linear) to provide desired control behaviour, usually acting on an error signal.

**COOPER-HARPER RATING:** A method for quantifying pilot opinion of an aircraft handling task, in terms of perceived controllability and operational effectiveness.

**CROSS-OVER FREQUENCY:** 'Gain cross-over' is when the gain equals unity (0 dB), 'phase cross-over' is when phase equals -180 degrees. These are the frequencies at which stability margins are measured.

**DAMPING:** Attribute that determines the nature of a response, in terms of the rate of decay of oscillatory behaviour.

**DC BLOCK:** See high pass filter.

**DEAD-BEAT (RESPONSE):** Exhibiting no overshoot when tracking a step input signal.

**DEAD-ZONE:** Non-linearity in which no output is achieved until the input exceeds some threshold.

**DECADE:** Frequency interval in which the frequency changes by a factor of ten.

**DECIBEL (dB):** Defined at each frequency as  $10 \log_{10} (g)$ , where  $g$  is a ratio of powers, or  $20 \log_{10} (g)$  if  $g$  is a ratio of voltages or signal amplitudes.

**DEFECT:** The non-conformance of an item to one or more of its required parameters, within the limits defined in the specification.

**DERIVATIVE CONTROL/ACTION:** A function proportional to the rate of change of the applied signal (i.e. differentiation with respect to time).

**DESCRIBING FUNCTION:** Approximation of non-linear behaviour (amplitude dependence) of a system element by modelling the gain and phase characteristics of the fundamental component of its Fourier transform.

**DIGITAL:** Data represented by using integers, usually as a binary sequence (e.g. 00110110).

**DISSIMILAR REDUNDANCY:** Multiplex arrangement where different lanes have different software and / or hardware, to perform the same function.

**DISTURBANCE:** A signal or force acting on a system which is usually unwanted and might impair the quality of control.

**DROP-BACK:** A reduction in attained angle, following the removal of an angular rate demand.

**DUPLEX:** Having two hardware lanes operating in parallel to produce a consolidated output, with monitoring for detection of a single failure.

**ELECTRICAL SIGNALLING:** Full authority command of control surface positions by means of electrical control stick / pedal transducers, whose outputs are electrically connected to the control surface actuators.

**ERROR:** A state resulting from a fault or human mistake and that is liable to lead to incorrect operation.

**ERROR SIGNAL:** A control system signal equal to the difference between a commanded output and its measured (achieved) output.

**FAIL OPERATIONAL:** The ability to continue to operate safely for the duration of a mission and without any loss in performance, following one or more system component failures.

**FAIL PASSIVE:** Any failure that can be ignored, in terms of its effect on performance and safety.

**FAIL SAFE:** The ability to continue to operate safely for a limited period (e.g. to allow return to base) but with a reduction in performance, following system component failures.

**FAILURE:** The termination of the ability of a previously acceptable item to perform its required function within the limits defined in the specification.

**FAULT:** See DEFECT

**FEEDBACK:** Any signal generated by a sensor device that is then used for corrective action.

**FEEDFORWARD:** Signal from the command path that by-passes the controller to 'boost' the downstream command to an actuator - improving transient response without affecting stability.

**FLY-BY-WIRE:** Full authority command of aircraft motion by means of electrical control stick / pedal transducers, whose outputs are summed with the outputs of aircraft motion sensors and electrically connected to the control surface actuators.

**FREQUENCY RESPONSE:** Variation of an output signal's magnitude and phase characteristics relative to a sinusoidal input signal, as frequency varies.

**FULL AUTHORITY:** Allowing the maximum useable range.

**FULL-STATE FEEDBACK:** All the system states are used as feedback signals.



**FUNCTIONAL REQUIREMENTS DOCUMENT (FRD):** specification of functional requirements (e.g. control laws).

**GAIN:** Control law parameter for providing a signal scaling capability.

**GAIN MARGIN:** The factor by which the gain may be increased or decreased before system instability results.

**GAIN SCHEDULE:** Variation of a gain with some measured scheduling variable(s).

**GOVERNOR:** A mechanical system for regulating a controlled parameter.

**HANDLING QUALITIES:** Piloting characteristics with respect to how easy or safe the aircraft is to fly.

**HANG-OFF (also HANG-ON):** Transient response characteristic whereby the commanded response fails to achieve its steady-state value within an acceptable time. Hang-off is associated with undershoot and Hang-on, with overshoot.

**HARD-OVER:** A failure that causes a control surface to rapidly drive its output to the authority limit.

**HAZARD:** A state of the system, often following some initiating event that can lead to an accident.

**HIGH PASS FILTER:** Attenuates low frequency signals, allowing high frequencies to pass.

**HYSTERESIS:** Non-linear function in which the input/output relationship for increasing an input is different from that for decreasing the input.

**INCEPTOR:** Physical device with variable force and/or motion, for enabling pilot input for flight control.

**INCIDENCE:** See ANGLE-OF-ATTACK.

**INCIDENT:** An event which results in equipment or property sustaining damage or any person receiving any injury, or which might have resulted in an accident.

**INTEGRATING FILTER:** Function for performing integral action on a signal.

**INTEGRITY:** Freedom from flaw or corruption (within acceptable limits).

**JUMP-RESONANCE:** Undesirable non-linear saturation with a sudden 'jump' in its frequency response characteristics.

**LANE:** A signal path containing all the hardware and functional elements of the control system, within a multiplex arrangement.

**LIMITED AUTHORITY:** Having access to part of the full range available.

**LIMIT CYCLE:** Bounded amplitude and fixed frequency oscillation of a system, which involves non-linear behaviour.

**LINE REPLACEABLE UNIT or ITEM:** An equipment item fitted into an aircraft.

**LINEAR SYSTEM:** Having no non-linearities; scaling any input signal scales all the outputs by the same factor. The 'Principle of superposition' applies.

**LINEAR QUADRATIC GAUSSIAN (LQG):** Linear design method that uses a quadratic cost performance and Gaussian noise to determine optimum feedback gains.

**LOW PASS FILTER:** Function that attenuates high frequency signals but allows low frequencies to pass.

**MINIMUM PHASE:** A stable system that has no zeros in the right half of the complex plane.

**MISSION-CRITICAL:** Loss of capability leading to possible reduction in mission- effectiveness.

**MODE (of the FCS):** A selectable function of the FCS, e.g. terrain following.

**MODERN CONTROL:** Design and analysis techniques which are generally considered to be post-1960, with particular emphasis on MIMO control.

**MOTIVATOR:** Any device provided to create forces and/or moments for manoeuvring a vehicle, usually via aerodynamic or propulsive controls.

**MULTI-INPUT MULTI-OUTPUT (MIMO):** A system that has at least two inputs, each with a corresponding controlled output, and with a significant interaction between the (open-loop) controlled variables.

**MULTIPLEX:** Having several hardware lanes to enable detection and isolation of equipment failures.

**MULTIVARIABLE CONTROL:** Theory and techniques for addressing multi-input multi-output systems.

**NATURAL FREQUENCY (DAMPED):** The frequency at which a system will tend to respond when excited by a sudden input.

**NICHOLS CHART:** Frequency response rectangular plot with gain in dB plotted against phase in degrees, with frequency varying as a parameter and including contours of closed-loop gain and phase characteristics superimposed (assuming unity negative feedback).

**NOISE:** Usually an unwanted signal corrupting the desired signal.

**NON-LINEARITY:** Characteristic which introduces amplitude dependency into a system; linear behaviour is not preserved, in that the output magnitude no longer scales with the input.

**NONMINIMUM PHASE:** Having zeros in the right-half complex plane.

**NOTCH FILTER:** Function that produces attenuation over a specified frequency range, normally with minimal attenuation either below or above that range.

**NYQUIST DIAGRAM:** Frequency response polar plot of real and imaginary parts in the complex plane, with frequency varying as a parameter.

**OPEN-LOOP:** Without the use of any feedback.

**ORDER:** The number of state variables of a dynamical system. For a minimal realisation, this corresponds to the degree of the characteristic polynomial of the corresponding transfer function.

**OVER-GEARING:** Where the control system gains have been increased beyond the point of optimum performance.

**OVERSHOOT:** Transient response characteristic whereby the commanded response exceeds its steady-state, usually measured as a percentage.

**PADE APPROXIMATION:** A low order rational transfer function approximation of a time delay function.

**PHASE:** The relative angle between sinusoidal input signal and an output signal's fundamental component.

**PHASE ADVANCE FILTER:** Function for providing low frequency phase lead, at the expense of increasing high frequency gain.

**PHASE MARGIN:** The amount of phase lag (or lead) a system can tolerate before instability is reached.

**PHASE PLANE ANALYSIS:** Rectangular plot of two system states, usually position and velocity, for analysing non-linear stability, e.g. limit-cycle behaviour.

**PHASE RETARD FILTER:** Function for providing high frequency attenuation, with the associated phase loss being recovered at higher frequencies.

**PILOT INDUCED OSCILLATION (PIO):** Phenomenon whereby the pilot inadvertently sustains an oscillation of the aircraft through inceptor movement, due to adverse coupling with the system dynamics. It is now known as Pilot INVOLVED oscillation or Pilot IN-THE-LOOP oscillation, to remove any implication that the pilot is to blame.

**PLANT:** That which is to be controlled, for example a flight vehicle.

**POLE:** Real or complex root of transfer function denominator polynomial; it corresponds to an eigenvalue of the system.

**POWER SPECTRUM:** Plot of power versus frequency (power is defined as the square of the signal magnitude).

**PRIMARY CONTROLS:** Those controls that are fundamental for the safe operation of the system.

**PROPORTIONAL, INTEGRAL AND DERIVATIVE (PID):** ‘Three term controller’ with inherent phase advance and tracking capability.

**QUADRUPLEX:** Having four hardware lanes operating in parallel to produce a consolidated output, with monitoring for detection of up to three failures.

**QUALIFICATION:** Process for demonstrating that the system meets the customer requirements.

**RANDOM FAILURE:** A failure that results from a variety of degradation mechanisms in the hardware.

**RATE LIMIT:** Physical or functional limit on rate of change of a parameter.

**RECONFIGURABLE CONTROL:** Re-distribution of system functions to maintain satisfactory operation, following loss of hardware or airframe damage.

**REDUNDANCY:** Duplication of components or software to improve system integrity.

**REDUNDANCY MANAGEMENT:** Flight control computing logic for ensuring that system integrity requirements are achieved. This involves monitoring multiple equipment lanes, consolidation of signals, and detection, isolation and reporting of failed equipment.

**REGULATOR:** A control system in which the design driver is satisfactory disturbance rejection, in order to hold some desired parameter value constant; command tracking is usually of secondary importance.

**RELIABILITY:** The probability that a system will be free from faults.

**RESONANT FREQUENCY:** Frequency at which a sharp change to the maximum ratio of system output magnitude to input magnitude is attained.

**RISE TIME:** The time taken for the system response to a step input to change from 10% to 90% of its steady-state value.

**RISK:** The combination of the frequency, or probability, and the consequence of an accident.

**ROBUSTNESS:** The ability of a system to tolerate variations in system parameters without undue degradation in performance, especially with respect to stability.

**ROLL-OFF:** Rate of gain reduction at extremes of frequency (usually specified as dB/decade or dB/octave).

**ROOT LOCUS:** Parametric plot showing variation of closed-loop poles, as a function of loop gain.

**SAFE:** The state in which risk is lower than the maximum acceptable risk.

**SAFETY:** The expectation that a system does not, under defined conditions, lead to a state in which human life is endangered.

**SAFETY-CRITICAL:** Failure or design error could cause risk to human life.

**SAMPLE AND HOLD:** Device for producing an analogue signal from a series of discrete digital pulses.

**SATURATION:** A state whereby authority limits are attained (or rate limit or acceleration limits are reached).

**SECONDARY CONTROLS:** Those controls which are not essential for safe operation of the system, but are likely to result in degraded performance if they are not available.

**SELF-MONITORING:** Capability of a lane of computing to detect its own failures.

**SENSOR:** Physical device for detection of inceptor positions, feedback measurements or scheduling information.

**SERVO-MECHANISM:** Control system in which the design driver is accurate tracking of a varying input signal; disturbance rejection is usually of secondary importance.

**SERVO-VALVE:** An hydraulic device applied to a control valve or ram for switching the pressure and controlling the direction and magnitude of flow of hydraulic fluid.

**SETTLING TIME:** Time taken for the commanded response to reach and stay within a small percentage (typically 2% or 5%) of its steady-state value.

**SIDESLIP:** The angle formed by the vector addition of an aircraft's body axis lateral velocity component and the X-Z plane component of the velocity vector, measured from the X-Z plane (i.e.  $\arcsin(v/V)$ ).

**SIMILAR REDUNDANCY:** Multiplex arrangement where different lanes have identical software and hardware to perform the same function.

**SINGLE-INPUT SINGLE OUTPUT (SISO):** System that has only one input with an associated controlled output.

**SLOW-OVER:** A failure that causes a control surface to slowly drive its output to the authority limit.

**STABILITY AUGMENTATION SYSTEM (SAS):** System for augmenting the stability of the basic vehicle, by using feedback.

**STABILITY MARGIN:** A measure of system stability - see GAIN MARGIN and PHASE MARGIN.

**STABLE:** Having a bounded response to a bounded input.

**STATES:** Variables to describe a dynamic system by using a vector differential equation.

**STATE-SPACE:** A matrix representation of first order vector differential equations for representing a system.

**STEADY-STATE:** Condition achieved after dynamics have decayed and states become constant.

**STEP INPUT:** An input applied instantaneously and then held constant.

**STRUCTURAL COUPLING:** The closed-loop interaction between the flight control system and the flexible airframe dynamics.

**STRUCTURAL MODE:** A natural frequency of vibration of an airframe.

**SUMMING JUNCTION:** Functional element in which error signals are generated or parallel signal paths are combined.

**SYSTEMATIC FAILURE:** A failure that is due to a fault in the specification, design construction, operation or maintenance of the system.

**TIME CONSTANT:** Time taken for a first order system time response to achieve 63% of its steady-state value, in response to a step input.

**TOLERANCE:** A predefined variation about a nominal parameter value.

**TRACKING:** Following of a reference or input signal.

**TRANSFER FUNCTION:** Ratio of polynomials in the Laplace variable, which describe the dynamic characteristics between two points within a system.

**TRANSIENT RESPONSE:** Time response of a system output to an input, involving a sum of exponential components which either decay (stable), diverge (unstable) or oscillate (neutrally stable).

**TRIMMING:** Adjustment of flight state and control settings to achieve constant translational and rotational accelerations of a vehicle (can be a steady-state).

**TRIPLEX:** Having three hardware lanes operating in parallel to produce a consolidated output, with monitoring for detection of up to two failures.

**UNSTABLE:** Having an unbounded response to a bounded input or state initial condition.

**VALIDATION:** The process of determining that the requirements are the correct requirements and that they are complete.

**VERIFICATION:** The evaluation of results of a process to ensure correctness and consistency with respect to the inputs and standards provided to that process.

**VOTER-MONITOR:** Algorithm for consolidation of input signals and cross-lane detection of failures.

**WARPING:** Phenomenon associated with digital implementation of an analogue design, whereby the frequencies in the analogue domain become offset in the digital domain.

**WASHOUT FILTER:** See high pass filter.

**WINDOWING:** Weighting of time domain samples prior to processing, to reduce calculation errors resulting from limited measurement information.

**ZERO:** Real or complex root of a transfer function numerator polynomial.

**Z-TRANSFORM:** Conversion of a discrete sequence into a ratio of polynomials. Analogous to the Laplace transform for continuous systems.

**This page has been deliberately left blank**



**Page intentionnellement blanche**

## ANNEX B: ACRONYMS

ACM	Air Combat Manoeuvring
ACT	Active Control Technology
ACTIVE	Active Control Technology for Integrated Vehicles
ACU	Actuator Control Unit
A-D	Analogue to Digital
ADC	Air Data Computer
ADP	Air Data Probe
ADS	Air Data System
ADT	Air Data Transducer
AFCS	Automatic Flight Control System
AFDS	Autopilot and Flight Director System
AGL	Above Ground Level
AHRS	Attitude and Heading Reference System
AMDS	Auto Manoeuvre Device System
AMSS	Attitude Motion Sensor Set
AMSU	Aircraft Motion Sensor Unit
AMSU	Air Motor Servo Unit
AoA	Angle of Attack
AoI	Angle of Incidence
AoS	Angle of Sideslip
AP	Auto-Pilot
APC	Aircraft Pilot Coupling
APU	Auxillary Power Unit
APR	Average Phase Rate
ASE	Aero-Servo-Elasticity
ASTOVL	Advanced Short Take-Off and Vertical Landing
ATC	Air Traffic Control
ATE	Automatic Test Equipment
ATM	Asynchronous Transfer Mode
ATP	Acceptance Test Procedure
AWL	All-Weather Landing
BIT	Built-In-Test
BUM	Back-up Mode
CAA	Civil Aviation Authority
CAP	Control Anticipation Parameter
CAS	Calibrated Air Speed
CAS	Command Augmentation System
CBIT	Continuous Built-In Test
CCDL	Cross-Channel Data Link
CCV	Control Configured Vehicle
CFIT	Controlled Flight Into Terrain
CHR	Cooper-Harper Rating
CSAS	Command and Stability Augmentation System
CTOL	Conventional Take-Off and Landing
CDA	Climb Dive Angle
CG	Centre of Gravity
CLAW	Control Law
CIU	Cockpit Interface Unit



D-A	Digital to Analogue
dB	deciBel
DDV	Direct Drive Valve
DECU	Digital Engine Control Unit
DF	Describing Function
DFBW	Digital Fly-By-Wire
DGPS	Differential Global Positioning System
DLC	Direct Lift Control
DME	Distance Measuring Equipment
DoF	Degrees-of-Freedom
DSP	Digital Signal Processing
DT&E	Developmental Test and Evaluation
EAP	Experimental Aircraft Programme
EAS	Equivalent Air Speed
EBU	Emergency Backup Unit
EFCS	Electrical Flight Control System
EFIS	Electronic Flight Instrument System
EHA	Electro-Hydraulic Actuator
EHS	Emergency Hydraulic System
EHSV	Electro-Hydraulic Servo-Valve
EMI	Electro-Magnetic Interference
EMU	Engine Monitoring Unit
ESTOL	Extremely Short Take-Off and Landing
FAA	Federal Aviation Authority
FADEC	Full Authority Digital Engine Control
FAR	Federal Aviation Regulations
FBL	Fly-By-Light
FBW	Fly-By-Wire
FCC	Flight Control Computer
FCGP	Flight Control Gain Panel
FCL	Flight Control Laws
FCP	Flight Control Processor
FCS	Flight Control System
FCTP	Flight Control Test Panel
FCU	Flying Control Unit
FFT	Fast Fourier Transform
FMC	Flight Management Computer
FMEA	Failure Modes and Effects Analysis
FMET	Failure Modes Effects Testing
FMECA	Failure Mode Effects and Criticality Analysis
FM/S	Flight/Mission Simulator
FOG	Fibre Optic Gyroscope
FOL	Flight Operation Limitation
FTI	Flight Test Instrumentation
FMS	Flight Management System
FQ	Flying Qualities
FTI	Flight Test Instrumentation
GAS	Gust Alleviation System
GLA	Gust Load Alleviation
g-LOC	g induced Loss Of Consciousness
GPS	Global Positioning System
GPWS	Ground Proximity Warning System
GRT	Ground Resonance Testing
GVT	Ground Vibration Testing

HDD	Head Down Displays
HILS	Hardware-In-the-Loop Simulation
HOS	High Order System
HOTAS	Hands-On-Throttle And Stick
HQ	Handling Qualities
HQR	Handling Qualities Rating
HQS	Handling Qualities Simulator
HQDT	Handling Qualities During Tracking
HUD	Head-Up Display
H/W	Hardware
IAP	Integrated Actuator Package
IAS	Indicated Air Speed
IBIT	Initiated Built-In Test
IFM	In-Flight Monitor
IFPC	Integrated Flight and Propulsion Control
IFR	Instrument Flight Rules
ILS	Instrument Landing System
ILS	Incidence Limiting System
ILS	Integrated Logistics Support
IMA	Integrated Modular Avionics
IMC	Instrument Meteorological Conditions
IMS	Inertial Measurement System
IMU	Inertial Measurement Unit
INU	Inertial Navigation Unit
IPT	Integrated Product (or Project) Team
ISA	International Standard Atmosphere
IVS	Integrated Vehicle System
JAA	Joint Aviation Authorities
JAR	Joint Aviation Requirements
JPT	Jet Pipe Temperature
JSF	Joint Strike Fighter
LAHOS	Landing High Order System
LCO	Limit Cycle Oscillation
L/D	Lift to Drag (ratio)
LE	Leading Edge
LINS	Laser Inertial Navigation System
LOD	Laser Obstacle Detector
LOES	Low Order Equivalent System
LOS	Low Order System
LQG	Linear Quadratic Gaussian
LQR	Linear Quadratic Regulator
LRI	Line Replaceable Item
LRU	Line Replaceable Unit
LVDT	Linear Variable Differential Transformer
MATV	Multi-Axis Thrust Vectoring
MAW	Mission Adaptive Wing
MBU	Mechanical Backup Unit
MCV	Main Control Valve
MECU	Mechanical Engine Control Unit
MFCS	Model Following Control System
MFCS	Manual Flight Control System
MGTF	Mobile Ground Test Facility

MIM	Mechanical Isolation Mechanism
MIMO	Multi-Input, Multi-Output
MLA	Manoeuvre Load Alleviation
MLC	Manoeuvre Load Control
MLS	Microwave Landing System
MSL	Mean Sea Level
MTBF	Mean Time Between Failures
MTP	Maintenance Test Panel
NDI	Nonlinear Dynamic Inversion
NWS	Nose Wheel Steering
OLOP	Open Loop Onset Point
PACT	Precision Aircraft Control Technology
PCS	Propulsion Control System
PA	Power Approach
PBIT	Power-up Built-In Test
PBIT	Periodic Built-In-Test
PBW	Power-by-wire
PCS	Primary Control System
PCS	Propulsion Control System
PCU	Power Control Unit
PCU	Pilot's Control Unit
PFCU	Powered Flying Control Unit
PFD	Primary Flight Displays
PId	Parameter Identification
PI	Proportional plus Integral
PID	Proportional, Integral and Derivative
PIO	Pilot Involved Oscillation
PIOR	Pilot Involved Oscillation Rating
PLA	Pilot's Lever Angle/Power Lever Angle
PLOC	Probability of Loss of Control
Ps	Static Pressure
PSC	Performance Seeking Control
P <sub>T</sub>	Total Pressure
PVI	Pilot-Vehicle Interface
RADALT	Radar Altimeter
RCAH	Rate Command/Attitude Hold
RCS	Reaction Control System
RCV	Reaction Control Valve
REDMAN	Redundancy Management
RFC	Reconfigurable Flight Control
RIU	Remote Interface Unit
RLG	Ring Laser Gyroscope
RM&T	Reliability, Maintainability and Testability
RSS	Relaxed Static Stability
RVDT	Rotary Variable Differential Transformer
RVTO	Rolling Vertical Take-Off
RVL	Rolling Vertical Landing
SAAHR	Standby Attitude and Heading Reference
SAS	Stability Augmentation System
SCAS	Stability and Command Augmentation System
SFCS	Survivable Flight Control System

SISO	Single-Input, Single-Output
S/MTD	STOL/Manoeuvre Technology Demonstrator
SPILS	Spin Prevention and Incidence Limiting System
SC	Structural Coupling
SCS	Secondary Control System
SFCS	Survivable Flight Control System
SPS	Secondary Power System
SSC	Side Stick Controller
SSI	Side-Slip Indicator
SSICA	Stick Sensor and Interface Control Assembly
STOL	Short Take-Off and Landing
STOVL	Short Take-Off and Vertical Landing
SV	Servo-Valve
S/W	Software
TAS	True Air Speed
TBT	Turbine Blade Temperature
TCAS	Terrain and Collision Avoidance System
TDNS	Time Domain Neal Smith
TE	Trailing Edge
TF	Terrain Following
TIFS	Total In-Flight Simulator
TO	Take-Off
TRC	Translational Rate Command
TRN	Terrain Referenced Navigation
TTU	Triplex transducer Unit
TV	Thrust Vector (or Vectoring)
TVC	Thrust Vector Control
UA	Up and Away
UAV	Unmanned Air Vehicle
UCAV	Uninhabited Combat Air Vehicle
VAAC	Vectored thrust Aircraft Advanced flight Control
V&V	Verification and Validation
VFR	Visual Flight Rules
VL	Vertical Landing
V/M	Voter/Monitor
VMC	Visual Meteorological Conditions
VMS	Vehicle Management System
VN	Vectoring Nozzle
VNCU	Vectoring Nozzle Control Unit
VOR	VHF Omnidirectional Range
V/STOL	Vertical / Short Take-Off and Landing
VSI	Vertical Speed Indicator
VTOL	Vertical Take-Off and Landing
WoW	Weight on Wheels
YD	Yaw Damper

**This page has been deliberately left blank**



**Page intentionnellement blanche**

## REPORT DOCUMENTATION PAGE

<b>1. Recipient's Reference</b>	<b>2. Originator's References</b> RTO-TR-029 AC/323(SCI)TP/23	<b>3. Further Reference</b> ISBN 92-837-1047-9	<b>4. Security Classification of Document</b> UNCLASSIFIED/ UNLIMITED
<b>5. Originator</b> Research and Technology Organization North Atlantic Treaty Organization BP 25, 7 rue Ancelle, F-92201 Neuilly-sur-Seine Cedex, France			
<b>6. Title</b> Flight Control Design – Best Practices			
<b>7. Presented at/sponsored by</b> the former Flight Vehicle Integration Panel of AGARD, and the Systems, Concepts and Integration (SCI) Panel of RTO.			
<b>8. Author(s)/Editor(s)</b> Multiple			<b>9. Date</b> December 2000
<b>10. Author's/Editor's Address</b> Multiple			<b>11. Pages</b> 214
<b>12. Distribution Statement</b> There are no restrictions on the distribution of this document. Information about the availability of this and other RTO unclassified publications is given on the back cover.			
<b>13. Keywords/Descriptors</b>			
Flight control Design Aviation safety Aviation accidents	Simulation Aircraft PIO (Pilot Induced Oscillations)	Lessons learned Best practices Handling qualities	
<b>14. Abstract</b>  Accidents due to adverse aircraft-pilot coupling phenomena in the latest technology aircraft occurred both in the US and in Europe, while other programs had less-well-publicized flight control development problems. These events showed that a robust and affordable solution to the development process of digital flight control systems was not universally available. This Technical Report begins with a review of some examples of flight control problems. They span the history of flight from the time when the practice of flying was preceding theoretical developments up to the recent events. There is a chapter detailing lessons learned from various programs with positive results. The review of problems and lessons learned leads into a chapter detailing a series of recommended design best practices. The best practices are laid out as a logical process with recommendations for avoiding the pitfalls that have led to problems in the past. The second part of the report continues with some theoretical aspects, such as flying qualities criteria and “carefree handling”, the latest results from analytical and research activities into PIOs, and modelling and system identification to support the design process. The report concludes with suggestions for required future research.			

**This page has been deliberately left blank**



**Page intentionnellement blanche**



RESEARCH AND TECHNOLOGY ORGANIZATION

BP 25 • 7 RUE ANCELLE

F-92201 NEUILLY-SUR-SEINE CEDEX • FRANCE

Télécopie 0(1)55.61.22.99 • E-mail mailbox@rta.nato.int

DIFFUSION DES PUBLICATIONS

RTO NON CLASSIFIEES

L'Organisation pour la recherche et la technologie de l'OTAN (RTO), détient un stock limité de certaines de ses publications récentes, ainsi que de celles de l'ancien AGARD (Groupe consultatif pour la recherche et les réalisations aérospatiales de l'OTAN). Celles-ci pourront éventuellement être obtenues sous forme de copie papier. Pour de plus amples renseignements concernant l'achat de ces ouvrages, adressez-vous par lettre ou par télécopie à l'adresse indiquée ci-dessus. Veuillez ne pas téléphoner.

Des exemplaires supplémentaires peuvent parfois être obtenus auprès des centres nationaux de distribution indiqués ci-dessous. Si vous souhaitez recevoir toutes les publications de la RTO, ou simplement celles qui concernent certains Panels, vous pouvez demander d'être inclus sur la liste d'envoi de l'un de ces centres.

Les publications de la RTO et de l'AGARD sont en vente auprès des agences de vente indiquées ci-dessous, sous forme de photocopie ou de microfiche. Certains originaux peuvent également être obtenus auprès de CASI.

## CENTRES DE DIFFUSION NATIONAUX

## ALLEMAGNE

Streitkräfteamt / Abteilung III  
Fachinformationszentrum der  
Bundeswehr, (FIZBw)  
Friedrich-Ebert-Allee 34  
D-53113 Bonn

## BELGIQUE

Coordinateur RTO - VSL/RTO  
Etat-Major de la Force Aérienne  
Quartier Reine Elisabeth  
Rue d'Evère, B-1140 Bruxelles

## CANADA

Directeur - Recherche et développement -  
Communications et gestion de  
l'information - DRDCGI 3  
Ministère de la Défense nationale  
Ottawa, Ontario K1A 0K2

## DANEMARK

Danish Defence Research Establishment  
Ryvangs Allé 1, P.O. Box 2715  
DK-2100 Copenhagen Ø

## ESPAGNE

INTA (RTO/AGARD Publications)  
Carretera de Torrejón a Ajalvir, Pk.4  
28850 Torrejón de Ardoz - Madrid

## ETATS-UNIS

NASA Center for AeroSpace  
Information (CASI)  
Parkway Center  
7121 Standard Drive  
Hanover, MD 21076-1320

## FRANCE

O.N.E.R.A. (ISP)  
29, Avenue de la Division Leclerc  
BP 72, 92322 Châtillon Cedex

## GRECE (Correspondant)

Hellenic Ministry of National  
Defence  
Defence Industry Research &  
Technology General Directorate  
Technological R&D Directorate  
D.Soutsou 40, GR-11521, Athens

## HONGRIE

Department for Scientific  
Analysis  
Institute of Military Technology  
Ministry of Defence  
H-1525 Budapest P O Box 26

## ISLANDE

Director of Aviation  
c/o Flugrad  
Reykjavik

## ITALIE

Centro di Documentazione  
Tecnico-Scientifica della Difesa  
Via XX Settembre 123a  
00187 Roma

## LUXEMBOURG

Voir Belgique

## NORVEGE

Norwegian Defence Research  
Establishment  
Attn: Biblioteket  
P.O. Box 25, NO-2007 Kjeller

## PAYS-BAS

NDRCC  
DGM/DWOO  
P.O. Box 20701  
2500 ES Den Haag

## POLOGNE

Chief of International Cooperation  
Division  
Research & Development Department  
218 Niepodleglosci Av.  
00-911 Warsaw

## PORTUGAL

Estado Maior da Força Aérea  
SDFA - Centro de Documentação  
Alfragide  
P-2720 Amadora

## REPUBLIQUE TCHEQUE

Distribuční a informační středisko R&T  
VTÚL a PVO Praha  
Mladoboleslavská ul.  
197 06 Praha 9-Kbely AFB

## ROYAUME-UNI

Defence Research Information Centre  
Kentigern House  
65 Brown Street  
Glasgow G2 8EX

## TURQUIE

Millî Savunma Başkanlığı (MSB)  
ARGE Dairesi Başkanlığı (MSB)  
06650 Bakanlıklar - Ankara

## AGENCES DE VENTE

## NASA Center for AeroSpace

Information (CASI)  
Parkway Center  
7121 Standard Drive  
Hanover, MD 21076-1320  
Etats-Unis

## The British Library Document

Supply Centre  
Boston Spa, Wetherby  
West Yorkshire LS23 7BQ  
Royaume-Uni

## Canada Institute for Scientific and

Technical Information (CISTI)  
National Research Council  
Document Delivery  
Montreal Road, Building M-55  
Ottawa K1A 0S2, Canada

Les demandes de documents RTO ou AGARD doivent comporter la dénomination "RTO" ou "AGARD" selon le cas, suivie du numéro de série (par exemple AGARD-AG-315). Des informations analogues, telles que le titre et la date de publication sont souhaitables. Des références bibliographiques complètes ainsi que des résumés des publications RTO et AGARD figurent dans les journaux suivants:

## Scientific and Technical Aerospace Reports (STAR)

STAR peut être consulté en ligne au localisateur de  
ressources uniformes (URL) suivant:  
<http://www.sti.nasa.gov/Pubs/star/Star.html>  
STAR est édité par CASI dans le cadre du programme  
NASA d'information scientifique et technique (STI)  
STI Program Office, MS 157A  
NASA Langley Research Center  
Hampton, Virginia 23681-0001  
Etats-Unis

## Government Reports Announcements &amp; Index (GRA&amp;I)

publié par le National Technical Information Service  
Springfield  
Virginia 2216  
Etats-Unis  
(accessible également en mode interactif dans la base de  
données bibliographiques en ligne du NTIS, et sur CD-ROM)



Imprimé par St-Joseph Ottawa/Hull  
(Membre de la Corporation St-Joseph)

45, boul. Sacré-Cœur, Hull (Québec), Canada J8X 1C6





## RESEARCH AND TECHNOLOGY ORGANIZATION

BP 25 • 7 RUE ANCELLE

F-92201 NEUILLY-SUR-SEINE CEDEX • FRANCE

Telefax 0(1)55.61.22.99 • E-mail mailbox@rta.nato.int

## DISTRIBUTION OF UNCLASSIFIED

## RTO PUBLICATIONS

NATO's Research and Technology Organization (RTO) holds limited quantities of some of its recent publications and those of the former AGARD (Advisory Group for Aerospace Research & Development of NATO), and these may be available for purchase in hard copy form. For more information, write or send a telefax to the address given above. **Please do not telephone.**

Further copies are sometimes available from the National Distribution Centres listed below. If you wish to receive all RTO publications, or just those relating to one or more specific RTO Panels, they may be willing to include you (or your organisation) in their distribution.

RTO and AGARD publications may be purchased from the Sales Agencies listed below, in photocopy or microfiche form. Original copies of some publications may be available from CASI.

## NATIONAL DISTRIBUTION CENTRES

## BELGIUM

Coordinateur RTO - VSL/RTO  
Etat-Major de la Force Aérienne  
Quartier Reine Elisabeth  
Rue d'Evère, B-1140 Bruxelles

## CANADA

Director Research & Development  
Communications & Information  
Management - DRDCIM 3  
Dept of National Defence  
Ottawa, Ontario K1A 0K2

## CZECH REPUBLIC

Distribuční a informační středisko R&T  
VTÚL a PVO Praha  
Mladoboleslavská ul.  
197 06 Praha 9-Kbely AFB

## DENMARK

Danish Defence Research  
Establishment  
Ryvangs Allé 1, P.O. Box 2715  
DK-2100 Copenhagen Ø

## FRANCE

O.N.E.R.A. (ISP)  
29 Avenue de la Division Leclerc  
BP 72, 92322 Châtillon Cedex

## GERMANY

Streitkräfteamt / Abteilung III  
Fachinformationszentrum der  
Bundeswehr, (FIZBw)  
Friedrich-Ebert-Allee 34  
D-53113 Bonn

## GREECE (Point of Contact)

Hellenic Ministry of National  
Defence  
Defence Industry Research &  
Technology General Directorate  
Technological R&D Directorate  
D.Soutsou 40, GR-11521, Athens

## HUNGARY

Department for Scientific  
Analysis  
Institute of Military Technology  
Ministry of Defence  
H-1525 Budapest P O Box 26

## ICELAND

Director of Aviation  
c/o Flugrad  
Reykjavik

## ITALY

Centro di Documentazione  
Tecnico-Scientifica della Difesa  
Via XX Settembre 123a  
00187 Roma

## LUXEMBOURG

See Belgium

## NETHERLANDS

NDRCC  
DGM/DWOO  
P.O. Box 20701  
2500 ES Den Haag

## NORWAY

Norwegian Defence Research  
Establishment  
Attn: Biblioteket  
P.O. Box 25, NO-2007 Kjeller

## POLAND

Chief of International Cooperation  
Division  
Research & Development  
Department  
218 Niepodleglosci Av.  
00-911 Warsaw

## PORTUGAL

Estado Maior da Força Aérea  
SDFA - Centro de Documentação  
Alfragide  
P-2720 Amadora

## SPAIN

INTA (RTO/AGARD Publications)  
Carretera de Torrejón a Ajalvir, Pk.4  
28850 Torrejón de Ardoz - Madrid

## TURKEY

Millî Savunma Başkanlığı (MSB)  
ARGE Dairesi Başkanlığı (MSB)  
06650 Bakanlıklar - Ankara

## UNITED KINGDOM

Defence Research Information  
Centre  
Kentigern House  
65 Brown Street  
Glasgow G2 8EX

## UNITED STATES

NASA Center for AeroSpace  
Information (CASI)  
Parkway Center  
7121 Standard Drive  
Hanover, MD 21076-1320

## SALES AGENCIES

NASA Center for AeroSpace  
Information (CASI)

Parkway Center  
7121 Standard Drive  
Hanover, MD 21076-1320  
United States

The British Library Document  
Supply Centre

Boston Spa, Wetherby  
West Yorkshire LS23 7BQ  
United Kingdom

Canada Institute for Scientific and  
Technical Information (CISTI)

National Research Council  
Document Delivery  
Montreal Road, Building M-55  
Ottawa K1A 0S2, Canada

Requests for RTO or AGARD documents should include the word 'RTO' or 'AGARD', as appropriate, followed by the serial number (for example AGARD-AG-315). Collateral information such as title and publication date is desirable. Full bibliographical references and abstracts of RTO and AGARD publications are given in the following journals:

## Scientific and Technical Aerospace Reports (STAR)

STAR is available on-line at the following uniform resource locator:

<http://www.sti.nasa.gov/Pubs/star/Star.html>

STAR is published by CASI for the NASA Scientific and Technical Information (STI) Program  
STI Program Office, MS 157A  
NASA Langley Research Center  
Hampton, Virginia 23681-0001  
United States

## Government Reports Announcements &amp; Index (GRA&amp;I)

published by the National Technical Information Service  
Springfield  
Virginia 22161  
United States  
(also available online in the NTIS Bibliographic Database or on CD-ROM)



Printed by St. Joseph Ottawa/Hull  
(A St. Joseph Corporation Company)  
45 Sacré-Cœur Blvd., Hull (Québec), Canada J8X 1C6