

Lightning *over Water*

...ing America's
...s for
...on

DISTRIBUTION STATEMENT A
Approved for Public Release
Distribution Unlimited

Matsumura

Steeb

Gordon

Glenn

Herbert

Steinberg

The research described in this report was sponsored by the United States Army and by the Office of the Secretary of Defense (OSD). The research was conducted in RAND's National Defense Research Institute, a federally funded research and development center supported by the OSD, the Joint Staff, the unified commands, and the defense agencies under Contract DASW01-95-C-0059, and in RAND Arroyo Center, a federally funded research and development center sponsored by the United States Army under Contract No. DASW01-96-C-0004.

Library of Congress Cataloging-in-Publication Data

Lightning over water : sharpening America's light forces for rapid-reaction missions /
John Matsumura ... [et al.].

p. cm.

"MR-1196-A/OSD."

Includes bibliographical references.

ISBN 0-8330-2845-6

1. United States. Army. Infantry. 2. Light infantry—United States. 3. United States. Army—Airborne troops. I. Matsumura, John.

UD160 L57 2000

355'.033273—dc21

00-036920

RAND is a nonprofit institution that helps improve policy and decisionmaking through research and analysis. RAND® is a registered trademark. RAND's publications do not necessarily reflect the opinions or policies of its research sponsors.

© Copyright 2000 RAND

All rights reserved. No part of this book may be reproduced in any form by any electronic or mechanical means (including photocopying, recording, or information storage and retrieval) without permission in writing from RAND.

Published 2000 by RAND

1700 Main Street, P.O. Box 2138, Santa Monica, CA 90407-2138

1200 South Hayes Street, Arlington, VA 22202-5050

RAND URL: <http://www.rand.org/>

To order RAND documents or to obtain additional information, contact

Lightning *over Water*

*Sharpening America's
Light Forces for
Rapid Reaction
Missions*

20001211 109

John Matsumura

Randall Steeb

John Gordon

Russell Glenn

Tom Herbert

Paul Steinberg

MR-1196-A/OSD

Prepared for the
United States Army and the Office of the Secretary of Defense

RAND
Arroyo Center • NDRI

Approved for public release; distribution unlimited

Foreword

AMERICA'S ARMY, THE FORCE OF CHOICE in carrying out our national military strategy, is at a crossroads. It must become more capable for future scenarios, and to do this, light forces will need to become more lethal, survivable, and tactically mobile. At the same time, our forces must be able to get to the battlefield fast—lightning fast. While reshaping tomorrow's light force to meet these objectives presents a formidable challenge, the blueprint is being worked today. And it will be created cooperatively within the Army, from our planners and policymakers, to our scientists and technologists, down to our warfighters.

This book represents a first step toward this goal. While working as a multidisciplinary team themselves, the authors have interacted with a wide range of experts from the Department of Defense and the Army. As an objective of this interaction, they have explored and assessed many new ideas, operational concepts, and technologies for improving light forces to give them greater rapid-reaction capability for tomorrow's battles. State-of-the-art modeling and simulation tools are used to help assess these ideas, concepts, and technologies in a systematic, objective, and ultimately meaningful way.

The American public and the Army's soldiers deserve the best we can give them to fight and win tomorrow's battles. Hard choices have to be made to improve the composition of the Army's light and heavy forces, speed them to battle, and even revolutionize how we fight. This book provides useful insights for America's Army, and it will generate constructive dialogue on where and how light forces should be reshaped.

Louis Caldera
Secretary of the Army

Preface

SINCE THE END OF THE COLD WAR, the U.S. Army has largely been operating in a “come as you are” format, responding to one major regional war and a series of crises around the world with equipment and doctrine optimized for that earlier Cold War era. In some sense, the momentum of the acquisition process is now resulting in a mismatch of capability with respect to emerging needs. Although one perception is that the Army now has more combat capability than it may need, which may result in inefficiencies, another perception is that the Army does not have the right kind of capability, which may result in an inability to operate effectively in future contingencies.

The fundamental strength of today’s Army lies in its ability to fight and win a major theater-level war, and this ability exists through a deliberate intent to field the most capable mechanized force possible. It is easy to argue that the Army leadership succeeded in this intent, since no anticipated enemy force can match the firepower and maneuver capability of a combined arms mechanized U.S. force, equipped with the M1-series Abrams main battle tank, the M2-series Bradley infantry fighting vehicle, and the AH-64 Apache attack helicopter. Nonetheless, as the world continues to thaw out from the stability once imposed by a bipolar superpower rivalry, the likelihood of major theater-level war is giving way to increased numbers of smaller regional conflicts and crises. New crises and conflicts are continuing to emerge around the world, and as the frequency of such events continues to increase, so does the need to adjust the U.S. capability for direct response to, and intervention within, these situations.

Both the U.S. Army and U.S. Marine Corps have a capability for rapid reaction through their prepositioned forces. But these capabilities tend to be limited in application to a locality (in the case of land prepositioned forces) and littoral regions (in the case of afloat prepositioned forces). Through its *Global Engagement* vision, the U.S. Air Force has reshaped its overarching strategy for conventional rapid-reaction capability around the world, given that air power is inherently suited for such responsiveness. But as potent as modern air power has become, by itself it has proved inadequate for decisively resolving certain kinds of crises. Thus, there is a recognized need for ground forces that can go anywhere and respond rapidly. To address this need, both the Secretary of the Army and the Chief of Staff of the Army are calling for a fundamental change in strategy. More specifically, they are calling for developing forces that are *strategically responsive across the full spectrum of military operations*. Although there is new dialogue on what might be done, there is also considerable research that has examined many of the issues now coming to light, such as, “How might light forces be changed to offer greater rapid-reaction capability?”

This book represents a compilation of research drawn from numerous studies conducted by the authors in the past few years on the topic of improving light air-deployable forces. The focus is on the topic of new operational concepts along with the underlying enabling technologies. Three very different means for improving rapid-reaction capability are considered and analyzed in detail, with both strengths and weaknesses included in the assessment. This book was written primarily for the soldiers who will be developing such future capabilities; however, policymakers and technologists involved in improving rapid-reaction capability should also find it of interest.

Information used to support this book was taken from research conducted by the authors for the following sponsors: the Defense Science Board (DSB) with GEN (ret.) David Maddox and Dr. Donald Latham; the Office of the Secretary of the Army for Research, Development, and Acquisition (SARDA) with Dr. A. Fenner Milton; the Defense Advanced Research Projects Agency (DARPA) with Dr. David Whelan; and U.S. Army Training and Doctrine Command (TRADOC) with MG Robert Scales, Jr. The research projects were conducted within the Force Development and Technology Program of RAND Arroyo Center and the Acquisition and Technology Policy Center of RAND's National Defense Research Institute (NDRI). Both the Arroyo Center and NDRI are federally funded research and development centers, the first one sponsored by the United States Army, the second one sponsored by the Office of the Secretary of Defense, the Joint Staff, the unified commands, and the defense agencies. Questions about this book can be forwarded to:

John Matsumura
1700 Main Street
Santa Monica, CA 90407
e-mail: John_Matsumura@rand.org

Contents

<i>Foreword</i>	iii
<i>Preface</i>	v
<i>Acknowledgments</i>	xi
 <i>CHAPTER ONE</i>	
<i>Introduction</i>	1
Operation Desert Shield: The Vulnerability of Light Forces in an Early-Entry Role	1
The Changing Role of Ground Forces	3
The Shortfall in Rapid-Reaction Capability	6
Options for Resolving the Shortfall in Rapid-Reaction Capability	7
The First (Middle) Path: Enhancing Current Light Forces	9
The Second (Lower) Path: Making Light Forces Smaller and More Dispersed	9
The Third (Upper) Path: Introducing Maneuver to Light Forces	9
Which Path or Paths to Follow? The Need for Sound Analysis	11
Organization of This Book	13
 <i>CHAPTER TWO</i>	
<i>How Current Light Forces Perform Against a Heavy Threat: Establishing a Base Case</i>	15
Setting the Context for the Base Case Analysis	15
Base Cases for Three Scenarios	15
The Force Mix for the Three Scenarios	21
Experiencing Desert Storm—As It Might Have Been	23
After-Action Reports of the Three Scenarios	27
Chapter Summary	32
 <i>CHAPTER THREE</i>	
<i>Following Path 1: Enhancing the Current Light Forces</i>	33
What Is the RFPI ACTD?	33
The Focus of RFPT—Exploring New Concepts Made Viable by Emerging Technologies	36
Candidate and Potential RFPI Systems	36
Options for Improved Light Forces in the Three Scenarios	43
Experiencing Desert Storm II: Upgraded DRB	44
After-Action Reports	47
After-Action Reviews for the Three Scenarios: Base Case Versus Upgraded DRB	47
Excursion: What If the Enhanced DRB Faced a Future Heavy Force?	51
Excursion: How Do Other Indirect-Fire Systems Compare with EFOG-M?	57
Chapter Summary	62

CHAPTER FOUR***Following Path 2:******Making Light Forces Smaller and More Dispersed*** 65

Defense Science Board's Small, Dispersed Forces Concept	66
Analysis Context	66
Experiencing the Small, Dispersed Forces Concept	68
After-Action Review of the DSB Small, Dispersed Forces Concept	69
TRADOC's Light Battle Force Concept	80
Analysis Context	80
Experiencing the Light Battle Force Concept	87
After-Action Review of the Light Battle Force Concept	89
DARPA's Small Unit Operations (SUO) Concept	96
Analysis Context	96
Experiencing the SUO Concept in Mixed Terrain	99
After-Action Review of the SUO Concept	100
Chapter Summary	103

CHAPTER FIVE***Following Path 3:******Introducing Maneuver to Light Forces*** 105

Context for the Analysis	105
Analysis Goals	105
Scenario Context	106
The Threat	108
How the Air Insertion Phase Was Modeled	110
How the Ground Combat Phase Was Modeled	112
Experiencing the Vertical Envelopment Concept	114
After-Action Review for the Vertical Envelopment Concept	117
The Air Insertion Phase	117
Summary of Results for the Air-Insertion Phase	123
The Ground Combat Phase	124
Chapter Summary	137

CHAPTER SIX***Additional Challenges for Light Forces*** 139

Military Operations in Urban Terrain—An Example of Expanding the Box	139
Avoiding Urban Operations	140
Preparing for “Offensive” Urban Warfare	141
The Strategy of Preemption	141
Jungle and Forest Operations	148
Simulation and Modeling for Complex Terrain	149
Chapter Summary	152

CHAPTER SEVEN

Conclusions	153
Options for Developing Rapid-Reaction Capability	153
Path 1: Enhancing the Current Light Forces	154
Path 2: Making Light Forces Smaller and More Dispersed	155
Path 3: Introducing Maneuver to Light Forces	155
Acquisition-Related Implications	156
Framework for Assessing Force Applicability	157
Developing a Strategy	159
Using a Combination of Paths	159
Example Application: Stopping an Enemy Invasion	159
Other Considerations	161
 Epilogue: A Vision Into the Future	 163
Appendix	
A: A Concise and Selective History of U.S. Light Force Projection	165
B: RAND's High-Resolution Force-on-Force Modeling and Simulation Capability	171
C: Technologies Over the Near and Far Term for Light, Rapid-Reaction Forces	187
D: Robotics: Augmenting the Soldier?	201
E: List of Figures	213
F: List of Tables	217
G: List of Abbreviations	219
 Bibliography	 223

Acknowledgments

THIS BOOK AND THE WORK IT REPRESENTS were made possible by the collaborative efforts of many persons. The authors wish to thank the following sponsors of the research who shared their visions of where light forces should go: Dr. A. Fenner Milton, formerly with the Office of the Assistant Secretary of the Army for Research, Development, and Acquisition; MG Paul Von Kaenel, formerly with the Office of the Deputy Chief of Staff (Army) for Operations and Plans; Dr. Donald Latham, GEN(R) David Maddox, MG(R) Jasper Welch, and Dr. Theodore Gold, with the Defense Science Board; MG Robert Scales, formerly the Deputy Chief of Staff for Doctrine and now at the Army War College; and Dr. David Whelan, Director of DARPA's Tactical Technology Office.

Others who contributed to the research include Mr. Walter Hollis, the Deputy Under Secretary of the Army for Operations Research; Dr. Michael Andrews, the Chief Scientist of Research and Technology in ASA(ALT); Dr. John Parmentola, formerly the Director of Technology in ASA(ALT); BG(R) Huba Wass de Czege and COL Steve Kirin at TRAC; COL Daniel Bourgoine at TRADOC; COL Karl Horst and COL Leo Brooks with the XVIII Airborne Corps; LTC Burt Mizusawa in the Office of the Secretary of the Army. We would also like to acknowledge the many discussions and interactions provided by the following organizations: the Armed Forces Staff College, the Army War College, the Army Science Board, ASA(ALT), the Defense Science Board, USD(A&T), and U.S. Army TRAC and TRADOC.

The authors had widespread research support over the past few years within RAND as well. Dr. Kenneth Horn, director of the Force Development and Technology Program in the RAND Arroyo Center, provided overarching guidance for the research. Dr. Eugene Gritton, director of the Acquisition and Technology Policy Center in the National Security Research Division, was instrumental in developing ties with DARPA and guiding research dealing with OSD issues. Keith Brendley, former RAND researcher, helped formulate many of the early concepts embodied in the rapid force projection work. The modeling and simulation team at RAND, comprising Scot Eisenhard, Gail Halverson, Phyllis Kantar, Bill Sollfrey, and Angela Stich, helped to develop new capabilities and tools for representing advanced systems and performed numerous analytic studies. Many different Army fellows stationed at RAND made substantial contributions to the work, including COL Kemp Littlefield, COL Eduardo Cardenas, LTC Donald Hinton, LTC Mark Lees, LTC Ernst Isensee, and MAJ Steven Strukel. The authors also had numerous useful discussions on rapid-reaction capability with Terry Covington, James Chow, Jon Grossman, John Pinder, and many other colleagues at RAND.

To help produce this book we would like to thank the following individuals. June Kobashigawa helped with the assembly of the manuscript. Donna Betancourt helped us overcome the many administrative hurdles. Ron Miller, Pete Soriano, Barbara Angell, and Mary Wrazen provided artwork and design. Nikki Shacklett provided the editing. We would especially like to thank our reviewers, Mr. James Quinlivan, former Director of the Arroyo Center, and Dr. Walter Perry, who added both style and substance to the final product. Finally, the authors collectively would like to thank their families for their unyielding understanding and support. Without this, the research that went into this book would not have been possible.

Introduction

Operation Desert Shield: The Vulnerability of Light Forces in an Early-Entry Role

ON AUGUST 2, 1990, THE NATION OF KUWAIT FELL to invading Iraqi units in a matter of hours. In the days following the initial aggression, Iraqi forces made several incursions into Saudi territory. The Saudis' ability to rebuff these violations or stop a renewal of the attacks was limited.¹ Military logic dictated that the Iraqis continue their successful offensive and seize Saudi Arabian airfields, ports, and oil fields (Scales et al., 1993, p. 50). If successful, Iraq would have controlled 40 percent of the world's oil reserves.²

At 9:30 P.M. on August 6, the 82nd Airborne Division received an alert notification from its corps headquarters. The division routinely stood organized for short-notice contingencies. At the time of notification, the 2nd Brigade was the Division Ready Brigade-1 (DRB-1): the ground maneuver brigade designated to deploy most rapidly. The brigade had three battalion task forces, each similarly assigned a relative alert status. For example, the 4th Battalion, 325th Airborne Infantry Regiment was the Division Ready Force-1 (DRF-1) at the time of notification, with a two-hour assembly requirement.³ In less than three days, the lead elements of the battalion were on the ground at Saudi Arabia's Dhahran International Airport,⁴ with the remainder of the 2nd Brigade in-country by August 14. Divisional units accompanying this initial force included an Apache attack helicopter battalion, a 105mm artillery battalion, a platoon of multiple-launch rocket systems (MLRS), a Sheridan light tank company, and other supporting elements (Caraccilo, 1993, pp. 4, 16).

Army leaders estimated that an 11-division Iraqi force was in Kuwait or its immediate environs. The senior XVIII Airborne Corps officer in Saudi Arabia expected that an attack from the north would consist of six enemy divisions, some of which would be Saddam Hussein's elite Republican Guard units.⁵ Such a force would have included approximately 1,460 tanks, 3,200 other armored or mechanized fighting vehicles, and 76,200 Iraqi soldiers.⁶ The soldiers of the 2nd Brigade numbered only 2,300 (Freedman and Karsh, 1993, p. 94). All that stood in defense of the ports and airfields so critical to the defense of Saudi Arabia were this brigade, American support units, and Saudi and Gulf Cooperation Council (GCC) forces that had either been in place or had raced to northeastern Saudi Arabia in the previous few days.⁷

Upon arrival in Southwest Asia, the 2nd Brigade, 82nd Airborne Division mission was to defend Dhahran and Ad Dammam airfields and port facilities. Three days later, on August 12, the mission was changed to defend the port at Al Jubayl, 110 miles to the north, in preparation for the arrival of U.S. Marines.⁸ Planners readying guidance

for the protection of Al Jubayl accounted for the limited U.S. ground force strength. The brigade's soldiers focused on the coast road and other nearby avenues of approach; defensive plans included using sabkhas (coastal salt flats) that would slow or stop any Iraqi armor attempting to cross that softer ground.⁹ Such obstacles would have been used in conjunction with tube-launched, optically-tracked, wire-guided (TOW) missile and other anti-tank systems to support the engagement of Iraqi armor and mechanized forces at long range before the enemy could bring its fires to bear on the less well-protected and relatively immobile Americans.

In the event of an Iraqi attack, 2nd Brigade, 82nd Airborne Division soldiers' defensive efforts would have been aided by U.S. and coalition air support, Arab forces positioned north and east of the ports, the long distances from the Kuwaiti border to the port of Al Jubayl, the immaturity of the enemy's logistical and command and control (C2) systems, and a high level of training and *esprit de corps*. Nonetheless, a number of factors would have severely challenged the success of the defense, including a force ratio that greatly favored the adversary, the large number of avenues of approach available to the attackers, a lack of other than a skeletal sustainment apparatus, and limited means to deal with an enemy in armored and mechanized vehicles.

But the enemy did not come. Airborne soldiers provided security as the 16,500-man Marine Corps brigade disembarked beginning August 14, 1990 (Flanagan, 1994, p. 23; Scales et al., 1993, p. 84). By August 20, the 1st Brigade of the 82nd Airborne Division had joined its predecessors; four days later, the 3rd Brigade was on the ground in the Gulf.¹⁰ The XVIII Airborne Corps' 101st Air Assault and 24th Infantry (Mechanized) Divisions arrived during the following weeks. Although the probability of a successful coalition defense increased with each unit's arrival, there had undeniably been a period of severe vulnerability; the first ship loaded with tanks and other fighting vehicles of the 24th Infantry (Mechanized) Division did not arrive in Saudi Arabia until August 31, and it was September 25 before the entire division had arrived (Schubert and Kraus, 1995, pp. 80–81).

As the above discussion shows, the 2nd Brigade, 82nd Airborne Division accomplished its mission in Operation Desert Shield, but it did so by default. Taking nothing away from the light forces deployed, the situation in which they found themselves in Southwest Asia in 1990 was clearly nowhere near as "stressing" as it might have been, because Hussein's heavier forces did not behave as one would predict and did not take advantage of the apparent overmatch they had. Had they advanced into Saudi Arabia, as one would have expected, would the light forces in place have been able to delay their advance without suffering massive casualties? Moreover, if Hussein's heavier forces themselves had been more capable, would the 2nd Brigade, 82nd Airborne Division's much smaller and lighter forces have been lethal and survivable enough to have had a decisive impact on the battle?

While it is interesting to speculate in hindsight on such questions, the issues are more than just academic. The effectiveness of U.S. light forces¹¹ in rapid-reaction situations—exemplified by the widely acknowledged vulnerability of the U.S. force during

the Desert Shield buildup—is an increasing national concern. The remainder of this chapter begins by describing the changing role of ground forces before turning to a discussion of concerns about the shortfall of such forces in this role. It then sets out three possible paths for reshaping light forces to meet this shortfall, an unavoidable issue that high-level Department of Defense (DoD) decisionmakers will need to contend with in the near future. It concludes by highlighting the need to *analytically* assess the merits and weaknesses of new concepts and technologies along any of the three paths.

The Changing Role of Ground Forces

The role of ground forces is being transformed by changes in both the nature and the uncertainties of conflict. In terms of the nature of conflict, the spectrum—or range—of conflict has altered dramatically. Figure 1.1 shows the spectrum of conflict during the Cold War, with its focus on the high likelihood of conventional war and the less likely, but still prominent, possibility of nuclear war. In that world, with the focus on countering one major threat in Europe, prepositioned heavy forces were the hedge against attack, and light forces were focused more on dealing with insurgency and terrorism. (For a more detailed discussion of the history of light forces, see Appendix A.) More specifically, Army light infantry divisions were created in the mid-1980s as a way to provide “global flexible response” and were designed for low- and mid-intensity conflict and as “strategically deployable rapid-responding, flexible light forces.” For a detailed account of the development of the light division, see Romjue (1993).

Figure 1.2 shows the current spectrum of conflict, which is clearly much more varied and extensive. The range of conflict possibilities—starting with peace and peace-keeping and humanitarian operations, ranging through country conflicts and regional

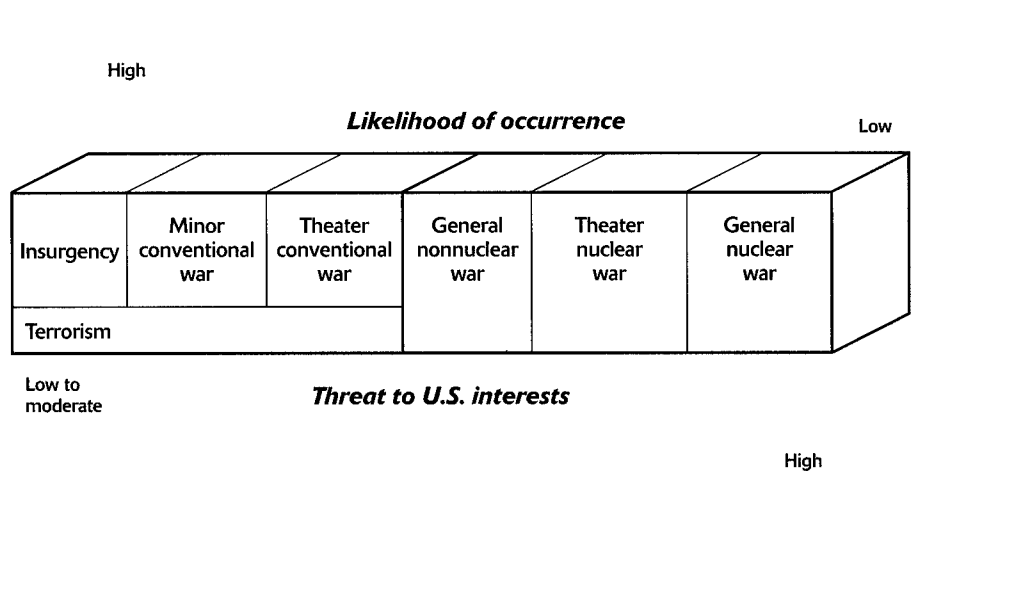

SOURCE: Johnson, Pace, and Gabbard (1998).

Figure 1.1—Spectrum of Conflict During the Cold War

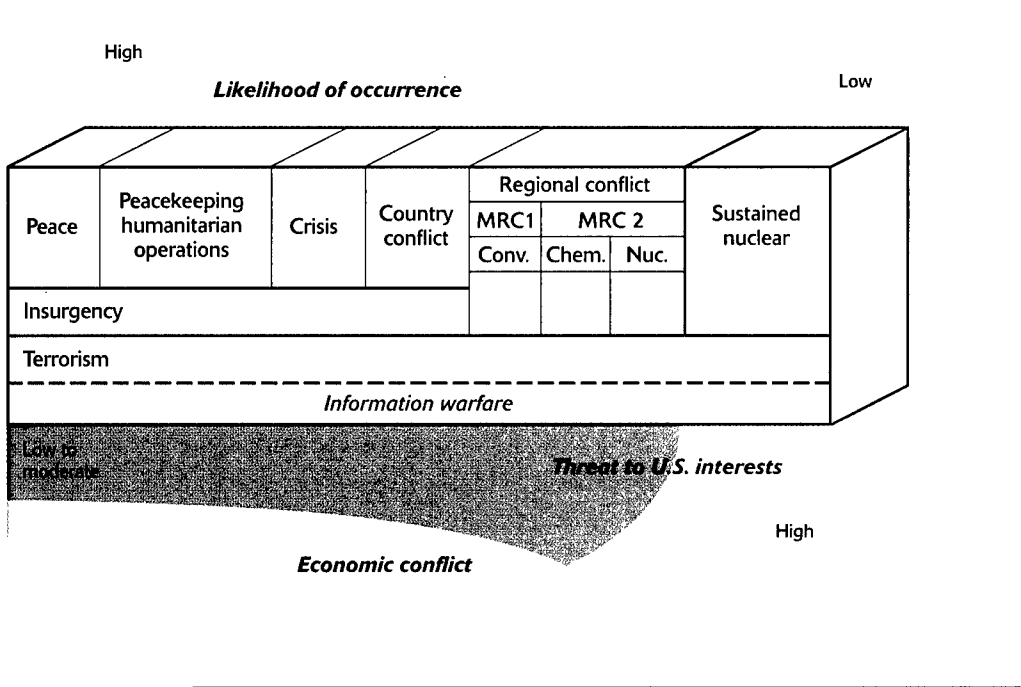

SOURCE: Johnson, Pace, and Gabbard (1998).

Figure 1.2—Current Spectrum of Conflict

conflicts (major regional contingencies, or MRCs), and up to sustained nuclear war—presents challenges to military planners. In addition to playing the traditional role in insurgency and terrorism operations—which have grown in scope—light forces are playing a new role in humanitarian operations (like Somalia) and in MRCs (like the Gulf War scenario described above).

And it is not just the nature of conflict that has changed. The uncertainty about where those conflicts—or military operations—can occur has also grown. In the Cold War, the focus was predominantly on major conventional war in Europe, where forces were already present and, as mentioned above, where the military had stores of prepositioned equipment to outfit reinforcing units as they arrived in theater. Even during the Gulf War, the military could rely, to some extent, on prepositioned equipment both in Southwest Asia and afloat nearby.

However, in the world pictured in Figure 1.2, uncertainty about where conflicts and military operations can occur has increased dramatically, in part because of the possible number and kinds of operations. And as the figure shows, the spectrum includes more than one potential MRC, for example, one in Southwest Asia and one in Korea. When the potential for conflict is so global in nature, it becomes more difficult for military planners to rely on traditional prepositioned forces as a hedge against conflict breaking out.

Although the U.S. military is responding to the changing nature and uncertainties of conflict by making air power improvements and by introducing prepositioned

forces afloat for heavy units, these options may be limited in their overall effectiveness, availability, or responsiveness to crises around the globe. And while airlifting heavy forces as they are currently equipped into such situations is technologically possible, it is unlikely that enough airlift will be available to bring significant numbers of heavy forces into theater rapidly, even with optimistic projections on inter- and intra-theater airlift.

Under the circumstances described, the prospect of using the light forces, and air-borne forces in particular—which are intended for rapid projection to trouble spots—against larger and heavier forces, including heavy armored forces, in the early phase of conflict has become an accepted reality. Calls for reexamining the role of light forces in these situations have come from many sources. The “Army After Next” initiative conducted by the U.S. Army is one example.¹² That initiative is looking out years into the future to determine likely demands placed on U.S. military forces based on current projections of the political-military environment.

Current RAND research is examining alternative plausible worlds beyond the major competitor world envisioned as the baseline for warfighting exercises. While the study identifies a wide spectrum of plausible worlds that involve the use of light forces in different ways, one in particular—defined as “U.S. polarity”—envisioned an environment in which lethal and survivable forces are fundamental. In this world, where the United States remains dominant militarily, economically, and politically but faces selected hostile regional powers (such as Iran and North Korea), the Army will need to prepare for intimidation by such powers with weapons of mass destruction (WMD), major theater warfare against a regional competitor using asymmetric strategies, and sporadic peace operations in areas challenged by communal violence or natural disaster. Other RAND research has found that the future Army will need a light and lethal component—one that must be easily deployable across intercontinental distances and will have operational mobility, the ability to engage and defeat hostile armored forces, long-range systems for use against logistics and assembly areas, and an intelligence, surveillance, and reconnaissance (ISR) suite capable of detecting massed infantry movement in all-weather conditions (see Matsumura et al., 1997).

Another recent call for examining the role of light forces in the future has come from the congressionally mandated Commission on Roles and Missions (CORM) of the Armed Forces. The CORM was created in 1993 by Congress to review and evaluate “current allocations among the Armed Forces of roles, missions, and functions” and to “make recommendations for changes in the current definition and distribution of those roles, missions, and functions.”¹³ In one of its many commissioned studies, the CORM asked RAND to examine the need to change the roles and missions of light forces—in this case, both Army light forces and Marine expeditionary forces—and rec-

commend potential changes. One of the broader conclusions about light forces was that their importance will grow in the post-Cold War world (Kassing, 1994, p. 57):

Taken together, this analysis indicates greater, not lesser challenges for U.S. expeditionary forces. RAND policy analyses imply that DoD will need more capable expeditionary forces to deal with better prepared opponents. More rapid response capabilities are also called for as forward presence declines. Finally, more manpower could be needed to sustain extended humanitarian, peace enforcement, and peacekeeping deployments. Compared to heavy Army units, the flexibility, deployability, and supportability of light Army and expeditionary Marine forces could give them a comparative advantage in the post-Cold War era.

The Shortfall in Rapid-Reaction Capability

Beyond establishing the growing importance of light forces in new roles, Kassing (1994) also called attention to the growing concern over whether such forces “have the survivability and killing power for future major regional contingencies” [p. 64]. If light forces are to be used as the rapid-response force in such major regional contingencies, they will need to have much greater survivability and lethality to operate effectively against an increasingly wide range of situations and threats, particularly conflict against heavy forces.

This concern has also been raised by the Defense Science Board (DSB), which has called for greater attention on improving rapid-reaction capability. More specifically, in its 1996 and 1998 summer studies, the DSB, with RAND assisting, examined the limitations of light forces among other force capabilities. The studies explored new technologies and operational concepts for improving these forces from a number of different perspectives. DSB (1996) documents a detailed analysis of the survivability of light forces, such as those deployed in Desert Shield. Not only did this analysis reaffirm the expectation that such forces do not have enough capability to contend with a larger attacking armor force, it also illustrated *why* such forces would probably not succeed. While different solutions posited by the DSB helped to improve survivability, no single solution emerged as a panacea; rather, the analysis showed that a system-of-systems-based approach for improving them would be necessary.

DSB (1998) considered a range of options for improving rapid-reaction capability from a joint warfighting perspective to meet future demands in the 2010 time period.¹⁴ These began from ideas described in *Joint Vision 2010* (Joint Chiefs of Staff, 1995) and evolved from there in the respective DSB sessions.

One key conclusion of these DSB studies was that a wide range of capabilities—including improved reconnaissance, surveillance, and target acquisition (RSTA) capabilities, C2 capabilities, remotely delivered precision-guided munitions (PGMs), and improved logistics—must be introduced into existing light or air-deployable forces to make them a viable contender for future rapid-reaction missions. In this forum, many creative ideas were introduced to assist with the rapid-reaction challenge. For example, the idea of converting the launch tubes of nuclear submarines (once reserved for nuclear

weapons) for tactical ballistic missiles such as ATACMS armed with PGMs was explored. Providing such low-visibility, on-site/on-demand responsive firepower can provide lethality to rapid-reaction forces in a way that currently does not exist.

The Defense Advanced Research Projects Agency (DARPA) has also identified key limitations in rapid-reaction capability and has explored new operational concepts. Specifically, the small unit operations (SUO) program analyzed the idea of extremely small, light units that would rely on advanced precision weaponry for firepower. In theory, these forces could be inserted overnight to help keep a crisis from worsening. Other initiatives sponsored by DARPA, such as the military applications of robotic systems, have application to improving rapid-reaction capability.

Despite the many initiatives that have offered ideas, albeit in the form of analyses and experimentation, the shortfall in rapid-reaction capability still exists nearly a decade after the Gulf War. In retrospect, the Kosovo crisis may have also raised the attention level for more capable rapid-reaction capability—forces that could both deploy rapidly to a crisis *and* provide significant and robust combat power. Although the delay of bringing ground forces into Kosovo could be directly attributed to political indecision, it is probable that such indecision was linked to the risk of bringing current forces into the theater. A particular limitation may have been the lack of protection and sustainability associated with using current airborne forces against Serbian armor.

At the same time, however, the highly survivable and lethal U.S. mechanized forces would have taken considerably more time to both deploy and employ.¹⁵ Thus, to some extent, decisionmakers faced a paradox similar to the one they faced in Desert Shield: Current U.S. airborne forces consisting mostly of light infantry were not likely to be effective against the larger Serbian mechanized armored force; and U.S. mechanized forces, though significantly more capable than Serbian forces, could not be applied with great enough flexibility and speed to put an early end to the atrocities. Further, had a resolution not been reached, the use of U.S. mechanized forces would probably have been in the form of a counteroffensive operation, which may have come with a series of additional challenges.

Options for Resolving the Shortfall in Rapid-Reaction Capability

Although the shortfall in rapid-reaction capability is generally well recognized, the response to it can take on a wide range of forms. RAND analysts, having participated in the aforementioned research activities, helped in both conceptualizing and assessing a major cross-section of ideas for solving the rapid-reaction shortfall. A beginning point for this line of research within RAND's Arroyo Center and National Defense Research Institute goes back roughly ten years, to the aftermath of Desert Storm. During that time, DoD defined a number of research thrusts created within a Science and Technology Master Plan to respond to, among other things, critical weaknesses identified in Desert Storm. One of seven major thrusts identified was that of Advanced Land Combat—a thrust that put the perceived limitations of light airborne forces directly under the spotlight.

A direct outcome of the Advanced Land Combat thrust was the creation of the first Advanced Concept Technology Demonstration (ACTD). The name for this ACTD eventually evolved to the Rapid Force Projection Initiative (RFPI). The RFPI ACTD provided a hands-on means for soldiers to experiment with new concepts and technologies. Although the focus was on providing near-term capabilities and on leveraging commercial technologies, as new ideas were raised in this forum, many additional initiatives emerged outside the ACTD—some of them concentrating on farther-term capabilities that would permit more formidable changes in force effectiveness.

These changes could take on one or more combinations of forms, including not only changes in operational concept and equipment (new technologies), but also changes in force organization and design. There are also varying degrees to which each of these changes might occur. How these changes are envisioned to reshape light forces for greater rapid-reaction capability can be broken up into three broad paths. Providing a framework and exploring these paths to help resolve the rapid-reaction shortfall represents the primary impetus for this book.

Figure 1.3 conceptually arrays the three different paths for improving rapid-reaction capability considered within this book. Each path represents a very different means to get to a similar end: a force that offers more overall capability than the current light airborne forces but is still very quickly deployable. While not intended to be mutually exclusive in application, the three paths are analytically treated separately so that their respective strengths and weaknesses can be distinctly examined. It is recognized that a *combination* of the different paths or some of the distinct elements and technologies within each one might be the optimum route for the Army to ultimately pursue. As such, high-payoff systems and technologies are highlighted in the quantitative analysis of each path, presented in subsequent chapters.

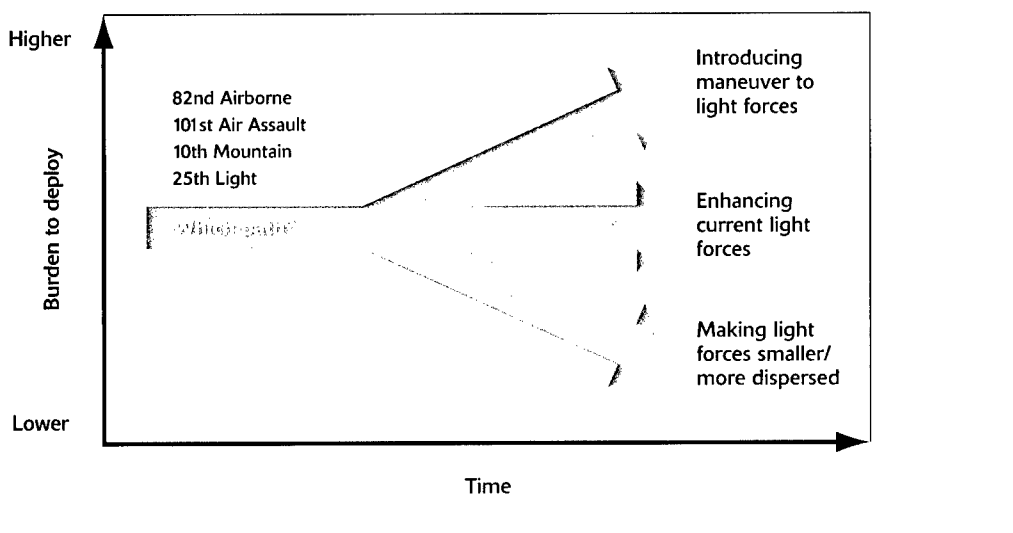

Figure 1.3—Three Different Methods for Developing a More Effective Rapid-Reaction Capability

The First (Middle) Path: Enhancing Current Light Forces

This path examines what might be considered an evolutionary change from current rapidly deployable forces, such as the Division Ready Brigade of the 82nd Airborne. Here, the force remains as a small, mostly self-contained unit with a force structure similar to the DRB, but it is given the capability to fight and survive in a mission that might otherwise require a larger, heavier force. This could be accomplished by introducing a modified operational concept(s) and by incorporating many underlying, enabling technologies, which include advanced RSTA, C2, and weapon systems. These modified operational concepts involve substantially greater indirect-fire capability than a current light force would have. More specifically, by linking precision munitions to a range of advanced indirect-fire weapons to an integrated sensor and C2 network, substantially more firepower can be brought to bear on an attacking enemy, essentially providing much greater indirect firepower and, thus, lethality at substantially longer ranges. More descriptive detail and discussion of the impact of this operational concept and equipment will be provided in Chapter Three.

The Second (Lower) Path: Making Light Forces Smaller and More Dispersed

Another method for improving light forces involves removing the notion of area control by massed ground forces almost entirely. Here, a very small, highly dispersed force would be deployed in a threatened region. These virtually independent dismounted teams would be equipped with advanced sensor systems for establishing on-site intelligence, and advanced C2 giving them the capability to call in remotely located long-range fires. If the deploying force is very small and dispersed, it has been argued that the enemy would have great difficulty engaging it (e.g., it presents a target with no obvious center of mass); thus, that force would be much more survivable than a typical rapid-reaction force. It was noted early on that such a force may not be capable of holding terrain, but might be sufficient for denying the enemy full use of it.

This general path has taken on several distinct forms, including a DSB-generated concept that is similar to one espoused in the U.S. Marine Corps (USMC) Sea Dragon proposal, the U.S. Army's Training and Doctrine Command (TRADOC) light battle force concept, and DARPA's small unit operations (SUO) concept.¹⁶ All of these are examined in detail in Chapter Four. This path extensively builds on the previous concept, not only by drastically changing the organization of the force, but also by changing the philosophy of ground warfare with its greatly increased dependence on external RSTA and remote firepower (Matsumura et al., 1997).

The Third (Upper) Path: Introducing Maneuver to Light Forces

Another method for responding to the limitations of current rapid-reaction capability is to make a major adjustment to the nature of the force itself. More specifically, new ideas and technologies are emerging that can enable some level of operational and tactical maneuver combined with rapid deployment. Vertical envelopment concepts being explored out of the TRADOC are one example of such a major shift. Most of the rapid-

reaction capability envisioned in these concepts more closely resemble heavy forces than current-day light forces. That is, rather than emphasizing dismounted infantry, these concepts involve infantry mounted in lightweight but highly capable vehicles that could be airlifted close to battle positions by large inter/intra-theater lifters or, possibly, by large rotary-wing, tilt-rotor, or tilt-wing aircraft.

Speed and knowledge are key tenets of the viability of such concepts. By using agile air and ground platforms for strategic through tactical maneuver and by achieving information supremacy, a quick response from the continental United States (CONUS) to the battlefield could theoretically be attained. Critical technologies that bring about information dominance, agile dissemination of the information, and ultra-efficient, lightweight, but lethal platforms would be necessary, where some combination of advanced lightweight composite armor and active protection systems (APS) mounted on a lightweight chassis would be used to supplant more conventional, heavy armor plates.

The fundamental notion for a relatively lightweight, perhaps middleweight force, has recently gained attention. In addition to TRADOC, other organizations such as the Office of the Secretary of the Army for Research, Development, and Acquisition have come up with similar, albeit somewhat heavier, force designs. These forces would be airlifted into theater by C-130J class aircraft, and ground platforms would consist of variants of the Future Scout and Cavalry System (FSCS) currently in development, among other vehicle designs. Research as part of the 1998 DSB Summer Study examined the SARDA concept among others as part of a Joint Service concept for enhancing rapid-reaction capability (Matsumura et al., 1999). More descriptive detail and discussion of the impact of redesigning the force with maneuver capability are provided in Chapter Five.

Although the three different paths involve improving light forces to give them greater rapid-reaction capability, they do so in significantly different ways—by improving one or more of five critical parameters of rapid-reaction missions:

- *Kind of mission* (e.g., peace operations, forced entry, area defense, local attack).
- *Type of environment* (e.g., open, close, urban, contaminated).
- *Level of threat* (e.g., size, sophistication).
- *Kind of threat* (e.g., militia, light infantry, mechanized, combined arms).
- *Responsiveness into theater* (e.g., few days, week, few weeks).

Path 1 enhances a current DRB through new concepts of operation and enabling technologies. These should help to improve both the levels and kinds of threat that can be addressed. Path 2 substantially reduces the size and footprint of the force, transitioning much of the firepower to remotely located systems. These changes should dramatically improve force responsiveness, but they may reduce the kinds of mission, levels of threat, and kinds of threat that can be successfully addressed. Path 3 introduces maneuver to the force by equipping it with a lightweight family of vehicles. This change may reduce force responsiveness into theater, but it can potentially improve the kinds of mission, types of environment, levels of threat, and kinds of threat that can be addressed by the force.

Which Path or Paths to Follow? The Need For Sound Analysis

Ultimately, efforts to improve light forces to give them greater rapid-reaction capability, making them more lethal and survivable and more germane to future conflicts, require policymakers to make decisions now that will affect military capabilities down the road. These decisions—whether about organizational structure, force designs, new operational concepts, and enabling technologies—can lead to irrevocable consequences. Unfortunately, ideas that look good on paper do not always meet expectations when they are implemented. This means that the selection of one path or a combination of paths should be based on a sound analytic foundation that gives policymakers confidence in the choices they make.

The analyses presented in this book are all driven by an extensive and broad-based simulation environment, one that has evolved over many years of development at RAND. In an evolutionary manner, new concepts and technologies have been added into the simulation environment as needed to meet the objectives of the research. The process of developing the simulation environment has been an interactive one. In essence, building the environment (which included developing the scenarios used with it) has involved importing and applying a wide range of analytic and simulation tools, refining those tools to represent new systems and technologies, and determining the appropriate level of model resolution. This resulted in the development of specialty models, such as acoustic models and smart-munition representations.

This effort, in turn, has relied heavily on a wide-ranging knowledge base that exists at RAND. Personnel who have contributed to this research include a mix of technologists, operations research (OR) analysts, logisticians, and scenario specialists. In addition, in developing the scenarios, RAND personnel worked extensively with a range of DoD organizations. And in developing the concepts, a number of senior defense officials, military users, and system developers and testers were consulted. Finally, in many instances, field tests and early-user experiments were observed, resulting in lessons learned that were employed to further refine the modeling and simulation environment and the scenarios where applicable.

Appendix B discusses in more detail the locally distributed simulation environment RAND has assembled over the years to model the many different aspects of ground combat. Here, we merely summarize the current scope of the modeling effort, shown in Figure 1.4.

Starting in the center of the figure, the RAND version of JANUS serves as the primary high-fidelity, force-on-force combat effectiveness simulation and provides the overall battlefield context; JANUS is capable of modeling as many as 1,500 individual systems on a side. To the right of JANUS in the figure, the combination of the RAND Target Acquisition Model (RTAM) and the Cartographic Analysis and Geographic Information System (CAGIS) enable us to represent detailed target detection/acquisition phenomenology as needed, including those associated with low-observable vehicles. The C2 model, which is linked to JANUS, relies on an architecture that is generally based on components of the highly notional RFPI C2 concept and components of the Ad-

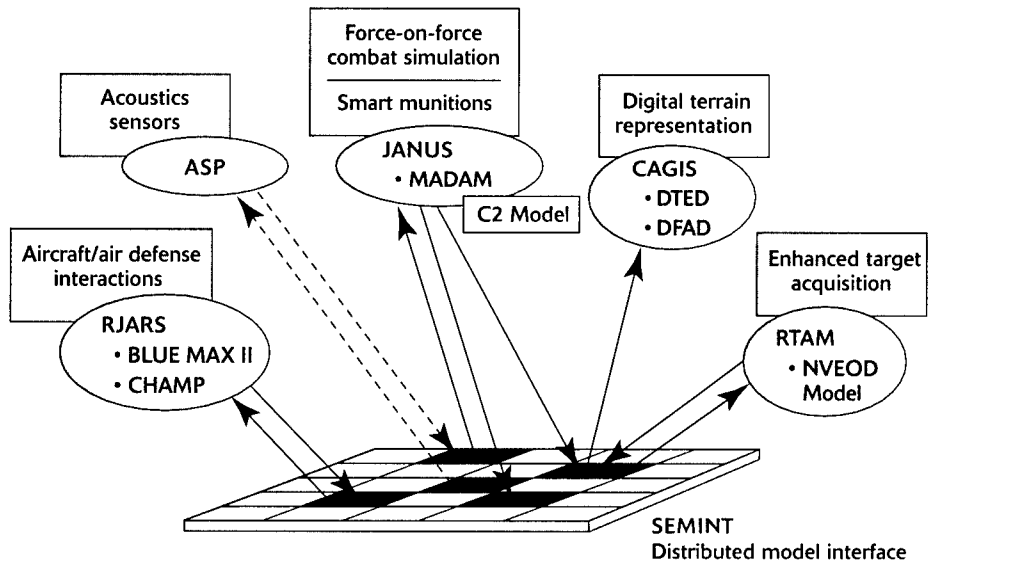

Figure 1.4—Current Scope of RAND Modeling Effort

vanced Field Artillery Tactical Data System (AFATDS). It models delays associated with message transmission, options planning, and assignment of weapons to targets. It also represents delays and degradations caused by the loss of C2 nodes and the subsequent reconfiguration.

Represented on the far left of the figure, RAND's Jamming Aircraft and Radar Simulation (RJARS) provides a means to simulate the detection, tracking, flyout, and fusing of air defense missiles fired against helicopters and unmanned aerial vehicles (UAVs). The Model to Assess Damage to Armor with Munitions (MADAM), in conjunction with CAGIS, simulates the dispensing, search and target-acquisition process, and attack sequence of smart munitions, including chaining logic, multiple hits, shots at hulks, unreliable submunitions, and so forth.

The Acoustic Sensor Performance (ASP) model, a recent addition to the suite of models, allows us to simulate in detail acoustic phenomenology for a number of different systems, such as the acoustic overwatch sensor, wide area munitions (WAM), the intelligent minefield (IMF), and the air-deliverable acoustic sensor (ADAS). As shown in the figure, the ASP is linked to JANUS, which enables us to expand our analysis of individual sensors' performance in the few-on-few environment to a "system-on-system" analysis in a large-scale, many-on-many situation.

Finally, we use the Seamless Model Integration (SEMINT)—a distributed model interface—as a way to enable all these simulations to communicate during an exercise.

Organization of This Book

This book explores new ideas and the underlying concepts, technologies, and organizations that can help address the current shortfall in rapid-reaction capability. The book refrains from recommending a single solution to the shortfall, instead focusing on increasing awareness of the problem and providing a collection of possible solutions, highlighting their many advantages and disadvantages through analysis. Perhaps, through subsequent dialogue and corresponding analysis, a more definitive solution to the rapid-reaction shortfall will emerge. This research draws extensively on recent RAND work that was conducted for the DSB, DARPA (in conjunction with USMC), the Joint Staff, and the U.S. Army—research in which the authors of this book were directly involved.

To help define the problem, Chapter Two provides a base case showing why existing light airborne forces may not succeed in a relatively recent context—the Desert Storm era. This base case is used as the foundation for the analyses in Chapters Three, Four, and Five, which correspond to the three paths shown in Figure 1.3. Chapter Three focuses on path 1, in which rapid-reaction capabilities are enhanced through near-term changes in concept and technologies and in which force structure and organization remain as they currently are. Chapter Four continues the discussion by exploring path 2 for improving rapid-reaction capability, which proposes making light forces smaller and more dispersed. Chapter Five extends the discussion further by looking at path 3, which introduces maneuver to such forces (inherently making them heavier). In each chapter we follow a similar structure, setting up the context for analyzing a scenario(s), showing how a “lieutenant” serving in the notional rapid-reaction unit might experience that scenario, and then presenting the analysis results for that scenario and others in the form of an “after-action review.”

Chapter Six highlights some of the special challenges that go along with reshaping rapid-reaction forces for the future, looking in particular at the potential role of light forces in military operations on urbanized terrain (MOUT). Finally, Chapter Seven concludes this work by summarizing opportunities and implications for responding to the rapid-reaction shortfall.¹⁷

Appendix A provides a brief historical perspective on the evolving role of light forces. Appendix B presents a more detailed description of the analytic simulations, models, and tools used for the RAND analysis. To help readers visualize the numerous systems mentioned throughout the book, Appendix C presents renditions of these systems, as well as a brief discussion of capabilities. Appendix D provides a short think piece on the increasing role that robotics might play on the future battlefield.

CHAPTER ONE ENDNOTES

- 1 Cordesman and Wagner (1996), p. 54. These authors write that the Saudi units in the vicinity of the Kuwaiti border consisted only of a small armor brigade in King Khalid Military City and a national guard unit without tanks.
- 2 Cordesman and Wagner (1996), pp. 55–56. Twenty percent of these oil reserves were in Iraq and Kuwait; an additional 20 percent were in Saudi Arabia.
- 3 "Oral history interview (DSIT AE 017): LTC John R. Vines," p. 1 (footnote). The lower the DRB or DRF number, the shorter the time given between notification and deployment.
- 4 The battalion's first elements disembarked in Saudi Arabia at 5:00 P.M. on August 9, 1990. See "Command Report Narrative: Desert Shield & Desert Storm," prepared by Headquarters, 82nd Airborne Division, Fort Bragg, NC, January 20, 1992, pp. 1–2. The time at Fort Bragg was 10:00 A.M., August 9, 1990, or seven hours earlier than Saudi time.
- 5 Scales et al. (1993), p. 82. The XVIII Airborne Corps was the 82nd Airborne Division's immediate senior headquarters. The corps also included the 101st Air Assault Division, the 24th Infantry Division (Mechanized), and other units.
- 6 These values assume that four of the six attacking divisions would have been regular force organizations (mechanized or armored) and that the remaining two divisions would have been Republican Guard armored or mechanized divisions. For assets assigned to these division types, see Cordesman and Wagner (1996), p. 124.
- 7 Schubert and Kraus (1995), p. 55. Roughly 2,000 Egyptian commandos who had arrived on August 6, 1990, were farther to the west (in the vicinity of Hafr al-Batin). See Pimlott and Badsey (c1992), p. 91. McCausland (1993, p. 10) states that "leading elements of the Egyptian Army landed on 11 August." Khaled bin Sultan (1995, pp. 8–11) notes that Moroccan and Egyptian forces were "the first friendly Arab forces to fly to our aid." He explains the early paucity of Saudi troops along the northern border and the nation's efforts to reinforce this area.
- 8 "Oral History Interview (DSIT AE 017): LTC John R. Vines," p. 2. Movement to Al Jubayl was made with the help of Saudi Arabian transportation assets. See "Command Report Narrative: Desert Shield & Desert Storm," p. 2.
- 9 Scales et al. (1993), p. 85, and "Oral History Interview (DSIT AE 017): LTC John R. Vines," p. 11.
- 10 Schubert and Kraus (1995), p. 53. Cohen et al. (1993, Table 23) gives August 13, 1990, as the closing date for the 2nd Brigade, 82nd Airborne Division, and August 17 as that for the 1st Brigade. Swain (1994, p. 356) agrees with August 14 as the 2nd Brigade's closing date but does not provide information on the closings of the division's other two ground maneuver brigades.
- 11 For the purposes of this study, "light forces" are ground forces with all of the following characteristics: force structure is significantly influenced by the need for rapid deployment by air, the organization's infantry forces have no organic motorized, mechanized, or armored vehicles for movement on the battlefield, and organic maneuver and fire support systems are lighter and have less armor protection than the contemporary mechanized infantry, armored infantry, or armor unit standard.
- 12 The terminology "Army After Next" has since been replaced with an initiative referred to as "Army 2010 and Beyond."
- 13 See the National Defense Authorization Act for FY 1994, Conference Report, p. 198.
- 14 This was only one of several important issues studied by the DSB; others included methods of contending with a weapons of mass destruction (WMD) threat.
- 15 In addition to the time needed to bring such forces into theater, the heavy weights of combat vehicles themselves would have required modification to bridges affording access to the area.
- 16 The USMC Sea Dragon effort is a five-year experimental process of innovation and experimentation that embodies several key experiments—Hunter Warrior, Urban Warrior, and Capable Warrior. Each of these, under the supervision of the Marine Corps Warfighting Lab, envisions a smaller but more lethal force.
- 17 Although this book focuses on the future Army, the authors clearly recognize that the Army operates with, and relies on, the forces of the other services. As various options are examined in this work, the likely contribution of the other rapid-reaction elements of the Joint force will be highlighted and their relationship to Army operations considered.

**HOW CURRENT LIGHT FORCES
PERFORM AGAINST A HEAVY THREAT:
*Establishing a Base Case***

AS WE SAW IN CHAPTER ONE, WHEN LIGHT FORCES WERE USED in a rapid-reaction capacity to confront the heavier forces of Saddam Hussein's Army in Desert Storm, they succeeded in their mission. As noted, however, they succeeded only by default, since the attack never came. In essence, the light forces performed as a deterrent force. But what if deterrence had failed and the attack *had* come—if Saddam's heavy forces had advanced and engaged the much lighter and less mobile American force that was screening the critical Saudi ports? Of course, that was August 1990. Nearly a decade later, how well would a light force equipped with modern capabilities fare in repelling a larger heavy force?

In this chapter we use the modeling tools described at the end of Chapter One to analyze the use of current-capability light forces as a rapid-reaction force against a larger heavy force, working with different scenarios that vary in terms of terrain and mission. The results of that analysis serve as a "base case" for future analysis—the starting point for the analytical excursions in Chapters Three, Four, and Five that examine the impact of the alternative rapid-reaction paths discussed in Chapter One.

In the remainder of this chapter, we define the three scenarios in more detail, first by describing the scenarios themselves and then by describing the weapon systems available to both sides. Then we describe the events in a narrative fashion from the vantage point of a lieutenant participating in the conflict. We then "play" the scenario, using high-resolution constructive modeling to assess force-on-force system performance, making use of the results from the modeling runs to describe outcomes.¹ Finally, we present an "after-action review" of the battle the lieutenant experienced, as well as the battles in the different scenarios, describing the results in more detail by using the actual outputs of the simulation.

Setting the Context for the Base Case Analysis

The base case focuses on how light forces, portrayed here as the 82nd Division Ready Brigade (DRB), as configured at the time of Desert Storm, would perform against a heavy threat. Below we look at the different scenarios and then examine the force mixes (Blue and Red) for each one.

Base Cases for Three Scenarios

One of the key concerns in dealing with the effectiveness of the light forces in a rapid-reaction mission against a larger, heavier force is how well such a force does across a spectrum of plausible cases. Here, we use three scenarios to represent that spectrum—

scenarios that vary across terrain and, in one case, across mission. Table 2.1 summarizes the attributes of the scenarios and their key parameters.

In essence, the first and second scenarios are the same except for the terrain. In the Southwest Asia (SWA) scenario, the terrain is open with long lines of sight (LOS), whereas in the East Europe scenario, the terrain is much closer. Such variation enables us to explore the impact of terrain on force performance, particularly more stressing (i.e., more limited LOS) conditions and their influence on technology. Whereas in the first and second scenarios a full light infantry brigade (DRB) faces a heavy threat in a prepared defense, in the LANTCOM scenario a partially attrited DRB in the second phase of a forced-entry operation faces a slightly less heavy threat from a hasty defense. Next, we look at each scenario in more detail.

SWA scenario. Figure 2.1 shows the SWA scenario graphically, revealing that it takes place in Saudi Arabia. The mission of the Blue light force is to defend a critical junction along the major pipeline road (shown on the figure). A Red division (consisting of two armor regiments and one mechanized infantry regiment) is attacking, its objective to destroy the Blue force and control the road network. The immediate Red objective is to defeat the Blue force, since the road junction has critical strategic value both for access to oil fields and for logistics and resupply in supporting a continued ground offensive. Blue is positioned on high ground, but this is typically only 20–40 meters above the Red force.

Table 2.1—Three Basic Scenarios and Key Distinguishing Parameters

Scenario	Terrain	Threat	Mission
SWA (Saudi Arabia)	Open and flat, with moderate trafficability; line of sight = 3–5 kms	Red heavy division consisting of two armor regiments attacking along two primary avenues of approach	Blue light infantry conducting prepared defense
East Europe	Close and rough, with limited trafficability; line of sight = 1–3 km	Red heavy division consisting of two armor regiments attacking along two primary avenues of approach	Blue light infantry conducting prepared defense
LANTCOM (Latin America–Atlantic Command)	Close and rolling hills (partially covered), with limited trafficability; line of sight = 1–5 km	Red heavy division (–) consisting of two brigades and a battalion attacking along three primary avenues of approach	Partially attrited Blue light infantry conducting hasty defense following a forced entry

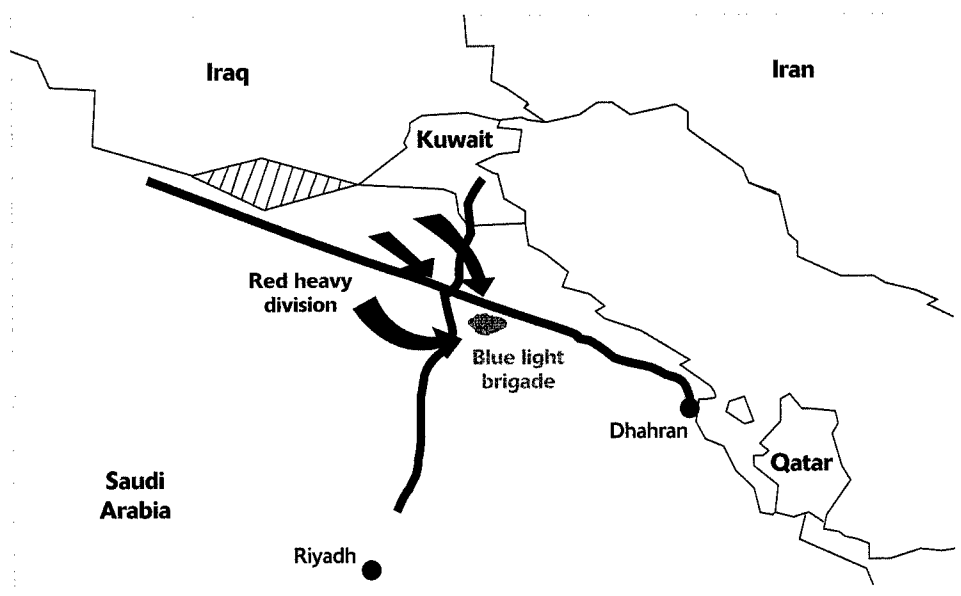

Figure 2.1—SWA Scenario: An Overview

Blue sets up in a large-perimeter (270-degree) hasty defense with a battalion to the north, a battalion to the south, and a company strongpoint in the center (as shown in the JANUS screen image in Figure 2.2). Most of the Blue combat elements, including personnel, are designated as in “defilade” in JANUS and therefore tend to be much less vulnerable to both indirect artillery fire and direct-fire weapons than if they were in the open. Red attempts to envelop the Blue force with two armor regiments to the north and a mechanized infantry regiment to the south. In both the north and south attacks, Red initially uses the existing road networks as much as possible. As the Red force closes with the Blue force, it separates into company-sized columns and then into attack formation. Because the terrain is only moderately trafficable, the travel speed of the Red vehicles is reduced automatically in JANUS as the vehicles move off-road for the attack.

The East Europe scenario. Figure 2.3 shows the East Europe scenario. The basis for this conflict originates from a border dispute, motivated by the goal of ethnic reconsolidation. UN or NATO action involves quick emplacement of allied forces to dissuade an attack. Nonetheless, the attack proceeds without delay and unexpectedly escalates into general warfare involving the U.S. light airborne forces. The figure represents only the U.S. portion of the much larger, allied force defense. (In the graphic, lines represent roads, and cross-hatched areas represent urban centers.)

As in the SWA scenario, Blue once again is in a hasty defensive posture, with Red attacking along multiple axes, and is organized in a large-perimeter defense, optimizing its position in the inherently limited LOS environment (Figure 2.4). In addition to terrain contours that can block LOS, foliage, which is much more prolific in this envi-

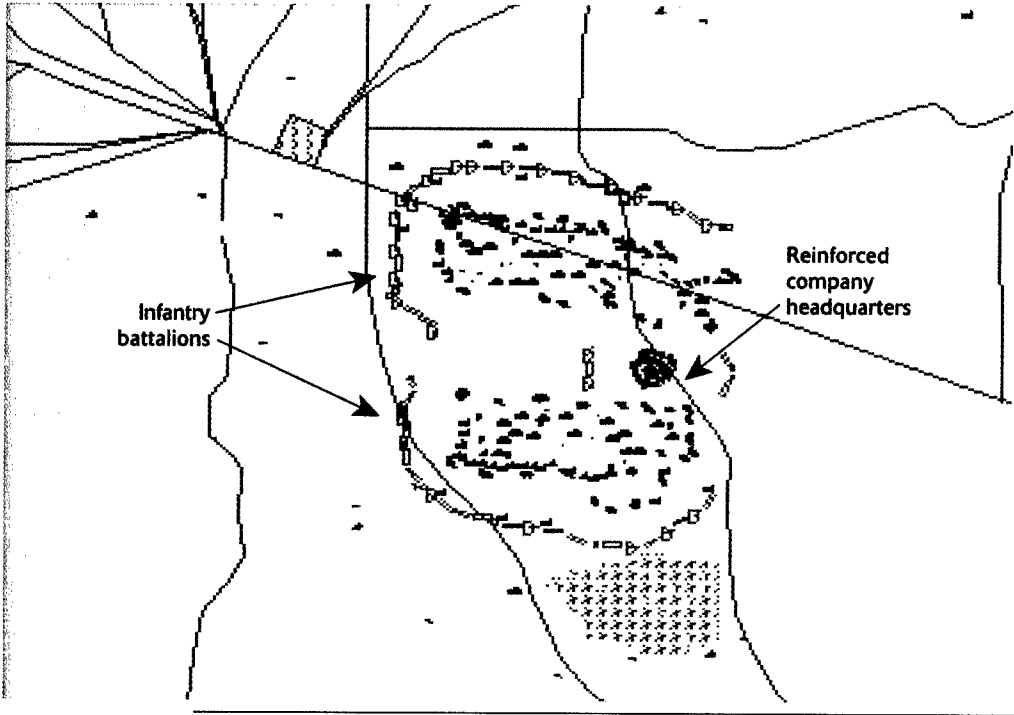

Figure 2.2—Depiction of DRB Hasty Defensive Position in SWA Scenario

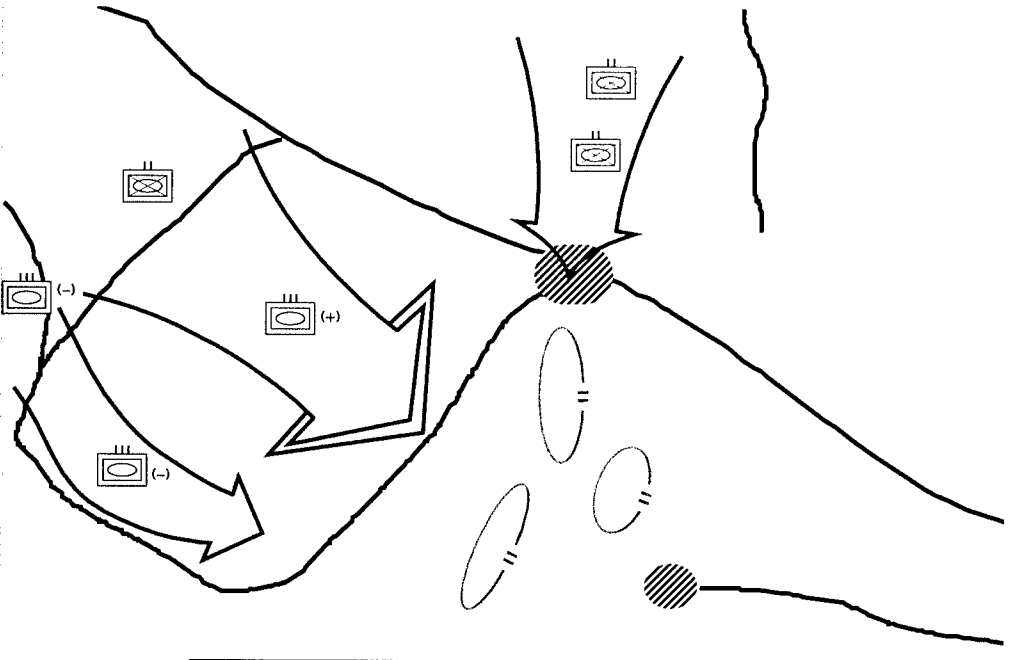

Figure 2.3—East Europe Scenario: An Overview

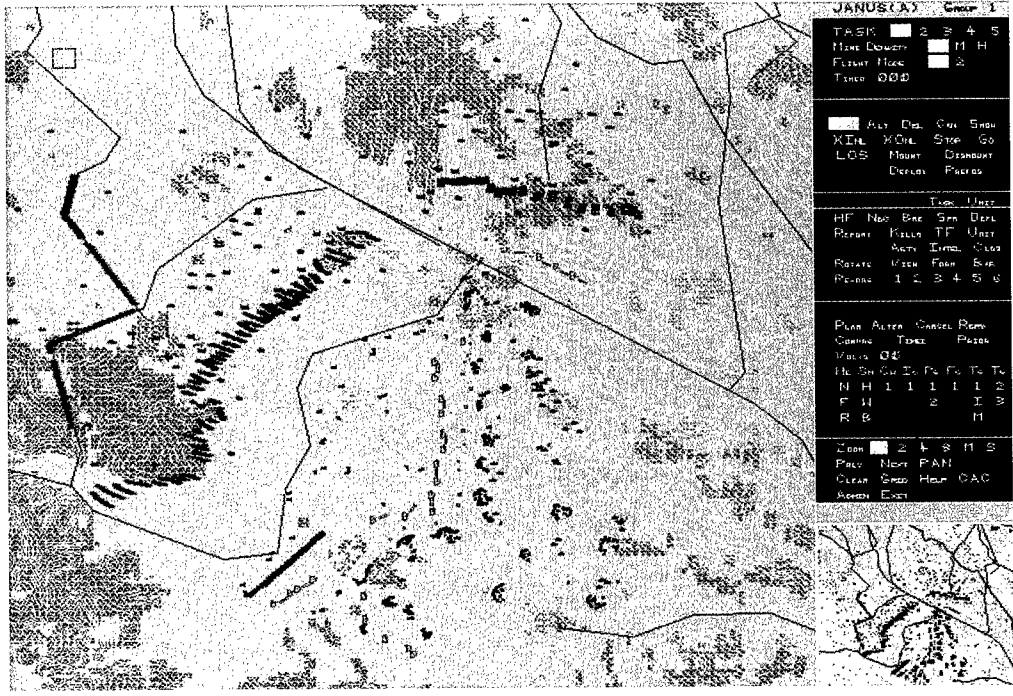

Figure 2.4—JANUS Depiction of DRB Hasty Defensive Position in East Europe Scenario

ronment, provides additional LOS reductions. The armor attack is from the west and the mechanized infantry attack is from the north. The key difference between this scenario and the previous one is the terrain. This environment contains much shorter LOSs and even more limited trafficability, with the typical LOS about 2–3 kilometers in the areas Red chooses to attack.

The LANTCOM scenario. In the LANTCOM scenario, the Blue force objective is to hold a key strategic point, in this case an airstrip for bringing in follow-on forces. Thus, Blue forces need to hold this terrain until heavy reinforcements (which are already en route) can arrive. Figure 2.5 shows the Red and Blue positions at the beginning of the simulation. The Red objective is to destroy the Blue force before reinforcements can arrive. Preparatory fires from Red self-propelled artillery—firing improved conventional munitions (ICMs) and high-explosive (HE) rounds—support the deliberate Red armor attack.

The LANTCOM scenario represents the second phase of a forced-entry operation. The first phase of the scenario involved an engagement with local militia forces, which resulted in some losses to the Blue force. Because the Red main effort does not occur until after this initial engagement, the partially attrited DRB is presumed to have had some time to regroup and establish a hasty defense. In our version of the scenario, we

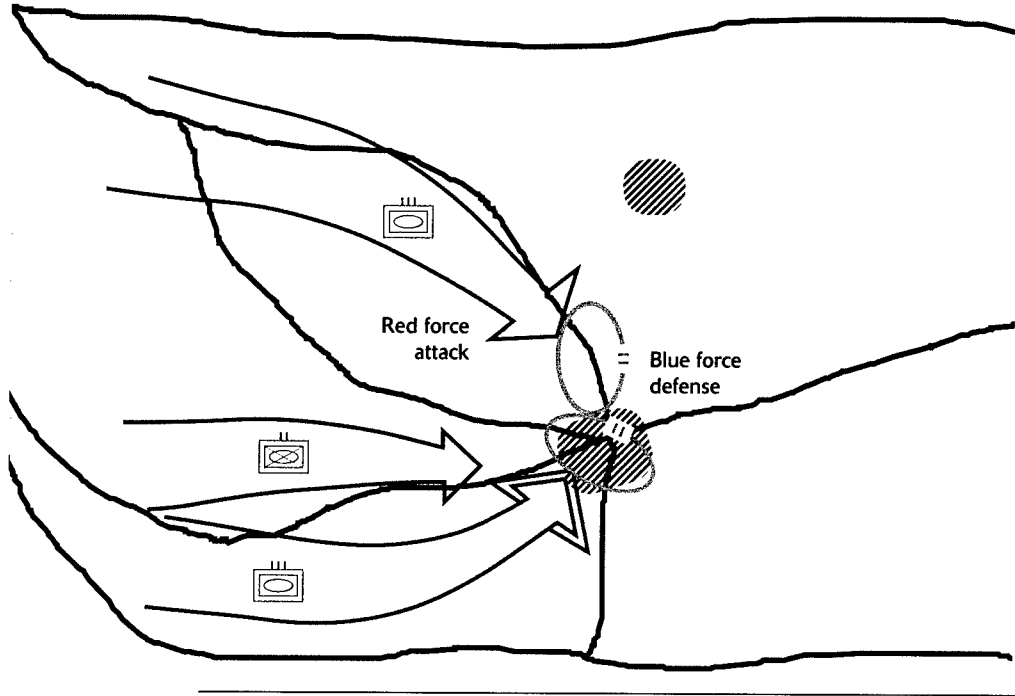

Figure 2.5—LANTCOM Scenario: An Overview

assumed that tactical air (Air Force and/or Navy fixed-wing) was able to conduct interdiction missions as the Red main effort approached the DRB. No close support during the engagement was assumed. Joint Surveillance and Target Attack Radar System (JSTARS) provides initial situation awareness to the Blue commander but does not contribute to the targeting of his indirect-fire weapons. Logistics support elements are not included in the JANUS simulation (although they were included in the airlift analysis).

The LANTCOM scenario is a high-stress variation of a scenario developed by the Army.² Because of its rolling, partially covered terrain, variations of this scenario were used to examine the military usefulness of weapon systems. In this scenario, a partially attrited Blue DRB (following forced entry) faces a substantially larger Red force, a division (-)³ consisting of two brigades and a battalion attacking along three primary avenues of approach, as shown in Figure 2.6.

The attrited DRB (assumed to be at roughly 66 percent strength) is assumed to have enough time to set up a defensive position, complete with extensive ground-based RSTA, before the Red attack. The main body of the Blue force (two battalions) is positioned around a town. Forward of this (to the west) are RSTA systems spread over the likely Red areas of advance. The Red forces in the northeast are moving to block reinforcing Blue heavy forces marching from a seaport off the screen. The area shown is approximately 60 by 60 kilometers.

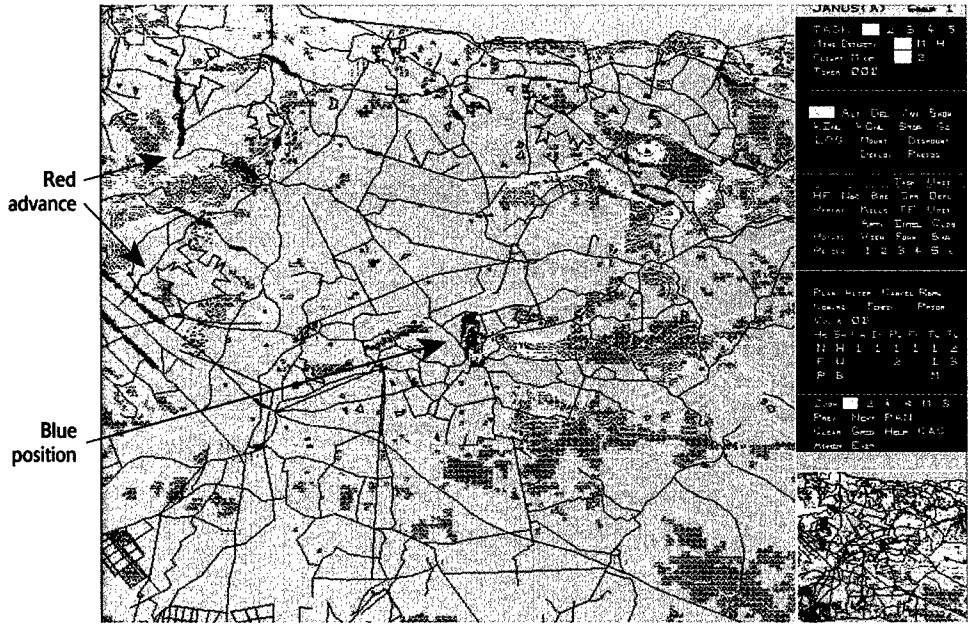

Figure 2.6—Depiction of DRB Hasty Defensive Position in LANTCOM Scenario

We make some key assumptions in the scenario. First, we assume that the DRB must be attacked by the threat force. That is, the DRB is defending a critical objective and Red cannot bypass it. The DRB is also assumed to be air-dropped near the objective, with enough time before the start of conflict to set up a defensive position.

Second, the basic rules of engagement assumed in the scenario require both Red and Blue forces to “fire upon recognition” of their respective adversaries prior to weapons launch. We envisioned that “fire on detection” would be too permissive a criterion for weapons launch, and “fire on identification” would be too restrictive for either force.⁴ In other lower-intensity conflicts, the “fire on identification” criterion may be more appropriate, and in some cases we considered it as an excursion in this work.

The Force Mix for the Three Scenarios

Table 2.2 shows the Blue and Red base case force mixes for the three scenarios. We determined the force mixes by working with personnel at Fort Benning’s Dismounted Battlespace Battle Lab (DBBL), which yielded information about the composition of 82nd DRB, the basis for the force mixes. In this case, the force mixes for the SWA and East Europe scenarios are identical. In these two scenarios, Red forces outnumber Blue forces (on an element-to-element basis) by a ratio of four to one. This count does not reflect the qualitative difference between the combat elements of the light airborne force and the enemy heavy force. For example, although a Dragon missile and a T-72 tank count as one element each, they are qualitatively different pieces of equipment.

Table 2.2—Base Case Force Mix for the Three Scenarios

Scenarios	Blue Forces	Red Forces
SWA (Saudi Arabia)	15 HMMWV-Scouts 58 HMMWV-TOWs 54 Dragons 18 Stingers 6 Apaches 14 Sheridans 8 155mm howitzer 18 105mm howitzer	323 T-72S (tanks) 219 BMP-2 (APCs) 35 BTR-60 (APCs) 30 120/180 MRL (rocket artillery) 72 152 SPH (cannon artillery) 16 HAVOC/HIND (helicopters)
East Europe	Same as above	Same as above
LANTCOM	34 HMMWV-TOWs 4 AGS 24 Javelin 6 Apaches 8 155mm howitzer 18 105mm howitzer	131 T-72S 131 BMP-2 6 120/180 MRL 12 152 SPH 6 HAVOC/HIND

The Blue forces shown in Table 2.2 for the first two scenarios are comparable to what the 82nd Airborne DRB consisted of in the Desert Storm time frame (around the time that the initial analysis was performed). Generally, this DRB has one airborne brigade headquarters company, three airborne infantry battalions, one artillery battalion (105mm towed), one air defense artillery battery, one attack helicopter company, one armor company, and one artillery battery (155mm towed). Several points should be highlighted about the DRB's equipment. First, when the analysis was performed the 82nd Airborne was still armed with Dragon anti-tank missiles. Today, the Army has replaced the Dragon with the much more effective Javelin system. Additionally, we included corps-level Apache attack helicopters rather than the Kiowa Warrior, modified OH-58s that the 82nd was armed with at the time we were conducting this simulation. As of the time of this writing, the 82nd is still equipped with the Kiowa Warrior. All told, the DRB includes 4,297 tons of equipment and contains 3,450 soldiers.

The Red forces possess some sophisticated weapons, including T-72S tanks with AT-11 (fire-on-move) missiles, BMP-2 and BTR-60 armored personnel carriers (APCs) with BMPs armed with AT/P-6 missiles, self-propelled 120mm and 180mm multiple rocket launchers (MRLs), and 152mm self-propelled howitzer cannons (2S3), and mobile air defense units (2S6) with radar track linked to both guns and missiles. The enemy does not have sophisticated overhead RSTA and must rely on command vehicle forward-looking infrared (FLIRs) and visual recognition for the direct-fire engagement.

The force mix for the LANTCOM scenario is similar to the one used for the first two scenarios, except that both sides are attrited to reflect the scenario described above. Four armored gun system (AGS) platforms were included in the analysis, since they were envisioned to be a key direct-fire system in the force. Although acquisition decisions have since eliminated this particular program, they are included here as a surrogate for a notional future direct-fire capability.

The SWA scenario is intended to represent the Operation Desert Storm scenario from the Gulf War. Here, we use it to replay Desert Storm—referred to here as Desert Storm II—sometime shortly after the first incursion in 1990 but well before current day. In this base case, the Iraqi active protection system (APS) Shtora present in 1990 was assumed to be upgraded to include direct anti-chemical energy capability. Also, the ZSU-23/4 systems were upgraded to 2S6 systems, which have been on the arms market for some time. Below, we show how the scenario plays out from the perspective of a lieutenant in command of one of the infantry platoons in the DRB.

Experiencing Desert Storm—As It Might Have Been

IT WASN'T UNTIL THE FIRST ROUND ACTUALLY EXPLODED no more than 100 meters from his position that the lieutenant realized that the attack was for real. After the blinding flash from the explosion followed by the thundering boom, there was a numbing moment of reverberating silence. His only real protection was the shallow bunker he and his radio operator had been able to dig less than 24 hours before. He could see no movement around him in the darkness, but he knew enough to know not to move out of position. For it was this shallow cavity that had saved him from the white-hot metal fragments that splintered everywhere just moments ago. With his heart racing, the lieutenant felt that this was by far the most surreal moment of his life. Although they had practiced this kind of mission many times at the NTC (National Training Center at Fort Irwin), now the attack was happening for real. Their objective was to protect a critical road junction that led to both the oil fields to the southeast and the Saudi capital to the southwest. Failure in this mission would mean a much more difficult and drawn-out campaign for the allied force in the future.

That first explosion was only a calibration round. It was followed by a deafening barrage, which landed even further behind him. He knew that the Iraqi forces were trying to destroy his unit's C2 network, but he also knew that they were guessing as to its exact location. His brigade, the 1st Brigade, was the designated DRB of the 82nd Airborne Division. The brigade had reached its defensive positions less than 48 hours earlier. Its soldiers had had enough time to spread out into a hasty defensive position on the desert's local high ground and find the best cover and concealment

areas. They fully anticipated a massive artillery prep and took necessary precautions. Nonetheless, as the barrages continued, the lieutenant wondered what losses, if any, had yet occurred.

Because the force airdropped into the area, was foot-mobile, and needed to maintain contact, personnel were only able to disperse over a small area a few kilometers on a side. They were able to dig protective foxholes and use the low-lying brushy foliage for camouflage.

As soon as the enemy artillery fire paused, he heard confirmation coming through his single channel ground and air radio system (SINCGARS) from his company commander that the Iraqi armor was, in fact, on the move. They were 30 kilometers out, northwest. Intelligence was indicating a regiment-sized unit heading east to maneuver for an attack from the north. His infantry battalion was protecting the northwestern front, and his company commander said that

based on the latest information, their company would not see the first of the fighting. Two other Iraqi regiments were reported to be moving in the same area, the first following the lead regiment and the second heading south; neither was fully committed at this point.

The latest round of intelligence reports estimated that contact with the first enemy regiment would occur within two hours on the northern front. Although the artillery bombardment continued, not surprisingly, the effort was now clearly being focused on the northern front to “soften it” for the subsequent maneuver attack.

It wasn't until half an hour after the lieutenant's position started receiving fire that a report came through, passed down from the tactical net (TACNET), that friendly air strikes were inbound. He guessed these were the F-16s coming out of Doha. Although he knew he would not be able to see them, he listened through the bombardment for their presence. Unable to hear or feel the familiar sound of the massive gas turbines mounted on the aircraft (a sound he had learned to appreciate during the exercises at the NTC), he was able to clearly distinguish the “popping” of friendly rounds to his rear. He determined that the enemy must be in range of the 155mm towed howitzers, maybe even the 105mm, about 15 kilometers away. He thought of the DIVARTY Q-36 counter-fire radars he had seen at NTC. Surely these were now directing American fires at the enemy guns. It wouldn't be long now before the enemy arrived.

He envisioned masses of T-72s, the enhanced versions, some equipped with APS, rapidly approaching in attack formation to dislodge his dug-in unit. He knew his unit's job was to stop the attacking armor—as many of them as they could, anyway. His platoon's primary anti-armor weapon was the Dragon anti-tank missile. Although his men had substantial training with the Dragon, he knew its range of less than 1,000 meters would put his gunners well within the range of most enemy direct-fire systems, and casualties were very likely. Nervously, the lieutenant took a quick trip around the platoon's positions, checking on camouflage and reassuring his men.

The report came through from the TACNET. Although transmitted and passed down to him in pieces, the report indicated that the air strike was over. Leaving his platoon sergeant temporarily in charge, he scampered off to company HQ to see what information was available. Once there, it was apparent that the fire support team chief was getting some information by listening in on the DIVARTY Command Fire net. From what information was passed, he was able to determine that a portion of the enemy vehicles were successfully engaged while on the road. The JSTARS provided a good cue for the mixed strike package of F-15Es and F-16Cs, both armed with unguided bombs and Maverick missiles.

Although a large number of aircraft were compressed into enemy airspace, amounting to about two squadrons' worth of strike aircraft (some 48 fighters) dedicated to interdicting the enemy advance, only about 30 vehicles were notably damaged on this attack. Part of the reason for this much lower than expected effectiveness was the enemy's highly automated, preplanned maneuver reaction once the air attack commenced. The enemy formation quickly and methodically dispersed into what was essentially a variation of their attack formation, effectively reducing their density to the massed smart munition attack from above. As a result, most of the smart munitions detonated harmlessly into the soil below, with most of them never even having a chance to engage the enemy armor.

The effectiveness of the 155mm and 105mm tube artillery similarly was lower than expected. Munitions that were fired against the attacking armor consisted of high-explosive (HE) and dual-purpose, improved conventional munition (DPICM) rounds. The ability to kill moving armor with HE and DPICM was truly tested here. The 155mm towed howitzers fired hundreds of rounds during the enemy's attack. Even though updates on enemy movement were being sent by the forward-emplaced scouts, who served as the forward air controllers, only two kills of enemy vehicles were registered. The battlefield damage assessment (BDA) was being confirmed by overhead intelligence assets.

While both air and artillery strikes against the enemy armor clearly should have had a demoralizing effect on the enemy, the latest intelligence reports indicated that the attack was still continuing and moving at a very fast rate. More information indicated that the two-regiment enemy attack from the north was breaking into two distinct attacks, one heading to the north of the DRB and one heading to the northwest. The third enemy regiment was conducting a more extensive maneuver operation, which appeared to be a flank attack to the south of the DRB. All three regiments appeared to be fully committed at this point. Essentially, the enemy had maneuvered to cover nearly 180 degrees around the DRB. The lieutenant's company commander told him that he had better get back to his platoon position. It would not be long now.

The last hope to preclude a direct-fire engagement with the dug-in light forces were the Apache AH-64s from XVIII Airborne Corps that had landed with the ground force. This system was the most taxing of the force to make functional. They were painstakingly reassembled and then carefully readied for attack—each Apache was armed with 16 Hellfire missiles, which were cued by the advanced Longbow millimeter wave (MMW) radar and fire control system. As the enemy closed for attack, the plan was to use the Apaches to provide a circle of protection for the ground forces. Although few in number, these systems had proved in many previous analyses and exercises to be highly lethal against moving armor.

Had it not been for one enemy system, the Apaches might have succeeded in their defense. As it turned out, just a few years earlier the enemy had acquired and trained quite extensively with the state-of-the-art Russian Tunguska 2S6 tactical anti-aircraft system. Not only did this system have two 30mm 2A38 twin-barreled, liquid-cooled guns electronically steered by a radar, it was also equipped with eight laser-guided surface-to-air SA-19 missiles. While the guns could only reach out to 4 kilometers, the supersonic missiles could reach out to 8 kilometers. It was these missiles that were the Apaches' nemesis.

Now back in his foxhole, the lieutenant could see two Apaches move into position to establish their "ring of defense" to protect the men on the ground and the objective behind. He sought and found some comfort in the firepower contained in these systems, which seemed so close. They reminded him of tanks rather than aircraft, especially when they were moving slowly and hovered only a few feet above the ground. Looking around, he could see some of his men peering out from their fighting positions. Clearly, they were excited to see the powerful Apaches. Flying low, it appeared that the Apaches would be almost impossible to see, even by the 2S6 Tunguskas. However, to allow the Longbow radar a chance to "see" the battlefield, the Apaches had to increase their altitude if only

for a moment. As he thought through the range of attack options, in one swift motion he saw the first Apache rise to take its look, getting its cue from the scouts in front. The Apache had risen no more than 30 feet when something happened that he had never seen before. There was a bright streak, a small white explosion, and then a larger yellow-orange one. The helicopter began to cant harshly and awkwardly. It had been hit, and it was on its way back down to the ground. Although he was expecting to hear another explosion, as the Apache fell below his line of sight there was hardly an audible sound of the impact over the other battlefield fire. Perhaps the pilots made it out okay.

While this was occurring, the second Apache was able to complete its look. When it was back in a relatively low, safe position, he saw it launch one, two, and then three Hellfires. He could not hear the subsequent explosions afar or see whether they had found their targets. Already the Apache was moving to a new location to repeat its attack. Of the six Apaches dedicated to the fight, two were lost. The remaining four returned to the forward area arming and refueling point (FAARP) to get a new supply of Hellfires. Getting out of his foxhole, the lieutenant crawled to a small nearby knoll to get a better look. Out in front of the company's position, he could see burning vehicles. All told, the Apaches collectively killed fifteen enemy vehicles—a help but nowhere near enough to stop the attack.

Unlike previous transmissions, this time his SINCGARS roared, seemingly with a life of its own. The messages were loud, frantic, and garbled. The direct-fire battle on the ground had now begun. Although the DRB was occupying a considerable amount of terrain, with the contrast between the darkness of the night and the brightness of the weapons, the battle to his right flank seemed very close. The first direct-fire weapons to be fired were the relatively long-range TOW missiles, which were mounted on high-mobility, multipurpose wheeled vehicle (HMMWV) platforms. He could barely see the outline of the enemy to the north through his FLIR. A quick sweep over the horizon showed no targets in his platoon's area of responsibility.

One thing he had to remind himself of was that he would likely see the enemy well before he could engage them. With the use of a night sight, his gunners would detect enemy targets out to about three kilometers, but the range of the Dragon missile was less than one kilometer. He would have to wait patiently before engaging the approaching enemy.

Although he had tried to mentally prepare for the armor attack over the past two hours, when it came it looked nothing like what he had envisioned. For some reason, he was expecting 10 or 12 targets, maybe a few more that would encroach within a larger wave. As the enemy tanks emerged over the horizon, they were massed in one local area, not nearly as spread out as he had thought. Headed directly toward him were about 50 tanks. His heart sank. Although he knew that there were sixteen HMMWV-TOWs just to his rear, he also knew they were hopelessly outgunned. He also realized that his infantry company had about six Dragon teams protecting that same western front—and they would have to take whatever the HMMWV-TOWs could not.

The TOWs were fired as soon as the enemy entered into range. Through his FLIR, he could see some of what looked like T-72s being hit by the missiles. There were certainly other vehicles, maybe BMPs that were also among the disabled. Oddly enough, he could also make out the hemispheric explosions centered around some of the tanks; these were the telltale signs of the tanks' APS. In the

distance and to his flank, several tanks appeared to be burning or smoking. Yet most of the attack was still coming.

He could see flashes emanating from the enemy tanks' muzzles indicating that they were firing back, but at this point the enemy was still too far away to pose a threat to them. The artillery was different. Within two or three minutes of the TOWs opening fire, the enemy artillery started bombarding the area to his rear from where the TOWs were firing. He hoped that there would be another F-16 air strike, but he knew there was no way the aircraft could be turned around fast enough. Similarly, a second wave of Apaches was not available to help with this fight. No, this battle was now theirs and theirs alone. He anxiously monitored the massive formation of approaching T-72s. As they quickly moved into range, he silently said a prayer and radioed to his Dragon teams to get ready to open fire. The knowledge that the Dragons could not start shooting until they were themselves well within the range of the enemy tanks' onboard machine guns was now his main concern.

After-Action Reports of the Three Scenarios

Clearly, the outcome of the battle in Desert Storm II, played out in the SWA scenario, is not a good one for Blue forces. The real question is, "what happened during the battle?" And, of course, we are also interested in the analogous results for the more stressing scenarios of East Europe and LANTCOM. Here, we take a look at the three base cases for the scenarios in the form of after-action reports—analyses of the outputs of the simulation model runs for the three cases in terms of some key outcome measures.

When we look at the simulation results of battles to determine how well the DRB performed against its adversary (here and elsewhere in the book), we focus on one outcome measure among others: the loss-exchange ratio (LER). The LER captures the ratio of Red losses to Blue losses, and the numbers shown in the results signify the mean of at least 30 JANUS-based runs.⁵ It is important to remember that in all scenarios, Red forces significantly outnumber Blue forces (even in the attrited case of LANTCOM); thus, low ratios (even though positive for Blue forces) still result in poor overall battle outcomes. LERs are used because they constitute one objective measure of force performance. In actuality, the LERs vary considerably across the span of a simulated battle (where possible the LER is shown as a function of time); thus, the "final" LER reported is often only a representative and relative measure of force performance. Beyond LERs, we also examine other outcome measures, including target kills per system for the Blue forces and Blue force survival by system at the end of the battle.

Across all three scenarios we found a number of similarities. Because the DRB was intentionally deployed into a situation where it was greatly outnumbered, it was no surprise that in all three scenarios, *the current or base case DRB could not sustain a defense against the larger attacking armor force*. Interestingly enough, although the DRB does not have the firepower to repel the attack of the larger force, it does achieve respectable LERs toward the end of the battle (between 3:1 and 5:1, depending on scenario). Most of this is a result of a very intense direct-fire battle. Also similar

across all three scenarios, the DRB either draws or loses the initial indirect-fire portion of the battle. Although such simulation results need to be taken in context, we believe that there is enough evidence to suggest that this part of the battle in particular represents one of the key limitations of the current DRB. The following discussion amplifies on this conclusion.

Figure 2.7a shows, for the two similar scenarios, the LER over the course of the simulated battle, which runs 75 minutes for the SWA and East Europe scenarios. (Figure 2.7b shows the LER over 55 minutes for the LANTCOM scenario.) Looking first at the SWA and East Europe scenarios, the LER over time shows how the respective battles unravel. In the first few minutes, during the indirect-fire battle, very little attrition occurs, simply because the forces are positioned out of range of each other. As the Red force begins its advance toward the DRB, the DRB begins to fire its artillery. Although the attacking Red combat vehicles are relatively lucrative targets at this initial phase (when they are moving in columns), the limited lethality of the dual-purpose improved conventional munition (DPICM) rounds and the inability of HE rounds to hit moving targets produced very low lethality. Likewise, because the DRB is in defilade, the Red artillery preparatory fires also yielded relatively low lethality. LERs were between 1:1 and 2:1 for the DRB across both scenarios at this stage of the battle, being slightly higher in East Europe because the Red armor, with its slower-moving vehicles in the tougher terrain, is more susceptible to artillery fire.

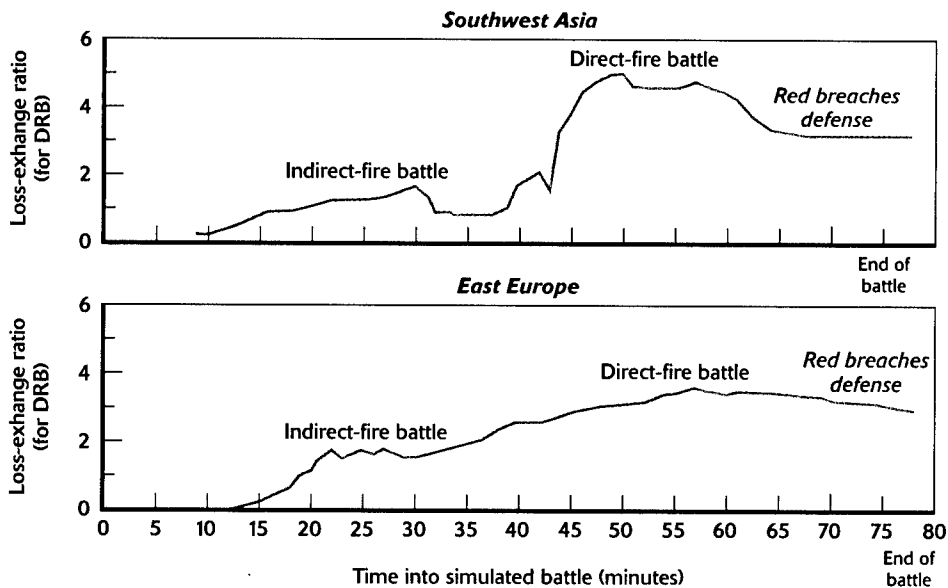

Figure 2.7a—LERs Over Time for SWA and East Europe Scenarios:
Base Case DRB (Fixed-Wing Aircraft Kills and Losses not Included)

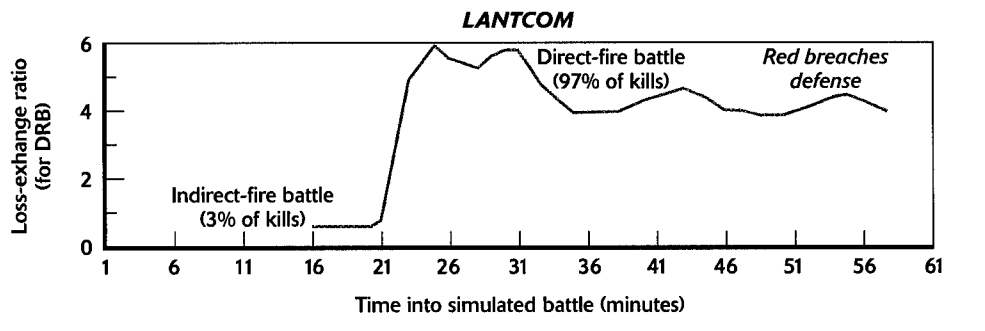

Figure 2.7b—LER Over Time for the LANTCOM Scenario:
Base Case DRB (Fixed-Wing Aircraft Kills and Losses not Included)

Attrition on both sides begins to occur at a more rapid rate during the direct-fire, close battle. The front line of the direct-fire battle for the DRB is the Apache/Hellfire attack. Even though the Apaches are assumed to stand off (because of Red's highly capable enemy air defense), they typically can see farther and attack first because of their ability to improve their LOS with altitude. This was the case in SWA; however, the terrain in East Europe precluded a successful Apache standoff attack. As the direct-fire battle progressed, other direct-fire assets—HMMWV-TOWs, Sheridans, and Dragons—participated. Although the DRB systems tend to have a range advantage over the enemy systems, the massive attack by Red quickly became the deciding factor. The LER in both cases—which rose as high as 5:1 in SWA and 3:1 in East Europe—dropped as the DRB defense was breached at the end of the simulated battle. As was mentioned earlier, it should be noted that the Army has replaced its Dragon systems with Javelins. However, since the cancellation of the AGS, there is no immediate replacement for the Sheridans that were included in this base case scenario.

Turning to the LANTCOM scenario shown in Figure 2.7b, we see a similar story. The base case Blue DRB shows a very low LER for the indirect-fire battle in the first 20 minutes. In effect, it is losing the indirect-fire battle against the overmatching Red long-range artillery. The Blue LER increases as the engagement moves into the direct-fire phase, but Blue is still penetrated and overrun. The final LER—as shown in the figure—is 4:1.

We now turn to how individual systems performed during the simulated battle. Figure 2.8a shows simulation results at the end of battle (after the breach of the DRB defense) in terms of kills for the individual systems for SWA and East Europe; Figure 2.8b shows the detailed results for LANTCOM. Again, we start with the similar SWA and East Europe scenarios.

In the SWA scenario, 247 Red systems were destroyed by the Blue force, while in East Europe 279 systems were destroyed—mostly by the HMMWV-TOWs, as shown in the pie charts. Looking at the bar charts to the right, however, we see that relatively few systems of the original Blue force remain. The numbers above the bars show the

Southwest Asia**East Europe**

Figure 2.8a—Simulation Results at the End of the Battle for SWA and East Europe Scenarios: Base Case DRB

total number of systems at the start of the conflict; the colored bars reflect the percentage of the force remaining. Thus, in the case of the HMMWV-TOWs in the SWA scenario, there were originally 58 at the start of the battle, with only about 25 percent or 15 remaining at the end of the battle. With the exception of the Apaches, which fly only a single mission in the 78 minutes of simulated SWA battle (and which do not play at all in the East Europe battle), the Blue force suffers very high attrition.

In the SWA scenario, the Red force penetrated the DRB defense in the north by committing one armor regiment to lead the attack, with the second armor regiment following closely in reserve. At the time of breach, the second regiment was almost completely intact. In the East Europe scenario, the Red force was able to turn the southern flank, penetrate the Blue force, and destroy it.

What is the primary reason the Blue force does not survive the Red attack? We can directly attribute the outcome to the “close-in” location of the engagements. More specifically, Blue’s two primary killers, the HMMWV-TOWs and the Sheridans, engage at points on the battlefield where they are exposed (within the LOS of the missiles and main guns of enemy systems). Even though the DRB has some sensor and weapons range advantages over the assumed capabilities of the attacking force, it is only a mat-

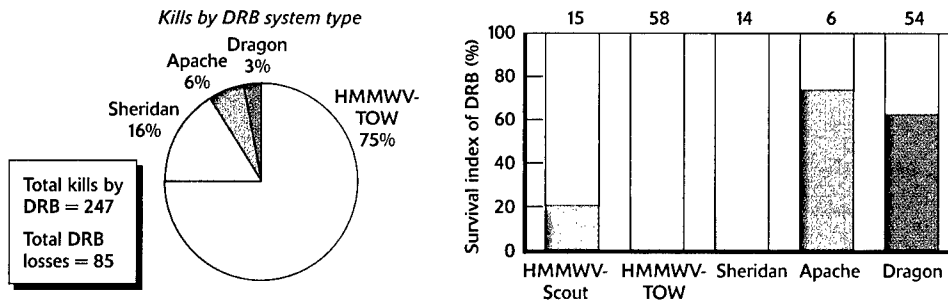
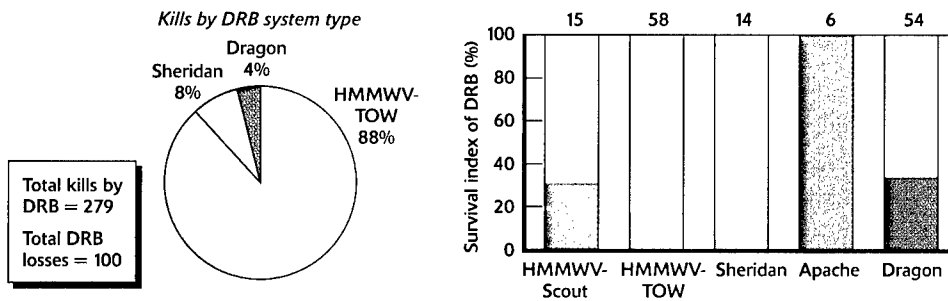
LANTCOM

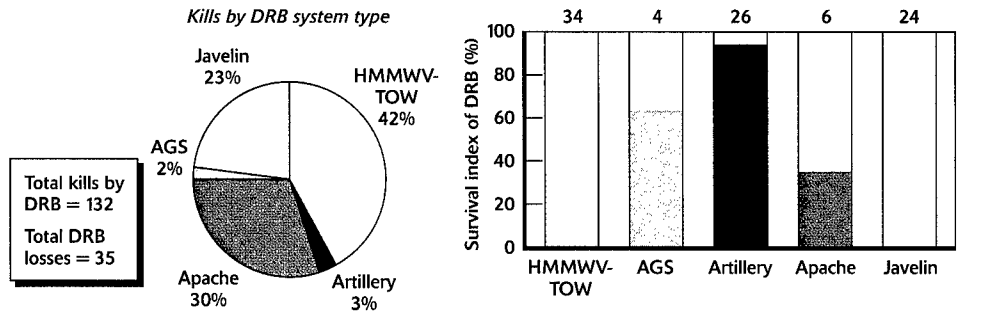

Figure 2.8b—Simulation Results at the End of the Battle for the LANTCOM Scenario: Base Case DRB

ter of time before Blue is overwhelmed by Red’s larger force. Many of the engagements occur relatively late in the simulated battle at relatively close range (well within 4 kilometers), even in the relatively open terrain of the SWA scenario.

When we look at the LANTCOM scenario target kills per system in Figure 2.8b, we see that about 132 Red systems are destroyed by the Blue force. As was true in the SWA and East Europe scenario, most of these kills come from the HMMWV-TOWs. And once again, the Blue force suffers very heavy attrition, losing more than half its TOWs and Apaches, as well as about half its AGS platforms.

In summary, then, when we analyze the DRB performance in the different “spaces” of the battle—indirect fire and direct fire (close battle) for the three scenarios—we see a fairly clear story. First, in examining the indirect-fire battle, we see that the current artillery systems, towed 105mm and 155mm howitzers and the associated rounds (DPICM and HE) do not provide significant attrition against the armored, mobile Red force. Next, in the close battle, we see that the direct-fire weapons of the DRB outperformed those of the attacking force. With longer-range sensors and weapons reach, the DRB was generally able to start the close fight before the attacking force could. But this advantage was short-lived. As the Red force continued its advance, the DRB range and reach advantage was reduced, resulting in a notable drop in the overall LER.

At the end of the close battle or time of breach of the DRB defense (58 minutes into the simulation),⁶ we gathered statistics to determine whether the Red force was likely to continue the attack. As it turned out, at this time in the battle, both forces suffered relatively high attrition. The Red force had roughly 70 percent of its forces intact. Likewise, the DRB had 70 and 65 percent of its forces intact, in the SWA and East Europe scenarios respectively. However, because of the much closer parity of exchange at this time in the battle, with Red having a much larger overall force remaining and Blue having very few mobile systems, the breach of the DRB defense is altogether likely, resulting in a catastrophic loss.

Chapter Summary

This chapter examined how a current DRB from the 82nd Airborne Division might fare against a capable, division-sized enemy armor heavy force. The results are not encouraging. Even with air and attack helicopter support, the current-generation light force proves to be at a significant disadvantage.

The main shortfalls across all the scenarios were as follows:

- Limited capability to locate the rapidly approaching enemy force.
- Inability to inflict enough damage on the advancing enemy armor with today's indirect-fire weapons, leading to an intense direct-fire engagement.
- Vulnerability of the current generation of direct-fire systems.
- Very limited tactical mobility.

Finally, the current U.S. force was not well protected from enemy fires of all types.

The results did vary by terrain type. Interestingly, the DRB did relatively better in the open terrain of SWA, where its TOWs could exploit their long range, whereas in the closer terrain of Eastern Europe and LANTCOM, the outcomes were worse, since the enemy could close the range into a more advantageous direct-fire battle.

Although the DRB always destroyed more enemy systems than it lost, the kill ratio—the LER explained earlier—was not sufficient to prevent the enemy from penetrating the DRB's positions, because of the enemy's numerical advantage. In the next three chapters, we explore the three different paths outlined earlier for improving rapid-reaction force capability.

CHAPTER TWO ENDNOTES

- 1 Modeling and simulation is used here as a method for analyzing force-on-force performance only. Although battlefield systems are played down to the vehicle and soldier level, they are treated as entities and are "played" out by their physical characteristics and performance limitations rather than psychological or behavioral ones. Also, the simulations are often run well beyond the likely termination of a battle, for the purposes of collecting data in an effort to answer the question "What might have happened?"
- 2 TRAC High-Resolution Scenario 33.7.
- 3 The designation "division (-)" indicates a division made up of less than the normal three brigades.
- 4 Detect, recognize, and identify are formally distinguished in the JANUS combat simulation through application of the Johnson criteria; JANUS uses the U.S. Army Night Vision electro-optical detection algorithm to determine sensor-to-target performance.
- 5 In general, the lower the ratio, the worse the outcome is for Blue forces in the battle. In other words, LERs below about 5:1 or 6:1—i.e., the loss of 5 or 6 Red systems (elements) for every 1 Blue system (element)—usually mean that Blue forces lose the battle. LERs up to around 9:1 generally signify a draw for Blue forces, while LERs above 10:1 usually constitute a Blue win—i.e., Red is defeated in place and Blue has sufficient systems to continue to fight another engagement.
- 6 Approximately one hour (more specifically, 58 minutes) is an important time in the battle, nearing the end of the close fight; this represents Red's likely decision time for its forces to continue or call off the attack.

FOLLOWING PATH 1:

Enhancing the Current Light Forces

THE PREVIOUS CHAPTER ESTABLISHED A BASE CASE to see how well a light force such as the 82nd DRB equipped with modern capabilities—sensors, weapons, and support—would fare in repelling a capable larger heavy force. What we saw in all three scenarios was that the base case force did not fare well in a rapid-reaction role against a powerful, armored opponent. Given this outcome, what possible solutions might be available in the near future to enhance the current light forces and improve this outcome?

This chapter, which examines the consequences of following the first path described in Chapter One, looks at the results of upgrading current rapid-reaction forces with a near-term concept and enabling technologies. It does so by examining the RFPI ACTD (briefly discussed in Chapter One)—one of the most significant near-term looks at improving rapid-reaction capabilities.¹ The ACTD's goal was to “put maturing technologies in the hands of soldiers” to give them an opportunity to evaluate firsthand the utility of those technologies. The RFPI ACTD was specifically focused on evaluating new advanced concepts along with enabling technologies to help improve the light force's capability during the early phase of conflict.

We shall first describe the RFPI ACTD and RAND's role in it; we then examine some of the near-term RFPI ACTD concepts and enabling technologies. Finally, we examine the results of modeling these new capabilities in the same three scenarios used for the base case, again supplying a soldier's-eye experience of the SWA scenario and then following up with the after-action reviews of all three scenarios. As part of that review, we also examine how the upgraded DRB would do against a *future* heavy threat. Finally, we include an excursion that compares the enhanced fiber-optic guided missile (EFOG-M)—one of the key upgrades examined in chapter—with other indirect-fire system alternatives.

A key assumption in our analysis here of path 1 is that the basic DRB structure is held constant. Systems are added or deleted, but the basic organization of the DRB remains the same. As systems are added, others are deleted to hold the amount of required airlift relatively constant. In addition, no major enhancements are made to the tactical mobility of the DRB, again to remain within a fixed strategic lift allocation. Chapters Four and Five will examine other, more radical, alternatives to the current DRB when we assess the impact of following the other two paths.

What Is the RFPI ACTD?

The RFPI ACTD can be understood as a multifaceted experiment that employed the model-test-model paradigm, shown in Figure 3.1, in which near-term technologies

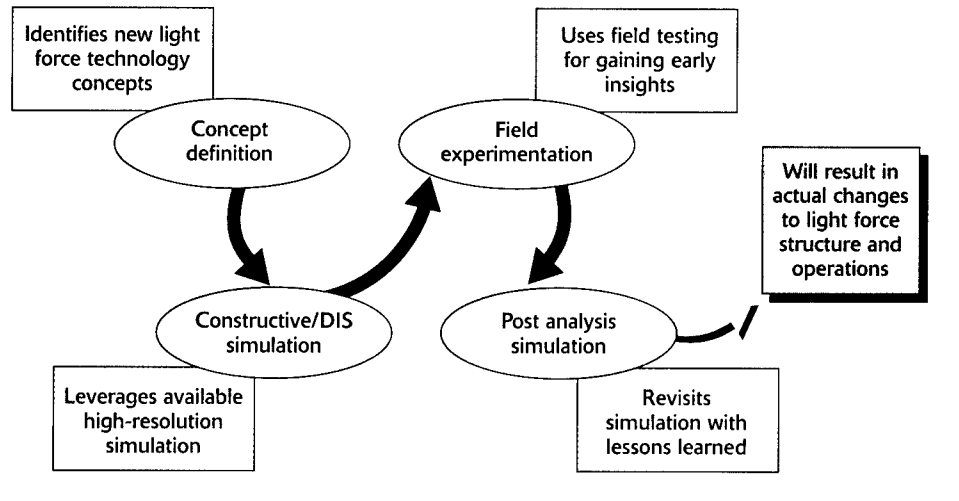

Figure 3.1—The Model-Test-Model Paradigm

applicable to light forces were identified, modeled, tested, refined, and, in some cases, actually introduced into the force. The effort began in 1992 and was managed by what was then known as the U.S. Army Missile Command (MICOM), located at Redstone Arsenal and overseen by what was then known as the Office of the Secretary of the Army for Research, Development, and Acquisition (SARDA). The first set of experiments were conducted and reported on in 1998.

The process starts with concept definition, in which new light force concepts are identified. Once promising concepts are identified, along with the technologies that enable them, some combination of constructive simulation and/or distributed interactive simulation (DIS) is used to examine how effective these concepts and technologies are in multiple scenarios (e.g., in different situations and varied terrain). (These simulation methods are described in more detail in Appendix B.) With relatively little investment, various concepts can be examined to see if they are worthy of pursuing in more expensive and time-consuming field or virtual experimentation. In this sense, the modeling activity is not by any means a stand-alone system designed to provide an answer for policymakers. Rather, it is a tool to “guide” policymakers and researchers and give them feedback on which avenues are the more promising ones to pursue. “Lessons learned” from the experimentation process are, in turn, analyzed in simulation, where more cases are run and then other variations explored. In principle, promising concepts that move successfully through the model-test-model paradigm would be implemented in the field, leading to actual changes to light force structure and operations.

RAND, as part of its Rapid Force Projection Technologies (RFPT) project, was a member of the simulation team led by MICOM. RAND’s primary charter was to explore new technology concepts that could potentially improve U.S. light and airborne forces; as such, it had responsibilities in each stage of the model-test-model paradigm. For example, RAND was instrumental in the concept development of many of the new

systems, in particular the hunter–standoff killer concept. RAND also participated in other parts of the ACTD, including observing field experiments of various advanced technology demonstrators (ATDs), interacting with various users for exploration of tactics, techniques, and procedures (TTPs), and performing much of the postanalysis constructive simulation. RAND’s main contribution to the RFPI, however, was its responsibility for the JANUS-based constructive simulation and analysis environment discussed previously in Chapter One and in more detail in Appendix B.

RAND has a long history of exploring, analyzing, and modeling the types of systems envisioned for RFPI. In fact, RAND’s early conceptual work on such light force options as “Bird Dog” and “Shotgun” (a hunter–standoff killer design)—which is shown in Figure 3.2—distributed sensor networks, low-observable scout systems, sensor-to-shooter C2 concepts, reduced crew platforms, and battlefield robotics helped in formulating the initial definition of the RFPI program. The results of these efforts are summarized in Steeb et al. (1995).

Other RAND projects at the time, such as Armor/Anti-Armor, Future Conventional Forces, Advanced Concepts for Light Forces, the Deep Fires Study, and Military Applications of Robotic Systems, were leveraged for contribution to RFPI.

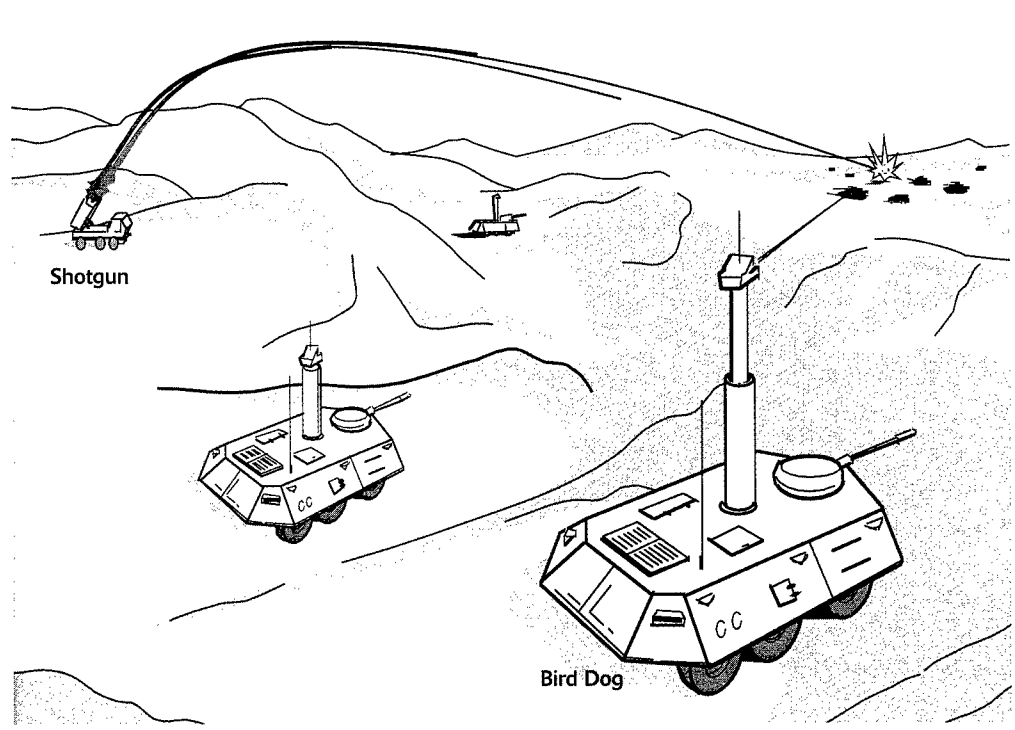

Figure 3.2—Depiction of an Early Hunter–Standoff Killer Concept

The Focus of RFPT: Exploring New Concepts Made Viable by Emerging Technologies

As mentioned above, RAND's efforts for the RFPI were under the auspices of the RFPT project, whose key goal was to explore new concepts made possible by emerging technologies. Ultimately, there are many different concepts for improving light force capability. RFPT research has, so far, explored two different concepts to improve light forces: improved direct fire and improved indirect fire through hunter–standoff killers.

An important avenue for enhancing light force capability is to improve its *direct-fire* weaponry. In this area, new technologies are already playing a role. For example, sensor technologies can be used to increase the range of detection and acquisition, new information-processing technologies and automatic target-recognition methods can be used to reduce fire cycle times, and weapons technologies can be used to increase range, accuracy, lethality, and rates of fire.

Another means for improving a light force is to improve its *indirect-fire* capability, such as through the hunter–standoff killer concept mentioned above. That is, instead of emphasizing the force's ability to fight “toe-to-toe” in the direct-fire battle, this concept shifts the focus to the indirect-fire battle. The RFPI is largely made up of this hunter–standoff killer concept, which involves separating the target-engagement cycle into two distinct components: A distinct “hunter” system detects, acquires, tracks (if needed), and hands off target information to a distinct “killer.” The hunter can be placed in relatively inconspicuous spots on the battlefield (performing relatively “silent” or passive detections without producing highly visible firing signatures), while the killer can be positioned relatively far back and out of the LOS of the targets. An entire suite of technologies is emerging that can enable this concept (some of which are already envisioned for improving the direct-fire capability).

Figure 3.3 shows the exemplary components of the hunter–standoff killer concept. Hunters—manned and unmanned, air or ground, and mobile or stationary—sense the presence, position, and status of enemy systems. They communicate the intelligence and targeting data to C2 nodes, which quickly match targets to weapons based on range, availability, and effectiveness. Killers—ranging from mortars to cannons to missiles—fire different types of munitions at the targets. Battle damage assessment (BDA) may sometimes be done by the hunters and possibly the weapons themselves. Global positioning system (GPS) technology can be used extensively throughout the force for positioning and navigation.

Candidate and Potential RFPI Systems

Focusing on the hunter–standoff killer concept, the RFPI examined a wide range of manned and unmanned reconnaissance, surveillance, and target acquisition (RSTA) assets, C2 systems, direct-fire weapons, indirect-fire weapons, obstacles, multifunction weapon systems, and self-protection systems. Table 3.1 provides a list of the systems, both the candidate ones and—since the list of RFPI systems varied rapidly with research, development, testing, and analysis of new concepts—other systems that were

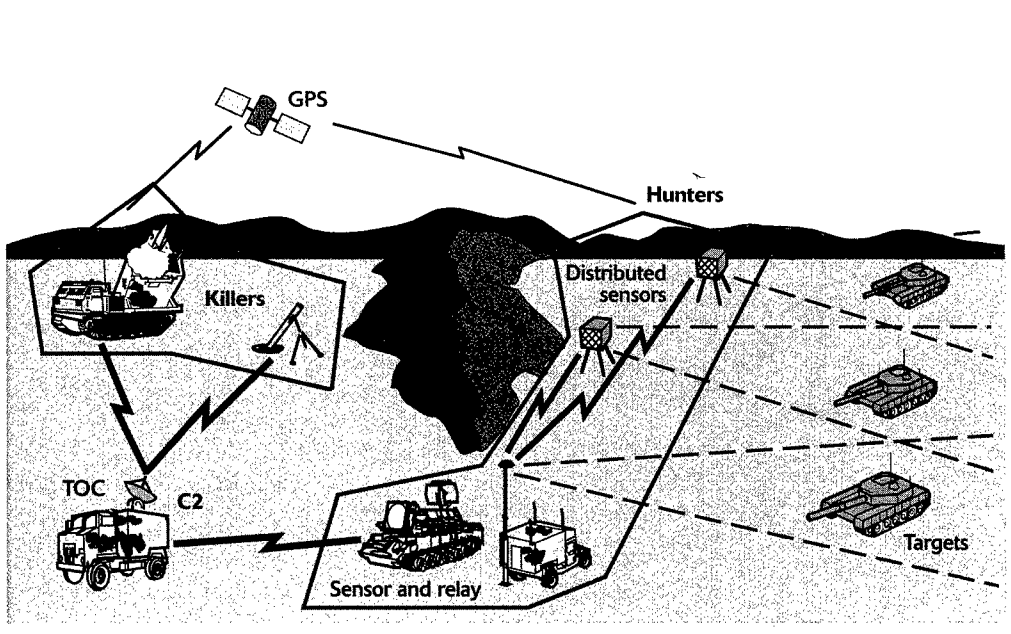

Figure 3.3—Depiction of the Hunter–Standoff Killer Concept

also of interest to RFPI, referred to as potential systems. The candidate systems were those assessed in either live or virtual experiments in the ACTD. Images of many of the key systems are included in the text below, but Appendix C provides a much more comprehensive set of images of the systems and renderings of potential ones, along with other information about the corresponding systems.

RSTA. Because the hunter–standoff killer concept relies on comprehensive and discriminating sensing, the RFPI suite of systems comprises a wide range of manned and unmanned, ground and air, and imaging and nonimaging RSTA components. Candidate systems begin with the Hunter vehicle, a HMMWV-based, target-acquisition system; this four-ton vehicle with a crew of two uses an advanced sensor suite on an extendible mast and can be equipped with a reduced-signature package. The reconnaissance, surveillance, targeting vehicle (RST-V) is a more advanced, lighter variation of the Hunter scout vehicle.

Unmanned sensors include unmanned aerial vehicles (UAVs), unmanned ground vehicles (UGVs), and unattended sensor nets, which are simply deployed and turned on. UAVs include such systems as the small (6-foot wingspan) expendable drone (EX-DRONE) and the larger (20-foot wingspan) Hunter aircraft. Both of these can carry FLIRs, video cameras, GPS receivers, and video communication links, although the larger aircraft allow larger payloads and longer flight times. Both the improved remotely monitored battlefield sensor system (IREMBASS) and remote sentry are stationary unmanned, distributed ground sensors.

Table 3.1—Candidate and Potential RFPI Systems by Function

Function	Systems	
	Candidate	Potential
RSTA (Saudi Arabia) (reconnaissance, surveillance, target acquisition)	<ul style="list-style-type: none"> • Hunter vehicle • Unmanned aerial vehicle (UAV) • Improved remotely monitored battlefield sensor system (IREMBASS) • Remote sentry • Air-deliverable acoustic sensor (ADAS) 	<ul style="list-style-type: none"> • Video imaging projectile • Unmanned ground vehicle (UGV) • Joint surveillance target attack radar system (JSTARS)
C2 (command and control)	<ul style="list-style-type: none"> • RFPI C2 • Light digital TOC 	<ul style="list-style-type: none"> • RFPI C2 excursions
Direct fire	<ul style="list-style-type: none"> • Javelin • Armored gun system (AGS) • AGS with line-of-sight antitank (LOSAT) 	<ul style="list-style-type: none"> • Comanche/Longbow • Smart target-activated fire and forget (STAFF) • Guardian/directed energy
Indirect fire	<ul style="list-style-type: none"> • Precision-guided mortar munition (PGMM) • Lightweight 155mm howitzer • High-mobility artillery rocket system (HIMARS) <ul style="list-style-type: none"> – Sense and destroy armor (SADARM) – Damocles 	<ul style="list-style-type: none"> • Precision multiple-launch rocket system (MLRS) • Army tactical missile system (ATACMS) • Brilliant anti-tank (BAT) submunition • Smart 105mm
Obstacles	<ul style="list-style-type: none"> • Wide area munition (WAM) 	
Multifunctional	<ul style="list-style-type: none"> • Enhanced fiber-optic guided missile (EFOG-M) • Intelligent minefield (IMF) 	<ul style="list-style-type: none"> • Hydra (obstacle)
Self-protection		<ul style="list-style-type: none"> • 3rd generation smoke

The air-deliverable acoustic sensor (ADAS) is a five-microphone sensor system, built by Textron Systems Corporation, that can locate, track, and, to some extent, classify enemy vehicles over large areas by using their acoustic signatures. Modeling of this system is described below in the after-action review section of this chapter.

Potential RSTA systems include the video imaging projectile, a 155mm artillery round that ejects a video sensor on a parafoil, which can be used to survey a location before committing an artillery barrage. UGVs such as the 1-ton MDARS vehicle or the 4-ton robotic HMMWV might be used to deploy or reposition ground sensors, mines, or other weapons, with special applicability in high-risk areas. Improved versions of the joint surveillance target attack radar system (JSTARS) may be available to the light force for long-range surveillance and targeting. Images of some of these systems are provided in Figure 3.4.

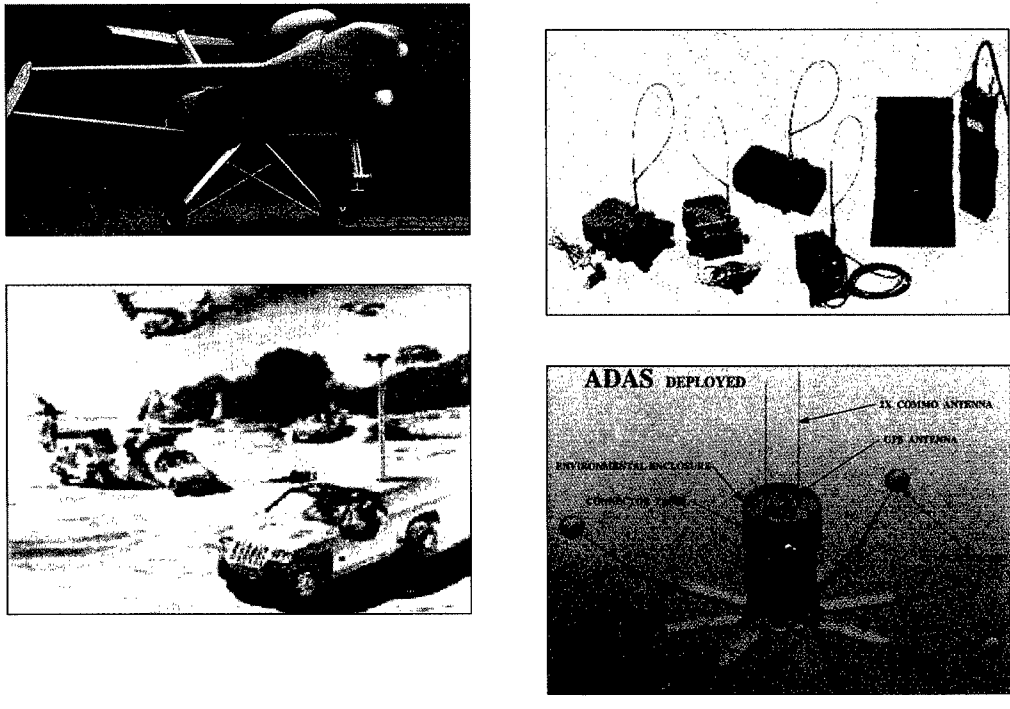

IREMBASS image courtesy of U.S. Army CECOM. RSTV rendering courtesy of Defense Advanced Research Projects Agency.

*Figure 3.4—Some Light Force RSTA Systems:
Tactical UAV, IREMBASS Distributed Sensors, RST-V Platform, and ADAS*

Command and control. The RFPI C2 system was envisioned to be a networked set of C2 nodes with automated routing and decisionmaking overseen by human operators; it would rely mostly on SINCGARS links for connectivity. The potential RFPI C2 excursions may include additional networks, decision aids, and automation; these were envisioned to be incorporated into a system referred to as the light digital tactical operations center (LDTOC).

Direct-fire weapons. Candidate RFPI direct-fire systems included a wide range of infantry, light vehicle, and medium-weight vehicle systems. These included Javelin, which is a short-range shoulder-fired anti-tank guided missile, the 18-ton-plus Armored Gun System (AGS), which is a light tank with a 105mm main gun, and Line-of-Sight Antitank (LOSAT), which is a kinetic energy missile (KEM) that can be fired from pods, replacing the main gun turret. At the time the RFPI analysis was conducted, the Army was still seriously considering introducing AGS to replace the M-551 Sheridans, which were then still present in the 82nd Airborne Division or (later) XVIII Airborne Corps.

Rotary-wing armor killers include the Apache attack helicopters and OH-58 scout helicopters. Alpha-model Apaches and the OH-58s employ direct-fire laser-guided Hellfire missiles. Potential future direct-fire systems include Comanche, the RAH-66 low-observable scout-reconnaissance helicopter that is scheduled to replace portions of

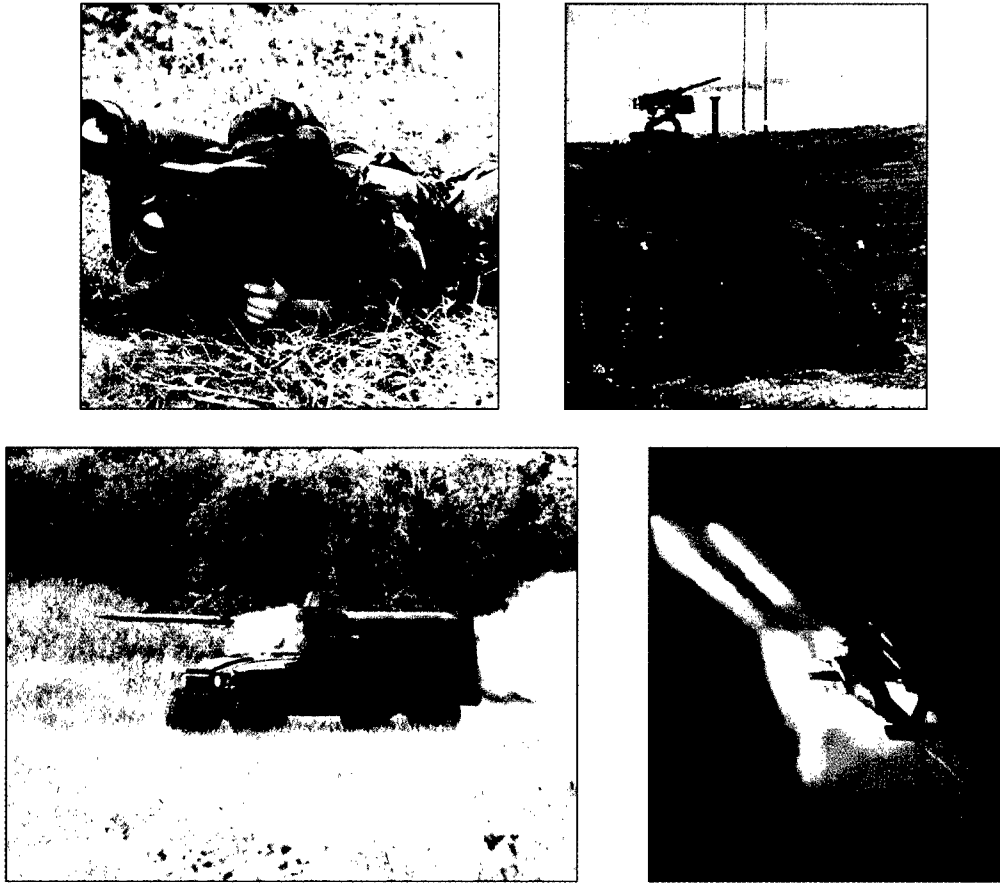

Images courtesy of ASA(ALT).

*Figure 3.5—Some Direct-Fire Weapons:
Javelin, AGS, LOSAT Missile, and Apache (Firing Hellfire)*

the AH-64 and OH-58 force. It carries a long-range, fire-and-forget millimeter-wave (MMW) radar-guided missile or laser-guided Hellfire missiles. The new Apache D models also use the Longbow version of the missile. Another potential system is the smart target activated fire and forget (STAFF), which is a medium-range, top-attack, tank-fired smart round which would extend the range of the AGS. An even farther-out future concept is a notional laser beam weapon-carrying vehicle.² Some examples of direct-fire weapons are shown in Figure 3.5.

Indirect-fire weapons. Candidate indirect-fire weapons include precision-guided mortar munitions (PGMM), the lightweight 155mm howitzer (LW-155), and the high mobility artillery rocket system (HIMARS). PGMM consists of an 81mm or 120mm mortar round with a semi-active laser (SAL) for terminal homing and either an infrared (IR) or MMW for autonomous target acquisition. LW-155 is a towed, helicopter-liftable 4.5-ton howitzer able to fire rounds with sense and destroy armor (SADARM)

submunitions, smoke, illumination, and many other rounds. The high mobility artillery rocket system (HIMARS) is a 14-ton wheeled vehicle (based on a 5-ton truck chassis) carrying a pod of six multiple-launch rocket system (MLRS) rockets, which could be loaded with dual-purpose improved conventional munitions (DPICM), SADARM, or Damocles munitions (described in Appendix C). Many of these smart munitions may benefit from GPS or inertial guidance. A conceptual addition to these developmental systems is the Smart 105mm, a very lightweight howitzer firing a submunition with a large footprint and shaped-charge lethal effects. Some examples of these indirect-fire systems are shown in Figure 3.6.

Obstacles. The one candidate obstacle is the wide area munition (WAM), which is used as an autonomous obstacle, capable of engaging combat vehicles out to a 100-meter range. This system uses a small microphone array to detect nearby armor vehicles and lofts a Skeet-like munition over the target in the direction of nearest approach.

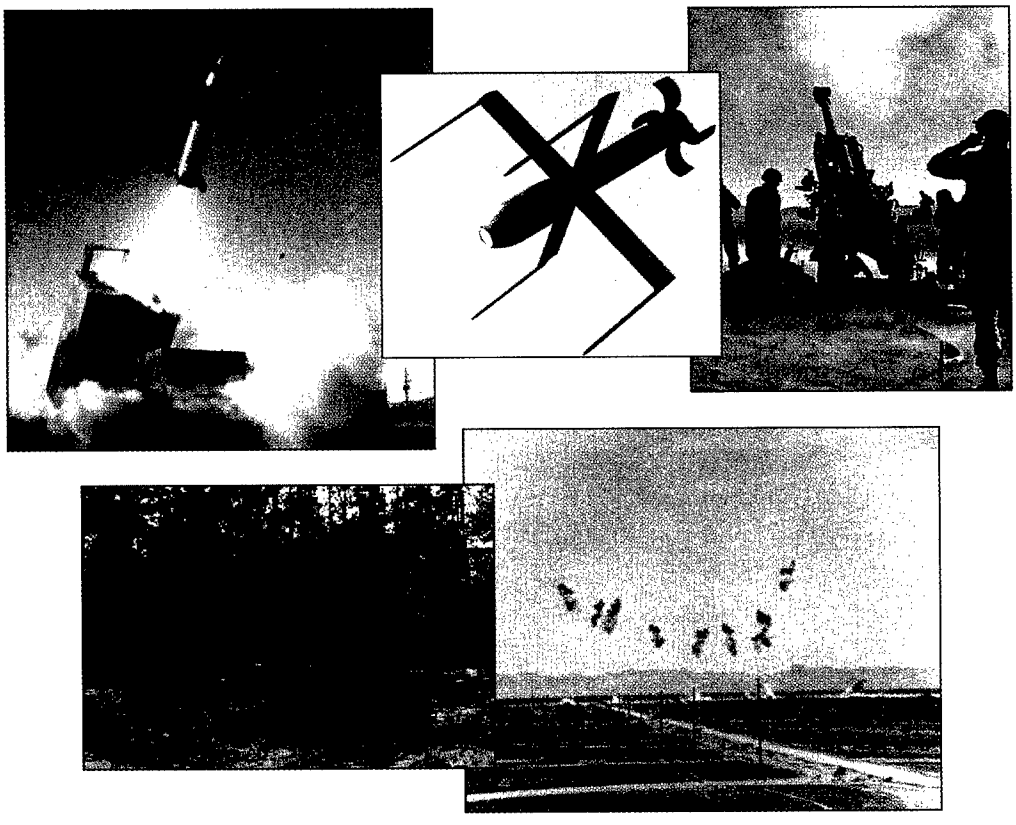

Images courtesy of Fort Sill.

Figure 3.6—Some Indirect-Fire Launchers and Submunitions:
 ATACMS and MLRS, BAT Submunition, Towed 155mm Howitzer, HIMARS,
 and SADARM Submunition

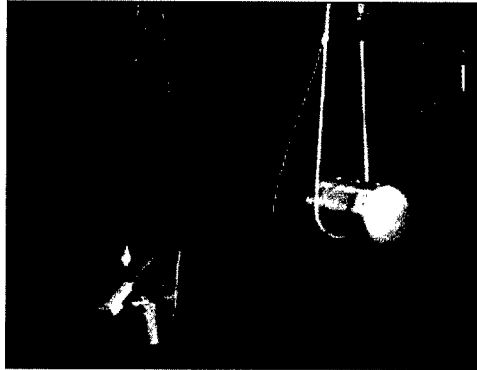
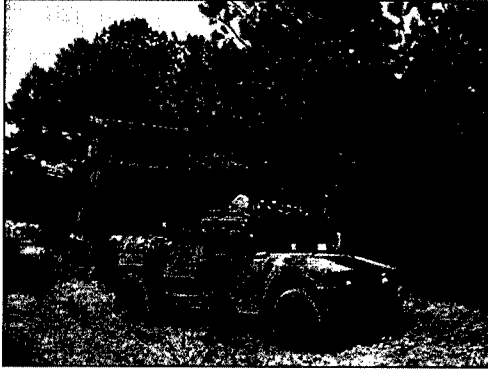

Images courtesy of the Enhanced Fiber Optic Guided Missile Project Office, Redstone Arsenal.

Figure 3.7—Fiber-Optic Guided Missile and Launcher

Multifunctional systems. Multifunctional systems can act as both sensor and weapon. Candidate systems include the enhanced fiber-optic guided missile (EFOG-M), a 15-kilometer range missile with a GPS antenna/receiver onboard and an imaging sensor in the nose that sends back video to the operator along a fiber-optic link. Six EFOG-M missiles are mounted on a HMMWV platform (see Figure 3.7). This system flies slower and has a longer time of flight than the other indirect-fire systems, but it has a very high level of delivery accuracy and a large munition footprint because of its man-in-the-loop imaging and control. EFOG-M is especially applicable to the future battlefield because it can engage both stationary and moving vehicles and slow-moving helicopters.

A second multifunctional system is the intelligent minefield (IMF). This complex ensemble of systems is envisioned to leverage acoustic information from WAMs and other acoustic sensors. Improvements over WAM include a gateway for transmitting contacts back to a manned station, along with the rules for engaging targets and coordinating attacks. The acoustic information is combined (“fused”) and used to better engage targets both by the minefield and through coordinated attacks with other systems. An exploratory system (by Aerojet) is the Hydra, a low-cost addition to the IMF, consisting of an inexpensive commercial video system boresighted to an explosively forged penetrator (EFP), which is connected to, and controlled by, an operator console through the use of fiber-optic lines. With the video capability, this system can also provide overwatch and detonation of a conventional minefield (e.g., claymore mines).

Self-protection. In this category, only one system of relative near-term technologies was examined: 3rd generation smoke, an obscuring agent with the reported capability of occluding visible, IR, and MMW signals. The primary problem with this system appears to be the ability to keep the hot and variably sized smoke particles aloft long enough to be effective.

The concepts and technologies we model in the rest of this chapter are drawn from those discussed above.

Options for Improved Light Forces in the Three Scenarios

To build the improved light forces, we started with the base case DRB defined in Chapter Two and systematically added various new capabilities (discussed above) to this force. First, we introduced an “improved direct-fire capability.” To represent this, we selected two key direct-fire systems that the U.S. Army was pursuing at that time—the AGS to replace the Sheridan, and the Javelin shoulder-fired anti-tank missile to replace the Dragon.

Second, we built on this improvement by adding a representative “hunter–standoff killer” capability to the DRB. To represent this upgrade, we selected a reduced-signature hunter vehicle (with mast-mounted sensors) and the enhanced fiber-optic guided missile (EFOG-M). These two systems work as a team, with the forward-positioned hunter vehicle acquiring targets and handing them off to the more safely positioned EFOG-M platform. (Refer back to Figure 3.3 for an illustration of the concept.)

Finally, we further altered the force by streamlining the hunter–standoff killer with “fast C2.” Essentially, the RFPI envisions using an improved C2 system, based on the U.S. Army light tactical operations center (TOC). Although at the time of this work the architecture had yet to be defined, we were able to simulate the effect of one key parameter—the time it takes to hand off target information between hunter and standoff killer—by halving the C2 delay time between hunter and standoff killer.

Table 3.2—Base Case and Improved DRB Force Mix for the Three Scenarios

Scenarios	Blue Forces: Blue Case DRB	Blue Forces: Upgraded DRB	Red Forces
SWA	15 HMMWV-Scouts 54 Dragons 18 Stingers 6 Apaches 14 Sheridans 8 M198s 58 HMMWV-TOWs	15 HMMWV-Scouts 54 Javelin 18 Stingers 6 Apaches 14 AGS 18 HMMWV-TOWs 24 Hunter 18 EFOG-M	323 T-72S (tanks) 219 BMP-2 (APCs) 35 BTR-60 (APCs) 30 120/180 MRL (rocket artillery) 72 152 SPH (cannon artillery) 16 HAVOC/HIND (helicopters)
East Europe	Same as above	Same as above	Same as above
LANTCOM	34 HMMWV-TOWs 4 AGS 24 Javelin 6 Apaches 8 155mm howitzer 18 105mm howitzer 18 forward observers 2 UAV	13 HMMWV-TOWs 4 AGS ^a 24 Javelin 6 Apaches 8 155mm howitzer 18 105mm howitzer 12 EFOG-M 18 forward observers 2 UAV 6 Hunter 18 Remote sentry 36 Overwatch sensors	131 T-72S 131 BMP-2 6 120/180 MRL 12 152 SPH 6 HAVOC/HIND

^a At the time the analysis was conducted, systems like the Sheridan were still integral to the 82nd Airborne’s DRB. In addition, the Army was considering introducing the AGS as a replacement for the Sheridan, plus elsewhere in the force structure.

The force mixes have been changed to reflect these improvements made to the Blue light forces, with the Red forces remaining as they were in the base case. Table 3.2 shows the new force mixes for the three scenarios. The boldface elements reflect changes from the base case shown in Table 2.2.

In building the “enhanced DRB,” we assume that the airlift is fixed. In other words, only about 4,300 tons of equipment can be airlifted within the requisite deployment window, regardless of the composition of the equipment. This is because the resources available to deliver the light airborne forces are also assumed to be fixed, with approximately 108 sorties (54 C-5s and 54 C-141s) being required to move the current DRB into theater and 37 C-141s required per day for resupply (Steeb et al., 1996a).

Thus, when the different specific DRB upgrade options are added—in this case, direct fire, hunter–standoff killer, and fast C2—we examined what must be traded out, which is reflected in Table 3.2. For the direct-fire systems, it is essentially a one-for-one swap. For every AGS added to the force, one Sheridan is removed, and for each Javelin added to the force, one Dragon is removed, as shown in the table. In incorporating systems associated with the hunter–standoff killer, it is not as clean a swap. Only some of the HMMWV-TOWs are swapped out for a precalculated ratio of Hunter vehicles and EFOG-M platforms. We assumed that the fast C2 concept did not require any additional hardware, so there was no airlift change associated with this last upgrade.

Experiencing Desert Storm II: Upgraded DRB

*THE LIEUTENANT KNEW FROM HIS ADVANCED INTELLIGENCE ASSETS that an artillery attack was likely. When the first artillery shell exploded, he knew it signified the opening round of a battle that his DRB would finish. After all, they had just completed extensive training with a new engagement concept along with the latest in weapons technologies. The concept, called **hunter–standoff killer**, would allow the DRB to effectively extend its reach many times over the more traditional direct-fire battles they had practiced just a few years ago. Instead of engaging the massed armor when his men were vulnerable to enemy return fire from a few kilometers out, they were now armed with missiles linked by fiber optics that could be “flown” out as much as 15 kilometers to engage the enemy’s tanks. The lieutenant knew that because the missile trajectory was “nonballistic,” the enemy could not backtrack it to its launcher and guide counterfire back in. This would be the first time the EFOG-Ms would be used in battle, and the first time his men would fire one outside of a training exercise.*

In addition to the EFOG-Ms, the DRB was equipped with precision-guided weapons, smart enough to search and engage enemy armor by themselves. Some of these weapons were delivered by mortars, some by towed artillery, and some by the new HIMARS via the MLRS rockets. The MLRS rockets were loaded with smart munitions called Damocles that would greatly improve the effectiveness of each volley. To provide the needed “eyes” to cue the various weapons, a wide range of

both manned and unmanned sensor systems were positioned forward, with both Army helicopters and some USAF aircraft.

As the battle began with the first barrage of enemy artillery fire, the DRB answered with counter-battery fire using both the new smart 155mm sense and destroy armor (SADARM) submunitions and HIMARS with Damocles. Both of these weapons had proved in recent operational testing to be at least an order of magnitude more lethal than DPICM and HE rounds. Aware of this capability, the enemy artillery attempted to overcome the counterfire by operating in a very fast “shoot-and-scoot” cycle, firing and then moving in a few minutes to a new position. Although such tactics gave the enemy some survivability against smart and dumb rounds, they also slashed the total volume of fires it could put on the DRB location: the enemy artillery would start to fire but then quickly stop, resulting in disparate volleys of relatively short duration.

Although the DRB’s counterfire soon subdued the enemy’s artillery, it did not stop the ground maneuver, which was now under way. With all of the recent improvements in RSTA, the DRB now knew with certainty where the enemy was located at any given time—not just the general direction of the attack, but the size of force components and movement of the enemy’s vehicles. This detailed knowledge allowed the lieutenant’s battalion commander to inform and prepare the rest of the unit well in advance of the attack. And while this information, by itself, would provide some benefit, when combined with the DRB’s precision it would allow considerably greater lethality at range.

It wasn’t until half an hour after they started receiving fire that a report came through, passed down from the TACNET, that friendly air strikes were inbound. The lieutenant guessed that they were coming out of Doha. While he knew he would not be able to see them, he listened for their presence as he monitored the enemy’s movement toward the DRB on his tactical display. He expected the air strike would be focused on the lead vehicles in the attack. This would not only serve to buy

more time for the DRB but would tend to demoralize the following vehicles. Shortly after it began, the air strike was over. It claimed some enemy vehicles, causing some disruption, but was nowhere near enough to stop the enemy’s advance. From this point forward, the battle would belong to the DRB.

Perhaps one of the most significant improvements the DRB incorporated over the past few years was new RSTA capability. Over the past few years, a wide range of tactical sensors, including the ADAS, unmanned sensor, and the new “Hunter” scout vehicle, were incorporated into the force. As the enemy began its attack maneuver against the DRB, details on its movement were acquired by the sensor network and sent to the light digital TOC, which then seamlessly disseminated the information.

The indirect-fire battle against the armor began as soon as the vehicles moved into range of the EFOG-M platforms. Cued by the ADAS sensor network, which covered the DRB’s sector as far out as 20 kilometers, EFOG-Ms were launched as the enemy formation moved into range. The first information the lieutenant received indicated the attack was initially occurring to the northwest. These forces would be engaged by Alpha Company’s EFOG-Ms. Although information sent through SINCGARS indicated that the first wave of EFOG-Ms were successful, the sheer number of enemy vehicles overwhelmed them. Observers also reported that the enemy’s APS recently installed on their T-72s were managing to destroy some of the EFOG-Ms as they engaged. As the enemy continued to advance, the lieutenant re-

ceived a report from his "hunters" (i.e., two different sets of ADAS systems were providing the direct cues for his company) that five heavy-tracked vehicles had entered the target area of interest (TAI). His platoon responded.

The lieutenant's platoon immediately engaged the lead vehicles. As he had practiced many times before, he quickly plotted the waypoints for his EFOG-M attack. He then ordered two missiles fired in quick succession. Once both of them were up and on their way, the gunner opened the camera on the lead missile. The weapon was flying at relatively low altitude but was moving at 100 meters per second (about 280 miles per hour). As it flew, the gunner correlated the images he saw through the camera with the missile locator on his control panel. It was interesting to see the missile automatically turn at each waypoint, using GPS for guidance. As both missiles reached the target area the gunner could now see the enemy vehicles, their image transmitted from the camera on the nose of the EFOG-M through the fiber-optic cable to his control station. At this point, he took over the missile's flight controls, lining up boresight directly on the lead vehicle. As the missile neared, he could confirm that the target was indeed a T-72. He kept the missile pointed directly at the vehicle until impact. Then he switched the control panel to show the second missile's camera, which was now approaching the target area. From its transmitted image, he could confirm that the first missile successfully engaged the lead tank. The gunner aimed the second missile at the next T-72.

The lieutenant heard through his SINCGARS that the Apache mission was ready to go, but he fired more missiles and would continue to do so as long as possible. They had practiced joint attack operations while at the NTC. In this case, the EFOG-Ms and Apaches would have to share the same airspace, since they were engaging the same target set. The missiles led, with the Apache attack not far behind. Because the EFOG-Ms not only reduced the total number of enemy systems (including air defense) but also caused considerable disruption, the Apache mission was executed with great success. Most of the Hellfires launched found their targets, resulting in kills of over 60 enemy vehicles, although one Apache was lost to the enemy air defense network.

Down to their last two missiles, the platoon fired them as the Apaches began their withdrawal. At this point in the battle, the information flow through SINCGARS indicated that the enemy had sustained significant losses but was continuing its attack. The surviving enemy vehicles had now moved within 5 kilometers of the DRB and were about to be engaged by the HMMWV-mounted TOW missiles. These systems had good fields of fire with the flat and featureless terrain. In addition to the HMMWV-TOWs, the enemy was now encroaching into direct-fire range, and the Javelin gunners would soon be joining the fight. Unlike the old Dragons, the Javelins could fire at ranges much greater than that of the machine guns on the approaching tanks. Additionally, the Javelin gunners were able to move as soon as they fired, since the weapons were fire-and-forget, another big difference from the slow, short-range Dragons that had to be guided all the way to the target. As the carnage of the direct-fire battle continued, the enemy began to fragment; the lieutenant could see the remnants of enemy companies dashing for what cover was available rather than continuing to advance. It was evident that the DRB would succeed in its mission to defend the critical road junction, protecting the oil fields to the south and establishing the entry point for follow-on U.S. heavy forces.

After-Action Reports

Unlike in the base case SWA scenario, we see that with the near-term incremental upgrades shown in Table 3.2, the outcome is considerably more favorable: *The DRB was able to repel a much larger, current-generation heavy force.* Is this true for all three scenarios? In addition, how did the various improvements to the DRB contribute to its performance? To answer these questions, we now examine (as we did in Chapter Two) the modeling and simulation results for the three scenarios for the three cases in terms of some key outcome measures.

After-Action Reviews for the Three Scenarios: Base Case Versus Upgraded DRB

When we examine the LER for the two bounding cases of terrain, SWA (representative open terrain) and East Europe (representative close terrain), it is apparent that the upgrade options described above—improved direct-fire capability, hunter-standoff killer capability, and fast C2—provided considerable improvement to the DRB. Figure 3.8 shows the respective (cumulative) improvement in LER obtained by the three different upgrade options compared to the base DRB at the same time in the battle, 58 minutes into the simulation. While in the base case DRB the LER was not good enough to result in a successful defense against the Red force, the DRB with the enhancements was able to decisively stop the attack in the SWA scenario and marginally fight to a draw in the East Europe scenario.³

Notably, the addition of just the direct-fire upgrades (AGS and Javelin) improved the force, but not enough to turn the tide. It was not until the hunter-standoff killer

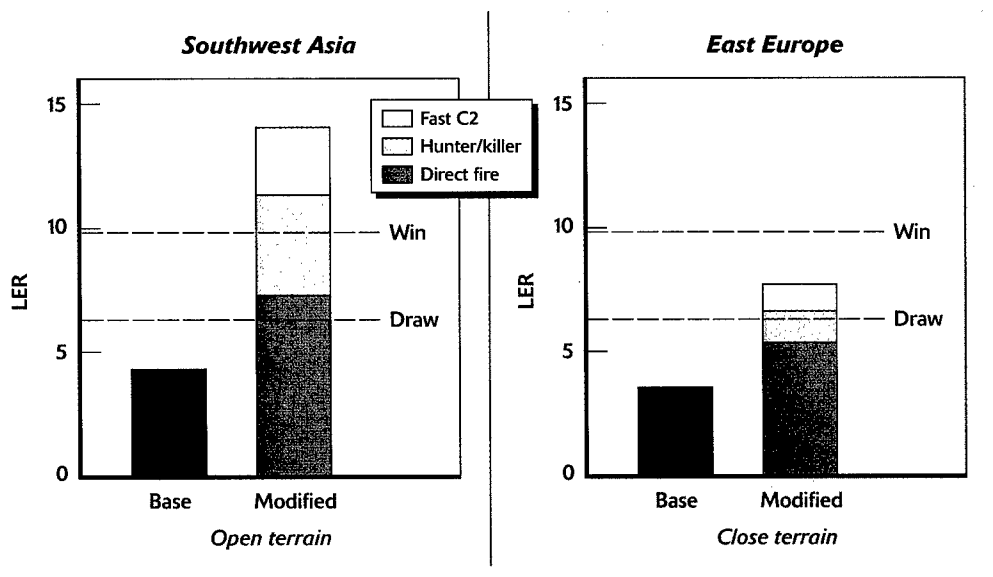

Figure 3.8—Effect of Upgrades on LERs in SWA and East Europe Scenarios

concept (hunter vehicle and sensor suite with EFOG-M) was introduced that a winning LER could be achieved in SWA and a draw in East Europe.

Figure 3.9 shows the improvement to the LER over time from the upgraded DRB (the brown lines) compared with the base case LER curves shown before (the blue lines). In the SWA scenario in particular, the LER was actually as high as 30 at the end of the indirect-fire battle. The contribution of the hunter-standoff killer systems in this scenario is very evident—the battle, as far as the DRB was concerned, could start much sooner and could be waged at much longer ranges, well before the main force became susceptible to Red’s direct-fire assets.

Although not as dramatic, the impact of the hunter-standoff killer systems in the East Europe scenario is still quite evident. The LER improved by a factor of two leading into the direct-fire battle. In the LANTCOM scenario (here with EFOG-M forward), Blue begins with a high LER because of EFOG-M kills. The upgraded DRB then moves into the direct-fire phase with a much more favorable force ratio than was present with the baseline DRB.

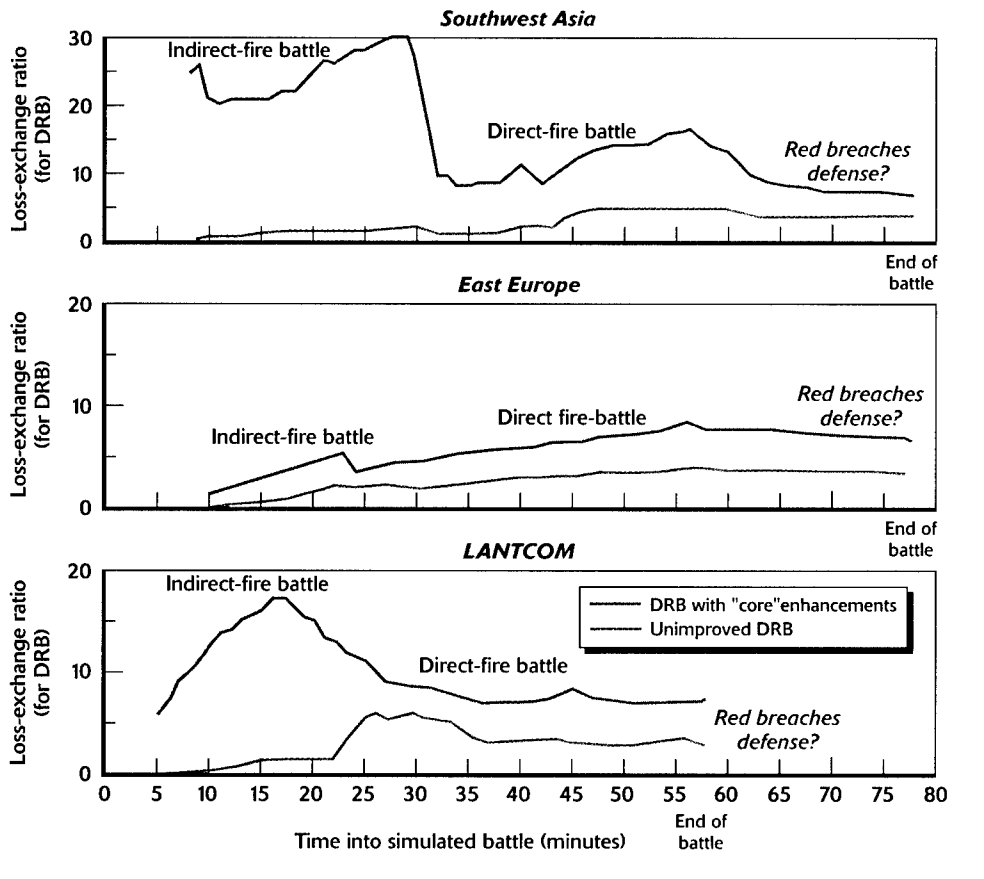
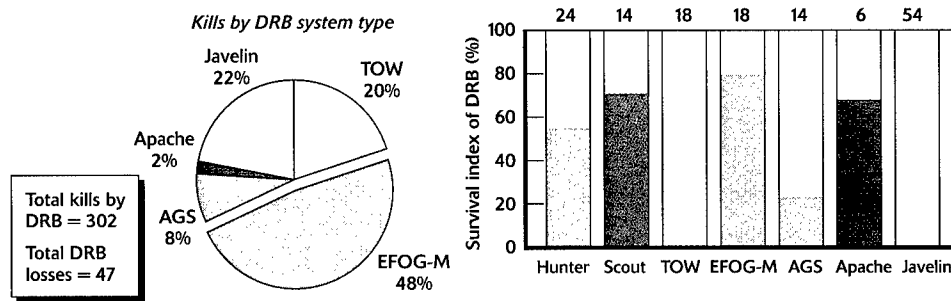

Figure 3.9—LER Over Time for the Three Scenarios: Upgraded DRB

Southwest Asia



East Europe

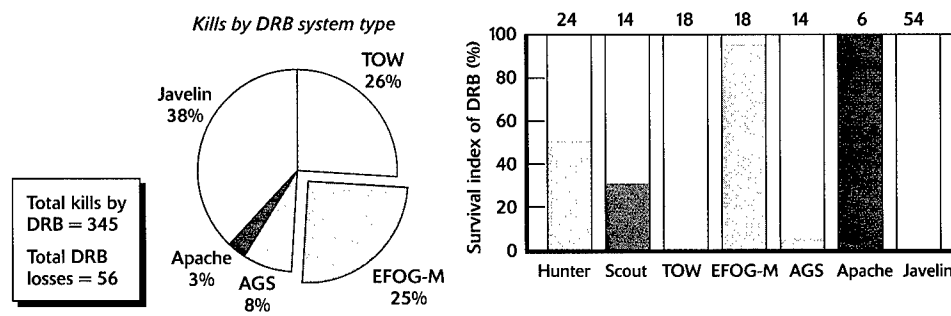

Figure 3.10a—Simulation Results at the End of the Battle for SWA and East Europe Scenarios: Percent of Elements Left

Figure 3.10a shows the outcome of the simulated battle for the SWA and East Europe scenarios in terms of percent of Blue capability remaining (although we envision that Red would probably have called off the battle before breaching the enhanced DRB defensive position). Many more Red systems are attrited (302 in the upgraded case versus 247 in the base case for SWA and 345 versus 279 in East Europe); however, the survivability numbers of the DRB reveal an even more profound difference. The upgraded DRB sustained only about half the losses of the base case DRB. Unlike the base case DRB, which was mostly attrited at the end of battle, this force is still intact, particularly so in the SWA scenario.

Moreover, whereas the primary weapon in the base case was the HMMWV-TOWs, two new systems—the EFOG-M and Javelin—provide the bulk of the lethality in the enhanced DRB force. Since HMMWV-TOWs were traded out for an equal number of EFOG-Ms, we would expect that some of the HMMWV-TOW contribution would go down. However, in the SWA scenario, the EFOG-M made a proportionally much higher contribution than the HMMWV-TOW. Also notably, the Javelin, which was a one-for-one exchange for the Dragon system, provided a significantly higher share of the overall force lethality in this case. A similar outcome was seen in the mixed-terrain case of LANTCOM as well, shown in Figure 3.10b, where EFOG-M constituted over half of the total DRB lethality.

LANTCOM

Figure 3.10b—Simulation Results at the End of the Battle for LANTCOM Scenario: Percent of Elements Left

The enhanced DRB does considerably better than the base case DRB, largely because of the hunter–standoff killer concept. This concept clearly allowed the fight to begin much earlier and from much farther away. Unlike in the base case, where the engagements were occurring within 4 kilometers of the force elements, in the enhanced case the engagements started from beyond 8 kilometers. This not only increased the window in which Red systems could be attacked, resulting in higher DRB force lethality, but also allowed for a “metering in” of the Red force to the direct-fire battle. That is, when the Red force closed, its systems were fewer in number and could more easily be managed by the DRB’s direct-fire systems. *Thus, with this “shaping of the battlefield,” there was improved DRB lethality accompanied by higher overall DRB survivability.*

Although the DRB upgrades led to improvement in all three scenarios, the level of improvement was quite different between the scenarios with open and close terrain. More specifically, the benefit was considerably less apparent in the close terrain of East Europe. Examining the scenario data showed that the hunter vehicle’s ability to “see” was the primary distinguishing factor. That is, in the limited-LOS terrain, not only were the hunter vehicle sensor ranges much shorter, reducing the number of calls for fire from the EFOG-M platforms, the hunter vehicles also tended to be more susceptible to unexpected or “chance” encounters with the advancing enemy force.

In summary, the enhanced DRB performed as one might expect. The new direct-fire systems had higher lethality, allowing for a higher overall LER. Adding the hunter–standoff killer concept was a key enhancement that provided enough initial fire-power to change the dynamics on the battlefield—greatly reducing the possibility of being overrun. Fast C2 allowed for more effective hunter–standoff killer performance; not only were more rounds delivered, they were placed with greatly reduced error (less target movement until round impact).

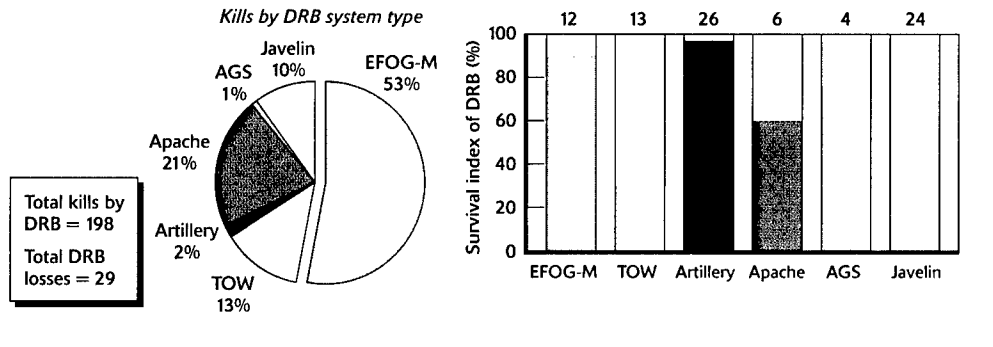
Although it is worthwhile to note that the enhanced DRB does substantially better than the current DRB, a few critical questions remain to be answered. Namely, what would happen if the enhanced DRB had to face a sophisticated future enemy force?

How might other advanced precision-guided weapons fare in lieu of the EFOG-M? These questions were addressed as simulation excursions; the answers to these questions are provided in the following subsections of this chapter.

Excursion: What If the Enhanced DRB Faced a Future Heavy Force?

So far, we have examined the effectiveness of the current and enhanced DRB against a current-generation enemy force. But how would this upgraded DRB perform against a *future* heavy force? Here we consider this question, using the SWA and East Europe scenarios.

Upgrading the Red threat. A future heavy force is generally defined here as a force with enhanced weapon systems, including high-tech Russian systems either currently available on the arms market or nearing the end of their development. Table 3.3 shows what we have done to improve the Red threat in terms of sensors, armor, weapons, and air defenses. The upgrades we postulated for enemy forces covered several dimensions. Improved sensors (FLIRs) were provided to all threat elements, instead of being available to just the command vehicles. Armor was improved to reflect the state-of-the-art Russian tank (T-80+ versus T-72) and armored personnel carrier (BMP-X versus BMP-2). More effective munitions supplanted their current counterparts: the longer-range AT-8 (5-kilometer missile) replaced the AT-5 (4-kilometer missile), and a smart munition referred to as the MCS-E1 (very similar to the U.S. Army’s SADARM) replaced the HE artillery round. Also, very high-end air defense was provided. Generally, these high-tech systems were swapped into the enemy force in a one-for-one exchange with the old systems.

Upgraded DRB performance versus upgraded future Red heavy threat. Figure 3.11 shows that when the changes in Table 3.3 are made, a future threat force is able to significantly improve its performance against both the base DRB and the enhanced DRB. Essentially, Red is able to change the LER to where only a draw could be achieved in SWA and a loss occurs in East Europe. Although the enhanced DRB with the “core” RFPI enhancements still does considerably better than the base case DRB, the upgrades

Table 3.3—Upgrades to Red Threat

Dimensions	Current	Upgrade
Sensors	FLIRs to command vehicles only	Improved FLIRs to all threat elements
Armor	Tanks: T-72 BMPs: BMP-2	Tanks: T-80+ BMPs: BMP-X
Weapons	Antitank: AT-5 Rocket artillery: HE	Antitank: AT-8 Rocket artillery: MCS-E1
Air defenses	SA-8	SA-15, plus SA-19 (as part of 2S6 system)

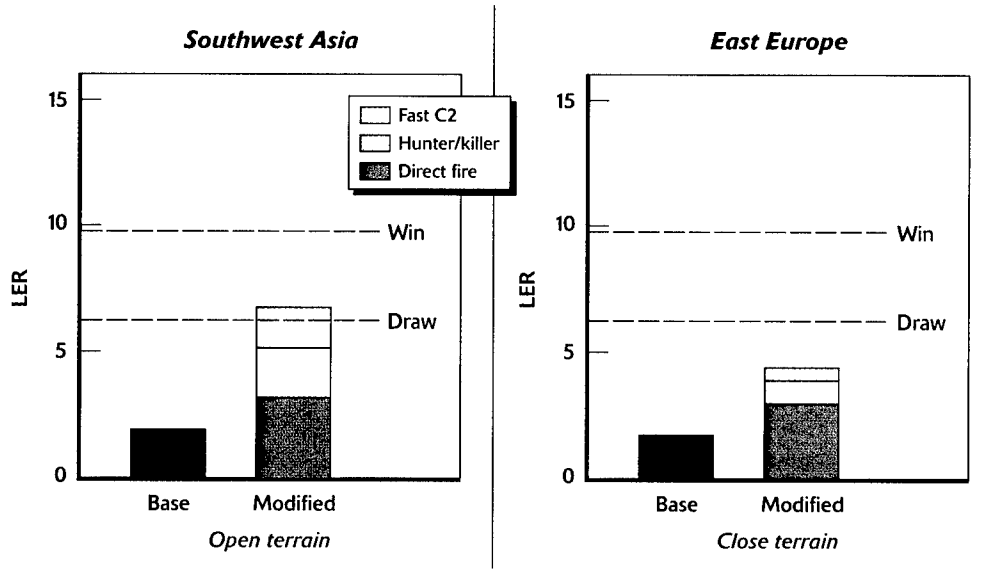

Figure 3.11—Effect of Red Upgrades on LERs in SWA and East Europe Scenarios

are not sufficient to accomplish the stated force objective—repel the attacking Red force—especially so in East Europe.⁴

Why doesn't the base or enhanced DRB fare as well against the future threat? First, the improved threat sensors allowed earlier detection of Blue's forward-based scouts and hunter vehicles. Early DRB losses of these systems translated to less situation awareness and a significant reduction in calls for indirect fires.

In addition to the loss of the "eyes" on the battlefield, which reduced the amount of Blue indirect fire, the Red systems were more capable in the direct-fire battle. Red's improved sensors, in conjunction with its longer-range missiles, greatly reduced the DRB's close combat advantage. The Red force was able to fight on a level closer to parity, and the LER was effectively reduced from around 4:1 down to 2:1.

Also, the addition of the smart artillery munition proved to be effective against the DRB. Even though such "first-generation" munitions as the MCS-E1 do not have a very large footprint, the DRB systems were still susceptible to these weapons because they are relatively stationary.⁵

Improving the enhanced DRB to counter the future heavy threat. Given this result, we made some improvements to the upgraded DRB, adding additional RFPI systems to the force. For possible RSTA improvements, we considered two "unmanned" systems, the remote sentry (FLIR with acoustic cue) and a UAV (based on a close-range concept such as the CL-227 Sentinel). Additional direct-fire upgrades we examined included a kinetic energy missile (with relatively fast firing rates) for the AGS. We examined the impact of WAM. And we also assessed the impact of augmenting the force with other indirect-fire systems, including shorter-range (relative to other indirect-fire systems) PGMMs and longer-range rocket artillery (HIMARS) with MLRS rockets containing

SADARM. As mentioned before, all these adjustments were made assuming constant airlift, where swap-outs of current DRB counterpart systems were made as necessary to the DRB; for example, adding HIMARS required some of the towed howitzers to be removed from the force. (See Table 3.1 and discussion for a description of these systems.)

Results for both scenarios. Figure 3.12 shows the impact each RFPI system makes to the upgraded DRB LER. We found that most systems can provide at least some further improvement to the LER, but these tend to be relatively incremental improvements at best. The UAV did not survive in East Europe against radar-guided air defenses. The short-range PGMMs were competing with the direct-fire systems and consequently did not provide meaningful improvement to the LER. HIMARS as an individual system traded in to the DRB was seen to be effective in SWA, but it was not assessed in East Europe because there were not enough sightings of company-sized targets by the hunter sensors to call for this type of massed fire.

It is important to make the distinction that some systems come to the DRB with little or no airlift cost. For example, the remote sentry, the LOSAT missile, and WAM provided improvements without mandating a major swap-out. Other larger and heavier systems had to be “traded in,” replacing other DRB systems. Thus, some systems should intuitively offer improvement, while others could increase or decrease the overall LER. Interestingly enough, when all the listed systems are included in the simulation (the combined bars in the figure), there was a complementary improvement to the overall LER. One example of this: WAM slows down the Red force and presents more opportunities for the other Blue indirect-fire weapons to engage the force from afar. The

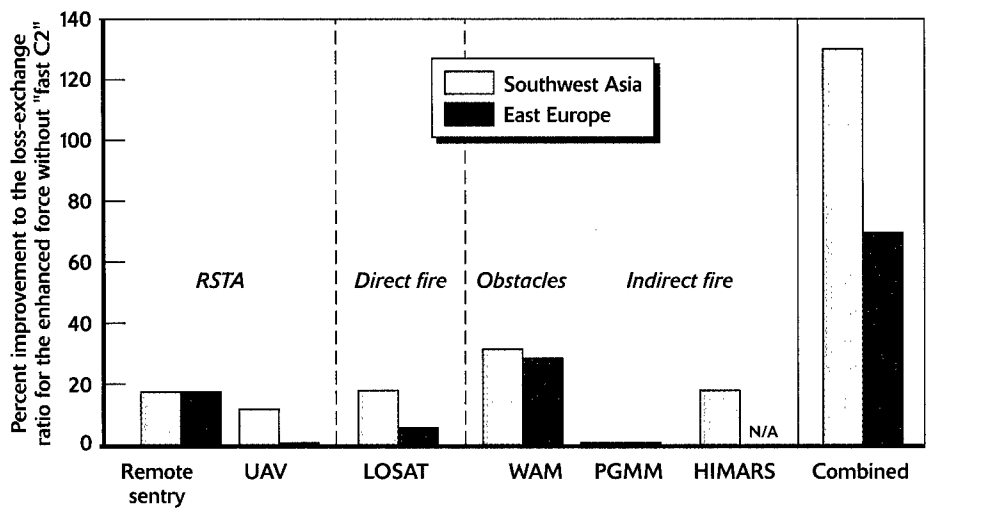

Figure 3.12—Effect of Additional DRB Upgrades on LERs in SWA and East Europe Scenarios

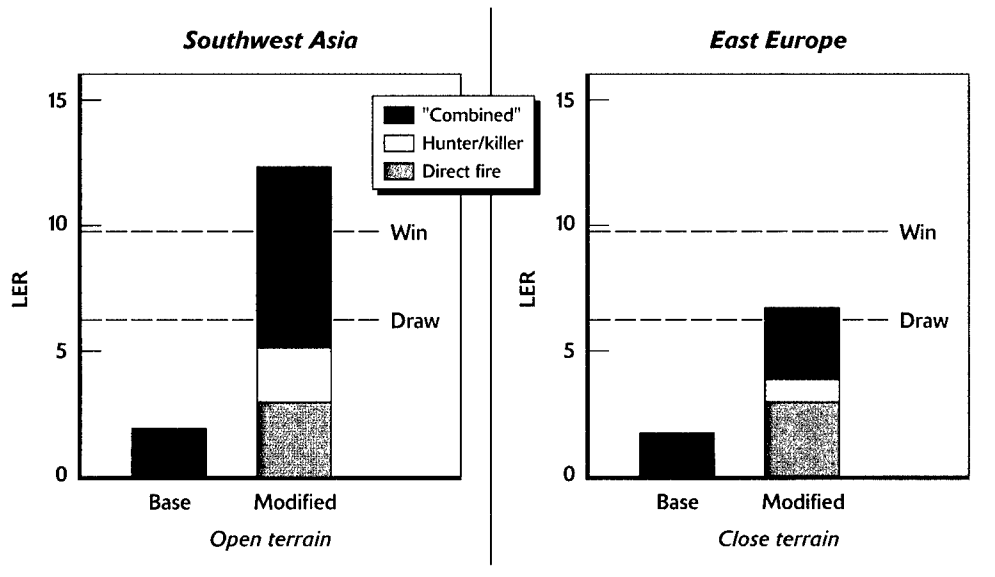

Figure 3.13—Effect of Combined Strategy on LERs in SWA and East Europe Scenarios

end result is improvements of around 140 percent in the SWA scenario and around 80 percent in Eastern Europe

Figure 3.13 shows the effect on the LER from employing the combination of the aforementioned RFPI systems (with improved direct fire and hunter–standoff killer systems). In the SWA scenario against a future threat, the combination of systems provided enough improvement to the LER to offer a win, with an LER of 12.5 at the end of the close battle. Although there was considerable improvement to the LER in the East Europe scenario, it was only barely enough to achieve a draw. For this scenario, we explored other means for achieving a win.

Improving results in the East Europe scenario. Two reasons were identified for the inability of the DRB, even with the combination of RFPI systems, to achieve a win in the East Europe scenario (with the hunter–standoff killer system providing substantially less benefit than expected). First, the added smart munitions were not exploitable because their relatively small footprints (75-meter radius in this case) were unable to effectively “encounter” mobile targets in a dispersed attack formation. Although directly related to the quality of the RSTA available in this scenario, a larger-footprint munition that could better “seek” targets might have provided a means for ensuring an encounter with the combat elements of the attacking force.

The second reason why the “combined” DRB did not win was directly attributed to sensor availability. The postsimulation analysis showed that most of the forward-positioned sensors (manned hunter vehicles, remote sentries, and UAVs) did not survive throughout the engagement in East Europe. So even though the situation was target rich, the DRB was unable to fully capitalize on its indirect-fire systems.

To examine these possible shortfalls, we postulated the following improvements to the DRB: (1) add in a larger-footprint submunition (3x radius) to increase the probability of “encounter,” and (2) add in a large (300-element) distributed sensor net.

In terms of the latter change, the modeling was performed using a distributed sensor system called the air-deliverable acoustic sensor (ADAS).⁶ Unlike the remotely monitored battlefield sensor system (REMBASS) used in the Vietnam War, which could be used to detect the presence of enemy vehicles at predetermined locations, ADAS can locate, track, and, to some extent, classify enemy vehicles over large areas by using their acoustic signatures. Compared to other sensors, ADAS can be rapidly emplaced (through either forward observers (FOs) en route to their deep positions or through helicopter delivery), has a relatively stealthy presence once deployed, can cover areas beyond LOS, and has relatively low levels of required maintenance.

In modeling the ADAS distributed sensor system, we found two key limitations: (1) an incompleteness of information and (2) a lower than expected level of accuracy during target location. Each of these limitations was a strong function of the “baseline” pattern of emplacement. We found that by modifying the laydown, mostly by adding more sensors, both limitations could be overcome. Figure 3.14 shows how changing the number of sensors overcame the incompleteness problem. As shown, doubling the number of sensors from 21 (7 sets of 3) to 42 (14 sets of 3) nearly doubled the number of total acquisitions. Tripling the number of sensors to 63 (21 sets of 3) further improved performance.

Increasing the number of sensors within the battlespace also improves the target location error (TLE), as shown in Figure 3.15. As expected, the higher density of sensors resulted in many more closer-in acquisitions, where more localized bearing lines also al-

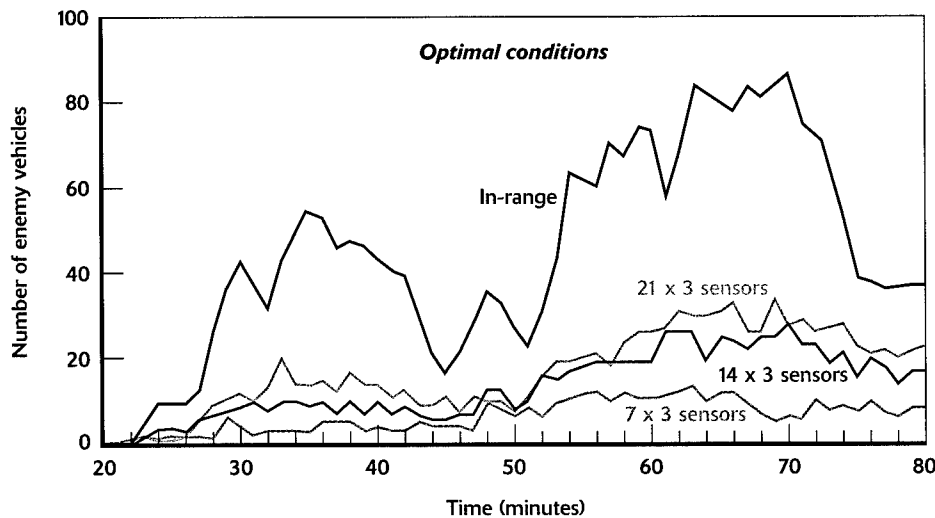

Figure 3.14—Effect of Increasing the Number of ADAS Sensors on Completeness

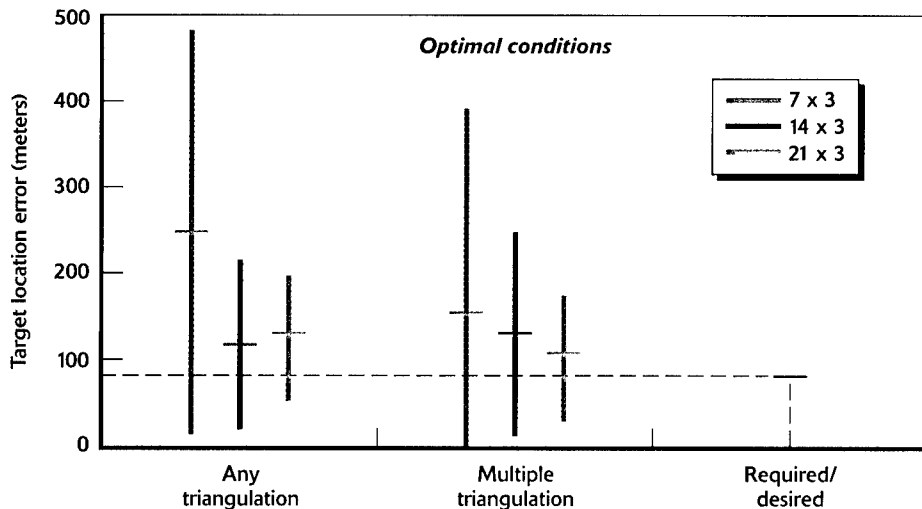

Figure 3.15—Effect of Increasing the Number of ADAS Sensors on Target Location Errors

lowed more correct correlations and closer-in acquisitions. These key improvements reduce both the average TLE and the associated standard deviation. Although the numbers of sensors assessed still does not enable ADAS to achieve the required/desired 80-meter error, the error was reduced substantially, to about 125 meters, compared to the 250- and 160-meter errors seen before.

These initial analyses suggested that acoustic sensors are a very good match with the larger-footprint weapons also modeled here. Although the required/desired levels of accuracy were not met, the larger-footprint weapon was more than adequate for successfully engaging targets.

Figure 3.16 bears this out by showing that when a full 300-element distributed sensor net and larger-footprint munitions are added to the DRB in the East Europe scenario, the DRB can improve the LER to the level of a decisive win. The figure shows the cumulative effects of first adding in the advanced artillery and then the sensor net. As it turned out, the more advanced artillery with a

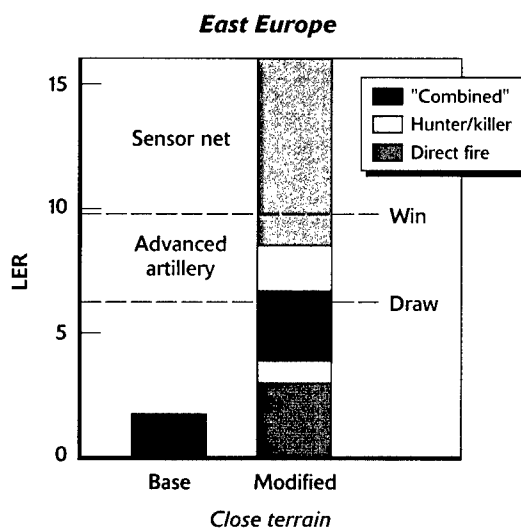

Figure 3.16—Effect of Adding in Notional Systems on LERs in East Europe Scenario

larger-footprint smart munition was not sufficient to provide a win. Rather, the lack of a good RSTA system proved to be the deciding factor. By adding the distributed sensor net, the DRB performance at the end of the close fight yielded an LER of 16.

Excursion: How Do Other Indirect-Fire Systems Compare with EFOG-M?

EFOG-M was the key advanced indirect-fire weapon system evaluated in many of the modeling runs. Given its current acquisition uncertainty and its relatively high cost per round, one natural question would be, How effective are other indirect RFPI systems compared to EFOG-M? In this excursion (which uses the LANTCOM scenario), we examine how EFOG-M performs compared with four other RFPI systems: (1) HIMARS-Damocles, (2) PGMM, (3) Smart 105, and (4) 155 SADARM, all used in the anti-armor role. (See Table 3.1 and Appendix C for descriptions of these systems.)

Figure 3.17 shows some first-order characteristics of the different indirect-fire systems. The range of the weapons varies considerably, from the shorter-range PGMM-IR and EFOG-M (15 kilometers) to the longer-range HIMARS/Damocles (40 kilometers). The ranges shown are the maximum for howitzers and mortars without rocket assistance and for MLRS rockets with a smart-munition payload. Since operationally there appeared to be value associated with attacking deep, both of the short-range systems were assessed in two ways—positioned back with the main force and positioned forward, effectively increasing their “reach” on the battlefield. (This was applied to both EFOG-M, as shown above in the analysis, and to PGMM, even though the EFOG-M because of its self-contained launch operation was envisioned to be much more capable performing in this way.)

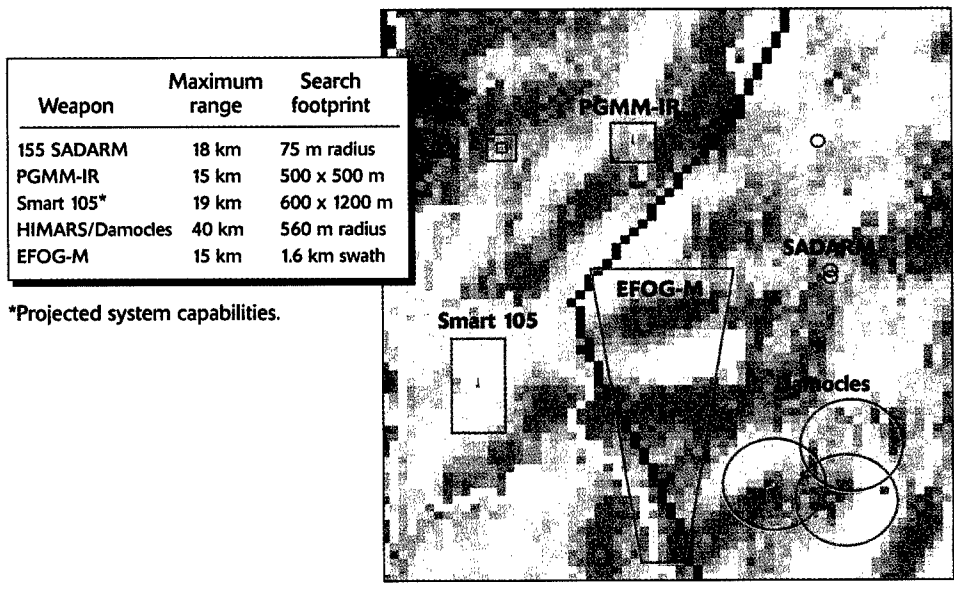

Figure 3.17—Some First-Order Characteristics of Different Indirect-Fire Systems

In addition to range, the indirect-fire systems also vary in the size of their munition search footprints. This characteristic generally defines the munition's ability to encounter a target and is a function of its sensor field-of-view and its maneuver capability. The figure shows the relative sizes of the search footprints of the different munitions.

What happens when we compare the alternatives? When we substitute different indirect-fire systems for EFOG-M (using the DRB system trade-out approach), we find that only one of the alternatives performs as well as EFOG-M, using LER as the key measure.⁷ The low-performing systems and munitions were PGMM and 155 SADARM, which do only somewhat better than the baseline DRB force (LER = 4.1). PGMM did not do very well for several reasons: movement of the targets under the footprint during the flyout, competition with direct-fire systems such as TOW and Apache, and multiple attacks on the same target. 155 SADARM had greater range than PGMM, but with its small footprint, it was generally not very effective at engaging moving armor targets.

Interestingly enough, because of its large footprint, HIMARS-Damocles showed its added contribution to counterbattery fire even when used in the anti-armor mode. Using this system provided an outcome between a draw and a win. Both Smart 105 and EFOG-M resulted in wins. Replacing the 12 EFOG-M launchers in the enhanced DRB with 12 105mm howitzers resulted in a higher LER (11.5 versus 10). Much of this occurs because of the resulting large numbers of cannons (now a total of 30) that can all fire the effective Smart 105 round. However, in a more analogous comparison (the 8 155mm cannons are traded out for 12 more EFOG-M launchers), 24 EFOG-M launchers result in an even higher LER than the 30 105mm cannons with Smart 105 (13.7 versus 11.5).

Figure 3.18 compares the efficiency of the different systems and munitions by looking at rounds or missiles fired and targets killed. EFOG-M, with its man-in-the-loop control, was by far the most efficient. The other systems varied widely in efficiency. PGMM and 155 SADARM fired large numbers of rounds but killed few targets. HIMARS-Damocles achieved a high percentage of kills per rocket, but each rocket contained three submunitions. Smart 105 achieved a substantial number of kills, but it fired almost three times as many rounds as EFOG-M launchers fired missiles. (TTPs on rounds fired per target were designed to yield a high expected probability of kill, approximately 1.0.)

In addition to total rounds fired and kills, the table at the bottom of Figure 3.18 shows (beyond the LERs discussed above) the pounds of munition weight per kill, the total tons per kill of each indirect-fire alternative's slice (which includes the launcher, ordnance, and support vehicles), and the approximate number of C-141 equivalent sorties for that alternative's slice. Some of these factors require additional explanation. For example, the number of tons attributed to 24 PGMMs and 24 EFOG-Ms were each more than twice that of 12 EFOG-Ms, even though all these systems are HMMWV-mounted. This is because each 24-system, two-company section adds a headquarters unit not present in the 12-system force. Smart 105 and 155 SADARM have an even

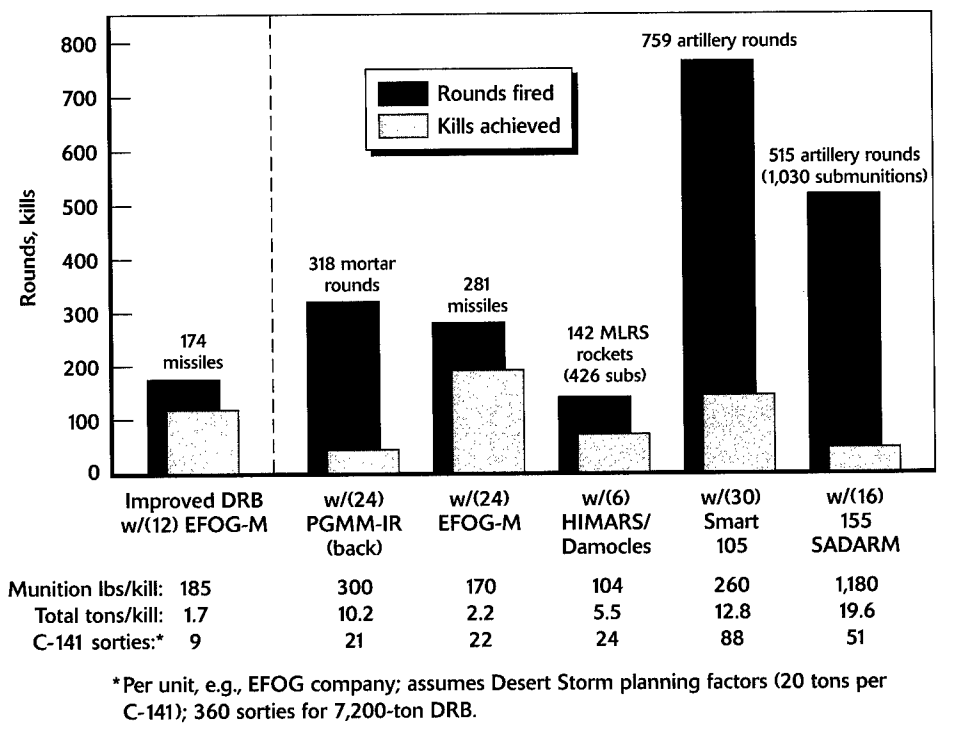
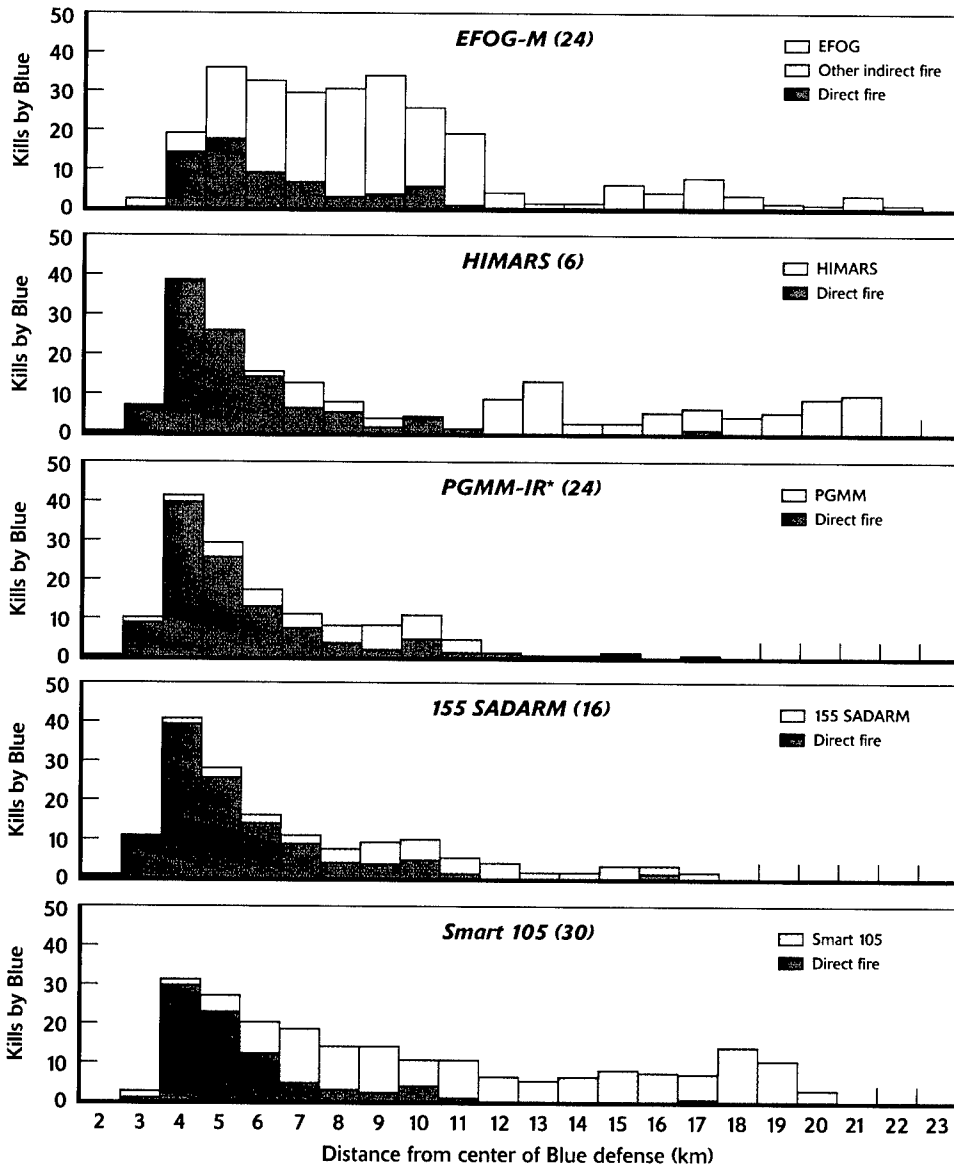

Figure 3.18—Comparison of Efficiency of Different Indirect-Fire Systems

higher weight burden, since we have to include the standard ordnance (smoke, illumination, HE rounds, etc.), along with their trucks and handling systems. When these systems were traded in against HMMWV-mounted EFOG-Ms and PGMMs, only the launchers and smart munitions components and support were considered.

The reach of each weapon system was determined by a combination of its range and its position on the battlefield (the TTPs assumed), while the weapon's effectiveness, by distance, was determined by simulation. HIMARS/Damocles and PGMM-IR exhibited very different distributions of kills by range. Figure 3.19 shows kills by the advanced system, which are shown separately from the kills by all other systems combined. All results are cumulative over time up to the same stopping point, approximately one hour after the start of the battle. EFOG-M (24) was able to fire at longer ranges (with some of the systems placed forward) and at danger close, resulting in kills spread over the battlefield. HIMARS was primarily a mid- to long-range system, unable to fire close to its own troops because of its large-munition footprint and MLRS rocket ballistic error. PGMM-IR was a close-in system and often competed for targets with other systems in the force.

Unlike EFOG-M, the cannon-fired artillery rounds have extremely fast flight speed (thus reducing errors associated with target movement). Even so, the 155 SADARM had a low level of mid-range kills, primarily because of the seeker's small footprint,



*Ground-based RSTA repositioned to account for shorter reach of mortars.

Figure 3.19—Comparing the Reach of the Different Indirect-Fire Systems

which limited its ability to encounter the mobile targets. This contrasted sharply with the broad range of kills by the conceptual Smart 105 system, which had a much larger footprint combined with a fast response.

Besides comparing the systems side by side, we also compared the added benefit of different systems in conjunction with some EFOG-Ms (where the EFOG-Ms are positioned forward).⁸ Because we are including two types of advanced indirect-fire systems,

fewer numbers are available than before. Generally, we found the alternative systems and munitions replacements tended to complement EFOG-M in different ways. PGMM-IR and 155 SADARM both contribute a small but significant number of kills, without stealing from the EFOG-M kills. PGMM kills are closer in than 155 SADARM and tend to fill in some of the interval when EFOG-M launchers are moving.⁹ 155 SADARM kills are farther out and actually increase EFOG-M kills slightly, apparently by destroying Red systems that threaten EFOG-M launchers and hunters during the pullback.

HIMARS-Damocles had two effects: It engaged targets at very long range and it provided a means for highly lethal counterbattery fire, reducing losses from Red artillery. This results in a higher LER than would be expected from the number of kills by Blue. Smart 105 is a very lethal system, with its moderate range and high probability of acquisition and kill. The 18 105mm howitzers are able to achieve more kills than the 12 EFOG-M launchers.

Figure 3.20 summarizes the results of the analysis of indirect-fire alternatives, in terms of both data comparison and performance assessment. The data we used to characterize each indirect-fire system generally originated from its developer. Although we questioned the validity of certain items, we ultimately used the data provided. In some cases, it was apparent that systems in conceptual or early development stages incorporated more optimistic projections than those proven in testing. Nonetheless, using the data as provided (shown on the left side of the figure), in conjunction with TTPs recently discussed with the user/developer, allowed us to assess the performance of the different indirect-fire concepts in the context of the stressing LANTCOM scenario.

The combination of data, TTPs, and interactions with other systems on the battlefield (including C2 network/delays) provided the opportunity to quantify performance at a higher level (as summarized on the right side of the figure). For example, the ability to encounter targets was partly determined by the data (sensor capability, time of flight, etc.) but was also influenced by the C2 interactions. Another example, the ability to reach, was determined partly by the range of the weapon but also by the placement (using inherent mobility) on the battlefield. EFOG-M was the only weapon that could generate targets on its own, identify targets after launch (increasingly important in lower-intensity conflicts), and provide a means for battle damage assessment (BDA). Finally, both EFOG-M and Smart 105 appeared to be high-leverage weapons for the DRB, especially against mobile targets. On the other hand, both PGMM and 155 SADARM did not fare as well.

In summary, among the indirect-fire options, EFOG-M provided the highest LER, while Smart 105 and HIMARS with Damocles offered the next-highest LERs. Smart 105, because of its large numbers, good reach, large footprint, fast response, and high lethality, was an attractive system. HIMARS was relatively efficient in terms of kills per rocket with the large-footprint Damocles munition, but it was restricted to company-sized targets and, with its substantial system weight, had only a few launchers to work with. Finally, the smaller-footprint smart munitions (PGMM and SADARM) did

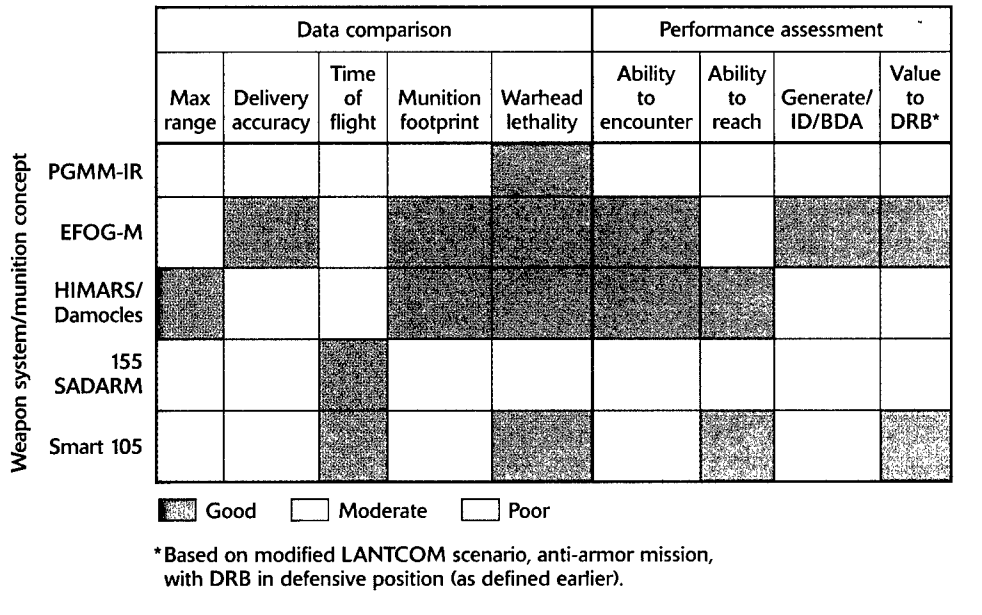

Figure 3.20—Summary of Data Comparison and Performance Assessment for Indirect-Fire Alternatives

not fare well against moving armor because the targets would often move out of the encounter zone of the munition.

Chapter Summary

In this chapter we examined enhancements for current rapidly deployable forces, such as the 82nd Airborne Division DRB. We found that without changing numbers of systems, required lift, organization, or mission, new systems and tactics could strongly improve overall force effectiveness. Replacing direct- and indirect-fire systems, adding air and ground sensors, and streamlining the C2 system allowed the force to operate successfully, even though it was outnumbered by attacking enemy armor. Of the various weapons in these near-term forces, EFOG-M was found to have the greatest efficiency of operation. As the conditions became more stressful, with close terrain and a more advanced threat, a richer mix of sensors and weapon systems was required.

The primary operational difference observed by using a new concept and enabling technologies was the extension of the DRB's battlespace. The approaching enemy heavy force was engaged at much greater range by precision systems that could kill armor. Across-the-board improvements were noted in enemy systems killed and enhanced survivability for the U.S. force. This is not to say the battles would have been easy, for in several cases it is likely that the enemy could still have closed in on the DRB in a final attempt to overrun its defenses. Additionally, it should be noted that the different terrain types in the three cases again had considerable effect on the outcome. The relatively open terrain of SWA facilitated target detections and long-range engagements,

while the closer terrain of Eastern Europe hindered the process, leading to more direct-fire fighting.

The direct-fire battle, the “end game” of the defense if you will, was still important, even critical. In this set of cases, the direct-fire battle was made less stressing because the enemy had suffered so many casualties from standoff systems before it closed into direct-fire range.

This chapter was fundamentally based on current structure fighting with conventional tactics. The next chapter will examine the potential of not only enhancing the sensor and weapon systems of the DRB, but also fighting in a much more dispersed manner, where tactical concepts will vary as well as the weapons.

CHAPTER THREE ENDNOTES

- 1 The RFPI was a joint effort between the Office of the Secretary of Defense (OSD) and the U.S. Army; RAND support to the RFPI ACTD was jointly sponsored by USD(A&T) and ASA(RDA).
- 2 Different concepts have been researched and early versions demonstrated by defense contractors. These include TRW and its solid-state laser system and Westinghouse and its chemical mid-wave IR laser technology.
- 3 Recall that a loss is represented by an LER below 6:1; a draw, by LERs greater than 6:1 and less than 10:1; and a win, by LERs greater than 10:1.
- 4 In simulating the future Red force, we presumed the attack would be carried out like it was for the existing Red force (where Red attempts to overwhelm the smaller DRB from multiple axes of attack). In the future, the threat may adopt new ways to fight that mirror recent U.S. thinking (e.g., dispersed forces, maneuver by fire, use of deception), which were not assessed in this work.
- 5 It is postulated that a certain level of mobility, similar to artillery operating in shoot-and-scoot mode, may reduce the effects of top-attack weapons. However, this was not examined in this work.
- 6 ADAS is a five-microphone sensor system being built by Textron, Electronic Systems Division. Other unmanned ground sensors are being considered for ground forces, and ADAS provides a good exemplary use of such systems.
- 7 Other measures include cost-effectiveness and lethality per round fired and lethality per pound of deployment weight (for the respective units), which were also examined in the analysis (see Figure 3.18).
- 8 Forward placement of EFOG-M was used in this instance because of excursion sequencing; later runs showed rear placement to be superior.
- 9 PGMM-IR is one of several smart mortar cases examined; the most effective of these cases is when it is placed back in the force.

FOLLOWING PATH 2:

Making Light Forces Smaller and More Dispersed

IN THE PREVIOUS CHAPTER WE EXAMINED some relatively near-term upgrades to improve the capability of light forces placed in rapid-reaction missions, working mostly with RFPI concepts and technologies within the context of ACTDs. Although the ACTD's focus, by intention, was on providing near-term capabilities and on leveraging maturing technologies, as ideas were raised in this forum, new initiatives emerged, many concentrating on the farther term, which would permit more formidable changes. These changes took on one or more combinations or forms, including changes in equipment with new technologies, changes in operational concept, changes in force design, and changes in force structure.

In this chapter we shall consider concepts that have explored making light forces smaller and more dispersed. The fundamental logic behind these concepts is that dramatic improvements in precision-guided and smart weapons can enable a bigger share of battlefield firepower to be brought in from great distances, thus, in theory, requiring a smaller presence of organic weapons ("organic weapons" being those possessed by the unit itself). If fewer organic weapons are needed, then the ground force itself can be made smaller. In addition, if the ground force is smaller and lighter and dispersed, it is harder to find and thus a much more difficult target for enemy forces. Finally, because of the relatively small unit size, many units could be placed on a battlefield fairly quickly, even faster than a traditional light airborne unit.

Several recent initiatives have examined the idea of making light forces smaller and more capable. In this chapter we examine three such efforts:

- One from the DSB, based on a reduced-size division ready brigade.
- One from TRADOC, based on its light battle force concept.
- One from DARPA, based on its small unit operations (SUO) concept.

As in the previous chapters, we first set up the context for each analysis. Then we present the "soldier perspective" of the concept, followed by after-action reviews that provide detailed outcomes of the analysis.

Defense Science Board's Small, Dispersed Forces Concept

Analysis Context

The Office of the Secretary of Defense formed the DSB Task Force on Tactics and Technology for 21st Century Military Superiority to explore new concepts for making a relatively small and rapidly deployable force capable of accomplishing missions that would otherwise require a large, massed force. The DSB identified different ways of achieving a capable small, dispersed force. One concept that was examined in detail represents an evolutionary change from the current small forces, such as the DRB of the 82nd Airborne Division. In it, the force is envisioned to remain a small, mostly self-contained unit such as a DRB, but it is given the mission and capability of a larger unit, such as a division. This may be accomplished by augmenting many of the DRB's current components with advanced RSTA, C2, and weapon systems and removing less-relevant systems. While similar in some ways to the RFPI ACTD, this concept, rather than emphasizing organic capability, stresses joint "external" capabilities, such as remotely located RSTA and long-range fire-support system technologies.

RAND supported the DSB effort by using high-resolution simulation to explore and quantify the potential contributions of the small, dispersed force concept in a specific set of circumstances—the early-entry phase of a major contingency, when only light forces are in place. These light forces are required to defend a high-value area against a large attacking armor force.

The scenario used here is the same LANTCOM scenario discussed in Chapters Two and Three and illustrated in Figures 2.5 and 2.6; in addition, in the base case we use the same force mix described in Chapter Two and illustrated in Table 2.2. In upgrading the base case DRB in this chapter, we examine different parts of the DSB concept sequentially.

The first series of modeling runs examined RSTA performance. We augmented the base case DRB with a reconnaissance system similar to the Commander's Observation Vehicle for Elevated Reconnaissance (COVER) system. With COVER, scout vehicles are given a small tethered UAV that yields a largely unobstructed overhead view (see Figure 4.1). We then added two RFPI systems: acoustic sensor arrays and remote sentries. The last RSTA system added was a standoff high-altitude endurance (HAE) UAV (based loosely on the DARPA Tier II+, Global Hawk system) with foliage-penetrating synthetic aperture radar (SAR) and ground moving target indicator (GMTI) radar.

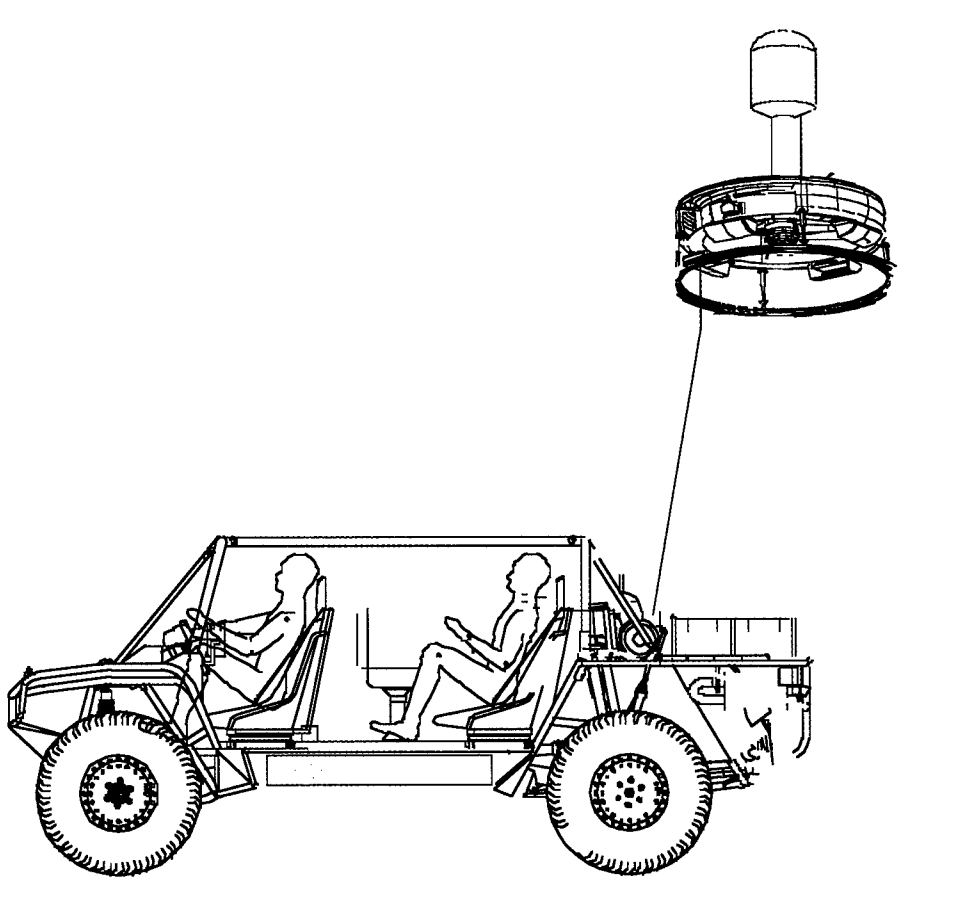

Image courtesy of Perceptronics, Inc.

Figure 4.1—Early Drawing of COVER System

The second set of runs examined the application of joint weapons options that are not organic to the DRB, including ground, air, and naval long-range systems. These excursions were made under more optimal RSTA conditions, with all systems included in the force mix.

The final set of runs looked at the utility of force dispersion. The base units were spread out over an area 5 to 6 times as large as in the base case. This dispersed force was attacked with two different levels of enemy artillery preparatory fires.

Experiencing the Small, Dispersed Forces Concept

ALTHOUGH THE LIEUTENANT'S UNIT OCCUPIED THE HIGH GROUND and had the theoretical advantage in battlefield position, it was difficult to fully see it that way. The mixed terrain only permitted partial views of the enemy's avenues of approach, and there were many blind spots that concealed the enemy's possible attack route toward them. He knew his brigade commander would use the new scout vehicles, the ones with an attached UAV that could hover above the treetops, to help with these blind spots. A combination of unmanned sensors and acoustic sensors were also being used, the latter to help compensate for LOS-restricted positions. As a final aid for overcoming the obscuring terrain, the unit had an HAE UAV, derived from the new Global Hawk. With its foliage-penetrating (FOPEN) radar, the UAV would give the unit overhead coverage and thus near-real-time situation awareness.

To help reduce the unit's overall detectability and to make it more survivable, his force was spread out much more than normal. Since the brigade had access to an unprecedented amount of remotely located firepower—in addition to strike aircraft, there were over 100 Navy versions of the Army tactical missile system (ATACMS) armed with brilliant anti-tank (BAT) submunitions sitting off the coast some 100 miles away—the lieutenant knew the unit could call on lethal fires for protection when needed. Since TACMS are ballistic missiles, they could travel well over Mach 2 for much of their flight, taking only minutes to reach their destination to support the ground forces.

As the enemy began its attack, the HAE UAV provided a good indication of the intent of the enemy's advance. The main attack was coming from the northwest. The overwhelming size of the enemy force dwarfed his unit's manpower and presence, but the lieutenant knew that most of their own firepower was waiting offshore. As soon as the forward-emplaced RSTA network could locate the enemy's armored vehicles, they would call for fire missions. His job was to direct the reconnaissance teams located to the west. To do this, he needed to be in the battalion command and control vehicle (C2V), not only to see the "big picture" but also to plan the long-range call for fire. After all, it was his teams who were at risk.

*Initially, he used the unmanned systems to provide targeting information on the approaching enemy. It always impressed him to see the level of automation now embedded in the C2 process—much different from the old days. Rather than wait for the enemy to enter a preplanned named area of interest (NAI) and a target area of interest (TAI) and then issue a call for fire, he could easily select engagement areas **on the fly**. Once a platoon-sized grouping of vehicles was identified, a call for fire was issued against the location (with appropriate lead being automatically computed). Since the*

The overwhelming size of the enemy force dwarfed his unit's manpower and presence, but the lieutenant knew that most of their own firepower was waiting offshore

submunitions in the TACMS had a very large footprint, targeting error was not as important as it used to be. As calls were made, he had to wait roughly 10 minutes before the effects took place. Through the optical sensors, called remote sentries, he could sometimes see the damage as it was happening. The monitor layout in the C2V resembled that of a newsroom, with different reports and imagery coming in simultaneously and being rapidly processed.

The battle was slow to unfold. Sometimes they would wait for the BDA report to come in and then assemble another fire mission. But as the battle progressed, soon the brigade was firing at will without waiting for BDA. The TACMS were used quite liberally, and they were running out.

*At this point in the battle, the enemy had been greatly reduced in mass. By the numbers alone, the Blue force had already won. But the lead enemy tanks kept coming. These lead tanks had no idea how many vehicles behind them had been destroyed by the Blue force. As they closed in on their objective, the lieutenant in the C2V could see that **his teams** were now in direct-fire range of the enemy tanks. Since the force was so dispersed and had little in the way of organic firepower, he knew that the next fire mission would arrive far too late. Besides, he would need to call for fire right on top of his own position.*

It didn't take more than a minute until he heard the order come in: "Vacate headquarters!" He grabbed his objective crew-served weapon (OCSW) as he headed for the hatch. He could actually feel the vibration from the approaching enemy tanks. "Where do we go now?" he thought quietly to himself. This would not be a good day for the Blue force.

After-Action Review of the DSB Small, Dispersed Forces Concept

Here we look briefly at the base case analysis, and then we examine the results of upgrading the base case in terms of the DSB small force concept discussed above, answering four key analysis questions:

- What kinds of opportunities do different RSTA concepts provide?
- How do different levels of target acquisition affect long-range weapon performance?
- Given best RSTA, can external long-range weapons defeat armor attack, or will units need organic capability?
- How does dispersion affect the indirect- and direct-fire engagement dynamics?

Base case analysis. As the discussion in Chapter Two for the LANTCOM scenario made clear, a base case DRB does not fare well against a large attacking force. Figure 4.2 shows how available RSTA organic to the base case DRB supported the battle.¹ Comparison of the location of target acquisitions to the location of engagements reveals that the target acquisition ended up supporting an intense direct-fire battle. Although the target acquisition capability may have cued the indirect-fire systems—105mm and 155mm towed howitzers—since there was little overall lethality, it can be argued that this capability was not fully utilized. This is especially so since most of the Blue direct-fire systems were self-targeted anyway, as they directed their fires at targets they themselves identified.

What different RSTA concepts provide. In upgrading the base case DRB, we first examined the situation awareness that several different combinations of future RSTA systems provided. Starting with what the base case DRB already has—forward observers

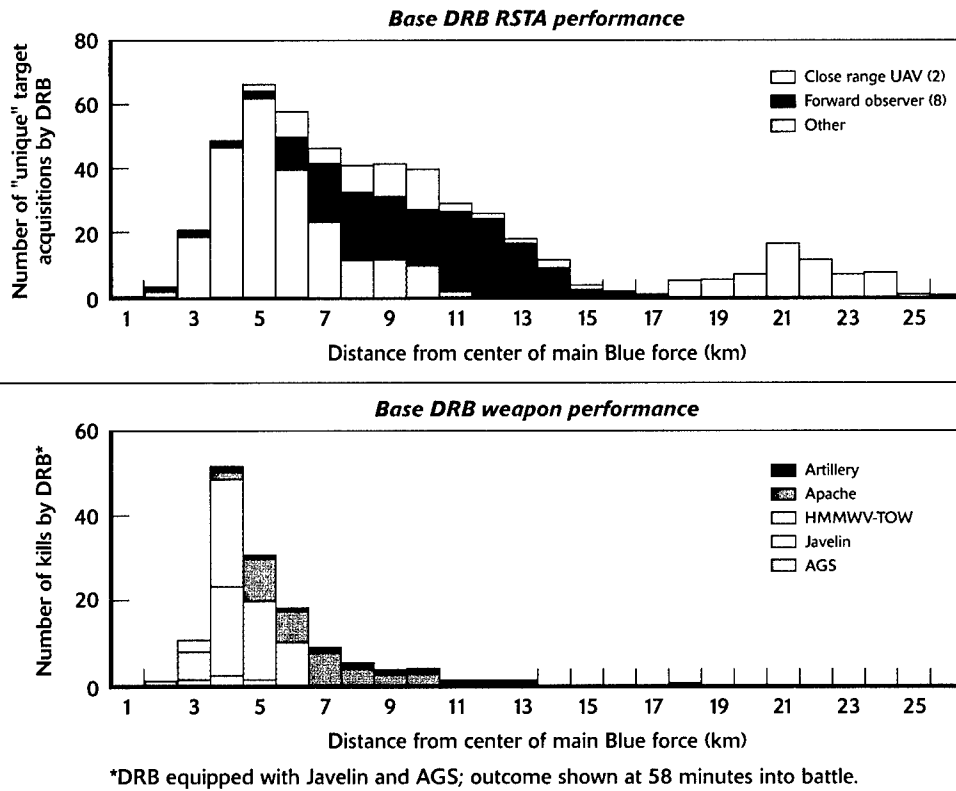

Figure 4.2—Contribution of RSTA to Base Case DRB Performance in the LANTCOM Scenario

(FOs) with laser rangefinders and designators and tactical UAVs with stabilized FLIRs—we added some future systems.

The future systems included COVER (a small tethered UAV 200 feet above its associated scout vehicle),² distributed acoustic sensors and acoustic/imaging remote sensors (similar to those envisioned in the RFPI ACTD), and high-altitude endurance (HAE) UAVs. All except HAE UAV are modeled explicitly. Acoustic phenomena such as non-LOS sensing, triangulation among sensors, and target loudness levels are all represented in the model. Imaging system sensitivity is similarly captured, using modifications of detection model algorithms. However, the HAE UAV with GMTI radar is represented statistically. A standoff system should be able to perform GMTI across the entire region quickly. In foliage-penetration mode, it should be able to penetrate brush easily and trees with some difficulty. The resulting picture should show most moving targets, but with limited location accuracy and type discrimination.

Overall, we found that ground-based RSTA gives accurate but limited coverage, while overhead systems complete the picture but with much less accuracy. Below we discuss this finding in more detail.

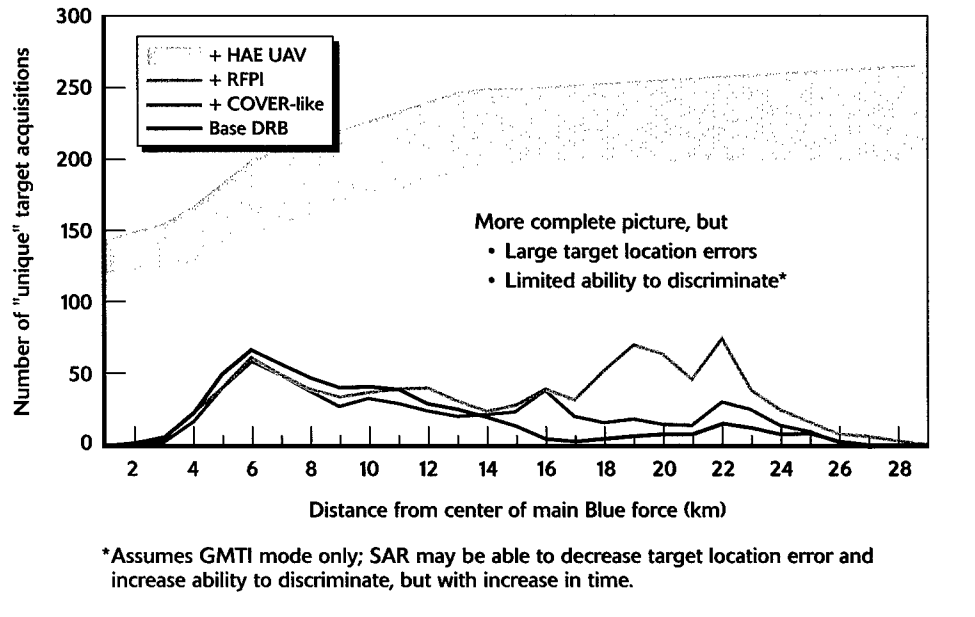

Figure 4.3—Effectiveness of Adding in Each RSTA System

Figure 4.3 shows by range a comparison of RSTA detection completeness as each system is added. The base case DRB systems—FO, UAV, and direct-fire platforms—are shown by the black line, with many detections at 14 kilometers or closer. Adding the COVER-like systems (in hide positions) provides more detections at depth, and the distributed unattended (RFPI) sensors further fill out the long-range detections. HAE UAV (the thick lined band across the top) gives a picture of virtually all enemy systems.

The quality of detection also varies with system. Basic DRB systems are typically “eyes on the target” and tend to be high-accuracy, high-confidence detections. The other systems tend to have less accuracy and discrimination of target type, with HAE UAV in its GMTI mode just providing indications of unit size, speed, and general area. SAR-mode imaging of the targets can be done by the UAV with high resolution and good location accuracy, but this takes significantly more time than GMTI and covers much smaller areas, as returns have to be integrated over a several-degree rotation angle around the target.

As shown in Figure 4.4 (the counterpart to Figure 4.2 for the upgraded DRB), although advanced RSTA—exemplified here by a force with COVER-like systems and RFPI unattended sensors—provides detection over much of the battlefield, the organic indirect-fire weapons associated with the base case DRB cannot capitalize on the information. The lethality of the force is essentially the same as it was with the base RSTA, shown in Figure 4.2. We also noted few opportunities to effectively reposition the Blue force with the added RSTA contacts.

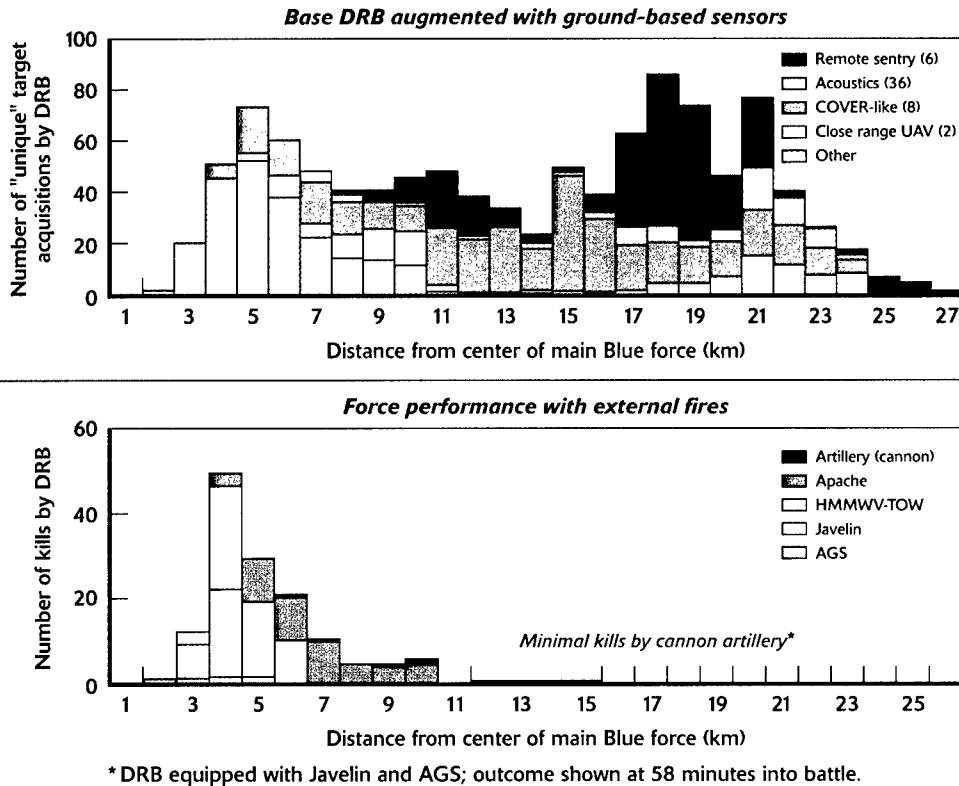

Figure 4.4—Contribution of RSTA to Upgraded DRB Performance

The effect of adding a remotely located long-range weapon. Given how little the upgraded RSTA systems contributed to the DRB performance (because the DRB did not have the weapons to fully capitalize on it), we introduced a new long-range weapon to be located external to the force itself. This weapon was represented in the analysis as a responsive ballistic missile with large-footprint advanced submunitions, based on the ATACMS Block II. We applied this new capability to the same conditions examined before to determine what the effects of different levels of RSTA combined with such “external” fire support would be. Up to a point, we found that adding a remotely located, long-range weapon could improve force performance. We explain this finding in more detail below.

We assumed that the time-on-target (TOT)—the time from target detection to munitions arriving at the predicted point—was 10 minutes for the long-range weapon. Standard TTPs for this weapon required company- or battalion-sized targets to be present, because the weapon dispensed many individually targeted smart submunitions. In our simulation runs, an active-duty artillery officer calculated lead distances and targeted the munitions as targets presented themselves on the JANUS simulation screen.

Table 4.1—Effectiveness of Remote Missile by Level of RSTA

DRB Force	Number of Missiles Fired	Number of Missile Kills	Number of Direct-Fire Kills	LER
Base case DRB RSTA (FOs and UAVs)	N/A	N/A	136	4.2
COVER-like system	18	58	126	5.0
Plus RFPI ground sensors	34	106	107	6.8
Plus HAE UAV	36	119	106	6.8

NOTE: Missiles with large-footprint submunition fired at targets with 10-minute time-on-target response.

Table 4.1 shows that with base case DRB RSTA (FOs and UAVs), no appropriate target opportunities were seen for the long-range weapon. When the COVER-like system was added, nine aimpoints were selected (fired at with two missiles each). This resulted in 58 kills by the long-range missiles and a reduction of direct-fire kills. Further adding two RFPI RSTA systems (acoustic sensors and remote sentry) roughly doubled the number of aimpoints and kills. Interestingly enough, adding the HAE UAV did very little beyond what the ground sensors provided. The minimal increase with HAE UAV over the RFPI sensor network seemed to be the result of the decreasing usefulness of further data. Most large targets were seen with the distributed ground sensor network, and the large-footprint submunition made up for targeting errors induced from partial information. Nonetheless, the more complete information from the HAE UAV greatly increased the commander’s confidence in conducting a fire mission.

It is worthwhile to point out, in all cases above, that there was still a substantial direct-fire battle, with more than 100 target kills by Apache, TOW, AGS, and Javelin. Well over half of all enemy vehicles survive the attack. Figure 4.5 highlights the problem. Even with the substantial target acquisition in the RFPI RSTA case, only a percentage of Red systems were engaged and destroyed by the long-range missile system.

We determined five reasons why long-range target kills were so much lower than the number of long-range acquisitions. First, many of the targets were spotted in groups of one to three—smaller groupings than required for calls for fire, even when the same targets were seen repeatedly. Second, there was a refractory period during missile flyout, in which the commander would have to wait for BDA on the targets before firing more missiles. Third, most targets were moving and would often turn at road junctions or transition into spread battle formations. This resulted in some misses with the 10-minute TOT. Fourth, the submunitions followed a group logic, in which they would distribute themselves among the targets. This logic was imperfect and often concentrated the submunitions toward high-signature targets, resulting in overkills. Finally, as the engagement ensued, targets became attrited and spread out, resulting in more difficult targeting and submunition encounters. In general, the third and fourth reasons are moderately important in this scenario, while the others have somewhat lesser impacts.

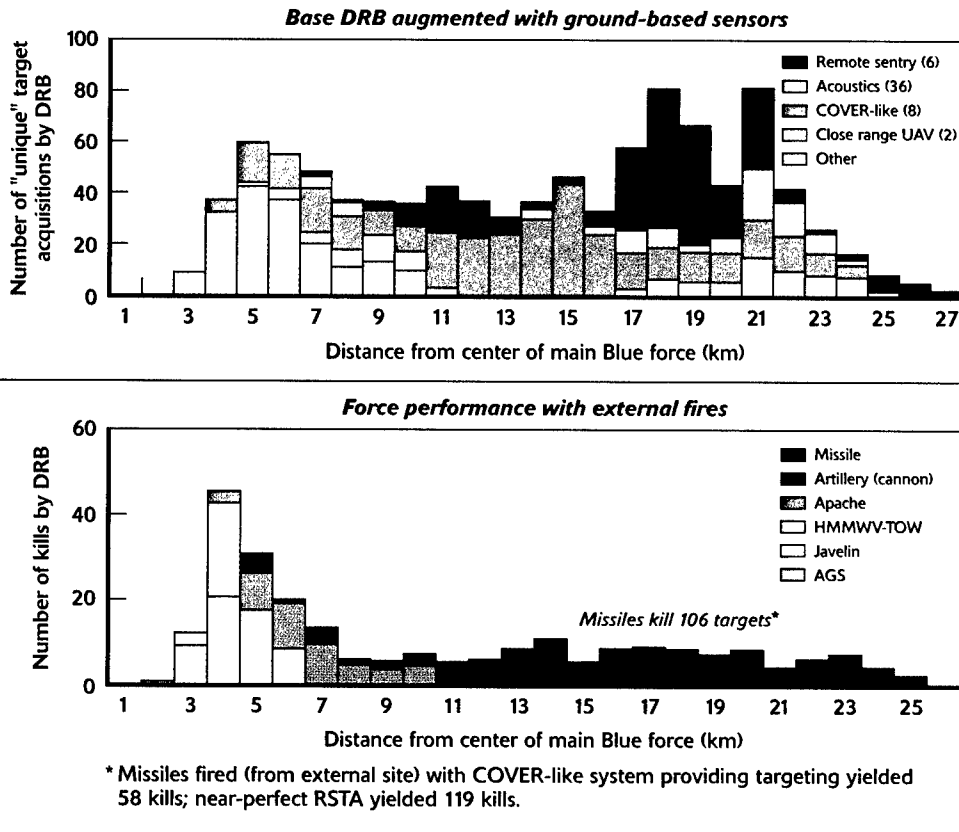

Figure 4.5—Contribution of RSTA and External Missile to Upgraded DRB Performance

Are the external long-range weapons the limiting factor? An important question was whether external, long-range fires alone could stop the enemy attack. Accordingly, we assumed near-perfect RSTA (all systems including HAE UAV) and examined the effectiveness of two different long-range weapon systems: the long-range ballistic missile with large-footprint submunitions assumed before and another air-delivered weapon with small-footprint submunitions. To look at many factors, we examined a subset of the LANTCOM scenario, and all runs were made with our smart munition model running in stand-alone mode. Interesting cases from this stand-alone parametric analysis were then examined in the larger force-on-force context in the JANUS simulation.

Assuming the best RSTA case, we varied two parameters in our excursions with the two long-range weapon systems. First, the timelines were varied to be instantaneous (this can be thought of as immediate C2 and a very fast flyout, or as updating right over the target; it results in zero delay in the stand-alone analysis and a one-minute delay in the force-on-force simulation, for munition drop), and 10- and 20-minute TOTs. The second factor was the volume of fires applied. A conservative criterion was one missile or one munition dispenser (canister) per aimpoint, while unconstrained fires typically

had four times as many missiles or canisters launched (with additional aimpoints). In terms of target set, we only targeted the dense on-road target set.

Figure 4.6 shows results for the large-footprint submunitions delivered by missile. The Y-axis is kills per missile, while the X-axis is the percent of total targets killed. For example, on the X-axis, a 50 percent score means that 44 of the 88 targets are killed. The lines for each TOT assumption (instantaneous, 10-minute, and 20-minute) show that diminishing numbers of targets are killed as the volume of fires goes up. In all cases, an increase in the number of missiles launched results in an increase in the total number of kills but substantially reduces the number of kills per missile. The lines also show that 10-minute TOT has almost the same efficiency as instantaneous TOT, because the large-footprint submunition is able to make up for targeting errors induced during such short times.

It should be noted that the results shown above are for a single volley attack, without use of BDA and later reattack of the targets. Our JANUS excursions showed somewhat greater effectiveness with multiple-volley attacks using BDA.

Figure 4.7 shows the comparable results for the smaller-footprint weapon. The smaller-footprint weapon showed markedly higher sensitivity to TOT, as one would expect. A 20-minute TOT yielded fractional kills per munition dispenser, because the target moved out of the footprint, even with lead applied to the targeting on a road. At 10-minute TOT, the weapon was more effective but still limited. Also, higher volumes of fire did not show the same level of saturation found with the large-footprint weapon. Nonetheless, a diminishing marginal returns effect was seen. Instantaneous delivery was

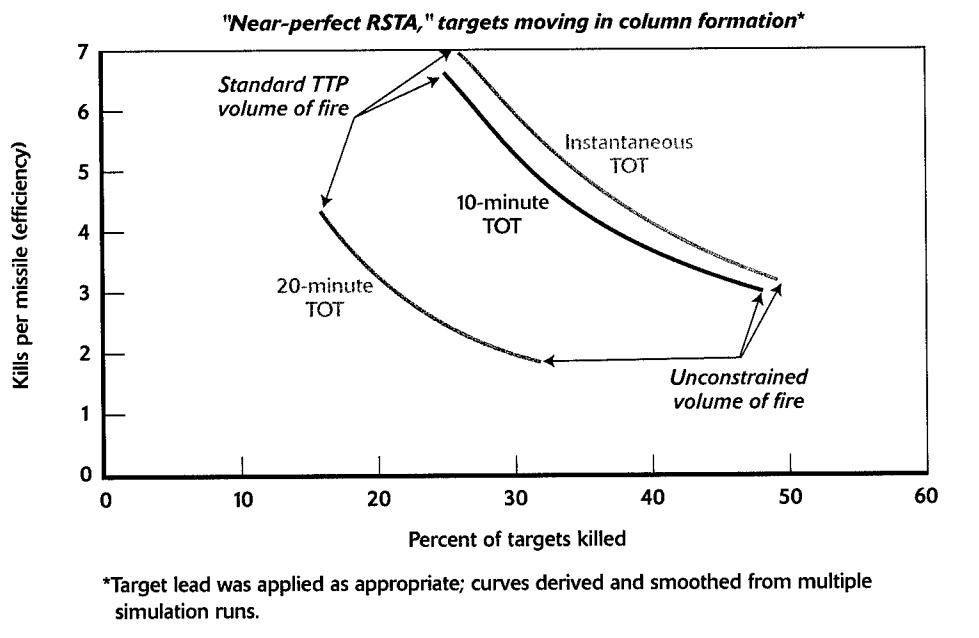

Figure 4.6—Impact of Large-Footprint Weapon on Target Set

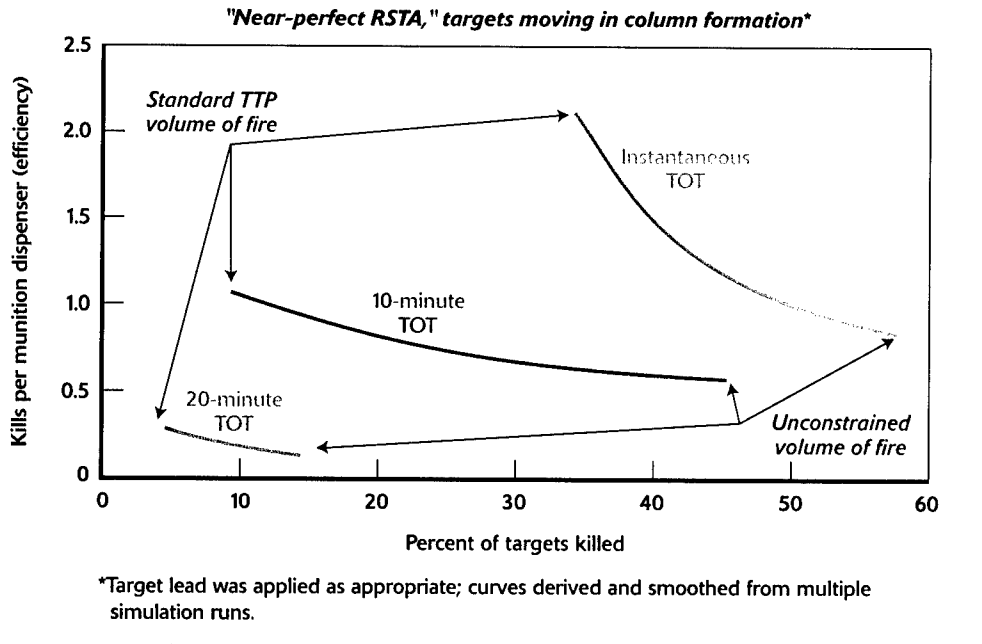

Figure 4.7—Impact of Small-Footprint Weapon on Target Set

highly effective with this system, yet it still yielded no more than 50 percent kills of the total target set, even with very high volumes of fire.

We then extended the results obtained in the stand-alone smart munition model by making excursions with the larger-scale JANUS simulation. Here, we examined the impact of volume of fires and reduced timelines on the effectiveness of the large- and small-footprint weapons. The runs differed from those in the stand-alone smart munition model in several ways: the entire threat force was engaged, multiple volleys were fired, and BDA was present. In all cases, near-perfect intelligence (ground sensors and HAE UAV) was assumed.

Volume of fires was varied by increasing the number of missiles or munition dispensers per aimpoint, and in some cases by adding more aimpoints. Just as with the stand-alone runs, we found that higher volumes of fires led to decreasing marginal returns. We also noted that higher volumes of fires resulted in more rounds landing near friendly forces. No hits were seen, however, because the Blue vehicles were typically stationary, with limited signatures.

Improved TOT had very different effects with the two weapons, as seen in the stand-alone simulation. The large-footprint, missile-delivered weapon was able to compensate well for target movement during flyout, while the small-footprint, air-delivered weapon would often miss moving targets when there was a time delay.

Figure 4.8 illustrates the combined effect of volume of fires and TOT for the large-footprint weapon. The upper graph shows a volume of fires roughly twice that shown earlier. We find that roughly doubling the number of missiles achieves only 50 percent more target kills.

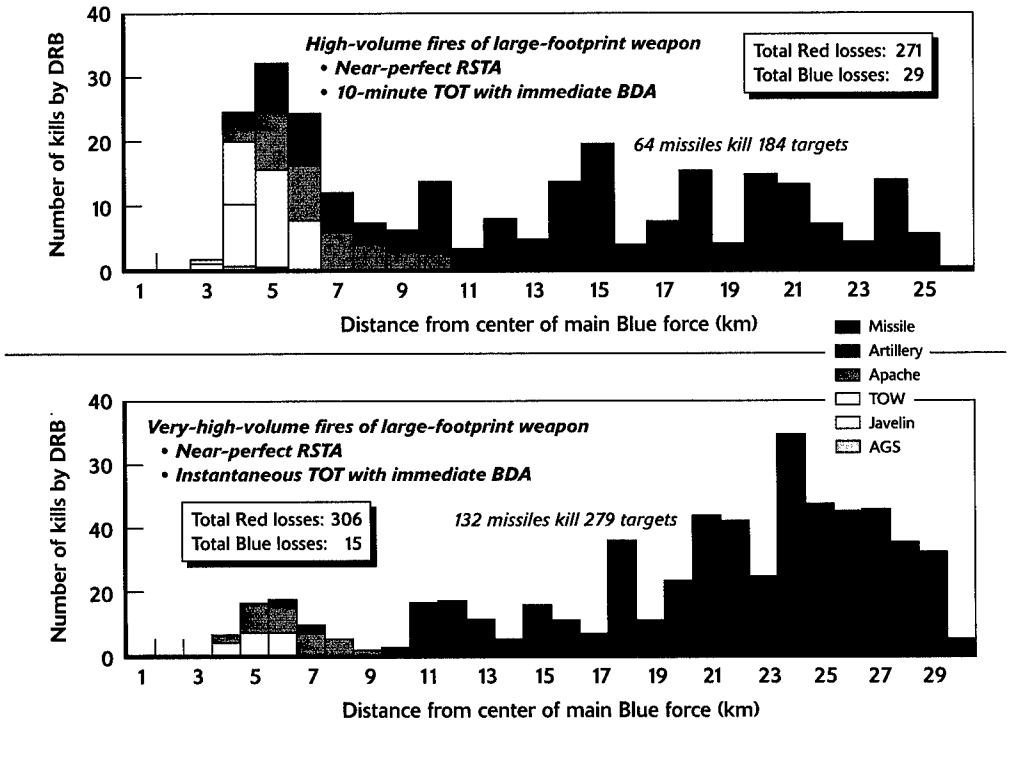

Figure 4.8—Combined Effects of Volume of Fires and TOT for Large-Footprint Weapon

A major change is shown in the lower graph. Here, we roughly quadruple the number of missiles and change the TOT to instantaneous. Long-range missile kills now occur farther out, causing much more enemy attrition than seen in earlier cases. *However, even with these exceptional conditions—near-perfect RSTA, instantaneous TOT, and very high volume of fires—a significant portion of the attacking enemy force survives.*

There is a better way to enhance force protection. In Chapter Three, we examined a wide variety of advanced organic indirect-fire weapon systems, among them EFOG-M, HIMARS/Damocles, 155 SADARM, Smart 105, and PGMM. This work highlights some of the apparent differences (and the complementary nature) of these organic systems when used in conjunction with the external long-range fire systems.

Both of the external long-range fire systems we have considered are multiple submunition concepts designed to attack massed armor targets. They work well when the targets move in predictable patterns across roads and open areas, and they are especially good at chokepoints.

The shorter-range organic systems range from multiple submunition concepts to individually targeted missiles and artillery rounds. Many of these are able to attack individual targets moving from cover to cover with short opportunity windows. Some systems such as EFOG-M are also able to discriminate in flight between target types—live

and dead, friendly and enemy, and high value and low value. Other weapons, such as HIMARS/Damocles, are effective at longer ranges in counterbattery fire.

Figure 4.9 illustrates the differences between a very-high-volume external missile attack and a more balanced attack (using standard TTPs) employing both external and organic indirect fire. The very-high-volume missile attack (the same graph we saw in the bottom half of Figure 4.8) results in large numbers of kills at deep ranges, but the ability to attrit (and the level of efficiency) drops off at closer ranges—resulting in a small residual direct-fire battle. In contrast, the more balanced attack, which uses standard TTPs, results in relatively moderate attrition at deep ranges, and many of the closer-in engagements are handled by more efficient organic indirect fires. High-value enemy artillery targets are targeted primarily by HIMARS/Damocles, while armor is primarily targeted by EFOG-M. The “shape” of the attrition is significantly different between the long-range external and combined external/organic cases, but the outcomes, in terms of direct-fire battle intensity and overall LER, are quite similar.

In an additional excursion (not shown here), two less active indirect-fire systems, HMMWV-TOW and AGS, were removed from the scenario. This resulted in the same overall lethality (number of Red systems killed), but it reduced the Blue losses by 30 percent.

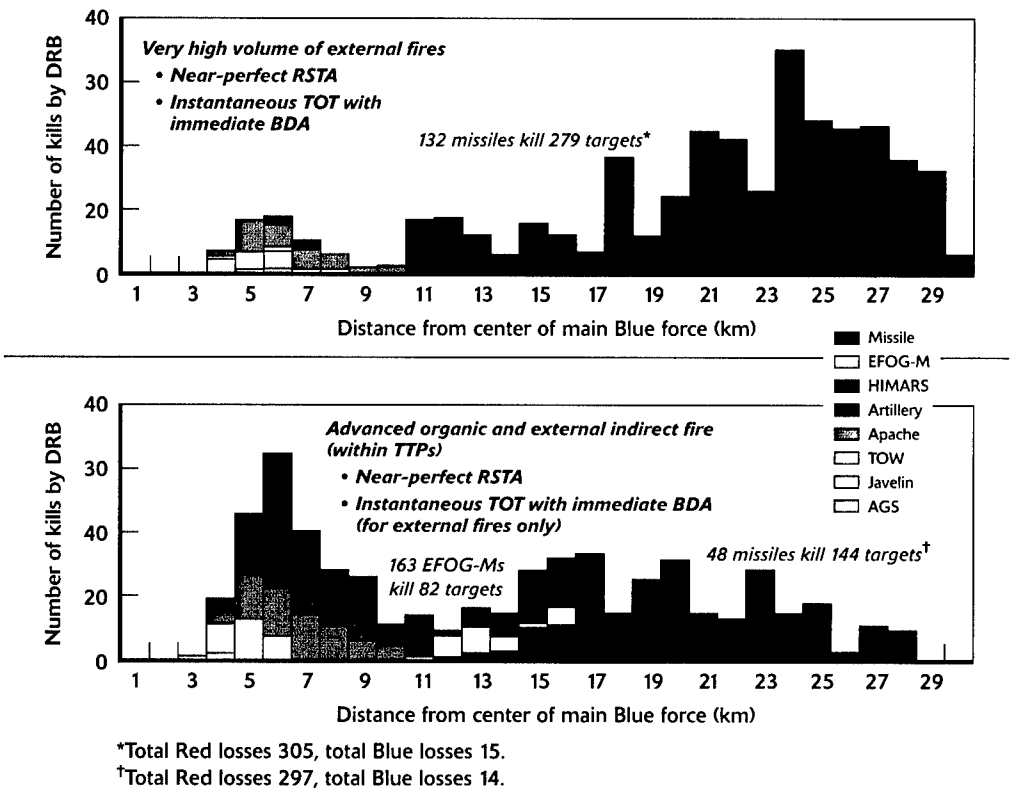

Figure 4.9—How Organic and External Fires Complement One Another

How dispersion affects indirect- and direct-fire engagement dynamics. As a final part of the analysis, we examined the impact of force dispersion. With the base case DRB, we found that a rough, first level of Blue dispersion resulted in fewer losses to enemy artillery, as one would expect. At the same time, the larger defended perimeter resulted in a more heated direct-fire battle and easier Red penetration. In a similar vein, we looked at a first level of dispersion of the Red force. This resulted in a moderate reduction of the effectiveness of Blue long-range fires. These findings are discussed in more detail below.

The actual level of dispersion is shown graphically in Figure 4.10. The original Blue DRB laydown involved positioning the force on a dominant hill mass approximately 4 kilometers long and 2 kilometers across. Dispersion of the force kept one battalion on the hill mass and the second battalion on high ground to the south. Interlocking, supporting fires were still possible between the battalions, but the area covered by the force expanded by 5 to 6 times compared to the original formation. Red also modified its attack against the dispersed force, shifting its thrusts and massing its fires against new areas. The dispersion illustrated represents a simplistic first level of spreading the force.

We found that dispersion of the Blue force did in fact reduce its losses to enemy artillery. The dispersion effect was greater with the moderate level of artillery found in the basic scenario than when artillery was increased to higher levels (36 SP-152mms instead of 12 in the basic complement; 90 total Red artillery systems instead of 18 originally).

The picture changed dramatically in the direct-fire battle. Regardless of Red artillery level, the dispersed force suffered more direct-fire losses and achieved a lower overall LER than the nondispersed forces. This appeared to be because the larger perimeter resulted in less efficient overlapping fields of acquisition and fire for Blue and permitted

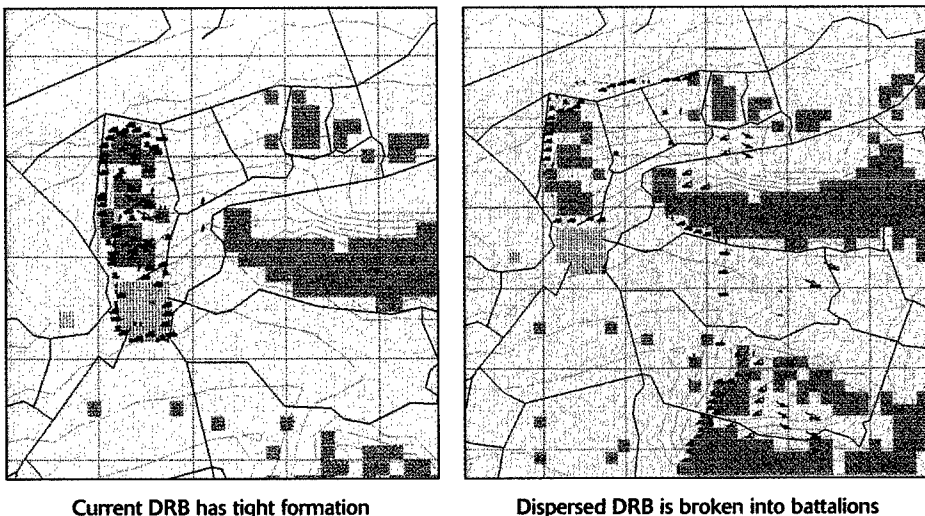

Figure 4.10—How a DRB Might Be Dispersed

more efficient simultaneous application of Red firepower. Red was better able to mass fires and penetrate the thinner Blue perimeter.

Red has many options to counter the effects of long-range fires. One of the most fundamental is to disperse itself. We examined a first step in this direction, by breaking up the battalion units along the roads into company-sized ones, with commensurate spacing down the echelons. The force was then more spread out and targeting was more difficult: missiles were fired later, fewer launches were made, and total kills were reduced. The effect would have been even greater, but the dispersed target spacing was in many places a better match with the large-footprint weapon's spread logic than the nondispersed target set, resulting in fewer overkills and misses. Further spacing may not exhibit this behavior.

In general, the DSB concept for enhancing small dispersed forces with external RSTA and weapons offers tremendous potential for improving the outcome of battle. However, the concept relies on many steps to operate effectively: acquiring targets, passing information, assigning weapons, dispensing munitions, performing BDA, and many others. Each of these steps must function well for the concept to succeed.

Up to a point, we found that adding layers of ground-based and overhead RSTA could significantly improve situation awareness and enhance the application of external fires. The situation estimate can seldom be both complete and accurate, though, and different types of sensors contribute different inputs to the overall picture. In cases where there was overlapping coverage, the redundancy nevertheless added value in the form of commander confidence in committing rounds.

The notion of "if you can see it, you can kill it" was not demonstrated here. External fire support may exhibit long flyout and cycle times and may not be able to engage targets as decisively as organic weapons can. This can be especially true if the enemy uses deliberate countermeasures.

In view of such uncertainties, a force equipped with organic firepower appears to be essential, especially so when either an objective must be protected or an area denied to the enemy. Although our research does suggest that the amount of organic capability can be reduced given a significant presence of effective external RSTA and fire support, the most attractive and robust solution for enhancing the capability of small forces was a mix between advanced organic systems *and* external systems.

TRADOC's Light Battle Force Concept

Analysis Context

RAND used a similar methodology to analyze the effectiveness of a light battle force concept. The effort fits into AAN's mission statement to "conduct broad studies of warfare to about 2025 to frame issues vital to the development of the U.S. Army after about 2010 and provide those issues to senior Army leadership in a format suitable for inte-

gration into TRADOC combat development programs” (from the initial Army After Next Mission Statement, TRADOC, 1996). To some extent, this AAN concept is a natural follow-on to the DSB research, in that it also relies extensively on both high levels of RSTA and remote, long-range (referred to here as “reachback”) weapons. In some ways, however, it takes the DSB concept some steps further. Most notably, the unit is completely dispersed, no longer occupying a specific area, and weapon systems have been replaced by immobile weapon “pods,” which can house a wide range of precision-guided weapons.

Generally, AAN is recognized as synergistically capturing and harnessing two critical elements for future warfare: speed and knowledge. With respect to intertheater mobility, the light battle force is envisioned to be an extremely fast, deployable force. This light battle force shares some characteristics with the Marine Corps’ Hunter-Warrior concept and with DARPA’s SUO force (described below). This light battle force, however, is not confined to littoral regions and is not envisioned to require a port or even an airfield to establish itself. Advanced airframes play a critical role in deploying the force, but once it is deployed, this force is not envisioned to have significant tactical mobility. Used primarily in a defense, this force relies heavily on information dominance and advanced precision-guided firepower (including U.S. Air Force integration) to repel an attacking force.

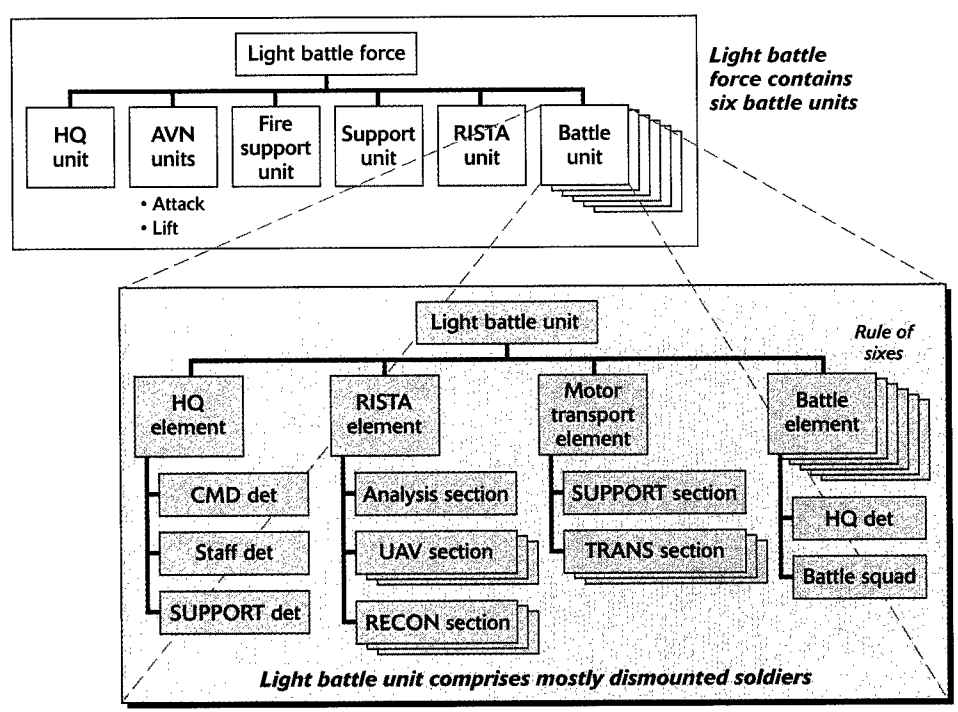

Figure 4.11—Strawman Organization for a Light Battle Unit

Figure 4.11 shows the organization of the light battle unit, which has been specified by TRADOC according to the rule of sixes: six battle units in battle force, six battle elements in a battle unit, and six battle squads in a battle element. Our simulation-based analysis employs a battle unit or more, with each combat entity in the unit being modeled individually. In addition to the battle unit, a slice of the larger battle force—aviation, fire support, RISTA (reconnaissance, intelligence, surveillance, and target acquisition), and other assets—is attached.

The light battle force concept is pictured in Figure 4.12. Enemy armor is detected with high-altitude UAVs, tactical close-range UAVs, and FOs from the battle element itself.³ The contacts are communicated back through airborne and terrestrial relays to the battle unit and to higher echelons of command. Calls for fire are made to organic assets—such as artillery, EFOG-M, and air defense pods—and to external assets—such as arsenal ship, MLRS launchers with ATACMS missiles, and Tac Air. Not shown are such additional aspects as Army aviation, airborne radar platforms, and GPS satellites.

The work focused primarily on the AAN light battle force, although many of the technologies and concepts also apply to the heavy battle force. The underlying concepts of AAN examined include information dominance and predictive planning, rapid and very light deployment, creation of quick-strike ambushes, and coordination of a variety of different standoff weapons.

For the analysis, we used one scenario from a large array of possible scenarios that vary in their terrain characteristics, threat sophistication, and environmental conditions. The chosen scenario involves a very rapid deployment mission to defend a large region

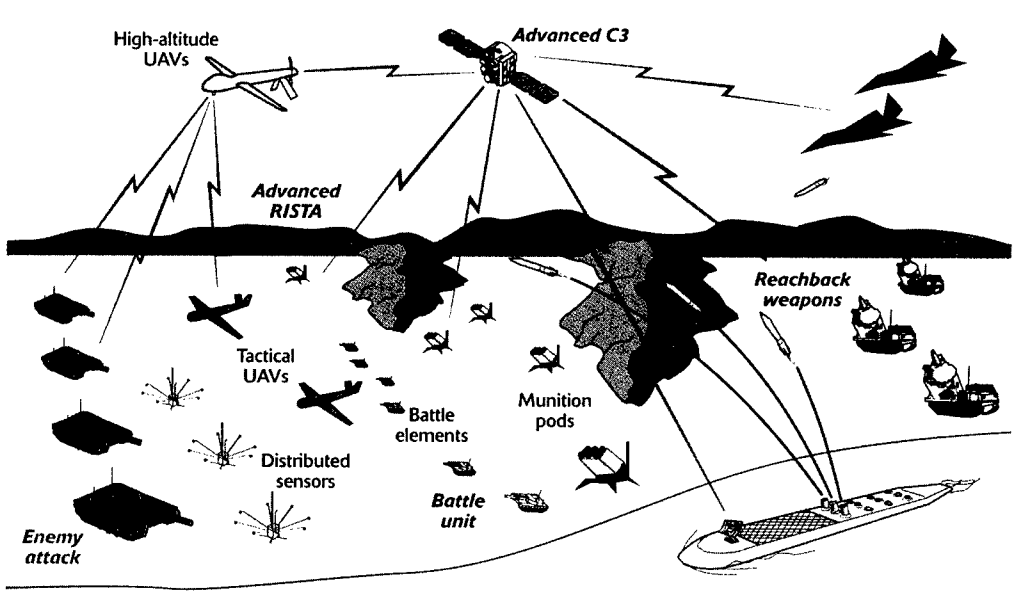

Figure 4.12—The Light Battle Force Concept

from encroachment and takeover by a neighboring power. The scenario takes place on mixed terrain, which includes both open areas and hilly, vegetated regions. With minimal warning time, the light battle unit is transported and then deployed over several hours during the night. The enemy launches its combined force attack at first light using mechanized armor and helicopters.

The primary mission of the light battle unit is to defend the region from being taken over by the enemy invasion. This suggests that the light battle unit must either repel the attack or slow it enough so that additional forces can be positioned to repel the attack. In lieu of a complete takeover, the enemy's intermediate objective is to advance into towns, some of which are as little as 10–15 kilometers from the international border. Political constraints do not allow the battle unit to either deploy across the international border or conduct any preemptive actions.

The Red plan of attack is shown in Figure 4.13. Red intends to make three thrusts across the international boundary with two advanced heavy brigades per thrust. The region shown is approximately 60 kilometers north-south and 100 kilometers east-west, where the terrain is mixed in nature—some open areas and other areas with hills and foliage. Although there is an extensive road network, for the most part it is not used because of the broad nature of the attack. Nonetheless, the attack moves quickly because of the cross-country mobility of the enemy vehicles (55 kilometers per hour). Many small towns act as intermediate objectives as Red moves quickly east. Red has approximately 1,500 systems, 200 of them advanced helicopters that move in three waves with the ground forces. Although air-based firepower can potentially respond rapidly to this enemy attack, tactical mobile air defenses preclude overflight with im-

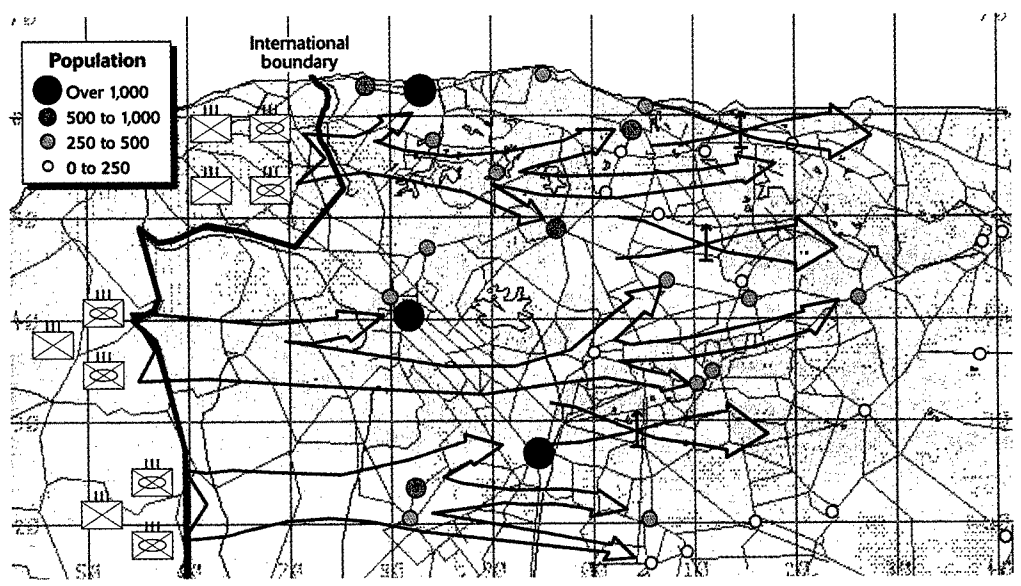

Figure 4.13—Red Plan of Attack

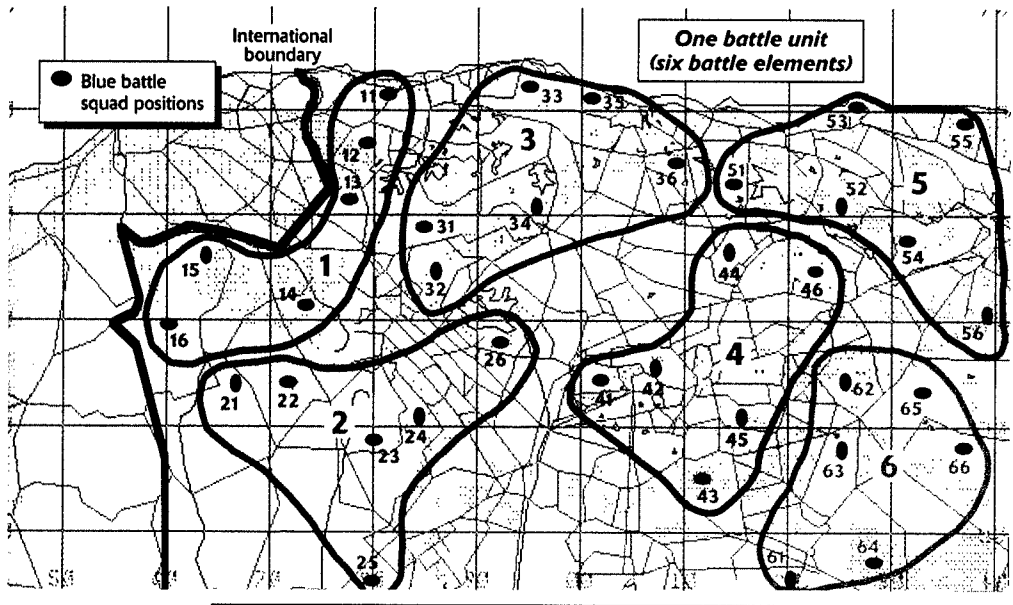

Figure 4.14—Laydown of Battle Units into Elements and Squads

punity. (Air supremacy has not yet been established.) Additionally, the combined urban areas and foliage can reduce the ability to find, engage, and destroy mobile targets from afar.

Because the Blue force is a light force equipped with only a few vehicles (primarily for the fire direction centers (FDCs) and fire support elements (FSEs)), most of the AAN forces remain stationary during the roughly 100-minute battle. There are 114 weapon pods, made up of three types: anti-armor artillery, advanced EFOG-M, and air defense. Each battle element has six seven-man squads, along with three tactical UAVs. The light battle unit additionally has six airborne radar systems (similar to AWACS in capability) and a high-altitude endurance UAV. To determine the coverage performance of the base set of AAN sensors, no distributed sensors were used in this set of runs. Also, since this is a division-level combat effectiveness model, lack of robustness in organizational structure is not tested (e.g., the ability to conduct 24-hour operations).

Figure 4.14 shows the organizational structure of the deployed battle unit. As noted earlier, a battle unit consists of six battle elements, and each battle element contains six battle squads. Each of the six battle elements is color-coded, and the lines containing their respective squads give some notion of each element's area of responsibility.

Figure 4.15 depicts the planned deployment of Blue battle squads and their allocations of munition pods. The white polygons indicate engagement areas for the battle unit. These areas were selected based on trafficability of terrain, road networks, proximity to intermediate objectives, and foliage level. When possible, Blue battle squads were not positioned inside engagement areas to minimize potential fratricide. The positioning of munitions pods is less restrictive. The Blue force depicted represents the

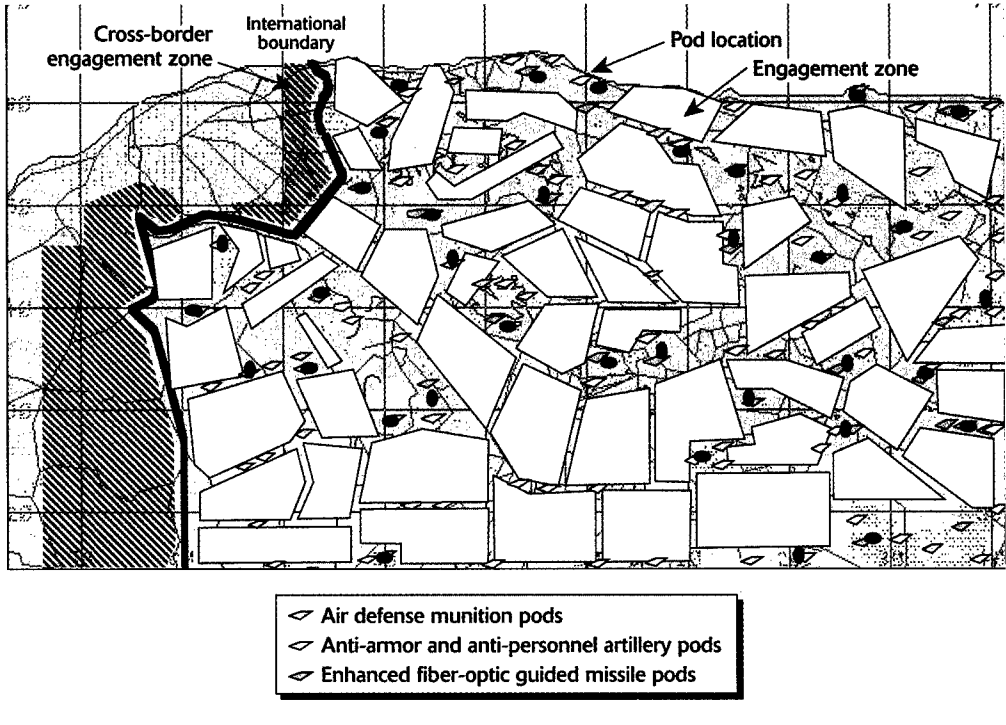

Figure 4.15—Integrated AAN Light Battle Unit in a Defensive Laydown

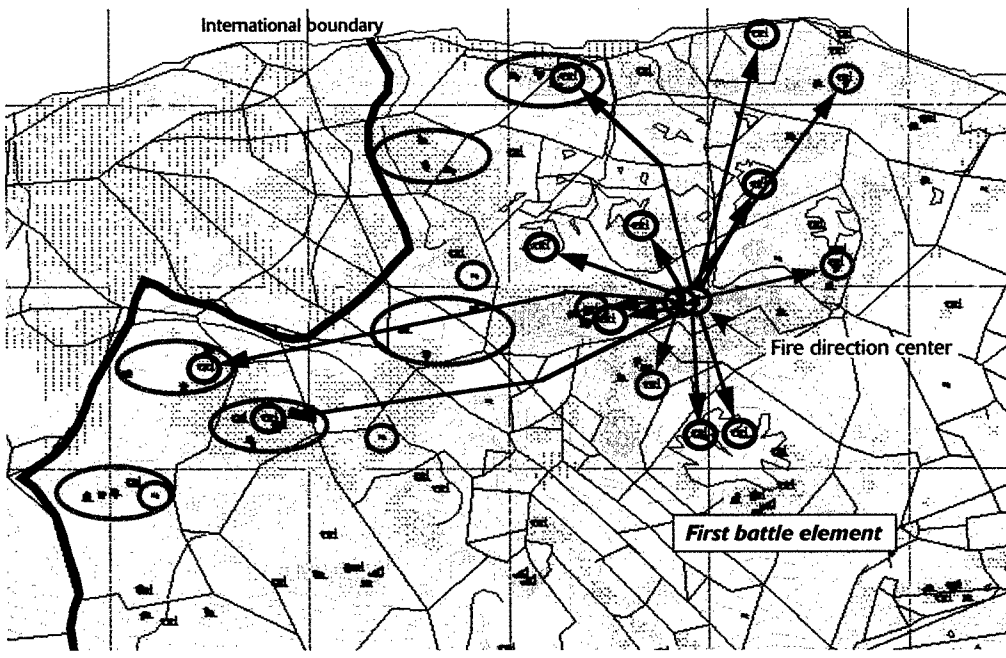

Figure 4.16—Example of C3 Link Between FDC and Artillery Pods

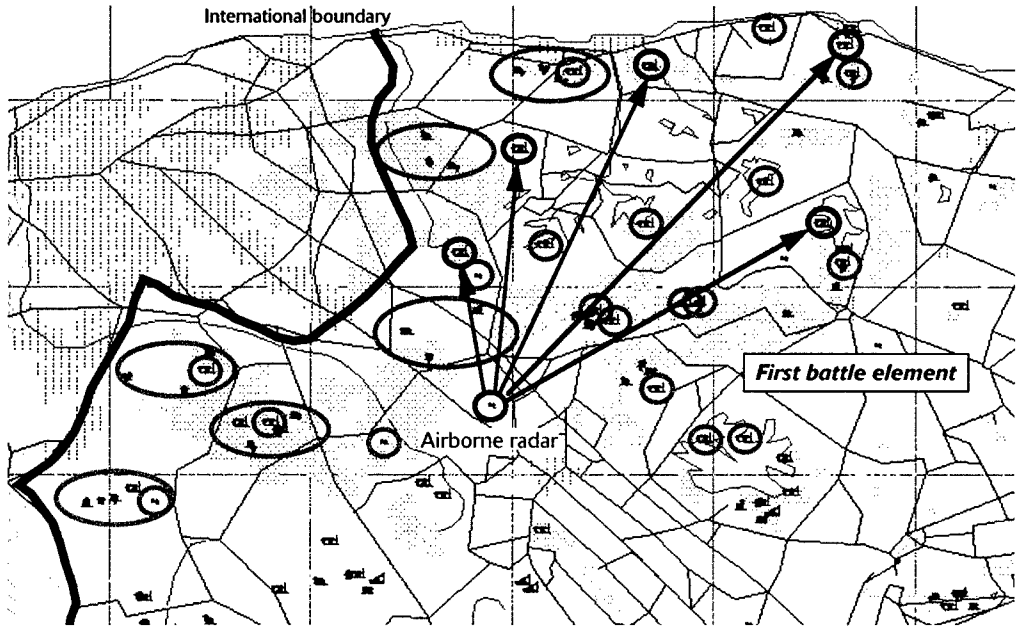

Figure 4.17—How Air Defense Is Cued

dismounted fighting elements of one complete battle unit that will participate in the indirect-fire battle. In some runs, an additional battle unit was equipped with direct-fire weapons (Javelin) and positioned in the towns for local defense.

One of the more extensive changes made to the model was in C2 modeling (coded into the MADAM model). Message passing nodes, LOS blocking, and delays are modeled between the sensors, battle unit and battle element FDCs and FSEs, and the weapon systems. Loss of any node, such as an FDC, results in a delay to reconfigure the system. Connections between the higher-level battle force TOC and the other elements are assumed (with delays only) and not explicitly modeled.

Figure 4.16 illustrates how we modeled fire support in the simulation. It shows the deployment of the anti-armor firing battery supporting the first battle element in JANUS. The FDC for the firing battery is circled in red. Ten of the 60 artillery pods are connected to this FDC, and they cover a large area that includes the area of responsibility of the first battle element.

A separate fire control system is used for air defense, the links of which are shown in Figure 4.17. That figure illustrates the deployment of an air defense firing battery (five pods) supporting the first battle element. As a reference point, the AWACS-like airborne radar platform is circled in red.

Experiencing the Light Battle Force Concept

THEY HAD BEEN DROPPED INTO POSITION the night before. Within minutes of arriving, the lieutenant confirmed radio contact with the other elements of his platoon. The radio was critical, for his four seven-man teams were dispersed over a large area. One team was about six kilometers to the north, another two were some five kilometers to the west, the direction from which the enemy would approach, and the fourth team was six or seven kilometers to the south. This was quite a bit of turf for one lieutenant to manage.

Interspersed among his teams were several weapon pods—the “rocket-in-a-box” that had first been issued to the force about two years ago. Most of his pods were anti-armor: EFOG-Ms and MLRS-type rockets. Both types launched vertically. Quickly, he made electronic status checks on the unmanned pods. Each team had to be able to call for fire from any pod, which meant that good comms was critical. Each team also had its own machine guns and Javelins. But it was not their mission to engage the enemy with those weapons unless they absolutely had to. With 5 to 8 kilometers between teams, it was pretty dangerous to expose yourself. Instead, they would fight with the precision weapons in the pods—plus other systems like the rockets from their supporting HIMARS that were 20 to 30 kilometers to the rear.

Within about 15 minutes of arrival, the company commander was polling the platoons and teams to ensure they were about where they were supposed to be. So far, so good. Digital communication was good, the teams had landed intact, and final positioning was taking place. The lieutenant looked down the valley to the east, toward the town. It was about 8 kilometers away. He knew another platoon was setting up inside it in case the enemy penetrated down the valley. The town was a key road junction and had to be held. Maybe the enemy wouldn't come; if it did, maybe the carrier that was offshore would pound its armor before it could reach them, and maybe if any armor broke through, his platoon could destroy enough so that the enemy would stop. Maybe. He wondered if any local civilians would stumble across his weapons pods that were scattered about. There were anti-tamper devices on each one. Hopefully, they wouldn't get too curious if they saw one.

Camouflage was set up, foxholes dug, and the FLIRs positioned where they could get the best view. Occasionally, the lieutenant would do a digital check with his teams, confirming they were ready.

Several hours passed. The sun was now up, and there was no sign of the enemy—no word that the border had been violated. Maybe their arrival deterred the aggressive neighboring country—surely it would not want to fight now that U.S. forces had arrived. Maybe.

The tension was incredible as the rockets headed west toward their targets. Although it was only about 3 minutes of flight time, it seemed an eternity. Suddenly, the voice net came alive. It was Sergeant Watkins: “Hits, we have hits!”

At 10:00 A.M., the word finally came from the company commander: hostilities likely. Firing had already started in several areas of the border. The lieutenant listened but could not hear any firing. Not yet. He made another digital check with the teams. So far, all quiet. Not for long, though.

Just before 10:15 A.M., he heard the roar of rockets passing overhead. Then there were explosions in the town—lots of explosions. Looking back to the west, toward the border, he could see smoke. The border was about 10 kilometers away, and he had two teams up there. A few minutes later, he could hear artillery fire coming from the area of the border. It did not take long for his western teams to go into action.

On his digital display he saw the first targets appear: a string of red dots on the main road leading across the border. About two minutes later, a digital burst transmission from Sergeant Watkins arrived: "Tgts at TP 1A, am engaging." Suddenly he heard a loud "whoosh" sound to the rear. An EFOG-M had just launched from one of the pods, no more than 3 kilometers from his position. He was surprised that one of the pods was that close. There was another launch, then another. The tension was incredible as the rockets headed west toward their targets. Although it was only about 3 minutes of flight time, it seemed an eternity. Suddenly, the voice net came alive. It was Sergeant Watkins: "Hits, we have hits!"

Minutes later came the hum of approaching helicopters. Before he could see them, enemy artillery burst on the ridge to his left; then there was more shell fire on the hilltop to his right. The enemy must be trying to suppress possible U.S. positions for the helicopters. Suddenly, not 500 meters away, four low-flying helicopters—Hinds—swept by. Amazing how close they were. He spun around and watched them roar down the valley toward the town. Then, there was a flash from the ground and a fast streak toward one of the helicopters. It launched a flare, but it made no difference—a huge explosion sent the aircraft plowing into the side of the valley. The remaining three aircraft lifted over the ridge and passed behind the town, out of sight.

By now, there were more missile launches from his platoon's area. The sergeants in charge of the teams to the west and south were calling for fire. On his commander's display, the lieutenant could see many of the targets they were engaging. Data from the nearby UAVs was being fed into the unit's info net, giving him a pretty good picture of the battle. So far, so good.

The firing had been going on less than 30 minutes when a report came in from one of the teams to the west: "Taking much fire. Think they know about where we are—am displacing to BP 2C." Next, it was Sergeant Watkins again, "Eight confirmed tank or APC hits. Enemy slowing down. Some have dismounted and are heading toward my position. Have to displace." With his two critical western teams—the ones blocking the road—having to move, the lieutenant knew that he had to take up the fight from his location. Looking back at his command display, he could see the red dots on the road. Some were probably hit already, but most would still be alive. The data link to the UAVs was still good. Okay, now it was time to cover the withdrawal of the two teams. The lieutenant's radioman generated a call for ATACMs fire against the road. The target was described as two companies. Although he could not see them from his location, the lieutenant felt the UAV data must be right. Who would handle the call for fire did not matter—either the HIMARS battery or the destroyers off the coast. That wasn't his problem; all he had to do was get the call for fire in. Off it went via digital burst.

Minutes went by, but no fire. Suddenly he could see vehicles down in the valley. Were they the covering force of the allied nation, or were they enemy? Then he heard the supersonic roar of the ap-

proaching missiles. In the distance, he could see the explosion several thousand feet up as the war-heads separated to unleash their BAT submunitions. He glanced again at the command display. Great, there are still targets there. There should be some hits. There must be some hits. But now the crack of cannon fire down in the valley drew his attention back there.

Up the valley came about 10 armored vehicles, tanks, and APCs. Somehow they had gotten past Sergeant Watkins. They were clearly nervous, firing at any cluster of buildings to their front or flank. They were headed toward the town and would become the problem of the platoon positioned there with its Javelins. Meanwhile, where were the two teams to the west?

After-Action Review of the Light Battle Force Concept

One of the key concepts behind the AAN light battle force is that it can hide and wait for the right opportunity to create a “virtual ambush,” massing fires at range on enemy forces when they are most vulnerable. One of the biggest assumptions associated with this concept is the viability of immobile weapon pods. *Thus, a considerable amount of attention is paid to this particular characteristic of the force for our analysis.*

To see if the pods could be effectively hidden while waiting for the right opportunity (and often being bypassed by enemy systems), we examined four levels of camouflage: (1) deployment in the open; (2) digging them in to place them in defilade; (3) a combination of digging them in and adding camouflage; and (4) assuming a level of signature control for keeping the pod “low observable” (LO). Each of these was a parametric level rather than a physical system performance metric. Defilade assumed that the pod was partially concealed. Camouflage reduced thermal and visible signatures by 50 percent, and the LO condition reduced them down to 25 percent of their original level. In addition to the above analyses, we also examined the effect on system survivability of immediate firing when targets were detected (activation modes), rather than waiting for an ambush (quiescent mode).

Signature management of the pods was found to be a critical aspect of pod survivability, as shown in Figure 4.18. The X-axis shows the four levels of camouflage described above. When the pods were placed in the open without camouflage, even though deployed in tactically advantageous positions, virtually all pods were detected and killed, mostly by the overflying helicopters. Digging the pods in or hiding them in terrain folds (defilade) did not reduce the number detected, but it did strongly reduce the number lost to enemy fire. This is attributable to the large number of Red systems (1,500) that will probably spot each pod several times over but will have fewer opportunities for effective shots as they move past the pods in defilade compared to when they are in the open. As modeled, defilade plus camouflage was still not sufficient to hide pods from all the advanced sensors of the attacking force; however, it did further reduce the impact of Red weapons, since the numbers of shot opportunities go down, as do the probabilities of hit and kill. The defilade and LO condition, finally, made the systems both hard to detect and hard to kill from even relatively short ranges.

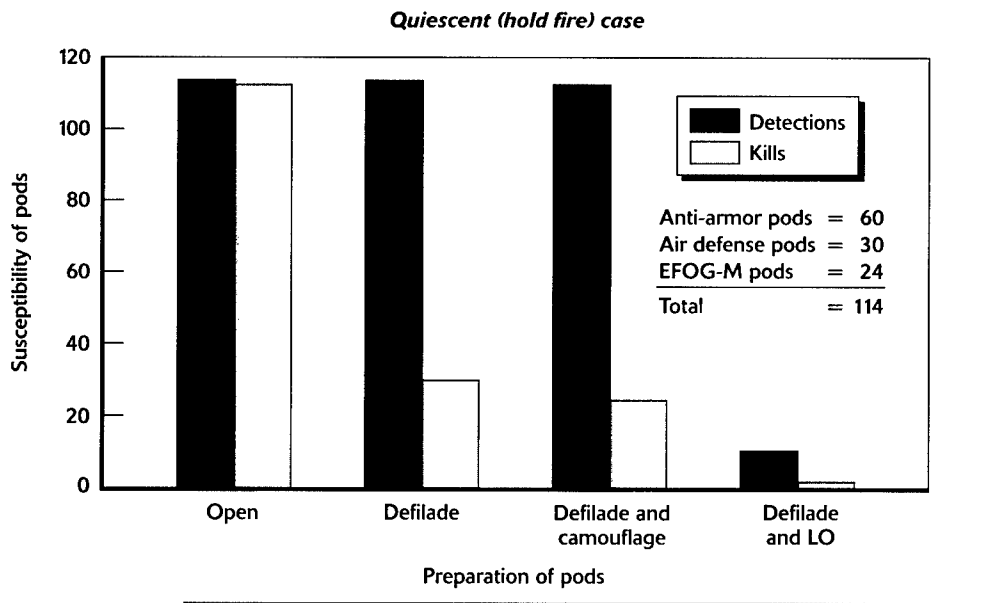

Figure 4.18—Susceptibility of Pods by Camouflage Method: Quiescent Mode

We reexamined the case where the weapon pods were in defilade and camouflage (third case above) to see if it made a difference if the pods were activated. More specifically, we asked, “Is there survivability through fires?” The results are shown in Figure 4.19. Thus, in the quiescent or ambush mode, we saw that most pods were detected and about 25 percent were killed. However, as the battle unit’s weapons were activated,

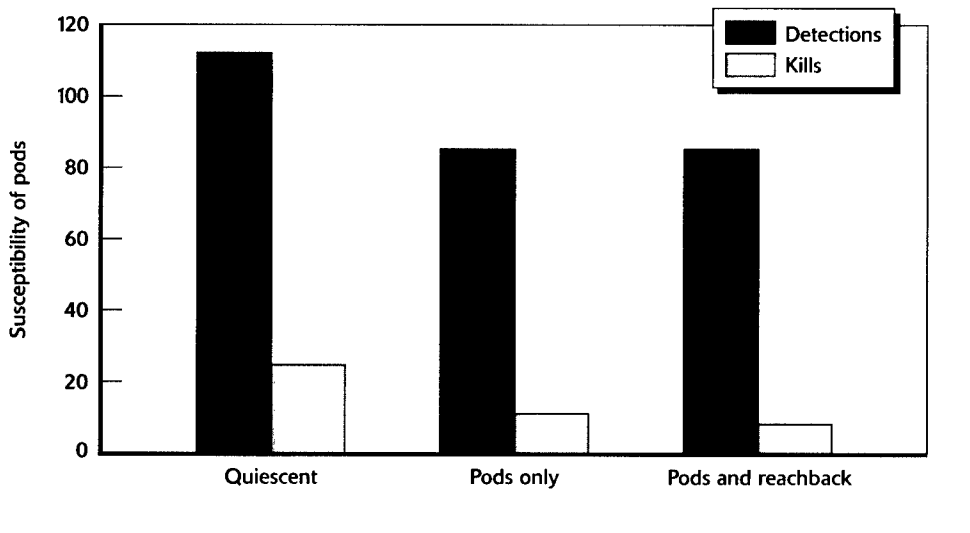

Figure 4.19—Susceptibility of Pods by Various Modes

some added survivability could be gained, essentially buying some survivability through fires. When pods alone were allowed to fire, the number of pods lost was halved; when both pods and reachback weapons were used, even fewer pods were lost. These increases in survivability resulted from earlier kills of systems that would have otherwise seen and destroyed the pods.

In ideal conditions, the application of one battle unit with its organic firepower—including anti-armor artillery, the EFOG-M, and air defense pods—is able to attrit a large percentage of the lead enemy units. The addition of the reachback weapons—in this case, ATACMS with BAT (and also possibly Tac Air)—improved on overall force performance in total number of kills. However, the most notable reachback contribution was in kills with respect to time, as shown in Figure 4.20.

Specifically, in the first 30 minutes, the kills of the lead vehicles went from 150 to almost 300, nearly doubling force lethality. If enough compression of kills occurs (kills within a small period of time), one can argue that a “shock” effect can be created; this shock effect can temporarily disrupt or even stop the attack. If followed up or exploited by a subsequent attack, perhaps a limited direct-fire engagement by a maneuvering unit (such as a heavy battle unit or a Force XXI unit), even greater levels of damage can be attained. But since the light battle unit cannot maneuver, it cannot exploit these key opportunities.

Examining the larger set of data from the entire force, we divided the duration of the battle into 30-minute segments, as shown in Figure 4.21. When no reachback weapons are present and the units rely on anti-armor artillery, advanced EFOG-M, and air defense pods to ambush the enemy, the attrition is very orderly. About 50 percent of

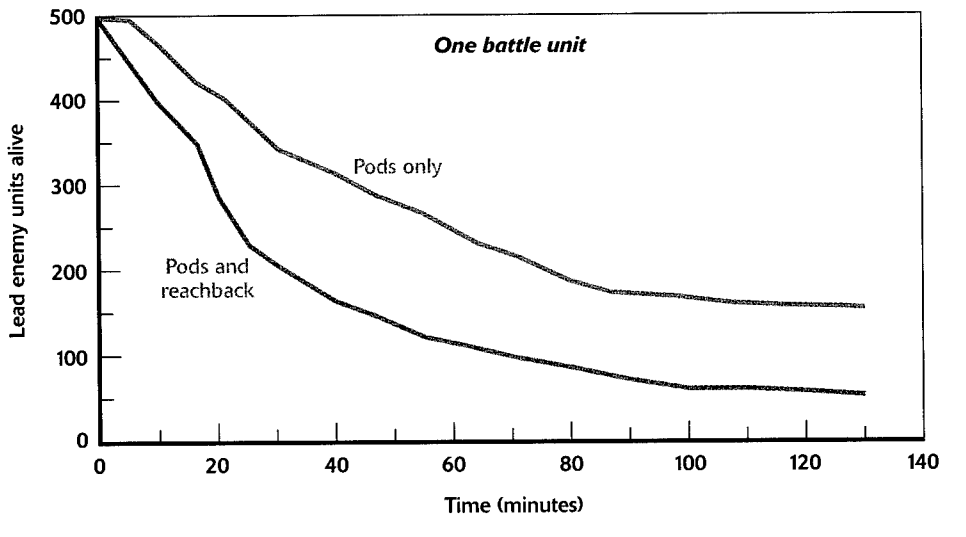

Figure 4.20—The Impact of Reachback Weapons on Lead Enemy Units

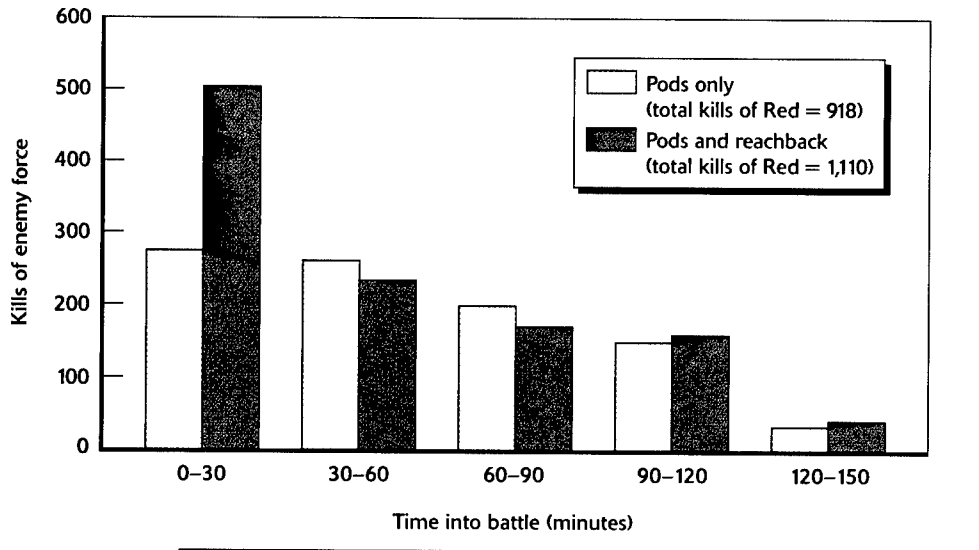

Figure 4.21—Effectiveness of Pods and Pods with Reachback Weapon on Kills of Enemy Force

the 1,500+ Red units have been killed by 90 minutes into the battle, and the attacking force would likely go to ground.

With ATACMS in the force as the reachback weapon augmenting the pod weapons, the outcome is decided much earlier. Approximately one-third of the enemy systems are killed, many of them across the border, in the first 30 minutes, which may be enough of a shock to stall the attack. About 50 percent are killed by 60 minutes and about 65 percent by 90 minutes.

In both cases, it is evident that given time, since both reachback and the organic pods consist of precision-guided weapons, the ability of this force to attrit an attacking force is quite formidable. But many of the urban areas are only 10-15 kilometers from the border and could provide sanctuary to the attacking force.

Moreover, the battle unit's success comes at some significant cost, particularly if the battle lasts longer. As Figure 4.22 shows, if the battle is allowed to continue to completion (the full 150 minutes), over one-third of the battle unit can be lost to enemy fires. Most of the battle unit's losses were the result of receiving direct fire from the attacking Red air and ground units. Since most of the soldiers were deliberately positioned to acquire targets to lay weapons, they had some level of LOS to the attacking force. Even though they were in defilade, the soldiers were still vulnerable to Red attacking systems. It is interesting to note that the use of reachback weapons did not considerably alter the survivability outcome in this case.

As effective as the battle unit was, there was no guarantee that one battle unit with reachback weapons would succeed entirely in its mission to halt the attacking force, for two key reasons. First, it is unclear how much attrition will be required to repel an attacking force in the future (e.g., at what point does the attacking force stop?). Second,

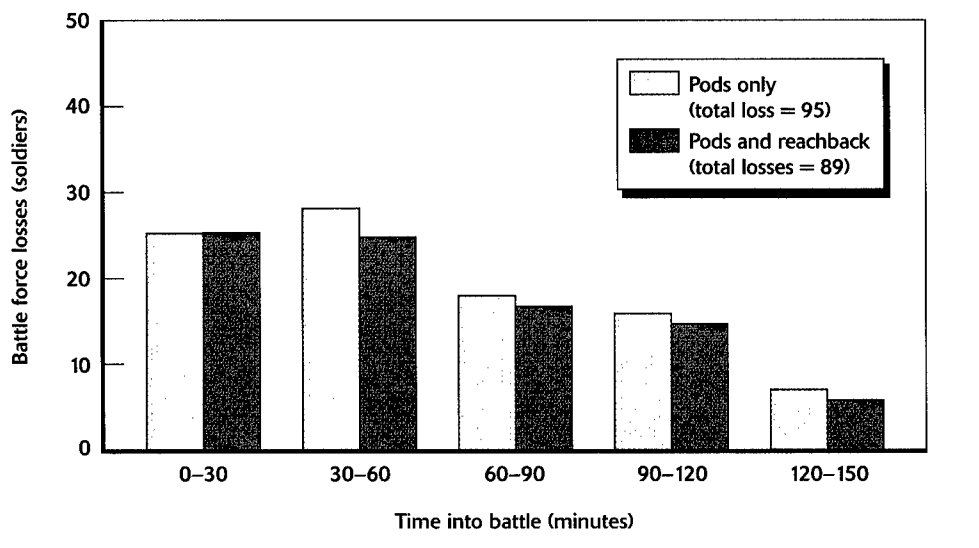

Figure 4.22—One Battle Unit's Losses over the Simulated Battle

after advancing as little as 10 to 15 kilometers, the enemy force could seek refuge in the many urban areas, instead of continuing the attack. As good as reachback weapons were at providing firepower, they could not prevent enemy movement over terrain. For these reasons, we deemed that a single battle unit primarily employing indirect fires was not sufficient to ensure mission success, even with the other ideal scenario conditions assumed.

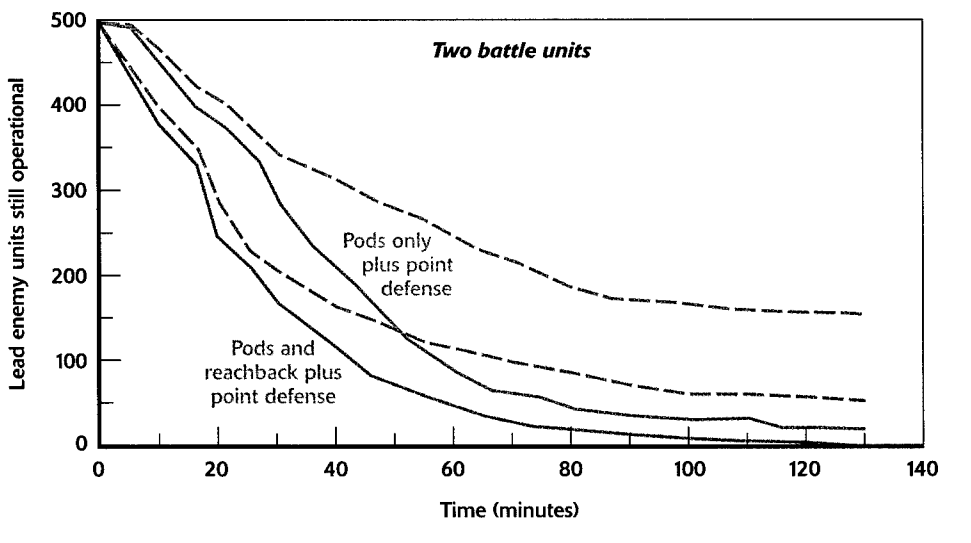

Figure 4.23—Effectiveness of Employing Two Battle Units

Thus, we employed an additional battle unit, heavily armed with direct-fire weapons around the urban areas. The effects of this “point defense” capability were quite compelling, as shown by Figure 4.23. In the case where direct fire was added, both the previous curves (the dotted lines) almost reach the full attrition level (the solid lines). That is, with or without reachback, nearly all the lead elements of the attacking force were destroyed. Because of the units in point defense in the towns, the urban areas were not penetrated.

However, as successful as the two battle units were in accomplishing their mission, protecting the urban areas resulted in higher overall losses for Blue, as shown in Figure 4.24. If the battle is allowed to continue to completion (the full 150 minutes), well over one-third of a battle unit is lost. Interestingly enough, even though the mission is now successful with one battle unit in point defense, the loss-exchange ratio for Blue is *less* favorable. The primary reason for this is the additional losses the battle unit must sustain to protect the urban areas. That is, unlike employing weapons from afar (reachback), which incur less contact with enemy, employing weapons in a point defense results in more contact and more losses.

This suggests that if producing attrition with minimal losses is the only objective, reachback and organic indirect-fire pods might be a possible solution. But if the objective includes protecting or controlling terrain, then a combination of direct- and indirect-fire weapons appears to be required.

When we examine how the firepower is used for the three classes of weapon systems present in the AAN light battle units—reachback, organic weapon pods, and close-range direct-fire systems—we find that each contributes differently to the battle (see Figure 4.25). Reachback lethality is primarily early in the battle, when the enemy systems

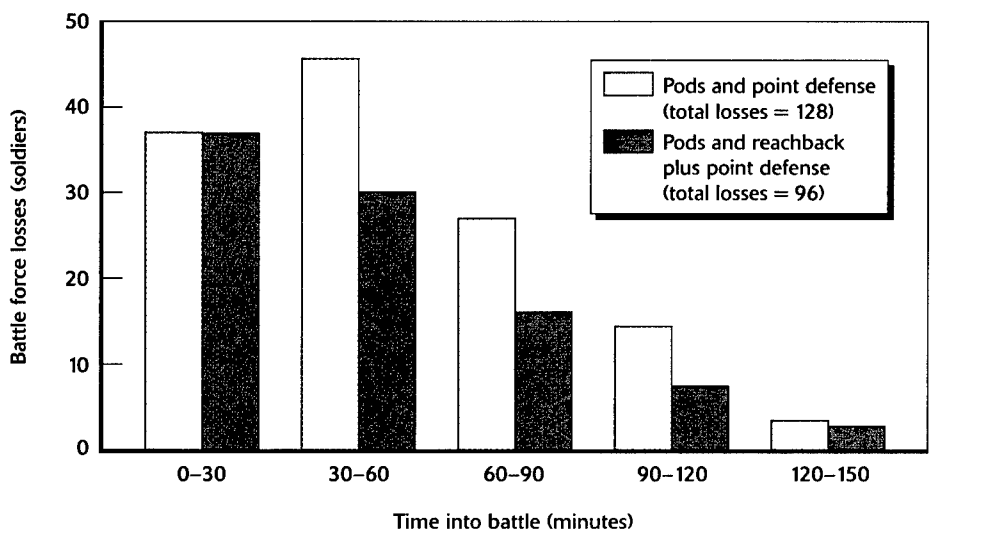

Figure 4.24—Two Battle Units’ Losses over the Simulated Battle

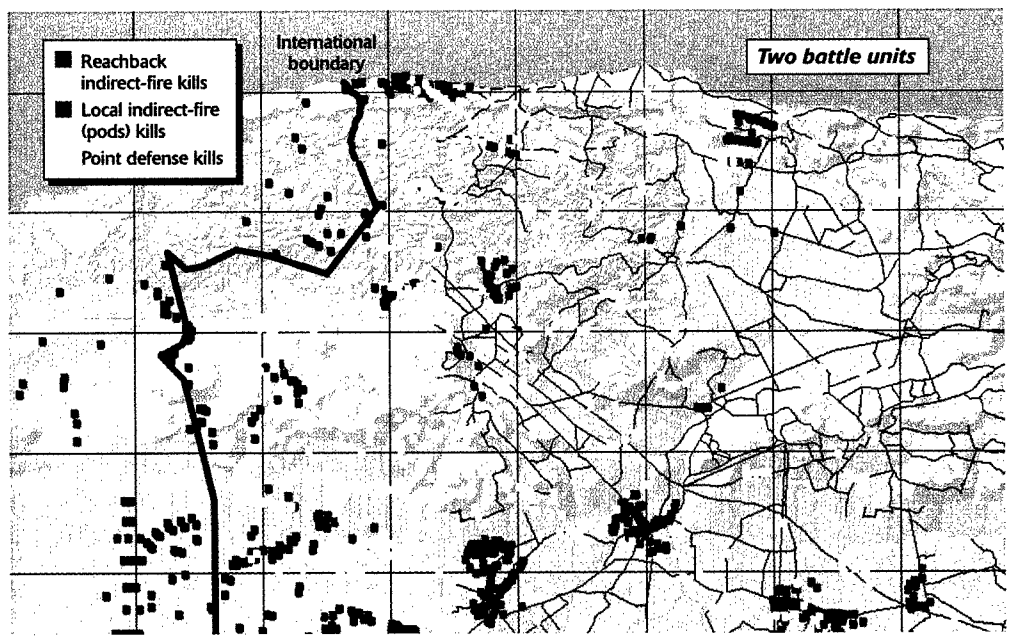

Figure 4.25—Light Battle Force's Successful Engagements on the Battlefield

are attacking in massed formation and at range. Some of the targeting is even done against rear echelons across the international boundary. A surprising amount of lethality was seen from the weapon pods, mostly because they span the entire spectrum of the defended zone. Close-range, direct-fire kills concentrate around the urban areas, and these kills represent the last but perhaps the most critical line of defense.

Based on the analysis, we found that all weapons associated with the light battle units (reachback, organic indirect-fire pods, and direct-fire weapons) played a role in the defensive mission. However, there were some notable limitations. Indirect-fire weapons (because of their long cycle times) were unable to achieve decisive attrition over either time or space on the battlefield. For example, reachback systems employed en masse could attrit a substantial portion of an enemy force with little or no losses to Blue; however, this kind of attrition is more opportunistic and less systematic than that needed to actually halt or repel an attacking force. Direct-fire weapons provided short enough cycle times to systematically respond to the changing presented threat, but they sometimes exposed soldiers to enemy fire. However, this aspect was seen as essential for controlling the time and location of attrition.

Also notable, the light battle units were limited by their lack of maneuver capability. In several instances, they were not able to reposition out of harm's way from the large attacking force. Also, they were unable to exploit the effects of the simultaneous and highly effective indirect-fire attacks which, in theory, could have led to greater overall force synergy.

DARPA's Small Unit Operations (SUO) Concept

Analysis Context

DARPA's SUO concept shares some similarities to both the DSB and the TRADOC concepts. The primary impetus for this concept is the desire to stabilize a contingency situation almost overnight, while minimizing the number of troops at risk and avoiding direct-fire engagements altogether. This ambitious set of goals resulted in a concept that is similar to the last one (seeding stealthy FOs, sensors, and weapons over a large area), but at such a low density and footprint to be almost undetectable.

In this concept there are no mobile assets, with the exception of two HMMWVs in each 7- to 9-man team and three high-altitude UAVs for the larger operation. The HMMWVs are not armed with anything more than machine guns, and they are generally equipped with command, control, and communication equipment. Each small team is responsible for a large area, often more than 100 square kilometers. The force has many nonmobile, unmanned assets dispersed through the region to help it accomplish its mission. These include detection and targeting sensors, communication relays, and short- and long-range missile pods, similar to those described in the TRADOC concept. There are three echelons present in the force: the small teams with some local fire support, a tactical command post (TACCP) able to call in fires from the short- and mid-range organic assets, and a Joint Task Force (JTF) able to direct fires from long-range standoff weapons.

From a manpower perspective, the SUO concept is simpler than the current 82nd Airborne DRB, the varied set of units comprising the DSB force, and even the AAN light battle element. An SUO force that should be able to cover a large area (60 by 60

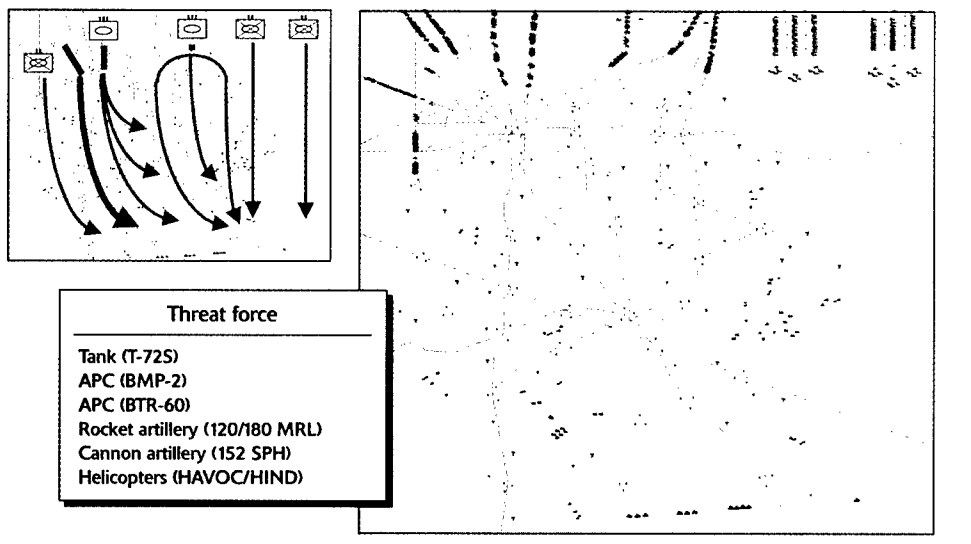

Figure 4.26—Dispersed SUO Defensive Force in SWA

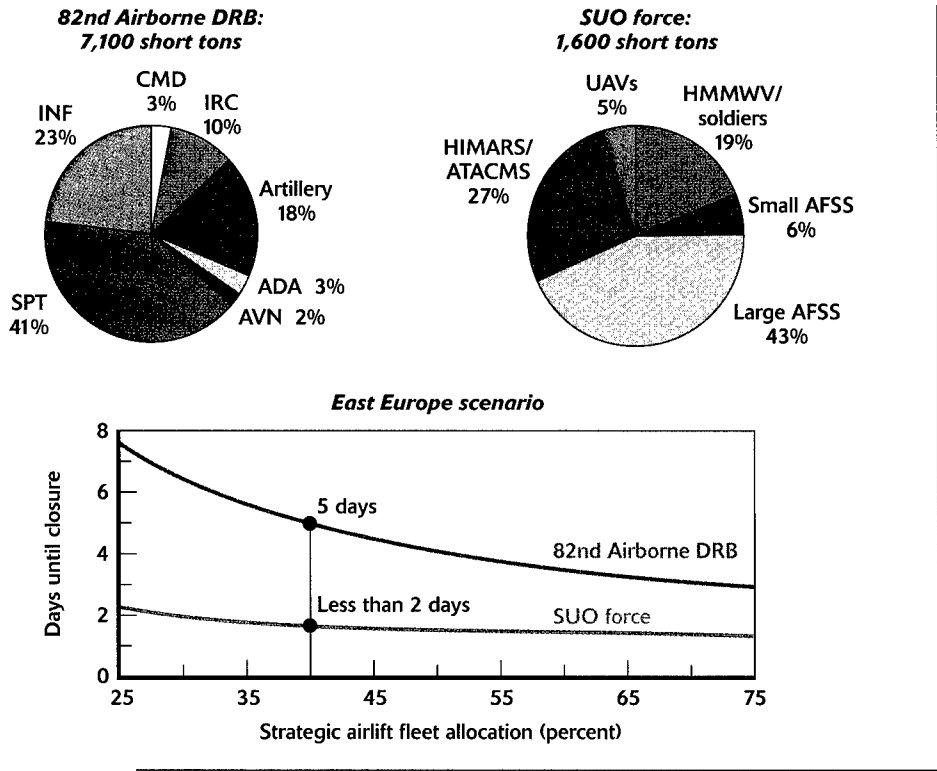

Figure 4.27—Comparison of Lift Load and Days for DRB and SUO forces

kilometers or so) might be made up of only about two dozen vehicles and a few hundred soldiers. Teams would have one scout vehicle and one fire control vehicle each. An entire group of six teams would be controlled by two TACCPs and by one JTF node. In our preliminary force organization, the surveillance and communication assets would include 30 remote sentries, 108 acoustic sensors (in sets of three), 18–100 ground communication relays (depending on terrain), and 12 UAV communication relays. Weapons would include 10 large AFSS pods (advanced fire support system), 14 small AFSS pods, and 10 ATACMS launchers.

The scenarios used in our study of this concept are the SWA and East Europe ones described in Chapters Two and Three, but with small teams dispersed throughout the 60 by 60 kilometer area. An additional scenario involved infantry operations in an airfield seizure and defense. As shown in Figure 4.26 for SWA, this force could be spread out over the entire area. The graphic on the left shows that the enemy will try to drive right through the defended area, destroying the light force as they go. The graphic on the right depicts the highly dispersed emplacement of six Blue small units, controlled by two TACCPs. The more stressing East Europe scenario was calculated to require eleven teams and three TACCPs. The airfield seizure only required two teams.

The deployed weight of the SUO force, even with pessimistic assumptions on the number of personnel (400) and heavy expenditures of missiles and pods, is substantially smaller than the 82nd DRB. Figure 4.27 compares the mix of systems in the two forces, and indicates that the SUO force would have less than one-fourth the lift requirement of the 82nd DRB or an RFPI force. In fact, the use of containerized missiles in place of vehicles may make the force more efficient to transport. The time needed to move to East Europe, under the assumption of 40 percent airlift availability, drops from about 5 days to less than 2 days.

The SUO force is made up of three command levels and numerous communication links. The graphic in Figure 4.28 shows how we model many of these interactions and decisionmaking entities in our simulation environment. Target messages are transmitted to communications relays until the message reaches its destination, usually an associated FDC. Every retransmission node within range (data input) and line-of-sight (model calculation) receives and retransmits each message. Target acquisitions are then processed and either result in fire from assets at that level, or are passed on to the next echelon for processing there.

Communication relay requirements differ strongly for open and close terrain. As shown in Figure 4.29, we were able to ensure connectivity with an order-of-magnitude fewer relays in the open SWA terrain compared to the close, covered East Europe terrain. This is not an exact ratio, of course, because many of the other systems already act as relays—AFSS, SUO vehicles, and UAVs—thus reducing the need for some dedicated relays. We also found that relay range was critical. Nine-kilometer range links (normal SINCGARS range) led to excessive losses and delays, even in SWA, unless they were augmented with longer-range UAV links. Fifteen- and 30-kilometer range links were both capable of achieving the throughput and timing needed to engage targets.

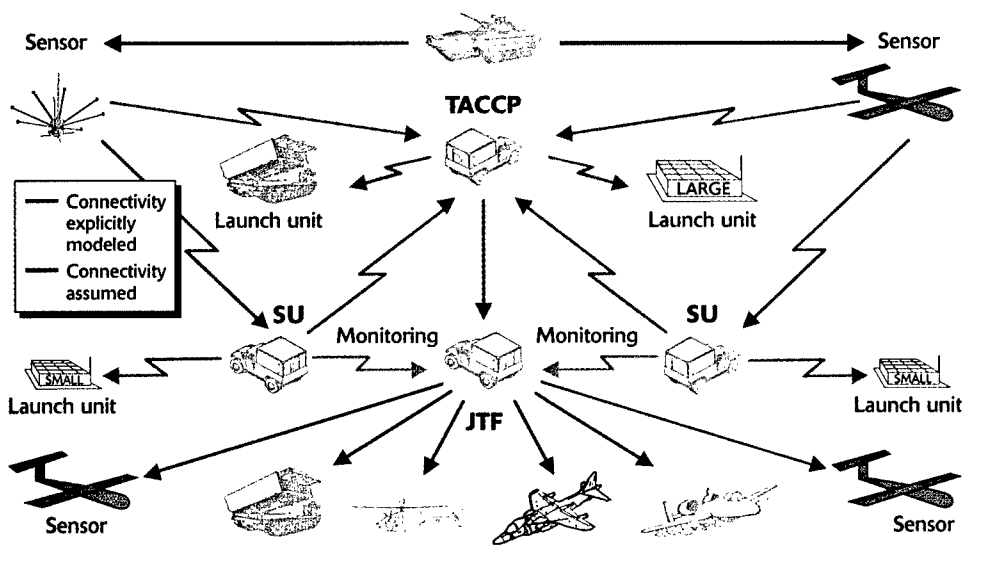

Figure 4.28—Assumed C2 Structure and Communications Connectivity

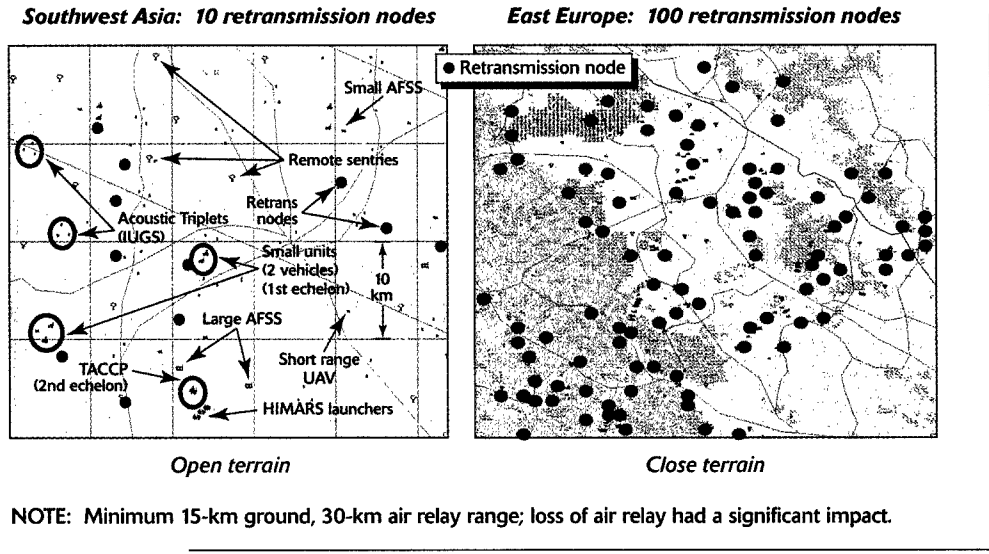

Figure 4.29—Communications Relay Densities Needed in Open and Close Terrain

Experiencing the SUO Concept in Mixed Terrain

THE LIEUTENANT LIKED THE IDEA that he no longer had to spread camouflage paint on his face and hands, but he worried whether the stealthy outfit he was wearing would do the job deep inside enemy lines. He adjusted the laser protective visor and computer display on his helmet, performed a functional test of his GPS and communication system, and had the loadmaster check his thermal and radio frequency signatures. It was paramount that he not be detectable, because he would be lying in wait and the enemy might drive right by his position in the coming battle.

There would be little help if he were caught sitting in the C-130J aircraft; he checked out the SITREPS one last time and plotted where he wanted his surveillance and weapons assets to be placed. Soon thereafter, he felt the shove of the computer-driven actuators as the equipment plunged out into the night air, billowing out their parafoils. There was a muffled clatter as they started their small hushed propellers, on their way to designated locations, guided there with the help of GPS. He hoped most of them would land right side up and not on top of someone's chicken coop.

Surveillance images showed an enemy column moving quickly from cover to cover. He determined the best engagement sectors, tagged known noncombatant vehicles and buildings on his screen, and waited for further intelligence from his team.

The jumpmaster signaled him that it was his turn next. He felt like he was in Delta Force, about to embark on a clandestine mission. But he wasn't a Delta. He wasn't even a Ranger. He was airborne infantry and a 49 to boot. "For god's sake," he thought quietly to himself as he heaved himself into the cold darkness below.

Once on the ground, he joined up with his team. He climbed in the C2V and checked the situation. Lots of enemy armor headed this way, led by a

recon force with surveillance UAVs. Noncombatants were also spread throughout the area, with plenty of civilian vehicles occupying and, at some points, choking the roads.

Surveillance images showed an enemy column moving quickly from cover to cover. He determined the best engagement sectors, tagged known noncombatant vehicles and buildings on his screen, and waited for further intelligence from his team. The FOs soon passed along data on enemy vehicles, decoys, high-value targets, and danger areas. Some of these targets were larger units than he could engage, so he passed them up the chain to the JTF. The rest were his. Each time he called for fire from one of "his" containerized weapon pods. He had little time to shoot out the whole ordnance load, since the enemy counterfire was able to "walk in" artillery on it, reducing the pod to a mass of expensive shards. The battlefield was now illuminated with burning enemy hulks, but his force did not get away unscathed. Two small teams were discovered and had to hunker down under heavy fire, taking multiple casualties. The enemy soon went to ground, but this was not the end of the lieutenant's problems. Now he had to call for extraction of his force, including the casualties.

After-Action Review of the SUO Concept

We examined several mixes of weapons and weapon loadouts (how many weapons in each type of pod) for the small force. Figure 4.30 shows that the baseline SUO force with a mix of small and large AFSS (with 16 and 25 missiles each) and ATACMS was quite lethal and fairly efficient in its fires. Removing ATACMS and increasing the loadout of small AFSS to 25 rounds strongly decreased effectiveness, partially because over half the SUO vehicles were lost. Going to large AFSS only and increasing the loadout to 50 rounds gave very good lethality, but again led to the loss of over half the SUO vehicles. Finally, small AFSS, with its shorter range (20 kilometers versus 40 kilometers for large AFSS), led to poor lethality and poor survivability. Only with a mix of all weapons was the outcome successful.

In the close terrain East Europe scenario, we varied the end-to-end timelines to determine the effect on lethality of the different weapons. Zero delay in this case is actually faster than the baseline case in the excursions, since there are no communications or decisionmaking delays, which would normally require from a little less than one minute to more than two minutes.

From Figure 4.31, it is evident that there is an immediate small dropoff in effectiveness of both the large and small AFSS between zero and two minutes. This small effect is in accordance with the moderate-size footprint of the Damocles munition, which an enemy vehicle can traverse in several minutes. Major dropoffs occur between two and five minutes and between five and ten minutes. For large-footprint ATACMS-BAT, the first dropoff does not occur until between five and ten minutes.

Messaging timelines also had a significant impact on the small unit's effectiveness. For example, we parametrically varied the times for communication delay from zero to 1.5 seconds. A constant degradation of lethality was seen as the timelines got longer, with kills dropping from 460 to 360 when time delays went from 0.3 seconds to 1.5 sec-

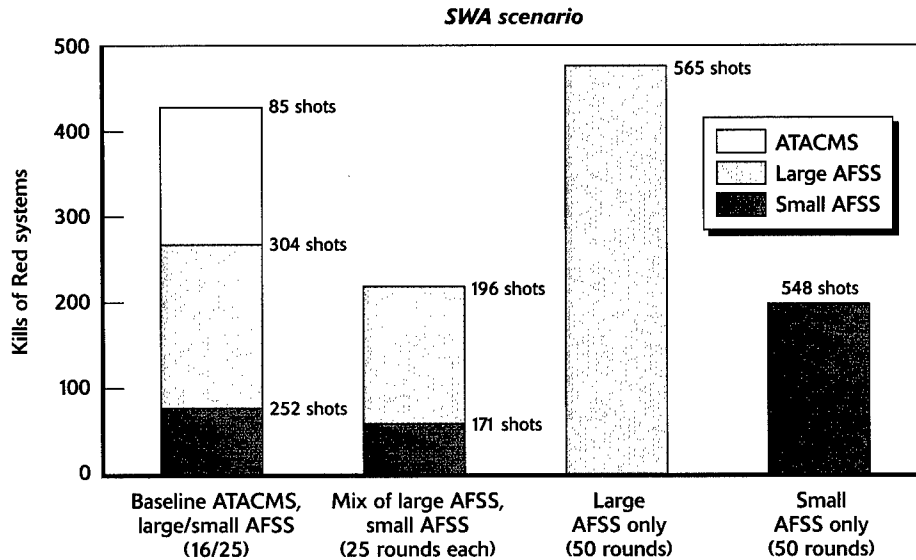

NOTE: Baseline case was preferred due to significantly greater survivability of reconnaissance, surveillance, and targeting vehicles.

Figure 4.30—Effect of Weapons Mix and Loadout on Force Lethality

onds. Part of the reason for the degradation is the large number of relays performed to get a message from the sensor to the shooter. This was typically 5–10 relays in SWA and 15–20 relays in East Europe. When we examined all 32,560 message transmissions in an exemplary run, resulting from 7,974 targeting messages, we found that over half of

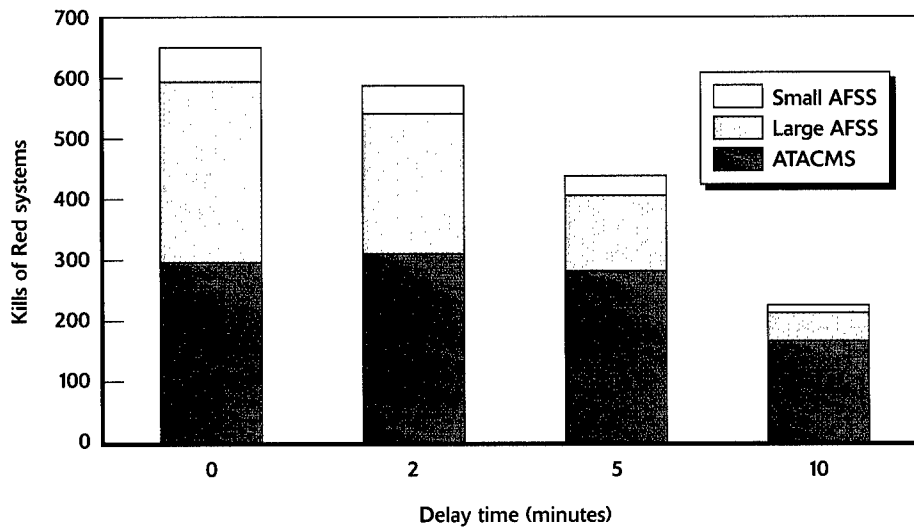

Figure 4.31—Effects of Time Delays on Short-, Medium-, and Long-Range Missiles

all messages to the TACCPs and to the JTF were useless—launcher out of ammo, inappropriate for the target, or too late for engagement.

The weapons examined in the excursions are a small set of the possible ones being considered for the SUO concept. Additional ones, many of which have been described and modeled in earlier sections, are Tac Air, loiter weapons, lightweight artillery, smart obstacles, attack helicopters, and naval fires (gun and missile). Each of these systems has a different range, footprint, mobility, and preferred target set. For example, smart mines may not achieve a large number of kills, but they could slow the enemy force enough to make them good targets for other weapon systems; loiter weapons can wait for targets to emerge from cover, but they are limited by their endurance.

One problem with these many disparate weapon systems is airspace deconfliction. Tac Air requires that corridors be dedicated for many minutes, negating the use of AT-ACMS and other missiles for key intervals. New procedures may be needed to allow assets to be used simultaneously, resulting in greater levels of shock and attrition.

Several capabilities emerge as critical to the SUO concept and, as a result, constitute key vulnerabilities the enemy could try to exploit. The first is comprehensive sensing of all relevant information: enemy position, composition, and status, own locations, terrain and weather, and so forth. Red may try to mask its presence, use decoys, or destroy the Blue sensor network. Next, the force must be able to communicate and display this information quickly and accurately to all sites that need it. Once this level of situation awareness is achieved, the force must be able to use precision standoff weapons to defeat the targets located. The SUO force is light and unable to carry sufficient armor protection, so to survive it will have to rely on reduced signatures, avoidance of enemy positions or other dangers, and use of preemptive firepower. One of the more vulnerable areas for the SUO force is that there are many stages of coordination required to successfully target mid- to long-range precision indirect fires. All these new capabilities will require new TTPs, and some of them may open up opportunities for the enemy.

In response to the many possible Red countermeasures, the SUO force must react with its own counter-countermeasures. Some of these would enable the insertion and extraction to occur with few losses, such as sterilizing corridors by suppressing enemy defenses. Some would reduce the vulnerabilities and increase the lethality of the multistep sensor-shooter process. They might include reducing vehicle and team signatures, employing deception and decoys, and designing communications for low probability of intercept and anti-jam capability. The force itself may even be tailored for given missions, including use of light strike forces with 10- to 30-ton armored vehicles.

Chapter Summary

In this chapter we presented three different ways to make light forces even smaller than they are now but also give them access to capabilities that aren't readily in their arsenal. As the force was made smaller, it was hypothesized that to enhance survivability it

would have to be more dispersed, far more than a typical early-entry force. Additionally, in some areas, we considered the impact of signature reduction.

Although there was considerable merit in making light forces even smaller than they are now, in that they can deploy with greater speed and have greater survivability, we observed major limitations in the kinds of missions that such a force could accomplish. For example, a small dispersed force would probably have to rely more on remotely located, “reachback” weapons for its lethality. As a result, instead of holding terrain as a typical light airborne force may be required to do, the best this force might expect to accomplish with such weapons would be to deny the enemy use of terrain. One apparent solution to resolve this was to heavily uparm the force with greater organic firepower. But doing so effectively makes it less of a “small” force, increasing both its signature and its deployment time.

CHAPTER FOUR ENDNOTES

- 1 Two tactical UAVs flying at approximately 1,000 meters over the battlefield provide the deeper acquisitions, at 18–24 kilometers. These close-range UAVs were flown to maintain some level of standoff from the attacking force (no overflight) and, thus, were assumed to be survivable in this analysis.
- 2 Since the COVER system is still not yet fully defined, we refer to it as a “COVER-like” system throughout the book.
- 3 Distributed sensors, such as the air-deliverable acoustic sensor shown in Figure 3.4, can also be used to provide additional information to the force.

FOLLOWING PATH 3:

Introducing Maneuver to Light Forces

IN CHAPTER THREE WE EXAMINED what might be considered relatively conventional solutions to improve light forces, and we assessed their ability to function in the rapid-reaction role (the path 1 option). In Chapter Four we explored both the possible benefits and the limitations of making light forces smaller and more dispersed (the path 2 option), which by some standards might be considered a major departure from the way forces operate today. In this chapter we examine change in the other direction—the path 3 option—introducing maneuver to light forces, thus giving them more capability than they currently have but also making them heavier than they are now.

Although bringing the ideas explored in this chapter to fruition would likely involve a longer overall timeline than some of the other concepts considered so far, perhaps as far out as 10–30 years, RAND’s Arroyo Center and National Defense Research Institute are exploring them now. More specifically, this chapter presents analysis that has considered introducing maneuver—combined operational and tactical—into relatively light forces. The concept examined here is considered to be a “vertical envelopment” concept because it relies greatly on air mobility at the operational or tactical level to achieve mission success. Implementing the concepts will inevitably involve making many other changes to light forces beyond those proposed for combat aspects; some of these non-combat-related changes are not addressed in this work. Thus, as was the case with Chapters Three and Four, the research presented here is exploratory rather than final.

As in the previous chapters, we first set up the context for the analysis. Then we present the “soldier-level” view of the analysis, followed by after-action review analyses that elaborate on the outcomes of the scenario.

Context for the Analysis

Analysis Goals

Unlike the previous concepts examined in this book, which involved emplacing a relatively stationary ground force that relied heavily on remote fires for survivability and lethality, the concept examined in this chapter concentrates on adding combined tactical and operational maneuver by introducing a light- to medium-weight family of vehicles within a force to accomplish rapid-reaction mission objectives. As a result, a larger spectrum of missions can be addressed with this kind of force.¹ There are also some situations for which this kind of force might be less applicable (e.g., difficult or complex terrain) than a dismounted infantry-based force. Moreover, this notional force would

probably be more of a challenge to deploy. Although streamlined CONUS-to-battlefield positions are assumed in the concept, two major phases were considered in this research: (1) an air insertion of the force and (2) the ground combat itself. Both phases must be successfully completed for overall mission success.²

To assess the viability of the air-insertion phase, we used the high-resolution modeling capabilities described in Chapter One. More specifically, CAGIS was used to model terrain, CAGIS Helicopter Advanced Mission Planner (CHAMP) served as the aircraft flight planner, and RJARS was used to assess the air-ground combat interactions. To assess the effectiveness of the ground-combat phase, additional force-on-force simulation tools were necessary, including ASP for distributed sensor representation, the C2 model to determine information processing time and completeness, JANUS as the force-on-force model, MADAM for the simulation of smart munitions effects, and a separate model for assessing active protection systems (APS).³

In the air-insertion phase of the analysis, we examined the capability of a notional advanced airframe (roughly a C-130-sized aircraft) to insert a ground force into the enemy rear area under different assumptions and conditions. For the ground-combat phase, we examined three different operational concepts with differing levels of ground maneuver. In all cases, this involved an early-entry neutralization or disruption of a mobile, elite enemy unit located behind enemy lines. All of the concepts were similar in that they employed the aggressive use of long-range attack weapons, such as aircraft delivering standoff weapons like joint standoff weapon (JSOW) and ballistic missiles like Navy and Army versions of the tactical missile system (TACMS). However, the three concepts examined in this research were quite distinct from each other in the level of tactical maneuver and the subsequent application of force. The details of these concepts will be described in the later portion of this chapter.

Scenario Context

The scenario assumes that an enemy force has invaded a U.S. ally and that American forces are mobilized and poised to enter the fray approximately one week after the onset of hostilities. During the first week of battle, enemy forces have managed to advance approximately 200 kilometers, overwhelming the initial allied forces' attempts to halt the invasion. Allied forces have temporarily stopped the invading forces across a broad front, as depicted in Figure 5.1. (The area of engagement shown in the image is several hundred kilometers on a side, with grid lines at 50 kilometers.)

The invading forces, low on fuel and ammunition, have been temporarily stopped by coalition forces and are waiting for their operational reserve to reach the forward line of own troops (FLOT) and punch through the fragile allied defenses. Red's operational reserve is made up of a heavy, elite division advancing with one brigade up and two brigades back, trailed by sufficient logistics, in the form of fuel and ammunition, to reestablish momentum after reaching the FLOT. The vignette chosen for analysis allows for a range of different U.S. military force responses against this elite heavy division. The force's objective is to attack the division en route to front line and thus pre-

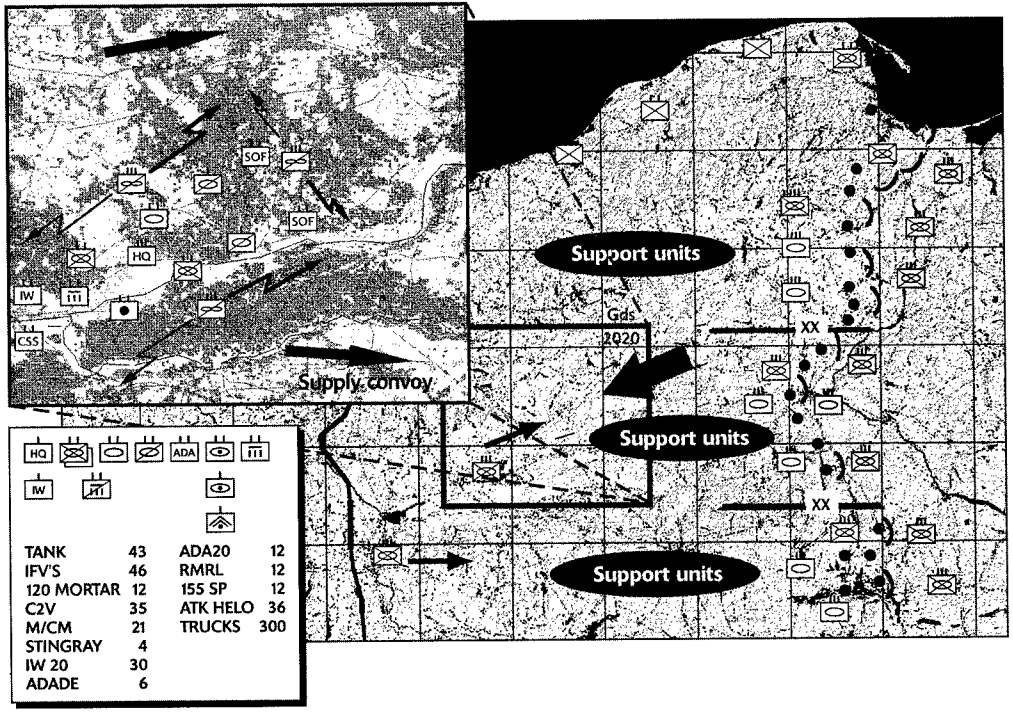

Figure 5.1—Representation of Enemy Advance and Coalition Force Battle Positions

vent it from delivering its much-needed reinforcements.⁴ To accomplish its mission, the U.S. ground force will be air-inserted well into enemy-occupied territory but in front of the reserve enemy division. But because of the mixed, foliated terrain, opportunities to engage the enemy are limited. The key requirement for the U.S. force is to destroy, or at least disrupt, the enemy reserve division before it can reach the front and reinvigorate the offensive.

The enemy commander has secured his rear area with lighter infantry units along the northern sea approach, protecting against an amphibious assault on his flank, and he has bolstered his rear area and main supply route (MSR) defenses with state-of-the-art air defenses, ranging from advanced gun-missile combination (2S6) short-range, low-altitude systems to long-range, high-altitude systems such as the SA-17 and SA-12, which protect against airborne and air mobile assaults.

The scale and topography lends itself well to deep attack operations. The battlespace is sufficiently small to provide little warning time for an enemy who may detect approaching aircraft, yet large enough to encourage joint operations, including both interdiction and maneuver. Unlike Operation Desert Storm, the terrain is sheltered enough to provide cover for an advance. Although the scenario is hypothetical, existing digital terrain was used (East Europe) and various organizations such as the Defense Intelligence Agency (DIA) and the National Ground Intelligence Center (NGIC) were

consulted in shaping the notional adversary's capabilities, composition, and application of force in this time frame.⁵

Success in this scenario requires the United States to project power well behind enemy lines. Although this would most likely be implausible with today's forces and associated capabilities, it is envisioned that a set of possible "solutions" can be identified through some combination of dominant maneuver—strategic, operational, and tactical—precision engagement, full-dimensional protection, and focused logistics, in conjunction with new or enabling technologies.

The Threat

In terms of the threat, we look at both the enemy air defense threat that the ground force must face during the air insertion and the mechanized enemy division that the inserted light ground force must face after insertion.

Air defense threat. One asymmetric strategy that a future threat is likely to employ to counter U.S. air power is a sophisticated integrated air defense network. The air defenses depicted in this scenario are intended to represent a "high-end" opponent of the 2020 era. Today, the Russian army is capable of fielding the type of air defense system depicted in this research. In coming years, other armies may be able to employ similar integrated air defense systems.

For our threat, we presume that long-range, high-end systems such as Russian SA-12s and SA-17s are emplaced throughout the depth of the battlespace.⁶ Since these are relatively mobile, tactical surface-to-air missiles (SAMs), they can accompany the advancing mechanized formation. In addition to these long-range systems, we include medium-range systems such as SA-15s and short-range systems such as 2S6s, SA-18 man portable air defense systems (MANPADS), and anti-aircraft artillery (AAA) in the network. (A more detailed discussion of the actual systems is presented in Appendix C.)

Although these air defenses operate in a stand-alone mode and can be quite formidable, they can become significantly more of a challenge when integrated. More specifically, these air defenses are represented as "partially integrated" in our simulation. A number of early-warning radars (both air- and ground-based) are emplaced throughout the depth of the battlefield. These systems can provide cueing for the SAMs, allowing them to remain quiescent and thus more difficult to find. In some cases, such as with the MANPADS, which tend to be passive systems, it is unlikely that the U.S. force would be able to locate them in the time frame being examined in this analysis.

The enemy air defenses are allocated by echelon. The corps-level, long-range, high-altitude defenses are represented by SA-12 and SA-17 batteries. We assumed the enemy corps depicted on the map is in charge of the enemy's main effort; other forces are off the map to the south and west and would be accompanied by two battalions (a total of six batteries) of SA-12s and two battalions (also six batteries) of SA-17s. By the time this vignette takes place, we assume each battalion has already lost one battery because of U.S. and allied suppression of enemy air defenses (SEAD).

In terms of the air defenses organic to the divisions themselves, the quantities and types of systems were derived from various literature searches, together with input from DIA and NGIC on how many systems regional opponents could have by the 2020 period. Again, we assumed that the enemy's divisional air defenses have suffered losses by the time the vignette takes place. The divisions along the FLOT are assumed to be at roughly 75 percent strength in air defense systems when the vignette starts. In this case, we assume 9 SA-15s, 12 2S6/SA-19s, 48 SA-18s, and 6 SA-13s per division deployed along the FLOT.

Figure 5.2 shows the locations of the high-altitude enemy air defense instituted in the scenario. The lower-quality air defense artillery (ADA) units are along the coast. As the enemy force advanced into the territory of the U.S. ally, lower-quality units (truck-mounted infantry, for example) were deployed along the coast to protect it against a flanking amphibious assault.

The air defense network is partitioned into three sections for analysis: the upper-left quadrangle is the Northern Sea air approach; the lower-right quadrangle is the Eastern cross-FLOT air approach; and the lower-West-Central quadrangle is the ground combat zone modeled in JANUS. Each of these areas was examined separately. The upper-right quadrangle was not considered as an air approach for analysis because of the extreme distances insertion aircraft would need to traverse and because it was assumed to be populated by air defenses of an adjoining enemy unit (not shown).

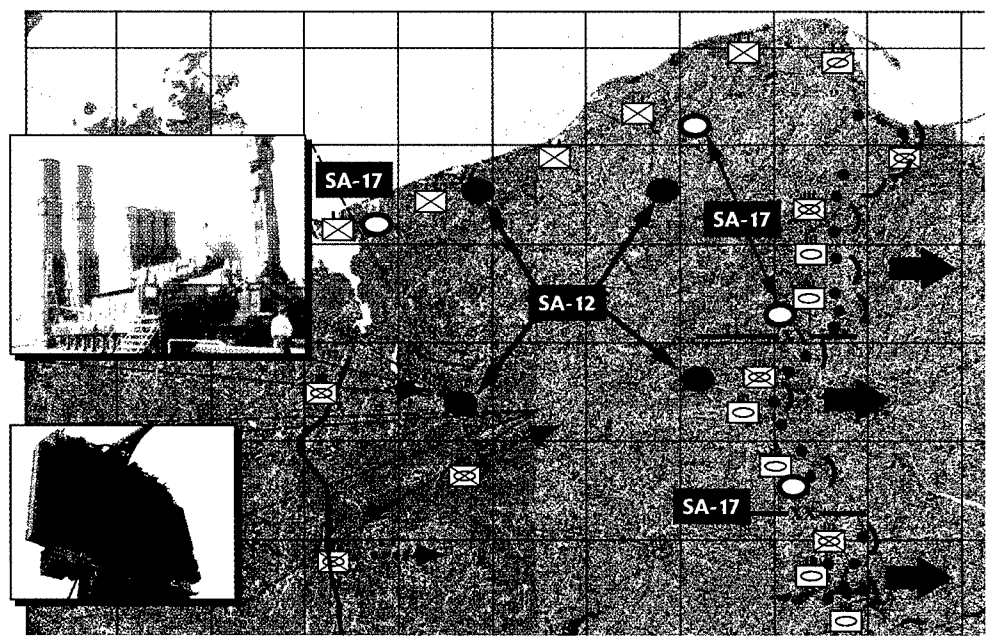

Figure 5.2—Location of High-Altitude Enemy Air Defense Systems

The enemy ground force. The composition of the enemy ground force unit—the lead enemy regiment of the division—is shown in Table 5.1.

Table 5.1—Red Force Mix in the Lead Regiment of Elite Division

Combat Element	Number
Tank	43
IFV	46
120mm mortar	12
C2V	35
M/CM	21
Stingray	4
IW 20	30
SA-15 ADU	6
2S6 ADU	12
RMRL	12
155 SP	12
Attack helicopter	36
Truck	300

This enemy regiment, one of three in the division en route to the front, is intended to be representative of a high-quality threat of the 2020–2025 period. It includes a mix of sophisticated ground vehicles (direct and indirect fire), plus supporting attack helicopters from its parent division. The regiment also includes powerful air defenses in the form of 2S6 and SA-15 self-propelled systems. Some of these air defenses may have been attached from division level.

How the Air Insertion Phase Was Modeled

The air transport modeled in CHAMP and RJARS for this analysis was a relatively large fuselage and employed tilt-rotor technology. Essentially, it was a C-130-sized aircraft, capable of carrying a large payload; see Figure 5.3. The data and input to the simulations was developed by RAND in coordination with the U.S. Army Aviation Research, Development, and Engineering Center and represents a projection of capability assuming appropriate investments in technology.⁷

The air insertion itself was assumed to take place during daylight hours with good weather. A total of 84 aircraft were inserted, with 42 using the northern, sea-air approach and 42 using the eastern, land-air approach. The aircraft were flown in a tight trail formation at approximately 200 feet in altitude and at a speed of approximately 240 knots.

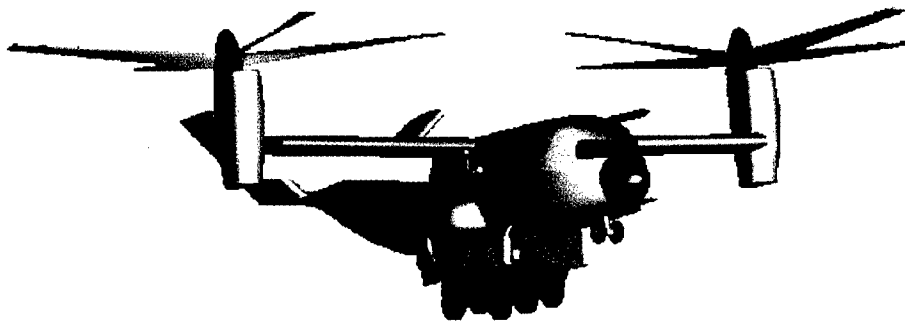

Figure 5.3—Notional Tilt-Rotor Air Transport Aircraft

Representation courtesy of Dr. Michael Sculley of Aviation-ARDEC.

The air defense network operated in a completely autonomous C2 mode (weapons free—no integration). Aviators were given locations of all threats, except for MANPADs (SA-18s) and AAA. Neither tank main guns nor small-arms fire were modeled as threats, nor were anti-helicopter mines included in the threat array. IR countermeasure effectiveness was projected to the scenario time frame based on current technology trends.

Discussions with the Army aerodynamics engineers researching tilt-rotor signature issues led to rough estimates of this class of tilt-rotor transport’s optical, IR, and radio frequency (RF) signatures.⁸ Transport aircraft have typically not been designed to be stealthy; however, to analytically explore the potential contribution of stealth, we postulated that a prop-driven transport could have the signature characteristics of a low-observable (LO) helicopter.

The analysis entailed varying several key parameters expected to have a significant impact on mission outcome. Each set of aviators generated flight paths based on a given amount of situational awareness (SA) and a specific set of flight tactics. We then varied the level of SEAD and the aircrafts’ IR and RF signatures in the RJARS model.

Table 5.2 shows the flight path locations and profiles considered. The aviators who flew the flight paths were a mixed group of RAND analysts and Navy and Army aviators. The run sequence was based on the availability of aviators. The set of flight paths generated enabled RAND to explore a large range of parameters.

Table 5.3 shows the 24 excursions examined during the analysis. Where possible, we first attempted to test either end of the envelope for each parameter before delving into the middle ground, where arriving at a point solution would be difficult at best. Through this process we attempted to draw more general conclusions about which parameters dominated the outcomes. For example, for the medium-level SA excursions, we first examined the baseline and LO signature cases without SEAD and with a high level of SEAD. From those outcomes, we could then determine whether the medium-level SEAD cases would offer additional information to the analysis. Similarly, in the high-level SA excursions, we first examined the baseline signature cases without SEAD and with medium-level SEAD, and from these outcomes we could determine whether the high-level SEAD case would provide additional information to the analysis. The note to Table 5.3 explains the different levels of situational awareness and SEAD.

Table 5.2—Flight Path Locations and Profiles Considered in Air Maneuver Analysis

Flight Path	Path Profile
Baseline	200 feet AGL/240 knots
Low and slow	50 feet AGL/60 knots
Low and fast	70 feet AGL/200 knots
Very low and slow	20 feet AGL/100 knots
Medium altitude	20,000 feet AGL/330 knots

NOTE: AGL is above ground level.

Table 5.3—Excursions Examined in the Air Maneuver Analysis

Flight Path Description	Parameters Examined											
	Medium-Level Situational Awareness						High-Level Situational Awareness					
	No SEAD		Medium SEAD		High SEAD		No SEAD		Medium SEAD		High SEAD	
	Base sig	Low sig	Base sig	Low sig	Base sig	Low sig	Base sig	Low sig	Base sig	Low sig	Base sig	Low sig
Baseline	X	X			X	X						
Low & slow	X	X			X	X	X	X	X	X	X	X
Low & fast							X	X	X	X	X	X
Very low & slow											X	X
Medium altitude							X		X			

DEFINITIONS: Medium-level SA provides intelligence on 50 percent of SAMs (type and location). High-level SA provides 100 percent intelligence. No SEAD means all air defense units are active. Medium SEAD means SA-12s and SA-17s are removed. High-level SEAD means SA-12s, SA-17s, SA-15s, and 2S6s are removed. Base signature corresponds to a large-body aircraft. Low signature corresponds to a notional low-observable helicopter.

How the Ground Combat Phase Was Modeled

In terms of the ground combat phase, we modeled RSTA and C2 capabilities, and the three operational concepts with varying levels of maneuver discussed above.

Modeling RSTA and C2 capabilities. RSTA and C2 capabilities tend to result from interactions of many factors, such as search areas and sensitivities of overhead assets like JSTARS and satellite sensors, inputs from signal intelligence (SIGINT), electronic intelligence (ELINT), and other indicators collected from air and ground platforms, degradations from communications relay delay times and losses, and effects of weather, terrain, and countermeasures. For simplicity, we postulated three parametric levels for RSTA and C2 capabilities, established by expert consensus, allowing us to roughly assess the importance of improvements in each of these. These are shown in Table 5.4.

The lowest level of RSTA was set to be similar to current-day operations. No foliage penetration was assumed, about 40 percent of targets in the open could be detected and

Table 5.4—Assumed RSTA and C2 Capabilities

Assumed RSTA Capabilities			
Level/Measure	Low Level	Mid-Level	Near-Perfect
Coverage foliage/open	0/40%	20%/70%	100%/100%
Accuracy/Discrimination	200m/detect	100m/recognize	1m/identify
Latency/update interval	5 min/continuous	1 min/continuous	real-time/continuous
C2 Capabilities			
Level/Measure	Nominal	Fast	Instantaneous
Fusion	100%	100%	100%
Delay	30 min	5 min	None

located, but not recognized, and the time from detection to receipt of the information at the command center is five minutes. It should be noted that enemy vehicles passed through many canopied areas even while they were on roads. The mid-level RSTA improves the low level to 20 percent foliage penetration (FOPEN), 70 percent in the open, recognition rather than detection only, and the time of receipt drops to one minute. The near-perfect case was instituted to determine the extreme case: complete coverage at high accuracy, discrimination, and timeliness.

C2 capabilities also started low, with a 30-minute delay for processing the information, deciding how to engage, and passing commands to a shooter. Fly-out times of the munitions are in addition to this. The mid-level drops the C2 delay to 5 minutes, and the bounding case has no time delay.

Ground operational concepts modeled. The three operational concepts considered vary the overall level of maneuver and type of force application (although all cases rely heavily on the aggressive use of standoff attack). The first concept concentrates solely on standoff attack, using B-2 and F-15 delivered JSOW and Navy and Army versions of TACMS cued by observers on the ground. These long-range weapons attempt to stop the advance of the elite enemy units.

The second concept involves the insertion of a consolidated force (an advanced infantry battalion with two immediate-ready companies (IRCs) to the standoff fires. This insertion requires establishing a lodgment and securing airfields for C-17s. Once in, the force flanks the enemy unit. The hope is that the enemy force will perceive this as a serious threat and turn to attack in response, thus delaying the enemy's march toward the front line to the east.

The third concept changes the picture to one of dispersed U.S. forces inserted deep to disrupt and attrit the enemy force throughout the battlespace. This concept was developed by SARDA but is also shared by TRADOC through its AAN and Mobile Strike Force research. In this particular application, a small ten-team force using three of the seven types of vehicles specified in the SARDA concept were employed. We also considered a variation of this concept, where instead of using the agile maneuver forces against the enemy's combat forces, these forces concentrate on the "softer" logistics and supply vehicles.

Measures of effectiveness. Assessments often concentrate on enemy attrition (and own losses) as the primary measure of effectiveness (MOE) in modeling and simulation. The dynamics of the ground battle in this analysis are such that disruption of the enemy operation—denying him the ability to move or resupply, slowing his progress, dispersing his forces, or degrading his coordination capabilities—may be as important as attrition. Shock effects (heavy losses over short time, in small areas, or of key systems) may also disrupt the advance.

The degree of disruption MOE still needs considerable refinement. Here, we use the simulation environment to help provide context for thinking about the disruption aspect of the mission in our scenario:

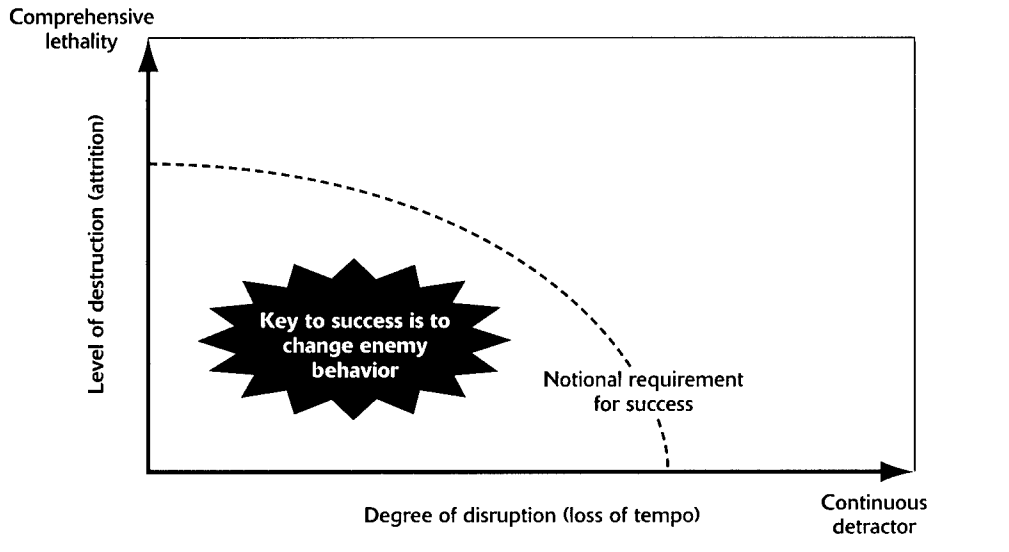

Figure 5.4—Measures of Effectiveness in Analysis

- Can the forces be inserted and extracted?
- Can they find good, soft, “support” targets?
- What is the impact of engaging moving combat-support vehicles?
- Can forces materially influence the effects of long-range fires? (What do “eyes on the ground” add?)
- Can forces do direct attack on enemy combat forces?
- How important are (1) tactical mobility, (2) RSTA, (3) organic weapons, and (4) long-range fire’s responsiveness?

Thus, in presenting the analysis results, we attempt to characterize the outcomes of the scenario along two major dimensions: level of destruction and degree of disruption. As shown by the dotted curve in Figure 5.4, some combination of these two factors should be sufficient to change enemy behavior.

Experiencing the Vertical Envelopment Concept

THINGS HAD BEEN REALLY HECTIC. As he sat in his vehicle, the lieutenant wondered how long he had gone without sleep. But now he could rest knowing that it had been a highly successful day.

Many hours earlier, the company commander called the officers and key NCOs together to explain the upcoming mission to them. They all knew the war was now about six days old. Reports indicated that although the enemy had made deep penetrations into allied territory, it was almost certainly losing momentum. The commander said that this was the time to strike. They were to load the wait-

ing air transports for a move against the enemy. The plan called for the Marines to seize a lodgment along the coast into which they would deploy and then attack. The target, they were told, was an enemy division heading toward the front line to try to get the enemy's advance back on track. This would mean that they would have to overfly some parts of enemy airspace to accomplish their mission. Not a pleasant thought. Using a medium-altitude corridor created just recently by an aggressive joint SEAD campaign, they were able to get the transports in without major event. The Weasels were up just in case any emitters came on line.

After a relatively short two-hour flight, the lieutenant's transport augured down into the airfield, located in a small port city. Waiting for them were guides from their unit and some Marines. The Marine Expeditionary Unit (MEU) had seized the port several hours earlier and pushed far enough inland to make sure the airfield was safe from any man-portable air defense missiles. Now came transport after transport, 84 in all, hustling in and out of the airfield as fast as possible.

The captain came over to say that the company was assembling in the fields near the church. All platoons were to double-check their communication gear and plug into the UAV net. Several of the unmanned aircraft had already been vectored off to examine the roads they would take toward the enemy division, which was about 50–60 kilometers to the south. No time to lose: the attack had to get going before the enemy could react to it. As he moved his platoon into the assembly area, the lieutenant heard Marine artillery firing and saw Navy jets streak in over the coast, heading south toward the enemy division.

After less than 30 minutes on the ground, the company was on its way. They passed beyond the Marine lodgment and headed south in platoon groups. Four companies, maybe 50 vehicles, were headed along three different routes. As his vehicles moved along the road, the lieutenant could see their progress on his command digital display. He soon started to see "red" icons on the screen—the UAVs were finding targets. Minutes later, he heard the supersonic roar of TACMS overhead. They had come either from the ships offshore or from his unit's HIMARS that had arrived via air.

After about 30 minutes of road marching, the command display started to light up. The lead company was in contact farther up the road. Minutes later, orders from the company commander arrived, directing his platoon to take a different road, farther to the west, to bypass the fight up ahead. No need to get bogged down there.

Nearly an hour went by. No contact yet—just frightened civilians looking out of their windows as the platoon passed a couple of small villages. Attack helicopters flew overhead, heading toward the

enemy. Glancing at his display, the lieutenant could see that the foe now appeared to be about 15–20 kilometers away. The fight was already in progress elsewhere—two companies were in contact. Then a new digital message arrived from the company commander: "1st Platoon assume BP 1 by 1400 hours. 2nd Platoon assume BP 2 at same time. 3rd Platoon prepare to attack the enemy west of BP 3, on order." That meant him—be prepared to attack enemy west of battle position 3. The message was relayed to his four sergeants in the other vehicles. Darting

They all knew the war was now about six days old. Reports indicated that although the enemy had made deep penetrations into allied territory, it was almost certainly losing momentum.

along another road, the lieutenant took his platoon behind a hill about 5 kilometers from BP 3. Still no enemy.

Just as his platoon was getting into its hide position, he heard firing from about 3–4 kilometers away. It was 1st Platoon. A quick glance at the display showed its vehicles. They were in contact. He could see on his screen “info copies” of calls for fire that 1st Platoon and the company commander were generating. For 10 minutes or so, there was heavy firing in the area of BPs 1 and 2. The reports indicated that the company was fighting part of an enemy mechanized battalion—maybe more. Apparently the enemy had been largely taken by surprise to find American light mechanized units so far in his rear area. Now the fight was on.

Suddenly the voice command net came alive. It was the company commander: “Get to BP 3 now and attack the enemy along the road. The UAVs show that the battalion trains of this enemy unit are hung up along that road. I’ll keep the head of the enemy column busy from here. You have to be in and out before 1500—fighters are inbound to hit the road after that.” A quick message to the four sergeants was all it took to get the platoon moving around the hill toward the road. The rest of the company was now about 5–8 kilometers to the east, engaged with the enemy’s combat vehicles. The lieutenant knew that his target was vulnerable trucks and supply vehicles.

Leaving the road, now bounding cross-country, the platoon navigated through the data it was receiving from the overhead UAVs. The fight to the east was clearly shown on the screen. Now he could also see the red icons of vehicles stopped on the road leading back to the west. Only a couple of minutes to go now. He sent two of his vehicles into the woods to pop out as they reached the top of a small ridge overlooking the road. He then led the other two vehicles back down onto the road and headed toward the enemy vehicles. Hopefully they were trucks, not stopped APCs or other fighting vehicles.

As he pulled out onto the road he spotted them. A line of trucks parked up against the trees, just off the road. They were about 900–1,000 meters away. “Gunner, fire at will,” he barked into the microphone. “Engaging,” was the terse reply he heard on his headset. The 35mm chain gun roared as the lead enemy vehicles burst into flames. The other two vehicles followed him onto the road and opened fire. More trucks went up in flames as they sprinted toward the enemy column, closing the range to less than 500 meters. Troops could be seen piling out of the burning vehicles, running into the woods.

Suddenly, he saw more tracers hitting the column from up on the ridge. It was his other two vehicles coming out of the woods. Raking the enemy column, they maneuvered down the slope to join the rest of the platoon. As they reached the road, there was an explosion on one of his vehicles, inflicted by an enemy soldier with a shoulder-fired anti-tank weapon. The vehicle skidded to a stop. The three crewmen started to get out under covering fire from the rest of the platoon. Meanwhile, the lieutenant called for indirect fire farther down the road.

As the three crewmen climbed aboard one of the other vehicles, the lieutenant ordered the platoon to withdraw. They had been in contact with the enemy for less than five minutes. He took a quick count. About 20 enemy trucks were destroyed, plus a couple of armored command vehicles, and

two towed air defense guns. He had lost one vehicle. The crew had escaped, thanks to the new Kevlar composite internal protection system that gave them excellent personnel protection. Now it was time to get away—the fighters would finish the job.

By that evening, the task force was returning to the USMC perimeter, which had been expanded while they were off on their mission. The 50 vehicles in his battalion, working with their supporting fighters, helicopters, and missiles from the nearby ships, had hit the enemy division hard in its flank. Probably 250 enemy vehicles of all types had been destroyed, all for the loss of about a dozen vehicles (mostly unmanned robotic vehicles) and three helicopters from his task force.

After-Action Review for the Vertical Envelopment Concept

As we saw in the previous section, once inserted, the notional ground force was very effective in disrupting the enemy regiment by destroying its softer support units. Here, we provide the analysis results for both the air insertion and several different kinds of ground combat with various levels of maneuver.

The Air Insertion Phase

The first challenge for the vertical envelopment operation was the air insertion, in which air transports must penetrate enemy airspace and land in contested areas. Even with the help of future technologies, this is envisioned to be a very difficult mission. Table 5.5 summarizes the results of the 24 air maneuver excursions shown earlier in Table 5.3. A cursory examination of the results of missions requiring penetration of enemy airspace yields the following general observations:

- SEAD is a critical part of the insertion mission.
- Greater SA can improve survivability, except when enemy air defense systems are not disrupted.
- Stealth by itself tends to lose its effect at slow speeds.
- Slower flight speeds allowed lower altitudes to be obtained during penetration of enemy airspace
- Extreme combinations of stealth, SA, SEAD, and flight tactics may be needed to achieve survivability at low altitude.
- With SEAD of high-level enemy air defenses, medium-altitude penetration becomes an option for deployment of force.

While none of the observations proves remarkable or counterintuitive, the results do demonstrate a consistency across all the excursions. Below we show the results of the different flight paths flown by the different operators.

The baseline paths. Figure 5.5 illustrates, for the base case, the attrition of the airframes over time and by air defense system. This figure reveals that in this scenario the SA-12 is the most dangerous threat to the airframes, followed closely by the 2S6 and the SA-15. The two approaches led to the transport aircraft being exposed to different ADA

**Table 5.5—Results of Excursions Examined in the Air Maneuver Analysis
(Percent Transports Surviving)**

Flight Path Description	Parameters Examined											
	Medium-Level Situational Awareness						High-Level Situational Awareness					
	No SEAD		Medium SEAD		High SEAD		No SEAD		Medium SEAD		High SEAD	
	Base sig	Low sig	Base sig	Low sig	Base sig	Low sig	Base sig	Low sig	Base sig	Low sig	Base sig	Low sig
Baseline	0%	0%			0%	25%						
Low & slow ^a	40%	57%			93%	98%	62%	79%	79%	88%	93%	100%
Low & fast							19%	63%	56%	87%	56%	87%
Very low & slow											62%	87%
Medium altitude							0%		100%			

DEFINITIONS: Medium-level SA provides intelligence on 50 percent of SAMs (type and location). High-level SA provides 100 percent intelligence. No SEAD means all air defense units are active. Medium SEAD means SA-12s and SA-17s are removed. High-level SEAD means SA-12s, SA-17s, SA-15s, and 2S6s are removed. Base signature corresponds to a C-130 sized tilt-rotor. Low signature corresponds to a notional low-observable helicopter.

^a Over-water-only cases.

systems. The transports flying in from the ocean were well within the range of a SA-12 and several SA-15s before landfall. Roughly 90 percent of the transports were destroyed before they traveled 10 kilometers in from the coast. SA-15s were able to attrit the rest as they progressed inland. The transport aircraft across the FLOT were later shot down by a combination of 2S6s, SA-15s, SA-17s and SA-18s. The 2S6s shot down roughly half the transports flying cross-FLOT.

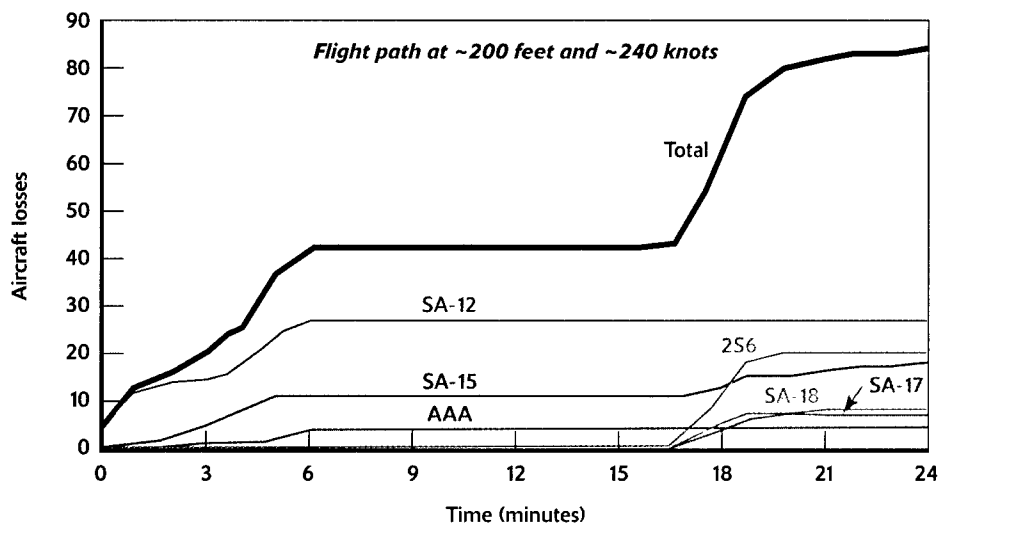

Figure 5.5—Attrition Rate Over Time in Base Case

Running the base case with a notional signature reduction (results shown in Figure 5.6) did not change overall mission survivability.⁹ This was because the SAM radars were still able to pick up the signature assumed for the aircraft. The acquisition ranges were limited more by the terrain than by the radar signature of the aircraft. In both assumed signature cases, RF SAM kills occurred at ranges significantly less than the RF missiles' maximum ranges because of the low altitude at which the aircraft were flying.

Thus, increasing the amount of SEAD alone did not tend to change overall mission survivability (in this case, we assumed away all SA-12s, 15s, and 17s). However, it was interesting to note that the base-signature aircraft did survive longer. Again, we used a representative "best case" signature to bound the problem. In this case, we were able to get some realized survivability gains (about 30 percent of the airframes survived).

One other option to increase aircraft survivability is to clear flight corridors for ingress and egress. From an aviation tactics standpoint, all known SAM sites along the flight path would have to be suppressed to make the mission a "Go." We note that even in this case, mission success is not guaranteed. Additional tactics and technology are needed. Combining aggressive SEAD and stealthy aircraft enabled some aircraft to survive the mission. While the attrition rate was high, the notion of combining several survivability-enhancement techniques clearly had merit.

Low and slow paths. To measure the effect of flight paths, we examined how reducing altitude (and speed) would affect aircraft survivability. With these new sets of paths, we started by examining the outcomes of excursions grouped by various SA levels. Here, we noted that increased SA reduced the effectiveness of the emitting SAMs because the pilots were able to avoid or reduce their exposure to known SAM locations. In this case, we examined only the group of transports flying in from the ocean: the low and slow

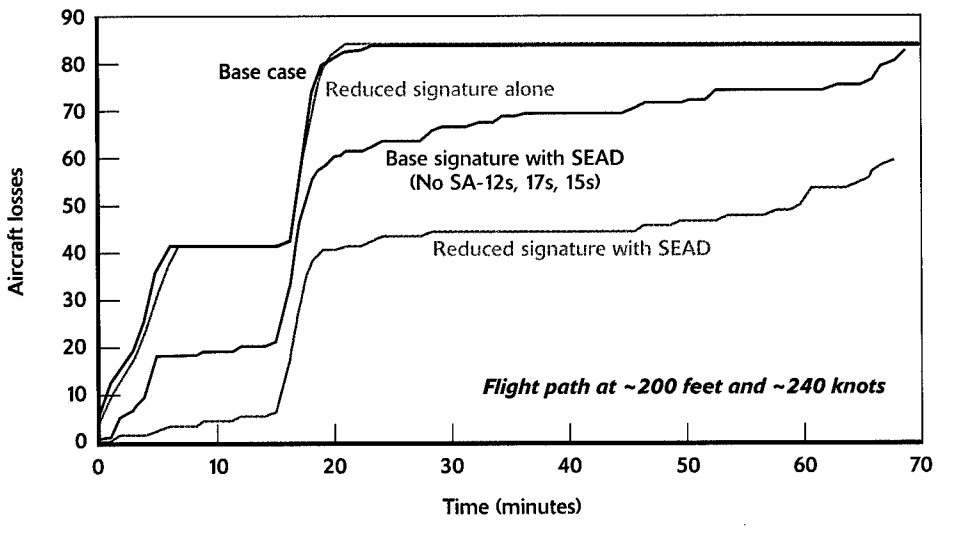

Figure 5.6—Effect of Reducing Signature and Increasing SEAD on Base Case

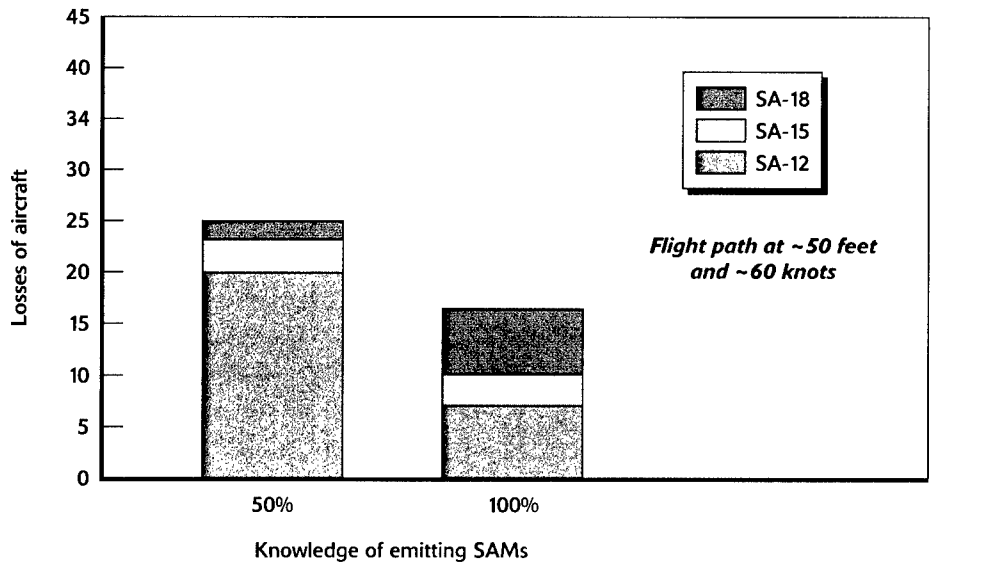

Figure 5.7—Effect of Increasing SA (Knowledge of Location of Emitting SAMs) on Low and Slow Case

case (see Figure 5.7). The pilot attempted to either fly around or under the RF SAM sites that appeared on the flight planning aid (CHAMP).

The limited aerodynamics of the transport aircraft resulted in some SA-12 kills, even when the pilot knew where all the SA-12s were, because the aircraft could not totally avoid two SA-12 missile sites. The SA-12's target acquisition radar can detect a two-square-meter aircraft at over 250 kilometers.¹⁰ SA-12 missiles can engage targets at 100-kilometer ranges. It is therefore not surprising that over a 250-kilometer path traversing enemy-held terrain, active SA-12s have multiple opportunities to engage the transport aircraft examined here.

The next series of runs—shown in Table 5.6—examined the effects of variable levels of SEAD. When the SA-12s, 15s, and 17s were suppressed, mission survivability was significantly increased. The SA-12 and SA-17 are not easily jammed and will, therefore, require an aggressive SEAD campaign. SA-15s can be jammed, but enemy tactics and improved versions of the SA-15 could make jamming of the missile more difficult. Also noteworthy, the use of a jammer against radar may have a countereffect, since it can represent a beacon to cue optically guided ADA such as AAA and IR SAMs. Other ADA assets such as the 2S6 will switch to the AAA mode when jammed. Also, systems like the 2S6 and SA-15 can switch from radar to optical mode, using (conditions permitting) optical target acquisition and engagement when radar emissions have been jammed. There were very few non-RF ADA systems defending the coastline, and as the table clearly shows, only the SA-18s were able to successfully engage the air transports when the high-end SAMs were suppressed.

Table 5.6—Effects of Variable Levels of SEAD on Mission Survivability: Low and Slow Case

Air Defense System	No SEAD	No SA-12, SA-17	No SA-12, SA-15, SA-17	No SA-12, SA-15, SA-17, Stealth
SA-12	6	0	0	0
SA-17	0	0	0	0
SA-15	3	5	0	0
SA-18	7	4	5	0
2S6	0	0	0	0
AAA	0	0	0	0
Total losses	16	9	5	0

42 air transports flying in from the ocean.

Use of stealth further increased mission survivability. The lower-IR signature of the aircraft led to no losses to the SA-18s. The use of very good situational awareness, effective SEAD, and stealthy aircraft makes this type of mission even more feasible. The main challenge would be to locate the majority of enemy active and passive air defense systems as the mission was being planned and then get continuous real-time updates while the aircraft are in flight.

Two distinct observations were noted in conducting the analysis with these flight paths. First, the flight speed was slow, less than 60 knots. In the future, ground vehicles could possibly drive to the landing site in a comparable amount of time. Second, the ADA environment was relatively free of optical ADA systems, not necessarily expected in a mission flying over a front-line enemy division (cross-FLOT).

Low and fast paths. We also assessed the survivability of the air transport force with a faster ingress speed. Presumably, if aircraft must fly over terrain, they will have greater difficulty maintaining low-altitude flight; as a result, they could either fly faster at some cost in altitude or fly much slower. This set of cases focuses on the faster ingress option.

Table 5.7 shows the results of these cases. The cross-FLOT mission was successful in avoiding SA-12s, SA-15s, and 2S6s because of good SA of their location. The large number of SA-18s and AAA, however, limited mission survivability. Stealth significantly reduced the number of aircraft attrited by these systems. Still, a 20 percent attrition rate

Table 5.7—Effects of Variable Levels of SEAD on Mission Survivability: Low and Fast Case

Air Defense System	No SEAD	No SA-12, SA-17	No SA-12, SA-15, SA-17, Stealth
SA-12	0	0	0
SA-17	16	0	0
SA-15	0	0	0
SA-18	15	14	7
2S6	0	0	0
AAA	11	14	1
Total losses	42	28	8

42 air transports flying cross-FLOT.

is likely to be unacceptable. IR jammers and SEAD against AAA sites could reduce the attrition further, potentially to acceptable levels. Small-arms fire, as well as tanks and BMPs, were not included in this model and could significantly raise the number of losses. Tactics and technologies for dealing with the optical and IR air defense threats may need to be developed for these flight paths.

Very low and slow paths. One other approach is to bring the flight paths very close to ground level. Here, the transports are assumed to have capability that would allow them to “hug” the terrain. Paths started out with 42 aircraft punching through one point along the coast and 42 aircraft punching through one point of the FLOT. After the initial ADA penetration, each group of 42 split into 3 groups of 14. Paths were similar to previously presented cases. (Exceptions to this were the 20-foot AGL and 100-knot speed versus the previous case’s 240-knot, 70-foot AGL.) Paths from the ocean punch through at the SA-17 site, which was destroyed before the transports entered the area. Cross-FLOT paths went through the city/town slightly in front of the FLOT and between SA-15s on either side of the town.

The aviators from the U.S. Army Aviation School developed TTPs based on the very specific assumptions shown below.

- Extensive reconnaissance prior to the mission.
- All emitters’ positions known.
- Some fraction of nonemitter ADA assets known.
- Some fraction of enemy ADA will move during the insertion mission.
- High-end SAMs, C2, and airborne radar platforms are suppressed.
- Real-time intelligence is provided to attack aircraft.
- Aircraft would fly at night/dusk to limit the effectiveness of optically guided ADA.
- All aircraft make maximum use of SIRFC.
- Fixed-wing activity will diffuse the focus of threat ADA.
- Air Force and Navy will be flying tactical and/or operational missions during insertion.
- Flight paths will be 20 feet above the ground and at 100 knots over suspected RF SAM covered/engagement areas.
- Transports will fly in groups of 14 in a tactical trail formation with a 50-meter separation.

The results of the excursions employing these TTPs are shown in Table 5.8 and are comparable to cases already flown and examined (specifically those cases with high SA, high SEAD, and stealth). Again, the limiting factors were the optical and IR air defense threats.

Medium altitude paths. One other method of countering the effects of low-altitude air defense systems is to fly above their engagement envelopes. These sets of paths were

Table 5.8—Mission Survivability Levels: Very Low and Slow Case

Air Defense System	Ocean	Cross-FLOT	Ocean and Stealth	Cross-FLOT and Stealth
SA-12	0	0	0	0
SA-17	0	0	0	0
SA-15	0	0	0	0
SA-18	10	11	5	4
2S6	0	0	0	0
AAA	2	9	0	2
Total losses	12	20	5	6

42 air transports per mission (ocean or cross-FLOT); flight path at 100 knots, 20 feet above ground level over land.

flown above the range of AAA, MANPADs, 2S6s, and SA-15s, generally 20,000 feet or higher.

The strategy of flying above the range of low/medium-range SAMs was used successfully during Desert Storm. As long as the high-altitude SAMs are suppressed, this strategy works. For vertical envelopment tactics performed by Army units, the challenge would occur when aircraft had to descend toward their landing zones. This implies that for a portion of the mission, the aircraft could be in the range of the short-range SAMs, MANPADs, and anti-aircraft guns. If these two problems can be dealt with, (e.g., sterilization of the landing zones), then this medium-altitude ingress is clearly a viable approach.

Summary of Results for the Air-Insertion Phase

Analysis of the data from the ingress excursions yields the following insights:

- With low-altitude ingress and with some situational awareness of emitter locations, the aircraft can avoid SA-12s, and some SA-15s, SA-17s, and 2S6s. In our postulated enemy ADA scenario, not all RF SAM systems could be avoided.
- High levels of SEAD will be needed to countermeasure emitting air defense systems. Even one long-range RF SAM site can inflict significant damage to the AAF squadron.
- Stealth and large amounts of responsive SEAD are required to counter the effectiveness of AAA and MANPADs during low-altitude ingress.
- Flying through areas of higher-density AAA and MANPADs (such as that encountered in the cross-FLOT) will lead to relatively high (approximately 20 percent) aircraft losses.
- Mid-altitude ingress is a viable option if the long-range SAMs can be suppressed and the landing area secured from AAA and MANPADs.

The Ground Combat Phase

We separately examined three different maneuver concepts for the ground combat phase, assuming that the air-insertion phase was successful.¹¹

Maneuver Case 1: standoff attack operation. The stages of the first concept are delineated in Figure 5.8. Generally, a joint-SEAD (JSEAD) operation aided by Special Operations Forces (SOF) opens air corridors to the target units. Army aviation is used to bolster the coalition defense along the forward edge of battle area (FEBA). Naval missile fires from the amphibious ready group (ARG) concentrate on the lead and northern enemy units, while air strikes (B-2 and F-15 with JSOW) attack the lead and southern units. The primary objective is to attrit the units sufficiently so that they cannot close with the units in contact.

Specific phases of the battle plan are as follows:

- U.S. air/helicopter/ground assets combine with coalition SEAD to open air corridor(s). SOF are inserted to provide human intelligence (HUMINT) and BDA.
- Army attack helicopters destroy a motorized rifle regiment (MRR) in center tank division along FEBA. U.S. infantry conducts infiltration in support along with limited air support and field artillery (FA). Marine expeditionary unit (MEU) seizes a beach on the north coast. U.S. air attacks are intended to attrit and slow lead and northern MRRs (priority on lead).

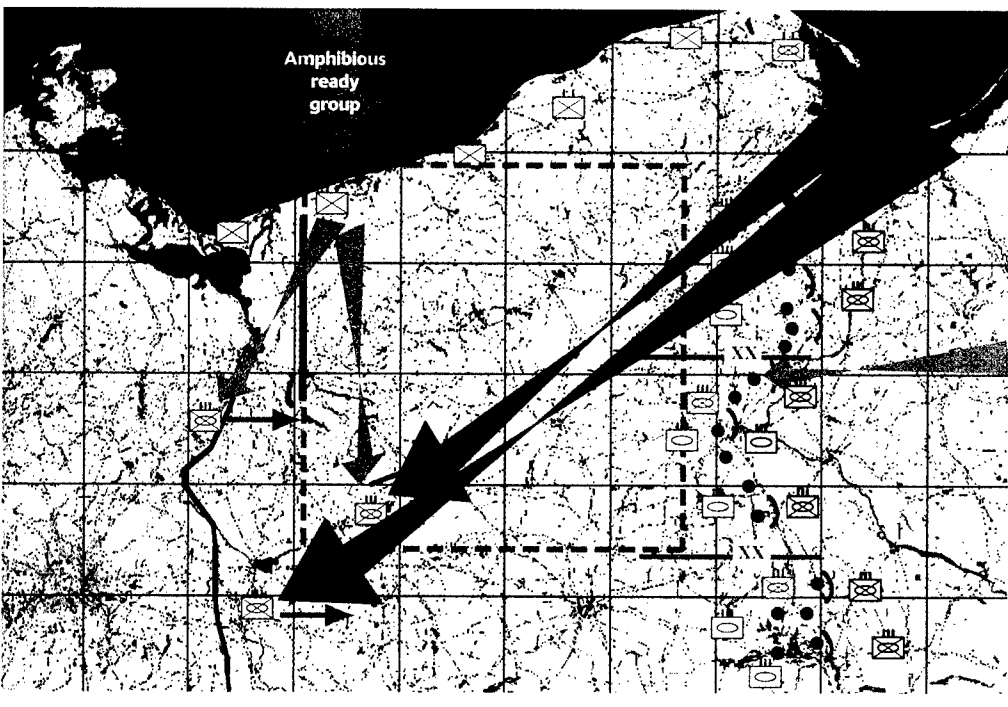

Figure 5.8—Depiction of Maneuver Case 1: Standoff Attack Operation

- MEU attacks to defeat northern MRR. U.S. air shifts priority of attack to defeat southern MRR (80 percent) and continues to attack lead MRR.
- MEU continues attack on northern MRR. Air attack continues against southern MRR.

For Case 1, the planners set up separate engagement zones for aircraft and missiles. This was done to ensure deconfliction of the assets. The aircraft launch their JSOW canisters from as much as 70–80 kilometers away, but this is still in the envelope of the long-range, high-end air defense systems, such as SA-12 or SA-17. Accordingly, we assume JSEAD is successful against these systems. The planners still have a difficult task targeting the smart munitions, since there are only limited open areas between covering foliage and some amount of lead must to be programmed into the targeting points to compensate for the weapon's long (10-minute) fly-out time.

The TACMS missiles also have difficulty with overhead cover and have a similarly long fly-out time, since they are typically fired at almost maximum range. These weapons, equipped with brilliant submunitions, home in on the louder targets, such as tanks and BMPs.

Table 5.9 shows the conditions for TACMS engagements for six different Case 1 excursions (A–F) involving the different levels of RSTA and C2 shown earlier in Table 5.4. Each excursion varied the level of detection probability (low, medium, and high) in both foliage and open areas. The timeliness of information (latency), engagement method decision time, and time of flight were also varied in each excursion. Only in cases of perfect information (high) was BDA used in target planning.

Targeting methodology included the following steps:

- **Decide:** location and number of missions fired determined by expected high-priority target (HPT) consisting of six or more armored vehicles and targets of opportunity.
- **Detect:** track all HPTs or targets of opportunity for engagement in open areas along the three major avenues of approach.
- **Deliver:** fire missions into target areas with calculated lead time to interdict HPT or targets of opportunity. Each JSOW contained two submunitions.

Each fire mission used two TACMS per engagement with multiple submunitions.

Table 5.10 shows the results of the six excursions in Case 1. Terrain and composition of target sets had a significant effect on TACMS efficiency. Advantages from better intelligence on enemy forces were hindered by suitable target areas (open terrain) and ineffective destruction of vehicles with low acoustic signatures (combat support (CS) vehicles). However, more TACMS were fired in cases with better intelligence because the target methodology was used to engage HPTs and targets of opportunity. All told, the percentage of total kills (both combat and CS) was much higher for the TACMS than for the JSOW, ranging from 33 percent to 80 percent versus 28 percent to 30 percent.

Table 5.9—Conditions for TACMS Engagements

Excursion	Prob (Tree)/ Prob (No Tree)	Latency (min)	BDA	C2 Delay (min)	Time of Flight (min)	Total Lead Time (min)	Remarks
A	0/.4 (Low)	5	No	5	10	20	Sensor to HQ to shooter
B	.2/.7 (Med)	1	No	5	10	16	Sensor to HQ to shooter
C	1/1 (High)	0	Yes	5	10	15	Sensor to HQ to shooter; BDA used
D	0/.4 (Low)	5	No	0	10	15	Sensor to shooter
E	.2/.7 (Med)	1	No	0	10	11	Sensor to shooter
F	1/1 (High)	0	Yes	0	10	10	Sensor to shooter; BDA used

Table 5.10—Results for JSOW and TACMS Engagements

Excursion	JSOW Fired	JSOW CS Kills	JSOW CBT Kills	Total JSOW Kills	TACMS Fired	TACMS CS Kills	TACMS CBT Kills	Total TACMS Kills
A	144	33	7	40 28%	40	2	16	18 45%
B	144	34	6	40 28%	60	1	19	20 33%
C	144	33	7	40 28%	68	2	21	23 34%
D	144	34	6	40 28%	40	3	29	32 80%
E	144	34	6	40 28%	48	1	25	26 54%
F	144	33	10	43 30%	68	4	32	36 53%

As shown in Figure 5.9, the greatest effect on the enemy appears to be in excursions D–F (shortest lead times), when the Red combat vehicle force was degraded by more than 12 percent. However, although the combination of improved intelligence and shortened “lead times” significantly improved the TACMS targeting effectiveness, the level of total Red attrition from TACMS and JSOW kills never rose above 15 percent. Under the most advantageous conditions, the maximum level of attrition in Case 1 was not sufficient to prevent Red forces from conducting future MRR-level combat operations, in which Red should be able to continue toward its objective.

It should be noted that standoff attack might be improved by using other tactics, such as riskier, low-altitude delivery of weapons, or by using orbiting alternative munitions. These options were not examined in this study, but we would expect them to be complicated by issues of SEAD, survivability, and deconfliction.

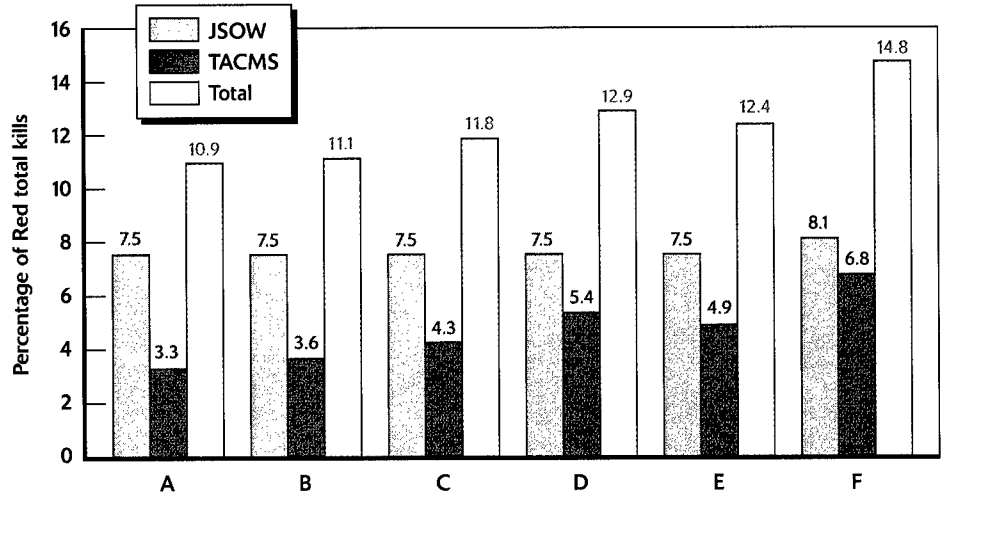

Figure 5.9—Total Percent of Red Kills in Each Case 1 Excursion

Standoff attack did poorly in this scenario. This cannot be attributed to RSTA and C2 capabilities, however, because even in the bounding case (comprehensive information, high level of accuracy, continuous update, no time delay), an average of less than one kill per weapon was achieved. This inefficient performance could be traced to many underlying factors, several of them scenario-related, such as the degree of threat dispersion (ability of the threat to “reshape itself” to appear to be a less lucrative target) and the level of foliage on the terrain. Most of the factors had to do with the relatively long time-to-target associated with the use of these weapons at range. Others had to do with the logic associated with multiple submunition weapon systems.

Figure 5.10 summarizes the results of Case 1 by plotting the outcome on the destruction/disruption axes discussed earlier. We find that standoff attack achieved a limited amount of attrition (killing 62 to 79 of the 550 enemy systems in the lead regiment, broken out in Table 5.2). This level of attrition was found to increase strongly if foliage was omitted. We found, for example (in a separate “bald earth” run) that 195 kills were obtained. On the other hand, enemy countermeasures such as the use of decoys, active protection systems, and force dispersion could reduce the number of kills below that achieved earlier.

In all these cases, the enemy might suffer little disruption. The standoff strikes seldom hit specific, high-value vehicles, such as C2 or bridging assets, and do not have a localized “shock” effect. Rather, they attrit sporadically along the column, and the hulks would be expected to provide little obstacle to movement, particularly in this trafficable terrain. Only in the case with no cover would significant disruption be expected. These results suggest that firepower alone, operating in the absence of friendly maneuver units, would be limited in its ability to stop a rapidly advancing enemy force.

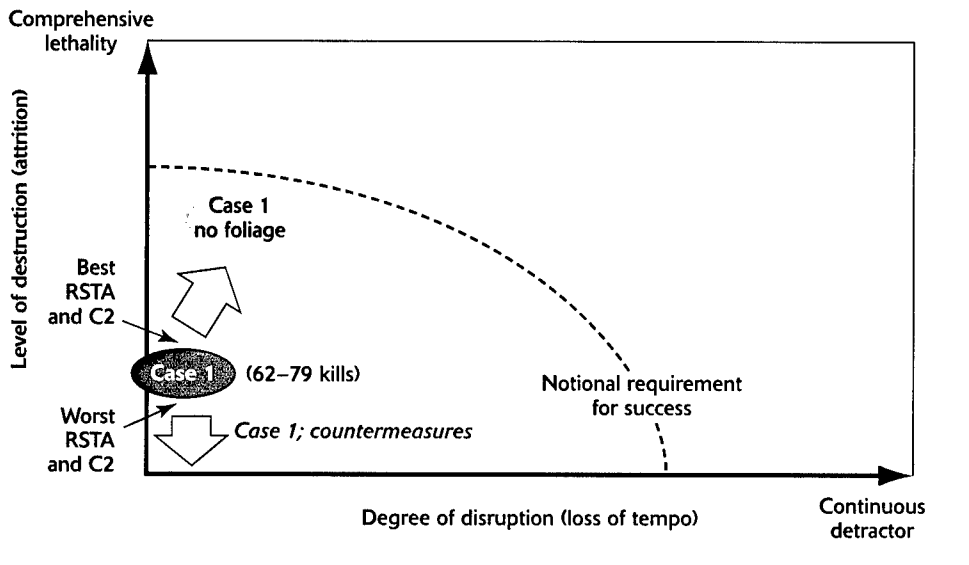

Figure 5.10—Summary of Case 1 Results

Maneuver Case 2: standoff weapons and ground insertion to block key reserve

division. As shown in Figure 5.11, Case 2 also carries out the JSEAD and standoff attack missions, but it adds the insertion of a cohesive ground force. The ground force is made up of a MEU and an airborne infantry battalion augmented with future systems such as EFOG-M, LW-155, Outrider (a small tactical UAV), and ADAS. The airborne battalion is augmented by two immediate-ready companies (IRCs), which together have 4 M1s and 4 M2s. The MEU first establishes a lodgment at the coast, enabling the Army ground force to be inserted to the flank of the lead elite enemy regiment. By enhancing their apparent size with deception devices, the IRCs try to provide a sufficient threat to turn the lead regiment. If successful, they use a combination of fire and maneuver to try to attrit and disrupt the enemy attack. In this case the U.S. ground force was assumed to have been inserted in the enemy's rear area via C-17 aircraft. The previous analysis indicated the potential danger of overflying enemy territory with transport aircraft. The case described below could, therefore, be thought of as an instance of such a force being inserted into either the enemy rear or flank, depending on the effectiveness of the opposing air defenses.

Specific phases of the battle plan are as follows:

- Battle begins with JSEAD and SOF insertion. Air begins attrition of lead MRR. MEU lands to establish lodgment and FAARP to the north. IRC expands lodgment.
- Airborne battalion establishes battle position north of lead MRR route of advance. IRC maneuvers to flank lead MRR.
- Combination of ground forces, helicopters, and fixed-wing aircraft attack MRRs to delay and then defeat.

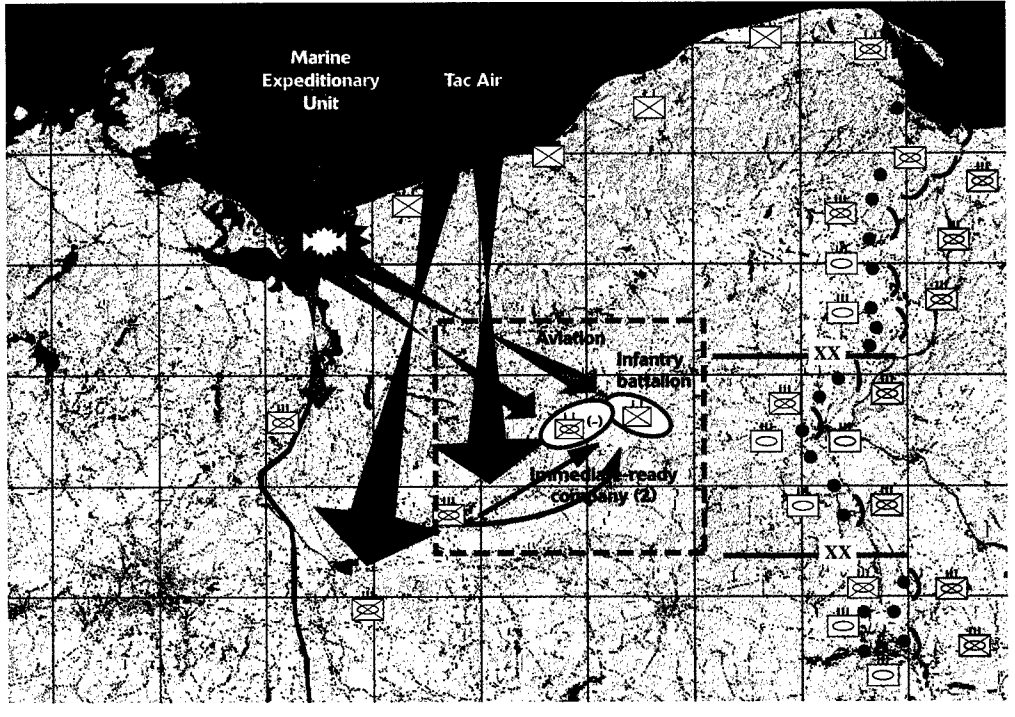

Figure 5.11—Depiction of Maneuver Case 2: Standoff Attack and Ground Insertion to Block Key Reserve Division

- Dilemma is created for the enemy commander by threatening his operation with a ground unit capable of physically interdicting lines of communication (LOCs) and destroying combat units.

Case 2 changes the situation dramatically, but only if Red chooses to turn and attack the battalion-sized force.¹² Even with two IRCs, the limited tactical mobility of this force renders it a relatively stationary, defense-based force.

Once in, the U.S. force should have sufficient firepower to (1) present a serious threat to the enemy, (2) effectively engage (or at least delay) the enemy armor, and (3) successfully disengage and egress. If the force is bypassed, it does not accomplish its mission.

Assuming that the enemy turns to attack, when simulated, the results suggest that ground force could substantially improve on the lethality obtainable by standoff fires alone. However, part of the cost of this additional lethality comes in losses to the ground force.

The results of Case 2 are summarized in Figure 5.12. In addition to increasing the lethality of the U.S. response, Case 2 also increases the force's robustness, where weapons in close proximity (e.g., direct fire) can be significantly more difficult to countermeasure. Nonetheless, since once in place, this force lacks mobility on par with the enemy, it can be bypassed. Even if the enemy chooses to engage this force, depending on the circumstances, it can opt to either fight with its overwhelming numbers or break off a smaller unit to contain this force. The lack of tactical mobility of this U.S. force is significant.

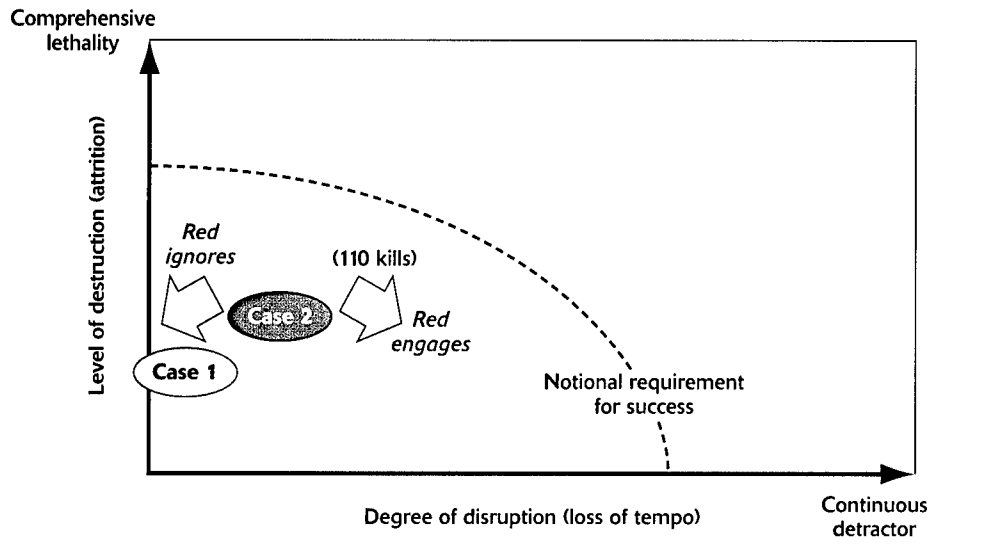

Figure 5.12—Summary of Case 2 Results

Maneuver Case 3: standoff attack and agile ground maneuver to engage key reserve division. As shown in Figure 5.13, in Case 3, standoff attack and quick-deploying maneuver forces are used to attrit and disrupt the enemy operation at many points. The JSEAD operation hits air defense sites throughout the region and, at the

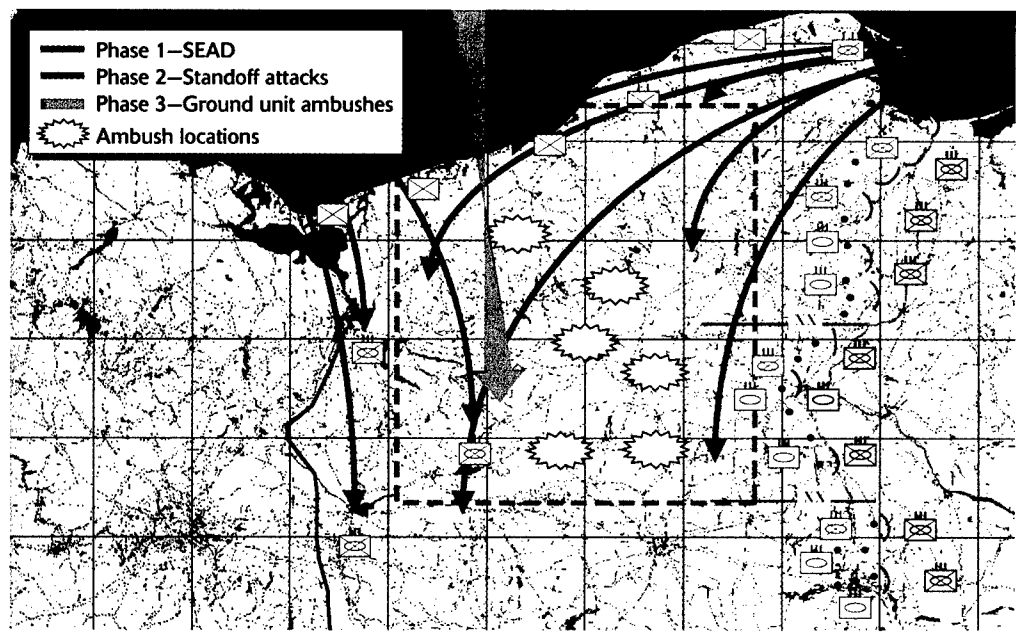

Figure 5.13—Depiction of Maneuver Case 3:
Standoff Attack and Agile Ground Maneuver to Engage Key Reserve Division

same time, cuts a corridor through for an insertion. Standoff attacks target all the elite units, while the ground units are deployed along the enemy's routes of advance. Here, specially designed, highly agile ground vehicles are used (see Figure 5.14). The ground units set up ambushes and plan for egress routes to their next attack points. Three types of enhanced medium-weight vehicles are used: future combat vehicles with LOSAT direct-fire kinetic energy (KE) systems, fire support vehicles with advanced (30-kilometer) fiber-optic guided missiles, and robotic vehicles that can call in fires during the ambush and in the egress phase, in which they may be left behind. All these systems can be airlifted by C-130s.

Specific phases of the battle plan are as follows:

- U.S. air/helicopter/ground assets are combined with coalition JSEAD to open air corridor(s). SOF are inserted to provide HUMINT and BDA.
- Long-range standoff attacks conducted by Joint Task Force assets (both aviation and artillery).
- Light, highly maneuverable ground force conducts direct-fire ambushes to destroy the lead regiment.
- Air attack continues against northern and southern MRRs.

Case 3 represents a departure from the way a conventional ground force might operate today. Here, there is a deep insertion of advanced maneuver forces, which attack the enemy forces at many points, carrying out ambushes and moving to the next en-

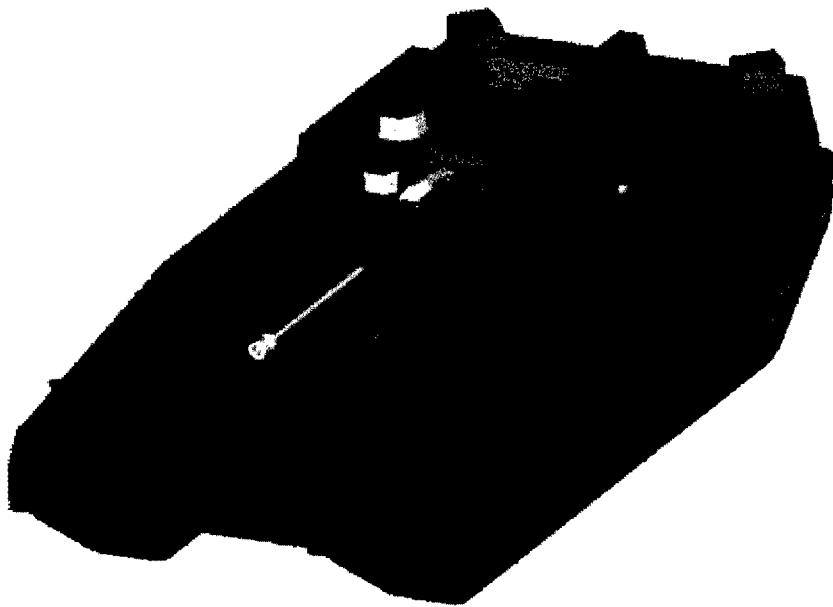

SOURCE: SARDA briefing, *Enhanced Alternative Strike Force*, 1998 (provided by Dr. John Parmentola).

Figure 5.14—Exemplary Future, Lightweight Ground Combat Vehicle Associated with Enhanced Strike Force

agement opportunity. This is done in concert with standoff fires. The maneuver forces make use of a family of roughly 20-plus-ton tracked and wheeled vehicles that are airliftable on C-130s. Of the seven platforms currently envisioned for this notional force, we chose a subset for use in the scenario. Each of the ten teams in our organization has seven direct-fire future combat vehicles, four fire support vehicles, two robotic scouts, and one air defense vehicle. The 140 total vehicles make up two battle units, roughly a third of a full battle force.

The aircraft engagement zone is as before, but the missile engagement zone is shifted to the middle column of the enemy advance. In this way, the large-footprint submunitions from standoff fires will not overlap onto friendly forces.

Again, SEAD is critical to the mission. Enemy air defenses endanger the aircraft lofting JSOW, the transports inserting the ground forces, and even the TACMS missiles targeting the center column. Current levels of RSTA and C2 are probably insufficient to carry out this operation. The insertion requires extensive, up-to-date knowledge of enemy strength and locations. We only instituted “moderate” and “high” levels in these runs.

Given a successful insertion, we found that the combination of standoff fires and organic direct and indirect fires was very effective. Some losses were sustained by the U.S. ground forces, but the overall lethality of the combination of fires was far greater than for standoff weapons. One enemy countermeasure to this operation is to react to the ambushes by placing fire on likely further ambush locations. We found that this increased Blue losses but did not significantly change the outcome. Other enemy countermeasures should also be explored.

We noted earlier the difficulty of inserting a ground force deep in the enemy rear, given that Red would be expected to have a capable air defense network. Some alternatives to a direct, low-altitude insertion were also considered.

The first possibility assumes good intelligence on planned enemy movements, along with an opportunity to insert before the invasion. The Blue maneuver force is stealthily inserted, waits for the attack, is bypassed, and initiates the ambush.

The second alternative, deployment from the ground, involves tactical air insertion to a region outside the enemy air defenses. For example, the Marine MEU might seize a lodgment on the coast into which Army forces are quickly deployed via C-130. Once safely on the ground, the highly mobile Army force leaves the amphibious lodgment area and heads toward the flank of the targeted enemy force. Maneuver vehicles then must move quickly and stealthily to the engagement areas and may require in-route refueling points. As an option, refueling may perhaps be accomplished using fuel bladders delivered by powered parafoils using GPS guidance.

Deployment from the air, finally, may be achieved using several means. The SEAD campaign may open several corridors, or there may simply be some weak points in the enemy perimeter. A set of airfields may be secured and multiple insertion areas established. The flight profile may entail high-altitude overflight (above the radar SAMs) followed by circling in on the landing areas.

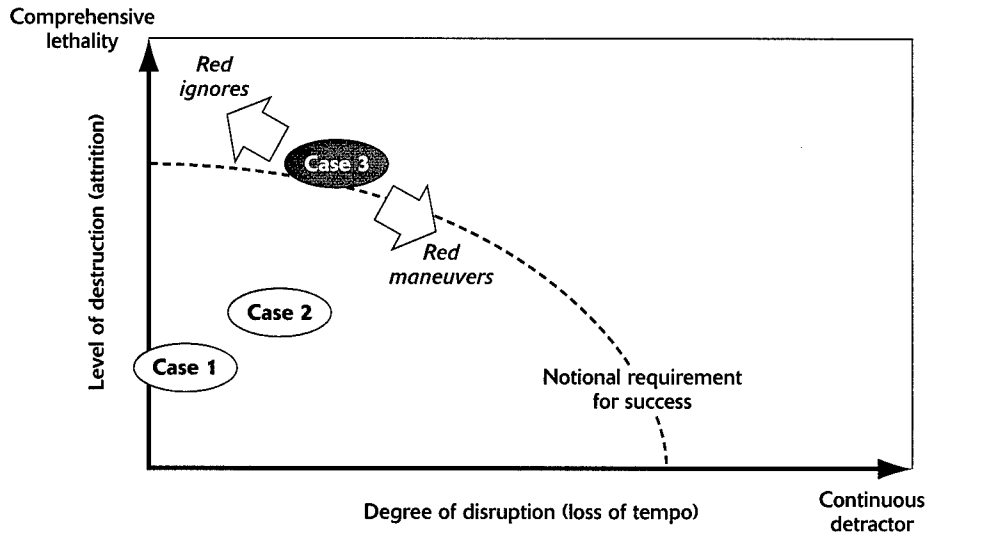

Figure 5.15—Summary of Case 3 Results

Figure 5.15 summarizes the results of Case 3. Standoff with agile maneuver, in this scenario, achieved sufficient lethality to likely stop the Red force, even if disruption were not considered. Disruption was also present because of the shock associated with the ambush,¹³ because of the ability of the direct-fire and organic indirect-fire systems to target specific high-value targets, and because the presence of a capable force threatening the enemy rear may force the opponent to change his plans.

Red countermeasures will likely reduce the impact of this force, but the effects should be limited because there are many different targeting mechanisms in Case 3. These include long- and short-timeline systems, autonomous and man-in-the-loop control, seekers using different spectra, and direct-fire systems able to sweep the battlefield. Standoff systems alone, on the other hand, utilize only a few different targeting modalities and thus would be expected to be more easily countered.

Variation of Case 3: standoff attack and agile ground maneuver to engage deep, soft targets. This variation of Case 3, referred to as Case 4 for simplicity, represents another way to use the same agile maneuver force. As shown in Figure 5.16, the concept is the same as the previous case, in which highly agile ground maneuver forces are inserted to stop the deep elite enemy unit. However, these forces are positioned further to the west to directly engage the enemy logistics and supply vehicles (more specifically, these include resupply trucks, C2 vehicles, and self-propelled artillery units), which in this scenario, because of the great levels of dispersion, follow well behind the lead combat units. These “softer” targets are seen as highly desirable because any engagement of these forces would likely create havoc for enemy movement, while minimizing the risk to the attacking U.S. force (since these enemy units have substantially less combat power). However, because the agile U.S. forces will need to get past the enemy combat

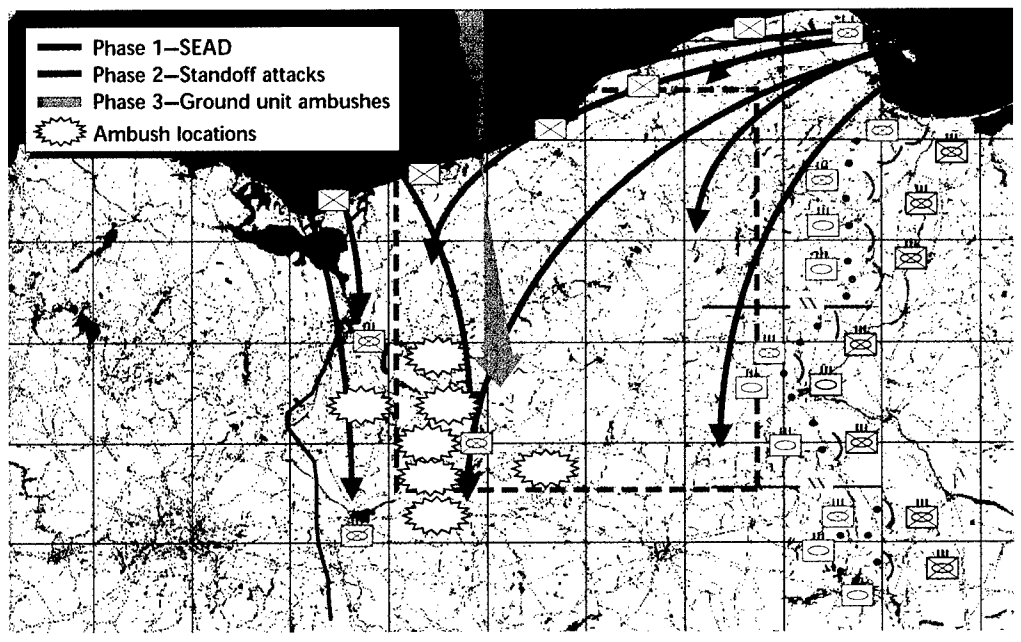

Figure 5.16—Stages of Maneuver Case 4:
Standoff Attack and Agile Ground Maneuver to Engage Soft Targets

units to get to these soft targets, a certain level of “stealthiness” may be required. Additionally, good, real-time situational awareness might allow an advancing U.S. force to bypass enemy combat formations and instead maneuver toward more vulnerable enemy supply, air defense, and command elements that are far less able to defend themselves in a ground battle.

One shortcoming of the agile maneuver force is its vulnerability to massed direct fires. This may be avoided by attacking less dangerous elements such as resupply vehicles, C2 centers, air defense sites, assembly areas, and artillery units. These attacks should have a major impact on the enemy advance, yet result in few U.S. losses, provided the agile maneuver units can extricate quickly after striking. Special excursions with such a maneuver showed an order-of-magnitude fewer losses than when attacking similar-sized armor units.

Figure 5.17 summarizes the results of Case 4. Since the agile ground forces were competing with long-range standoff fires for the same more lucrative logistics and supply vehicles (CS targets), overall lethality was not as high as seen in the earlier case. However, because there was considerably more focused lethality on a specific target set, where all of the additional kills were directed against the soft logistics and supply vehicles, the effect of disruption would be significantly, perhaps exponentially, higher.¹⁴ How much higher remains to be quantified. (To some extent, this may reinforce the notion that simulation tools, including the ones used here, tend to focus on attrition effects, which tend to be much more measurable. Other effects such as reduction in

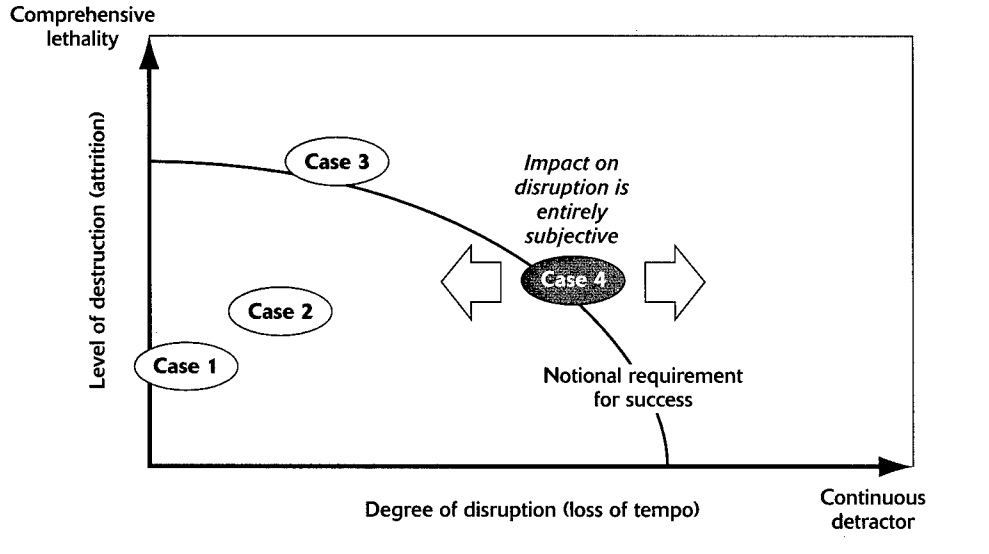

Figure 5.17—Summary of Case 4 Results

morale because of significant losses in short periods, for example, tend to be unaccounted for.)

Figure 5.18 summarizes the results of the analysis of the three different concepts (four cases). Case 1, which involved the aggressive use of standoff fires, resulted in a respectable 12 percent attrition against the overall enemy force. One advantage of this concept was that because direct exposure to the enemy was minimal, no losses occurred—assuming high-altitude JSEAD was successful. Case 2, which involved both standoff fires and what might be considered a conventional ground force insertion, provided increased lethality (and robustness), but at the cost of considerable losses to the U.S. force.

Case 3 represented a substantial increase in lethality over Cases 1 and 2. The two sets of numbers for Case 3 show different enemy reaction to the concept. If Red ignores the ambush and presses on, about 6 percent of the Blue force is lost, primarily the direct-fire fire support vehicles. If Red reacts to the initial ambushes by stopping (resulting in significant delay) and directing fire support missions into ambush locations, U.S. losses increase to about 12 percent. Organic direct and indirect fires each contributed as many kills as standoff fires. In fact, because of the shock of the ambush, enemy losses of less than 50 percent may well be sufficient to disrupt the enemy march. If so, fewer direct-fire ambushes may need to be triggered, reducing U.S. losses further.

Case 4 represents a significant departure from the way we think about assessing force effectiveness. Rather than a force-on-force engagement analysis, this tends to be a force effects analysis, where most of the effects may not be based on attrition. Thus, to some extent we have only begun to characterize the effects of this concept.

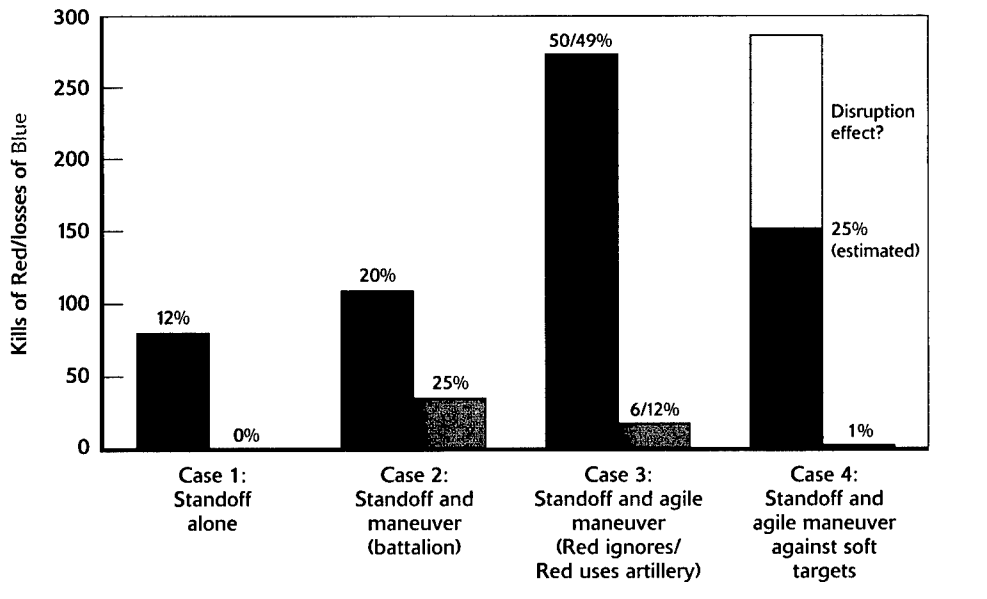

Figure 5.18—Summary of Four Cases

Overall, we found that standoff attack, using long-range ground, naval, and air-delivered weapons, had limited effect. Weapons were seen to be poorly matched to the targeting opportunities that presented themselves in this mixed terrain. Even near-perfect levels of RSTA and C2 could not overcome the combination of long weapon fly-out times and short enemy exposure opportunities.

Ground forces, however, were more responsive and selective in their fires. In combination with standoff weapons, they were able to decisively defeat the enemy force. Of course, this comes at a cost. Some of the agile maneuver vehicles were lost to enemy fires, and the insertion itself may be extremely difficult.

We also found that improved RSTA and C2 were far more important to ground force operations than to joint standoff attack, the opposite of what one might expect. Comprehensive, up-to-date information was a requisite for the deep insertion, setting up the ambush, targeting local indirect fires to isolate the ambush, and disengaging and egressing from the area. Much less information appeared to be necessary to target the large-footprint, autonomous-acquisition standoff weapons.

Finally, a key decision is how much of the fight should be assigned to the different weapon systems. The long-range fires were effective only in open areas against sizable units. The local indirect-fire units were lethal, but had limited resupply. The direct-fire systems were selective but open themselves up to return fire if gaps are not provided by the other weapons.

Chapter Summary

In this chapter, modern adaptations of vertical envelopment were explored and assessed. The specific concepts studied applied both aggressive precision fires and a range of different levels of tactical and operational maneuver. And while the concepts were initially conceived for a number of different purposes and time frames, they have clear applicability for resolving the current rapid-reaction shortfall.

Although the value of precision fires has been shown in Desert Storm, their limitations were brought out in Kosovo. The research conducted here reinforces the significant value but also the inherent limitations of future precision-fire capability against a sophisticated adversary in difficult terrain. At the same time, the research highlights the value and limitations of bringing maneuver into rapid-reaction missions.

In particular, the benefit of agile maneuver (depicted by Cases 3 and 4 with specialized ground vehicles) was seen to be multifold. First, it provided a means for overall mission success, in cases where only limited maneuver cases (Cases 1 and 2) resulted in mission failure. Second, maneuver provided a much larger scope of operations that could be performed within the rapid-reaction force (e.g., limited attacking engagements were possible), with emphasis on exploitation.

The positive outcomes seen with maneuver—illustrated in the various scenarios in this work—will not represent a major surprise to the ground warfighting community at large. Nonetheless, the *viability* of creating such a force capability still remains to be resolved. Obvious challenges that still remain for enabling the vertical envelopment concepts include the following: (1) the technological feasibility of creating relatively lightweight, lethal, and survivable ground vehicles, (2) the ability to operationally deploy such a force without unacceptable losses to enemy air defenses, and (3) the ability to support and resupply this force. While new technologies offer some promise, it is still too early to determine definitively how applicable many will be. As more research and experiments are conducted, better assessments of both the viability and the utility of maneuver for rapid-reaction missions can be made.

CHAPTER FIVE ENDNOTES

- 1 Conducting offensive missions is more likely with a force that has maneuver capability.
- 2 The air insertion phase is treated here with much more attention because a mounted force will likely require much greater “access” to the airspace than the dismounted infantry-based force assessed in the previous chapters.
- 3 See Chapter One and Appendix B for more detail on the modeling and simulation tools.
- 4 The U.S. forces could operate conventionally, helping to shore up the coalition defense by establishing a safe haven offshore in the northeast and deploying additional heavy forces and air power. Unfortunately, this would require excessive time for buildup, and the coalition force is near breaking.
- 5 The points of contact were MAJ David Steen from DIA and Mr. Stephen Proctor from NGIC.
- 6 Both the quantity and quality of enemy air defenses can have a significant impact on air-mech viability or on other vertical envelopment concepts.
- 7 Specific information was taken from a research paper, *Advanced Airframe and Attack Aircraft Platform Concepts*, produced by Dr. Michael Sculley, October 1997. This work was developed as technical input for the Army After Next, Tactical and Operational Mobility Integrated Idea Team.
- 8 The values of these signatures are comparable to those of a multiengine transport plane.
- 9 Roughly the estimated signature for a small-sized, low-observable helicopter; as unlikely as it would be to achieve such a signature in a transport aircraft even two decades from today, it was used analytically to represent a lower bound.
- 10 Reference to SA-12 performance is given in *Jane's 1998–1999, Land-Based Air Defence*, Jane's Information Group, Surrey, England, 1998.
- 11 In the first option, very little insertion is required because no combat vehicles were involved. The other three options involved significant air insertion demands.
- 12 One option available to the U.S. forces might be the use of electronic warfare (EW) methods to increase the signature of this relatively small force. Increasing the signature might help to force an engagement with the enemy force.
- 13 Once the local ambush began, a large proportion of the kills were achieved within a relatively short time, roughly five minutes.
- 14 The additional lethality was focused on the same target, neutralizing the enemy's active capability in one area, in this case resupply. Enemy CS losses were roughly 8 percent for Case 1, roughly 30 percent for Case 4.

Additional Challenges for Light Forces

IN THE PREVIOUS CHAPTERS WE FOCUSED on how to improve rapid-reaction capability through the reshaping of light forces to fight larger armored adversaries, such as those faced in the last war and in many recent crises since then. In all the cases examined—whether the light forces were enhanced, made lighter and more dispersed, or made more maneuverable—the primary focus was on preparing them for warfare against an enemy in a conventional combat scenario. However, future rapid-reaction missions can involve a wide variety of situations and circumstances that might be considered less “conventional.” In this chapter, we begin to explore other challenging rapid-reaction situations with which future forces may need to contend. Although we focus on the challenge of complex terrain, in particular military operations on urbanized terrain (MOUT), other dimensions of this analysis would ideally include jungle warfare, military operations other than war (MOOTW), and operations in a nuclear, biological, or chemical (NBC) environment.

Operations in these environments create conditions that can make combat extraordinarily difficult. For MOUT, some challenges include: very short LOS, three-dimensional fields of fire, collateral damage from rubble, obstacles, and booby traps, restrictive rules of engagement (ROEs), restrictive movement, and the always confounding problem of “mission creep.” For the other aforementioned dimensions, many of the same challenges are likely to be faced, including extremely short LOS and very restrictive movement. In these situations, because of the complexity of the terrain, the relative RSTA advantage may not be realized. As a likely result, the impact and relevance of standoff capabilities would be reduced, and at the same time the importance of physical presence, organic capability, and possibly the need for maneuver would be increased.

Military Operations in Urban Terrain—An Example of Expanding the Box

The likelihood of U.S. forces engaging in MOUT is increasing. Greater urbanization is a clearly established trend in most parts of the world, and it will present U.S. forces with significant challenges. Historically, operations in urban terrain have tended to “level the playing field” between two opposing forces, with less well trained and equipped organizations frequently able to exploit the urban environment to negate or reduce advantages held by the other side.

How should U.S. policymakers respond to the growing need to deal with MOUT? At the highest level, they have three very different choices: (1) mandate at the highest

policy level the already-existing military tenet to avoid fighting in urban areas (on a large scale) altogether, (2) train, organize, and equip soldiers so that they are prepared to conduct large-scale urban warfare successfully,¹ and (3) use existing and planned resources to prevent, contain, and/or minimize the occurrence of large-scale urban warfare. Each option is discussed below.

Avoiding Urban Operations

The first option reflects the chief lesson learned from numerous past urban operations—a lesson now reflected in both the Marine Corps and Army urban field manuals: avoid fighting in cities when possible.² Urban combat tends to be marked by high levels of collateral damage and friendly casualties; as a result, it should be the last resort. Unfortunately, valid as this lesson may be, the option of avoidance is often dismissed as unrealistic. This is not to suggest that urban warfare cannot be avoided; in many cases, it has been avoided in the past and will continue to be in the future through a variety of means. However, having a comprehensive national-level policy that proclaims avoidance of MOUT for all situations would likely put too much of a restriction on applying military force, perhaps to the point where an enemy would invariably exploit such a policy.

Beyond this concern, some amount of warfare in urban areas is inevitable. For example, warfare in urban areas may be an unexpected consequence of carrying out other operations associated with national policy, such as the MOOTW discussed below. Specifically, sufficient stability and support elements, such as peace enforcement operations, may undergo “mission creep,” resulting in unexpected escalation and higher-than-anticipated intensity of conflict. An apparently stable situation can undergo radical change, becoming an unstable and even untenable combat environment in a matter of hours. Since materiel and conduct of forces for such MOOTW can be considerably different from that needed for combat in other situations, forces can easily find themselves unprepared from both a training and equipment perspective.

In other cases, combat in urban areas may be necessary because immediate action is required and the geography happens to be a built-up area. Examples of these cases might be the retrieval of critical materiel, the neutralization of a weapon or facility, or personnel rescue. In these special cases, MOUT tends to be a very localized operation, with a very narrow mission focus; these types of operations are sometimes referred to as “precision MOUT” or “surgical MOUT” and are typically handled by highly specialized and trained forces.³

Another problem is that the threat will likely become more sophisticated. In looking at the world arms market, it becomes immediately apparent that a wide range of sophisticated sensor, communications, position location, obstacle, and weapon systems are obtainable, many at low cost. These include night-vision devices, miniature surveillance cameras, GPS receivers, cellular phones, secure radios, a variety of mines and booby traps, and even microwave beam weapons that can defeat missile electronics and smart or precision-guided weapons. For example, according to NGIC, 28 countries are

developing or producing such smart/precision-guided weapons.⁴ Use of weapons may also be less restricted than it is in the United States, where there are treaties or sanctions in effect against using gas grenades, anti-personnel mines, booby traps, and other devices. Moreover, in discussions with the Department of Energy (DoE), we found that the threat may have access to satellite imagery and multispectral sensing, as well as textured, multispectral camouflage.⁵

Preparing for “Offensive” Urban Warfare

The second option of better preparing the current force for urban combat would seem to be the logical solution and is often treated as the default way to approach the future MOUT challenge. A cursory examination, however, reveals that there is little in the way of high-level doctrine for responding to large-scale MOUT crises. This is notably the case for the conduct of joint MOUT.⁶ In the absence of such guidance, it is no surprise that the solution space associated with this second option is largely determined from the bottom-up, incremental-change perspective.

For example, the emphasis of two key MOUT initiatives under way—the U.S. Army/USMC MOUT ACTD and the USMC Hunter Warrior experiment—tends to be on the lower tactical and, marginally, operational levels. Both examine how to deal with “high-intensity” MOUT.⁷ This often takes the form of a deliberate operation planned from the onset and, by design, one that is planned and executed with many similarities to infantry operations in nonurbanized terrain. For example, clearing an enemy that is occupying a built-up urban area might require forces to identify key approaches for attack and then engage by forcibly attriting or ejecting the enemy through direct contact.

Both of these initiatives include exercises that allow warfighters to explore new tactics, organization, and equipment. Nonetheless, these efforts are near term in scope and likely to produce recommendations for change at relatively lower levels because they are designed that way from the outset.

These approaches may be effective at the tactical and operational levels in smaller urban areas, but they are likely to be infeasible at the higher strategic level because of the associated cost of preparing soldiers en masse for this relatively specialized form of combat.⁸ More important, even if the expenditure was made, it is quite possible that manpower requirements for modern megalopolises would exceed U.S. force strength capabilities. This suggests that if preparing the current force is to be viable, a brand new doctrine and strategy will have to be created; this appears feasible by the 2015–2020 time frame, but unlikely before that.

The Strategy of Preemption

From a historical perspective, one might argue that some urban contingencies could have been prevented if extensive preparations had been made, backed up by the threat of quickly closing rapid-reaction capability. This perspective—the basis for the third option—is similar to the first option of avoiding urban combat, but the notion of actively *preventing* or deterring urban combat—or at least *containing* its scope—clearly

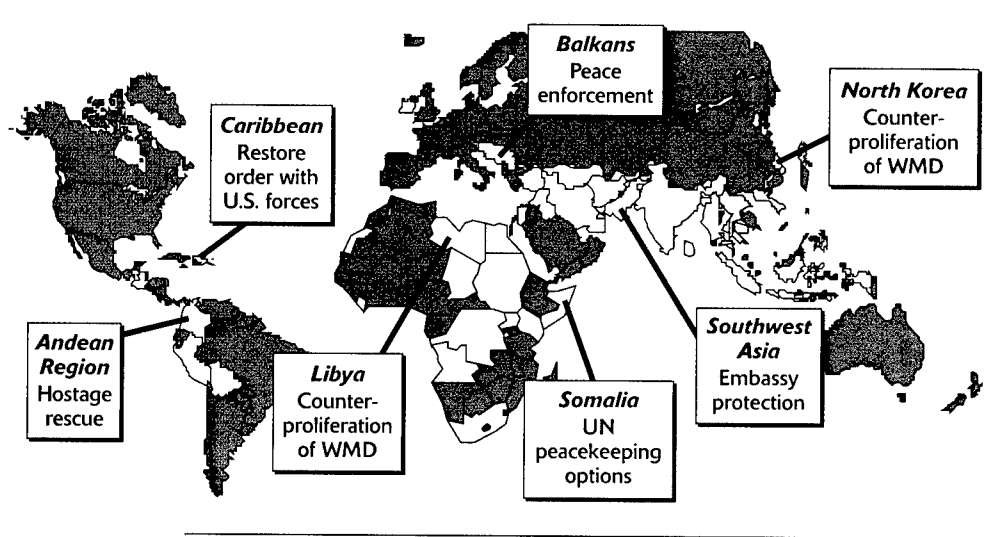

Figure 6.1—Location of Potential Hot Spots

changes the focus of the initiative. In this option, the light rapid-reaction capability might take on the specialized form of the light elements described in Chapter Four or, more likely, a variant of the light mechanized forces of Chapter Five.

Taken together, this MOUT option might involve three critical components: (1) indigenously preparing the urban environment, (2) using highly responsive forces, and (3) adopting new “offset” capability. Each is discussed below. We then discuss how the three components would need to interact as part of a concerted strategy.

Indigenously preparing the urban environment. Since preemptive defense is not possible in all urban areas, the first step in preemptive preparation of urban areas is to identify the areas at risk. Potential hotspots around the globe are highlighted in yellow on Figure 6.1, and some well-known examples are identified.

Unfortunately, although a rapid-reaction force may be equipped with sophisticated equipment, it may not be able to deploy to the urban area for several days.⁹ In that time the enemy could take the city, forcing the rapid-reaction force to attack an entrenched foe.

A more effective approach might be to prepare our allies’ vulnerable cities with a series of systems and technologies. These systems and technologies could then delay and attrit the advancing enemy, buying time for the rapid-reaction force. Such an action might even deter an enemy from considering an attack on the urban area in the first place.

The first steps in this preparation/preemption process are to instrument the city with secure, surreptitious sensors and to pass on this information both to decisionmakers locally and back to CONUS. The sensors should be able to collect information about enemy activities, locations, force sizes, battle damage, weapon types, noncombatant

status, environmental conditions, and road trafficability. There should even be intrusion sensors in some key buildings to indicate occupancy.

Redundant secure lines should be used to distribute the resulting information. These lines will probably need to be high bandwidth to support voice, data, and images and to overcome the overhead from encryption. Software radios will need to be given to trained, trusted members of the local populace, facilitating passage of HUMINT. These radios will also have to be controllable in case they fall into enemy hands.

Structures critical to the safety and well-being of the urban area will have to be protected. There will also need to be backup generators, communication systems, emergency water supplies, and medical treatment facilities.

A key aspect of protecting the urban area is the installation of remotely controlled obstacle networks. Pop-up commercial vehicle barriers are currently available and can be placed on avenues of approach to the urban areas (such barriers are currently in place in South Korea) or on city streets themselves. More futuristic obstacles, such as superlubricants, sticky foams, and smoke generators, can be located at key canalizing points. Jammers, RF bombs, and other canister or munition-type systems can be placed or lofted as needed.

Noncombatant control can take the form of ensuring marked routes to shelters, dispensing identity tags for noncombatants and neutral forces, and even using calmatives or incapacitators to control mobs.

All these actions need to be controlled using command centers. Some of these should be mobile to avoid detection, localization, and neutralization by the enemy, while others may be located in protected structures. The C2 centers should have access to building blueprints, city infrastructure plans, and other information needed to coordinate a response.

Once an urban area is so prepared, one can implement a preemptive defense, such as the tiered defense concept developed by the U.S. military officers at the Engineer School at Fort Leonard Wood. When given a plan map of the Camp Lejeune MOUT training site, these officers prepared a tiered defensive concept plan for the complex, in which an engineer platoon, along with an infantry company for overwatching fires, could effectively defend the town against a battalion or possibly a brigade of attacking Red forces. Approximately four truckloads of equipment were estimated to be needed: smart mines, command-detonated explosives, booby traps, and building demolitions were all part of the notional plan. The idea is that the force would engage the attacking force at range along the likely avenues of approach, continue to activate belts of defenses as they approached, and then bring down the buildings themselves as the Red force penetrated. The Engineer School had previously used this type of defense very successfully in exercises at Fort Hood.

Figure 6.2 shows a diagram of that layered defense of the Camp Lejeune MOUT site. The Engineer School experts designed a defense for the town using Blue systems and tactics.¹⁰ The outer layer of defenses is shown by circles (H stands for Hornet), representing WAMs and Volcano—helicopter-deployed anti-tank mines. Inside this layer

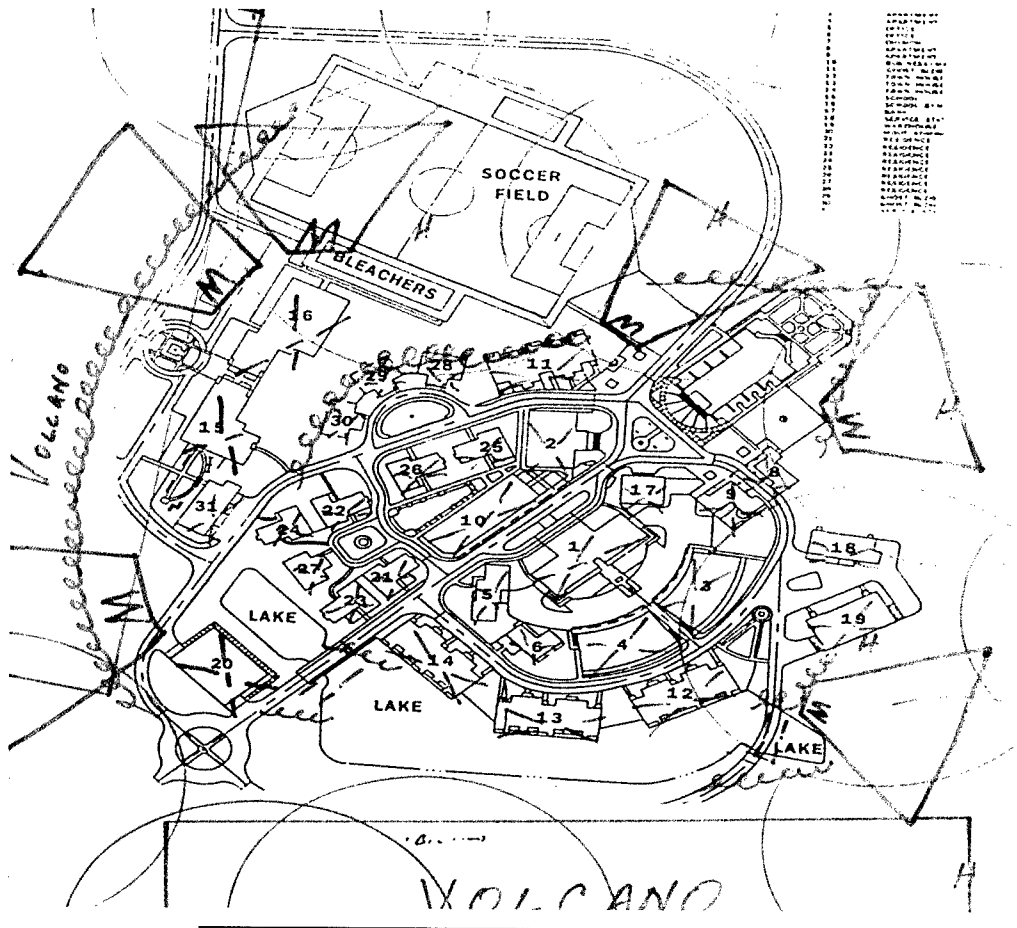

Figure 6.2—Diagram of Engineer School Layered Defense of Camp Lejeune

are the Modular Pack Mine System (MOPMS) elements—command-detonated mines and concertina wire. All the buildings, finally, can be rigged with explosive charges and can be dropped if taken by an adversary.

In many ways, these exercises show that current offensive concepts—such as those that are a part of option 2 described above—can be overcome and countered, even with limited resources. Interviews with participants in demonstrations at Camp Lejeune and the McKenna facility at Fort Benning revealed some of the problems anticipated for urban fighting: the vulnerability of air-mechanized deployment of forces, the ease of engaging ground vehicles supporting an infantry attack on the buildings, the unreliability of smoke in windy conditions, and the risks associated with soldiers moving through buildings. In all the demonstrations, soldiers were fighting at extremely close (less than 50-meter) ranges.

Interviews with the soldiers at the demonstrations highlighted the key difficulty of entering and moving through enemy-held buildings. They noted the time-consuming and manpower-intensive nature of interior fighting and brought up the problems of

dealing with noncombatants. Commanders indicated that a 4:1 to 8:1 advantage of the defender over the attacker is typical, even with nonrestrictive ROEs. It was evident that the defender could often inflict enough damage and losses to make the mission unwinnable with current systems and tactics.

Using highly responsive forces. The second component involves inserting and coordinating with a rapid-reaction force, in this case one along the lines of the AAN “air-mech insertion” described in Chapter Five. We might also consider relying on an air-based “halt” campaign—in which bombers are planned to deploy quickly and deliver hundreds or even thousands of smart munitions and GPS-guided weapons. Unfortunately, this is not sufficient in many cases, because the bombers require too much time and space to operate. Figure 6.3 summarizes the results of high-resolution simulation runs and a weapons-effects computational model, showing that many real-world situations are not suited to such responses. The enemy has plenty of time to enter and secure key objectives, such as in Seoul or Tel Aviv, before the bombers can attrit him sufficiently to stop his advance.

In a similar fashion, ground forces are also limited in their ability to close quickly and block an enemy from reaching key urban areas. Even a very light force (e.g., the 82nd Airborne Division) requires many days to close and be ready for combat. Heavier mechanized forces may be able to close quickly with future fast sealift, but even these may arrive too late to prevent an enemy from occupying key urban areas. The minimum time for each of these options, even with future improvements in deployment, appears to be about 5–8 days to most of the “hot spot” areas of the world. We envision that an air mobile force such as that described in Chapter Five will not initially be able to block

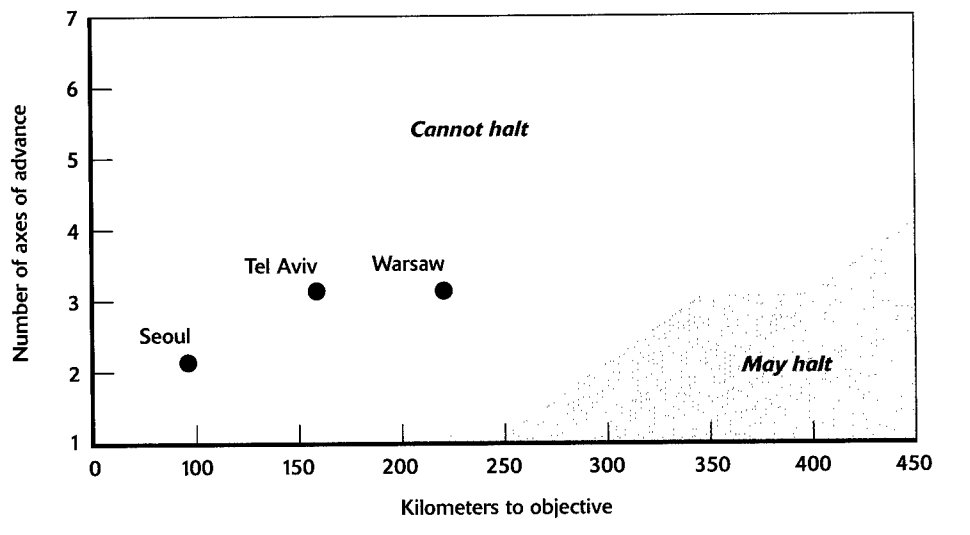

Figure 6.3—Limitations of Air-Based Halt Campaigns

an enemy from an urban area but, if suitably modified, will be able to close in a few days and aid in the defense (and, if necessary, the eviction) of the enemy.

Adopting new “offset” capability. As mentioned above, much of the training and preparation for MOUT has emphasized close combat. In fact, the focus of the MOUT ACTD appears to be on near-term demonstration of new technologies primarily designed to aid the warfighter in room-to-room, building-by-building clearing.¹¹ In this section, we discuss options that should minimize this high-attrition close combat, using remote means for intelligence gathering, isolation of enemy units in the city, and precision fires from range.

Three concepts make up our “offset” approach to MOUT. The underlying principle behind these concepts is that the main proportion of the urban fight may be carried out at standoff and that the enemy may be forced away from his favored position. Risky interior engagements should, as much as possible, be relegated to unmanned air and ground systems.

Two of these concepts—termed “sector and seal” and “nodal warfare”—represent departures from current tactics, especially sector and seal. This concept involves the use of standoff sensors to determine enemy locations and the deployment of isolation devices from afar to seal off the enemy from sensing or attacking our own forces. Nodal warfare also uses standoff sensors and weapons, but its main goal is to locate and disable key nodes, such as C2 sites, communications relay platforms, power sites, water supplies, airports, and air defenses. These methods also extend current concepts of ejecting entrenched defenders through the use of comprehensive situation awareness and standoff weapons. One notion is to predetermine enemy egress routes and then flush them out in a desired direction. Thus, rather than playing into the strengths of an urban defense, these concepts “entomb” the would-be defenders, deny them infrastructure access, and force them into disadvantageous positions.

The third concept, noncombatant control, uses technology to identify, tag, and move noncombatants out of the combat zones. In some cases, the inhabitants may even be enlisted to gather intelligence and coordinate movements.

Implementing these concepts will probably require expanding the time required to complete a given mission—resulting in a “casualties for hours” tradeoff.

A strategy for employing the three components. By themselves, none of the three strategies would be sufficient to provide an adequate preemptive defense. If unopposed, an enemy attacking a large urban area might take several days to occupy and defend it. Indigenous reaction without any concerted preparation of the city might take some time to initiate a response and then would likely have little effect on the outcome. Adding preemptive defensive preparations would have an immediate effect and would result in more enemy attrition and disruption, but without additional fires it would probably also simply delay the occupation.

The effects of long-range fires and rapid-reaction forces are also expected to be inadequate by themselves. These responses may arrive after much of the enemy force is

already established in the urban area. The rapid-reaction units would then be forced to root out the enemy forces at high cost. Long-range fires, even precision ones, would have extensive collateral damage and noncombatant losses when targeted against enemy positions in the city.

However, the effects of all three components are expected to be highly synergistic. Defensive preparations used in concert with rapid-reaction forces should work together to prevent entry, disrupt the enemy attack, produce slow-moving targets for mid- and long-range fires, and result in substantial attrition. Enemy units that do achieve a lodgment in the cities can then be isolated and evicted using offset engagement techniques combined with limited numbers of close combat operations.

What might such a synergistic scenario look like? An example scenario for a prepared urban area might start with a surprise attack from a nearby border. The enemy force is quickly detected by the prepositioned air and ground sensor net. Obstacles set in belts outside the city soon slow the attack to a crawl. Coordination of the enemy force is degraded quickly by jammers, smoke, and coalition rocket, cannon, and mortar fire, along with air attacks.

Nevertheless, some portion of the enemy attack may succeed in the first few hours or days and part of the city may be occupied. The invaders are tracked, slowed, and isolated using in-town obstacles. When the rapid-reaction force from neighboring areas or CONUS is able to close, its fires are immediately directed from mobile and stationary C2 centers. Long-range naval, air force, and ground fires are similarly targeted from the C2 centers. A portion of the ground force may be designated to clear any enemy strongholds in the city. This would be done using offset engagement.

Figure 6.4 illustrates some of the process. Prepositioned defensive belts extend far from the city periphery, allowing precision fires from the city and from rapid-reaction

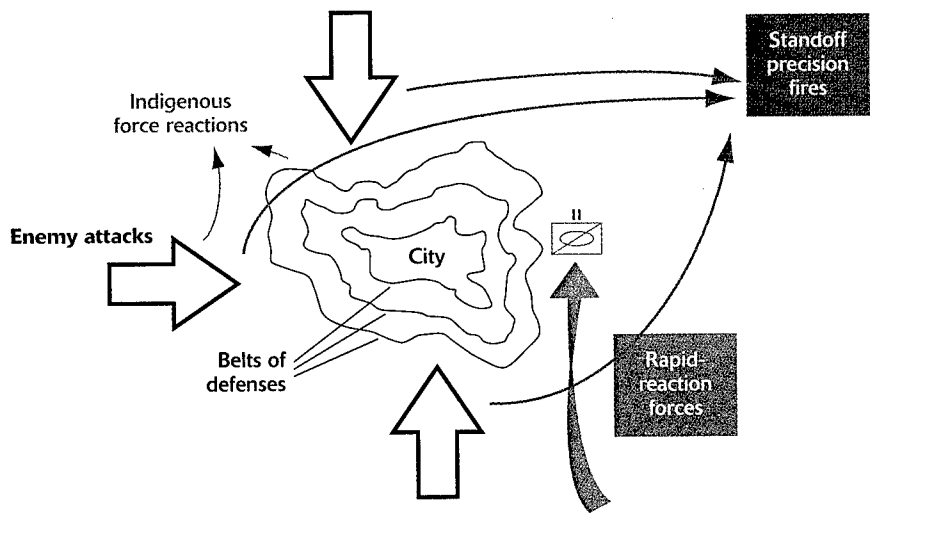

Figure 6.4—How the Three Components of Option 3 Work in Synergy

forces to concentrate on the slowed targets. These belts allow a coordinated fall-back, with increasing canalization of the attackers.

Part of the key to successful defense outside city boundaries is the recent development of wide-area (smart) mines and other new technologies. Smart mines can cover large areas, killing or slowing ground vehicles and low-flying helicopters. Higher-altitude air mobile operations may be stopped using increasingly capable man-portable and vehicle-mounted air defense systems. Software radios and the tactical internet can coordinate indigenous, rapid-reaction, and long-range fires. Fast-setting foams can set up obstacles or can establish bridges over broken terrain. Robotic air and ground vehicles can resupply the defenders with additional sensors, obstacles, and weapons as they are needed. Fast-reacting weapons with the ground forces can engage fleeting targets, and standoff precision fires can go after key nodes and moving targets in the open.

Preemptive preparation of urban areas against attack is not a new idea. Seoul, Tel Aviv, Grozny, and many other cities have extensive preparations from many avenues of approach. One difference between those traditional defenses and the concepts put forth here are the many new technologies that enable flexible, effective disabling of enemy attacks. Only in the last few years have new microsensors, mobile commercial communication systems, three-dimensional visualization tools, robotic security and resupply systems, special foams, and other technologies matured to the point where they can contribute to flexible, cost-effective defenses. Unlike historical defenses such as walls, ditches, minefields, and protective fires, many of these systems can be shifted quickly to the specific areas being attacked. Using offset tactics, they can also capitalize on the principles of massed fires, hitting an enemy's most vulnerable points, seizing the initiative with counterattacks, and using multimode, redundant systems which cannot easily be countermeasured.

Jungle and Forest Operations

In addition to the challenges posed by fighting in an urban environment, U.S. rapid-reaction forces could also be confronted with fighting in jungle or heavily forested areas. Indeed, there are locations around the world where urban areas are in close proximity to jungle or heavy forest, including Southeast Asia, South America, and parts of Europe. Even as urbanization increases in those areas of traditional U.S. interest, large tracts of jungle and forest remain.

When deploying into such areas, rapid-reaction forces could be confronted with terrain that can severely affect the capability of their organic or supporting sensor suites. As was recently shown in Kosovo, dense forests can provide substantial concealment, even for mechanized forces. The American experience in Vietnam is another example of how jungle can significantly degrade U.S. reconnaissance capabilities.

Not only does forest and jungle degrade reconnaissance systems, it also has significant impacts on precision munitions, slashing their effectiveness virtually to zero. During research for the 1998 DSB, RAND examined the effect of heavily forested terrain on air- and missile-delivered precision munitions. These munitions were being used

to engage enemy mechanized units in road-march formation where there was substantial foliage in the immediate area around (and even overhanging) the road. Even with smart munitions such as BAT and SFW, this study found that foliage reduced the number of kills by roughly 60 percent. This reduction in the potential effectiveness of long-range, interdiction-type weapons could have a significant impact on the operations of rapid-reaction units that may be relying on interdiction to meter the flow of enemy forces moving in their direction.

Forest and jungle will also have a major impact on the direct-fire or close battle. Engagement ranges will be closer, thus giving short-range weapons—including small arms and light anti-armor weapons—more opportunity to enter the battle. U.S. experience in the Pacific theater in World War II and in Vietnam during the 1960s and early 1970s showed that combat in heavily forested areas significantly increases the likelihood of short-range, direct-fire engagements. The jungles of Vietnam also showed the innovation likely to come from a determined enemy, such as spoofing systems that can fool REMBASS, soldiers able to co-opt U.S. radios, and extensive use of decoys. Accordingly, technology areas that may require greater emphasis include sensor systems that can penetrate foliage, enhanced lightweight armor for individual soldiers, secure communication devices, and munitions that can identify and engage targets located under trees.

Simulation and Modeling for Complex Terrain

How can such unconventional military operations be simulated and modeled? To a limited extent, we can use the JANUS simulation environment used throughout the analyses described in this book to explore these challenging situations. JANUS and its integrated models can characterize many aspects of exterior fighting in urban areas, along with firing from openings in buildings. Jungle operations with overhead cover, difficult movement, and short lines of sight can also be represented to some extent. Even combined arms engagements in MOOTW situations can be examined. Unfortunately, the JANUS suite of models is much more appropriate for modeling conventional warfare between mechanized forces than MOUT or MOOTW operations. Interior fighting between dismounted soldiers is extremely difficult for JANUS to accurately portray, as are the degrading effects of buildings and foliage on communications, mobility, weapons, and command and control.

The JANUS-based suite of models provides a two-dimensional map view of the combat situation and, like many constructive models, does not represent many of the special aspects of MOUT. For example, Figure 6.5 is a rendering of the British Army's Copehill Down, one of the premier MOUT training sites in the world. The three-dimensional view shows the importance of building structure, look-down aspects from windows and firing ports, sloped roofs, and many other issues that JANUS does not address.

Even so, a three-dimensional rendering may not be sufficient to model all the critical aspects of urban areas. For example, Figure 6.6, a photograph of one of the Copehill Down roads, shows the complexity of fighting. Training exercises often use un-

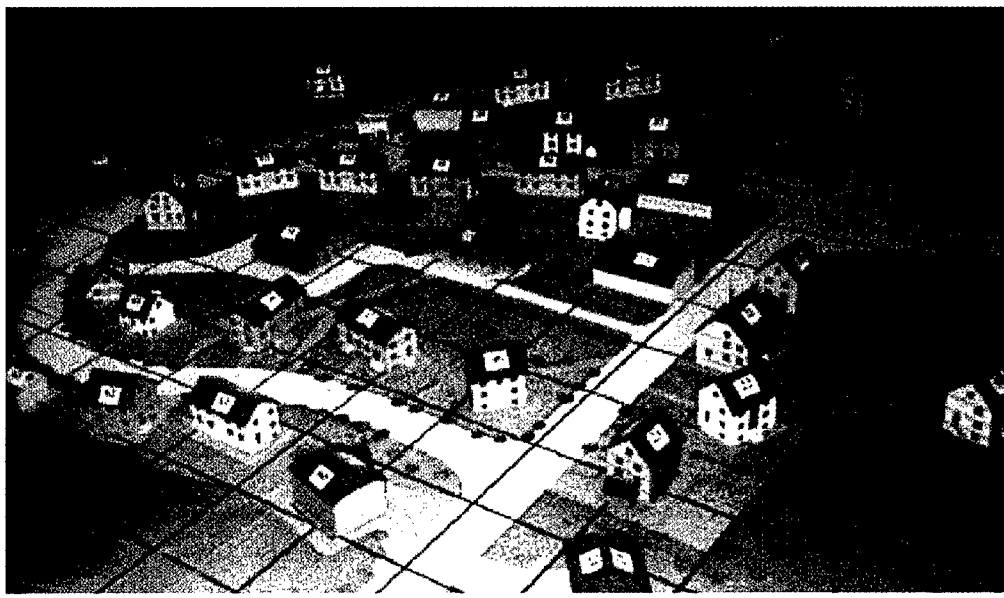

Figure 6.5—Three-Dimensional Rendering of Copehill Down

derground areas covered by logs and rubble. These may be occupied shortly after troops have passed and then the troops will be engaged from the rear, with the snipers moving to the next position after taking a few shots. Other subterranean areas include sewers, subway areas, and basements. Such areas are very difficult to model with simulation.



Figure 6.6—Photograph of Road at Copehill Down

We examined three other promising constructive simulations for MOUT analysis. The first, CAEN, was originally based on JANUS. It is a MOUT-specific simulation developed by the Centre for Defense Analysis in the United Kingdom. The current simulation is written in Turbo-Pascal, but it has been ported to Symbolics machines and will soon be ported to Suns. Joint Combat and Tactical Simulation (JCATS) is a soon-to-be-available combination model incorporating the best features of JTS and JCM, which have been in extensive use with many agencies. IUSS is a special-purpose physiological modeling tool that can supplement the other models.

CAEN makes a nice start at modeling more aspects of urban operations than JANUS because it represents portions of building interiors, shows two-dimensional and three-dimensional views from different locations, and models more special aspects of MOUT. However, it is somewhat limited in scope, since it currently can display an area of only 5 by 5 kilometers and since it limits forces to company size and below.¹²

JCATS, now nearing release for general application, may provide the greatest amount of scale and resolution of any of the simulations examined.¹³ Unlike CAEN and JANUS, it can model interior fighting, with representations of floors, walls, interior doors, and many other building characteristics. Enemies, friendly forces, and non-combatants can have many different affiliations. While JANUS equips each entity with two sensors maximum, JCATS allows as many as four. Areas as large as 600 kilometers on a side can be played, with as many as 20,000 entities present. Suppression is projected to include both the standard forms of JANUS and CAEN, but also a secondary suppression during which the entity moves to a hide posture. There is some discussion about how much three-dimensional visualization and replay will be present, but the user should be able (as in CAEN) to call up perspective images from different vantage points.

IUSS is a special PC-based model that primarily gauges the effects of exertion and protective equipment on soldier physiological performance. The movements and conditions from a larger simulation such as JANUS or CAEN can be input to IUSS and an assessment made of the movement speed and soldier capability. These outputs (particularly important in stressful MOUT and jungle vignettes) can be returned to the larger simulation or used independently in off-line analyses.

The constructive models examined provide a basis for answering many key questions about MOUT, jungle, and MOOTW operations, but there are still many aspects that are as yet too hard to emulate. Among these are many of the issues brought up at MOUT training sites: noise and confusion from weapons and obscurants, rapid changes in mission, and problems with communications and position-location systems. Some of these aspects may be captured in distributed interactive simulation (DIS) systems, but the processing power and interaction levels required may be prohibitive. The most cost-effective approach may be to determine the impacts of many of these effects off-line from DIS systems and field tests, and then feed the resulting factors (reduced reaction times, reduced accuracy, etc.) into constructive simulations.

Chapter Summary

Many of the observations to this point are simple ones. It is becoming increasingly clear that the United States and its allies cannot respond quickly enough to stop an aggressive force from taking over many key urban areas. Going in and driving out an entrenched aggressor from a newly occupied urban area can be a costly proposition, even with dramatic new tactics and technologies. Preemptive preparation and halt operations can buy time, but by themselves they are probably not enough to stop or deter an aggressor.

One approach for MOUT application appears to be a combination of preemption, rapid-reaction ground forces, and standoff fires. These disparate capabilities need to be orchestrated from a unified command and control center to achieve the greatest shock, delay, and disruption of the enemy attack. Because of the likely responsiveness needed for such missions, it seems prudent to incorporate MOUT and other special force capabilities (including jungle warfare, MOOTW, and NBC) anticipated for the future in any rapid-reaction modernization or redesign initiative. Required combat capabilities in these areas may ultimately define the boundary of requirements for future rapid-reaction force characteristics.

CHAPTER SIX ENDNOTES

- 1 Success is defined as the capability to succeed militarily with minimal numbers of U.S. casualties and tolerable noncombatant and collateral damage.
- 2 See USMC Operational Handbook 8-7 and U.S. Army Field Manual FM 90-10-1.
- 3 By doctrine, "precision MOUT" tends to be very restricted MOUT operations (e.g., tight rules of engagement, ROEs) where the enemy is thoroughly mixed with the noncombatants. "Surgical MOUT" operations are those that "include special-purpose raids, small precision strikes, or small-scale personnel seizure operations in a MOUT environment." Source: FM-90-10-1, G-1 to G-2 of Change 1.
- 4 Personal communication with Michael Holthus at the National Ground Intelligence Center, 1997.
- 5 In this case, DoE sources included Bechtel Nevada, SO Technologies, and Lockheed-Martin.
- 6 Reflecting comments about multiservice and coalition-based operations made by many individuals during a RAND-Dismounted Battlespace Battle Lab MOUT Conference, February 1998.
- 7 This type of MOUT is distinguished, by doctrine (FM-90-10-1, G-1 to G-2 of Change 1), from "precision MOUT" and from "surgical MOUT."
- 8 A major component of the emerging solutions focuses on improving close combat capabilities (e.g., fighting block-to-block, building-to-building, and room-to-room); however, the number of soldiers required to conduct this kind of operation in a large, modern city is likely to be enormous. At the same time, committing such large forces to close combat will often result in unacceptable casualty levels.
- 9 Even the very light DRB of the 82nd Airborne, tasked to be the "first to fight," can require as much as 4–6 days to deploy to distant locations such as Southwest Asia.
- 10 The plan was limited to Blue options and tactics; if carried out by enemy forces, it could be expanded to include anti-personnel mines, booby traps, and even weapons of mass destruction. The enemy would also not be constrained by our ROEs and could use noncombatants as hostages or shields.
- 11 For a detailed discussion of the MOUT ACTD and of current doctrine and training status, see the ACTD Web site, <http://www.geocities.com/Pentagon/6453/index.html>, and Glenn (1998). (Web site accessed and running on August 21, 2000.)
- 12 Neal Shepard of CDA indicates that they have recently expanded the terrain area to 10 by 10 kilometers.
- 13 See the JCATS Web site, <http://www.jwfc.jfcom.mil/genpublic/jw500/jcats/>, for a description and demonstration of the system. (Web site accessed and running on July 28, 2000.)

Conclusions

Options for Developing Rapid-Reaction Capability

LOOKING BACK ON RECENT HISTORY, if Kosovo serves as any example (and Operation Desert Storm before that), there seems to be little doubt in the minds of policymakers that the U.S. Army can be improved to better address the initial phases of combat. In particular, the Army can be made ready to respond with virtuosity to rapid-reaction missions within an increasingly complex geopolitical climate; this is especially the case for situations that mandate immediate reaction and in which hostile mechanized forces are present.¹ It is apparent that the overall *magnitude* of the mechanized threat in any given scenario will be smaller than what was faced during the Cold War, but it is also quite evident that the total *number* of different threats that may have to be addressed has increased substantially. Essentially, it can be argued that the threat has “globalized,” meaning that the U.S. Army may need to deal with a much broader range of opponents, in many diverse locations, and through many kinds of missions, perhaps more so than at any other point in its history.

Such a threat globalization forces us to look hard at the U.S. Army’s shortfall in rapid-reaction capability. The Army today is configured largely as it was for the Cold War: mostly heavy-mechanized units designed to defend against a massive armor invasion, augmented with some light infantry-based units designed for a variety of contingencies.² As the uncertainty of the threat has grown, much of the heavy-mechanized force is now unlikely to be in a place where it is needed. Prepositioning heavy-mechanized forces, whether land- or sea-based, may serve as a hedge for some situations, but certainly not all. And projections of airlift capability suggest that it will take too long to move heavy forces to distant locations to allow for early participation (or deterrence) in the developing phase of a conflict.

While some have argued that tactical air power is a viable alternative for addressing future rapid-reaction needs in lieu of ground forces, this kind of response has its own key limitations. In some instances, air power can coerce an adversary to take alternate approaches to warfare, but even recent history suggests that air power alone lacks the potential to provide a decisive effect below the strategic level.³ This inability mandates the development of other rapid-reaction capabilities.

Examination of the various options implies by default that rapid-reaction capability will still need to reside within light ground forces that can be airlifted quickly to trouble spots. But the current light forces have inadequate firepower, mobility, and protection for many missions.⁴ On the surface, given all the changes occurring in the geopo-

litical arena, basic planning suggests that the Army should reshape light forces along the following critical mission parameters:

- The kind of missions it will need to address;
- The environment it will need to operate in;
- The level of threat it will need to defeat;
- The kind or nature of threat it will have to address;
- The responsiveness with which it will need to deploy.

Although each parameter listed poses a significant challenge by itself, the parameters are often interwoven. In some sense, while the overall magnitude of the threat may have been decreasing, the number and complexity of threats have been on the rise. The loss of clarity has compounded the rapid-reaction challenge.

How can we respond to this challenge? Much of this book has been focused on exploring how ground forces, in particular light airborne forces, might adapt to meet future rapid-reaction needs. In general, these efforts fell into one of three different paths:

- Path 1: Enhancing the current light forces.
- Path 2: Making light forces smaller and more dispersed.
- Path 3: Introducing maneuver to light forces.

Each of these paths has its own advantages, risks, and costs, as summarized below. Nevertheless, one or more of these options may have to be acted on to ensure that the United States remains fully capable for future conflicts.

Path 1: Enhancing the Current Light Forces

The first path postulates improving rapid-reaction capability forces by enhancing current light airborne forces. These forces must be trained with a new operational concept and equipped with some new combination of systems. The technologies used to enable the concept may be similar to ones explored in the recent Rapid Force Projection Initiative (RFPI) Advanced Concept Technology Demonstration (ACTD). This option would keep the structure of today's light forces basically intact, but it would increase survivability and lethality by adding various RSTA, C2, and precision-guided weapons to the existing organizations.

Major advantages of this force over a current light airborne force were found to include the following:

- Substantially greater lethality and survivability against a larger armor force.
- Greater likelihood of accomplishing traditional defensive missions.

Major disadvantages were as follows:

- Vulnerability of light units to enemy artillery fire and massed direct-fire systems because of the lack of organic armor protection and mobility.
- High constraints on light-unit offensive capability, and the enemy's ability to bypass the force because of its lack of mobility.

Path 2: Making Light Forces Smaller and More Dispersed

The second major path is more revolutionary and will mean restructuring the units themselves, making them even lighter and smaller and giving them technology that lets them operate in a highly dispersed mode through the use of advanced sensors and communications systems. The role of light forces in this option would be to disperse and fight primarily by calling in long-range, “reachback” fires provided by the Army and other elements of the joint force. This force would survive by being small and stealthy. The most noteworthy aspect of this option is its responsiveness: forces can get into position quickly, probably 24 to 48 hours sooner than a light airborne brigade with its vehicles and personnel. Even a couple of days can mean the difference between defending a threatened region and having to expel an entrenched attacker.

Major advantages of this option include the following:

- Ability of the force to get in place sooner than a light airborne force.
- Greater degree of dispersion thus minimizing the force’s susceptibility to being attacked and attrited.

Major disadvantages of this option include the following:

- Greater degree of dispersion, which makes holding ground an unlikely prospect.
- Limits on offensive capability.
- Possibility that the enemy will be able to bypass widely dispersed elements.
- Lack of tactical mobility, potentially resulting in “local” force vulnerabilities if the area is overrun.

Path 3: Introducing Maneuver to Light Forces

The third path calls for an increase in the tactical mobility and firepower of light airliftable forces by giving them advanced combat vehicles. These combat vehicles would make use of aggressive survivability and lethality technologies, but they would also be lighter.⁵ Among the three paths explored in this research, this one would require by far the most significant change to current forces. Not only would it mean a complete reequipping of at least a portion of today’s ground forces, it would also entail a reorganization of how such a force would need to fight, including changes in training and doctrine.⁶ Another, perhaps less taxing, method to achieve the same end would be to convert a selected heavy force. That is, instead of trying to make a light force more maneuverable, make a heavy force dramatically lighter and, thus, more deployable. In the end, the same goal of having a rapid-reaction capability with a significant amount of maneuverability would be attained.

Regardless of how such a capability is ultimately achieved, major advantages of this option include the following:

- A rapid-reaction force that can achieve a much larger number of missions and that has greater offensive ability because of the enhanced mobility and firepower conferred by advanced vehicles.

- Greater flexibility to operate in different environments and situations, many of which could only be accomplished previously with dismounted forces.
- Greater capability to take on both small-scale contingencies and major operations, because of the protection from small arms and artillery provided by the force's vehicle armor and mobility.
- Enhanced leveraging of precision long-range weapons when linked to vehicles equipped with advanced RSTA and C2 technologies.

Major disadvantages of this option include the following:

- Increased strategic airlift requirement or longer time to deploy the unit, compared with other light force options;
- The need for significant changes in force structure and training because of the addition of a sophisticated family of vehicles into the force.

Acquisition-Related Implications

Each of the paths comes not just with different force effectiveness implications, as discussed above, but also different acquisition-related ones. These implications include the *cost* of creating and maintaining the unit, the *schedule* or time required to develop and train the force, and the *risk* associated with acquiring the new capabilities. Ultimately, such fiscal constraints will weigh on determining which, if any, paths are taken.

From an acquisition standpoint, path 1 seems the easiest to implement. It has the fewest structural implications, since it essentially means enhancing current light airborne forces with a new concept and associated technologies. Structure would change very little, but resources would have to be reallocated to buy the new weapons and RSTA systems that this option requires.

Path 2 would require modest changes. It would involve reorganizing at least a portion of today's light units. Regular training on the more dispersed tactics and reliance on indirect-fire reachback systems would be key to this option. The Army could either reorganize one or more of its light divisions (including the 82nd Airborne) to achieve the capabilities called for in this option or create new light units of battalion or greater size located at corps level. Additionally, the type of light force called for in this option would probably have to rely heavily on both overhead sensing and reachback fires provided by the Navy and Air Force. Therefore, the modernization programs of those services would be particularly important to this option.

Path 3 would be the most significant and capital-intensive course of action because it requires developing and fielding new light- or medium-weight combat vehicles, along with changes to organization, tactics, training, and support. The overall cost would, of course, depend on the number of units created. For example, an Army decision to convert two armored cavalry regiments would have far fewer resource implications than a plan to convert the 82nd Airborne, the 10th Mountain, and the 25th Light Infantry.

*Table 7.1—Relative Impact of Different Paths for Improving Light Forces
(Over Current Light Forces)*

Critical Rapid Reaction Parameters	Path 1: Enhancing Current Light Forces	Path 2: Making Light Forces Smaller and More Dispersed	Path 3: Introducing Maneuver to Light Forces
Kind of mission (e.g., Peace ops, force entry, area defense, local attack)	No change in capability	Decrease in capability	Significant increase in capability
Type of environment (e.g., Open, close, urban, contaminated)	No change in capability	No change in capability	Increase or decrease in capability
Level of threat (e.g., Size, level of sophistication)	Increase in capability	No change in capability	Significant increase in capability
Kind of threat (e.g., Militia, light infantry, mechanized, combined arms)	Increase in capability	Decrease in capability	Significant increase in capability
Responsiveness into theater (e.g., Few days, weeks, few weeks)	No change in capability	Significant increase in capability	Decrease in capability

Framework for Assessing Force Applicability

As noted earlier, we identified five critical parameters that helped to define future rapid-reaction needs: kind of mission, type of environment, level of threat, kind of threat, and responsiveness into theater. On the whole, while all three paths offer significant benefits over a current airborne light force, they also come with some drawbacks in relation to these five parameters, as shown in Table 7.1.

Kind of mission. By adding maneuver, the capability associated with path 3 addresses head-on the fundamental issue of threat “globalization.” Our assessment reveals that path 2, despite its revolutionary form, would result in a decrease in mission robustness over current light airborne forces. In particular, the path 2 option might have to sacrifice mission objectives to minimize casualties. The research also illustrated the difficulty for such a force to hold terrain—an element that may be of greater, not less, importance in the future.

Type of environment. All three paths provided only marginal improvements in the emerging environments to be faced by U.S. forces—complex terrain, low-intensity conflict, and so forth. The only exception was path 3, which could improve force applicability in MOUT or a contaminated environment because of the added protection offered by the advanced, highly mobile vehicles. At the same time, however, the advanced vehicles associated with this force could well be ineffective in constrictive terrain,

such as jungle environments. There, dismounted infantry aided by dispersed sensors and relatively short-range, personal weapons might represent the primary option.

Level and kind of threat. With regard to the level and kind of threat that can be addressed, both path 1 and path 3 provided improvements to current light forces. (Path 3 was deemed to offer considerably more improvement.) To some extent, path 2 might actually reduce the level of threat that could be addressed, since “reachback” weapons involved in the concept leverage precision-guided weapons and, thus, tend to be less appropriate for handling threats other than massed armor. That is, this concept has marginal ability to address infantry-based threats or enemy forces that can operate with short exposure to top attack weapons.

Responsiveness into theater. In considering responsiveness into theater, path 2 forces offered substantial improvement over current light airborne forces because of their smaller overall size and weight. Path 1 mimics current airborne responsiveness. Path 3 would likely result in a force that has greater airlift burden and, thus, longer timelines into theater. On the other hand, path 3 would minimize one of the major shortfalls of today’s light units—their lack of tactical mobility and protection. Current light forces cannot fully exploit successes of indirect-fire systems by applying maneuver to decisively defeat an enemy. This advanced maneuvering force would take maximum advantage of innovations as they emerge: directed-energy weapons, ubiquitous sensing, hybrid (powered and/or buoyant) airlifters, robotic vehicles, stealth treatments, and so forth. It could also streamline the vertical organization of today’s forces, in which information and commands tend to move up and down many echelons, leading to a more horizontal organization that allows faster response and greater efficiency in calls for fire.⁷

The issue of how the Army would reallocate force structure and resources to realize any of the paths presented in this book is also a contentious topic. For the foreseeable future, it is unlikely that the Army can count on any significant increase in either its budget or its force structure. Therefore, any of the paths or options presented here, and especially any combination of them, would likely require the Army to reprioritize its resources.

Although for analytic reasons we have treated the three paths to a better rapid-reaction capability as distinct options, they should not be seen as mutually exclusive for implementation. As brought out earlier, the idea of employing a *combination* of the paths to resolve a very wide range of growing rapid-reaction needs may be the most prudent way to go. However, pursuing multiple paths would likely burden an already stressed Army budget. As a result, pursuit of the respective options may have to come at the sacrifice of some current and planned programs. In particular, programs that represent strengthening the “counteroffensive” capability of today’s heavy-mechanized forces might have to be weighed with respect to bringing such new capabilities on-line. In addition, programs of other services, such as fighter improvements, carrier developments, and ballistic missile defense, may all be less necessary with a more capable rapid-reaction force.

Developing a Strategy

Using a Combination of Paths

Each of the three paths explored offers both relative strengths and relative weaknesses over a present-day light airborne force. In many ways, such dissimilar concepts have characteristics that complement each other. A capability designed for meeting the wide range of tomorrow's rapid-reaction challenges might take on a form that embodies all three paths, provided the affordability issue can be resolved.

If all three paths were pursued, the notional rapid-reaction capability would consist of three major components. It would include a stealthy, small, and very-fast-deploying force that would rely on nonorganic fire support, an enhanced airborne force similar to the 82nd DRB that would be equipped with substantial organic precision fires, and a mounted force equipped with highly agile maneuvering vehicles that can provide both indirect- and direct-fire capability. By our assessment, the technology either already exists or can be developed to create all three components. In fact, even though the three components have different end capabilities, the underlying tactics and technologies used to build them would have considerable overlap, possibly yielding an *economies of scale* effect.

Example Application: Stopping an Enemy Invasion

In theory, the range of capabilities could be designed to accomplish a wide range of different missions. As an example, we consider how these capabilities could be used in one of the more difficult missions that currently exists: stopping an enemy invasion.

The application of this force would require the following phases. The first phase would be to insert the stealthy, small force as soon as possible, perhaps as soon as 24 to 48 hours after notification (see Figure 7.1 for a notional picture of force deployment over time); this force would be used to both gather intelligence and deny an encroaching enemy control of terrain. Such a stealthy and small force could initially be colocated with its equipment onboard prepositioned ships and require relatively little overall peacetime commitment. The forward positioning should normally allow for more rapid deployment to trouble spots than for a CONUS-based force. Nonetheless, no matter where it is based, this force would be easily deployed at the beginning of hostilities because of its light infantry composition (equipped with high-tech sensors, C2 capability, and access to remote weapons), as described in Chapter Four.

As far as tasks go, the force would use a wide range of resources to gather intelligence about the situation as it develops. At the same time, the force would have the capability to slow any advance by the enemy. While previous analysis described in this book shows that such a force would be unlikely to be able to control terrain, it could be used to deny the enemy control and use of the terrain. Effectively, through the application of remote, long-range fires (such as allied, USAF, and/or Navy aircraft or long-range missiles), it could partially attrit the enemy. If deployed early enough in the de-

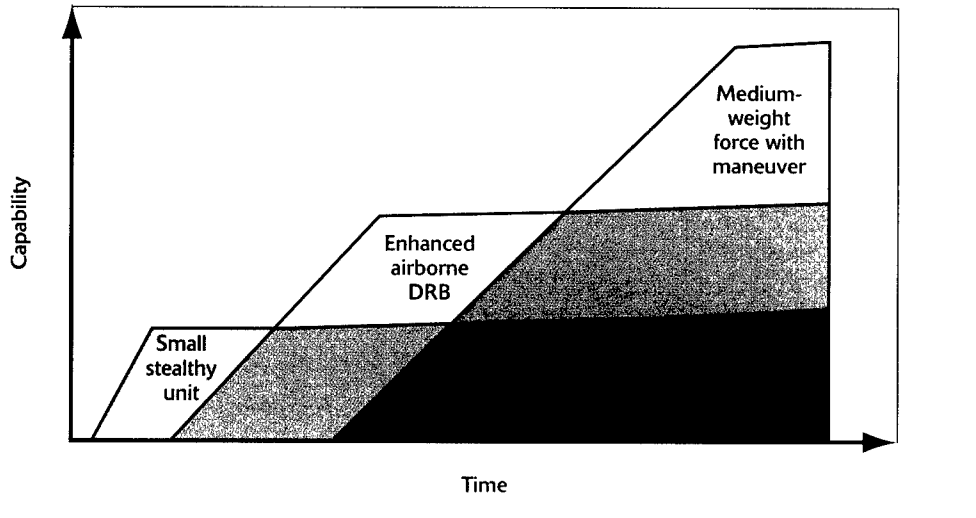

Figure 7.1—Notional Deployment of the Three Types of Units for Stopping Enemy Invasion

velopment of the crisis, these forces could also be used to organize local forces and coordinate air operations.

The second phase of the mission would involve deploying a force based on an enhanced 82nd Airborne DRB, as described in Chapter Three. This force would be deployed perhaps as soon as 3 or 4 days after notification. Its objective would be to create a forward defensive position much like that of the DRB. However, this position could be farther forward than usual because the application of the initial stealthy and small force will have slowed the enemy advance and provided some level of protection that would not otherwise have existed. The enhanced DRB would also be used to create a lodgment or airhead from which to expand operations.

The third phase of the mission entails using a maneuver force in offensive operations against the attacker. The forward lodgment created by the enhanced DRB would allow the light mechanized force, or “medium-weight” force (described in Chapter Five) to land safely and build up unit strength. When enough capability was established (perhaps 6 or 7 days after notification), this force would then conduct lightning-fast maneuver strikes against the already partially attrited enemy force. Because the enemy would have been engaged by both the remote fires of the small stealthy force and the advanced organic precision fires of the DRB, it would be vulnerable to attack by the relatively light maneuvering force. Since the maneuver force would have superior tactical mobility over the enemy, it would be used less in a “toe-to-toe” fight and more in ambush, flanking, or swarming operations.⁸ More research is being conducted to explore other ways to fight with faster but relatively less-protected vehicles.

Other Considerations

Global urbanization trends ensure that MOUT will be an increasingly likely prospect for ground forces in coming years. Unless proper decisions are made about equipment, training, and organization, U.S. rapid-reaction forces could see many of their advantages in technology and technique diminished in a MOUT environment. Research has also introduced the possibility of new operational concepts, focusing on standoff fires, sealing off areas, and use of unmanned systems to help deal with the unique conditions of urban operations. The potential difficulties of operations in heavily forested or jungle areas should also be considered in developing any new capability.

Many of the sensors and weapons upon which U.S. forces are placing great stock can be either severely degraded or even negated in heavily foliated areas. It is not obvious that technology will be able to quickly overcome this problem, and the enemy is likely to capitalize on this weakness. Finally, as changes and enhancements to the light forces are made in coming years, the reality is that smaller contingencies and missions involving noncombatants will populate the overall mission spectrum and should be addressed in current planning.

Although the research described in this book has covered a wide range of issues, particularly with force effectiveness, there are still many questions that should be answered as the Army moves toward change. Is technology the primary answer, or is it the human component (organization, selection, training, and motivation) that makes the difference? Will specialized, uniquely trained units for each type of mission (MOUT, small-scale contingencies, high-intensity warfare) ultimately be needed, or can one or a few types of forces be tailored as necessary? How can multi-service, joint, and coalition operations be linked with new Army concepts, and how can these operations be facilitated? How will the enemy operate to defeat new innovations, and how can these countermeasures be countered? What is the cost of change, and what is the metric that reflects reduced casualties, better responsiveness, and improved deterrence?

Clearly, there are many questions that need to be resolved as the Army remakes itself into a more responsive force, with greater rapid-reaction capability. Some of these can benefit from additional study and analysis. Others may require experimentation. Still others may require field testing, training, and implementation to be fully understood. With regard to becoming more prepared for the new millennium with greater rapid-reaction capability, the Army *is* at a crossroads, and the time to select a direction is now.

CHAPTER SEVEN ENDNOTES

- 1 U.S. light airborne forces were referred to disparagingly as a “speed bump” or a “trip wire” among soldiers and planners during the Operation Desert Shield build-up, as they were perceived to have only a minimal effect against an Iraqi armor attack.
- 2 The Army consists of six “heavy-mechanized” divisions versus four “light” divisions, which include the 101st Air Assault Division.
- 3 Modern aircraft equipped with the latest in advanced technology, via both sensors and weapons, proved on the whole to be unsuccessful at engaging critical targets at the tactical level in Kosovo in 1999.
- 4 There are major opportunities for improving light forces. Technology is making enormous strides in computer processing and graphics, communication networks, sensor capabilities, robotic systems, and precision-guided weapons. Some of these technologies originate from commercial spinoffs, and, in many other cases, they are deliberate initiatives within the military.
- 5 Although the vehicles might weigh from 10 to 20 tons, they would have offensive capability that is not present in the other two options.
- 6 In fact, because this force has added protection and mobility, it might be better suited than the other options for MOUT, stability operations, and low-intensity conflict. Doctrine and training should include entirely new procedures for tailoring the force and changing its tactics for these types of operations.
- 7 Of special interest might be use of light- to medium-weight vehicles with common chassis and interchangeable payloads. Various concepts have considered families of vehicles with a common platform, but this would extend the notion to one of reconfiguring vehicle types during deployment as a means of tailoring the force.
- 8 Swarming here refers to the use of a relatively large number of vehicles to conduct rapid cycles of concomitant attack and disengagement (e.g., while some vehicles are attacking others are disengaging). These operations are highly dependent on information dominance.

A Vision Into the Future

ALTHOUGH IT SEEMED LIKE A LIFETIME AGO, only 25 years had passed since the turn of the millennium when a major initiative was taken to improve our rapid-reaction capability. At the time there had been considerable debate over which direction the light force enhancements should go. There were lots of ideas. Many were analyzed, some were selected for experimentation; in the end, however, only a few concepts survived. Fortunately, these key concepts were not only fielded but were done so with an extensive training initiative in place.

And it was a good thing too, because only a year after this force was fielded, a sequence of hostilities broke out, one right after the other, all of which necessitated the use of rapid military response. In some of these cases, just the presence of credible peacekeeping forces was sufficient to contain the situation, while in others, military force was used to halt atrocities, defend allies, and protect national interests. He remembered how, in one of those operations years ago, he was only a lieutenant in the Army when his unit was called on alert and flown overseas in 24 hours. Their mission was to retrieve compromised nuclear weapons. Although the enemy had actually detonated one of the low-yield nuclear warheads in the major access port to try to stop military action, his force was designed, trained, and equipped to handle even these kinds of situations and environments.

Unhindered by the threat of these weapons, his unit continued with the rapid execution of an offensive ground operation. It resulted in a quick and decisive reclamation of a small stockpile of nuclear weapons with few casualties, putting a decisive end to the year of terrorism that held the world hostage.

The costs were extensive. Some turbulent times passed with major program shifts, cross-service budget cuts, and accelerated fielding of equipment, along with massive rewriting of all the doctrine and field manuals. As a result of the rapid force transition, there were several years of dramatic change when new high-tech lightweight systems were replacing the earlier generation of systems. Fortunately, this change was managed with extreme care. From the warfighters to the scientists and technologists to the policymakers and planners, they worked as a team. These forces were barely ready in time. But they were ready.

*As he put his feet up on the large oak desk in his oval office, evaluating the new set of modernization changes being proposed by the Army leadership, he reflected back those two and a half decades to when he was just a lieutenant fresh out of training, when the first of these crises in the new millennium broke out. Yes, they **were** ready.*

**A CONCISE AND SELECTIVE HISTORY OF
U.S. LIGHT FORCE PROJECTION**

IN THE YEARS JUST BEFORE AND DURING THE NAPOLEONIC WARS, lightly equipped infantry skirmishers established themselves as a battlefield force to be reckoned with. Tasked to delay and disrupt approaching squares of enemy infantry, they deployed well forward of regular foot soldiers drawn up in ranks. These light fighters accomplished their missions by fighting dispersed rather than shoulder-to-shoulder, by using the superior mobility that individual men's movement allowed, and by utilizing longer-range and more accurate rifles rather than the muskets carried by those in squares. They also used a form of maneuver that capitalized on these other capabilities. Dispersed yet mutually supporting, the light infantrymen would reposition to attack the flanks of threatening enemy formations and would withdraw between the protective ranks of their own compatriots when an adversary's infantry or cavalry approached too closely. Mobility, dispersion, standoff lethality, and superior maneuver made them deadly effective and highly survivable in an era when more heavily equipped infantry was the norm.

Yet even the most combat-effective force, whether light infantry or otherwise, is of little value unless that capability can be brought to the theater of operations in a timely manner. Americans have historically been well served by their ground forces in this regard. The ability to move Army units to an objective when necessary was crucial to the United States winning its freedom and to the preservation of the nation in its earliest years. The tactical mobility of Revolutionary War leader Nathanael Greene's troops and that commander's effective division of his army when necessary were key to his exhausting the British enemy. The simple threat of a ground force presence was enough to cause the collapse of the first significant challenge to the Constitution when George Washington himself led forces into Pennsylvania during the 1794 Whiskey Rebellion. Whether Washington crossing the Delaware River or U.S. soldiers and marines deploying to the Persian Gulf, this ability to mass sufficient combat power where needed, when needed has been fundamental to successful force projection.

America's 21st-century armed forces must be capable of rapidly moving ground forces overseas. Initial deployments may be followed by other organizations, the transport of which is more deliberate, but there will be a period during which the first representatives of U.S. resolve must be ready to accomplish assigned missions with no one to their right and left on the field of battle. Unfortunately, the size and weight limitations that make a force, be it infantry, cavalry, artillery, or otherwise, that is light enough to deploy rapidly constrain such an organization's combat power. On the one hand, the force must arrive in-theater in time to meet the demands of national interests. On the

other, it must possess the firepower, mobility, maneuver capability, and survivability to accomplish the tasks essential to fulfilling those demands. In a world where even the poorest of nations can probably field an armored or mechanized force of some strength, this dichotomy between speed and combat power poses what is perhaps a force projection military's greatest challenge. Light forces, equipped with lighter and smaller systems designed to maximize attainable combat power, are an effort to answer this challenge.

The forerunners of today's light forces were often the tools deployed to defend the nation's interests. In the young nation's first overseas land operation (notably, a joint undertaking), U.S. naval agent William Eton crossed six hundred miles of north African desert in April 1805 with a force of eight marines, one Navy midshipman, and some one hundred mercenaries in an effort to force the release of U.S. Navy prisoners of war (Dupuy and Dupuy, 1977, pp 780–781). Ulysses S. Grant broke away from a burdensome logistical tail and completed one of the great feats of American maneuver to wreak havoc in Mississippi and eventually capture Vicksburg on July 4, 1863. Mobility and the ability of light cavalry to operate in small, dispersed units were keys to the U.S. stabilization of the 19th-century American west.

It was not until World War II, however, that U.S. ground force projection escaped *terra firma*. Although generally limited to intratheater operations such as airborne drops in support of the Normandy invasion, aircraft had become an accepted means of transporting men and materiel onto the battlefield by the 1940s. A new era of far more rapid application of military force was at hand. Yet the additional speed and freedom from ground obstacles came with costs. Previously, unless the exigencies of extraordinary mission demands precluded it, America's marines and soldiers generally reached their destinations with equipment on par with if not superior to that of their adversaries. Air transport often precluded achievement of this parity. Size and weight restrictions set sharp upper bounds on the capabilities with which a force could deploy. As mechanization and armored vehicles came of age, forces that could reach a theater by air found themselves outclassed when it came to firepower and protection. The same characteristics that had aided America's light force predecessors (mobility on difficult terrain and the ability to disperse to reduce the likelihood of detection or effective engagement) were now not merely valuable, they had become essential to survival.

Air-dependent force projection operations also demonstrated that light forces could defeat heavier adversaries despite these constraints to achieve dramatic successes. The use of airborne units to secure key transportation nodes in support of the Normandy invasion served to both disrupt German decisionmaking and facilitate movement inland once amphibious units landed and fought their way off the beaches. Avoiding or outmaneuvering fixed defensive positions permitted foot-mobile paratroopers to move to their objectives and dig in before armor or mechanized threats could be brought to bear. The greatest threat to these operations, enemy air, was kept at arm's length while men and equipment dropped from the skies, reorganized, and accomplished their assigned missions. In the Pacific theater, the 11th Airborne Division's

successful February 1945 Los Baños raid, conducted to free prisoners of war from the Japanese, similarly combined air, sea, and land capabilities, good intelligence, and well-conceived mission design to allow these light forces to accomplish their difficult mission.

When missions were chosen less wisely, however, or when intelligence failed, light forces could be grossly outclassed by the firepower an enemy could bring to bear. The failure of the combined U.S.-British Operation Market Garden in 1944 was in considerable part attributable to the Allies being unable to overcome German 9th and 10th Panzer Division elements sent into the objective area shortly before the offensive (Devlin, 1979, p. 479). Similarly, the presence of enemy armor at Avellino had earlier complicated an already risky mission for the 509th Parachute Battalion during its late 1943 support of the Salerno bridgehead:

The paratroopers had advanced nearly two miles when an alert German sentinel sent them diving for roadside ditches with a long burst from his machine gun. Off in the direction of the gunfire, the paratroopers could see the distinct outlines of several tanks . . . There were tanks in the crossroads area, and plenty of them. More than a battalion . . . The Germans had them outgunned. Machine gunners buttoned up inside the tanks started spraying the area, cutting down any paratroopers foolhardy enough to come close to them. The paratroopers fired back, but their bullets bounced harmlessly off the tanks. Several flares shot high into the sky cast an eerie red glow over the battlefield and exposed every paratrooper not lying in a ditch. One by one the Germans picked them off. (Devlin, 1979, pp. 311–312.)

Though author John English might conclude that “infantry that has neither the means nor inclination to fight on its own is hardly worthy of the name,” the reality was quite simply that lift capabilities supporting rapid long-range movements kept these early air-transported forces from having sufficient firepower and mobility to confront a well-equipped adversary of any sophistication (English, 1984, p. 218).

This inevitable tension between deployability and combat power carried over into the Cold War, during which strategic movement of light forces played an integral role in defense plans for Western Europe. The presence of U.S. mechanized and armored divisions in Germany lent a ready means of supporting what were likely to be the first ground force reinforcements to arrive from the United States. Light forces were often assigned to heavier units during training to exercise potential wartime relationships. Planners in Europe accounted for the limited mobility of the light force soldier. Foot-mobile organizations were habitually ordered to defend key terrain, generally forested or urban, that provided concealment and the means to construct defenses against Warsaw Pact artillery, armor, and air attacks. Exercise results showed that ill-conceived assignment to easily bypassed or overrated terrain left the relatively immobile force behind enemy lines with little hope of resupply or extraction. Well-selected terrain, or missions that took advantage of light force stealth and dispersion, demonstrated that heavy and light organizations could at times work effectively together when the relative strengths and weaknesses of each were taken into account (see also Glenn, 1990, pp. 35–37). Nevertheless, both command post and field training events repeatedly

showed that light force disadvantages in maneuver, firepower, and survivability often threatened mission success when light units were pitted against tanks, infantry fighting vehicles, and enemy air on West European terrain.

Operation Just Cause pitted Americans against some 4,000 Panamanian Defense Force (PDF) combat troops in late 1989. It also demonstrated what light force maneuver and firepower parity could accomplish. The Panamanians' heaviest equipment consisted of 28 armored cars. Other units included 18 paramilitary Dignity Battalions (Cole, 1995, p. 37). In addition to Marine Corps and Army light armor and mechanized elements, the U.S. force included soldiers from the 7th Infantry Division (Light), paratroopers of the 82nd Airborne Division, 6th Expeditionary Battalion Marines, the Army's 193rd Infantry Brigade (based in Panama), and special operations forces. Initial U.S. light force missions included the seizure of key terrain and the destruction of known enemy forces located in and around Panama City and the canal. Wise allocation of objectives was critical to the ultimate outcome. Missions requiring extensive movement, such as the attack on La Comandancia, were given to units equipped with or supported by light tanks or armored personnel carriers (APCs). Light forces accompanying these organizations rode in the APCs until near the objective. Airborne and special operations forces were dropped on or near their objectives to try to surprise the adversary and minimize ground movement times. When possible, attack helicopters or AC-130 aircraft provided fire support. The conscious effort to match capabilities with missions led to few confrontations in which the Americans did not have the advantage.

Christmas 1989 in Panama, Christmas 1990 in the Persian Gulf: Less than a year after its participation in Operation Just Cause, the soldiers of the 82nd Airborne joined their compatriots in the 101st Airborne (Air Assault) and 24th Mechanized Divisions in the defense of Saudi Arabia, Operation Desert Shield. Again it was the light fighter who was first on the ground, but in the deserts of the Middle East the threat was far more intimidating than that posed by 28 armored cars. The invaders of Kuwait counted their tanks, infantry fighting vehicles, artillery pieces, and other heavy armament by the thousands. Between the Iraqi enemy and Saudi Arabia's invaluable ports stood little more than a screen of Arab units and a thin red, white, and blue line of 82nd Airborne Division soldiers. Whether because of the U.S. presence, the logistical difficulties inherent in supporting the long attack south, or a combination of these and other reasons, the enemy failed to continue its southward movement. Outgunned and at a severe mobility disadvantage in the open desert terrain, the mettle of the Americans would have been seriously tested had the attack taken place.

At 7:00 P.M., September 18, 1994, 16 United States Air Force C-130 aircraft loaded with paratroopers were en route to Haiti. A second group stood poised on North Carolina runways to follow them. To the south, at Fort Stewart, Georgia, Army Rangers likewise readied to don parachutes. These soldiers' collective objective was "to return to office the democratically elected president of that country and the creation of a stable and secure environment in which democratic institutions could take hold." Eventually a total of 62 aircraft loaded with fighting men and equipment

would be in the air, destined for combat insertion at critical locations (Kretchik, Baumann, and Fishel, 1998, pp. ix and 76). In the closing moments before the Americans jumped into the night air, a political settlement caused a dramatic change of mission from one of forcible entry to permissive landings. As had been the case in Pennsylvania over two hundred years before, the approach of the American force had been threat enough to bring about the attainment of national objectives.

History demonstrates that light forces can serve U.S. interests through both the actual commitment to combat operations and the mere threat of such commitment. As there can be no guarantee that the coercive effect will be sufficient, America's force projection capability must be a capable one if it is to serve as an effective implement of policy. In addition to those events highlighted above, Korea, the Dominican Republic, Vietnam, Grenada, Somalia, and myriad other post-World War II operations have, for better or worse, confirmed the validity of this requirement. In today's world, that sufficiency often demands speed in application and successful execution once a force arrives in a theater. However, as has been the case since air deployment began during World War II, speed and the delivery of sufficient combat power are elements in tension. Speed is possible only with the deployment of lighter forces; light forces as of yet suffer significant limitations when facing heavier opposition.

The light infantryman of today lacks the combination of mobility, superior weapons range, maneuver, and survivability advantages that made his Napoleonic forebears so effective. Being prepared to meet the demands of national defense means that a deploying must (1) be light enough to be transportable by air, (2) possess or control the firepower necessary to accomplish its missions, (3) have sufficient mobility to both move and maneuver effectively after arrival, and (4) survive against assaults by enemy heavy forces and be able to logistically sustain itself. No advances in doctrine or training can sufficiently fulfill all these requirements given the confines of currently available weapons systems. Ongoing research efforts, however, offer promise that solving outstanding problems is possible within the next generation. Today's potential U.S. adversary, regardless of how well equipped he might be, has good cause to respect the dedication and training of America's light infantryman. Tomorrow he may learn to fear him.

RAND'S HIGH-RESOLUTION FORCE-ON-FORCE MODELING AND SIMULATION CAPABILITY

Overview

MUCH OF THE RESEARCH IN THIS VOLUME has been accomplished using RAND's high-resolution force-on-force simulation environment, which is composed of a large network of locally distributed models and simulations. The major components of the network are shown in Figure B.1. JANUS represents the centerpiece of the network. It is a system-level, stochastic, two-sided, interactive ground combat simulation/wargame. At different times it has been used for combat developments, doctrine analysis, tactics investigation, scenario development, field test simulation, and training. The RAND version of JANUS models up to 1,500 individual combat systems per side (including up to 100 indirect-fire systems). Each system can move, detect, and shoot over a 200-kilometer-square, three-dimensional, terrain representation based on National Intelligence Mapping Agency DTED level I, II, and III data.

Combat systems, such as tanks, infantrymen, and helicopters, are defined by the quantitative attributes of the real or notional systems being modeled, e.g., size, speed, sensor, armament, armor protection, thermal/optical contrast, and flyer-type (for helicopters and fixed-wing aircraft). The vulnerability of systems are characterized by prob-

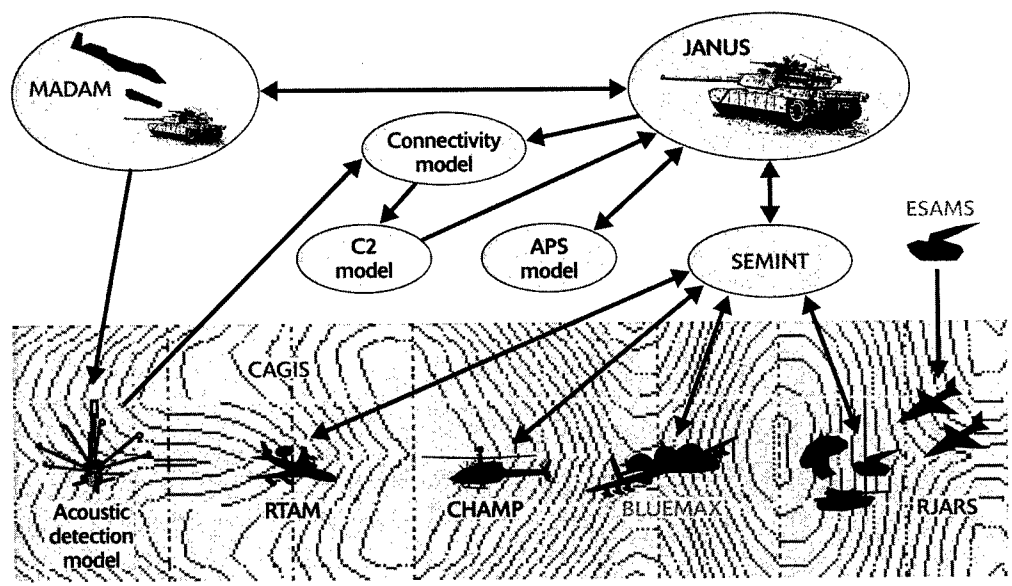

Figure B.1—Major Components of RAND's Force-on-Force Modeling Suite

ability of hit ($P(h)$) and probability of kill ($P(k)$) datasets individually associated with weapon-versus-system pairs. Up to 250 different systems and types of weapons may be defined per side. Each system may be armed with up to 15 different weapons, and it may search and detect with two different sensors, employing a modification of the Night Vision Electro-Optics Laboratory (NVEOL) detection model. Fixed-wing and rotary-wing systems' flight characteristics are described by two different flight modes, each composed of altitude, speed, and an associated probability of detection by various radar types.

RAND makes use of Standard High-Resolution scenarios, made available by U.S. TRADOC Analysis Center (TRAC), and modifies them as necessary to meet individual project objective needs. When no such standard scenarios are available, or necessary modifications to existing scenarios are too extensive to be practical, scenarios or vignettes are developed at RAND to isolate and examine essential elements of analysis (EEA) identified within the objectives of individual projects. An appropriate level of awareness of each scenario's validity with respect to likely "real-world" situations and contingencies is maintained, and assumptions are always based on "best available data." Vignettes are thoroughly gamed interactively, then carefully scripted to ensure "reasonable" tactics and behavior in the absence of human reaction and intervention.

Although JANUS affords the capability of modeling engagements at the division-versus-division level, typical vignettes are developed at the level of battalion task force-versus-brigade or brigade-versus-division. Vignettes are normally scripted to run for 60 minutes or less (real time). The model typically runs at or faster than real time in the batch (or systemic) mode, depending upon the complexity of the vignette. Each vignette is iterated 30 or more times for statistical validity, and the resulting statistics are analyzed, both by individual run and by the entire ensemble of runs.

The principal strength of JANUS as an analytical tool is its ability to capture the direct and synergistic effects of altering a multitude of model input parameters. The completeness of the output available to the analyst permits a detailed examination of the individual impact attributable to each parameter change, and it aids in quantifying the contribution of synergy to net outcomes. This, combined with the wide range of input data formats the model is capable of accepting—e.g., tabular, calculated, human interaction, etc.—results in a flexible high-resolution simulation, applicable to a variety of ground combat issues. Further, the model's graphic display capability gives the analyst the ability to examine spatial-temporal behavior, thereby aiding the analytic process by directing focus to causal chains occurring during simulation.

The JANUS model has some limitations. The most notable are described below.

Scenario generation and development. JANUS's capability may be described as cumbersome, manpower-intensive, and time-consuming. The initial route assignments relating to scheme of maneuver, as well as subsequent fine tuning, both require repeated manual inputs to each system. This time-intensive process limits the ability to examine force effectiveness across a wide range of environments in timely fashion.

Perfect targeting information. JANUS detects and locates targets according to accurate ground truth; that is, only live enemy targets are detected and acquired. Acquisition is at system level with no uncertainty in identification (e.g., an APC-X is always detected and identified as an APC-X). Acquired targets are located both accurately and precisely, without target location error. This often results in an overstatement of the accuracy of fires and an underestimate of ammunition consumption.

Direct-fire suppression. JANUS models suppression by straight probability, given a target is acquired, fired upon, and not hit and killed (typically 0.25). JANUS firing events are event driven in that a target must first be acquired, and the probability of single-shot kill (PSSK) must be calculated from the P(h) and P(k) tables to determine if it is sufficient to trigger a firing event.¹ This only roughly models direct-fire suppression and "reconnaissance by fire" and often results in a net understatement of both force effectiveness and ammunition consumption.

Destroyed vehicle (hulk) representation. Vehicles assessed as "destroyed" in JANUS are "administratively" removed from the battlefield. Although their positional data is recorded in output files, they are not considered for future acquisition and present no hindrance to allocation of fires or live vehicle movement. This results in, once hulks become abundant, an overstatement of trafficability for moving vehicles and an overstatement of the opposing force's ability to distinguish live targets.

Nonintelligent behavior. Systems in JANUS often do not recognize or react to changing battlefield situations or environments. Specifically, without human interaction, a surviving tank in a task force that has been decimated will continue to follow its preassigned path regardless of circumstances. Systems being fired upon and suppressed will not seek cover or assume a defilade condition; vehicles trailing a vehicle that has entered a minefield will follow their preassigned paths into the minefield.

Vertical line of sight. JANUS does not calculate vertical line of sight as a precursor to probability of detection and acquisition. This results in a serious shortfall in the model's ability to accurately model interactions in and around buildings and other structures.

There have also been a number of significant model upgrades to JANUS at RAND. One of the more important of these is the increase in terrain size and features. With the advent of JANUS/A, the terrain database changed significantly over JANUS/T.² The major change involved replacement of the seven city and seven vegetation densities per grid cell with seven PLOS (probability of line of sight) values per grid cell. The motivation for this was to give the user more control over PLOS values, in particular, to be able to modify them for seasonal changes in foliage density. JANUS/A terrain also added two new arrays for movement factors in urban and vegetation areas, each with seven density levels and three mover types (wheeled, tracked, and footed). Velocity through a cell then became a function of the new urban and vegetation factors instead of a function of the cell's density level.

A second major improvement was the integration of other models through the addition of a program called the Seamless Model Integration (SEMINT). This was done to overcome some of the key JANUS representational shortcomings. SEMINT integrates multiple RAND simulation and support programs into one communicating, symbiotic system, even though the participating models may be written in different programming languages and run on different hardware under different operating systems. In effect, SEMINT gave us the ability to improve JANUS's algorithms without modifying them. By connecting the JANUS ground combat model with the RTAM target acquisition model, the RJARS ground-to-air combat model, the BLUE MAX (fixed-wing) and CHAMP (helicopter) flight planners, and the CAGIS cartographic system, we were able to conduct a much more comprehensive JANUS-based simulation. As currently configured, JANUS conducts the ground battle, calling on RTAM to provide more accurate calculation of detection probability on special low-observable vehicles. Should the conflict involve helicopter or fixed-wing operations, the flight planners determine flight paths for the missions flown against the actual JANUS threat, then RJARS conducts the defense against the aircraft—including detection, tracking, jamming and SAM operations. CAGIS provides consistent geographic information to all the simulations, while SEMINT passes messages among the models and maintains a Global Virtual Time to keep the models in synchronization.

The basic models we used are shown in Figure B.2. Generally, these include a force-on-force combat model (JANUS) with several “attached” models such as Model to Assess Damage to Armor with Munitions (MADAM) for simulated emerging smart and

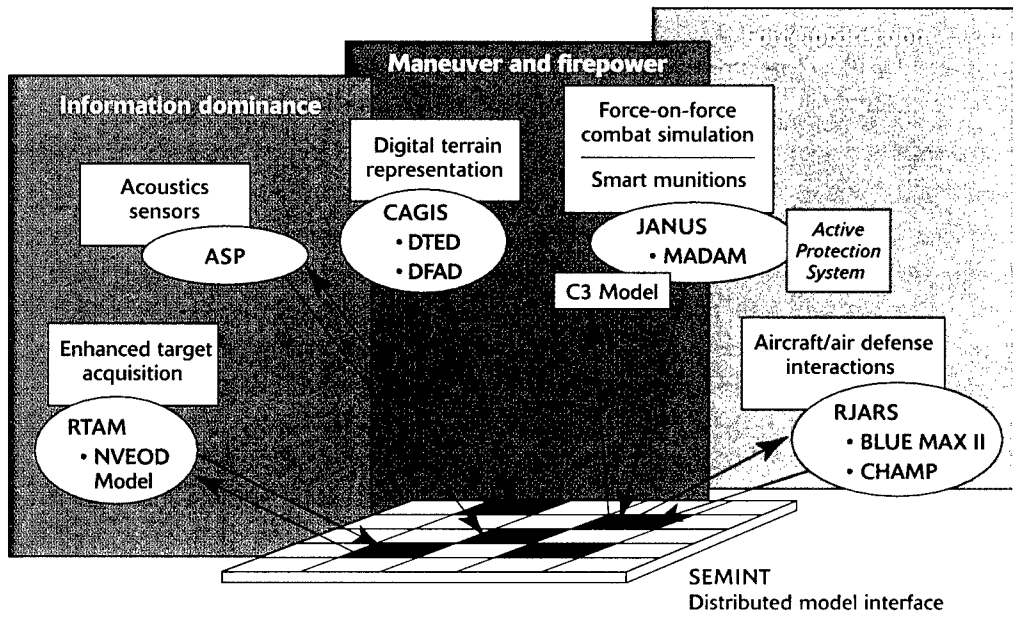

Figure B.2—Organization of Models and Their Impact on Different Aspects of Combat Missions

brilliant munitions, a C3 model for better assessing the impact and degradations of C3, and a newly created active protection model. Other models include: the Cartographic Analysis and Geographic Information System (CAGIS) for enhanced digital terrain representation, the Acoustic Sensor Program (ASP) for modeling acoustic sensor phenomenology, RAND's Target Acquisition Model (RTAM) for enhanced target acquisition techniques, and RAND's Jamming Aircraft and Radar Simulation (RJARS) for simulated surface-to-air interactions. Many of these models will be described in more detail in the sections below.

Line-of-Sight (LOS)-Based Communications Model

A simple, LOS-based communications model was added to JANUS in hopes of capturing some of the effects of communications-associated delays due to routing, and hardware and network reliability. The model accounts for the following phenomena:

- LOS communication requirement
- Communications hardware reliability
- Communications network reliability
- Packet delays (in seconds)
- Bandwidth limitations (number of messages handled simultaneously)
- Communications range limitations (kilometers)

Targeting messages, developed by sensors detecting targets for subsequent attack by indirect fire, are passed, in order, to three consecutive echelon decisionmaking nodes for allocation of indirect-fire assets. The sensor fuses the target information to determine at which echelon the appropriate asset to service the target resides. This determines the initial destination (address) for the targeting message.

The sensor will then attempt to send the message directly to that address. If that attempt fails (either due to range, LOS, or availability), an intermediate communications node with message retransmission capability will be sought for relay.

As shown in Figure B.3, each transmission of each message is recorded in an output file as an audit trail for subsequent postprocessing and analysis. This output file records message tag number, time of transmission/receipt, sending and receiving node coordinates, cumulative range of transmissions, cumulative number of retransmissions, disposition of message at each decisionmaking node, and ultimate disposition of each message.

The CAGIS display (left side of figure) is a graphic representation of the routing of a message from a Tactical Command and Control Post to a launcher with 10 intermediate hops. Decisionmaking for this process is carried out in the command and control model, described in the next section.

Fire Support Command and Control (C2) Model

Once a detection is made by a forward observer (FO) unit, the detection is passed to its first available paired launcher. After the FO unit successfully passes the detection, it cannot pass another detection for a specified time period (30 seconds).

Graphic depiction of the propagation of a targeting message in JANUS

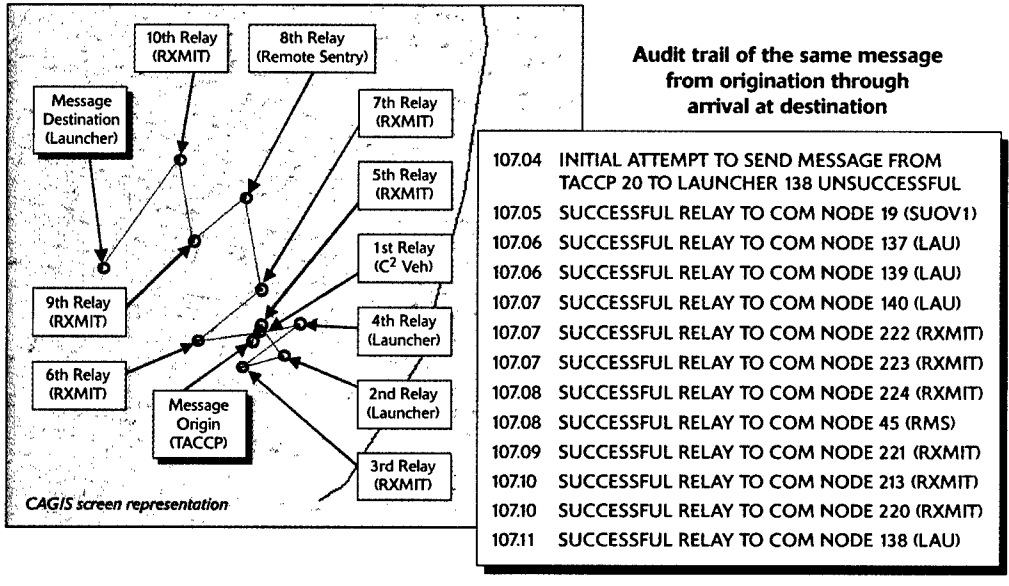

Figure B.3—Walk-Through of Command and Control Process in Simulation

When the launcher gets the detection, several things may occur depending on what type of projectile is being fired. Each different projectile (these include precision-guided munition, Copperhead, SADARM, ICM, TGW, EFOG-M, and many others) has its own logic. For example, for Copperhead, JANUS first determines the next available firing time for the launcher. Then it checks to make sure it has a valid mission to the target. A Copperhead mission is valid if the following conditions are satisfied:

- The range from the launcher to the target is within the minimum and maximum range capabilities of the launcher;
- The single shot probability of kill (SSPK), based on the range between the FO unit and the target, is greater than or equal to 0.05;
- The probability of line of sight (PLOS) between the FO unit and the target is greater than or equal to 0.1;
- There are no smoke blockages between the FO unit and the target; and
- The geometry relating to angle of fall and aimpoint offset between the FO unit and the launcher is satisfied.

Once mission validity is determined, the fire mission is planned by placing the following information into the fire queue: launcher unit, missile projectile type, number of tubes, FO unit, target unit, target aimpoints, and firing time. The missile is then launched at the appropriate firing time. Time of flight (TOF) of the missile is determined

between the launcher and the target; this is needed for calculating the delay time for the FO unit.

When appropriate, the C2 model calls the MADAM model if smart or brilliant munitions are fired. MADAM is described in a later section.

Fiber-optic guided missiles such as EFOG-M have very different representations of behavior. A given launcher may be linked with several artillery forward observers to cue a missile launching, and conversely, each FO may be linked to up to ten different launch units. Once the FO detects a target, he waits a specified delay time (assumed to be coordinate processing time) before transmitting the target information to a linked launch unit. The delay time depends upon the number of targets and whether they are clustered in a target set. If they are clustered (within 150 meters of each other), targeting is made to the calculated centroid. Targets are processed on a first come–first served (FCFS) basis.

One unique aspect of EFOG-M is that it can use its sensor to pass back additional detections. After the mission has traveled 75 percent of the distance between the launcher and the coordinates to which it was cued, it turns on its sensor and immediately passes any detections back to its launcher. If the detection is passed within the ripple time of the previous launch, then the launcher can immediately ripple another missile at new target coordinates. If the detection occurs after the specified ripple time, then the launcher must wait until all missiles in flight have been grounded.

The C2 system, configured into three echelons, is diagrammed in Figure B.4. Using this structure, a variety of organizations can be modeled.

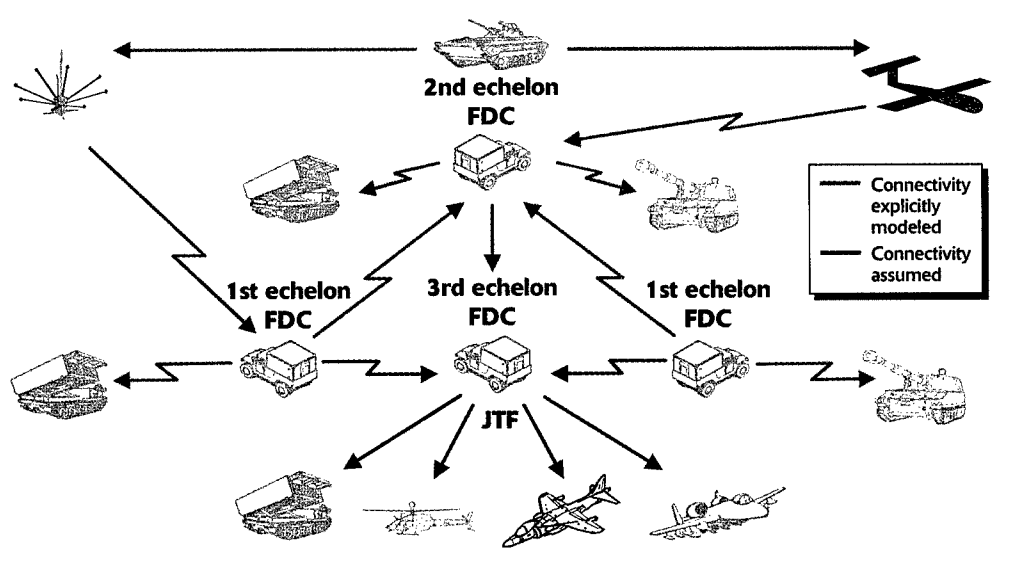

Figure B.4—Command and Control Organization in Simulation

Active Protection System (APS) Model

This modeling effort had three primary objectives: (1) to create a generic, parameterized active protection system (APS) model, (2) to validate that model and use it to characterize a variety of appropriate APS concepts, and (3) to integrate those APS characterizations into a force-on-force simulation (JANUS).

The four APS threat-classification levels are based on threat and concept characteristics. The *threat* definitions are

- **F&F:** fire and forget. Weapons with onboard seekers.
- **CLOS:** command line of sight. Missiles are guided by an operator optically tracking the target. The missile corrections are then transmitted to the missile by wire or the missile searches for and “rides” a laser designation beam.
- **Ballist:** Ballistic. Weapons are fired on a ballistic trajectory and are in free flight from discharge to impact with the target.
- **EFP:** explosively forged penetrator. Examples of these are SFW (sensor-fused weapon) and SADARM (sense and destroy armor).
- **KEP:** kinetic energy penetrator. Examples of these are APFSDS (armor-piercing, fin-stabilized, discarding sabot) tank rounds and hyper velocity missiles.

The *concept* definitions are

- **Soft-kill:** this concept involves keeping the missile from landing on the target by confusing or defeating its guidance or seeker systems, and it includes measures such as dazzlers, smoke, reflectors, and so forth.
- **Hit-to-kill:** this involves actually launching a projectile(s) to strike the incoming missiles and thereby either destroy or divert them.
- **Fragmentation:** this involves the employment of a burst-type weapon that generates fragments intended to destroy, divert, or induce premature detonation of incoming missiles.
- **Momentum transfer:** this consists of launching high-velocity, high-mass projectiles intended to divert incoming missiles.

The model assigns classification levels as delineated in Table B.1.

Table B.1—Classification Scheme for APS Systems

APS Classification	Guidance Mechanism	Type of Munition	Type of Countermeasure	Range
Level 1	F&F/CLOS	EFP	Soft-kill	Long
Level 2	F&F/CLOS	EFP	Hit-to-kill	Medium
Level 3	F&F/CLOS	EFP	Fragmentation	Short
Level 4	Ballist	KEP	Momentum transfer	Close

The APS model then produces three basic calculations corresponding to (1) the protection provided to a vehicle by an APS, (2) the likelihood of a vehicle surviving an attack, and (3) the extent to which the protection provided by an APS is degraded when its host vehicle survives an attack.

The JANUS database was supplemented by a classification designation for each weapon defined. The model modifies the standard JANUS engagement routines (detection, acquisition, fire/shoot, assess) to incorporate the effects of the APS model into simulation engagement outcomes.

Cartographic Analysis and Geographic Information System (CAGIS)

CAGIS was developed at RAND to support those simulations that needed to use a wide variety of terrain types and feature data. These inputs included the Defense Mapping Agency's (since renamed the National Information and Mapping Agency) standard Digital Terrain Elevation Data (DTED) and Digital Feature Attribute Data (DFAD), LANDSAT and SPOT satellite imagery, and other sources of digitized roads and features such as the TIGER data base. CAGIS is a collection of procedures that provides:

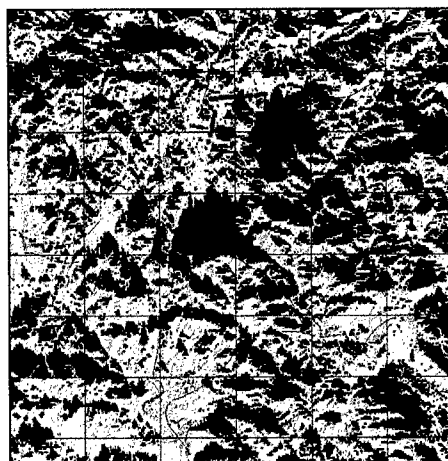

- This is a 1992 LANDSAT image of the Kuwait City harbor and its surrounding land features and facilities.
- The image was mosaiced, warped and registered to the underlying DTED Level II terrain for use in high-resolution, force-on-force simulations.
- CAGIS procedures are capable of this processing on currently available computer engines in a matter of tens of minutes.
- The black in this image depicts the terrain masking of an airborne sensor positioned 65,000 feet above mean sea-level (MSL) due south at 150 nautical miles from the center of the image.
- The light gray depicts the additional terrain masking for the same sensor positioned at only 35,000 feet above MSL due south at 150 nautical miles from the center of the image.
- The red in the image depicts the target vehicles detected at 65,000 feet but masked at 35,000 feet.
- CAGIS is capable of processing this data for analysis in a matter of minutes.

Figure B.5—Exemplary Cartographic Information in Simulation

- A user-friendly interface for interactive or batch applications based on the use of windows.
- Graphics and image display capability for geographic data.
- Image processing for DTED and similar pixel-oriented datasets.
- Graphics processing for roads, rivers, border, flight paths and similar datasets.
- Table processing for data with geographic coordinates related to the image or graphics data sets.

Examples of CAGIS images for Kuwait City and for a mountainous area are shown in Figure B.5.

MADAM: Smart Munitions Model

The Model to Assess Damage to Armor by Munitions (MADAM) greatly extends the capability of JANUS to represent smart and brilliant munitions. The core model was originally written by the Institute for Defense Analysis (IDA). RAND has added significant additional capability in the form of upgrades capable of modeling the technologies associated with the following munitions, among others:

- SADARM (sense and destroy armor)
- Sensor-fused weapons (SFW, also called Skeet)
- Damocles, a large-footprint submunition
- Low-cost autonomous attack submunition (LOCAAS)
- Terminal guidance warhead/terminally guided projectile (TGW/TGP)
- Precision-guided mortar munition (PGMM)
- Brilliant anti-tank (BAT) submunition
- Wide area munition (WAM)

MADAM exists as a stand-alone model used for parametric analyses as a precursor to force-on-force runs. The model also resides as a subroutine in JANUS, called whenever a smart munition is used. The stand-alone version of the model runs in the CAGIS environment. Threat laydowns from JANUS scenarios are imported into CAGIS to provide context and targeting information for analysts during the conduct of parametric stand-alone analyses.

The model provides capability for dealing with and analyzing chain logic, false alarm rates, hulks, submunition reacquisition, shots, hits, and kills. It also models bus, munition, and submunition reliability. Figure B.6 illustrates the operation of MADAM using the BAT submunition.

Acoustic Sensor Program

The Acoustic Sensor Program (ASP) was developed in support of the Rapid Force Projection Initiative. The model was a necessary adjunct to the JANUS model in order to satisfactorily represent one of the “leap-ahead” technologies associated with two systems in development, the wide area munition (WAM) and the air-deliverable acoustic sensor (ADAS). The model was originally developed to represent an eight-microphone

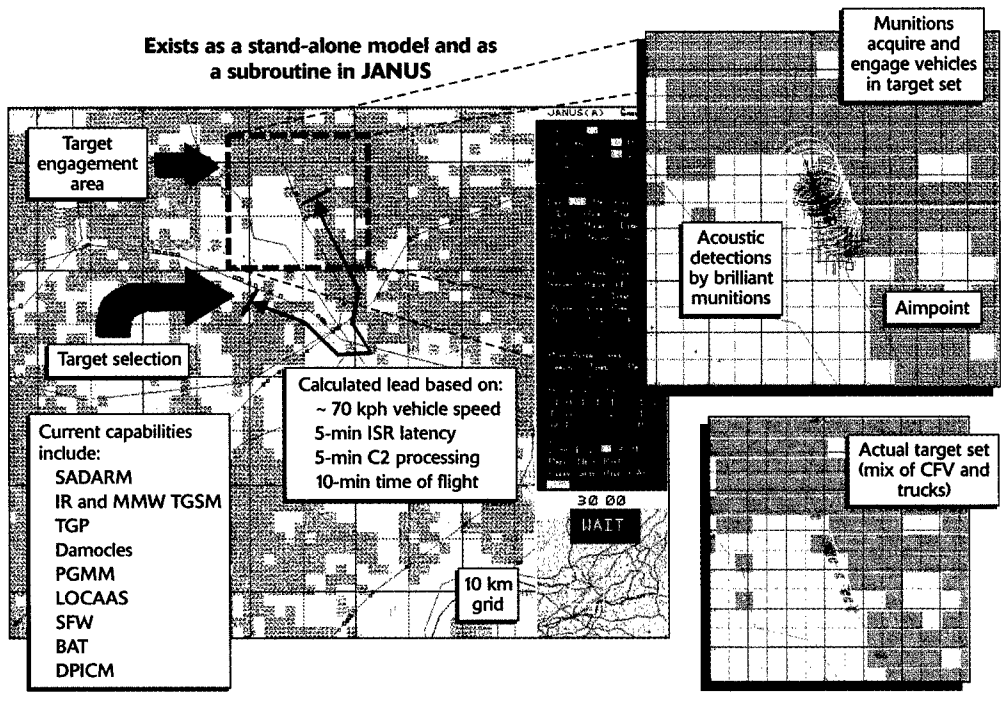

Figure B.6—Modeling BAT Submunition Effects with MADAM

array designed by Alliant Technologies, and later it was modified to represent the ADAS system developed by Textron Systems Corporation.

The model offers a reasonable depiction of the phenomenology associated with ground-based acoustic sensors, including the ability to detect, locate, track, and to some extent classify vehicles over large areas. The model algorithms may be modified by environmental factors, such as terrain roughness, and weather conditions, such as wind direction and ambient noise. Additionally, the model fuses data from multiple sensors in imperfect fashion and presents a target acquisition picture complete with calculated errors attributable to both sensor capability and fusion error.

ASP was a departure from the approach taken by defense contractors and research laboratories, which was to develop highly detailed, engineering-level models of individual sensors that model the phenomenology very well, taking into account environmental factors and fusion. Such models are cumbersome to run and would be unfeasible to incorporate into force-on-force simulations. The approach taken with ASP was to incorporate enough of the phenomenology to evaluate the technology while stressing the interface between acoustic sensors and other battlefield operating systems. In this way the technology could be best evaluated for its merit as a system of systems.

The model permits the specification of four classes of vehicle: heavy tracked, medium tracked, heavy wheeled, and light wheeled. Data for the average sound pressure level (SPL) for each classification of vehicle for the scenario being examined in-

corporates the effects of weather and terrain. Each vehicle is assigned a unique signature within its classification based on a draw distributed normally about the mean SPL for each class of vehicles. This permits the tracking of vehicles and also aids in the fusion of data from multiple sensors.

Like MADAM, the ASP model was designed to run in either stand-alone mode or as a subroutine in JANUS. When running in the stand-alone mode, target laydowns may be either generated by hand or read from previous JANUS runs into the stand-alone model for analysis. In the stand-alone mode, the model is capable of running several hundred iterations in a few minutes, making it ideal for parametric analysis.

When running as a subroutine in JANUS, ASP is called once per minute to provide updated detection and target acquisition information. The subroutine feeds the fire support command, control, and communications model in JANUS. Acoustic sensors may be designated as communications nodes, and the targeting information generated by these nodes is treated in a fashion identical to the information generated by the imaging detections produced from the Night Vision Electro-Optical Division (NVEOD) algorithms. An example of the model operation is shown in Figure B.7.

RAND Jamming and Radar Simulation (RJARS)

RJARS was developed in the mid-1980s as an intermediate alternative to the excessively detailed, highly accurate ground-to-air models designed to represent specific systems, and the other extreme, excessively aggregated ground-to-air models that represented only gross effects of very nonspecific systems. Using the Jamming Aircraft and Radar Simulation (JARS) created by Johns Hopkins University Applied Physics Laboratory as

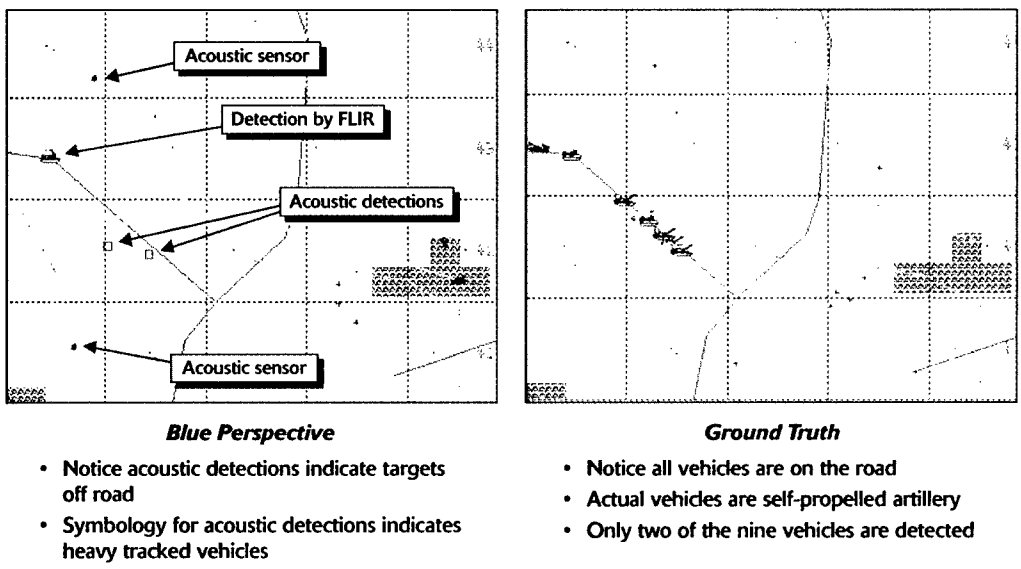

Figure B.7—Representation of the Acoustic Model in Simulation

a basis for development, RJARS is the product of years of significant enhancement and now provides a reasonable approximation of the highly detailed models, but in a more dynamic, force-on-force context.

The enhancements comprise original code and pieces and portions of previously written and tested representations from other models. For example, the portions of RJARS pertaining to clutter, multipath, and diffraction are derived from the ALARM (A Computer Model for Low-Altitude Radar Propagation over Irregular Terrain) model developed by Lincoln Laboratory. Other phenomena associated with radar were derived from the GRAM (Generic Radar Assessment Model) models developed by BDM International. Missile engagements, including fly-out and end-game assessments, are simplified versions of those contained in ESAMS (Enhanced Surface to Air Missile Simulation). The optical and infrared system representations are derived from both ESAMS and the Night Vision Electro-Optical Laboratory. Finally, the aircraft vulnerability portion of RJARS is derived from RADGUNS (Radar Directed Gun System Simulation) developed by the U.S. Army Foreign Science Technology Center.

The current model is able to evaluate the outcome of large numbers of radars and launchers engaging large numbers of aircraft; represent detection, acquisition and tracking by radar, infrared, and optical sensors; simulate both missile and gun engagements; represent airborne jamming of air defenses; model air defense command and control dynamics (battalion level and below); and quantify aircraft signatures in three axes.

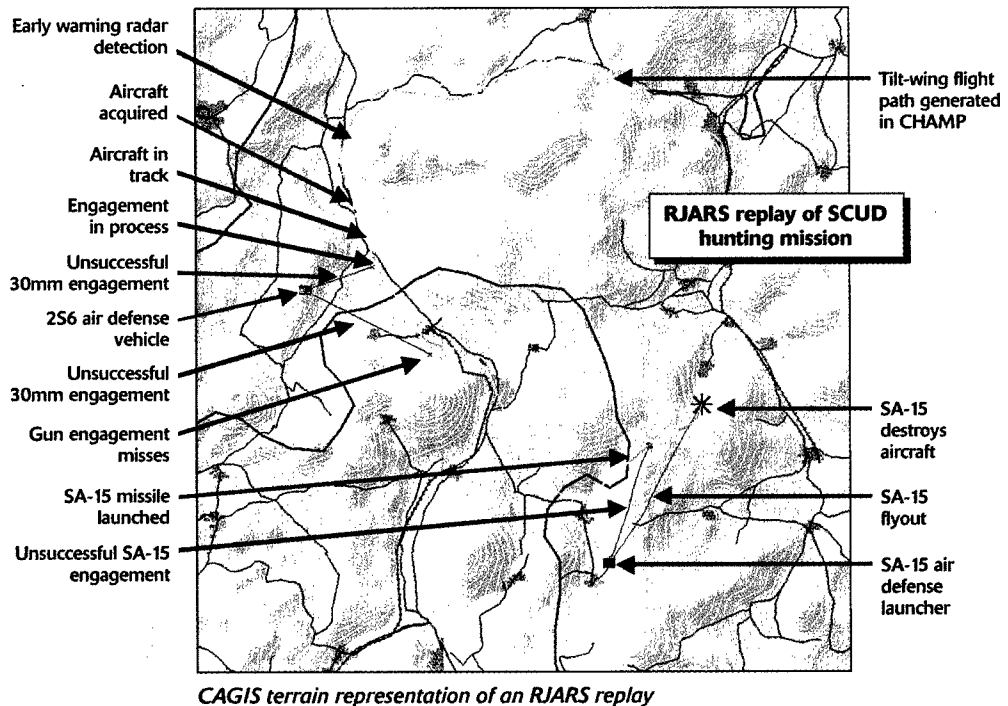

Figure B.8—Example of RJARS Graphic Output

nario inputs and cues that force or drive the analyst to fly reactively. The graphical displays include radar warning information, path profile view with potential obstacles, perspective view, and target information.

The output paths generated by these planners serve as input to be evaluated in the full force-on-force simulation environment

RAND Target Acquisition Model (RTAM)

RTAM was developed to evaluate low-observable technologies in a force-on-force context. Many force-on-force models such as JANUS set optical and thermal contrasts for vehicles at the simulation start and maintain them constant through the course of that run. RTAM not only allows dynamic shifts of contrast, but also represents changing background brightness and clutter. It does so by calculating a dynamic contrast of each low-observable vehicle in comparison to the background pixels it passes (provided by LANDSAT imagery). RTAM also models scene congestion, color contrast, hot spots, and glint and edge effects associated with multifaceted vehicles.

As shown in Figure B.10, the algorithms used in RTAM are based on Night Vision Electro-Optical Laboratory routines, and CAGIS is used to underlay the standard JANUS terrain data with LANDSAT data.

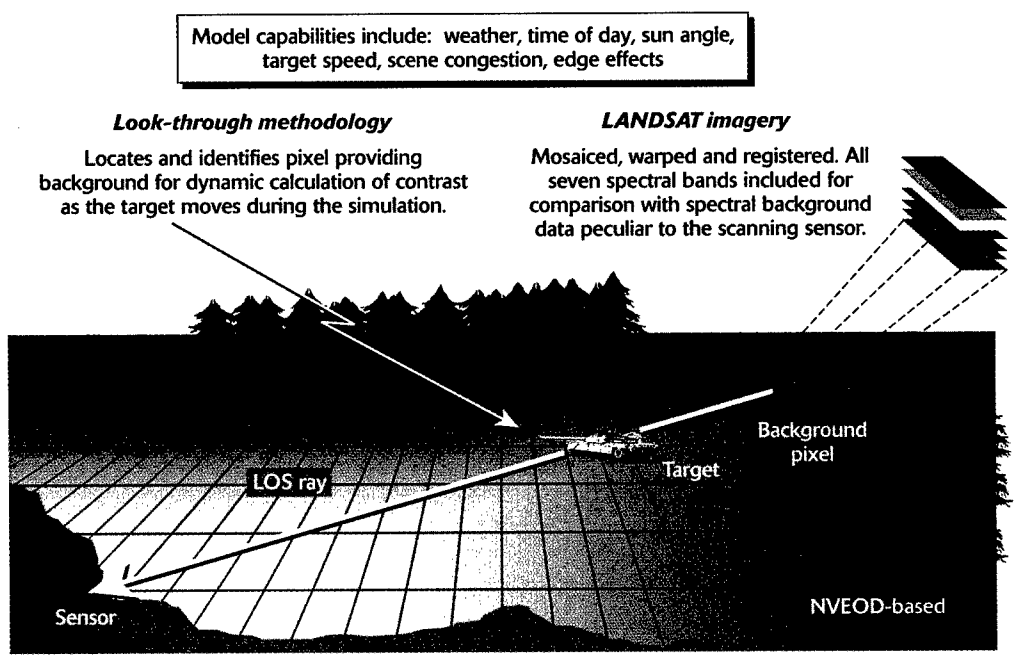

Figure B.10—Representation of RTAM Methodology in Simulation

Simulation Postprocessor

The JANUS postprocessor was written in SAS (Statistical Analysis System) to take advantage of the enormous sorting, ordering, manipulative, and computational power offered by that software when dealing with prohibitively large, free-form datasets. This was necessary due to the large datasets (hundreds of gigabytes) for each excursion.

The postprocessor also prepares data for plotting on terrain maps in order to spot spatial-temporal relationships. These graphic displays use varying icons and colors to represent large numbers of different parameters in a single display.

Current options available in the postprocessor include Blue and Red killer-victim scoreboards, means and confidence intervals, summary statistics such as force and loss-exchange ratios, weapon efficiencies, communication system statistics, and events by time and range.

APPENDIX B ENDNOTES

- 1 This level is $P > 0.05$ in the current version.
- 2 The earlier JANUS/T version was concerned primarily with training, while JANUS/A facilitates the use of the model for analysis.

TECHNOLOGIES OVER THE NEAR AND FAR TERM FOR LIGHT, RAPID-REACTION FORCES

THROUGHOUT THIS BOOK, WE HAVE DISCUSSED many different technologies that light forces may employ. Here we assemble information about the systems, describe their development cycle, and show images of many of them in operation. These systems span the range of concepts from Rapid Force Projection to Army After Next, and include technologies for MOUT. Table C.1 summarizes the systems by function and by time period.

Table C.1—Near- and Far-Term Light Force Systems by Function

Function	Systems	
	Near Term (Present to 15 years out)	Far Term (15 to 30 years out)
RSTA (reconnaissance, surveillance, and target acquisition)	<ul style="list-style-type: none"> • RST-V (reconnaissance, surveillance, targeting vehicle) • COVER (commander's observation vehicle for elevated reconnaissance—a tethered UAV) • Close-range unmanned aerial vehicle (UAV) <ul style="list-style-type: none"> – High altitude endurance UAV – Unmanned ground vehicle (UGV) • Improved remotely monitored battlefield sensor system (IREMBASS) • Remote sentry • Air-deliverable acoustic sensor (ADAS) • Joint surveillance target attack radar system (JSTARS) 	<ul style="list-style-type: none"> • Video imaging projectile • Microelectromechanical (MEMS) sensor net • Acoustic imaging system <ul style="list-style-type: none"> – Thru-wall imaging radar – Ground and foliage penetrating SAR radar
C2 (command and control)	<ul style="list-style-type: none"> • RFPI C2 • Light digital TOC <ul style="list-style-type: none"> – Sensor fusion system 	<ul style="list-style-type: none"> • Battlefield visualization tools
Direct fire	<ul style="list-style-type: none"> • Javelin • Armored gun system (AGS) • AGS with line of sight antitank (LOSAT) <ul style="list-style-type: none"> – Follow-on to TOW (FOTT) 	<ul style="list-style-type: none"> • Comanche/Longbow • Smart target-activated fire and forget (STAFF) • Guardian/directed energy • Electromagnetic/ electro-thermal (EM/ET) gun

Continued

Table C.1 Continued

Indirect fire	<ul style="list-style-type: none"> • Precision-guided mortar munition (PGMM) • Lightweight 155mm howitzer • High-mobility artillery rocket system (HIMARS) with MLRS rockets and ATACMS missiles <ul style="list-style-type: none"> – Sense and destroy armor (SADARM) – Damocles – Brilliant anti-tank submunition (BAT) – Fuel-air explosives 	<ul style="list-style-type: none"> • BAT improvement (MMW) • Scramjet MLRS missile and 155mm round • Low-cost autonomous attack submunition (LOCAAS) • Advanced fire support system (AFSS) • Advanced robotic engagement system (ARES)
Obstacles	<ul style="list-style-type: none"> • Wide area munitions (WAM) • Aqueous and sticky foams • Anti-helicopter mines 	<ul style="list-style-type: none"> • Super-lubricants • Controllable obstacles
Multifunctional	<ul style="list-style-type: none"> • Enhanced fiber-optic guided missile (EFOG-M) • Intelligent minefield (IMF) • Hydra (remote-controlled obstacle) 	<ul style="list-style-type: none"> • Unmanned combat aerial vehicles (UCAVs) • LongFOG, Polyphem
Nonlethal weapons	<ul style="list-style-type: none"> • Anti-personnel <ul style="list-style-type: none"> – Foams – Nets – Calmatives – Acoustic weapons – Soft projectiles • Anti-materiel <ul style="list-style-type: none"> – Combustion inhibitors – Foams – Laser dazzlers 	<ul style="list-style-type: none"> • Anti-personnel <ul style="list-style-type: none"> – Energy weapons – Airbags – Advanced calmatives • Anti-materiel <ul style="list-style-type: none"> – EMP (electromagnetic pulse) devices – Laser optics crazing/retro-reflection
Airlifters	<ul style="list-style-type: none"> • C-130 • CH-47 • UH-60 • MI-26 	<ul style="list-style-type: none"> • JTR • Tilt-rotor • SSTOL • Aeroship • Fast ship
Self-protection	<ul style="list-style-type: none"> • Multispectral smoke • Active protection system (APS) 	<ul style="list-style-type: none"> • 3rd generation smoke • Laser air defense • Laser APS • RF bombs

RSTA

The light force will rely on a wide variety of systems for its eyes and ears. These don't have to be big or expensive to gather information on the battlefield, and it is sometimes even essential for them to be small and proliferated to assure coverage and avoid losses. The smallest sensors currently envisioned are scatterable microdevices the size of a seed or smaller. Figure C.1 shows a recent DARPA concept for seeded microsensors with multiple forms of sensing.¹ Because processors, power supplies, and communications devices have become so tiny, the limiting factor for MEMS (microelectromechanical system) sensors is often the aperture size for the wavelength being sensed—sound, visual, IR, radar, and so forth. MEMS sensors down to the size of dust particles have even been postulated, at least for the shorter-wavelength applications. These tiny devices, generally on the order of a few centimeters across or smaller, could be hand-emplaced or de-

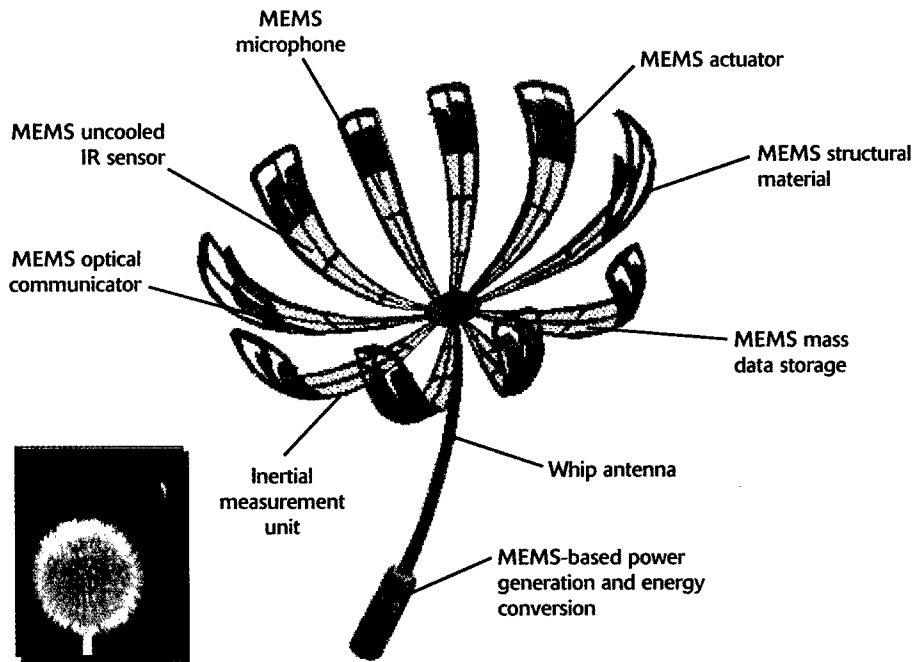

Image courtesy of Defense Advanced Research Projects Agency.

Figure C.1—Example of Seeded Microsensor Concept

ployed using artillery rounds, missiles, or manned or unmanned ground and air vehicles. The sensors would be inexpensive enough to scatter and leave behind. They should be able to wake up when disturbed, and intercommunicate back to a collecting node. Of course, without big improvements in battery life or duty cycles in which they sleep most of the time, they would likely have a short operating life.

The next step up in sensing would be unattended, shoebox-sized and larger sensing arrays. Some of the first of these unattended ground sensor (UGS) were widely used in Vietnam under the name REMBASS (remotely monitored battlefield sensor system). These were simple sensors which detected noise sources, ground vibrations, or hot objects and radioed back their presence. They gave no information about direction or range, only an indication that something had passed within some short distance of the sensor. Recent versions (called improved REMBASS or IREMBASS) were smaller, more sensitive, and had better position location. Nevertheless, detection, identification and location of targets require more capable systems. Two of the more important of these are the air-deliverable acoustic sensor (ADAS) and remote sentry, both described previously in Chapter Three. ADAS consists of an array of systems, each with five microphones and associated processing, which can detect and triangulate moving vehicles based on their distinctive signatures. These sensors don't require line of sight to the targets, but they are affected by noise, wind, and thermal effects. Remote sentry goes one step farther by using the microphones to cue a TV/FLIR imaging sensor toward the target. (For a good overview of UGSs, including REMBASS and remote sentry, see

Hewish (1998).) This is not always successful, because the acoustic sensor can hear targets over the hill, while the imaging sensor requires LOS. If well positioned, though, this should not be a problem. Detection ranges up to 2 kilometers for the acoustic sensor and 4–5 kilometers for the imaging sensor are reasonable. Future versions may be equipped with laser radar or MMW radar to give more information about vehicle type and status. Figure C.2 illustrates some of the tactical sensors and designators available to the soldier.

Hand-held sensors are especially important for MOUT and low intensity operations. Soldiers need to know if a person is carrying weapons, if booby traps are present, or if a room is occupied. Dissimilar metal detectors are claimed to be able to determine if a person is hiding a weapon, at least at close range. At longer ranges, radio frequency systems are said to be able to resonate and detect characteristic metallic structures such as the barrel of a rifle. Through-wall radar can take several different forms, from a hand-held radar “flashlight” to a vehicle-mounted synthetic aperture radar. Depending on the wavelength being emitted, these systems can penetrate one or several walls (un-

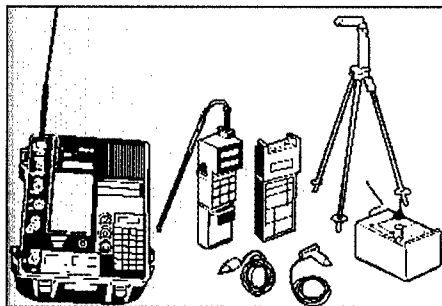

IREMBASS sensor

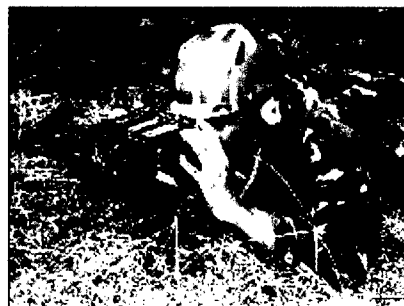

MELIOS target designator



RST-V reconnaissance vehicle

IREMBASS image courtesy of U.S. Army CECOM. RST-V image courtesy of Defense Advanced Research Projects Agency

Figure C.2—Some Tactical Sensor Systems

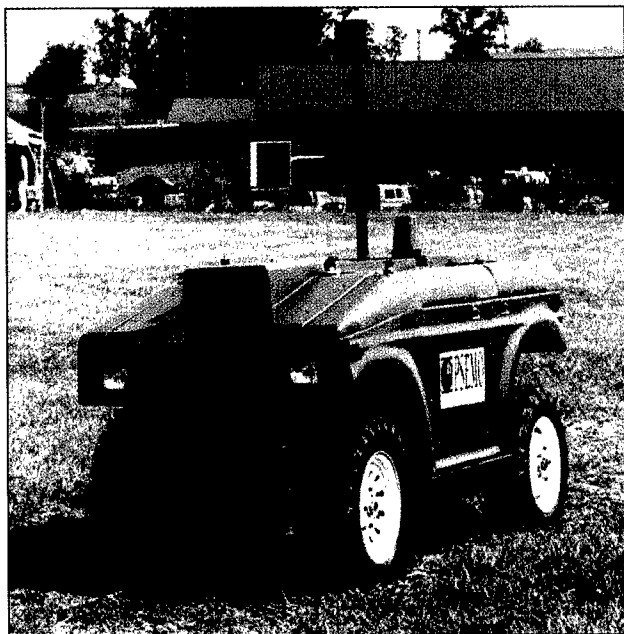

Image courtesy of General Dynamics Robotics Systems.

Figure C.3—Small (2000-pound) MDARS Robotic Vehicle

less metal shielding defeats them), detect moving entities, or even resolve images to a few inches, perhaps enough to tell if a terrorist is holding a weapon on a hostage.²

Ability to move is also important for the sensor network, particularly if the rapid-reaction force is maneuvering. Even if the force is stationary, the commander may need to orient reconnaissance assets on a particular area during times of risk or opportunity. Sensor mobility may follow many of the patterns in nature—the platforms might crawl, run, hop, fly, or hover. In fact, demonstrated systems for robotic platforms have been legged, wheeled, tracked, winged, and bladed. There have even been prototypes of biobots (insects and other animals equipped with sensors and control mechanisms).

Some larger mobile sensors include robotic scout vehicles, such as the 2000-pound MDARS platform shown in Figure C.3, the fully autonomous HMMWV exercised in DARPA's Demo II program (see Appendix D, Figure D.1), and the future scout vehicle (RST-V, shown in Figure C.2) proposed by DARPA. All of these systems provide detailed targeting information at the ground level, using large-aperture, long-range IR and visual imaging systems, many of which are mounted on extensible masts for best coverage and concealment. Typical detection ranges for these systems are 2–8 kilometers when searching for armor vehicles, and 1–3 km when looking for dismounted infantry.

Occupying the next layer up in the realm of sensor platforms are overhead assets, such as tactical and strategic UAVs, aerostats, JSTARS, and satellites. Overhead assets typically cannot see into areas covered by foliage, buildings, and camouflage, but they do cover large open areas quickly. Figure C.4 shows a variety of systems that may be available to the light forces. These include JSTARS (a manned aircraft standing off more

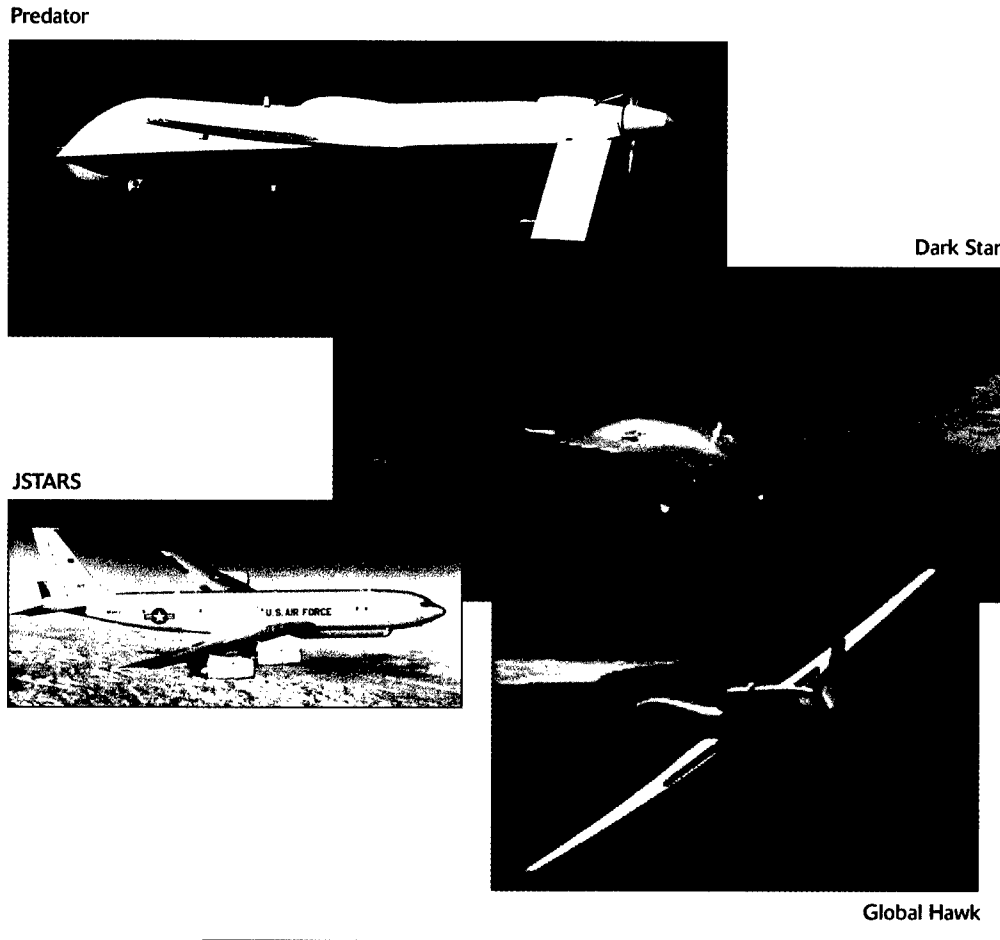

Predator image courtesy of General Atomics-ASI; Global Hawk image courtesy of Northrop Grumman Aeronautical Center; and Dark Star image courtesy of Lockheed Martin Skunk Works.

Figure C.4—Manned and Unmanned High Altitude Sensing Aircraft

than 100 kilometers from the force), high-altitude, overflying UAVs such as the stealthy Dark Star and the long-endurance Global Hawk, and low-altitude close-range UAVs such as Outrider and Predator. All of these can carry sizable payloads, including long-range SAR radars. Some of these radars can range out to hundreds of kilometers and even penetrate foliage and light cover. Real-time correlation of images from Predator and JSTARS was also recently demonstrated (see Kegan, 1999).

A special type of sensor under development is the video sensing projectile. Several different versions of this have been proposed, including one in which the round spins over the area of interest and the onboard TV camera scans the area, sending back images. Another design is targeted at an area then billows out a parachute, stabilizes, and scans the ground as it descends.

C2

Command and control refers to the presentation of information, planning courses of action, decisionmaking about options, and coordination of actions of the force. C2 is

sometimes extended to C4, for command, control, communications, and computers. An honest appraisal of how it has historically been done would take it to C6, for confusion and collapse. This is where the term “fog of war” really sets in. Light forces have to rely on situational awareness, fast decisionmaking, and decisive action to survive. Unlike heavy forces, they cannot just depend on overwhelming firepower and armor to defeat the enemy. Thus, they are extremely sensitive to the proper orchestration of sensing, maneuver, and fires from a variety of scattered assets, and when things go wrong, they can go very wrong indeed.

Most concepts for future light forces envision (1) some form of communications network that can pass information throughout the force, (2) a fusion capability that can combine inputs from multiple sources, and (3) an automated tactical operations center subject to human operator override. The communication function can be low bandwidth, such as SINCGARS and the prototype soldier’s radio, it can include high-bandwidth links such as satellite and surrogate satellite repeaters (UAVs and aerostats acting like more expensive satellites), or it can be multimode, such as the tactical internet. These options range from a low of perhaps 2 kilobits per second for SINCGARS to many megabits for some satellite and high-capacity links. Time latencies are similarly diverse, ranging from milliseconds to minutes. Figure C.5 illustrates several of the key systems. The diagram on the upper left of the figure shows the links present in the Forward Area Air Defense Command and Control (FAADC2) system. Here inputs from as-

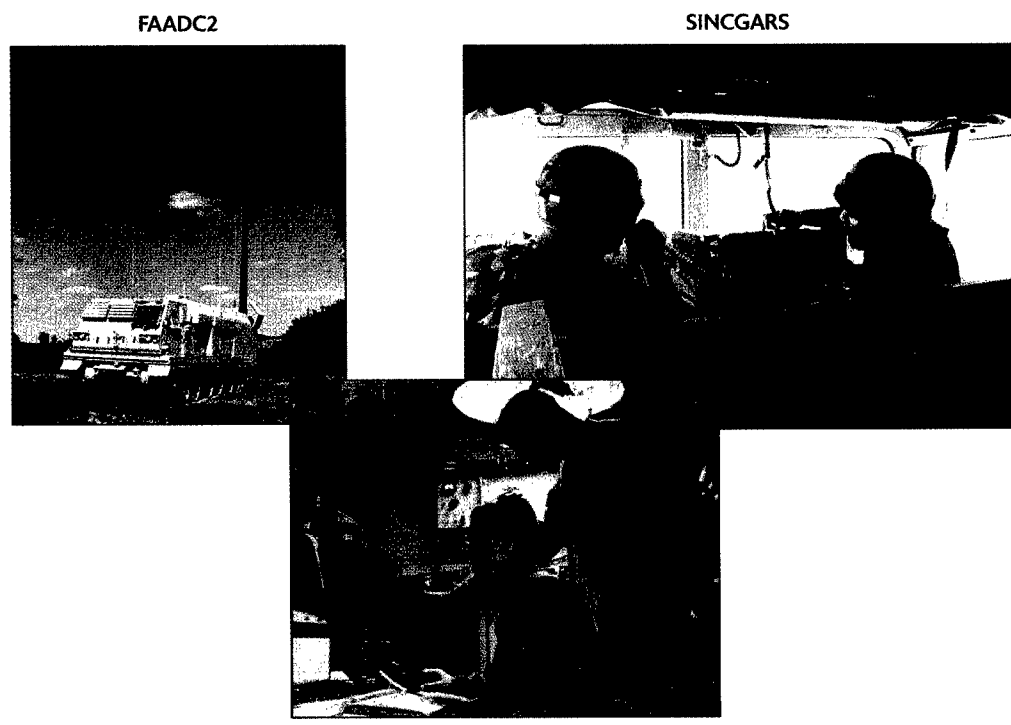

Diagrams and images courtesy of Fort Sill.

Figure C.5—Examples of Command, Control, and Communications Systems

sets such as E2-C aircraft are downlinked to filter centers that then send targets to missile launchers. Tactical fire control is somewhat simpler, as shown by the AFATDS (Advanced Field Artillery Tactical Data System) components. Forward observers (or TAC-FIRE radar systems) input target sets with portable entry devices, and the data is passed to fire direction centers and then to missile launchers or cannon batteries. Individual soldiers and teams, finally, use SINCGARS to communicate voice and data messages. There are many problems with this system in hilly, vegetated, or urban areas, and other communication devices are being fielded for these areas.

Fusion and presentation of information for future rapid-reaction forces has been envisioned in the form of small, HMMWV-mounted command centers. Visualization and decision-aiding systems such as ARDEC's virtual reality mission planning model and CECOM's battle planning and visualization tool can show target and friendly locations, age and confidence of the information, planned actions, and expected outcomes. These systems are essential for such functions as deconfliction of targets (making sure multiple shooters do not fire at the same target), deconfliction of the airspace (ensuring friendly missiles and aircraft do not collide), synchronization of fires and maneuver, projection of nonlethal effects, and coordination of logistics. The intent is to have each user supplied with a tailored, up-to-date common picture.

Direct-Fire Weapons

Direct-fire systems are typically weapons that engage targets in direct line of sight. Modes include rounds fired using chemical and electrical energy, guided and unguided missiles, and laser beams. These destroy things in very different ways: kinetic energy is essentially a spear that produces penetration and spalling, shaped-charge weapons result in a directed explosive burst, top attack typically fires an explosively forged penetrator (EFP) as the weapon flies over, and lasers produce burning and crazing. The simplest weapons are main guns firing APFSDS (armor-piercing, fin-stabilized, discarding sabot) rounds and HEAT (high energy anti-tank) rounds. APFSDS rounds are Mach 5, very dense (depleted uranium) long-rod penetrators that have enough energy to pierce thick armor and pass through enemy vehicles. HEAT rounds use explosive power and are very good against soft targets (e.g., trucks and BMPs) but typically cannot penetrate as much armor as APFSDS rounds. Both types of rounds typically have a maximum range of 3–4 kilometers (although some kills in Desert Storm were at around 5 kilometers). No guidance is present and little is needed, as the round is downrange in 2–3 seconds and accuracy is a few feet. Because of their weight and recoil, these large conventional guns are usually found only on main battle tanks. Because of improving protection on tanks, even larger guns (140mm and above) have been proposed for future systems. (For a good overview of planned improvements in both weapon systems and protection, see Ogorkiewicz (1997).)

Electromagnetic and electrothermal (EM and ET) guns do about the same thing as conventional tank rounds but use electric energy (in ET this is supplemented with chemical reactions) to provide the propelling force. The problem here is sufficient energy stor-

age. A typical shot might consume 10–20 megajoules of energy, which requires the use of very large flywheels, supercapacitors, or jet engines to provide more than a few shots. Potential velocities are higher than for conventional guns, however, and may provide greater range and lethality for the same size weapon. If the energy storage problems are solved, these weapons may be mounted on medium or even lightweight vehicles.

Missiles can also reach Mach 5 speeds and above. The hypervelocity missile, also known as the kinetic energy missile (KEM) or line-of-sight antitank (LOSAT) weapon, uses a powerful solid propellant rocket motor to accelerate a “spear” or long-rod penetrator to 1,600 meters per second or more. The operator in the vehicle can then control the missile by sending infrared signals to sensors on the tail. Vehicles as light as the HMMWV have been proposed as firing platforms for the KEM (see Figure C.6). A light tank version has also been prototyped, carrying six missiles in each of two pods. It can engage targets at intervals of 2-3 seconds and at ranges of 5 kilometers or more. A long-range, farther-future variation proposed for AAN has ranges more than twice that of KEM.

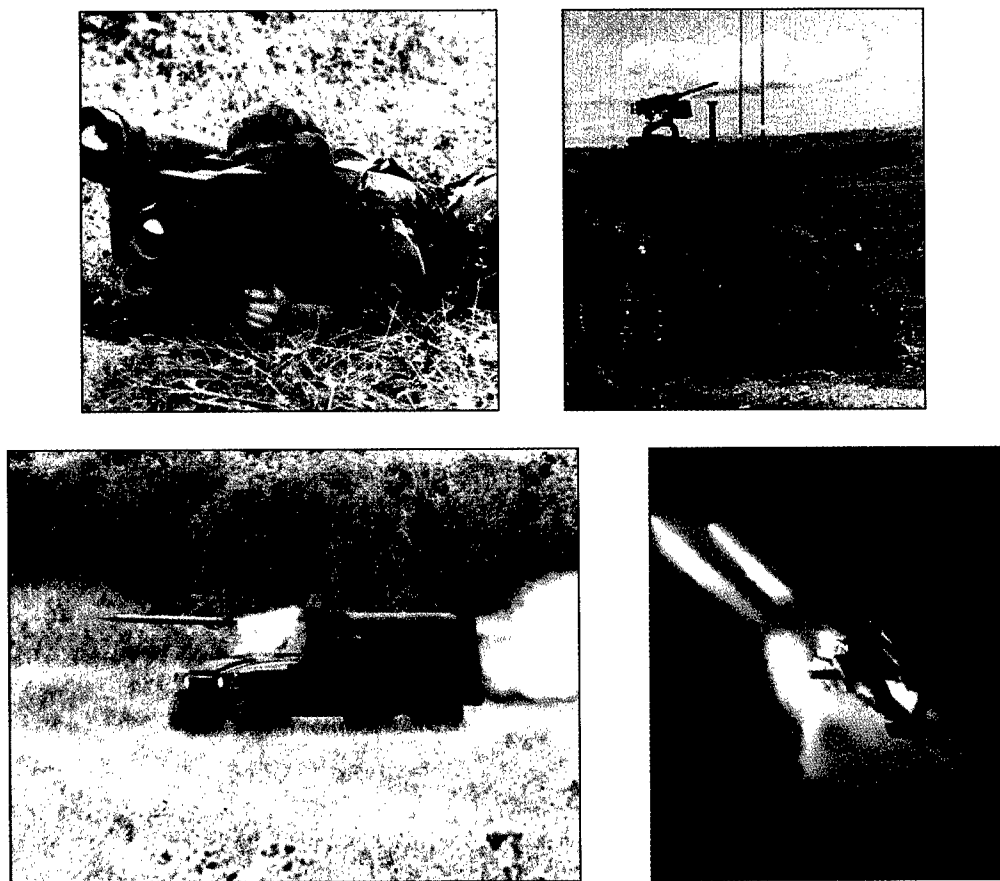

Images courtesy of ASA(ALT).

Figure C.6—Direct-Fire Munitions Come in Many Forms

Slower missiles include TOW (tube-launched, optically-tracked, wire-guided), Javelin, Hellfire, and Maverick. All of these use some form of control to guide the missile to the target. Hellfire has gone through many improvement cycles and now has special variations for shipboard operations, low trajectories, cloud conditions, and reactive armor (Lange, 1998).

Laser weapons appear to be much farther in the future. Here chemical or solid-state lasers place energy directly on the target and attempt to burn or blind the vehicle.

Indirect-Fire Weapons

Indirect fire typically means that the target is engaged beyond line of sight, using a high trajectory to place munitions in the area. Targeting may be from reconnaissance assets in the air or on the ground, and the indirect-fire platform itself can be tens or even hundreds of kilometers from the target area. The sequence of engagement is much more complex than for direct-fire systems, and it typically includes stages involving target sensing, decisions by fire direction centers, actions by launch platforms, flyout by missiles or projectiles, and ejection and activation of submunitions over the target area. The simplest examples are mortars and towed howitzers. These are exemplified by the M-113 mounted 120mm mortar vehicle and the M-109 155mm self-propelled howitzer. Variations of the M-109 have been around for over 30 years. The latest, called Paladin, weighs 32 tons and fires up to four rounds per minute up to a range of almost 30 kilometers. A future, heavier system called Crusader has greater range, protection, and firing rate. These platforms are somewhat heavy for rapid-reaction airliftable forces, however. Lighter-weight systems include the 9,000-pound lightweight towed 155mm howitzer and the 4,000-pound towed 105mm howitzer.

Missile systems typically provide greater range and payload compared to the cannons and mortars, but they are usually much more expensive on a per-round basis. MLRS (Multiple Launch Rocket System) can fire MLRS rockets up to 32–50 kilometers (the longer range depending on planned improvements), and ATACMS missiles up to 300 kilometers. The launcher can load, arm, and ripple fire a 12-missile load in 5 minutes.³ This system is also too heavy for most rapid-reaction forces. A much lighter (28,000-pound instead of 53,000-pound) HIMARS launcher carries a half-load of six MLRS missiles or a single ATACMS missile, and can be loaded on a C-130. Two of the indirect-fire systems are illustrated in Figure C.7, including the Copperhead laser-guided 155mm round.

Obstacles

These are devices to slow or attrit the enemy force, but they usually must be emplaced before the enemy's advance over the area. Conventional land mines are cheap and nondiscriminating—hence the number of treaties outlawing their use. Recent variations focus on armor vehicles or helicopters only, can be turned on and off, and do not have to be stepped on or rolled over to activate. A prime example is the wide area munition (WAM), termed Hornet. This system is capable of sensing and engaging combat vehi-

Crusader SPH and reloader

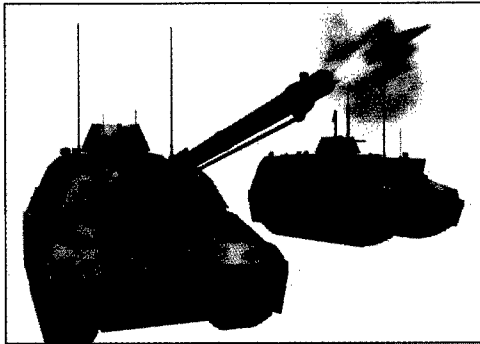

MLRS launcher and firing MLRS missile



M-113 with 120mm mortar



Laser-guided Copperhead hitting target



Images courtesy of Fort Sill.

Figure C.7—Some Exemplary Indirect-Fire Systems

cles out to a 100-meter range. It uses a small microphone array to detect nearby armor vehicles and lofts a smart submunition over the target in the direction of nearest approach. Even if many targets are missed, these weapons have a disruption effect. The enemy column slows down or has to maneuver around burning hulks, and is susceptible to other fires.

Anti-helicopter mines are similar in nature to anti-armor mines, but they discriminate helicopter acoustic signatures (typically blade noise) and engage at longer ranges, out to 400 meters or so. These can be laid along ravines, next to ridge lines, and on other likely helicopter avenues of approach.

Controllable obstacles are command-activated lethal and nonlethal devices that can be left in place for long periods. Especially good for covering approaches to urban areas, these can release foams, erect vehicle barricades, fire explosively formed projectiles against armor, or eject lethal anti-personnel shrapnel or ball bearings (e.g., remotely controlled claymore mines). The Hydra system from Aerojet General is a good example of a controllable system, as it uses small video cameras boresighted with explosively forged projectiles. Up to six cameras can be linked back to a soldier by fiber-optic cable.

Multifunctional Systems

Multifunctional systems can act as both sensor and weapon. Good examples are fiber-optic guided missiles (FOG-Ms), loitering submunitions, lethal UAVs, space weapons, and intelligent minefields. Many countries are now developing FOG-Ms, with the primary ones being the U.S. EFOG-M and Euromissile's Polyphem. The EFOG-M missile has a 15-kilometer range and a speed of 100 meters per second; it has a GPS antenna/receiver onboard and an imaging sensor in the nose that sends back video to the operator along a fiber-optic link. Six EFOG-M missiles are mounted on a HMMWV platform. Polyphem is a larger FOG-M, with a 60-kilometer maximum range, a speed of 200 meters per second, and a very large (20-kilogram) warhead. EFOG-M is designed to attack armor and other mobile targets, while Polyphem seems more suited to high-value deep targets such as C2 centers, AD sites, helicopter FAARPS, and long-range missile batteries. Both systems can send back information about the battlefield as they fly out to their targets. Both systems have successfully completed initial demonstrations of their capabilities.

Lethal UAVs or UCAVs also send back video information and can attack targets of opportunity, but typically they have a much longer time on station than FOG-Ms. Two versions of UCAVs have been proposed: a low-cost, hit-to-kill concept based on a small airframe such as Exdrone, and a higher-cost concept which carries missiles onboard. UAVs such as Predator and Outrider should have the payload capability to carry sensor packages, communication sets, and air-to-ground missiles such as Hellfire, TOW, or Javelin. At the other extreme is the small LOCAAS (low-cost autonomous attack submunition), which can fly for 30 minutes or so, detect targets with its onboard laser radar, and dive in to attack them. Images of the developmental LOCAAS and FOG-M systems are shown in Figure C.8.

The intelligent minefield is a combination of the acoustic sensor array and wide area mine concepts described earlier. Here an array of mines and "gateway" fusion and com-

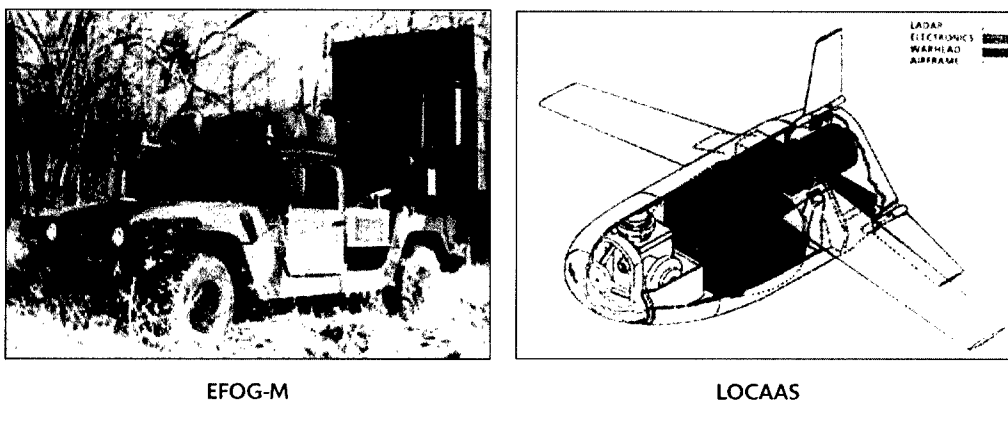

Figure C.8—Enhanced Fiber-Optic Guided Missile and LOCAAS Loitering Weapon Systems

munication nodes will detect targets and, when given the command, engage these targets at the opportune time. Because targets can be detected at a much greater distance than they can be engaged (often detection occurs at 2–3 kilometers for armor vehicles, but engagement is at 0.1 kilometer or less), the IMF may frequently be more important as a reconnaissance asset than as an obstacle.

Self-Protection

As vehicles in the rapid-reaction forces become lighter and smaller, they are able to carry less armor and must resort to other means of self-protection. These include speed, agility, firepower, stealth, and probably most important, use of active protection systems (APS). New advances in APS are cropping up around the world. These vehicle add-on systems are able to defeat a wide variety of weapons by detecting the incoming missiles or rounds and triggering smoke grenades, laser dazzlers, fragmentation grenades, and protective missiles. These systems may even be able to break up long-rod penetrators, by shearing them in flight with metal plates or altering their trajectory with explosives. The Russian Arena, Shtora, and Drozd systems, several of which are in production on export vehicles such as the T-72 and T-80 tanks, utilize many of these protective devices.⁴ U.S. developmental systems, such as Boeing's SLID (small low-cost interceptor device), further enhance protection with a small, maneuverable hit-to-kill interceptor missile.

A special self-protection technique for urban areas is the use of "designer" multispectral smoke. This smoke would obscure all sensor wavelengths from visual to IR to millimeter wave, but it would have spectral windows at the sensor frequencies of the friendly forces. This would allow dismounted soldiers and vehicles to scoot from position to position while under cover of smoke. The difficulty is producing multispectral smoke with variably sized particles, some sizes of which are missing, thus producing the windows.

Airlift

Tactical airlift is now being performed by well-proven systems: UH-60 medium-lift and CH-47 heavy-lift helicopters and C-130 cargo aircraft. These craft have some survivability, speed, and range problems, though, as indicated in Chapter Five. A rapid-reaction force must be able to penetrate close to the enemy, carry both light and medium weight vehicles (sometimes up to 30 tons), and land and take off from either small open areas or short, unprepared airstrips. The only new tactical transport aircraft in recent years, the V-22, has good range and speed but little payload capability.

The next generation of lifters are expected to be more capable, and some are fast seacraft rather than aircraft. New rotorcraft include the proposed joint tactical rotorcraft (JTR), with up to a 10-ton payload and 170-knot speed, and the advanced airframe (AAF), with a 15-ton payload and 300-knot maximum speed. The JTR is configured as a conventional helicopter with special survivability packages, and the AAF is envisioned as a tilt-rotor, essentially a scaled-up and more expensive V-22. As planners

have considered larger ground vehicles (up to 30 tons) for their rapid-reaction forces, designers have moved to the notion of SSTOL (super short takeoff and landing) aircraft. Such an aircraft is planned as a follow-on to the C-130, designed to be able to land and take off (fully loaded) on a 600-foot unprepared runway. Two versions have been proposed: a tilt-wing design with a very slow 40-knot stall speed, and a conventional fixed-wing aircraft with huge jet engines. Beyond these, the last two options are not true aircraft at all, but fast ships and hybrid aircraft. Ingalls Shipbuilding has proposed very fast ships with 60- to 80-knot capability and 10,000-ton capacity. Such a ship could carry a fully equipped brigade of light forces almost anywhere in the world in 4–5 days. Of course, such a ship might be vulnerable to attack at sea, so the disembarkation port would have to be secure. A hybrid aircraft concept is being developed by Lockheed Martin. This is a huge “aerocraft” that is half airplane and half blimp. It is designed for fast loading and unloading of up to a million pounds of cargo (Fulghum and Wall, 1999). With both commercial and military investment, the Hindenberg-sized aircraft could deploy forces at 125 knots, reaching most areas in the world in 2–3 days.

APPENDIX C ENDNOTES

- 1 For a summary of military applications of MEMS sensors, see Brendley and Steeb (1993) and the DARPA MEMS Web page, <http://www.darpa.mil/MTO/MEMS>. (Web site accessed and running on July 28, 2000.)
- 2 Images provided by Raytheon through-wall radars are reproduced in “Surveillance Through Walls and Other Opaque Materials,” International Society for Optical Engineering (OE Reports), August 1995, pp. 1–3.
- 3 A good description of the MLRS system can be found on the World Wide Web at <http://sun00781.dn.net/man/dod-101/sys/land/m270.htm>. (Web site accessed and running on July 28, 2000.)
- 4 Even the small (18-ton) Russian 2S25 light tank is said to be fitted with the Arena defensive system, increasing weight by 300 kilograms, according to a short article in *International Defense Review*, May 1999, p. 14.

ROBOTICS: AUGMENTING THE SOLDIER?

ROBOTIC SYSTEMS WERE FOUND TO BE USEFUL for the future force concepts described throughout this book. In fact, bomb disposal robots, mine-clearing devices, tactical UAVs, and other simple, radio-controlled applications have emerged recently to take over more and more functions normally assigned to soldiers. The stumbling blocks to more sophisticated use of such robotic systems have included processing power, communications limitations, control time delays, myopic machine vision, and bulky components. Many of these problems have been resolved recently with breakthroughs in microchips, miniaturized sensors, automatic target recognition programs, GPS/INS navigation systems, and broadband communication links. DARPA and the services quickly recognized the opportunities with these innovations and have included robotic systems in all of their concepts for future forces. Some of these systems are intended to essentially replace the human operator in risky or difficult situations, while others extend the capabilities far beyond what a human can perform.

We should note that there are different characterizations or definitions of robotic systems, and that many of the concepts described in earlier chapters might be considered some form of robotics. Unattended ground sensors such as the ADAS acoustic array and seeded microsensors have many of the characteristics of robotic systems. They incorporate multispectral sensors, onboard processing, and coordination with other automated systems. They may even trigger actuators (fire weapons, change field of view, etc.), but they do not exhibit mobility, an aspect we include in our specialized definition of a robotic system. In a similar manner, automated planning and rehearsal systems perform difficult computational tasks and even provide extensive visualization of options, but they are not mobile.

UGVs and UAVs do have all the characteristics of robotic systems, and they operate in several different modes. They may operate under continuous supervision by human operators (much like radio-control systems), they may be semi-autonomous with occasional operator commands, or they may be fully autonomous, sent off to achieve objectives without supervision. Examples of the important, intermediate level of semi-autonomy are vehicle-following systems, low-speed self-driving vehicles with manual override, and unmanned ground and air vehicles with limited autopilot capability. It is expected that most military systems will have some degree of human control or oversight.

Over the past seven years, DARPA has managed a significant military UGV program concentrating on partially or fully autonomous ground robotic vehicles. This pro-



Image provided by Lockheed-Martin.

Figure D.1—HMMWV-Based UGV Used in DARPA Demo II Program

gram has demonstrated a wide variety of new technologies and systems in a series of laboratory and field exercises. The initial series (Demos A, B, and C) focused on vehicular movement and coordination, demonstrating many technologies needed for operational UGV application: obstacle recognition and avoidance, information sharing, position location, path replication, and others. These exercises culminated in Demo II, conducted in June 1996.¹ This large-scale operational demonstration was executed as a Battle Lab Warfighting Experiment, or BLWE, and illustrated many new technologies. These included dynamic path planning (taking into account enemy positions and line of sight), cooperative navigation among multiple robotic HMMWVs, multispectral imaging (with IR, visual, and acoustic sensors), and automatic target recognition under both stationary and moving conditions. The work currently continues as Demo III, in which the HMMWVs have been replaced with smaller, more agile vehicles (see Seffer, 1998). Also, Demo III has changed the focus from one of replacing soldiers in hazardous tasks to one of taking over entirely new functions.

RAND's role in Demo II was to provide analytic support, assessing the military utility of UGVs using high-resolution force-on-force combat simulation. To accomplish this, several different missions and scenarios were explored, which generally paralleled the DARPA Demo II field exercises. We also attempted to determine the level of capability needed, beyond that demonstrated in the field, to achieve mission success.

Missions Explored

Three different missions were explored in Demo II: a deep attack mission, a reconnaissance/counter-reconnaissance mission, and a MOUT operation. These three missions were selected to exercise the full range of robotic activities, including sensing, hiding, maneuvering, and engaging the enemy. The deep attack mission, for example, involved a HMMWV-based UGV acting in a largely autonomous mode, where it self-navigated to a location, conducted surveillance, acquired targets, and subsequently

called for indirect fires (mortar volleys). A wide range of basic capabilities associated with a deep attack mission were demonstrated. In the test itself, though, the UGV was slow to get into position (making it vulnerable to enemy detection and fire), and it was equipped with a sensor too limited in range for this difficult task.

We used a deep attack scenario in our simulation to extend the results of this first mission in the BLWE. The scenario was similar to the East Europe, close-terrain one used for recent RFPI analyses. Recall from Chapter Two (see Figures 2.3 and 2.4) that there is a Red heavy division (-) attacking a tightly packed Blue defensive position with two light battalions from the 82nd DRB. There are advanced weapon systems in the Blue force: EFOG-M in most cases, 155 SADARM and HIMARS with Damocles in others. We made several excursions with UGVs (eight HMMWV-sized platforms) added to the force and placed well forward (some 10–15 kilometers from the main Blue force). Recall that in the original runs with this scenario reported in Chapter Three, Blue needed special reconnaissance assets to locate and engage the Red force successfully.

The second BLWE scenario, a recon/counter-recon mission, involved three UGVs coordinating in a series of probing operations, attempting to locate enemy forward elements and pass on information. This demonstrated that UGVs can potentially take the place of manned scouts in high-risk missions and save lives, but at the expense of own losses. In fact, two of the three were lost to enemy fire in the BLWE.

The simulation scenario for the recon/counter-recon scenario was developed especially for this project. As shown in Figure D.2, both Red and Blue are conducting a meeting engagement on rough, close terrain. Both forces send out recon elements to move to contact. The Red commander opts to break off two mechanized armor com-

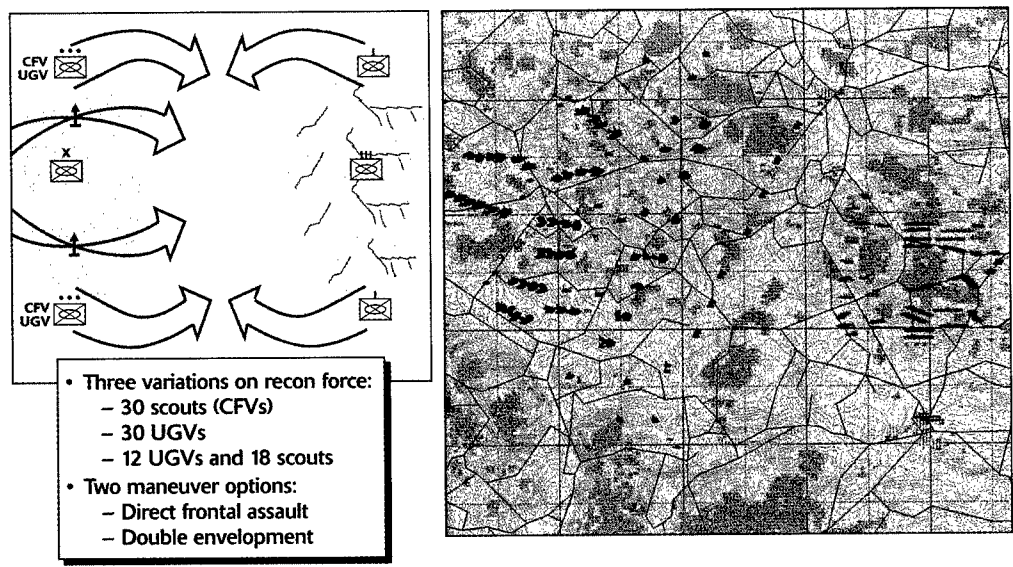

Figure D.2—Recon/Counter-Recon Scenario Emphasized UGV Maneuver

panies from his regiment to conduct a recon mission. At the same time, the Blue commander has the same idea and breaks off two recon squads of cavalry fighting vehicles (CFVs) accompanied by helicopter air support. This recon mission attempts to flank the Red force and is seen as being very high risk. The excursions examine the potential benefits of replacing or complementing CFVs with UGVs.

The MOUT demonstration, finally, involved the use of different UGVs ranging from HMMWV-based ones for exterior surveillance to small tele-operated platforms for penetration into the town. It was evident that the current state of the technology was not up to the level of stealth or agility of a soldier, but the test showed that UGVs could nevertheless contribute well to situational awareness and tactical presence.

The MOUT simulation vignette (see Figure D.3) was adapted from an existing scenario based on a Sarajevo mission. Blue is escorting a resupply or humanitarian convoy of trucks through the downtown area. Blue leads with HMMWV scouts equipped with .50 caliber machine guns, and changes routes if an enemy ambush is spotted in time. Red has prepared an ambush partway through the town, with cratering charges along the road and infantry in the nearby buildings. Red waits until most of the convoy is in the killing zone and opens fire. Typically, the lead vehicles are hit and the convoy is halted. When Blue UGVs are present, they lead the convoy and periodically stop to scan the buildings and find Red units. These UGVs are presented with many problems specific to urban operations: fratricide issues, short lines of sight, need for agility, and so forth.

The field tests in Demo II served to demonstrate that UGV technology can assist in various missions, but it did not show what improvements might be needed to ensure op-

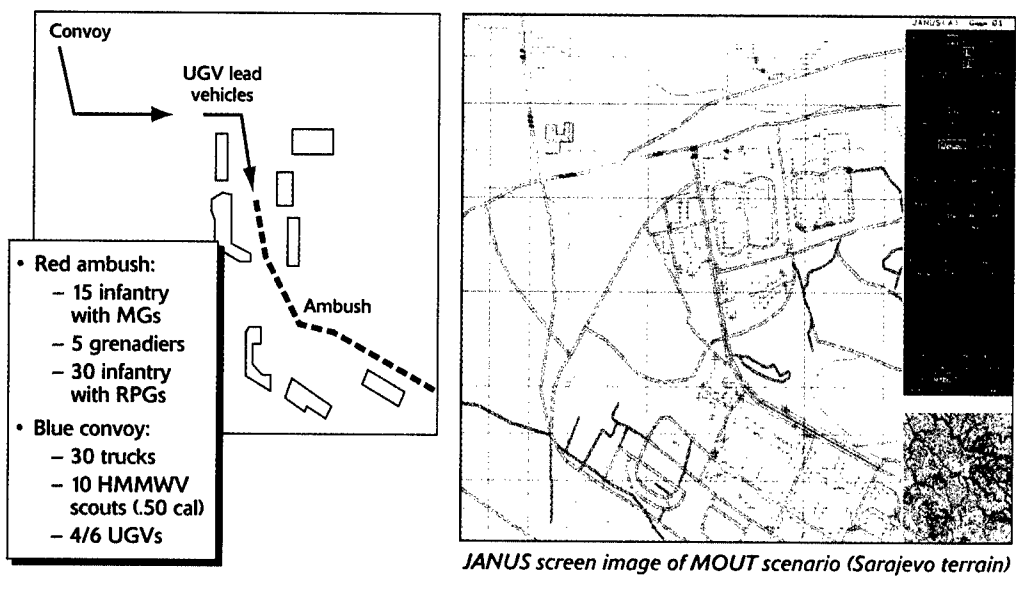

Figure D.3—MOUT Scenario Highlighted High-Risk "Pointman" Function

erational utility. The intent of our work was to use simulation to extend Demo II scenarios to larger engagements, explore the effect of changing system characteristics and technologies, and provide some recommendations for further work. Specifically, we posed two key questions. First, can UGVs improve RSTA coverage and situational awareness? It was expected that UGVs, with similar sensor capabilities as manned systems, may be used more aggressively—with greater risk and potentially greater return. Second, can UGVs improve overall battle outcomes? Given that they offer added RSTA benefits, is this benefit meaningful and does it translate into greater force lethality, force survivability, or both? In particular, can UGVs save lives and, if so, at what cost?

As a last area of interest, we also asked “What might be some other ideas (besides those shown in Demo II) for exploiting UGVs on the battlefield?” To a large extent, we focused on possible applications in which the UGVs augment or complement manned systems rather than replace them.

Research Findings

Can UGVs Increase Surveillance Coverage?

In general, we found that UGVs could be emplaced much deeper and provide more extensive coverage than manned sensor systems. This was found in both the deep attack and recon/counter-recon missions. The sensing ranges in the MOUT scenario were so short that no range or coverage advantage was present with UGVs.

Figure D.4 shows cumulative “detection images” that accrue during the course of a simulated battle. The left image in the figure shows detections for the forward observer (FO)-only case (some detections are from EFOG-Ms also). The middle image shows detections with UGVs and FOs present, and the right image shows the extreme

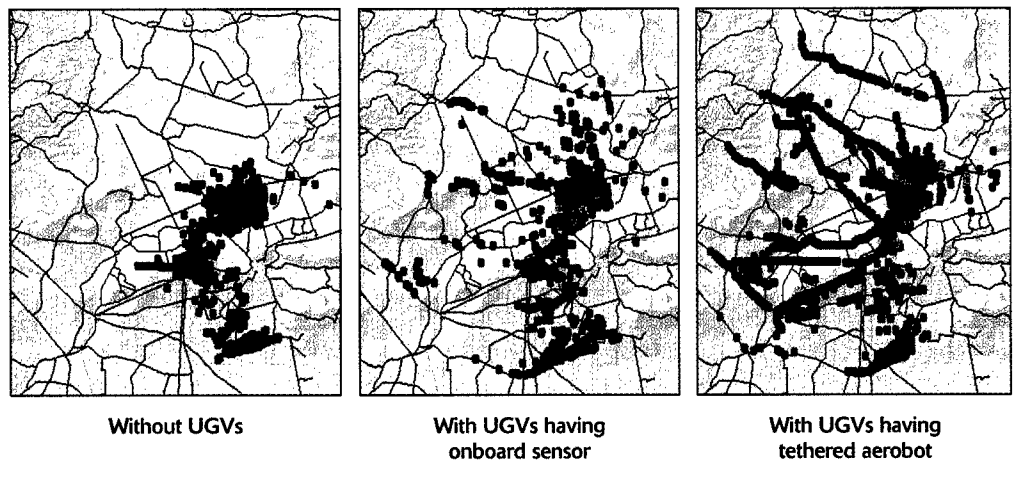

Figure D.4—UGVs Were Found to Greatly Increase Situational Awareness in Deep Attack Scenario

case of UGVs with tethered aerobots (a sensor-carrying hovering device flying above the vehicle at the end of a power and data cable). As more RSTA assets are added, detections occur earlier and deeper and are more complete. Of course, the commander is not able to see the entire scene; even in the best case only a third or so of the enemy force is visible at any one time.

In the recon/counter-recon mission, UGVs provided a significant share of the total recon force detections. Because the terrain is very close and the scenario involves a considerable amount of movement, sensor height and range did not strongly influence performance. Instead, reduction in the UGV size turned out to be a more significant factor. By reducing the UGV to half its size, almost twice the number of detections occurred, mainly because the UGV was harder to detect and to kill. Even further size reduction improved the detections yet again.

Can UGVs Result in Improved Battle Outcomes?

Here we see how this added situational awareness and forward presence translates to battle outcomes. In the deep attack scenario, with UGVs out forward and FOs back, kills by EFOG-M increased by about 20 percent, overall Blue losses decreased by about 20 percent, and loss-exchange ratio increased by about 25 percent compared to the FO-only case. The dynamics of the battle change also. With UGVs calling in deeper fires than the FOs, more of the attrition takes place farther out, and the close, direct-fire battle becomes more manageable for Blue.

Sensor quality on the robotic systems had a profound effect on battle outcome, even though the UGVs were only a small part of the force in the deep attack scenario. As shown in Figure D.5, we considered a low-, moderate-, and high-quality sensor (cor-

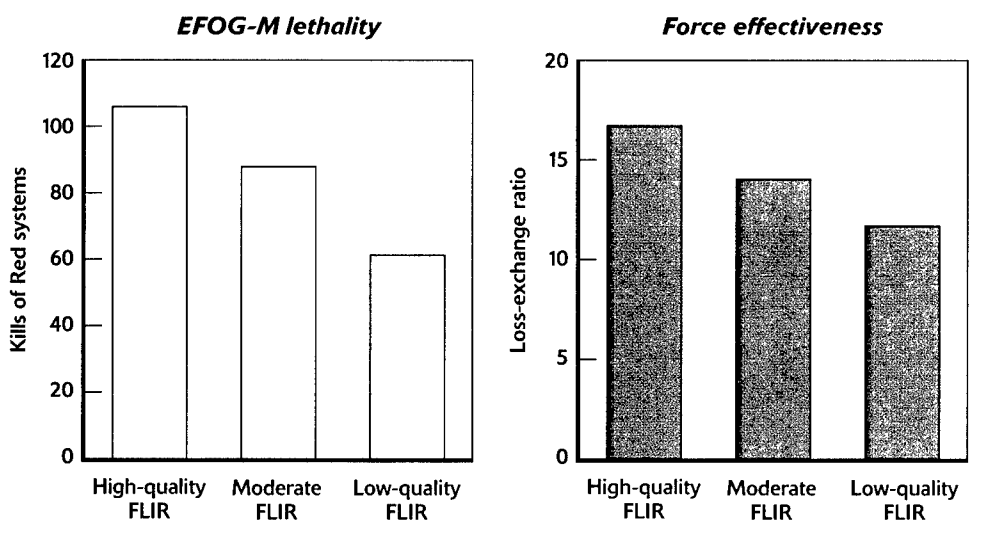

Figure D.5—Quality of Sensor Had Major Impact on Outcome of Deep Fires Scenario

responding roughly to 2-, 4-, and 6-kilometer maximum detection ranges for tank-sized targets). Generally, as the sensor was improved, the number of target detections increased, which increased the number of calls for fire and ultimately allowed a larger volume of fires to be placed over deep targets.

To better understand the survivability issues, we next looked at the impact of speed and size on UGV survivability. As might be expected, the UGVs are better off in stationary, hide positions than when they are withdrawing slowly. Movements cue the enemy to the systems and draw fire. As the speed is increased to a level comparable to the speed of the attacking force, many of the UGVs are better able to maintain stand-off (see Figure D.6).

In the recon/counter-recon mission, the impact of UGVs on saving lives was substantially different from that seen in the deep attack mission. When FOs are used here, they are generally dug in and bypassed, making them highly survivable. But as they are used more and more aggressively, for deeper coverage, they sustain more losses. And this is where the primary UGV benefit comes in. Because UGVs can reach farther out and be used more aggressively and with less reservation, they can extend the battlespace. Depending on the tactic taken with the FOs, UGVs can either save lives or improve battle outcomes in this scenario.

In this maneuver scenario, the UGVs' calls for indirect fire almost always took more time than the faster direct-fire weapons associated with the Red recon elements. Consequently, we explored the effect of adding a direct-fire weapon—mounted Javelins—to the UGVs with a very fast cycle time for response. The UGVs' overall survivability decreased because their firing signature resulted in much more return fire than against

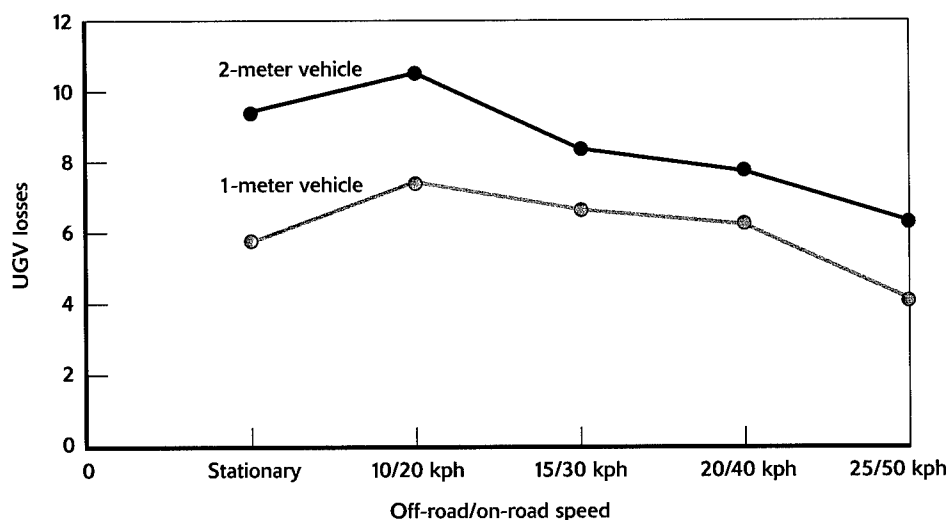

NOTE: EFOG-M in force, moderate-quality FLIR on UGV.

Figure D.6—UGV Speed and Size Also Impacted UGV Survivability in Deep Fires Scenario

unarmed UGVs, but their lethality increased dramatically. In fact, they produced far more kills than the accompanying manned CFVs. With armed UGVs, the overall LER rose 15 percent. Given that the recon portion of the battle is a small part of the overall battle, this is an impressive result. This initial exploration should be expanded to examine other weapons and tactics for lethal UGVs.

UGV speed had a moderate effect on mission outcomes in the recon/counter-recon scenario. At low speeds (characterized as 10 kilometers per hour off-road and 20 kilometers per hour on-road, with further reductions due to terrain slope), the UGVs were not able to keep up with the manned vehicles. They were also not able to get to the enemy artillery before it was able to fire several missions against Blue. As shown in Figure D.7, with faster speeds, UGVs have significantly lower losses and are able to kill rear area artillery much more effectively.

The recon/counter-recon mission most strongly showed the capability of UGVs to save lives. In this high-risk mission, savings were seen with both the frontal assault and the double envelopment tactics. In the frontal assault with only manned cavalry fighting vehicles (CFVs), over a third of these systems were lost. When these systems were replaced by UGVs, about the same number of UGV losses occurred, with the same overall performance. In the less risky recon mission (double envelopment), about 20 percent of the CFV losses were averted, again with similar overall battle performance.

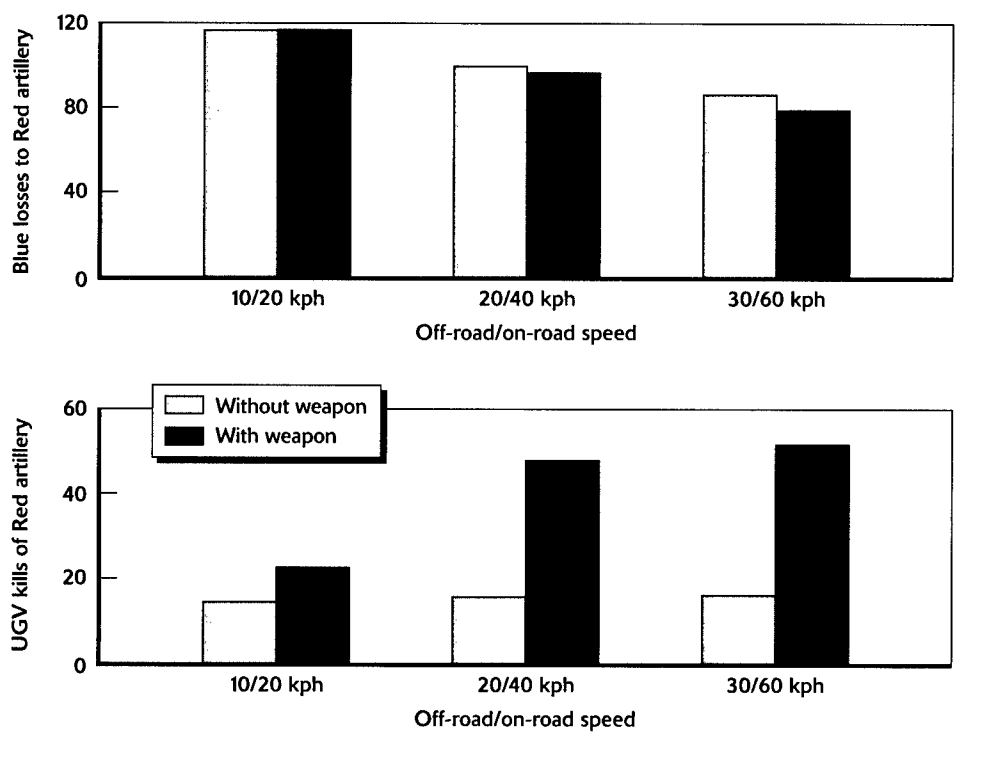

Figure D.7—In Recon/Counter-Recon Scenario, UGV Speed and Weapon Both Impact Outcomes

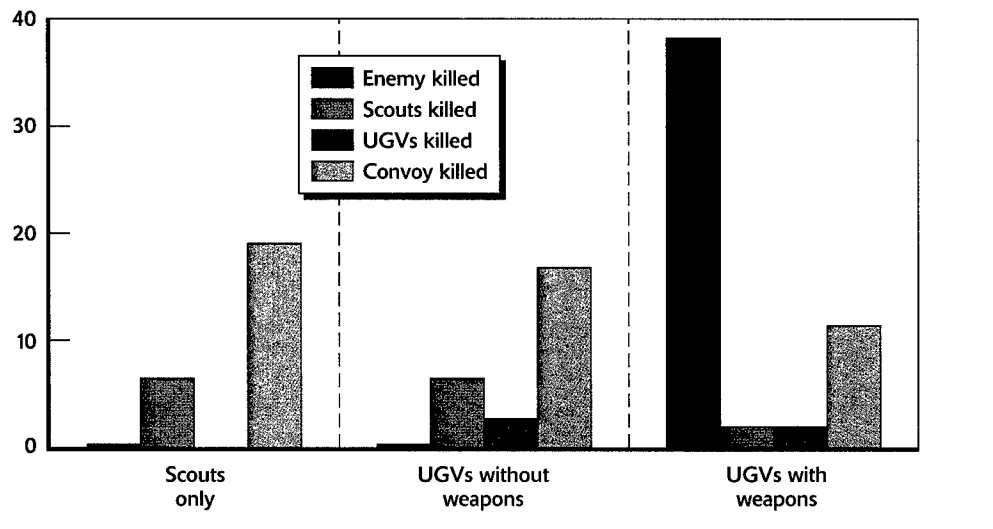

Figure D.8—MOUT Scenario Shows That Ambush Is More Survivable When UGVs Are Equipped with Weapons

The MOUT scenario illustrated two phenomena with the use of UGVs. The first is that unarmed UGVs in a convoy have the potential to dilute the losses of manned vehicles. This is seen in a comparison of the first two sets of columns in Figure D.8. With (manned) scouts only, few enemy are killed, and most of the scouts and convoy are lost. When unarmed UGVs are interspersed in the convoy, fewer elements of the convoy are lost, at the expense of the UGVs. The second phenomenon is that armed UGVs (.50 caliber machine guns) change the nature of the outcome: a large proportion of the enemy are killed, and fewer scouts, convoy vehicles, and UGVs are lost.

The MOUT scenario involved an intense, short-range engagement, with most detections and fires under a few hundred meters. Accordingly, most technology and packaging options for the UGVs had little effect. We did not run excursions in which the UGVs have greater protection against small-arms and/or missile fire. Such protection may add to the cost and bulk of the system, but could make the difference in a “pointman” situation.

Summary

It is apparent that robotic systems have great potential on the future battlefield, both for saving lives and for carrying out missions that manned systems cannot accomplish. They can strongly improve a force’s situational awareness. They can also achieve stealth and endurance, and they can operate with impunity in the face of biological, chemical, electronic, and nuclear effects. They can even deliver nonlethal weapons without being affected. In all of the missions we examined, future robotic systems would make strong contributions to the force. Improvements over the levels of speed, range, and survivability are needed over the Demo II prototypes, but these should be achievable in the next few years.

The types of missions open to autonomous or semi-autonomous robotic vehicles are expanding rapidly. Some of the newer ones are deception and feigned attacks, NBC surveillance, logistics support and forward area resupply, obscurant dispensing, and physical security. All of these missions require some level of mobility, environmental sensing, onboard processing, and payload capacity. Many of these functions can be accomplished very simply, just by adding special components to existing robotic systems.² More specialized applications that require special platforms are also in development, such as the robotic crab, a lobster-sized device that can scuttle over the surf zone, clearing it of mines and obstacles (see Cooper, 1995).

Microelectromechanical (MEMS) systems provide some revolutionary opportunities for robotic systems. Robotic vehicles (UAVs and UGVs) can seed centimeter-sized microsensors over the battlefield and interrogate them periodically. The robotic systems may communicate with the sensors using radio signals or a technique such as bouncing back laser signals from modulated corner reflectors (see Brendley and Steeb, 1993). The MEMS devices themselves can act as electronic disablers, be mounted as backpacks on insects (biobots), or (when loaded onto microaircraft) fly in restricted areas such as through buildings, across rooms, and even in tunnels.³

At the same time, there are limitations to robotic capabilities. Countermeasures may be more effective against these systems than against manned vehicles. If the robotic systems are of the type that must be continuously supervised, the communications may be detected, or the control commands and information feedback may be jammed or spoofed. If the systems are more autonomous, the limitations of automatic target recognition (ATR) may become evident if the enemy uses decoys and deception. Most robotic systems will also probably be slower than their equivalent manned systems, at least for the near future, and may thus be in exposed positions for longer periods.

All of these opportunities and shortcomings need to be examined using simulations, prototypes, field tests, and exercises. And the evaluation criteria are different for manned and unmanned systems. For example, it is not enough that an unmanned system be faster, more survivable, or more lethal than the equivalent manned system. It may not even be enough to provide a completely new function that a warfighter cannot do. Robotic systems have to work synergistically with the soldiers and show an improvement in overall battle outcome (they cannot be too costly or burdensome for the advantage they are providing), they must be robust against easy countermeasures, and they must operate under different rules than manned systems. This last point is exemplified by situations where some level of fratricide by human soldiers may be unavoidable and even acceptable, but the same loss of life caused by a robot is catastrophic. The use of microaircraft, miniature robots, and biobots to gather information may be an unacceptable invasion of privacy in any conflict short of mid- to high-intensity war. Finally, the recent images of Iraqi soldiers surrendering to a UAV in the Gulf War let us know that completely new cultural ground will be broken as robotic systems take over more of the fight.

APPENDIX D ENDNOTES

- 1 Gage (1995) ably summarizes this and other DARPA- and OSD-sponsored efforts. Further information and images are available at the Demo II Web site, <http://www.cis.saic.com/previous/demoII/demoII.html>. (Web site accessed and running on July 28, 2000.)
- 2 See <http://www.nosc.mil/robots/images/> for images of UGVs in development. (Web site accessed and running on July 28, 2000.)
- 3 Radio-controlled aircraft as small as 59 grams have been flown, as described on the Web at <http://www.ezonemag.com>. (Web site accessed and running on July 28, 2000.) Estimates of near-term microflight aircraft weights have dropped down to as low as 5 grams, including video camera, power supply, aircraft controller, motor, and communications system.

LIST OF FIGURES

1.1	Spectrum of Conflict During the Cold War	3
1.2	Current Spectrum of Conflict	4
1.3	Three Different Methods for Developing a More Effective Rapid-Reaction Capability	8
1.4	Current Scope of RAND Modeling Effort	12
2.1	SWA Scenario: An Overview	17
2.2	Depiction of DRB Hasty Defensive Position in SWA Scenario	18
2.3	East Europe Scenario: An Overview	18
2.4	JANUS Depiction of DRB Hasty Defensive Position in East Europe Scenario	19
2.5	LANTCOM Scenario: An Overview	20
2.6	Depiction of DRB Hasty Defensive Position in LANTCOM Scenario	21
2.7a	LERs Over Time for SWA and East Europe Scenarios: Base Case DRB (Fixed-Wing Aircraft Kills and Losses not Included)	28
2.7b	LER Over Time for the LANTCOM Scenario: Base Case DRB (Fixed-Wing Aircraft Kills and Losses not Included)	29
2.8a	Simulation Results at the End of the Battle for SWA and East Europe Scenarios: Base Case DRB	30
2.8b	Simulation Results at the End of the Battle for the LANTCOM Scenario: Base Case DRB	31
3.1	The Model-Test-Model Paradigm	34
3.2	Depiction of an Early Hunter-Standoff Killer Concept	35
3.3	Depiction of the Hunter-Standoff Killer Concept	37
3.4	Some Light Force RSTA Systems: Tactical UAV, IREMBASS Distributed Sensors, RST-V Platform, and ADAS	39
3.5	Some Direct-Fire Weapons: Javelin, AGS, LOSAT Missile, and Apache (Firing Hellfire)	40
3.6	Some Indirect-Fire Launchers and Submunitions: ATACMS and MLRS, BAT Submunition, Towed 155mm Howitzer, HIMARS, and SADARM Submunition	41
3.7	Fiber-Optic Guided Missile and Launcher	42
3.8	Effect of Upgrades on LERs in SWA and East Europe Scenarios	47
3.9	LER Over Time for the Three Scenarios: Upgraded DRB	48
3.10a	Simulation Results at the End of the Battle for SWA and East Europe Scenarios: Percent of Elements Left	49
3.10b	Simulation Results at the End of the Battle for LANTCOM Scenario: Percent of Elements Left	50
3.11	Effect of Red Upgrades on LERs in SWA and East Europe Scenarios	52
3.12	Effect of Additional DRB Upgrades on LERs in SWA and East Europe Scenarios	53
3.13	Effect of Combined Strategy on LERs in SWA and East Europe Scenarios	54
3.14	Effect of Increasing the Number of ADAS Sensors on Completeness	55
3.15	Effect of Increasing the Number of ADAS Sensors on Target Location Errors	56
3.16	Effect of Adding in Notional Systems on LERs in East Europe Scenario	56

3.17	Some First-Order Characteristics of Different Indirect-Fire Systems	57
3.18	Comparison of Efficiency of Different Indirect-Fire Systems	59
3.19	Comparing the Reach of the Different Indirect-Fire Systems	60
3.20	Summary of Data Comparison and Performance Assessment for Indirect-Fire Alternatives	62
4.1	Early Drawing of COVER System	67
4.2	Contribution of RSTA to Base Case DRB Performance in the LANTCOM Scenario	70
4.3	Effectiveness of Adding in Each RSTA System	71
4.4	Contribution of RSTA to Upgraded DRB Performance	72
4.5	Contribution of RSTA and External Missile to Upgraded DRB Performance	74
4.6	Impact of Large-Footprint Weapon on Target Set	75
4.7	Impact of Small-Footprint Weapon on Target Set	76
4.8	Combined Effects of Volume of Fires and TOT for Large-Footprint Weapon	77
4.9	How Organic and External Fires Complement One Another	78
4.10	How a DRB Might Be Dispersed	79
4.11	Strawman Organization for a Light Battle Unit	81
4.12	The Light Battle Force Concept	82
4.13	Red Plan of Attack	83
4.14	Laydown of Battle Units into Elements and Squads	84
4.15	Integrated AAN Light Battle Unit in a Defensive Laydown	85
4.16	Example of C3 Link Between FDC and Artillery Pods	85
4.17	How Air Defense Is Cued	86
4.18	Susceptibility of Pods by Camouflage Method: Quiescent Mode	90
4.19	Susceptibility of Pods by Various Modes	90
4.20	The Impact of Reachback Weapons on Lead Enemy Units	91
4.21	Effectiveness of Pods and Pods with Reachback Weapon on Kills of Enemy Force	92
4.22	One Battle Unit's Losses over the Simulated Battle	93
4.23	Effectiveness of Employing Two Battle Units	93
4.24	Two Battle Units' Losses over the Simulated Battle	94
4.25	Light Battle Force's Successful Engagements on the Battlefield	95
4.26	Dispersed SUO Defensive Force in SWA	96
4.27	Comparison of Lift Load and Days for DRB and SUO forces	97
4.28	Assumed C2 Structure and Communications Connectivity	98
4.29	Communications Relay Densities Needed in Open and Close Terrain	99
4.30	Effect of Weapons Mix and Loadout on Force Lethality	101
4.31	Effects of Time Delays on Short-, Medium-, and Long-Range Missiles	101
5.1	Representation of Enemy Advance and Coalition Force Battle Positions	107
5.2	Location of High-Altitude Enemy Air Defense Systems	109
5.3	Notional Tilt-Rotor Air Transport Aircraft	110
5.4	Measures of Effectiveness in Analysis	114
5.5	Attrition Rate Over Time in Base Case	118
5.6	Effect of Reducing Signature and Increasing SEAD on Base Case	119
5.7	Effect of Increasing SA (Knowledge of Location of Emitting SAMs) on Low and Slow Case	120
5.8	Depiction of Maneuver Case 1: Standoff Attack Operation	124
5.9	Total Percent of Red Kills in Each Case 1 Excursion	127
5.10	Summary of Case 1 Results	128
5.11	Depiction of Maneuver Case 2: Standoff Attack and Ground Insertion to Block Key Reserve Division	129

5.12	Summary of Case 2 Results	130
5.13	Depiction of Maneuver Case 3: Standoff Attack and Agile Ground Maneuver to Engage Key Reserve Division	130
5.14	Exemplary Future, Lightweight Ground Combat Vehicle Associated with Enhanced Strike Force	131
5.15	Summary of Case 3 Results	133
5.16	Stages of Maneuver Case 4: Standoff Attack and Agile Ground Maneuver to Engage Soft Targets	134
5.17	Summary of Case 4 Results	135
5.18	Summary of Four Cases	136
6.1	Location of Potential Hot Spots	142
6.2	Diagram of Engineer School Layered Defense of Camp Lejeune	144
6.3	Limitations of Air-Based Halt Campaigns	145
6.4	How the Three Components of Option 3 Work in Synergy	147
6.5	Three-Dimensional Rendering of Copehill Down	150
6.6	Photograph of Road at Copehill Down	150
7.1	Notional Deployment of the Three Types of Units for Stopping Enemy Invasion ...	160
B.1	Major Components of RAND's Force-on-Force Modeling Suite	171
B.2	Organization of Models and Their Impact on Different Aspects of Combat Missions	174
B.3	Walk-Through of Command and Control Process in Simulation	176
B.4	Command and Control Organization in Simulation	177
B.5	Exemplary Cartographic Information in Simulation	179
B.6	Modeling BAT Submunition Effects with MADAM	181
B.7	Representation of the Acoustic Model in Simulation	182
B.8	Example of RJARS Graphic Output	183
B.9	Flight Path Planning in Simulation	184
B.10	Representation of RTAM Methodology in Simulation	185
C.1	Example of Seeded Microsensor Concept	189
C.2	Some Tactical Sensor Systems	190
C.3	Small (2000-pound) MDARS Robotic Vehicle	191
C.4	Manned and Unmanned High Altitude Sensing Aircraft	192
C.5	Examples of Command, Control, and Communications Systems	193
C.6	Direct-Fire Munitions Come in Many Forms	195
C.7	Some Exemplary Indirect-Fire Systems	197
C.8	Enhanced Fiber-Optic Guided Missile and LOCAAS Loitering Weapon Systems ...	198
D.1	HMMWV-Based UGV Used in DARPA Demo II Program	202
D.2	Recon/Counter-Recon Scenario Emphasized UGV Maneuver	203
D.3	MOUT Scenario Highlighted High-Risk "Pointman" Function	204
D.4	UGVs Were Found to Greatly Increase Situation Awareness in Deep Attack Scenario .	205
D.5	Quality of Sensor Had Major Impact on Outcome of Deep Fires Scenario	206
D.6	UGV Speed and Size Also Impacted UGV Survivability in Deep Fires Scenario	207
D.7	In Recon/Counter-Recon Scenario, UGV Speed and Weapon Both Impact Outcomes	208
D.8	MOUT Scenario Shows That Ambush Is More Survivable When UGVs Are Equipped with Weapons	209

LIST OF TABLES

2.1 Three Basic Scenarios and Key Distinguishing Parameters16

2.2 Base Case Force Mix for the Three Scenarios22

3.1 Candidate and Potential RFPI Systems by Function38

3.2 Base Case and Improved DRB Force Mix for the Three Scenarios43

3.3 Upgrades to Red Threat51

4.1 Effectiveness of Remote Missile by Level of RSTA73

5.1 Red Force Mix in the Lead Regiment of Elite Division110

5.2 Flight Path Locations and Profiles Considered in Air Maneuver Analysis111

5.3 Excursions Examined in the Air Maneuver Analysis112

5.4 Assumed RSTA and C2 Capabilities112

5.5 Results of Excursions Examined in the Air Maneuver Analysis
(Percent Transports Surviving)118

5.6 Effects of Variable Levels of SEAD on Mission Survivability: Low and Slow Case ...121

5.7 Effects of Variable Levels of SEAD on Mission Survivability: Low and Fast Case ...121

5.8 Mission Survivability Levels: Very Low and Slow Case123

5.9 Conditions for TACMS Engagements126

5.10 Results for JSOW and TACMS Engagements126

7.1 Relative Impact of Different Paths for Improving Light Forces
(Over Current Light Forces)157

B.1 Classification Scheme for APS Systems178

C.1 Near- and Far-Term Light Force Systems by Function187

LIST OF ABBREVIATIONS

AA	Anti-Armor	COVER	Commander's Observation Vehicle for Elevated Reconnaissance
AAA	Anti-Aircraft Artillery	CR	Close Range
AAN	Army After Next	CS	Combat Support
ACTD	Advanced Concept Technology Demonstration	CSS	Combat Service Support
AD	Air Defense	DARPA	Defense Advanced Research Projects Agency
ADA	Air Defense Artillery	DCSOPS	Deputy Chief of Staff Operations
ADAS	Air-Deliverable Acoustic Sensor	DFAD	Digital Feature Attribute Data
AFATDS	Advanced Field Artillery Tactical Data System	DIA	Defense Intelligence Agency
AFSS	Advanced Fire Support System	DIVARTY	Division Artillery
AGL	Above Ground Level (altitude)	DoD	Department of Defense
AGS	Armored Gun System	DPICM	Dual-Purpose Improved Conventional Munitions
APC	Armored Personnel Carrier	DRB	Division Ready Brigade
APFSDS	Armor-Piercing, Fin-Stabilized, Discarding Sabot	DRF	Division Ready Force
APS	Active Protection System	DSB	Defense Science Board
ASP	Acoustic Sensor Program	DTED	Digital Terrain Elevation Data
ARES	Advanced Robotic Engagement System	DUSA	Deputy Under Secretary of the Army
ARG	Amphibious Ready Group	EFOG-M	Enhanced Fiber-Optic Guided Missile
ATACMS	Army Tactical Missile System	EFP	Explosively Forged Penetrator
ATD	Advanced Technology Demonstration	EM	Electromagnetic
ATR	Automatic Target Recognition	EMP	Electromagnetic Pulse
AVN	Aviation	ESAMS	Enhanced Surface to Air Missile Simulation
AWACS	Airborne (Early) Warning and Control System	ET	Electro-thermal
BDA	Battle Damage Assessment	F&F	Fire and Forget
BAT	Brilliant Anti-Tank	FA	Field Artillery
BLWE	Battlefield Lab Warfighting Experiment	FAADC2	Forward Area Air Defense Command and Control
C2	Command and Control	FAARP	Forward Area Arming and Refueling Point
C2V	Command and Control Vehicle	FDC	Fire Direction Center
C3	Command, Control, and Communications	FEBA	Forward Edge of Battle Area
CAEN	Close Action Environment	FFRDC	Federally Funded Research and Development Center
CAGIS	Cartographic Analysis and Geographic Information System	FLIR	Forward-Looking Infrared
CLOS	Command Line of Sight	FLOT	Forward Line of Own Troops
CONUS	Continental United States	FO	Forward Observer
CORM	Commission on Roles and Missions		

FOPEN	Foliage Penetration Radar	LOSAT	Line-of-Sight Antitank
FOTT	Follow-on to TOW	MADAM	Model to Assess Damage to Armor with Munitions
FSCS	Future Scout and Cavalry System	MANPADS	Man-Portable Air Defense System
GCC	Gulf Cooperation Council	MEMS	Microelectromechanical System
GMTI	Ground Moving Target Indicator	MEU	Marine Expeditionary Unit
GPS	Global Positioning System	MICOM	Missile Command
HAE	High Altitude Endurance	MLRS	Multiple-Launch Rocket System
HE	High Explosive	MMW	Millimeter Wave
HEAT	High Energy Anti-Tank	MOOTW	Military Operations Other Than War
HIMARS	High-Mobility, Artillery Rocket System	MOPMS	Modular Pack Mine System
HMMWV	High-Mobility, Multipurpose Wheeled Vehicle	MOUT	Military Operations on Urbanized Terrain
HSOK	Hunter-Standoff Killer	MRC	Major Regional Contingency
HQ	Headquarters	MRL	Multiple Rocket Launcher
ICM	Improved Conventional Munition	MRR	Motorized Rifle Regiment
IDA	Institute for Defense Analysis	MSR	Main Supply Route
IFV	Infantry Fighting Vehicle	NAI	Named Area of Interest
IMF	Intelligent Minefield	NBC	Nuclear, Biological, Chemical
INS	Inertial Navigation System	NEA	Northeast Asia
IR	Infrared	NGIC	National Ground Intelligence Center
IRC	Immediate-Ready Company	NTC	National Training Center
IREMBASS	Improved Remotely Monitored Battlefield Sensor System	OR	Operations Research
ISR	Intelligence, Surveillance, and Reconnaissance	ORD	Operational Requirements Document
IUSS	Integrated Unit Soldier System	OSD	Office of the Secretary of Defense
JANUS	Two-Sided Force-on-Force Ground Combat Model	PDF	Panamanian Defense Force
JCATS	Joint Combat and Tactical Simulation	PGM	Precision-Guided Munition
JSEAD	Joint Suppression of Enemy Air Defenses	PGMM	Precision-Guided Mortar Munition
JSOW	Joint Standoff Weapon	PLOS	Probability of Line of Sight
JSTARS	Joint Surveillance Target Attack Radar System	RADGUNS	Radar Directed Gun System
JTF	Joint Task Force	REMBASS	Remotely Monitored Battlefield Sensor System
JTR	Joint Tactical Rotorcraft	RF	Radio Frequency
KEM	Kinetic Energy Missile	RFPI	Rapid Force Projection Initiative
KEP	Kinetic Energy Penetrator	RFPT	Rapid Force Projection Technologies
LANTCOM	Atlantic Command	RISTA	Reconnaissance, Intelligence, Surveillance, and Target Acquisition
LDTOC	Light Digital Tactical Operations Center	RJARS	RAND's Jamming Aircraft and Radar Simulation
LER	Loss-Exchange Ratio	ROE	Rules of Engagement
LO	Low Observable	RSTA	Reconnaissance, Surveillance, and Target Acquisition
LOC	Line of Communication	RST-V	Reconnaissance, Surveillance, and Targeting Vehicle
LOCAAS	Low-Cost Autonomous Attack Submunition		
LOS	Line of Sight		

RTAM	RAND's Target Acquisition Model	UGV	Unmanned/Uninhabited Ground Vehicle
SADARM	Sense and Destroy Armor	USAF	United States Air Force
SA	Situational Awareness	USMC	United States Marine Corps
SAL	Semi-Active Laser	WAM	Wide Area Munition
SAM	Surface-to-Air Missile	WMD	Weapons of Mass Destruction
SAR	Synthetic Aperture Radar		
SARDA	Secretary of the Army for Research, Development, and Acquisition		
SEAD	Suppression of Enemy Air Defenses		
SEMINT	Seamless Model Integration		
SFW	Sensor-Fused Weapon		
SIGINT	Signal Intelligence		
SINCGARS	Single Channel Ground and Airborne Radio System		
SIRFC	Suite of Integrated Radar Frequency Countermeasures		
SITREP	Situation Report		
SLID	Small Low-Cost Interceptor Device		
SOF	Special Operations Forces		
SPH	Self Propelled Howitzer		
SPL	Sound Pressure Level		
SPT	Support		
STAFF	Smart Target Activated Fire and Forget		
SUO	Small Unit Operations		
SWA	Southwest Asia		
TACCP	Tactical Command Post		
TACMS	Tactical Missile System		
TACNET	Tactical Net		
TAI	Target Area of Interest		
TLE	Target Location Error		
TOC	Tactical Operations Center		
TOF	Time of Flight		
TOT	Time On Target		
TOW	Tube-Launched, Optically-Tracked, Wire-Guided		
TGP	Terminally Guided Projectile		
TGW	Terminal Guidance Warhead		
TRAC	TRADOC Analysis Center		
TRADOC	Training and Doctrine Command		
TTP	Tactics, Techniques, and Procedures		
UAV	Unmanned/Uninhabited Aerial Vehicle		
UCAV	Unmanned Combat Aerial Vehicle		
UGS	Unattended Ground Sensor		

BIBLIOGRAPHY

- AAN Air-Mechanized Battle Force, briefing charts, TRADOC, June 5, 1997.
- Abbe, Wm. Whipple, et al., *Military Operations in Built-Up Areas in the Fulda Corridor, Year 2000. MOBA Phase III*, Fort Belvoir, Virginia: Army Engineer Topographic Labs, June 1977. (DTIC AD-C013 871)
- Advanced Research Projects Agency, *Military Operations*, report on a workshop sponsored by ARPA and AMC, Arlington, Virginia: Defense Advanced Research Projects Agency, KR0345-74, n.d.
- AFCEA, "High-Technology Divining Rod Points Out Human Presence," *SIGNAL*, October 1996, pp. 53-54.
- Army Combined Arms Center, *Military Operations in Built-Up Areas (MOBA) Study Report*, Vol. II, Appendices D thru T, Fort Leavenworth, KS, November 1976. (DTIC AD-C009 062)
- Army Engineer Topographic Labs, *Effects of Built-Up Areas on Armor Operations in the Fulda Corridor MOBA*, Phase II, Fort Belvoir, VA, September 1976. (DTIC AD-C026 173)
- Army Engineer Topographic Labs, *The Effects of Structured Landscapes on Armor Operations in Natural Corridors of Movement, Federal Republic of Germany (FRG)*, Phase I, Study, Built-Up Areas and Structured Landscapes, FRG, The Strategic View, Fort Belvoir, VA, June 1975. (DTIC AD-C004 087)
- Army Foreign Science and Technology Center, *Group Combat in Built-Up Areas*, Charlottesville, VA, January 1, 1982. (DTIC AD-B066 025)
- Baetke, R. E., et al., *Advanced Investigations of Low Signature Weapon Concepts for Military Operations in Built Up Areas (MOBA)*, Seattle, WA: Boeing Aerospace Co., April 2, 1976. (DTIC AD-C005 562)
- Bartlett, G. Thomas, and Amnon Birenzvice, *Chemical Ventilation Characteristics of an Elemental MOBA Structure*, Aberdeen Proving Ground, MD: Army Armament Research and Development Command, Aberdeen Proving Ground Chemical Systems Lab, June 1982. (DTIC AD-B066 796)
- Bartlett, LeRoy, III, *Field Artillery Support to Military Operations in Built-Up Areas*, Fort Leavenworth, KS: U. S. Army and General Staff College, May 1976. (DTIC AD-B017 211)
- Birenzvice, Amnon, *The Vulnerability and Protectability of Facilities Against Penetration of Chemical Warfare Agents*, Aberdeen Proving Ground, MD: Aberdeen Proving Ground Chemical Systems Lab, March 1983. (DTIC AD-B072 771)
- Blacksten, H. Ric, and Fred W. Leuppert, *Advanced Concepts and Analysis of Minefield Systems in Military Operations in Built-Up Areas*, Arlington, VA: KETRON Inc., October 15, 1976. (DTIC AD-C009 190)
- Blacksten, H. Ric, and George Schecter, *Wall Breaching Devices/Concepts/Technologies*, Vol. I, Main Report, Arlington, VA: KETRON Inc., March 1980. (DTIC AD-B049 408)

- Blacksten, H. Ric, and George Schechter, *Wall Breaching Devices/Concepts/Technologies*, Vol. II, Appendices A–D, Arlington, VA: KETRON Inc., March 1980. (DTIC AD-B049 409)
- Blacksten, H. Ric, and John G. Fox, *An Analysis of Soviet Countermine Equipment and Doctrine in Military Operations in Built-Up Areas*, Arlington, VA: KETRON Inc., October 15, 1976. (DTIC AD-C009 512)
- Boatman, J., M. Hammick, and B. Sauerwein, "The Future of Armored Recce," *International Defense Review*, October 1992, pp. 965–973.
- Boatman, John, "The WEEKUS Forces 'Not Ready' for Urban Warfare," *Jane's Defence Weekly*, International Edition (JDW), Vol. 23, No. 14, April 8, 1995, p. 18.
- Boatman, John, and Barbara Starr, "USA Looks for Answers to the Ugliness of Urban Warfare," *Jane's Defence Weekly*, International Edition (JDW), Vol. 20, No. 16, October 16, 1993, p. 25.
- Bonsignore, E., "Russian Gun-Launched Anti-Tank Missiles," *Military Technology*, July 1993, pp. 64–68.
- Boone, Mark R., *NPSNET: Real-Time Walkthrough and Rendering of Urban Terrain*, Monterey, CA: Naval Postgraduate School, June 1993. (DTIC AD-A271 743)
- Boyko, Robert G., "Just Cause MOUT (Military Operations on Urban Terrain): Lessons Learned," *Infantry*, Vol. 81, No. 3, May–June 1991, pp. 28–32.
- Brendley, K., and R. Steeb, *Military Applications of Microelectromechanical Systems*, Santa Monica, CA: RAND, MR-175-OSD/AF/A, 1993.
- Bruce, James, "Middle East Arab Veterans of the Afghan War," *Jane's Intelligence Review (JIR)*, Vol. 23, No. 14, April 8, 1995, p. 18.
- Caraccilo, Dominic J., *The Ready Brigade of the 82nd Airborne in Desert Storm: A Combat Memoir by the Headquarters Company Commander*, Jefferson, NC: McFarland & Company, 1993.
- Cassady, J. F., *Transportability for Better Strategic Mobility*, MTMCTEA Pamphlet, 1987, pp. 70–71.
- Cayot, Charles L., "Training in the Big City: Signal Corps MOUT (Military Operations on Urban Terrain) Is Training as They Will Fight," *National Guard*, Vol. 7, No. 4, September 1992, p. 175.
- Coates, Joseph F., *The Nature of Cities—Background Notes to the Study of Low Level Combat*, Arlington, VA: Institute for Defense Analyses, Science and Technology Division, Note N-720, May 1970.
- Cohen, Eliot A., et al., *Gulf War Air Power Survey, Volume V: A Statistical Compendium and Chronology*, Office of the Secretary of the Air Force, 1993.
- Cole, Ronald H., *Operation Just Cause: The Planning and Execution of Joint Operations in Panama*, February 1988–January 1990, Washington, D.C.: Joint History Office, 1995.
- Collins, John M., *America's Small Wars: Lessons for the Future*, Washington, D.C.: Brassey's, 1991.
- Combat Engineer Systems Handbook*, U.S. Army Engineer School, Fort Leonard Wood, MO, April 1991.
- Communicated by Superintendent, A.O.R.G. (Report requested by D. Inf.), *Street Fighting*, Fort Belvoir, VA: Defense Technical Information Center, Army Operational Research Group Report No. 167, June 24, 1986. (DTIC AD-A955 123)
- Cooper, Gerald E., and Bruce Dunn, *Helicopter Masking Analysis*, Washington D.C.: Office of the Chief of Engineers (Army), Washington D.C. Engineer Studies Group, 1973. (DTIC AD-P000 603)

- Cooper, Pat, "Robotic Crab Offers DOD New Advantage Over Surf Mines," *Defense News*, April 24–30, 1995, p. 12.
- Cooper, Roy, *Deployment and Sustainment Strategy for Notional Strike Force*, Deputy Assistant Secretary of the Army for Research and Technology, briefing charts, June 29, 1998.
- Cordesman, Anthony H., and Abraham R. Wagner, *The Lessons of Modern War: Volume IV: The Gulf War*, Boulder, CO: Westview Press, 1996.
- Crusader: The Army XXI Firepower Revolution*, briefing charts, n.d.
- C4 Directorate, Joint Staff, *Information Superiority Campaign Plan—Enabling the Vision*, Pentagon, Washington, D.C., n.d.
- Dalton, James L. II, commentary (on Reduction of Strong Point, San Manuel, Luzon, P.I., to Headquarters 25th Infantry Division), Headquarters I Corps and G-3 Sixth Army, *Reports—Battle of San Manuel—161st Infantry Regiment*, 325-INF(161)-0.3, February 8, 1945.
- Darman, Peter, *Surprise Attack: Lightning Strikes of the World's Elite Forces*, New York: Barnes & Noble Books, 1993.
- Defence Research Agency (Fort Halstead), "Close Action Environment: A Two Sided Close Combat Wargame," pamphlet, Kent, TN, DRATL9398, 1994.
- Defence Research Agency (Fort Halstead), "JANUS (BGWG): A Two Sided Closed Computer Wargame Operational Studies (Land)," pamphlet, Kent, TN, DRATL9467, 1994.
- Defense Science Board (DSB) 1996 Summer Study Task Force, *Tactics and Technology for 21st Century Military Superiority*, Vol. 1–3, Washington, D.C., 1996.
- Defense Science Board (DSB) 1998 Summer Study Task Force, *Joint Operations Superiority in the 21st Century*, Vol. 1 & 2, Washington, D.C., 1998.
- Denson, R. H., et al., *Materials Systems Investigation for MOBA/MOUT (Military Operations in Built-Up Areas/Military Operations on Urbanized Terrain) Live-Fire Training Villages*, Vicksburg, MS: Army Engineer Waterways Experiment Station Mississippi Structures Lab, DTIC AD-B089 193, October 1984.
- Department of the Army, *Army After Next (AAN)*, briefing charts, n.d.
- Devlin, Gerard M., *Paratrooper! The Saga of U.S. Army and Marine Parachute and Glider Combat Troops During World War II*, New York: St. Martin's Press, 1979.
- Dewar, Michael, *War in the Streets: The Story of Urban Combat from Calis to Khafji*, Newton Abbot, Devon: David & Charles, 1992.
- Donnelly, Thomas, Margaret Roth, and Caleb Baker. *Operation Just Cause: The Storming of Panama*, New York: Lexington, 1991.
- Dormeyer, M. J., *Adequacy of Doctrine for Armor in MOUT (Military Operations on Urban Terrain)*, Fort Leavenworth, KS: Army Command and General Staff College, 1983. (DTIC AD-B078 445)
- Dupuy, R. Ernest, and Trevor N. Dupuy, *The Encyclopedia of Military History from 3500 B.C. to the Present*, New York: Harper & Row, 1977.
- Dzirkals, L. I., et al., *Military Operations in Built-Up Areas: Essays on Some Past, Present, and Future Aspects*, Santa Monica, CA: RAND, R-1871-ARPA, June 1976.
- Eikenberry, Karl W., "Improving MOUT (Military Operations on Urban Terrain) and Battle Focused Training," *Infantry*, Vol. 83, No. 3, May–June 1993, pp. 36–39.
- Ellefsen, Richard A., *Military Operations in Built-Up Areas—Morphological and Functional Characteristics of Built-Up Urban Areas*, Mountain View, CA: GTE Products Corp.—Mountain View California Sylvania Systems Group—Western Division, March 10, 1973. (DTIC AD-B061 744)

Ellefsen, Richard A., *Urban Terrain Zone Characteristics*, Fort Belvoir, VA: Defense Technical Information Center, Technical Memorandum 18-87, September 1987. (DTIC AD-A185 640)

English, John A., *On Infantry*, New York: Praeger, 1984.

Epting, Richard M., *Military Operations on Urbanized Terrain (MOUT) Training for the European Environment*, Fort Leavenworth, KS: Army Command and General Staff College, June 5, 1981. (DTIC AD-B061 490)

Evans, Julie (Contract Support), memorandum to DSB Task Force on Summer Study on Joint Operations, Attendees, April 8, 1998.

Fields, Craig I. (Chairman of Defense Science Board Task Force), *Defense Science Board 1996 Summer Study Task Force on Tactics and Technology for 21st Century Military Superiority*, Vol. 1, Washington, D.C.: Office of the Secretary of Defense, October 1996.

Fields, Craig I. (Chairman of Defense Science Board Task Force), *Defense Science Board 1996 Summer Study Task Force on Tactics and Technology for 21st Century Military Superiority*, Vol. 2, Part 1, Supporting Materials, Washington, D.C.: Office of the Secretary of Defense, October 1996.

Fields, Craig I. (Chairman of Defense Science Board Task Force), *Defense Science Board 1996 Summer Study Task Force on Tactics and Technology for 21st Century Military Superiority*, Vol. 3, Part 1, Technology White Papers, Washington, D.C.: Office of the Under Secretary of Defense for Acquisition and Technology, October 1996.

Flanagan, E. M., *The Angels: A History of the 11th Airborne Division*, Novato, CA.: Presidio, 1989.

Flanagan, Edward M., Jr., *Lightning: The 101st in the Gulf War*, Washington, D.C.: Brassey's, 1994.

Flynn, K. S., and J. Miller, "Hunter-Killer Operations," *Armor*, July-August 1993, pp. 48-50. *Force XXI Heavy Division: Conservative Heavy Interim Design-Objective (as of 14 May 97)*, briefing charts.

Force XXI Operations, TRADOC Pamphlet 525-5, 1994.

Fratzel, Margaret A. (prepared by), *Analysis Plan for the Army After Next: Fall Wargame, November 1996 and Winter Wargame, January-February, 1997*, Fort Leavenworth, KS: TRAC Study and Analysis Center, January 10, 1997.

Freedman, Lawrence, and Efraim Karsh, *The Gulf Conflict, 1990-1991: Diplomacy and War in the New World Order*, Princeton, NJ: Princeton University Press, 1993.

Frost, Roger, "'Street Smart' Soldiers Aspects of Training for Urban Operations," *International Defense Review*, Vol. 21, No. 3, March 1, 1988, p. 261.

Fuel-Efficient AAN Task Group (prepared by), *Fuel-Efficient Army After Next*, White paper, March 1997.

Fulghum, David, and Robert Wall, "Mammoth Half-Blimp Seen as Future Airlifter," *Aviation Week and Space Technology*, February 22, 1999, pp. 26-27.

Gage, Douglas, "A Brief History of Unmanned Ground Vehicle (UGV) Development Efforts," *Unmanned Systems*, Vol. 13, No. 3, Summer 1995, pp. 9-17.

Glenn, Russell W., *Combat in Hell: A Consideration of Constrained Urban Warfare*, Santa Monica, CA: RAND Report, MR-780-A/DARPA, 1996.

Glenn, Russell W., et al., *Getting the Musicians of Mars on the Same Sheet of Music: Army-Joint, Multinational, and Interagency C4ISR Interoperability*, Santa Monica, CA: RAND, DB-288-A, 2000.

Glenn, Russell W. "Give Me a Heavy-Light," *Armor* 99, September-October 1990, pp. 35-37.

- Goodman, G. W., "Army's Fire Javelin Antitank Weapon: 'Fire and Forget' Past Problems," *Armed Forces Journal International*, October 1992, pp. 14-15.
- Gourley, S. R., "Fighting with Fires: U.S. Artillery Modernization," *Military Technology*, December 1994, pp. 8-14.
- Grimes, V. P., "U.S. Army Begins Digitization Build-Up," *International Defense Review*, August 1994, pp. 51-54.
- Grimm, Henry F., Jr., *A Review and Summary of Department of Defense Activities and Technologies in Support of Mapping of Built-Up Areas*, Columbus, OH: Battelle Columbus Labs Ohio Tactical Technology Center, BATT-R-4538, August 1974.
- Greenleaf, W. A. Coates, L. Shockley, M. Porter, J. Gray, and R. Roland, *BEWSS Support of Rapid Force Projection Initiative*, Huntsville: CDC Report TR-95-6064, December 1994.
- GTE Government Systems Corp.—Mountain View—California Sylvania Systems Group—Western Division, *Military Operations in Built-Up Areas*, Mountain View, CA, September 30, 1973. (DTIC AD-C051 992)
- Hain, David B., *Sufficiency of Doctrine for the Use of Armor in Military Operations on Urban Terrain*, Fort Leavenworth, KS: Army Command and General Staff College, June 3, 1994. (DTIC AD-B189 030)
- Hammick, Murray, "From the Shoulder Instant Infantry Fire Support," *International Defense Review (IDR)*, Vol. 23, No. 12, December 1, 1990, p. 1355.
- Hammick, M., "Eagle-Eyed Mortar Munitions," *International Defense Review*, December 1991, pp. 1353-1355.
- Hartle, Anthony E., *Breaching Walls in Urban Warfare*, Theses (for U. S. Army and General Staff College, Fort Leavenworth), Fort Belvoir, VA: Defense Technical Information Center, June 1975. (DTIC AD-B006 686)
- Headquarters, Department of the Army, *An Infantryman's Guide to Combat in Built-Up Areas*, Baltimore, MD: U. S. Army Publications Distribution Center, Field Manual FM 90-10-1, May 12, 1993.
- Headquarters, Department of the Army, *Tactical Air Control Party/Fire Support Team (TACP/FIST) Close Air Support Operations*, Washington D.C., TC 90-7; TACP 50-22; USAFEP 50-38; PACAFP 50-38; AACP 50-22, September 1988.
- Herzog, Chaim, *The War of Atonement*, Boston, MA: Little, Brown and Company, 1975.
- Hewish, Mark, "Shoulder-Fired Anti-Tank Weapons in the U. S.," *International Defense Review*, Vol. 23, No. 12, December 1, 1990, p. 12.
- Hewish, Mark, "Silent Sentinels Lie in Wait: Unattended Ground Sensors," *Jane's International Defence Review*, January 1998, pp. 48-52.
- Hewish, M., and R. Pengelley, "Acoustics on the Battlefield," *Defense Electronics and Computing* (Supplement to IDR 4/1990), pp. 47-49.
- Ikrath, K., Skudera, W., and C. M. DeSantis, *Short-Range Radio Communications System for Military Operations in Built-Up Areas*, Fort Monmouth: Army Electronics Command, March 1977. (DTIC AD-B019 648)
- IIT, *Low Risk Blue Force*, briefing charts, June 4, 1997.
- Jane's Information Group, *FY90 DoD Appropriations Passed: Army Munitions Procurement Defense Budget Intelligence (DBI)*, Vol. 10, No. 49, December 11, 1989.
- Jane's Information Group, *FY90 DoD Appropriations Passed: Army Munitions Procurement Turbine Intelligence (TI)*, Vol. 10, No. 49, December 11, 1989.

- Jane's Information Group, "The WEEKUS Streetfighting Must Be Improved," *Jane's Defence Weekly, International Edition (JDW)*, Vol. 23, No. 3, January 21, 1995, p. 11.
- Johnson, Dana, Scott Pace, and C. Bryan Gabbard, *Space: Emerging Options of National Power*, Santa Monica, CA: RAND, MR-517, 1998.
- Joint Chiefs of Staff, *Information Superiority*, Pentagon, Washington, D.C., n.d.
- Joint Chiefs of Staff, *Joint Vision 2010*, Washington, D.C., 1995.
- Jureidini, Paul A., and R. D. McLaurin, *Military Operations in Selected Lebanese Built-Up Areas, 1975-1978*, Alexandria, VA: Abbott Associates, Inc., June 1979. (DTIC AD-B040 213)
- Kassing, D., *Light Army and Marine Expeditionary Force Roles and Functions, Perspectives from RAND Research*, Santa Monica, CA: RAND, PM-283-CRMAF, 1994.
- Kegan, Mark, "Unmanned Aerial Vehicle Relays Pictures to Airborne Radar System," *Signal*, May 1999, pp. 61-63.
- Kennedy, John R. (School of Advanced Military Studies, USAC&GSC, Fort Leavenworth), *Players or Spectators? Heavy Force Doctrine for MOUT (U)*, Monograph report, Alexandria, VA: Defense Technical Information Center, January 8, 1990, Unclassified. (DTIC AD-A234 969)
- KETRON Inc., *Gaming Models for Military Operations in Built-Up Areas: User Documentation*, Vol. 1 [MOBACS User Manual], Arlington, VA, November 1976. (AD-B017 171)
- KETRON Inc., *Gaming Models for Military Operations in Built-Up Areas*, User Documentation, Vol. 2 [Terrain Data Model, European Site 1], Arlington, VA, November 1976. (DTIC AD-B017 172)
- KETRON Inc., *Gaming Models for Military Operations in Built-Up Areas*, User Documentation, Vol. 3 [Methodology], Arlington, VA, November 1976. (DTIC AD-B017 173)
- KETRON Inc., *Gaming Models for Military Operations in Built-Up Areas*, User Documentation, Vol. 4 [MOBACS Programmer's Guide], Arlington, VA, November 1976. (DTIC AD-B017 174)
- KETRON Inc., *Selected Ammunition Employment in Military Operations in Built-Up Areas*, Arlington, VA, July 31, 1975. (DTIC AD-C003 015)
- Killebrew, Robert B., "The Army After Next: TRADOC's Crystal Ball Eyes the Services' Shape Beyond Force XXI," *Armed Forces Journal International*, October 1996, pp. 36-45.
- Kratz, H. A., *Combat in Built-Up Areas*, Charlottesville, VA: Army Foreign Science and Technology Center, March 1977. (DTIC AD-B029 519)
- Kretchik, Walter E., Robert F. Baumann, and John T. Fishel, *Invasion, Intervention, "Intervention": A Concise History of the U.S. Army in Operation Uphold Democracy*. Fort Leavenworth, KS: U.S. Army Command and General Staff College, 1998.
- Lambourne, Robert D., et al., *Communications Operations in Built-Up Areas*, Vol. I, Mountain View, CA: GTE Sylvania, June 30, 1973. (DTIC AD-C026 951)
- Lange, Adam, "Hellfire: Getting the Most from a Lethal Missile System," *Armor*, January-February, 1998, pp. 25-30.
- Langston, Marv, *DARPA Information Systems Office DIRO Program Review*, Defense Advanced Research Projects Agency, briefing charts, April 1, 1998.
- Liddell Hart, B. H., *Strategy*, New York: Frederick A. Praeger, 1968.
- Lind, G., R. D'Alessandro, and I. Herzer, *A Precision Standoff Weapon Concept for MOBA*, New York: Riverside Research Institute of New York, August 17, 1975. (DTIC AD-C004 245)
- Longley, A. G., and P. L. Rice (Tropospheric Telecommunications Laboratory), *Prediction of Tropospheric Radio Transmission Loss Over Irregular Terrain: A Computer Method—1968*, Boulder, CO: ESSA Research Laboratories, ESSA Technical Report ERL 79-ITS 67, July 1968.

- MacGregor, Douglas A., and Stephen M. Orloff, *CAA Analysis: Breaking the Phalanx*, briefing charts, Concepts Analysis Agency (U.S. Army's Center for Strategy and Force Evaluation), n.d.
- Manners, Geoffrey, "The Berlin Dilemma," *Jane's Defence Weekly (JDW)*, Vol 7. 23, No. 8, February 28, 1987, p. 331.
- Marine Corps Combat Development Command, *Close Support End-to-End Assessment (CSEEA) Military Operations in Urban Terrain (MOUT) Seminar War Game: ASSESSMENT*, Quantico, VA, 1997. (For official use only.)
- Marine Corps Development and Education Command, *Military Operations on Urbanized Terrain (MOUT)*, Quantico, VA: U. S. Marine Corps, Operational Handbook Number 8-7, November 19, 1980.
- Matsumura, J., R. Steeb, T. Herbert, M. Lees, S. Eisenhard, and A. Stich, *Analytic Support to the Defense Science Board: Tactics and Technology for 21st Century Military Superiority*, Santa Monica, CA: RAND, DB-198-A, 1997.
- Matsumura, J., R. Steeb, E. Isensee, T. Herbert, S. Eisenhard, and J. Gordon, *Joint Operations Superiority for the 21st Century: Analytic Support to the 1998 Defense Science Board*, Santa Monica, CA: RAND, DB-260-A/OSD, 1999.
- Milton, Fenner A., *Army After Next Proposal for Ground Combat Vehicles*, Headquarters Department of the Army, OASA (RDA), briefing charts, August 19, 1998.
- Morningstar, James K., "Javelins and Skirmishers on the Battlefield," *ARMOR*, May-June 1996, pp. 37-40.
- Morrow, Walter E. Jr., *1998 DSB Summer Study, Joint Operational Superiority in the 21st Century—Joint Vision Team A (Capabilities Panel)*, briefing charts, April 14, 1998.
- McCausland, Jeffrey, *The Gulf Conflict: A Military Analysis*, Adelphi Paper 282, London: Brassey's, 1993.
- McConnell, Malcolm, *Just Cause: The Real Story of America's High-Tech Invasion of Panama*, New York: St. Martin's Press, 1991.
- McEnery, Keven T., *The XIV Corps Battle for Manila; February 1945*, Fort Leavenworth, KS: Army Command and General Staff College, June 4, 1993. (DTIC AD-A273 960)
- McJilton, Walter N., and William C. Mullen, *Tactical Communications in a Built-Up Area (Small City)*, Aberdeen Proving Ground, MD: Human Engineering Lab, October 1977. (DTIC AD-B024 271)
- McLaurin, R. D., *Military Operations in the Gulf War: The Battle of Khorramshahr*, Alexandria, VA: Abbott Associates, Inc., July 1982. (DTIC AD-B067 661)
- McLaurin, R. D., *The Battle of Tyre*, Aberdeen Proving Ground, MD: U. S. Army Human Engineering Laboratory, Technical Memorandum 15-87, August 1987. (DTIC AD-A185 243)
- McLaurin, R. D., and Lewis Snider (Abbott Associates, Inc.), *Recent Military Operations on Urban Terrain*, Aberdeen Proving Ground, MD: U. S. Army Human Engineering Laboratory, Technical Memorandum 12-82, July 1982. (DTIC AD-B067 653)
- McLaurin, R. D., and R. Miller, *Military Forces in Urban Antiterrorism*, Aberdeen Proving Ground, MD: U. S. Army Human Engineering Laboratory, Technical Memorandum 12-89, October 1989. (DTIC AD-A217 669)
- McMichael, Scott R., *A Historical Perspective on Light Infantry*, Fort Leavenworth, KS: Combat Studies Institute, 1987.
- Mullen, O. L., and Ellsworth B. Shank, *The Use of the 40mm Grenade Launcher in a MOBA Environment*, Aberdeen Proving Ground, MD: Human Engineering Lab, July 1978. (DTIC AD-B031 418)

- Mullen, O. L., et al., *Evaluation of 105mm HEAT, HEP and KE Projectiles Against Masonry Structures*, Aberdeen Proving Ground, MD: Ballistic Research Labs, August 1977. (DTIC AD-C011 905)
- Mullen, O. L., et al., *Evaluation of LAW-LAWT Munitions Against Masonry Structures*, Aberdeen Proving Ground, MD: Ballistic Research Labs, August 1977. (DTIC AD-C011 417)
- Mullen, William C., *Evaluation of the STARBRU Ladder for Use in Military Operations in Built-Up Areas*, Aberdeen Proving Ground, MD: Human Engineering Lab, October 1978. (DTIC AD-B032 375)
- Nash, T., "'Smart' Mortar Munitions Tilting the Balance," *Military Technology*, September 1991, pp. 78–81.
- Naval Ocean Systems Center (NOSC), *Operational Guidelines for Urban Communications*, Fort Belvoir, VA: Defense Technical Information Center, October 14, 1983. (DTIC AD-A153 938)
- Norman, Kurt D., and George M. Schwartz, "Scout MOUT (Military Operations on Urban Terrain Training Exercise): Model for Future Cavalry Training," *Armor*, Vol. 102, No. 5, September–October 1993, pp. 36–41.
- Ogorkiewicz, R., *Technology of Tanks*, Vols. I and II, Surrey, England: Jane's Information Group, 1991.
- Ogorkiewicz, R. M., "Transforming the Tank," *Jane's International Defence Review*, October 1997.
- O'Connell, James W., *Is the United States Prepared to Conduct Military Operations on Urbanized Terrain?* Newport, Rhode Island: Naval War College, Department of Operations, February 13, 1992. (DTIC AD-B163 784)
- O'Keefe, John A., "DIS/HLA Compatible Human Instrumentation," briefing presented November 7, 1996 at MOUT Simulation Meeting held at STRICOM (Orlando, FL), Natick, MA: Advanced Systems Concept Directorate (Natick Research, Development and Engineering Center), November 2, 1996.
- O'Keefe, John A., "IUSS Support to MOUT," briefing presented November 7, 1996 at MOUT Simulation Meeting held at STRICOM (Orlando, FL), Natick, MA: Advanced Systems Concept Directorate (Natick Research, Development and Engineering Center), November 2, 1996.
- Packett, Virgil L., II, *Air Mechanization: The Direction and Dynamics of Army Aviation from a Combined Arms Perspective*, thesis, U. S. Army Command and General Staff College, Fort Leavenworth, KS, 1985.
- Pegrum, Barrie, and J. R. Wilson, "Training to Stay One Step Ahead of the Enemy," *Jane's Defence Weekly, International Edition (JDW)*, Vol. 12, No. 24, December 16, 1989, p. 1336.
- Pengelly, R., "Tank Ammunition Development," *International Defense Review*, April 1994, pp. 39–46.
- Pettijohn, William C., *Weapon Effects in Cities*, Vol. I, Santa Monica: CA: Intrec, Inc., December 1974
- Pettine, J. F., *MAU (Marine Amphibious Unit) Helicopter Operations in Urban Areas*, Newport, Rhode Island: Naval War College, Department of Operations, March 6, 1985. (DTIC AD-B095 190)
- Pimlott, John, and Stephen Badsey, *The Gulf War Assessed*, London: Arms and Armour, c1992.
- Plaster, John L., *The Ultimate Sniper*, Boulder, CO: Paladin Press, 1993.
- Pope, C. N., M. Vuong, R. G. Moore, and S. S. Cowser, "A Whole New CCTT World," *Military Science and Technology*, May 1995, pp. 6–17.
- Renier, James J., et al., *Military Operations in Built-Up Areas (MOBA)*, Washington D.C.: Army Science Board, January 1979. (DTIC AD-B034 309)

Reorganizing the U.S. Army for the 21st Century and Beyond: Concepts for Change at the Start of a New Revolution in Military Affairs, briefing charts.

Robinson C. A., Army Charges Toward Future Seizing Technology's Strength, *Signal*, May 1995, pp. 79–85.

Robinson, C. A., "Geospatial Information Pinch Creates Digital Balancing Act," *Signal*, November 1995, pp. 45–49.

Romjue, John L., *The Army of Excellence: The Development of the 1980s Army*, Office of the Command Historian, U.S. Army Training and Doctrine Command, 1993.

Russell, George H., Commentary (to Commanding Officer of 161st Infantry), February 17, 1945.

Scales, Robert H., et al., *Certain Victory*, Washington, D.C.: Office of the Chief of Staff, United States Army, 1993.

Schecter, George, *Technology Workshop on Military Operations in Built-Up Areas (MOBA)*, Arlington, VA: KETRON Inc., August 30, 1974. (DTIC AD-C006 315)

Schecter, George, *Technology Program for Military Operations in Built-Up Areas (MOBA)*, Aberdeen Proving Ground, MD: Human Engineering Lab, August 1977. (DTIC AD-B023 071)

Schecter, George, *Low Signature Launchers Devices/Concepts/Technologies*, Vol. I, Main Report, Arlington, VA: KETRON Inc., March 1980. (DTIC AD-B049 410)

Schecter, George, and Donald Farrar, *Camouflage in Built-Up Areas*, McLean: McLean Research Center Inc., May 10, 1983. (DTIC AD-B074 334)

Schecter, George, and H. Ric Blacksten, *Low Signature Launchers Devices/Concepts/Technologies*, Vol. II, Appendices A–D, Arlington, VA: KETRON Inc., March 1980. (DTIC AD-B049 414)

Schubert, Frank N., and Theresa L. Kraus (eds.), *The Whirlwind War: The United States Army in Operations DESERT SHIELD and DESERT STORM*, Washington, D.C.: Center of Military History, 1995.

Seffer, George, "Army Experiments with Ground Robotic Vehicles," *Army Times*, September 28, 1998, p. 24.

Shank, Ellsworth B., and Brenda K. Thein, *MOUT/Assault Weapon Status*, Aberdeen Proving Ground, MD: Human Engineering Lab, June 1980. (DTIC AD-C022 696)

Spiller, Roger J., *Combined Arms in Battle Since 1939*, Fort Leavenworth, KS: U.S. Army Command and General Staff College Press, 1992.

Steeb, R., K. Brendley, T. Covington, T. Herbert, and D. Norton, *Light Forces—Heavy Responsibilities: The Role of Technology in Enabling Future Early Entry Forces to Fight and Survive*, Santa Monica, CA: RAND, MR-473-ARPA, 1995.

Steeb, R., J. Matsumura, et al., *Rapid Force Projection: Exploring New Technology Concepts for Light Airborne Forces*, Santa Monica, CA: RAND, DB-168-A/OSD, 1996a.

Steeb, R., J. Matsumura, T. Covington, T. Herbert, S. Eisenhard, and L. Melody, *Rapid Force Projection Technologies: A Quick-Look Analysis of Advanced Light Indirect Fire Systems*, Santa Monica, CA: RAND, DB-169-A/OSD, 1996b.

Stewart, Douglas, "MOUT (Military Operations on Urban Terrain) Battle Drills for Infantry and Tanks," *Infantry*, Vol. 83, No. 3, May–June 1993, pp. 40–42.

Stix, G., "Fighting Future Wars," *Scientific American*, December 1995, pp. 92–98.

Sullivan, John D., *Detonation of a Spray-Generated Fuel-Air Cloud on the Exterior of a Building*, Aberdeen Proving Ground, MD: Army Ballistic Research Lab, July 1980. (AD-B051 283)

Sullivan, GEN G., and LTC J. Dubic, *Land Warfare in the 21st Century*. U.S. Army War College Fourth Annual Conference on Strategy, February 1993.

bin Sultan, Khaled, *Desert Warrior: A Personal View of the Gulf War by the Joint Forces Commander*, New York: HarperCollins, 1995.

Swain, Richard M., *"Lucky War": The Third Army in Desert Storm*, Fort Leavenworth, KS: U.S. Army Command and General Staff College Press, 1994.

Tactical Technology Office (Defense Advanced Research Projects Agency), *Advanced Fire Support System*, briefing charts, Arlington, VA, November 7, 1996.

Tactical Technology Office (Defense Advanced Research Projects Agency), *Welcome to the DARPA Small Unit Operations Industry Briefing*, briefing charts, Arlington, VA, January 16, 1997.

Thein, Brenda K., and David R. Coltharp, *Interim Standards for the Construction of MOBA Structures for Weapons Effects Tests*, Aberdeen Proving Ground, MD: Human Engineering Lab, December 1978. (DTIC AD-B033 760)

Thein, Brenda K., et al., *A Comparison of SMAW and LAW Warheads Against Various Masonry Targets*, Aberdeen Proving Ground, MD: Human Engineering Lab, January 1978. (DTIC AD-C015 041)

Thein, Brenda K., et al., *Guidelines for Testing Various Weapons/Munitions Against MOBA Structures*, Aberdeen Proving Ground, MD: Human Engineering Lab, October 1979. (DTIC AD-B043 329)

Thomas, Timothy L., *The Caucasus Conflict and Russian Security: The Russian Armed Forces Confront Chechnya (Parts One and Two of a Three Part Study)*. Actions from 11–31 December 1994), Fort Leavenworth, KS: Foreign Military Studies Office.

"TOW: An Example of Continuous Upgrade," *National Defense*, February 1991, pp. 30–33.

TRADOC Analysis Center, *Mobility Insights from Army After Next Analyses*, briefing charts, Fort Leavenworth, KS, May 20, 1997.

TRADOC Analysis Center, *Military Art Workshop*, briefing charts, Fort Leavenworth, KS, May 4–5, 1997.

"U.S. Army to Demonstrate Fiber-Optic Missile and Guided Mortars," *International Defense Review*, June 1994, p. 13.

U. S. Army Material Command, *Precision Munitions in Army Vision 2010: A Vital Component of Decisive Operations*, Picatinny Arsenal, New Jersey: TACOM-ARDEC, n.d.

U. S. Army STRICOM, *Let's Pretend*, pamphlet on Advanced Distributed Simulation Technology II (ADST II), Orlando, FL: U. S. Army STRICOM and Program Management Office of Lockheed Martin ADST II, 1996.

U. S. Army STRICOM, *User's Guide "How to do Business with ADST II"*, Orlando, FL: U. S. Army STRICOM and Program Management Office of Lockheed Martin ADST II, ADST-CDRL-XLSE-9600033A, August 5, 1996.

U. S. Army Training and Doctrine Command, *Army After Next: 1997 Winter Wargame, 27 January–6 February 1997—Game Book*, Fort Monroe, VA: Doctrine Directorate, U. S. Army Training & Doctrine Command, 1997. (For official use only.)

U.S. Army Training and Doctrine Command, *Army After Next: 1997 Winter Wargame, 27 January–6 February 1997—State of the World 1995–2020*, Fort Monroe, VA: Doctrine Directorate, U. S. Army Training & Doctrine Command, 1997. (For official use only.)

U.S. Army Training and Doctrine Command, *Force XXI Operations*, Fort Monroe, VA, Pamphlet 525–5, 1994.

Wass de Czege, Huba, *Air Mechanization by 2025?*, briefing charts, May 20, 1996.

Watman, Kenneth B., and Daniel P. Raymer, *Airpower in the U.S. Light Combat Operations*, Santa Monica, CA: RAND, MR-457-AF, 1994.

Womack, S., "The AGS in Low-Intensity Conflict: Flexibility is the Key to Victory," *Armor*, March-April 1994, pp. 42-44.

Yates, Lawrence A., *Power Pack: U.S. Intervention in the Dominican Republic, 1965-1966*, Fort Leavenworth, KS: Combat Studies Institute, 1988.

Zachau, John S., "Military Operations on Urban Terrain," *Infantry*, Vol. 82, No. 6, November-December 1992, pp. 44-46.

As the world continues its post-Cold War thaw, fears of major theater-level war have given way to a reality of increased numbers of smaller regional conflicts and crises. There is a growing need for a quickly deploying, rapid-reaction capability—in particular, U.S. Army light forces—to directly respond to these events. From the Gulf War through strife in the Balkans to subsequent challenges, one of the roles such light ground forces are being asked to play is that of defender against a much heavier enemy force; this raises the issue of how such light forces can be made both survivable and lethal enough in these missions.

Although policymakers have offered many ideas on how to make light forces more capable for such missions, these ideas run the risk of “looking good on paper but not in practice.” In *Lightning Over Water: Sharpening America’s Light Forces for Rapid-Reaction Missions*, the authors consider three very different means—or paths—for improving rapid-reaction capability, drawing on a program of research on the topic of improving light, air-deployable forces. This research is grounded in a sophisticated simulation-based modeling environment and in a framework that addresses the process of designing such a force, with a focus on analyzing both new operational concepts and the underlying enabling technologies.

This book is aimed at the warfighters who will be using such future capabilities, giving them a sense of what they would do and how they would work. It is also directed at the policymakers charged with making fundamental strategic decisions about future light forces, including decisions about what systems to acquire and what changes to make in organization, operational concepts, and training and doctrine.

ISBN 0-8330-2845-6



MR-1196-A/OSD