

# LOAN DOCUMENT

PHOTOGRAPH THIS SHEET



INVENTORY

DTIC ACCESSION NUMBER

LEVEL

High altitude Observatory (HALO)  
Upgrade

DOCUMENT IDENTIFICATION

2000

**DISTRIBUTION STATEMENT A**  
Approved for Public Release  
Distribution Unlimited

DISTRIBUTION STATEMENT

ACCESSION FOR	
NTIS	GRAM <input checked="" type="checkbox"/>
DTIC	TRAC <input type="checkbox"/>
UNANNOUNCED JUSTIFICATION <input type="checkbox"/>	
BY	
DISTRIBUTION/	
AVAILABILITY CODES	
DISTRIBUTION	AVAILABILITY AND/OR SPECIAL
A-1	

DISTRIBUTION STAMP

DATE ACCESSIONED

DATE RETURNED

20000814 213

DATE RECEIVED IN DTIC

REGISTERED OR CERTIFIED NUMBER

PHOTOGRAPH THIS SHEET AND RETURN TO DTIC-FDAC

H  
A  
N  
D  
L  
E  
  
W  
I  
T  
H  
  
C  
A  
R  
E

UNCLASSIFIED



## HIGH ALTITUDE OBSERVATORY (HALO) UPGRADE

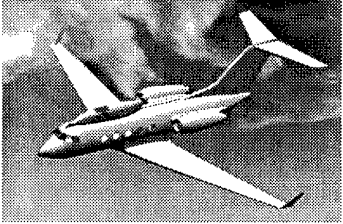

by  
 Rob Moskal, Garry Booker, and Mark Williamson, Aeromet Inc, Tulsa, OK  
 Mike Lash, U.S. Army Space and Missile Defense Command, Huntsville, AL  
 Jim Kiessling, Ballistic Missile Defense Organization, Pentagon

DISTRIBUTION STATEMENT A: Approved for public release; distribution is unlimited.

UNCLASSIFIED

### Abstract

The Ballistic Missile Defense Organization (**BMDO**) has requirements for the collection of missile Test and Evaluation data including photodocumentation, characterization of target scenes, metric and radiometric characterization of systems, and phenomenology/signature data. This paper will describe the upgrade platform being designed and developed for the High Altitude Observatory (**HALO**) to address these requirements. The paper will also address the data-flow and computation effort designed to support rapid data products and prototype future sensor platforms that could be applied to surveillance applications.

The HALO aircraft has a legacy as a reliable BMDO data collection asset. This data collection has been limited to sensors mounted inside the HALO aircraft cabin while viewing missile scenes through optical windows. The traditional approach has limited data collection capabilities due to window transmission, window aperture, and field of regard (**FOR**). The HALO upgrade will alleviate these problems with the installation of a pod mounted on the top of the HALO aircraft.

The HALO Upgrade consists of a set of subsystems that provide for an integrated open port sensor system. These are: A pod including air vehicle modifications, a pointing subsystem, the acquisition subsystem, tracking subsystem, real-time processor subsystem (**RTPS**), and a surveillance processor subsystem (**SPS**). The system will include 6 cameras and all necessary processing to provide real-time data reduction to a quick-look data product and recording capabilities necessary to retain all data and meta-data from the six cameras and supporting activities. The pod will include a 35 cm modified cassegrain telescope, an acquisition sensor suite (2 medium wave infrared (**MWIR**) sensors and one visible sensor), and a tracking sensor suite ( 1 MWIR, 1 long wave infrared (**LWIR**), and 1 visible sensor). (continued on next page)

UNCLASSIFIED



## HALO Upgrade Presentation Outline

1. **Program Overview**
2. **System / Subsystem Overview**
3. **HALO Upgrade Capabilities**
4. **Technology Development For Ballistic Missile Surveillance**
5. **Conclusion**

UNCLASSIFIED

### Abstract (cont.)

The HALO Upgrade pod design will incorporate a rotating-barrel concept which will allow for the acquisition and tracking of targets through a large field of regard while minimizing the port opening. This system will allow for the acquisition and tracking of targets on both sides of the aircraft and at elevation angles directly above the aircraft.

The HALO Upgrade acquisition and tracking sensors will interface to a high speed digital processing and storage system located in the aircraft cabin. The processing subsystems are divided into logical systems including a RTPS and a SPS. The RTPS will interface directly to the in-pod camera subsystems and provide real-time target identification, sensor background estimation and removal, radiometric calibration, frame to frame detection associations, utilization of stabilized LOS track angles and pixel locations to form a highly accurate sensor angle-angle target track history. In addition, the RTPS will permit human-in-the-loop improvements such as intelligent target selection. A surveillance processor subsystem will provide computer sizing for future algorithm development such as launch detection determination, missile type and payload assessment, missile tracking and trajectory estimates, lethal object discrimination, target object map, impact point prediction, impact detection, and kill assessment.

These items will be discussed utilizing the following outline:

- 1.) Program Overview
- 2.) System / Subsystem Overview
- 3.) HALO Upgrade Capabilities
- 4.) Technology Development for Ballistic Missile Surveillance
- 5.) Conclusion

UNCLASSIFIED



## 1. Program Overview

- 1.1 Program Points of Contact
- 1.2 Schedule
- 1.3 Major Milestones
- 1.4 Legacy HALO/IRIS Capabilities
- 1.5 Motivation for Upgrade
- 1.6 Design Requirements
- 1.7 Design Approach

UNCLASSIFIED

### **1.1 Program Points of Contact**

The HALO Upgrade is sponsored by the Ballistic Missile Defense Organization (**BMDO**) and managed by the U.S. Army Space and Strategic Defense Command (**USASMDC**). The prime contractor is Aeromet, Inc. of Tulsa OK.

### **1.2 Schedule**

An overview of the program schedule

### **1.3 Major Milestones**

Major milestones associate with the HALO Upgrade Program

### **1.4 Legacy HALO Capabilities**

A brief description of the existing HALO aircraft and sensors is provided.

### **1.5 Motivation for Upgrade**

The HALO Upgrade will provide support critical measurements and be a testbed to study advanced surveillance concepts.

### **1.6 Design Requirements**

Desired and required system capabilities are included here.

### **1.7 Design Approach**

This section delineates some of the design concepts offered by the government and the prime contractor.

UNCLASSIFIED



## 1.1 Program Points of Contact

---

**U.S. Army Space & Missile Defense Command**

- Mr. Mike Lash, HALO Program Manager, SMDC-TC-SS



---

**Ballistic Missile Defense Organization**

- CDR Roy Wood, HALO Upgrade Program Manager
- Mr. Jim Kiessling, Technical Director for Test, Simulation, and Evaluation



---

**Aeromet, Inc., Tulsa, OK**

- Mr. Rob Moskal, Program Manager
- Mr. Garry Booker, V.P. Operations
- Mr. Mark Williamson, Chief Engineer



UNCLASSIFIED

The **U.S. Army Space and Missile Defense Command (USASMDC)** is the executing government agency for the HALO Basic Effort (i.e., operations and maintenance, and mission support) and the HALO Upgrade project.

- Mr. Mike Lash, U.S. Army Space and Missile Defense Command, Attn: SMDC-TC-SS/  
Mr. Mike Lash, 256-955-3872 or Mike.Lash@smdc.army.mil.

The **Ballistic Missile Defense Organization (BMDO)** is the HALO Upgrade sponsoring government agency.

- CDR Roy Wood, 7100 Defense Pentagon, 703-693-1611 or Roy.Wood@bmdo.osd.mil.
- Mr. James Kiessling, 7100 Defense Pentagon, 703-693-1572, ext 1406 or James.Kiessling@bmdo.osd.mil

**Aeromet Inc.** is the prime contractor to USASMDC for the Airborne Test and Measurement Support (**ATMS**) (DASG-60-99-C-0067). Aeromet has been the incumbent ATMS contractor since the mid 1970's. The current ATMS contract began concurrent with the initiation of the HALO Upgrade project on September 24, 1999.

- Mr. Rob Moskal, HALO Program Manager, Aeromet, Inc., 112 Beechcraft Drive, Jones Riverside Airport, Tulsa, OK 74132, 918-299-2621, rmoskal@aeromet.com
- Mr. Garry L. Booker, Vice President, Operations, Aeromet, Inc., 112 Beechcraft Drive, Jones Riverside Airport, Tulsa, OK 74132, 918-299-2621, gbooker@aeromet.com
- Mr. Mark Williamson, HALO Upgrade Chief Engineer, Aeromet, Inc., 112 Beechcraft Drive, Jones Riverside Airport, Tulsa, OK 74132, 918-299-2621, mwilliamson@aeromet.com

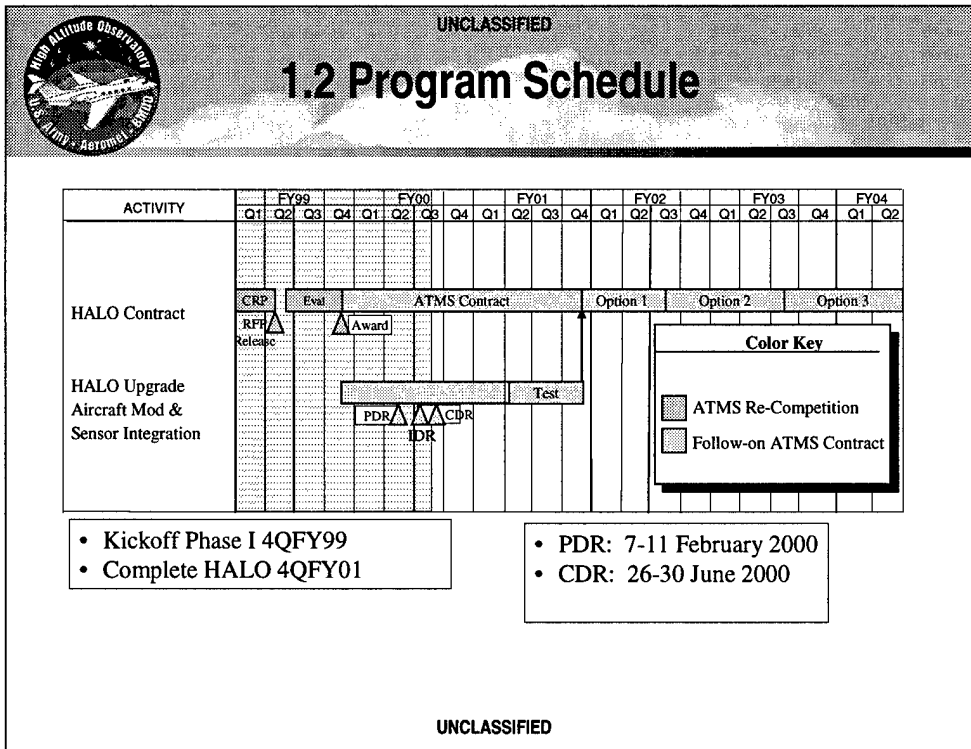

Aeromet, Inc. successfully competed and was awarded the ATMS contract on September 24, 1999. The ATMS is a 5 year contract including a two-year base option and three one-year extension options. The HALO upgrade is a completion CLIN scheduled for a 2 year duration.

UNCLASSIFIED



## 1.3 Major Milestones

<p style="text-align: center;"><b>1999</b></p> <ul style="list-style-type: none"> <li>✓ 24 Sep 99 - Contract Award</li> <li>✓ 8 Oct 99 - Internal Kick-Off Meeting.</li> <li>✓ 14 Oct 99 - External Kick-Off Meeting at SMDC.</li> <li>✓ 3 Nov 99 - IBR</li> <li>✓ 2 Dec 99 - SRR</li> </ul>	<p style="text-align: center;"><b>2000 (continued)</b></p> <ul style="list-style-type: none"> <li>• 26-30 Jun 00 - CDR</li> <li>• 31 Jul 00 - First RTPS Delivery Complete</li> <li>• 11 Aug 00 - Post CDR TDP</li> <li>• 2 Oct 00 - Second RTPS Delivery</li> <li>• 2 Nov 00 - Test, Installation, Operations Integration Conference</li> </ul>
<p style="text-align: center;"><b>2000</b></p> <ul style="list-style-type: none"> <li>✓ 7-10 Feb 00 - PDR</li> <li>✓ 1 Mar 00 - Surrogate Ready to Host Equipment Installations</li> <li>✓ 7 Mar 00 - Post PDR TDP</li> <li>✓ 1-30 Apr 00 - Baseline Flight Test Window</li> </ul> <p style="text-align: center;">↓</p>	<p style="text-align: center;"><b>2001</b></p> <ul style="list-style-type: none"> <li>• 20 May 01 - Airworthiness Flight Test</li> <li>• 21 Jun 01 - Subsystem SIL Testing Complete</li> <li>• 13 Jul 01 - Mission system integration complete and start of mission systems flight Test</li> <li>• 1 Oct 01 - Initial Operational Capability</li> </ul>

UNCLASSIFIED

The Program Major Milestones are provided.



UNCLASSIFIED

## 1.4 Legacy HALO/IRIS Capabilities

- **Supported over 100 SDIO/BMDO missions since inception in 1985**
- **Three Optical Platforms Installed Inside Cabin**
  - IRIS, Alpha, & Beta Platforms
  - Independent Stabilized Gimbaled Mirror Systems
  - Target Acquisition Provided via Airborne Pointing System (APS)
- **System Optical Aperture and Sensitivity Limited By Aircraft Window Size**

- **Gulfstream IIB**
  - 45,000+ ft. altitude capability
  - 7.5 hour endurance
- **Adaptable instrumentation to accommodate guest sensors**



UNCLASSIFIED

The HALO aircraft was originally a Learjet Model 35 for five years, starting in 1985. In 1988, it was combined with the Infrared Instrumentation System (IRIS), which was originally a separate Learjet model 36. By far the majority of HALO/IRIS missions have been conducted since the combined system was converted to the present Gulfstream II-B in 1990. IRIS is operated by CACI/ASG of Huntsville, AL. Aeromet, Inc. operates two highly customizable platforms, designated Alpha and Beta, which may contain high speed imagers, spectrometers, and/or radiometers. IRIS, Alpha and Beta are all independently stabilized and pointed. Aeromet also operates all HALO support systems, including the Airborne Pointing System (APS) and range interfaces, and operates the aircraft itself.

The HALO aircraft has observed more ballistic missile defense tests than any other airborne optical asset. Although the HALO/IRIS has a legacy of being a reliable data collection asset, the asset has been limited to sensors mounted inside the aircraft cabin viewing through optical window materials (zinc sulfide, zinc selenide, and fused silica). This approach, while relatively economical, has limited data collection capabilities due to window transmission (affecting system sensitivity), window aperture (impacting sensor aperture and field of regard).

The HALO Upgrade will alleviate these problems with the installation of a pod mounted on the top of the fuselage. Moving the sensor package outside the fuselage offers many other advantages, such as of utilizing cold ambient temperature and of relieving space constraints inside the cabin.



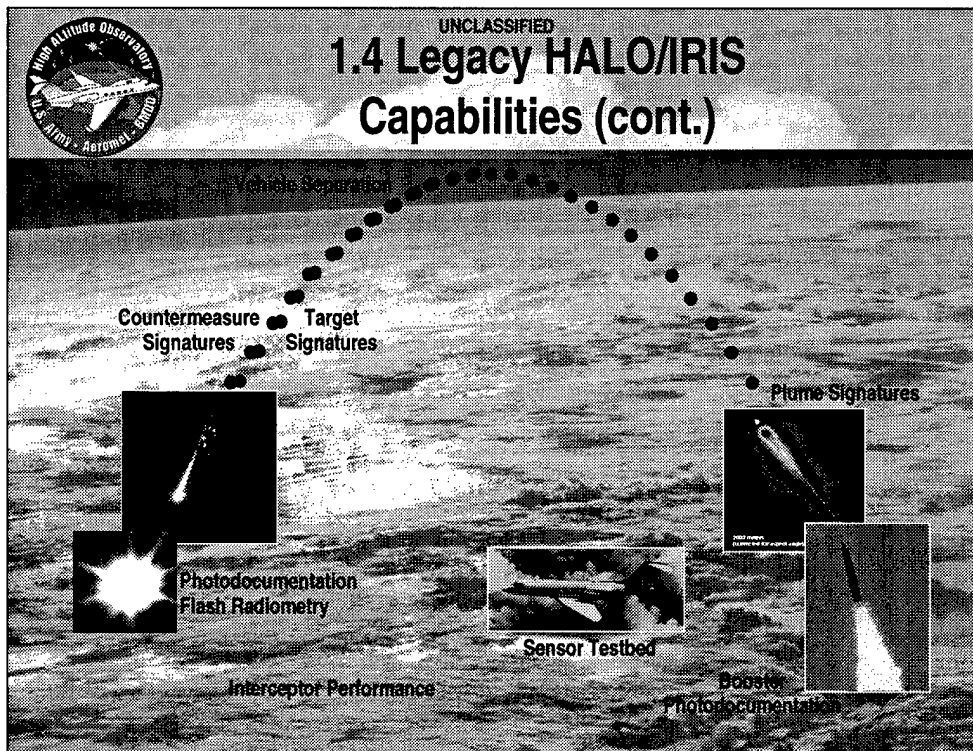

HALO/IRIS supports all phases of ballistic missile flight. Applications have included photodocumentation and radiometry for launch anomaly detection and analysis, boost-phase plume signatures, vehicle deployment sequencing, target and countermeasure signatures for discrimination support, reentry vehicle characterization, interceptor fly-out support and kill assessment. Waveband coverage has included ultraviolet, visible, and infrared up to 12 microns. Instrumentation has included mostly imagers, but also has included spectrometers and high speed radiometers.

UNCLASSIFIED

## 1.5 Motivation for Upgrade

**Currently No Sensor Meets All of BMDO Infrared Data Collection Needs**

**Critical Measurement Support**

- Target Signature measurements, multi-band apparent signatures
- Trajectory Estimation, launch point, apogee, impact point
- Ancillary measurements, Atmospheric characterization, temporal backgrounds

---

**Study Advanced Concepts**

- Transient events, explosions fires and other indications of military activity
- Target Typing, via observation of plume signature

UNCLASSIFIED

As directed by the BMDO Director, the BMDO Chief Engineer's System Architecture Engineering Board chartered an External Infrared Sensor Study (EIRSS) to examine the existing and emerging ballistic missile defense external sensor data collection needs and to make recommendations on the most cost-effective external infrared sensor platforms to collect this data. The EIRSS effort was supported by BMDO, the Services and Intelligence Agencies and included requirements for foreign systems (tactical and strategic threats) and domestic missile/interceptor tests. The EIRSS team reviewed existing assets and capabilities and made detailed assessments of technical performance, as measured by National Missile Defense (NMD) and Theater Missile Defense (TMD) requirements, versus cost of operations.

In addition to the Critical Measurement Support and Advanced Concepts requirements shown above, new requirements driven by emerging Tactical Ballistic Missile (TBM) threats require a very large field of regard and the ability to track from either side of an aircraft with extreme sensitivity and stability. The HALO Upgrade concept emerged as the most cost-effective method to satisfy these objectives.

A conclusion of the EIRSS team was that the vast majority of external sensor requirements could be met with relatively inexpensive airborne assets, with one exception -- the ability to collect highly-resolved imagery of reentry vehicles for aimpoint selection. Another important conclusion was that much of the modern technology available to address these requirements can be packaged in a business class aircraft (a Gulfstream) which will attain long-term cost savings.

UNCLASSIFIED



## 1.6 Design Requirements

- **Meet BMDO electro-optical requirements for ballistic missile Test & Evaluation (T&E)**
- **Required**
  - Radiometric characterization of the system(s)
  - Collection of phenomenology and signatures
  - Characterization of target scene suitable of diagnostic evaluation of event
  - Metric characterization of the system(s)
  - High quality photo-documentation
- **Desired**
  - Real-time track development
  - Target-object mapping (TOM)
  - Real-time discrimination of threat objects for target complex
  - View and collection of non-missile targets

UNCLASSIFIED

The HALO Upgrade requirements were expanded and refined in a modification to the ATMS Statement of Work (SWTC-S-38-97), released in a small-business competition on February 26, 1999. The ATMS contract was awarded to Aeromet, Inc. on September 24, 1999.

The prime objective of the HALO Upgrade is to obtain visible and IR imagery and multi-spectral data on missile systems during testing in order to establish the expected signature levels and any temporal variation in the signatures that could possibly affect TMD and NMD system performance. The collected data will be used in the design and validation of Ballistic Missile Defense (BMD) systems systems performance, discrimination technology programs and threat predictive models.

UNCLASSIFIED



## 1.7 Design Approach

- **Modify HALO Aircraft To Include Open Port Large Aperture / Large Field of Regard System**
- **Maximize Utilization of COTS/GOTS Components**
- **Follow “Skunk Works” Program Guidelines**
- **Integrated Product Team (IPT) Organization**

UNCLASSIFIED

The design approach for obtaining a very large field of regard with an open port is to incorporate a rotating-barrel concept. This will allow for the acquisition and tracking of targets on both sides of the aircraft and at elevation angles directly above the aircraft. While this is highly desirable for domestic test support, it is essential for foreign non-cooperative data collection, since an aircraft will be required to track from both sides of a holding pattern.

The use of existing commercial off-the-shelf (**COTS**) technology, such as light-weight high-speed computers, will allow the entire system to fit within the space and weight capacity of the Gulfstream aircraft, a medium-sized corporate jet. Airborne systems of similar capability have been installed only in large transport (cargo-class) aircraft. An example of government off-the-shelf (**GOTS**) technology that are employed include interceptor-quality focal plane arrays (**FPAs**) that were developed with BMDO funding. The use of these FPAs is considered a risk-reduction step for interceptor development programs.

The HALO Upgrade is required to be developed in only two years, and 5%-10% of the cost of similar systems. This is being accomplished with very close cooperation between government and contractors and liaison on a day-to-day basis. The contractor team has been kept relatively small, and much of the engineering work is being coordinated with integrated product teams.

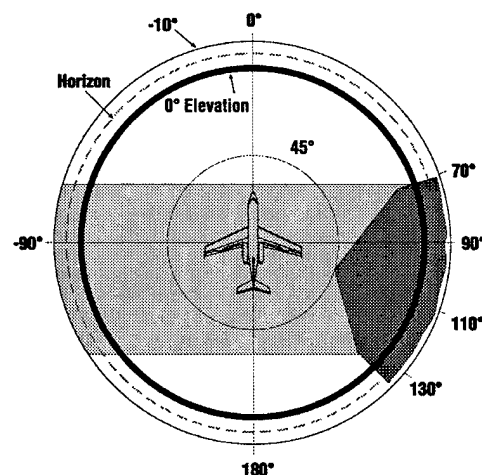

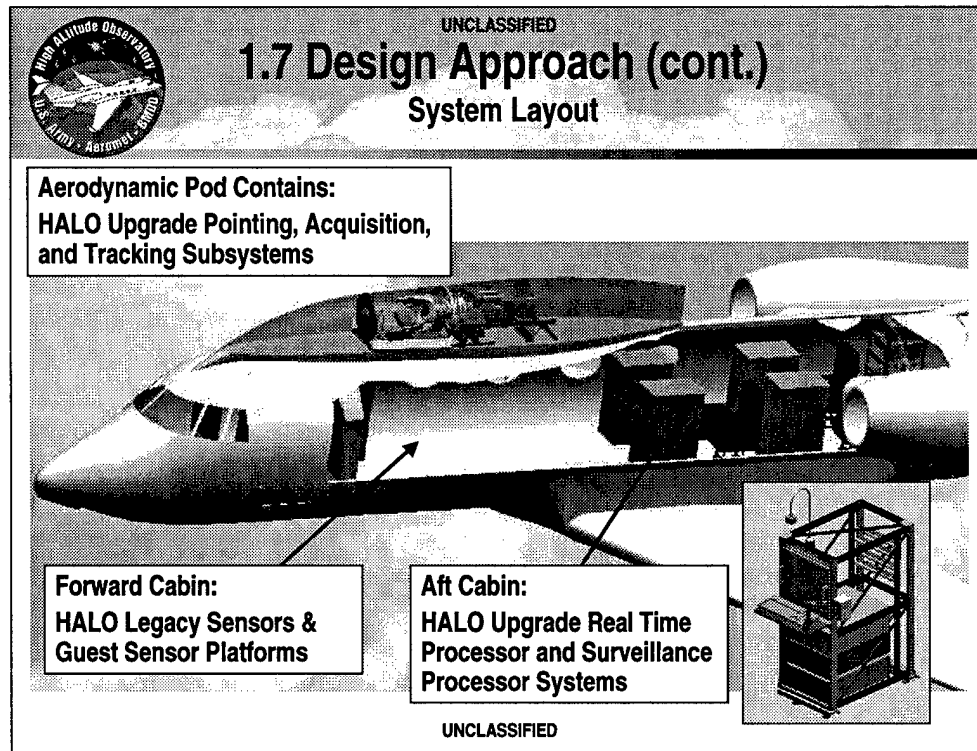

Equipment located within the pod will include a 35 cm aperture modified Cassegrain telescope, a wide field of view (**WFOV**) acquisition sensor suite (2 MWIR sensors and one visible sensor), and a narrow field of view (**NFOV**) tracking sensor suite (1 MWIR, 1 LWIR, and 1 visible sensor)

The HALO Upgrade acquisition and tracking sensors will interface to a high speed digital processing and storage system located in the aircraft cabin. The processing subsystems are divided into logical systems including a RTPS and a SPS. The RTPS will interface directly to the in-pod camera subsystems and provide real-time target identification, sensor background estimation and removal, radiometric calibration, frame to frame detection associations, utilization of stabilized LOS track angles and pixel locations to form a highly accurate sensor angle-angle target track history. In addition, the RTPS will permit human-in-the-loop improvements such as intelligent target selection. The SPS will provide computer sizing for future algorithm development such as launch detection determination, missile type and payload assessment, missile tracking and trajectory estimates, lethal object discrimination, target object map, impact point prediction, impact detection, and kill assessment.

UNCLASSIFIED



## 1.7 Design Approach (Cont.)

### Systems Integration Laboratory (SIL)

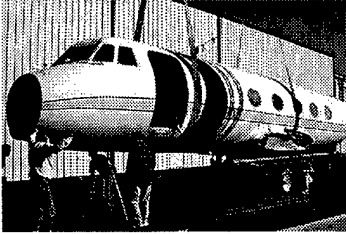
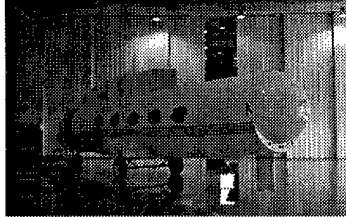
**SIL OBJECTIVES**

- Maximize systems integration and test before first flight.
- Conduct performance measurements.
- Minimize HALO downtime during integration and test efforts.

**SIL Features**

- Class 100,000 clean room
- Surrogate Gulfstream airframe
- Scene simulator - algorithm development and RTPS/SPS testing

UNCLASSIFIED

The HALO Upgrade will be a modification to an operational BMDO/SMDC asset. Since the aircraft is scheduled to support numerous missions, meeting the two-year schedule presents a significant challenge not faced by similar development programs of the past. The approach chosen to deal with this challenge is a concerted effort in systems integration, including a surrogate Gulfstream aircraft. While the HALO/IRIS remains operational, the surrogate will be used during the ground-test phase to perform as many systems tests and performance measurements as possible in a ground-test mode. This will ensure that the ground-test phase of the actual HALO aircraft is minimized, and that most of the air vehicle integration issues (e.g. cable lengths and ergonomics) will be addressed without impacting HALO/IRIS mission support.

Another feature of the systems integration effort is the development of a scene simulator. This system will simulate the output of each camera system so that computer hardware and algorithms may be tested rigorously in the laboratory (and surrogate air frame) prior to the first flight.

UNCLASSIFIED



## 2. System / Subsystem Overview

- 2.1 Subsystem Overview**
- 2.2 Pointing Subsystem**
- 2.3 Acquisition Subsystem**
- 2.4 Tracking Subsystem**
- 2.5 Real Time Processor Subsystem (RTPS)  
and Surveillance Processor Subsystem  
(SPS)**

UNCLASSIFIED

The HALO Upgrade system / subsystem overview includes information on all of the prime mission equipment.

UNCLASSIFIED

## 2.1 Subsystem Overview

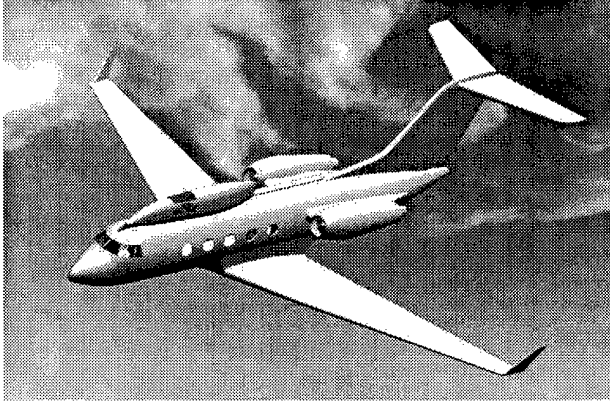

**Designed to meet current and future BMDO data collection requirements**

UNCLASSIFIED

**Major Subsystems**

- Pointing Subsystem
- Acquisition Subsystem
- Tracking Subsystem
- RTPS and SPS

### **MAJOR SUBSYSTEM FUNCTIONS**

#### Pointing Subsystem

- Open-port
- Horizon-to-horizon and below horizon

#### Acquisition Subsystem

- Two MWIR sensors, one visible sensor (~2 degree FOV)
- Filter wheels

#### Tracking Subsystem

- LWIR, MWIR and visible sensors (~ 0.3 degree FOV)
- Filter wheels

#### Real-Time Processor Subsystem

- 30 Hz radiometric data
- Digital storage (raw and processed)
- 100-1000 simultaneous sightings

#### Surveillance Processor Subsystem

- Angle-angle track generation
- Closed-loop tracking
- Real-time discrimination

The HALO Upgrade consists of a set of subsystems that will provide for an integrated open port sensor system. Subsystems will include the air vehicle itself, a pointing subsystem, acquisition subsystem, tracking subsystem, RTPS, and a SPS. The system will include six cameras and all necessary processing to provide real-time reduction to a quick-look data product and recording capabilities necessary to retain all data and meta-data from the six cameras and supporting activities.



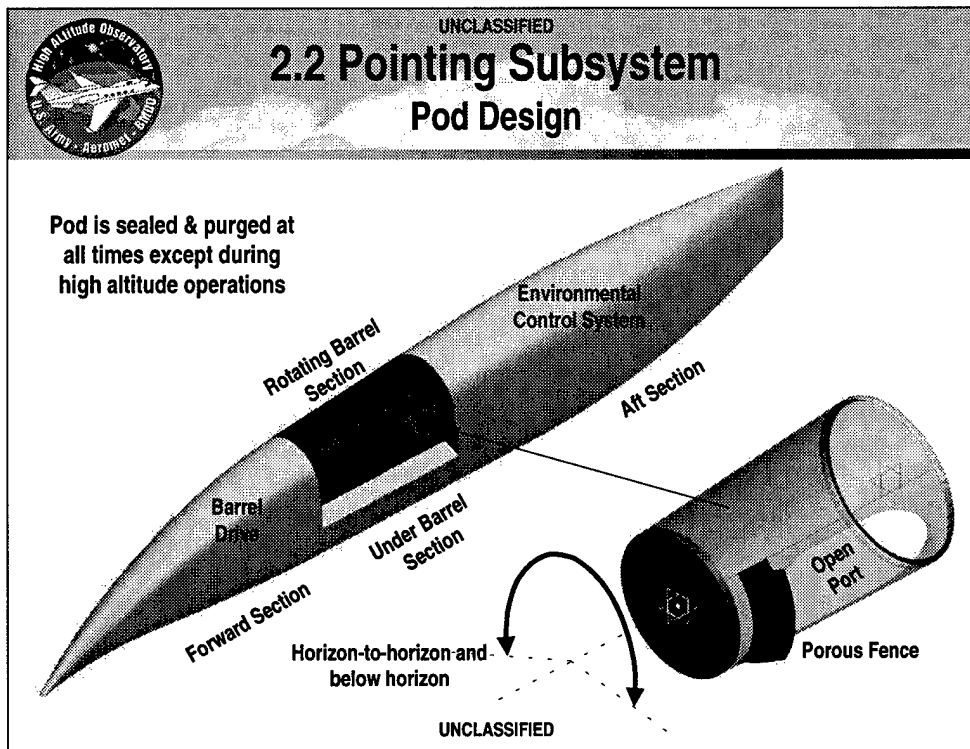

The HALO Upgrade incorporates an aerodynamic pod that contains the Pointing, Acquisition, and Tracking Subsystems. The pod is designed to house and protect the optical systems, provide favorable aerodynamic environment for open port viewing, manage the environment for the optical equipment, and minimize the impact on aircraft performance and handling qualities. Computational fluid dynamics (CFD) along with empirical knowledge was utilized to determine the optimal pod shape for various flight conditions and aircraft altitudes.

The open port flow control is optimized by controlling the shear layer development, entrainment of and reattachment by utilizing a leading ramp forward of the open port and providing an aft ramp. The leading ramp utilizes a 40% porous fence angled at 60 degrees. This guarantees controlled shear layer development and offsets the shear layer from the open port. The aft ramp provides a controlled shear layer reattach location and reduces pressure oscillations in the sensor cavity to minimize cavity resonance.

An environmental control management system (ECMS) is provided to assist with the stabilization of the optical path temperature, pre-cooling the optical path prior to take-off, and to provide conditioned air to prevent frosting of optics at altitude and minimize contamination of optical surfaces. The ECMS consists of a self sufficient unit that does not need to be recharged before each mission and can utilize minimal ground support equipment (standard electrical power and standard shop air).

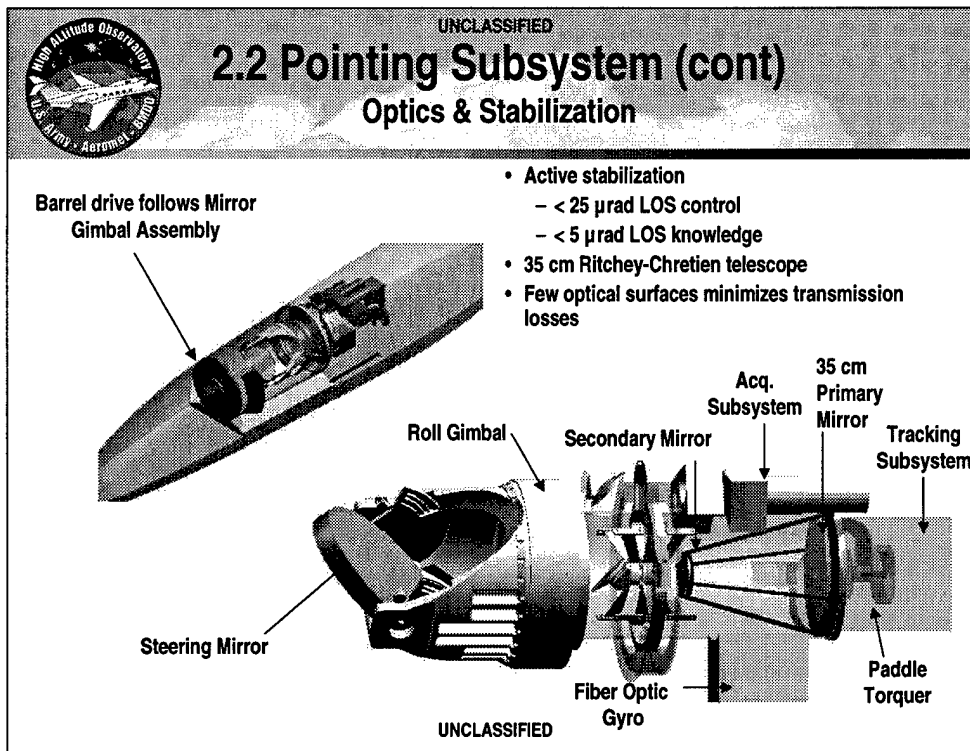

The pointing subsystem includes all of the components required to point and stabilize the target line-of-sight. These components include a steering mirror and roll gimbal to direct the line-of-sight. The optical bench (cylindrical tube) and associated components are mounted via a low friction spherical bearing at the center of gravity. This bearing is located immediately behind the central obscuration. A fiber optic gyro system is mounted on the optical bench to measure and provide pointing stabilization feedback. The system is actively stabilized using paddle-torquers. The active stabilization will allow for better than 25  $\mu$ rad line-of-sight control and better than 5  $\mu$ rad line-of-sight knowledge.

A 35 cm aperture, F/6 Ritchey-Chretien telescope design employing employing passive baffling to reduce background is mounted internally to the optical bench. The central obscuration will be used to mount the folding mirror for the acquisition subsystem cameras optical path. The central obscuration will also be the area for mounting the structure to the spherical bearing. This bearing will be between the folding mirror and the telescope secondary mirror.

The entire pointing system is directly aligned and calibrated via star sightings. The attitude reference unit is aligned to an earth centered inertial coordinate system (**ECI**). The inertial rate sensor rate biases, mirror gimbal alignment corrections and NFOV focal plane alignment corrections are estimated using stellar alignments.

UNCLASSIFIED

## 2.3 Acquisition Subsystem

### Optical Path and Subsystem Overview

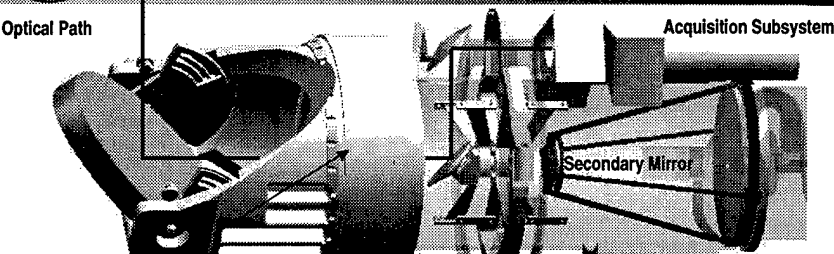

- > 1.5 degree field of view
- Integrated COTS cameras
- 6-position filter wheels for all cameras
- 2 MWIR cameras - 30 Hz frame rate
  - 320x256 InSb
  - 2 to 5  $\mu\text{m}$ , NEFD <  $1 \times 10^{-13}$  W/cm<sup>2</sup>
  - Closed cycle coolers
- Visible - 512 x 512 CCD

- Fiber-optic digital interfaces
  - Digital data (all sensors)
  - Digital command & control
    - √ Gain, gate, integration time
    - √ Filter wheel control, NUC
- On-board calibration sources
  - Hot / cold flood sources

UNCLASSIFIED

The acquisition subsystem consists of 3 sensors. These sensors include 2 medium wave infrared (MWIR) sensor and 1 visible sensor. The MWIR sensors are 320x256 InSb detector packages that utilize closed cycle coolers. The entire acquisition sensor package including six position filter wheels is located on the outside optical bench. The optical path of the acquisition system utilizes the central obscuration of the modified cassegrain (Ritchey-Chretien) telescope by placing a fold mirror on the front side of the obscuration. An additional fold mirror is utilized to direct the optical path into the acquisition subsystem where a series of beam-splitters direct the energy to the acquisition subsystem detectors. The field of view of the acquisition sensor subsystem is specified to be greater than 1.5 degrees with a system noise equivalent flux density (NEFD) of less than  $1 \times 10^{-13}$  W/cm<sup>2</sup>.

All camera digital data signals will be time-tagged and transferred to the in-cabin RTPS via a fiber optics digital interface.

The steering mirror can be directed down to view a hot/cold uniform flood-source to perform a pre-mission non-uniformity-correction (NUC).

UNCLASSIFIED

## 2.4 Tracking Subsystem

### Optical Path and Subsystem Overview

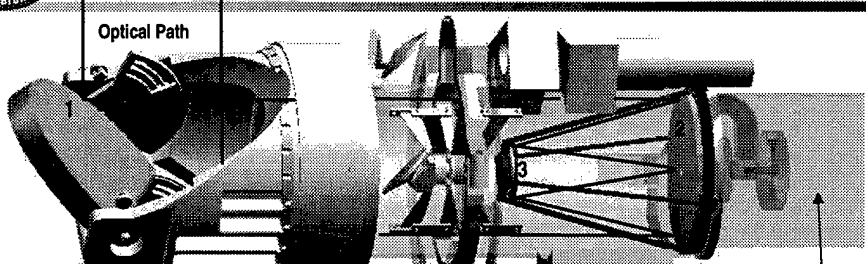

Optical Path

- 0.25 degree field of view
- Common/custom dewar for MWIR/LWIR
- Closed cycle coolers
- 6 position filter wheels for all sensors
- LWIR – 30 Hz frame rate
  - 256 x 256 HgCdTe SC 117 SCA
  - 8 to 12  $\mu\text{m}$ , NEFD  $\leq 1 \times 10^{-16}$  W/cm<sup>2</sup>
- MWIR – 30 Hz frame rate
  - 256x256 InSb AE 194 SCA
  - 2.5 to 5  $\mu\text{m}$ , NEFD  $\leq 1 \times 10^{-16}$  W/cm<sup>2</sup>
- Visible – 1024x1024 CCD using 2x2 binning

- Fiber-optic digital interfaces
  - Digital data (all sensors)
    - √ Gain, gate, integration time
    - √ Filter wheel control, NUC
- On-board calibration source
  - Hot/cold flood source

UNCLASSIFIED

The tracking subsystem provides the primary data collection sensors for the HALO upgrade system. These sensors include 1 MWIR sensor, 1 LWIR, and 1 visible sensor. The MWIR and LWIR sensors are located in a custom dewar termed the dual color infrared system (**DCIS**) located immediately behind the primary mirror. The MWIR sensor is a 256x256 InSb detector and the LWIR sensor is a 256x256 HgCdTe detector. The MWIR and LWIR detectors are located inside a custom dewar. Each detector has independent cold-fingers and associated cryo-coolers. The LWIR detector will be maintained at 55 degrees Kelvin and the MWIR detector will be maintained at 77 degrees Kelvin. The optical path of the tracking system utilizes the full 35 cm aperture of the Ritchey-Chretien telescope. The field of view of the tracking sensor subsystem is specified to be approximately 0.25 degrees with a system noise equivalent flux density (**NEFD**) of less than  $1 \times 10^{-16}$  W/cm<sup>2</sup>.

All camera digital data signals will be time-tagged and transferred to the in-cabin RTPS via a fiber optics digital interface.

The steering mirror can be directed down to view a hot/cold uniform flood-source to perform an infrared sensor non-uniformity-correction (**NUC**).

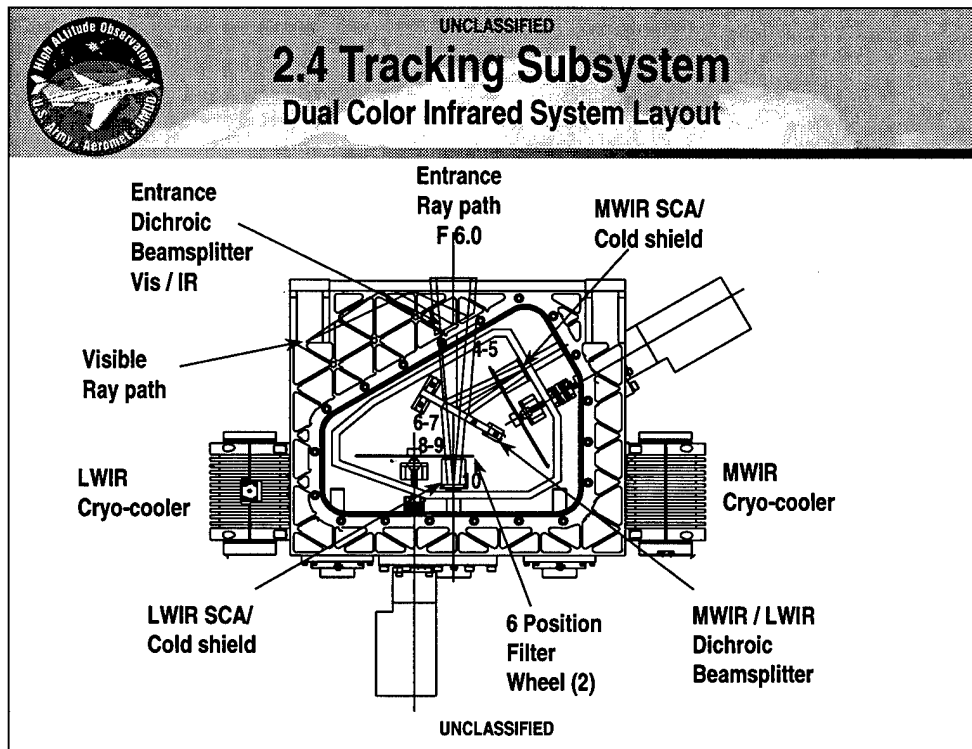

The DCIS is a custom dewar system whose entrance aperture is a dichroic visible / infrared beam splitter (dichroic beamsplitter #1). The visible energy at the entrance aperture dichroic is reflected to the tracking subsystem visible camera. The transmitted infrared energy is directed to a MWIR/LWIR beam splitter (dichroic beamsplitter #2) where the LWIR energy is transmitted and the MWIR energy is reflected.

Each detector contains a six position filter wheel with various band-passes. The six position filter wheel will nominally contain 5 bandpass filters and one blank for background measurements. The system is designed to minimize optical surfaces while maximizing transmission to the infrared detectors. The background radiation is minimized using individual detector cold shields and also using cold baffling. The inner walls are at a temperature of 155K for reducing background.

UNCLASSIFIED

## 2.5 RTPS/SPS System Overview

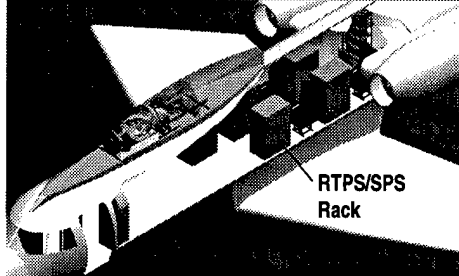
- High Performance
  - 4 GFLOPS processing power
  - 12 AltiVec G4 processors
  - 900 Gbytes RAID-3 digital storage
    - √ 1 hour data storage (raw & processed)
  - 18-inch flat touch-panel displays
  - Fiber-optic data channels

- Real time processor functions
  - Target identification
  - Conversion to radiometric units at 30 Hz
- Surveillance processor functions
  - Track options
    - √ External queue for initial acquisition
    - √ Manual track
    - √ Angle-angle track generation
    - √ Closed loop track function
  - Spare processing (real-time discrimination)
  - Track generation algorithm



UNCLASSIFIED

The HALO Upgrade acquisition and tracking sensors will interface to a high speed digital processing and storage system located in the aircraft cabin. The processing subsystems are divided into logical systems including a RTPS and a SPS. The RTPS will interface directly to the in-pod camera subsystems and provide real-time target identification, sensor background estimation and removal, radiometric calibration, frame to frame detection associations, utilization of stabilized LOS track angles and pixel locations to form a highly accurate sensor angle-angle target track history. In addition, the RTPS will permit human-in-the-loop improvements such as intelligent target selection. A SPS will provide computer sizing for future algorithm development such as launch detection determination, missile type and payload assessment, missile tracking and trajectory estimates, lethal object discrimination, target object map, impact point prediction, impact detection, and kill assessment.

The HALO Upgrade hardware includes a Mercury 9U chassis with 12 AltiVec G4 processors and various I/O interface cards. The Mercury system performs command and control to all of the pod sensors as well as receive all of the sensor data via a fiber optic interface. Both raw and processed digital data is stored to a redundant array of independent disk (**RAID**) system. The RTPS also interfaces to the pointing and stabilization system and has the capability to perform closed loop track.

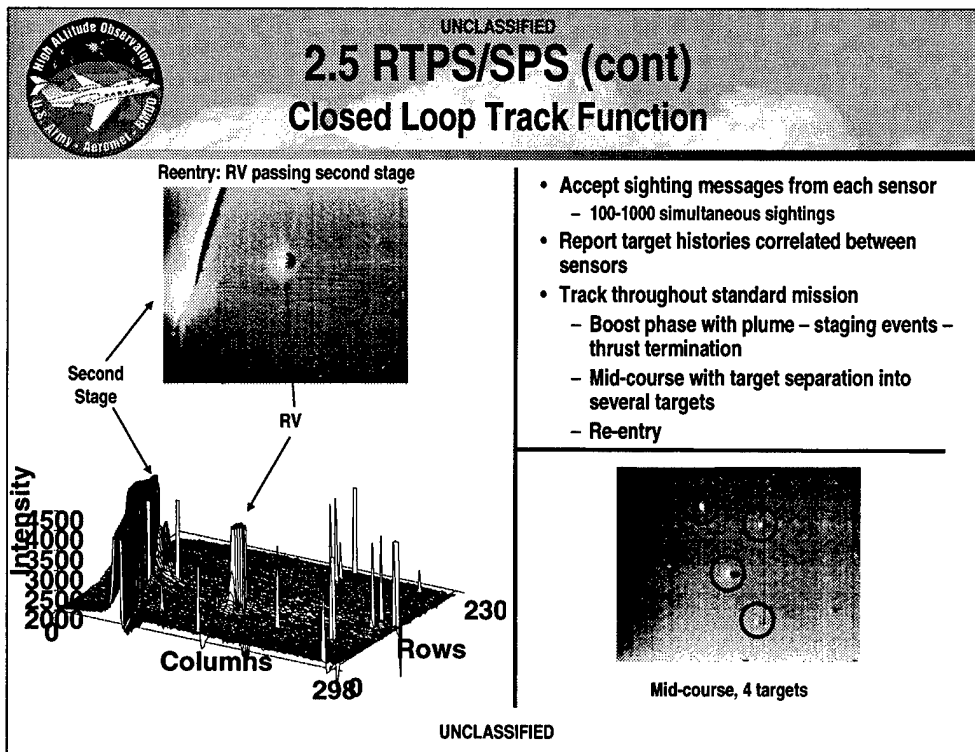

A closed loop track function will reside in the SPS and provide pointing control information to the pointing subsystem. These function will accept up to 1000 simultaneous messages from each sensor. The tracking operator can select computer highlighted target(s) to place in a closed loop track. The closed loop tracking function utilizes all sensor wave-bands (visible through LWIR) to assist in maintaining a closed loop track. The track function is intelligent enough to track through a standard ballistic missile launch including boost phase (plume, staging events, thrust termination), mid-course with target separation into several targets, and re-entry.

As pointing messages are received, the closed-loop-track function logs the pointing message into a history file to allow extrapolation from the last pointing data to the current time. Upon receipt of a sighting message, a current pointing estimate is determined using the pointing history file. The current pointing estimate, together with current camera values are used to transform location data for each target from pixel coordinates to LOS coordinates. Once the targets are in LOS coordinates, they are correlated with existing target tracks. If no correlation exists, a new track is initiated. Target object maps (**TOMs**) are built for current sensor including correlation with observations from other sensors. A closed-loop algorithm updates the position of the primary target or target complex, or selects a new primary target if required. The closed-loop algorithm will then generate a pointing error for the manage mirror function (**MMF**). An operator specified LOS offset and dithering, if requested, are applied to the primary target position and an error signal is generated and sent to the MMF.

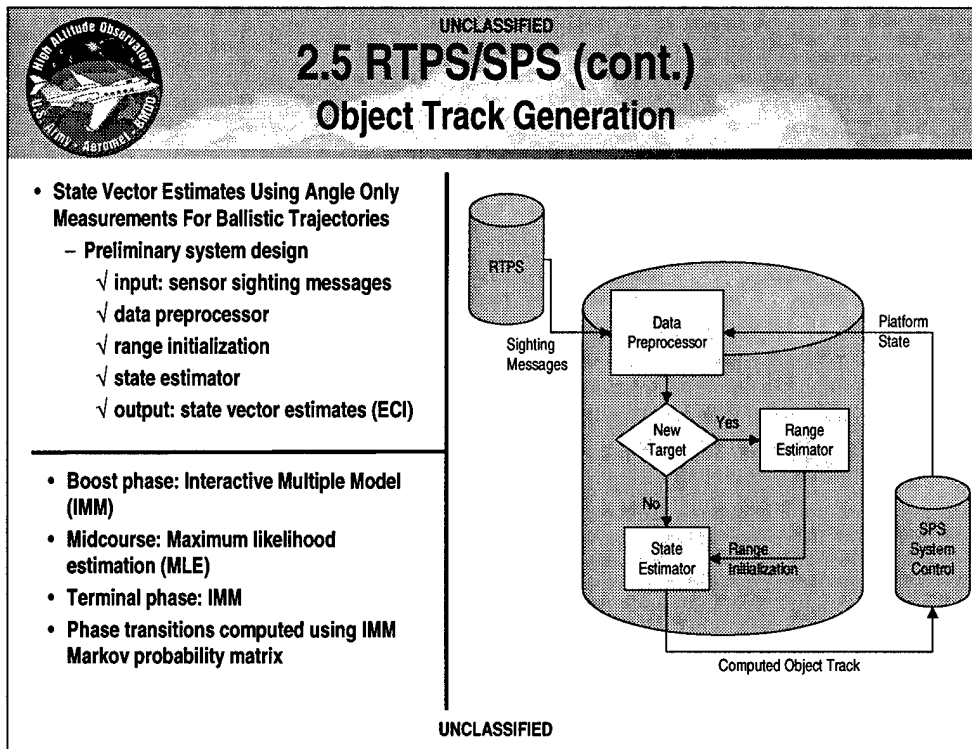

The SPS object track generate function receives sighting messages from the RTPS and provides a state vector estimate using angle only measurements for ballistic trajectories. The data preprocessor will sort sighting messages to determine if a new target has been identified and provide the sighting message to the range estimator function upon identification. The range estimation function will perform a modified Laplace method for more than three observation, energy constrained technique (a priori knowledge of energy of missile trajectory), geo-location from launch point, and monocular passive ranging (boost phase objects). A sufficient number of range estimates are calculated for initialization of the state estimator function. The object track generation track filter architecture utilizes interactive multiple model (IMM) for boost phase, maximum likelihood estimation (MLE) for midcourse, IMM for terminal phase, and IMM Markov probability matrix for phase transitions.



UNCLASSIFIED



### 3. HALO Upgrade Capabilities

- **3.1 Subsystem Performance**
- **3.2 Improved Operational Capability**
- **3.3 System Sensitivity**

UNCLASSIFIED

The HALO aircraft has historically provided reliable and important data to the BMDO user community. This has been achieved by viewing targets through optical windows located in special frames modified to interface to the Gulfstream standard windows. This method was effective, but significantly limited the sensor systems FOR, sensor aperture, and sensitivity (limited by window transmission). This section will provide an overview of the sensor system specifications, the improved operational capability associated with a larger FOR, the improved system sensitivity, and improved capabilities for HALO data collection to support NMD systems development.

UNCLASSIFIED	
 <h2 style="text-align: center;">3.1 Subsystem Planned Performance</h2>	
Item	Planned Performance
Field of Regard	Azimuth: +20 degrees to -35 degrees from aircraft abeam Elevation: -10 degrees through Zenith to -10 degrees
Optical Performance	35 cm Ritchey-Chretien Open Port Telescope (Diffraction Limited Performance at 4 microns) NFOV: >0.25 degrees
Tracking Sensors (Using primary telescope optical path)	0.25 degree FOV (All cameras frame at 30 fps and have spectral selectivity via 6 position filter wheels) LWIR: 256x256 HgCdTe, <1x10 <sup>-16</sup> W/cm <sup>2</sup> from 8 to 12 microns MWIR: 256x256 InSb, < 1x10 <sup>-16</sup> W/cm <sup>2</sup> from 2.5 to 5 microns Visible: 1,000 x 1,000 CCD with 2x2 pixel binning
Acquisition Sensors (Optical path using telescope central obscuration)	>1.5 degree FOV (All detectors have spectral selectivity via 6 position filter wheels) MWIR 1: 320x256 InSb, <1x10 <sup>-13</sup> W/cm <sup>2</sup> from 2 to 5 microns MWIR 2: 320x256 InSb, < 1x10 <sup>-13</sup> W/cm <sup>2</sup> from 2 to 5 microns Visible: 1,000 x 1,000 CCD with 2x2 pixel binning
Real Time Surveillance Processor / Surveillance Processor Subsystem	4 GFLOPS , 12 Altivec Processors, 900 GBytes RAID-3 Storage >1 Hour Data Storage (Raw & Processed data from all cameras) Touch Panel Displays, Fiber optical interfaces
Pointing and Stabilization	Determine sensor line-of-sight within 5 microradians Control LOS position within < 25 microradians Bandwidth: ≥ 50 Hz / Active and passive stabilization to minimize line-of-sight jitter.
UNCLASSIFIED	

The system specification for field of regard, optical performance, tracking sensors, acquisition sensors, RTPS/SPS, and pointing/stabilization are provided.

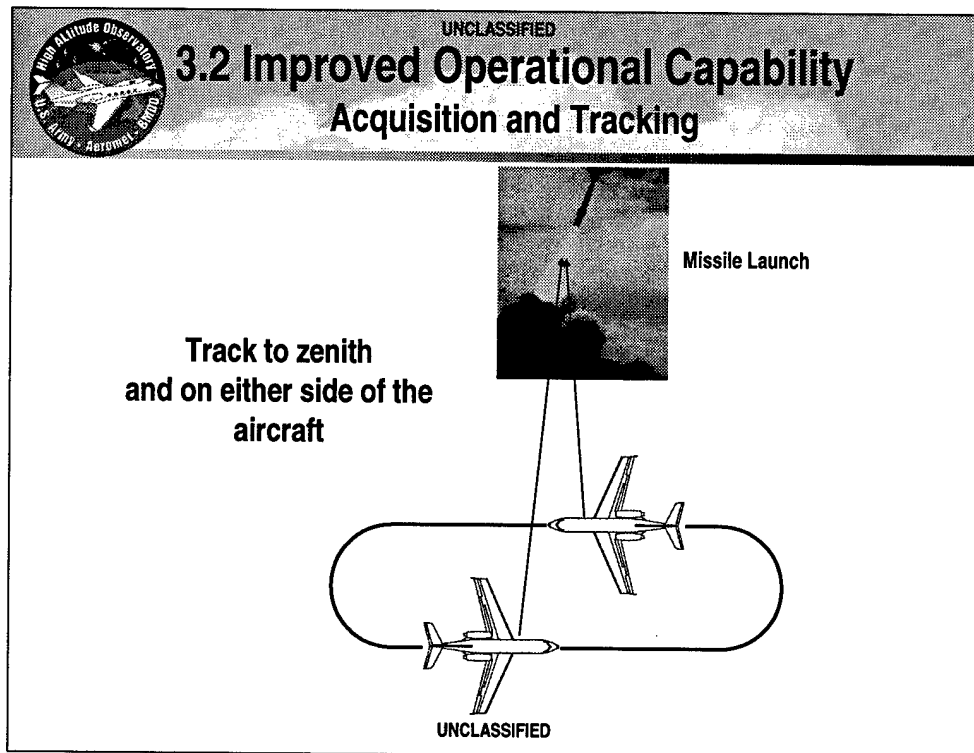

The HALO Upgrade rotating barrel concept provides significant improvement for target acquisition and tracking. The tracking system will allow for target acquisition on either side of the aircraft. This will allow for initial acquisition to take place on either side of the holding pattern significantly reducing the risk of missing important data due to the aircraft not being in position to allow the sensor systems to acquire and track the target.

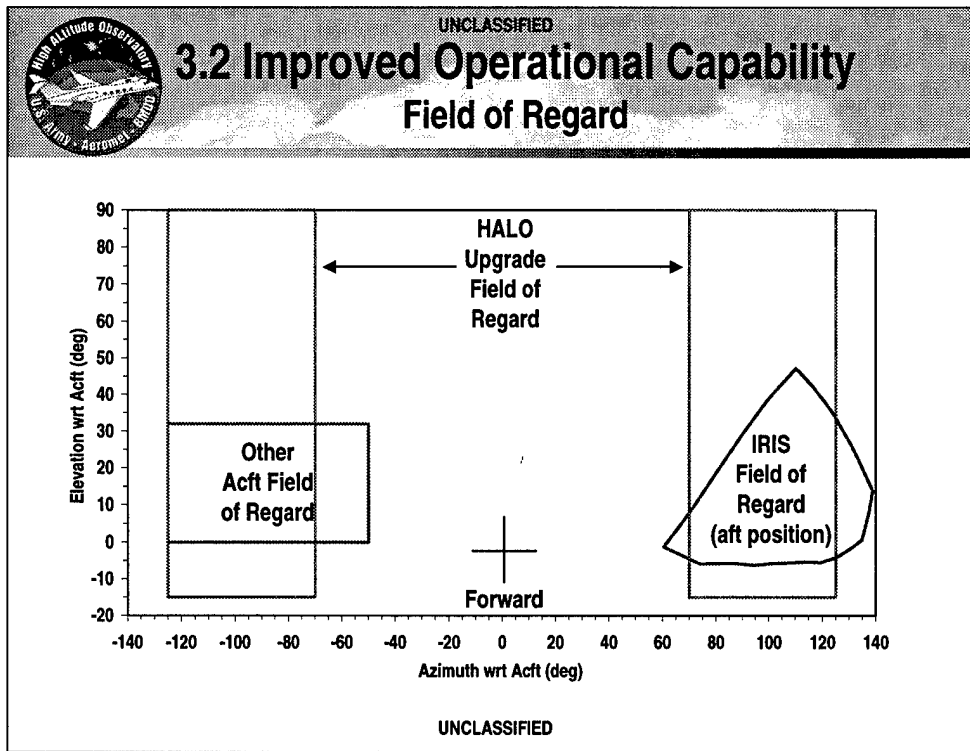

The chart graphical depicts the HALO Upgrade field of regard. The horizontal axis represents the azimuth from the nose of the aircraft (0 degrees) with the vertical axis representing elevation angle (0 degrees at wing level to +90 degrees at zenith). The infrared instrumentation system (IRIS) field of regard and other aircraft field of regard are provided for reference.

The ability to track targets at high elevation angles, on both sides of the aircraft, and at angles directly above the aircraft provides a significant advantage for mission planning. This system will allow a constant track to be maintained on TMD targets that have high lofted trajectories similar to the HERA missile at White Sands Missile Range. In addition, the system will greatly improve slant range and tracking capabilities for NMD targets similar to the EKV targets at Kwajalein Missile Range (KMR).

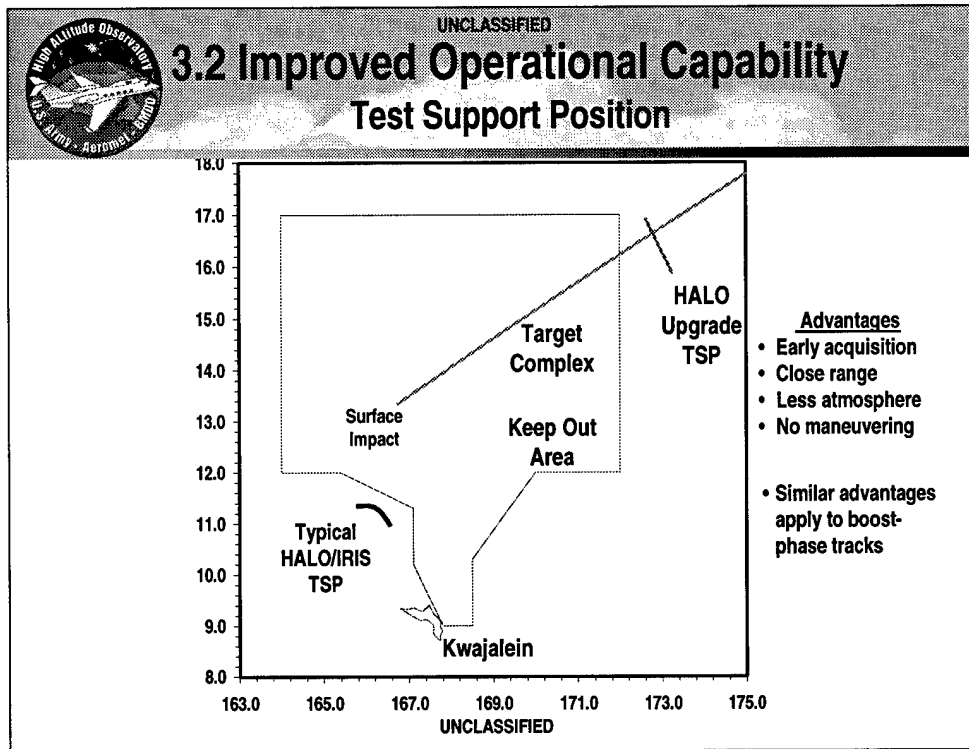

This chart depicts the HALO Upgrade's improved operational capability or flexibility to position the aircraft to collect data on NMD type targets. The traditional HALO/IRIS test support position (TSP) was limited by 45 degree uplooking elevation angle. This required increasing slant range to allow for target complexes at high altitude to be maintained in the sensor field of regard. The typical in-cabin sensor TSP is depicted in the diagram on the southwest corner of the KMR keepout area. The HALO upgrade will allow for TSPs significantly uprange as depicted in the TSP provided on the northeast side of the KMR keepout area. This will allow for significantly earlier target acquisition associated with the closer slant range, improved atmospheric transmission, and reduced risk because no aircraft maneuver (bank aircraft to improve elevation angle acquisition) is required.

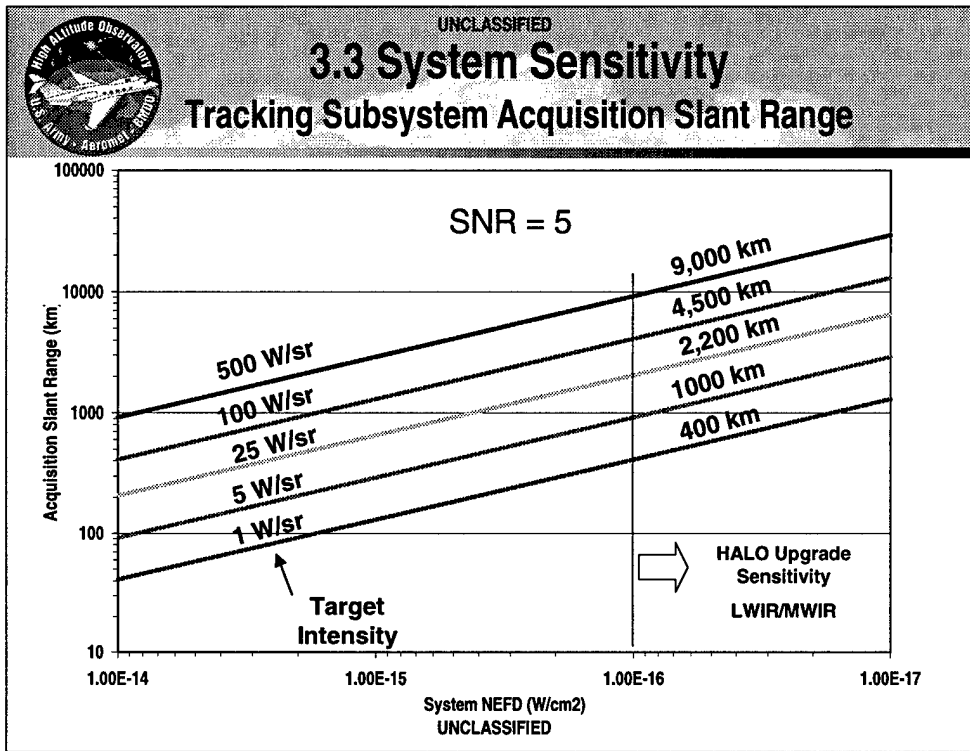

This chart depicts the acquisition slant range for the tracking subsystem MWIR and LWIR cameras. Both sensors are specified to have an NEFD of less than  $1 \times 10^{-16}$  W/cm<sup>2</sup>. An signal to noise ratio (SNR) of 5 is assumed adequate for initial target acquisition. The acquisition slant ranges are provided for targets of varying intensity including 1 W/sr through 500 W/sr targets.



UNCLASSIFIED

## 4. Technology Development For Ballistic Missile Surveillance

**4.1 Applications**

**4.2 Potential Follow-on Paths**

UNCLASSIFIED

As well as providing significant improvements to meeting the BMDO domestic data collection requirements, the HALO upgrade provides significant opportunities for technology development and risk reduction for potential follow-on programs.

UNCLASSIFIED



## 4.1 Applications

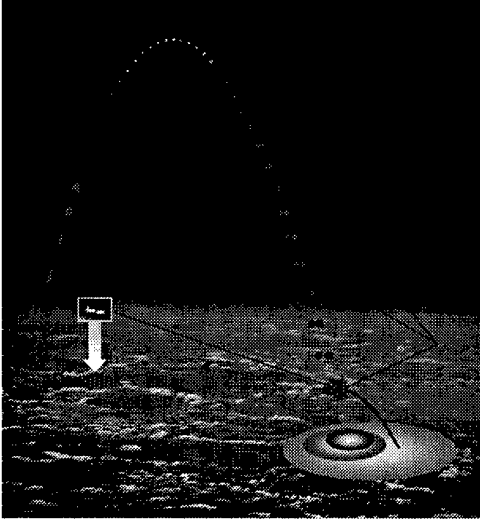

- Remote Sensing at Slant Ranges > 500 km
- Large Aperture E/O Sensors
- Integration of Sensor On Mobile Platform
- High Speed Data Processing

Technology  Development

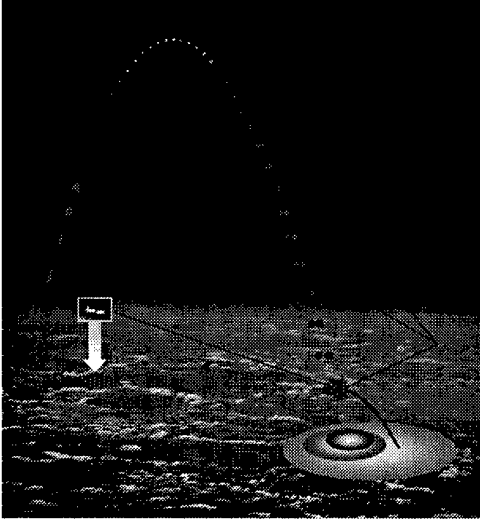

- Reconnaissance
- Direct Tactical Support (DTS)
- Perpetual Surveillance (PS)

UNCLASSIFIED

The HALO Upgrade has the capability to develop prototype and develop technology for emerging technologies. These include applying and fusing three emerging classes of technology -- electro-optical surveillance sensors, C4 systems, and high-altitude long-endurance air vehicles -- offers an innovative means to carry out three important unfulfilled missions within ballistic missile surveillance: 1) Reconnaissance, 2) Direct Tactical Support (**DTS**), and 3) Perpetual Surveillance (**PS**). The greatest opportunity of this approach is the potential to apply the same fundamental solution to all three of these critical missions and thereby realize economies of scale, affordable and rapid deployment, mission interoperability, and on-demand fleet size scalability.



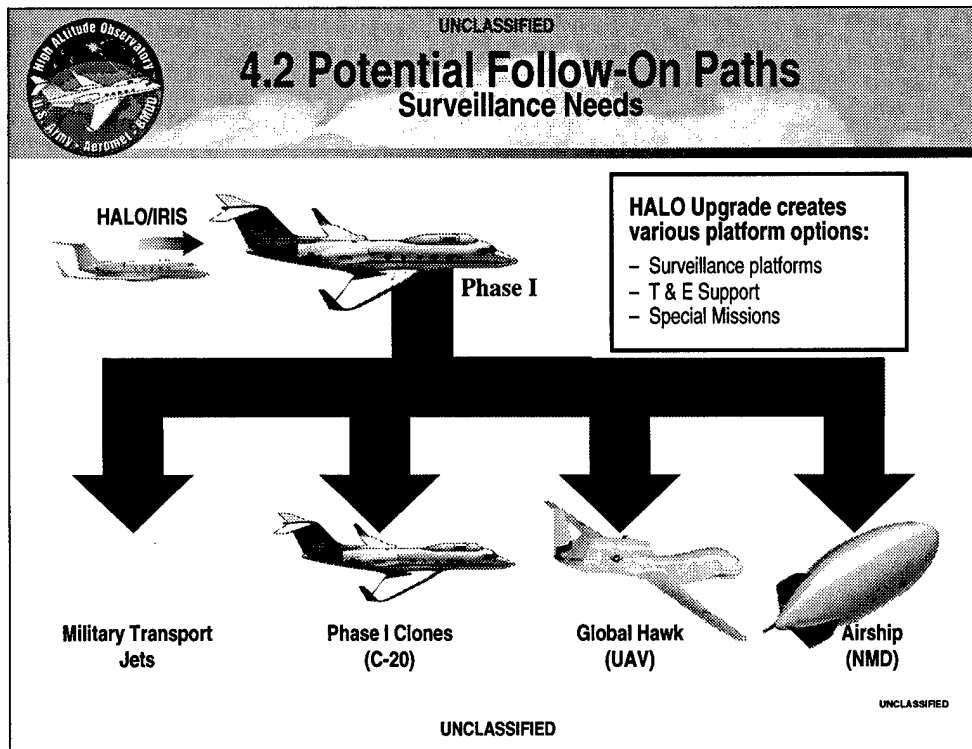

This HALO Upgrade sensor technology utilizes scalable architecture, and can be easily transferred to other air vehicles. These include a number of air vehicles including high-altitude long-endurance business jets, military transport jets, high-altitude long-endurance unmanned air vehicles (**UAVs**), and high-altitude airships. The HALO Upgrade will assist in prototyping and risk reduction for technical evaluation including sensor development and performance, overall system technology, and air vehicle performance.

UNCLASSIFIED

## 5. Conclusion

Designed to meet current and future BMDO data collection requirements\*



\* BMDO requirement for high-resolution aim-point selection data requires fly-along sensor package (FASP)

### Features

- Low development cost
- Low annual O&M cost
- System Exceeds MWIR & LWIR Sensitivity Requirements
- Large field of regard
- Multiple sensor
- Filter selectivity
- Real-time radiometry
- Real-time track generation
- Processors sized for algorithm development
- NMD risk reduction
- Higher altitude performance
- Minimal ground support
- Accommodates guest sensors

UNCLASSIFIED

The HALO Upgrade provides significantly improved data collection capability for relatively low development and O&M cost. The system exceeds the required MWIR and LWIR BMDO sensitivity requirements and is designed to allow for significantly improved mission planning logistics. This is accomplished via the rotating barrel design which allows targets to be tracked on both sides of the aircraft including objects located at the aircraft zenith. The system is designed to require minimal ground support and provide world wide operation for a wide range of BMDO tests.