

**Final Report**

30 July 1996



**OptiMETRICS, INC.**  
*Research & Engineering*

**GROUND VEHICLE SYSTEM  
(GVS) INTEGRATION AND  
DESIGN OPTIMIZATION MODEL**

*Prepared For:*

U.S. Army Tank-automotive and Armaments Command  
Warren, MI 48397-5000

Under Contract No: DAAE07-95-C-R076  
CDRL: A002

*Prepared By:*

William D. Horton

19990318 061



**OptiMETRICS, INC.**  
3115 Professional Drive  
Ann Arbor, MI 48104-5131

**DTIC QUALITY INSPECTED 4**

# REPORT DOCUMENTATION PAGE

*Form Approved*  
OMB No. 0704-0188

Public reporting burden for this collection of information is estimated to average 1 hour per response, including the time for reviewing instructions, searching existing data sources, gathering and maintaining the data needed, and completing and reviewing the collection of information. Send comments regarding this burden estimate or any other aspect of this collection of information, including suggestions for reducing this burden, to Washington Headquarters Services, Directorate for Information Operations and Reports, 1215 Jefferson Davis Highway, Suite 1204, Arlington, VA 22202-4302, and to the Office of Management and Budget, Paperwork Reduction Project (0704-0188), Washington, DC 20503.

1. AGENCY USE ONLY (Leave Blank)	2. REPORT DATE July 1996	3. REPORT TYPE AND DATES COVERED Final 20 June 1995-30 June 1996	
4. TITLE AND SUBTITLE Ground Vehicle System Integration (GVSI) and Design Optimization Model		5. FUNDING NUMBERS  DAAE07-95-C-R076	
6. AUTHOR(S)  William D. Horton		8. PERFORMING ORGANIZATION REPORT NUMBER  OMI-574	
7. PERFORMING ORGANIZATION NAME(S) AND ADDRESS(ES) OptiMetrics, Inc. 3115 Professional Drive Ann Arbor, MI 48104-5131			
9. SPONSORING/MONITORING AGENCY NAME(S) AND ADDRESS(ES) U.S. Army Tank-automotive and Armaments Command Warren, MI 48397-5000		10. SPONSORING/MONITORING AGENCY REPORT NUMBER	
11. SUPPLEMENTARY NOTES			
12a. DISTRIBUTION/AVAILABILITY STATEMENT  Approved for public release; distribution is unlimited		12b. DISTRIBUTION CODE	
13. ABSTRACT (Maximum 200 words)  <p>This report documents the Ground Vehicle System Integration (GVSI) and Design Optimization Model. GVSI is a top-level analysis tool designed to support engineering tradeoff studies and vehicle design optimization efforts. The model uses simplified functional and parametric relationships to evaluate system performance issues. GVSI's primary function is to illustrate the dependence of various system and subsystem functions; the goal is to provide a better understanding how a change in the performance of one subsystem affects the rest of the vehicle.</p> <p>The GVSI development focused on definition of an architecture that links vehicle functions at the system, subsystem, and component levels. The process first defined a Ground Combat Vehicle (GCV) in terms of four major functions: Lethality, Survivability, Mobility, and Sustainability. An in-depth analysis of each function followed and identified critical performance parameters and relationships. This process also supported development of functional expressions, identified common input and output parameters, and established linkages between multiple system and subsystem functions.</p> <p>GVSI resulted from a Small Business Innovative Research (SBIR) proposal submitted to the US Army Tank-automotive and Armaments Command (TACOM) in June 1995. This report and delivery of the prototype model to the Government complete the Phase I SBIR program.</p>			
14. SUBJECT TERMS System Analysis                      Modeling Ground Vehicles                      Trade Off Analysis		15. NUMBER OF PAGES 85	16. PRICE CODE
17. SECURITY CLASSIFICATION OF REPORT UNCLASSIFIED	18. SECURITY CLASSIFICATION OF THIS PAGE UNCLASSIFIED	19. SECURITY CLASSIFICATION OF ABSTRACT UNCLASSIFIED	20. LIMITATION OF ABSTRACT UNLIMITED

## TABLE OF CONTENTS

EXECUTIVE SUMMARY .....	1
1.0 INTRODUCTION .....	2
1.1 GVSI OVERVIEW .....	2
1.2 OBJECTIVE .....	3
1.3 MODEL APPROACH .....	3
1.4 MODEL LIMITATIONS .....	4
1.5 REPORT STRUCTURE .....	5
1.6 REFERENCES .....	5
2.0 GROUND VEHICLE REPRESENTATION IN GVSI .....	7
2.1 FUNCTIONAL DEFINITION .....	7
2.1.1 OVERVIEW .....	7
2.1.2 GCV FUNCTIONS .....	7
2.2 LETHALITY .....	8
2.2.1 TARGET ACQUISITION .....	9
2.2.2 FIRE CONTROL .....	10
2.2.3 WEAPON SYSTEM .....	10
2.2.4 SWEEP VOLUME .....	10
2.2.5 SUMMARY OF LETHALITY FUNCTIONS .....	11
2.3 SURVIVABILITY .....	12
2.3.1 THREATS .....	12
2.3.2 SYSTEM SURVIVABILITY .....	13
2.3.3 SUMMARY .....	15
2.4 MOBILITY .....	15
2.4.1 MOBILITY DRIVERS .....	15
2.4.2 MOBILITY CHARACTERISTICS .....	15
2.4.3 SUMMARY .....	16
2.5 SUSTAINABILITY .....	17
2.5.1 RELIABILITY, AVAILABILITY, AND MAINTAINABILITY .....	17
2.5.2 CONSUMPTION OF EXPENDABLES .....	17
2.5.3 HUMAN FACTORS .....	18
2.5.4 SUMMARY .....	18
2.6 SYSTEM REPRESENTATION SUMMARY .....	19
3.0 LETHALITY .....	20
3.1 FUNCTIONAL REPRESENTATION .....	20
3.2 TARGET ACQUISITION SYSTEM .....	20
3.2.1 APPROACH TO CHANGING TARGET ACQUISITION .....	20
3.2.2 SYSTEM IMPACT .....	20
3.2.3 OTHER IMPACTS .....	23
3.3 FIRE CONTROL SYSTEM .....	25
3.3.1 APPROACH TO CHANGING PERFORMANCE .....	25
3.3.2 SYSTEM IMPACT .....	29
3.3.3 OTHER IMPACTS .....	30
3.4 WEAPON SYSTEM .....	31
3.4.1 APPROACH TO CHANGING PERFORMANCE .....	31
3.4.2 SYSTEM IMPACT .....	32
3.4.3 OTHER IMPACTS .....	32
3.5 SWEEP VOLUME .....	33
3.5.1 APPROACH TO CHANGING PERFORMANCE .....	33

3.5.2 SYSTEM IMPACT .....	34
3.5.3 OTHER IMPACTS.....	34
4.0 SURVIVABILITY .....	36
4.1 FUNCTIONAL REPRESENTATION.....	36
4.2 SUSCEPTIBILITY REDUCTION.....	36
4.2.1 DETECTION AVOIDANCE .....	36
4.2.2 HIT AVOIDANCE.....	43
4.3 VULNERABILITY REDUCTION.....	48
4.3.1 PENETRATION AVOIDANCE.....	48
4.3.2 KILL AVOIDANCE .....	49
5.0 MOBILITY .....	52
5.1 FUNCTIONAL REPRESENTATION .....	52
5.2 SPEED .....	52
5.3 ACCELERATION .....	55
5.4 MAXIMUM GRADE.....	56
5.5 TURNING RADIUS .....	58
5.6 GROUND PRESSURE.....	60
5.7 CROSS COUNTRY MOBILITY .....	62
6.0 SUSTAINABILITY.....	64
6.1 FUNCTIONAL REPRESENTATION .....	64
6.2 RELIABILITY, AVAILABILITY, AND MAINTAINABILITY (RAM) .....	64
6.2.1 FUNCTIONAL REPRESENTATION.....	64
6.2.2 APPROACH TO CHANGING PERFORMANCE.....	64
6.2.3 SYSTEM IMPACT .....	65
6.2.4 OTHER IMPACTS.....	65
6.3 CONSUMPTION OF EXPENDABLES .....	65
6.3.1 AMMUNITION CONSUMPTION .....	65
6.3.2 FUEL CONSUMPTION.....	65
6.4 HUMAN FACTORS .....	66
6.4.1 FUNCTIONAL REPRESENTATION.....	66
6.4.2 APPROACH TO CHANGING PERFORMANCE.....	66
6.4.3 SYSTEM IMPACT .....	66
6.4.4 OTHER IMPACTS.....	67
7.0 GVSI IMPLEMENTATION.....	68
7.1 OVERVIEW.....	68
7.2 GVSI OPERATION.....	68
7.2.1 MODEL STRUCTURE.....	68
7.2.2 SCREEN DISPLAYS .....	69
7.2.3 GVSI OPERATION.....	71
8.0 CONCLUSIONS .....	73
8.1 SUMMARY.....	73
8.2 RECOMMENDATIONS.....	73
APPENDIX A - END NOTES .....	74
APPENDIX B -OPERATING INSTRUCTIONS.....	76

## LIST OF ILLUSTRATIONS

FIGURE 1. THE VEHICLE DESIGN PROBLEM.....	2
FIGURE 2. GVSİ DEVELOPMENT PROCESS.....	3
FIGURE 3. GCV FUNCTIONAL REPRESENTATION. ....	7
FIGURE 4. LETHALITY CHARACTERISTICS.....	9
FIGURE 5. IMPACT OF CHANGING SIGHT APERTURES. ....	9
FIGURE 6. SWEEP VOLUME IMPACT.....	11
FIGURE 7. A LAYERED APPROACH TO VEHICLE SURVIVABILITY.....	13
FIGURE 8. MOBILITY CHARACTERISTICS. ....	16
FIGURE 9. SUSTAINABILITY CHARACTERISTICS. ....	17
FIGURE 10. IMPACT OF CHANGING OPTICAL APERTURES. ....	22
FIGURE 11. EFFECT OF CHANGING SIZE OF OPTICAL APERTURES. ....	23
FIGURE 12. SYSTEM IMPACT OF CHANGING TARGET ACQUISITION (SIZE AND WEIGHT) ..	24
FIGURE 13. TARGET RECTANGLE.....	25
FIGURE 14. TARGET REPRESENTATION IN POLAR COORDINATES. ....	26
FIGURE 15. SWEEP VOLUME.....	33
FIGURE 16. POTENTIAL SIGNATURE MANAGEMENT APPLICATIONS.....	40
FIGURE 17. SURVIVABILITY PAYOFF VERSUS SIGNATURE REDUCTION. ....	41
FIGURE 18. SCENARIO FOR EVASIVE MANEUVERS.....	45
FIGURE 19. CONSIDERATIONS FOR MAXIMUM GCV ROAD SPEED.....	54
FIGURE 20. MAXIMUM GRADE REPRESENTATION.....	57
FIGURE 21. VEHICLE TURNING RADIUS. ....	59
FIGURE 22. GVSİ STRUCTURE. ....	68
FIGURE 23. GVSİ SCREEN DISPLAYS. ....	69
FIGURE 24. LETHALITY SCREEN DISPLAY.....	70
FIGURE 25. SURVIVABILITY SCREEN DISPLAY.....	70
FIGURE 26. MOBILITY SCREEN DISPLAY.....	71

## LIST OF TABLES

TABLE 1.	VOLUMETRIC DIVISION OF A TYPICAL BATTLE TANK .....	4
TABLE 2.	LETHALITY IMPACTS ON GCV PERFORMANCE .....	11
TABLE 3.	THREATS TO GROUND COMBAT VEHICLES .....	12
TABLE 4.	GCV SURVIVABILITY MEASURES AND APPLICATIONS .....	14
TABLE 5.	GCV SURVIVABILITY APPROACH VERSUS THREAT .....	14
TABLE 6.	SURVIVABILITY IMPACTS ON VEHICLE DESIGN.....	15
TABLE 7.	MOBILITY IMPACTS ON GCV PERFORMANCE.....	16
TABLE 8.	SUSTAINABILITY IMPACTS ON GCV PERFORMANCE.....	18
TABLE 9.	GCV SYSTEM FUNCTIONS AND PERFORMANCE CHARACTERISTICS.....	19
TABLE 10.	IMPACT OF SIZE REDUCTION ON BLUE VEHICLE LOSSES .....	37
TABLE 11.	IMPACT OF SIGNATURE REDUCTION ON GCV LOSSES.....	41
TABLE 12.	SURVIVABILITY IMPROVEMENT FOR SIGNATURE REDUCTION.....	42
TABLE 13.	SURVIVABILITY IMPACT OF EVASIVE MANEUVERS .....	44
TABLE 14.	SURVIVABILITY IMPACT OF COUNTERMEASURES .....	47
TABLE 15.	COUNTERMEASURE EFFECTIVENESS VERSUS % BLUE LOSSES .....	47
TABLE 16.	TYPICAL VALUES FOR ENGINE AND POWER TRANSFER EFFICIENCY .....	52
TABLE 17.	TYPICAL VALUES FOR ROLLING RESISTANCE .....	53
TABLE 18.	TYPICAL VALUES FOR $\Theta$ .....	53

## **EXECUTIVE SUMMARY**

This report documents the Ground Vehicle System Integration (GVSI) and Design Optimization Model. GVSI is a top-level analysis tool designed to support engineering tradeoff studies and vehicle design optimization efforts. The model uses simplified functional and parametric relationships to evaluate system performance issues. GVSI's primary function is to illustrate the dependence of various system and subsystem functions; the goal is to provide a better understanding how a change in the performance of one subsystem affects the rest of the vehicle.

The GVSI development methodology focused on definition of a model architecture that links vehicle functions at the system, subsystem, and component level. The process first defined a Ground Combat Vehicle (GCV) in terms of four major functions: Lethality, Survivability, Mobility, and Sustainability. An in-depth analysis of each function followed and identified critical performance parameters and relationships. This process also supported development of functional expressions, identified common input and output parameters, and established performance linkages between multiple system and subsystem functions.

This report describes GVSI development, identifies performance relationships among GCV functions, and defines the model structure. It also documents the interrelationships among system, subsystem, and component performance characteristics. Appendices provide a list of references, operating instructions for a limited model prototype, and the prototype model software.

This project resulted from a Small Business Innovative Research (SBIR) proposal submitted to the US Army Tank-automotive and Armaments Command (TACOM) in June 1995. The Contracting Officer's Technical Representative was Mr. James Overholt, who is assigned to the Modeling and Simulation Group at the TACOM Research, Development, and Engineering Center (TARDEC). This report, and delivery of the prototype GVSI model to the Government, complete delivery requirements of the Phase I SBIR program.

## 1.0 INTRODUCTION

### 1.1 GVSI OVERVIEW

The design of a ground combat system is a constant effort to balance subsystem performance, capabilities, and interactions. System engineers faced with the need to optimize ground system functions often encounter situations where they must trade off performance in one area without fully understanding the impact that design change has on the rest of the system (Figure 1). A number of high resolution engineering models simulate discrete vehicle performance characteristics and evaluate performance at the subsystem level, but there is no simple model to support analyses of the system-level impacts of interactions among multiple vehicle functions and subsystems.

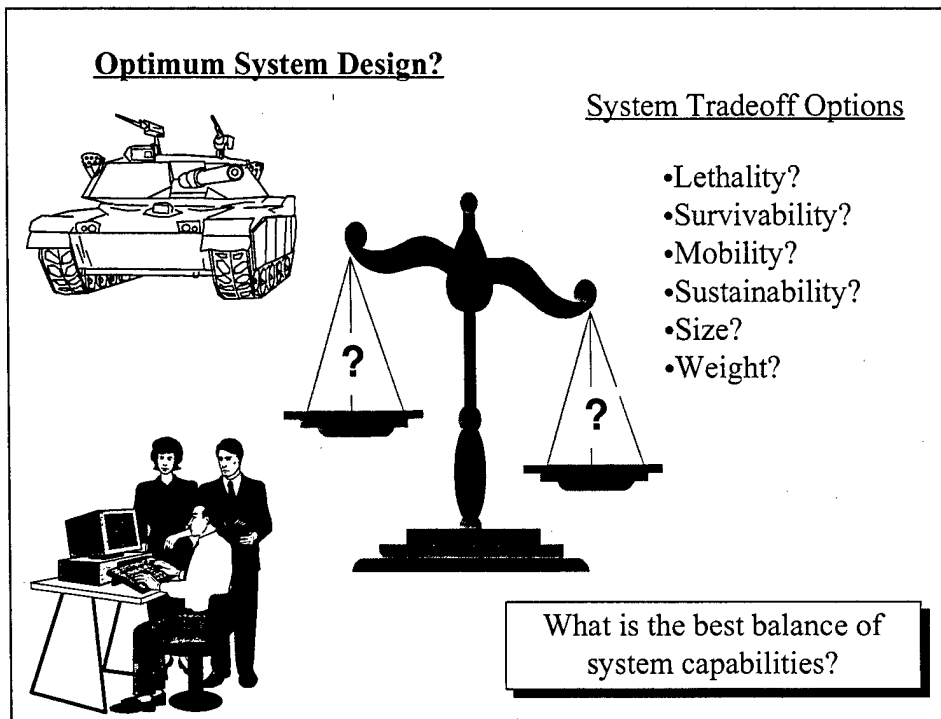

Figure 1. The vehicle design problem.

The Ground Vehicle System Integration (GVSI) and Design Optimization Model is an integrated analysis tool designed to fill this void. As a model of subsystem functions, GVSI uses simplified parametric relationships to evaluate vehicle design alternatives and to trace the "ripple effects" of changing specific aspects of a ground vehicle's design. When fully implemented, GVSI will facilitate assessments of vehicle design options and support performance tradeoffs made by systems engineers who want to understand the



interrelationships among multiple system functions. This report documents a Phase I Small Business Innovative Research (SBIR) effort that initiated GVSI development and identifies the performance relationships used by the model.

### 1.2 OBJECTIVE

The GVSI objective is to support engineering tradeoff and vehicle optimization efforts. Two primary issues addressed by GVSI are:

- a. **What system functions have the greatest impact on GCV performance?**
- b. **How do changes in one system function impact others?**

### 1.3 MODEL APPROACH

GVSI development followed the two-step process shown in Figure 2. Model definition focused on four basic, system-level functions that define the capabilities of a Ground Combat Vehicle (GCV): **Lethality, Survivability, Mobility, and Sustainability**. Decomposition of each function identified constituent elements that supported a more complete vehicle representation in GVSI.

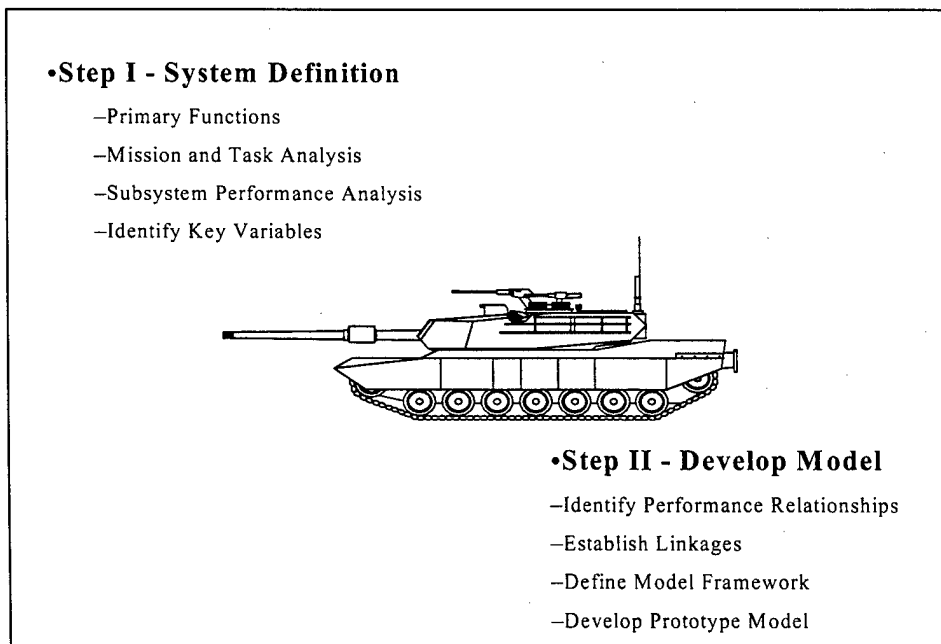

Figure 2. GVSI development process.

Further analysis of these characteristics identified subsystem performance and functional relationships that may influence GCV operations at the system level. This analysis also identified input and output variables and enabled identification of functional areas where the contribution of a specific performance characteristic “crossed over” and impacted other system functions. Identification of these parameters allowed development of linkages between subsystem functions and established the framework for understanding how a change in one function impacted other system attributes. At the conclusion of this step, GVSI development established performance relationships and linkages, the model’s framework, and produced a simple, spread-sheet model that illustrates the relationship between vehicle survivability and mobility.

#### 1.4 MODEL LIMITATIONS

- The model uses simplified performance relationships to describe system functions. Some expressions are explicit representations of subsystem characteristics and are documented; others are parametric relationships that estimate the system-level impact of changing a specific aspect of vehicle performance.
- The desire to keep GVSI an unclassified model limited survivability characterizations to representative threats and an unclassified survivability database developed by the US Army Materiel Systems Analysis Activity (AMSAA).
- Attempts to characterize features such as engine power density, Reliability, Availability, and Maintainability (RAM), and human factors issues revealed a lack of simple, first order models capable of relating the performance of these functions to system performance. In many situations, GVSI assumed simple linear relationships (direct or inverse) between selected functions and designated vehicle characteristics.
- A major assumption is that armored vehicle design will follow the historical trends shown in Table 1 (1:55)<sup>\*</sup>. GVSI used this data to estimate the impact of changing performance in selected areas.
- The model also used a combat-loaded Abrams tank as a representative GCV against which to baseline performance and functional descriptions at system and subsystem levels.

TABLE 1. VOLUMETRIC DIVISION OF A TYPICAL BATTLE TANK

System Element	% Volume
Crew & Stowage	48
Power Plant	38
Swept Volume of Gun	8
Ammunition	6

<sup>\*</sup> This annotation refers to data sources and technical references used in GVSI development. The first number in parenthesis is the reference number for the endnote contained in Appendix A; the second number is the page of the referenced source that contains or supports the information used in this report.

## 1.5 REPORT STRUCTURE

The structure of this report parallels the GVSI development process. Section 2.0 defines a generic GCV and decomposes each function into critical performance characteristics. Sections 3.0 - 6.0 document the model's implementation of system lethality, survivability, mobility, and sustainability functions. Each section describes GVSI's functional representation of the designated performance trait and discusses the model's approach to representing changes in system performance. For each functional element, the report describes the system impact of a performance change and then discusses the impact this change has on other system capabilities. Section 7.0 summarizes the model's implementation of all subsystem capabilities and functions and describes system and subsystem interfaces for each function and performance characteristic. Section 8.0 concludes the report and recommends model enhancements for follow-on development as part of a Phase II SBIR effort. Appendices document information used in this report and include the prototype GVSI model.

## 1.6 REFERENCES

Reference information used by GVSI included performance data from vehicle design books and government models. Specific source documents included:

Boas, Mary L., *Mathematical Methods in the Physical Sciences*; John Wiley & Sons, Inc., New York, NY, 1966.

Comstock, Gary R., *GroundWars Database Record Retrieval System*, US Army Materiel Systems Analysis Activity, Aberdeen Proving Grounds, MD; September 1991

Dewitt, Terry, Verbal discussion of the Army's 70-Ton Tank Test (1988-1989); US Army Armor Center Directorate of Force Development, Ft Knox, KY, 1996

Farr, CL, and Leeming, DW; *Military Ballistics - A Basic Manual*, Brassey's Battlefield Weapons Systems & Technology Series, Volume X; Brassey's Defence Publishers; Maxwell House, 74 Worship Street, London, EC2A 2EN, 1983.

Goad, KJW; and Halsey, DHJ; *Ammunition (Including Grenades and Mines)*, Brassey's Battlefield Weapons Systems & Technology Series, Volume III; Brassey's Defence Publishers; Maxwell House, 74 Worship Street, London, EC2A 2EN, 1982.

Miller, Irwin and Freund, John E.; *Probability and Statistics for Engineers*, Prentice-Hall, Inc., Englewood Cliffs, NJ, 1985.

Neimeyer, William A., *Signature Reduction/Armor System Effectiveness Tradeoffs*, US Army Materiel Systems Analysis Activity Study, US Army Materiel Systems Analysis Activity, Aberdeen Proving Grounds, MD, 13 June 1991

Ogorkiewicz, Richard M., *Technology of Tanks*, Vol I and II, Jane's Information Group, Limited, Sentinel House, 163 Brighton Road, Coulsdon Surrey, UK. 1991.

Pollock, David H., ed., *Countermeasure Systems*, The Infrared and Electro-Optical Systems Handbook, Vol 7; Infrared Information Analysis Center, Environmental Research Institute of Michigan, Ann Arbor, MI, 1993.

Project Manager, Survivability Systems, *Survivability Design Guide for Ground Combat Vehicles*, Program Executive Office, Armored Systems Modernization, Project Manager, Survivability Systems, Warren, Michigan, April 1994.

Rheinmetall, *Handbook on Weaponry*, Second English Edition, Rheinmetall GmbH, Dusseldorf, Germany, 1982

Rodgers, AL; Fowler, IBR; Garland-Collins, TK; Gould, JA; James, DA; and Roper, W; *Surveillance and Target Acquisition Systems*, Brassey's Battlefield Weapons Systems & Technology Series, Volume VII; Brassey's Defence Publishers; Maxwell House, 74 Worship Street, London, EC2A 2EN, 1983.

Ryan, JW, *Guns, Mortars, & Rockets*, Brassey's Battlefield Weapons Systems & Technology Series, Volume II; Brassey's Defence Publishers; Maxwell House, 74 Worship Street, London, EC2A 2EN, 1982.

Sears, Francis W. and Zemanski, Mark W., *University Physics, Part 1 and 2*, Addison Wesley Publishing Company, Reading, MA, 1970.

TM 9-2350-255-10-1 (Volume 1 of 3), *Operator's Manual Operator Controls and PMCS, Tank, Combat, Full-Tracked, 105-mm Gun, M1 (2350-01-061-2445), General Abrams*; Headquarters, Department of the Army, November 1981.

Tytler, I.F.B.; Thompson, N.H.; Jones, B.E.; Wormell, P.J.H.; and Ryley, C.E.S.; Royal Military College of Science, Shrivenham, U.K.; *Vehicles and Bridging*, Brassey's Battlefield Weapons Systems & Technology Series, Volume I; Brassey's Defence Publishers; Maxwell House, 74 Worship Street, London, EC2A 2EN, 1985.

## 2.0 GROUND VEHICLE REPRESENTATION IN GVSI

### 2.1 FUNCTIONAL DEFINITION

#### 2.1.1 OVERVIEW

The primary mission of tanks and armored fighting vehicles is to close with and destroy the enemy. To accomplish this task, ground combat vehicles must shoot, survive, move, and sustain operations on the battlefield. Any system-level representation of a GCV must therefore consider the four basic functions in Figure 3. Analysis of each attribute enables characterization of lower level functions that define expected levels of GCV performance. In many cases, these subsystem attributes and capabilities are interrelated; changing the performance of one function will impact other GCV functions.

#### 2.1.2 GCV FUNCTIONS

A functional decomposition of system-level capabilities will isolate and identify critical features that contribute to mission accomplishment. System functions associated with lethality, for example, include design features that influence the ability to destroy targets at extended ranges. Survivability functions encompass all factors that enable a vehicle to conduct operations in a hostile environment. Mobility addresses system attributes that affect the vehicle's ability to move from one place to another. Sustainability considers all features that influence the system's ability to continue battlefield operations for extended periods of time.

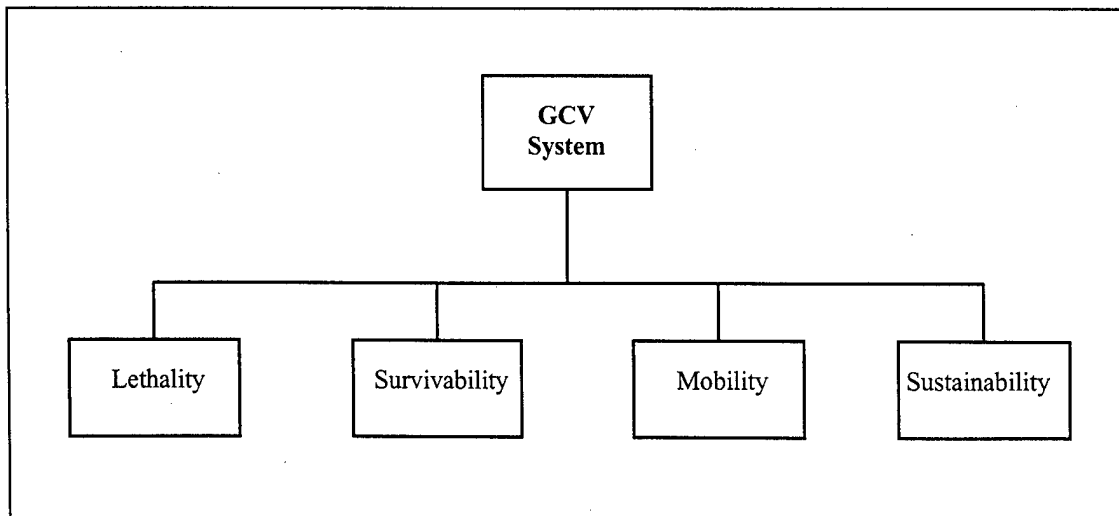

Figure 3. GCV functional representation.

## 2.2 LETHALITY

Functionally, a number of factors influence the ability to engage and defeat targets at extended ranges. A system level lethality expression is (1:192):

$$L_{\text{SYSTEM}} = P_{\text{Det}} * P_{\text{Rel}} * P_{\text{Hit}} * P_{\text{Pen}} * P_{\text{Kill}} \quad (1)$$

Where:

- $L_{\text{SYSTEM}}$  is the lethality of the system;
- $P_{\text{Det}}$  = the probability of detecting a threat target;
- $P_{\text{Rel}}$  = the probability that the weapon system will operate when needed;
- $P_{\text{Hit}}$  = the probability of hitting the target
- $P_{\text{Pen}}$  = the probability that the round penetrates the target
- $P_{\text{Kill}}$  = the probability of killing the target once the round penetrates

GVSI assumes the main armament system will fire whenever the gunner pulls the trigger ( $P_{\text{Rel}} = 1.0$ ), and, if a round hits a target, the target dies ( $P_{\text{Kill}} = 1.0$ ). With these assumptions, equation 1 becomes:

$$L_{\text{SYSTEM}} = P_{\text{Det}} * P_{\text{Hit}} * P_{\text{Pen}} \quad (2)$$

Primary contributors to system lethality support the detection, hit and penetration functions listed in Figure 4. The subsystem related to probability of detection is the target acquisition system. The platform's fire control system determines the probability of hitting a target, and weapon and ammunition design determine probability of penetration. The ability to engage a target with the gun at maximum depression and elevation angles also influences lethality; GVSI defines this factor as Swept Volume.

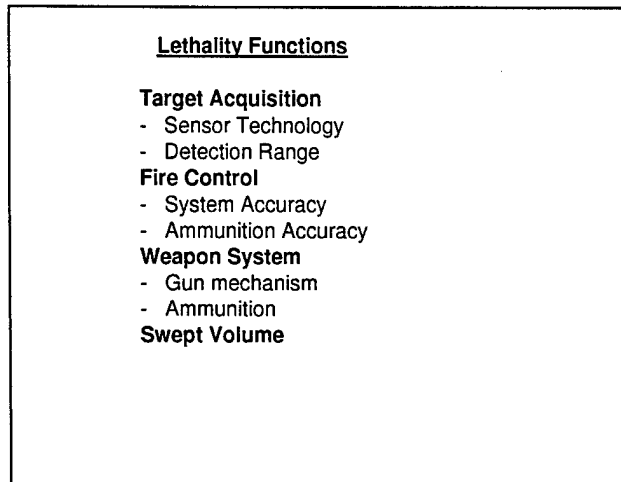

Figure 4. Lethality characteristics.

### 2.2.1 TARGET ACQUISITION

Probability of detection ( $P_{det}$ ) is a function of the operator being able to discriminate a target from a cluttered background; improving target acquisition increases the range at which an operator detects a target or changes the range at which a given  $P_{det}$  occurs. GVSI assumes human operators use direct view optics operating in the visible spectrum and Forward Looking Infrared (FLIR) systems operating in the Long Wave Infrared (LWIR) spectral region. Since the sensor's aperture influences the ability to detect targets at extended ranges, improving probability of detection will increase the size of the sensors' apertures (2:29). As seen in Figure 5, this change will increase protected volume requirements and increase system size and weight.

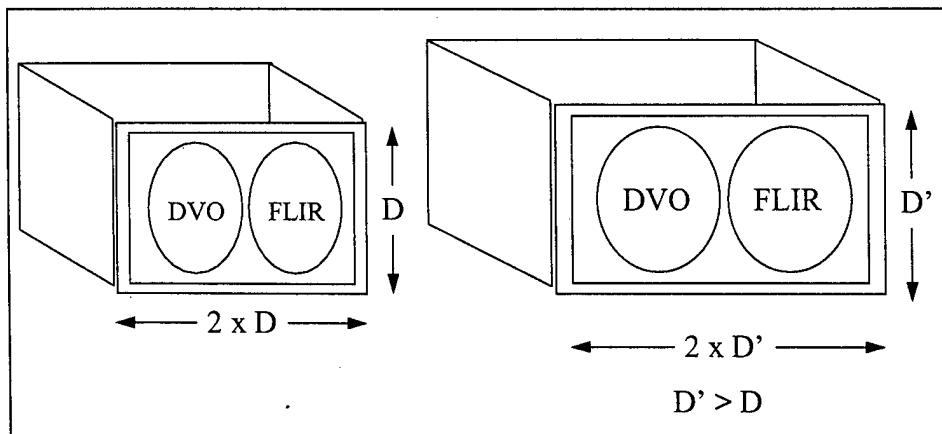

Figure 5. Impact of changing sight apertures.

Gunners usually fire at whatever targets they detect. An improved target acquisition capability means that gunners may attempt longer range engagements. Without other changes to the system lethality, however, improving  $P_{det}$  may produce a situation in which the system has a reduced probability of hitting the target or, if it hits, a reduced probability of penetrating it.

### **2.2.2 FIRE CONTROL**

Once the crew detects a target, the fire control subsystem determines the ability to hit that target at extended ranges. Fire control performance issues consider intrinsic and random errors that result from the weapon's basic design, the design of ammunition, and sighting errors. Changing the system's fire control and  $P_{hit}$  will change the number of rounds needed to hit a target and will also change the number of threats that can be successfully engaged before the GCV requires ammunition resupply. An adjustment to GCV fire control can therefore increase system lethality by increasing the number of on board kills and, since the system's basic load will last longer, may also improve system sustainability. Conversely, an increase in  $P_{hit}$  may also reduce the number of rounds that need to be carried by the vehicle. This reduces the volume required to store ammunition and, in turn, may also reduce vehicle size, weight, and vulnerable area.

### **2.2.3 WEAPON SYSTEM**

After engaging a target, the ammunition must penetrate the armor and produce behind-armor effects sufficient to kill or incapacitate the threat's crew. The weapon's ability to achieve this target effect is a function of the projectile's muzzle velocity, impact velocity, dimensions, and mass. Any changes to weapon performance may increase recoil forces produced by the gun when it fires or increase the explosive power of onboard projectiles and may affect survivability measures designed to reduce the hazards of exploding projectiles within the GCV.

### **2.2.4 SWEPT VOLUME**

An historical measure of GCV engagement capability has been the ability to engage targets with the gun at maximum elevation or depression. If the GCV accommodates an internal gun design, as seen in Figure 6, the turret's internal volume must allow the system operator to load and fire the gun while it is at maximum depression (1:46). The GCV's main armament depression limit will therefore impact the system's minimum height requirements. Changing main gun depression limits will increase or decrease size requirements and may change system weight.



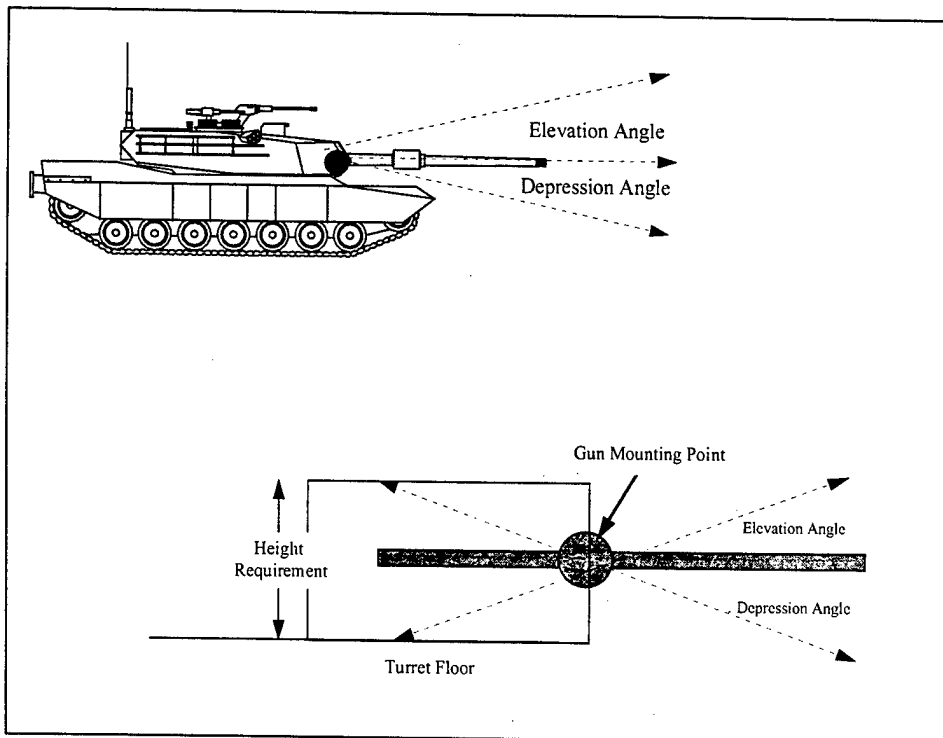

Figure 6. Swept volume impact.

### 2.2.5 SUMMARY OF LETHALITY FUNCTIONS

Many lethality functions impact GCV performance, but a number of these features also influence other system-level functions. Table 2 summarizes each lethality attribute and its potential impact on the system.

TABLE 2. LETHALITY IMPACTS ON GCV PERFORMANCE

Lethality Element	Lethality Characteristic	System Impact
Target Acquisition	Detect at extended ranges	<ul style="list-style-type: none"> <li>• Larger sight apertures for visual and thermal sights</li> <li>• Additional armor to protect a larger sight enclosure</li> <li>• Probability of hit affected by change in detection range</li> <li>• Probability of penetration/kill affected by change in range</li> </ul>
Fire Control	System Accuracy	<ul style="list-style-type: none"> <li>• Increased number of stowed kills</li> <li>• Same basic load lasts longer</li> </ul>
Weapon System	Gun Ammunition	<ul style="list-style-type: none"> <li>• Gun/ammo parameters impact system weight, under-armor volume requirements</li> <li>• Round volume determines on-board stowage requirements (typically 6% of system volume)</li> <li>• Round/propellant also determines compartmentation needs and weight/volume budgets for anti-fratricide bars)</li> </ul>
Swept Volume	Main gun elevation and depression angles	<ul style="list-style-type: none"> <li>• Size and height impact (interior must accommodate gun and recoil while at max depression)</li> </ul>

## 2.3 SURVIVABILITY

Survivability includes all aspects of system's design that enable it to operate in hostile environments (3:2). Mathematically, the probability of a system surviving a threat attack is:

$$S_{\text{SYSTEM}} = 1 - [P_{\text{Det}} * P_{\text{Hit|Det}} * P_{\text{Pen|Hit}} * P_{\text{Kill|Pen}}] \quad (3)$$

Where:

- $S_{\text{SYSTEM}}$  is system's overall probability of survival;
- $P_{\text{Det}}$  is the probability of being detected by threat sensors;
- $P_{\text{Hit|Det}}$  is the probability of being hit by a threat weapon if detected;
- $P_{\text{Pen|Hit}}$  is the probability of being penetrated if hit; and
- $P_{\text{Kill|Pen}}$  is the probability of being killed if penetrated

### 2.3.1 THREATS

Threats to ground vehicles generally fall into two general groups: Direct Fire and Indirect Fire weapons. Direct fire weapons require a line-of-sight to their targets; indirect fire threats engage GCVs from behind the horizon. Table 3 categorizes these threats.

Direct fire threats include long rod, kinetic energy penetrators and weapons that use shaped charges as their defeat mechanism. These threats may be cannon-launched projectiles or missiles, antitank guided missiles (ATGMs) launched from ground, vehicular, or airborne platforms, or rocket propelled grenades fired by dismounted soldiers. Indirect fire threats include conventional artillery rounds as well as smart, top attack threats that attempt to engage the weakest part of the GCV.

TABLE 3. THREATS TO GROUND COMBAT VEHICLES

Threat	Class	Type	Category	Examples
Direct	Kinetic Energy	Unguided	Cannon-launched	Long Rod Penetrators
		Unguided	Cannon-launched Rocket-Propelled	HEAT Rounds RPGs
	Chemical Energy	Guided	Command to Line Of Sight	Manual - Sagger 1 Semi-automatic - TOW
			Designated	Krasnapol
			Beam Riding	AT-10/11
			Homing	IR/mmW - Javelin
Indirect	Dumb	High Explosive	Impact Fuzed Proximity Fuzed	Ground burst Air burst
		Dual Purpose ICM	Impact Fuzed	Top attack
		"Smart"	Sensor Fuzed (Fallers)	Infrared
	Millimeter wave			STAFF
	Dual mode			SADARM
	Terminally Guided (Fliers)		Infrared	BAT
			Millimeter Wave	MLRS/TGW

### 2.3.2 SYSTEM SURVIVABILITY

A number of survivability applications or enhancements are available to protect the GCV from attack by these threats. Given design constraints, however, system engineers plan for the balanced application of survivability measures to provide optimal protection against expected threats. As Figure 7 suggests, integration of these survivability measures into GCV design results in a layered self-defense approach that includes susceptibility and vulnerability reduction measures.

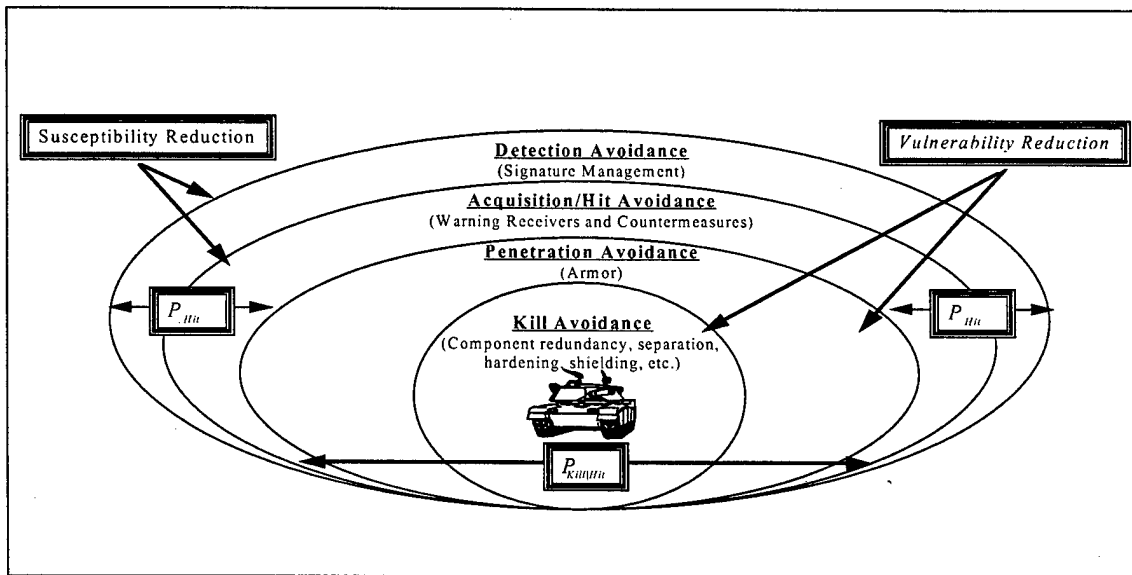

Figure 7. A layered approach to vehicle survivability.

- a. **Susceptibility Reduction.** Susceptibility reduction measures include all aspects of a system's design that reduce the threat's ability to hit the platform. Susceptibility reduction concepts include *Detection Avoidance*, and *Hit Avoidance*. *Detection Avoidance* measures reduce the performance of threat target acquisition systems. Two general detection avoidance approaches included in GVSI are size reduction and signature management/control. Size reduction degrades the threat sensor's ability to resolve the GCV as a target; signature control minimizes the contrast between the GCV and its background. *Hit Avoidance* measures influence threat engagements before the incoming munitions hit the GCV. Two general hit avoidance concepts are evasive maneuvers and countermeasures. Evasive maneuvers are tactical responses taken to degrade probability of hit and include aggressive acceleration and deceleration and rapid movement to cover. Countermeasures are designed to degrade threat fire control and guidance mechanisms. Both hit avoidance concepts require an early warning or situational awareness capability.

- b. Vulnerability Reduction.** Vulnerability reduction measures attempt to minimize the effects of a threat weapon after it hits the GCV platform. *Penetration Avoidance* is that part of vulnerability reduction that deals with armor design and implementation. The other aspect of vulnerability reduction, *Kill Avoidance*, minimizes behind-armor effects. Specific Kill Avoidance concepts modeled in GVSI are compartmentation and spall liners. Compartmentation measures control explosive effects within the system. Spall liners are interior coatings that reduce the spall and/or shrapnel produced when a penetrating round hits the vehicle's outer envelope.

Table 4 summarizes each of these survivability measures, their applications, and the survivability approach modeled within GVSI.

TABLE 4. GCV SURVIVABILITY MEASURES AND APPLICATIONS

Typical Survivability Applications			
Survivability Concept	Avoidance Area	Survivability Application	Survivability Approach
Susceptibility Reduction	Detection	Reduced Size	Smaller vehicle
		Reduced Contrast	Signature control
	Hit	Evasive Maneuver	Warning + Acceleration
		Countermeasure	Warning + Countermeasure
Vulnerability Reduction	Penetration	Armor	Passive or Active
	Kill	Minimize behind armor effects	Compartmentation
			Spall Liner

Functionally, survivability enhancements influence different threats in different ways. As seen in Table 5, some enhancements will defeat a wide range of threats; others are effective against selected systems. Implementation of these measures may reduce the significance of one type of threat, but may increase susceptibility or vulnerability to attack by another. Survivability enhancements may also impact other GCV functional areas. For example, adding armor to improve ballistic protection may add weight to the system and reduce its mobility.

TABLE 5. GCV SURVIVABILITY APPROACH VERSUS THREAT

Threat	Class	Type	Applicability of Survivability Approach							
			Detection Avoidance		Hit Avoidance		Penetration Avoidance	Kill Avoidance		
			Size	Signature Mgmt	Evade	CM	Armor	Comp.	Spall Liner	
Direct	Kinetic Energy	Unguided			X		X	X	X	
		Unguided			X		X	X	X	
	Chemical Energy	Guided	CLOS			X	X	X	X	X
			Designated	X		X	X	X	X	X
			Beam-Riding			X	X	X	X	X
Homing	X		X	X	X	X	X	X		
Indirect	Dumb	High Explosive			X		X	X	X	
		Dual Purpose ICM	X		X		X	X	X	
	"Smart"	Sensor Fuzed	X	X	X	X	X	X	X	
		Terminally Guided	X	X	X	X	X	X	X	

### 2.3.3 SUMMARY

Table 6 summarizes system survivability approaches that impact system design and performance.

TABLE 6. SURVIVABILITY IMPACTS ON VEHICLE DESIGN

Survivability Application and Impacts on Vehicle Design		
Area	Approach	System Impact
Detection	Smaller vehicle	Reduced interior volume; reduced weight?
	Signature control	Blend w/background; added weight may reduce speed, degrade RAM
Hit	Evasive Maneuvers	Dodging threat requires high speed/acceleration capability; implicit requirement for early warning
	Countermeasure	Warning + CM, some added weight; power demand increased
Penetration	Armor	Increased weight from armor; reduced speed, cross country mobility, RAM
Kill	Compartmentation	Added weight due to anti-fratricide bars and other compartmentation techniques
	Spall Liner	Added weight; reduced interior volume for crew?

## 2.4 MOBILITY

System mobility encompasses tactical, operational, or strategic issues. From GVSI's perspective, *Tactical Mobility* includes those aspects of system performance that enable a GCV to move from point to point on the battlefield. *Operational Mobility* includes system characteristics that enable a GCV to move between battle zones; *Strategic Mobility* impacts the ability to move between theaters of operation. Since GVSI focuses on system specific design issues, the current model focuses on tactical mobility.

### 2.4.1 MOBILITY DRIVERS

System mobility drivers are those features that influence the system's ability to produce power, transfer the power to the tracks, and to use that power to move across the battlefield. The primary mobility drivers include the GCV's power train, suspension, engine horsepower, vehicle and track dimensions, and system weight (1:77).

### 2.4.2 MOBILITY CHARACTERISTICS

GCV mobility characteristics address the functional processes associated with the movement of the system across the battlefield. The system mobility characteristics included within GVSI are listed in Figure 8.

- | <u>Mobility</u>   |
|---|
| <ul style="list-style-type: none"> <li>• Speed</li> <li>• Acceleration</li> <li>• Max Grade</li> <li>• Turning Radius</li> <li>• Ground Pressure               <ul style="list-style-type: none"> <li>-- Nominal Grnd Pressure</li> <li>-- Mean Max Pressure</li> </ul> </li> <li>• Cross Country Mobility</li> </ul> |

Figure 8. Mobility characteristics.

Each characteristic represents a critical aspect of vehicle performance. Speed is the rate of movement from one point to the next; GCVSI assumes the vehicle moves at maximum speed across a hard-paved surface. Acceleration considers the vehicle's ability to "dash" across the battlefield. Max grade is the maximum vertical angle at which the vehicle is able to maintain a steady rate of uphill (or downhill) movement. The vehicle's turning radius is a measure of the system's agility on the battlefield. Ground pressure is a measure of the platform's off road mobility and considers the weight of the vehicle per unit track area in contact with the ground (Nominal Ground Pressure), as well as the design of the GCV's suspension (Mean Maximum Pressure). Cross country performance considers the system's off road performance as a function of soil trafficability.

**2.4.3 SUMMARY**

Table 7 summarizes GCV system mobility issues, the impact they have on system design, and the manner in which they may be affected by other changes in GCV functions.

TABLE 7. MOBILITY IMPACTS ON GCV PERFORMANCE

Mobility Element	Mobility Characteristic	System Impact
Tactical Mobility	<ul style="list-style-type: none"> <li>• Speed</li> <li>• Acceleration</li> <li>• Max Grade</li> <li>• Turning Radius</li> <li>• Ground Pressure               <ul style="list-style-type: none"> <li>- Nominal Ground Pressure</li> <li>- Mean Max Pressure</li> </ul> </li> <li>• Cross Country Mobility</li> </ul>	<ul style="list-style-type: none"> <li>• Engine size; power transfer mechanism, system weight; reduced when GCV weight increased.; increased fuel usage</li> <li>• Engine, GCV size and weight; impacts Hit Avoidance; reduced when weight increases; increased fuel usage</li> <li>• Engine, suspension; provided greater agility; reduced when weight increases</li> <li>• Improved agility and survivability (Hit Avoidance); varies with vehicle size</li> <li>• Improved cross country mobility, track size and vehicle width impacted; also affects ride quality and crew comfort (sustainability); degraded with increasing weight</li> <li>• Increased flexibility/agility (Hit Avoidance); degraded with increased weight</li> </ul>

## 2.5 SUSTAINABILITY

Sustainability functions enable the GCV to continue operations for extended periods without needing repairs or resupply. Included are basic mechanical and reliability aspects of system operation, the system's dependence on on-board consumables, and the ability of the crew to operate within the tank's protected volume for extended periods of time. This function also considers the amount and type of expendables such as ammunition and fuel, as well as the rate at which they are consumed. Figure 9 lists the system sustainability factors used in GVSI.

### 2.5.1 RELIABILITY, AVAILABILITY, AND MAINTAINABILITY

This function describes the system's ability to operate without requiring special mechanical attention. Contained within this function are:

- Mean Miles Between Failure (MMBF) - the average distance the GCV will travel before incurring some sort of mechanical failure
- Operational Availability (Ao) - a measure of the probability that the system will function properly;
- Mean Time to Repair (MTTR) - a measure of the time required to return a part, or system, to operational status.

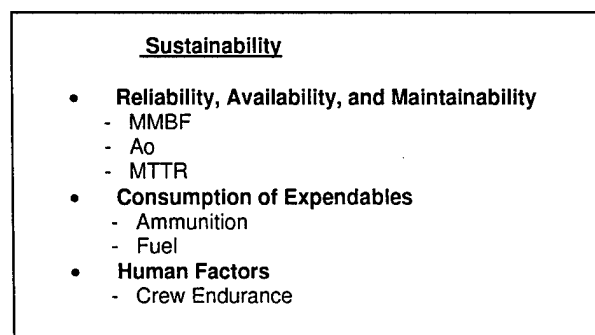

Figure 9. Sustainability characteristics.

### 2.5.2 CONSUMPTION OF EXPENDABLES

This feature represents the GCV's ability to operate for extended periods of time without requiring resupply and focuses on two of the most important consumables carried by the platform: ammunition and fuel. Ammunition consumption considers the number of rounds of main gun ammunition carried on the vehicle and, given the system's fire control capability, the number of threat targets that can be engaged or destroyed before the GCV needs ammunition resupply. Fuel consumption is related to the distance and time the vehicle can travel without requiring additional fuel and is driven by other system functions such as mobility and system weight.

### 2.5.3 HUMAN FACTORS

Human factors represents the ability of the GCV crew to operate for extended periods while inside the vehicle and is a function of the interior volume allocated for the crew and the ride quality. Historically, 48% of the vehicle's volume is reserved for crew and storage, and vehicle designers typically allocate 1.2m<sup>3</sup> per crew member. GVSI assumes that the internal space allocated for today's tank crew men is sufficient for the crew to operate for a given period. If the internal volume is reduced, the model assumes that the crew's ability to operate while under armor will be impaired. If the size of a vehicle crew is fixed, (for example, at four) a reduction of interior volume will degrade the system's ability to conduct extended operations. Ride quality is a human factor issue that relates to the amount of absorbed power the crew can withstand as the vehicle moves across the battlefield. As system weight increases, or as speed and acceleration increase, the absorbed power transferred to the crew will be increased, and ride quality will be degraded.

### 2.5.4 SUMMARY

Table 8 summarizes GCV system sustainability issues, the impact they have on system design, and the manner in which other functions may affect them.

TABLE 8. SUSTAINABILITY IMPACTS ON GCV PERFORMANCE

Sustainability Element	Sustainability Characteristic	System Impact
Reliability, Availability, and Maintainability	<ul style="list-style-type: none"> <li>• MMBF</li> <li>• Ao</li> <li>• MTTR</li> </ul>	<ul style="list-style-type: none"> <li>• All factors impacted by system weight and complexity</li> </ul>
Consumption of Expendables	<ul style="list-style-type: none"> <li>• Ammunition</li> <li>• Fuel</li> </ul>	<ul style="list-style-type: none"> <li>• Resupply impact from stowed kills</li> <li>• Engine efficiency, consumption increases system weight or increase in mobility characteristics</li> </ul>
Human Factors	<ul style="list-style-type: none"> <li>• Crew Endurance</li> <li>• Ride Quality</li> </ul>	<ul style="list-style-type: none"> <li>• Impacts internal volume requirement</li> <li>• Limits weight and cross country speed</li> </ul>



## 2.6 SYSTEM REPRESENTATION SUMMARY

The GCV system defined in this report will be depicted as listed in Table 9.

TABLE 9. GCV SYSTEM FUNCTIONS AND PERFORMANCE CHARACTERISTICS

Lethality	Survivability	Mobility	Sustainability
<b>Target Acquisition</b> - Sensor type - Detection Range	<b>Susceptibility Reduction</b> - Detection Avoidance -- Size -- Signature - Hit Avoidance -- Evade -- CM	<b>Tactical Mobility</b> - Speed - Acceleration - Max Grade - Turning Radius - Ground Pressure -- Nominal Grnd Pressure -- Mean Max Pressure - Cross Country	<b>Reliability, Availability, and Maintainability</b> - MMBF - Ao - MTTR
<b>Fire Control</b> - System Accuracy - Ammo Accuracy	<b>Vulnerability Reduction</b> - Penetration Avoidance -- Armor - Kill Avoidance -- Compartmentation -- Spall Liner		<b>Consumption of Expendables</b> - Stowed load - Fuel
<b>Weapon System</b> - Gun Mechanism - Ammunition <b>Swept Volume</b>			<b>Human Factors</b> - Crew Endurance - Ride Quality

### 3.0 LETHALITY

#### 3.1 FUNCTIONAL REPRESENTATION

The basic expression for system lethality (reference Equation 2) is:

$$L_{\text{SYSTEM}} = P_{\text{Det}} * P_{\text{Hit}} * P_{\text{Pen}}$$

Where:

$P_{\text{Det}}$  = Probability of Detection and is a function of the GCV's target acquisition system;

$P_{\text{Hit}}$  = Probability of Hit and is a function of GCV's fire control system; and

$P_{\text{Pen}}$  = Probability of Penetration and is a function of the weapon and its ammunition.

#### 3.2 TARGET ACQUISITION SYSTEM.

Target acquisition defines the GCV's ability to detect targets at extended ranges.

##### 3.2.1 APPROACH TO CHANGING TARGET ACQUISITION.

An improvement in target acquisition will either increase the probability of detection at all ranges or increase the range at which the system achieves a given probability of detection. Extending the range at which the system achieves a given  $P_{\text{Det}}$  increases the GCV's ability to influence battlefield operations at longer ranges. Since "extending the battlefield" appears to be a useful measure of performance, GVSI assumes that an improvement in target acquisition will increase the range at which the system can detect a threat. Both approaches will require a change in optical system performance.

##### 3.2.2 SYSTEM IMPACT

Changing an optical system's design must consider the range to the target, the target's angular dimensions, and the minimum resolvable target that can be detected by a sensor at any given range. The range to a potential target can be expressed as (1:40):

$$R = \frac{D_{\text{Tgt}} * 1000}{\alpha} \quad (4)$$

Where:

R = Target range (meters)

$D_{\text{Tgt}}$  = Target dimension (meters)

$\alpha$  = Target's angular dimension (mrad)

rearranging terms, the target's angular dimension is:

$$\alpha = \frac{D_{Tgt} * 1000}{R} \quad (5)$$

For an optical system, the minimum resolvable target is (1:29):

$$\alpha = 1.22 * \frac{\lambda}{D_{Obj}} \quad (6)$$

Where:

$\lambda$  = Wavelength in which the optical system operates (meters)

$D_{Obj}$  = Diameter of the optical system's objective lens (meters)

Setting the minimum resolvable target equal to the target's angular dimensions yields:

$$1.22 * \frac{\lambda}{D_{Obj}} = \frac{D_{Tgt} * 1000}{R} \quad (7)$$

Target acquisition performance is a function of the light gathering capability of an optical system and is related to size of the sensor's aperture. For GVSI, the target acquisition parameter of interest is  $D_{Obj}$ . Solving Equation 7 for  $D_{Obj}$  results in:

$$D_{Obj} = \frac{1.22 * \lambda * R}{D_{Tgt} * 1000} \quad (8)$$

For a given target size (2.3m is the width of a NATO standard target), assuming no optical aberrations. From Equation 8, the sensor's performance varies linearly with the size of its objective lens. Under these conditions, GVSI assumes that increasing  $P_{Det}$  will also increase the diameter of the objective lens as indicated in Figure 10. This change in GCV performance translates to a change in the size of the optical system:

$$D'_{Obj(Vis)} = D_{Obj(Vis)} * \left( 1 + \frac{\delta_{(Vis)}}{100} \right) \quad (9)$$

and

$$D'_{Obj(FLIR)} = D_{Obj(FLIR)} * \left( 1 + \frac{\delta_{(FLIR)}}{100} \right) \quad (10)$$

where  $\delta ( )$  is the percentage change in the objective lens diameters for the DVO (Vis) and FLIR (FLIR) channels of the GCV's target acquisition system.

An increase in the optics' size increases the amount of protected internal volume. For the Abrams tank, the structure protecting the sensors is rectangular, and the width is sufficient to house both a DVO and a FLIR. The size of the sensor apertures also determines the height of the structure. Given Figure 10, GVSI assumes the length of the target acquisition system ( $L_{TA}$ ) will remain the same for both visual and thermal systems. The total increase in protected volume is then:

$$[L_{TA} * D_{Obj(Vis)}'^2 - L_{TA} * D_{Obj(Vis)}^2] + [L_{TA} * D_{Obj(FLIR)}'^2 - L_{TA} * D_{Obj(FLIR)}^2] \quad (11)$$

which reduces to:

$$L_{TA} * [D_{Obj(Vis)}'^2 - D_{Obj(Vis)}^2] + L_{TA} * [D_{Obj(FLIR)}'^2 - D_{Obj(FLIR)}^2] \quad (12)$$

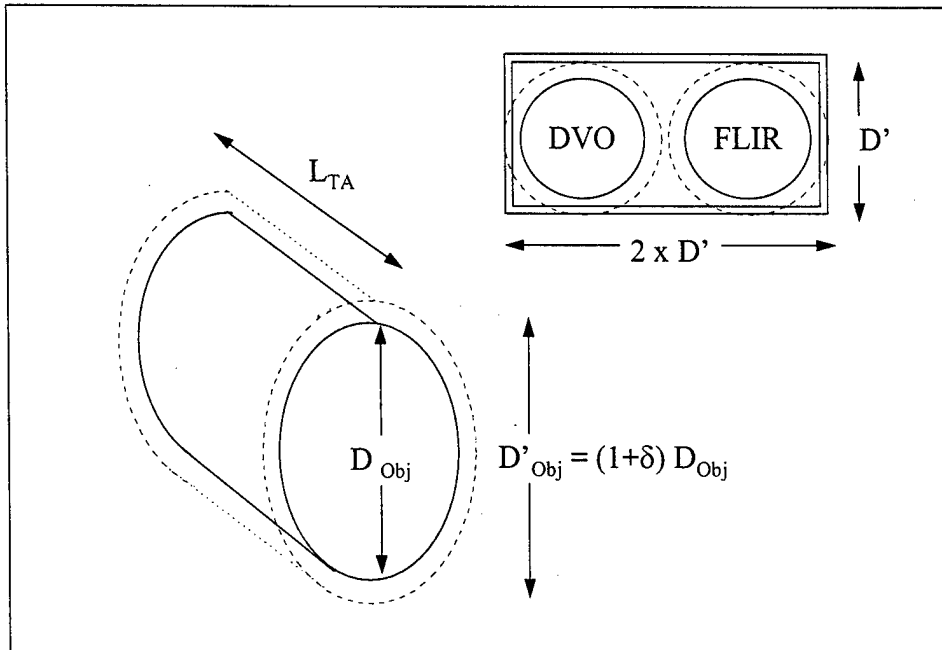

Figure 10. Impact of changing optical apertures.

But:  $D_{Obj}' = D_{Obj} * \left(1 + \frac{\delta}{100}\right)$

so the change in the area covered is:

$$D_{Obj}'^2 - D_{Obj}^2 = [D_{Obj} * \left(1 + \frac{\delta}{100}\right)]^2 - D_{Obj}^2 = D_{Obj}^2 \left[ \left(1 + \frac{\delta}{100}\right)^2 - 1 \right] \quad (13)$$

Given an areal density ( $A_d$ ) for the ballistic cover on the target acquisition system shown in Figure 11, the increase in weight that accompanies the increase in protected volume is:

$$W_{TA} = A_d * (D_{Obj}'^2 - D_{Obj}^2) = A_d * \left[ D_{Obj}^2 \left[ \left(1 + \frac{\delta}{100}\right)^2 - 1 \right] \right] \quad (14)$$

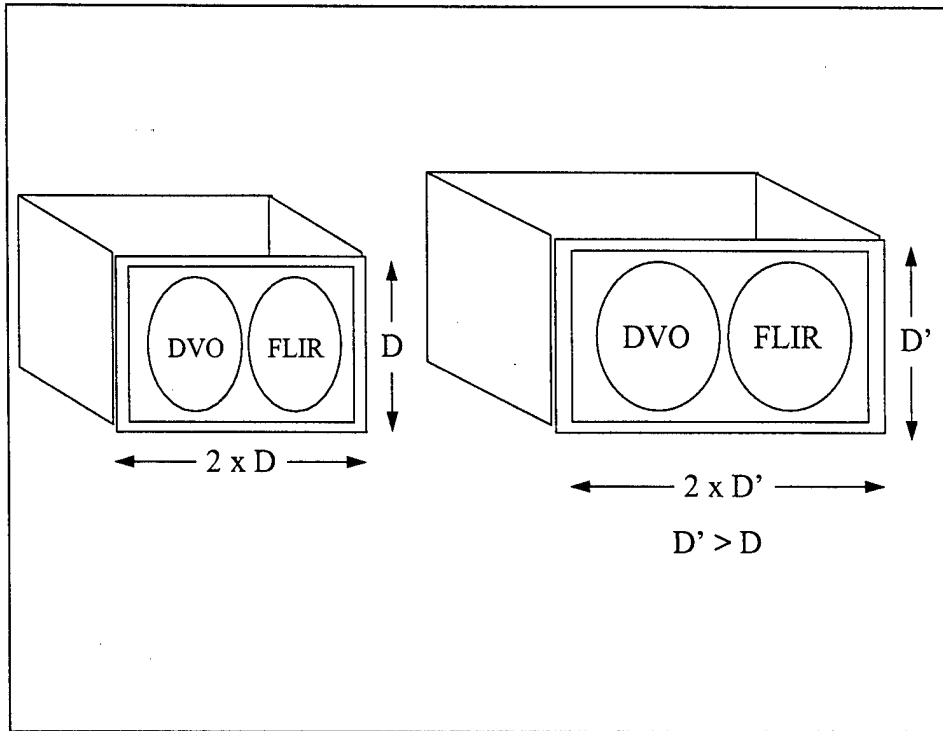

Figure 11. Effect of changing size of optical apertures.

Assuming a specific probability of detection for visual and thermal sights, a  $\delta\%$  increase in detection capability is assumed to change the diameter of the system's optics by:

$$D_{Obj}' = D_{Obj} \left( 1 + \frac{\delta}{100} \right)$$

and increase weight by:

$$A_d * \left[ D_{Obj}^2 \left[ \left( 1 + \frac{\delta}{100} \right)^2 - 1 \right] \right]. \quad (15)$$

The relative increase in system weight will then be:

$$\left[ \left[ \left( 1 + \frac{\delta}{100} \right)^2 - 1 \right] \right]. \quad (16)$$

### 3.2.3 OTHER IMPACTS

- a. **Other Lethality Functions.** Changing GCV  $P_{Det}$  will also impact fire control and weapon system performance. If the target acquisition system enables detection at longer ranges, it is reasonable to assume that the gunner will attempt to engage that target. The next section will show that the system's  $P_{Hit}$  and  $P_{Pen}$  vary inversely with range. Consequently, while an increase in  $P_{Det}$  extends

detection range and capability, it can also degrade other aspects of system lethality.

- b. **Survivability.** Increasing the size of the optics will increase system size and weight. Because there is a weight increase, there is also a reduction in mobility and in the system's ability to evade a threat. As seen in Figure 12, changing the size of a sight aperture by  $\delta$  % increases system height by  $\delta * D$ . The relative change in system characteristics,  $\beta$ , is then:

$$\beta = \frac{\delta * D_{OBJ}}{H} \quad (17)$$

Where:

- $\beta$  = Relative increase in GCV size  
 $D_{OBJ}$  = Diameter of objective lens (meters)  
 $H$  = System height (meters)

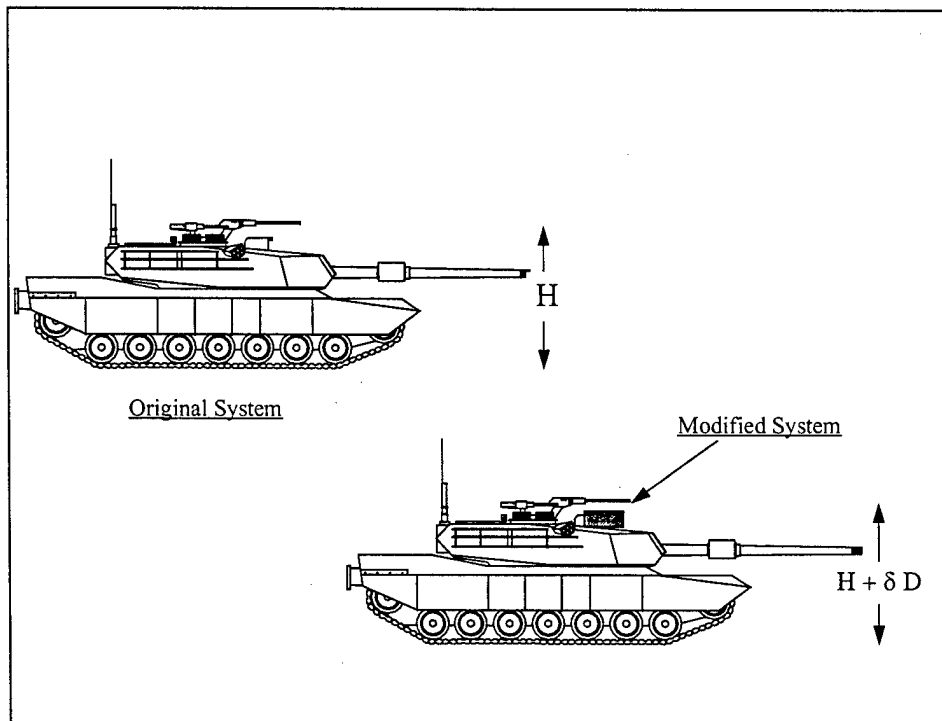

Figure 12. System impact of changing target acquisition (size and weight).

If the change in size has a linear affect on threat target acquisition, increasing system height by  $\delta$  will increase the threat's probability of detecting the GCV by  $\delta$  also. If system weight increases linearly with system size, and if a GCV's mobility is dependent on system weight, then  $\delta$  also represents a decrease in a GCV's ability to evade a threat.

- c. **Mobility.** The increase in system weight that accompanies a change in GCV target acquisition will have a negative effect on system mobility. The GCV's maximum speed will be reduced, as will acceleration. The increased weight will also increase GCV ground pressure and decrease cross country performance.

- d. **Sustainability.** Increased weight will also have a negative effect on GCV sustainability functions. Assuming that system RAM and fuel consumption vary inversely with system weight, then the increased weight will degrade system RAM by  $\delta$  %. Fuel consumption will also increase by  $\delta$  %.

### 3.3 FIRE CONTROL SYSTEM

The GCV's fire control system influence the system's probability of hitting its intended target ( $P_{hit}$ )

#### 3.3.1 APPROACH TO CHANGING PERFORMANCE

Probability of Hit is a function of sighting error and ammunition dispersion. Sighting error, represented by the terms  $\mu_x$  and  $\mu_y$  includes gunner aimpoint errors across horizontal and vertical axes (2:211). Ballistic dispersion errors,  $\sigma_x$  and  $\sigma_y$ , encompass dispersion in horizontal and vertical axes.

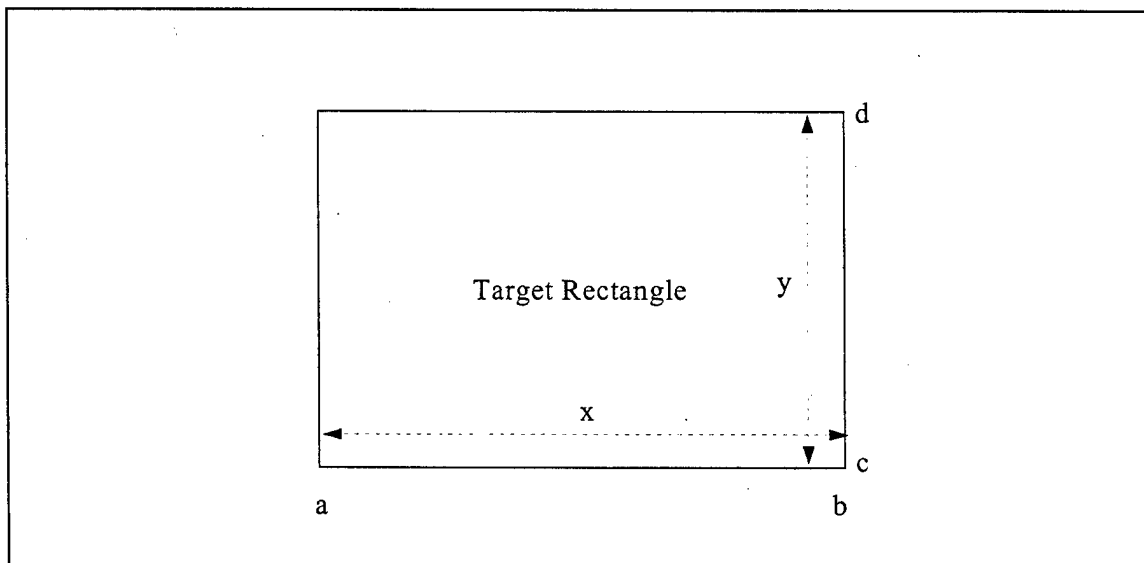

Figure 13. Target rectangle.

If a target is a rectangle, with dimensions a, b, c, and d, and horizontal and vertical dispersion for the center of the target are represented as x and y, with  $a \leq x \leq b$ , and  $c \leq y \leq d$ , as in Figure 13, the probability of hitting the target with one shot, for a sighting error  $\mu_x, \mu_y$  and dispersion  $\sigma_x, \sigma_y$ , is (2:211):

$$P_{SH} = \int_{x=a}^b \int_{y=c}^d \Phi(x, y) dx dy \quad (18)$$

where the associated probability density function is:

$$\Phi(x, y) = \frac{1}{2\pi\sigma_x\sigma_y} e^{-\frac{1}{2}\left[\left(\frac{x-\mu_x}{\sigma_x}\right)^2 + \left(\frac{y-\mu_y}{\sigma_y}\right)^2\right]} \quad (19)$$

If  $x$  and  $y$  are independent and if the ballistic dispersion of the rounds is  $\sigma_x = \sigma_y = \sigma$ , then the probability distribution density can be represented as (2:213):

$$\phi(x, y) = \frac{1}{2\pi\sigma^2} e^{-\frac{1}{2\sigma^2}\left[(x-\mu_x)^2 + (y-\mu_y)^2\right]} \quad (20)$$

Changing to polar coordinates  $r$  and  $\alpha$ , as shown in Figure 14, with:  $x = \mu_x + r \cos \alpha$  and  $y = \mu_y + r \sin \alpha$

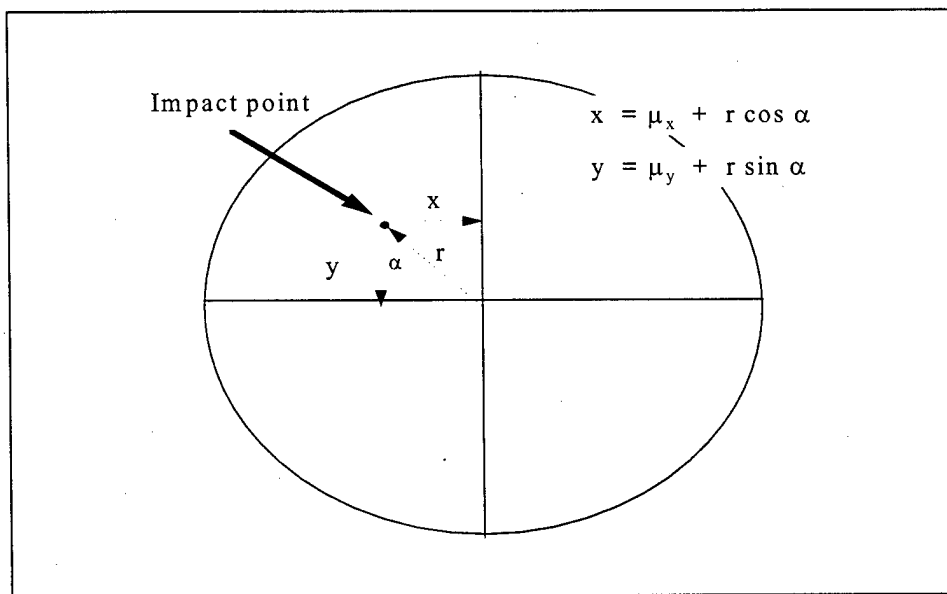

Figure 14. Target representation in polar coordinates.

Then  $\phi(x, y)$  transforms to (2:213):

$$\phi(r) = \frac{r}{\sigma^2} e^{-\frac{r^2}{2\sigma^2}} \quad (21)$$

If the mean point of impact of the system's fired rounds coincides with the center of the target area, the probability of hitting this target with a single shot is:

$$P_{SH} = 1 - e^{-\frac{r^2}{2\sigma^2}} \quad (22)$$



Relating  $P_{SH}$  to the GCV's engagement range, recall that the target's angular dimension is:

$$\alpha = \frac{D_{Tgt} * 1000}{R} \quad (23)$$

Where, in this case, the target area is assumed to be  $D_{Tgt} = 2r$ , so

$$\alpha = \frac{2r * 1000}{R} \quad (24)$$

and

$$r = \frac{1}{2} a * R * 10^{-3} \quad (25)$$

In polar coordinates, the system's probability of hit as a function of engagement range, is then:

$$P_{SH} = 1 - e^{-\frac{\left(\frac{1}{2} \alpha * R * 10^{-3}\right)^2}{2\sigma^2}} \quad (26)$$

Changing  $P_{Hit}$  requires a change in either sighting error ( $\mu$ ) or ballistic dispersion ( $\sigma$ ). From Equation (20), the biggest change to a weapon system's  $P_{Hit}$  occurs if  $\sigma$  changes. If  $\sigma' = \delta\sigma$ , then Equation (26) becomes:

$$P_{SH} = 1 - e^{-\frac{\left(\frac{1}{2} \alpha * R * 10^{-3}\right)^2}{2(\delta\sigma)^2}} \quad (27)$$

Which can be represented as part of a Maclaurin series expansion as:

$$P_{SH} = 1 - \left[ 1 + \left[ \frac{\left(\frac{1}{2} \alpha * R * 10^{-3}\right)^2}{2(\delta\sigma)^2} \right] + \frac{\left[ \frac{\left(\frac{1}{2} \alpha * R * 10^{-3}\right)^2}{2(\delta\sigma)^2} \right]^2}{2!} + \dots \right] \quad (28)$$

Discounting higher order terms, Equation 28 approximates the single shot hit probability:

$$P_{SH}' = 1 - \left[ 1 + \left[ \frac{\left( \frac{1}{2} \alpha * R * 10^{-3} \right)^2}{2(\delta\sigma)^2} \right] \right] \quad (29)$$

which reduces to:

$$P_{SH}' \approx \frac{\left( \frac{1}{2} \alpha * R * 10^{-3} \right)^2}{2(\delta\sigma)^2} = \left( \frac{1}{\delta^2} \right) \frac{\left( \frac{1}{2} \alpha * R * 10^{-3} \right)^2}{2(\sigma)^2} \approx \left( \frac{1}{\delta^2} \right) P_{SH} \quad (30)$$

Given the probability of a single, independently fired round hitting a target, GVSI assumes that once an engagement begins, it will continue until the target is hit. This assumption produces a system probability hit of (2:200):

$$P_{Hit} = 1 - (1 - P_{SH})^n \quad (31)$$

Where:

$P_{SH}$  = The probability of a single round hitting the target, and  
 $n$  = The number of rounds required to hit the target

If  $n = 2$ , Equation 31 becomes:

$$P_{Hit} = 1 - (1 - P_{SH})^2 = P_{SH}(2 - P_{SH}) \quad (32)$$

System's probability of hit also determines number of rounds ( $n$ ) required to achieve a desired target effect:

$$n = \frac{1}{P_{Hit}} \quad (33)$$

If  $n=2$ , the system level probability of hit is then:

$$P_{Hit} = P_{SH}(2 - P_{SH}) = 2P_{SH} - P_{SH}^2 \quad (34)$$

Changing single shot probability of hit by  $\delta$ , such that  $P_{SH}' = \delta P_{SH}$ , then:

$$P_{Hit}' = \delta P_{SH}(2 - \delta P_{SH}) = 2\delta P_{SH} - (\delta P_{SH})^2 \quad (35)$$

and the change to the system's  $P_{Hit}$  is then:

$$\Delta P_{Hit} = P_{Hit}' - P_{Hit} = P_{SH}[\delta * (2 - (\delta * P_{SH})) - (2 - P_{SH})] \quad (36)$$

and the relative change in probability of hit is:

$$\frac{\Delta P_{Hit}}{P_{Hit}} = \frac{P_{SH}[\delta(2 - \delta * P_{SH}) - (2 - P_{SH})]}{P_{SH}(2 - P_{SH})} \quad (37)$$

which reduces to:

$$\frac{\Delta P_{Hit}}{P_{Hit}} = \frac{\delta(2 - \delta * P_{SH})}{(2 - P_{SH})} - 1 \quad (38)$$

This changes the number of rounds required to achieve a desired target effect.

If  $n = \frac{1}{P_{Hit}}$  then  $n' = \frac{1}{P_{Hit}'}$ , and

$$n' = \frac{1}{\delta * P_{SH}(2 - \delta * P_{SH})} \quad (39)$$

### 3.3.2 SYSTEM IMPACT

The system impact of changing the single shot probability of hit is to reduce the number of rounds required to hit a target. If hitting a target produces a kill, then increasing the probability of hit increases the number of targets that can be killed by the ammunition carried on board the vehicle. Alternatively, an increase in probability of hit also means that the system can be expected to engage and kill the same number of targets with fewer rounds. If the GCV's ammunition stowage capacity is based on the expected number of targets to be killed, then (2:217):

"Stowed Load" =  $n * \text{Stowed Kills}$ :

$$n = \frac{SL}{SK} \quad (40)$$

Where:

SL = Stowed load  
SK = Stowed kills

An improvement to  $P_{Hit}$  will either increase the number of stowed kills or reduce the number of rounds that need to be carried within the vehicle.

To increase Stowed Kills (SK):

$$SK' = \frac{SL}{n'} = \frac{SL}{\frac{1}{P_{Hit}'}} = P_{Hit}' * SL \quad (41)$$

The change in stowed kills is then related to changes in  $P_{SH}$  by:

$$SK' = SL * [\delta * P_{SH}(2 - \delta * P_{SH})] \quad (42)$$

It is also possible to reduce stowed load (SL) requirements:

$$SL' = n' * SK = \frac{SK}{P_{Hit}'} = \frac{SK}{\delta * P_{SH}(2 - \delta * P_{SH})} \quad (43)$$

Since the number of stowed kills equates to the system's stowed load divided by  $P_{Hit}$  :

$$SL' = \left[ \frac{1}{\delta * P_{SH}(2 - \delta * P_{SH})} \right] * \frac{SL}{N} = \left[ \frac{P_{SH}(2 - P_{SH})}{\delta P_{SH}(2 - \delta P_{SH})} \right] * SL \quad (44)$$

and the new (equivalent) stowed load becomes:

$$SL' = \left[ \frac{(2 - P_{SH})}{\delta(2 - \delta P_{SH})} \right] * SL \quad (45)$$

### 3.3.3 OTHER IMPACTS

- a. **Other Lethality Functions.** If the ability to hit a target improves, GCV target acquisition should enable detection and engagement at longer ranges. As will be seen in the next section,  $P_{Pen}$  varies inversely with range. Consequently, an increase in  $P_{Hit}$  may extend engagement range and increase lethality, but can also degrade system  $P_{Pen}$ .
- b. **Survivability.** If the change in  $P_{Hit}$  reduces onboard ammunition requirements, the amount of explosives carried within the GCV decreases, and this results in an overall decrease in the vulnerable area within the GCV and a decrease in compartmentation requirements. The reduction in compartmentation equates to improved vulnerability reduction (kill avoidance). The increase in kill avoidance is assumed linear with respect to the number of main gun rounds carried by the GCV, so a  $\delta$  % reduction in stowed load will result in a  $\delta$  % improvement in kill avoidance.
- c. **Mobility.** If a change in  $P_{Hit}$  reduces ammunition requirements, there will be a reduction in system weight. Since ammunition volume traditionally occupies 6% of the GCV's volume, GVSI assumes a  $\delta$  % reduction in ammunition quantity translates into a  $\delta * 0.06$  change in system volume. If GCV system weight is proportional to its size, there will be a  $\delta * 0.06$  change to system weight. This weight change will impact all GCV mobility characteristics; the effects are increased speed, improved acceleration, reduced ground pressure, and improved cross country mobility
- d. **Sustainability.** Improving GCV fire control will improve system sustainability in one of two ways. If the change in  $P_{Hit}$  leads to a reduction in stowed load, the expected change in system weight will improve system RAM by  $\delta * 0.06$  and reduce fuel consumption by  $\delta * 0.06$  as well. On the other hand, if the stowed load remains constant, and stowed kills increase by  $\delta$  %, then there will be no change to system RAM or fuel consumption, but there will be a  $\delta$  % improvement in ammunition consumption.

### 3.4 WEAPON SYSTEM

Weapon and ammunition parameters determine the GCV's ability to kill a target after hitting it.

#### 3.4.1 APPROACH TO CHANGING PERFORMANCE

The penetration capability of a round is (3:109):

$$\frac{m_p V^2}{d^3} = c \left( \frac{t}{d} \right)^N \quad (46)$$

where:

$m_p$	=	Projectile Mass (Kg)
$V$	=	Impact velocity (m/s)
$d$	=	Projectile diameter (mm)
$c$	=	Constant (6.6 for Rolled Homogenous Armor)
$t$	=	Armor thickness (mm)
$N$	=	1.37

If target penetration means a "kill", increased penetration will increase system lethality.

The thickness of an armor plate penetrated by a round is given by (2:560):

$$t = 0.7 \sqrt{\frac{m_p^{0.5} V}{A d^{0.75}}} \quad (47)$$

where:

$m_p$	=	Projectile Mass (Kg)
$V$	=	Impact velocity (m/s)
	=	$V_o(1 - a * R)^2$

with:

$V_o$	=	Muzzle Velocity (m/s)
$R$	=	Range (m)
$a^*$	=	Ballistic drag coefficient

$$= \frac{a}{\cos \alpha} \quad (49)$$

where:

$\alpha$  = elevation angle (0-5 degrees), and

$$a = \frac{c_{3/2} \rho \pi d^2}{16m} \quad (50)$$

with:

$\rho$  = air density and,  
if  $V_o$  = Mach 4.7, then  $c_{3/2} = 0.2$

$A$	=	Empirical factor	=	1600
-----	---	------------------	---	------

### 3.4.2 SYSTEM IMPACT

Options for increasing penetration include:

Increasing projectile mass, such that  $m_p' = X_{proj}m_p$ :

$$t' = \sqrt[0.7]{\frac{m_p'^{0.5} V}{Ad^{0.75}}} = \sqrt[0.7]{\frac{X_p^{0.5} m_p^{0.5} V}{Ad^{0.75}}} = \sqrt[0.7]{X_p^{0.5}} * t \quad (51)$$

Increasing velocity, such that  $V' = X_{vel}V$ :

$$t' = \sqrt[0.7]{\frac{m_p^{0.5} V'}{Ad^{0.75}}} = \sqrt[0.7]{\frac{X_{vel} m_p^{0.5} V}{Ad^{0.75}}} = \sqrt[0.7]{X_{vel}} * t \quad (52)$$

Decreasing projectile diameter, such that  $d' = X_{proj}d$ :

$$t' = \sqrt[0.7]{\frac{m_p^{0.5} V}{Ad'^{0.75}}} = \sqrt[0.7]{\frac{X_{vel} m_p^{0.5} V}{A X_{proj}^{0.75} d^{0.75}}} = \sqrt[0.7]{\frac{1}{X^{0.75}}} * t \quad (53)$$

or any combination of the above. Changing ammunition performance may also change the volume of individual rounds and increase storage compartment requirements. From Table 1, ammo stowage is approximately 6 % of system volume. Therefore, increasing ammo volume by X percent will increase system volume requirements by same percentage ( $X * 0.06$ ), but, if system volume must remain constant, changes to ammunition volume will cause an overall degradation to kill avoidance. GVSI assumes this degradation factor will be equivalent to the increase in ammunition volume requirements.

### 3.4.3 OTHER IMPACTS.

- a. **Other Lethality Functions.** Changing  $P_{pen}$  impacts target acquisition and fire control performance. If the system's ability to penetrate a target improves, the GCV's target acquisition and fire control systems should also enable longer range engagements.
- b. **Survivability.** If changing  $P_{pen}$  changes ammunition performance, the explosive power carried within the GCV will increase and the vulnerable areas within the vehicle will also increase. This change in system performance will decrease the effectiveness of existing compartmentation techniques and reduce the expected performance of existing kill avoidance concepts. Assuming that a  $\delta\%$  improvement in ammunition performance increases onboard explosive power by  $\delta\%$  also, changing  $P_{pen}$  will cause a  $\delta\%$  degradation in kill avoidance.
- c. **Mobility.** If the change in  $P_{pen}$  increases system weight by  $\delta = X * 0.06$ , there will be a negative impact on system mobility. The increased weight will reduce speed and acceleration capabilities, increase ground pressure, and reduce cross country mobility.
- d. **Sustainability.** The system weight increase expected to accompany an increased  $P_{pen}$  will affect GCV sustainability by degrading system RAM and

increasing fuel consumption. If RAM and fuel consumption vary linearly with system weight, then a  $\delta\%$  increase in weight degrades RAM by  $\delta\%$  and increases fuel consumption by  $\delta\%$ .

### 3.5 SWEPT VOLUME

The turret volume that the weapon sweeps out as it elevates and depresses to the limits of its elevation field of regard determines the swept volume. Swept volume includes the space reserved for the breech and interior part of gun, ammunition load length, and gun recoil (if recoil length is greater than ammunition load length).

#### 3.5.1 APPROACH TO CHANGING PERFORMANCE

Changing gun depression and elevation angles will change swept volume (SV) and impact height. Given Figure 15 below (4:46):

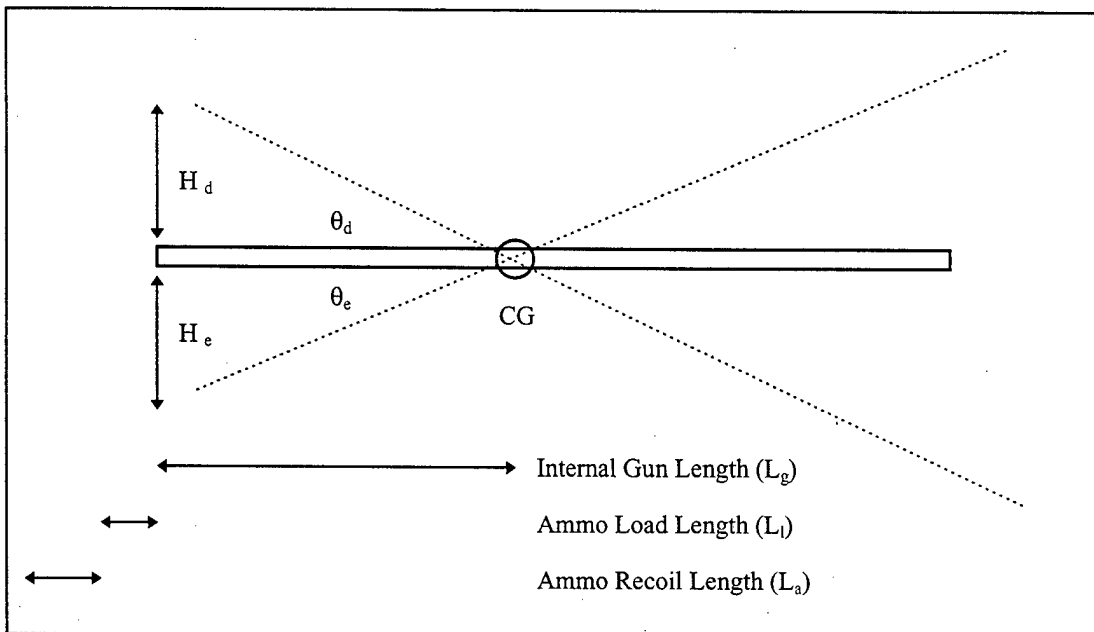

Figure 15. Swept volume.

Where:

- $L_l$  = Ammo Load Length
- $L_a$  = Ammo Recoil Length
- $L_g$  = Internal Gun Length
- $\theta_e$  = Elevation angle
- $\theta_d$  = Depression Angle
- $H_d$  = Height requirement imposed by depression angle
- $H_e$  = Height requirement imposed by elevation angle
- $L = L_l + L_g$  = Total length of the gun
- $H_d = L_g * \tan \theta_d$
- $H_e = L_g * \tan \theta_e$

$$H = H_d + H_e = L_g (\tan \theta_d + \tan \theta_e) = \text{Total height requirement imposed by the gun's elevation and depression angles}$$

the swept volume is the volume traced by the gun as it elevates and depresses. This volume equals the Length x Width x Height of the "swept wedge" within the turret.

$$SV = \frac{1}{2} * L_g * w * L_g * (\tan \theta_d + \tan \theta_e) \quad (54)$$

$$SV = \frac{1}{2} * L_g^2 * w * (\tan \theta_d + \tan \theta_e) \quad (55)$$

Changing elevation and depression angles impacts swept volume as follows:

$$SV' = \frac{1}{2} L_g^2 w (\tan \theta'_d + \tan \theta'_e) \quad (56)$$

The change in SV is then:

$$\Delta SV = \frac{1}{2} L_g^2 w [(\tan \theta'_d + \tan \theta'_e) - (\tan \theta_d + \tan \theta_e)] \quad (57)$$

and the percent change in SV becomes:

$$\frac{\Delta SV}{SV} = \frac{\frac{1}{2} * L_g^2 w [(\tan \theta'_d + \tan \theta'_e) - (\tan \theta_d + \tan \theta_e)]}{\frac{1}{2} * L_g^2 w (\tan \theta_d + \tan \theta_e)} \quad (58)$$

which reduces to:

$$\frac{\Delta SV}{SV} = \frac{(\tan \theta'_d + \tan \theta'_e)}{(\tan \theta_d + \tan \theta_e)} - 1 \quad (59)$$

### 3.5.2 SYSTEM IMPACT

Swept volume (SV) historically accounts for 8% of the system volume. Therefore, changing swept volume by  $\delta$  % changes system volume requirements by  $\delta$  % \* 0.08. If system weight varies linearly with system volume, changing a vehicle's swept volume by  $\delta$  % changes weight by  $\delta$  % \* 0.08 as well. If system volume is changeable, changing swept volume will alter under armor volume requirements for the total system; if system volume is fixed, changing swept volume will change the amount of under armor volume available for other functions.

### 3.5.3 OTHER IMPACTS

- a. **Other Lethality Functions.** Changing SV changes the EFOR of the main armament system. There are no other direct effects on lethality.
- b. **Survivability.** Increasing size and weight increases GCV detectability and reduces the GCV's ability to evade a threat. As seen previously, if the change in system size has a linear affect on threat acquisition, then increasing system height by  $\beta$  will increase the threat's probability of GCV detection by  $\beta$  also. If



weight increases linearly with system size, and if GCV mobility is dependent on system weight, then changing SV by  $\delta\%$  increases system weight by  $\delta * 0.08$ . This increase in weight degrades system mobility and leads to a  $\delta * 0.08$  percent decrease in the GCV's ability to evade a threat.

- c. **Mobility.** If the change in SV increases system weight by  $\delta = X * 0.08$ , there will be a negative impact to system mobility. The increase in weight will result in proportionate changes to the GCV mobility: reduced speed and acceleration, increased ground pressure, and reduced cross country mobility.
- d. **Sustainability.** Increased weight will have a negative effect on GCV sustainability. The added weight will degrade system RAM by  $\delta\%$ . Fuel consumption will increase by  $\delta\%$  as well, and cause a  $\delta\%$  degradation in consumption of expendables.

## 4.0 SURVIVABILITY

### 4.1 FUNCTIONAL REPRESENTATION.

The basic expression for system survivability is:

$$S_{SYSTEM} = 1 - [P_{DET} * P_{HIT|DET} * P_{PEN|HIT} * P_{KILL|PEN}] \quad (60)$$

Where:

- $P_{DET}$  = The probability of the threat detecting the GCV;
- $P_{HIT|DET}$  = The probability of the GCV being hit once it is detected by a threat;
- $P_{PEN|HIT}$  = The probability of the GCV being penetrated once it is hit; and
- $P_{KILL|PEN}$  = The probability of the GCV being killed if penetrated

Survivability features that influence the threat's  $P_{DET}$  and  $P_{HIT|DET}$  are termed susceptibility reduction measures; design approaches that influence  $P_{PEN|HIT}$  and  $P_{KILL|PEN}$  are vulnerability reduction measures.

### 4.2 SUSCEPTIBILITY REDUCTION.

#### 4.2.1 DETECTION AVOIDANCE

Detection avoidance applications influence the threat's target acquisition capability. As seen previously, it is possible to consider the target acquisition capability of any system in terms of the following expression:

$$\frac{1.22 * \lambda}{D_{OBJ}} = \frac{D_{TGT} * 1000}{R} \quad (61)$$

Where, from the threat perspective:

- $\lambda$  = the wavelength at which the threat sensor operates;
- $D_{OBJ}$  = the diameter of the threat's objective lens;
- $D_{TGT}$  = the width of the GCV that is resolved by the threat sensor;
- $R$  = the range from the GCV to the threat sensor

Survivability concepts that reduce GCV detectability will either reduce the size of the vehicle and make it less resolvable by the threat's optical system or reduce the contrast between the vehicle and its surroundings. Rearranging terms, the above expression becomes:

$$R = \frac{D_{TGT} * 1000}{1.22 * \lambda} * D_{OBJ} = \frac{1000}{1.22 * \lambda} * D_{TGT} * D_{OBJ} \quad (62)$$

Equation 62 shows it is possible to relate target acquisition in terms of a detection range. From the lethality perspective, the goal is to extend the range at which a sensor can detect a target; from the survivability perspective, the goal is to reduce the

range at which the threat sensors can detect the GCV. Similarly, reducing the vehicle's signature will have an impact on the amount of energy collected by the sensor's aperture. Both approaches will reduce the range at which the threat sensor can detect the GCV.

**a. Size Reduction**

- (1) **Functional Representation.** Reducing GCV size reduces the ability of the threat sensor to resolve the GCV as a target, and Equation 62 suggests a linear relationship between vehicle size and threat sensor performance.
- (2) **Approach to Changing Performance.** GVSI assumes that reducing the size of a vehicle will reduce the threat's probability of detection. The measure of performance for this survivability measure is the reduction in GCV losses that occurs from this detection avoidance application. The US Army's Materiel Systems Analysis Activity (AMSAA) briefly examined the survivability benefit associated with size reduction and documented these results in a survivability database. Table 10 is an extract of this database (1).

TABLE 10. IMPACT OF SIZE REDUCTION ON BLUE VEHICLE LOSSES

Threat Sensor FLIR (3 Km)	Baseline	Height Reduction		Width Reduction		Length Reduction		Length, Width, Height Reduction	
		-10%	-20%	-10%	-20%	-10%	-20%	-10%	-20%
Blue Losses	3.7	3.4	3.0	3.0	3.0	3.0	3.0	3.0	2.0
D Losses	0	-.3	-.7	-.7	-.7	-.7	-.7	-.7	-1.7
% D Losses	0	-8.8	-23.3	-23.3	-23.3	-23.3	-23.3	-23.3	-46.0

AMSAA's results suggest the following survivability benefits accrue when the size of a GCV is changed:

- Reducing GCV height by up to 20% improves Blue survivability by approximately the same amount. [GCV height reduction of 10% improves Blue survivability by 8.8%; reducing GCV height by 20% improves survivability by 23.3%. ]
- Reducing GCV width by 10% will increase survivability by 23.3%, but there is no additional payoff associated with further GCV width reductions.
- Reducing GCV length by 10% improves GCV survivability by 23.3%, but there is no additional payoff associated with further GCV length reductions.
- Reducing all GCV dimensions (length, width, and height) by 10% improves GCV survivability by 23.3%; reducing all GCV dimensions by 20% doubles the survivability payoff to 46%.

- (3) **System Impact.** Given the results documented in Table 10, GVSI's representation of the impact of size reduction on GCV survivability is:

- Reducing GCV height by x% will improve survivability by x% for x <= 20%;

- Reducing GCV width by 10% improves survivability by 23%; further width reduction has no impact on survivability;
- Reducing GCV length by 10% improves survivability by 23%; further length reductions have no impact on survivability; and
- Reducing all GCV dimensions will have the greatest payoff. Reducing all dimensions by X% results in a 2X% survivability payoff.

**(4) Other Impacts.**

- (a) Other Survivability Characteristics.** GVSI assumes that vehicle size is related to weight. If GCV size is reduced and engine performance remains the same, the power to weight ratio of the vehicle should increase and so should the maximum speed. From the survivability perspective, this change in system performance should improve the GCV's ability to evade the threat (a Hit Avoidance survivability measure).
- (b) Lethality Impact.** From the discussion in Section 3.5, reducing the height of the vehicle will reduce the Elevation Field of Regard. The practical impact is a reduction in the maximum depression angle for the main gun. As seen in Equation 59, the percentage change in swept volume (SV) is:

$$\frac{\Delta SV}{SV} = \frac{(\tan \theta'_d + \tan \theta'_e)}{(\tan \theta_d + \tan \theta_e)} - 1 \quad (63)$$

with:

$$\tan \theta_d = \frac{H_d}{L_g} \quad (64)$$

and

$$\tan \theta_e = \frac{H_e}{L_g} \quad (65)$$

where:

- $\theta_d$  = Main gun depression angle;
- $\theta_e$  = Main gun elevation angle;
- $H_d$  = Vehicle height requirement imposed by the main gun's depression angle;
- $H_e$  = Vehicle height requirement imposed by the main gun's elevation angle;
- $L_g$  = Length of the main gun contained within the turret;

Substituting the values of Equations 64 and 65 into equation 59 yields the following expression:

$$\frac{\Delta SV}{SV} = \left[ \frac{\left( \frac{Hd'}{Lg} + \frac{He}{Lg} \right)}{\left( \frac{Hd}{Lg} + \frac{He}{Lg} \right)} \right] - 1 = \left( \frac{Hd'+He}{Hd+He} \right) - 1 \quad (66)$$

If the total internal turret volume available for main gun elevation and depression is represented by the expression:  $H = Hd + He$ , and if changes to the size of the GCV are reflected in the vehicle's overall height, so that:

$$H' = \delta * H$$

where  $\delta$  is the height change imposed on the GCV, then equation 65 becomes:

$$\frac{\Delta SV}{SV} = \left( \frac{Hd'+He}{Hd+He} \right) - 1 = \frac{H'}{H} - 1 = \frac{\delta * H}{H} - 1 = \delta - 1 \quad (67)$$

As seen in the equation above, any GCV size reduction effort that changes platform height by any value ( $\delta$ ) will degrade the vehicle's elevation field of regard by the same value of  $\delta$ .

- (c) **Mobility Impact.** Reducing size will reduce system weight and, as suggested above, increase the vehicle's horsepower to weight ratio. This change in vehicle performance will produce a linear increase in speed and acceleration, improve platform agility, and, by reducing ground pressure, enhance cross country mobility.
- (d) **Sustainability Impact.** Reduced size (and weight) would be expected to improve system RAM proportionately and, by reducing fuel consumption, improve GCV sustainability.

**b. Signature Control.**

- (1) **Functional Representation.** Functionally, signature management applications attempt to make some change to the radiation that the GCV emits or reflects. The goal of this survivability measure is to reduce the threat sensor's ability to detect the GCV as a target against a cluttered background. Potential signature management applications include the measures listed in Figure 16 (2:188).

## Potential Signature Management Techniques

- Obscuration
  - Tarps
  - Camouflage
  - Shielding
- Shape Tailoring
- Appliques
- Active Cooling

Figure 16. Potential signature management applications.

- (2) **Approach to Changing Performance.** Changing the amount of energy emitted or reflected from the target ( $\Delta M_T$ ) changes the power that can be collected by a threat sensor. The total power radiated from a target vehicle (and collected by a sensor) is:

$$P_C = \left( \frac{M_T * A_T}{\pi} \right) \left( \frac{\pi * D_{OBJ}^2}{4R^2} \right) = \frac{M_T * A_T * D_{OBJ}^2}{4R^2} \quad (68)$$

where:

$M_T$	=	Target emittance in Watts/Area
$D_{OBJ}$	=	Optics Diameter
$A_T$	=	Area of target at distance R from the lens of the sensor
$R$	=	Range to the target

When GCV emissions or reflections are changed, the power collected by the sensor changes as indicated in Equation 68.

$$\Delta P_C = \frac{\Delta M_T * A_T * D_{OBJ}^2}{4R^2} \quad (69)$$

If the optical power collected by a sensor is a measure of the sensor's probability of detection, then Equation 68 shows that a  $\delta$  % change in GCV signature will cause a  $\delta$ % change to collected optical power. GVSI assumes this change in sensor performance will be reflected as a  $\delta$  % reduction in  $P_{Det}$ .

- (3) **System Impact.** For existing vehicles (and the baseline platform used by GVSI), signature reduction applications will probably occur through the use of add-on materials. As these materials are applied to the platform, they will add weight to the host platform. As with size reduction efforts, the measure of performance for signature reduction is the percent change vehicle losses that accompanies a percent change in vehicle signatures. The effectiveness of these appliques were also previously examined by AMSAA. Table 11 summarizes the survivability benefits

associated with reducing a fully exposed tank's visual and thermal signatures by 25, 50, 75, and 90 percent (1).

TABLE 11. IMPACT OF SIGNATURE REDUCTION ON GCV LOSSES

	Threat Sensor (Visibility)	Losses of Baseline Vehicles	25% Signature Reduction	50% Signature Reduction	75% Signature Reduction	90% Signature Reduction
GCV Losses	DVO (7)	4.4	4.2	2.8	1.4	1.0
	FLIR (3)	3.4	3.2	3.0	2.3	1.3
D Losses	DVO (7)	0	-2	-1.6	-3.0	-3.4
	FLIR (3)	0	-2	-4	-1.1	-2.3
% D Losses	DVO (7)	0	-4.5	-36.4	-68.2	-77.3
	FLIR (3)	0	-5.9	-11.8	-32.4	-61.8

These results suggest the biggest payoff in survivability occurs when visible signatures are reduced to at least 75%; the survivability benefits for thermal management appear highest when the signature can be reduced to at least 90%.

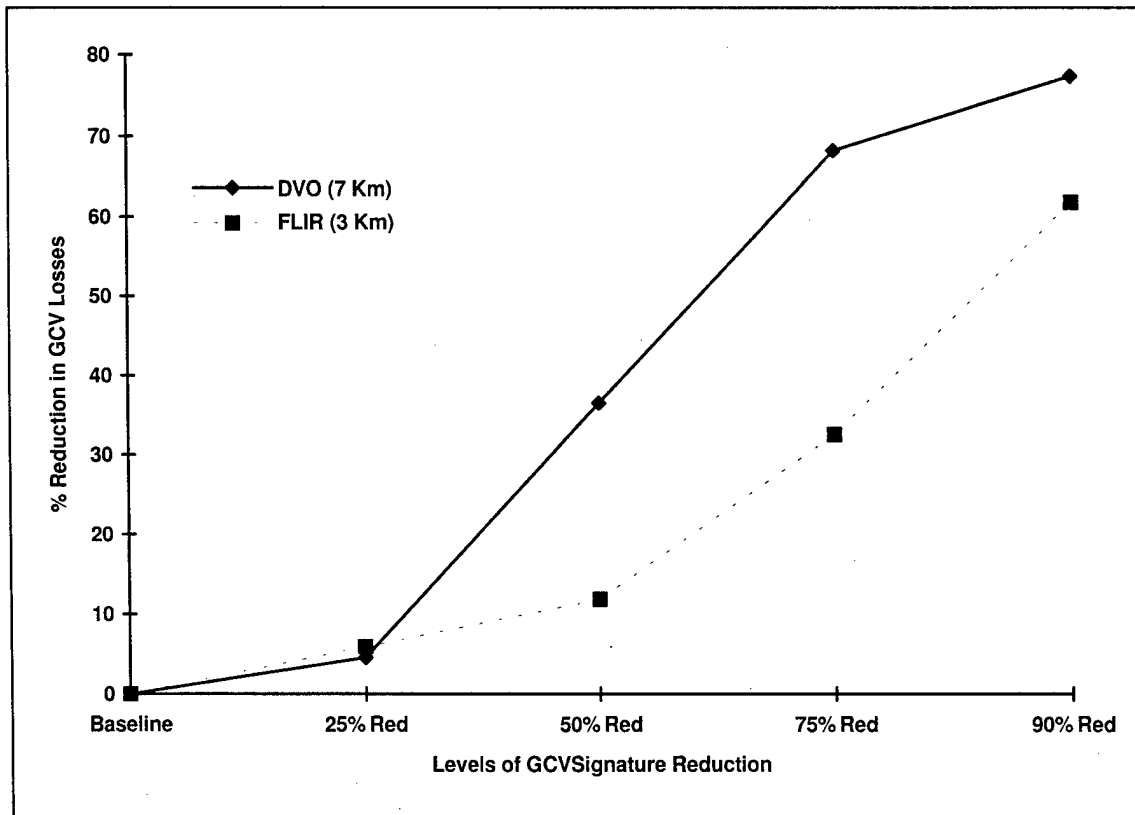

Figure 17. Survivability payoff versus signature reduction.

Figure 17 illustrates that, under certain conditions, there is an almost linear relationship between GCV survivability and signature reduction applications for DVO and FLIR scenarios.

Given these observations, the following conclusions were made for GCVSI:

For GCVs targeted by threat DVOs:

- There is a 1% improvement in GCV survivability for every 5.6% reduction in visible signature up to a 25% reduction in the GCV's baseline signature
- There is a 1% improvement in GCV survivability for every .8% reduction in signature for GCV values that are between 25 and 75% of the baseline signature
- For signature values that are between 75 and 90% of the baseline platform, there is a 1% improvement in GCV survivability for every 1.6% reduction in vehicle signature

For GCVs targeted by threat FLIRs:

- There is a 1% improvement in GCV survivability for every 4.2% reduction in thermal signature up to a 50% reduction in the GCV's baseline signature
- There is a 1% improvement in GCV survivability for every 1.2% reduction in signature for GCV values that are between 50 and 75% of the baseline signature
- For signature values that are between 75 and 90% of the baseline platform, there is a 1% improvement in GCV survivability for every .5% reduction in vehicle signature

GVSI implements these observations through Table 12.

TABLE 12. SURVIVABILITY IMPROVEMENT FOR SIGNATURE REDUCTION

Threat Sensor	Levels of Signature Reduction Applied to the GCV (% of GCV Signature Reduction)			
	0-25	25-50	50-75	75-90
DVO	0.18	1.25	1.25	0.63
FLIR	0.24	0.24	0.83	2.00

GVSI assumes a user will specify a percent reduction in vehicle signature. Survivability benefits are cumulative for different levels of signature reduction. For user inputs of "δ", where δ is the percent reduction in GCV signature, the improvement to survivability is:

Against DVOs, the cumulative effects of increased signature reduction are:

$$\begin{aligned}
 D\%_{\text{Det Avoidance}} &= [ X * 0.18]; & 0 < X < 25 \\
 D\%_{\text{Det Avoidance}} &= [ 25 * 0.18] + [(X-25) * 1.25]; & 25 < X < 75 \\
 D\%_{\text{Det Avoidance}} &= [ 25 * 0.18] + [ 50 * 1.25] + [ (X-75) * 0.63]; & X > 75
 \end{aligned}$$

Combining terms, GVSI represents signature reduction benefits as:

$$\begin{aligned}
 D\%_{\text{Det Avoidance}} &= [ X * 0.18]; & 0 < X < 25 \\
 D\%_{\text{Det Avoidance}} &= 4.50 + [(X-25) * 1.25]; & 25 < X < 75 \\
 D\%_{\text{Det Avoidance}} &= 67.0 + [ (X-75) * 0.63]; & X > 75
 \end{aligned}$$

Against FLIRs the cumulative effects of increased signature reduction are:



$$\begin{aligned}
D\%_{\text{Det Avoidance}} &= [ X * 0.24]; & 0 < X < 50 \\
D\%_{\text{Det Avoidance}} &= [ 50 * 0.24] + [ (X-50) * 0.83]; & 50 < X < 75 \\
D\%_{\text{Det Avoidance}} &= [ 50 * 0.24] + [ 25 * 0.83] * [ (X-75) * 2]; & X > 75
\end{aligned}$$

Combining terms, GVS<sub>I</sub> represents thermal signature reduction benefits as:

$$\begin{aligned}
D\%_{\text{Det Avoidance}} &= [ X * 0.24]; & 0 < X < 50 \\
D\%_{\text{Det Avoidance}} &= 12 + [ (X-50) * 0.83]; & 50 < X < 75 \\
D\%_{\text{Det Avoidance}} &= 32.75 * [ (X-75) * 2]; & X > 75
\end{aligned}$$

(4) **Other Impacts.** Limited data is available to assess the impact of adding signature reduction materials to a GCV; however, it is possible to draw some general conclusions:

- Adding material to a vehicle will impact the external size and shape of the vehicle.
- Changes in platform size occur because the signature reduction materials will be added to the outer structure of the vehicle to shield signatures or dissipate energy produced by the vehicle.
- If signature reduction materials reduce emissions in one spectral region, they may actually increase vehicle signatures in other spectral regions.
- Adding materials to the external structure will increase system weight. Although precise data are not available for this report, past estimates of the weight impact of signature reduction material suggest that reduction of a vehicle's thermal signature by 50% will impose a 1000 pound weight burden on the platform, or 20 pounds for every percent reduction in signature for each spectral region of concern.
  - (a) **Impact on Other Survivability Characteristics.** Increasing GCV weight will reduce the platform's available speed. From the survivability perspective, this change in system performance should degrade the platform's ability to evade the threat (a Hit Avoidance survivability measure).
  - (b) **Lethality Impact.** No Impact.
  - (c) **Mobility Impact.** Increasing system weight 20 pounds for every per cent reduction in signature for each spectral region covered will reducing the vehicle's horsepower to weight ratio and decrease speed and acceleration. The extra weight will degrade agility, and, by increasing ground pressure, reduce cross country mobility.
  - (d) **Sustainability Impact.** Increased weight will degrade system RAM proportionately and, by increasing fuel consumption, degrade GCV sustainability.

#### 4.2.2 HIT AVOIDANCE

Hit Avoidance measures attempt to degrade the threat's probability of hit. Generally, hit avoidance concepts include tactical and technical responses (or countermeasures) to a threat. Tactical countermeasures include GCV actions taken when the system is exposed to an engagement. Examples of tactical countermeasures

include evasive maneuvers and suppressive counterfire. Technical countermeasures assume activation of one or more on-board devices that will degrade threat fire control or guidance systems. Examples of technical countermeasures include decoys, jammers, false target generators, and obscurants. Both technical and tactical countermeasures require situational awareness or an early warning capability to be effective. Hit avoidance systems used in GVSI include evasive maneuvers and an electronic countermeasure that jams a threat's guidance system.

**a. Evasive Maneuvers.**

- (1) **Functional Representation.** Functionally, evasive maneuver represents the GCV's inherent ability to avoid being hit by an incoming threat. This survivability response assumes the vehicle detects the threat and then uses aggressive movement such as rapid changes of direction or acceleration to evade the incoming projectile.
- (2) **Approach to Changing Performance.** GVSI's representation of this countermeasure assesses the survivability benefit associated with a change in vehicle speed while the vehicle is being engaged by kinetic energy (KE) rounds and ATGMs. Previous efforts to examine these payoffs, as documented by AMSAA's Ground Wars Database Retrieval System, confirm that changing a vehicle's speed produces a survivability payoff. Table 13 summarizes these benefits and suggests that evasive maneuvers have different payoffs for different threats and for different tactical responses (1).

TABLE 13. SURVIVABILITY IMPACT OF EVASIVE MANEUVERS

Red Threat	Red Sensor	Blue Evasive Response	Baseline Speed		1.5 x Baseline Speed		2.0 x Baseline Speed	
			Losses	% D Losses	Losses	% D Losses	Losses	% D Losses
KE	FLIR	Pause in defilade	3.6	-	3.5	-2.8	3.5	-2.8
KE	FLIR	No pause in defilade	3.8	-	4.0	+5.3	3.9	+2.6
ATGM	FLIR	Pause in defilade	7.6	-	7.2	-5.3	6.7	-11.8
ATGM	FLIR	No pause in defilade	8.0	-	7.4	-7.5	6.9	-13.8

If the GCV accelerates after the threat engages with a KE projectile, and if the GCV's maximum speed is increased to 1.5 times its baseline capability (for a total of 50% increase in vehicle speed), and if the vehicle pauses while in defilade, there is a small survivability benefit (2.8% reduction in losses). If there is no pause once the GCV reaches defilade, then there is actually a reduction in survivability (a net increase in blue losses).

Against ATGMs, evasive maneuver benefits are more pronounced. If speed increases by 50%, and the GCV pauses while in defilade, vehicle losses are reduced by 5.3%; if speed is increased by another 50% (to 2X the baseline GCV speed), vehicle losses are reduced by 11.8%. If the vehicle does not pause when in defilade, GCV losses are reduced by 7.5% for a 50% increase in speed, and by 13.8% if GCV baseline speed is doubled.

- (3) **System Impact.** GVSI's representation of the vehicle survivability vs. evasive maneuvers assumes the crew will employ the most effective response to defeat all threats. This response, as shown in Figure 18, is to race to a defilade position and pause before resuming its attack. Although there are limited data, AMSAA's database suggests a linear

relationship between GCV speed and survivability against KE and ATGM threats.

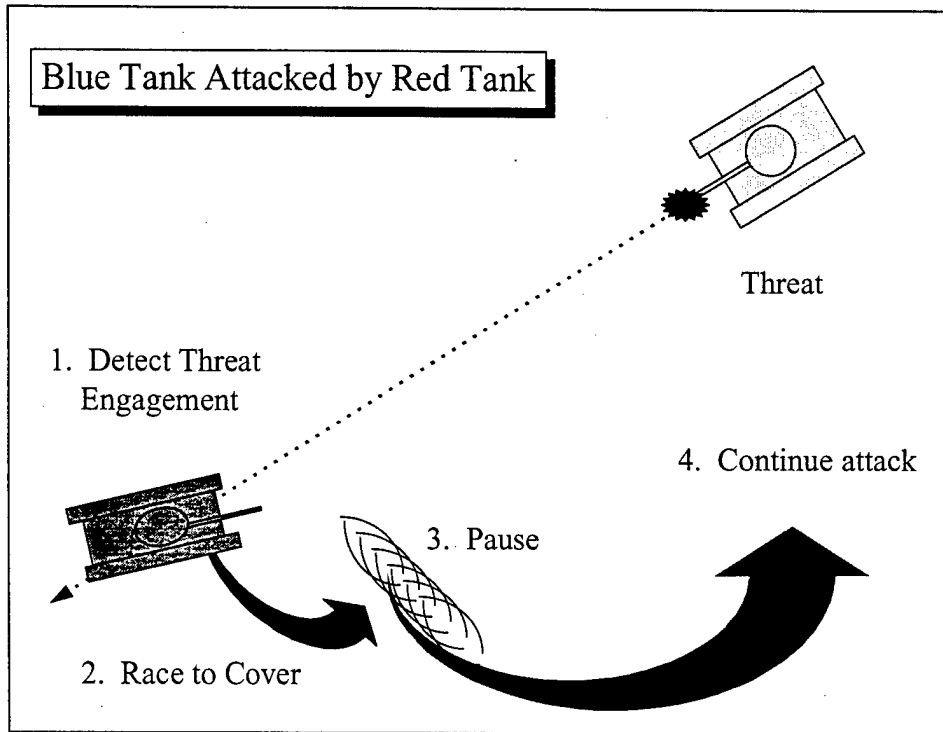

Figure 18. Scenario for evasive maneuvers.

For KE engagements and GCV speeds up to 1.5 times the vehicle's baseline, the estimated performance relationship for KE survivability is:

$$\frac{\Delta\% \text{ Blue Losses}}{\Delta\% \text{ Speed Increase}} = \frac{2.8}{50} = 0.056$$

or, against KE threats, there is a 0.056 increase in GCV survivability for each 1% increase in vehicle speed, for values up to 1.5 times GCV speed. For ATGM engagements, survivability payoffs appear nearly linear up to speeds of 2.0 times the GCV baseline speed. The assumed performance relationship for ATGM survivability is therefore:

$$\frac{\Delta\% \text{ Blue Losses}}{\Delta\% \text{ Speed Increase}} = \frac{\frac{5.3}{50} + \frac{6.5}{50}}{2} = .118$$

or, against ATGM threats, there is a .118 increase in GCV Survivability for each 1% increase in GCV speed, for values up to 2.0 times GCV speed.

For a top level model such as GVSI, there is an equal probability of encountering a KE threat and an ATGM threat. Consequently, the survivability payoffs for KE and ATGM engagements are averaged, with equal weight given to KE and ATGM engagements for conditions of 1.5 and 2.0 times the baseline speed. This approach produces an average, system-level survivability payoff for evasive maneuvers:

$$\frac{\text{KE} + \text{ATGM}}{2} = \frac{\frac{2.8}{50} + \frac{0}{50}}{2} + \frac{\frac{5.3}{50} + \frac{6.5}{50}}{2} = \frac{0.028 + 0.118}{2} = 0.073$$

The GVSI performance relation is that there is a 0.073 increase in GCV survivability for each % increase in GCV speed, for values up to 100% of the vehicle's baseline speed.

- (4) **Other Impacts.** Increasing the vehicle's ability to use evasive maneuvers against a threat is equivalent to increasing platform speed. This change in GCV performance will have the following impacts on the system.
- (a) **Impact on Other Survivability Characteristics.** Increasing the GCV's speed will make the GCV more detectable against a stationary background. GVSI assumes there is a proportionate, and linear increase in the threat's probability of detecting the vehicle.
  - (b) **Lethality Impact.** No Impact.
  - (c) **Mobility Impact.** Increasing the system's evasive capability equates to an increase in speed and agility. GVSI assumes there will be a proportional (and linear) impact on vehicle speed, acceleration, and cross country mobility.
  - (d) **Sustainability Impact.** Increased system speed will place a greater demand on the vehicle's power train and will degrade system RAM proportionately. The increase in system speed will also increase overall fuel consumption and degrade that aspect of element of system sustainability and will degrade system ride quality.

b. **Countermeasures.** Countermeasures are devices that degrade the performance of a threat weapons system. To be effective, a countermeasure system must include both a warning and a reaction capability. Both devices must have access to the environment.

- (1) **Functional Representation.** GVSI assumes a countermeasure system is a black box that has been added to a platform. The countermeasure, as implemented, will reduce a threat's ability to hit the GCV target and affect the threat's probability of hitting the GCV as shown in equation

$$P_{\text{HIT}(\text{TH})}' = -\delta * P_{\text{HIT}(\text{TH})} \quad (70)$$

The AMSAA GroundWars database assumes most countermeasures will be similar to a false target generator or a decoy. Against ATGMs, the appropriate measure of performance is the probability of successfully decoying the threat. A countermeasure system that is 25% effective, for example, will cause 25% of the missiles fired at the GCV to hit the ground before impacting the vehicle target. The benefits associated with this type of Hit Avoidance system are shown in Table 14 (1).

TABLE 14. SURVIVABILITY IMPACT OF COUNTERMEASURES

Threat Sensor	Baseline		25% Effective CM		50% Effective CM		75% Effective CM	
	Blue Losses	% D Blue Losses	Blue Losses	% D Blue Losses	Blue Losses	% D Blue Losses	Blue Losses	% D Blue Losses
Optical (3 Km)	3.7	-	3.1	-16.2	2.2	-40.5	1.3	-64.8
FLIR 1 (3 Km)	6.3	-	5.4	-14.3	4.3	-31.7	2.4	-61.9
FLIR 2 (3 Km)	8.0	-	6.9	-13.8	5.1	-36.3	2.8	-65
Average % D in Blue Losses				-14.8		-36.2		-63.9

- (2) **Approach to Changing Performance.** Table 15 examines the average effectiveness of the countermeasure across the various threats and suggests a roughly linear relationship between countermeasure effectiveness and GCV survivability.

TABLE 15. COUNTERMEASURE EFFECTIVENESS VERSUS % BLUE LOSSES

% CM Effectiveness	% Reduction in Blue Losses	% Change in Blue Losses
25	14.8	14.8
50	36.2	21.4
75	63.9	27.7

- (3) **System Impact.** GVSI assumes the countermeasure will only be employed against susceptible threats and that the device effectiveness can be averaged. Given this assumption, the countermeasure performance relationship will be:

$$\frac{14.8}{25} + \frac{21.4}{25} + \frac{27.7}{25} = 0.592 + 0.856 + 0.1108 = 0.852 \approx 0.85$$

If a countermeasure is applied to a ground vehicle, the survivability benefit reflected in GVSI is:

$$\Delta_{SurvCM} = 0.85 * \delta_{CM} \tag{71}$$

Where:

$D_{SurvCM}$  = Change in GCV survivability that results from use of the CM

$\delta_{CM}$  = Assumed % of countermeasure effectiveness

Typically, countermeasures are not large or bulky items, and GVSI assumes they will have little impact on a GCV's overall size and weight. One integration burden possessed by countermeasures, however, is their power demand. GVSI assumes the countermeasure draws power directly from the engine and diverts this power from the rest of the system. The impact is a reduction in power available to move or accelerate the platform. Although there is limited data to support any specific assessment of power requirements vs. CM effectiveness, past experience with the US Army's AN/VLQ-6/8a Missile Countermeasure Device (MCD) suggest that countermeasure power demands can be associated with the system's field of regard.

The MCD defeats a wide variety of ATGMs. Although it is mounted on a vehicle turret and has a 360 degree field of regard, its instantaneous field of regard is limited to the size of its output beam. The MCD output beacon is 40 degrees wide, and the most effective system requires 1200 watts (1.5 horsepower) from the host platform. The size of the beam, as currently configured, covers 11% of the GCVs total field of regard. Increasing the size of the output beam will increase the instantaneous Field of Regard Coverage, but will also require additional power (the relationship, again, is assumed to be linear). If a 40 degree beam requires 1200 watts, a 90 degree beam (covering 25% of the GCV's instantaneous field of regard) would require approximately 2727 watts (~ 3.4 hp). Increasing the output beam to 50 and 75 % of the GCV's instantaneous field of regard will require concurrent increases in power (6.8 and 10.2 hp) from the engine. For GVSI impact and modeling purposes, an increase in CM effectiveness from 25 to 50 and from 50 to 75 percent will each draw an additional 3.4 HP. Given the Abrams as a baseline system (power available from the engine = 1500 hp), 3.4 horsepower equates to .23 % of the available power; a one per cent increase in CM effectiveness would therefore require an increase in power of approximately .1%.

- (4) **Other Impacts.** Adding a countermeasure to the GCV platform will reduce the platform's susceptibility to attack by ATGMs, but may also have other system level impacts.
- (a) **Impact on Other Survivability Characteristics.** Adding a countermeasure system may increase system height and make the platform more detectable to threat sensors. GVSI assumes that the "box" representing the countermeasure system will add .5 meters to the system.
  - (b) **Lethality Impact.** No Impact.
  - (c) **Mobility Impact.** The power used by the countermeasure will not be available for use by other system components. GVSI therefore assumes that application of a countermeasure will reduce available engine power. This, in turn, will decrease the amount of power used to move the vehicle across the battlefield.
  - (d) **Sustainability Impact.** Increased power usage by the countermeasure and the additional drain placed on the engine will degrade system RAM. GVSI assumes that the increased power consumption will decrease system RAM, and sustainability, proportionately.

### 4.3 VULNERABILITY REDUCTION

#### 4.3.1 PENETRATION AVOIDANCE

- (1) **Functional Representation.** The thickness and weight of the vehicle's armor package determines the ability of the threat to penetrate the GCV. Changes to the armor will affect the threat's probability of penetrating the system's ballistic envelope.

(2) **Approach to Changing Performance.** Historically, armor accounts for 45-51% of a system's weight. Averaging out these contributions suggests that armor will usually constitute 48% of the GCV system's weight. GVSI assumes a  $\delta$  % increase in armor protection will cause a comparable decrease in threat penetration capabilities and therefore increase overall platform survivability.

(3) **System Impact.** Increasing armor protection by  $\delta\%$  will degrade threat probability of penetration by  $d\%$  in accordance with the following equation:

$$\Delta_{SurvAR} = \delta_{AR} \quad (72)$$

Where:

$D_{SurvAR}$  = Change in GCV survivability that results from the improved armor

$\delta_{AR}$  = Assumed % of armor improvement

(4) **Other Impacts.** Increasing the levels of armor protection will increase system weight by:

$$\Delta_w = 0.48 * \delta_{AR} \quad (73)$$

Where:

$\Delta_w$  = The % increase in overall system weight

- (a) **Impact on Other Survivability Characteristics.** Adding weight to the vehicle will decrease speed proportionately and cause a proportionate reduction in the GCV's ability to evade the threat.
- (b) **Lethality Impact.** No Impact.
- (c) **Mobility Impact.** The increased system weight will reduce speed and acceleration, increase ground pressure, and reduce the system's cross country mobility.
- (d) **Sustainability Impact.** Increased weight will degrade RAM proportionately and increase fuel consumption by the same ratio.

#### 4.3.2 KILL AVOIDANCE

##### a. Compartmentation.

- (1) **Functional Representation.** Compartmentation is a vehicle design philosophy intended to minimize the effects of perforating rounds. Compartmentation schemes vent the explosive effects of deflagrating rounds outside of the vehicle and away from the crew. GVSI uses the Abrams compartmentation scheme as a baseline concept.

- (2) **Approach to Changing Performance.** Compartmentation issues and impacts are determined by GCV lethality concerns. System level compartmentation requires an internal structure and internal volume to properly vent explosive forces of detonating rounds. The design of many compartmentation schemes is based on the performance of an existing type of ammunition. Any changes to ammunition carried by the vehicle, to include the quantity of rounds carried and the performance characteristics of each round, will impact compartmentation issues and requirements. For current systems, proper venting of internally generated explosive forces depends on maintaining a ratio between the ammunition vent area and the ammunition compartment volume. This venting ratio is given by:

$$\frac{\text{Vent Area}}{\text{Compartment Volume}} = 0.32 \quad (74)$$

Any change to ammunition quantities or performance caused by changing the system's lethality characteristics will impact the effectiveness of the overall compartmentation design. For GVSI, changing ammunition performance equates to increasing the explosive power of each round. This functional change will be assumed to have an inverse effect on the existing compartmentation scheme.

- (3) **System Impact.** Changing ammunition performance or quantity by  $\delta\%$  will degrade system compartmentation by that same factor. Many compartmentation schemes use antifratricide bars, and each bar contributes to system weight. GVSI assumes that changes to ammunition performance will cause proportional increase in the strength and weight of the antifratricide bars. Historically, ammunition weight accounts for 6% of the total system weight. GVSI assumes that the weight impact of the modified antifratricide bars will also add  $0.06 * \delta$  to system weight.
- (4) **Other Impacts.** The added weight of new fratricide bars will contribute to overall system weight values. Other system level impacts caused by induced changes to GCV compartmentation schemes are:
- (a) **Impact on Other Survivability Characteristics.** Adding weight will decrease speed proportionately and reduce the GCV's ability to evade the threat.
  - (b) **Lethality Impact.** No Impact.
  - (c) **Mobility Impact.** The increased system weight will reduce speed and acceleration, increase ground pressure, and reduce the system's cross country mobility.



- (d) **Sustainability Impact.** Increased weight will degrade RAM proportionately and increase fuel consumption at the same ratio.

**b. Spall Liners**

- (1) **Functional Representation** Spall liners are interior coatings designed to minimize the internal effects of non-perforating rounds.
- (2) **Approach to Changing Performance.** GVSI limits spall liner application to the crew compartment. The traditional allocation of internal volume for a single crew man varies from 1.2 to 2.0 cubic meters (GVSI assumes an average value of 1.6 m<sup>3</sup>). A recent US system to consider the application of spall liners is the Future Armored Resupply Vehicle (FARV). During system preliminary design of this system, US Army technical managers estimated that adding a spall liner to the interior of the three man crew compartment would add 3674 pounds to the system design. Assuming the internal space of the FARV followed the same allocation of crew space as other systems, use of a spall liner will add approximately 1200 pounds to system weight for every protected crew member. For a tank, a spall liner for four crewmen will add 4800 pounds to the system. GVSI assumes that the crew members occupy approximately half the vehicle's internal volume and that a spall liner will reduce system vulnerability by 50%.
- (3) **System Impact.** Since the Abrams tank does not use a spall liner, the decision to use a spall liner is a "Yes" or "No" question for the GVSI user. A GCV spall liner, if implemented, will increase Kill Avoidance by 50%, but will also add 4800 pounds to the system.
- (4) **Other Impacts**
  - (a) **Impact on Other Survivability Characteristics.** Adding weight will decrease speed proportionately and reduce the GCV's ability to evade the threat.
  - (b) **Lethality Impact.** No effect.
  - (c) **Mobility Impact.** The increased system weight will reduce speed and acceleration, increase ground pressure, and reduce the system's cross country mobility.
  - (d) **Sustainability Impact.** Increased weight will degrade RAM proportionately and increase fuel consumption at the same ratio.

## 5.0 MOBILITY

### 5.1 FUNCTIONAL REPRESENTATION

System mobility measures the GCV's ability to move across the battlefield. Unlike previous discussions on lethality and survivability, system mobility is a deterministic function. Specific mobility characterizations within GVSI address functions associated with moving from one point to another and include:

Speed (road speed and cross country);

- Acceleration (or "Dash") capabilities;
- Negotiation of natural and man-made obstacles at the fastest possible; and
- Movement over various terrain ranging from soft soil to hard ground/roads.

### 5.2 SPEED

- Functional representation.** A primary measure of GCV performance is the maximum road speed the vehicle can attain.
- Approach to changing performance.** Speed is related to available engine power, sprocket power, and "road load" (1:77).

Available engine power (or sprocket power) is the power delivered to sprockets and defines the power available for moving the vehicle. *Available engine power* is equal to the net power from the engine multiplied by the efficiency of power transfer subsystems that exist between the engine and the sprockets. *Net power* equals the gross power produced by the engine minus losses incurred from diverting power to other system components or functions. Power transfer subsystems are mechanical components that transform the engine power into a form used to move the vehicle. Examples of power transfer systems that exist within tracked vehicles are the transmission and its final drive assemblies. Typical values for Engine and Power Transfer Efficiency are in Table 16 (2:227).

TABLE 16. TYPICAL VALUES FOR ENGINE AND POWER TRANSFER EFFICIENCY

Component	Efficiency
Engine	0.85
Transmission	0.90
Final Drive	0.97
System Efficiency	0.74

The engine power that is available to move the GCV is expressed as (1:77):

$$P_A = (P_E - P_L) * P_{TE} \quad (75)$$

Where:

- $P_A$  = Available engine power (also called sprocket power)
- $P_E$  = Gross engine horsepower
- $P_L$  = Power losses (Engine power diverted to perform other system functions)

$P_{TE}$  = System Power Transfer Efficiency and is the product of the efficiencies of all power transfer subsystems that exist between the engine and the sprockets.

**Road Load** is the sum of the resistive forces a vehicle encounters when it moves. The "road load" of any system includes rolling resistance, aerodynamic drag, and gradient resistance. The Road Load is defined as (1:77):

$$RL = RRC * W + \sin\theta * W = (RRC + \sin\theta) * W \quad (76)$$

where:

- RL = Road load = rolling resistance + gradient resistance
- RRC = Rolling Coefficient of Resistance
- $\theta$  = Gradient angle
- W = System Weight

Rolling resistance is the product of system weight and rolling resistance coefficient. The coefficient of rolling resistance varies with the type of surface and the speed the vehicle moves. Table 17 lists typical values for this parameter (1:56).

TABLE 17. TYPICAL VALUES FOR ROLLING RESISTANCE

Surface	Low Speed	High Speed
Hard Road	0.045	0.080
Turf	0.065	0.100
Plowed Field - Good	0.100	
Plowed Field - Bad	0.180	

Gradient resistance is the resistant force encountered by the vehicle while trying to go up a slope. This parameter equals the product of the system weight (W) and sine of the gradient angle ( $\theta$ ). Table 18 lists typical values for  $\theta$  that a vehicle may encounter while traveling on and off paved roads.

TABLE 18. TYPICAL VALUES FOR  $\theta$

On-Road	Off Road
1-3	30-40

As Figure 19 indicates, maximum GCV road speed depends on system weight, engine power, road load, and gradient or slope on which the vehicle is operating.

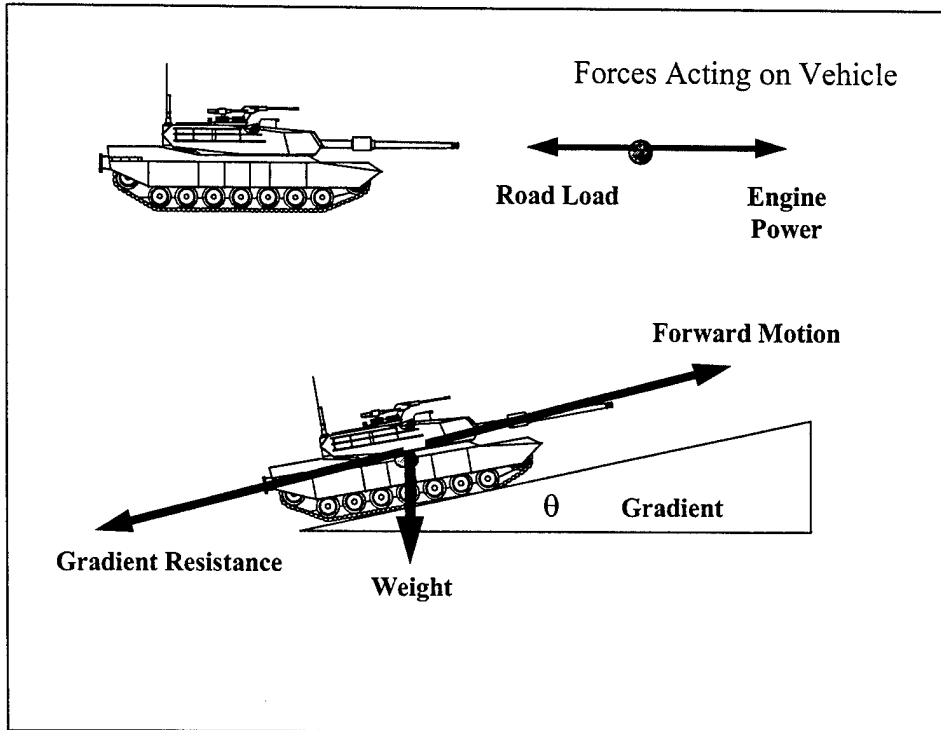

Figure 19. Considerations for maximum GCV road speed.

- c. **System Impact.** A ground vehicle's maximum road speed is represented by the following relationship (1:77):

$$V_{Max} = \frac{P_E * P_{TE}}{(RRC + \sin\theta) * W} \quad (77)$$

Where:

- $V_{Max}$  = Maximum Road Speed  
 $P_E$  = Engine Power  
 $P_{TE}$  = Power Transfer Efficiency

Changes to the vehicle's maximum road speed result from changes to the system's weight, its engine power, or power transfer efficiency. If a system's weight changes ( $W' = \delta W$ ):

$$V_{Max}' = \frac{P_e * P_{TE}}{(RRC + \sin\theta) * W'} = \frac{1}{\delta} V_{Max} \quad (78)$$

If the system's power changes ( $P_e' = \Delta * P_e$ ) or power transfer efficiency ( $P_{TE}' = \phi * P_{TE}$ ) change, however, then

$$V_{Max}' = \frac{\Delta P_e * \phi P_{TE}}{(RRC + \sin\theta) * W} = \Delta * \phi * V_{Max} \quad (79)$$

**d. Other Impacts.**

- (1) **Other Mobility Functions.** Changing maximum possible speed will change the system's acceleration capability and maximum gradient the system can traverse.
- (2) **Lethality.** No Impact
- (3) **Survivability.** Increasing speed will increase platform detectability against a stationary background, but it will also improve the system's ability to evade the threat. GVSI assumes that increasing GCV speed by a specific percentage ( $\delta$ ) will reduce detectability by  $\delta\%$ , but will improve the system's ability to evade a threat by  $\delta\%$  also.
- (4) **Sustainability.** Increasing maximum system speed will degrade RAM and increase fuel consumption. GVSI assumes that changes in platform speed will produce proportional reductions in system RAM and a similar increase in fuel consumption.

**5.3 ACCELERATION**

- a. **Functional Representation.** This mobility characteristic is a measure of the platform's ability to change its speed and is a measure of the platform's ability to move from point to point on the battlefield.
- b. **Approach to Changing Performance.** Changes to system acceleration capabilities occur as a result of changing system weight or the Net Tractive Effort.

The acceleration potential of any ground platform is represented as (2:230):

$$F_T - F_R = m_T(1 + \gamma)\alpha \quad (80)$$

Where:

- $F_T$  = Net Tractive Effort = Available Power =  $(P_{MAX} - P_{LOSS}) * P_{TE}$
- $F_R$  = Rolling Resistance =  $W * (m_{Rolling})$
- $m_{Rolling}$  = Coefficient of rolling resistance
- $\mu_T$  =  $M\alpha\sigma\sigma\ \phi\ \zeta\eta\iota\chi\lambda\epsilon$
- $\gamma$  = Inertia mass factor
- $\alpha$  = Acceleration

- c. **System Impact.** The change in acceleration caused by changing Net Tractive Effort is:

$$\alpha' \Rightarrow \Delta\alpha = \frac{F_T' - F_R}{m_T(1 + \gamma)} \quad (81)$$

If the change to the system's rolling resistance is negligible compared to the change in Net Tractive Effort, then

$$\Delta\alpha \approx \frac{F_T'}{m_T(1 + \gamma)} = \Delta * \frac{F_T}{m_T(1 + \gamma)} \quad (82)$$

Changes to system acceleration caused by changes in system weight are represented as:

$$\alpha' \Rightarrow \Delta\alpha = \frac{F_T - F_R}{m_T'(1+\gamma)} \quad (83)$$

and

$$\Delta\alpha = \frac{(Pe * P_{TE})' - (W' \mu_{Rolling})}{m_T'(1+\gamma)} \quad (84)$$

which can also be represented as:

$$\Delta\alpha = \frac{(Pe * P_{TE})'}{m_T'(1+\gamma)} - \frac{(W' \mu_{Rolling})}{m_T'(1+\gamma)} \quad (85)$$

where  $W' = M_T'g$ , ( $g = 9.8m/s^2$ )

substituting values for  $W'$ , equation 82 becomes:

$$\Delta\alpha = \frac{(Pe * P_{TE})'}{m_T'(1+\gamma)} - \frac{(g * \mu_{Rolling})}{(1+\gamma)} \quad (86)$$

If the second term is small compared to the first, then

$$\Delta\alpha \approx \frac{(Pe * P_{TE})'}{m_T'(1+\gamma)} = \frac{1}{\Delta} \frac{((Pe * P_{TE}))}{m_T(1+\gamma)} = \frac{1}{\Delta} \alpha \quad (87)$$

#### d. Other Impacts.

- (1) **Other Mobility Functions.** None
- (2) **Lethality.** No Effect
- (3) **Survivability.** Increasing GCV acceleration will increase platform detectability when the vehicle is moving across a stationary, cluttered background. As with vehicle speed, GVSJ assumes a linear and proportional increase in the threat's probability of detection. Increased platform acceleration will degrade threat hit probability, however.
- (4) **Sustainability.** Increased acceleration imposes additional strain on GCV engine and suspension elements. GVSJ assumes that increasing acceleration imposes a proportional degradation to system RAM. Improved acceleration will also increase fuel consumption by a comparable amount.

### 5.4 MAXIMUM GRADE

- a. **Functional representation.** As seen in Figure 20, the maximum grade is the maximum angle at which the vehicle is able to maintain a steady motion.

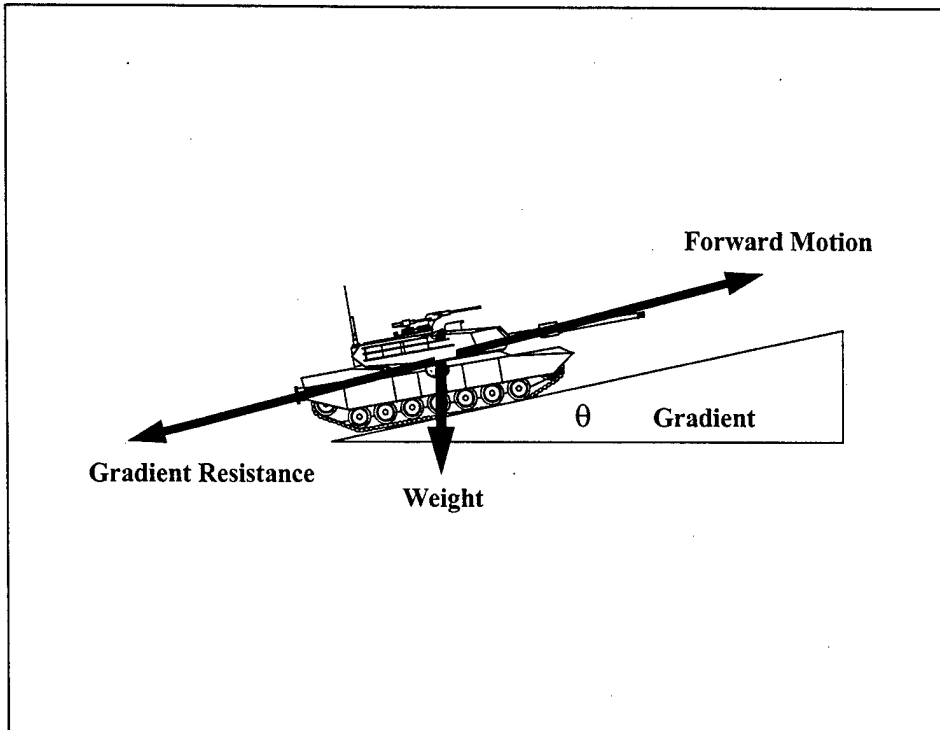

Figure 20. Maximum grade representation.

- b. **Approach to Changing Performance.** As seen previously, the maximum gradient traversable by a GCV that is maintaining a constant forward speed is:

$$(RRC + \sin\theta) * W = \text{Tractive Effort} = \frac{P_{\text{Sprocket}}}{V_{\text{Max}}} \quad (88)$$

Where:

RRC = Rolling Resistance

$\theta$  = Gradient Angle

W = Weight

$P_{\text{sprocket}} = P_e * P_{TE}$

$V_{\text{max}}$  = Max Speed

This expression reduces to:

$$\sin\theta = \frac{P_e * P_{TE}}{W * V_{\text{Max}}} - RRC \quad (89)$$

and the maximum gradient traversable by the ground vehicle is therefore:

$$\text{so, } \theta = \sin^{-1} \left[ \left( \frac{P_e * P_{TE}}{W * V_{\text{Max}}} \right) - RRC \right] \quad (90)$$

- c. **System impact.** The maximum gradient passable by a GCV is also a measure of the height of the obstacles the vehicle can cross. The maximum gradient value,  $\theta$ , varies with system weight and power as:

$$\theta' = \sin^{-1} \left[ \left( \frac{P_e * P_{TE}}{W * V_{Max}} \right) - RRC' \right] \quad (91)$$

$$\theta' = \sin^{-1} \left[ \left( \frac{P'_e * P_{TE}}{W * V_{Max}} \right) - RRC \right] \quad (92)$$

$$\theta' = \sin^{-1} \left[ \left( \frac{P_e * P'_{TE}}{W * V_{Max}} \right) - RRC' \right] \quad (93)$$

**d. Other Impacts.**

- (1) **Other Mobility Functions.** Changing the maximum gradient requirements may impose additional demands on engine power. Changing maximum gradient requirements also reduces the maximum speed attainable by the vehicle and the system's acceleration potential.
- (2) **Lethality.** None
- (3) **Survivability.** None
- (4) **Sustainability.** Changing the platform's maximum gradient will put an additional strain on the engine. GVSI assumes the impact of this strain will be a proportional degradation to system RAM. Increased power requirements are also assumed to cause a proportional increase in fuel consumption.

**5.5 TURNING RADIUS**

A system's turning capability is a measure of battlefield agility. Rapid turns during a threat engagement can contribute towards improving the platform's overall performance and improve system survivability.

- a. **Functional representation.** GVSI represents the turning radius of a GCV as the distance between the center of the turning arc and the centerline of the platform as seen in Figure 21 (2:276).

The turning radius of the system depicted in Figure 21 is given by (2:275-276):

$$R = \frac{V_o + V_i}{V_o - V_i} * \frac{c + \beta L}{2} \quad (94)$$

Where:

- R = Radius of turn
- V<sub>o</sub> = Velocity of the outer track
- V<sub>i</sub> = Velocity of the inner track
- c = Distance between the center line of the tracks
- L = Track length on the ground
- b =  $\frac{2a}{L}$   
with a = distance from center of turn radius to the center of the tracks  
= 0 if there is no track slippage on the ground



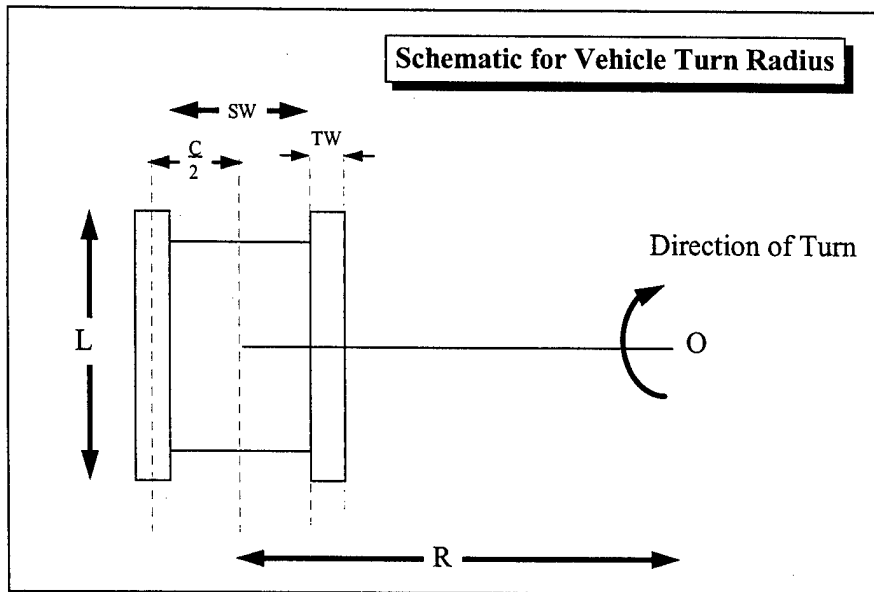

Figure 21. Vehicle turning radius.

For a top level model such as GVSI, assume there is no slippage. With this situation, the vehicle's turning radius becomes:

$$R = \frac{V_o + V_i}{V_o - V_i} * \frac{c}{2} \quad (95)$$

If  $c$  is the distance between the center of the two tracks, and each track is  $TW$  wide, then:

$$c + TW = \text{System Width (SW)}$$

$$\text{and } c = SW - TW$$

Therefore, from Equation 94, the turning radius of a tracked vehicle will change as the system's width changes according to the following relationship:

$$R' = \frac{V_o + V_i}{V_o - V_i} * \frac{c'}{2} \quad (96)$$

and

$$R' = \frac{V_o + V_i}{V_o - V_i} * \frac{(SW' - TW)}{2} \quad (97)$$

- b. Approach to changing performance.** If the change in system width ( $SW$ ) is represented as  $SW' = \delta SW$ , then the turning radius of the GCV changes as:

$$R' = \frac{V_o + V_i}{V_o - V_i} * \frac{(\delta SW - TW)}{2} \quad (98)$$

and the relative change in the system's turning radius  $\Delta R'$ , then becomes

$$\Delta R' = \frac{R' - R}{R}$$

$$\Delta R' = \frac{\left(\frac{V_o + V_i}{V_o - V_i}\right)\left(\frac{\delta SW - TW}{2}\right) - \left(\frac{V_o + V_i}{V_o - V_i}\right)\left(\frac{SW - TW}{2}\right)}{\left(\frac{V_o + V_i}{V_o - V_i}\right)\left(\frac{SW - TW}{2}\right)}$$

$$\Delta R' = \frac{\left(\frac{\delta SW - TW}{2}\right) - \left(\frac{SW - TW}{2}\right)}{\left(\frac{SW - TW}{2}\right)}$$

$$\Delta R' = \frac{(\delta SW - TW) - (SW - TW)}{(SW - TW)}$$

$$\Delta R' = \frac{SW(\delta - 1)}{SW - TW} \tag{99}$$

**c. System impact.** If platform width changes, the vehicle's turning radius will also change. Typically, vehicle designers attempt to keep the ratio between the length of the vehicle and its width (L/C) between 1.5 to 1.8, and GVSI imposes a size constraint such that changes to vehicle width or length must conform to the same ratios.

**d. Other Impacts.**

- (1) **Other Mobility Functions.** None.
- (2) **Lethality.** None.
- (3) **Survivability.** Changing GCV turning radius will increase system agility and the ability of the platform to evade the threat. Similarly, changing the dimensions of the vehicle to achieve the modified turning radius will change the size of the vehicle and may reduce the threat's ability to resolve the GCV as a target. Changing GCV width or length by any percentage would change GCV survivability in accordance with the relationship established in paragraph 4.1.1 (Size Reduction).
- (4) **Sustainability.** As the vehicle's turning radius changes (gets smaller), there will be an increased strain put on the platform's suspension. The percent change in turning radius is therefore assumed to cause a similar degradation in system RAM.

**5.6 GROUND PRESSURE**

This characteristic is a measure of the platform's off road performance. There are two related characteristics associated with the pressure the GCV exerts on the ground: Nominal Ground Pressure and Mean Max Pressure.

a. **Nominal Ground Pressure.**

- (1) **Functional representation.** Nominal Ground Pressure (NGP) for a tracked vehicle equals the weight of the vehicle per track divided by the track area in contact with the ground (1:51). NGP reflects the ability of the vehicle to cross different types of terrain, and, by definition, is:

$$NGP = \frac{\left(\frac{W}{2}\right)}{(TW * TL)} = \frac{1}{2} \left( \frac{W}{TW * TL} \right) \quad (100)$$

Where:

W = Weight of System  
TW = Track Width  
TL = Length of Track in contact with the ground

- (2) **Approach to changing performance.** If GCV system weight changes by  $W' = \delta W$ , then:

$$NGP' = \frac{1}{2} * \left( \frac{\delta W}{TW * TL} \right) = \delta NGP \quad (101)$$

- (3) **System Impact.** Changes in NGP occur as a result of other changes to GCV system functions. As system weight increases, so will NGP.

(4) **Other Impacts.**

(a) **Other Mobility Functions.** Changes to NGP will also cause changes in the system Mean Max Pressure (MMP). These changes are addressed in the next section.

(b) **Lethality.** None.

(c) **Survivability.** None.

(d) **Sustainability.** None.

b. **Mean Maximum Pressure (MMP).**

- (1) **Functional Representation.** This parameter, related to system NGP, accounts for pressure variations along the length of the track when it is on the ground and is used as a basis for comparing vehicle performance on soft soils (2:346).

- (2) **Approach to Changing Performance.** By definition, MMP equals the mean value of pressure maxima under the tracks. The functional expression for MMP is (2:347):

$$MMP = \frac{0.63W}{n * b * c * (pd)^{0.5}} \quad (102)$$

Where:

W = Vehicle Weight  
n = Number of road wheels per side

- b = Track width
- c =  $\frac{\text{Plan Area of Track Link}}{p * b}$
- p = Pitch of track links (m)
- d = Road wheel diameter

(3) **System Impact.** When GCV weight changes as  $W' = \delta W$ , then

$$MMP' = \frac{0.63\delta W}{n * b * c * (pd)^{0.5}} = \delta MMP \quad (103)$$

(4) **Other Impacts.** MMP changes are generally forced by other changes in system functions.

- (a) **Other Mobility Functions.** Changes in MMP will impact the platform's cross country mobility. These changes are discussed in the next section.
- (b) **Lethality.** None.
- (c) **Survivability.** None.
- (d) **Sustainability.** None.

## 5.7 CROSS COUNTRY MOBILITY

a. **Functional representation.** Cross country mobility is an important measure of the GCV mobility.

b. **Approach to Changing Performance.** A platform's cross country mobility depends on soil trafficability, the vehicle cone index and the depth to which the tracks sink into the ground (sinkage). The Vehicle Cone Index (VCI) describes the strength of the weakest soil that permit 1 or 50 vehicles of a particular type to cross over it and is a function of soil type. For wet clay soil (2:352),

$$VCI_1 = 1.86 * MMP \quad (104)$$

$$VCI_{50} = 0.66 * MMP \quad (105)$$

The sinkage of tracks into the ground is dependent on the type of soil traversed and the vehicle's weight. For clay soils, sinkage (z) is expressed as (2:352):

$$z = 0.26 * n * (pd)^{0.5} * \left( \frac{MMP}{CI} \right)^{2.5} \quad (106)$$

Where CI = the Cone Index

c. **System Impact.** For a given soil, then the sinkage of the vehicle into the ground as it moves cross country will vary as the MMP varies. This relationship is:

$$z' = 0.26 * n * (pd)^{0.5} * \left( \frac{MMP'}{CI} \right)^{2.5} = \delta^{2.5} * Z \quad (107)$$

**d. Other Impacts.**

- (1) **Other Mobility Functions.** Changing the platform's cross country mobility requirements will drive changes to the platform's weight or its suspension characteristics.
- (2) **Lethality.** None.
- (3) **Survivability.** None.
- (4) **Sustainability.** None.

## 6.0 SUSTAINABILITY

### 6.1 FUNCTIONAL REPRESENTATION

System sustainability refers to vehicle design features that enable the system to conduct extended operations without repair or resupply. Three general characteristics associated with GCV sustainability are:

- **Reliability, Availability, and Maintainability (RAM);**
- **Consumption of Expendables; and**
- **Human Factors**

### 6.2 RELIABILITY, AVAILABILITY, AND MAINTAINABILITY (RAM)

#### 6.2.1 FUNCTIONAL REPRESENTATION

RAM issues deal with the reparability of the platform and consider the frequency of malfunctions and the effort required to maintain the system. Within this category are three subgroups:

- **Operational Availability (Ao)** - the probability the system will be operable when needed;
- **Mean Miles Between Failure (MMBF)** - the average distance the system travels without suffering a mechanical failure; and
- **Mean Time To Repair (MTTR)** - the average time required to repair a broken part or system.

RAM is a complex system performance issue, and there appear to be few top level models available to assess RAM's impact on system performance or the impact changes to system functions and characteristics will have on RAM. An issue of major concern over recent years has been the impact of system weight on RAM. In the late eighties, Project Manager, Abrams tank systems, conducted a series of field tests to investigate the RAM impact of increased tank weight. These so-called "70-Ton Tank Tests" produced empirical data on tank reliability as a function of system weight.

#### 6.2.2 APPROACH TO CHANGING PERFORMANCE

GCV assumes system weight will be the primary influence on RAM. Information obtained from Government sources suggest that, up to a limit of 70 tons, there is an inverse linear relationship between system weight and RAM. An increase in system weight, produced by changes to any GCV characteristic or system level function, is assumed to degrade GCV RAM by the same amount (1).

### 6.2.3 SYSTEM IMPACT

If GCV weight increases by  $\delta\%$ , system RAM will be degraded by the same amount. Mathematically, this relationship is:

$$RAM' = (1 - \delta) * RAM \quad (108)$$

where:

- $\delta$  = The % increase in system weight
- RAM = The original system reliability parameter
- RAM' = The system's new reliability factor

### 6.2.4 OTHER IMPACTS

RAM is primarily determined by input from other system and subsystem characteristics. As portrayed in GVSI, system RAM will change whenever any system or subsystem function changes system weight.

## 6.3 CONSUMPTION OF EXPENDABLES

The most significant consumables carried by many GCVs are ammunition and fuel. The GCV's ability to operate for an extended period of time without requiring resupply of either of these commodities is a critical aspect of system sustainability.

### 6.3.1 AMMUNITION CONSUMPTION

- a. **Functional representation.** The number of rounds carried by a GCV and the number of rounds required to produce a specified target effect will impact the number of targets that can be engaged before the system requires ammunition resupply. The primary determinant of this characteristic is system  $P_{hit}$ .
- b. **Approach to Changing Performance.** Modifications to system  $P_{hit}$  will change efficiency with which the GCV uses its on-board ammunition. Increasing  $P_{hit}$  by a value of  $\delta$  will increase the stowed kills carried by the platform and the amount of time between required ammunition resupply operations by the same amount.
- c. **System Impact.** Changes to system  $P_{hit}$  and ammunition quantities will also induce changes in ammunition sustainability. Increasing  $P_{hit}$  by  $\delta\%$  will increase ammunition sustainability by  $\delta\%$ .
- d. **Other Impacts:** Ammunition sustainability is primarily determined by other system and subsystem characteristics.

### 6.3.2 FUEL CONSUMPTION

- a. **Functional representation.** On-board fuel capacity and rate of fuel consumption determine the distance a GCV can travel without refueling. This performance factor is primarily influenced by system weight, speed, and acceleration requirements. Changes in system weight, speed, or acceleration will increase GCV's demand for fuel.

- b. **Approach to Changing Performance.** GVSI assumes a linear relationship between fuel consumption and system weight and speed. Increases of  $\delta\%$  in either of these system characteristics will increase fuel consumption by the same factor.
- c. **System Impact.** Change in fuel consumption rates are driven by other factors such as system weight, speed, and acceleration. Changes of  $\delta\%$  in any of these values will degrade fuel sustainability by the same value.
- d. **Other Impacts:** None.

## 6.4 HUMAN FACTORS

### 6.4.1 FUNCTIONAL REPRESENTATION

GVSI considers human factors to encompass two categories: crew endurance and ride quality. Crew endurance relates to the amount of time a GCV crew can spend inside their vehicle; ride quality refers to the amount of absorbed power the crew can withstand as the vehicle moves cross country.

### 6.4.2 APPROACH TO CHANGING PERFORMANCE

Changing the GCV's internal volume is assumed to reduce the amount of space allowed for the crew and will impair the crew's ability to operate for extended periods of time. GVSI also assumes that the system's ride quality will change as the cross country mobility changes.

### 6.4.3 SYSTEM IMPACT

Historically, 48% of the vehicle's volume is reserved for crew and storage, and, typically,  $1.2\text{m}^3$  is reserved for the crew. Any changes to the internal volume of the platform, caused by either a change in other system parameters or a change in overall vehicle size, will induce a linear change in crew endurance. Similarly, changes to cross country mobility performance will also directly reflect changes in ride quality.

Implementation of these functions in GVSI uses the Abrams as the baseline. The model normalizes the internal volume of the Abrams tank to 1.0 and assumes that this internal volume will support a crew endurance factor of 1.0 and a ride quality of 1.0. Changes of  $\delta\%$  to internal volume will reduce crew endurance by a factor ( $\delta$ ), and the relationship is linear. Additionally, changing system weight or cross country performance by  $X\%$  will impose a greater strain on the GCV suspension system and cause a concomitant reduction in ride quality.



#### **6.4.4 OTHER IMPACTS**

Human factors, as represented in GVSI, are primarily determined by other system and subsystem characteristics.

## 7.0 GVSI IMPLEMENTATION.

### 7.1 OVERVIEW

This section addresses implementation of all previously discussed characteristics in a spreadsheet-based engineering model.

### 7.2 GVSI OPERATION.

#### 7.2.1 MODEL STRUCTURE

In its current configuration, GVSI is an Excel 5.0 Workbook that consists of eight inter-connected worksheets. Figure 22 illustrates the model's structure. At the top level, the user inputs values for each of the functional characteristics discussed in previous sections of this report. (Since other functions define RAM characteristics, GVSI does not support RAM inputs to the model.) These inputs flow down to three "Functional Impact" worksheets: Lethality, Survivability, and Mobility. These worksheets reflect inputs in each functional area and contain the results of related calculations. The third tier organizes user inputs and sends the information to the appropriate worksheet where all calculations are performed. These calculations flow back to the summary sheet. GVSI does not assign weighting values to specific functions yet, so the model sums the values within each functional area and divides by the number of affected characteristics. These values represent the system-level parameters contained in level 2 worksheets. System values within the top level work sheet reflect an average of the system-level functions contained in the second level.

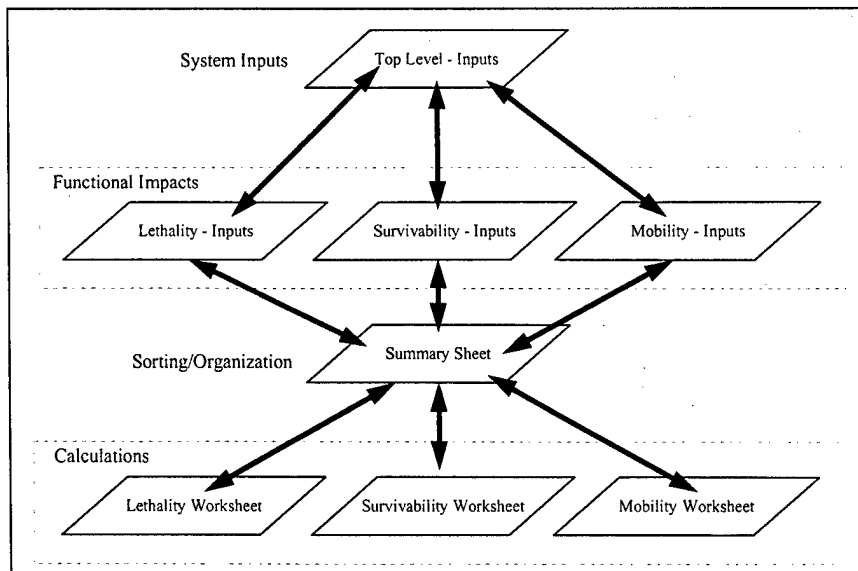

Figure 22. GVSI structure.

The top level worksheet enables the user to input desired performance values. At any point during a session the user can switch to a second tier work sheet and examine how changing performance in one functional area impacts other system characteristics.

### 7.2.2 SCREEN DISPLAYS

The worksheets at levels one and two share the format contained in Figure 23. At the top of each screen display, a block of cells describe the system functions. The first row of these cells contain the functional labels, the second row shows normalized functional values that describe the baseline system. The third row contains calculated values that relate the impact of changing various characteristics. The bottom half of each sheet is organized into four functional blocks. Each block contains three columns. The "Characteristic" column identifies the functional characteristic; the middle column contains a numeric value for the baseline system (GVSI uses the Abrams tank as a baseline for this example). The right hand column in each functional block contains the GVSI input. Each worksheet is protected; the only areas that allow user input within GVSI are the GVSI cells at the top level worksheet. For GVSI, all inputs reflect a per cent change in performance: a value of 1.25 for "Armor" equates to a 25% improvement in armor performance. Similarly, the model interprets a user input of 0.9 for the "Speed" characteristic as a 10% degradation in that characteristic.

Ground Vehicle System Integration and Design Optimization Model			
Lethality	Survivability	Mobility	Sustainability
1.0	1.0	1.0	1.0
Δ	Δ	Δ	Δ

Lethality		
	Abrams	Δ
•Target Acquisition	1.0	
•Fire Control	1.0	
•Weapon Performance	1.0	
•Swept volume	1.0	

Survivability		
	Abrams	Δ
•Size	1.0	
•Signature	1.0	
•Evade	1.0	
•Countermeasure	1.0	
•Armor	1.0	
•Compartmentation	1.0	
•Spall Liner	1.0	

Mobility		
	Abrams	Δ
•Speed	1.0	
•Acceleration	1.0	
•Maximum Grade	1.0	
•Turning Radius	1.0	
•Ground Pressure		
- NGP	1.0	
- MMP	1.0	
•Cross Country Mobility	1.0	

Sustainability		
	Abrams	Δ
•RAM	1.0	
•Expendables		
- Fuel	1.0	
- Ammunition	1.0	
•Human Factors	1.0	

Figure 23. GVSI screen displays.

Changes in system functions affect other characteristics and functions in different ways. Consequently, each functional screen within GVSI differs slightly in appearance. At the Tier 2 functional levels, the user only sees those characteristics that are affected by the functional inputs. Figures 24 through 26 represent the lethality, survivability, and mobility screens, respectively.

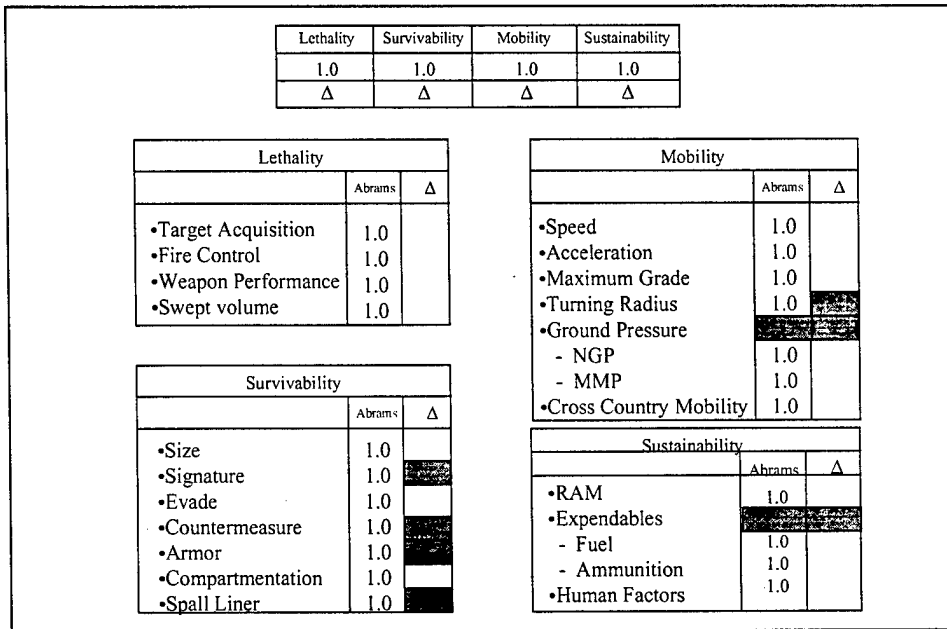

Figure 24. Lethality screen display.

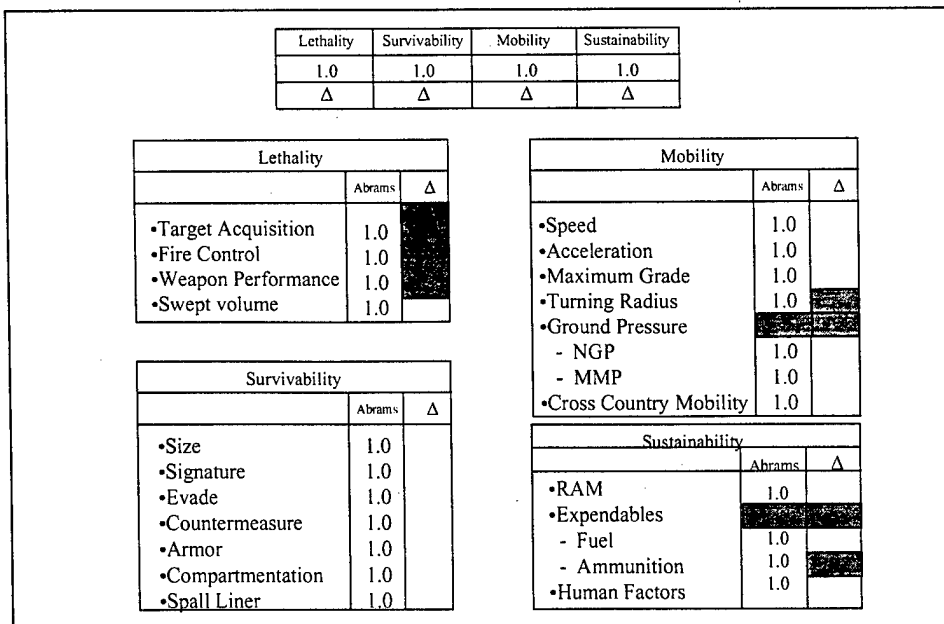

Figure 25. Survivability screen display.

Lethality	Survivability	Mobility	Sustainability
1.0	1.0	1.0	1.0
Δ	Δ	Δ	Δ

Lethality		
	Abrams	Δ
•Target Acquisition	1.0	
•Fire Control	1.0	
•Weapon Performance	1.0	
•Swept volume	1.0	

Survivability		
	Abrams	Δ
•Size	1.0	
•Signature	1.0	
•Evade	1.0	
•Countermeasure	1.0	
•Armor	1.0	
•Compartmentation	1.0	
•Spall Liner	1.0	

Mobility		
	Abrams	Δ
•Speed	1.0	
•Acceleration	1.0	
•Maximum Grade	1.0	
•Turning Radius	1.0	
•Ground Pressure		
- NGP	1.0	
- MMP	1.0	
•Cross Country Mobility	1.0	

Sustainability		
	Abrams	Δ
•RAM	1.0	
•Expendables		
- Fuel	1.0	
- Ammunition	1.0	
•Human Factors	1.0	

Figure 26. Mobility screen display.

### 7.2.3 GVSI OPERATION

All worksheets are protected to prevent accidental entry. The model is designed to be user-friendly, however. Instructions for using GVSI assume the user is familiar with computers, Windows, and Excel 5.0.

1. GVSI is stored under the file name "GVSI.XLS". Copy this file to your computer's hard drive. Start Excel 5.0, and then load the spreadsheet.
2. The top level worksheet is labeled GVSI-Top Level. If the model doesn't display this worksheet after the workbook loads, switch to the worksheet by clicking on the appropriate tab at the bottom of the screen.
3. Select any cell in the right hand column of the function blocks and input a numeric value.
4. Press return.
5. The model calculates and displays all performance changes caused by the new value.
6. Select the next cell and make an entry. All changes are automatically recalculated.
7. To see the impact of changes that occur between functions, switch to one of the following worksheets: GVSI-Lethality, GVSI-Survivability, or GVSI-Mobility.
8. Click back to the GVSI-Top Level worksheet to continue the inputs.
9. At any time during the session, the user has the option to automatically reload the model's default values. There are two ways of accomplishing this:

- a. Open the "Tools window" on the Excel Menu bar. At the bottom of this list of menu options are four commands:

- \* Reload GVSI Defaults
- \* Reload Lethality Defaults
- \* Reload Survivability Defaults
- \* Reload Mobility Defaults.

Pointing to these values and clicking on the command will automatically reset the selected values.

- b. Use a hot key. Pressing the "Cntrl" key and the first letter of each category automatically reloads the values. (Example: Press Cntrl-L to reload lethality values; Cntrl-G to reload all GVSI defaults.)
10. The user can document changes to system design by either saving the model to a different file or printing the spreadsheet out.
11. At the conclusion of the session, close the spreadsheet as you would any other spreadsheet workbook.

## 8.0 CONCLUSIONS

### 8.1 SUMMARY

This report documented development of a top level analysis tool that can help systems engineers and top level managers obtain a better understanding of the interrelationships that exist within the design of a ground combat vehicle. This effort has clearly demonstrated the feasibility of such an analysis tool. Critical steps taken during the development of this model identified critical system functions and performance relationships. Implementation of these characteristics in a multi-dimensional spreadsheet illustrates an analytical approach that can facilitate top-level design and engineering tradeoff studies.

### 8.2 RECOMMENDATIONS

Although GVSI provides an integrated approach to systems design and analysis, there are many opportunities to improve this model. Recommendations for future enhancements include:

- a. Refine performance relationships. Information used to support development of lethality and mobility performance was obtained from commercial sources and may not reflect all functional interactions and performance relationships used in government design efforts. Updating these relationships used in GVSI will enable the model to provide more credible results.
- b. Integrate high resolution engineering models used by the Army's Tank-automotive and Armaments Command and other Government agencies to design vehicles and other systems.
- c. Make the model more interactive and enable users greater flexibility in the design of system inputs and performance values. Add a module that allows a user to establish weighting values for different performance characteristics and functions.
- d. Add a vehicle database within existing model's architecture to enable the system to address other ground vehicles.
- e. Conduct additional survivability modeling to identify survivability benefits and performance trends with greater confidence.
- f. Integrate cost and performance relationships within the model's structure.
- g. Link the model and its output to interactive graphic design tools used by the Government to design new combat systems and identify new concepts.

## APPENDIX A

### END NOTES

#### **Section 1**

1. **Vehicles and Bridging , Brassey's Battlefield Weapons Systems & Technology Series, Volume I;** Tytler, I.F.B.; Thompson, N.H.; Jones, B.E.; Wormell, P.J.H.; and Ryley, C.E.S.; Royal Military College of Science, Shrivenham, U.K.; Brassey's Defence Publishers; Maxwell House, 74 Worship Street, London, EC2A 2EN, 1985.

#### **Section 2**

1. **Vehicles and Bridging , Brassey's Battlefield Weapons Systems & Technology Series, Volume I;** Tytler, I.F.B.; Thompson, N.H.; Jones, B.E.; Wormell, P.J.H.; and Ryley, C.E.S.; Royal Military College of Science, Shrivenham, U.K.; Brassey's Defence Publishers; Maxwell House, 74 Worship Street, London, EC2A 2EN, 1985.

2. **Surveillance and Target Acquisition Systems, Brassey's Battlefield Weapons Systems & Technology Series, Volume VII;** Rodgers, AL; Fowler, IBR; Garland-Collins, TK; Gould, JA; James, DA; and Roper, W; Brassey's Defence Publishers; Maxwell House, 74 Worship Street, London, EC2A 2EN, 1983.

3. **Survivability Design Guide for Ground Combat Vehicles,** Project Manager, Survivability Systems, Program Executive Office, Armored Systems Modernization, Project Manager, Survivability Systems, Warren, Michigan, April 1994.

#### **Section 3**

1. **Surveillance and Target Acquisition Systems, Brassey's Battlefield Weapons Systems & Technology Series, Volume VII;** Rodgers, AL; Fowler, IBR; Garland-Collins, TK; Gould, JA; James, DA; and Roper, W; Brassey's Defence Publishers; Maxwell House, 74 Worship Street, London, EC2A 2EN, 1983.

2. **Handbook on Weaponry,** Rheinmetall, Second English Edition, Rheinmetall GmbH, Dusseldorf, Germany, 1982

3. **Technology of Tanks, Vol I and II,** Ogorkiewicz, Richard M., Jane's Information Group, Limited, Sentinel House, 163 Brighton Road, Coulsdon Surrey, UK. 1991.

4. **Vehicles and Bridging , Brassey's Battlefield Weapons Systems & Technology Series, Volume I;** Tytler, I.F.B.; Thompson, N.H.; Jones, B.E.; Wormell, P.J.H.; and Ryley, C.E.S.; Royal Military College of Science, Shrivenham, U.K.; Brassey's Defence Publishers; Maxwell House, 74 Worship Street, London, EC2A 2EN, 1985.

#### **Section 4**

1. **GroundWars Database Record Retrieval System,** Comstock, Gary R., US Army Materiel Systems Analysis Activity, Aberdeen Proving Grounds, MD; September 1991

2. **Countermeasure Systems, The Infrared and Electro-Optical Systems Handbook, Vol 7,** Pollock, David H., ed.; Infrared Information Analysis Center, Environmental Research Institute of Michigan, Ann Arbor, MI, 1993.



## **Section 5**

1. **Vehicles and Bridging** , **Brassey's Battlefield Weapons Systems & Technology Series, Volume I**; Tytler, I.F.B.; Thompson, N.H.; Jones, B.E.; Wormell, P.J.H.; and Ryley, C.E.S.; Royal Military College of Science, Shrivenham, U.K.; Brassey's Defence Publishers; Maxwell House, 74 Worship Street, London, EC2A 2EN, 1985.
2. **Technology of Tanks, Vol I and II**, Ogorkiewicz, Richard M., Jane's Information Group, Limited, Sentinel House, 163 Brighton Road, Coulsdon Surrey, UK, 1991.

## **Section 6**

1. Dewitt, Terry, Verbal discussion of the Army's 70-Ton Tank Test (1988-1989); US Army Armor Center Directorate of Force Development, Ft Knox, KY, 1996

## APPENDIX B

### OPERATING INSTRUCTIONS

(Note: These instructions assume familiarity with computers, Windows, and Excel 5.0.)

1. GVSI is stored under the file name "GVSI.XLS". Copy this file to your computer's hard drive. Start Excel 5.0, and then load the spreadsheet.
2. The top level worksheet is labeled GVSI-Top Level. If the model doesn't display this worksheet after the workbook loads, switch to the worksheet by clicking on the appropriate tab at the bottom of the screen.
3. Select a cell in the right hand column of the function blocks and input a numeric value.
4. Press return.
5. The model calculates and displays all performance changes caused by the new value.
6. Select the next cell and make an entry. All changes are automatically recalculated.
7. To see the impact of changes that occur between functions, switch to one of the following worksheets: GVSI-Lethality, GVSI-Survivability, or GVSI-Mobility.
8. Click back to the GVSI-Top Level worksheet to continue the inputs.
9. At any time during the session, the user has the option to automatically reload the model's default values. There are two ways of accomplishing this:
  - a. Open the "Tools window" on the Excel Menu bar. At the bottom of this list of menu options are four commands:
    - \* Reload GVSI Defaults
    - \* Reload Lethality Defaults
    - \* Reload Survivability Defaults
    - \* Reload Mobility Defaults.

Pointing to these values and clicking on the command will automatically reset the selected values.
  - b. Use a hot key. Pressing the "Cntrl" key and the first letter of each category automatically reloads the values. (Example: Press Cntrl-L to reload lethality values; Cntrl-G to reload all GVSI defaults.)
10. The user can document changes to system design by either saving the model to a different file or printing the spreadsheet out.
11. At the conclusion of the session, close the spreadsheet as you would any other spreadsheet workbook.