

NEW PROCESSING OF COMPOSITE GRIDS FOR AEROSPACE APPLICATIONS

Stephen W. Tsai and Kevin K.S. Liu
Department of Aeronautics and Astronautics
Stanford University
Stanford, CA 94305-4035

FINAL REPORT

AFOSR GRANT F69620-98-1-0099

19990302047

Reproduced From
Best Available Copy

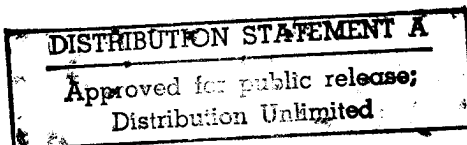

February 1999

REPORT DOCUMENTATION PAGE

0052

Public reporting burden for this collection of information is estimated to average 1 hour per response, including the gathering and maintaining the data needed, and completing and reviewing the collection of information. Send comments regarding this burden estimate or any other aspect of this collection of information, including suggestions for reducing this burden, to Washington Headquarters Services, Directorate for Information Operations and Reports, 1215 Jefferson Davis Highway, Suite 1204, Arlington, VA 22202-4302, and to the Office of Management and Budget, Paperwork Reduction Project (0704-0188), Washington, DC 20503.

1. AGENCY USE ONLY (Leave blank)		2. REPORT DATE Feb 99	3. REPORT TYPE AND DATES COVERED Final 11/97 - 11/98	
4. TITLE AND SUBTITLE New Processing of Composite Grids for Aerospace Applications			5. FUNDING NUMBERS F69620-98-1-0099 (Grant)	
6. AUTHORS Stephen W. Tsai and Kevin K. S. Liu				
7. PERFORMING ORGANIZATION NAME(S) AND ADDRESS(ES) Department of Aeronautics & Astronautics Stanford University, MC 4035 Stanford, CA 94305-4035			8. PERFORMING ORGANIZATION REPORT NUMBER	
9. SPONSORING/MONITORING AGENCY NAME(S) AND ADDRESS(ES) USAF Office of Scientific Research AFOSR/NA Bolling AFB, DC 20332-8080			10. SPONSORING/MONITORING AGENCY REPORT NUMBER	
11. SUPPLEMENTARY NOTES To be published in the Proceedings of the 44th SAMPE Symposium, May 24-27, 1999				
12a. DISTRIBUTION/AVAILABILITY STATEMENT			12b. DISTRIBUTION CODE	
13. ABSTRACT (Maximum 200 words) Composite grids offer a unique combination of performance and cost for many aerospace structures. A particular process suitable for shells of revolution is discussed in detail. This process has been developed by Stanford University.				
14. SUBJECT TERMS Composites materials, isogrids, manufacturing			15. NUMBER OF PAGES 12	
			16. PRICE CODE	
17. SECURITY CLASSIFICATION OF REPORT Unclassified	18. SECURITY CLASSIFICATION OF THIS PAGE Unclassified	19. SECURITY CLASSIFICATION OF ABSTRACT Unclassified	20. LIMITATION OF ABSTRACT Unlimited	

NEW PROCESSING OF COMPOSITE GRIDS FOR AEROSPACE APPLICATIONS

Stephen W. Tsai and Kevin K.S. Liu*
Department of Aeronautics and Astronautics
Stanford University
Stanford, CA 94305-4035

ABSTRACT

Composite materials exhibit their highest stiffness and strength in unidirectional format. Any deviation from this lead to lower fiber volume fractions, and lower properties. Composites grids can be exceptionally stiff and strong if their ribs are unidirectional. Several approaches have been published in recent years. Modeling of multidirectional grids is simple because it follows the assumptions of netting analysis; i.e., all ribs are beams. Grids are networks of ribs joined at their nodes. It will be shown that grids offer an attractive balance between properties and manufacturing. For shells of revolution, one generic manufacturing process, called TRIG, shows several advantages over other processes. Cost effective applications that can be derived from TRIG will be discussed.

KEY WORDS: Composite Structures, Design, Manufacturing, Applications

1. FORMS OF COMPOSITE MATERIALS

For composite materials to compete with existing materials, performance/cost issue has been a perpetual challenge for years. The highest performance is in unidirectional tapes and tows. Any deviation from this form degrades the performance of composites. This can be seen by the comparative properties of straight versus bent fibers. Woven fabrics, for example, have lower properties because fibers are not kept straight. An equally important effect of wavy fibers in a fabric and preform is the lower fiber volume fraction that further reduces performance.

* Now with Applied Materials, Santa Clara, CA

Although fibers are kept straight within each ply in a multidirectional laminated composite, micro cracking and delamination are two most commonly encountered failure mechanisms. These matrix-related failures occur much earlier than fiber failures under tension or compression. The premature failures severely limit laminate performance.

In Vetrotex figures below, the uniaxial tensile strengths and stiffness of various forms of glass/epoxy composites versus fiber volume fractions are shown. The highest performing composite is the unwoven form where the fibers are straight and their volume fraction can be over 60 percent. In fact, in pultrusion and filament winding, fiber fraction can be higher than 70 percent.

Any multidirectional lamination and/or woven and braiding formats reduce the properties. Preforms for resin transfer molding are made from woven fabrics. The resulting composite products have inferior properties because fibers are not kept straight and fiber fraction is usually less than 40 percent.

The worst performance occurs when fibers are chopped into short lengths. This is done to enhance processing as in the cases of mats, sheet molding compound (SMC) and bulk molding compound (BMC). While composite stiffness is affected only slightly in these forms as compared with continuous fibers, strength suffer significant loss. Another factor that further reduces strength properties of chopped fiber composite is the wide deviation of properties that vary from point to point. To achieve some level of reliability, a large margin of safety must be taken.

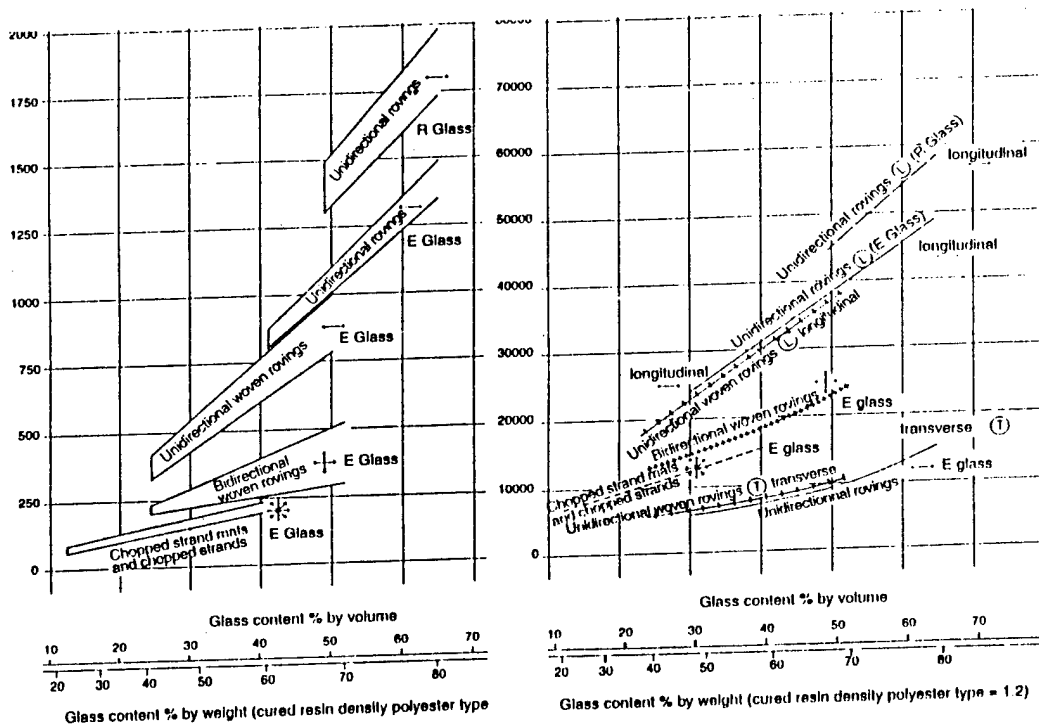

Figure 1 Composite strength and stiffness properties as functions of fiber volumes.

Summarizing an important consideration for the form of composite materials, superior properties of unidirectional plies and laminates are sacrificed by fabric and preform for three reasons: 1) fibers are not kept straight, 2) fiber volume fraction is lowered, and 3) complex fiber architecture can initiate local failures.

Chopped and discontinuous fibers offer worse properties. (The loss in composite stiffness is less than that of strength.) The gain in formability may not offset the loss of properties. While individual fibers may be straight, their orientation is random. The effective stiffness of the composite is drastically reduced. The loss of strength of discontinuous fibrous composites can be attributed to the lack of continuity in fibers' load carrying capability. Reliance on the matrix to transfer loads from fiber to fiber is very inefficient.

It is therefore a challenge in composite materials design to balance between performance and cost as dictated by fiber form and manufacturing process. Composite grids have high performance because fibers in the ribs are unidirectional and straight. Manufacturing processes can be built from wet winding which is inherently low cost. We can thus achieve one of the best balances between performance and cost. These advantages make a compelling case for grids.

2. GRID MANUFACTURING PROCESSES

Isogrids have been used for many applications including rocket interstage by Boeing (formerly McDonnell Douglas), jet engine covers by Pratt & Whitney, and pressure hulls of International Space Station shells by NASA/Marshall. These grids were made from machining solid metallic plates. In fact, one of the earliest aerospace applications of metallic grids was the Wellington bomber of WWII which had an exceptionally damage tolerant design using a grid as the substructure. Grids made from unidirectional composite ribs, however, would give much improved structural performance and less weight. High stiffness and strength of the ribs are derived from the unidirectional form of the fibers.

Historically, there have been many examples of multidirectional grids made from unidirectional composite tows. Examples include those by the Soviets for rocket interstages, a German space frame for a telescope, South African railway towers, and a Japanese patented frame for concrete reinforcement for some time. A common weakness of these grids has been the unconsolidated ribs and rib intersections. Uncontrolled ribs are low in buckling resistance. Uncontrolled intersections are low in strength.

A process pioneered by USAF Phillips Laboratory (in Albuquerque, NM) used rubber tooling as the guide for an interlaced isogrid. Because of the soft tooling, the ribs did not have well-defined geometry and smooth surface finish. The triple-layered rib intersection was replaced by an offset having three double-layered intersections. The grid then consisted of two basic triangles, one with sharp corners and the other with blunted corners. A similar configuration was also proposed by Russian workers. Strictly speaking this double-triangular grid was neither isotropic nor homogeneous. Furthermore additional space was not provided for the double-layered intersections. Additional space at these intersections would alleviate "traffic jam" which would strengthen these nodal points. In addition, labor intensive operations were required to manually apply compaction during tow layup, bagging for during curing and tool removal after curing.

Papers and presentations on composite grids have appeared in recent years. In 1996, Goldsworthy et al covered the development of the Starship's fuselage reinforced by an angle-grid and some other applications (1). McCloy et al. of Alliant Systems just reported their isogrid containment cylinder made by fiber placement (2). They presented a very elaborate tooling concept. The basis of the design as a structure, however, was not described in detail. Silverman et al also presented their composite isogrid for spacecraft

components (3). The manufacturing process of a reflector was described. Their ribs were flanged instead of being rectangular. In all these papers, the underlying principle in favor of grids was not cited. The big picture is missing. Do we need grids because of their performance and/or cost? How do they compare with other structural forms? Can we have a back of the envelope calculation? For performance there is a simple answer and will be shown later in this paper. For cost the issue is far more complicated and can only be answered qualitatively.

A Stanford process for shells of revolution of bi- and tridirectional grid is based on a patented Tooling Reinforced Interlaced Grid or TRIG. The resulting grid shells have well-defined and smooth-finished ribs. The triple-layered intersections have much enlarged space to allow the intersecting ribs to spread out laterally. In TRIG process, ribs can be laminated and hybridized so the stiffness, thermal expansion and conductivity of the grid can be optimized.

The dimensions of the ribs and the repeating cells in the grid are sized and optimized, as described by Chen and Tsai (4). We found that rib volume fraction should be 10-20 percent. The size of the repeating cells should have six or more across the smaller dimension of the structure. The grid will then be elastically homogenized for both static and dynamic analyses. The optimization of the grid based on its effective stiffness becomes considerably simpler than modeling when ribs are discrete. In the latter case, remeshing is necessary whenever rib geometry is changed.

There are other variations of hard and soft tooling for bi-, tri- and quadri-directional grids. A patented "egg crate" concept by Lockheed Martin, for example, used hard tooling for each cell on a grid and cured under mechanically applied forces. This process may be suitable for flat grids with small overall dimensions. For shells of revolution, TRIG offers a flexible and low cost process for both low and high volume productions. The shells of most interest are cylindrical, conical and spherical.

3. WHAT IS TRIG?

Stanford's composite grids have been applied to reinforcement for concrete columns, fairings, satellites, and floor panels. In TRIG process, the starting material are tubes shown in Figure 2 below. Tubes are then sliced or contoured and positioned to form the tooling for subsequent interlacing. The tooling forms the lateral surface or the sidewall of the ribs.

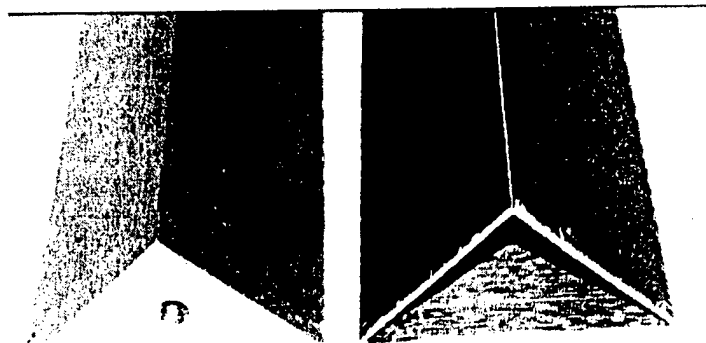

Figure 2 Picture showing triangular tool and tube

For unidirectional composite ribs, the fibers in the starting tubes are oriented along the 90 degree or hoop direction. For isogrids, the tooling tube is an equilateral triangle. In fact, the precise shape and size of the triangle are determined by the geometry and loading conditions on the shell of revolution:

1. Geometry: cylindrical, conical or spherical
2. Material(s) and lamination of the tooling tube
3. Material(s) of the interlacing

To make an isogrid or trigrid cylindrical shell the starting tubes are contoured to have curvatures corresponding to the ID and OD of the shell. The height of the cut h will be the thickness of the shell. This is shown in Figure 3 below:

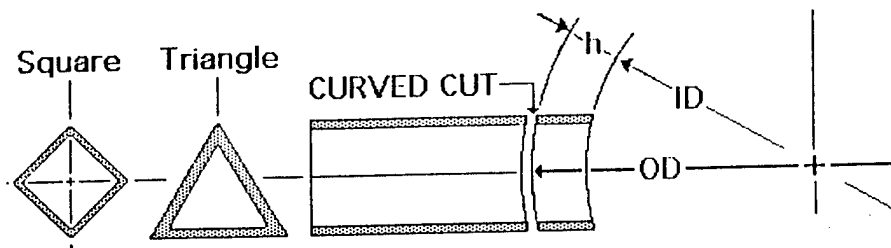

Figure 3 Tooling tubes are cut with a contour to fit cylindrical mandrels

The contoured tubes become the hard tool and become an integral part of the final grid. They will define the lateral surface of the ribs in a grid as well as provide the grooves that will guide the wet tows in filament winding. The positioning of the tooling and the subsequent interlacing are shown in Figure 4.

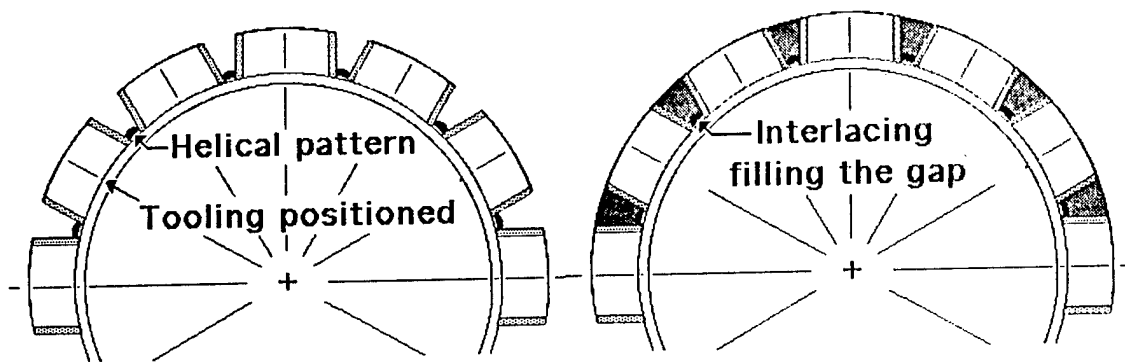

Figure 4 Positioning tooling onto a mandrel and subsequent interlacing

The groove formed by the tooling is V-shaped having the same enclosed angle as that formed by the arch length of tooling. The centerline of the tooling is normal of the mandrel. The tension in the tows will naturally guide the tows to the bottom of the grooves. As another advantage of the TRIG, the winding paths need not be geodesic. The V-shaped ribs of a TRIG processed grid consist of two parts: the outer wall from the tooling tube and the interior core from the interlacing. The tooling tube can be laminated and hybridized; the interlacing is formed by unidirectional tows of one or more materials. These variables are useful if CTE (coefficient of thermal expansions), thermal conductivity and others are considered.

In circular cylindrical and conical shells, the space of intersections of ribs is widened in two or three directions. This will accommodate the multiple layers of intersecting tows and the "traffic jam" is relieved. When soft tooling is used, the grooves that define the rib

sidewalls normally have constant widths, not V-shaped. This is necessary for the removal of the rubber tooling after curing. Hence there is no widened space provided to spread the tows at rib intersections.

Examples of square and angle grids by TRIG are shown in the pictures in Figure 5 below. Wet winding results in not only low cost (for not using prepreg) but also smooth and strong rib intersections.

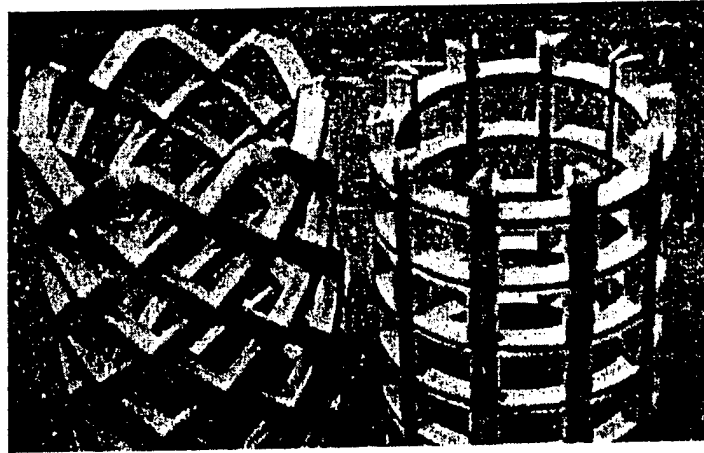

Figure 5 Pictures of TRIG cylinders

4. OTHER ADVANTAGES OF TRIG

For filament winding shells of revolution, one of the simplest winding patterns would be a helical pattern. The angle is usually larger than 0 degree. The simplest isogrids would be $[0/\pm 60]$ or $[90/\pm 30]$, or more general trigrids $[0/\pm \phi]$ or $[90/\pm \phi]$. For TRIG processes, hoop or 90-degree tows are interspersed between the $[\pm \phi]$ helical winding. The placing of 90-degree tows cannot be continuous and is interrupted by the helical tows. It is more advantageous for TRIG process to have 0-degree plus helical tows. While 0-degree tows are not as easy as helical tows, for grids the 0-degree ribs are few in number and far fewer than the number of tows of a solid laminated shell. Having the V-shaped grooves as guides, longitudinal winding becomes much more doable than laying a homogeneous a 0-degree layer.

Other advantages include:

1. For shells of revolution filament winding is by far the lowest cost manufacturing process as compared with fiber placement, layup, braiding and RTM processes. Grids are particularly suited for filament winding using either soft or hard tooling. TRIG can be classified as hard tooling.

2. Wet winding results in further cost savings for which prepregs are no longer necessary. The cost of prepreg can be several times higher than that of the fiber. Fiber placement needs a machine that costs millions of dollars, expensive tooling and prepreg. It is therefore inherently more costly than wet winding. The speed of application of composite tows by filament winding can be one or two orders of magnitude higher than fiber placement. Debaulking, vacuum bagging or autoclaving and all the attendant consumables add additional costs to fiber placement and common layup processes. If mass production is

ever considered, there is really no competition between filament winding and fiber placement. Fiber placement is restricted to complex shapes that include concave surfaces. For shells of revolution, filament winding has well established cost and extensive database.

3. TRIG process for building multidirectional grids is unique because there are several design options not possible with grids made from tooling for direct interlacing (e.g., the Phillips Lab approach). The tooling tube in TRIG can be designed to have all hoop wound tubes (which would be [0] along the ribs in a grid) or an angle-ply laminate. The latter combined with interlacing material(s) along the ribs can offer a wide range of thermal expansions from positive to negative values. (A very high negative CTE can be achieved, for example, by [0/±30] from a high-strength carbon laminate.) Matching CTE of the supporting grid with that of the another structure would reduce significantly the thermal stresses resulting from cryogenic to room temperature change.

4. TRIG processed shells having double curvatures will automatically provide more spacing at rib intersections and do not need to use a rib offset (the Phillips Lab approach) to relieve the triple-layered nodes in a tridirectional grid. To provide double curvature nodes, the preferred rib directions for trigrad shells are [0] and [±φ], but not [90] and [±φ']. Along the [90] path, the groove would have parallel walls, not V-shaped.

5. TRIG can be used to manufacture grids with or without skins. In fact, it is preferred to have grids as the load-carrying frame. Skins are there for functions other than load bearing. Keeping water out or holding pressure in may be good reasons to have one or two skins. We have found that skins are often the weak link because micro cracking in the skin occurs much earlier than rib or node failure.

6. TRIG can have smooth or faceted contours of a shell of revolution. A faceted design is particularly advantageous from the cost standpoint for conical and spherical shells which have continuously changing curvatures. Another TRIG feature is the possibility of integrating cylinders with conical or spherical heads in a trigrad vessel or fairing. The winding pattern can transition smoothly from one section to another, on or off geodesic paths. Thus continuous filament winding patterns can be accomplished which in turn significantly reduces manufacturing cost.

7. TRIG relies on identical, repeating triangles to form a grid. The openings of these triangles permit ready insertion of identical insulation or pressure-bearing slabs. For faceted shells, these slabs can be flat. That eliminates the need for multiple curvatures for the slabs if a smooth exterior surface of a shell is desired. The insert can prevent ribs from buckling. The compressive strength of the grid is thus increased.

8. Grids can be sized to take all the loads. Skins can be purely functional; i.e., to keep the water out or to use glass or ceramic slabs for transparency. An example of faceted cylinder is shown in Figure 6. This is an illustration of the geometry only, not an example of TRIG made grid.

9. Semi spherical heads can be made by TRIG in the same way cylinder are made. The key is to have identical triangles that would cover the entire spherical surface. An example of a TRIG processed sphere is shown in Figure 7. This was made under the direction of Dr. Keith Alexander, University of Canterbury, Christ Church, New Zealand.

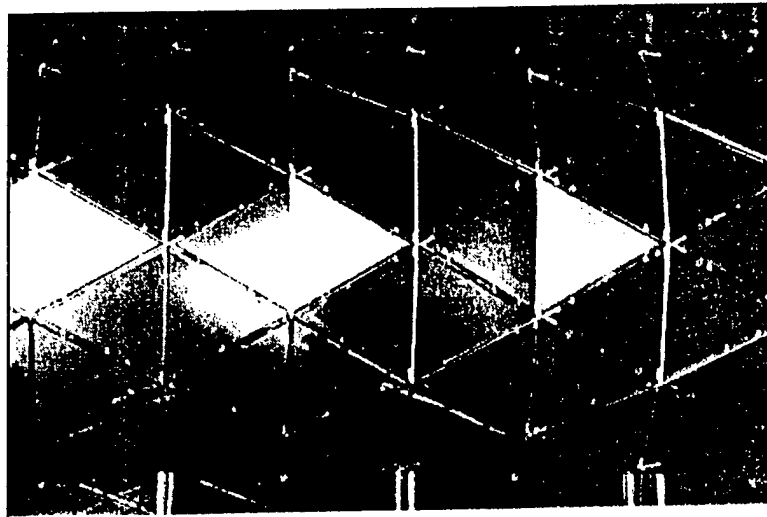

Figure 6 A faceted cylinder

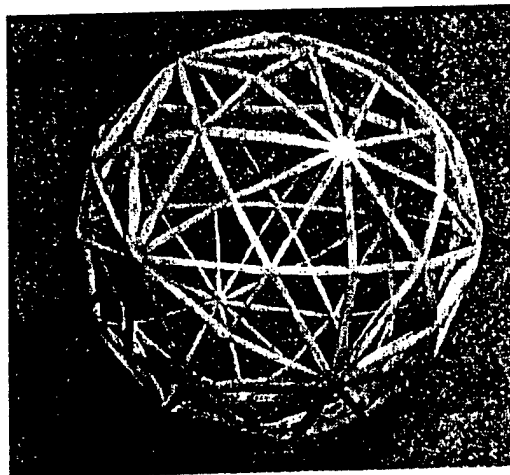

Figure 7 Picture of a faceted sphere.

10. A picture shows a faceted vessel for a deep diving vehicle. This is shown in Figure 8. Only the faceted hemispherical head and its tooling are shown.

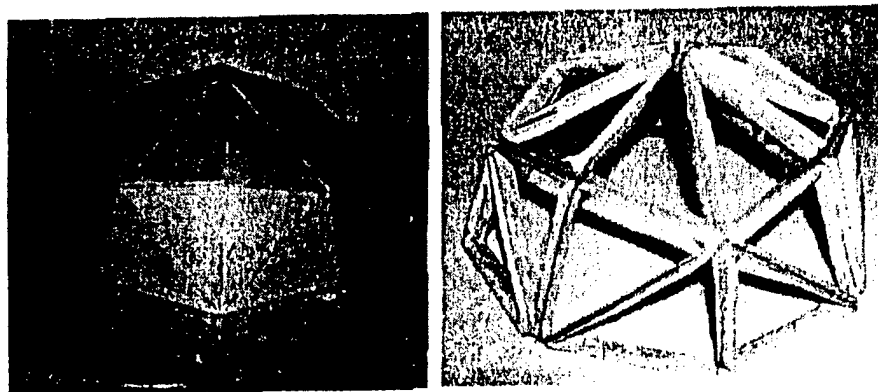

Figure 8 Tool and grid of faceted faces of a hemispherical shell.

This vessel is intended to be used as an instrument package that can reach any depth around the globe.

5. VARIATIONS OF TRIGRID SHELLS

There can be many variations of the TRIG process. Isogrid is a special trigrid. The basic cell can be any triangle. Each rib can have different dimensions and different hybridization. Such variations can be embedded in the tooling tubes (for the case of thermal properties, for example) or in the interlacing material(s). The height of the tooling tube may be higher than that of the interlacing. In Figure 4, tooling and interlacing have the same height. This configuration may be effective if we consider the tooling to provide the grid stiffness, while the interlace provide more strength than stiffness. A simplification of the TRIG process for trigrids can be made if two triangular tools are bonded back to back to form a diamond tool. Only interlacing required for the trigrid will be in the helical pattern. The [0] or [90] ribs are discontinuous or piece-wise continuous. While the structural performance of this simplified TRIG is lower than that of a true TRIG (with complete interlacing in all rib directions), there can be a significant cost saving in manufacturing. Diamond shaped tooling is shown in Figure 9 below where two triangles can be either bonded or filament wound and co-cured.

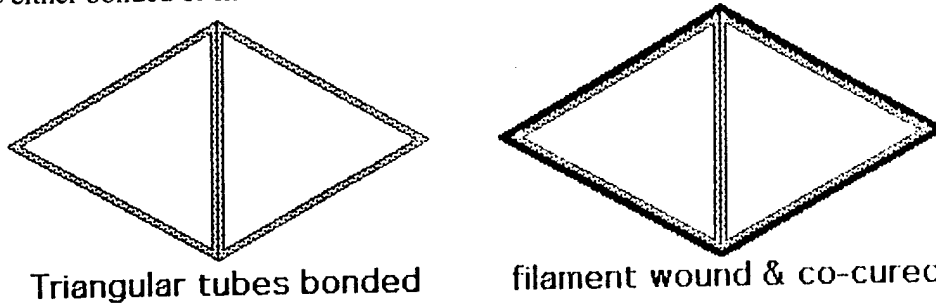

Figure 9 Diamond tool formed by two triangles.

The diamond tools can be positioned, shown below on the left of Figure 10, and interlaced with a helical pattern, shown as solid lines on the right. The vertical ribs are discontinuous, not interlaced. This rib direction can be set along either the hoop or longitudinal direction. The selection will be dictated by the loading conditions. The diamond shaped tooling can also be formed by bonding four triangles together. We will then have a quadri-directional grid that can be made by helical winding. Both the [0] and [90] ribs are discontinuous.

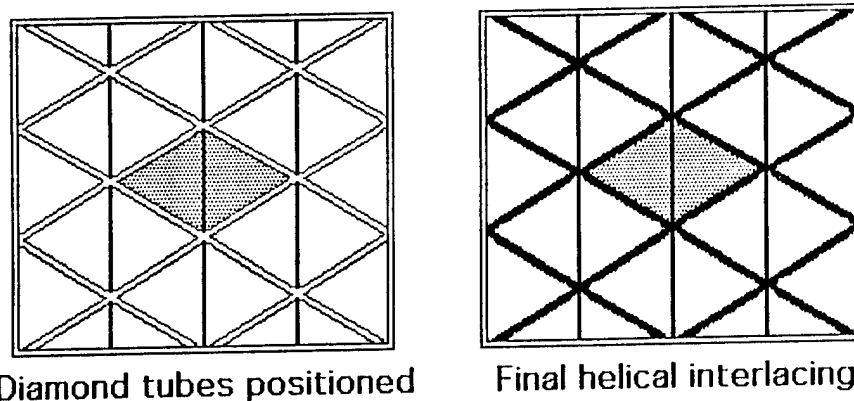

Figure 10 TRIG process for trigrids with vertical rib being discontinuous: diamond tooling positioned on the left and interlaced on the right.

A completed isogrid flat panel and cylindrical shell by diamond tooling are shown in Figure 11. The material of construction is all carbon: carbon tubes and carbon interlacing.

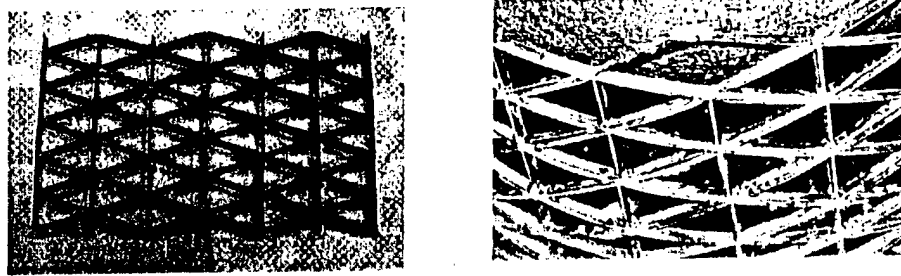

Figure 11 Trigrids with one discontinuous rib in flat plane and cylindrical shell.

TRIG process can be applied to conical shells as well. Triangular and diamond shaped tooling will have sizes changing with the diameter of the shell. This is different from circular and spherical shells where one triangle can cover the entire surface. Due to the changing diameter of conical shells, faceted ones would be considerably simpler to make than shells with variable curvatures. The mandrel, however, must also be faceted. The resulting grid will be analogous to the hemispherical shell shown in Figure 7.

6. ANALYSIS

Stress analysis for grids is exceptionally simple, in fact, simpler than laminated plate theory. Grids use terms and definitions analogous to composite laminates. Typical terms are shown in Figure 13 below for square grid on the left and isogrid on the right.

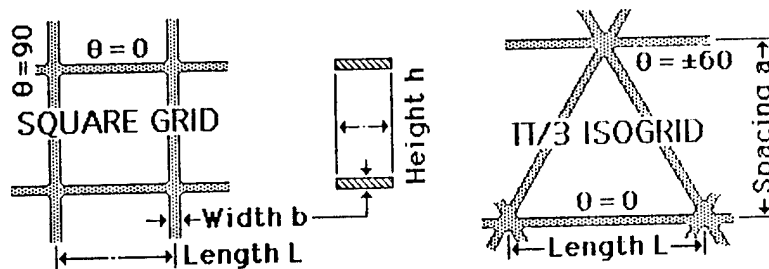

Figure 13 Definitions of square and isogrids.

In the early days of composite materials, modeling was based on netting analysis, simply stated: loads in a structure are carried by unidirectional fibers. From balance of forces, the membrane loads to resist internal pressure of a cylindrical vessel would be most efficiently carried by fibers oriented with a helical angle of 55.75 degrees. It turns out that composite grids are the physical reality of what netting analysis tried to portray more than 40 years ago. Each rib is modeled as a beam subjected to bending, twisting and axial loads. The stiffness of the grid is not sensitive to the end conditions of the ribs, hinged or clamped. Failure of a rib can be by tensile or compressive overstress or Euler buckling.

In TRIG processed grids, the intersection points or nodes are widened and also subjected to higher compaction pressure during processing. This is particularly true for faceted grids. We can therefore assume that the nodes having a greater cross sectional area would be stronger than the ribs.

There are two important design parameters for grids. The first is the rib stiffness E_{rib} and the other, the rib volume fraction f . The latter is analogous to fiber volume fraction for a unidirectional composite ply. For square and isogrids the rib fraction can be easily derived and the results are shown in Figure 14. Rib length is L and width b .

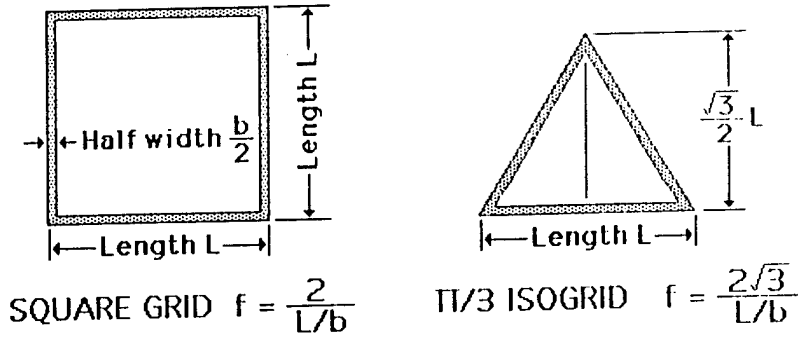

Figure 14 Rib volume fraction of square and isogrids as functions of rib aspect ratio L/b .

The rib volume fraction is expressed in terms of the rib aspect ratio L/b . For the same rib aspect ratio, isogrid has higher rib fraction. Conversely, for the same rib fraction isogrid has higher rib aspect ratio. Various rib fractions of isogrids are shown in Figure 15. Analogous rib fractions for square or other grids can be drawn.

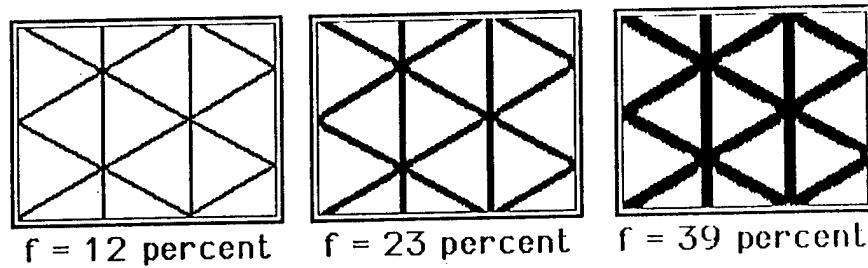

Figure 15 Visual presentation of various rib fractions of an isogrid.

For effective grids, volume fractions between 10 and 20 percent are recommended. When rib fractions become 40 percent the grids are also known as waffle plates. They can be defined as a grid where rib buckling is not possible. When rib fraction becomes lower than 10 percent, rib buckling strength may be too low for most applications.

Grid stiffness in terms of rib stiffness can be easily derived for square and isogrid. The stiffness along the ribs is simply the rib stiffness corrected by rib width and spacing. A simple rule-of-mixtures relation exists between the rib and grid stiffness. This is very reassuring for designers. Like cross-ply laminate, a square grid is orthotropic with a square symmetry. There are three independent constants. The elastic moduli are shown in Figure 16 below. Suffice to say, similarly simple relations can be derived for rectangular grids or square grids having different widths and/or materials along the $[0]$ and $[90]$ ribs.

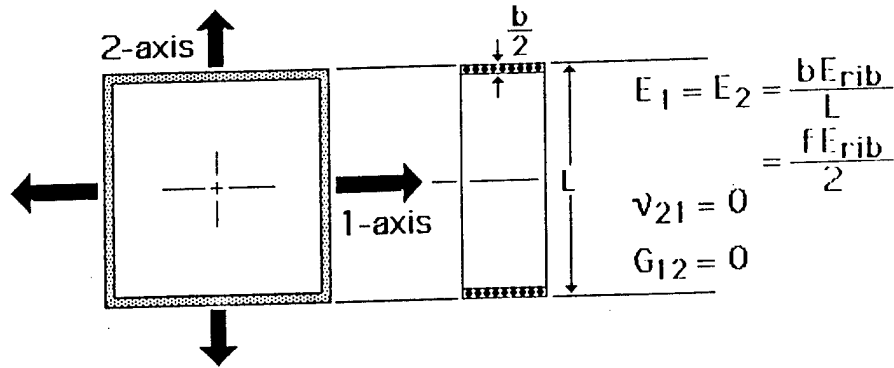

Figure 16 Elastic moduli of a square grid in a simple rule-of-mixtures relation.

For isogrids, the grid stiffness is modeled by analyzing two equilateral triangles. This can be seen as a repeating unit in a grid, shown in Figure 17 below. This grid configuration has more balanced stiffness between extension and shear. It is suitable for most applications where stable structures are desired. Unlike square and rectangular grids, the shear modulus of the grid is $3/8$ of the effective Young's modulus. We therefore recommend trigrids over square grids for general applications. Square grids are useful when there is no shear loading.

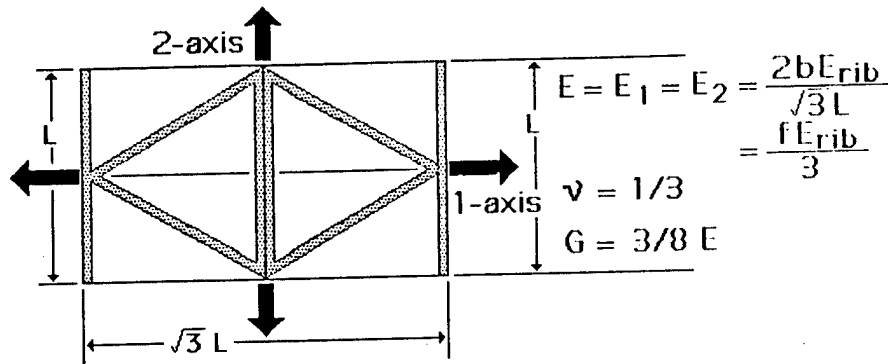

Figure 17 Elastic moduli of an isogrid in terms of the rib stiffness and volume fraction.

The stiffness in the diamond structure is contributed by the on-axis ribs only. The off-axis ribs are there to transfer the applied tensile loads. If load is applied along the 2-axis. Following the same approach as the square grid, the area correction is simply the two rib width divided by the horizontal distance, $1.73L$.

If the load is applied along the 1-axis, the off-axis ribs acting as a mechanism will impose compressive stress on the same double ribs in the figure. The resulting stiffnesses of the repeating element will be the same. The two orthogonal stiffnesses are equal.

Poisson's ratio for the repeating element can be rationalized by considering the extension along the off-axis ribs due to an applied tensile load. It can be shown that the resulting Poisson's ratio is $1/3$.

Shear modulus for isotropic materials follows a simple relation that

$$G = \frac{E}{2(1+\nu)} = \frac{3E}{8}$$

Thermal expansions and thermal conductivities of grids can be similarly derived by considering growth or flow of heat through the ribs only. The ribs of TRIG processed grids may be designed to have a CTE to match that of another structure to which the grid may be attached.

Heat flow out of the plane of the grid can be prevented by inserted insulation slabs. This heat can also be modeled using an effective radial conductivity of a grid with insulating slabs.

7. CONCLUSIONS

Composite grids have been advocated for their performance and cost over similar metallic grids. For shells of revolution, TRIG process may be particularly effective because filament winding using wet tows can provide strong interlacing. Filament winding is a continuous process, not interrupted by debaulking and vacuum bagging. Curing does not require autoclave. Wet winding also facilitates the spreading of the tows at rib intersections.

Tooling remains the greatest challenge for TRIG, as is for more processes. As interest in composite grids increases, we can expect greater opportunities for composite materials in the years to come. We would expect that new manufacturing processes will emerge as the performance and cost advantages are demonstrated. Cylindrical, conical and spherical shells are the most likely grid structures that can compete in performance, cost and delivery time.

Based on our findings thus far we believe that the most effective use of grids will be that without load carrying skins. Grids will carry all the load while skins are there for functional reasons such as insulation, transparency, pressure, weather and other hostile environments. Skins present not only attachment problems but often fail before the grid. This is the opposite of sandwich panels where the skins carry the load and the core is for functional reason. In a way we are going back to the structural concept that the Wright brothers used.

8. ACKNOWLEDGEMENT

The authors are grateful for the support of this work by the National Science Foundation, Air Force Office of Scientific Research, and others. The prototypes built by Julie Wang and students at Stanford University are also gratefully acknowledged.

9. REFERENCES

1. B. Rutan, C. Hiel and B. Goldsworthy, SAMPE J., 32 (5), pp. 18-23, (1996).
2. M. McCloy, M. Deckers and Vern Benson, SAMPE J., 35 (1), pp. 22-29, (1999).
3. E. Silverman, M. Rhodes and J. Dyer, SAMPE J., 35 (1), pp. 51-58, (1999).
4. H.J. Chen and S.W. Tsai, Journal of Composite Materials, 30 (4), pp. 503-534. (1996).