

Second World Congress for Electricity and Magnetism in Biology and Medicine

ABSTRACT BOOK

The Bioelectromagnetics
Society

Society for Physical Regulation
In Biology and Medicine

WORLD CONGRESS FOR ELECTRICITY AND MAGNETISM IN BIOLOGY AND MEDICINE

The Bioelectrochemical
Society

European Bioelectromagnetics
Association

With the Participation of:



IEEE EMBS
IEEE SCC28
IEEE COMAR

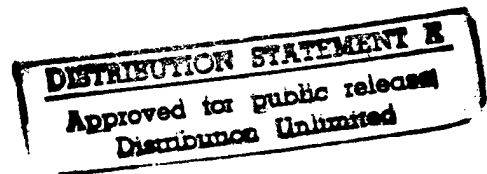

URSI Commission K



AEI

19970811 088

DTIC QUALITY INSPECTED 2

June 8-13, 1997

Palazzo della Cultura e dei Congressi
Bologna, Italy

SECOND WORLD CONGRESS

Officers

Jørgen Bach Andersen - President
Aalborg University, Denmark

**Martin Blank - Vice President (BES) and
Technical Program Chair**
Columbia University, USA

**Ferdinando Bersani - Vice President
(EBEA)**
University of Bologna, Italy

**Mary Ellen O'Connor - Vice President
(BEMS)**
University of Tulsa, USA

Kent Hoffman - Vice President (SPRBM) and Secretary/Treasurer
Murray Electronics, USA

Governing Board

John D'Andrea - BEMS
Maurice Hinsenkamp - EBEA
James Lin - BEMS
Fred Nelson-SPRBM

Subrata Saha - SPRBM
Peter Semm - EBEA
Betty Sisken - BES
James Weaver - BES

Technical Program Committee

Martin Blank, Chair
Ferdinando Bersani
Ewa Czerska
Guglielmo D'Inzeo
Paul Gailey
Reba Goodman
Ben Greenebaum
Kjell Hansson Mild
Maurice Hinsenkamp
Raphael Lee
Richard Luben

B. Andrea Melandri
Eberhard Neumann
Mary Ellen O'Connor
Charles Polk
Betty Sisken
Maria Stuchly
Shoogo Ueno
Bernard Veyret

ex officio
Jørgen Bach Andersen
William Wisecup

Local Committee

Ferdinando Bersani
University of Bologna

Ruggero Cadossi
University of Modena

Guglielmo D'Inzeo
University of Rome

Paolo Vecchia
NIOH, Rome

Andrea Cossarizza
University of Modena

Santi Tofani
Servizio Di Fisica Sanitaria, Ivrea

Maria Rosaria Scarfi
I.R.E.C.E., Naples

Management Support

W/L Associates, Ltd., 7519 Ridge Road, Frederick, MD 21702, USA

Disclaimer: Abstracts were reviewed by the Technical Program Committee for technical content and appropriateness for this Congress. Optical scanning procedures used to prepare this abstract booklet may have introduced errors, for which we apologize. These abstracts were not edited by the Technical Program Committee. Individuals wishing to reference or quote abstracts should obtain author's permission.

Printed in the U.S.A.

REPORT DOCUMENTATION PAGE			Form Approved OMB No. 0704-0188	
Public reporting burden for this collection of information is estimated to average 1 hour per response, including the time for reviewing instructions, searching existing data sources, gathering and maintaining the data needed, and completing and reviewing the collection of information. Send comments regarding this burden estimate or any other aspect of this collection of information, including suggestions for reducing this burden to Washington Headquarters Service, Directorate for Information Operations and Reports, 1216 Jefferson Davis Highway, Suite 1204, Arlington, VA 22202-4302, and to the Office of Management and Budget, Paperwork Reduction Project (0704-0188), Washington, DC 20503.				
1. AGENCY USE ONLY (Leave blank)	2. REPORT DATE 8 AUG 97	3. REPORT TYPE AND DATES COVERED		
4. TITLE AND SUBTITLE Second World Congress for Electricity & Magnetism in Biology & Medicine Abstract Book		5. FUNDING NUMBERS		
6. AUTHOR(S) W/L Associates, Ltd. Multiple Authors		8. PERFORMING ORGANIZATION REPORT NUMBER		
7. PERFORMING ORGANIZATION NAME(S) AND ADDRESS(ES) Second World Congress c/o W/L Associates, Ltd. 7519 Ridge Rd. Frederick, MD 21702		10. SPONSORING / MONITORING AGENCY REPORT NUMBER		
9. SPONSORING / MONITORING AGENCY NAME(S) AND ADDRESS(ES) Office of Naval Research Ballston Centre Tower One 800 North Quincy St. Arlington, VA 22217 (J.A. Majde)		11. SUPPLEMENTARY NOTES N/A		
12. DISTRIBUTION / AVAILABILITY STATEMENT Approved for Public Release		13. ABSTRACT (Maximum 200 words) The Second World Congress Technical Program Committee developed a balanced, forward-looking program to represent the interest of the four organizing scientific societies. Four major tracks (physical, biological, medical sciences and technology) are presenting all parts of the program. Over 650 abstracts from 27 countries were reviewed, and those accepted are contained in the publication. The program consisted of Plenary lectures, minisymposiums, and contributed poster reports.		
14. SUBJECT TERMS Bioelectromagnetics; Health Effects of EMF; Therapeutic Applications of EMF		15. NUMBER OF PAGES 341		
17. SECURITY CLASSIFICATION OF REPORT Unclassified		18. SECURITY CLASSIFICATION OF THIS PAGE Unclassified		
18. SECURITY CLASSIFICATION OF ABSTRACT Unclassified		20. LIMITATION OF ABSTRACT		
19. PRICE CODE				

Standard Form 298 (Rev. 2-89)

PLENARY LECTURES

OVERVIEW

BIOELECTROMAGNETISM IN THE HISTORY OF BOLOGNA. F. Bersani. Department of Physics, University of Bologna, 40127 Bologna, Italy.

It is generally accepted that Luigi Galvani (1737-1798) should be considered the founder of Bioelectricity. At that time electric therapies were already proposed in the practical clinic, but were also regarded by many scholars, mainly physicists, with great suspicion, and sometimes as a mere quackery.

Galvani who was a skilled practical doctor, but also a professor of Anatomy at the University of Bologna, started a series of observations about the effects of a metallic arch on frog muscle contractions and postulated the existence of a sort of "animal electricity". He published his observations in a famous essay entitled "De Viribus electricitatis in motu musculari".

The Galvani's discoveries opened the door to one of the most interesting debate of the history of Science. In particular, Volta proposed a different interpretation of Galvani's findings, suggesting that the electricity was not inherent in the living organisms but was a product of the contact between two different metals. It is now clear that the truth was in between, and it is also apparent that the discovery of the electric pile by A. Volta was inspired by the analysis of the Galvani's work. It is interesting to remark how Galvani's ideas about "animal electricity" declined after Volta won the controversy, even if Galvani's nephew, Giovanni Aldini, professor of Physics and strict collaborator of Galvani himself, tried to continue the work of his uncle and published in 1804 an interesting book entitled "Essai theorique et experimental sur le Galvanisme", in which he also proposed the application of electricity, delivered by the electric pile, to the reanimation of patients after a sudden death or after asphyxia (forerunner of the defibrillation technique) and to neurological and mental diseases (forerunner of the electroshock therapy).

Only about 30-40 years later Galvani's ideas stimulated a new trend of studies in the field of electrophysiology. The great physiologist Du Bois Reymond clearly considered Galvani a precursor of neurophysiology and electrophysiology. It is interesting to note that the ideas seeded by Galvani will be picked up 30 years later by another scientist coming from the same geographic area, Carlo Matteucci, born in Forli, a small town close to Bologna, who was the first to measure the so called "action potential" of nerves. In the history of Bioelectromagnetism in Bologna, we cannot forget to mention Augusto Righi (1850-1921), an outstanding experimental physicist, who demonstrated the optical properties of the microwaves on the line of Hertz and Maxwell. He also reinterpreted some of Galvani's experiments, suggesting that in some of them the muscle contraction was due to a microwave emission. Last, but not least, we must remind that Bologna was the native town of

Guglielmo Marconi, widely recognized as the founder of the telecommunication age.

EPIDEMIOLOGICAL STUDIES ON HEALTH EFFECTS OF ELECTROMAGNETIC FIELDS. T. Tenforde. Pacific Northwest National Laboratory, Richland, Washington 99352, USA.

Considerable controversy has surrounded the issue of health effects of electromagnetic fields in the extremely low-frequency (ELF) range, with the major concern being potential carcinogenic effects of these fields. In this overview presentation, epidemiological evidence both for and against carcinogenic effects of ELF fields will be reviewed and evaluated. Epidemiological data will also be evaluated in the context of carcinogenesis studies conducted with both *in vitro* and *in vivo* test systems, with a particular focus on laboratory studies related to tumor promoting effects of ELF fields. Current issues related to possible health effects of electromagnetic fields over a broad range of frequencies, from ELF to microwaves, will be briefly summarized.

ADVANCES IN MEDICAL DIAGNOSTIC & THERAPEUTIC APPLICATIONS. L. Vodovnik, D. Miklavcic and T. Bajd. Faculty of Electrical Engineering, University of Ljubljana, SI-1000 Ljubljana, Slovenia.

In the past decade a range of new electromagnetic diagnostic procedures was added to the classical repertoire of ECG, EMG, EEG and evoked potentials. Some of the modern techniques like MRI and computerized tomography (CT) are firmly established in the clinic, some other techniques are less known. Magnetic brain stimulation seems to be a powerful tool in neurophysiology as well as spinal cord stimulation for testing nerve conduction during surgery. Magnetoencephalography (MEG) and magnetocardiography (MCG) offer new insights into brain and heart function but until now have not seemed to survive the clinical tests. The same fate might be true also for positron emission tomography (PET) and superconducting quantum interference devices (SQUID) which measure extremely small magnetic fields in biological systems.

In therapy there exists a wealth of electrotherapeutic procedures which are applied for various diseases and disabilities. The therapeutic frequencies range from microwaves to DC. Microwaves are used for hyperthermia of tumors and thermotherapy of the musculoskeletal system in physical medicine and rehabilitation. Electrical currents and electromagnetic fields are used in transcutaneous drug delivery, improvement of blood flow and to accelerate healing of wounds, bones and regeneration of crushed nerves. New avenues of electroporation assisted drug and gene delivery are also very exciting.

Since it is impossible to present a complete survey of existing techniques, we shall concentrate on three recent therapeutic modalities

- Functional electrical stimulation (FES),

- Electrical wound healing and
- Electro-immunomodulation and tumor treatment.

On FES a brief review will be given regarding movement, breathing, coughing, hearing, seeing, heart pacing, micturition, sex, spasticity and pain. On wound healing the effects of electrical current on decubitus ulcers will be examined. Finally the potential of various electrical modalities on immunomodulation and cancer treatment will be discussed. In these three modalities the relation between knowledge of basic mechanisms and clinical application will be presented. It is interesting to observe that there is not always a simple correlation between knowledge of biologic mechanisms and treatment of patients. Thus for example FES is firmly based on the action potential which was observed already by Galvani and carefully studied for decades. In contrast electrotherapy of wounds was first clinically applied and only later the fundamental research was started. The most complicated are conditions in cancer research. In spite of an enormous amount of laboratory studies the results in epidemiological and clinical studies are quite contradictory. Therefore any extrapolation from fundamental studies to clinical investigations should be performed with a proper amount of caution.

References:

- Kralj, A. and Bajd, T., *Functional electrical stimulation: Standing and walking after spinal cord injury*, CRC Press, Inc., Boca Raton, Florida, 1989.
- Blank, M. (Editor), *Electricity and magnetism in biology and medicine*, Review and research papers presented at The First World Congress for Electricity and Magnetism in Biology and Medicine, Orlando, Florida, 1992.
- Bronzino, J. D. (Editor), *The biomedical engineering handbook*, CRC Press IEEE Press, 1995.

MECHANISMS

BIOPHYSICAL CHEMISTRY OF SIGNAL TRANSDUCTION. E. Neumann. Faculty of Chemistry, University of Bielefeld, D-33501 Bielefeld, Germany.

Chemical signal transduction is a powerful concept originally developed for the regulatory coupling between the *extracellular* hormone binding and the resulting *intracellular* changes, for instance, in the second messenger activation leading to alterations in the kinase-catalyzed phosphorylations finally controlling DNA transcription activity, cell growth, differentiation and metabolism. Indeed, chemical signal transduction across cellular membranes is a crucial mechanism not only on the level of a single cell, but also for chemical cell-to cell communication.

There are a variety of common features with another type of chemically mediated biocommunication: the synaptic signal transmission operating with neurotransmitter substances. Biological communication based on signal transduction "is a complex meshwork of transduction structures in which GTP-binding proteins (G-proteins), cell-surface receptors, the extracellular matrix and the vast cytoskeletal network are

joined in a community of effort ..." (M. Rodbell), i.e., in complex cascades of reaction cycles [1].

It is the chemical transduction and transmission system of cellular communication, which is supposed to be one of the key targets for potential interactions with external electric and magnetic fields (EMF). In particular, the initial step of the extracellular binding of the signaling substances, hormones or neurotransmitters, to the respective surface-receptors at the electrochemical interface of the transducing membrane structure, is frequently the subject of detailed theoretical analysis of EMF effects in terms of electrochemical reaction moments[2].

The reaction steps subsequent to the ligand binding are closely associated with the transducing membrane and are thus potentially affected by changes in the natural transmembrane electric field. The signal transduction concept further specifies that the ligand binding causes conformational changes in the receptor proteins. These ligand-triggered structural changes alter the association of the receptors with the G-proteins. The G-proteins have a dual function. They shuttle, on the cytosolic membrane side, between the surface receptors and membrane-bound enzymes such as adenylate cyclase or phospholipase C, producing second messenger substances. The G-proteins are therefore the actual signal transducers relaying to the enzymes the receptor response induced by the ligand binding.

Physicochemically, it is remarkable that the signal transduction cascade operates with highly charged compounds such as GTP, ATP, Mg^{2+} , and involves cluster structures such as the $\beta\gamma/\alpha$ (GTP/GDP) G-protein subunit complex and larger aggregates of G-proteins. For comparison with the cholinergic neurotransmission, the extramembraneous vestibules of the acetylcholine receptor protein (AChR) exhibit a majority of anionic groups accumulating cations for the channel currents [3,4]. Besides this particular electrostatic feature the acetylcholine receptors are organized in clusters of dimer-channels and give rise to the appearance of oligochannels. Protein clusters therefore can function as cooperative systems with high sensitivity to external stimuli [2]. In addition, cluster structures are candidates for metastable states and ligand-induced hysteresis cycles endowed with memory properties [3].

From an analytical point of view, the extent and rate of elementary chemical processes, as encountered in signal transduction and transmission, can be quantitatively treated in terms of the measurable quantities, such as the degree of ligand binding and exchange of bound water molecules as well as the extent of conformational change. The field effects and molecular-mechanistic details are covered by explicit expressions for the field dependence of the respective distribution constants and rate coefficients [2].

It is of particular interest that external electromagnetic fields can, in principle, interfere with the electrochemical reactions of the signal transduction and transmission proteins which, as a rule, are never isolated in small numbers. Rather, they are present in large numbers and frequently cooperatively organized as effective amplification devices, to ensure thermodynamic stability and thus functional reliability.

References:

1. M. Rodbell: Signal transduction: Evolution of an idea. *Bioscience Reports*, 15: 117-133 (1995).
2. E. Neumann: Electric and magnetic field reception, in: *Encyclopedia of Molecular Biology and Molecular Medicine* (ed. Meyers R.A., VCH-Publ., New York), 2: 172-181(1996).
3. F. Boege, E. Neumann, E.J. Helmreich: Structural heterogeneity of membrane receptors and GTP-binding proteins and its functional consequences for signal transduction. *Eur. J. Biochem.*, 199: 1-15 (1991).
4. E. Neumann: The initiation of the muscle action potential. *Arch. Physiol. Biochem.*, 104: 731-744 (1996).

MECHANISTIC LINKS BETWEEN PHYSICAL AND BIOLOGICAL PROCESSES. M. Blank. Department of Physiology and Cellular Biophysics, Columbia University, New York, New York 10032, USA.

The reductionist approach of science requires linkage of studies at different levels of complexity. In elucidating the mechanism of biological effects of EM fields, we must show that molecular interactions in simple systems can affect cellular function in complex biological systems. Recent studies of two membrane enzymes, the "ion pump" Na,K-ATPase and the mitochondrial cytochrome C oxidase, show:

- that EM fields interact with charge movements crucial to enzyme function, and
- that there is a direct relation between EM field interaction and enzyme activity.

Electric and magnetic fields penetrate the enzymes to different extents.

- Magnetic fields affect mobile charges throughout the protein. They increase activity, but the effects become smaller as the number of charges increases with enzyme activity.
- Electric fields only affect charge distribution at interfaces, but the thickness of the interface depends on the number of charges present. Fields can penetrate into the interior at low enzyme activity (few charges) when all mobile charges are needed to polarize the interface. At high activity (many charges), there are enough charges to polarize the interface without penetrating to the interior. Mobile charges unaffected by the applied field are not coordinated, and interfere with field-driven charge conduction in the enzyme. Because of this, electric fields *increase* function at low activity and *decrease* function at high activity.

The measured thresholds for magnetic field effects on Na,K-ATPase(2-3mG) and on cytochrome C oxidase (5-6mG), are in the range where transcription is stimulated (<8mG), and is also near the threshold in epidemiological studies (2mG) that link magnetic field exposure to human diseases. The affected charge movements in EM field interaction with cytochrome C oxidase are probably electron flow, and it is possible to calculate the numbers of electrons affected under particular conditions. This type of interaction could be involved in stimulation of transcription, since magnetic fields may interact with electrons moving along the stacked base pairs within DNA.

References:

- M Blank and L Soo (1992) The Threshold for Alternating Current Inhibition of the Na,K-ATPase. *Bioelectromagnetics*, 13:329-333.
- M Blank (1995) Electric and Magnetic Field Signal Transduction in Na,K-ATPase. *Adv Chem* 250:339-348.
- M Blank, L, Soo and V Papstein (1995) Effects of Low Frequency Magnetic Fields on Na,K-ATPase Activity. *Bioelectrochem. Bioenerg.*, 38:267-273.
- M Blank and L Soo (1996) Threshold for Na, K-ATPase Stimulation by EM Fields. *Bioelectrochem. Bioenerg.*, 40:63-65.
- M Blank and R Goodman (1997) Do Electromagnetic Fields Interact Directly With DNA? *Bioelectromagnetics*, in press.
- M Blank and L Soo (1997) Frequency Dependence of Na, K-ATPase Function in Magnetic Fields. *Bioelectrochem. Bioenerg.*, in press.
- We thank the Heineman Foundation for their support.

SIGNAL TRANSDUCTION EFFECTS OF NON-IONIZING ELECTROMAGNETIC FIELDS. R. Luben. Division of Biomedical Sciences and Department of Biochemistry, University of California, Riverside, California 92521, USA.

Low energy, nonionizing electromagnetic fields at extremely low frequencies have received a great deal of attention in recent years as a possible factor in disease. However, acceptance of these fields as a possible cause of disease has been slow because the field strengths involved are so low that our present understanding of biophysics does not offer a mechanism explaining the interaction of fields with cells in a way that could account for the observed effects. A central hypothesis in our studies has been that EMF can affect cells by modifying their sensitivity to signaling agents (e.g., hormones, growth factors, or tumor promoting agents) which regulate cell growth and function *in vivo*. These effects are largely the result of modifications in the sensitivity of membrane signal transduction systems by which hormones or growth factors initially interact with cells. Recent findings in our lab and others indicate that EMF exposure influences protein phosphorylation dependent pathways responsible for growth factor and proto-oncogene regulation of cell proliferation and differentiation. Based on these findings, an experimentally testable hypothesis will be presented by which short term exposures to relatively low field strengths of EMF can produce long term changes in cell function. Such models can be used to explain how observed *in vitro* and *in vivo* effects of EMF, both beneficial and potentially hazardous, may occur without violating the constraints of universal laws.

ELECTROMECHANICAL COUPLING IN SKELETAL DISEASE. S.R. Pollack. Department of Bioengineering, University of Pennsylvania, Philadelphia, Pennsylvania 19104-6392, USA.

The principle functions of bone are mechanical support and mineral homeostasis. In addition bone provides the essential site of hemopoiesis. To perform these functions throughout life, the cells of bone must maintain bone mass through a process of functionally directed remodeling. This remodeling is achieved through a cell coupled system of bone formation and resorption. The system is controlled by a complex of humoral and local chemical signaling molecules capable of directing cell function and by mechano-electric stimuli derived when bone is in mechanical function during activities of daily life and from exogenous application. Excellent paradigms have evolved for studying chemical signaling transduction, biochemical pathway analysis and final cellular response. However, cell based understanding of mechano-electric transduction, certainly in the case of small signals, have not yet been satisfactorily explained nor, in the case of electric and magnetic stimulation for low frequencies and low field amplitudes, considered feasible from a theoretical perspective.

The relationship of bone form to function has been articulated for more than 100 years and reports on electrical stimulation of bone growth and repair have been in the modern literature approaching 50 years. Failure to develop a cell based mechanistic explanation for these observations has not occurred for lack of trying. This presentation presents a possible approach to development of a mechanistic model whereby mechano-electric stimulation of bone cells occurs on two levels. The first is through the modulation of the highly developed chemical signaling system and the second through direct or indirect coupling to specialized receptors. This working hypothesis is consistent with experimental results involving bone cell response to fluid flow.

Modulation of chemical signaling pathways can occur for example via conformational changes in catalytic enzyme or in extra and intra cellular receptor sites and by altered mass transport of signaling ligands due to fluid flow or matrix deformation. In addition, specialized mechanoreceptors have been identified and evidence of their involvement in fluid flow has been proposed. Extension of methods to explore this hypothesis for direct cell strain and electric and magnetic field coupling to bone cells are under development. However low amplitude low frequency EM field transduction remains a significant theoretical problem when field amplitude is much less than 1 v/m and the frequency precludes intracellular penetration.

BIOMEDICAL APPLICATIONS OF ELECTRIC PULSES. L.M. Mir. URA 147 CNRS, Institut Gustave Roussy, 94805 Villejuif, France.

In pharmacology, most of the current drugs are molecules acting on receptors located at the cell surface. However, in anticancer pharmacology, cytotoxic drugs have their targets located inside the cells. Moreover, the new promising therapies that are emerging are based on specific modifications of cell gene expression. Therefore, these therapies will use products (natural or modified oligonucleotides in antisense or antigene strategies, or DNA, non chemically modified and non inserted in viral vectors, in gene therapy) that also have intracellular targets. However, these two types of molecules (oligonucleotides and DNA) are hydrophilic polyelectrolytes unable to freely diffuse through the plasma membrane.

The control of plasma membrane crossing is of the highest importance in cell physiology and homeostasis. The internalisation of all the metabolites necessary to cell functions (sugars, amino acids, cofactors, ions, ...) is mediated and controlled by membrane transporters or channels. This is not the case for macromolecules and for xenobiotics. These molecules fall into three categories: (i) a few small molecules enter the cells because they take the place of physiological molecules on the transporters (e.g.: anticancer drugs such as melphalan or methothrexate); (ii) the lipophilic molecules for which the plasma membrane is not a barrier diffuse through the lipid bilayer (e.g.: many anticancer drugs); (iii) the non permeant molecules, that are hydrophilic and devoid of transporters or channels, cannot cross the plasma membrane.

The non permeant molecules can be found in the cell : indeed they can be engulfed into cell internal vesicles by the process of endocytosis. However, in these vesicles, non permeant molecules are still separated from the cell cytosol by an uncrossable membrane. Cell membrane permeabilization is the only way to allow the non permeant molecules to reach the true cell inside, i.e. the cell cytosol, where they can interact with DNA, RNA, the ribosomes, etc..

Chemical permeabilization by means of detergents or other amphiphilic molecules results in long term changes in the membrane composition that can perturb the cell physiology. Therefore, physical procedures for cell permeabilization are very attractive.

Transient and reversible cell permeabilization can be achieved through the application of short and intense electric pulses to cells or to tissues (1). Under appropriate experimental conditions, more than 90% of the cells can be permeabilized, with a loss of cell survival inferior to 10%(2). Cell electroporeabilization is not a thermal process. It results from the induction of a transmembrane potential change imposed by the external electric field and it can be achieved in all cell types: bacteria, yeast, animal and plant cells. Cell electroporeabilization allows the internalization of DNA, proteins, drugs and dyes into the cell cytosol for research in biology and for medical purposes (3).

Bleomycin is a currently used anticancer drug that has few side effects but that is not highly efficient. In fact bleomycin

is a non permeant molecule: this molecule is very cytotoxic but its efficacy is restricted by the cell membrane crossing (4). Cell electropermeabilization dramatically increases the effects of bleomycin, both *in vitro* anti *in vivo* (4, 5). We have proposed a new antitumor approach that we termed electrochemotherapy (5). Electrochemotherapy is based on the combination of the delivery of non permeant cytotoxic molecules (like bleomycin) and of permeabilizing electric pulses applied to the solid tumor masses to be treated. Chemotherapeutic agents (bleomycin, cisplatin, and in the future, oligonucleotides, DNA, and other non permeant molecules) can be injected systemically or intratumorally. Antitumor electrochemotherapy has been tested on transplanted or spontaneous, subcutaneous or internal tumors, in mice, rats and rabbits (6).

Biomedical applications of the electric pulses are not limited to electrochemotherapy (7). Indeed, cell electropermeabilization also allows (i) the *ex vivo* electroloading of non permeant or low permeant molecules (e.g. antibiotics or inositol hexaphosphate) into either white or red blood cells and (ii) the increase of the transdermal drug delivery obtained by iontophoresis (8). Moreover, the transient modifications of the cell membrane generated by the same type of electric pulses make also feasible (i) the fusion between cells, between cells and liposomes, and between cells and tissues, as well as (ii) the electroinsertion of membrane proteins (e.g. glycophorin or recombinant CD4 molecules) into cell membranes like the membrane of the red blood cells (9).

However up-to-date, antitumor electrochemotherapy is the most developed biomedical application of the electric pulses. Phase I/II clinical trials have proved electrochemotherapy feasibility on humans, as well as good antitumor effects (10). New trials are in progress.

Most often, cancer is a general disease. Although electrochemotherapy is a local treatment, combination of electrochemotherapy with appropriate immunotherapies has led to the obtention of systemic antitumor effects in mice and rabbits (11). This promising combination should expand the indications of the antitumor electrochemotherapy in cancer treatment.

References:

1. Neumann, E. *et al.* *EMBO J.* 1: 841-5, 1982; Tsong, T.Y. *Biophys. J.* 60: 297-306, 1991.
2. Mir, L.M. *et al.* *Exp. Cell Res.* 175: 15-25, 1988.
3. Orlowski, S., and Mir, L.M. *Biochim. Biophys. Acta.* 1154: 51-63, 1993.
4. Orlowski, S. *et al.* *Biochem. Pharmacol.*, 37: 4727-33, 1988; Poddevin, B. *et al.* *Biochem. Pharmacol.*, 42(S): 67-75, 1991; Mir, L.M. *et al.* *Gen. Pharmacol.*, 27: 745-8, 1996.
5. Mir, L.M. *et al.* *Eur. J. Cancer*, 27: 68-72, 1991; Belehradec, J. Jr. *et al.* *Eur. J. Cancer*, 27: 73-6, 1991.
6. Selford, L.G. *et al.* *Biochem. Biophys. Res. Commun.*, 194: 938-43, 1993; Sersa, G. *et al.* *Bioelectrochem. Bioenerg.*, 35: 23-7, 1994; Heller, R. *et al.* *Bioelectrochem. Bioenerg.*, 36: 83-7, 1995.
7. Mir, L.M. *et al.* *Bioelectrochem. Bioenerg.*, 38: 203-7, 1995.

8. Sixou, S. and Teissie, J. *Biochem. Biophys. Res. Commun.*, 188: 860-6, 1992; Bruggemann, U. *et al.* *Transfusion* 35: 478-86, 1995.
9. Heller, R. *et al.* *Biochim. Biophys. Acta*, 1024: 185-8, 1990; El Ouagari, K. *et al.* *Eur. J. Biochem.* 219: 1031-9, 1994; Zeira, M. *et al.* *Proc. Natl. Acad. Sci. USA* 88: 4409-13, 1991.
10. Belehradec, M., *et al.* *Cancer*, 72: 3694-700, 1993; Domenge, C. *et al.* *Cancer*, 77: 956-63, 1996; Heller, R. *et al.* *Cancer*, 77: 964-71, 1996.
11. Mir, L.M. *et al.* *J. Immunother.*, 17: 30-8, 1995.

HEALTH ASPECTS OF MOBILE COMMUNICATION.

K.A. Hossmann. Max-Planck-Institute für Neurologische Forschung, 50931 Cologne, Germany.

The wide and growing use of mobile communication has raised concerns about adverse interactions of electromagnetic radiation with the human organism and, in particular, the brain. *In vitro* studies - and to a lesser degree also some *in vivo* investigations - have provided positive evidence of biological effects induced by high intensity radiofrequency or microwave radiation but there is little information on the possible health hazards at the frequency and intensity range of analogue or digital radiotelephones. However, most of the available data suggest that such hazards are unlikely as long as the radiation intensity remains in the athermal range.¹

As far as the brain is concerned, controversial observations have been made on the effect on spontaneous EEG activity which either increased or decreased, depending on the species (rat, rabbit or human), the duration of exposure or the EEG frequency bands. Some authors reported abnormalities of sleep pattern but the kind of disturbances - increase or decrease of REM or total sleep duration, changes of sleep onset latency - varied. There are also equivocal reports on the effects on neurotransmitter systems, such as increased or decreased norepinephrine content or acetylcholine esterase activity. The variability of these results suggests that specific alterations - if present - are probably of little functional importance.

In a comprehensive study from our laboratory, rats were exposed for 4 hours to pulsed (GSM) or continuous 900 MHz radiation with a specific brain absorption rate of up to 7.5 W/g. The genomic response of the brain was studied by investigating the regional distribution of immediate-early genes, heat shock proteins and a variety of astro- and microglial marker proteins both at the transcriptional (*in situ* hybridizations) and the translational level (immunohistochemistry). In addition, the proliferative activity of brain cells was assessed by the bromodeoxyuridine method and the permeability of the blood-brain barrier by immunostaining of extravasated serum proteins^{2,3}. These studies revealed some minor -probably stress related - abnormalities immediately after microwave exposure but no lasting disturbances after one week. In particular, there were no indications of any proliferative or morphological changes of the brain. Our data are, therefore, in support of the existing literature that mobile communication does not pose a

long-term public health hazard. However, further experiments may be necessary to fully exclude this possibility.

1. McKinlay, A.: Possible health effects related to the use of radiotelephones. Recommendations of a European Commission Expert Group. Paper presented at the International Seminar on "Biological effects of nonthermal pulsed and amplitude modulated RF electromagnetic fields and related health hazards", Munich, November 20-22, 1996
2. Fritze, K., Wiessner, C., Kuster, N., Sommer, C., Gass, B., Hermann, D., Kiessling, M. and Hossmann K.-A.: Effect of GSM microwave exposure on the genomic response of the rat brain (submitted for publication).
3. Fritze, K., Sommer, C., Schmitz, B., Mies, G., Hossmann, K.-A., Kiessling, M., Wiessner, C.: Effect of GSM microwave exposure on blood-brain barrier permeability in rat (in preparation).

TOWARD THE 21ST CENTURY

THE FUTURE TECHNOLOGY OF MOBILE TELEPHONE SYSTEMS. J. Bach Andersen. Center for Personkommunikation, Aalborg University, DK-9220 Aalborg Ø, Denmark.

Mobile telephone systems show very large growth rates all over the world, with forecasts of 100 Million users in USA in 2004, and the penetration in some countries already now approaches 30%. It is expected that in a foreseeable future the total number of mobile phones will exceed the fixed telephones, and a large part of the population will thus be exposed to the fields surrounding a mobile phone. It is therefore natural that concerns have been expressed about the possible health risks related to this exposure, and that extensive research programmes involving epidemiological, biological and medical studies are being initiated around the world. In contrast to ionizing radiation radio-frequency radiation is in general much less understood in the biological and medical community, and it is therefore the purpose of the talk to describe in some detail those technical and physical aspects of modern wireless digital telephones, which can be of relevance for epidemiological, biological, and medical studies.

It is important to distinguish two frequency regions, the high frequency region and the low frequency region. The high frequencies carry (thus the name carrier) the power, and these frequencies are important for the antennas, the distribution in the tissue, the propagation of the radio waves, and for allocation between different regions and services. For present systems these frequencies are around 900 MHz and 1800-1900 MHz. Some first generation analogue systems have carrier frequencies also at lower frequencies like 450 MHz. New satellite systems will have new type of handheld terminals with a different type of polarization, higher power levels, and in the 2000 MHz region. It can be expected that higher frequencies up to 60 GHz (60,000 MHz) will be employed in the future. Whether the carrier frequencies themselves are of biological relevance is an interesting question.

The time averaged power (averaged over times much longer than the information rate, but shorter than typical times for power variations) is supposed to be the active biological agent. The power is related to the square of the signal, so the power is fluctuating with the square of the amplitude. For technical reasons signal modulations are often chosen as constant magnitude (also called constant envelope), so if we only look at the signal itself without any switching and other low frequency variations the power would be constant. This is the case for FM (frequency modulated signals for analogue systems) and many digital modulations. In cellular communications for many users the protocols dictate considerable variations in the power. Access systems like FDMA, TDMA, and CDMA will be looked at from a power variation point of view. They differ widely in their power spectra and their coherence properties.

POLICY AND ELECTROMAGNETIC FIELDS. I. Nair. Department of Engineering and Public Policy, Carnegie Mellon University, Pittsburgh, Pennsylvania 15213, USA.

After a period of high publicity and visibility, the EMF issue and hence policy is in a relatively quiescent state. This talk will examine the current status of policy in the area of low frequency electric and magnetic fields from the perspectives of the various stakeholders - the public, utilities, and government.

Factors relevant to policy concerns are: the importance of electricity and other devices to modern day living; the incomplete science; the public visibility of the issue; and the numerous economic interests. Because of these, policies have been made more in response to public and other pressures rather than on some examined cautionary principle. The one principle introduced in this context - that of prudent avoidance - has received support from some parties and opposition from others.

Salient principles from the literature on risk analysis and the history and philosophy of science and technology, as well as ethical principles could yield a framework for examining policy. For example, when examining public perception of the issue, it is important to realize that in both the RF and ELF spectral regions, there are two classes of exposure in which different concerns are raised. Public exposure from facilities such as transmission lines or cellular telephone towers raise a different level of concern than consumer devices such as appliances and cellular telephones. This is a case of the known fact in risk literature that voluntary risks are perceived differently than imposed risks over which a person feels no control. History of science and technology tells us that the current stage of EMF policy is typical of emerging science and life cycle of technologies. The principles of biomedical ethics - respect for autonomy, beneficence, non-malificence and justice - have been used by one utility to examine their policies [2].

This presentation will discuss these various aspects and examine to what extent it is possible to construct a framework to describe current policies. Such an examination may yield some insights for future directions for public and private

policies.

[1] Morgan, M. Granger, "Prudent Avoidance", *Public Utilities Fortnightly*, 26-29, March 15, 1992.

[2] Electric and Magnetic Field Management: The Prudent Avoidance Concept, *Electric Hydro-Quebec Report*, October 1995.

HORIZONS IN SCIENCE; PHYSICAL REGULATION OF LIVING MATTER AS AN EMERGENT CONCEPT IN HEALTH AND DISEASE. W.R. Adey, J.L. Pettis Memorial Veterans Administration Medical Center and University School of Medicine, Loma Linda, California 92357, USA

Steadily increasing use of electric power in all industrialized societies has sharply modified and increased the electromagnetic (EM) environment many thousands of times over natural levels. There is great and growing use of radiofrequency and microwave devices. Our exposure to these fields has no counterpart in the natural environment. Natural low-frequency fields bathe all life on earth from conception to death. Generated principally in equatorial zones by thunderstorm activity with energies of billions of coulombs, they exhibit peaks at frequencies between 8 and 32 Hz (Schumann resonances). Schumann fields are weak, with electric components around 0.01V/m, and magnetic fields of 1-10 nanotesla. These weak *oscillating* fields contrast with the earth's much larger *static* geomagnetic field (typically around 50 microtesla, or 50,000 times stronger than the oscillating fields). In sharp contrast, typical 60Hz ambient fields in U.S. urban environments are in the range 0.03-0.3 microtesla, but substantially higher near many domestic and industrial appliances.

In a strongly cooperative worldwide endeavor over the past 20 years, a small community of bioelectromagnetic researchers has pursued the goal of identifying elemental aspects of possible bioeffects of environmental EM fields. In laboratory studies at cell and molecular levels, and in animal models, they have examined 1) stimulus parameters of intensity, frequency and intermittency of exposure reportedly linked to EM bioeffects; 2) evidence for one or more sites of EM field action at the cellular level, consistent with accepted biological models of biophysical, biochemical and physiological organization; and 3) models of physical mechanisms necessary to account for an ever increasing range of bioeffects attributed to EM fields where tissue heating is not a mediating factor.

On the one hand, laboratory findings now bridge increasingly to epidemiological studies, offering mechanistic models of EM field action in regulation of cell growth and tumor formation, in aberrant neuroendocrine functions, in altered immune status, and in oxidative stress associated with neurological diseases that include Alzheimer's, Parkinson's and certain forms of epilepsy, as well as the phenomena of aging. On the other hand, laboratory studies have opened a broad vista of potential therapeutic applications for certain EM fields, including delayed fracture union, wound healing, nerve regeneration, cancer therapy, and pain management.

In many instances, first interactions of EM fields with tissues occur at cell membranes¹. Both ELF and ELF-modulated RF fields interact at cell membrane receptors with neurotransmitters, hormones and cancer-promoting chemicals. From these receptors, inward signals activate a cascade of enzymes controlling metabolism, messengers, and cell growth.

In the search for mechanisms mediating first detection of weak EM fields in tissue, growing theoretical and experimental evidence points to free-radical mechanisms as one possible substrate. This model proposes that magnetic fields may interact with free radicals produced in on-going chemical reactions, and modify the rate and amount of reaction product². Activation of the cell membrane glutamate receptor in brain tissue initiates synthesis of the free radical nitric oxide, a process modulated by magnetic fields (1Hz, 0.1 millitesla) and implicating nitric oxide as a normal regulator of electroencephalographic (EEG) rhythms, and in the pathophysiology of epilepsy³.

ELF magnetic fields (60Hz, 0.1 millitesla) also modulate a cell membrane receptor-mediated enzyme cascade in pre-B lymphocytes, with the implication that ELF fields may interfere with programmed-cell-death (*apoptosis*).⁴ Surviving clones may eventually participate in B-cell leukemia of childhood, the commonest form of childhood leukemia and linked epidemiologically to EM field exposure. Apoptosis is triggered when matrix proteins surrounding cells lose their binding to cell surface receptors (*integrins*). *Apoptosis resistance*, rather than cell proliferation, is suggested as the major defect causing unchecked cell growth in carcinoma cells. It leads to clinical resistance to chemotherapy and to ionizing radiation therapy⁵.

Concepts of DNA damage as a sole and sufficient basis for tumor formation (*genotoxic carcinogenesis*) are challenged by these findings. As a new tool in cancer research, bioelectromagnetic research offers evidence that tumors may result from factors not acting directly on nuclear DNA, but rather at cell surfaces and in the intercellular matrix (*epigenetic carcinogenesis*)⁶.

In a broader perspective, tissue sensitivities defined through electromagnetic field exposure have extended a broad horizon to a first understanding of biological regulation through physical processes at the atomic level. These atomic mechanisms, though operating at far lower energy levels than chemical reactions in the fabric of biomolecules, may nevertheless function as regulators on the rate and amount of product of certain enzymatic biochemical reactions.

References:

1. Adey W.R. (1992) In *Interactions of Low, Level Electromagnetic Fields in Living Systems*, B. Norden and C. Ramel, eds. Oxford University Press. pp. 47-77.
2. McLaughlan K, Steiner U.E. (1992) *Molec. Physics* 73:241-263.
3. Bawin S.M., et al. (1996) *Bioelectromagnetics* 17:388-395.
4. Uckun FM, et al. (1995) *J. Biol. Chem.* 270:27666-70.
5. Fritsch S.M., et al. (1996) *J. Cell Biol.* 134:793-9.
6. Adey W.R. (1996) In: *Mobile Communication Safety*, N. Kuster, Q Balzano, J.C. Lin, eds. New York, Chapman and Hall. pp. 95-131.

MINISYMPOSIA

MS-1 - MELATONIN

Organizers: Robert Liburdy and Wolfgang Löscher

Dr. Richard Stevens, in 1987, hypothesized that electric and magnetic fields can affect pineal gland melatonin secretion *in vivo*, which, in turn, can influence mammary (breast) carcinogenesis. A number of experimental studies have been conducted to test the hypothesis. Although this literature is still evolving and consensus is being built, it is fair to say a) there exists credible scientific support for this hypothesis and, importantly, b) this support encompasses *in vitro*, *in vivo*, and epidemiological research. The melatonin hypothesis, thus, currently represents one of the more well documented/tested interactions in the field of bioelectromagnetics. This minisymposium has several goals. First, the melatonin hypothesis will be introduced and its salient biological features and assumptions will be discussed. The latest laboratory research testing this hypothesis will be presented in a review format to highlight important scientific findings. Speakers will address important studies in a) *in vitro*, b) *in vivo*, and c) epidemiological research and, where possible, emphasis will be placed on integrating these observations. A summary reviewing melatonin's role in carcinogenesis, including mammary (breast) carcinogenesis, will provide an opportunity to place the scientific findings in further perspective.

MS-1-1

BREAST CANCER AND USE OF ELECTRIC POWER.

R.G. Stevens. Battelle, Pacific Northwest National Laboratory, Richland, Washington 99352, USA.

Breast cancer is a disease of modern life. As societies industrialize, risk increases, yet it is unclear which of the myriad changes coming with industrialization drives this increase. One important hallmark of modern life is the pervasive use of electric power. Electric power produces light-at-night (LAN) and anthropogenic electric and magnetic fields (EMF), either or both of which may alter pineal function and its primary hormone, melatonin, thereby, perhaps, increasing the risk of breast cancer. This hypothesis, stated a decade ago, is now receiving considerable experimental and epidemiological attention. The circumstantial case for the hypothesis has three aspects to it: 1) light effects on melatonin, 2) EMF effects on melatonin, and 3) melatonin effects on breast cancer. The strongest of these aspects is light effects on melatonin. It is clear that the normal nocturnal melatonin rise in humans can be suppressed by light of sufficient intensity. The evidence for an effect of melatonin on breast cancer in experimental animals is strong, but the evidence in humans is scant and difficult to gather. The most limited aspect of the circumstantial case is EMF effects on melatonin. Whereas a half dozen independent laboratories have published findings of suppression in animals, there are inconsistencies, and there are conflicting reports in humans.

The direct evidence bearing on the hypothesis is sparse but provocative. Two laboratories have published data showing increases in chemically-induced breast cancer in rats by an AC magnetic field. In addition, several laboratories have reported an EMF-induced reversal of melatonin's oncostatic action on a human breast cancer cell line *in vitro*. The epidemiological evidence is very limited, but has offered some support as well. An effect of electric power on breast cancer would have profound implications, and this possibility deserves continued investigation.

MS-1-2

MAGNETIC FIELDS AND BREAST CANCER: EXPERIMENTAL *IN VITRO* STUDIES AND THE MELATONIN HYPOTHESIS. R.P. Liburdy. Lawrence Berkeley National Laboratory, University of California, Berkeley, California 94720, USA.

The melatonin hypothesis, originally formulated by Dr. Richard Stevens in 1987 and summarized in the cover story of *Cancer Research* (July 15, 1996), proposes that magnetic and electric fields may act to suppress or time-shift pineal gland production of melatonin *in vivo*. Subsequent plausible biological consequences, as originally discussed by Dr. Stevens, may lead to an increased risk of breast cancer. Since 1987 there have been a number of animal studies which lend scientific support to this hypothesis (refer to companion minisymposium abstracts). Complementing this *in vivo* research are *in vitro* studies, investigating whether field interactions may alter melatonin activity at the target cell level. This putative cellular level field effect could act in conjunction with a field effect altering melatonin secretion at the whole animal level.

One important biological activity of physiological levels of melatonin (originally reported by Dr. David Blask) is a reduction of MCF-7 human breast cancer cell growth *in vitro*. MCF-7 cells represent one of several estrogen-receptor positive (ER⁺) human mammary tumor cell lines widely employed in breast cancer research. The growth inhibitory effect of melatonin on MCF-7 cells obtained from Dr. Blask's laboratory has been independently confirmed in several laboratories, including ours. Dr. Blask and colleagues hypothesized that this *in vitro* function of melatonin may have significant biological relevance to the regulation of human breast cancer cell growth. Therefore, we undertook cell culture studies to test whether environmental-level magnetic fields may influence this natural oncostatic function of melatonin.

To perform true environmental-level magnetic field exposures of cells in culture we designed and implemented a special system employing identical 4-coil, Merritt-type exposure coils housed in mu-metal shielding chambers to eliminate spurious magnetic fields generated inside commercial incubators. Simultaneous exposure of cells to either 0.2 or 1.2 μ Tesla, 60Hz magnetic fields (rms) [DC magnetic field < 0.5 μ Tesla] can be accomplished using these exposure systems. We have observed that continuous exposure of MCF-7 human breast cancer cells *in vitro* to an environmental-level 1.2 μ Tesla (12

mG), but not a 0.2 μ Tesla (2mG), 60Hz magnetic field, can completely block the growth inhibitory action of the hormone melatonin.

The reproducibility of this field interaction, using environmental-level μ Tesla magnetic fields with melatonin, has been independently tested by three laboratories using cells and serum from identical sources. Dr. Larry Anderson of PNNL, Richland, Washington, Dr. Carl Blackman of the EPA and Dr. Richard Luben of the University of California at Riverside have each reported in abstract form a) confirmation of the original finding of Dr. Blask (melatonin can inhibit MCF-7 cell growth), and b) confirmation of our original finding (a 1.2-1.5 μ Tesla, 60Hz magnetic field blocks or inhibits melatonin's action). In these replication studies laboratory protocols and experimental design were similar but not identical to those used in our laboratory.

Collectively, this body of *in vitro* research establishes that environmental-level 60Hz magnetic fields can alter melatonin's antiproliferative activity in human breast cancer cells. The significance of these findings is that a replicated bioeffect involving melatonin has been identified with the potential for elucidating possible biological mechanisms. Moreover, the potential exists for translation to relevant *in vivo* experiments involving melatonin and environmental-level magnetic fields.

Supported by the Office of Utility Technology, Utilities System Division, U.S. Department of Energy under contract DE-ACO3-76SF00098

MS-1-3

ROLE OF α -ADRENERGIC STIMULATION FOR THE RESPONSE OF CULTURED PINEAL GLANDS OF DJUNGARIAN HAMSTERS TO WEAK MAGNETIC FIELDS (50 Hz). A. Lerchl and M. Niehaus. Institute of Reproductive Medicine, University of Münster, D-48129 Münster, Germany.

Experimental data have suggested that the pineal gland may play a central role in the possible health risks of weak electromagnetic or magnetic fields (EMF). The chief hormone of the pineal gland, melatonin, was shown to possess antiproliferative properties in certain cancer cell types; the actions of melatonin as a potent radical scavenger have demonstrated that the hormone is possibly a natural protectant against certain carcinogens which act through the formation of radicals such as OH \cdot . Studies have indicated that the production of melatonin is suppressed by EMFs. Thus, if weak EMFs are able to suppress melatonin, this may be one possible explanation for experimental and epidemiological data linking exposure to EMFs to increased incidence of cancer.

We are investigating direct effects of weak EMFs on isolated pineal glands. For this purpose, pineal glands from adult Djungarian hamsters (*Phodopus sungorus*) were collected after sacrifice and immediately transferred to special glass chambers. Oxygenated buffer was perfused at a flow rate of 0.4 ml min $^{-1}$ for 8 hrs, and fractions of the perfusates were collected every hour. For each experiment, 24 chambers were

used, assembled in 3 groups. Each group of 8 chambers was surrounded by a Helmholtz coil with antiparallel wiring, which was connected to one of three generators through a "black box", (ensuring both true sham exposure conditions and a blind experimental fashion. Melatonin concentrations in the fractions were estimated by a sensitive and reliable radioimmunoassay

Data obtained so far have shown that sine wave or rectangular magnetic fields at flux densities of 86 μ Tesla, 8.6 μ Tesla, or 0.86 μ Tesla had no influence on the melatonin production when the glands were stimulated by isoproterenol, a relatively pure B-adrenergic agonist. However, recent experiments reveal that the situation is different when the production of melatonin is stimulated by noradrenalin, the natural neurotransmitter of the pineal gland which stimulates both the β -adrenergic as well as the α -adrenergic pathway. The latter pathway is known to increase the intracellular concentration of calcium (Ca $^{2+}$) as well. In the latest experiment we stimulated the pineal glands with noradrenaline (10 $^{-7}$ M) and were able to show that exposure to magnetic fields at 86 μ Tesla resulted in a significant (p<0.03) decrease in melatonin production. This effect was more pronounced when the glands were exposed to rectangular fields as compared to the exposure to sine wave fields.

The data confirm the assumption that Ca $^{2+}$ may play a key role in the responses of pineal glands exposed to weak magnetic fields. Furthermore, the experiments corroborate earlier findings in rats where rectangular-shaped magnetic fields suppressed pineal melatonin concentrations whereas sine wave fields did not. We conclude that the suppressive effects of weak EMFs on isolated pineal glands depend both on the way of pharmacological stimulation and on the wave form of the applied fields.

MS-1-4

MAGNETIC FIELDS AND BREAST CANCER: EXPERIMENTAL *IN VIVO* STUDIES ON THE MELATONIN HYPOTHESIS. W. Löscher, M. Mevissen and M. Häubler. Department of Pharmacology, Toxicology and Pharmacy, School of Veterinary Medicine, D-30559 Hannover, Germany.

In 1987, Stevens presented a hypothesis that use of electric power may increase the risk of breast cancer. This hypothesis was based on a number of experimental reports indicating an effect of light and extremely low frequency (ELF) *electric* fields on pineal melatonin production, and on the relationship of melatonin to mammary (breast) carcinogenesis. However, at the time when this hypothesis was presented it was not known if ELF (50 or 60-Hz) *magnetic* fields (MF) affect pineal melatonin production in experimental animals and/or humans. Furthermore, there was no experimental evidence for increased breast cancer development or growth in response to MF exposure. This prompted us to carry out a series of experiments designed expressly to test the "melatonin hypothesis" of MF-promoted breast cancer development and growth in female rats.

Based on the melatonin hypothesis, chronic exposure to an ELF (50 or 60-Hz) MF suppresses the normal nocturnal synthesis of pineal melatonin. Because melatonin physiologically suppresses estrogen production by the ovary and prolactin production by the pituitary, a melatonin reduction would in turn result in increased estrogen and prolactin production and thereby induce increased turnover of the breast epithelial stem cells at risk for malignant transformation. In other words, the likelihood that breast stem cells are affected by cancer causing agents (e.g., chemical carcinogens) such as occurring in the environment would be increased by reduced production of melatonin. In addition, in view of the oncostatic effect of melatonin on breast cancer growth, the development and growth of breast cancer, once initiated, would be facilitated by reduced melatonin levels. The risk of tumor formation could be further increased by the possible link between MF, melatonin and the immune surveillance system. Melatonin has been shown to stimulate various immune parameters involved in tumor defense mechanisms so that MF exposure, via reduction in melatonin might impair the immune response to tumor cells. All these alterations in response to MF exposure, and probably several additional MF-induced effects not directly linked to melatonin, might ultimately increase the risk of breast cancer formation.

To directly prove this hypothesis, we studied if alternating MFs of low flux density enhance tumor development or growth in the DMBA (7,12-dimethylbenz(a)anthracene) model of breast cancer in female rats. The dosing protocol of the chemical carcinogen DMBA chosen for the MF experiments induced palpable mammary tumors in about 40-60% of sham-exposed control animals within 3 months after application. For the MF experiments, groups of 36-99 rats were exposed to a 50-Hz MF for 24 h/day 7 days/week for 13 weeks; control groups were sham-exposed under the same environmental conditions as the MF-exposed rats. Four flux densities were studied in a total of 660 rats (including sham-exposed controls): 0.3-1 μT , 10 μT , 50 μT , and 100 μT . Already 8 weeks after DMBA application, MF-exposed rats exhibited significantly more palpable tumors than sham-exposed animals in the experiments with 50 and 100 μT . At autopsy, i.e. at the end of the 13 weeks period of MF-exposure, incidence of macroscopically visible mammary tumors was significantly enhanced in the experiment with 50 μT (25.5% above control) and 100 μT (50% above control). No increase in mammary tumors was seen in the experiment with 0.3-1 μT , while a 10% (non-significant) increase was determined in the experiment with 10 μT . Linear regression analysis of the data from the 4 experiments indicated a highly significant linear relation between flux density and increase in number of macroscopically visible mammary tumors at time of autopsy. Histopathological examination of tumors from the 100 μT experiment indicated that MF exposure did not only increase tumor growth but also affected progression to malignancy, since exposed rats exhibited a significantly higher number of adenocarcinomas than controls. Furthermore, tumor size was significantly higher in MF-exposed rats. A replication of the experiment with 100 μT again resulted in a significant increase in tumor incidence in MF-exposed rats (see detailed data in the paper of Mevissen

et al. presented at this meeting). Collectively, the data demonstrate that long-term exposure of DMBA-treated female rats promotes the growth and progression of mammary tumors in a highly dose-related fashion, thus substantiating the melatonin hypothesis.

In several of the experiments described above and various additional studies in female rats, we determined plasma levels of melatonin, estrogen and prolactin, breast tissue activity of ornithine decarboxylase, i.e. a key enzyme involved in cell proliferation, and immune system parameters. At least in part, data from these experiments indicate that melatonin is involved in the carcinogenic effects of ELF MF in the DMBA model as found in our laboratory.

MS-1-5

50-Hz MAGNETIC FIELD EXPOSURE AND MELATONIN IN THE RATS. M. Kato, T. Shigemitsu, K. Yamazaki, T. Kikuchi and W. Ooba. Hokkaido University, CRIEPI, TEPCO, Sapporo 005, Japan.

In order to understand possible effects of magnetic field exposure on biological systems, it is important to carry out the experiments under well defined experimental conditions. Circularly polarized, elliptically polarized at various ratios of major versus minor axes, as well as linearly polarized fields can be found under AC three-phase transmission lines (Deno;1976, Yasui;1994). Although circularly polarized field does not exist at the ground level, we have carried out exposure experiments of the circularly polarized, elliptically polarized and linearly polarized fields for the later consideration of the possible mechanisms of the exposure on the animals.

We have constructed two identical exposure systems for exposure and sham-exposure, and placed the two systems in the same room. The two systems are 3.7 meters apart from center to center. Because of the two systems are placed in the same room, about 2% of the magnetic field of the exposure system spill over into the sham-exposure systems.

Male rats of Wistar-King and Long-Evans strains were exposed to differently polarized fields with different strengths for 6 weeks continuously. So far we have carried out 21 exposure experiments. Plasma as well as pineal melatonin were assayed by RIA. Circularly polarized magnetic fields stronger than 1.4 μT suppressed plasma and pineal gland melatonin. This finding has been replicated consistently in 5 experiment completed over a period of 7 years from 1989 through 1995. Elliptically polarized fields with a ratio of major versus minor axes at 4:1 at either 1.4 or 7 μT did not suppress melatonin. However, elliptical field with 2:1 ratio, which does not exist at the ground level, at 7 μT suppressed melatonin. Linearly polarized fields of either horizontal or vertical orientation did not suppress melatonin at 1 μT although at 5 μT field exposure reduced plasma melatonin concentration.

Induced current within the living body may be a candidate of interface between magnetic fields and responding cells. For this reason we analyzed the induced current density and absorbed power density of circularly, elliptically and linearly

polarized magnetic fields under certain assumptions. The analyses show that the variation of the current density and absorbed power density with the time were different according to the type of magnetic fields.

MS-1-6

THE EFFECTS OF EXPOSURE TO MAGNETIC FIELDS ON MELATONIN IN HUMANS. J.S. Reif and J.B. Burch. Department of Environmental Health, Colorado State University, Fort Collins, Colorado 80523, USA.

Magnetic fields have been shown to induce changes in production of the pineal hormone, melatonin, although this phenomenon has not been studied thoroughly in humans. In a study of electric blanket users, Wilson *et al.* (1990) noted a reduction in nocturnal melatonin production (measured as urinary 6-hydroxy-melatonin sulfate [6-OHMS]) in some subjects following 8 weeks of electric blanket use accompanied by a rebound following cessation of use. A similar reduction in daytime 6-OHMS followed by a post-exposure rebound was reported recently in a study of 108 railway workers exposed to 16.7 Hz magnetic fields (Pflugler *et al.*, 1996). Graham *et al.* (1996) studied nocturnal melatonin production in men exposed overnight to magnetic fields under laboratory conditions. Overall, plasma concentrations of melatonin were not reduced; however, suppression of melatonin by 200 mG exposures and enhanced melatonin suppression by light was noted among men with low preexisting melatonin levels. In a replicate study, no overall effect on melatonin was found, nor was the enhanced sensitivity in low-melatonin subjects reproducible. We studied the effects of magnetic field and ambient light exposures on melatonin production in a group of 192 electric utility workers. Individual magnetic field and light exposures were quantified over three 24 hour work days and divided into work, sleep and other, non-work intervals. Melatonin production was measured as creatinine-adjusted urinary concentration and total nocturnal 6-OHMS (ng) excretion in post-shift or overnight samples. Magnetic field, light and 6-OHMS data were log transformed and analyzed using repeated measures analysis of variance, multiple linear regression, or the Proc Mixed procedure of SAS. Exposure metrics based on field intensity (arithmetic, geometric mean, cumulative exposure, cumulative exposure above 2 mG) or temporal field characteristics were used to evaluate whether magnetic field exposures during each time period (work, home, other, sleep) influenced melatonin production. To evaluate the intermittency of magnetic field exposures, the rate of change metric (RCM), based on the root mean square variation in successive measurements, was used (Wilson, *et al.*, 1996). The standardized rate of change metric (RCM* = RCM/St. Dev.) was used to evaluate the temporal stability of the magnetic field exposures. In general, workplace magnetic field intensity and intermittency were higher in workers with job titles related to electric power distribution and generation than in a comparison group of utility office and maintenance staff. Age, gender, season, and ambient light exposures were significant predictors of 6-OHMS excretion; all analyses

relating magnetic field exposures and 6-OHMS excretion were performed with adjustment for these factors. There were no differences in melatonin excretion among distribution, generation and comparison workers. Workplace magnetic field exposures were associated with lower daytime 6-OHMS concentrations on the second and third days of measurement ($p < 0.05$). Temporally coherent (low RCM*) magnetic field exposures at home were associated with lower nocturnal 6-OHMS concentrations ($p < 0.01$). Additional analyses are in progress. Our results provide evidence that certain magnetic field exposures are associated with reduced day and nighttime 6-OHMS excretion in electric utility workers. The intensity and temporal characteristics of magnetic fields appear to be involved in melatonin suppression in this population. Further research on the effects of magnetic fields on human melatonin including characterization of field components, relationship to photoperiod and genetic variability in response is recommended.

This work was supported by the U.S. DOE Office of Utility Technologies and grant RO1ES08117 from NIEHS, NIH.

M-1-7

MELATONIN: THE PINEAL GLAND'S ANTICANCER MOLECULE. D.E. Blask. Bassett Research Institute, Cooperstown, New York 13326, USA.

Physiological and/or pharmacological levels of melatonin, the chief neurohormone of the pineal gland, have been shown to modulate a variety of different biological processes that are involved in the regulation of circadian rhythms, seasonal reproduction, sleep, retinal physiology, vascular tone, free radical scavenging, metabolism, immunity and neoplasia. Because of its lipophilic and hydrophilic nature, melatonin is able to cross all morphophysiological barriers and influence the biology of the cell from the plasma membrane to the nucleus. Melatonin's growing reputation as an anticancer molecule is derived from both *in vivo* and *in vitro* studies. Experiments *in vivo* have demonstrated that the circadian-timed administration of pharmacological amounts of melatonin in a variety of animal models of carcinogenesis inhibit tumor growth. Pharmacological concentrations of melatonin in some *in vitro* experiments have also been shown to exhibit cytotoxic activity on cancer growth. However, a majority of *in vitro* studies using estrogen receptor positive human breast cancer cell lines demonstrate a cytostatic effect of physiological levels of melatonin. Also arguing for a role of the physiological melatonin signal in thwarting neoplastic cell growth are *in vivo* studies showing that elimination of the nocturnal melatonin signal, either via pinealectomy or constant light exposure, enhances cancer growth. As yet, no definitive signal transduction pathway has been shown to convey melatonin's oncostatic message to the intracellular processes controlling cancer cell growth. Recent work from our laboratory strongly indicates that both pharmacological and physiological levels of melatonin inhibit cancer growth by blocking the tumor uptake of the long chain essential fatty acid, linoleic acid, and its metabolism to a potentially

important growth signal transduction molecule, 13-hydroxyoctadecadienoic acid.

MS-2 - STANDARDS

Organizers: John Osepchuk and Martino Grandolfo

After about three decades of efforts to develop standards for the safe use of electromagnetic energy (EMF), there is now serious consideration of international harmonization of such standards. Differences remain with refined standards across the whole spectrum, 0 to 300 GHz, in some countries while in other countries standards remain incomplete. In at least one country, there is consideration of an alternative to standards, i.e., "prudent avoidance." Despite these differences, there is increasing liaison relationships and other communications between standards organizations. A trend toward harmonization is underway. Are there obstacles? Will it happen? Speakers from around the world, including Eastern Europe, will seek to answer these questions.

MS-2-1

EMF STANDARDS FOR OCCUPATIONAL AND ENVIRONMENTAL EXPOSURE IN EASTERN EUROPEAN COUNTRIES: PRESENT STATUS AND TRENDS FOR INTERNATIONAL HARMONIZATION. S. Szmigielski and R. Kubacki. Center for Radiobiology and Radiation Safety, Military Institute of Hygiene and Epidemiology, 00-909 Warsaw, Poland.

EMF exposure standards in Eastern European countries are traditionally based on the concept of protection against hazards or risks that are uncertain but where the causal relationship with past exposures can be postulated with a considerable degree of suspicion. The standards are established to protect human beings not only against effects of direct coupling of EMFs (thermal effects at exposures to 100 - 300,000 MHz, induced currents at 0.1 - 100 MHz) but also against hazards related to indirect coupling of EMFs (e.g. strong contact currents which may occur in large metallic objects localized in relatively weak high frequency electric fields).

Therefore, the EMF standards in Eastern European countries were established for all frequencies at the range 0.1 - 300,000 MHz at considerably lower levels than those proposed for West European countries. The standards and basic restrictions levels established in Poland, Czech Republic and Hungary will be presented and discussed in detail. The above three standards follow a similar concept, although the final solutions and levels for limited exposure of workers and residents are different. A 15 year experience with application of Polish EMF standards, being at present one of the most restricting standards in Eastern European countries, will be briefly discussed.

The present standards in Eastern European countries differ considerably from the European Prestandard ENV 50166 and need reconsideration. In Poland it is still postulated that the

EMF standards should provide protection against hazards related to indirect coupling of EMFs, therefore the future proposal will set the limits for exposure of workers and residents at lower limits than the ENV 50166 Prestandard.

MS-2-2

THE EUROPEAN PRE-STANDARD ENV 50166 "HUMAN EXPOSURE TO ELECTROMAGNETIC FIELDS" IN CONTEXT. B. Kunsch. Austrian Research Centre Seibersdorf, 2444 Seibersdorf, Austria.

The European prestandard ENV 50166 deals with the prevention of adverse effects of human exposure to electromagnetic fields in the frequency range from static fields up to electromagnetic radiation of 300 GHz. Electromagnetic fields interact with the human body through a number of physical mechanisms. At low frequencies stimulation of nerves and muscle tissue, and at high frequencies heating were considered as established effects, respectively. Therefore the ENV is divided into two parts. Part 1: 0 - 10 kHz and Part 2: 10 kHz - 300 GHz. As regards reports on long term effects such as the induction or promotion of certain types of cancer this literature as well as the views of relevant national and international bodies on this matter were scrutinised and it was found that the currently available evidence had not established such a connection. By the end of 1997 the ENV 50166 has to be converted in a full standard (EN) or withdrawn.

Some European countries have already developed national standards or guidelines for the protection of the population from electromagnetic fields. The CENELEC Prestandard is the result of their national electrotechnical committees' harmonization effort. International documents in the field of protection against electromagnetic fields which are particularly important for European countries have also been published on WHO level and by the Commission of the European Union.

The International Commission on Non Ionizing Radiation Protection (ICNIRP) and, previously, the International Non-Ionizing Radiation Protection Committee (INIRC) of the International Radiation Protection Association (IRPA) developed guidelines at 0 Hz, 50/60 Hz and in the high frequency range from 100 kHz to 300 GHz in 1994, 1990, and 1988, respectively. (Subsequently reference is made to all these institutions as ICNIRP). Guidelines over the entire frequency range are currently under preparation. In August 1994 the Commission of the European Union (CEU) published an amended proposal for a council directive on the minimum safety and health requirements regarding the exposure of workers to the risks arising from physical agents. Noise, vibration, optical radiation and electro-magnetic fields and waves are covered.

The legal implications of CENELEC standards, ICNIRP guidelines and CEU directives are quite different. CENELEC as well as its member organisations, the national electrotechnical committees, are private organisations with no legal power. Nevertheless in practice many of their standards are referred to in legislation thus raising them to a legally

relevant status. Even without this, however, compliance with standards is often regarded as fulfillment of general safety requirements stipulated in legislation without detailed specification. Often ICNIRP guidelines are regarded as being particularly safe as the limit values are developed purely on health aspects without considering their economic impact. In contrast, directives of the CEU do carry legal power within the EU member states. Therefore the decision process in the Commission is of utmost interest for European countries.

This paper compares CENELEC's ENV limits with those limits given by ICNIRP and the CEU Directive proposal as well as by ANSI/IEEE and FCC being aware that such a comparison can only be approximate because of differing definitions. Furthermore, the forthcoming CENELEC activities including the work on standards for mobile telecommunication equipment which was mandated by the European Commission are briefly outlined.

MS-2-3

LIMITS FOR ELECTRIC AND MAGNETIC FIELDS: GROUNDS AND DEVELOPMENTS AT EUROPEAN COMMUNITY LEVEL. G. Gouvras. European Commission, DG V, L-2920 Luxembourg.

The presentation will be focused on the framework of health protection requirements and legal instruments at European Community level. Reference will be made to research activities initiated and funded by the European Commission, the Commission's proposal for the adoption of a directive for the protection of workers against physical agents and the mandate given to CENELEC.

MS-2-4

STANDARDS ACTIVITIES IN THE UNITED STATES. R.C. Petersen. Lucent Technologies/Bell Laboratories, Murray Hill, New Jersey 07921, USA.

The development of recommendations and standards relating to human exposure to electromagnetic energy has been an on-going activity in the United States for more than four decades. The committee that has taken the lead is the Institute of Electrical and Electronics Engineers (IEEE) Standards Coordinating Committee 28 (SCC-28), which was formerly the American National Standards Institute (ANSI) C95 Committee. (Although the IEEE sponsors SCC-28, IEEE membership is not a requirement to participate.) The open consensus process, the broad expertise of the committee members (approximately 100) and the detailed literature review process ensure that the resulting standards represent consensus of the scientific community. This talk will briefly discuss the process that led to the ANSI/IEEE C95.1-1991 standard, what is now being done to address recognized deficiencies, recommendations by other organizations, e.g., the National Council on Radiation Protection and Measurements, and harmonization with federal agencies and international organizations.

MS-2-5

NATO ACTIVITIES AS AN AID TOWARD INTERNATIONAL HARMONIZATION OF EMF STANDARDS. B.J. Klauenberg and M.R. Murphy. Radiofrequency Radiation Division, Armstrong Laboratory, Brooks Air Force Base, Texas 78232, USA.

The North Atlantic Treaty Organization (NATO) has a long history supporting scientific research and standardization guidance development for radiofrequency radiation. The NATO Military Agency for Standardization (MAS), through the General Medical Working Party, develops Standardization Agreements (STANAGs) that are necessary for achieving commonality, compatibility, interchangeability, and interoperability among the 16 member nations. The history of NATO standardization for RFR personnel protection and the interconnection with NATO scientific research programs will be discussed. The review process for the recent revision of STANAG 2345 for protection of NATO personnel will be discussed.

MS-2-6

REGULATIONS AND RECOMMENDATIONS IN SWEDEN. G. Anger. Swedish Radiation Protection Institute, S-171 16 Stockholm, Sweden.

Compulsory regulations regarding occupational exposure to radiofrequency fields have been in force in Sweden since 1987. They were issued by the National Board of Occupational Safety and Health as ASF 1987:2 "Electromagnetic Fields" and cover 3 MHz - 300 MGz. The new European pre-standard ENV 50 166-2 was adopted as Swedish standard (not compulsory) during 1995. Future revisions of ASF 1987:2 will undoubtedly be based on the European standard.

A new application of using microwaves for the purpose of drying buildings after water leakages has forced the Swedish Radiation Protection Institute to issue a specific regulation in 1995 to protect the general public in these special situations. The regulation, which is mandatory for the user of the microwave drying equipment, is based on the levels of exposure laid down in the European pre-standard.

The low-frequency part of the European pre-standard ENV 50166-1 was not accepted as a Swedish standard. However, five governmental authorities have during 1996 agreed upon a common recommendation regarding low frequency fields. The recommendation is based upon a "prudent avoidance" concept and is issued as a guide for decision-makers. The intention of the guide is to bring the EMF issue into proper perspective and to suggest methods to facilitate a comparison of different actions.

MS-2-7**HARMONIZATION OF STANDARDS THROUGH THE INTERNATIONAL EMF PROJECT.** M.H. Repacholi. World Health Organization, Geneva, Switzerland.

Over the next 5 years the International EMF Project, in conjunction with ICNIRP, and the responsible international and national agencies, will develop better health risk assessments from exposure to electromagnetic fields. This will be through literature reviews to identify gaps in knowledge, development of focused research programmes, and publications with improved assessments of EMF induced health hazards. It is expected that a consensus will develop among the Project partners on the approaches needed to deal with any health hazards. This should enable ICNIRP to draft widely acceptable international guidelines an exposure limits to EMF. This will be discussed.

MS-3 - HYPERTHERMIA

Organizers: C.K. Chou and Cafiero Franconi

Since ancient civilization, heat, applied through fire, hot sand, and hot water, were and are still used for medical applications. Diathermy, the heating of body parts by modern technology utilizing electromagnetic energy (shortwaves and microwaves) or by sonic energy (ultrasound), has been widely used in physical therapy for more than 50 years, with indigenous tissues and organs treated to ameliorate pain and to enhance function. During the last 30 years, electromagnetic and ultrasound hyperthermia for cancer therapy has been implemented worldwide at higher and more critical temperatures with superficial, deep and endocavitary neoplasms being now the targets. Recent failure of two phase III trials in the U.S.A. and insurance reimbursement problems have caused a decrease in clinical activity there. However, more recent positive phase III trials in Europe keep the hope for hyperthermia high. In Asia, hyperthermia researchers are also very active. In this Minisymposium four speakers will share their hyperthermia experiences.

MS-3-1

PRESENT AND FUTURE DEVICES FOR SIMULTANEOUS THERMORADIOTHERAPY OF SUPERFICIAL TUMORS. E.G. Moros, W.L. Straube and R.J. Myerson. Radiation Oncology Center, Mallinckrodt Institute of Radiology, Washington University School of Medicine, St. Louis, Missouri 63108, USA.

For more than twenty years it has been known that the simultaneous administration of hyperthermia and ionizing radiation results in enhanced cell killing. Nevertheless, most clinical experience up to date have been with sequential delivery schemes. Simultaneous delivery has been discouraged due to many logistical/technical problems and the lack of specific heating systems for this purpose. This

presentation will report on the devices and techniques that have been developed and that are under development at our institution to achieve both better tumor thermal coverage, and simultaneous delivery of heat and radiation in the treatment of superficial tumors. Two systems will be described, the first one is currently being used clinically in a phase I/II trial and the second is under development. The first system consists of a modified commercial multielement planar ultrasound applicator coupled to a medical linear accelerator for the simultaneous delivery of photon beam therapy and hyperthermia. This approach takes advantage of the properties of ultrasound to remove all nonuniformly perturbing parts out of the radiation beam path using a static acoustic reflector. The clinical logistics and experience with this system will be summarized. The second system is a novel design named SURLAS (Scanning Ultrasound Reflector - Linear Array System) that combines a linear ultrasound array and a scanning acoustic reflector to achieve conformal/controllable power deposition patterns while allowing simultaneous delivery of external beam therapy using a medical linear accelerator. The SURLAS will allow simultaneous administration of superficial ultrasound hyperthermia and high energy electron beam therapy (>16 MeV). The present system can only be used in combination with high energy photon beams. A dual-array, dual-frequency prototype, named the DAS (Dual Array System), that evolved from the SURLAS is also being developed. Because the DAS operates at two different frequencies simultaneously, it is capable of on-line penetration depth control. The advantages of this new system with respect to the present clinical system, such as power conformability and penetration depth control, will be discussed in light of experimental results and numerical simulations. Supported by NIH grants R29-CA63121 and R01-CA71638, and a grant from the Whitaker Foundation.

MS-3-2

INTERSTITIAL HYPERTHERMIA TREATMENT PLANNING THAT TAKES THE LARGE BLOOD VESSELS INTO CONSIDERATION. G.M.J. Van Leeuwen, A.N.T.J. Kotte, J. De Bree, H. Crezee, J.F. Van der Koijk, B.W. Raaijmakers and J.J.W. Lagendijk. Radiotherapy Department, Utrecht University Hospital, 3584 CX Utrecht, The Netherlands.

In cooperation with the Daniel Den Hoed Kliniek in Rotterdam we have developed a 27 MHz multi-segment, multi-electrode interstitial hyperthermia system. For the calculation of the temperatures knowledge about the large blood vessels is important. Therefore, the blood vessels are, before implantation, imaged using Magnetic Resonance Angiography. A planning system has been developed which allows the user to simultaneously view the imaged vasculature, the anatomy with the identified tumour and the intended implant. By choosing apparently safe needle positions the risk of bleeding, highly dangerous in the case of brain implants, can be reduced. For the prediction of the temperature distribution during treatment we have developed

a model for the calculation of the absorbed power distribution and a thermal model.

Our thermal model is capable of calculating the thermal effects of individual blood vessels. In the model these vessels are described as geometrical objects, independent of the resolution used for the temperature simulation. In practice however, we will at best be able to construct geometrical descriptions of blood vessels with diameters of at least 0.5 mm from the MRA data sets. Therefore the thermal effects of the 'small' vessels must be accounted for in an alternative way. We are using the thermal model, together with a tool that generates detailed artificial vasculatures, to develop the best strategy for doing this. Candidates for this strategy are a local heat-sink, an increased thermal conductivity coefficient and a continuation of the vasculature with a typical arrangement of smaller vessels, as well as combinations of these methods. To see the thermal effects of different classes of vessels, steady state temperature distributions calculated for heated tissue with highly detailed artificial arterial and venous networks have been compared with temperature distributions obtained for tissue with only part of the detailed networks present. It was found that even for low perfusion values very elaborate arterial networks are necessary for the blood to reach thermal equilibrium within the discrete vasculature. Recently the option of a local heat-sink was implemented: in user-specified volumes at the end of each terminal artery the amount of heat is withdrawn that is necessary to bring the blood at the local tissue temperature.

With this line of research and the development of tools for reconstruction of blood vessels from MRA data in progress, evaluation of our hyperthermia treatment system has been going on using simple large vessel configurations, as well as fairly elaborate artificial vessel networks providing either homogeneous or heterogeneous perfusion in the modelled tissue region. The simulations have demonstrated the benefits of longitudinal power steering as is possible using multi segment electrodes.

The experimental verification of the thermal model is being carried out using isolated bovine tongues that are perfused using an open circuit with roller pump and heated with our interstitial heating system. Measured temperature profiles in one plane of the tongue are compared with temperatures calculated with our thermal model.

This research was supported by the Dutch Cancer Society.

MS-3-3

CHALLENGES IN HYPERTHERMIC BIOLOGY *IN VIVO* AND *IN VITRO*. A. Laszlo. Section of Cancer Biology, Mallinckrodt Institute of Radiology, Washington University School of Medicine, St. Louis, Missouri 63130, USA.

There has been an renewed interest in using hyperthermia for the treatment of cancer and other diseases, either by itself, or in combination with radio- and chemotherapy. The purpose of this talk is to review issues in the *in vivo* and *in vitro* biology of hyperthermia.

Exposure of cells growing in culture to elevated temperatures leads to clonogenic cell death, in a temperature/time dependent manner. Although the exact details of the mechanisms involved are still being worked out, it appears that an exposure to elevated temperatures triggers signal transduction events at the plasma membrane, which in concert with heat-induced perturbation of cellular proteinaceous structures, leads to the alteration of nuclear processes. This in turn leads to cell death. Although apoptosis can be induced by hyperthermia in certain cell types, it is not the predominant mode of cell death after hyperthermia. Recent work has indicated that hyperthermia may induce a novel mode of cell death, which is different from both necrosis and apoptosis. Several factors affect the degree of heat induced cell killing, including the cell cycle phase, nutritional status and pH. Cells in S phase, which are resistant to ionizing radiation, are more sensitive to heat than other phases of the cell cycle. This fact, combined with the observation that hypoxic cells are not protected from heat induced cell killing, is the foundation of the biological rationale for using hyperthermia in the clinic. Exposure to elevated temperatures also sensitizes cells to ionizing radiation and certain chemotherapeutic agents in a synergistic manner. The effect is maximal when the exposure is simultaneous, thus offering a challenge in the design of clinical heat delivery systems to take advantage of these effects. When cells are exposed to a brief hyperthermic treatment and are allowed to recover before a further heat challenge, they develop thermotolerance, which is the ability to survive otherwise lethal heat treatments. This phenomenon appears to involve a specific set of proteins, called the heat shock proteins. Understanding the mechanisms by which human cells in culture are more resistant to hyperthermia than their rodent counterparts remains an important challenge.

The challenge of hyperthermia biology *in vivo* has been to apply the insights obtained from the *in vitro* studies. Although the cellular effects of hyperthermia in tissues are similar to those found in cells in culture, there are also significant physiological effects. Thus, hyperthermia leads to the impairment of several physiological functions in a time/temperature dependent manner. Of these, the most important is blood flow and possibly increased oxygenation, which could play a role in radiosensitization. The phenomenon of thermotolerance and intrinsic heat resistance with respect to these endpoints has been demonstrated in model tumor systems of both rodent and human origin. Understanding the mechanisms involved, their relevance to the situation in the clinic, as well as the design and implementation of predictive assays is the major challenge in increasing the efficacy of this treatment modality.

PRESENT AND FUTURE OF THE APPLICATION OF COMBINED HYPERTHERMIA AND CHEMOTHERAPY.

R.D. Issels. GSF-Institut für Klinische Hamatologie, D-81377 München, Germany and Medizinische Klinik III, Klinikum Großhadern, D-81377 München, Germany.

INTRODUCTION: Major approaches to enhance the therapeutic effectiveness of chemotherapy in locally advanced or metastatic disease include:

(a) the application of alternated cycles of multidrug combined regimens, (b) increasing the conventional dose and dose intensity by the use of growth factors (e.g. G-CSF, GM-CSF) and (c) the use of high-dose chemotherapy followed by transplantation of autologous bone marrow or by transplantation of peripheral blood progenitor cells separated from the individual patient before starting ablative chemotherapy.

Another approach to synergistically enhance the efficacy of chemotherapeutic agents is their simultaneous clinical application with hyperthermia (thermochemotherapy). Beside direct cytotoxicity ($>42.5^{\circ}\text{C}$), hyperthermia causes thermal enhancement even at moderate temperatures (range of 40°C - 44°C), which leads to an increased kill of tumor cells by chemotherapeutic agents if one compares their effect at 37°C alone. More recently, heat induced surface expression of the 72 kD heat shock protein (HSP72) has been found in human tumors but not in normal cells. CD3 negative large granular human lymphocytes (natural killer = nk cells) can recognize the HSP72 expression.

Rational and different approaches for thermochemotherapy

- Systemic Chemotherapy combined with Whole Body Hyperthermia (WBH) for metastatic disease
 - Isolated Hyperthermia Perfusion (IHP) for regional advanced disease of extremities (e.g. melanoma, soft tissue sarcoma)
 - Systemic Chemotherapy combined with Regional Hyperthermia (RHT) for local advanced tumors at different sites (e.g. pelvic, abdomen, extremities)
- a) Systemic Thermochemotherapy (WBH)

As most cancers refractory to conventional therapy are systemic diseases, the proposal that whole body hyperthermia (WBH) in combination with systemic chemotherapy be used to treat metastatic disease is an inherently attractive approach. Several different physical techniques have been utilized for the induction of WBH. The temperature distributions that develop during WBH are presumably more uniform than those that can be achieved with locoregional heating, although they are limited to the maximum of 41.8°C - 42°C . A recent up-date of phase I/II studies on WBH combined with systemic chemotherapy will be given.

b) Isolated Hyperthermic Perfusion (IHP)

Administration of cytotoxic drugs by moderate hyperthermic perfusion is currently used predominantly for the treatment of malignant melanoma but also for soft tissue sarcoma of the limbs. The particular technique of isolated hyperthermic limb perfusion using an extracorporeal circuit allows high doses of a selected drug to be delivered to a precise region.

The rationale, the clinical trials at several institutions and their results for different stages of disease, will be shortly reviewed.

c) Regional Hyperthermia Combined with Systemic Chemotherapy (RHT)

Regional hyperthermia (RHT), by the clinical use of all annular phased array system for deep-seated malignancy, has more extensively been studied in the last years. The annular array (AA) consists of eight pairs of radiating horn-type resonant cavities in an octagonal geometry with apertures surrounding the patient's abdomen and pelvis (Sigma-60 AA) in a similar manner to that used for computed tomographic scanning. As a result of the clinical studies, temperatures in the therapeutic range near 42°C have in general been achieved in deep seated tumors. However, nonuniformity of temperature distributions with large temperature gradients have been found as a general heating characteristic of deep-seated sites, this being most likely dependent on variation in local blood flow during heating.

The most important aspect of this form of thermochemotherapy is the advantage of applying full-dose systemic standard chemotherapy at the same time as the tumor temperature is elevated.

Results of phase II studies as well as the protocols of ongoing phase III trials will be presented.

CONCLUSION: There is substantial evidence from preclinical and clinical data that efficacy of chemotherapy can be enhanced by the simultaneous application of hyperthermia. In the application of thermochemotherapy one may use, for example, systemic heating (WBH), isolated hyperthermic perfusion (IHP), or regional heating (RHT) of the tumor-bearing area of the body, as shown in solid tumors. The choice of heating technique is strongly dependent upon the specific characteristics of the tumor to be treated. The selection of chemotherapy should be based upon preclinical data showing thermal enhancement of its antiproliferative activity under heating conditions. The dose and dose intensity of chemotherapy in clinical heating protocols should be comparable to standard regimens of medical oncology. The application of thermochemotherapy is now being tested in ongoing prospective clinical trials in regard to its impact on local control and survival.

MS-4 - MOLECULAR ELECTRONICS & BIOCOMPUTING

Organizers: Felix Hong and Alessandro Chiabrera

This session deals with an emerging field for which bioelectrochemistry plays an important role. Research in molecular electronics and biocomputing aims at the development of future devices with components laid out at the nanometer spatial scale where conventional microelectronic devices may not function properly. This is the spatial range where intermolecular interactions, such as hydrogen bonding, hydrophobic, van der Waals and electrostatic interactions, give rise to a rich repertoire of biochemical reactions. Hong's introductory talk highlights the difference between a conventional digital computer and the human brain. In

discussing the mixed digital and analog information processing, he pointed out the importance of electrostatic interactions as a prevalent mechanism for molecular switching of reaction pathways as well as for dynamic network control. Examples both from natural systems and prototype devices are given. Engbersen's talk on CHEMFET (chemically modified field effect transistors) demonstrates how a combination of electrochemical principles and ingenious molecular designs led to prototype devices that take advantage of chemical specificity of molecules in ion sensing. Chiabrera's talk exploits a particular aspect of short range molecular interactions - the effect of external electric fields on a molecular dipole array. The nonlinearity inherent in this type of interaction forms a paradigm for single molecular elementary processors and memory designs. De Rossi's talk on molecular sensing and actuation systems highlights some of the more promising features of molecular sensors and actuators. Electronic and ionic macromolecular conductors now offer much broader uses in these applications. Aizawa's talk on biomolecular and cellular networks addresses the problem of molecular interfacing of protein-based devices. The essence is designs of electrochemical reactions that facilitate transfer of information from a sensing molecule to a conventional electrode. He also talks about cellular engineering in which neuronal growth in culture is guided by various methods including an electrical one. Time permitting, Aizawa also plans to summarize Japan's Bioelectronic Project, which involved cooperation of academia, government and industry and which was funded by the Ministry of International Trade and Industry from 1985 through 1995.

MS-4-1

ROLE OF ELECTROCHEMISTRY IN MOLECULAR ELECTRONICS AND BIOCOMPUTING. F.T. Hong. Physiology Department, Wayne State University, Detroit, Michigan 48201, USA.

One of the key factors in the advance of microcomputer technology is the miniaturization of the hardware components. Yet some scientists and engineers have predicted that miniaturization will eventually reach a limit where the quantum size effect and the thermal effect will make the operation of a digital computer unreliable. In contrast, the human brain is constructed from nanometer scale components and relies on a myriad of biochemical reactions which require nanometer scale proximity of biochemical components.

A conventional digital computer is strong on number crunching yet weak on higher cognitive functions, as compared to the human brain. The most important difference is the implementation of a mixed digital and analog mode of computation in the brain. This presentation examines the performance of a bioorganism from the point of view of the control laws that link the input to the output of a specific computational step. A digital computer utilizes strictly deterministic control laws by exploiting the physical properties of individual components but not the chemical

properties. The brain utilizes control laws that exhibit weak determinism; it is not completely random but not completely deterministic. In proceedings from the level of intracellular biochemical reactions, to mesoscopic processes at the membrane level, and then to signal transmission and processing at the neural network level, the control laws cover a wide range of the "gray scale" of determinism: from random collision of biochemical intermediates in the solution phase, to ion channel "fluctuations", to bistate (digital) switching of nerve impulses (action potentials). The sequence of information processing is neither completely "unstructured" nor completely "hard-wired." What make these dynamic structures and dynamic control laws possible are short-range intermolecular forces including electrostatic interactions. For example, electrostatic interactions are important in the salt-bridge formation for the maintenance of a stable protein conformation. A key biochemical switching process, phosphorylation/dephosphorylation, partly involves an electrostatic mechanism. A key enzyme in biochemical pathway switching, protein kinase C, requires an electrostatic mechanism for its activation. Electrostatic interactions are also important in the maintenance of quasi-network structure in mitochondria and in photosynthetic reaction centers. Such interactions allow for dynamic allocation of resources and are made possible by membrane fluidity. It is possible that visual phototransduction utilizes a field-effect-transistor(FET)-like switching mechanism for the well known amplification process.

While a purely digital system is readily designed by a "top down" approach, Nature, "designed" the human brain via a long and dynamic process of evolution, characterized by a "bottom-up" approach. While studies of the systems performance of the human brain inspired a number of "fancy" designs, the molecular implementation (molecular electronics) is extremely difficult because of the "top-down" nature of the prescribed design. The "bottleneck" of research and development in molecular electronics is still the fabrication step instead of the design step. In overcoming many technical difficulties, investigators often developed ingenious techniques of immobilizing biochemical components on a solid substrate. We hope this practice is only a tentative measure because it inadvertently eliminates the possibility of maintaining a dynamic structure which is essential for an "intelligent" machine to function. The practice also eliminates the intrusion of occasional and subtle "errors" inherent in analog processing that may be a source of ingenuity and creativity of the human brain.

MS-4-2

CHEMICALLY MODIFIED FIELD EFFECT TRANSISTORS FOR SELECTIVE ION DETECTION. J.F.J. Engbersen. MESA Research Institute, University of Twente, 7500 AE Enschede, The Netherlands.

During the last decade there has become a growing need for miniaturized sensors for (on-line) detection of low concentrations of ions in aqueous media. These sensors can be applied in water quality monitoring, biomedical analysis,

biomonitoring and can provide direct information for localisation of environmental pollution. The chemical sensor system must then replace current methods of discontinuous sampling, followed by analysis in the laboratory. The innovative technology in semiconductor materials, micro-engineering, sensor and molecular engineering shows great promise for the fabrication of microsensors by IC technology. Solid state pH-sensors based on ion-sensitive field effect transistors (ISFETs) are already commercially available and it is expected that these soon will be followed by chemically modified field effect transistors (CHEMFETs) capable to detect activities of other ionic species in solution. Important advantages of these devices are their small size (typically, 1.2 x 3 mm), very fast response time, robustness and their low output impedance which makes special shielding of wiring not necessary. Moreover, these microsensors can be produced in large quantities at potential low costs.

An ISFET measures the electrical field perpendicular to the gate oxide of the semiconductor. In contact with an aqueous solution, ionisation of hydroxyl groups present on the gate oxide surface develops a surface potential which directly influences this electrical field and makes the device responding to changes in pH of the contacting solution. Application of the field effect transition principle for detection of other ionic species than protons, requires the deposition of an ion-selective membrane on top of the gate oxide of the ISFET. The response to the activity of analyte ions in solution is then caused by the development of a membrane potential above the gate. Problems of pH and carbon dioxide interference which decrease the selectivity and stability of the sensor have been solved by placing a buffered hydrogel layer in between the gate oxide and the sensing membrane. The hydrogel layer keeps the dissociation of the surface hydroxyl groups at the gate oxide constant and thus the surface potential constant. Requirements which have to be put to the ion-sensitive polymeric membranes are that they have sufficiently elastomeric properties and electrical conductance. The selectivity for a specific ion is introduced by incorporation of ion-selective receptor molecules into the membrane. The architecture of these chemically modified field effect transistors will be discussed. Much research has been done in recent years to improve the ion selectivity and the lifetime of these sensors by design of novel ion and development of new membrane materials. Recent progress in the development of CHEMFETs for the selective detection of Na^+ , K^+ , Cs^+ , Ca^{2+} , heavy metal ions, NO_2^- , NO_3^- , F^- , and phosphate will be presented during the lecture.

MS-4-3

ELECTRIC CONTROL OF MOLECULAR DIPOLES: A PARADIGM FOR INFORMATION PROCESSING.

A. Chiabrera¹, S. Cincotti², M. Parodi¹ and M. Storace¹.
¹Department of Biophysical and Electronic Engineering, University of Genoa, 16145 Genoa, Italy. ²Department of Electrical and Electronic Engineering, University of Cagliari, 09123 Cagliari, Italy.

The biological paradigms contributed by cognitive and neurobiological sciences and the physical limits of electronic circuit integration and of information processing define a general framework for any engineering attempt at the emulation of the intelligent performance of the human brain. The emerging picture suggests that intelligent information processing should occur at the molecular level and should use, as single elementary processors, molecules characterized by short-range interactions among close neighboring molecular processors. As an intrinsic character, a molecular array is the physical realization of a cellular automaton and offers the possibility of parallel-processing information at an atomic scale of integration, beyond the anticipated physical limits on circuit integration and on computation. Amphiphilic films obtained in a Langmuir-Blodgett trough and transferred onto a solid hydrophobic substrate are chosen as plausible artificial paradigms, which implement the previous concepts (see fig.). A 2-D periodic array of molecular dipoles contacted by suitable electrodes is shown to offer two paramount properties necessary for intelligent processing of information, i.e., non-linearity and memory. A model of the dipolar head interactions on the film plane is formulated and studied. The orientation angle of each dipole component tangential to the film surface is the physical state variable that carries the information parallel - processed by the molecular assembly. The spontaneous patterns of the dipoles at thermodynamic equilibrium are obtained. In the presence of an exogenous field, the dipole lattice shows a nonlinear behavior based on hysteretic phenomena. Input, output and control electrodes are introduced to explore the possibility of transforming the 2-D dipole array into an elementary molecular processor. The external characterizations of two- and three-port molecular circuits are obtained. The two-port characteristic (one input / one output) is a sigmoid with hysteresis. The three-port characteristic (two inputs / one output) emulates an *Exclusive NOR*. These results are propaedeutic to any further attempt to analyze more complex molecular circuits, as they prove the intrinsic capability of simple molecular cellular arrays to process information, opening a new vista for information technologies.

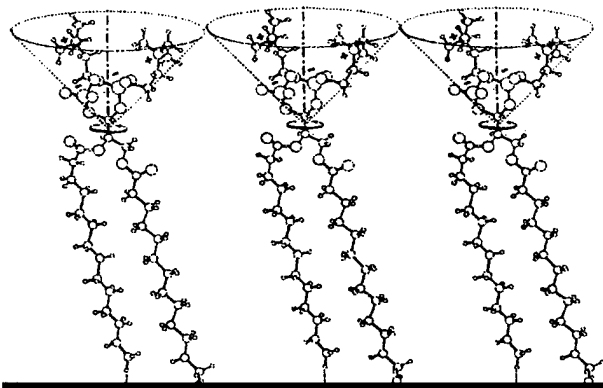

MS-4-4

MOLECULAR SYSTEMS FOR SENSING AND ACTUATION. D. De Rossi. Centro "E. Piaggio", Faculty of Engineering, University of Pisa, 56126 Pisa, Italy.

Organic materials can be used to create new sensors and actuators capable of measuring physical, chemical, and biological parameters, and of generating controllable forces and displacements.

These novel transduction systems, which arise from research into the intrinsic energy conversion characteristics of molecular aggregates and from development in molecular electronics, possess specific capabilities that may improve upon those of conventional materials.

Electronic and ionic macromolecular conductors now offer much broader uses in transducers as active elements and are the subjects of intense investigations in several laboratories worldwide. The field discussed here is vast and varied. This talk seeks to highlight some of the most promising features and to point out the future prospects for molecular engineering for artificial senses and music-like actuators.

The quest for sensors capable of detecting and monitoring a large variety of chemical and biochemical species has brought about the need for highly selective and sensitive organic layers, with tailored chemical and biological detection properties that can be incorporated into electrochemical, microelectronic, or optical devices.

On the other hand, the parallel endeavor aimed at the conception and implementation of devices mimicking the human senses requires only that the system has a global, albeit imprecise, perception of its environment. These systems have been much less investigated in the past, but they promise great advances in the near future.

MS-4-5

BIOMOLECULAR AND CELLULAR NETWORKS FOR BIOELECTRONIC DEVICES. M. Aizawa. Department of Bioengineering, Tokyo Institute of Technology Nagatsuta, Midori-ku, Yokohama 226, Japan.

Protein-based bioelectronic devices have gained a keen interest due to their characteristic molecular functions. Fabrication technology of protein-based bioelectronic devices has, however, not been sufficiently developed. In our

laboratory, several functional proteins have been modified chemically or genetically to make them possible to be self-assembled on the electrode surfaces.

Glucose oxidase, which is a typical electronic protein specifically for biosensing device, was modified chemically with an electron mediator, ferrocene, and a thiol compound. An electron hopping pathway of ferrocene was constructed within a glucose oxidase molecule. The glucose oxidase was also tagged by a thiol group, which had a strong affinity to gold. The chemically modified glucose oxidase was successfully self-assembled on the gold electrode surface to form a monolayer and demonstrated an efficient electron transfer from the redox center of the enzyme to the electrode.

Protein A, which is a binding protein specific for the Fc part of immunoglobulin (IgG), antibody, was genetically tagged by glutathione. Glutathione-tagged Protein A was self-assembled on the gold electrode surface to form a protein array. Anti-IgM antibody molecules were self-assembled on the surface of the Protein A array, which was followed by self-assembly of IgM. Each layer of the protein assemblies was molecularly imaged by AFM (atomic force microscopy).

Cellular bioelectronic devices have also attracted researchers to develop novel bioelectronic devices for information processing. Among various animal cells, neurons should be most attractive. Neurons were cultured on the various solid matrices surfaces to form artificially designed neuron networks. Two different methods were applied to guide the direction of neurite outgrowth. Two dimensional neuron networks have successfully been fabricated on the matrix surface as designed.

MS-5 - BIOLOGICAL SIGNAL TRANSDUCTION

Organizers: Jesse Siskin and Mats-Olof Mattsson

Eukaryotic cells have evolved a multitude of mechanisms that allow a great diversity of reception and subsequent intracellular processing of external signals. Typically, a signal will affect an ion channel, or a molecule that via enzymatic activity directly or indirectly changes the properties of preexisting macromolecules. Effects are thus often acute and transient after stimulation, but can also give rise to more long-lasting events by induction or repression of gene expression. A number of studies within the field of bioelectromagnetics research have focused on events that may occur early on after onset of magnetic field exposure. Such studies include monitoring of ion fluxes and production of second messenger molecules. In the present symposium, studies are presented that try to determine whether ELF electromagnetic field exposure of mammalian cells can affect intercellular signaling (gap-junction communication), Ca^{2+} -homeostasis, second messenger associated systems, and protein phosphorylation. Data to be presented show systems and parameters that do not respond to the employed exposure, but also indicate distinct exposure related effects. Furthermore, certain of these effects are dependent on frequency and flux density of the exposure. A critical analysis and discussion of these and other studies may well open new avenues of research, where precisely designed experiments

can lead to a deeper understanding of the potential interactions between magnetic fields and biological processes.

MS-5-1

EARLY MOLECULAR EVENTS IN THE HUMAN T-LYMPHOBLASTOID CELL LINE JURKAT AFTER ELF MAGNETIC FIELD EXPOSURE. M.O. Mattsson¹, K. Hansson Mild², E. Lindström¹, U. Valtersson¹, M. Still¹ and E. Lundgren³. ¹Department of Cellular and Developmental Biology, Umeå University, S-901 87 Umeå, Sweden. ²National Institute for Working Life, Umeå, Sweden. ³Department of Applied Cell and Molecular Biology, Umeå University, Umeå, Sweden.

Several lines of investigation of *in vitro* systems have shown effects of weak extremely low frequency (ELF) magnetic fields (MF) on cellular functions. However, there is yet no known singular biologic mechanism(s) that can explain effects on e.g. DNA and RNA synthesis, ion fluxes, signal transduction events, enzyme activity, cell growth rate etc. It has furthermore been argued that the employed field strengths are too low to overcome the thermal noise in the system. We have during the last years reported on experiments that show various kinds of responses in the human lymphoblastoid cell line Jurkat after exposure to ELF fields (25-100 Hz) at variable flux densities (0.05-0.20 mT). The noted effects have been rapid fluctuations in intracellular Ca²⁺, production of the second messenger inositol-tris-phosphate (IP₃), expression of luciferase reporter gene constructs with Ca²⁺-dependent promoters/enhancers, and on activity of the enzyme ornithine decarboxylase (ODC). Taken together, the data obtained from this cell line suggest that more than one initial interaction between the applied MF and the cell may well be at hand.

Supported by grants from Work Environment Fund, National Radiation Protection Board, and ELFORSK AB.

MS-5-2

GAP JUNCTION MEDIATED CALCIUM SIGNALING DURING EXPOSURE TO MAGNETIC FIELDS. R.B. Stagg, L.J. Kinne, S. Engström, R.A. Jones and W.R. Adey. J.L. Pettis Memorial Veterans Medical Center, Loma Linda, California 92357, USA.

The presence in living tissues of functional gap junctions is believed to have importance for the regulation of cell homeostasis. It has been hypothesized that growth regulating molecules could move freely within interconnected cell ensembles maintaining growth under tight constraints. Disruption of gap junctions leading to the loss of intercellular communication is thought to be a the significant step in the escape from controlled growth observed during neoplastic development. Past studies have implicated (Adey, 1990) and demonstrated (Ubeda *et al*, 1995) the gap junction channel as a site affected by electromagnetic field (EMF) exposure. These studies that have used dye transfer to determine presence or absence of gap junction channels but have failed

to determine the physiological status of the channels. Direct observation of a biological signal transferred from cell to cell via gap junctions would provide good experimental evidence for the functional status of the gap junction.

OBJECTIVES: We have developed an assay to determine functional status using calcium intercellular signaling via gap junctions. These studies are designed to use a biologic second messenger signal for testing gap junction permeability in cells exposed to magnetic fields.

METHODS: We have used digital image analysis of fluo-3 fluorescence to characterize the calcium wave response in Chinese hamster ovary (CHO) and fetal rat lung (FRL) cells microinjected with inositol triphosphate (IP₃). Exposed or sham exposed cells were grown on 25 mm round glass cover slips, loaded with fluo-3 (10 μM) and maintained at 37°C with 5% CO₂ for the duration of the experiment. Exposures were to vertical 100 μT_{rms}, 1 and 60 Hz sinusoidal magnetic fields (MF) generated by a 14 cm diameter circular coil mounted on a Plexiglas microscope stage. Exposures began 10 minutes prior to data collection and continued for the duration of the experiment.

RESULTS: Intercellular calcium waves generated by microinjection of IP₃ into a single cell were observed as increases in cytoplasmic calcium that propagate outward to adjacent cells. Propagation speeds in these 20-30 μm cells was approximately 1 cell/sec., with 80-100 cells per field at 40x magnification. Heptanol treatment of cells inhibited the intercellular calcium wave demonstrating the gap junction was the site of intercellular signal transfer. Calcium wave velocity was determined from distance vs time plots produced from images collected at specific time intervals. Calcium waves propagation in CHO cells has a mean propagation rates of 19.4 ± 1.3 μm/sec (n = 18). Calcium waves propagation in FRL cells exposed to a 1 Hz, 100 μT_{rms} MF was not significantly different (p = 0.19) from sham exposed cells. The mean propagation rates ± SEs were 21.9 ± 0.6 μm/sec (n = 24) and 21.9 ± 0.7 μm/sec (n = 24) for exposed and sham exposed cells, respectively. Similar cultures of cells exposed to a 60 Hz, 100 μT_{rms} MF have a velocity of 21.0 ± 0.6 μm/sec (n = 10) vs sham exposed cells which propagate at 21.4 ± 1.0 μm/sec (n = 10).

DISCUSSION: Calcium waves provides a biologically significant measure of functional gap junction communication. Normal cells, cultured under standard conditions and demonstrating normal gap junction communication do not demonstrate sensitivity to the MFs used in these studies. Past studies have seen MF-induced disruption of gap junction communication under conditions where normal regulation is altered. Studies to look at MF effects under phorbol ester stressed conditions will be discussed.

This research is sponsored by the Department of Veterans Affairs and the Department of Energy, Office of Utility Technologies, Contract No. DE-AI01-95EE34020.

MS-5-3

TYROSINE KINASE AND PHOSPHOLIPASE C-DEPENDENT INTRACELLULAR Ca^{2+} TRANSIENT IS INDUCED BY 50 Hz ELECTROMAGNETIC FIELD IN FIBROBLASTS. J. Bomans¹, C. Lambert¹, P. Scarpa², B.V. Nusgens¹, W. Legros² and C.M. Lapière¹. ¹Laboratory of Connective Tissues Biology, Tour de Pathologie B23, ²Department of Applied Electricity, Institute Montefiore B28, University of Liège, B-4000 Sart Tilman, Belgium.

The biological effects of electromagnetic fields (EMF) are controversial and their target(s) largely unknown making difficult the interpretation of the epidemiological studies. Modulation of the Ca^{2+} ions has been described as a potential target of EMF in a few established cell lines. We analyzed the effects of EMF on intracellular Ca^{2+} by real-time, single cells LASER confocal microscopy in human and animal skin fibroblasts (F) loaded with the Ca^{2+} -sensitive fluorophore Fluo3-AM.

Subconfluent monolayer of F were exposed to symmetrical, sinusoidal EMF of 50 Hz generated by a coil (30 spires, diameter 8 cm) placed on the stage of the microscope providing a homogeneous EMF perpendicular to the cell layer and controlled conditions of duration and intensity (in the range of 110 to 900 μ T). The temperature of the culture medium was recorded by a thermocouple. In our experimental conditions, the warming up was less than 0.1°C at the maximum intensity. The level of vibrations measured with a piezoelectric based accelerometer type 4381 placed on the microscope stage was similar with and without exposure to EMF. A microscope field taken at random in the culture dish was observed with the 60x objective and the fluorescence reflecting the intracellular concentration of calcium ions [Ca^{2+}]_i was measured in each individual F during a 250 sec exposure with data acquisition every 5 sec. A significant proportion of the EMF-exposed F showed an increased intracellular [Ca^{2+}]_i lasting for 30-60 seconds before returning to the baseline and waving from the cytoplasm towards the nucleus. The proportion of cells responding to ELF increased proportionally from 11% at 110 μ T up to a maximum of 72% at 450 μ T and leveled off at 900 μ T. A pulse of 25 sec induced a signal similar to a permanent exposure and the response was similar at 22°, 28° or 37°C. Mitomycin-growth arrested cells responded in a similar proportion indicating that the [Ca^{2+}]_i transient did not depend on the stage of the cell cycle. The integrity and viability of the cells were assessed by histoautoradiography using ³H-thymidine uptake, mitochondrial activity by MTT measurements and their capacity to respond to bradykinin by a synchronous peak of fluorescence returning to the baseline within 20-30 sec in 100% of the cells. The addition of EGTA for 5 min in the extracellular medium, of lanthanum chloride or mibefradil suppressed the EMF-induced [Ca^{2+}]_i transient while nifedipin was not inhibitory suggesting that plasma membrane Ca^{2+} channels of the T-type were, at least in part, involved in the process. The internal calcium stores also participated in [Ca^{2+}]_i increase since BAPTA or thapsigargin, an inhibitor of endoplasmic reticulum ATPase-dependent Ca^{2+} pump, suppressed it. F deprived of serum or supplemented with

heated serum or plasma lost their capacity to respond to EMF suggesting that heat labile components of serum and the occupancy of their receptors participated to the process. This was further supported by the suppression of the EMF induced [Ca^{2+}]_i by inhibitors of tyrosine kinases (TK), with a broad spectrum activity as genistein and herbimycin A or specific to TK-receptors as tyrphostin 23. PLC γ , known to be activated and phosphorylated by TK, also participated to the EMF signaling since the [Ca^{2+}]_i was inhibited by D609 or Neomycin.

These data indicate that EMF are able to induce an intracellular signaling by Ca^{2+} in fibroblasts made permissive by activation of (a) receptor(s)-mediated TK activity.

MS-5-4

SIGNALING INDUCED BY CROSS-LINKING OF SURFACE IgM IN B CELL LYMPHOMA CELL LINES: A MODEL SYSTEM FOR EVALUATING EMF EXPOSURE METRICS AND BIOLOGICAL SIGNIFICANCE. S.C. Miller, I. Kazakova and M. Furniss. Signal Transduction Laboratory, Pharmaceutical Discovery Division, SRI International, Menlo Park, California 94025, USA.

Studies by Luben's and Uckun's laboratories suggest that cell surface protein tyrosine kinases (PTKs) may be important in the response to 100 μ T 60 Hz electromagnetic field (EMF) exposure. Therefore, as a first step toward a replication effort we have independently developed a model system to evaluate the most biologically potent aspect of EMF exposure.

OBJECTIVE: We have validated an experimental methodology using Western blotting and chemiluminescence detection to demonstrate repeatable and robust effects induced by the cross-linking of surface IgM (sIgM). This well understood signal activates PTK dependent signaling pathways regulating B cell growth and apoptosis. Our objectives are to 1) determine if there is a causal relationship between EMF exposure and robust bioeffects; 2) determine if an EMF exposure metric is important; and 3) identify the biophysical mechanism(s) responsible.

METHOD: The human B cell lymphoma cell lines Daudi and Nalm6 were obtained from the American Type Culture Collection (ATCC) or Uckun laboratory, respectively. Cells were grown in RPMI-1640 media supplemented with 10% fetal calf serum (FCS), glutamine and antibiotics. Initial studies to validate the methodology were done with the Daudi cell line. Two distinct experimental designs were used to change the biological state of the cells prior to EMF exposure (60 Hz at 100 μ T for 30 min) using a computer controlled *in vitro* Magnetic Field Linear Exposure System Model 2 (LES-002, Electric Research and Management, Inc.). The system consists of two exposure chambers surrounded by magnetic coils and a third sample chamber which is not. T-25 flasks (3-6 x 10⁶ cells in 4.5 ml) were placed in defined positions resulting in three flasks in the SHAM and three flasks in the EMF chambers and two flasks in the SAMPLE chamber. A positive control flask in another incubator was treated with anti-IgM (1 μ g/ml, F(ab')₂) to induce sIgM cross-linking at

the same time the EMF exposure was initiated under double-blind experimental conditions. Flasks were removed after 30 min of exposure, immersed in an ice-bath, and moved to the laboratory for sample work-up. Cells were harvested, washed, cell pellets lysed in hot SDS sample buffer, sonicated and protein values were determined in duplicate by the BCA protein assay reagent (Pierce). Equal amounts of protein (30 µg) were fractionated on 10% SDS gels (Novex), transferred to Immobilon-P membranes, and phosphotyrosine containing proteins detected by the RC20-HRP antibody (Signal Transduction Laboratory) and chemiluminescence (Super Signal substrate, Pierce). As a final step to verify equal protein loading and transfer, blots were stained with India ink.

RESULTS: Time-course and dose-response studies with anti-IgM demonstrated significant and reproducible changes in phosphotyrosine protein profiles compared to controls. The 100 µT 60 Hz EMF had no significant effect. The focus of our ongoing work is to use this sensitive methodology to determine whether bioeffects are dependent on an EMF exposure metric quantitatively defined by intensity and frequency of the AC field and intensity and orientation of the DC field, as suggested by the published work of Blackman and colleagues.

DISCUSSION: The robust procedure described here to detect biologically significant changes in phosphotyrosine profiles of proteins provides a framework of biological signal transduction required for a replication effort using Nalm6 cells obtained from the Uckun laboratory.

This work was supported by NIH grant GM48229 and NIEHS grant ES07127 to S.C. Miller.

MS-5-5

BASELINE CALCIUM LEVELS, CALCIUM SPIKING ACTIVITY AND EXPERIMENTALLY-INDUCED CALCIUM TRANSIENTS DURING EXPOSURE TO MAGNETIC FIELDS. J.E. Sisken and R. Shahidain. Department of Microbiology and Immunology, University of Kentucky, Lexington, Kentucky 40536, USA.

Since calcium ion (Ca^{2+}) regulation is a plausible cellular target of ELF EMF, numerous investigators have examined the effects of these fields on Ca^{2+} transport, on free cytosolic calcium ion concentrations ($[\text{Ca}^{2+}]_i$) in agonist-stimulated cells or in otherwise unstimulated cells, and on biological processes which are Ca^{2+} -dependent. However, the results of such studies have not provided a consistent picture since various investigators report increases, decreases or no effects on whatever calcium-related variables were under study. In this talk I will first briefly review an extensive series of previously reported (1) and more recent experiments we have done to determine whether or not sinusoidal ELF EMF can affect either baseline $[\text{Ca}^{2+}]_i$ or calcium spiking activity in cultured ROS 17/2.8 cells. In these studies cells were exposed to a range of frequencies from 16 to 180 Hz at field strengths ranging from 3 to 717 Gauss. Induced electric fields ranged from 2.6 µV/cm to 5.12 mV/cm. Sham controls involved identical treatments of cells except that the parallel

wound coils of the system were energized with opposite polarities to yield a net zero field. Details of our exposure system and luminescence recording and calibration methods have been published (2,3). The data were analyzed with the use of probit plots. The conclusion from all of these studies is that we are still unable to detect any effects of these fields on either baseline $[\text{Ca}^{2+}]_i$ or calcium spiking behavior under any conditions so far studied.

In the second part of this paper, we propose that if ELF EMF can directly affect Ca^{2+} regulation, among the most likely and important systems affected would be those Ca^{2+} influx and efflux mechanisms that become activated when cells are exposed to various mitogenic agents. These are a) the so-called capacitative calcium entry system which is activated following mitogen-induced release of Ca^{2+} from intracellular stores and b) the extrusion mechanisms which are largely responsible for returning $[\text{Ca}^{2+}]_i$ to steady state levels following agonist-induced transient increases. These systems are readily amenable to experimental manipulation and analysis. The rationale underlying this suggestion, a brief review of the findings of previous investigators which are or are not consistent with this notion and some of our own preliminary experiments will be presented.

1. Sisken, J.E., Mullins, R.D., Shahidain, R. and Sisken, B.F., Seventeenth Annual Meeting of the Bioelectromagnetics Society, Boston, Mass. June 18-22, 1995. p. 60 (abstract).
2. Mullins, R.D., Sisken, J.E., Hejasse, H.A.N. and Sisken, B.F. *Bioelectromagnetics* 14:173-186, 1993.
3. Newcomb, T.G., Mullins, R.D., and Sisken, J.E. *Cell Calcium* 14:539-549, 1993.

Supported in part by Electric Power Research Institute (EPRI), Palo Alto, Calif. contract RP2965-20 and by contract RP3349-08 which is funded jointly by the East Kentucky Power Cooperative and EPRI.

MS-6 - EXPOSURE CONTROL IN THE LABORATORY

Organizers: Yngve Hamnerius and Martin Misakian

To be able to perform reliable and reproducible experimental laboratory studies, exposure control is a key issue. The minisymposium addresses questions such as ELF and RF *in vitro* and *in vivo* studies, background fields, AC and DC fields, coupling to the test sample, SAR-determinations.

MS-6-1

EXPOSURE PARAMETERS DURING STUDIES WITH ELF MAGNETIC AND ELECTRIC FIELDS. M. Misakian. National Institute of Standards and Technology, Gaithersburg, Maryland 20899, USA.

Following a brief introduction to terminology that describes power frequency and other extremely low frequency (ELF) magnetic and electric fields, a short survey is given of methods for simulating and characterizing in a laboratory setting fields encountered in the environment. The remainder

of the talk will focus on candidate exposure parameters that may be considered during *in vivo* and *in vitro* laboratory studies with ELF magnetic and electric fields. The possible exposure parameters for animal studies exposed to electric fields include surface electric fields and induced (internal) electric fields and currents. The candidate exposure parameters during animal and cell culture studies with magnetic fields include induced electric fields and currents, field polarization, and the alternating as well as static magnetic field. The complexities in characterizing some of the above parameters because of differences in geometry will be discussed.

This work is supported by the Department of Energy, Office of Utility Technologies, through interagency agreement DE-AI01-93CE34002.

MS-6-2

Moved to MS-10-1.

MS-6-3

COMPUTING DOSIMETRY FROM SUB-ELF TO LF FOR *IN VITRO* EXPERIMENTS. B. Bianco and A. Chiabrera. ICEmB at DIBE, University of Genoa, 16145 Genoa, Italy.

Two important aspects related to the design of *in vitro* bioelectromagnetic experiments and to their reproducibility are the microdosimetries of the exposure dishes and of the exposed cells [1,2]. The dosimetry at the dish level can be performed both experimentally and theoretically. The dosimetry at the cell level can be performed, in most practical cases, only theoretically. The following problems related to computing microdosimetry are addressed:

- 1) the electromagnetic characterization of the culture medium in the dishes, by means of the so called "mixture" theories.
- 2) the electromagnetic characterization of the cell as made of spherical multilayers which emulate the cell media.

The results prove that computing microdosimetry can be successfully accomplished. It is a valuable tool for improving the reliability quality and the reproducibility of experiments.

1) B. Bianco, A. Chiabrera, E. Moggia, T. Tommasi, Design of exposure systems for *in vitro* experiments and their quality control, Proc. COST 244 Meeting on Methods for Exposure Assessment Related to Standards and Design and Quality Control of Laboratory Experiments, European Commission, DG XIII, pp. 3 - 9, Athens, Greece, 25 - 28 March 1995.

2) A. Chiabrera, Y. Hamnerius, B. Bianco, B Bergquist, T. Kenny, Design guidelines for *in vitro* and *in vivo* exposure conditions at sub-ELF/LF and their quality control, COST 244 Position Document, European commission, DG XIII, February 1996 and 18th Annual Meeting of BEMS, Victoria B.C., Canada, June 9-14, 1996.

MS-6-4

***IN VITRO* AND *IN VIVO* DOSIMETRY OF RF AND MICROWAVE EXPOSURE.** C.C. Davis. Electrical Engineering Department, University of Maryland, College Park, Maryland 20742, USA.

The widespread use of cellular wireless communications technology, and some perceptions that the associated RF and microwave exposures may have adverse health consequences, have lead to renewed interest in studies of the biological effects of RF and microwave exposure. To make such experiments meaningful careful dosimetry is required. This is much more easily done for *in vitro* experiments than is the case for *in vivo* experiments. Generally, the exposure metric that is desired is the specific absorption rate (SAR), which allows an assessment of the thermal loading imposed by the exposure and allows a distinction to be made between experiments where thermal effects are likely to be significant and those where they are not.

I will review various methods for determining the SAR in both *in vitro* and *in vivo* exposures. The most reliable technique is based on a direct measurement of the rate of heating produced at the onset of exposure. With minimally-perturbing thermistor probes, and SAR levels on the order of 1W/kg, this is relatively straight forward for *in vitro* exposures. For a sample with specific heat C and SAR S the rate of sample heating is $(dT/dt)_h = S/C$. For small temperature elevations above ambient the rate at which a sample returns to equilibrium is determined by Newton's law of cooling, namely $(dT/dt)_c = -\alpha(T-T_{eq})$, where α is a constant that is unique to the exposure arrangement, and T_{eq} is the equilibrium temperature at when $S = 0$. The overall temperature curve obeys the differential equation

$$\frac{dT}{dt} = \frac{S}{C} - \alpha(T - T_{eq}),$$

which is readily solved to determine S [1]. Examples involving dosimetry in waveguide exposure systems at 2450 MHz, TEM cells at 835 MHz, and co-axial lines at 27 MHz will be given. For *in vivo* exposures direct measurement of the SAR is generally very difficult and indirect methods must be used. If a sophisticated model of the exposed object, for example a human head or whole animal, and the radiation source, can be developed, then by using numerical techniques for solving Maxwell's equations with the appropriate boundary conditions, it is possible to provide a realistic assessment of the exposure. To make such modelling realistic the model should have sufficient detail and its properties should match those of the real system. It is particularly important to have data on the complex dielectric properties of the tissues included in an animal model in order to obtain reliable predictions of the SAR. The validity of such theoretical modelling can be checked by experiments on simple model exposed objects.

It is easy to make errors when estimating the exposure received in an experiment. Some of the potential pitfalls include: meniscus and other geometry effects in *in vitro* exposures, inadequate spatial mapping of the exposure, and assumptions about the efficiency of cooling of the exposed sample.

References:

[1] K.H. Joyner, C.C. Davis, E.C. Elson, E.M. Czerska, and P. Czerski, *Health Physics*, 56, 303-307, 1989.

MS-7 - LEARNING AND MEMORY: EFFECTS AND MECHANISMS

Organizers: Richard Lovely and Eugene Lyskov

Exposure to electromagnetic fields has been shown to effect functions of the central nervous system including learning and memory in mammals and other vertebrates. In this symposium five speakers will present recent research findings that typify effects of EMF exposure both on animal learning generally and on spatial learning specifically. The latter studies were conducted in rodents which makes the observed findings particularly salient: spatial learning in rodents has direct correlates to learning and memory in humans. Thus, EMF exposure effects on rodent spatial learning have direct implications for EMF exposure on human learning and memory; effects on other forms of animal learning should similarly be of interest to us as they may have implications for other forms of human learning, memory and cognitive processes.

MS-7-1

MAGNETIC FIELDS AND SPATIAL LEARNING IN MICE. Z.J. Sienkiewicz, R.G. Haylock and R.D. Saunders. National Radiological Protection Board, Chilton, Didcot, Oxfordshire OX11 0RQ, United Kingdom.

INTRODUCTION: The electric fields and currents induced by exposure to power frequency electromagnetic fields could affect either the processing or storage of information in the brain and lead to observable changes in behaviour. A number of studies have reported changes in memory-related behaviours in rodents exposed to magnetic fields although the conditions under which effects can be elicited are not well defined. These experiments were conducted to determine the effect of acute exposure to 50 Hz magnetic fields on a spatial discrimination learning task in mice.

METHODS: Adult, male mice were trained over 10 days to run a radial arm maze for food. Experimental animals were exposed to a vertical, sinusoidal 50 Hz field either during each testing session or before each session. Control animals were sham-exposed. Performance was measured using maximum likelihood techniques to calculate the probability that an animal would not re-enter any given arm of the maze.

RESULTS: Brief exposure to a range of magnetic fields from 5 μ T to 5 mT during testing had no effect on learning. Exposure for 45 minutes at 0.75 mT immediately before testing resulted in a slower rate of acquisition, but animals eventually learned the task as well as controls. However, these changes were abolished by the introduction of a 45 minute interval between exposure and testing.

DISCUSSION: These results provide additional evidence to indicate that acute exposure to magnetic fields may cause

subtle changes in nervous system function. Specifically they indicate that immediate, prior exposure to an intense magnetic field (at a flux density about 10^4 higher than levels found in private houses) impairs the acquisition of a spatial foraging task by adult mice. This deficit is only transitory and exposure does not affect overall accuracy. Further studies are investigating the effects of different field strengths and durations of exposure.

Some of these studies were funded in part by the Health and Safety Executive.

MS-7-2

NON-IONIZING ELECTROMAGNETIC FIELDS AND SPATIAL LEARNING AND MEMORY FUNCTIONS.

H. Lai. Bioelectromagnetics Research Laboratory, Center for Bioengineering, University of Washington, Seattle, Washington 98195-7962, USA.

Spatial learning and memory functions in rodents have been suggested to be related to cognitive and memory functions in humans. Since much is known about the neural mechanisms of spatial learning, studies on the effects of electromagnetic field exposure on spatial learning provide a powerful mean for understanding the effects of the fields on the chemistry and functions of the central nervous system. Research in our laboratory has shown that acute exposure to microwaves or a 60-Hz magnetic field induces spatial learning and memory deficits in the rat performing in the radial-arm maze and water maze. Our results can be summarized as follows:

(1) After 45 min of exposure to pulsed 2450 MHz microwaves (2 μ sec pulses, 500 pps, 1 mW/cm², average whole body SAR 0.6 W/kg), rats showed retarded learning while performing in the radial-arm maze to obtain food rewards, indicating a deficit in spatial "working memory" function. This behavioral deficit was reversed by pretreatment before exposure with the cholinergic agonist physostigmine or the opiate antagonist naltrexone, whereas pretreatment with the peripheral opiate antagonist naloxone methiodide showed no reversal of effect. Our neurochemical and neuropharmacological research suggests that μ , δ , and κ opioid receptors in the septo-hippocampal cholinergic pathway are involved in this behavioral deficit.

(2) Exposure to a 60 Hz magnetic field (45 min, 0.75 mT) immediately before each training session in a radial-arm maze significantly retarded the learning. Pretreatment with the cholinergic agonist physostigmine before magnetic field exposure reversed its effect on spatial learning. Data from this experiment indicate that magnetic field-induced spatial 'working memory' deficit is caused by the effect of the field on cholinergic systems.

(3) Rats were trained in six sessions to locate a submerged platform in a circular water-maze. They were exposed to a 60 Hz magnetic field at 1 mT for one hour immediately before each training session. In addition, at one hour after the last training session, they were tested in a probe trial in which the platform was removed and the time spent in the quadrant in which the platform was located during the training sessions was scored. There was no significant difference between

magnetic field- and sham-exposed (control) rats in learning to locate the platform. However, swim speed of the magnetic field-exposed rats was significantly slower than that of the controls. Magnetic field-exposed animals spent significantly less time during the probe trial in the quadrant of the maze that contained the platform. Swim patterns of the magnetic field-exposed animals during the probe trial were different from those of the controls. They did not seem to search for the 'missing' platform. These results indicate that magnetic field exposure causes a deficit in spatial 'reference memory' in the rat. Rats subjected to magnetic field exposure probably used a different behavioral strategy in learning the maze.

MS-7-3

EXPOSURE TO A 50 Hz MAGNETIC FIELD IMPAIRS WORKING MEMORY AND ACQUISITION OF MOTOR SKILL IN RATS. M. Chernyshev¹, M. Duko¹, A. Koslov², M. Druzin², L. Bakanova², Z. Alexanyan¹ and E. Lyskov¹. ¹Institute of Human Brain, ²Institute for Experimental Medicine, St. Petersburg, Russia.

OBJECTIVES: Some studies indicate that memory and learning might be affected by acute exposure to ELF magnetic fields. In particular changes in spatial learning in radial-arm and water maze performance have been observed in rodents exposed to power line frequency fields. There were also indications that these effects might depend on the magnitude of DC component, suggesting some kind of ion resonance mechanisms. The present experiments were conducted to study the efficiency of the working memory and acquisition of the motor skills in rats exposed to 50 Hz magnetic fields in combinations with different static components.

METHODS: Adult, 7 months old male albino rats (average weight 180-200 g) were used. Before behavioural tests animals were exposed for 30 minutes to vertical AC/DC fields with different parameters: EI: 50 Hz, 45 μ T (rms.); DC, 65 μ T (considered as conditions for Ca⁺⁺ parametric resonance); EII: 50 Hz, 45 μ T; DC, 14-17 μ T; and EIII: 50 Hz, 2-4 μ T; DC, 14-17 μ T (background of exposure facility, considered as sham). The interval between the end of exposure and beginning of behavioural tests did not exceed 10 minutes. Behavioural tests. Y-maze. Thirteen rats were pretrained to find food pellet in particular locations in the two arm maze following visual cue - DC lamp on. The door between start compartment and the goal arm was opened either 1 second before turning the cue light off (non-delayed choice), or in 5 seconds after arming the light off (delayed choice). The average level of correct performance before exposure in non-delayed and delayed conditions was 90% and 70%, respectively. Each rat was tested twelve times (twice to three different exposure conditions as in non-delayed well as in delayed conditions). Reaching test. Forty eight rats were used in this one-trial test required the acquisition of particular motor skill - reaching food pellet from the narrow tube set in a cage wall. The following phases were measured: 1. Adaptation to a new environment (from the placing into the cage to the first taking food from a floor). 2. Active search (from the taking food from a floor to taking it from the tube

by tongue). 3. Acquisition of instrumental movement reaction (from taking food by tongue to the first attempt to use the forepaw). 4. Acquisition of specialised motor co-ordination (from the first attempt to use forepaw to the first successful reaching by forepaw). 5. Realisation of the skill (time of the 10 successful reachings). The sample was randomly divided to three equal sub-groups and each animal was tested once, after the only one kind of exposure.

RESULTS: Significantly higher error rate in Y-maze delayed performance was found after EI and EII (36% and 35.8%, respectively) in comparison with sham exposure - EIII (30.5%). The difference between effects of EI and EII exposures was not significant. No field related changes were observed in non-delayed performance. Total time of the acquisition of the reaching reflex was found comparable in all sub-groups regardless to exposure conditions. However, time of the adaptation to a new environment was found significantly shorter whereas acquisition of instrumental movement reaction and specialised motor co-ordination were longer after EI comparing with both EII and EIII exposures.

DISCUSSION: Data obtained might be considered as additional evidence that acute exposure to ELF magnetic fields may cause changes in brain processes associated with memory and learning. Specifically, they show that prior exposure to 50 Hz field impairs working memory and acquisition of motor skills. Effects observed should be discussed taking into account their close interrelations with other basic processes i.e. selective attention and emotions. Therefore, field related shortening of the adaptation to a new environment may indicate the complex influence of magnetic fields on different brain functions. These results also show that exposure to the same magnitude 50 Hz magnetic field may differently affect behaviour dependently on the DC component.

MS-7-4

A LOW FREQUENCY AND LOW INTENSITY OF MAGNETIC FIELD EXPOSURE DURING PREGNANCY AND THROUGH LACTATION LOWERS LEARNING ABILITY AND RECOGNITION MEMORY IN OFFSPRING. N. Hagino, T. Nozaki, J. Odashima and W.D. Winters. Department of Cellular and Structural Biology, The University of Texas Health Science Center at San Antonio, San Antonio, Texas 78284-7762, USA.

The experiments were designed to examine if low frequency and low intensity of magnetic field(MF) exposure during brain development has an effect on learning and recognition memory(choice accuracy in delay time) in mice.

Parental female mice and male mice were purchased from Charles River laboratory. One group was exposed to a MF and another group was not exposed to a MF and housed in the animal room (MF was less than 0.2 mG) as a control. Offspring from a MF exposed group were transferred to the animal room at 3 weeks of age. Twenty (20) offspring in a MF-exposed group and twenty (20) offspring in a control group in each experiment were transferred to the testing room

for behavior (MF was less than 0.2 mG) at 5 weeks of age. Using the T-branch one-way maze, the examination of the ability of learning was begun at 5 weeks of age and continued for 2 weeks, and the choice of accuracy in delay time (recognition memory) was begun at 7 weeks of age and continued for 2 weeks. The choice of accuracy in delay time was examined again at 25 and 60 weeks of age in offspring. Two identical MF exposure units were located in the same room with a distance of 7.5 meters (ambient MF was less than 0.2 mG). When one side of the unit was activated with a 500 mG 60Hz CP MF, a 0.7-1.0 mG 60Hz stray MF was detected at the other side of the unit. The procedures of MF exposure for parental mice were as follows;

A. Exposure of a 500 mG 60Hz CP MF: (1) Open Study - parental mice were exposed to a MF; (a) during pregnancy and through lactation; (b) during pregnancy only; and (c) during lactation only. (2) Double Blind Study - parental mice were exposed to a MF (a) during pregnancy and through lactation.

B. Exposure of a 0.7-1.0 mG 60Hz Stray MF: (1) Open Study - parental mice were exposed to a stray MF (a) during pregnancy and through lactation. (2) Double Blind Study - parental mice were exposed to a stray MF (a) during pregnancy and through lactation.

RESULT A. Exposure of a 500 mG 60Hz CP MF: It was observed in open study that when offspring were exposed to a MF during pregnancy and through lactation, offspring demonstrated low ability in learning at 5 weeks of age. Moreover, they demonstrated low choice accuracy in delay time at 7 weeks of age. Furthermore, offspring also demonstrated low choice accuracy in delay time at 25 and 60 weeks of age. The double blind study confirmed the results of open study that MF exposure during pregnancy and through lactation disturbed learning and recognition memory in offspring in mice. Moreover, when offspring were exposed to a MF during pregnancy only or during lactation only, offspring demonstrated a regular ability in learning at 5 weeks of age and regular choice accuracy in delay time at 7 weeks of age. However, they demonstrated low choice accuracy in delay time at 25 weeks of age and they also demonstrated same patterns of low choice accuracy in delay time at 60 weeks of age.

RESULT B. Exposure of a 0.7-1.0 mG 60Hz stray MF: It was observed in open study that when offspring were exposed to a stray MF during pregnancy and through lactation, offspring demonstrated regular ability in learning at 5 weeks of age and regular choice accuracy in delay time at 7 weeks of age. However, they demonstrated low choice accuracy in delay time at 25 weeks of age and they also demonstrated same patterns of low choice accuracy in delay time at 60 weeks of age. The double blind study confirmed the results of open study that the stray MF exposure during pregnancy and through lactation disturbed choice accuracy in delay time at 25 weeks of age, but not at 7 weeks of age.

Our studies provide the information that an exposure of 500 mG 60Hz CP MF during pregnancy and through lactation disturbs learning and recognition memory in offspring in young life. Moreover, an exposure of very low intensity of stray MF (0.7-1.0 mG 60Hz) during pregnancy and through

lactation or of 500mG MF during pregnancy only or lactation only does not disturb learning and recognition memory in offspring in young life. However, they demonstrate low choice accuracy in delay time at 25 weeks of age and the patterns of choice accuracy in delay time was like that of age related declining of recognition memory at 60 weeks of age, and they also demonstrate same patterns of low choice accuracy in delay time at 60 weeks of age. Moreover, the patterns of low choice accuracy in delay time are also similar to the patterns of choice accuracy in delay time in depressive mice induced by zinc sulfate. Therefore, the question remains to be answered; whether an exposure of very low intensity of stray MF causes such neurological disorder as depression or an exposure of very low intensity of stray MF accelerates aging in mice.

The study was supported partially by CRIEPI, Japan.

MS-7-5

FORMING OF MEMORY PROCESS (IMPRINTING) IN CHICKENS AFTER PRIOR EXPOSURE TO LOW LEVEL EMF. Y.G. Grigoriev and V.S. Stepanov. The State Research Centre of Russia, Institute of Biophysics, 123182 Moscow, Russia.

Earlier we showed that the imprinting is a good model for investigating neuroembryology affects of low level of various physical factors.

In that experiment 83 chicken embryos were examined. Embryos were exposed to 9 GHz microwaves for 5 minutes in 24 hours after the beginning of its incubation (a power density was 40 $\mu\text{W}/\text{cm}^2$).

The imprinting stimulus was a 10-Hz flashing light (photostimulator); the differential stimulus was 2 Hz. For the qualitative evaluation of imprinting the following criteria were used: 1) the time during which chickens were near stimuli; 2) the number of approaches and contacts with the stimuli. Double blind test procedure was used.

The changes in imprinting after exposure to EMF as well as modification of these effects by exposure to low doses of ionising radiation were observed.

Later experiments showed the possibility of fixation of EMF in embryonic brain with imprinting stimulus frequency during natal period and conservation of this information after birth.

MS-8 — ELECTRIC TRAUMA

Organizers: Raphael Lee and James Weaver

The structure and properties of biological materials can be altered by exposure to strong suprphysiological electric fields. Because of the insulting shell structure of cells, the plasma membrane experiences is the primary target of imposed fields. Both the lipid bilayer and membrane proteins can be altered by imposed transmembrane potentials that are three to four times greater than physiological potentials. The lipid bilayer can become transiently or stably permeabilized to

relatively impermeant solutes and membrane proteins can become denatured, particularly the voltage-gated ion channels. In living cells the metabolic consequences to this can further the primary damage process. In practice, large fields can be medically harmful or under controlled conditions used for medical benefit. Controlled transdermal delivery of drugs by transient skin electropermeabilization is one example of a medical application, but side effects must be understood. Severe and extensive injury to skeletal muscle and nerve tissue followed by permanent disability or death resulting from high-voltage electric shock is an example of harmful effects. This minisymposia will cover the range of medical consequences of human tissue exposure to supraphysiologic electric fields ranging from lightning injury to emerging technology in transepithelial drug delivery. Finally, promising new drug therapy to control damage will be discussed.

MS-8-1

DEVELOPMENT OF AN ANIMAL MODEL OF LIGHTNING INJURY WITH FLASHOVER UTILIZING A TABLE-TOP LIGHTNING GENERATOR.

M.A. Cooper¹ and T.P. Kotsos².
¹Department of Emergency Medicine, ²Bioengineering Program, University of Illinois, Chicago, Illinois 60612-7354, USA.

HYPOTHESIS: The rat is an appropriate animal model of lightning injury and can be used to determine the lethal level (LD₅₀) of lightning utilizing an inexpensive, table-top lightning generator.

BACKGROUND AND JUSTIFICATION: Nearly 90% of lightning victims survive the injury but often have permanent sequelae. Many clinical and pathophysiological questions of the pathway and mechanism of injury as well as treatment modalities remain unanswered. As in other injuries, a major way to study these remains the use of an animal model.

The rat was chosen because it is small, inexpensive, easy to handle, and its physiological and neuropsychological characteristics are well known. In prior experiments with rats, Ishikawa *et al.* determined the LD₅₀ to be 62.6 ± 11.9 joule/kg but purposely avoided flashover in their experiments by implanting the source electrode in the animal's scalp. We feel that determination of pathway and true LD₅₀ for lightning injury must involve flashover in order to set it apart from other electrical injuries. Therefore, the first steps in our investigations are refinement of the equipment and determination of the LD₅₀ using flashover.

This work has been approved by the University of Illinois Institutional Review Board (proposal 96-014).

DESCRIPTION OF LIGHTNING GENERATOR: The device consists of a 100-kv energy source, four capacitors of different sizes, a wave shaping circuit, and a Lexan animal platform. The voltage and current amplitudes vs. time through the animal will be measured. The delivered current wave shape T₁₀₋₉₀ = 8 μsec, the following T₅₀ = 20 μsec, ~10kA.

METHODS: General: Anesthetized rats will be secured on the animal platform. To attain flashover, shocks will be

administered from an electrode 1.5 cm from the animal's head. Flashover will be documented photographically.

LD₅₀: Shocks will be administered at 30 joule/kg increments until lethality is attained (LD_{est1}). A second animal will be shocked at the LD_{est1} to validate the estimate and determine if LD₅₀ if sequential shocks have a cumulative effect.

Shocks will be increased until a reliable estimate of the mortal dose is attained (LD_{est2, 3, 4, etc.}). Subsequently, the range of shocks will be narrowed to 10 joules/kg increments around the estimated mortal dose (LD_{estfinal} -10, LD_{estfinal}, and LD_{estfinal} +10). Three animals will be shocked at each narrowed energy level x three repetitions and the LD₅₀ calculated in the standard fashion.

PATHWAY: Necropsies will be performed on animals that expire as well as on survivors which will be sacrificed at four days post shock for evidence of current pathway.

DISCUSSION: While pioneering animal work has been done by both the Japanese and the Australians, further work needs to be done to develop a credible animal model for medical research. This paper describes a unique instrument and an initial experimental model. Future work will include investigation of specific injury patterns as well as neuropsychological injury, previously reported by us for humans.

MS-8-2

MYOCARDIAL ELECTROPORATION DURING ELECTRICAL DEFIBRILLATION.

L. Tung, B. O'Neill and V. Sharma. Department of Biomedical Engineering, The Johns Hopkins University, Baltimore, Maryland 21205, USA.

The use of controlled electrical shock is a practice commonly used today as a therapy to manage cardiac arrhythmia. However, high intensity electrical fields are generated in the tissue adjacent to the shock electrodes, and unintentional tissue injury and dysfunction may result if the shock intensity is too high in conjunction with implantable lead systems. Considerable experimental work exists suggesting that electroporation may be the underlying cause for tissue injury under these conditions [Tung, 1996]. Several factors that influence the processes of electroporation and recovery have been investigated in our laboratory in artificial planar bilayers and patches of mammalian cell membranes.

We have found that the voltage onset and dynamics of electroporation in azolectin planar bilayers are influenced in a protective manner by addition of the surface active agent, poloxamer 188 [Sharma *et al.* 1996]. Using voltage clamp protocols, the electroporation threshold following a 10 μs rectangular test pulse was on average 67 mV higher for poloxamer-treated membranes (n=23) compared with control membranes (n=26) (p<0.06). Electroporation did not occur instantaneously with the leading edge of the pulse, but rather with a mean latency delay significantly longer for the poloxamer-treated membranes.

An alternative means to limit electroporation may be in the proper choice of waveform shape. Rectangular and truncated exponential waveforms are used in the clinical and research arenas, and were compared with regard to voltage onset of

electroporation in rat ventricular membrane patches using previously published techniques [O'Neill and Tung, 1991]. We found that the electroporation threshold for 5 msec duration exponential pulses having 67% tilt (n=57) was on average 100 mV greater than that for equal duration rectangular pulses (n=64) (p<0.01). The mean latency delay for electroporation was significantly shorter for exponential pulses than for rectangular pulses. These findings suggest that electroporation occurs in cell membranes in a manner that is highly waveform-dependent.

Additional experiments were performed to compare the cases of 5/10 ms biphasic truncated exponential waveforms having variable amplitude second phases (40%, 20%, and 10% of the amplitude of the first phase). Patch clamp experiments on guinea pig ventricular cell membranes show that electroporation by the first phase of the waveform results in a significant increase in membrane conductance. The elevated conductance is reduced (recovers) immediately upon the voltage reversal of the second phase, and there appears to be an optimal amplitude of around 20% for recovery of conductance. These results extend previous observations that asymmetrically shaped biphasic rectangular pulses promote a more rapid recovery of the membrane following electroporation compared with purely monophasic pulses [Tovar and Tung, 1992].

O'Neill, R.J. and Tung, L. A cell-attached patch clamp study of the electroporation of amphibian cardiac cells. *Biophys J* 59:1028-1039, 1991.

Sharma, V., Stebe, K., Murphy, J.C., and Tung, L. Poloxamer 188 decreases susceptibility of artificial lipid membranes to electroporation. *Biophys J* 71:3229-3241, 1996.

Tovar, O. and Tung, L. Electroporation and recovery of the cardiac cell membrane with rectangular voltage pulses. *Am J Physiol* 263:H1128-H1136, 1992.

Tung, L. Detrimental effects of electrical fields on cardiac muscle. *Proc IEEE* 84:366-378, 1996.

MS-8-3

ELECTROPORMEABILIZATION INDUCED FREE RADICAL INJURY. B. Gabriel and J. Teissié. IPBS-CNRS, UPR 9062, 31062 Toulouse, Cédex 4, France.

Living cell membrane can be permeabilized transiently when pulsed by short strong external electric field pulses (electroporation). The molecular and cellular bases of cell electroporation are still unclear. The transient electroinduced membrane organization which supports enhanced permeability is topologically limited on the surface of the cell, but its structure is unknown. It cannot be described as well defined lipidic pores but involves the cell machinery. Electroporation must be considered as a stress for the cell. Using the chemiluminescent probe lucigenin, we show that electroporation of Chinese hamster ovary cells induces generation of oxygen-reactive species by electroporated cells (oxidative jump). Working on the cell population, we observe that i) the oxidative jump intensity is directly correlated to the extent of cell

electroporation, ii) a metal-ion-catalyzed Haber-Weiss reaction is part of the generation process, and iii) cell survival after electric treatment is directly correlated to this oxidative jump. This oxidative jump is an important contribution to the electrical trauma. The latter observation has to be associated with the cell-damaging action of oxygen-reactive species. A protective action of antioxidants is present against the lethal effect of electroporation. The maximum electroinduced amount of oxygen-reactive species is equivalent to 0.1 nmol O₂⁻/10⁸ cells. The topological distribution of this oxidative stress was investigated by photochemical time-dependent methodology. Analysis of the photooxidation reaction of 5-(N-hexadecanoyl)-aminofluorescein, a membrane light-sensitive fluorescent probe, shows that the reaction is accelerated when the cell population is electroporated. The increase of reactivity appears to be correlated to the activator effect of oxygen-reactive species generated during the oxidative jump, and suggests that these species are localized near the permeabilized part of the cell membrane. Spatial heterogeneity of the photooxidation reaction is indeed directly observed using fluorescence digitized videomicroscopy imaging of single electroporated cell. The generation of oxygen-reactive species is not homogeneous on the cell surface but is specific to the electroporated membrane part.

Benov, L.C. *et al.* (1994) *Gen. Physiol. Biophys.* 13, 85-97.

Gabriel, B. and Teissié, J. (1994) *Eur. J. Biochem* 223, 25-33.

Gabriel, B. and Teissié, J. (1995) *Biochim. Biophys. Acta* 1266, 171-178.

Gabriel, B. and Teissié, J. (1995) *Eur. J. Biochem* 228, 710-718.

Hafeman, D.G. *et al.* (1984) *Biochim. Biophys. Acta* 772, 20-28.

Halliwell, B. (1978) *FEBS lett.* 92,321-326.

Maccarrone, M. *et al.* (1995) *Biochem. Biophys. Res. Commun.* 206, 238-245.

Malinin, V.S. *et al.* (1989) *Bioelectrochem. Bioenerg.* 22, 37-44

Rols, M.P. and Teissié, J. (1990) *Biophys. J.* 58, 1089-1098.

Sies, H. (1986) *Angew. Chem. Int. Ed. Engl.* 25, 1058-1071.

MS-8-4

INJURY ASSOCIATED WITH HIGH VOLTAGE PULSING FOR TRANSDERMAL DRUG DELIVERY. J.C. Weaver. Harvard-MIT Division of Health Sciences and Technology, Massachusetts Institute of Technology, Cambridge, Massachusetts 02139, USA.

Transdermal drug delivery based on electrical interactions is of increasing interest. Iontophoresis using prolonged transdermal voltages in the range $U_{skin} < 5$ V is well established¹ and a new method using high voltage (HV; $U_{skin} > 5$ V) offers considerable promise.² Iontophoretic molecular transport is believed to involve pre-existing aqueous pathways, with many associated with the skin's appendages (sweat ducts and hair follicles), whereas creation of new pathways away from appendages occurs for HV pulses

causing $U_{\text{skin}} > 50$ V. Iontophoresis is generally limited by skin irritation for steady current densities above 0.5 mA cm^{-2} . In contrast, HV pulsing involves a low duty cycle electrical exposure. Typical HV pulsing protocols used in research involve either "short" (≤ 1 ms) or "long" (≥ 100 ms) pulse durations. Although large voltages (e.g. 500 to 1,500 V) are often applied to nearby electrodes, the intrinsic variable voltage divider associated with the intervening electrolyte and the skin results in maximum transdermal voltages which are much smaller (e.g. $U_{\text{skin}} \approx 20$ to 150 V).³ Further, the voltage across the barrier, the SC, is almost the same, i.e. $U_{\text{sc}} \approx U_{\text{skin}}$. Transdermal molecular transport is greatly enhanced by even a few HV pulses. Our hypothesis is that electroporation of multilamellar bilayers within the stratum corneum (SC) occurs, creating new aqueous pathways that allow increased molecular transport. Essentially all experimental studies to date are consistent with the electroporation hypothesis, and this suggests what might be involved in injury. Two pulse magnitude ranges are distinguished: (1) those causing $5 > U_{\text{sc}} > 50$ V, leading to electroporation of cells lining appendages, and (2) $U_{\text{sc}} > 50$ V, involving electroporation of multilamellar lipids within the SC.

Injury expectations should recognize that the SC is an essentially dead structure. Thus HV pulsing that leads to either short term reversible, or to essentially irreversible, aqueous pathways is not intrinsically injurious. Instead, the nearby viable epidermis should be considered. Potential injury mechanisms include direct electric field interactions with macromolecules, local heating within the SC, and creation of chemical imbalances in the viable epidermis. The latter include transepidermal water loss and stimulation of the epidermis by transdermally delivered therapeutic compounds. Introduced chemical irritants or allergens can cause a local dermatitis, and inadvertent introduction of pathogenic microorganisms would be a clear hazard. Note, however, that these potential insults are chemically or biological specific; they are not intrinsic to HV pulsing.

To date, experimental assessment of possible injury is very encouraging, but clearly incomplete. *In vitro* experimental results to date reveal no visible changes by light microscopy for short pulses, although visible alterations are evident for some long pulses. *In vivo* experimentals are also encouraging, so that the overall prospects for acceptable levels of injury are promising.

1. Sage, B. H., Iontophoresis. in *Percutaneous Penetration Enhancers*, E. W. Smith and H. I. Maibach, Eds., CRC Press, pp. 351 - 368, 1995.
2. Weaver, J. C., R. Langer, and R. O. Potts, Tissue Electroporation for Localized Drug Delivery, 1995. in *Electromagnetic Fields: Biological Interactions and Mechanisms*, M. Blank, Ed., American Chemical Society, pp. 301 - 316.
3. Pliquett, U., R. Langer, and J. C. Weaver, "Changes in The Passive Electrical Properties of Human Stratum Corneum due to Electroporation," *Biochim. Biophys. Acta*, vol. 1239, pp. 111 - 121, 1995.

Supported by NIH grant RO1-ARH4921, and Whitaker Foundation grant RR10963.

MS-8-5

MOLECULAR SEALING OF ELECTROPERMEABILIZED CELL MEMBRANES WITH BLOCK COPOLYMER SURFACTANTS. R.C. Lee and M. Capelli-Schellpfeffer. University of Chicago, Chicago, Illinois 60637, USA.

Increased ionic permeabilization of cell membranes as a result of damage is a mechanism of tissue necrosis in many common human diseases. These include ischemia-reperfusion injury (i.e. myocardial infarction, cerebrovascular stroke, others), radiation injury, thermal burns, frost-bite and electrical shock. Progress toward effective interventional therapy for these diseases is predicated upon developing strategies to seal damaged cell membranes.

Many natural cellular proteins act to stabilize cell membranes in response to damage. Synthetic mild surfactant polymers also produce similar effects. The effect of neutral dextrans and pluronics on the transport properties of electroporeabilized and heat permeabilized biological membranes have been recently reported^{1,2,3,4}. Results from these laboratories clearly indicate that Poloxamer 188 binds to permeabilized lipid bilayers or cell membranes to result in restoration of ionic transport properties. The exact mechanisms of membrane sealing has not been demonstrated. *In-vivo* studies have provided corroboration. Electroporated skeletal muscle and nerve in anesthetized rat hindlimbs using with twelve 4 millisecond duration square wave 150 volt/cm field pulses at the mid-thigh level were exposed to various clinically used surfactants. Membrane integrity was monitored by continuous quantitative SPECT imaging of $\text{Tc}^{99\text{m}}$ -pyrophosphate, a calcium chelator, content in the mid-thigh region. Poloxamer 188 and other pluronics have been reported to reduce $\text{Tc}^{99\text{m}}$ -pyrophosphate incorporation reflecting muscle membrane sealing¹. The result has been increased muscle and nerve survival¹.

Because of the board medical applications scientific interest in the problem of membrane sealing has grown rapidly. Attention has now been primarily focused on understanding the molecular mechanisms of surfactant induced membrane sealing. Known actions of poloxamers on membranes included dehydration, cross-linking of membrane proteins, slowing of phospholipid self-diffusion and membrane swelling³. These actions may explain the membrane sealing effects.

References:

- (1) Lee, Pan, River, Li Ji and Wollmann: *Proc. Natl. Acad. Sci.* 89(10):4524-4528, 1992
- (2) Padanilam, Bischof, Lee, Cravalho, Tomkins, Yarmush, and Toner: in *New York Academy of Science, Vol. 720*, pp. 111-123, 1994
- (3) Sharma, Stebe, Murphy and Tung: *Biophysical J.* 71:3229-3241, 1996
- (4) Kolodgie, Farb, Carlson, Wilson, Virmani, *J. Am. Coll. Cardiol.* 24:1098-1108, 1994

MS-9 — HF-FIELDS AND CELL PHYSIOLOGY

Organizer: Gerd Friedrich

The effects of high frequency fields on all levels of life from molecules to the intact organisms have been tested. The application of high frequency fields on different biological targets requires thorough evaluation of the experimental setups to assure reproducible exposure conditions. Setups matching these conditions have been constructed for the exposure of molecules, cells, proliferation, signal transduction, and membrane currents have been investigated. On the level of human beings, the electroencephalogram and cognitive functions have been tested.

MS-9-1

DNA AND PROTEIN EXPOSED TO MODULATED FREQUENCY RADIATION. W. Rürger. Ruhr-University Bochum, Faculty for Biology, D-44780 Bochum, Germany.

There is increasing discussion on possible biological damage inflicted on organisms exposed to electromagnetic radiation. Exposure of men to electromagnetic fields is connected with modern life and since e.g. caused by TV, microwave, radio and mobile telephones, exposures cannot be avoided. However, there are fears that these exposures might cause mutations and induce cancer.

For many reasons, procaryotic organisms are useful in tracing biological damage inflicted by physical or chemical agents. Therefore, we designed simple experiments that should allow to test the effects of electromagnetic fields on biological material. Since damages as mentioned above, often occur at that level of DNA or of proteins binding to DNA, the experiments should allow to test whether DNA or proteins are damaged if exposed to an electromagnetic field. All samples were exposed in a well defined waveguide, in volumes of 0,1 ml. The petri dishes applied in the mutagenicity tests were openly exposed, without a lid.

In one series of experiments, we tested the survival of bacteriophages over a total exposure time of three months and we did not find any reduction of the survival as compared to control phages which had not been exposed but remained under otherwise unchanged conditions. We conclude that neither the DNA nor the proteins of the sensitive infection apparatus of this virus were damaged in the electromagnetic field.

Likewise, we have exposed closed circular DNA. The introduction of single or double strand breaks into the closed circle would become visible after electrophoresis on polyacrylamide gels by a change in the migration velocity. Again, no differences were observed among samples exposed to the electromagnetic field as compared to unexposed controls.

Further we tested mutagenicity of four bacterial strains, lacking different DNA repair mechanisms. No increase in mutagenicity was observed during a one week exposure to the electromagnetic field.

Following the ideas that electromagnetic radiation might

damage or change hydration of macromolecules we tested as to whether DNA exposed to an electromagnetic field was partially denatured. But also in these experiments no shifts in the optical densities were observed with samples exposed in parallel with the measurement in the waveguide and unexposed controls. Also, the kinetics of the enzyme β -galactosidase remained identical in samples exposed to the field and unexposed controls.

As the result of our experiments we conclude that the electromagnetic fields as applied in our experiments, do neither inflict detectable direct damage to DNA nor to proteins.

MS-9-2

HIGH FREQUENCY ELECTROMAGNETIC FIELDS CAN EFFECT ION TRANSPORT THROUGH LIPID BILAYER MEMBRANES. G.H. Boheim¹, S. Meder¹, A. Wienand¹, G. Wrobel¹, V.W. Hansen², H. Kammerer² and F. Wilczewski². ¹Biophysical Chemistry of Membranes Group, Ruhr-Universität Bochum, D-44780 Bochum, Germany. ²Department of Theoretical Electrical Engineering, Bergische Universität Wuppertal, D-42097 Wuppertal, Germany.

The growing use of pulsed high frequency (HF) electromagnetic fields in communication technology has raised concerns about possible effects on living matter. Up to now, the evidence for such interactions is circumstantial and few plausible mechanisms have been proposed on the basis of theoretical model calculations.

We have constructed a 900 MHz waveguide for the exposure of planar lipid bilayer membranes to pulsed and continuous HF fields. Excess membrane currents with defined amplitudes and relaxation times are observed in pure lipid bilayers as well as in membranes doped with the channel forming peptides gramicidin A, alamethicin or the depsipeptide carrier valinomycin. We attribute these excess currents to an increased ion complexation rate in a layer of membrane associated water that interacts with the electric field component of the 900 MHz electromagnetic wave.

INFLUENCE OF VARIOUS HF FIELDS ON GROWTH BEHAVIOUR OF HL-60 CELLS TO INVESTIGATE CANCER PROMOTING EFFECTS.

R. Fitzner¹, E. Langer¹, C. Reitmeier¹, E. Zemann¹, J. von Bülow², R. Elsner³, W. Storbeck³, H. Eisenbrandt⁴, J.P. Griegat⁴ and K. Brinkmann⁵. ¹Institut für Klinische Chemie und Klinische Biochemie, Universitätsklinikum Benjamin Franklin der Freien Universität, D-12200 Berlin, Germany. ²Evangelisches Waldkrankenhaus Spandau, Abt. für Laboratoriumsmedizin, D-13589 Berlin, Germany. ³Institut für Nachrichtentechnik, Technische Universität, D-38092 Braunschweig, Germany. ⁴Forschungsverbund "EMV Biologischer Systeme", Institut für Hochspannungstechnik, Technische Universität, D-38106 Braunschweig, Germany. ⁵Leiter des Forschungsverbundes "EMV Biologischer Systeme", Institut für Hochspannungstechnik, Technische Universität, D-38106 Braunschweig, Germany.

OBJECTIVES: Suspension cultures of HL-60 human leukemia cells are exposed in different high frequency exposition sets. The question of these *in vitro* tests is, if an additional growth promotion of already transformed human tumor cells and consequently a cancerogenic effect can be proved. Indicators of growth speed are the doubling time and the thymidine kinase activity in standardized suspension cultures. Cells exposed to electromagnetic fields are compared with identical non-exposed control cells. Thymidine kinase is an enzyme which catalyses the phosphorylation of thymidine into thymidine monophosphate. Thymidine triphosphate generated from thymidine monophosphate is required for the DNA synthesis.

METHODS: Following high frequency exposition sets (with a signal generator and a band amplifier) are used: A GTEM cell, a TEM cell, a 900 MHz rectangular waveguide and a 1800 MHz rectangular waveguide.

For the *in vitro* tests human leukemic HL-60 cells are cultured in RPMI 1640 medium. Cell suspensions in polystyrol tubes are put in two acrylic glass holding fixtures, which are connected with two thermostats. These are using oil as a cooling fluid and maintain a constant temperature of 37°C. One holding fixture is placed in the exposition set, the other one in a HF screening box. Doubling times are calculated from duration of culture time and the initial and ending cell count. TK activity in the cell culture supernatants is determined with a radio enzyme assay.

SUMMARY: HL-60 cells are exposed for 24 and 72 hours in the GTEM cell at 900 and 1800 MHz pulsed with 217 Hz. SAR values are 12,5 mW/kg at 900 MHz and 91 mW/kg at 1800 MHz. The frequency in the TEM cell is 380 MHz pulsed with 17,65 Hz. Exposition time takes 24 hours and the SAR value is 80 mW/kg.

Exposition lasts 24 hours in 900 MHz rectangular waveguide and in 1800 MHz rectangular waveguide pulsed with 217 Hz. SAR values are 200 mW/kg in 900 MHz waveguide and 80 and 1700 mW/kg in 1800 MHz waveguide.

Resulting doubling times and TK activity of the exposed cells do not systematically differ from those of the control cells. The tests don't show an additional growth promotion of

human leukemia cells in any of the various HF exposition sets.

Based on the available results, a cancerogenic effect of electromagnetic fields can therefore not be established.

TECHNICAL ASPECTS OF EXPERIMENTS ON BIOLOGICAL EFFECTS OF RF-FIELDS. V.W. Hansen. Lehrstuhl für Theoretische Elektrotechnik, Bergische Universität Wuppertal, D-42097 Wuppertal, Germany.

The paper reports on the technical aspects of five experiments on biological effects of RF-fields (frequency about 900 and about 1800 MHz) which were performed recently by support of the *Forschungsgemeinschaft Funk*, Germany. The experiments can be separated into two groups. In the first group the samples of biological materials are small compared to the wavelength. In this case the main part of the exposure system is a rectangular hollow waveguide, which was designed for pure fundamental mode operation (TE₁₁-mode) in the frequency range under consideration. The adapters for the feed line and for the termination were optimized to achieve minimum reflexion in order to guarantee the propagation of only one wave. The containers for the samples were made of lowloss dielectric materials. All openings of the waveguides were carefully designed using RF-shielding materials. Measurements proofed that almost perfect shielding was obtained; thus, interferences with sensitive, electronic equipment outside the waveguide were avoided.

For the interpretation of any result the electromagnetic field inside and close to the biological samples must be known, including the effects of all installations required inside the waveguide (material of containers, of cooling equipment, of electrodes etc.). The field distribution can be determined by measurements in some cases; however, with very small samples even very small sensors will cause drastic interferences. Thus, we preferred numerical procedures which additionally benefit from the fact that the field of the fundamental waveguide mode, which is the starting point of the analysis, is exactly known and that stability and uniqueness of the field distribution are guaranteed. We mainly applied Finite Differences (FD) and Finite Element (FE) methods. By this the required resolutions were obtained for samples larger than about 0.1 ml. For experiments on cells and especially on cell membranes (thickness of the membrane about 5nm) the resolution has to be improved considerably. Applying a special hybrid method, which is a combination of an integral equation method and the FE-approach, a resolution of less than 1 µm for an experiment on planar lipid membranes has been achieved up to now.

Test signals of commercial mobile telephones as well as amplitude modulated signals with modulation parameters corresponding to the GSM-standard were applied as signals.

For experiments with volunteers, however, rooms of sufficient size were required in order to achieve a comfortable environment for the persons under test. Numerical analysis of the test room showed that it was necessary to equip the room with HF-absorbers in order to avoid multiple reflexions

at walls, ground, and ceiling, which would result in a nonreproducible field distribution. External parasitic fields were measured and recorded in the frequency range of 5Hz to 3GHz. The field was generated by a commercial mobile telephone. The antenna and the power were adjusted in such a way that the German standard DIN/VDE 848, part 2, exposure condition 2, was met.

MS-9-5

THE INFLUENCE OF HIGH-FREQUENCY ELECTROMAGNETIC FIELDS ON THE CALCIUM SIGNALING IN EXCITABLE AND NON-EXCITABLE CELLS. R. Meyer, F. Gollnick, K.W. Linz, C.v. Westphalen and S. Wolke. Physiologisches Institut, D-53111 Bonn, Germany.

Calcium is an important messenger in excitable and non-excitable cells. Changes in this messenger system induced by electromagnetic fields would cause numerous changes in cells. Weak amplitude modulated radiofrequency (RF) fields have been shown to enhance calcium efflux from excitable cells. If fields emitted by modern telecommunication devices would cause comparable effects, this might impair the health of people using them. Thus, a series of investigations has been carried out to check the interference of high frequency fields with the calcium homeostasis of different cell types.

METHODS: As representative of excitable cells isolated ventricular heart muscle cells and as representative of non-excitable cells Jurkat T-lymphocytes were selected. Cardiac cells were freshly isolated, whereas lymphocytes were cultured. Cytoplasmic calcium concentration was measured in both cell types using fura-2 in combination with image analysis. In cardiac cells of the guinea pig and the rat membrane potential, action potential, the L-type calcium current, and the potassium currents were recorded with patch clamp pipettes in whole cell recording mode. As exposure system a TEM-cell (for calcium and electrophysiological recordings) and rectangular waveguides (for electrophysiological recordings) were used. Exposure to fields of 900 MHz and 1800 MHz pulsed with 217 Hz (GSM) was included in all different experiment types. Electrical recordings were also carried out at 180 MHz CW, to simulate analog transmission. In the TEM-cell only relatively low SAR-values could be gained: at 180 MHz 80 mW/kg, at 900 MHz 15 mW/kg, and at 1800 MHz 5-15 mW/kg. In the waveguides SAR-values up to 880 mW/kg could be achieved. Independently of the cell type and the field composition, the fura-2 experiments consisted of three parts: 500 s of sham exposure in the beginning, followed by 500 s of exposure or sham exposure, and 500 s of chemical stimulation at the end. Electrical recordings of a single heart cell were performed during sham exposure and exposure alternately. Experiments were usually carried out at 36°C except for some control experiments at 24°C (electrical recordings).

RESULTS: The cytoplasmic calcium concentration of Jurkat T-cells could be changed by chemical stimulation with anti-CD3 antibody, whereas field exposure did not change the internal calcium significantly. The cytoplasmic calcium

concentration of heart cells could be changed by chemical stimulation (high external potassium), but was not influenced by the presence of RF fields neither in resting nor in depolarized cells (Wolke *et al*, 1996, *Bioelectromagnetics* 17, 144-153). The recordings of membrane potential, action potential, L-type calcium current, and potassium current in heart cells did not reveal any changes, which could be attributed to the presence of the RF field. Decrease of the external temperature from 36°C to 24°C resulted in longer action potentials, smaller L-type currents, and a shift of the steady state activation and inactivation curves to more positive potentials as expected. Also at the lower temperatures the exposure did not change the recorded electrical parameters.

DISCUSSION: The recordings of cytoplasmic calcium show that in our experiments the function of this messenger system could not be influenced by the presence of the RF-field. The absence of any changes in the electrical recordings demonstrate that neither the binding of the calcium ions to the channels nor to the external surface of the membrane nor the permeation of the ion through the L-type channel is influenced by the RF field. Although these findings cannot be extended to any cell type and species they do not deliver any hint for a non-thermal action of the fields on the measured parameters.

MS-9-6

CEREBRO-BIOLOGICAL EFFECTS IN LOW-FREQUENCY PULSED RF-FIELDS. J.F. Spittler, P. Calabrese and W. Gehlen. Neurologische Universitätsklinik, Knappschafts-Krankenhaus, Bochum-Langendreer, Germany.

Possible effects of the transmitting field of mobile telephones on brain function have been predominantly reported in small numbers of cases. The EEG served as the basic parameter in most cases. However, it cannot always be established whether observed alterations are biological electromagnetic effects on the brain and whether they are detrimental.

METHODS: We investigated 52 normal healthy volunteers, age 20-38 years, by means of EEG. The examination was carried out in a room equipped with RF absorbers; external parasitic fields were measured and recorded in the frequency range 5 Hz to 3 GHz. During the 11th-20th minute in a 30 minute-EEG recording 25 test subjects were exposed to the transmitting field of a commercial mobile telephone, 27 served as controls without field exposure. The transmitted power was 8 W, the frequency was 914,2 MHz (GSM-test modus). The antenna was set up at a distance of 45 cm above the subjects' heads, the field strength in the heads' area was approximately 40 V/m (not exceeding the limit according to DIN/ VDE 0848). The EEG was recorded with a digital facility (electrode positions according to the international 10/20 system, impedances <10kOhm). In order to control vigilance the volunteers repetitively had to count to 10 and then press a key. For further evaluation the spectral power (μV^2) was used. Aliasing resulting from the modulation frequency of the mobile telephone (217 Hz) projecting into the EEG frequency range (0,5-30 Hz) could be avoided by

using a scanning frequency of 500 Hz. Artifact elimination was carried out by mathematical means cutting off the measured values >2 standard deviations.

RESULTS: The visual evaluation of color-coded diagrams of the spectral power in the frequency range under observation (0,5-30 Hz) showed no effects of field exposure (11th-20th minute) compared with the preceding and subsequent 10 minutes as well as in comparison between exposed and non-exposed individuals. For usual frequency bands the mean power values were calculated in the three measurement phases for selected electrode positions (Cz, T3, T4, P3, P4, O1, O2). In a multivariate analysis of variance the average values showed no significant differences ($F = 1,78576$, $df = 42$, $p = 0,178$).

CONCLUSION: We tested the transmitting field generated by a mobile telephone on the human electroencephalogram. In a controlled comparative study of 52 normal adult subjects no significant impact could be observed.

MS-9-7

NEUROPSYCHOLOGICAL PERFORMANCE OF HEALTHY SUBJECTS UNDER LOW-FREQUENCY PULSED RF-FIELDS. P. Calabrese, J.F. Spittler and W. Gehlen. Neurologische Universitätsklinik, Knappschafts-Krankenhaus, Bochum-Langendreer, Germany.

This study was aimed to investigate possible effects of low-frequency pulsed RF-fields on some cognitive functions in healthy volunteers.

METHODS: We examined 52 normal subjects (26 m; 26 f) aged 20-38 years ($\bar{x}=26.2$ yrs), by exposing them to a transmitting field of a commercial mobile telephone while performing neuropsychological tests of attention and memory. The transmitted power was 8W, the frequency was 914,2 MHz (GSM-test modus). The antenna was set at a distance of 45 cm above the subjects head assuring a field strength of approximately 40 V/m in this area without exceeding the limit value according to DIN/VDE 0848. The neuropsychological test-battery consisted of a computer-guided attention-test-set (vigilance-test, alertness-test, go/no-go task, working memory-test) and a German adaptation of the Rey auditory verbal learning paradigm. The neuropsychological tests were carried out in a room equipped with RF-absorbers to control external parasitic fields. The subjects were randomly split up into 2 subgroups each of them performing the tests under non-exposition as well as under RF-exposition condition either in a first or in a second examination-phase according to a crossover-design.

RESULTS: A comparative analysis of the two group-data failed to show any statistical differences in the attention and memory-related measures.

CONCLUSION: We conclude from this study that there are no detectable transmitting field-related cognitive effects under this field strength.

MS-10 — BIOLOGICAL EFFECTS OF CELLULAR TELEPHONES

Organizers: Mays Swicord and Bernard Veyret

The recent expansion of telecommunications, and in particular personal telecommunications, has led to public concern about the health hazards of electromagnetic fields. Largely anecdotal information has raised concerns about cancer, headaches, sleep disorders and various other symptoms or health conditions. A large body of literature exists on the biological effects of radiofrequency and microwave radiation. However, the bioeffects data base related to cancer or other suggested health responses to cellular telephones is small, and even a smaller number of these studies have considered exposure specifically from radiotelephones or other radio systems. A number of studies are currently underway or are being planned. However, definitive answers about health hazards related to the use of radiotelephones are unlikely to come about in the short term. This minisymposium provides a review of current research in epidemiology, *in vitro* and *in vivo* biological effects studies and dosimetry. The scientific issues as well as current or planned research will be discussed. The first talk in this minisymposium will be on dosimetry of *in vivo* and *in vitro* studies. This talk will describe the complexities and limitations of determining experimental exposure parameters and be given by Niels Kuster. The next two talks will describe the current experimental studies which address the health issues of cellular telephones. *In vitro* studies will be reviewed by Bernard Veyret and Mays Swicord will review the *in vivo* studies. A discussion of exposure standards relevant to cellular phones will be presented by Gianni Mariutti. The final talk in this session will describe current epidemiological studies and provide a description of the pitfalls and limitations of such studies. This epidemiology review will be presented by John Boice.

MS-10-1

DOSIMETRY OF RF LABORATORY EXPERIMENTS. N. Kuster. Swiss Federal Institute of Technology (ETH), CH-8092 Zurich, Switzerland.

INTRODUCTION: Previous experience has clearly demonstrated the near impossibility in most cases of reliably estimating the induced field distributions without proper analysis for a particular setup. In retrospect, many experiments conducted with great biological care have turned out to be of limited value due to severe shortcomings in the exposure setup.

OBJECTIVES: In bioelectromagnetics only the most sensitive experiments should be conducted. This can only be accomplished by using cell lines or animal models that have been shown to be highly sensitive in their response to other physical or chemical agents and are well characterized with respect to possible artifacts. Any departure from this proviso would entail the risk of creating further artifacts and altering

the sensitivity, and should therefore be avoided. This places strict requirements on the exposure setup.

REQUIREMENTS:

- *Signal source:* The signal source should be precisely defined (frequency, modulation scheme, power stability, noise level, etc.).
- *Induced field strength:* The induced field strength at the site of the investigated cells should be well defined. In the case of health risk assessments, it is important that the setup allow induced field strengths which exceed the maximum field strength occurring in human tissue under actual exposure situations. For *in vivo* studies the variations of the induced field levels due to any movements of the animal, anatomical variations, effects of growth in long-term experiments, etc. must also be carefully assessed. In addition, whole-body temperature increases during exposure should be estimated in order to exclude any effects due to whole-body heating.
- *Field distribution:* A large number of cells/animals are usually exposed to increase the sensitivity of the experiment. However, the increased statistical significance of using a large number can only be fully realized if all the cells/animals are exposed to the same field strength. This is often very difficult to accomplish.
- *Environmental controls:* Most *in vitro* experiments usually require strict environmental controls, e.g., temperature, sterility, stabilized temperature (<1°C), atmospheric control, accessibility during the experiments, etc. For *in vivo* experiments, the stress levels caused by the setup (e.g., by restraining the animals) should be kept as low as possible, and the resulting effects should be carefully assessed by running a cage control.

METHODS: A large range of sophisticated experimental and numerical tools for performing reliable dosimetric assessments with high spatial resolution have been developed during the past few years and are now commercially available. A survey of these tools, including a discussion of their advantages and disadvantages, has recently been published [1]. Examples of studies successfully conducted employing such tools to analyze and optimize exposure setups are also discussed.

CONCLUSIONS: In conclusion, the tools to optimize exposure setups are available. However, research groups must overcome any disinclination towards interdisciplinary projects, and funding bodies must be made aware of the relatively high cost of a good setup.

References:

- [1] N. Kuster, Q. Balzano, J.C. Lin, "*Mobile Communications Safety*," Chapman & Hall, 1997, pp. 278.

MS-10-2

IN VITRO LABORATORY EXPERIMENTS RELATED TO MOBILE COMMUNICATIONS. B. Veyret. Wave Matter Interaction Laboratory, College of Chemistry and Physics, University of Bordeaux, France.

In vitro investigations of bioeffects of microwaves have been numerous but they have not yet provided much information

relevant to mobile communications. Cellular models are useful although they lack the fundamental interaction between organs and systems. Exposure conditions are in principle easier to control than for animal experiments: SAR determination and temperature control are more readily achieved, with the help of experimental and numerical dosimetry. However, many difficulties still exist in the choice of cells (either primary or tumour cells), in the way cells are used and in the choice of assay (proliferation, transformation, membrane events, etc.). The various possible experimental conditions will be described in relation with mobile communications: exposure systems, cellular models, modern analysis techniques, and interpretation of data.

Published data will be described briefly on the following topics: (i) genotoxic and mutagenic effects, synergy with cytotoxic agents, (ii) action on membranes, enzymes, ion fluxes, (iii) action on immune cells and (iv) efflux of calcium ion.

In summary, this tutorial will address the rationale for *in vitro* experiments, the design of such studies, and the information they can provide. Further research needs and on-going projects will be briefly described.

References:

A. F. McKinlay *et al.* Possible health effects related to the use of radiotelephones. *Proposals for a Research Programme by an European Commission Expert Group*. September 1997.

M. Repacholi *et al.* Health effects of exposure to low exposure levels of radiofrequency fields. Draft ICNIRP, WHO.

MS-10-3

IN VIVO LABORATORY EXPERIMENTS RELATED TO MOBILE COMMUNICATIONS. M.L. Swicord. Motorola Florida Corporate Electromagnetics Research Laboratory, Ft. Lauderdale, Florida 33322, USA.

The available literature contains relatively few *in vivo* studies using frequency and modulation characteristics representative of mobile communications devices. An assumption of frequency-independent effects allows evaluation of a somewhat larger database of microwave *in vivo* studies. While a few studies suggest an effect of microwaves on malignant and non-malignant disease in animal models, these findings are not consistent in their reporting of disease type or positive versus negative outcome. Many studies have shown a lack of any detectable effect of microwaves on survival disease incidence, and disease latency. Further studies currently planned or under way will provide a more complete evaluation of this issue. An analysis of the relevant published data on chronic and acute animal studies will be presented. This will include studies related to tumorigenesis, mutagenesis, tumor promotion, implanted tumor growth, DNA and chromosomal damage, neurochemistry, gene expression, and immunologic responses. Studies that are planned or in progress will be listed. The presentation will conclude with a discussion of the requirements for a quality *in vivo* research project.

THE CENELEC REPORT ON SAFETY REQUIREMENTS FOR MOBILE TELECOMMUNICATION EQUIPMENT.

G.F. Mariutti.
Physics Laboratory, Italian National Institute of Health,
00161 Rome, Italy.

A technical report "Considerations for Human Exposure to EMFs from Mobile Telecommunication Equipment in the Frequency Range 30 MHz-6GHz" has been issued by CENELEC in February 1997.

Said document, under mandate of EU DG III (Industry), has been prepared in more than two years work by an Interdisciplinary Working Group formed within the CLC SC211/B. The above mandate derives from the Directive 91/263 whose articles 4a and 4b stipulate that safety aspects specific to telecommunication terminal equipment, and not already covered by Directive 73/23/EEC, are essential requirements. According to DGIII document "The mandate aims to draft an European Standard defining safety requirements to protect human beings from hazardous thermal effects which may be caused by the use of mobile telecommunication equipment (MTE) in the 30 MHz-6 GHz frequency range". The CENELEC document, in a style of a standard, deals with the considerations of thermal effects for human exposure to electromagnetic fields from MTE. The effects specifically taken into consideration are those generally called "thermal". The basic restrictions and the reference levels are consistent with those of the European Prestandard, CENELEC ENV50166-2. The Working Group agreed that compliance with the ENV50166-2 provides comprehensive protection from adverse thermal effects due to exposure from MTE.

The report describes the measurement and numerical requirements for testing compliance with the basic restrictions. These requirements may also be extended to testing compliance with different basic restrictions. It does not consider the effects of emfs on implants such as cardiac pacemakers. Although MTE are all types of telecommunication equipment the content of the document is specifically concentrated on hand held and other portable wireless MTE.

EPIDEMIOLOGY AND CELLULAR TELEPHONES.

J.D. Boice, Jr.¹, W.J. Blot¹, J.K. McLaughlin¹, E.E. Hatch², M.S. Linet² and P.I. Inskip³. ¹International Epidemiology Institute, Rockville, Maryland 20850, USA. ²National Cancer Institute, Bethesda, Maryland 20892, USA. ³Texas A&M University, College Station, Texas 77843, USA.

Public concern about the possibility that cellular telephones may cause brain cancer, headaches, and other illnesses has precipitated a number of epidemiologic studies in the United States and elsewhere. The evidence for an association between mobile phone use and any ailment, however, is anecdotal and not based on observational or experimental

studies. Epidemiology can provide essential information on possible health effects from mobile phone use if (1) studies are well designed to minimize bias, (2) numbers of subjects are sufficient to minimize chance, (3) exposure is carefully assessed to minimize misclassification, and (4) other known or suspected risk factors are evaluated to minimize confounding.

The epidemiologic arsenal includes experimental and observational (cohort, case-control and ecologic) studies. Experimental studies, such as randomizing persons to use and not use mobile phones and then following them forward in time might be an approach to study headaches. If the mental problems are tied to a certain type of digital technology, then persons could even be randomized into groups that use two different types of phones and then objective criteria used to record headaches, migraines or mental disorders. In addition to the normal problems faced by epidemiologists of bias, chance and confounding, the investigation of headaches provides another difficulty because of the non-specific nature of the condition. Basing study results on self-reported episodes of headaches might be problematic. To be informative, studies would require reproducible and valid criteria to classify "headaches" such as, perhaps, those requiring medical attention, frequency and intensity of medication use, or a specific medical diagnosis such as migraine.

Prospective or cohort studies follow experiments in the scientific quality of information they produce. Subjects who use and do not use mobile phones are followed in time and events recorded. Studying brain cancer in this manner is problematic, however, because the event of interest is relatively rare, only about 6 deaths per 100,000 per year or about 18 new cases per 100,000 per year. Thus large numbers followed for several years would be required. Exposure assessment is challenging also because the exposure is likely to be episodic and also cumulative over time. A possible design would be to obtain subscriber lists from phone companies, and link these lists to national cancer incidence and mortality files. If frequency of phone use were available in the company records, then dose response evaluations could be conducted. Cancer incidence would be more informative than mortality. Detailed exposure assessment could be conducted using a nested case-control within the cohort design.

Case-control studies evaluate the frequency of mobile phone use among subjects who have and do not have the disease of interest. If the population prevalence for mobile phone use is 6 to 15%, then study sizes of 800 cases and 800 controls would be more than adequate to detect a two-fold risk. A major problem would be relying upon a subject's memory to ascertain phone use, but this might be addressed through linkage with phone company records. On the other hand, a personal interview permits evaluation of any confounding exposures such as occupational factors.

Ecologic studies might attempt to link the incidence of brain cancer, for example, with the rise in mobile phone sales over calendar years. While often useful in generating hypotheses, such studies have limited value in testing hypotheses since exposure to individuals is not known and other factors, such as improvements in brain cancer detection technology, can

influence interpretation. Further, "latency" and exposure-intensity issues are difficult to address.

MS-11 — BONE AND CARTILAGE

Organizers: Roy Aaron and Maurice Hinsenkamp

Electromagnetic stimulation of bone have in specific pathological situations well documented observations of therapeutic effects, although issues of signal and dosing optimization and device design remain to be established. New information indicates that extracellular matrix synthesis in articular cartilage may be stimulated by electromagnetic fields as well. Within the past two years, substantial new information has appeared suggesting that electromagnetic stimulation of bone and cartilage cells may stimulate transcription and synthesis of growth factors and that this may be a common mechanism of action of these fields in several model systems. This symposium will review clinical studies with electromagnetic stimulation of bone repair followed by discussion of chondrogenic cell differentiation by electromagnetic stimulation in endochondral ossification. Finally, the latest information on stimulation of growth factors in the TGF β /BMP family and IFG series will be presented.

MS-11-1

CARTILAGE DIFFERENTIATION AND BONE HEALING. M. Hinsenkamp. Erasmus Hospital, Brussels University, 1070 Bruxelles, Belgium.

How cells respond to EMF exposure remains an unanswered question. However, from the reliable results observed, puzzling mechanisms can be reassembled and a coherent hypothesis can be drawn.

The EMF used have the following characteristics (2.4 mT peak, 4 V/m peak, 225 μ sec., one pulse repeated 20 times during 4.6 ms, 15 Hz burst frequency). In *in vitro* cultures of limb buds from mice embryos exposed to EMF an increase in the amount of acid GAG in the cartilaginous matrix ($p < 0.01$) is observed, associated with a better morphological structure of the skeletal segments ($p < 0.05$). Faster ossification is observed in chicken and quail embryos. 24/24h EMF *in vivo* exposure for 100h of 168 embryonic tibial segment of quail embryos shows a significant increase in the ossification rate of up to 140% over the control ($p < 0.001$). (Hinsenkamp, 1985, 1994).

As acidification of GAG is the immediate sequence before ossification, it can be concluded that the ossification rate is increased due to the faster maturation of the cartilaginous matrix preceding the early stage of ossification. This conclusion is sustained by an animal model of a fresh fracture and a clinical study on non unions. The animal model, a tibial osteotomy on rats shows an early increase of the callus rigidity. In a clinical study of 262 non unions, the healing rate of hypertrophic non unions, having large preexisting cartilaginous buds, is significantly higher (86.1%) than for

atrophic non unions, with no preexisting cartilaginous buds (56.1%, $p < 0.001$).

In all these observations only the potential functions of the cells were activated and this activation is specifically oriented in the direction of an acceleration of the normal differentiation of the cells. The same embryonic effect related to cyclic mechanical loading was observed by Burger (1991). This gives one more coherent observation relating mechanical and electrical stimulation. Also all these effects are observed in the biological substrata placed in stress conditions as they are in metastable thermodynamic equilibrium. In normal physiological conditions the cells appear unaffected by the EMF.

MS-11-2

ELECTROMAGNETIC FIELD STIMULATION OF OSTEOTOMIES. G.C. Traina. Dipartimento di Scienze Biomediche e Terapie Avanzate, Sezione di Clinica Ortopedica, Università di Ferrara, 44100 Ferrara, Italy.

Low frequency pulsing electromagnetic fields (PEMFs) have been utilised to heal un-united fractures with a success rate of 84%. Very few double blind studies have been published on the treatment with PEMFs of non-unions because of the difficulties in recruiting patients. Electromagnetic stimulation has been performed with a PEMF generator (Biostim, Igea, Italy) that uses a frequency of 75 Hz, a magnetic field intensity of 20-30 Gauss and an impulse width of 1.3 ms. To be able to quantify the effect of PEMF stimulation on the osteogenesis in humans we have focused on osteotomy healing, a bone healing model that has attracted our interest since several years. The osteotomy is a fracture created by the orthopaedic surgeon always at the same site within a bone, it is immobilised with a synthesis device, both the surgical procedure and the post-operative treatment are standardised and uniform for all patients. For this reason the number of variables that can be controlled is quite high considering a clinical study. The results have been evaluated on the bases of X-ray analysis.

Three studies have been performed over the years: one involving thirty-two femoral intertrochanteric osteotomies and one involving forty tibial valgus osteotomies. Another study has been conducted in a group of fifty subjects undergoing massive allograft where eighty-three osteotomies were present at the interface between the allograft and the recipient bone.

Studies were aimed at evaluating both success rate and time to healing.

In all 3 studies no difference was observed in the healing rate at follow-up, specifically all femoral and tibial osteotomies healed.

When the healing time and the X-ray evolution were taken into consideration we found in all case that the healing process was accelerated by PEMF stimulation. In the femoral osteotomies both at 45 and 90 days after surgery the X-ray of the osteotomy line evaluated by an image analyser proved to be less visible and in a more advanced phase of healing in active stimulated subjects than in controls ($p < 0.01$). In the

tibial osteotomies X-ray images at day 30 and 60 after surgery demonstrated that 72.2% of the osteotomies in the stimulated group had already healed at day 60 compared to 26.4% in the control group ($p < 0.04$). Finally the allograft study showed that the healing time of the osteotomies in the active group was 6.7 months compared to the 9.4 months of the control group ($p < 0.001$). The results of these studies demonstrate that PEMF stimulation can effectively stimulate bone healing in humans. PEMFs seem to be able to optimise the osteogenetic response and to shorten the healing time.

MS-11-3

STIMULATION OF CHONDROGENIC DIFFERENTIATION IN EXPERIMENTAL ENDOCHONDRAL OSSIFICATION BY LOW FREQUENCY ELECTROMAGNETIC FIELDS. R.K. Aaron. Department of Orthopaedics, Brown University School of Medicine, Providence, Rhode Island 02903, USA.

Endochondral ossification is the basic process of skeletal morphogenesis including embryogenesis, longitudinal growth, and fracture repair. Low frequency electromagnetic fields (LF-EMF) have been shown to affect aspects of endochondral ossification on the clinical, tissue, and cellular levels notably, the repair of fractures and nonunions, fracture callus cells *in vitro*, growth plate chondrocytes, and embryonic limb rudiments. This presentation will review the effects of LF-EMF on endochondral bone development and then describe a series of experiments studying the effects LF-EMF on a model of experimental endochondral ossification. The model of decalcified bone matrix-induced endochondral ossification recapitulates the cell biology of endochondral bone formation, particularly as regards the differentiation of mesenchymal cells to chondrocytes. This model has been used to examine differentiation, under LF field stimulation, with morphological, biochemical, and molecular techniques. Cell recruitment and proliferation do not appear to be affected by exposure to the fields. Proteoglycan synthesis, glycosaminoglycan accumulation, and the spatial accumulation of cartilage appear earlier and are increased, indicating the earlier appearance of phenotypically expressed chondrocytes. This is confirmed by the measurement of increases in mRNA for proteoglycan and collagen and the appearance of these messages earlier in the developmental sequence in response to field stimulation. Other experiments suggest that the response is located in cell populations in the mesenchymal phase, before bone and cartilage differentiation. These studies suggest that the LF field stimulation is altering gene expression for the two major extracellular proteins - proteoglycan and type II collagen thus constituting evidence for enhanced chondrogenic differentiation. Subsequent calcification and bone production are dependent upon the stimulation of mesenchymal precursor cells and the enhanced chondrogenic differentiation.

Growth factors and morphogens in two major gene families, TGF β /BMP, and IGF, are important in early chondrogenic differentiation and bone formation. Other presentations in this symposium will explore the effects of LF-EMF upon

these two major gene families in connective tissues. Together with data presented here, a plausible mechanism of action of ELF fields upon endochondral ossification, based upon alterations in gene expression, can be suggested.

MS-11-4

TGF β SUPER GENE FAMILY MEMBERS ARE EFFECTED BY ELECTRIC AND MAGNETIC FIELD EXPOSURE. D.McK. Ciombor. Department of Orthopaedics, Brown University School of Medicine, Rhode Island Hospital, Providence, Rhode Island 02903, USA.

Electric and magnetic fields have been shown to alter gene expression and synthesis of extracellular matrix proteins in several connective tissue models. The mechanism by which cells respond has not yet been fully elucidated. One hypothesis, involving the signaling response to EMF fields suggests that the endogenous growth factors are generated which then act in an autocrine and/or paracrine manner to amplify the biological response.

The TGF β super gene family contains several members which have been shown to be active in connective tissue. The bone morphogenic proteins (BMPs), as their name suggests were initially found in bone and were implicated early in fracture healing as both chemokines and morphogens. Since their discovery by Urist in the late 1960's BMPs have been identified as members of the transforming growth factor family and are encoded by different genes. The activity of TGF β and the BMPs have been well described in connective tissue systems both *in vivo* and *in vitro*. The effects seen vary largely due to dose and the specificity of the responding cell. Several groups, including our laboratory, have shown effects of EMF on connective tissue systems which are believed to be mediated by TGF β and the BMPs. Experimental endochondral ossification induced in adolescent male rats by subcutaneous implantation of decalcified bone matrix (DBM) in the manner of Reddi and Higgins. Animals bearing implants were placed in standard cages surrounded by current carrying coils, a PEMF was applied (EBI Bone Healing System), similar to that used clinically for bone healing. The field is of a pulse burst configuration with each burst lasting for 5 μ s and repeated at 15 pps. Control animals were treated identically but without exposure to the pulsed magnetic field. Exposure was carried out for 8 hours/day. The animals were sacrificed and the tissue resulting from the implantation (ossicles), was harvested on days 6 and 8 of formation, during peak chondrogenesis. Total RNA was extracted by the method of Chomczynski and sized for Northern blotting on a 1% agarose gel. Probes for aggrecan, TGF- β 1, osteogenic protein 1 (OP-1, BMP-7), IGF Ia and IGF II were labeled with 32 P by primer extension and used to identify appropriately sized messenger RNA. All mRNA was normalized for loading by a ratio to GAPdh, run concurrently ($n = 3 - 8$ / group).

These results, together with others showing an increase in mRNA for TGF- β (Bourginione, *et al.*) in dermal fibroblasts, BMP-2 and BMP-4 (Stevens, *et al.*; Nagai and Ota) in osteoblasts, suggest that an increase in gene expression of

local cytokines may be involved in the effect of pulsed fields on connective tissue.

Averaged Normalized Values

		Day 6 Control	Day 6 Exposed	Day 8 Control	Day 8 exposed
Aggrecan	8.0kb	3.9 ¹	13.3* ¹	6.2	17.8*
	7.4kb			6.1	22.5*
TGF-β1		19.2	28.2*	21.0	54.1*
OP-1	2.2kb	11.4	7.6	n.d.	n.d.
	1.4kb	17.7*	8.8	n.d.	n.d.
IGF-II		n.d.	n.d.	1.7	0.6
IGF Ia	8.0kb	0	5.8*	n.d.	4.8
	7.0kb	5.2	7.8*	2.8	n.d.

*=p≤0.05

¹=combined averages of 8.0 and 7.4 kb band

n.d. = not detectable

MS-11-5

COMBINED MAGNETIC FIELDS STIMULATE INSULIN-LIKE GROWTH FACTOR PRODUCTION BY POTENTIAL TRANSCRIPTION FACTOR-DEPENDENT MECHANISM(S). J.T. Ryaby¹, F.F. Cai¹, T.L. Howard¹, P.L. Culley¹, F.P. Magee¹, D.J. Baylink² and J.A. DiDonato³. ¹OrthoLogic, Phoenix, Arizona 85034, USA. ²Mineral Metabolism, Pettis VA Hospital, Loma Linda, California 92357. ³Department of Medicine, University of California, San Diego, La Jolla, California 92093-0636, USA.

INTRODUCTION: The ability to enhance fracture healing using an exogenous biophysical input, such as non-invasive combined magnetic fields (CMF), offers the potential for development of therapeutic devices for fracture healing and other musculoskeletal applications. The overall hypothesis of this research was that IGFs mediate the magnetic field stimulation of fracture healing. This hypothesis was tested in osteoblast and fracture callus, using the closed femoral fracture model in the rat. The results indicate that CMF stimulates IGF-I/II production in osteoblasts and fracture callus (1,2). To understand further the mechanism of these effects, we are using artificial reporter gene constructs to study CMF effects on transcription factor dependent regulation of gene expression. The transcription factors investigated to date are NFκB and several members of the STAT family.

METHODS: The osteoblast-like cell lines MC3T3-E1, TE-85, U2; and primary human osteoblasts (HOB) were maintained by weekly passage in DMEM or α-MEM containing 10% calf-serum. CMF (0.4 G sinusoidal p-p AC/0.2 gauss DC, 15.3, 76.6 Hz) exposure is generated by circular double-wound Helmholtz coil pairs with a toggle switch providing for true sham or active exposure conditions. Rat fracture callus was generated using the closed femoral fracture model (2). IGF-I and -II levels in conditioned medium were determined by radioreceptor and radioimmunoassay, respectively. For some experiments, osteoblasts were transiently transfected with 2X NFκB luciferase plasmid construct (J16) to assess CMF effects on transcription factor activity. For assessment of STAT

activity, electrophoretic mobility shift assays have been performed on nuclear extracts. Expression vectors for IκB and NFκB were used for co-transfection experiments.

RESULTS: CMF exposure for 30 minutes increased IGF-II levels in both TE-85 and HOB cells within 60 minutes post-stimulus. Fracture callus exposed *in vitro* also demonstrated increased levels of both IGF-I and -II. As a positive control, parathyroid hormone (PTH) increased IGF-I levels in fracture callus to a greater extent than did CMF compared to sham controls; with the converse observed for IGF-II levels. In transfected and non-transfected osteoblast-like cells, no direct effect on NFκB or STAT 3/5 activity has been observed. However, inhibition of cytokine induced transcription factor activation has been observed with CMF exposure.

DISCUSSION: These results demonstrate that short term exposure to CMF can stimulate production of IGFs in both osteoblast and fracture callus. Transcription factor activation has not been shown to be directly affected by CMF, although modulation of cytokine effects on i.e. NFκB have been observed. Present effort is focused on testing CMF effects on IGF promoter-reporter gene constructs and performing co-transfection experiments to delineate the signal transduction pathways responsible for CMF effects. In summary, these results suggest that one mechanism by which CMF may stimulate growth factor production is by inhibition of cytokine signaling activity *in vivo*.

References:

- 1) R.J. Fitzsimmons, J.T. Ryaby, S. Mohan, F.P. Magee, D.J. Baylink (1995) Combined Magnetic Fields Increase IGF-II in TE-85 Human Osteosarcoma Bone Cell Cultures. *Endocrinology* 136: 3100-3106.
- 2) J.T. Ryaby, R.J. Fitzsimmons, N.A. Khin, P.L. Culley, F.P. Magee, A.M. Weinstein, D.J. Baylink (1994) The role of insulin-like growth factor in magnetic field regulation of bone formation. *Bioelectrochemistry and Bioenergetics* 35: 87-91. This work was supported by NIH, Veterans Administration and OrthoLogic.

MS-12 — BIOENERGETICS

Organizers: Andrea Melandri and Dean Astumian

All membrane processes, particularly those involving transport of ions or electrons, are interlinked by the electric potential difference across the membrane. In this minisymposium, various aspects of the interaction between charge transport processes and electric fields (of either internal or external origin) will be discussed from both the experimental and theoretical perspective. Key questions include: What are the structural origins of field sensitivity?; How do imposed electric fields influence the function of charge transporter?; How is the interaction of an external field modulated by noisy fields present across all membranes?; Can charge transporter interact with each other to give rise to coherent behavior? These and other questions will be addressed by the five speakers in this minisymposium, with an eye towards clarifying possible avenues of approach towards a better understanding of the interaction between electric fields and biological organisms.

MS-12-1**STRUCTURE/FUNCTION RELATIONSHIP IN CYTOCHROME C OXIDASE OF *P. DENITRIFICANS*.**

B. Ludwig. Biozentrum, University of Frankfurt, D-60439 Frankfurt, Germany.

The 3D structures of a mitochondrial and a bacterial cytochrome c oxidase have recently been solved at 2.8 Å. Using the bacterial enzyme as (i) a structurally simpler model and (ii) a system easily amenable to mutagenesis, the function of its four subunits will be discussed in terms of current ideas of electron transport and proton translocation, including data from site-directed mutagenesis experiments. Specific reference will be made to the interaction of cytochrome c with the oxidase complex, the ligands for the Cu_A center in subunit II, to potential residues involved in providing proton pathways to/from the binuclear (heme-copper) center in subunit I, and to the function of its smallest subunit (IV).

MS-12-2

STOCHASTIC RESONANCE AND TRANSDUCTION OF ELECTRIC ENERGY BY Na,K-ATPase. T.Y. Tsong and T.D. Xie. Department of Biochemistry, University of Minnesota, Minnesota, USA and Department of Biochemistry, Hong Kong University of Science & Technology, Hong Kong.

Previous work has shown that F₀F₁-ATPase of mitochondria, Na,K-ATPase and Ca-ATPase of human erythrocyte, can harvest energy from applied electric fields to perform chemical work, e.g. synthesis of ATP, or pumping of cations uphill. In the case of Na,K-Pump, both oscillatory and fluctuating electric fields have been used as energy source. It was found that there were windows of field amplitude and field frequency for the optimal transduction of energy. An electric field of given amplitude, frequency, and waveform has all the elements of an electric signal. Thus, these observations are taken to mean that a membrane enzyme or transporter can recognize and interact with a specific electric signal to perform chemical work. This paper will summarize our previous data and then use the system to answer a crucial question in the study of the biological sensory transduction: Can a high level white electric noise mask, or amplify a low level electric signal in a biological signal transducer? A broad band white electric noise was added to different levels of electric signal, either in a sinusoidal or in a random-telegraph fluctuating waveform. Oubain-sensitive Rb pumping activity was measured with a signal plus an increasing noise level fed into the system. Results indicate that a low level electric noise enhances the efficiency of energy transduction. However, the effect diminishes at a high noise level. Stochastic Resonance will be discussed in the context of these experiments.

MS-12-3**SPONTANEOUS ONSET OF COHERENCE AND ENERGY STORAGE BY A MEMBRANE TRANSPORTER IN AN LCR ELECTRIC CIRCUIT.**

R.D. Astumian¹ and I. Derenyi². ¹Departments of Surgery and of Biochemistry and Molecular Biology, University of Chicago, Chicago, Illinois 60637, USA. ²Department of Physics, Eotvos University, Budapest, Hungary.

Recent experiments have shown that oscillating or fluctuating electric fields can drive thermodynamically uphill transport of ions catalyzed by a molecular ion pump, the Na,K ATPase. Energy from the field substitutes for the energy normally provided chemically by adenosine triphosphate (ATP). Theory suggests that if the transport reaction is very far from equilibrium the energy flow can be reversed - that power can flow from the downhill transport process into the electric field. Here we show that in an electric circuit with inductance, small fluctuations in the net polarization of the transporters in the membrane can be spontaneously amplified and entrained, resulting in the onset of coherent behavior and energy storage in the circuit. The calculations are done using realistic values of the kinetic constants and circuit elements, so the approach may form the basis for a technique to study the kinetic and dynamic behavior of membrane enzymes. More importantly, by splitting the system into a transport reaction with very simple linear kinetics, and a passive electric circuit, the results offer insight into mechanisms by which feedback allows for spontaneous oscillatory behavior when a system is far from equilibrium.

MS-12-4

TRANSIENT Na/K-ATPase CURRENTS: COMPARISON OF ATP CONCENTRATION JUMP OR VOLTAGE PULSE EXPERIMENTS. G. Nagel, T. Friedrich and E. Bamberg. Max-Planck-Institut für Biophysik, D-60596 Frankfurt, Germany.

We have shown that in a giant excised patch a transient outward current, followed by a decay to a stationary pump current, can be observed after photolysis of caged ATP with a laser flash of 308 nm wavelength (Friedrich *et al.*, 1996, *Biophys. J.* 71:2486-2500). This signal is Na and ATP dependent and can be abolished by ortho-vanadate. Whereas the rate of the decay of the signal is related to ATP and caged ATP binding and dissociation, the rate constant of about 200 s⁻¹ of the rising phase reflects a transport step of the Na,K-ATPase (presumably the E₁P-E₂P conformational change), which compares well with experiments using purified Na,K-ATPase on lipid bilayer membranes (Fendler *et al.*, 1987, *FEBS Letters* 224:83-88).

By subtraction of voltage pulse induced currents in the absence of ATP from the ones with ATP present, it is also possible to obtain Na,K-ATPase current transients with a monoexponential decay, with a rate constant which is the sum of the forward and backward rates of the voltage dependent equilibrium (Hilgemann, 1994, *Science* 263:1429-1432). We

obtained these voltage induced Na,K-ATPase current transients additionally from the same patch and the transferred charges and voltage dependent rate constants were compared with data from caged ATP experiments. Again we find a rate constant of about 200 s^{-1} at 24°C and 0 mV for the electrogenic forward step. We conclude from these extended measurements that the electrogenic Na^+ translocation step has a rate constant of 200 s^{-1} at 24°C and 0 mV or is limited by a preceding electroneutral step ($\text{E}_1\text{P}-\text{E}_2\text{P}$ transition) with this rate constant.

Supported by the Deutsche Forschungsgemeinschaft.

MS-12-5

BACTERIORHODOPSIN: A NON-LINEAR PROTON PUMP. R.A. Bogomolni¹ and H. Tributsch². ¹Department of Chemistry and Biochemistry, University of California, Santa Cruz, California 96064, USA. ²Department of Solare Energetik, Hahn-Meitner-Institut, 14109 Berlin, Germany.

The family of archaeobacterial rhodopsins structurally resemble the visual rhodopsins of higher animals. The bacterial sensory rhodopsins I and II (sR-I and sR-II) are also photosensory receptors (in bacterial phototaxis) but their signal relay mechanism requires interaction with membrane transducers homologous to eubacterial chemoreceptor proteins rather than with G-proteins as is the case in visual transduction. Bacteriorhodopsin, bR, and halorhodopsin, hR, however function as light-driven ion pumps for protons and chloride respectively converting photon energy into ionic electrochemical potential to drive metabolic processes. These different functions result from subtle modifications of a common molecular design.

Bacteriorhodopsin's pumping function is usually studied in subcellular vesicles or with purified bR reconstituted in lipid vesicles. In these systems we have recently observed light-induced oscillations in the membrane electrical potential and in the pH gradients generated by bacteriorhodopsin indicating that bR exhibits characteristics similar to those observed in non-linear systems exhibiting positive feedback and autocatalysis. Under specific illumination regimes, bR concentration and pH photo-oscillations became sustained. A series of control experiments designed to test whether these non-linear effects were contributed by other membrane components, strongly suggest that bacteriorhodopsin itself manifests the positive feedback elements necessary for this oscillatory phenomenon.

In liposomes, both damped and sustained oscillations in the pH of the medium were observed. Interestingly, the pH oscillation frequency was found to be half of that reported for the electrical potential by the fluorescent dyes. It appears that the dye responds to the field strength, irrespective of the sign of the field vector, whereas the pH oscillations are synchronous with the sign of the electrical potential gradient. Frequency entrainment, quasi periodic and chaotic responses were recorded in response to periodic light stimuli. The observation of sustained macroscopic oscillations implies that the entire liposome (or vesicular) ensemble appears to function in a synchronous way, suggesting that bR-generated

proton pumping waves must accompany membrane potential oscillations. Synchronization is perhaps elicited by the external pH since the proton pump is known to be pH and electric potential dependent and the absolute pH and buffering capacity of the solution strongly affected the presence and quality of oscillations. This photo-oscillating behavior reveals a new regulatory mechanism that could be relevant to both the sensory and energy transduction function of these chromoproteins.

MS-13 — IONIC CURRENTS IN DEVELOPMENT

Organizers: Richard Nuccitelli and Ken Robinson

The study of the role of ionic currents and electric fields in development has made impressive advances in the past few years. In this symposium we will first briefly review the historical development of the techniques used to detect embryonic fields and then researchers in this area will present their latest findings in support of an active role for electric fields in vertebrate development. The final speaker will describe new developments in measurement techniques to detect the specific ions carrying the current as well as a technique which will allow field detection outside of tissues in air, the biokelvin probe.

MS-13-1

LATERAL ELECTRIC FIELDS GENERATED BY WOUND CURRENTS IN HUMAN SKIN PROVIDE AN EARLY SIGNAL FOR WOUND HEALING. R. Nuccitelli¹, B. Farboud², K.S. Fang² and R.R. Isseroff². ¹Section of Molecular and Cellular Biology and ²Department of Dermatology, University of California, Davis, California 95616, USA.

Human skin is a polarized epithelial multi-layer that generates a transepithelial potential across itself of 16-60 mV, inside positive (Barker, *et al. Am. J. Physiol.* 1982; 242:R348-66). Any wound or break in the skin becomes a low resistance pathway for a wound current driven by the transepithelial potential. This wound current flows out the wound site from every direction in the epidermal multi-layer around the wound, and in so doing generates a lateral electric field in this multi-layer with the negative pole of the field at the wound site (fig. 1).

We have recently reported that human keratinocytes actively migrate towards the negative pole of a physiological dc electric field *in vivo* (Nishimura, *et al., J. Cell Sci.* 1996; 109:199-207; Sheridan, *et al. J. Invest. Dermatol.* 1996; 106:642-646). We found that keratinocytes migrate randomly on collagen in fields of 5 mV/mm or less, but in larger fields they migrate towards the negative pole of the field, exhibiting galvanotaxis. This cathodally-directed movement exhibits increased directedness with increasing field strengths between 10 and 100 mV/mm. We observed a maximally directed response at 100 mV/mm with half of the cells responding to the field within 14 min.

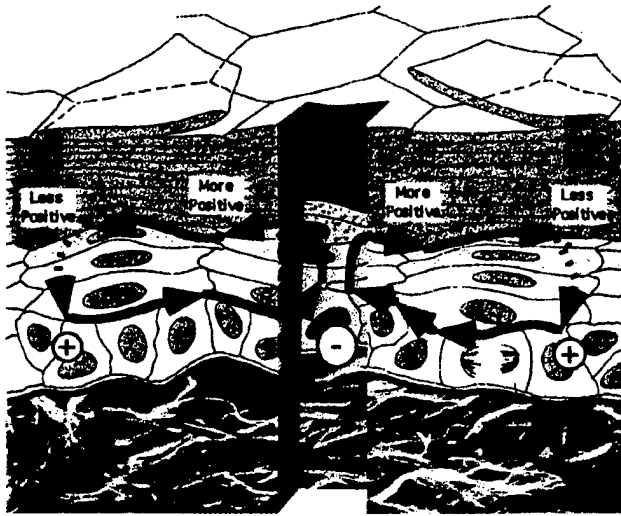

Fig. 1. Cut-away view of the wound current pattern in the multi-layered epidermis near a wound in human skin.

Here we report studies of the signal transduction pathways used by keratinocytes during galvanotaxis. We have used several inhibitors of protein kinases to investigate their involvement in galvanotaxis. The PKC inhibitors, H-7 and bisindolymaleimide I, did not inhibit galvanotaxis despite inhibiting PKC activity in keratinocytes. Similarly, the inhibitors of CaM kinase, W-7, and myosin light chain kinase, ML-7, had no effect on galvanotaxis. However, treatment with the protein kinase A inhibitor, KT5720, resulted in a two-fold decrease in directional response compared to controls while maintaining the same translocation speed. All of the tyrosine kinase inhibitors tested (genestein, lavendustin A, tyrphostin AG1478, tyrphostin B46 and PD158780) primarily decreased the migration rate but had little effect on directionality with one exception, PD158780. At concentrations of 0.5 μM and above, PD158780 abolished migration directionality and at 0.5 μM there was no reduction in translocation speed. We conclude that human keratinocytes use both PKA and tyrosine kinases in the signal transduction cascade involved in galvanotaxis.

MS-13-2

ELECTRIC EMBRYOS: THE EMBRYONIC EPITHELIUM AS A GENERATOR OF DEVELOPMENTAL INFORMATION. K.R. Robinson, M. Messerli and A. Palmer. Department of Biological Sciences, Purdue University, West Lafayette, Indiana 47907, USA.

Work in this laboratory has centered on two interrelated topics. One concerns the nature and mechanism of the responses of cultured embryonic cells to applied dc electrical fields. The second involves the measurement of endogenous electrical fields in embryos, the physiology of the generation of endogenous fields, and the developmental consequences of their disruption. Our overall aim is to determine if endogenous electrical fields provide spatial information for

the patterning of the developing vertebrate embryo.

It is now well established that applied electrical fields can influence the direction of growth and migration of embryonic cells *in vitro*. Unlike the controversial matter of the effects of weak, low-frequency electromagnetic fields on biological systems, the responses of cell to dc fields have been replicated in numerous laboratories in well-controlled experiments. As a consequence, the phenomena are relatively non-controversial.

Xenopus embryo spinal neurites in culture respond to an applied field by turning toward the cathode. The cells are able to sense astonishingly small fields, down to 7 mV/mm, which corresponds to a voltage difference across the growth cones of considerably less than 1 mV. Neural crest cells, which migrate long distances in vertebrate embryos in order to form the peripheral nervous system as well as other structures, are similarly sensitive to applied fields. They too exhibit a cathodal response and migrate toward the negative pole. *Xenopus* myoblasts show a different response. When allowed to develop in the presence of a field, they form their long axes parallel to field vector. Colin McCaig (University of Aberdeen) and his colleagues have recently enlarged the catalog of known responses. They observe that mammalian corneal epithelial cells, when grown in culture in the presence of a field of 150 mV/mm, align the plane of cell division at right angles to the applied field (personal communication).

Are the responses of cells to dc electric fields merely a laboratory curiosity or are they part of the normal development process? We have found that the embryonic epithelium becomes an active electrogenic organ almost as soon as it is formed, producing an inwardly-positive transepithelial potential. In addition, there are a series of developmentally-controlled leaks in the epithelium such that large currents leave the embryo, resulting in substantial electrical fields (up to 50 mV/mm) within the interstitial spaces of the embryo - the very spaces through which neurons and neural crest cells must grow and migrate to find their targets. If these fields are disrupted, development, particularly of the nervous system, is drastically altered. More recently, we have found that a fluorescently-labeled protein, when microinjected into the interstitial space of *Xenopus* embryos, diffuses asymmetrically and appears to be electrophoresed by the endogenous field. This raises the possibility that the endogenous fields regulate the distribution of secreted morphogenetic molecules that are involved in pattern formation. We see this as an alternate way that epithelially-generated fields may control development, in addition to the directional effects on cell growth and migration.

MS-13-3

ENDOGENOUS AND APPLIED ELECTRIC FIELDS DURING DEVELOPMENT AND REGENERATION OF THE CNS. R.B. Borgens. Center for Paralysis Research, Purdue University, West Lafayette, Indiana 47907, USA.

Early embryonic ectoderm possess a marked potential difference across itself. This ectodermal battery drives ionic

current out of the blastopore and margins of the neural folds, the latter disappearing when the neural tube is formed. Neural fold currents are associated with three dimensional gradients of extracellular voltage within the neural plate that can be modified by externally applied voltages. This results in severe developmental abnormality - particularly in that of the forming brain and spinal cord. Once the rudiments of the early brain and spinal cord are formed, a substantial electrical potential is maintained across their neuroepithelial walls. Experimental reduction of this potential by specific ion channel blockade results in disaggregation of these structures and a failure in morphogenesis, particularly in the developing cranial enlargement. Embryonic cells removed to culture from these normally developing regions of the embryo are very sensitive to gradients of applied voltage. Cell polarity, architecture, and migration can be strikingly altered or guided by weak, applied, DC fields. These observations suggest endogenous extracellular voltage gradients may act as an early control of morphogenesis and pattern formation. These studies have practical application in medicine. Applied voltages can induce regeneration of severed nerve processes in a variety of animal models including the adult guinea pig spinal cord, and are associated with a functional recovery from spinal cord injury.

MS-13-4

NEW PROBES FROM OLD ADVANCES IN THE NONINVASIVE DETECTION OF BIOCURRENTS.
P.J.S. Smith. BioCurrents Research Center, Marine Biological Laboratory, Woods Hole, Massachusetts 02543, USA.

Many aspects of cell biology depend on the flux of molecules asymmetrically distributed across the plasma membrane. Where changes in the flux are large and rapid, conventional electrophysiological methods record the voltage changes associated with their passage. However, many biological processes underlying ion transport, development, disease and repair involve slow changes in the flux of critical ions, such as calcium and protons. To measure, in real time, the flux of these ions under virtual 'steady-state' conditions requires a different approach to conventional techniques. Novel solutions utilizing self-referencing non-invasive probes are considered in this presentation.

The original self-referencing probes developed for biological use (Jaffe and Nuccitelli, 1974) comprised a high capacitance metal electrode vibrating at frequencies of 100 - 300Hz. This device capacitively couples to the weak voltages associated with transmembrane ion flux. The nanovolt signals are extracted via a lock-in amplifier. Over the years this system has been further developed to include 2-dimensional vectorial measurement and computer control. This original current probe has to its advantage both robustness and sensitivity but lacks the ability to discriminate specific ions or measure non-electrogenic events. Further, oscillating in a lissajous pattern it creates a vortex-like mixing, intrusive to all but the most robust cells. These problems are solved with the self-referencing ion-selective probes (see Smith, 1995).

These ion probes are new derivatives of the older self-referencing voltage probe but are based on commercially available ionophores. As with the current probe their strength lies in being self-referencing thus greatly reducing the drift inherent to ion-selective liquid membranes. An extracellular differential configuration also removes these electrodes from problems associated with a lack of selectivity and voltage sensitivity. Collectively, the ion-selective probes have opened up new horizons in the study of cellular ion homeostasis and transport, particularly in measurement of calcium, potassium and proton flux. Biological examples dealing with the neural tissues, including neurons and microglia, will be discussed illustrating the application of this technology to investigating the homeostatic ion regulation and the direct measurement of pump and porter activity.

Further techniques selective for particular ions or molecules are being developed using polarographic probes, where voltages applied to a reaction surface cause current to flow via redox chemistry. Our prototype system reliably measures oxygen gradients around single cultured cells. Many chemicals can be measured in this manner including nitric oxide, insulin and several other organic compounds.

All the techniques discussed measure weak voltages or measure chemical fluxes in aqueous media. Much biology, however, takes place at gaseous interfaces, such as plant growth and development, as well as human skin biology. Our next device, named the BioKelvin Probe, measures the frequently substantial aerial voltages associated with subcutaneous current flow. Preliminary data from this technique on photo and gravitropic responses in growing plant seedlings will be discussed.

Jaffe, L.F, and Nuccitelli, R. (1974) *J. Cell Biol.* 63, 614-628.
Smith, P.J.S. (1995) *Nature* 378, 645-646.

This work is supported by the NIH/NCRR program, grant no P41 RR01395 (PJSS).

MS-14 — TRANSDERMAL DRUG DELIVERY AND NONINVASIVE SENSING

Organizers: James Weaver and Russell Potts

Noninvasive medical procedures are of increasing interest for reasons of both health care quality and reduced cost. The use of electric fields to control and drive molecular transport has drawn particular attention because of (1) the prospect of achieving medically useful analyte sampling or drug delivery rates without mechanically invading the human body, and (2) electrical processes can be controlled by increasingly complex computer-based miniaturized systems at progressively lower cost. Important mechanistic and clinical issues will be presented by speakers who are active participants in this growing area of research and development.

MS-14-1

IONTOPHORESIS DRUG DELIVERY SYSTEMS P. Green. Becton Dickinson Transdermal Systems, Fairlawn, New Jersey 07410, USA.

Small wearable, battery powered transdermal patches are currently being developed by a number of drug delivery companies. These drug filled systems contain a microprocessor that is capable of delivering drugs, through the skin, in a variety of complex dosing patterns, rather like a noninvasive programmable infusion pump. In controlled human clinical trials, the safe and effective delivery of organic drug molecules as well as small peptides such as calcitonin and octreotide has been demonstrated. The drug delivery process, known as iontophoresis, is also utilized for acute and chronic administration of drugs which require tight continuous dosing or on-demand pulsatile delivery. Iontophoresis is expanding greatly the range of drug candidates for transdermal administration. For certain drugs iontophoresis is an enabling technology for commercial success.

MS-14-2

COMPARISON OF IONTOPHORESIS AND ELECTROPORATION: DRUG ENHANCEMENT AND TOLERANCE. V. Preat, A. Jadoul and R. Vanbever. Universite Catholique de Louvain, Unite de Pharmacie Galenique, 1200 Brussels, Belgium.

Drug delivery across skin offers a noninvasive, user-friendly alternative to conventional routes of administration. However, the skin's out layer, the stratum corneum, is an extremely effective barrier which prevents transport of most drugs at therapeutic rates. Chemical and physical approaches have been investigated to increase and extend transdermal drug delivery. Iontophoresis is an electrical method that has received widespread attention: a low density electric current (i.e. $< 0.5 \text{ mA/cm}^2$) applied for minutes or hours is used to drive molecular transport. Recently, intermittent application of short (e.g. ms), high voltage (i.e. 100V) pulses (electroporation) has been shown to increase transport across skin, probably by a mechanism involving the creation of transient aqueous pathways in the stratum corneum lipid bilayers. This report will give an overview of electrically enhanced transdermal drug delivery. It will focus mainly on the mechanisms involved in enhancement in drug transport, the parameters affecting molecular transport. Tolerance issues will be discussed.

MS-14-3

NONINVASIVE IONTOPHORETIC GLUCOSE SENSING. J.A. Tamada and R.O. Potts. Cygnus Therapeutic Systems, Redwood City, California 94063, USA.

Results from the Diabetes Care and Complications Trial show that tight blood glucose control significantly reduces the long-term complications of diabetes mellitus. In that study, frequent self-testing of glucose and insulin administration resulted in a significant reduction in long-term complications. This protocol, however, also resulted in a three-fold increase in the frequency of hypoglycemic incidents. Currently, self-testing requires a drop of blood for each measurement. The pain and inconvenience of self-testing, along with the fear and danger of hypoglycemia has led to poor patient acceptance of a tight control regimen, despite the clear long-term advantages. A continuously worn, non-invasive method to periodically measure glucose would provide a convenient and comfortable means of frequent self-testing.

Guy *et al.* demonstrated a non-invasive method to transport glucose through the skin using low level electrical current. The technique, called reverse iontophoresis, relies upon the outward migration of physiological ions (e.g., Na^+ , Cl^-) under the influence of an electrical potential. Through momentum transfer uncharged molecules such as water and glucose are also extracted in a process known as electroosmosis. Finally, due to the net negative charge of skin at physiological conditions, there is preferential cation transport, and hence, preferential glucose collection at the cathode.

To provide a quantitative measurement, the flux of glucose extracted across the skin must correlate with blood glucose in a predictive manner. The results presented here show a quantitative relationship between blood and extracted glucose in patients with diabetes.

MS-14-4

MEDIUM VOLTAGE SKIN ELECTROPORATION: THEORY AND EXPERIMENT. Y. Chizmadzhev¹, A.V. Indenborn¹, P.I. Kuzmin¹, S.V. Galichenko¹, J.C. Weaver², and R.O. Potts³. ¹The A.N. Frumkin Institute of Electrochemistry Academy of Sciences, 117071 Moscow V-71, Russia. ²Harvard-MIT Division of Health Sciences and Technology, Cambridge, Massachusetts 02139, USA. ³Cygnus Therapeutic Systems, Redwood City, California 94063, USA.

Transdermal drug delivery has well known potential advantages, which have motivated a variety of approaches to altering the skin's barrier to ion and molecular transport. The main barrier to charged species is the stratum corneum (SC), an approximately 20 μm thick layer that contains both hydrated corneocytes and multilamellar lipid bilayer membranes. Naturally occurring structures (sweat gland ducts and hair follicles) penetrate the SC. In the case of sweat gland ducts, the interior openings comprise "macropores" which below the SC are surrounded by two layers of cells connected by tight junctions. Such structures

are candidates for electroporation, in which the four bilayer membranes of the double cell layer is altered by applied voltages. In addition, the SC itself has been hypothesized to experience electroporation for short pulses that result in the transdermal voltage, U_{skin} , reaching 30 to 70 V. At low voltages, ionic transport takes place by iontophoresis, with U_{skin} of a few volts. The combined theoretical and experimental study presented here emphasizes the case of moderate transdermal voltages, 10 to 60 V.

Supported by the Russian Foundation for Basic Research grant No. 96-03-34059, Cygnus, Inc., grant RO1-ARH4921, and Whitaker Foundation grant RR10963.

MS-14-5

RECENT ADVANCES IN SKIN ELECTROPORATION: MECHANISM AND EFFICACY.

J.C. Weaver¹, U.F. Pliquett^{1,2}, T.E. Zewert¹, R. Vanbever^{1,3}, T.O. Herndon⁴, T.R. Gowrishankar¹, T. Chen⁵, M.R. Prausnitz^{1,6}, T.E. Vaughan¹, Y. Chizmadzhev⁷, V. Preat³ and R. Langer^{1,3}. ¹Harvard-M.I.T. Division of Health Sciences and Technology, Massachusetts Institute of Technology, Cambridge, Massachusetts 02139, USA; ²Present address: Fakultät für Chemie, Universität Bielefeld, Bielefeld, Germany; ³Universite catholique de Louvain, Unite de pharmacie galenique, Brussels, Belgium; ⁴Lincoln Laboratory, Massachusetts Institute of Technology, Lexington, Massachusetts 02173, USA; ⁵Department of Chemical Engineering, Massachusetts Institute of Technology, Cambridge, Massachusetts 02139, USA; ⁶School of Chemical Engineering, Georgia Institute of Technology, Atlanta, Georgia 30332, USA, ⁷The A.N. Frumkin Institute of Electrochemistry Academy of Sciences, 117071 Moscow V-71, Russia.

BACKGROUND: Rapid, controlled molecular transport across human skin is of great interest for transdermal drug delivery and non-invasive chemical sensing. The main barrier is the stratum corneum (SC), which can be described by a "brick wall" model in which the dead, hydrated corneocytes are the bricks, and the surrounding multilamellar lipid bilayer membranes are the mortar.

METHODS: We have carried out many studies using "high voltage" (HV) pulses (duration = 1 to 300 ms) that typically cause the transdermal voltage to reach $U_{\text{skin}} \approx 30$ to >100 V. Our hypothesis is that for such pulses the primary event is electrical creation of aqueous pathways that penetrate the multilamellar lipid bilayer membranes of the SC. Initial studies demonstrated that 1 ms pulses caused up to 4 orders of magnitude increase in transdermal transport for charged molecules up to $\approx 1,000$ gm/mol. Subsequent studies showed that larger, highly charged molecules such as antisense oligonucleotides ($\approx 7,000$ gm/mol) and heparin (3,000 to 30,000 g/mol) can be transported at useful rates, and that transport is spontaneously localized.

RECENT RESULTS AND THEIR POTENTIAL SIGNIFICANCE: Five questions must be answered affirmatively if skin electroporation is to make a major impact:

[1] Can rapid, controlled delivery of all sizes of molecules be accomplished? Yes - by using different pulsing protocols, some extended with chemical enhancers, almost any size molecule can be transported rapidly across human skin. In one broad extension "microconduits" are formed across the SC, so that, for example, large amounts of antibody molecules ($\approx 150,000$ gm/mol) were transported.

[2] Can a small area of skin suffice? Yes - spontaneous transport localization occurs with distant electrodes, so that specialized electrode/reservoir devices can be used to force transport through small, predefined regions, while simultaneously avoiding pain.

[3] Can inexpensive electronic devices be used? Yes - pulsing has a low duty cycle, and the computational requirements for a "smart technology" are modest.

[4] Can sensation and pain be minimized or avoided? Yes - specialized electrode/reservoir devices can localize electric fields to the SC, so that nearby nerves are not stimulated.

[5] Can acceptable levels of side effects be achieved? Probably - studies to date are extremely encouraging, but to date this question has been addressed in only a preliminary way.

PRESENT OUTLOOK: The mechanism of skin electroporation is consistent with all our results. Specifically, the primary event appears to be creation of aqueous pathway segments that connect adjacent corneocytes across the SC, forming straight-through, SC-spanning pathways. Secondary events such as heating or chemical interaction can cause changes in the primary pathways. If acceptable levels of side effects are found, skin electroporation should make a major impact in medicine.

Supported by NIH grant ROI-ARH4921, Whitaker Foundation grant RR10963, and the MIT Lincoln Laboratory Advanced Concepts Committee.

MS-15 — SOFT TISSUE HEALING

Organizers: Betty Sisken and Ruggero Cadossi

The papers in this minisymposium will discuss results on soft tissue lesions using direct current or electromagnetic fields. Dr. Miklavcic will present data on treatment of tumors with direct current, Dr. Goldman will discuss modification of proliferation in wounds using electric fields. Dr. Cadossi will demonstrate how electromagnetic field treatment will protect soft tissue from ischaemic injury. Drs. Sisken and McCaig will both discuss the use of electric or electromagnetic fields on growth and regeneration of primary nerve tissue.

GROWTH FACTORS IN PRESSURE ULCERS TREATED WITH ELECTRICAL STIMULATION.

R. Karba¹, B. Wraber-Herzog², H. Benko³ and J.T. Ryaby⁴.

¹Faculty of Electrical Engineering, University of Ljubljana, Slovenia. ²Institute of Microbiology, Medical Faculty, University of Ljubljana, Slovenia. ³Institute of the Republic of Slovenia for Rehabilitation, Ljubljana, Slovenia. ⁴OrthoLogic, Phoenix, Arizona 85034, USA.

Significant beneficial effect of pulsed electrical stimulation on healing of ischemic chronic wounds has been demonstrated in the past several-year study (*Wounds* 3(1), 1991, and *IEEE Trans Rehab Eng* 2(4), 1994). Stimulation parameters originally derived from functional electrical stimulation and mimic natural activity of motoneurons enervating skeletal muscles. Chronic wounds are all characterized by ischemia as the principal reason for their appearance and persistence. Slight, hardly perceivable contractions of electrically stimulated muscles in the wound area improve blood perfusion of tissues and consequently enhance or else trigger healing of chronic wounds. They are induced by 4-second trains of biphasic, charge-balanced current pulses of 0.25 ms and repetition frequency of 40 Hz, which rhythmically exchange with pauses of the same duration. Beside faster healing of pressure ulcers treated with electrical stimulation, development of thinner, more elastic and aesthetic scar was observed, leading in the long term to less wound reopening. Cascade of physiological processes, which lead to healing of the wound, is connected with the activity of growth factors and other cytokines. They are involved in signal transduction and co-ordination in the wound micro-environment. Analyses of endogenous growth factors in the wound exudate thus enable insight into the mechanisms of molecular regulation of the healing process. Our analyses of exudate from pressure sores treated with pulsed electrical stimulation involved three growth factors, which play major roles in the healing process. Platelet-derived growth factor (PDGF) is an important regulator of proliferation and migration of cells, which are involved in production of collagen and granulation tissue. Basic fibroblast growth factor (bFGF) was included as direct mediator of angiogenesis, and transforming growth factor β (TGF β) due to its role in formation of the extracellular matrix and scar.

Following introduction of electrical stimulation, significant lowering of PDGF and bFGF concentrations was observed in exudate from pressure ulcers, compared to the control period. It was accompanied by faster healing, which appeared contradictory. It can, however, be explained by possible effect of electrical stimulation on expression of cellular receptors for these growth factors and binding of initially free molecules from the extracellular fluid. Lower concentrations of PDGF and bFGF might also be actual normal concentrations required for successful healing, while higher values measured in wounds during control treatment reflected a system with lost control of growth factor production. Concentrations of TGF β in exudate from pressure ulcers were extremely low in the control period and also after beginning of electrical stimulation when the wounds healed successfully. This is

characteristic of wounds, which heal without formation of scar and the newly developed tissue closely resembles structure of the normal uninjured skin.

ELECTRIC FIELDS AND PROLIFERATION IN A WOUND MODEL.

R. Goldman. Department of Rehabilitation Medicine, University of Pennsylvania, Philadelphia, Pennsylvania, USA.

INTRODUCTION: It remains hotly debated whether electrotherapy promotes wound healing. An intriguing related question is if the ubiquitous skin battery provides a "natural electrotherapy". Our goal is to elaborate the DNA and protein synthetic response of dermal fibroblasts to electric fields similar to postulated endogenous fields in wounds.

METHOD: Dermal equivalent matrix (DEM) was used, as fibroblasts in this tissue construct are phenotypically similar to dermal cells. *Fabrication:* AG1519 dermal fibroblasts (human foreskin) were combined with rat tail collagen (Collaborative Biomedical) according to the method of Bell (1979). *Maturation:* Each matrix contracted into a disk about 1% its initial volume in 3 days, and 0.5% at 8 days in DMEM with 5-20% calf serum. *Electric exposure:* The dose (direct coupled) is defined as $E = \rho \times J$, where E is electric field, J is current density, and ρ is resistivity of matrix. Resistance was determined just before electric exposure by a four-point technique: Geometry of the matrix was determined optically, and ρ derived therefrom. Matrices were mounted in rectangular dishes (Quadriperm or Nunc) in polycarbonate mounts orthogonal to J . Current was pre-selected to provide a given E , and verified from the voltage across a 1,000K standard resistor measured with an HP 34401A digital multimeter. For most experiments matrices were mounted in serum free DMEM, but for some, 2% fetal calf serum. Matrices were then exposed to E for 12 hours, and pulsed with ³H-thymidine 16-24 hours after exposure onset. For some experiments ³H-proline label was applied for the total 24 hours. *Assay:* Matrices were collagenase-digested. DNA was determined by a fluorometric method and ³H-thymidine incorporation by TCA precipitation. ³H-proline incorporation measured total protein, collagen, and non-collagen protein.

RESULTS: *3 Day matrices:* Amplitude response was determined from 20 to 1000 mV/m, at 10 Hz, and 200-2000 mV/m, 66 kHz. A 30% decrease in ³H-thymidine incorporation was observed at 10 Hz (repeatably, from 8 to 1000 mV/m), and 66 kHz (200 and 500 mV/m). In some experiments, there was a corresponding decrease in total DNA/matrix. There was an increase in proline counts in media, but not in cells or matrix. *8 Day matrices:* At 10 Hz, total DNA increased significantly at 41 mV/m and 50 mV/m, but not at 20, or >60 mV/m. Consistently, ³H-thymidine increase was noted at 41 and 50 mV/m only. At 41 mV/m, both DNA and ³H-thymidine increase was observed at 10 Hz, but not at 100 Hz. At 41 mV/m, 10 Hz, ³H-thymidine incorporation was elevated at 18-24 hours after onset of electric exposure, and maximal at 18-22 hours.

DISCUSSION AND CONCLUSION: *Decrease* in cell number occurred over a broad range of amplitude and frequency in 3 day "immature" matrices, including the postulated endogenous range (<100 Hz and <100 mV/m). Additionally, we found evidence for a soluble protein factor in media which might mediate this response. However, *increase* in proliferation was observed for 8 day "mature" matrices, but to stimuli within a narrow window of amplitude and frequency. The S phase occurred from 18-24 hours after stimulus initiation, consistent with fibroblast cell cycle kinetics. We know that human replaces rat collagen in DEM with time, and suggest that this might mediate this difference in proliferative response. Further work will determine whether the extracellular matrix composition directs cells in wounds to undergo apoptosis, or proliferation in response to electric fields similar to endogenous fields.

Goldman R. and Pollack S. *Bioelectromagnetics*, 17: 445-449, 450-457.

NIH HD07425, KO8HD01065.

MS-15-3

ELECTRIC DIRECT CURRENT IN TUMOR TREATMENT. D. Miklavcic¹, T. Jarm¹, M. Cemazar² and G. Sersa². ¹University of Ljubljana, Faculty of Electrical Engineering, 1000 Ljubljana, Slovenia. ²Institute of Oncology, 1000 Ljubljana, Slovenia.

Throughout the history electrotherapy (ET) has been suggested repeatedly as a local treatment for cancer. In the last two decades however the number of scientific reports regarding ET increases constantly. ET has been used in experimental as well as in clinical oncology, both as the only mean and in combination with radiotherapy and chemotherapy. In our work ET by direct current (DC) in the range from 0.1 to 1.8mA of 15 to 90 minutes duration has been performed on different tumor models in immunocompetent and immunodeficient mice. The current was delivered via needle electrodes implanted in different numbers in the tumor and subcutaneously in surrounding healthy tissue. Also a configuration of the electrodes was used where both electrodes were placed outside of the tumor so that the current flowed through it ("field" configuration). The electrodes were made of different metals like Pt-Ir alloy, platinum, gold, silver and titanium. ET as a single shot treatment by means of direct current in the range of 0.2 to 1.8mA retarded tumor growth significantly; higher the currents greater the growth delay. The growth delay obtained was prolonged also by using longer treatment duration. In experiments where three electrodes were inserted in the tumor and two or three were placed subcutaneously outside of the tumor better effects were obtained when compared to single electrode treatment. By the use of multiple electrode array complete tumor remission was observed; at the highest current up to 40% cures were obtained. In anodic and cathodic ET (i.e. one of the electrodes inserted in the tumor, the other in its vicinity) and with "field" ET equal tumor growth delay was observed. The dynamics in the development of tumor necrosis after the treatment and tumor

growth following ET in different electrode configurations was however different in all three cases. The later observation lead us to suspicion of multiple mechanisms involved in observed phenomenon. By means of modelling current distribution and performing various measurements (i.e. bioelectric potential, pH, temperature, blood perfusion and oxygenation, metal dissolution from the electrodes) we considered various possible mechanisms. Within the current and treatment duration limits employed in our experiments the involvement of tumor bioelectric potential and its changes as well as tumor temperature rise have been ruled out on the bases of measurement results. The measurement of pH in all different electrode configuration and results obtained on the bases of mathematical model employed indicate extracellular shifts of pH as a major factor in the case of anodic and cathodic ET. The mechanisms underlying tumor growth retardation due to ET in "field" configuration however are still not completely clear. The results obtained on amount of metal in the tumor dissolved from the anode due to DC suggested involvement of other mechanisms than the suspected metal toxicity. Reduced tumor perfusion was observed after "field" ET but was highly dependent on tumor model used. Experiments performed by "field" ET on nude and immunocompetent mice using the same tumor cell line indicate the involvement of specific immune response. Furthermore combinations of ET by direct current with biological response modifiers such as IFN- α , IL-2 and TNF- α improved tumor response to ET. Very successful combinations proved to be a peritumoral application of tumor necrosis factor TNF- α and intratumoral application of genetically engineered IL-2 secreting CHO cells accompanied by ET in "field" configuration. Both combinations resulted in twenty to forty percent cures whereas in single treatments this was not the case.

MS-15-4

EVALUATION OF TWO PRF-EMF AMPLITUDES AND MELATONIN CONCENTRATIONS ON NEURITE OUTGROWTH IN DORSAL ROOT GANGLIA. B.F. Sissen¹, E. Leman¹, P. Resig¹, M. Markov² and A.A. Pilla². ¹Center for Biomedical Engineering and Department of Anatomy and Neurobiology, University of Kentucky, Lexington, Kentucky 40506-0070, USA. ²Department of Orthopedics, Mt. Sinai, New York, USA.

INTRODUCTION: Embryonic dorsal root ganglia neurons (DRG) grow and differentiate *in vitro* when treated with electric or electromagnetic fields (DC, PEMF and PRF-EMF), agents as dbcAMP, and growth factors, primarily nerve growth factor (NGF). The outgrowth of neurites (length and number) is used to determine these growth parameters. Virtually no studies have investigated the effects of melatonin on this *in vitro* system. Melatonin and its interaction with EMF is an area of intense research although most studies have focussed on this interaction in cancer cells. We report on melatonin's effect alone and on the action of melatonin with pulsed radiofrequency electromagnetic fields (PRF-EMF) of different amplitudes on the growth of cultured

sensory neurons.

OBJECTIVE: The objective of this study was to determine: (1) the influence of 27.12 MHz PRF-EMF of different amplitudes on neurite outgrowth in the presence or absence of NGF, (2) the influence of melatonin on the growth and differentiation of DRG sensory neurons and (3) the effect of melatonin and 27.12 MHz of different amplitudes on neurite outgrowth.

METHOD: Dorsal root ganglia from nine day chick embryo were explanted onto collagen-coated 12 well plates; 3-4 ganglia were placed in each well of two plates. They were fed with Neurobasal media containing B₂₇ supplement (Gibco Co., NY). Saline control solution and three concentrations of beta nerve growth factor (5, 10 and 20 ng/cc) were tested on sham (untreated) control explants and 27.12 MHz PRF-EMF treated explants to assess the interaction of PRF-EMF with NGF. Two concentrations of melatonin (0.03 mM and 0.003 mM, Sigma, St. Louis, MO) were also tested in wells of control and PRF-EMF plates. At the treatment time experimental plates were placed on top of a circular (20 cm diameter) pancake coil (computer-controlled softPulse, EPI, Pompano Beach, FL) for 30 min daily for 3 days. The PRF-EMF signal employed was a 500 μ sec burst of 27.12 MHz sinusoidal waves, repeating at 1 pulse/sec. The incident magnetic field tested had peak amplitudes in the wells of 0.1 and 0.2 gauss. The pancake coil was placed in an all-wood incubator heated remotely to 36-37°C. Sham controls (unexposed) were placed on top of the applicator when the coil was not powered for 30 min/day. The plates were cultured for a total of 60 hrs. after which both treated and untreated cultures were fixed in 10% buffered formalin or 4% paraformaldehyde. Data were collected on photographs by recording the length of neurites from the edge of the original explant to the tips of the growth cones (Sisken *et al.*, 1995). Significance between experimental and control was determined using a Two Factor Analysis of Variance.

RESULTS AND DISCUSSION: The overall objective was to screen various amplitudes to determine if there are specific "windows" of PRF-EMF for enhancing neurite outgrowth. Comparisons among all groups indicated that NGF addition consistently stimulated neurite length and that only 0.2 gauss PRF-EMF augmented this NGF-effect. The same type of augmentation occurred when neurite numbers were analyzed, that is an increase in numbers of neurites when explants were exposed to 0.2 gauss, but not with 0.1 gauss. The addition of melatonin alone produced inconsistent results when compared to unexposed saline controls. However, when explants were treated with 27.12 MHz PRF-EMF in the presence of either concentration of melatonin, significant stimulation of both neurite length ($p < 0.005$) and number ($p < 0.025$) was obtained with the 0.2 gauss amplitude signal but not with 0.1 gauss. The results of this study support our published results on the interaction of 27.12 MHz PRF-EMF and NGF (Sisken *et al.*, 1995) in stimulating neurite outgrowth *in vitro*. It also extends our initial observations of the stimulatory interaction of melatonin and a 2 gauss, 65 μ sec, 80 Hz, 27.12 MHz PRF-EMF signal that is to be reported at this meeting (Leman *et al.*, 1997). The stimulation of neuronal growth in terms of increased neurite number probably represents increased

preservation of neurons, an important aspect in an injury model which this DRG system represents. Elongation of the nerve cell body as measured by neurite length is another important parameter for determining nerve regeneration. This work was supported in part by Electropharmacology Inc., Pompano Beach, FLA.

MS-15-5

PROTECTIVE EFFECT OF ELECTROMAGNETIC FIELD EXPOSURE ON ACUTE SOFT TISSUE ISCHAEMIC INJURY. R. Cadossi. Department of Medical Oncological and Radiological Sciences, University of Modena, 41100 Modena, Italy.

Low frequency pulsing electromagnetic fields have been used to promote the healing of acute and chronic skins lesions. Positive effects of PEMFs have been reported both in animal studies and in humans. In addition PEMF exposure has proven to be able to limit tissue necrosis following an acute ischaemic injury. The protective effect of electromagnetic fields has been described in 3 different animal models, all having relevant clinical implications. PEMF have been able to increase the survival of the skin free flap in rats. In animals exposed to electromagnetic fields the percent of skin surviving the acute vascular deficit increased by 30%. Of course similar effects could be much more relevant if this effect could be observed in other tissues like the brain or the myocardium.

A study was conducted in rabbits undergoing an acute vascular injury of the brain, immediately after ligation of 3 arteries the head of the animals was exposed to PEMFs for 6 hours. Compared to controls exposed animals had a smaller necrotic area as measured by MRI, an increased number of healthy neurones as demonstrated by histology and finally the recovery of the animals as documented by somatosensory evoked potentials was earlier and more intense in exposed animals.

Finally we have recently completed a study with 340 rats in which an acute ischaemic myocardium injury was created by ligation of the left coronary artery. In these animals the necrotic myocardium was evidenced by vital staining with triphenyltetrazolium: a 30% reduction of the necrotic area was observed in the animals exposed to PEMFs (24 hours) as compared to the non-exposed controls. Prolonged exposure up to 6 days did not affect the area of necrosis. Injection of fluorescent microspheres evidenced an increase of vascular invasion of the necrotic area: 11.3% in controls as against 24.3% in the exposed animals. No effect from exposure to PEMFs was found in the reperfusion model.

The results reported here show that exposure to PEMFs is able to limit the area of necrosis following an acute vascular deficit. The effect is connected with the first hours of exposure. We suggest that the effect of the PEMFs is the protection of the "risk" area; a possibility is that PEMF reduce the damage caused by local accumulation of free radicals. The protective effect of PEMFs observed on necrosis from acute ischaemia, both in skin free-flaps in rats, in experimental cerebral infarcts in rabbits and in rat

myocardium infarcts is quite consistent, and might have important clinical implications.

MS-16 — BIOPHYSICAL MECHANISMS

Organizer: Jan Walleczek

In the search for the biophysical mechanisms by which electric or magnetic fields may induce biological responses, it is helpful to distinguish between primary physical and secondary biological mechanisms. This minisymposium provides information on both types of mechanisms. First, physically-plausible examples are given for primary field interaction targets in biological systems. Dr. Grissom (Univ. Utah) describes magnetic field interactions with electron spins during radical recombination processes ("magnetochemistry") in enzyme systems *in vitro*. The limits of magnetic field coupling to magnetite, a biogenic ferromagnetic material, are discussed by Dr. Kirschvink (Calif. Inst. of Technology, Pasadena), including the possibility of magnetochemical interactions near magnetite particles. Next, important characteristics of secondary biological mechanisms are examined which may help translate a microphysical field effect into a macroscopic biological response. The subsequent presentations focus on nonlinear processes as part of the secondary response mechanism. Dr. Collins (Boston Univ.) explains the phenomenon of stochastic resonance in biology within the context of enhancing the detection sensitivity of humans to external stimuli. Dr. Astumian (Univ. Chicago) discusses theoretical work showing that far from equilibrium conditions can enhance the sensitivity of a biochemical system to weak external fields. Finally, Dr. Eichwald (Stanford Univ.) reviews a general mechanistic framework which integrates primary magnetic field effects on radical recombination with secondary mechanism related to self-organized information processing in biological signaling.

MS-16-1

BIOCHEMICAL MAGNETIC FIELD EFFECTS THROUGH CHANGES IN RADICAL PAIR RECOMBINATION. C.B. Grissom. Department of Chemistry, University of Utah, Salt Lake City, Utah 84112, USA.

The rate of some biochemical reactions with radical pair intermediates can be altered by the application of a DC magnetic field in the range 10-3000 gauss (1-300 mT). The external magnetic field alters the rate of intersystem crossing between the singlet and triplet electron spin states, and thereby alters partitioning of the radical pair intermediate between nonproductive recombination and product formation. Our laboratory has used this technique to show that a kinetically-competent radical pair intermediate is formed in the coenzyme B-12 dependent enzyme ethanolamine ammonia lyase. We have now extended this approach to the study of a heme-containing enzyme, horseradish peroxidase.

In this reaction, the rate of electron transfer from substrate to enzyme shows a biphasic dependence on magnetic field in the range 10-1000 gauss (1-300 mT). The experimental magnetic field effect on electron transfer coincides with the calculated magnetic field dependence, as predicted by the diffusional model of radical pair recombination.

This work is supported in part by a grant from the National Institute of Environmental Health Sciences (ES05728).

MS-16-2

MAGNETITE AS A TESTABLE PHYSICAL MECHANISM FOR NON-SENSORY EMF BIOLOGICAL EFFECTS: ELF TO MICROWAVES.

J.L. Kirschvink¹ and M.H. Nesson². ¹Division of Geological & Planetary Sciences, California Institute of Technology, Pasadena, California 91125, USA. ²Department of Biochemistry and Biophysics, Oregon State University, Corvallis, Oregon 97331, USA.

Magnetite (Fe₃O₄) and greigite (Fe₃S₄) are the only ferro- or ferrimagnetic minerals that are known to be formed under biological control by living organisms. Matrix mediated biomineralization processes control the deposition of these minerals within membrane-bound vacuoles called 'magnetosomes', and their natural functions include acting as a biophysical transducer for magnetotaxis in microorganisms and magnetoreception in higher animals. However, clean-lab magnetometry and TEM studies of magnetic extracts from mammalian tissues indicate that additional magnetic material is present that appears unlikely to play a role in magnetoreception. Rock magnetic data from human and mouse brain in particular indicate a broad distribution of single-domain (SD) material, which is confirmed by the TEM examination of extracts. The data indicate the presence of dense aggregations of magnetically interacting SD magnetite particles, perhaps associated with specialized cells (magnetocytes). However, the organization of this material is far different than that of magnetite involved in sensory processes, as it lacks the coherent chain-like organization of the magnetosomes.

We have suggested that the strong static magnetic field surrounding these particles may be important for the promotion of magnetochemical reactions within or close to the magnetosome membranes¹, where the static field produced by the magnetite varies from ~10 mT up to 400 mT; this intensity range is enough to promote stability of triplet intermediate states in charge transfer reactions. As magnetite biomineralization evolved at least 2 billion years ago², evolution has had ample opportunity to exploit the unique environment of the magnetosome membrane for as yet unknown biochemical purposes.

Several recent theoretical analyses suggest that aggregations of biogenic magnetite may be capable of responding to artificial magnetic fields in both the ELF³⁻⁵ and microwave⁶ ranges, at field levels and power densities normally thought to be too weak to produce biological effects. These hypotheses could be tested by *in vitro* studies of culturable magnetite-precipitating cells.

1. Kirschvink, J.L. *EOS, Trans. Am. Geophysical Union* 75, 178-179 (1994).
 2. Chang, S.-B.R. & Kirschvink, J.L. *Ann. Rev. Earth & Planetary Sciences* 17, 169-195 (1989).
 3. Kirschvink, J.L. *Geological Magazine* 115, 139-150 (1978).
 4. Kirschvink, J.L., Diaz-Ricci, J., Nesson, M.H. & Kirschvink, S.J. *Magnetite-based Magnetoreceptors: Ultrastructural, Behavioral, and Biophysical Studies* (Electric Power Research Institute (EPRI), Palo Alto, California, USA, 1993).
 5. Polk, C. *Bioelectromagnetics* 15, 261-270 (1994).
 6. Kirschvink, J.L. *Bioelectromagnetics* 17, 187-194 (1996).
- Supported by Electric Power Research Institute Contract WO-4307-03.

MS-16-3

NOISE-ENHANCED SENSORY DYNAMICS. J.J. Collins. Department of Biomedical Engineering, Boston University, Boston, Massachusetts 02215, USA.

Traditionally, noise has been viewed as a detriment to signal detection and information transmission. Recently, however, it has been shown that noise can enhance the detection and transmission of weak signals in certain nonlinear systems, via a mechanism known as stochastic resonance (SR). In general, SR indicates that the flow of information through a system (i.e., the coherence between the input stimulus and the system response) is maximized when the input noise intensity is set to a certain value. In this talk, we describe studies wherein we demonstrate SR type behavior in: (a) model neurons, (b) rat cutaneous sensory neurons, (c) the human proprioceptive system, and (d) the human touch-sensation system. We discuss how from a bioengineering standpoint, this work suggests that it may be possible to develop a noise-based technique for lowering sensory detection thresholds in humans. Such a technique could be applied to healthy individuals and used in situations which require fine motor control. Such situations could involve the use of micro-devices, such as micro-controllers and micro-surgical instruments. From a clinical standpoint, a technique of this sort could be particularly relevant for individuals with elevated sensory thresholds, such as older adults and patients with peripheral neuropathy.

MS-16-4

ENHANCED SENSITIVITY OF A BROWNIAN BIOMOLECULAR MOTOR TO A WEAK EXTERNAL FIELD. R.D. Astumian and M.B. Tarlie. Departments of Surgery and Biochemistry, University of Chicago, Chicago, Illinois 60637, USA.

Recent work has shown that many biomolecular motors, (including DNA and RNA polymerase, kinesin, and myosin (muscle)) and pumps such as the Na,K ATPase can be modelled as Brownian ratchets, where ATP binding,

hydrolysis, and dissociation of products cause a time dependent modulation of the height of energy barriers along the kinetic pathway. We show that such a Brownian ratchet can have all enhanced response to an applied electric field, and the sensitivity (the change of the rate per change in field) is maximum at very small field strengths. The calculations can be done in the context of elementary diffusion theory and electrostatics, and analytic expressions given for simple model systems.

MS-16-5

SELF-ORGANIZED DYNAMICS IN BIOLOGICAL INFORMATION PROCESSING AND RESPONSE TO ELECTROMAGNETIC AND OTHER STIMULI. C. Eichwald and J. Walleczek. Bioelectromagnetics Laboratory, Department of Radiation Oncology, School of Medicine, Stanford University, Stanford, California 94305-5124, USA.

OBJECTIVE: Biological systems exhibit a complex response behavior when exposed to external stimuli, including biochemical as well as physical ones. Biological signaling processes become activated under far from thermal equilibrium conditions [1]. Within these signaling pathways protein molecules and specifically enzymes operate as control elements that transfer and process information [2]. Therefore, any change in the activity of these control elements induced by external perturbations - including electromagnetic fields - inevitably leads to a change in biological signaling processing. We argue that interpretation of electromagnetic field effects in biological systems has to account for both: (1) the primary physical interaction mechanism that enables the coupling of the external field to the biological system, and (2) the secondary biological response being related to information processing.

METHODS: A model is presented that includes: (1) a microscopic description of a primary coupling step for magnetic fields to enzymes based on radical pair theory [3], and (2) a macroscopic description for the secondary biological response based on self-organized, nonlinear dynamics. The latter description consists of a system of two coupled nonlinear oscillators representing enzyme-controlled reactions. The first, oscillator serves to encode information whereas the second oscillator acts as a detector. We discuss the response behavior of the detector to different kinds of stimuli including periodic and deterministic chaotic ones. In particular, the response behavior to sub-threshold perturbations is studied in the presence of noise from the perspective of stochastic resonance [4].

RESULTS: (1) The microscopic description based on radical pair theory in combination with enzyme kinetics enables an interpretation of reported magnetic field effects on the *in vitro* activity of B₁₂-dependent ethanalamine ammonia lyase [5]. A reasonable qualitative agreement between experimental data and model simulations is achieved [3]. (2) The macroscopic model of two coupled nonlinear oscillators shows that the detector is capable of generating information from sub-threshold input signals when exposed to noise. Information processing is enabled by the presence of noise (because the

input signal is sub-threshold) and is optimized by an intermediate level of noise. The latter represents the phenomenon of stochastic resonance, which has been observed in a great number of nonlinear systems including biological ones [4].

DISCUSSION: The approach outlined above represents a general framework for an interpretation of electromagnetic field effects in biological systems. The model is based on (1) a realistic description of the primary interaction mechanism in agreement with well-established physico-chemical concepts (radical pair mechanism), and (2) a macroscopic description of the self-organizing, nonlinear properties of biological information processing. Only the combination of both aspects allows for a self-consistent interpretation in agreement with physical (e.g., thermodynamics, energetics) and biological constraints.

[1] Eichwald, Kaiser, *Bioelectromagnetics* 16, 75 (1995); Eichwald, Walleczek, *ibid.* 17, 427 (1996).

[2] Bray, *Nature* 376, 307 (1995).

[3] Eichwald, Walleczek, *Biophys. J.* 71,623 (1996).

[4] Wiesenfeld, Moss, *Nature* 373, 33 (1995); Collins *et al.*, *Phys. Rev. E* 54, 5575 (1996).

[5] Harkins, Grissom, *Science* 263, 958 (1994).

MS-17 - NERVOUS SYSTEM

Organizers: S. Ghione and Mary Ellen O'Connor

The nervous system symposium covers five topics regarding current research on diverse aspects of the nervous system. Electric and magnetic fields have been shown to have effects on the electrical activity of the brain as well as on chemical transmission including norepinephrine, serotonin and the opioid system. Researchers will give a brief overview of their topic and then present the work from their laboratories. The relationship of the nervous system and behavior will be stressed in several presentations.

MS-17-1

EXTREMELY LOW FREQUENCY MAGNETIC FIELDS ALTER OPIOID FUNCTION: INVESTIGATIONS INTO THE DETECTION MECHANISM. F.S. Prato and M. Kavaliers. Bioelectromagnetics Western, Lawson Research Institute, Department of Nuclear Medicine and Magnetic Resonance, St. Joseph's Health Centre, London, Ontario N6A 4V2, Canada.

We have used a behavioural paradigm to investigate which energy transduction mechanism is implicated in the ELF attenuation of opioid-induced analgesia. Since 1984, it has been known that certain ELF magnetic fields can *reduce* the analgesic effect of either exogenous opiates (e.g. morphine) or endogenous opioids (e.g. enkephalin). We have demonstrated this effect in various species of rodents and molluscs and, in particular, the land snail *Cepaea nemoralis*. Other centres have reported that magnetic fields can affect

opioid-mediated actions in homing pigeons, mice and humans. After exposing large numbers of land snails in a variety of experimental protocols, we have accumulated evidence which suggests that the energy transduction mechanism:

1. does not involve induced electric fields. First, the effect does not scale with the frequency or amplitude of the ELF magnetic field [1]. Secondly, the effect could be shown to vary when the time derivative of the ELF magnetic field was held constant but the DC component of the ELF magnetic field was changed in direction [2].

2. likely does not depend on the presence of magnetite. The effect did not scale as predicted for a magnetite transducer, i.e. the effect should be greatest when the DC magnetic field component is at right angles to the AC magnetic field component [2].

3. is largely consistent with a parametric resonance model (PRM) with respect to ELF magnetic field frequency and amplitude response. In fact, the present PRM was used to predict the combination of ELF magnetic fields which would *increase* opioid-induced analgesia and preliminary data has confirmed this prediction [3]. As well, this combination of fields could decrease nociceptive sensitivity, indicative of the induction of analgesia [3].

4. is dependent on the presence of light. Effects of ELF magnetic fields on opioid analgesia are substantially reduced when the exposure occurs in the absence of light ($<10^{-6}$ W/m²) [4,5]. Further experiments suggest that the modulatory effects of light on the actions of the ELF magnetic fields occur at the detection mechanism rather than through any modifications in opioid function.

Further theoretical and experimental work should be directed towards:

1. incorporating conditions for non-parallel DC and AC magnetic fields and the light-dependency of the response into the resonance model, and

2. investigating the cellular site of action.

It is curious that both the detection mechanism operant in our opioid work and the mechanism implicated in animal magnetic orientation demonstrates sensitivity to both magnetic field direction and light. Is it possible that these mechanisms are, in fact, the same?

[1] Prato FS, Carson JLL, Ossenkopp K-P, Kavaliers M: Possible mechanisms by which extremely low frequency magnetic fields affect opioid function. *FASEB J* JUN/95, v9, p807-814

[2] Prato FS, Kavaliers M, Carson JLL: Behavioural evidence that magnetic field effects in the land snail, *Cepaea nemoralis*, might not depend on magnetite or induced electric currents. *Bioelectromagnetics* 1996, v17, p123-130

[3] Kavaliers M, Prato FS, Thomas AW: ELF magnetic fields increase opioid-induced analgesia in the land snail consistent with the predictions of the parametric resonance model (PRM) for K⁺. *18th Ann Mtg Bioelectromagnetics Soc*, 9-14/6/96 Victoria, British Columbia, p64-65, abs.B-4-4.

[4] Prato FS, Kavaliers M, Carson JLL: Behavioural responses to magnetic fields by land snails are dependent on both magnetic field direction and light. *Proc R Soc Lond B* 1996, v263, p1437-1442.

[5] Prato FS, Kavaliers M, Cullen AP, Thomas AW: Light-dependent and -independent behavioural effects of extremely low frequency (ELF) magnetic fields in a land snail are consistent with a parametric resonance mechanism (PRM). accepted for publication in *Bioelectromagnetics* 1996.

MS-17-2

EXPOSURE TO MAGNETIC FIELDS ATTENUATES SEVERITY OF SEIZURES DUE TO INJECTION OF PENTYLENETETRAZOL IN RATS. R.H. Lovely, J.A. Creim, L.A. Couch, D.J. Bates, D.L. Miller and L.E. Anderson. Pacific Northwest National Laboratory, Richland, Washington 99252, USA.

Experimental reports, small in number but consistent in effect, demonstrate that exposure to magnetic fields (MFs) is protective of induced seizures in animal models of epilepsy including 1) audiogenic seizures in genetically prone rats, 2) after discharge duration in kindled rats, and 3) in seizure severity, including lethality, in rats injected with the chemical convulsant pentylenetetrazol (PTZ). Ossenkopp and Cain (1991) first studied the effect of prior exposure to 60-Hz MFs on lethality induced by injection with PTZ and reported a 30% shift in the PTZ dose-response curve for rats exposed to MFs ranging from 0.05 to 0.185 mT for 60 minutes. In our labs we repeated these experiments and sham-exposed or exposed groups of 44 rats each to MFs for 60 minutes with a flux density of 0.1 mT followed by injection with 50, 55, 60 or 65 mg/Kg PTZ. All behavior was videotaped and scored by observers blinded to experimental conditions. Seizure severity was scaled as no response, loss of righting, tonic-clonic seizure and lethal outcome. The data were analyzed as cumulative prevalence of response outcome. Analysis of variance revealed effects of exposure on the prevalent outcomes of loss of righting, lethality and average seizure severity in those rats injected with 65 mg/Kg. No effects were observed at other doses. In light of the PTZ dose-notched effects, we reanalyzed the data reported by Ossenkopp and Cain and found that their observations of lethality were also significantly dose-notched at 60 mg/kg. No other dose of PTZ administered following exposure to 0.1 mT in their study produced significant differences in lethal outcomes. Though the two studies are consistent in observing a (high) dose-notched effect of MF on PTZ-induced behavioral outcome, we have no ready explanation for these observations. The dose-notching may be peculiar to the near-lethal dose administered ip. We are testing this hypothesis by switching to intravenous infusion via an indwelling jugular catheter to determine precise doses that produce initial focal seizure activity in individual animals (the myclonic jerk). If exposure to MFs do not alter the dose required to produce this initial focal seizure activity, then ours and other prior observations of a protective effect of MF exposure on PTZ outcome may be unique to the administration of near-lethal doses.

MS-17-3

HUMAN EXPOSURE TO OSCILLATING MAGNETIC FIELDS PRODUCES CHANGES IN PAIN PERCEPTION AND PAIN-RELATED SOMATOSENSORY EVOKED POTENTIALS. F. Sartucci¹, L. Bonfiglio¹, C. Del Seppia², P. Luschi², S. Ghione³, L. Murri¹ and F. Papi². ¹Dipartimento di Neuroscienze, Istituto di Neurologia and ²Dipartimento di Scienze del Comportamento Animale e dell'Uomo, University of Pisa, I-56126 Pisa, Italy. ³Istituto di Fisiologia Clinica, CNR Pisa, I-56126 Pisa, Italy.

In view of increasing human exposure to artificial magnetic fields, the interest in their biological effects is continuously growing. Previous studies by others and us have provided evidence that nociception is influenced by magnetic fields of a low intensity and extremely low frequency both in animals and humans.

We here report the effects of prolonged (2 hours) exposure to weak (0.2-0.7 Gauss), irregularly oscillating (0.026-0.067 Hz) magnetic fields generated by three pairs of orthogonal Helmholtz coils on human nociception. Pain perception thresholds were measured in eleven healthy volunteers by graded intracutaneous electrical stimulation before and after a two-hour magnetic or sham treatment. Pain-related somatosensory evoked potentials (SEPs) were also recorded under the same experimental conditions. After sham treatment, pain thresholds significantly increased, whereas after magnetic treatment a slight non-significant decrease in thresholds was found after both treatments pain-related SEP amplitude was reduced, but this decrease was more evident and statistically significant only after magnetic exposure.

The increase found in thresholds after sham exposure is attributable to stress-induced analgesia while their decrease after magnetic field exposure might indicate a suppression of stress-induced analgesia, in agreement with previous findings reported in animals. The significant reduction in the amplitude of pain-related SEPs observed after magnetic exposure provides the first evidence that human SEPs are influenced by this treatment.

MS-17-4

EFFECT OF PROLONGED EXPOSURE TO 50 Hz ELECTROMAGNETIC FIELDS ON NEUROTRANSMITTERS IN RAT BRAIN. L. Zecca, P. Cerretelli and C. Mantegazza. Istituto di Tecnologie Biomediche Avanzate-CNR, 20131 Milano, Italy.

Several *in vivo* studies described an effect of 50-60 Hz electromagnetic field (EMF) exposure on neurotransmitters, receptors and other structures of the brain. In the last few years epidemiology studies reported an increased risk of dementia related to occupational exposure to EMF.

We are summarizing here results on neurotransmitters and protein trend in rat brain after long term exposure to EMF given at different phases of the animal life. Particularly the concentration of norepinephrine (NE), serotonin (5-HT) and

its metabolite 5-hydroxyindoleacetic acid (5-HIAA) were measured in parietal and frontal cortex, and in ventral and dorsal hippocampus.

Three month old male rats (Sprague Dowley) and newborn rats on the first day of life were housed in three identical EMF exposure units for 10 months. Unit 1 was used for sham exposure, unit 2 was activated with 5 μ T - 1kV/m and unit 3 was activated with 100 μ T - 5kV/m. EMF exposure was 8 hours/day (9 a.m. to 5 p.m.) and 5 days/week (Monday-Friday). The adult rats were killed by decapitation after 1, 3, 6, 8 months of exposure and 2 months of field-off conditions. The newborn rats were sacrificed by decapitation at 2 weeks, 1, 3, 6, 8 months and 2 months of field-off conditions. The brains were immediately removed and frozen, dissected in different areas and assayed for neurotransmitter and protein content.

Changes in the trend of concentration of neurotransmitters were observed at different times. The concentration of 5-HT significantly increased ($p<0.05$) in frontal cortex of adult rats exposed for 1 month. In the parietal cortex of exposed adult rats was observed a significant decrease ($p<0.05$) in the 5-HIAA concentration after 3 months by comparing the sham group with pooled exposed groups. A significant decrease ($p<0.05$) for 5-HIAA content in parietal cortex was observed after 8 months in newborn rats exposed to the lower field strength. In the dorsal hippocampus a significant decrease ($p<0.05$) of the NE concentration was observed in newborn rats after 1 month exposure at lower field strength. In the ventral hippocampus a decrease ($p<0.05$) of the 5-HIAA content occurred in newborn rats exposed at lower field strength for 8 months plus 2 months in field-off conditions. A significant decrease ($p<0.05$) in the protein concentration of parietal cortex was found in rats exposed to both levels of field after 2 week. No changes were noted in the protein content of hippocampus.

An inhibition of the 5-HT system activity occurs in different brain regions (hippocampus and brain cortex) of rats exposed during the adult life and in rats starting the exposure on the first day of life as well. These effects are time-dependending and were observed at different periods in adult with respect to the newborn ones. The involvement of NE system was observed for the first time. A reversible impairment of the cortical maturation occurs after 2 week of exposure in newborn rats. All these data are in a good agreement with previous works and suggest that brain cortex and hippocampus are important target for EMF. Then EMF exposure could be regarded as a possible risk factor for neurodegenerative and psychiatric disorders. Based on this hypothesis further experimental and epidemiology studies should be planned in a near future.

This work was supported by ENEL-CNR Contract.

MS-18 — MICROWAVE AND MILLIMETER WAVE

Organizers: Shirley Motzkin and James Lin

It is well known that high power levels of nonionizing radiation can interact with living tissues. However, we do not know whether exposure to low levels are harmless or hold a threat still unproven. Cause and effect relationships have not

been demonstrated and mechanisms remain elusive. This minisymposium on microwaves and millimeter waves will introduce essential physical and biological concepts and report on experiments which have stimulated scientists throughout the world to labor in the vineyards of Bioelectromagnetics. We will introduce advances which have taken us to the state-of-the-art today. Although much work has been done, answers continue to be a source of contention and will remain contentious until mechanisms are understood. We hope to stimulate new ideas and extend the horizons to productive and fruitful conclusions.

MS-18-1

BIOLOGICAL EFFECTS OF MICROWAVE RADIATION. J.C. Lin. University of Illinois at Chicago, Chicago, Illinois 60607-7053, USA.

Our knowledge regarding the biological effects of microwave radiation has been increasing for several decades. It has become a focus of attention because of the accelerated use of microwave radiation for wireless communication over the past few years. Wireless communication systems use modulated forms of low power microwave radiation that was not investigated extensively in the past. It is well established that at sufficiently high power levels, microwave energy can produce adverse thermal effects on the functioning of the human body. However, aside from a skin burn that may result from direct contact with the radiating antenna, biological responses from gross tissue heating would be a minor consideration for exposure to radio frequency fields emitted by these wireless communication devices. Recent attention and research effort have converged on possible effects that may occur following prolonged or lifelong exposure at low levels. Since thresholds and SARs for biological effects both vary widely, many specific questions must be answered before any consistent, dependable and scientific conclusions can be drawn for the biological effects and safety of wireless mobile communication systems. Nevertheless, available data do not suggest any immediate cause for concern of an impending threat to the health of the population from acute or short term exposure to low level microwave radiation. Investigations to answer some questions are continuing. Many of them are designed to study the effects of long-term exposure. Some ongoing *in vitro* experiments include cell proliferation, DNA damage, gene expression, protein synthesis, embryonic development, and cancer promotion. The *in vivo* experiments involve DNA in brain cells, blood-brain barriers, neuroendocrine, electroneurophysiology, ocular effects, and CNS tumorigenesis that include T- cell lymphomas. This paper summarizes results from published studies and provides information on current research activity where appropriate. It includes carcinogenesis and cancer promotion by microwave exposure, and other *in vitro* and *in vivo* experimental studies that involve primarily the central nervous system and other tissues in the head. A brief description of epidemiological studies on microwave exposure is also included. When considering repeated, low level irradiation, the

possibilities of cumulative effects have been raised. While there is presently no confirmed evidence for cumulative effect, there is little information to the contrary. Large scale epidemiological investigations should also be undertaken among mobile communication and cellular telephone users who may be exposed to varying levels of microwave radiation over time. Better understanding is needed of the mechanisms of interaction between microwave radiation and biological systems, and of the significance of any observed effects. Enormous progress has been made in the difficult area of dosimetry. However, measurement of field distribution in and around a subject for exposure assessment remains a challenge, more so for large numbers of people. This type of quantitative information is also required for extrapolation from animal experimentation to human response.

MS-18-2

COMPUTER MODELING FOR MICROWAVE AND MILLIMETER WAVE DOSIMETRY. P. Bernardi, M. Cavagnaro and S. Pisa. Department of Electronic Engineering, University "La Sapienza" of Rome, 00184 Rome, Italy.

The evaluation of the field distribution and the temperature rise inside a body exposed to electromagnetic fields is important both for assessing safe human exposure, and for medical applications of EM fields. The field distribution depends on the exposed body geometry, the tissues electrical parameters, the source and environment characteristics.

While for simple geometries and exposure conditions the field can be evaluated by using analytical techniques, for real exposure conditions numerical techniques must be used [1]. In this last case it is essential to accurately model the radiating source, the inhomogeneous structure of the exposed body and reflecting objects eventually present in the exposure site [2].

Among the numerical methods, at present, the most interesting appears the finite-difference time-domain (FDTD) technique that allows the study of the field distribution inside a body exposed to a radiating source from RF to millimeter wave frequencies in a very efficient manner [3]. It is also possible to combine this technique with a finite difference scheme of the bio-heat equation for evaluating the temperature rise induced inside the body.

In this paper, the authors' most recent results obtained using this method will be outlined together with comparisons with results known in the literature.

[1] J.C. Lin, O.P. Gandhi, "Computational Methods for Predicting Field Intensity" in: *Handbook of Biological Effects of Electromagnetic Fields*, Edited by C. Polk and E. Postow, 1996.

[2] P. Bernardi, M. Cavagnaro, and S. Pisa, "Evaluation of the SAR Distribution in the Human Head for Cellular Phones Used in a Partially Closed Environment." *IEEE Transactions on Electromagnetic Compatibility*, vol. 38:3, pp. 357-366, August 1996.

[3] P. Bernardi, M. Cavagnaro, and S. Pisa, "Evaluation of the Power Absorbed in Human Eyes Exposed to Millimeter

Waves," *Int. Symp. on Electromagnetic Compatibility*, Rome (Italy), pp. 194-199, September 1996.

MS-18-3

RESONANCE RESPONSE OF *E. COLI* CELLS TO LOW INTENSITY MILLIMETER WAVES: DEPENDENCE ON CELL DENSITY AT DIFFERENT PHASES OF GROWTH. I.Y. Belyaev^{1,2}, Y.D. Alipov², V.S. Shcheglov² and V.L. Ushakov². ¹Department of Radiobiology, Stockholm University, S-106 91 Stockholm, Sweden. ²Department of Radiation Physics, Biophysics and Ecology, Moscow Engineering Physics Institute, Moscow 115409, Russia.

It has been shown in previous studies, that the effects of low intensity millimeter waves (MMW) on *E. coli* cells depend on: genetic peculiarities of a strain under study; growth stage of the bacterial culture; static magnetic field during exposure; time between exposure to microwaves and recording of the effect; power density (PD); frequency; and polarization of MMW. At the 51.755 GHz resonance frequency, the per-cell-normalized MMW effect was found to be cooperative, that is, to be dependent on cell density during exposure. This finding suggested an interaction of external applied fields with cell-to-cell communication. Cell density was also important in response of cells to weak electromagnetic fields (EMF) of extremely low frequency (ELF). It was hypothesized that the cells used chemical messengers or secondary radiation for intercellular communication in response to EMF. Only two cell densities were used in our previous research with MMW. In the present work, the resonance effect of MMW on *E. coli* cells was studied in the range from 4×10^7 to 9×10^8 cells/ml and compared with cooperativity in cell response to weak ELF magnetic fields. Since the resonant reaction of cells to MMW appeared to be dependent on the PD and phase of growth, the cell density dependence of the resonant MMW effect on *E. coli* cells at different non-thermal PD was investigated at logarithmic and stationary phases of growth. The *E. coli* K12 AB1157 cells were exposed to MMW at PD within 10^{-18} - 3×10^{-3} W/cm² and a frequency of 51.755 GHz. The changes in the genome conformational state (GCS) were analyzed by the method of anomalous viscosity time dependence (AVTD). Cells were exposed to MMW during 10 min at different cell densities. Before lysis, the cells were adjusted to the same cell density of 4×10^7 cells/ml and all AVTD measurements were run at this cell density. Significant effects were observed within 10-300 min after exposure. Kinetics of these effects depended on PD, stage of growth, and cell density during exposure. The MMW effect had a sigmoidal dependence on cell density during exposure with saturation at 6×10^8 cells/ml. Nalidixic acid, specific inhibitor of DNA-gyrase, was shown to abolish the MMW-induced changes in the GCS. The dependencies of MMW effects on cell density and the cell densities for saturation of the effects were very similar in this study and in previous study with weak ELF magnetic fields. Such similarities suggest the general mechanism for cooperative response of *E. coli* cells to weak EMF in wide frequency range. This

mechanism may include two stages: (i) primary reaction of some EMF-sensitive cells; (ii) secondary reaction of other cells which is caused by secondary radiation or/and chemical messengers such as radicals released by EMF-sensitive cells. The results suggest that DNA-gyrase is involved in the primary reaction of MMW-sensitive cells.

MS-18-4

SKIN: THE BEGINNING AND END OF MILLIMETER WAVE PENETRATION INTO THE BODY. M.C. Ziskin. Richard J. Fox Center for Biomedical Physics, Temple University Medical School, Philadelphia, Pennsylvania 19140, USA.

Skin is a fascinatingly complex structure with an efficiency of its construction carefully matched to its function. It is composed of epidermal, dermal, and subdermal layers, each of which is further divided into sublayers. Although histology is the primary technique for studying the skin, it is limited in portraying the skin's true dynamic three dimensional nature. The stratum corneum protects, while desquamating, the dermis binds, conforms, and protects while metabolizing and renewing, and the whole organ heals when injured. The skin has been found to possess many immunological functions and is now considered an important part of the immune system of the body.

The skin is especially important with respect to mm-wave irradiation as it is the site of the preponderant, if not total, absorption of the incident energy. Wavelengths of these energies are commensurable with the dimensions of biological structures within the skin. Interactions depend on the physical and electrical properties of these structures. These properties vary greatly depending on location in the body and on the state of hydration (sweating).

Cutaneous sensory receptors include rapidly adapting mechanoreceptors responding to an alteration of as little as 1 μm , nociceptors which fire in response to pinch or prick, and thermo-receptors which are exquisitely responsive to changes in temperature. Free nerve endings are found in all layers of the skin. Excessive stimulation of any of these receptors cause the sensation of pain. Pain is an important protective mechanism for avoiding excessive exposure to harmful environmental stresses.

MS-18-5

MILLIMETER WAVES: AN INITIATOR OF BIOELECTROMAGNETIC STUDIES. S.M. Motzkin. Polytechnic University, Brooklyn, New York 11201, USA.

Although high power levels of nonionizing radiation are known to destroy living tissues and cause heat related effects at select frequencies, intensities and periods of irradiation, it is still unknown whether electromagnetic fields (EMFs) at low levels are harmless or hold a threat yet to be demonstrated.

Early studies initiated primarily in the Soviet Union and other

Eastern European nations exposed a wide variety of organisms, cells, viruses, tumors, organs, and biopolymers to low level millimeter wave energy indicating sharp non-thermal frequency dependence suggestive of resonance for almost all biological components. Numerous studies undertaken reported widely divergent results and lacked reproducibility. The extensive variation in technical and experimental design, different species, biological cycles and exposures have prevented resolution of questions concerning bioeffect mechanisms. A knowledge of biophysical concepts and engineering technology are required to elucidate the molecular basis of EMF effects.

Minimal depth of penetration and maximum energy of absorption by surface cells suggest superficial effects. However, animal and human studies suggest internal structures affected by these physicochemical mechanisms, metabolism, rates of cell division may cause helpful or harmful effects.

The answers are inconclusive. To clarify our questions carefully done, replicable experiments must be carried out. Selected experiments will be discussed including *in vivo* and *in vitro* studies, relating to genetic systems, cellular, subcellular and organismal components as well as theoretical approaches.

MS-19 — POWER LINES AND PUBLIC HEALTH

Organizers: Ferdinando Bersani and Howard Wachtel

In its recent report the American National Academy of Sciences reviewed the scientific literature linking electrical power lines to human health effects - particularly childhood cancer. They concluded that these health effects could not be attributed specifically to the electrical and/or magnetic fields (EMF) produced by powerlines. However, they pointed out that the epidemiological evidence linking certain "High Current Configuration" powerlines with increased childhood cancer risk has yet to be adequately explained. This association was initially noted in two studies carried out in the Denver, Colorado (USA) area using a "wire code" exposure index based mainly on the thickness, and proximity of power lines (Wertheimer and Leeper, 1979 and Savitz *et al.* 1988). The elevated leukemia risk with high "wire codes" shown in these two studies was found again in Los Angeles, California (USA) - but as in the two Denver studies, no clear association with measured EMF and childhood cancer risk was seen (London *et al.* 1992). Recent European studies (primarily in Scandinavia) have reported additional epidemiological evidence suggesting that children living close to powerlines (high voltage transmission) suffer high rates of cancer than those living further away.

From these widespread studies it appears that there is something about living near certain types of power lines that is a risk factor for childhood cancer. However, no compelling link to EMF has emerged from an overview of the science--including numerous laboratory investigations as well as epidemiological ones-- What then is the basis for the connection between power lines and childhood cancer (or

other health effects)? This intriguing and very crucial public health question will be the focus of our symposium.

MS-19-1

ORIGINS OF THE "POWERLINE HEALTH EFFECTS" ISSUE AND ITS RELATIONSHIP TO THE INFRASTRUCTURAL DEVELOPMENT OF MODERN CITIES. H. Wachtel, Univ. of Colorado, Boulder, CO 80309 USA

The notion that living in homes near to certain types of power lines could be a health risk first came from a study carried out in Denver (Colorado, USA) by Wertheimer and Leeper (1979). They showed that children living within "High Current Configuration" (VHCC) corridors adjacent to thick wire transmission or distribution lines suffered an appreciably higher incidence of cancer (mainly leukemia). They attributed this elevated cancer risk to the 60 Hz magnetic fields produced by such power lines but they did not actually measure the fields in the children's homes. In a subsequent study by Savitz, Wachtel, Barnes, Trvdik and John (1988) both the "wire code" scheme (of Wertheimer and Leeper) and magnetic field measurements in homes were utilized. This study confirmed a childhood cancer risk associated with power line type and proximity--but not with magnetic fields measured in the homes. A similarly dichotomous result was obtained in Los Angeles a few years later by London *et al* (1991) who again showed a childhood leukemia risk associated with proximity to VHCC but not with measured magnetic fields--even though they extended these measurements to 24 hours or longer. These three USA epidemiological studies along with comparable results from Scandinavia inspired an extensive program of laboratory studies (using intact animals as well as isolated cells and tissues). As a whole, these biological studies have not been able to substantiate carcinogenic effects from exposure to the magnitudes of 60 Hz magnetic fields found in homes (below 1 microtesla). This was emphasized in the recent report of the USA National Academy of Sciences.

What other physical or chemical agents may be linked to proximity of VHCC distribution (or transmission) lines--and are such agents plausibly carcinogenic? Some insight into this important question can be gleaned simply by examining how modern cities (such as Denver and Los Angeles) evolved with highly interrelated infrastructural features. As these cities grew rapidly over the past century, high capacity power lines (VHCC) tended strongly to be co-located with major traffic avenues. This pattern became even more dominant in the past several decades since "Residential Underground Cable" has been used to create low traffic (cul-de-sac type) neighborhoods bordered by highly trafficked boulevards. Such patterns of urban development yield intrinsic relationships between "wire code" categories and several environmental factors--such as localized air pollution; nocturnal lighting, noise--as well as socioeconomic status. There is evidence that volatile organic compounds (e.g. Benzene) in automobile exhaust fumes are carcinogenic in adults but the issue has not been clarified with regard to

childhood cancer. The carcinogenic plausibility of other agents related to power line (VHCC) proximity is even less clear but has to be viewed in comparison to the implausibility of weak magnetic fields acting as carcinogens.

MS-19-2

EVALUATION OF BIAS IN EPIDEMIOLOGIC RESEARCH. K.L. Ebi. Electric Power Research Institute, Palo Alto, California 94303, USA.

Results from epidemiologic studies may provide important information when deciding whether or not a risk factor is a cause of a disease. The established criteria for evaluating causality include an assessment of whether or not the results of epidemiologic studies are valid and reproducible. A lack of validity can arise from a number of potential sources of error which may bias the estimates of the association between the risk factor and the disease. Some of the important potential sources of error in studies of the association of cancer with living close to higher voltage power lines include selection bias and confounding. Selection bias can arise when there are systematic differences in the characteristics of those included and not included in a study. For example, this could result if controls living closest to higher voltage power lines were under-represented. Confounding can arise when both the exposure and the health outcome are associated with another factor. Recent research suggests that residences close to higher voltage power lines have several neighborhood factors in common other than potentially increased exposure to magnetic fields. Two of these factors, rental status and traffic density, are associated with childhood cancer, proximity to power lines and with each other, creating the potential for confounding of the association between power lines and cancer. Criteria will be presented for evaluating the reported associations between cancer and proximity to higher voltage power lines.

MS-19-3

CHILDHOOD CANCER RISKS ASSOCIATED WITH RESIDENTIAL ENVIRONMENT AND LIFESTYLE FACTORS LINKED TO HIGH WIRE CODE HOMES. R.L. Pearson, Radian International LLC, Denver, Colorado USA.

Past epidemiological studies have observed that high wire codes, devised as a surrogate metric for exposure to magnetic fields from power lines near a home, are associated with childhood cancer occurrence while measured magnetic fields from these power lines are not. This apparent paradox has several possible explanations. One such explanation is that another factor such as exposure to an environmental pollutant or a socioeconomic or lifestyle characteristic of the family may be more directly linked to cancer occurrence. We have determined that in Denver wire code is associated with many factors related to the home and neighborhood including the layout of streets in the neighborhood, the age of the home, the

location of the home within the city, whether the home is rented or owned, the type of water main serving the home and the traffic density on nearby streets weighted for distance. We have also determined that rental housing in the Denver area tends to be in higher traffic areas of the city. Of these wire code associated factors, rental status of the home and distance weighted traffic density of nearby streets are also associated with childhood cancer occurrence. In addition, we have suggestive evidence of confounding of wire code childhood cancer risk by distance weighted traffic density. We are continuing to explore distance weighted traffic density as a link to a causal agent for childhood cancer. This work is being sponsored by the Electric Power Research Institute under contract number WO2964-22.

MS-19-4

CHARACTERISTICS OF ELECTRIC AND MAGNETIC FIELDS PRODUCED BY POWER LINES BY COMPARISON TO CURRENTS KNOWN TO PRODUCE ADVERSE HEALTH EFFECTS. F. Barnes. University of Colorado, Boulder, Colorado 80309, USA.

The magnetic fields generated by power lines have been reputed to be associated with a variety of health effects including the incidence of childhood cancer. In this paper we will provide some estimates of the induced currents which may be generated by these time-varying magnetic fields in typical environments. These currents will be compared with naturally occurring currents and induced current densities which are known to produce biological effects such as shock and changes in the growth rates for cells.

In addition to comparing amplitudes, the fluctuating nature of naturally occurring signals will be compared to the stable or coherent characteristics of the fields from power distribution systems. The implications of this difference on possible detection of low-level signals by biological systems will be discussed in terms of the signal-to-noise ratio and the effective time over which the biological system may be expected to integrate an externally applied signal. The possibility of direct magnetic field interactions will be briefly discussed.

MS-20 — MACROMOLECULAR SYNTHESIS

Organizers: Reba Goodman and Jerry Phillips

Numerous reports in the bioelectromagnetics literature have documented a variety of effects of electromagnetic field stimulation on animal and cellular systems. Although no biological mechanisms have yet been demonstrated to explain how these effects might occur, many of them appear to require changes in gene expression. Characteristic of gene expression is the synthesis of macromolecules: RNA from DNA through the process of transcription; protein from RNA through the process of translation; and DNA itself during replication that precedes cell proliferation. All of these processes require the input of signals which are transduced

into molecular actions that lead to changes in cellular structure and function. It is the purpose of this minisymposium to discuss these processes and the role that electromagnetic field exposure might play in their regulation.

MS-20-1

CHANGES IN GENE EXPRESSION FOLLOWING EMF EXPOSURE. G.E. Woloschak¹, T. Paunesku¹, C.M. Chang-Liu¹, L. Loberg², J. Gaugher², D. McCormick² and A. Milosavljevic³. ¹Center for Mechanistic Biology and Biotechnology, Argonne National Laboratory, Argonne, Illinois 60439-4833, USA. ²IIT Research Institute, Chicago, Illinois 60616-3793, USA. ³CuraGen Incorporated, Branford, Connecticut 06405, USA.

OBJECTIVE: We have hypothesized that specific genes are modulated in response to low-frequency EMF. Identification of these genes will determine specific intracellular pathways affected by the exposure. In the experiments reported here we have documented changes in gene expression associated with 24 h of EMF exposure.

METHOD: Exposures were set up using 60-Hz magnetic fields at an intensity of 1G for lengths of time up to 24 h. Experimenters were blind as to which cultures were exposed. We applied the technique of differential display for detection of mRNAs induced in cells following EMF exposure. RNAs were harvested, and cDNAs were synthesized using reverse transcriptase; they were then amplified using conditions previously described. A sensitive differential display gel was run using ³²P-end-labeled primers and comparing the patterns of expression in unexposed and EMF-exposed cells. Bands showing differential expression were first partially sequenced and then screened on high-density filters arrayed with 31,000 ordered cDNAs (normalized human infant brain library of B. Soares). Positive clones, which represent those present in the induced bands, were scored by computer analysis after screening membranes with a mass probe. Once positive clones were identified, the cloned cDNA represented in the dot was selected from the freezer and used for further sequencing and studies of EMF-induction. Determinations of the sequence of input bands that scored positive vs. the sequence of identified cDNA clones that scored positive were compared.

RESULTS: Most of the changes in gene expression accompanying EMF exposure were moderate, ranging from 20-100%. However, differential display analysis of approximately 5% of the genome of expressed sequences revealed that four genes changed following EMF exposure. Bands from the differential display gels were extracted and sequenced.

DISCUSSION: While the changes in gene expression observed here were modest, the fact that several genes changed following EMF exposure suggests that there is a cellular response to EMF. Since these changes are modest, the biological significance is unclear. Identification of additional genes which may be altered in expression following EMF exposure is underway.

Supported by the U.S. Department of Energy, Office of Health

and Environmental Research under Contract No. W-31-109-ENG-38, and by NIH Grant #ES-07141-02.

The submitted manuscript has been created by the University of Chicago as Operator of Argonne National Laboratory ("Argonne") under Contract No. W-31-109-ENG-38 with the U.S. Department of Energy. The U.S. Government retains for itself, and others acting on its behalf, a paid-up, nonexclusive, irrevocable worldwide license in said article to reproduce, prepare derivative works, distribute copies to the public, and perform publicly and display publicly, by or on behalf of the Government.

MS-20-2

ELF-PULSED MAGNETIC FIELDS MODULATE OPIOID PEPTIDE GENE EXPRESSION IN MYOCARDIAL CELLS. C. Ventura¹, G. Pintus¹, G. Gottardi² and F. Bersani². ¹Institute of Biological Chemistry, School of Medicine, University of Sassari, 07100 Sassari, Italy. ²Department of Physics, University of Bologna, 40100 Bologna, Italy.

The possible influence of electromagnetic fields on gene transcription and translation is currently under study and debate. In particular, Grey provided evidence that the endogenous opioid systems can be affected by electromagnetic fields (Frey, *FASEB J.*, 7, 272-281, 1993). We have previously shown that the myocardial cells express both the prodynorphin gene and dynorphin B, a biologically active end-product which acts as a selective k opioid receptor agonist (Ventura *et al.*, *J.B.C.* 269, 5384-5386, 1994). In addition, the stimulation of cardiac k opioid receptors has been found to play a crucial role in the regulation of cytosolic Ca²⁺, pH homeostasis and cell contractility. The present work aims at investigating whether this dynorphinergic system may be affected by pulsed magnetic fields (PMF), of the type previously proved to be effective in promoting bone repair and modulating immune cell functions (Cadossi *et al.*, *FASEB J.*, 6, 2667-2674, 1992). Adult ventricular cardiac myocytes were enzymatically disassociated from the hearts of 2-3 month-old Wistar rats. The myocytes were then exposed to 50 Hz PMF with peak intensity of 1.4 mT, generated by a pair of Helmholtz coils connected to a pulse generator. Opioid peptide gene expression was investigated by assessing the levels of prodynorphin mRNA by the aid of a sensitive solution hybridization RNase protection assay. The exposure of myocardial cells to PMF for 4 h induced a 4-times increase in prodynorphin mRNA (8.7 pg mRNA/mg total RNA), as compared with unexposed cells (2.4 pg mRNA/mg total RNA). We also evaluated the expression of immunoreactive dynorphin B, as an index of prodynorphin mRNA translation into a biologically active opioid peptide. The results showed that the amount of dynorphin Bin the cells was significantly lower than that detected in their incubation media, suggesting a constitutive release of the opioid peptide shortly after synthesis. Interestingly, myocyte exposure to PMF significantly increase the levels of both intracellular and secreted dynorphin B. Our findings also suggest that the increase in prodynorphin gene expression elicited by PMF

might affect the cardiac cell functions through an autocrine mechanism.

MS-20-3

THE CELLULAR STRESS RESPONSE IS INDUCED BY ELECTROMAGNETIC FIELDS. R. Goodman¹, H. Lin¹ and M. Blank². Departments of ¹Pathology and ²Physiology, Columbia University Health Sciences, New York, New York 10032, USA.

Cells respond to electromagnetic (EM) fields as an environmental stress. Many lines of evidence show that exposure to environmental level 60 Hz EM fields induces stress genes and stress response proteins at normal growth temperatures. The induction of stress gene expression, by heat and other forms of stress, creates a programmed response in the genome of all eukaryotic and prokaryotic organisms and has used as a paradigm for inducible gene expression. The basic stress response (e.g., the reactions to sudden elevated temperature of heat shock, the introduction of heavy metals or amino acid analogs) occurs via a biochemical pathway that utilizes latent monomeric transcription factors (referred to as heat shock factors) that trimerize and translocate to the nucleus where they bind to heat shock elements, specific DNA sequences in the promoters of stress-inducible genes. Heat shock elements are composed of pentanucleotide modules, nGAAn, arranged as contiguous inverted repeats that bind heat shock factors (four have been identified), usually heat shock factor 1 the inducible transcription activator that regulates the transcription of these stress inducible genes. This sequence of events is similar in plant, animal and bacterial cells.

Several lines of evidence indicate that EM field exposure induces the expression of heat-inducible genes in the absence of elevated temperature:

- increased transcript levels for several stress genes, including HSP70, in dipteran salivary gland cells, yeast and human cells,
- activation of the heat shock puff that codes for hsp70 in *Drosophila melanogaster* salivary gland chromosomes,
- identification of the region of HSP70 promoter, sensitive to EM fields,
- increased binding activity of the heat shock element (HSE) to the HSP70 promoter, and
- alterations in protein synthetic patterns similar to those seen following heat shock.

The different effects of continuous and repeated EM field exposures demonstrate autoregulatory (feedback) control features in the EM-stimulated stress response that are similar to thermotolerance. Of particular interest is the emerging role of the chaperones (e.g., hsp70, hsp90) in facilitating assembly and movement of cellular proteins during stress and recovery from stress. The "recovery" from stress, specifically the phenomenon of down-regulation, suggests that the products of the stress genes themselves autoregulate the response.

Stimulation with low-frequency EM fields (<300Hz) points to an environmental stress that induces a cellular response

similar to that caused by increased temperature, but without elevated temperature. Although details of the mechanism of interaction of EM fields with cells remain unknown, the induction of the stress response appears to be an appropriate cellular response to a stimulus that is not normally part of its environment, and this may well provide a clue to the mechanisms involved.

We thank the NCI, the US Department of Energy and the Heineman Foundation for their support.

MS-20-4

THE BIOLOGICAL EFFECTS OF MICROWAVE RADIATION. S. Kwee¹ and P. Raskmark². ¹Institute of Medical Biochemistry, University of Aarhus, DK-8000 Aarhus C, Denmark. ²Institute of Communication Technology, Aalborg University, DK-9220 Aalborg Ø, Denmark.

In recent times the use of mobile telephones has accelerated, resulting in an increasing exposure of the environment to weak radiofrequency (RF) fields, transmitted from these devices.

In previous work we showed that cell growth is affected by exposure to weak electromagnetic (ELF) fields¹. Consequently the next thing to investigate was, if EM fields generated by microwave radiation, would have a similar effect on cell proliferation.

The field was generated by signal simulation of the Global System for Mobile communications (GSM) of 960 MHz. Cell cultures, growing in microtiter plates, were exposed in a specially constructed chamber, a Transverse Electromagnetic (TEM) cell. The Specific Absorption Rate (SAR) values for each cell well were calculated for this exposure system².

Experiments were performed on cell cultures of transformed human epithelial amnion cells (AMA), which were exposed in the TEM cell to 960 MHz microwave fields at 3 different power levels. The cells, growing in microtiter plates in monolayer cultures, were exposed for 20, 30 or 40 min respectively. Cell proliferation was determined immediately before exposure and again after a 24 hours' growth period. It was found that cell growth in the exposed cells differed from that in the control and sham exposed cells and a decrease in cell growth was seen. Cell proliferation during the period following exposure not only varied with the various SAR levels, but also with the length of exposure time. On the other hand repeated periods of exposure did not seem to change the effects. There was a general linear correlation between power level and growth changes.

However, the exposure time required to obtain the maximum effect was not the same for the various power levels. It turned out that at low power level the maximum effect was first reached after a longer exposure time than at higher power level. A similar phenomenon was registered in our studies on ELF electromagnetic fields³. Here we found that there was a linear correlation between the length of exposure time to obtain maximum effect and the field strength. The explanation could be found in terms of "window" effects or adaptation.

References:

1. S. Kwee and P. Raskmark: Changes in cell proliferation due to environmental non-ionizing radiation, 1. ELF electromagnetic fields. *Bioelectrochem. Bioenerg.* 36 (1995) 109.
2. K. V. Steffensen, P. Raskmark and G. F. Pedersen: FDTD calculations of the EM-field distribution in a microtiter suspension well. *Proceedings of the 244 COST meeting on "Biological effects relevant to amplitude modulated RF fields"*. Kuopio, 1995.
3. S. Kwee and P. Raskmark: The minimizing effect of electromagnetic noise on the changes in cell proliferation caused by ELF electromagnetic fields. *Proceedings of the 3rd International Congress of the European Bioelectromagnetics Association.* Nancy 1996.

MS-20-5

USE OF NON-MAMMALIAN MODEL SYSTEMS TO INVESTIGATE MECHANISMS MEDIATING BIOLOGICAL INTERACTIONS WITH ELECTROMAGNETIC FIELDS. D.M. Binniger. Department of Biological Sciences, Florida Atlantic University, Boca Raton, Florida 33431, USA.

The question of whether power frequency (60 Hz) electromagnetic fields (EMF) present a health risk to humans remains highly controversial. While a variety of biological responses to EMF under laboratory conditions have been reported, the molecular mechanisms that mediate these phenomena remain elusive. Insight into the biochemical and genetic mechanisms that transduce EMF into biologically responsive signals is critical for clarifying the putative role of EMF in the development of certain human cancers.

The yeast *Saccharomyces cerevisiae* is an ideal model organism for studying molecular mechanisms of eukaryotic gene expression. This single-celled fungus is highly amenable to traditional genetic techniques. Additionally, recombinant DNA techniques are available for yeast which are not yet technically feasible with more complex cells, especially those of humans. While completion of the Human Genome Project remains at least 5-10 years away, the DNA sequence of the entire yeast genome is now available. Thus, experimental approaches can be designed using yeast which are not available for the other model organisms typically used in EMF studies.

Has studying yeast actually contributed to our understanding of cancer in humans? An unexpected outcome of cloning human genes has been the discovery that many cancer-related genes are very similar in all eukaryotes—from yeast to humans. Numerous human genes involved in regulating cell growth and are defective in human cancers were first identified as CDC (cell division control) genes in yeast. First identified in genetic studies using yeast, molecular clones of the yeast genes were then used to identify the homologous genes in humans. There is an ever-increasing list of human cancer genes that have structural and functional homologies in yeast.

Clearly, not all aspects of biological effects in response to EMF can be addressed using yeast. The fruit fly, *Drosophila melanogaster*, offers an equally attractive model system for questions applicable to true multicellular organisms, such as possible EMF-effects on embryogenesis and cellular differentiation. Like yeast, *Drosophila* is highly amenable to both traditional genetic studies and molecular cloning techniques included DNA-mediated transformation.

Undoubtedly, there will be cell-specific effects which will only be uncovered from studies of mammalian cells and whole animal studies. However, previous work in other areas of cell biology has clearly shown that investigating simpler non-mammalian models builds bridges to aid in identifying the most relevant research questions in human cells.

We would like to thank the National Institute of Environmental Health Sciences, National Institutes of Health (R55 ES06130-01 and R01-ES07181A-01) for their support of this work.

MS-21 — EFFECTS ON THE IMMUNE SYSTEM

Organizers: Shashi Mehta and Claudio Franceschi

The objective of this symposium is to describe *in vivo* and *in vitro* studies of benign as well as genotoxic effects of low frequency electric and magnetic fields on animals and humans. The selected presentations will provide an overview of the effects of electric and magnetic fields on the immune system. The thymus will be considered as a possible target for field interactions. The presentations will also address immunological consequences of fields on the cell mediated immune responses. The focus will be to assess the modulation of growth factor production and binding to receptor proteins and the other proteins on the T-cell surface. Lymphocytes will be considered as a sensor for genotoxic effects of ELF electric and magnetic fields.

MS-21-1

IMMUNOLOGICAL EFFECTS OF ELF ELECTRIC AND MAGNETIC FIELDS: AN OVERVIEW. A. Cossarizza¹ and C. Franceschi^{1,2}. ¹Department of Biomedical Sciences, University of Modena, Modena, Italy. ²Center for Gerontological Research, INRCA, Ancona, Italy.

In the last years, a consistent number of papers have demonstrated that the *in vitro* exposure of immune cells to nonthermal extremely low-frequency (ELF) electromagnetic fields (EMF) can elicit molecular and cellular changes that might be relevant to the activity of the immune system *in vivo*. Nonionizing electromagnetic radiations with the same physical characteristics can also affect cells of the neuroendocrine and musculoskeletal systems. Notwithstanding the great amount of information that are now available, the underlying mechanisms by which such fields can induce cellular changes are poorly known. For example, it has not been clearly established the single contribution of electric or magnetic fields. In any case, it is known that a variety of intracellular molecules and structures

are relevant targets for the biological actions of ELF-EMF. Indeed, effects have been reported on the synthesis of DNA, RNA, and proteins; cell proliferation; cation fluxes and binding; production of mediators shared by the immune, nervous and endocrine systems such as cytokines; and membrane signal transduction (i.e., hormones, enzymes, and neuro-transmitters), among others. In most cases, such effects occurred as a result of short-term exposure of cells to ELF-EMF of extreme low intensities.

Cells of the immune system have been widely used in studies on the biological effects of ELF-EMF, for several reasons. Human lymphocytes are relatively easy to obtain, stimulate and analyze, and represent one of the most studied biological systems among eukaryotic cells. Human cells have obviously a crucial biological relevance, and one of the main goals of researches has always been that of putting forward hypothesis able of correlating results obtained *in vitro* with biological effects which were supposed to occur *in vivo*.

The immune system has been investigated at different levels. The first level was that of analyzing possible direct influences on its cells. Accordingly, assays capable of revealing cytogenetic damages (such as the sister chromatide exchange, micronuclei production, unscheduled DNA synthesis, among others) were performed either in lymphocytes exposed *in vitro* or in cells from human beings exposed *in vivo*. Other studies regarded the intracellular levels of protooncogenes after field exposure, or the intracellular concentration of ions crucial for cell physiology such as Ca⁺⁺. The purpose of these studies was to find possible molecular and cellular events related to the contrasting epidemiological reports of an increased incidence of leukemia in subjects environmentally or occupationally exposed to the fields.

The second level was that considering the effects of the fields on some immune functions. For this purpose, the attention was devoted to the proliferative capability of lymphocytes of different donors, cytotoxic functions of natural killer cells, production and utilization of soluble mediators, mitochondrial functionality, among others. A new concept which is emerging is that subgroups of human beings can be more sensitive to the biological effects of ELF-EMF. Data from our laboratory suggest that this was the case for aged people, or patients affected by chromosomal aneuploidities such as Down's and Turner's syndromes. The potential implications of these observations for the safety of the exposure to ELF-EMF, together with the individual variability of the response to such fields, cannot be underestimated.

MS-21-2

THYMUS AS A POSSIBLE TARGET OF 50 Hz ELECTRIC AND MAGNETIC FIELDS. M. Capri and D. Quaglino. Department of Biomedical Sciences, General Pathology, University of Modena, Modena, Italy.

Thymus is the central organ responsible for the production of immunocompetent T cells. Thymocyte proliferation and maturation is achieved as a consequence of the interactions with thymic stromal cells under the control of several mediators, produced by thymic microenvironment. The aim

of this study was to investigate the effects of the exposure to extremely low electro and magnetic fields (EMFs) on the rat thymus. Three different experiments were performed:

1. Male Sprague Dawley rats, 2 months old, were housed in the CESI (Milan, Italy) under standard conditions in a dark-light cycle. Animals were divided into three groups that were exposed or sham-exposed to 50Hz sinusoidal EMFs at 1 kV/m-5 μ T and 5kV/m-100 μ T, respectively. Exposure was performed for 8 months, 5 days/week, 8 hours/day. At sacrifice, the thymus was removed and processed for light and electron microscopy and for flow cytometry. The expression of CD8-CD4-, CD8+CD4, CD8-CD4+, CD8+CD4+, CD5+ α β TCR- and CD5+ α β TCR+ thymocytes was investigated. A long term exposure to EMF was associated with an enhanced cellular turnover as suggested by the increased number of mitotic and apoptotic events, whereas necrosis was only slightly modified; furthermore, collagen deposition was frequently observed in the exposed animals. Interestingly, the effects of the EMF appeared to be independent from the field strength, since major changes were noted after lowest field intensity exposure. Structural changes, however, were not sustained by significant changes in the characteristics of maturation and/or differentiation of thymocytes, as demonstrated by flow cytometry.

2. Male Sprague Dawley rats were exposed to the same EMFs in the same environmental conditions as before. Animals were exposed, i) from the second day after conception up to 15, 30 and 90 days after birth; ii) from 2 months up to 5 and 8 months of age. Rats were killed by decapitation and the thymus was removed and processed for immunocytochemistry. The presence and distribution of interleukin-2 (IL-2) and β -endorphin positive cells in the rat thymus were investigated. Results indicated that exposure to EMFs affects the presence of IL-2 and β -endorphin-positive cells in the thymus. At almost all exposure times, the percentage of IL-2 positive cells appeared statistically diminished both in the medulla and in the cortex, compared with age-matched unexposed animals. Surprisingly, in the rats exposed from conception up to 90 days of age to the lowest electromagnetic field intensity, an increase of IL-2 positive cells in the thymic cortex was observed. By contrast, the percentage of β -endorphin-positive cells decreased with time in almost all groups of exposed rats, compared with sham-exposed animals of the same age. However, a slight increase of β -endorphin-positive cells was found only in the cortex and in the medulla of rats exposed from conception up to 15 and 90 days of age.

3. Male Sprague Dawley rats 2 months old, housed in the CESI animal care facilities, were divided into three groups and exposed to the same EMFs as before, but under continuous light. At sacrifice, thymus was removed and processed for electron microscopy. Results showed that, in aged and light-stressed animals, thymus rapidly diminishes in size, because of massive death of cortical small lymphocytes and their destruction by macrophages; however, the concomitant exposure to EMF, especially at the lowest field strength, was associated with increased cellular turnover, as suggested by the augmented number of mitotic and apoptotic events, and with increased collagen deposition. On the

contrary, nuclear degenerations and necrotic areas were more frequently observed in animals exposed to the higher field strength, which therefore caused more pronounced degenerative features.

In conclusion, these data contributing to the understanding of the interactions between EMFs and biological systems suggest that: i) EMF exposure can interfere with the structural characteristics and/or tissutal organization of the thymus without altering, however, the phenotypic features of thymocytes; ii) the biological effects are exerted independently from field strength and are conceivable with the existence of window effects; iii) EMFs are able to modulate the amount of IL-2 and β -endorphin in thymic cells; iiiii) EMFs may reinforce the alterations due to a stress condition (i.e. continuous light) acting in a synergistic manner and determining a more rapid involution of the thymus which might be responsible for an increased susceptibility to the potentially hazardous effects of EMF.

MS-21-3

MAGNETIC FIELDS AND RECEPTOR-LIGAND BINDING DURING SIGNAL TRANSDUCTION IN HUMAN T-LYMPHOCYTES. R.P. Liburdy. Lawrence Berkeley National Laboratory, Berkeley, California 94720, USA.

Receptor-mediated signal transduction in the T-lymphocyte is triggered at the cell surface by ligand binding to the CD3 complex. This Ligand binding event sets into motion a cascade of biochemical reactions at the cell membrane that ultimately results in nuclear activity associated with cell proliferation. We have investigated whether magnetic fields influence the first step in this cascade, namely receptor-ligand binding, since a relatively small alteration in this early event has the potential to be amplified significantly during the signal transduction process.

Previously [1] we have observed that receptor-ligand binding is altered in Jurkat (E6.1) cells undergoing anti-CD3 activation in the presence of a 1 Gauss, 60Hz magnetic field. We have performed Scatchard analyses that indicate receptor-ligand binding involving anti-CD3 antibody binding to the CD3 receptor complex at the cell surface is enhanced in the presence of magnetic fields during 10 minute exposures at 37°C. These studies employed an antibody clone from Becton-Dickenson, Inc., as well as a second alternative antibody clone from Accurate Antibody, Inc.; both antibodies yield similar results.

In these studies we observed that Kd for receptor-ligand binding was not significantly altered by the magnetic field, however the effective number of high affinity binding sites for receptor-ligand binding was increased by approximately 30% ($p < 0.05$), and 21% ($p < 0.05$), for the two antibodies, respectively. Similar observations using the same cells and one of these antibody clones have been made independently by Dr. Walter Balcavage of the Indiana University School of Medicine [2]. Importantly, an increase in receptor-ligand binding is consistent with, and is a plausible explanation for an increase in intracellular calcium previously observed in

these cells during identical field exposure [3]. The above findings provide evidence in support of magnetic fields influencing receptor binding at the cell surface.

If these observations are generalizable to other cell types, such findings would have importance in understanding, at the molecular level, how relatively low magnetic fields exposure intensities for brief exposure times could lead to biologically significant alterations in target cells. In terms of possible medical applications, these *in vitro* data suggest that magnetic fields have the potential to increase receptor-ligand binding and this may have relevance for enhancing immune system function.

[1] V. Eckert & R.P. Liburdy (1996) BEMS meeting, Abst. A-6-5.

[2] W.X. Balcavage. *et al.* (1996) BEMS meeting, Abst. P-24B.

[3] R.P. Liburdy & V. Eckert (1995) BEMS meeting, Abst. 12-2.

Support provided in part by the Office of Utility Technology Utilities Systems Division, U.S. Department of Energy under contract DE-AC76SF00098.

MS-21-4

HUMAN IL-2 PRODUCTION AND BINDING TO ITS RECEPTOR PROTEINS ON ACTIVATED T-CELLS IS AFFECTED BY 60 Hz, 1 G SINUSOIDAL MAGNETIC FIELD EXPOSURE. S. Mehta¹, K. Johnson¹, H. Wanebo¹, D. Cherlin² and C. Polk². ¹Department of Surgery, Roger Williams Medical Center, Providence, Rhode Island 02908, USA. ²Department of Electrical and Computer Engineering, University of Rhode Island, Kingston, Rhode Island 02881, USA.

T-cell cytosolic increases in Ca⁺² levels due to 60 Hz magnetic field exposure have been reported. Such increases may affect IL-2 production and modify receptor proteins on human T-cells. Freshly prepared T-cells on activation undergo simultaneously two events: IL-2 gene transcription and upregulation of IL-2 receptor expression. Both events affect T-cell growth and effector function. We have chosen two independent systems to study these effects: PHA stimulation of Jurkat cells to release IL-2 and PHA preactivated human T-cells for IL-2 receptor binding studies. Jurkat (ATCC, Bethesda, MD) cells are routinely maintained at a cell density of 0.5x10⁶/ml in RPMI-1640 containing 10% fetal bovine serum with replenishment of fresh culture medium supplemented with 10% fetal bovine serum twice a week. For the assessment of IL-2 production, cells were incubated at a cell density of 0.5x10⁶/ml with PHA for a period of 24 hours in the presence and absence of a 1 G, 60 Hz magnetic field at various DC (0.07-0.59 G) field strengths. Results indicated a significant suppression of IL-2 production (50 to 70%, n=3). This suppression of IL-2 production was not due to modification of cell growth as seen in a parallel experiments under identical exposure conditions. For IL-2 binding to its receptor proteins on the cell surface, normal human T-cells were preactivated with PHA (0.75% v/v) for a period of 7 days at 37°C. The activated cells were

then subjected to standard receptor binding protocols with ¹²⁵I-IL-2. 10⁶ cells were incubated in the presence and absence of a 60 Hz, 1 G sinusoidal field for a period of 2-3 hours at various DC (0.07-0.6 G) field strengths. The cells were then washed and mixed with ¹²⁵I-IL-2 at 4°C for a period of 45 minutes in the presence and absence of 20 fold excess of cold rIL-2 to assess specific binding to the cell surface proteins. The exposed and control cells were then spun through an oil layer and were counted in a gamma counter to assess the modulation of receptor binding activity. In the presence of a DC field (0.4-0.6 G) a 1 G, 60 Hz sinusoidal field decreased the IL-2 receptor binding by 68 ±12% (n=5) on activated human T-cells. In the absence of a 1 G, 60 Hz field, IL-2 receptor binding was decreased 35% by a reduction in DC field strength from 0.5 G to nearly zero.

Taken together, these data suggest that both arms of the T-cell growth, IL-2 production and binding to its receptor proteins from 3 to 24 hours (leading to signal transduction for eventual growth and effector functions) are affected by exposures to AC/DC combinations.

This work was supported by NIEHS grant R29 ES 05970 and a grant from the Johns Hopkins Center for VDT research.

MS-21-5

BIOLOGICAL EFFECTS OF 60 Hz MAGNETIC FIELDS (MFs) AS IT RELATES TO THE IMMUNE SYSTEM. R. Mandeville, G. Mercier, F. Filiatrault and R. Ghostine. Institute Armand-Frappier, University of Quebec, Laval, Quebec H7N 4Z3, Canada.

In the last five years we have performed a large number of experiments to elucidate the effect of 60 Hz linear, sinusoidal continuous-wave MFs on the immune system in rats born and raised for different periods of time under fields of 2, 20, 200 and 2000 µT intensities. Our results indicate that a 6-weeks exposure to MFs induces on the one hand, a significant decrease in CD5+, CD4+ and CD8+ populations; while a significant increase of Natural Killer (NK) activity is observed on the other hand. Although no significant results were obtained from tests performed using peritoneal macrophages, namely H₂O₂ production and NO₂ secretion, we consistently observed a higher production of H₂O₂ for rats exposed to MFs when compared to either control or Sham-exposed animals. Linear regression analysis demonstrated a dose-response relationship between the changes in the immune functions observed and the MFs intensities used.

More recently, we have completed longer exposure periods and reporting that a-3 month exposure to the same fields demonstrated exactly the same effects on NK activity and on lymphocyte subpopulations in splenic cells. Moreover, a linear diminution of IL-2 activity and a linear increase in TNF was also demonstrated in these animals. However, animals exposed to 6 and 9 months respectively, did not show any significant alterations in all the immune parameters studied with the exception of a sustained increase in NK cell activity.

Presently we are carrying complementary studies to evaluate the immunotoxicity of EMF exposures. We will be reporting

our latest results on thymic lymphocytes (CD4+, CD8+ and CD4+CD8+ double positive cells) on CTL (Cytotoxic T lymphocytes) and on PFC (Plaque Forming cells).

We are also assessing the effect of the alterations in the immune system on host-resistance to bacterial infections (*Listeria monocytogenes*), as well as, on MADB107 mammary tumour development (primary and metastatic tumours) in the Fischer rats. Animals will be exposed to 60 Hz MFs of different intensities (Sham, 2, 20, 200, 2000 μ T) under double blind conditions. Groups of 10 animals will be injected after 8 weeks of exposure to MFs either intravenously (for metastasis production) or subcutaneously (for primary tumour development). Animals will be kept under the fields during the entire experimental period. This experiment will be repeated twice during the next year.

Until now, our results suggest that *in vivo* exposure of newborn rats to 60 Hz MFs of different intensities can induce significant immunological perturbations at the level of the effector cells of both natural and adaptive immunity. However, after prolonged exposures, these perturbations return to their basal level, illustrating the adaptability of the immune system to an environmental stressor.

This study is co-funded by Hydro Quebec and BC Hydro.

MS-21-6

LYMPHOCYTES: A SENSOR FOR GENOTOXIC EFFECTS OF ELF ELECTRIC AND MAGNETIC FIELDS. M.R. Scarfi. CNR-IRECE, 80124 Naples, Italy.

The exposure of humans to extremely low frequency (ELF) electromagnetic fields can occur in a variety of situations since they are present in the environment and are utilized in diagnostic and therapeutic procedures. Epidemiological studies have suggested a possible correlation between the exposure of humans to ELF fields and the incidence of leukemia (P.H. Ableson, *Science*, 245, 241, 1989; S. Shulman, *Nature*, 345: 463, 1990) and the possibility that they induce cytogenetic effects in human lymphocytes has received attention by some investigators, but the studies are few and not univocal (Scarfi *et al.*, *Alta Frequenza*, 58: 337, 1989; McCann *et al.*, *Mutation Res.*, 297: 61, 1993; Murphy *et al.*, *Mutation Res.*, 296: 221, 1993).

In the last years our research group has investigated possible genotoxic effects of ELF electromagnetic fields on human lymphocytes by applying both classical cytogenetic tests (chromosome aberrations) and the cytokinesis-block micronucleus (MN) technique.

Sinusoidal Electric Fields: Field characteristics: repetition frequency 50 Hz; field intensities: 0.5, 2, 5 and 10 kV/m. The effect of 72 h exposure was evaluated on 33 lymphocyte cultures obtained from blood of healthy subjects applying the MN assay and no genotoxic effects were found. Moreover, these fields did not affect the Mitomycin-C-induced MN formation, suggesting that they did not exert any synergistic or antagonistic effect with such chemical mutagen (Scarfi *et al.*, *Radiat. Res.* 135: 64, 1993).

Pulsed Magnetic Fields: Field characteristics: repetition frequency 50 Hz; field intensity 2.5 mT. This field was tested

on lymphocyte cultures from 21 health donors and no effect was found both in CA and MN tests (Scarfi *et al.*, *BBRC.*, 176: 194, 191; *Mutation Res.*, 306: 129, 1994). Nevertheless some interesting effects were found when we exposed to this field lymphocytes from subjects affected by Turner syndrome (Scarfi *et al.*, *Bioelectrochem & Bioenerg.*, 1997a, in press): MN frequency increased significantly with respect to control ones (two-tailed paired Student's t test: $p=0.007$). This last result suggests the importance to investigate not only on cells from the general population of healthy subjects, but also taken from particular subgroups, that for genetic disorders or other reasons, can present a particular responsiveness to electromagnetic fields.

Field characteristics: repetition frequency 100 Hz; field intensity 1.3 mT. After 72 h exposure, human lymphocyte cultures from 25 healthy donors showed a statistically significant increase of MN frequency and cell proliferation rate (Scarfi *et al.*, *Bioelectrochem & Bioenerg.*, 1997b, in press). A new set of experiments is in progress to evaluate the observed genotoxic effect employing the chromosome aberration test: preliminary results indicate a considerable enhance of chromosome aberrations in samples exposed to the field with respect to unexposed ones, suggesting that the repetition frequency plays a fundamental role in eliciting the effect. Further investigations are needed to verify which components of the signal employed was/were responsible for the observed effect.

Sinusoidal Magnetic Fields: Field characteristics: repetition frequency 50 Hz; Field intensities 0.05, 0.25, 0.5, 0.75, 1 mT. Lymphocyte cultures from whole blood of 42 health donors were set up, divided into 5 groups and for each group a different field intensity was tested. After 72 h exposure no genotoxic effects expressed a MN frequency, were found for all the field intensities tested. Cell proliferation resulted unaffected at 0.25, 0.5, and 0.75 mT, increased at 1.0 mT and decreased of 0.05, although a slight ($P=0.058$) trend towards a higher frequency was observed in samples exposed to 0.25 mT. These findings suggest that a 50 Hz sinusoidal magnetic field does not affect MN frequency but the field intensity is an important parameter concerning its influence on cell kinetics.

MS-22 — EXPOSURE ASSESSMENT

Organizers: Kjell Hansson Mild and Robert Kavet

EMF exposure assessment has evolved rapidly to shed light on exposure characteristics that were uncertain or completely unknown as recently as several years ago. Initially, epidemiologic researchers relied heavily on categorical surrogates of exposure, with residential studies employing wire codes or simple proximity to power lines, and occupational studies using mainly job titles. These approaches produced results suggestive of potential associations between some aspect of magnetic field exposure and childhood and adult cancers of several types. However, many questions remained as to the extent to which the surrogates misclassified exposure, both present and past, and the extent to which contemporaneous measurements were historically representative. Compounding the problem was the

recognition that the surrogate measures were most likely optimally applicable to measures of central tendency (i.e., arithmetic or geometric mean exposure), but that other exposure conditions, partially or poorly captured, might be indeed more relevant. The minisymposium will address (1) which magnetic field exposure characteristics are potentially relevant to the study of health outcomes; (2) the use of state-of-the-art instrumentation to help resolve issues about appropriate exposure metrics and to address new hypotheses; (3) how surrogate metrics, particularly wire codes, may be related to magnetic field exposure as a function of time into the past; and (4) how personal exposure monitoring has improved our knowledge of occupational exposures relevant to questions of chronic health effects, such as cancer, and short-term effects addressed in a variety of worker exposure guidelines.

MS-22-1

USEFUL DESCRIPTORS OF EXPERIMENTAL MAGNETIC AND ELECTRIC FIELD EXPOSURES.

P.A. Valberg. Gradient Corporation, Cambridge, Massachusetts 02138, USA.

Investigation of electric and magnetic field (EMF) "toxicology" requires specification of many more variables than is the case in chemical toxicology. Exposure intensity and timing are the primary, commonly used descriptors of EMF (and chemical) exposure. However, for EMF, a complete picture of exposure calls for about 18 separate choices, including EMF frequency-domain behavior, EMF spatial orientation and variation, superimposed fields, non-experimental or stray EMFs, and environmental changes correlated to EMF exposure. Characteristics of the exposed system (geometry, conductivity, composition, homogeneity, prior history) can also be important. A summary list of key EMF exposure parameters has been previously published (*Bioelectromagnetics* 16:396-401, 1995). The questions to be answered by the experimentalist are as follows:

Are crucial EMF (B-field, E-field) exposure parameters adequately characterized?

1. B-, E-field intensity	rms, p-p?	10. Polarization	$\leftrightarrow, \updownarrow, \circ ?$
2. Exposure duration	min, hrs?	11. Homogeneity	$\pm \% ?$
3. Exposure repetition	once, daily?	12. DC field strength	geomagnetic?
4. Circadian time	am, pm?	13. AC / DC angle	$\perp, \parallel ?$
5. Basic frequency, f	50-60 Hz?	14. Accessory, non-EMF exp.	lights, hum, °C?
6. Harmonic content**	3rd, 5th, ...?	15. Incidental B-, E-exposure	travel, spin?
7. Intermittency	$\square \square \square ?$	16. Culture dish geometry	$\perp, \parallel ?$
8. Transients (on/off, $dB/dt, f, \dots$)	$\updownarrow ?$	17. Animal positioning	stray amps?
9. Time coherence of f	$\pm \text{Hz} ?$	18. Active-sham, blinded	Y(!) / N(??)

** The waveform itself is most useful for non-sinusoidal or non-repetitive field variations

The significance of these exposure indices lies in the fact that

testing potential mechanisms by which EMF may be interacting with the biological system requires knowledge of all eighteen, e.g. :

- Induced electric currents would be influenced by no.'s 1, 5, 6, 8, 10 and 16.
- Possible role of the "free radical" mechanism would be determined by the sum total magnetic field from all sources (regardless of AC or DC) as given by no.'s 1, 8, 12, 13, and 15.
- Ion parametric resonance requires parallel AC and DC magnetic fields of specific frequency and intensity (no.'s 1, 5, 6, 12, 13 and 16).
- Microscopic ferromagnetic particles require perpendicular AC and DC magnetic fields, primarily at lower frequencies (no.'s 1, 5, 12 and 13).
- Phase-lock, integrating, or time-averaging mechanisms require coherency in space and time (no.'s 5, 6, 7, 8, 9 and 11).
- Most importantly, the validity of any EMF bioeffect reported will depend on adequately controlling both stray EMF exposures not called for in the experimental protocol (no.'s 12, 15 and 17) and non-EMF exposures that might confound the results (no.'s 14 and 18).

It is difficult to make progress in sorting out potential biophysical mechanisms, and in confidently separating out real versus artifactual results, when the EMF exposure is not adequately described. In fact, the best way to support or rule out a particular mechanism of interaction is to compare the bioeffects of two EMF exposures that are very comparable except for one or two parameters that are predicted to be crucial for this mechanism (e.g., superimposed field angles, frequencies, amplitudes, induced currents, coherence).

MS-22-2

ASSESSING EXPOSURE TO RESIDENTIAL MAGNETIC FIELDS. W.T. Kaune. EM Factors, Richland, Washington 99352, USA.

The first report of a connection between magnetic-field exposure and human disease was an epidemiologic residential study published in 1979. Many residential studies have been published since, a few of which have received considerable media attention and have stimulated wide-spread public interest and concern. All residential studies to date, and contemplated for the future, are of the case/control design. Hence, evaluation of "historical" magnetic-field exposure, that is, exposure that occurred in the past, is crucial to their success. Several techniques have been developed for the purpose. The first technique, developed in the U.S. during the late 1970's, was the wire-coding system of Wertheimer and Leeper. This system attempted to place types of overhead electric-power wiring near homes into categories on the basis of their imputed level of electric current. While modifications and alternatives to this system have been proposed, it is still the main method of wire coding in use at this time, and it now seems clear that the characteristics of overhead wiring that are most predictive of residential magnetic-field levels are simple proximity to transmission and three-phase

distribution lines. The second exposure-assessment technique introduced in the mid 1980's was direct magnetic-field measurements in residences. The first measurements made in actual studies were so-called "spot" magnetic-field measurements, that is, measurements made at a few locations at a few instants in time. Later studies extended these measurements to include magnetic-field recordings at fixed locations covering 24-h or longer periods of time. Other studies, especially in Europe where overhead distribution power lines are not as commonly used as in the U.S., attempted to calculate directly the magnetic fields produced by nearby transmission lines or used distance to nearby electric facilities as a surrogate measure. There are presently several new epidemiologic studies underway that have incorporated new types of residential exposure assessment, including: 1) personal-exposure measurements made with small magnetic-field meters worn by subjects; 2) the capture of magnetic-field waveforms, from which additional information can be obtained, such as magnetic-field polarization, harmonic structure, and spatial alignment; and 3) isolation of the magnetic fields produced by electric currents in the grounding systems of homes.

There is evidence suggesting that spot measurements and wire codes may be reasonable measures of exposure that occurred within the previous five years in homes. However, beyond about five years, there is little direct information supporting the idea that a contemporaneous magnetic-field measurement is an adequate surrogate for historical exposure. It is simply unknown how effective a wire code is as a measure of historical exposure, but we do know that wire codes are not strongly associated with contemporaneous exposure. Only one study of childhood leukemia, conducted in Sweden, has attempted to directly address the problem of historical exposure assessment. This study obtained results which are consistent with the notion that changes in power-line loading that occur over extended periods of time are sufficiently large to render a contemporaneous measurement, but perhaps not a wire code, an inadequate surrogate for long-past historical exposure. Future epidemiological studies might profitably follow the example of this last study and look for special situations where a rationale exists for historical exposure assessment.

MS-22-3

**OCCUPATIONAL PERSONAL EXPOSURE
MONITORING.** T.D. Bracken. T. Dan Bracken, Inc.,
Portland, Oregon 97202, USA.

Personal exposure (PE) monitoring can capture temporal and spatial variability of magnetic fields and accounts for the motion of the worker in occupational environments. It therefore has distinct advantages over survey measurements, fixed-location long-term monitoring, and analytic models in determining magnetic field exposures in occupational settings. PE monitoring can be used to estimate current and past exposures in epidemiologic and exposure assessment studies and to ascertain compliance with recommended guidelines. Commercially available PE meters are of two

basic types: those that integrate or accumulate exposure data over the duration of measurements and those that record a time-series of measurements at fixed intervals over the measurement period. The accumulating meters are comparable to traditional dosimeters for other environmental factors and provide a summary of exposure, such as cumulative exposure or time-weighted average exposure. Time-series meters record the temporal nature of exposure and can therefore be used to identify sources and locations of exposure when employed with time-activity record-keeping. Both types of meters typically record the resultant magnitude of the magnetic field with a bandwidth that includes power frequencies and spans several hundred hertz. Occupational PE monitoring studies have employed a wide range of sampling and measurement protocols, reflecting a diversity of purposes. These studies include: the distribution of accumulating meters by mail to randomly selected utility workers; the use of time-series meters and a self-reported time-activity diary by large numbers of workers at diverse sites; and the use of time-series meters synchronized to an observer-generated log of worker locations during specific tasks. Most PE monitoring has been performed by electric utility workers, likely to be the largest occupational group with high field exposures. Examination of data from several PE studies suggests that utility workers can be grouped into exposure groups by general job categories such as electrician, line worker, and substation operator. However, more detailed distinctions between job categories (e.g., distribution- versus transmission-line worker) are not warranted because of the variability of exposures within these groups. Data from five large PE monitoring studies of utility workers have been examined to estimate the magnitude, frequency, and duration of exposures at magnetic field levels that approach those cited in occupational guidelines. Exposures among utility workers above 0.05 millitesla (mT) generally occur during less than 1.0 percent of work time and exposure above 0.2 mT generally occur during less than 0.1 percent of work time. Most periods of exposure above these magnetic field levels are brief, but periods of several minutes or even in excess of an hour are possible. Data from general PE surveys of utility workers indicate that exposure measurements above 1.0 mT are extremely rare, occurring less than 0.002 percent of the total work time. In the majority of cases, high magnetic field exposures appear to be transitory. However, PE data from workers using bare-hand methods while bonded to the conductors of energized transmission lines indicate exposures above 1.0 mT can occur for periods exceeding several minutes. Such tasks are not likely to be included in general surveys due to their rarity and/or to safety considerations related to workers wearing meters. Outstanding issues related to occupational PE monitoring include: the lack of a biological basis for selection of measurement protocols and measured field attributes; reconciliation of exposure guidelines with PE measurement protocols, such as meter location and sampling rate; sampling strategies in light of PE variability and the rarity of high field exposures; assignment of historical exposures; and measurement of electric field exposures.

MS-22-4

MEASURING EMF CHARACTERISTICS AND BIOLOGICAL EXPOSURE METRICS. J.D. Bowman. National Institute for Occupational Safety and Health, Cincinnati, Ohio 45226, USA.

Although most epidemiologic studies have only assessed exposures to the time-averaged magnitude of the ELF magnetic field (B), EMF characteristics such as the frequency, temporal variability, spatial orientation, the static magnetic field, and ELF electric field may also contribute to biological effects reported by laboratory studies. This presentation surveys methods for measuring detailed EMF characteristics and assessing exposures to metrics which have been linked to biologic effects. A 1994 NIOSH/DOE workshop on "EMF Exposure Assessment and Epidemiology" discussed the most promising exposure metrics derived from biologic mechanisms: induced body currents, temporal coherence, ion parametric resonance, and the magnetic field intensity (B^2) averaged from 0 Hz through radio frequencies (RF). To assess exposures to induced body currents requires measurements of the electric field and the magnetic field derivative dB/dt over a wide frequency range, including high-frequency transients. Temporal coherence needs an ELF magnetic field dosimeter which can measure the frequency spectra every 0.1 second. For ion parametric resonances, the necessary measurements can be done by a waveform capture instrument with a three-axis probe which can accommodate the magnetic fields in the environment. For residential and most occupational fields, a fluxgate magnetometer probe is sufficient, but extreme workplace conditions may require a Hall effect probe to handle high static magnetic fields ($>300 \mu\text{T}$) or induction coils for oscillating fields with high magnitudes or frequencies ($>3000 \text{ Hz}$). The same combination of three-axis probes along with RF instruments can measure the B^2 metric. From these measurements, the exposure metrics are calculated with computer models. By using a variety of approximations, a few epidemiologic studies have estimated exposures to biological metrics so that cancer risks could be calculated. Using new instrumentation, many of these metrics have now been measured accurately in pilot studies. Nonetheless, an epidemiologic study must still resolve several scientific, instrumentation and study design issues in order to test whether exposure to a biologically-based EMF metric is associated with cancer and other diseases. Therefore, an alternative approach is to measure a wide variety of EMF characteristics with these new instruments in order to generate new hypotheses or to test future ideas. Developing an exposure assessment strategy from these alternatives is a major challenge for those who sponsor and design EMF epidemiologic studies.

MS-22-5

RF CURRENT MEASUREMENTS AND THE NEED TO INVOLVE THIS INTO THE MEASUREMENT SCHEMA. S. Tofani. Servizio di Fisica Sanitaria, Azienda Regionale USL 9, 10015 Ivrea (To), Italy.

Progresses in RF dosimetry have shown that very high localized SARs leading to significant thermal elevations may occur in standing humans exposed to electric fields which were allowed by the Safety Standards.

Field-strength limits that would protect against these high localized SARs would have to be very low (about 1/5 of the current Safety Standards limits). This would be unnecessarily restrictive for exposure situations where no good ground contact exists or for exposure in horizontally polarized fields. As an alternative safety measure, the most recent Safety Standards have introduced, in addition to the fields limits, current limits for ankles and wrists.

Limits on contact current have also been set to avoid RF shocks and burns that may result from contact with ungrounded metallic object in electromagnetic field environments.

The measurement of RF current is also of great help in valuating the RF near field exposure situations (mostly present in working environments), where high gradient fields pose the problem of correlating their measurement results with the correspondent exposure limits.

Different aspects of RF current measurement procedures, instrumentation needs and possible measurement accuracy obtainable in practical exposure situations will also be presented.

MS-23 — DC MAGNETIC FIELDS

Organizers: Shoogo Ueno and Arthur Rosen

There is now little controversy about the fact that static (DC) magnetic fields influence biological systems. Current research is directed at defining the magnitude of this influence and establishing those mechanisms which might explain this effect. Much of this work has been centered on the paramagnetic and diamagnetic properties of diverse biological systems. The purpose of the symposium "DC Magnetic Fields" is to review this work and to bring into focus some of the more current research in this field.

MS-23-1

EFFECTS AND MECHANISMS OF MODERATE INTENSITY STATIC MAGNETIC FIELDS. A.D. Rosen. Department of Neurology, State University of New York, Stony Brook, New York 11794-8121, USA.

Previous studies from our laboratory have shown that moderate intensity static magnetic fields alter the function of excitable tissue. The suggestion has been made that this phenomenon is the result of alteration in the behavior of

membrane calcium channels. The present study was undertaken to directly test this hypothesis by examining the effects of static magnetic fields on calcium current in GH₃ cells using the patch clamp methodology. Cells were grown, using conventional tissue culture techniques, in 35 mm polystyrene tissue culture dishes. At the time of recording the culture medium was exchanged with a solution consisting of 140 mM NaCl, 1 mM KCl, 20 mM CaCl₂, 10 mM HEPES, and 1 μM TTX. Whole-cell patch clamp recordings were made with pipettes filled with 120 mM CsCl, 10 mM K-EGTA, and 10 μM HEPES. Calcium currents were recorded in response to 100 msec voltage jumps from a holding potential of -80 mV. Jump increments were 5 mV to a maximum of +40 mV. Control recordings were obtained and, immediately thereafter, the cells were exposed to a homogeneous 120 mT static magnetic field, applied parallel to the floor of the culture dish. Data was obtained before exposure, during exposure, and 100 sec after the field was turned off. Maximum current and current-voltage relationships were computed on-line. Off-line analysis of the data consisted of a m3h Hodgkin-Huxley fit to each curve in each series in order to determine the activation time constant (τ_{u_m}) and the inactivation time constant (τ_{h_i}) as function of voltage. At 23°C, no changes were seen in any of the parameters measured. At 35°C a significant delay in activation time was noted during field exposure. There was, however, no change evident in the inactivation time. These findings are compatible with an alteration in the function of the intramembranous portion (β subunit) of the calcium channel.

MS-23-2

EFFECTS AND MECHANISMS OF INTENSE DC MAGNETIC FIELDS ON BIOLOGICAL, PHYSICAL AND CHEMICAL PROCESSES. S. Ueno and M. Iwasaka. Institute of Medical Electronics, Faculty of Medicine, University of Tokyo, Tokyo 113, Japan.

The biological effects of DC, or static, magnetic fields have been poorly understood. Recognition of the role of the diamagnetic, paramagnetic and ferri- or ferro-magnetic materials in the body helps in unraveling the underlying mechanisms of bioeffects. This paper focuses on the effects of intense static magnetic fields on the behavior of diamagnetic water and paramagnetic oxygen. The effect of strong magnetic fields on the embryonic development of frogs, the regulation of peripheral blood circulation and skin temperature in mice, blood coagulation and fibrinolytic processes, and other biochemical reactions are also discussed.

1. Parting of Water by Magnetic Fields (Moses Effect). When studying the properties of diamagnetic fluids in static magnetic fields up to 8T we observed the phenomena that the surface of the water was pushed back by magnetic fields of higher gradients. A simple calculation shows that the magnetic force acting on 100 ml of water at 20°C is 0.288 Newton, i.e. 1/3 of earth's gravity, when the water is exposed to a magnetic field of 8T and 50T/m.

2. The Effect of Magnetic Fields on Fibrinolytic Processes. Fibrin dissolution was observed and fibrinolytic activities were evaluated using a fibrin plate method. Mean levels of fibrin degradation products were higher when exposed to 8T magnetic fields. This phenomena is explained by the Moses Effect of the plasmin solution which penetrates well into fibrin gel.

3. Effect of Magnetic Fields on Combustion and Gas Flow. In examining oxygen dynamics in air we observed that flow patterns of gases are influenced by magnetic fields. Candle flames are pressed down and can be extinguished by magnetic fields. A model called the "magnetic curtain" has been introduced to explain this phenomena. The magnetic curtain is an invisible barrier which is produced in air by the interaction between magnetic fields and paramagnetic oxygen molecules. The interception of oxygen by the magnetic curtain extinguishes flames.

4. Redistribution of Dissolved Oxygen Concentration. The spatial distribution of oxygen concentration dissolved in water was measured by a dissolved oxygen meter. A clear redistribution of oxygen concentration was observed, and the dissolved oxygen concentration increased more than 10% around the center of the magnet.

5. Effect of Magnetic Fields on Peripheral Blood Circulation and Skin Temperature *In Vivo*. We studied the effect of 8T static magnetic fields on the peripheral blood flow, blood pressure, heart rate, and body temperature of an anesthetized rat. Blood flow decreased by 10% during magnetic field exposure. Blood pressure, heart rate and subcutaneous temperature continuously decreased during magnetic field exposure and recovered after removal from the magnetic field. Skin temperature decreases may be attributable to the accelerated evaporation of water from the skin by magnetic fields.

6. Embryonic Development of Frogs Under Intense Magnetic Fields. We studied the possible influence of intense magnetic fields up to 14T on the early embryonic development of *Xenopus laevis*. No apparent teratogenic effects were observed when the embryos were cultured under magnetic fields up to 14T for 20 hours from the stage of uncleaved fertilized eggs to the neurula stage.

7. Biochemical Reactions Catalyzed by Catalase, Xanthine Oxidase, and Other Enzymes Under Intense Magnetic Fields. We studied whether magnetic fields of up to 14T affect the activity of several enzymes. We observed no effect on the reaction of superoxide-dismutase, peroxidase, and xanthine oxidase. However, we observed changes in the absorbance of the reaction mixture of hydrogen peroxide and catalase during and after magnetic field exposures. The results indicate that magnetic fields affect the dynamic movement of oxygen bubbles that are produced in the reaction mixture by the decomposition of hydrogen peroxide, but not the catalytic activity of the catalase itself.

MS-23-3

MAGNETIC ORIENTATION OF FIBRIN AND OTHER BIOPOLYMERS. J. Torbet. C.N.R.S., EPM-MATFORMAG, 38042 Grenoble, France.

Most molecules, be they of biological or synthetic origin, have an innate magnetic anisotropy, usually diamagnetic in origin. Consequently in an applied magnetic field individual molecules experience a weak orienting torque which is, in general, so feeble that a significant degree of orientation is precluded. However, when molecules behave in an ordered co-operative fashion their magnetic anisotropies can accumulate so that the group anisotropy becomes large enough to result in near complete orientation. Sometimes even the modest fields produced by permanent magnets suffice although on the whole stronger fields are necessary. Fortunately ordered cooperativity is often found, suitable examples include semi-rigid polymers, liquid crystals, membrane sheets, and crystals. Members of all the principle classes of biopolymers (protein, lipid, polysaccharide and nucleic acid) have been fully magnetically aligned.

During the final stages of blood clot formation the soluble plasma protein fibrinogen is transformed into a polymeric fibrin gel network after activation by the enzyme thrombin. Fibrin is vital for haemostasis and wound repair and is also a major player in cardiovascular disease. Perfectly aligned gels of fibrin are produced following polymerisation in a strong magnetic field. Such gels have been used to study clot structure while the magnetically induced birefringence has been used to probe assembly and lysis in model systems and in the quasi-physiological conditions of whole human plasma. The birefringence signal is simply proportional to the concentration of fibrin even in plasma. A number of other biopolymers have been similarly aligned including collagen, actin, and microtubules. Magnetic orientation has also the potential to improve the properties of some biomaterials.

MS-23-4

BACTERIAL GROWTH UNDER STRONG MAGNETIC FIELD. M. Shoda, K. Nakamura, K. Tsuchiya, K. Okuno and T. Ano. Research Laboratory of Resources Utilization, Tokyo Institute of Technology, Nagatsuta, Midori-Ku, Yokohama 226, Japan.

INTRODUCTION: In order to investigate the effect of strong magnetic field on bacterial growth, we developed a new superconducting magnet biosystem (SBS). Five strains of *Escherichia coli* and one *Bacillus subtilis* and one genetically manipulated *B. subtilis* were selected. They were grown under homogeneous 7 tesla(T) and inhomogeneous 5.2-6.1 T magnetic fields in SBS aerobically and the growth of them was compared with that in geomagnetic field.

MATERIALS AND METHOD: SBS can produce a magnetic field strength of 0.5 to 7 T and the operational temperature is controllable within deviation of 0.1 degree. The air was supplied to the bacterial cells by a shaking unit[1]. SBS has a homogeneous 7T magnetic field region,

and outside of it, the gradient of the magnetic field is formed at the maximum slope of 23 T/m. When the cells are placed in the gradient region of the magnetic field, an inhomogeneous magnetic field can be imposed on the cells. Here, inhomogeneous magnetic field of 5.2-6.1T was selected.

As bacteria, five strains of *Escherichia coli*, K,B,WP2,WP2s, and WP100, and *Bacillus subtilis* MI113 were used. *B. subtilis* MI113(pC112) which is a genetically transformed MI113 with plasmid of pC112 which carries a gene of an antibiotic, surfactin was used as an antibiotic producer[2]. The cell number of each strain was measured for 24-72 h during cultivation in SBS.

RESULTS AND DISCUSSIONS: The effect of strong magnetic field on the bacterial growth was observed clearly in a stationary phase of growth. In the stationary phase, the cell number under magnetic field was about 2-4 times higher than that of a control, indicating that the strong magnetic field inhibits the death rate of the bacterial cells. This phenomenon was observed in all bacterial strains used and inhomogeneous 5.2-6.1 T magnetic field showed a significantly stronger effect than homogeneous 7 T. A genetically transformed *B. subtilis* MI113(pC112) produced higher concentration of antibiotic, surfactin under strong magnetic field, reflecting higher cell number under strong magnetic field compared with that in geomagnetic field.

The *rpoS* gene of *E. coli* which is expressed specifically in a stationary phase was fused with *lacZ* gene encoding β -galactosidase and the activity of β -galactosidase was measured under strong magnetic field. The fact that the activity of the enzyme was higher under strong magnetic field than under a geomagnetic field suggests that strong magnetic field activates the *rpoS* gene in a stationary phase.

References:

[1] K. Okuda, K. Saito, T. Kamikado, S. Ito, K. Matsumoto, K. Okuno, K. Tsuchiya, T. Ano and M. Shoda, New 7 T superconducting magnet system for bacterial cultivation, *Cryogenics*, 35, 41-47(1995).

[2] K. Nakamura, K. Okuno, T. Ano and M. Shoda, Effect of high magnetic field on the growth of *Bacillus subtilis* measured in a newly developed superconducting magnet biosystem, *Bioelectrochem. Bioenerg.* in press.

MS-24 — DRUG DELIVERY

Organizers: Richard Heller and Justin Teissié

Drug and gene therapy is dependent on the ability to deliver the desired substance to a specific target and the success of this delivery will have a direct impact on the effectiveness of potential treatments. As most drug targets are localized intracellularly and as gene expression is specifically mediated within a cell, therapy is dependent on being able to transport the molecule through cell membranes. In addition, transport of molecules through a tissue or the dermis is also a consideration in some drug therapy protocols. It has been demonstrated that electric fields can be used to overcome these natural barriers. Iontophoresis and electropermeabilization have been used for this purpose.

While both techniques have been used to facilitate transport through tissues and the dermis, electroporation has been the principle method for transport through cell membranes. This minisymposium will examine the basic mechanisms and some applications of both techniques.

MS-24-1

ELECTRICALLY MEDIATED MAMMALIAN CELL PERMEABILIZATION TO MACROMOLECULES. APPLICATION TO GENE TRANSFER. M.P. Rols, C. Delteil, M. Golzio and J. Teissié. IPBS-CNRS, UPR 9062, 31062 Toulouse Cédex, France.

Application of high electric field pulses to cells can lead to the free access to the cell cytoplasm under reversible conditions. Despite the increasing use of the method in cell biology, biotechnology and more recently in medicine, the molecular mechanisms involved are still to be elucidated.

Square wave electric field pulses are applied to Chinese hamster ovary cells. Electroporation to small molecules (i.e. mw less than 1000 D) is a three step process of induction and expansion of transient permeated structures that occurs during application of the electric pulses (μ s time range), and then of a slow annihilation of these structures, a phenomenon that depends on the temperature and on the cell cytoskeleton (min time range).

Electroporation to large molecules (i.e. DNA, enzymes, proteins) appears not to strictly obey the same law as for small molecules. There have to be present during pulsation to have a direct access to the cytosol. A key step is present during the pulse. We observe that in fact transfer into the cells is slow and that cells play an active role in these step of transfer.

Macromolecules such as high molecular weight fluorescent dextrans (FD-70) and enzymes (β -galactosidase) can enter the cells with efficiencies closed to 100% when present during the pulsation. Moreover, they are also observed to penetrate into the cells when added up to one hour after the electric field application, when penetration of small size molecules is no more present as previously reported by others. In that case, they are found into cytoplasmic macrovesicles and not homogeneously distributed into the cytoplasm. This phenomenon is inhibited when cells are pretreated with drugs affecting the cytoskeleton. Long term effects of electroporation are induced at the cell level.

Application to *in vivo* protein and gene transfer in murine melanoma is now developed in our laboratory. The B16 Bl/6 tumor is used as a model. Tumors are obtained by implanting s.c. fragments into the flanks of adult mice. Preliminary results show good correlation between *in vitro* and *in vivo* electric field conditions leading to permeabilization. *In vivo* protein and gene transfer have been obtained.

Rols M.P. and Teissié J. (1990) *Biophys. J.* 58:1089-1098

Teissié J. and Rols M.P. (1992) In "Guide to electroporation and electrofusion" pp 138-153

Rols M.P. and Teissié J. (1992) *Biochim. Biophys. Acta* 1111:45-50

Rols M.P., Delteil C., Serin G. and Teissié J. (1994) *Nucl. Acid. Res.* 22:540

Wolf H., Rols M.P., Boldt E., Neumann E. and Teissié J. (1994) *Biophys. J.* 66:524-531

Lambert, H., Pankov R., Gauthier J. and Hancock R. (1990) *Biochem. Cell Biol.* 68:729-734

Glogauer M., Lee, W. and McCulloch C.A. (1993) *Exp. Cell Res.* 60:904-811

Rols, M.P., Femenia, P. and Teissié, J. (1995) *Biochem. Biophys. Res. Commun.* 208:26-35.

MS-24-2

ELECTRICALLY ASSISTED TRANSDERMAL DRUG DELIVERY USING E-TRANS™ TECHNOLOGY. J.B. Phipps. ALZA Corporation, Minneapolis, Minnesota 55432, USA.

Soon after developing the first transdermal systems based on membrane-controlled delivery of lipophilic drugs, ALZA began exploration of electrically-assisted transdermal delivery of polar and ionic therapeutic agents. This method of delivery has been called iontophoresis or electrotransport. A decade of intensive research and development at ALZA has resulted in the creation of small, efficient electrotransport systems for continuous or time-varying, preprogrammed or on-demand, transdermal delivery of a broad range of hydrophilic agents. This presentation will review the key attributes of preferred drug candidates, as well as focus on the critical components and operational features of typical electrotransport systems.

ALZA, in collaboration with partner companies, has a number of electrotransport products under development and in clinical evaluation. The therapeutic agents studied in humans range from typical organic agents to polypeptides. Human clinical data will be presented to illustrate the striking similarity in drug plasma profiles resulting from intravenous drug infusion and transdermal electrotransport. Clinical data generated with a fentanyl electrotransport system, intended for patient-activated treatment of acute post-operative pain, will be used to demonstrate the unique capabilities of this drug delivery technology.

MS-24-3

SKIN ELECTROPORATION FOR TRANSDERMAL DRUG DELIVERY. V. Pr at, R. Vanbever, A. Jadoul and V. Regnier. Universit  Catholique de Louvain, Unit  de Pharmacie Gal nique, Industrielle et Officinale, 1200 Brussels, Belgium.

Skin electroporation has been explored as way of increasing, expediting and controlling transport across skin. Studies demonstrated that the application of short high-voltage pulses to skin can increase transdermal transport by several orders of magnitude. Compounds ranging in size from small ions to moderate-sized molecules (charged or neutral), to macromolecules can be delivered. Therapeutic level of drug

can be achieved *in vivo*. The phenomenon underlying enhancement is presently hypothesized to be electroporation of the *stratum corneum* lipid bilayers: new aqueous pathways would be created, local molecular transport occurring through these "electropores" by electrophoresis and diffusion. Control on delivery magnitude and rate was shown to be achieved by controlling the electrical features of the pulsing protocol (voltage - number- length) and/or the physicochemical parameters of the drug and solution. Alterations of skin functions, structure and electrical properties were evident following electroporation of skin, however the changes were generally mild and reversible. Thus, transdermal drug delivery using skin electroporation might be interesting as an alternative of the conventional routes of administration or of passive transdermal delivery.

MS-24-4

IN VIVO ELECTROPORATION FOR THE DELIVERY OF GENES TO NORMAL LIVER AND CANCEROUS TISSUE. M.J. Jaroszeski¹, R. Gilbert², C. Nicolau³, A. Atkin³ and R. Heller^{1,2}. Departments of ¹Surgery and ²Chemical Engineering, University of South Florida, Tampa, Florida 33612, USA. ³Molecular Hepatology Laboratory, Massachusetts General Hospital Cancer Center, Harvard Medical School, Charlestown, Massachusetts 02129, USA.

In vivo delivery of DNA to cells is currently a topic of widespread interest. Typically, the goal is to target gene delivery to a particular type of cell or to cells within a specific tissue. DNA delivery is performed as a means of transforming cells to produce new translation products. The delivery of genes that code for biologically active compounds is envisioned as a treatment for many diseases including cancer and metabolic disorders. One difficulty that has been encountered in the progression of these novel gene therapy treatments is inefficient gene delivery and insufficient expression.

Electroporation is a physical phenomena that temporarily disrupts cell membranes. When membranes are in a disrupted state it is possible for molecules that do not normally pass through the membrane to gain intracellular access. Electroporation has been used *in vitro* to deliver genes to cells. In addition, *in vivo* electroporation has been used clinically to load chemotherapeutic agents into tumor cells. A study to investigate the use of *in vivo* electroporation for gene delivery was initiated based on these successful uses of the technique. The study was biphasic. The first phase investigated the transformation of healthy rat liver tissue using two different reporter genes. The second phase involved the combined use of two different immunostimulatory molecules to treat established murine melanoma tumors.

Reporter gene plasmids containing either firefly luciferase or beta galactosidase were transferred to the right median lobes of Sprague Dawley rats. Reporter genes were first injected into the liver and then six direct current pulses were applied to the injection site. Pulses were administered using an array of six needles that were inserted around the perimeter of the injection site. Pulses, 100 μ s in duration, were administered in a manner that rotated the applied electric field around the treatment site. Peak luciferase expression was found to occur two days after

treatment. Electric field strengths of 1000 V/cm and 1500 V/cm were determined to provide the highest levels of luciferase expression, and a dose of 25 μ g of DNA per treatment was established as providing maximum expression. In addition, beta galactosidase was used to determine that the efficiency of hepatocyte transformation within the treatment site was approximately 30 percent.

Methods for the concurrent delivery of plasmids containing genes for B7-1 and IL-12 to established murine melanoma tumors were similar to those used for transforming rat liver. Tumor bearing animals that were treated with both plasmids followed by electroporation responded completely in 5 out of 6 cases. These five animals remained tumor free for 70 days which indicates successful delivery and transformation using electroporation. In contrast, groups of animals that were treated with pulses alone or plasmids alone showed no complete responses or partial responses.

Supported by the Departments of Surgery and Chemical Engineering, Univ. of South Florida.

MS-24-5

ELECTROMANIPULATION OF CELLS FOR THERAPEUTIC PURPOSES. C. Nicolau. Center for Blood Research Laboratories and Harvard Medical School, Boston, Massachusetts 02135, USA.

Electroinsertion consists of the application of pulsed electrical fields of microseconds duration and field strengths slightly below the critical value for electroporation, on a suspension of cells in the presence of a selected membrane protein having a membrane spanning sequence [1]. This procedure results in the implantation of the protein in the cell's plasma membrane. This method has been applied to the insertion of CD4, glycophorin and Interleukin-1 receptor into a variety of red blood cells and other cultured eucariotic cells [4].

100% of the RBC subjected to electroinsertion were shown to expose different CD4 or glycophorin epitopes [2,3]. Up to 10,000 glycophorin molecule/cells were inserted into mouse RBCs. CD4 or glycophorin electroinserted in RBC, upon reaction with monoclonal antibodies, showed significant patching similar to that observed on native membrane proteins [3].

Electroinsertion of FITC-labeled glycophorin or FITC-labeled CD4 into mouse (and human) RBC, followed by the quenching of FITC using anti-FITC mAb, yields 70% "correct" orientation of the inserted protein. *In vivo* study gave a normal half-life span of 12 days for both inserted glycophorin and CD4 in mouse RBC. [3,4]. Electroinsertion of full-length, recombinant CD4 into the red blood cell membrane has yielded an entity capable of preventing HIV-1 infection of target cells, *in vitro*. Moreover, when HIV-1 particles are incubated with RBC-CD4, fusion of the virus envelope with the RBC-CD4 plasma membrane occurs. Control RBC show none of these effects [5].

We have shown that RBC-CD4 inhibit *in vitro* unlike soluble CD4 infection of Peripheral transmission of HIV from patient isolates to normal PBL; soluble CD4 at a concentration of 10

µg/ml fail to block this transmission. CD4 in the RBC membrane represent -10ng/ml [6].

These data indicate that electroinserted CD4 behaves as a fully functional membrane receptor and, that RBC may be of significant therapeutic value, as we have shown in a Phase I clinical trial [7] and Phase II clinical trial under way.

Recently, we showed that about 40% of the liver cells could be productively transfected with a reporter gene by *in vivo* electroporation [8]. This shows significant potential for the efficient transfer and expression of suicide genes in solid tumors and for "naked" DNA vaccination [8].

References:

- 1) Y. Mouneimne, P.-F. Tosi, Y. Gazitt and C. Nicolau: *Biochem. Biophys. Res. Comm.*, 159: 34-40 (1989).
- 2) Y. Mouneimne, P. F. Tosi, R. Barhoumi and C. Nicolau: *Biochim. Biophys. Acta*, 1027: 53 (1990).
- 3) Y. Mouneimne, P.-F. Tosi, R. Barhoumi, and C. Nicolau. *Biochim. Biophys. Acta*, 1006, 83-89, 1991
- 4) C. Nicolau, Y. Mouneimne and P.-F. Tosi: *Analyt. Biochem.* 214: 1-10, (1993).
- 5) M. Zeira, P.-F. Tosi, Y. Mouneimne, L. Sneed, J. E. Lazarte, D. J. Volsky and C. Nicolau: *Proc. Natl. Acad. Sci. USA*, 88: 4409 (1991).
- 6) P.-F. Tosi, *et al: Blood* 87, 4839-4844 (1996).
- 7) B.F. Hollinger *et al: J. AIDS*. 9, 126-132 (1995).
- 8) R. Heller *et al. FEBS Lett.* 389, 225-228 (1996).

MS-25 — EPIDEMIOLOGY

Organizers: Maria Feychting and Eugene Sobel

Five talks on issues in EM Epidemiology are scheduled, emphasizing cancer. Dr. Anders Ahlbom will discuss fundamentals of epidemiological theory and methods pertaining to the conduct and analysis of studies on magnetic field exposure and cancer. He will discuss confounding, the effects of exposure misclassification, multiple comparisons, chance findings, and post hoc analyses. Dr. Birgitta Floderus will discuss assessment of magnetic field exposure in occupational studies, e.g. issues related to work shift measurements, average daily exposure of workers with specific job titles, and average or cumulative lifetime occupational exposure. Dr. Leeka Kheifets will provide an indepth review of the results of studies of magnetic field exposures and childhood brain tumors, demonstrating how initial results are not necessarily followed by confirmatory findings. Dr. Jukka Juutilainen will then evaluate the consistency of epidemiologic and experimental studies, particularly what laboratory findings would predict about the effects observed in epidemiological studies and the extent to which the actual observations fit the predictions. Dr. Christoffer Johansen will discuss epidemiological studies related to the use of cellular telephones and cancers. The rapid growth in the use of cellular telephones makes this research timely and important.

MS-25-1

EPIDEMIOLOGIC RESEARCH ON MAGNETIC FIELDS AND CANCER. A. Ahlbom. Division of Epidemiology, Institute of Environmental Medicine, Karolinska Institute, S-171 77 Stockholm, Sweden.

During the last two decades the hypothesis that exposure to weak extremely low frequency magnetic fields increases the risk of cancer has attracted a growing interest among epidemiologists, toxicologists, biologists, physicists, and others. Since epidemiologists rather consistently have found associations between magnetic fields and cancer in their studies epidemiology has to some extent been driving this research. One consequence of this has been an increasing interest for epidemiology among scientists in other disciplines. This has also affected the discussion about results from epidemiologic studies and scientists without epidemiologic training and with limited experience from epidemiologic research has participated in this discussion. As a result certain issues have received more attention than is usually the case in discussions regarding epidemiologic studies while other issues have received less attention. To some extent it appears as if scientists outside epidemiology perceive epidemiology differently than epidemiologists themselves. This seems to hold for the basic issues of what type of question that is addressed through epidemiologic research and what type of answer that is received. It also appears as if evaluation of studies and assessments of limitations and strengths in epidemiologic research are done differently by epidemiologists and others.

The aim of the present paper is to present some fundamentals of epidemiologic theory and methods and while doing so emphasizing certain issues that have been raised in discussions regarding studies on magnetic fields and cancer. The issues addressed include evaluation of confounding, effect of exposure misclassification, possibility of chance findings, multiple comparisons and post hoc analyses, and overall evaluation of epidemiologic findings.

MS-25-2

ASSESSING ELF MAGNETIC FIELD EXPOSURE IN OCCUPATIONAL STUDIES OF CANCER. B. Floderus. Institute for Environmental Medicine, Karolinska Institute, Stockholm S-171 77 and National Institute for Working Life, Solna, Sweden.

In risk assessments and discussions on extremely low frequency (ELF) magnetic fields (MF) and cancer, the research on residential exposure from power lines is often emphasized, while the research from the occupational setting is paid less attention. This does not seem reasonable, considering that, for example, in Sweden, less than 1% of the population is exposed to greater than 0.2 µT from power lines, while about 40% have workday mean value exceeding this same magnitude.

Research on occupational MF exposure and cancer holds uncertainties, mainly because of the high prevalence of MFs

in the work environment, the variety of MF sources causing a wide range of heterogeneous exposures, and the comparatively rapid changes of these sources and associated exposures over time. Coupled with these difficulties is the lack of knowledge regarding the relevant physical features of the fields and the biological mechanisms that may contribute to the development of cancer.

Some methodological issues will be addressed in detail, specifically, the lack of precision in exposure assessment, including the work shift measurement, the average exposure of workers with specific job titles, and the lifetime occupational exposure of individuals. Other unsolved questions are those connected with age and the treatment of different time parameters in exposure assessment and times of observation. The consequences of methodological problems in epidemiological studies of occupational MF exposure and cancer cannot be fully understood. But certainly, the non-differential misclassification errors of MF exposure will have driven many relative risk estimates towards the null. The methodological shortcomings should not have the effect that the research is ignored or abandoned, and neither should it lead to premature conclusions.

MS-25-3

CHILDHOOD BRAIN TUMORS AND EMF: A REVIEW OF THE LITERATURE. L.I. Kheifets¹, S.S. Sussman¹ and S. Preston-Martin². ¹Electric Power Research Institute, Palo Alto, California 94303-0813, USA. ²Department of Preventive Medicine, University of Southern California School of Medicine, Los Angeles, California 90033-0800, USA.

Since 1979, several residential studies have examined the potential association between exposure to power frequency (50-60 Hz) magnetic fields and childhood cancer (e.g., Wertheimer and Leeper, 1979; Savitz *et al*, 1988; Feychting and Ahlbom, 1993). Early on, research in this field examined childhood cancer as an end-point, while the majority of recently completed (e.g., London *et al*, 1991) and ongoing studies (one in the US and two in Canada) have focused on childhood leukemia. A few have focused exclusively on childhood brain tumors (e.g., Gurney *et al*, 1996; Preston-Martin *et al*, 1996). One ongoing study in the UK includes both leukemia and childhood brain tumors. Initially it appeared that the EMF association was stronger with childhood brain tumors than with leukemia (e.g. Ahlbom, 1988; Hutchinson, 1992), however, the results of several of the most recent studies of childhood brain tumors have found no association with EMF (Feychting and Ahlbom, 1993; Gurney *et al*, 1996; Preston-Martin *et al*, 1996).

While there exists many recent comprehensive reviews of the residential EMF epidemiologic literature (NHC, 1996; Kheifets and Kelsey, 1997), they do not attempt to cover the issue of childhood brain tumors and EMF in depth. It is our intent to fill this gap by presenting background information on descriptive epidemiology of known or suspected causes of childhood brain tumors, and by presenting a detailed review of studies that have examined the associations between EMF

(as represented by various surrogates) and childhood brain tumors. Given the paucity of ongoing studies of childhood brain tumors, this review is likely to remain current for some time.

References:

Ahlbom A. A review of the epidemiologic literature on magnetic fields and cancer. *Scan Work Environ Health* 1988;14:337-343.

Feychting M, Ahlbom A. Magnetic fields and cancer in children residing near Swedish high-voltage power lines. *Am J Epidemiol* 1993;138:467-481.

Gurney JG, Mueller BA, Davis S, Schwartz SM, Stevens RG, Kopeck K.J. Childhood brain tumor occurrence in relation to residential power line configurations, electric heating sources, and electric appliance use. *Am J Epidemiol* 1996;143:120-128.

Hutchinson GB. Carcinogenic effects of exposure to electric fields and magnetic fields. *Power Research Institute, Report TR-101175*, Palo Alto, CA 1992, pp: A6-A24.

Kheifets LI, Kelsey JL. Epidemiologic studies of electric and magnetic fields and cancer. IN: Lin JC (ed). *Advances in Electromagnetic Fields in Living Systems*, Vol 2, Plenum Press, New York, NY, pp. 29-62.

London SJ, Thomas DC, Bowman JD, Sobel E, Chang TC, Peters J. Exposure to residential electric and magnetic fields and risk of childhood leukemia. *Am J Epidemiol* 1991; 134:923-937.

National Research Council. Possible health effects of exposure to residential electric and magnetic fields. National Academy of Sciences, National Academy Press, Washington, DC, 1996.

Preston-Martin S, Navidi W, Thomas D, Lee PJ, Bowman J, Pogoda J. Los Angeles study of residential magnetic fields and childhood brain tumors. *Am J Epidemiol* 1996; 143:105-119.

Savitz DA, Wachtel H, Barnes FA, John EM, Tvrdik JG. Case-control study of childhood cancer and exposure to 60-Hz magnetic fields. *Am J Epidemiol* 1988;128:21-38.

Wertheimer N, Leeper E. Electrical wiring configurations and childhood cancer. *Amer J Epidemiol* 1979; 109:273-284.

MS-25-4

HEALTH RISKS OF ELF MAGNETIC FIELDS: AN EVALUATION OF THE CONSISTENCY OF EPIDEMIOLOGICAL AND EXPERIMENTAL STUDIES. J. Juutilainen. Department of Environmental Sciences, University of Kuopio, 70211 Kuopio, Finland.

Most reviews on the possible health risks of environmental ELF magnetic fields have reviewed the epidemiological and experimental evidence separately, without interdisciplinary attempts to evaluate the consistency of the different types of studies with respect to the types of biological effects, exposure-response relationships and hypothetical mechanisms that might be supported by both epidemiological and laboratory studies. Based on a review of the available literature, this presentation compares the findings of epidemiological studies with biological effects reported in

laboratory studies. The following variables will be considered in evaluating the consistencies and inconsistencies of the two types of studies:

1. magnetic field levels at which effects have been observed.
2. other aspects of exposure-response relationship. Based on experimental studies there could be field strength thresholds or windows. Intermittency, transients, coherence and resonances could also be biologically important. The discussion will include comparison of the epidemiological findings with these aspects of exposure.
3. types of cancer seen in epidemiological and animal studies.
4. initiation - promotion - progression. Laboratory studies are more consistent with promotion-type (or more generally cocarcinogenic) effects than cancer initiation. What would this predict about the effects observed in epidemiological studies and how do the observations fit the predictions?
5. melatonin as an explanation for the possible cocarcinogenic effects of ELF fields.

MS-25-5

EPIDEMIOLOGICAL RESEARCH ON MAGNETIC FIELD EXPOSURE FROM CELLULAR PHONES AND RISK OF CANCER. C. Johansen. Danish Cancer Society, Division for Cancer Epidemiology, DK-2100 Copenhagen Ø, Denmark.

It is not clarified whether exposure to electromagnetic fields in the radio frequency area is associated with the incidence of cancer. Studies of this association have included cellular studies and animal studies where exposure to radio frequency fields have been performed either in combination with known carcinogenic factors or alone. The overall conclusion from these studies is that it is possible to influence processes which are known to be related to the carcinogenesis in cells or tissue following exposure from sources closely related to the effect and frequencies which are used by cellular phone equipment. However, negative studies have been published as well. The main critique of these studies have been of methodological character which have included a critique of the size of the study, lack of control of other possible confounding carcinogenic factors, the anatomic focus of the exposure, and the strengths and time period which have been used. None of these cellular studies or animal studies have reported results following exposure from cellular phones and the suspicions that use of cellular phone equipment may be a promoting cause to cancer are solely based on studies where other sources have been used to the exposure. The increasingly use of cellular phones have generated an increasing interest in possible adverse health consequences due to exposure from mobile telecommunication systems.

The aim of the presentation is to review the existing epidemiological literature relevant to human health on the association between exposure to electromagnetic fields in the radiofrequency area and risk of cancer and while doing so address some of the methodological problems in these studies. In addition the method and material in an ongoing nationwide Danish cohort study will serve as an illustration of the difficulties in this research area.

MS-26 — BIOPHYSICAL MECHANISMS II

Organizers: Charles Polk and Istvan Szabo

Epidemiological studies and some laboratory experiments suggest that biological effects of electric or magnetic fields occur at field intensity levels that should not be detectable above noise present within the affected organisms. In this minisymposium several physical mechanisms will be discussed which could conceivably help to explain such observations. After a general introduction to non-linear dynamics, the topics covered will be experiments involving stochastic resonance in fish, proposed "real" resonance mechanisms, effects of incoherence of thermal noise from voltage-gated ion-channels on single cells and biological electron transfer.

MS-26-1

NONLINEAR DYNAMICS. W. Lauterborn. Drittes Physikalisches Institut, University of Göttingen, D-37073 Göttingen, Germany.

A survey is given on the basic notions and achievements of nonlinear dynamics. The theory starts with the state space spanned by the variables of a system and the dynamic evolution of the system as a trajectory (orbit) or more general, a flow in this state space. In dissipative systems trajectories head towards limit sets called attractors. They come in a variety of forms fixed point, limit cycle, torus, strange attractor. They all may coexist with their respective basin of attraction. When parameters are altered in a nonlinear system the attractors may change giving rise to bifurcations. There are four types of local bifurcations: period-doubling, saddle-node, Hopf and transcritical bifurcation. Examples for their appearance are given.

Of special importance for experimentalists is the new method of nonlinear time series analysis that makes use of the delay coordinate embedding where a one-dimensional time series is embedded into a high-dimensional space, a reconstructed state space. Embedding procedures and problems are addressed, for instance, the estimation of suitable reconstruction parameters. The embedded data yield a point set in a high-dimensional space that can be characterized in various ways, statically or dynamically. A static characterization is provided by the dimension of the set that may be fractal in the case of chaotic dynamics. A dynamic characterization is provided by the Lyapunov spectrum that measures the mean exponential increase or decrease of small perturbations on an attractor. A positive Lyapunov exponent (element of the Lyapunov spectrum) signifies a chaotic dynamics and a sensitive dependence on initial conditions. The Lyapunov exponents quantify the notion of chaos in a dynamical system. The new methods of nonlinear dynamics allow the detection of determinism in seemingly erratic signals should the determinism be low-dimensional. Often the method of surrogate data is used for this purpose where

the data are scrambled somehow to see whether this has an effect. Once the data have been embedded a model can be constructed that follows the dynamics in the reconstructed state space. This model, local or global, can then be used for prediction, noise reduction, monitoring and other applications.

MS-26-2

STOCHASTIC RESONANCE AND ELECTROMAGNETIC FIELD SENSITIVITY IN THE PADDLEFISH. F. Moss, L. Wilkens, X. Pei and D. Russell. Center for Neurodynamics, University of Missouri at St. Louis, St. Louis, Missouri 63121, USA.

Stochastic resonance (SR) is a counterintuitive process whereby a random force, called the "noise", can aid the detection and transmission of coherent information. The process has been observed in several classes of nonlinear systems, of which sensory neurons, are an example. In its simplest manifestation, systems exhibiting SR consist of only three ingredients: a threshold, a subthreshold information carrying signal and noise. Information is transmitted through, or detected by, the system by means of threshold crossings mediated by the noise. This paradigm is virtually identical with the simplest neuron model (McCulloch-Pitts) so it is not surprising that SR has been observed in several biological settings [1,2]. There is an optimal noise intensity for which the information transmission or detection is a maximum. Moreover, it has recently been shown that an array of interconnected stochastic resonance elements can further enhance the signal [3]. Could SR, or array enhanced SR, account for the remarkable sensitivity to weak electromagnetic fields exhibited by some animals? The sea-going shark is a classic example. We are investigating this question with another fish, the paddlefish, *Polyodon Spathula*. This is a fresh-water fish which feeds on plankton in the dark and murky depths, where its eyes are of little use, of some rivers in the U.S. and China. *P. Spathula* is characterized by a remarkable "paddle", or rostrum, anterior to the head and above the mouth. The paddle is covered by an array of more than 1000 electroreceptors similar to the Ampullae of Lorenzini found on sharks. It has recently been shown in this laboratory that the animal detects its planktonic prey, for example *Daphnia* or small brine shrimp, entirely by electromagnetic signatures sensed by the array of electroreceptors on the rostrum [4]. Plankton do emit very weak electric fields with characteristic frequency/amplitude signatures in the range 10^{-4} V/m. In this talk, an account will be given of our measurements of the frequency/amplitude sensitivity and of the search for SR effects using typical receptors of this fish. We will also discuss a search for evidence of signal enhancement via computation using simultaneous measurements at the afferent neuron and within the hindbrain.

1. J. Douglass, L. Wilkens, E. Pantazelou and F. Moss, *Nature* 365, 337 (1993)
2. J. Levin and J. Miller, *Nature* 380, 165 (1996)
3. J. Collins, C. Chow and T. Imhoff, *Nature* 376, 236 (1995)

4. L. Wilkens, D. Russell, X. Pei, and G. Gurgens, submitted to *Science*.

Supported by the U.S. Office of Naval Research, Physics Division.

MS-26-3

RESONANCES AND MAGNETIC FIELD DETECTION IN BIOLOGICAL SYSTEMS. S. Engström. J.L. Pettis Memorial Veterans Administration Medical Center, Loma Linda, California 92357, USA

The concept of resonance is considered as the basis for magnetic field detection in biological systems. Robust observational criteria for identifying resonant character are discussed. Care is taken to distinguish between physical and biological resonance, and I suggest that these two realms of interaction must be strongly coupled in order to achieve low-level magnetic field detection in biological systems.

A weak but persistent stimulus can exert a great influence on a dynamical system by adding a perturbation at appropriate times in a cycle already occurring in the system. The need to explain effects of weak (say, less than 100 μ T) but persistent (50/60 Hz) magnetic fields has generated interest in physical models with a natural timescale which would allow resonant interaction in this range of frequencies. Various proposed physical interaction models have been based on the observation that an ion with charge q and mass m , in the presence of a magnetic flux density B , may be associated with the Larmor frequency, $\Omega_L = qB/2m$. For example, an unhydrated calcium ion in a typical geomagnetic field ($B=50\mu$ T) has the natural frequency $\Omega_L=120$ Hz.

Utilizing a resonance involves matching frequencies, in this case the Larmor frequency of the ion oscillator system, and that of the applied magnetic field. In order to successfully resonate, the dynamical system also needs to "see" the applied stimulus for at least a good part of one period of its oscillation. This requires coherence-times on the order of milliseconds for an isolated atomic process. Experience from physics objects that this is several orders of magnitude too long for an isolated small scale oscillator in an biological environment.

We therefore need to evaluate the experimental data that inspires the search for resonant processes—what is the signature of a resonant phenomenon? Even if a particular mechanism such as the ion-oscillator model is assumed known, direct functional predictions have little value since the physical process and the final assay endpoint are very far apart indeed. What we need are robust indications of a resonant process. Examples are modes of the frequency response, especially multiple regularly spaced frequency maxima.

However, experimental results looking for a resonance phenomenon generally do not differentiate between a physical resonance and a resonating biological system which is simply driven by the physical transduction. Signatures of a resonance observed in the 50/60 Hz region are most convincingly interpreted as a biological event since there are many possible candidate processes which operate on the

appropriate timescale (tens of milliseconds), e.g. ion-channel dynamics, protein folding, intracellular communication etc.

A less restrictive assumption on the physical transduction mechanism is to consider the intrinsic timescale of the initial detection step. Coupled with an assumption on detector element isotropy, we arrive at an experimental hypothesis which directly asks a biological experimental model whether its fundamental transductive process is operating on a timescale faster or comparable/slower than the applied frequency. Experiments carried out in the Tamoxifen/Breast Cancer model of Harland and Liburdy, shows that the transductive process in this case is indeed slow. This fast/slow hypothesis further suggests that the way a microscopic process can attain millisecond coherence times, is by being strongly (bi-directionally) coupled to a downstream biological dynamical process.

This work is supported by the Fetzer Institute.

MS-26-4

DETECTION OF WEAK ELECTRIC FIELDS BY VOLTAGE-GATED ION CHANNELS: THE EFFECTS OF CHANNEL NOISE AND INCOHERENCE OF THERMAL VOLTAGE NOISE. P.C. Gailey. Oak Ridge National Laboratory, Oak Ridge, Tennessee 37831-6070, USA.

Several models have been proposed for establishing generalized lower limits for detection of weak electric fields by biological systems. Many of these models estimate the cell membrane potentials induced by internal electric fields (resulting from environmental electric or magnetic fields), and compare these perturbing potentials to thermal voltage noise occurring at the cell membrane. The model presented in this paper specifies voltage-gated ion channels as a candidate detector of membrane potential. Perturbations in membrane potential affect the open probability of these channels resulting in alteration of the ionic current through the membrane. Integrating this effect over time, the change in net charge displaced through the membrane can be predicted. Such changes have potential physiological relevance because the net charge in a cell is associated with the timing of action potentials, cell signaling, and a variety of other important processes.

Detection of a change in net charge requires that the change differs significantly from the random fluctuations in net charge transferred over some time period. Fluctuations in ionic currents result from the random gating of ion channels known as channel noise. In order to determine the fluctuations in net charge transferred, a random walk analysis of channel gating is performed. This analysis yields the variance in net charge transferred over a given time period, and the square root of this variance is the rms magnitude of the fluctuations or noise. Using a nominal criterion of $S/N=1$, an equation is developed relating the expected net charge displaced by the perturbing potential to the magnitude of the fluctuations in this quantity from the random walk analysis. The equation includes three primary variables - number of channels, magnitude of perturbing potential, and

the time period of interest. Holding any two of the variables fixed, the value of the third variable needed to meet the $S/N=1$ criterion can be found. Example calculations for sodium channels indicate that a 1 μV induced membrane potential can be detected in 5 ms if 2×10^7 channels are present. Assuming 10^4 channels per cell, an effect of this perturbation would require a system of 2000 synchronized cells - well within the range found in the human nervous system.

Two possible objections to the model are also addressed. First, it could be argued that thermal voltage noise at the cell membrane may exceed the perturbing potentials of interest. This objection requires that the thermal voltage noise be coherent over large areas of the membrane as expected if the membrane is modeled as a sheet with uniform conductivity. Most of the conductance of biological cell membranes, however, results from discrete ion channels. A model of these channels which includes both the channel resistances and the access resistances indicates that correlation of thermal voltage noise diminishes by about a factor of 10 per decade increase in the number of channels present. Thermal voltage noise that is uncorrelated between channels is part of the channel noise that is already included in the above model and will exert no additional effect on the S/N ratio. A second possible objection to the model is that shot noise resulting from the finite number of ions passing through the membrane will add significantly to the fluctuations in net charge transported. However, many cellular processes such as the generation of action potentials involve transport of such large numbers of ions that shot noise effects will be small relative to the channel fluctuations considered in this model.

MS-26-5

BIOLOGICAL ELECTRON TRANSFER. I. Nair. Department of Engineering and Public Policy, Carnegie Mellon University, Pittsburgh, Pennsylvania 15213, USA.

Biological electron transfer (BET) is the "long-range intermolecular and intramolecular electron transfer (ET) with little input of external energy" [1]. BET plays an important role in conferring the directionality and specificity of numerous biological processes, particularly those involving oxidoreductase action such as oxidative bursts in neutrophils and in signaling processes[2,3]. This presentation will delineate the features of biological electron transfer and explore the possibility that magnetic fields may affect electron transfer rates in biologically important molecules.

In general, there are three categories of electron transfer: classical enzymatic reactions involving covalent bonds; single electron or proton transfers; and single electron transfer over large distances through large proteins. BET refers to this third type. For example, an electron may be transferred over distances as large as 30 to 50 Å through one or more cofactors in a molecule of cytochrome c. This type of long-range, intraprotein electron transfer is nonadiabatic. It occurs over distances as large as 30-50 Å and requires very little energy input [4,5]. Biological electron transfers occur in classical enzyme reactions. Enzyme reactions have been

suggested as a medium for field interactions in the work of Astumian, Weaver and Adair on signal averaging of weak electric fields by cells [6].

BET has been studied most in well-defined cases such as ET between the redox active sites in a single protein such as hemoglobin or cytochrome c. There has been a large amount of work on ET reactions in metalloproteins and how the nature and structure of the protein affects the BET rates. Ru-modified cytochromes are a widely used model. This work has led to an understanding of the coupling between distant Fe and Ru ions in cytochrome c [4]. ET has also been used as a tool to trigger protein folding and study the subsequent changes [7]. This system may be a model system to begin the exploration of the effect of ELF fields, to study the rate of electron transfer and subsequent conformational change as a function of a ELF magnetic field.

Electron tunneling over long distances has been used in a quantum mechanical formulation to describe biological electron transfer. A semiclassical theory has been successful in describing most of the kinetics of BET in terms of three measurable parameters - free energy of reaction, reorganization energy and rate constant.

This talk will explore the applicability of the theory to the potential effect of an applied magnetic field on BET rates in a biological molecule. An applied ELF magnetic field may affect ET through modification of the density of states due to the field coupling with the electronic states involved in BET. What that means is that the field may be able to modify the reaction rate. While many details of BET are specific to reactions, the low energy input needed, long time constants and the dependence of the reaction rates on the surrounding molecular environment makes ET an attractive candidate for mediating the effect of ELF magnetic fields in biological processes.

[1] Moser CC, Page C, Farid RS, and Dutton PL, *J. Bioenerg. and Biomemb.*, 27, 263 (1995)

[2] Bolton JR, Mataga N, and McLendon G, *Electron Transfer in Inorganic, Organic and Biological Systems*, American Chemical Society, Washington, DC (1991).

[3] Moser CC, Keske JM, Warneke K, Farid RS, and Dutton PL, *Nature*, 355, 796 (1992)

[4] Winkler JR, and Gray HB, *Chem. Rev.*, 92, 369 (1992)

[5] Farver O and Pecht I, *FASEB J*, 5, 2554 (1991)

[6] Astumian RD, Weaver JC and Adair RK, *PNAS USA*, 92, 3740 (1995)

[7] Marcus RA and Sutin N, *Biochim. Biophys. Acta*, 811, 265 (1985)

[7] *Science*, 271, 1558 (1996)

Supported by the U.S. Department of Energy.

MS-27 - ELECTROMECHANICAL ENERGY TRANSDUCTION MECHANISMS

Organizers: Tibor Hianik and Vladislav Markin

The minisymposium "Electromechanical Energy Transduction Mechanisms" will be focused on various aspects of phenomena determining the protein-lipid interactions, mechanoreception, cell shape, neuronal shape transformation

as well as the thermodynamic and electrostatic of the bacterial flagellar motor. The contribution of Prof. T. Hianik will be concentrated on the consideration of mechanical properties of the bilayer lipid membranes on molecular level and on the role of membrane mechanics and thermodynamics in understanding the mechanisms of protein-lipid interactions. Prof. V.I. Passechnik will discuss the role of the membrane deformation in the functioning of ionic channels, which lay in the basis of mechanoreceptions. Mechanical and electrical forces play crucial roles in maintenance of cell shape and of the neuronal lectures of Prof. S. Svetina and Prof. V.S. Markin. The progress in understanding of the thermodynamics of flagellar motor and new electrostatic model will be presented by Prof. S.R. Caplan and Dr. D. Walz.

MS-27-1

MECHANICAL PROPERTIES OF LIPID BILAYERS AND PROTEIN-LIPID INTERACTIONS. T. Hianik. Department of Biophysics and Chemical Physics, Comenius University, 842 15 Bratislava, Slovakia.

Protein-lipid interactions play an essential role in the functioning of biomembranes. Due to certain specificity of these interactions lipids can influence the protein function. On the other hand, the functioning of membrane proteins which is accompanied by changes of their conformation, could influence the structure and physical properties of surrounding lipid environment. For the analysis of the mechanisms of protein-lipid interaction, the thermodynamics and mechanics parameters of lipid bilayers and proteoliposomes are important. Owing the different geometry of the hydrophobic moiety of proteins and that of lipids, as well as to the action of electrostatic and elastic forces, regions of altered structure may arise around protein molecules [1]. The formation of similar regions may represent one of the reasons of the occurrence of long-distance interaction in membranes.

This work analyzes the mechanical properties of both unmodified and protein modified bilayer lipid membranes and liposomes as well as solid supported bilayers. Two kinds of mechanical forces are considered - deformation of the bilayer in the direction perpendicular to membrane plane and volume compressibility of liposomes. The results obtained by electrostriction method [1] (study of transversal deformation of the membrane) and ultrasonic velocimetry [2] (study of volume compressibility of liposomes) showed, that mechanical properties of unmodified membranes, depend on lipid composition, hydrocarbon solvent, ionic strength and on the frequency of deformation. Mechanical properties of lipid bilayers are characterized by considerable anisotropy, i.e. moduli of elasticity are different in different direction of membrane deformation.

Interaction of proteins with lipid bilayers, such as bacteriorhodopsin, avidin-modified glucose oxidase as well as immunoglobulins and antigens resulted in considerable changes of mechanical properties of the membranes. The obtained results can be explained by existence of long-

distance protein-lipid interactions. The experimental results were quantitatively compared with those of calculation based upon elastic models within the Landau-de Gennes theory. Agreement between theory and experiments demonstrates that dominant elastic forces result from a mismatch of hydrophobic region of membrane and protein.

A practical applications of the methods of measurement of mechanical parameters of membranes for detection antigen-antibody reaction and for analysis of binding of enzymes to bilayer surface, which is important for construction of biosensors, are discussed.

References:

[1] Hianik T., Passechnik V.I., *Bilayer Lipid Membranes: Structure and Mechanical Properties*. Kluwer Academic Publishers, Dordrecht-Boston-London, 1995.

[2] Hianik T., Ottová-Leitmannová A., Tien H.T., Physical and chemical aspects of liposomes and some of their applications. In: *Vesicles* (Ed. M. Rosoff), pp. 49-77, Marcel Dekker, Inc. New York, 1996.

This work has been partly supported by European Commission in framework of Copernicus program (Project No CIPA-CT94-0231) and by Slovak Grant Agency VEGA (Project No 1/2190/95).

MS-27-2

MECHANO-ELECTRICAL AND ELECTRO-MECHANICAL ENERGY TRANSDUCTION MECHANISMS. V.I. Passechnik. ELDIS, Russian Academy of Sciences, 101 000 Moscow, Russia.

Mechanoreception is the possibility of a receptor to react to various mechanic stimuli: pressure, tension, sound waves, liquid stream etc. The reaction of any mechanoreceptor cell to the stimulus consists of a change of its membrane potential. Individual parts of the mechanoreceptor membrane react independently, i.e. a sensitive membrane presents itself as a mosaic of independent units, which are able to change their conductivity during membrane deformation. An elementary mechanosensitive unit (EMU) is composed of an ion channel and a part of receptor membrane attached to it. Its function consists of the change of the mean ion channel conductivity as a result of the deformation of this part of the membrane. The main goal of the physics of mechanoreceptors is to understand why the energy of the local center deformation is sufficient to induce the transition of the ion channel between states with various conductivity. There are some variants of solving this problem depending on the mechanoreceptor threshold sensitivity. The simplest situation is presented in blood vessel, where the mechanoreceptor response should be induced at pressure change of about $10^3 - 10^4$ Pa. In this case EMU consists of an ion channel and of attached piece of the bilayer. In a Paccinian corpuscle and hair-bearing receptors EMU includes probably some elements of membrane cytoskeleton filaments, which concentrate mechanical energy to the close environment of the ion channel-these mechanoreceptors are very sensitive. The highest sensitivity of mechanoreceptors is manifested in a Corti organ of the cochlea; and contains

combination of hair cell receptors mentioned above with electromechanical transduction generated by outer hair cells by means of changing their length in response to mechanical stimulation of the tips of their stereocilia. The 1000-fold increase of EMU is produced by positive feedback loop around outer hair cell - basilar membrane oscillations-receptor inner hair cells. The physical mechanisms of the elementary act of mechanoreception is discussed. The mechanoreceptor sensitivity can be expressed via a mechanosensitivity coefficient K, which is the ratio of the relative current amplitude change to the relative amplitude of area change. The value of K can be estimated via energy of elastic membrane deformations which take place during macromolecule dimension change in the process of opening and closing of EMU ion channel. The problem of high sensitivity of ion channels at high frequencies is considered, a possible model is proposed. As it follows from the model, the sensitivity decay due to finite value of times of open and closed states of the ion channel can be compensated by the increased sensitivity of elementary kinetic constants to mechanical deformation at high frequencies. The mechanisms of the electromechanical transduction in an outer hair are now under study. The main problems are as follows: (1) the molecular mechanisms of biological motility can't explain fast structure change of membrane dimension via applied an ac voltage to a cell membrane; (2) the voltage generated by ion channels is too small to induce high membrane potential. The possible experimental models to investigate the physical mechanisms of the elementary acts of mechanoreception as well as of electromechanical transduction are considered and the usage of these models to estimate the characteristic times of membrane transformations is discussed.

This work has been partly funded by The Commission of the European Communities (grant No CIPA-CT94-0231).

MS-27-3

SHAPES OF VESICLES AND CELLS UNDER THE EFFECT OF EXTERNAL FORCES. S. Svetina, B. Zeks, B. Bozic, V.Ph. Pastushenko and P. Peterlin. Institute of Biophysics, Medical Faculty and J. Stefan Institute, University of Ljubljana, 1105 Ljubljana, Slovenia.

Shapes of vesicles and cells are governed and in simpler cases also determined by the mechanical properties of closed lamellar membranes. Lamellarity of biological membranes is manifested by the bilayer structure of phospholipid membranes and by the presence of the accompanying membrane skeletons and glycocalices. When the layers forming a closed membrane are in contact but can in the lateral direction slide one by the other, the essential deformational modes are the area expansivity of the membrane neutral surface, the local membrane bending and the non-local membrane bending. Cell and vesicle shapes can be predicted by assuming that they correspond to the minimum of the respective membrane elastic energy. When cell or vesicle membranes are under the effect of external forces their shapes correspond to the minimum of the free

energy of the system which in addition to the membrane elastic energy involves the potential energies of the forces. Two examples are discussed: vesicle under the effect of axial forces and vesicle under the effect of the external electric field. In the first example the forces are applied at two distinct points of the vesicle membrane whereas in the second example the forces are acting over whole membrane surface. The analysis is presented which shows how the application of the axial pulling forces leads to the formation of membrane microtubes. The application of the external electric field also causes vesicle or cell shape transformations, with their extent depending on the relative contributions of the elastic and electric forces. A common feature of both treated examples are discontinuous shape transformations which may occur at continuously changing the magnitude of the applied forces.

MS-27-4

MECHANISM OF NEURONAL SHAPE TRANSFORMATION AND ITS ELECTRICAL CONSEQUENCES. V.S. Markin and D.L. Tanelian. Departments of Anesthesiology and Pain Management and Biomedical Engineering, University of Texas Southwestern Medical Center, Dallas, Texas 75235-9068, USA.

Neuronal processes can change their shape under the influence of mechanical or chemical stimulation. The driving force of this phenomenon is the internalization of membrane receptors leading to the formation of swollen varicosities (beads) connected by thin segments. The mechanisms for dendritic transformation based on the relationship between membrane area and neuronal process volume. The theory predicts the relationship between the initial dendrite radius and the average radii of the transformed dendritic varicosities and connecting segments, as well as the periodicity of the string of varicosities. The results of the model are in good agreement with experimental observations of this beading phenomenon in the spinal cord and brain.

Change of the shape of the neuronal process can complicate the propagation of action potentials. Three possible outcomes are considered: normal impulse propagation, action potential reflection, and conduction block. When action potential reflection is the prevailing condition, it can lead to both linear and nonlinear filtering of the incoming action potential train. Functionally, this process of dendritic transformation may serve as a mechanism for information processing along fine peripheral and central neuronal terminals.

Supported by the Sid W. Richardson Foundation.

MS-27-5

THE BACTERIAL FLAGELLAR MOTOR: (A) BRIEF REVIEW OF THERMODYNAMICS AND MODELS; (B) A NEW ELECTROSTATIC MODEL. S.R. Caplan¹ and D. Walz². ¹Department of Membrane Research and Biophysics, The Weizmann Institute of Science, 76100 Rehovot, Israel. ²Biozentrum, University of Basel, CH-4056 Basel, Switzerland.

The rotary motor responsible for the spinning of a bacterial flagellum is one of the most intriguing of microbiological systems, and it presents a major challenge from the viewpoint of bioenergetics. It is driven by a proton current and may be switched from counterclockwise to clockwise rotation without alteration of the direction of proton flow. A wide variety of models of the flagellar motor have been developed in recent years (Caplan and Kara-Ivanov, 1993). Among these, the two most convincing types of mechanism that have been analyzed quantitatively, in terms of what we know about the structure and function of the motor, are those based on fixed elastic elements analogous to muscle cross-bridges (e.g., Berg and Khan, 1983; Lauger, 1988; Meister *et al.*, 1989), and those based on electrostatic interactions (e.g., Berry, 1993; Doering *et al.*, 1995). In this study we reexamine these models, and show that the analyses that have been proposed suffer from difficulties both as regards torque generation and as regards switching.

The mechanism of coupling of the transmembrane flow of protons to the rotation of a bacterial flagellum is not as yet understood, but it may well be accomplished by means of a helical array of rotor elements interacting with a linear array of channel elements. Helical arrays or tilted rows were suggested both by Lauger (1977) and Macnab (1979, 1980). Berry (1993) was the first to consider a purely electrostatic model in which no structural complementarity is required between the rotor and the channel elements (force-generating units). He assumed the presence of alternating tilted rows of positive and negative charges, and showed that torque can be developed in such a system. Unfortunately, Berry's analysis leads to a number of incorrect and misleading conclusions. Since his model is intrinsically convincing and important it deserves careful reinvestigation. A new electrostatic model is presented in which the flaws have been overcome, and in contrast to earlier models (whether electrostatic or not) does not require synchronous action by the torque generators. It is shown that this model accounts quantitatively for much of the observed experimental data, and that switching and pausing occur as a consequence of minor conformational changes in the rotor.

References:

- Berry, R.M. 1993. *Biophys. J.* 64, 961-973.
Berg, H. C., and Khan, S. (1983). In *Mobility and Recognition in Cell Biology* (H. Sund and C. Veeger, eds.), pp. 485-497. De Gruyter, Berlin.
Caplan, S. R. and M. Kara-Ivanov. 1993. In *International Review of Cytology: A Survey of Cell Biology* (K. W. Jeon and J. Jarvik, eds.), Vol. 147, pp. 97-164. Academic Press, San Diego.
Doering, C., Ermentrout, B., and Oster, G., 1995.

Biophysical J. 69, 2256-2267.

Lauger, P. (1977). *Nature* 268, 360-362.

Lauger, P. (1988). *Biophys. J.* 53, 53-65.

Macnab, R. M. (1979). *Trends Biochem. Sci.* 4, N10-N13.

Macnab, R. M. (1980). In *Biological Regulation and Development* R. F. Goldberger, ed.), Vol. 2, pp. 377-412. Plenum, New York.

Meister, M., Caplan, S. R., and Berg, H. C. (1989). *Biophysical J.* 55, 905-914.

MS-28 — SENSORY PHYSIOLOGY

Organizers: Charles Rafferty and Peter Semm

This minisymposium will examine research issues and trends in the challenging and sometimes controversial area of magnetic and electric field reception in animals. It is widely accepted that some animals possess sensory systems which result in the perception of weak dc and low frequency electric and magnetic fields. One of the most widely researched areas is bird navigation. However, much work remains to understand the biophysical, biochemical, and cellular bases of sensory responses in animals. Both electric and magnetic field reception should be manifested at the cellular level and result in the stimulation of neural pathways. In the case of electroreception in fish, specialized cells have been identified that function specifically as electrochemical transducers of external fields. In other animals, specialized cells, possibly involving magnetite, that function as direct transducers of magnetic fields have been inferred based on several experimental and theoretical lines of evidence. In still other animals, sensitivity to magnetic fields has been reported, but no direct connection to adaptive receptor-based processes has been established. This minisymposium will provide a tutorial on these fundamental scientific issues and then focus on current research on the mechanisms of reception. The potential role of magnetite will be explicitly considered. Finally, inferences will be drawn regarding human health issues associated with EMF exposure based on recent advances in electroreception in fish.

MS-28-1

LIGHT-DEPENDENT AND MAGNETITE-BASED PROCESSES OF MAGNETORECEPTION PROVIDING DIFFERENT ORIENTATIONAL INFORMATION FOR BIRDS? W. Wiltschko¹, U. Munro² and R. Wiltschko¹.
¹Fachbereich Biologie der J.W. Goethe-Universität, Zoologie, D-60054 Frankfurt a.M., Germany. ²Department of Environmental Biology, University of Technology Sydney, Gore Hill, New South Wales 2865, Australia.

One of the two hypotheses on magnetoreception currently in discussion assumes that the magnetic field is perceived through light-dependent processes, the other favors processes based on magnetized material such as magnetite. In birds, there is evidence that both types of processes are involved in orientation. Since birds may use magnetic information in two

ways, namely as a compass indicating directions, and as part of the 'map' indicating position, the question arose what type of information is provided by either mechanisms. Attempts to answer this question involved testing migratory birds under different wavelengths of light to interfere with light-dependent processes, and treating them with a strong, brief magnetic pulse to affect the magnetization of small particles of magnetite as they are found in the birds' ethmoid region. Both treatments led to different results: Migrants tested under 443 nm blue light and 571 nm green light were normally oriented in the seasonally appropriate migratory direction, while birds tested under 633 nm red did not show orientation. This pattern of response was observed in Australian Silvereyes, European Robins and some warblers, and it seems to be independent of age and experience of the birds, as handraised young birds and experienced migrants responded in the same way.

The response to the treatment with a magnetic pulse, in contrast, varied with age and experience of the test birds. In young, inexperienced birds, there was no response at all; the birds continued in their normal migratory direction, whereas in experienced migrants, a ca. 90° deflection was observed, which was most pronounced during the first 3 days after treatment and then gradually faded away.

These findings indicate that light-dependent processes are involved in a mechanism used by all birds irrespective of age and experience, thus suggesting that the light-dependent mechanism provides magnetic compass information. The effect of the pulse treatment, on the other hand, suggests that magnetite might be involved in a mechanism available to old, but not to inexperienced birds. This points to a role of magnetite-mediated information in the navigational 'map'.

MS-28-2

A NEW INTERPRETATION OF THE EFFECT OF MAGNETIC TREATMENTS ON THE INITIAL ORIENTATION OF HOMING PIGEONS. F. Papi, P. Luschi and C. Del Seppia. Dipartimento di Scienze del Comportamento Animale e dell'Uomo, University of Pisa, I-56126 Pisa, Italy.

Disturbances in the initial orientation of homing pigeons following treatments with low frequency, weak magnetic fields, or with static fields, have been long attributed to a bird's failure to detect correct magnetic information useful for navigation. A similar effect produced by transportation in the dark has been considered as consistent with the idea of navigational impairment, as light deprivation would prevent magnetic detection en route.

However, a different interpretation involving influences on pigeons' emotional factors appears to be supported by the following experimental results. i) Exposure to oscillating magnetic fields produces a decrease in the concentration of μ opiate receptors in the pigeon brain. ii) Disturbances in orientation similar to those induced by magnetic exposure can be produced a) by injecting pigeons with the opiate antagonist naloxone and b) by exposing them to stress-inducing treatments, such as immobilization for 30 min. iii) Magnetic

exposure and transportation in the dark do not produce disturbances in orientation when pigeons are injected with the tranquilizer promazine before treatment.

Our conclusion is that the stress induced by the manipulation routinely occurring during a release is usually compensated; disturbances in orientation occur i) when magnetic treatment prevents opioid-mediated stress compensation, and ii) when additional stressors, such as transportation in the dark or immobilization, intervene. The pigeon navigational system is not affected, as shown by the normal homing speed and success of all the treated birds.

MS-28-3

THEORETICAL MODELS AND EXPERIMENTAL CONSTRAINTS ON MAGNETITE-BASED MAGNETORECEPTION. J.L. Kirschvink. Division of Geological & Planetary Sciences, California Institute of Technology, Pasadena, California 92215, USA.

Studies on vertebrates have shown that neurons associated with the ophthalmic branch of the trigeminal nerve respond selectively to small fluctuations in local magnetic field intensity, with little or no sensitivity to magnetic field direction. As these nerves ramify in tissues which contain the highest known concentrations of the ferrimagnetic mineral magnetite (Fe_3O_4), it supports the hypothesis the biogenic magnetite is the biophysical transducer in at least one class of sensory organelle. The apparent conservation both of this magnetite concentration and of the neural responses in evolutionary distant branches of the vertebrates suggests that these organelles evolved prior to the evolution of the *phylum Chordata*, which is consistent with the known 2 billion-year fossil record of biogenic magnetite preserved in the form of magnetofossils. Biophysical modeling of magnetite-based arrays indicate that nT-level sensitivity to small, extremely low frequency (< 10 Hz) magnetic fluctuations in the presence of ~ 50 μT geomagnetic background levels can be achieved. At present, biogenic magnetite provides the only biophysical transduction mechanism known which can account for the nT-level response to magnetic anomalies displayed by migratory and homing animals. Experiments using pulse-remagnetization techniques have demonstrated that a ferromagnetic material such as magnetite is indeed a component of the insect and avian magnetoreception systems. Although the ultrastructural search for these receptors *in situ* has been a frustrating 'needle-in-the-haystack' operation, it is fairly easy to extract from tissue digests linear chains of biogenic magnetite suitable for magnetoreception.

A major debate concerns whether magnetic compass (e.g., directional) information is obtained via the influence of light on pigments in the retina. However, much of the evidence for this suggestion rests on the failure of animals to orient in laboratory experiments in the presence of red light, a frequency which presumably does not activate the proper photopigments. However, in nature pure red light is only observed at dawn and dusk, and these are times when visual orientation cues are unambiguous. As magnetic compass orientation is usually expressed only in the absence of other

cues, it is not surprising that the presence of pure red light would lead to suppression of other compass orientation cues, including magnetism.

Supported by Electric Power Research Institute Contract WO-4307-03.

MS-28-4

WHAT SHARKS AND RAYS TELL US ABOUT THE EMF HEALTH ISSUE. A.J. Kalmijn. Scripps Institution of Oceanography, La Jolla, California 92093-0220, USA.

In recent electrophysiological studies on healthy, lightly relaxed thornback rays, single electroreceptor fibers were found to provide the animals with statistically significant information about low-frequency electric fields as weak as 20 nV/cm. Since the individual electroreceptor organs of elasmobranch fish, the ampullae of Lorenzini, are each innervated by several afferent nerve fibers and the animals have approximately one thousand ampullary sense organs, the results of the nerve recordings are in full support of the earlier established behavioral sensitivity of sharks and rays to electric fields of 5 nV/cm. Assuming a modest amount of central averaging, the new data suggest that the animals actually might sense the presence of electric fields already at a level of 1 nV/cm.

The high electrical sensitivity of sharks and rays results in part from the sizable lengths of the ampullary canals. Due to positive feedback driven by the active response of the sensory epithelium, the loss of signal along the ampullary canals is virtually nil for frequencies below 8 Hz. Hence, it is of crucial importance for the health cause to establish the presence or absence of anatomical structures and physiological functions concentrating the electrical signals across single-layered epithelia in higher animals, including men. Moreover, to be relevant, such structures and functions must be effective at the higher frequencies of interest, or the electrical signal must be rectified at the membrane level sufficiently so as to be operative in the lower-frequency range. The sensitivity of the Lorenzian ampullae is furthermore due to the small potential differences across the sensory epithelia needed to elicit meaningful behavioral responses in free-living sharks and rays. Thus, the smallest effective epithelial potential differences are definitely less than 25 nV and may be as little as 5 nV for frequencies below 8 Hz. The lesser sensitivity to higher-frequency fields is in part due to the frequency-dependent feedback of the Lorenzian ampullae. In the ionic model, that I developed based on the inferred biophysical operation of the ampullary organs, the frequency range is exclusively limited by capacitive reactances. How low the reactances actually are in the ampullae of Lorenzini and whether they might conceivably be sufficiently higher in other epithelia so as to render them sensitive to fields of 60 Hz is an issue presently under investigation.

The underlying principles of the ionic model not only conform to the results of the intracellular recordings that I made in intact sensory epithelia, but also are consistent with known ion-channel properties. Hence, any single-layered

epithelia, anywhere in the body, in particular in the central nervous system, can potentially be electrically as sensitive to electrical potential differences as the electroreceptor epithelia in the ampullae of Lorenzini of elasmobranch fish.

Concerning the effects of industrial electric fields on the sharks and rays themselves, I wish to note that the distribution of DC electric power by means of submarine cables definitely leads to electric fields in natural waters of the same magnitude as those which the sharks and rays rely on for orientation and navigation, in particular where the ocean itself is used as the return path.

This research was conducted under the auspices of the Electric Power Research Institute and the Office of Naval Research.

NOTES:

Physical Sciences

A. RF Mechanisms and Dosimetry

Chair: Igor Belyaev

A-1

BIOPHYSICAL CONSTRAINTS ON THE BIOLOGICAL EFFECTS OF RADIOFREQUENCY AND MICROWAVE RADIATION. R.K. Adair.

Department of Physics, Yale University, New Haven, Connecticut 06520-8121, USA.

I examine the constraints on the biological effects of the interactions of radio-frequency and microwave radiation imposed by thermodynamic noise. An analysis of the interaction of radiation with small biological elements at the cellular level shows that at power densities of 10 mW/cm² (or 100 W/m²), a level characteristic of occupational exposure limits, the interaction of the electric fields (of 200 V/m) with elements holding permanent charges or charge distributions will be masked by thermal noise and, hence, cannot be expected to generate biological effects. In particular, the viscosity of the biological media must strongly over-damp oscillatory motion and hence resonant effects are precluded. However, as pointed out by Schwan, the interactions of AC fields of 200 V/m with charges *induced* by the fields may generate energy transfers in systems of the order of kT in typical cells. The threshold field, E_t for significant effects might be as small as

$$E_t^2 = kT/\epsilon_0 V \quad (1)$$

where V is the volume of the cell. The forces associated with these effects can change the shape of the cells or result in forces between cells. Such effects are not nominally frequency dependent and biological effects, if they should exist, should not change radically over differences in frequency of a factor of two but can be expected to vary as E^2 or linearly with the power density near threshold.

I also examine the possible effects of such induced charges on the conformation of proteins which act as enzymes. Here we consider a two-configuration model of such a protein where the upper state is catalytically active and the lower state is not. If the states are separated by an energy w , the probability of the protein being catalytically active is

$$P = e^{-w/kT}/(1 + e^{-w/kT}) \quad (2)$$

Under a large electric field E induced charges can change the energy difference between the states by an amount of the magnitude of

$$dw = E^2 \epsilon_0 V \quad (3)$$

where V is now the volume of the protein and hence the current generated by the catalysis. However, even for very large fields and power densities, and large proteins and large currents, the change in current will be so small as to be

masked by shot noise.

The magnetic field part of radiative fluxes of 100 W/m² is only about 0.67 μ G and most magnetic effects are negligible, however Kirschvink has made the interesting suggestion that resonant microwave absorption by magnetite might induce biological effects. We show that a minimum requirement for such effects is the existence of cells holding more than 1000 magnetosomes that are sufficiently identical - that is have the same resonant frequency - so that they can interact with the incident radiation coherently.

A-2

VIBRATIONS IN MICROTUBULES. J. Pokorný, F. Jelínek, V. Trkal and F. Srobár. Institute of Radio Engineering and Electronics, Academy of Sciences of Czech Republic, 18251 Prague 8, Czech Republic.

Microtubules are important part of cell cytoskeleton, a highly dynamic structure that reorganizes continuously as the cell changes shape, divides, and responds to its environment. The biological role of microtubules in cell function and development is fundamental. Microtubules are polar structures whose minus ends are embedded in the centrosome which is assumed to be the major organizing center of microtubules. The cylindrical structure of microtubule can be considered as built from 13 protofilaments. Each of them is composed of alternating α - and β -tubulins (forming heterodimers) and packed in parallel to build a wall of a cylinder with a diameter of about 25 nm. The α - and β -tubulins are globular polypeptides which have the relative molecular mass about 55000.

Protofilaments may be considered to have certain type of translation symmetry which enables us to analyze their vibrations in terms of one-dimensional ordered chain used in solid state physics. The vibrating entities (particles) are the globular tubulin monomers (i.e. α - and β -tubulins) with masses m_1 and m_2 . The elastic force constant acting between monomers in a heterodimer and between two heterodimers is f_1 and f_2 , respectively (Fig. 1). Δ_1 and Δ_2 are the distances of equilibrium positions of the particles from the corresponding equidistant control points (the black dots in Fig. 1). From the classical equation of motion using solution in the form of Fourier components we get the dispersion relation $\omega_{\pm} = F(m_1, m_2, f_1, f_2, k, a)$ where k is the wave number and a is the distance between periodic control points (Fig. 1). Optical (ω_+) and acoustical (ω_-) branches of vibrations exist in the chain. Vibrations in a microtubule were analysed too. We assume that vibrations in a microtubule protofilaments are mutually coupled forming a common system of vibrations. The masses m_1 and m_2 in dispersion relation for a microtubule are 13 times greater than in a protofilament. Fig. 2 shows the optical (the full lines) and the acoustical (the dashed lines) branches of vibrations in a microtubule. As the bond between tubulin monomers in a heterodimer is assumed to be stronger than the bond between two heterodimers in a protofilament the corresponding elastic force constants are different ($f_1 = 10f_2$) too. The lowest frequency ($\nu \neq 0$) of vibrations may be

assessed from the condition $\lambda/2 = \lambda$ where λ is the length of the microtubule. If $\lambda = 10 \mu\text{m}$ and velocity $c_v = 10^2 - 10^3 \text{ ms}^{-1}$ the lowest frequency is in the range of $5 \times 10^6 - 5 \times 10^7 \text{ Hz}$.

As the heterodimer tubulin molecules are electric dipoles, vibrations in microtubules are connected with polarization waves and generate an electromagnetic field. The GTP molecules attached to β -tubulins may be hydrolyzed to GDP releasing energy which can cause transition from α conformation state to β conformation state of the tubulin heterodimer (shift of one monomer by 28° from the heterodimer axis). At least a part of the energy released is spent on excitation of vibrations. Conformation transition changes the whole system of vibrations especially the elastic force constants and frequencies of vibrations.

We may conclude that frequencies of vibrations in microtubules may be as low as $10^6 - 10^7 \text{ Hz}$. Tubulin heterodimers are electric dipoles and any vibrations have to generate an electromagnetic field. The vibrations are pumped by energy released from hydrolysis of GTP. Non linear effects can shift the vibrations far from thermodynamic equilibrium.

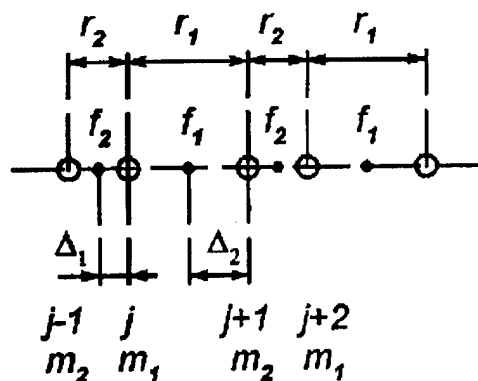

Fig. 1: One dimensional chain of particles.

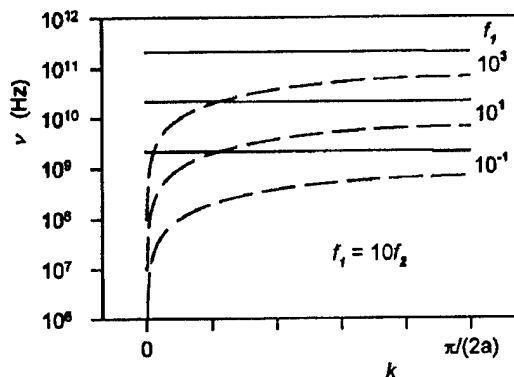

Fig. 2: Frequency ν versus wave number k for a microtubule.

A-3

MILLIMETER WAVES AS A FACTOR SYNCHRONIZING BIOLOGICAL PROCESSES IN IRRADIATED OBJECTS.

E.P. Khizhnyak¹ and M.C. Ziskin². ¹Institute For Cell Biophysics, Russian Academy of Sciences, Pushchino, Moscow Region 142292, Russia. ²Richard J. Fox Center for Biomedical Physics, Temple University Medical School, Philadelphia, Pennsylvania 19140, USA.

Interaction of millimeter wavelength electromagnetic irradiation (mm-waves) with biological structures is quite different from other regions of the electromagnetic spectrum, because most of the mm-wave energy is absorbed within a few tenths of a millimeter [Furia *et al.*, *IEEE Trans. Biomed. Eng.*, BME-33, 11, 1986]. Wavelengths in tissues become commensurable with sizes and shapes of biological structures, and the heterogeneity of biological objects such as the skin, becomes increasingly important. It has been demonstrated that mm-waves can produce a non-uniform heating pattern in irradiated objects, especially in the near-field area. Parameters of hot-spots are strongly dependent on: 1) the frequency (with an equivalent Q-factor of 500 or more); 2) the coupling conditions between the irradiating antenna and the irradiated surface; and 3) the heterogeneity and surface geometry of biological objects [Khizhnyak & Ziskin, *IEEE Trans. Biomed. Eng.*, BME-41, 9, 1994]. The non-uniform heating pattern is due to a geometrical resonance resulting from a secondary wave-mode interaction between an irradiated object and the corresponding critical cross-section of the mm-wave antenna.

THE EFFECT OF SYNCHRONIZATION IN THE PRESENCE OF MM-WAVES.

Space and time synchronization in different biological structures and processes can occur because: 1) biological objects have non-zero reflection and 2) heterogeneity of biological objects is not static. The pattern of electrodynamic heterogeneity is continuously changing due to different dynamic processes in living systems, such as opening and closing of sweat pores, or changes in capillary blood flow. Consequently, the distribution of mm-waves in an irradiated area will also change as a function of heterogeneity of irradiated objects. Such a situation creates a specific feedback where mm-waves play the role of the feedback carrier. Even thermal effects can change the pattern of heterogeneity of irradiated objects (for example, as a result of a local increase in evaporation) which leads to the appearance of new pathways of interaction between different parts of a biological structure through mm-waves.

EXPERIMENTAL CONFIRMATION. The reality of such a mechanism was experimentally demonstrated in studies of the dynamic characteristics of the process by which sweat pores in human skin open and close. Surface temperature dynamics of human skin irradiated by 10 mW/cm^2 , 40-72 GHz mm-waves from the open side of a horn antenna were studied using the method of infrared thermography (0.002 K temperature sensitivity, 60 frames per second, $20 \mu\text{m}$ spatial resolution). It has been found that: 1) hot-spots are formed in sweat pores as irradiation is turned on; 2) The dynamics and

synchronism of the opening and closing of sweat pores change during mm-wave exposure. Both effects are strongly dependent on the frequency of irradiation and on the coupling conditions between the horn antenna and the irradiated object.

A-4

INFLUENCE OF MOBILE TELECOMMUNICATION FIELDS ON LIGAND BINDING TO HYDROPHOBIC METALLO-PROTEINS. B. Bianco¹, A. Chiabrera¹, E. Moggia¹ and J.J. Kaufman². ¹ICEmB at DIBE, University of Genoa, 16145 Genoa, Italy. ²Orthopaedics Department, Mount Sinai School of Medicine, New York, New York 10029, USA.

A rather important application of bioelectromagnetics is the update of the scientific database for safety standards of RF electromagnetic fields, going beyond the current mechanistic assumption based on the disruption of the physiological metabolism if the e.m. power deposition is above 4 W kg^{-1} . The pervasive diffusion of hand-held transmitters (e.g. cellular telephones) is just the tip of the iceberg, because the anticipated global developments of mobile telecommunications will electromagnetically pollute the environment. Beside the experimental evidences scattered in the scientific literature, there is a lack of both understanding and consensus about the underlying mechanisms. One of the most widely studied biochemical processes is the binding of metal ions (e.g. Ca^{++}) to receptor proteins. A general model of the field interaction with the binding process is the quantum Zeeman-Stark model [1]. The model aims to capture the most important features of the interaction, avoiding all the details which could be obtained by means of a molecular dynamics simulation. The model addresses the following: collision frequency of the ligand ion inside the hydrophobic binding crevice of the receptor protein; an attracting endogenous force of the binding site highly non-linear with respect to the spatial coordinates; out-of-thermal equilibrium state of the ligand-receptor system, in absence of the e.m. exposure, due to the cell basal metabolism; thermal noise. The biochemical output is the probability of the receptor site to be occupied by the ligand ion. The steady probability change, due to a TEM sinusoidal carrier which emulates the field produced by mobile telecommunication equipment, has been evaluated in the frequency range 0.8-2 GHz for a putative "shallow" protein. For such a protein, the ion potential energy in the hydrophobic binding site is such that the energy difference between the ground level and the first excited level is hf_c , where h is the Plank's constant and f_c is the carrier frequency. At SAR above 0.1 Wkg^{-1} the aforesaid probability change can be larger than 30%. Such a result offers a biophysical basis for potential bioeffects of low-intensity RF fields, as those generated by hand-held transmitters.

[1] A. Chiabrera, B. Bianco, E. Moggia, T. Tommasi, J.J. Kaufman, Recent Advances in biophysical modelling of radio frequency electromagnetic field interactions with living

systems, Invited Paper, *Proc. of the State of the Science Colloquium, WTR and ICWCHR*, Rome, Nov. 13-15, 1995.

A-5

VALIDATION OF THE QUANTUM Z-S MODEL BY MEANS OF THE INTERACTION BETWEEN MW FIELDS AND ZN-PROTOPORPHYRIN SYSTEM. M. Zago¹, W. Rocchia², A. Palombo¹, E. Moggia², G. D'Inzeo¹, B. Bianco² and A. Chiabrera². ¹ICEmB, Department of Electronic Engineering, "La Sapienza" University of Rome, 00184 Rome, Italy. ²ICEmB, Department of Biophysical and Electronic Engineering, University of Genoa, 00155 Genoa, Italy.

The dynamics of the Zn-protoporphyrin IX has been assessed by means of molecular dynamics methods (Molecular Orbital PACKage). The conformational rearrangements of the protoporphyrin atoms during the Zn^{++} docking into the center of its binding site occurs in the picosecond scale, so that any microwave e.m. exposure can be considered as almost constant, with respect the dynamics of the constituent atoms induced by the ion displacement. The computer simulation of the complexation process with and without a low-intensity e.m. field has demonstrated the inhibitory effect of the exposure on the complex formation [1]. This result has been confirmed experimentally at 2.45 GHz [1, 2]. We have tested the predictive ability of the quantum Zeeman-Stark (Z-S) model of ligand binding [3] against the Zn-protoporphyrin system. Once and for all, the binding potential energy $U(\vec{r})$ of the Zn^{++} ligand has been numerically evaluated at various distances \vec{r} from the center of the binding site in absence of any electromagnetic exposure. The three parameters of the analytical relationship $U(\vec{r})$ used in the model have been obtained by fitting the numerical simulation, and the frequency range where the e.m. exposure should be effective in decreasing the Zn^{++} binding probability has been subsequently evaluated by means of the Z-S model.

In conclusion, this model offers a simple and rapid procedure for predicting the susceptibility of a biomolecule to e.m. fields. The comparison of this prediction with the aforesaid results is in progress.

[1] G. D'Inzeo, A. Palombo, L. Tarricone, M. Zago, "Electromagnetic field and molecular dynamics of Zn-protoporphyrin host-guest system"; *Abstract Book of the 3rd EBEA Congress*, Nancy, 1996.

[2] G. D'Inzeo, A. Palombo, L. Tarricone, M. Zago, "Molecular simulation studies to understand non-thermal bioelectromagnetic interaction"; *Abstract Book of the BEMS Seventeenth Annual Meeting*, p. 74, Boston, 1995.

[3] A. Chiabrera, B. Bianco, E. Moggia, M. Cavanna, J.J. Kaufman, "Theoretical models of RF EMF interaction with ligand binding"; Int. Seminar ICNIRP, WHO, BFS, on Biological Effects of Non-Thermal Pulsed and Amplitude Modulated RF Electromagnetic Fields and Related Health Hazards, Munich-Neuherberg, Nov 20-21, 1996.

NEURONAL CELLS UNDER ELECTROMAGNETIC EXPOSURE: A LINK BETWEEN MICROSCOPIC AND MACROSCOPIC MODELLING. F. Apollonio¹, G. D'Inzeo¹ and L. Tarricone². ¹Department of Electronic Engineering, "La Sapienza" University of Rome, 00184 Rome, Italy. ²Institute of Electronics, University of Perugia, 06131 Perugia, Italy.

In the recent past an increasing attention has been focused on environmental problems: a typical example is the evaluation of possible risks in the use of wireless communication systems due to effects of electromagnetic (EM) fields on cells [1]. Bioelectromagnetic effects at cellular level can be studied both at macroscopic and at microscopic level.

At macroscopic level the site of interaction is the whole cell together with its physiological activities; a typical example of macroscopic interaction site is the neuron and neuronal-membrane electrical activity. A generalized ionic model of the electrical activity of a neuronal membrane has been proposed in [2]. The model allows to get a good simulation of some known responses of the membrane in terms of its firing frequency and resistance in presence and in absence of the EM field [3].

At microscopic level the principal site of interaction is the cellular membrane and in particular ionic channels inside it. A well defined modelling technique (Markov Model: MM) has been proposed to simulate the behaviour of ionic channels when exposed to an electromagnetic stimulation [4].

Experimental observations have shown that the state of a protein channel in a membrane is "all-or-none": a channel appears open (conducting) or closed (non conducting), looking at it from outside; the possibility of different open states with different conductances has also been observed.

In this work a new approach to the study of such interactions has been proposed. It is based on defining a link between different modelling techniques at two distinct biological levels. Starting from the simulation results obtained considering a perturbation in the physiological conditions of ionic channels due to the EM fields associated to "pulsed" waveform signals, as GSM or DECT (typical wireless systems), it is possible to move to a higher level inside the biological scale. The MM technique gives results on the dynamical behaviour of ionic channels in terms of open or closed probability; if the channel is considered ohmic (experimentations confirm this with reasonable approximations) its conductance in a certain instant is proportional to the probability that the system is in an open state. At this point it is possible to introduce the different conductance values obtained, for each channel family (Potassium, Calcium, Sodium) with the MM modellization, in the generalized ionic model of the neuronal membrane. In this way the EM stimulus is only present in the microscopic level modellization; at the macroscopic level the electromagnetic presence is considered in the changes of the conductance values, outputs of the low-level model. The final results, outputs of the neuronal model, regard all the physiological parameters of the whole cellular membrane: the

membrane firing activity, the membrane resistance, the fluctuations of the inter-spike interval (ISI).

[1] K. Mann, J. Roschke, "Effects of pulsed high-frequency electromagnetic fields on human sleep", *Neuropsychobiology*, vol. 33, 41-47, 1996.

[2] P. Bernardi, G. D'Inzeo, S. Pisa, "A generalized model of the neuronal membrane electrical activity", *IEEE Transactions on Biomedical Engineering*, vol. 41, n° 2, 1994.

[3] P. Bernardi, G. D'Inzeo, S. Pisa, "Analysis of the interaction between Microwave Fields and Snail Neurons by an Ionic Model of the Membrane Electrical Activity", *Alta Frequenza, Special Issue on "Biological Effects of Electromagnetic Fields and Safety Standards"*, vol. LVIII, n° 4, pp. 355-360, 1989.

[4] G. D'Inzeo, S. Pisa, L. Tarricone, "Ionic Channels Gating under EM exposure: a stochastic model" *Bioel. & Bioen. Journ.*, 29, 290-304, 1993.

MAGNETIC FIELD DOSIMETRY - BIOPHYSICAL AND CLINICAL ASPECTS. M.S. Markov. Bioelectrochemistry Laboratory, Mount Sinai School of Medicine, Mount Sinai, New York, USA.

Electromagnetic field (EMF) dosimetry as a fundamental process of measuring physical quantities of electromagnetic field energy imparted to an absorbing body is a subject of this study. Dosimetry in bioelectromagnetic research was developed in two parallel but interacting and complimentary streams: theoretical and experimental. While theory of dosimetry is well defined for homogeneous objects, considerable work must be done for development of dosimetric models for inhomogeneous systems. Theoretical and experimental dosimetry deals mainly with simplified models and methods of measurements of electric fields (EF). Little attention was given to the high frequency magnetic fields (MF) dosimetry. Fields inside any physical body exposed to EMF can be calculated by solving Maxwell's equations subject to boundary conditions. However, the inhomogeneity of the dielectric properties of the biological systems and the complexity of the shape and structure of any cell, tissue, organ inside the biological body make the solution of these equations a difficult task. The exact understanding of distribution of MF within the body targets becomes more important because of increasing clinical usage of high frequency therapeutic devices (with radiofrequency and millimeter wavelength) for treatment of a variety of conditions including muscular-skeleton system, soft tissue injuries, wounds and burns. Several clinical studies have shown that different body parts accept and utilize the imparted EMF energy differently, primarily due to differences in the quantity and characteristics of soft tissue versus bone and cartilage. The interaction of EMF with different tissues of the human body depends on a variety of factors including the electrical and intrinsic properties of the target tissue, the orientation of this target with respect to the field vector, the physiological characteristics of the individual, and the dielectric properties of both the body and the environment. In

addition, the electromagnetic signal should not only satisfy the dielectric properties of the target tissue, but also induce sufficient voltage/current. The MF in the immediate vicinity of the applicator is a complicated function of the coil geometry, and the size and dielectric characteristics of the target tissue. The existing therapeutical units are designed in such way that the incident MF is predominant when compared with incident EF. Due to the high rate of change (dB/dt) the incident MF induces a significant EF inside the target tissue. Depending on the dielectric properties of the tissue, an induced electric current is present at target tissue. This current in turn induces MF that is opposite to the incident magnetic field. Since the MF probe cannot be placed inside the tissue target, it is usually positioned between the source of exogenous MF and the target. Therefore, the measured MF is a resultant field of the incident and back (induced inside the tissue target) magnetic fields. The dosimetry of the therapeutic systems utilizing high frequency EMF systems depends on the total impedance presented to the transmitter at any treatment site. A convenient engineering method is to measure the standing wave ratio which represents the ratio of the magnitude of the voltage across an unknown load to that across a 50-ohm load. To evaluate the bioeffects of radiofrequency fields, the magnetic field value and the impedance at different body targets need to be measured. It is essential to consider the magnetic field interactions with intended tissue target. Using these methods, a clear separation into two categories of the body targets depending on their soft tissue versus bone content was found. The composition and homogeneity of the treatment area affects the induced current pathways. Bone is a poorer conductor than soft tissue, therefore a smaller back MF is induced resulting in a larger measured MF. We already reported that the statistical analyses showed no significant differences as a function of volunteer race and age and few differences were found as a function of sex. These differences were mainly attributed to the differences in body fat content between men and women. The clinical importance of MF dosimetry revolves around the conclusion that the targeted tissue must be taken into consideration in order to achieve optimum treatment.

A-8

COMPARISON OF FD-TD AND EXPERIMENTALLY DETERMINED LOCAL AND WHOLE-BODY SAR IN A RHESUS MONKEY MODEL. J.M. Ziriak¹, C.M. Furse², J.A. D'Andrea¹, D.J. Hatcher¹, P.A. Mason³ and O.P. Gandhi². ¹Naval Medical Research Institute Detachment, Brooks Air Force Base, Texas 78235-5423, USA. ²Department of Electrical Engineering, University of Utah, Salt Lake City, Utah 84112, USA. ³Systems Research Laboratories, San Antonio, Texas 78235, USA.

The purpose of the measurements reported here were to compare specific absorption rates (SAR) of microwave radiation as predicted by finite-difference time-domain (FD-TD) and experimental measurements. Several microwave frequencies in the pre resonant, resonant, and post resonant

range of a rhesus sized homogeneous tissue monkey model were tested. The measurements will be compared to a future FD-TD heterogeneous tissue monkey model.

The homogeneous model was constructed of heavy gauge waterproof cloth cut and sewn in the shape of a rhesus monkey and filled with homogeneous muscle simulating material previously developed by Chou *et al.* (1984). Localized and whole-body dosimetric measurements of absorbed microwave energy in the model have been taken for frequencies from 102 MHz to 3 GHz using a thermographic camera, microwave compatible temperature probes, and a twin-well calorimeter. The thermographic images (Radiance I) have shown surface SARs differ considerably depending on microwave frequency. These have been corroborated by measurements of local SAR using microwave compatible temperature probes (Luxtron) implanted in the model.

Whole-body SAR measurements have been collected using twin-well calorimetry and have shown good agreement with predictions from the *Radio Frequency Dosimetry Handbook*. Images of the homogeneous monkey model were taken using a GE MRI at spacing of every two cm. The images were used to construct an accurate computer model with a resolution of 2x2x4 mm and 4x4x8mm. The models were placed 8 cells from a Retarded Time Absorbing Boundary Condition, and the simulations were run for 4 cycles of the wave. The incident field was a frontally-incident plane wave with a single frequency sine wave source. Layer averaged current and SAR distributions were computed using the FD-TD method for frequencies from 102 MHz to 4 GHz.

The calculated and measured whole-body SAR were very similar up to about 500 MHz. Above that frequency the calculated results appear to give high SARs. This was very likely due to resonances in the lower legs and difference in position of the legs between the computer model and the experimental model. At the whole-body resonant frequency (199 MHz) the majority of the power is absorbed in the torso and chest. The average SAR in the head peaked around 800 MHz.

A-9

CONVERGENT TECHNOLOGIES IN MICROWAVE DOSIMETRY. P.A. Mason¹, J.M. Ziriak², W.D. Hurt³, J.A. D'Andrea² and T.J. Walters¹. ¹Systems Research Laboratories, San Antonio, Texas 78235, USA. ²Naval Medical Research Institute Detachment, Brooks Air Force Base, Texas 78235, USA. ³Armstrong Laboratory, Radiofrequency Radiation Division, Brooks Air Force Base, Texas 78235, USA.

Although whole-body specific absorption rate (SAR) values provide useful information about the thermal burden resulting from exposure to electromagnetic fields (emf), there may be localized "hot spots" at the interface between tissue types, such as air and lung. However, it is impractical to place temperature probes every few mm throughout the body for all emf exposure conditions of interest to our laboratories. Therefore, it was essential to develop suitable block models of spheres, animals used in our laboratories, and a man that

could be incorporated into mathematical models (e.g., FD-TD, Mie) to predict localized SAR values. The computer-generated spheres were 66 and 105 mm in diameter and each 1 mm³ cube within the sphere was assigned dielectric values corresponding to 2/3 that of muscle. The animal block models were developed using magnetic resonance imaging (MRI) scans. The man block model was developed using the VisibleMan database (National Library of Medicine) in collaboration with the Center for Information-Enhanced Medicine (CieMed), National University of Singapore. Each pixel was color coded to correspond with a tissue type which was matched with dielectric values obtained from the data of Dr. Camella Gabriel¹. As of the present, SAR values predicted for the rat (370 g), exposed in the k-polarization, and spheres were compared to temperature increases observed and time-averaged SAR values calculated during actual exposure in the far field to 2.06-GHz radiation. Spheres used to collect the empirical data were composed of a material having the dielectric properties of 2/3 muscle (Chou *et al.*, 1984). This material was encased in two halves of a StyrofoamTM shell which were separated with silkscreen. Results for the computer-generated spheres showed that the Mie theory and FD-TD code predicted similar SAR values. For the spheres and rat, the highest predicted values were in the same regions as the highest temperatures as measured by infrared imaging and/or implanted temperature probes. Maximal heating of the 66 and 105 mm diameter spheres occurred in the center region and along the edge facing the horn, respectively. Maximal heating of the rat was on the surface of the nasal bone, around the ears, within the shoulder and axillary regions, and on the dorsal region of the neck. These convergent technologies validate the use of computational codes to predict SAR values and confirm that the amount of energy absorbed by tissue is dependent upon the animal's posture and orientation with respect to the field.

1. (<http://www.brooks.af.mil/AL/OE/OER/Title/Title.html>)

A-10

CONDITIONS FOR RESONANT ABSORPTION IN THE HUMAN HEAD FOR PLANE WAVE EXPOSURE.

C.M. Furse and O.P. Gandhi. Department of Electrical Engineering, University of Utah, Salt Lake City, Utah 84112, USA.

Electromagnetic absorption in humans is strongly dependent on frequency and is controlled not only by the properties of the tissue, but also by the shape and size of the body. This leads to resonances when the body or parts of the body absorb significantly higher amounts of energy than would be predicted simply from the respective physical cross sections. These resonances have been quantified in a general sense in the past, and it has previously been observed that the human head has a resonant frequency of approximately 150 to 200 MHz, depending on the exposure conditions [1]. This simulation used a 1.31 cm anatomically-based model of the body, and coarsely analyzed the overall resonant effects. This paper takes a closer look at the phenomenon of head resonance, and how it is controlled by the shape and exposure

of the model. The resonant effect is fairly strong in the human body and head, as shown in Table 1, for ungrounded plane wave exposure conditions at 200 MHz. The absorption cross section is nearly three times larger than the physical cross section for the head, indicating that at this resonant frequency, nearly three times as much power is absorbed in the head as would be predicted from the physical cross section. Head resonances for grounded models are now being further examined, and it is expected [1] that the absorption cross section will be slightly higher and the resonant frequency slightly lower.

Table 1: Head resonance conditions for heterogeneous human models.

Model	Head Resonant Freq. (MHz)	Absorption Cross Section /Physical Cross Section	Whole-Body Resonant Freq. (MHz)	Absorption Cross Section /Physical Cross Section
Adult	205	2.78	75	3.92
10-year old	270	2.84	100	3.88
5-year old	330	2.92	130	3.47

Using a 6 mm resolution MRI-based model of the human body, the distribution of power deposition was calculated using the finite-difference time-domain method. The distribution of absorbed power will be shown in three-dimensional graphics for frequencies ranging from 1 MHz to 915 MHz, to demonstrate the difference in power deposition in the body as a function of frequency, particularly with respect to resonance. This graphical representation provides significant insights into the nature of body resonances, in general, and head resonance, in particular.

1. O.P. Gandhi, Y-G. Gu, J.-Y. Chen, H. I. Bassen, "Specific Absorption Rates and Induced Current Distributions in an Anatomically-Based Human Model for Plane-Wave Exposures," *Health Physics*, Vol. 63, No. 3, pp. 281-290, September 1992.

A-11

DESIGN OF PHANTOM STRUCTURES FOR THE SIMULATION OF BIOLOGICAL EFFECTS OF EM RADIATION. S.A. Jaramillo¹, J.L. Sebastian² and M. Sancho². ¹Facultad de Ingeniería Electrónica, Universidad Pontificia Bolivariana, Medellin, Colombia. ²Facultad de Ciencias Físicas, Universidad Complutense, Madrid, Spain.

One of the main difficulties for an accurate analysis of the interaction of electromagnetic radiation with a living being is the simplistic models of organs and biological structures that are usually used in the simulations. The use of discrete numerical techniques specially adapted for inhomogeneous media and irregular shapes leads to much more satisfactory models. However, large computational times and computer memory are necessary in order to obtain a steady state solution.

This work presents a technique for the design of phantom

structures which shows a electromagnetic behavior, within the range 1 to 18 GHz, very similar to that of the real biological samples. In comparison with the classical models made of bulk lossy dielectric materials, the designed phantom structure is formed by a multilayered structure of complex permittivities.

The design of the structure is based on the experimental determination of the scattering parameters S_{11} (reflection) and S_{21} (transmission) of the biological sample. The possibility to change the number of layers, the thickness and the complex permittivity of each layer makes it possible to accommodate the electromagnetic RF behavior to that of the biological sample.

The experimental electromagnetic characterization of the biological sample is performed at a working frequency within the range 1-18 GHz by using a network analyzer. The sample has a rectangular shape and is placed in the center of a waveguide that is excited with the fundamental mode (TE_{10}).

In order to design a phantom structure that presents equal values of S_{11} and S_{21} (complex reflection and transmission coefficients) at the same working frequency, a technique has been developed, in which the modal analysis and an integral relation are used. The designed structure has the shape and dimensions of the biological sample and the analysis is performed with the structure placed at the center of the waveguide.

A parametric 3-D surface is obtained for the modulus of the reflection coefficient $|S_{11}|$ versus the phase ϕ_{11} and the frequency, being the varying parameters the real and imaginary part of the permittivity. A similar 3-D surface is obtained for the modulus of the transmission coefficient $|S_{21}|$ versus the phase ϕ_{21} and the frequency ω . The analysis of these surfaces makes it possible to obtain the permittivity, the thickness of each layer and the number of layers so that the structure will have a particular electromagnetic behavior.

A-12

WHOLE-BODY SAR IN A FULL-SIZE HUMAN MODEL AT 28.9 KHz. R.G. Olsen¹, B.J. Van Matre¹ and P. Hansen². ¹Naval Medical Research Institute, Detachment, Brooks Air Force Base, Texas 78235, USA. ²Naval Command, Control, and Ocean Surveillance Center, San Diego, California 92152, USA.

High-power transmitting stations in the VLF spectrum (3 to 30 kHz) continue to be of military importance at many sites all over the world. A typical VLF system transmits continuously at a power of one million watts or more with antenna towers that occupy hundreds of acres. Occupational exposure to relatively high field intensities is relatively common near the transmitter building and/or directly under the antenna array. Therefore, technicians who operate the console and riggers who climb the towers are irradiated on a daily basis. According to widely available RF dosimetry handbooks, whole-body SAR due to VLF exposure should be negligibly small even at high field intensities. Dosimetry handbooks, however, make certain assumptions such as uniform, plane-wave exposure that do not reflect actual

working conditions. Normally, workers are protected from RF shocks and burns but can be working, both indoors and outdoors, relatively close to conductors at high VLF voltages. This exposure configuration is definitely not one of uniform, far-field irradiation. Electric field (E-field) permissible exposure limits (PELs) are often exceeded, usually with no untoward effects since RF body currents are well below PEL. Therefore, the E-field PEL for occupational exposure may be overly restrictive as applied to high-power VLF transmitting sites. In an effort to corroborate handbook predictions of low average SAR for VLF exposure, we used the Navy-developed twin-calorimeter dosimetry system at a high-voltage testing facility near Forestport, New York. During exposure, a muscle-equivalent human model was placed under a circular (3.66 m dia) metal electrode suspended 3 m above a sheet metal-over-concrete floor. The VLF dielectric properties of the tissue-equivalent material were measured with an LCR meter and a 4-wire hookup; the relative dielectric constant was calculated to be 10,000 with a conductivity near 1.0 S/m. Our original intent was to operate the irradiation system at the highest possible voltage in order to obtain the most body heating. Unfortunately, other factors prevailed. Initial irradiation of the model with 30 kV (rms) applied to electrode produced a previously unobserved condition of burning at the top of the head; arcing was also observed at the foot of the model near the seams where there were tiny amounts of wet simulated tissue touching the metal floor. In order to eliminate all indications of overheating, we placed a small square of 6-mil polyethylene plastic under the model's "feet", reduced the applied voltage to 20 kV and were required to "fold down" the funnel-shaped portion of the top of the head. Our preliminary results for a 60-minute irradiation with a nominal E-field of 6.7 kV/m show an average SAR of 0.2 W/kg. Based on a strict comparison with handbook values, this result is higher than expected, but we can certainly conclude that exposure to VLF fields at or slightly above established PELs (614 v/m) will not produce excessive whole-body SAR.

Biological Sciences I

B. Cellular Responses

Chairs: Ewa Czerska and Gunter Obe

B-1

EFFECTS OF PULSED ELECTROMAGNETIC FIELDS (PEMF) ON HUMAN OSTEOBLAST-LIKE CELLS AND HUMAN CHONDROCYTES: AN *IN VITRO* STUDY. V. Sollazzo¹, L. Massari¹, A. Caruso², F. Pezzetti², M. De Mattei², A. Pellati² and G.C. Traina¹. ¹Dipartimento di Scienze Biomediche e Terapie Avanzate, Sezione di Clinica Ortopedica, Università di Ferrara, 44100 Ferrara, Italy. ²Istituto di Istologia ed Embriologia Generale, Università di Ferrara, 44100 Ferrara, Italy.

Pulsed Electromagnetic fields (PEMF) are used by Orthopaedics to promote bone healing in many pathologies.

It is known that osteoblasts and chondrocytes are targets of PEMF.

The goal of our work was to study the effects of low-frequency, low-energy pulsed electromagnetic fields (PEMF) on human osteoblast-like cells and human chondrocytes *in vitro*.

Osteoblasts were obtained from normal adult spongy bone specimens while chondrocytes from articular cartilage specimens collected during surgical procedures. Primary cultures were grown in Minimum Essential Medium (MEM) supplemented with 10% fetal calf serum (FCS) and antibiotics.

Bone nature of osteoblast-like cells was determined using antiosteonectin and antiosteocalcin antibodies and detecting the AMPc production in response to PTH stimulation. Chondrocytes were assayed with anticollagen II antibodies.

Osteoblasts and chondrocytes subcultures were plated into multidishes and placed between a pair of Helmholtz coils powered by a pulse generator (IGEA, Carpi, Italy, pulse duration 1.3 ms, 75Hz, duty cycle 1/10, intensity 23 Gauss) in a tissue culture incubator for 24 hours. ³H-thymidine was added to the culture medium. ³H-thymidine uptake and ³H-thymidine acid precipitable amount (as measure of cell proliferation) was evaluated.

In osteoblast-like cells maintained in the presence of 10% FCS, PEMF exposure increased cell proliferation rate. When osteoblasts were cultured with 0.5% FCS no significant difference was found in ³H-thymidine acid-precipitable incorporation as compared to the control.

In chondrocytes PEMF exposure induced a significant increase in cell proliferation as compared to control both when cells were grown in 10% FCS conditions and when cells were maintained in the presence of 0.5% FCS.

PEMF exposure induced no significant change in cell proliferation rate, as compared to control, both in osteoblasts and chondrocytes maintained in serum free medium.

Our data showed that PEMF exposure induced an increase in cell proliferation rate both in human osteoblast-like cells and in human chondrocytes. This stimulation appear to be conditioned by soluble factors present in the serum. Chondrocytes require a small amount of those factors (0.5% FCS) while osteoblasts need an higher concentration of the same factors (10% FCS).

B-2

IS THE HEAT SHOCK RESPONSE ACTIVATED BY EXPOSURE TO RF FIELDS?

A. Laszlo, M.S. Chen and T. Davidson. Section of Cancer Biology, Radiation Oncology Center, Mallinckrodt Institute of Radiology, Washington University School of Medicine, St. Louis, Missouri 63130, USA.

One of the concerns about the biological effects of electromagnetic fields is the discrimination between thermal and non-thermal effects. The exposure of mammalian cells to elevated temperatures leads to the induction of the heat shock response, via the activation of the heat shock factor (HSF). We wanted to explore the potential of using the activation of

the heat shock factor as an assay for thermal effects of exposure to electromagnetic fields. Towards this aim, we have investigated the sensitivity of the assay for the activation of HSF and ascertained the effect of exposure to RF electromagnetic radiation on the cellular status of HSF.

OBJECTIVES: 1) To develop a sensitive and reproducible assay for the activation of HSF in mammalian cells in culture and 2) to determine the effect of exposure to microwave frequency RF on the HSF of mammalian cells in culture.

METHODS: The activation of HSF was monitored by a gel mobility shift assay modified to optimize detection and resolution in our cell systems. In this assay, the activation of the binding capacity of HSF to an oligonucleotide probe containing four repeats of the consensus heat shock element which occurs when cells are exposed to a variety of agents, is monitored by a retardation of the electrophoretic mobility of the probe. Several cell lines, including mouse 10T1/2, hamster HA-1, rat NRK and human PEER cells were used in these studies. Exponentially growing cultures were exposed to 835.62 FMCW RF and CDMA RF in radial transmission line irradiator systems in which the SAR was determined to be 0.6 W/kg (see Moros *et al.*, *BEMS* 1996, Pickard *et al.*, *BEMS* 1997) in two different protocols. In the short protocol, cells were exposed to RF for 1, 2, or 4 hr. In the long protocol, cells were exposed to RF for 1 to 7 days. Nuclear extracts were prepared from control, sham exposed, RF exposed and heat shocked (positive control) cells and the ability to bind to the probe containing the heat shock element was monitored by the gel mobility shift assay.

RESULTS AND DISCUSSION: The gel mobility shift assay was modified to give optimal resolution and sensitivity with our cell systems. Under these experimental conditions the activation of HSF by a temperature shift as small as 1°C to 2°C for 15 min could be detected reproducibly in all of the four cell lines that we tested. This signal was about 10% of that observed with the temperature shifts of 6°-7°C which result in a maximum response. Using this assay, we could not detect the activation of HSF either after a short or a long term exposure to either FMCW or CDMA RF fields in any of the four cell lines that we tested. Given the sensitivity of our detection system we conclude that exposure to RF does not lead to the activation of HSF of the order of magnitude associated with a temperature shift of 1°C. Furthermore, these results confirm the quality of the temperature control in our exposure system.

CONCLUSION: It is concluded that exposure of mammalian cells to microwave RF does not lead to the activation of the heat shock response.

B-3

CYTOLOGICAL EFFECTS OF HIGH FREQUENCY ELECTROMAGNETIC FIELDS ON HUMAN LYMPHOCYTES *IN VITRO*.

G. Obe and A. Antonopoulos. Department of Genetics, University of Essen, D-45117 Essen, Germany.

Human peripheral lymphocytes were exposed to high frequency electromagnetic fields (HFEMF), as used in Handy-

telephones (900 and 1800 MHz) and police radio (380 MHz). Samples of heparinized blood from 15 different donors (female and male) were used in each experimental set-up, 5 ml cultures with 0.5 ml whole blood each for field and sham exposure were incubated in McCoy's 5A medium supplemented with fetal calf serum, phytohemagglutinin, antibiotics and 5-bromodeoxyuridine at 37°C. Cultivation took place in precision oilbaths.

The telephone simulating experiments were performed in a hollow conducting tube, the police radio simulating tests in a TEM-cell.

Cultures from each of the blood samples were incubated in the presence or absence of HFEMF for 48, 52, 56, 64 and 68 h including exposure to colcemid for 2 h to arrest cells in mitosis. At each time point, one exposed and one control culture were prepared.

Cells were prepared for microscopic analysis by staining the slides differentially.

Frequencies of cells in first (M1), second (M2), third or further mitosis (M3+) were determined by counting 100 metaphases for each fixation time. The difference (Δ) between exposed and unexposed cells with respect to M1, M2 and M3+ were evaluated and statistically analysed.

SCE were determined in 50 differentially stained M2-metaphases at the fixation time of 56 h. The mean number of SCE per cell were calculated.

Exposure of lymphocytes in whole blood cultures to HFEMF of 380, 900 and 1800 MHz did not influence the cell cycle when compared to control cultures. No significant effects on the frequencies M1, M2 or M3+ were found. Likewise the HFEMF did not influence the SCE frequencies.

B-4

THE EFFECT OF EXTREMELY LOW FREQUENCY MAGNETIC FIELDS ON THE NEURONAL ACTIVITY IN THE SUPRA-CHIASMATIC NUCLEUS OF THE RAT. O. Hiwaki. Faculty of Information Sciences, Hiroshima City University, Hiroshima 731-31, Japan.

INTRODUCTION: Extremely low frequency (ELF) magnetic fields, such as 50 or 60 Hz magnetic fields, have been reported to suppress the nocturnal production of pineal melatonin. The amount of melatonin produced in the pineal gland changes according to the circadian rhythm. The suprachiasmatic nuclei (SCN) in the hypothalamus of mammals function as the pacemaker of the circadian rhythm. In this study, the electrical activity of the cells in the SCN of the rat responding to ELF magnetic fields was investigated.

METHODS: The coil system, which consisted of three sets of 4-square Merritt coils, was employed to produce uniform magnetic fields in any direction. The coil system was placed in a magnetically and electromagnetically shielded room built with permalloy. Urethane anesthetized Wister rats were used as the subjects. A microelectrode was inserted stereotaxically into the SCN and was anchored to the skull with dental acrylic cement, and then the head of the rat was fixed horizontally at the center of the coil system. The rat was kept

in darkness during the experiments. The rat was exposed with 10 μ T magnetic fields directed along the following axes: parallel to the longitudinal axis of the head (x-axis), perpendicular to x-axis in horizontal plane (y-axis), and vertical axis (z-axis). The changes of the electrical activity of the neurons in the SCN with the frequency and the direction of the magnetic fields were observed.

RESULTS: The activity of the cells in the SCN was enhanced when the rat was exposed to the magnetic field in the range of 5 to 30 Hz. The magnetic fields directed along y-axis enhanced the activity much more than those along x-axis or z-axis. The magnetic fields less than 5 Hz or more than 30 Hz did not influence the neuronal activity in the SCN.

CONCLUSION: The activity of the neurons in the SCN of the rat was enhanced by ELF magnetic fields in the specific range of the frequency and direction.

B-5

A 12mG (1.2 μ Tesla) MAGNETIC FIELD INHIBITS TAMOXIFEN'S ONCOSTATIC ACTION IN A SECOND HUMAN BREAST CANCER CELL LINE: T47D. R.P. Liburdy, G.A. Levine, M.Y. Lee and J.D. Harland. Lawrence Berkeley National Laboratory, University of California, Berkeley, California 94720, USA.

OBJECTIVE: Previously we have demonstrated that continuous exposure of MCF-7 human breast cancer cells *in vitro* to an environmental-level 1.2 μ Tesla (12 mG), but not a 0.2 μ Tesla (2 mG) 60Hz magnetic field, inhibits or blocks the growth inhibitory action of the drug tamoxifen [1]. MCF-7 cells represent one of several estrogen receptor positive (ER⁺) cell lines widely employed in breast cancer research. To extend our previous findings with MCF-7 cells and assess the "robustness" of this field interaction with environmental-level 1.2 μ Tesla magnetic fields, we have initiated studies using T47D cells, a well characterized human breast cancer cell line that is ER⁺.

METHODS: We have tested the hypothesis that a 1.2 μ Tesla magnetic field will inhibit the oncostatic action of tamoxifen in a second human breast cancer cell line, T47D. T47D cells were obtained from ATCC and were maintained in special, low-level EMF cell culture incubators (0.2 μ Tesla 60Hz AC; \leq 0.5 μ Tesla DC), as described [1]. Cells were seeded at approximately 15,000 cells per well on day zero in 24-well titre plates (diameter \sim 16mm) using serum previously employed in MCF-7 studies [1,2]. Cells were harvested on subsequent days and counted employing a Coulter counter. (In previous studies MCF-7 cells were seeded at 10,000 cells/35mm plate and counted by hemacytometer [1].) Identically matched cell culture incubators were maintained at 0.2 or 1.2 μ Tesla magnetic field intensity (rms) [DC magnetic field $<$ 0.5 μ Tesla] using identical Merritt-type exposure systems with mu-metal shielding chambers to eliminate spurious magnetic fields generated by the incubators [1]. Simultaneous exposure of same passage cells to either 0.2 or 1.2 μ Tesla was accomplished using these exposure systems. All samples were coded with respect to

chemical treatment.

RESULTS: In three independent, blinded experiments, T47D cells showed significant inhibition (23%, 23%, 33%; $p < 0.05$) by 10^{-7} M tamoxifen during exponential growth over several days in the 0.2 μ Tesla field. This can be compared to an approximate 40% growth inhibition of MCF-7 cells by 10^{-7} M tamoxifen in previous experiments [1]. When same passage T47D cells were grown in the presence of 10^{-7} M tamoxifen in a 1.2 μ Tesla magnetic field a statistically significant ($p < 0.05$) growth inhibition of 16%, 16%, and 27%, respectively, was observed. Thus, the 1.2 μ Tesla magnetic field had a small but statistically significant effect on tamoxifen's action in all three experiments with T47D cells. This is similar to an approximate 17% growth inhibition observed previously for MCF-7 cells [1]. When a comparison is made of tamoxifen's action in a 0.2 compared to the 1.2 μ Tesla field, across the three T47D experiments, we find that the 1.2 μ Tesla field inhibited or blocked tamoxifen's action to a greater degree than the 0.2 μ Tesla field ($p < 0.05$).

DISCUSSION: We have observed that a second ER⁺ human breast cancer cell line, T47D, exhibits a reduction in tamoxifen sensitivity in the presence of a 1.2 μ Tesla magnetic field. We conclude that these findings are consistent with and extend our previous reported findings using MCF-7 cells [1]. To further characterize the relative "robustness" of this effect other cell lines are being investigated; refer to our companion abstract dealing with human glioblastoma cells.

[1] Harland, J. & Liburdy, R.P. *Bioelectromagnetics*, accepted (1996)

[2] Liburdy, R.P., et al., (1993), *J. Pineal Res.* 14:89-97.

Supported by the Office of Energy Management, Utilities System Division, US Department of Energy under contract DE-AC03-76SF00098, the NIH/NIEHS through Project CA07279, and by the Department of Army, U.S. Medical Research and Development Command through Project 2198.

B-6

CAN EMF EXPOSURE EMULATE A TUMOR PROMOTER? DESIGNING ENDPOINTS. Q. Tao, A. Micic and A. Henderson. Department of Biological Sciences, The Center for Gene Structure and Function, Hunter College and The Graduate Center of the City University of New York, New York, New York 10021, USA.

OBJECTIVE: The purpose of this research is to test whether EMF exposure produces a cell response analogous to that observed following exposure to tumor promoters. Providing proof that EMF exposure can be characterized as a tumor promoter presents a major challenge since there are no widely accepted means for identifying any putative tumor promoter. One feasible approach is based on the observation that phorbol esters can induce differentiation from a non-phagocytic suspension culture to an attached fibroblast-like culture in some progenitor cells. A series of measurable events occurs during the differentiative changes. The most critical is the initiation of phagocytic activity in the presence of tumor promoters; this is proportional to known *in vivo* promoting activity of phorbol esters (1). Other corollary

events occur following treatment with phorbol esters, however, including a change in cell surface markers.

METHOD: HL-60 cells were subjected to: ① no treatment; ② EMF exposure, and ③ growth in increasing doses (pg to ng) of TPA. EMF exposure was at 60 Hz (60 to 1000 mG_{rms}) for periods up to 24 hours. Early response (< 3 hours) to TPA or EMF exposure was identified by the induced appearance of the monophage-specific fluorescent cell surface marker, LFA-1. Phagocytic uptake of fluorescent particles was measured between 3 and 24 hours. Analysis was by fluorescence imaging microscopy and flow cytometry. The Helmholtz Coil Exposure System was designed and manufactured by ERM, Inc. All samples were subjected to the same environment.

RESULTS: Experiments that measured phagocytic activity in HL-60 cells show an increase in phagocytic uptake following EMF exposure (Figure 1). The increase was comparable to exposure to very low TPA concentrations. Preliminary experiments also show an increase in the appearance of LFA-1 at one hour exposure to EMF.

DISCUSSION: We have identified changes in cells following EMF exposure using simple automated techniques. A confirmation of the relationship between tumor promotion and EMF exposures cannot be positively made, however, until very large cell numbers are tested to provide the necessary level of statistical significance. If a correlation can be made, a defined endpoint for measurement of EMF bioeffects will be available. This will allow us to determine maximum exposure conditions, produce primary "dose-response" curves that can be used as a guide for further delineation of dose-related effects, and develop methods for comparison of EMF exposures to nongenotoxic carcinogens.

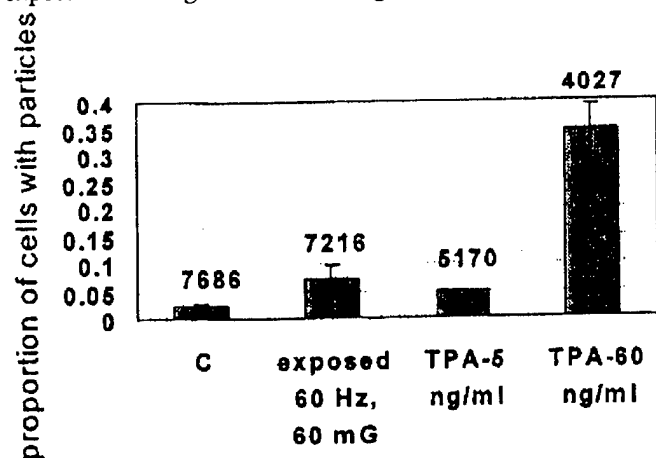

Figure 1. Phagocytic activity in HL-60 cells as measured by microscopy. Exposures were for 24 hours. Numbers are total cells counted.

1. Dertinger, S.D., Torous, D.K. and Tometsko, A.M. (1995). *Mutat. Res.* 334, 49-57.

This research was supported by NIH and a PSC-CUNY award.

B-7

LOW EMFs MODULATE NEURITE OUTGROWTH IN CULTURED RAT PHEOCHROMOCYTOMA PC12 CELLS. E.M. Abdulla, I.C. Campbell and G.S. Dawe. Neuroscience, Institute of Psychiatry, London SE5 8AF, United Kingdom.

Blackman *et al*, (1993ab) reported that low AC EMFs (4.5-10 μ T) can significantly inhibit or stimulate neurite outgrowth: whether stimulation or inhibition occurs is dependent on the propensity of the neuronal cells to differentiate. In our studies to date, we have grown primed PC 12 pheochromocytoma neurons under conditions which are weakly conducive to differentiation and under these conditions, neurite outgrowth is inhibited or stimulated depending on the level of the AC magnetic field.

The exposure system used in this study is computer controlled such that two identical parallel Helmholtz coil pairs installed in similar incubators, generate a uniform vertical DC magnetic field of $44 \pm 0.5 \mu$ T. In one of the incubators, the lower coil also generates a 50Hz AC magnetic field such that six stacked culture dishes receive a graded AC field ranging from $\sim 12.5 \mu$ T at the bottom to $\sim 4.5 \mu$ T at the top. The incubator receiving the AC magnetic field is computer blinded and the assessment of neurite outgrowth is thus performed 'blind'. The coil system in each incubator is contained in a mu metal box to minimize any uncontrolled magnetic flux from the environment.

Neurite outgrowth is stimulated by growing the neurons on laminin and by the addition of 50% of the optimal concentration of nerve growth factor (2.5 ng/ml NGF) over 23 hours. Image analysis reveals that neurite outgrowth is reduced by 36% at 5.5 μ T, reduced by 44% at 8.2 μ T but is increased by 45% at 10.6 μ T (all these changes are significant by ANOVA, $p < 0.05$; $n = 6$). There is no significant effect of culture dish stack position ($p < 0.05$) on neurite outgrowth.

At this point, our data is preliminary and several aspects of the research require further examination, for example, the continuous monitoring of magnetic flux, temperature and CO₂ in the various positions of the exposure system. However, it is interesting to have obtained data that in general concurs with other work which indicates that exposure to low EMF perturbs neuronal differentiation in culture.

Blackman, C.F., Benane, S.G. & House, D.E. (1993a) Evidence for direct effect of magnetic field on neurite outgrowth. *FASEB J.* 7. 801-806.

Blackman, C.F., Benane, S.G. & House, D.E. & Pollock, M.M. (1993b) Action of 50Hz magnetic fields on neurite outgrowth in pheochromocytoma cells. *Bioelectromagnetics*, 14(3), 273-286.

This work is supported by The EMF Biological Research Trust, UK.

B-8

LOSS AND GAIN OF CHROMOSOMES IN HUMAN CELLS FOLLOWING EXPOSURE TO ELECTROMAGNETIC FIELDS. M. Mashevich^{1,2}, L. Avivi¹, A. Barbul² and R. Korenstein². Departments of ¹Human Genetics and ²Physiology and Pharmacology, Sackler Faculty of Medicine, Tel-Aviv University 69978 Tel-Aviv, Israel.

Loss and gain of chromosomes (aneuploidy) characterizes cells prone to cancerous transformation. As there are numerous epidemiological studies implicating that exposure to low frequency electromagnetic fields (EM) increases human risks for cancer, we studied the level of aneuploidy in two human cell populations (PHA-stimulated lymphocytes and fibroblasts), following *in vitro* exposure to EM. The cell samples were exposed to EM in a pair of Helmholtz coils driven by 30 μ s rectangular voltage pulses at a frequency of 50Hz for 10 hours at 37°C. The peak magnetic field was 38.4 Gauss, and the rate of change of the magnetic field (dB/dt) was 1.3 Gauss/ μ s. In both cell types the frequency of aneuploid cells increased significantly ($p < 0.001$) after exposure to EM. Prior to the exposure the mean value of aneuploid cells was $5.2 \pm 0.4\%$ (mean \pm S.E.) in lymphocytes (15 samples) and $16.6 \pm 1.2\%$ in fibroblasts (16 samples). Following exposure the mean values of aneuploidy increased to $11.7 \pm 1.0\%$ and $24.4 \pm 1.3\%$ in lymphocytes and fibroblasts, respectively. Thus cells exposed to low frequency EM are subjected to loss and gain of genetic material, and as such are potential candidates for tumorigenesis.

B-9

MODULATION OF OSCILLATION AND SYNCHRONY IN THE CNS BY EXPOSURE TO WEAK ELF MAGNETIC FIELDS. K.A. Jenrow¹ and A.R. Liboff². ¹Department of Neurosurgery, Henry Ford Hospital, Detroit, Michigan 48202, USA. ²Department of Physics, Oakland University, Rochester, Michigan 48309, USA.

The emergence of synchronous bursting within neuronal ensembles is apparently mediated by both synaptic and nonsynaptic mechanisms. The contribution of nonsynaptic mechanisms has been most clearly demonstrated in the low-[Ca²⁺] hippocampal slice preparation, where synchronous bursting is observed in the absence of synaptic transmission (1). The nonsynaptic mechanisms implicated in producing this bursting activity include fluctuations in extracellular [K⁺] (2), neuronal electrotonic coupling (3), and (endogenous) field effects (4). Rhythmic slow wave activity (RSA) is another form of hippocampal oscillation most commonly observed *in vivo* in urethane-anesthetized rats, and *in vitro* in hippocampal slices bathed in carbachol, an acetylcholine agonist. Though synaptic transmission is required for the emergence of RSA, the relative contributions of nonsynaptic mechanisms are unknown. Bawin *et al* (5) has recently demonstrated that hippocampal RSA is destabilized by exposure to 1 Hz and 60 Hz sinusoidal

magnetic fields at intensities of 79.2 and 792 μTp *in vitro*. We report here that a 16 Hz sinusoidal magnetic field at an intensity of 40.9 μTp similarly destabilizes hippocampal RSA *in vivo*. Moreover, since all DC magnetic field components were nulled within the exposure volume, the possibility of resonance interactions is specifically precluded and a Faraday induction interaction is instead suggested. These results imply that nonsynaptic mechanisms in general, and field effects in particular, may be critical for the emergence and/or the stability of hippocampal RSA, and possibly other modes of hippocampal oscillation. The hippocampus may therefore represent a uniquely susceptible structure to exogenous field interactions.

1. J.G.R. Jefferies and H.L. Haas, *Nature* 300:448-450 (1982).
2. J.G.R. Jefferies and H.L. Haas, *J. Physiology* 354: 18S-201 (1984).
3. J.L. Perez-Velasquez *et al*, *J. Neurosciences* 14(7): 4308-17 (1994).
4. C.P. Taylor and F.E. Dudek, *J. Neurophysiology* 52:126-142 (1984).
5. S.M. Bawin *et al*, *Bioelectromagnetics* 17:388-395 (1996).

B-10

MOBILE-PHONE TYPE ELECTROMAGNETIC FIELDS DO NOT INFLUENCE GENETIC STABILITY IN YEAST? P. Gos², W.D. Heyer¹, J. Kohli¹ and B. Eicher².
¹Institute of General Microbiology, University of Berne, CH-3012 Berne, Switzerland. ²Swiss Telecom PTT, EE117, 3000 Berne 29, Switzerland.

The use of mobile phones is widely spread in industrialised countries. The question of possible biological interactions leading to health hazards is of public concern. One concern is that EMF may be involved in cancer. Because of the association of carcinogenesis with genome rearrangement, we address the question whether mobile-phone type EMF might influence mutation and recombination rates in yeast. We use standard assays for detection of reverse and forward mutation, as well as intra- and interchromosomal recombination in vegetative cells.

METHODS: Resting *Saccharomyces cerevisiae* cells of a diploid strain (Shiestl 1989) is exposed to EMF at 900 MHz with GSM burst (pulse width 577 μs , period 4.62 ms) in two anechoic chambers at 23°C. Both chambers can be used blindly with or without EMF exposure. The electronic set-up was carefully designed and tested to allow precise determination and stability of the radio frequency parameters as well as to minimise possible effects of external EMF sources. Per chamber 16 petri dishes can be exposed simultaneously for mutation-rate determination. The genetic systems include *his3* reversion by sister chromatid conversion, and interchromosomal recombination of *ade2* heteroallelic point mutations (selection for Ade⁺) in diploids. In addition forward mutation to canavanin resistance and loss of respiration (petite formation) are assayed in haploids. Mutation and recombination rates are determined for concurrently exposed and non-exposed cells.

RESULTS: Positive control experiments with chemical carcinogens and UV exposure have demonstrated the suitability of the genetic assays for the demonstration of recombination and mutations induction. Six experiments with EMF exposed and concurrent sham exposed cells at specific absorption rate (SAR) of 0.13 W/kg and 1.3 W/kg did not demonstrate statistically significant changes in inter- and intrachromosomal recombination as well as petite formation and canavanin resistance mutation rates after one hour exposure.

DISCUSSION: So far no enhancement of mutation and/or recombination rates by exposure of cells to mobile phone-type EMF has been demonstrated, but only a few studies have been published until now. Our results demonstrate that GSM electromagnetic fields in our experimental conditions cannot be considered as a mutagen for yeast cells. In yeast GSM mobile phones seems not to induce genome rearrangement but one important difference between yeast cells and higher eukaryote cells is their much bigger organisation and more complex regulation mechanisms which could modify greatly the cellular sensitivity to the environment. Therefore experiments with longer exposure time will be performed. Moreover, it is necessary to look at possible indirect effects in micro-organisms and in higher eukaryotes in order to answer the question of possible health hazards.

Reference:

Shiestl, RH (1989): Nonmutagenic carcinogens induce intrachromosomal recombination in yeast. *Nature* 337,285-288.

B-11

SYNERGISTIC EFFECTS OF UVA- AND EMF ON NEUROBLASTOMA CELLS. R. Galser, I. Ihrig, C. Heese and F. Schubert. Humboldt-University Berlin, Institute of Biology, Experimental Biophysics, D-10115 Berlin, Germany.

The induction of peaks of intracellular calcium, using the FURA-2-method in mouse neuroblastoma cells (C-1300, NB41A3) after application of pulsed and amplitude modulated (AM) electric fields was investigated. (AM: 5 kHz modulated with 16 Hz, field strength 80-800 V/m; pulses: 300 ms unipolar rectangular pulses. 5 - 50 pulses with one pulse per two seconds, field strength: 1 kV/m). We found that these effects clearly were increased by the UV-radiation (334nm and 380 nm) used for the excitation of the FURA-fluorescence. The observed field effect depends strongly on the sampling rate, and therefore on the dose of applied UVA radiation. Even without field applications, at high sampling rate, e.g. short measurement intervals and therefore high UVA irradiation, spontaneous intracellular calcium peaks occur. At low UVA treatment and no field application, no spontaneous calcium peaks could be observed. The radiation doses applied during the experiments were measured by a calibrated UV-enhanced photodiode. They were in the same order, as the UV-effects observed by others.

No effect on intracellular calcium even at high sampling rate, i.e. at high UVA-irradiation was found with modulated field.

The AM-field effects on cellular calcium occur only at high sampling rate. In contrast, the effects of pulsed electric fields occur even when the UVA dose was reduced by the lowest possible rate.

The UVA-induced alterations in cellular calcium concentration are blocked by neomycin. On the other hand pulsed field application in the presence of neomycin resulted in a greater portion of responding cells. Extracellular calcium was found to be necessary for UVA-induced calcium peaks but not for field induced calcium peaks. These findings indicate at least partly different mechanisms for the influence of electrical field and UVA on the cellular calcium regulation.

B-12

ELECTROMAGNETIC FIELD PROPAGATION IN CELLS ASSESSED BY LOCAL DAMAGE OBSERVATION. M. Milani¹, M. Costato², L. Ferraro¹, D. Batani¹ and C.E. Turcu³. ¹Physics Department, Milano University, 20133 Milano, Italy. ²Physics Department, Modena University, 41100 Modena, Italy. ³Rutherford Appleton Laboratory, Laser Facility, Chilton, Didcot, Oxon O11 0RD, United Kingdom.

Understanding, thus evaluating, the penetration depth of an electromagnetic (em) radiation, typically in the ionisation regime, where absorption process are mostly effective and secondary events still play a role, is an open problem. This is vital especially if cell various compartments (each performing different activities) are accounted for, and a proper dosimetric approach requires to assess the different energies deposited into those compartments to have a better guidance towards the relevant effects.

Two approaches share the common wisdom and can be used: (i) The penetration depth vs. photon energy (PD), and (ii) The localisation probability (LP).

The first one (PD) is the classical one and stems from the attenuation law of Lambert and Beer. It describes the expectation of a simple exponential decay of the incoming em field intensity governed by the term $exp[-kt]$ where t is the thickness and k is a factor which accounts for photon wavelength λ and material response to the selected wavelength, where the latter usually simply boils down into its density, since the cell is considered as a homogeneous material or even a cell suspension is considered as such. However the cell is a complex structure with several compartments and the homogeneous matter distribution approach looks quite crude. Thus for PD, the highest the photon energy, the deeper the penetration into a cell (or a tissue). Seen from a wave point of view, one visualises an em oscillatory field as a propagating wave undergoing a uniform absorption process.

The second one (LP) starts from the concept that first of all one should localise the incoming photon recalling that the absorption process is one of the way (a destructive one) to localise photons. From basic quantum mechanics this is a probability proportional to the photon wavelength λ (thus the photon can be anywhere into a volume λ^3). If one considers for example two ionising em sources, the first of 337 nm

(UV-A from a Nitrogen laser) and the second of about 2 nm (from plasma-produced quasi-monochromatic soft-X-rays) incoming into a yeast cell having a wall-membrane structure typically 200 nm thick, it is understood that the UV-A have the localisation probability confined into a larger volume (inside the cell), thus one should expect to find the photon absorbed into the cell deeper than with soft-X-rays (which are localised well inside the wall), and this is exactly the opposite to what one would expect from the PD approach.

We present an experimental approach to reach some clues on which of the above mentioned two approaches is suitable to handle the problem of study the possible cytoplasmic damage separated from nuclear and genetic damage. Since it is not possible to make a direct measure of the penetration depth into a cell, we have analysed different facets of the stress produced by the incoming ionising em radiation, in order to relate various effects to the most probable penetration depth: morphologic, metabolic, growth and reproduction. The target are *Saccharomyces cerevisiae* yeast cells which, whilst being relatively simple are good representative of mammalian cells. The em field comes from two sources: a 700 keV soft-X-rays and a 337 nm UV-A laser, both delivering in short pulses comparable energy amounts to the target.

Technology

C. Electrochemotherapy

Chairs: Damijan Miklavcic and Bertil Persson

C-1

DYNAMIC GAMMA-CAMERA STUDIES OF ¹¹¹IN-LABELLED BLEOMYCIN IN NORMAL RATS AND IN IMPLANTED TUMOURS (GLIOMA RG2, N32) AFTER *IN VIVO* ELECTROPERMEABILIZATION. P.E. Engström¹, B.R.R. Persson¹, A. Brun² and L.G. Salford³. ¹Department of Radiation Physics, ²Department of Neuropathology, ³Departments of Neuro-surgery, Division of Experimental Neurooncology, Lund University, S-221 85 Lund, Sweden.

Over the past 7 years, we have investigated the use of pulsed electric fields to alter tumour cell membranes in such a manner as to allow molecules to enter the cell interior. *In vitro* laboratory praxis of making cell membranes permeable by this process is named *electroporation*. When applied *in vivo* for therapeutic purpose we call it "*Electropermeabilization Tumour Therapy*" (ETT). In the present investigation we used a gamma camera to visualize the uptake, retention and clearance of radioactive ¹¹¹In-labelled Bleomycin in tumour and normal tissue. This was performed on rats treated with and without *in vivo* electropermeabilization. Fischer 344 rats was used with brain tumour cells implanted in the brain (RG2 cells) and transformed brain tumour cells implanted subcutaneously in the flank (N32 cells). Bleomycin (Lundbeck, Sweden) labelled with radioactive indium-111 was administered in

combination with electroporation. Bleomycin is a DNA specific drug which is highly cytotoxic once it is allowed access to the cytosol. The drug, however, is lipophobic and unable to penetrate the cell membrane but may be internalized into the cytosol by the use of electroporation. In the radioactive decay of indium-111, photons of 171 keV and 245 keV is emitted and recorded with a gamma camera.

¹¹¹In-bleomycin was given either intravenously as a bolus injection or intratumourally in a small volume during a few minutes. Electroporation was then performed on the 3rd and the 7th minute after drug administration using either needle electrodes inserted in the brain or external flat electrodes to cover the tumour on the leg. The drug uptake and clearance in the tumour and various parts of the body of the animals were recorded during a period of days with a gamma camera.

Among the animals bearing superficial N32 tumours in the flank, the group treated with ¹¹¹In-bleomycin followed by electroporation showed a 6 to 10 fold increase in tumour uptake compared to those given bleomycin only. The RG2 tumour carrying rats showed a twofold increase in drug uptake in the tumour relative to the controls given Bleomycin only. The uptake has shown to follow instantly after electroporation and maintains a stable level of tumour/tissue ratio over several days. The tumour growth of the subcutaneous N32 tumour in rats treated with bleomycin followed by electroporation was reduced 4 times compared to controls given bleomycin only. Of five RG2 glioma bearing rats, two showed a complete tumour remission after treatment with the In-bleomycin in combination with electroporation, whereas all animals given bleomycin only had to be sacrificed within 24 days after inoculation.

We conclude that electroporation performed after drug administration strongly enhances the cytotoxic effect of tumour treatment of brain and superficial tumours in rats. Furthermore, it presents opportunities to visualize and measure the drug uptake in the tumour and optimize the effect of electroporation tumour therapy.

C-2

ELECTROPORATION IN MUSCLE TISSUE: HOW LONG DOES THE ELECTROPORATION LAST? J. Gehl¹, S.L. Nielsen², T. Skovsgaard¹ and L.M. Mir³. ¹Department of Oncology, Herlev University Hospital, DK-2730 Herlev, Denmark. ²Department of Nuclear Medicine and Clinical Physics, Herlev University Hospital, DK-2730 Herlev, Denmark. ³LPPMB, URA 147 CNRS, Institut Gustave-Roussy, F-94805 Villejuif, France.

BACKGROUND: Electroporation combined with chemotherapy (electrochemotherapy, ECT) has been introduced in clinical studies, and is being further developed. An important aspect is the question of the duration of cell permeabilization after *in vivo* electric pulse (ep) delivery.

METHODS: Anaesthetized C57B1/6 mice were given iv ⁵¹Chrome-EDTA at different intervals in relation to ep. Ep were performed with a BTX square wave electroporator using

8 pulses, 99 µs pulse duration, frequency 1 Hz and ratio of voltage to distance of 1.2 kV/cm. Two needle arrays, each consisting of four needles, were placed 4 mm apart in the femoral muscles bilaterally. The electric pulses were applied only to the right femoral muscle (ep muscle). Mice were sacrificed 60 min after ⁵¹Chrome-EDTA injection, and a blood sample and tissue blocks from ep and non-ep muscle were taken out. After weighing, the samples were counted in a gamma-counter and the results expressed as counts per min/g tissue. Groups of 4-8 mice were given ⁵¹Chrome-EDTA from 20 min before ep to 120 min after (-20, -5, -2, -1, +1, +5, +10, +15, +30, +60, +120). After subtracting values for non-ep muscle, the net uptake as expressed in percent of blood value was determined. The Mann-Whitney non-parametric test for significance was used.

RESULTS: The highest uptake of ⁵¹Chrome-EDTA in muscle was found when the isotope was given 2 min prior to electric pulse delivery (mean 120% of blood value), and this was significantly different (p<0.05) from when the isotope was given 20 or 5 min (mean 69 and 68%, respectively) prior to ep. When ⁵¹Chrome-EDTA was given just around the time of ep (± one minute), the uptake was lower (mean 29 and 46%), and significantly different from -2 min with p < 0.05. When ⁵¹Chrome-EDTA was given 5 or 10 min after ep, the mean uptake was 79 and 90%, respectively. When ⁵¹Chrome-EDTA was given 15 min after ep the mean uptake was 48%, and the mean uptake remained at this level up till 120 min after ep (mean 55%). However, even when ⁵¹Chrome-EDTA was given 120 min after ep, the uptake in ep versus non-ep muscle was significantly higher (p = 0.01).

CONCLUSION: This study shows that, in the case of femoral muscle in mice, optimal time for injection of compounds when using *in vivo* electroporation is around 2 min prior to ep delivery. Furthermore, injection one minute or less before electroporation leads to significantly reduced uptake of the compound, possibly due to vascular constriction during ep delivery. It is also shown that a significant uptake is achieved up to ten min after ep, which indicates that the cells remain in the permeabilized state for this time. After 10 min, the uptake decreases but is still significantly different from uptake in non-ep muscle. This could indicate either that a certain proportion of the cells do not reseal or that ⁵¹Chrome-EDTA is for some other reason retained in the electroporated tissue.

ELECTROCHEMOTHERAPY ON LIVER TUMORS IN RABBITS. S. Orłowski¹, L.H. Ramirez², D.J. An³, G. Bindoula⁴, R. Dzodic⁵, J. Belehradek, Jr.², J.N. Munck⁴ and L.M. Mir². ¹URA 2096 CNRS, SBPM/DBCM CEA-Saclay, 91191 Gif-sur-Yvette, France. ²URA 147 CNRS-Institut Gustave-Roussy, 94805 Villejuif, France. ³Department of Thoracic Surgery, Xian Dong Hospital, Liling, 412200 Hunan, P.R. China. ⁴Département de Médecine-Institut Gustave-Roussy, 94805 Villejuif, France. ⁵Department of Surgery, Institute of Oncology and Radiology of Serbia, 11000 Beograd, Yugoslavia.

Electrochemotherapy is a new therapeutic approach combining the effects of a low-permeant cytotoxic drug, e.g. bleomycin, administered i.v., and cell permeabilizing electric pulses locally delivered on the tumors. The transient permeabilization of the cell membrane by the electric pulses allows the free access of bleomycin to its intracellular targets, largely enhancing the bleomycin cytotoxic effects. Electrochemotherapy efficacy has been proved so far on various transplanted subcutaneous murine tumors and on subcutaneous metastases of head and neck squamous cell carcinomas, melanoma metastatic deposits and basal cell carcinomas in humans.

Here we present the first study of the effects of electrochemotherapy on tumors transplanted to liver in rabbits. We used a new applicator of electric pulses consisting in an array of parallel and equidistant needle-electrodes to be inserted in tissues. Effects of the electric pulses alone or of the electrochemotherapy were assessed by histological analysis, tumor growth rates, survival of the treated animals and determination at the necropsy of the local disease progression as well as of the metastatic spreading. A transient blood hypoperfusion was seen in the electropulsed areas, in the presence or in the absence of bleomycin, related to electric pulse-dependent vasoconstriction, but this had no major effects on cell survival. Long term effects depended on the presence of bleomycin at the time of the electric pulse delivery. Almost complete tumor necrosis was observed after the electrochemotherapy, resulting from both bleomycin direct cytotoxic effects on electropereabilized tumor cells and indirect effects on the tumor vessels. A large reduction of tumor growth rate and significantly longer survival times were scored in comparison with control rabbits. Moreover, electrochemotherapy of liver tumors was well tolerated and devoid of systemic side effects. When electrochemotherapy was associated with a local interleukin-2 based immunotherapy, increased local antitumor effectiveness as well as a large decrease in the number of metastases were observed.

Thus the electrochemotherapy and its association with appropriate immunotherapies could become novel treatment modalities for liver tumors and other solid internal malignancies.

This work was supported by grants from Centre National de la Recherche Scientifique, Institut Gustave-Roussy, Association pour la Recherche sur le Cancer, and Institut Electricite Sante.

IN VIVO DELIVERY OF HEPARIN INTO ARTERIAL WALL WITH ELECTROPORATION CATHETERS. S.B. Dev¹, G.A. Hofmann¹, T.L. Preminger² and N.B. Dev². ¹Genetronics, Inc., San Diego, California 92121, USA. ²Division of Pediatric Cardiology, Case Western Reserve University, Cleveland, Ohio 44106, USA.

A major problem in cardiovascular diseases is the inability to deliver drugs locally at high enough concentration and sustain it by conventional means. We have already presented preliminary results^(1,2) and have shown that it is possible to achieve such goals by exploiting the technology of electroporation and deliver, *in vivo*, marker gene and DNA-binding molecules into arterial walls of rabbits and pigs. We report here extensive results on delivery of heparin, one of the most important antiproliferative and anticoagulative drugs, *in vivo*, into rabbit carotid artery using two different types of catheters - a modified Betman catheter (MBC) and a double balloon catheter (DBC), with electrodes incorporated. The long range aim of this work is to reduce restenosis, reblockage of artery that occurs in as much as 50% of the balloon angioplasty patients within six months, and also treatment of intravascular thrombus. Heparin is known to suppress smooth muscle cell proliferation after endothelial injury but is also capable of producing hemorrhage and other complications. We demonstrate that with MBC, where the electrodes are in contact with the artery, a very short application (~500 μ s) of pulsed electric field at ~50 V will allow even a very small quantity, 20 μ g, of fluoresceinated heparin (f-heparin) to be delivered into the vessel wall and sustained for as long as 12 hours, whereas there is rapid wash-out of the drug when the artery is not pulsed. The fabrication of the DBC, where one electrode is between the two balloons and a guidewire used as the other electrode, with radio-opaque markers in both the proximal and the distal balloons, is a device which will be easily realizable for clinical applications. Similar results have been obtained with the use of the DBC, although the electrodes are not in direct contact with the vessel wall. However, it is found that the pulse length for effective delivery is closer to 8-10 ms. We present detailed results on the successful deployment of the DBC under fluoroscopic guidance into the rabbit carotid artery which was accessed via the femoral. In all cases (n = 24 for MBC, n = 7 for DBC), it has been found that uptake of heparin, as seen in the fluorescence intensity, is consistently greater when the artery is pulsed compared to when it is not pulsed. By both HPLC and luminescence spectrometry of the pulsed and non-pulsed samples from various pulsing conditions, it has been shown that the fluorescein label does not come off the heparin - there is no evidence of liberation of free fluorescein - under the pulsing condition employed. We also show from the frozen sections of the carotid arteries, stained with mouse monoclonal anti-FITC and developed with diaminobenzidine (DAB), that uptake of f-heparin into intima, media and adventitial regions is very strong relative to the non-pulsed artery. Measurement of the pixel intensity

using an NIH Image Analysis software, in the region of the intense brown color that develops with DAB, shows that uptake is at least 100% more in the pulsed artery. Preliminary measurement of the blood coagulation parameters indicate that APTT, the activated partial thromboplastin time, is enhanced and is sustained for a longer time for the pulsed sample.

(1) *J. Am. Coll. Cardiology* Abstract #116152, 45th Annual Scientific Session, Orlando, Florida, 1996.

(2) *J. Am. Coll. Cardiology* Abstract #149341, accepted, 46th Annual Scientific Session, Anaheim, California, 1997.

C-5

ELECTROCHEMOTHERAPY WITH BLEOMYCIN: EFFECTS ON IMMUNE SYSTEM AND POTENTIATION OF ANTITUMOR EFFECTIVENESS BY TNF- α .

M. Cemazar¹, V. Kotnik², A. Kotnik³, V. Menart⁴, V. Gaberc-Porekar⁴, D. Miklavcic⁵ and G. Sersa¹.

¹Department of Tumor Biology, Institute of Oncology, SI-1000 Ljubljana, Slovenia. ²Institute of Microbiology and Immunology, SI-1000 Ljubljana, Slovenia. ³Institute of Public Health of the Republic of Slovenia, Virology Department, SI-1000 Ljubljana, Slovenia. ⁴National Institute of Chemistry, SI-1000 Ljubljana, Slovenia. ⁵University of Ljubljana, Faculty of Electrical Engineering, SI-1000 Ljubljana, Slovenia.

Electrochemotherapy is an antitumor treatment that utilizes locally delivered electric pulses to increase effectiveness of chemotherapeutic drugs. Application of electric pulses to tumor by percutaneously placed electrodes several minutes after administration of chemotherapeutic drug increases permeability of plasma membrane and allows nonpermeant drugs such as bleomycin to enter the cells and act on their intracellular targets. Although preclinical data indicate that immune responsiveness of the organism is important for obtaining cures of the tumors after electrochemotherapy with bleomycin, it is not known how electrochemotherapy itself affects the immune system of the organism. The aim of the study was first to determine the effects of electrochemotherapy with bleomycin on the natural resistance and immune responsiveness of SA-1 tumor bearing A/J mice, and second whether stimulation of immune cells by adjuvant immunotherapy with monocyte's stimulating biologic response modifier TNF- α can further increase antitumor effectiveness of electrochemotherapy.

Natural resistance was evaluated by the phagocytic and intracellular killing activity (oxidative burst) in monocytes and polymorphonuclear granulocytes from venous blood, and immune responsiveness by blast transformation of spleen mononuclear cells to mitogens. The percentage of monocytes in venous blood able to elicit oxidative burst was significantly increased 7 days after the electrochemotherapy and returned to normal values after 14 days. In addition, increased blast transformation of spleen mononuclear cells by stimulation with ConA (T lymphocytes activity) was found 14 days after electrochemotherapy treatment. These results demonstrate

that electrochemotherapy with bleomycin affects the immune system of the organism.

Antitumor effectiveness of electrochemotherapy using very low dose of bleomycin (1 μ g per mouse) combining with adjuvant immunotherapy with TNF- α was tested on SA-1 tumor bearing mice. The control treatments with TNF- α , bleomycin and electric pulses as single treatments did not have, or had moderate antitumor effect. Also, combined treatment with TNF- α and bleomycin, electrochemotherapy, as well as treatment with TNF- α and electric pulses had only moderate effect on tumor growth. On the contrary, electrochemotherapy combined with TNF- α , injected either intratumorally or peritumorally, resulted in prolonged tumor growth delay and in tumor cures. The increased anti-tumor effectiveness was neither the result of potentiated anti-tumor effectiveness of TNF- α due to exposure of tumors to electric pulses, nor due to interaction with BLM. Therefore, the effect of adjuvant TNF- α treatment might be immunomodulatory, augmenting the anti-tumor activity of electrochemotherapy, and possibly adding a systemic component to the localized electrochemotherapy treatment.

C-6

ENHANCED DELIVERY OF BLEOMYCIN USING ELECTRIC FIELDS FOR THE EFFECTIVE TREATMENT OF SKIN MALIGNANCIES.

R. Heller^{1,3,4}, M. Jaroszeski¹, F. Glass^{2,4}, C. Puleo^{1,4}, R. DeConti^{2,4}, D. Reintgen^{1,4} and R. Gilbert³. Departments of ¹Surgery, ²Internal Medicine and ³Chemical Engineering, University of South Florida, Tampa, Florida 33620, USA. ⁴Cutaneous Oncology Program, H. Lee Moffitt Cancer Center, Tampa, Florida 33612, USA.

Most chemotherapeutic agents are effective provided they are able to obtain access to their site of action. The principle barrier for nonpermeant agents that have an intracellular site of action is the cell membrane and cytotoxicity is dependent upon membrane permeability. Research accomplished during the past 10-15 years has shown that electric fields can be utilized to permeabilize cell membranes and allow molecules to gain greater access to the cytosol. One area that is being examined, is to use electropermeabilization as a means for delivering chemotherapeutic agents directly to tumors. This combined therapy is called Electrochemotherapy (ECT). Enhanced effectiveness of chemotherapeutic agents have been demonstrated in both preclinical and clinical trials using ECT.

Although effective, complete responses (CR) in a previous trial using intravenous bleomycin were only 43% and may have been due to the drug not being adequately concentrated within the tissue at the time of pulsing. This study was initiated to determine if ECT could be enhanced by administering the drug intratumorally. The bleomycin dose ranged from 0.5 to 2 units. The lesions received six or eight 99 μ sec pulses at an amplitude of 1.3 kV/cm ten minutes after bleomycin injection and injection of 1% lidocaine solution around the treatment site. The procedure was performed on 41 separate occasions on 32 different patients. Twenty basal

cell carcinoma, ten melanoma, 1 Kaposi's sarcoma and 1 squamous cell carcinoma patients were enrolled. All patients showed a response and 135 (99%) of 136 nodules responded with a complete response seen in 124 (91%) of the nodules. Biopsies performed on randomly selected nodules confirmed the clinical findings. All patients tolerated the procedure well and reported no significant side effects. Muscle contractions were evident during each pulse, but subsided immediately following the pulse. ECT using bleomycin administered i.t. appears to be an effective means of treating skin malignancies.

Supported by grants from Genetronics, Inc. and Depts. of Chem. Eng. and Surgery, Univ So. Florida.

C-7

IN VIVO ELECTROPORATION FOR DRUG DELIVERY TO RAT HEPATOMAS AND SARCOMAS.

R. Gilbert¹, M. Jaroszeski¹, V. Dang¹, J. Hickey² and R. Heller^{1,2}. Departments of ¹Chemical Engineering and ²Surgery, University of South Florida, Tampa, Florida 33620, USA.

The direct delivery of drugs to targeted tissues is an important tool for the potential treatment of many diseases. The administration of electric pulses can facilitate the cellular uptake of molecules (electroporation). This procedure has been used successfully *in vivo* to increase the effectiveness of chemotherapeutic agents for the treatment of several types of cancer (electrochemotherapy; ECT). Bleomycin has been used most often for ECT. Response rates of >80% have been obtained in both animal and human trials for malignancies of the skin. It is believed that these extremely encouraging results have been obtained because the electric pulses permeabilize the cell membranes and allow increased uptake of the desired molecule. Recently, ECT has been demonstrated to be effective in treating other tumor types. This study was initiated to determine if ECT could be used to effectively treat internal tumors such as hepatomas in an animal model and human rhabdomyosarcomas in athymic rats.

The treatment of hepatomas was performed in a Sprague Dawley rat model using N1S1 cells. After establishment of the tumor ECT was performed using various chemotherapeutic agents, such as bleomycin, cisplatin, doxorubicin, 5 fluoruracil, and taxol. Drugs were administered by intratumor injection followed by the application of six direct current pulses (1000 V/cm). Pulses were delivered using an array of 6 needles that rotated the applied electric field around the tumors. A total of 151 tumors were treated. One bleomycin, six cisplatin, three doxorubicin, two 5 fluoruracil, and two taxol doses were delivered to tumors using electric pulses. In addition, the effects of the drugs alone and electric pulses alone were assessed. The use of bleomycin with pulses resulted in an objective response rate of 85% and a 69% complete response rate. Animals treated with cisplatin and electric fields resulted in a complete response rate of 66.7%. Delivery of doxorubicin, 5 fluoruracil, and taxol resulted in low complete

response rates or no effect. Control tumors that were treated with each of the drugs alone showed little or no effect.

The study was extended to include the treatment of human rhabdomyosarcomas. This was performed in athymic rats. Tumors were allowed to grow for 7 days and then were treated with a single dose of bleomycin administered by intratumor injection followed by the application of six direct current pulses (1300 V/cm). Pulses were delivered using an array of 6 needles that rotated the applied electric field around the tumors. A total of 48 tumors placed into 4 groups: no treatment; electric pulses only; drug only; or ECT. The only tumors to show a response were the ECT treated tumors (100% complete response). All the other tumors continued to increase in size. The study is being continued to examine dose responses and the treatment of larger tumors.

Research was supported by Genetronics, Inc., San Diego and the Univ. South Florida Departments of Surgery and Chemical Engineering.

C-8

ELECTRIC-PULSE-INDUCED PERMEABILIZATION AND MOLECULAR TRANSPORT THROUGH PORCINE SKIN USING SURFACE ELECTRODES.

S.W. Hui¹, S.A. Gallo¹, P.G. Johnson¹ and A.R. Oseroff². ¹Biophysics and ²Dermatology Departments, Roswell Park Center Institute, Buffalo, New York 14263, USA.

This project is aimed to show the feasibility of using short electric pulses to facilitate the transport of drugs and genes through the skin barrier for therapeutic purposes. First, we measured the transient and long term changes of permeability of full thickness porcine skin following the application of a single or a train of electric pulses, as a basis for optimization of the electrical parameters for enhancing transdermal transport by electroporation. Two electrodes were attached to the *stratum corneum* of excised skin for transdermal electric pulse delivery and impedance measurement. Both transient and long term permeabilization were found to be dependent on the electrical exposure dose, i.e., the product of pulse voltage and cumulative pulsing (exposure) time. Skin resistance dropped to about 20% of its pre-pulsing value when pulsed beyond a critical dosage of 0.4 Vsec (with 20-40 volts across each skin path), but recovered rapidly within seconds after the pulse. Long term permeabilization of the skin required repeated pulsing with a minimum potential of 160 V (80 V across each skin path). The maximum long term resistance drop, to 35% of the initial value, required a dose greater than 200 Vsecs, and recovered slowly and seldom completely in tens of minutes to hours. The decrease and recovery of the resistance were dependent on the frequency and pulse length only for low dose electrical exposure.

Methylene blue, a water-soluble cationic dye, was used as a tracer, to study the penetration of molecules facilitated by electric pulses. Methylene blue was applied to the skin under electrodes attached to the outer surface of porcine skin. Pulse of up to 250 volt, 1 msec wide, were delivered at frequencies of 1-400 Hz. Absorbance spectra of dissolved punch biopsies were recorded to quantitate the total amount of dye in the

samples. Frozen sections were prepared and analyzed microscopically for penetration depth and concentration of the dye. Minimal penetration was seen at exposure doses below 2000 Vsec. Increasing the applied voltage or frequency of the pulses resulted in increasing dye penetration. Transport induced by electric pulses was several orders of magnitude greater than that by iontophoresis (0.2-0.5 mA for up to 60 min).

We believe that the enhanced transdermal transport of methylene blue is due to a combination of permeabilization of the *stratum corneum* by electric pulses, passive diffusion through the permeabilization sites, and electrophoretic transport by the electric pulses. This system may serve as a model for electroenhanced transdermal transport in a variety of applications in transdermal drug and gene deliveries.

C-9

MACROMOLECULES AS NOVEL TRANSDERMAL TRANSPORT ENHANCERS FOR SKIN ELECTROPORATION. M.R. Prausnitz¹, R. Vanbever² and V. Pr at². ¹School of Chemical Engineering, Georgia Institute of Technology, Atlanta, Georgia 30332-0100, USA. ²Unit  de Pharmacie Gal nique, Ecole de Pharmacie, Universit  catholique de Louvain, Brussels, Belgium.

Drug delivery across skin offers a noninvasive, user-friendly alternative to conventional oral or injected administration [1]. However, skin is an extremely effective barrier which prevents transport of most drugs at therapeutic rates. Recently, electroporation of skin using short (e.g., ms), high-voltage (e.g., 100 V) pulses has been shown to increase transdermal transport by many orders of magnitude [2,3]. We hypothesized that macromolecules, although not expected to enhance passive transport, could enhance electroporation-assisted delivery by stabilizing the increased permeability caused by high-voltage pulses. Previous work suggested that DNA could stabilize electropermeabilization of cell membranes [4] and heparin might stabilize electropermeabilization of skin [5,6] possibly by being inserted into "electropores" and hindering their closure.

To test this hypothesis, we examined the time scale of transport, the influence of electrical protocol, and the influence of macromolecule size, structure, and charge on enhancement of transdermal mannitol transport *in vitro* by heparin, dextran-sulfate, neutral dextran, and poly-lysine. Skin electroporation increased transdermal mannitol delivery by approximately two orders of magnitude. The addition of macromolecules further increased transport up to five-fold, in support of the proposed hypothesis. Macromolecules present during pulsing enhanced mannitol transport after pulsing for hours, apparently by a macromolecule-skin interaction. No enhancement was observed during passive diffusion or low-voltage iontophoresis, suggesting that macromolecules interact specifically with transport pathways created at high voltage. Although all macromolecules studied enhanced transport, those with greater charge and size were more effective. In conclusion, this study demonstrates that

macromolecules can be used as transdermal transport enhancers uniquely suited to skin electroporation.

References:

1. EW Smith, HI Maibach, eds. (1995) *Percutaneous Penetration Enhancers*, CRC Press, Boca Raton, FL.
2. MR Prausnitz, VG Bose, R Langer, JC Weaver (1993) Electroporation of mammalian skin: a mechanism to enhance transdermal drug delivery. *Proc. Natl. Acad. Sci. USA* 90:10504-10508.
3. R Vanbever, N Lecouturier, V Preat (1994) Transdermal delivery of metoprolol by electroporation. *Pharm. Res.* 11:1657-1662.
4. SI Sukharev, VA Klenchin, SM Serov, LV Chernomordik, YA Chizmadzhev (1992) Electroporation and electrophoretic DNA transfer into cells: the effect of DNA interaction with electropores. *Biophys. J.* 63:1320-1327.
5. MR Prausnitz, ER Edelman, JA Gimm, R Langer, JC Weaver (1995) Transdermal delivery of heparin by skin electroporation. *Bio/Technology* 13:1205-1209.
6. JC Weaver, R Vanbever, T Vaughan, MR Prausnitz. Transdermal molecular transport by electroporation: alteration by macromolecules introduced into aqueous pathways. submitted for publication.

C-10

THE COMBINATION OF CHEMOTHERAPY AND HIGH FREQUENCY HYPERTHERMIA IN PANCREATIC CANCER. F. Migeod¹, A. Scheller¹, U.G. Randoll² and F.F. Hennig². ¹Klinik Leonardis, D-70806 Stuttgart-Kornwestheim, Germany. ²Department of Traumatology, University of Erlangen-N rnberg, D-91054 Erlangen, Germany.

56 patients (27m, 29f) with inoperable (n=38) or recurrence (n=19) were treated with mitomycin C 15 mg/sqm dl, folinate acid 200 mg/sqm dl-5 and 5-FU 600 mg/sqm dl-5 /3w, simultaneously with high frequency (13,56 MHz) dl, 3, 5, 8, 10 (Oncocare, Bruker Cy.). Median age was 59,2 yrs. Pain reduced in n=43% (77%), CA19-dropped in 81%. Objective remissions (CT scan) were found in 49% (CR 2%, PR 31%, MR/NC 16%, PD 51%). Time till progress was 9,5 months, survival 8,7 months (non-responder) and 16,1 months (responder). Temperature control was achieved by a duodenal probe, sufficient temperature was reached in 87% (42,5 - 44,1 C ). We conclude that the hyperthermic effect is not only achieved by heating effects like hypoxia and acidosis, but also by bio-electric cell resonance effects. Special investigations were done according to the heat shock proteins: they are not only a major cause of tumour heat resistivity, but also of peritumoural immune cell attracting thus inducing apoptosis.

DEVELOPMENT OF ELECTROCHEMICAL TREATMENT AT THE CITY OF HOPE. C.K. Chou, N. Vora, J.R. Li, Y. Yen, R.L. Ren, J.A. McDougall and B.S. Zhou. Division of Radiation Oncology and Department of Medical Oncology, City of Hope National Medical Center, Duarte, California 91010, USA.

At the 1st International Symposium on Electrochemotherapy of Cancer held October 20-23, 1992 in Beijing, Dr. Xin Yu-ling of the China-Japan Friendship Hospital reported 2516 patients results. Electrochemical treatment (ECT) of cancer utilizes direct current to induce chemical changes that kill cancer cells. A low-voltage direct current is maintained between anodes and cathodes in a tumor to deliver a dose of 100 coulombs per cubic centimeter. Cells near the electrodes cannot survive due to electrophoresis of positive and negative ions, electrolysis of tissue fluid, and electroosmosis of water. Clinical results suggest that ECT can be effectively used as a local therapy. This method is especially suitable for old and weak patients who are unable to endure surgery, or for patients who have failed radiation or chemotherapy. In addition, this alternative method is simple and economical. However, ECT is not a well established method, e.g. different electrode configurations and doses have been used. The mechanisms of ECT anti-tumor effect are not well understood. Systematic basic research is necessary before this method can be accepted for cancer treatment in the United States.

OBJECTIVE: To make electrochemical treatment a useful alternative method for treating solid tumors.

METHODS: The study at the City of Hope started with a seed grant from the Office of Alternative Medicine in September of 1993 to study the electrochemical treatment of fibrosarcoma in C3H/HeJ mice and Fisher 344 rats. Different electrode insertion configurations and dose levels were tested and tumor free cure rate was used as the end point. *In Vitro* studies were conducted on human KB oral cancer cells, which included: 1) cytotoxicity study exposing cells to different electrical doses, 2) clonogenic assay to study colony-forming abilities of the cells after ECT, 3) thymidine incorporation assay, and 4) pH measurement.

RESULTS AND DISCUSSION: All treated mouse and rat fibrosarcomas showed necrosis and regression; however, later tumor recurrence reduced long term survival. When multiple treatments were implemented, the best three-month mouse tumor cure rate was 59.3%, and the best six-month rat tumor cure rate was 75.0%. These preliminary results indicate that ECT is effective on mouse and rat fibrosarcomas. The effectiveness is dependent on electrode placement and dosage. These results have been published in 18(1), 1997 of *Bioelectromagnetics*. Using human KB cells *in vitro*, ECT was found to delay cell growth. ECT clearly demonstrates dose-dependent tumor cell growth inhibition by colony-forming assay. The toxicity effect may be due to disturbed DNA synthesis, resulting in decreased cell proliferation. Using our preliminary laboratory results and the reported clinical results from China as a basis, a clinical protocol "Phase I/II Study of Electrochemical Treatment of Recurrent

Superficial Measurable Tumors" was submitted to the City of Hope institutional review board. For more than a year, the clinical protocol was reviewed and revised many times. Safety was the main concern since this treatment has not been reported in the United States. An investigational device exemption approval from the FDA resolved this concern. This approval is limited to one institution and 25 patients. Clinical study started on October 3, 1996 with the presence of Dr. Xin Yu-ling. Subsequently, more superficial tumor cases were treated. Initial results will be presented. Recently, we were funded by the Army Breast Cancer Research Program for two years to study ECT on rat breast cancer. The study is on 1) proper electrode placement, 2) optimal spacing and dosage, using MTF7 breast tumor on rats.

CONCLUSION: The results of these studies will help formulate a standardized ECT method for treating cancer patients and provide a better understanding of ECT mechanisms. A standardized method will enable physicians to treat those cancer patients who are untreatable with conventional therapies in a consistent and confident manner. The goal of this research is to make ECT a useful alternative method for treating localized cancer.

ELECTROCHEMOTHERAPY IN RESISTANCE TO cis-DIAMMINEDICHLOROPLATINUM(II) *IN VITRO* AND *IN VIVO* IN MICE. D. Miklavcic¹, M. Cemazar², B. Leon³, L.M. Mir³, J. Belehradec, Jr.³, M. Bonnay³, D. Fourcault³ and S. Sersa². ¹University of Ljubljana, Faculty of Electrical Engineering, 1000 Ljubljana, Slovenia. ²Institute of Oncology, 1000 Ljubljana, Slovenia. ³Institute Gustave-Roussy, 94805 Villejuif, France.

One of the ways to increase drug delivery into cells and tissues is by a local application of short intense electric pulses i.e. electroporation. This approach is used in electrochemotherapy (ECT) to potentiate antitumor effectiveness of chemotherapeutic drugs. This study was performed in order to determine whether ECT can be used to potentiate CDDP antitumor effectiveness in resistant cells *in vitro* and *in vivo*. In sensitive TBL.C12 and resistant cells TBL.C12Pt IC50 doses were determined *in vitro* by colony forming ability test after chronic incubation with CDDP and were 0.05 µg/ml and 0.46 µg/ml, respectively. Thus, indicating C12Pt cells to be resistant to CDDP by a factor 10. Platinum content in C12 and C12Pt cells after 1 and 4 hours with CDDP at IC50 doses was comparable.

ECT was performed by placing 10E6 cells in suspension (50 µl) with different CDDP concentrations between a pair of flat electrodes (distance 2mm) and applying 180V, 100 µs, 8 electric pulses at repetition frequency 1Hz. After 5 minutes incubation cells were diluted 1000x, plated for colonies (1000 cells/p.d.) and IC50 doses were determined for both cell lines. The IC50 dose was 2.2 µg/ml for sensitive and resistant cells. Platinum content at CDDP doses 20 µg/ml and higher was significantly increased after ECT in both cell lines as determined immediately after ECT or after 5 minutes incubation with CDDP by atomic absorption spectroscopy.

In vivo ECT was performed after tumors (C12 and C12Pt in C57 Bl/6 mice) reached 40-50mm³ volume by applying same electric pulses as above. Pulses were delivered via two parallel stainless steel plates (distance 8mm, V=1040V) pressed on the skin on each side of the tumors 4 minutes after i.v. injection of CDDP in doses 1 to 8mg/kg. Doubling time in control group in C12 model was 3.8 days and in C12Pt 4.0 days. Neither pulses alone nor CDDP in any dose produced more than 2 days growth delay in both tumor models. Potentiation of CDDP antitumor effectiveness by ECT in both tumor models was dose dependent. In C12 potentiation was 8 to 30 days of growth delay with respect to corresponding CDDP dose at doses 4 to 8 mg/kg. In addition 10 to 85% cures were obtained after ECT. In C12Pt potentiation of CDDP by ECT was also dose dependent and was 7 to 18 days of growth delay with respect to corresponding CDDP doses. However no cures were obtained but 6% at the highest dose (8 mg/kg).

In this study we demonstrated that in the CDDP resistance model ECT potentiates antitumor effectiveness of CDDP in both sensitive as well as in resistant cells. Although the resistance was entirely overcome *in vitro* this was not the case in *in vivo* conditions. Still, electrochemotherapy seems a promising approach in treatment of tumors exhibiting resistance to CDDP.

Medical Sciences

D. Epidemiology

Chairs: Jukka Juutilainen and Vincent DelPizzo

D-1

POSSIBLE ASSOCIATIONS BETWEEN RESIDENTIAL MAGNETIC FIELDS AND SOCIOECONOMIC STATUS. L. Hristova, V. DelPizzo, G. Lee and R.R. Neutra. California EMF Program, Emeryville, California 94608, USA.

We explored possible associations between several indicators of socioeconomic Status (SES) and residential front door spot measurements, assumed to be a crude proxy for residential magnetic field exposure. Subjects were controls in a study on pregnancy outcomes and were recruited among the members of a large Health Maintenance Organization (HMO). Therefore the sample is not representative of the general population, consisting of women of childbearing age, employed or dependent of an employed family member, living in suburban communities of the San Francisco Bay Area. Nevertheless, some strongly suggestive associations emerged. Subjects were classified dichotomously with respect to household income (<\$50,000 vs. 50,000+), education (college educated vs. non-college educated), occupation (professional vs. non-professional), and ethnicity (white vs. nonwhite). We also created an overall SES attribute by combining the individual attributes listed above. The data base is described by the following summary statistics:

Exposure	Frequency	Percent
<2mG	512	93.1
>2 mG	38	6.9

Ethnicity	Frequency	Percent
Nonwhite	114	20.7
white	436	79.3

Education	Frequency	Percent
non-college	349	63.5
college	201	36.5

Income	Frequency	Percent
<\$50K	417	75.8
>\$50K	133	24.2

Occupation	Frequency	Percent
non-profess.	280	50.9
professional	270	49.1

SES	Frequency	Percent
lower	505	91.8
higher	45	8.2

Subjects with an overall elevated SES (whites, college educated, professionals with an annual income >\$50,000), appear to have a reduced risk of living in a dwelling with a front door reading of 2 mG or more (OR = 0.61; 95% CI: 0.141-2.6), compared to other subjects. Ethnicity and occupation also appear to be factors (OR for whites vs. others = 0.71; CI: 0.3-1.5. OR for professionals vs. others = 0.74; CI = 0.4-1.4), while education showed little association (OR for college-educated vs. others = 0.90; CI: 0.4-1.8). Subjects with an annual household income of \$50,000 or more had an OR of 0.57 (CI: 0.2-1.4). Conversely, subject with an income of less than \$30,000 had an OR of 2.8 (CI: 1.4-5.8).

Although few of the associations observed in this small sample are statically significant, they argue for careful consideration of SES factors in both research and policy making.

D-2

MORTALITY PATTERNS AMONG THE INTERNATIONAL BROTHERHOOD OF ELECTRICAL WORKERS, 1982-87. C.F. Robinson, M. Petersen, S. Palu and J.P. Sestito. National Institute for Occupational Safety and Health, Cincinnati, Ohio 45226, USA.

This study evaluated the mortality of 31,068 members of the U.S. Electrical Workers' Union who died 1982-1987. Age-adjusted proportionate mortality ratios (PMRs) and proportionate cancer mortality ratios (PCMRs) were computed using the U.S. age-, gender-, and race-specific proportional mortality for the years of the study. For white male electrical workers, significantly raised mortality was observed for lung cancer (PMR=117), mesothelioma (PMR=357), melanoma skin cancer (PMR=124), leukemia (PMR=115, benign tumors (PMR=234), asbestosis (PMR=248), electrocutions (PMR=1145), and all fatal injuries (PMR=116). When proportionate cancer mortality analysis was used, the risks for these cancers remained

elevated, although the significance became borderline. Among 114 white women electrical workers, mortality due to leukemia (PMR=195) and breast cancer (PMR=124) was elevated, but not significantly. More than 82% of all electrical workers studied had greater than 30 years membership in the union and worked within the construction industry. The data show that electrical workers have elevated proportionate mortality for the diseases caused by asbestos (lung cancer and malignant mesothelioma) and from traumatic injuries, particularly electrocutions. Elevated mortality from leukemia and melanoma skin cancer may be related to electrical work and suggests further evaluation of possible risk factors is needed.

D-3

RISK FOR CANCER AMONG UTILITY WORKERS - A DANISH COHORT STUDY. C. Johansen and J.H. Olsen. The Danish Cancer Society, Division for Cancer Epidemiology, DK-2100 Copenhagen Ø, Denmark.

Occupational studies based on linkages of routinely collected data on cancer mortality or morbidity have shown that the risk for leukaemia is increased overall in jobs which imply above average exposure to 50-Hz electromagnetic field (EMF) strengths (NRPB 1992; Hardell 1995). Recently, a nested case-control study among electric utility workers in Quebec, Canada, and France showed an association between exposure to pulsed magnetic fields in the 50-60 Hz range and lung cancer (Armstrong 1994), which add to the previous findings in the same cohort of 223000 utility workers of an increased risk of leukaemia, particularly acute myeloid leukaemia, and of brain tumors (Theriault 1994). A cohort study from the US of 138000 male electric utility workers employed at five electric power companies showed increased mortality from brain cancer with a dose-response relationship (Savitz 1995), while another cohort study of 36000 utility workers from another part of the US found no increased mortality from leukaemia or brain cancer after adjustment for potential confounding factors (Sahl 1993). The most recently published nested case-control study of brain cancer deaths within a cohort of more than 84000 employees in the British national utility company found no indication of an association with exposure to magnetic fields (Harrington 1997).

AIM: In this study we report the incidence of cancer in a large, nation-wide cohort of employees in Danish electric utility companies and compare with the appropriate rates of cancer in the general population. The cancer pattern was related to period of employment, work tasks, estimated level of electromagnetic exposures and the likelihood of exposures to asbestos.

METHODS: The study population consisted of employees at 99 utility companies which supply all parts of Denmark with electricity. Basically, the cohort was established from employment records at each company. In order to evaluate the completeness of the employment records we made a search in the files of the Danish Supplementary Pension Fund and in the files of the public payroll administration of all counties in Denmark. Only the 32475 employees with more

than three months of employment were included in the analysis. A job-exposure matrix, which assigned four category levels of exposure to ELF electromagnetic fields (none, low, medium and high) to each combination of job-title and work area of the employees was constructed by four experienced engineers from the utility companies.

RESULTS: Overall, 3008 cancers were observed compared with 2825 expected, yielding a small but significantly increased risk of 1.06 (95%CI, 1.03 - 1.10). No excess was observed for breast cancer, leukemia or brain cancer among men or women. There seemed to be no effect of electromagnetic exposure on the relative risks for each cancer site even with the inclusion of years exposed to electromagnetic fields. These and other results will be reported.

D-4

ANALYSIS OF CANCER MORBIDITY IN POLISH CAREER MILITARY PERSONNEL EXPOSED OCCUPATIONALLY TO RADIOFREQUENCY AND MICROWAVE RADIATION. S. Szmigielski. Department of Biological Effects of Non-Ionizing Radiations, Center for Radiobiology and Radiation Safety of the Military Institute of Hygiene and Epidemiology, 00-909 Warsaw, Poland.

Few years ago the results of retrospective analysis of cancer morbidity for the whole population of career military personnel in Poland during the decade of 1970-1979 were published (S. Szmigielski *et al.* "Immunological and cancer-related aspects of long-term exposure to low-level microwave fields", In: *Modern Bioelectricity*, A.A. Marino (Ed.), M. Dekker Inc. N. York, 1988, p. 825), although at that time the exact size of the population and age distribution of the servicemen could not be given; therefore the results and their discussion were limited only to mortality rates (number of cancer cases per 100,000 subjects per year) for particular age groups (20-29; 30-39; 40-49 and 50-59 years) and localisations/types of the malignancies. In 1996 the continuation of the above study with retrospective analysis covering the 15-year period of 1971-1985 has been published (S. Szmigielski: Cancer morbidity in subjects occupationally exposed to high frequency (radiofrequency and microwave) electromagnetic radiation, *Science of the Total Environment (STOTEN)*, 1996, 180, 9-18).

About 3-4% of the personnel had documented occupational exposure to radiofrequency (RF) and/or microwave (MW) radiation and in this group nearly 9% of all malignancies diagnosed, giving the OER (Observed/Exposed Ratio) of 2.1 - 3.1. This difference in cancer morbidity related only to particular types of malignancies (adenocarcinomas of alimentary tract with OERs of 2.9-3.2, skin tumors - OER = 3.1 and haemopoietic and lymphatic neoplasms - OER = 6.7 for all age groups). Analysis of morbidity for defined types of haemopoietic/lymphatic malignancies has shown that the highest OERs arose for lymphosarcoma and non-Hodgkin lymphoma (8.3), acute lymphatic leukaemia (7.8), chronic myelocytic leukaemia (9.6) and acute myeloblastic leukaemia (5.5). However, the general conclusion for this analysis

indicated generally low number of registered cases and a need for both increasing size of the population observed and for longer period of observation has been postulated.

The present study covers again the whole population of military career personnel in Poland but the period of registration of cancer morbidity was broadened to the 20-year period (1970-1989) and the prospective study carried on during 1985-1989 has been included. Size of the population varied slightly from year to year with a mean count of about 124,500 persons each year; about 3,850 of them (3.1%) were considered each year as exposed occupationally to RF/MW. All subjects (non-exposed and exposed to RF/MW) were divided into age groups (20-39; 30-39; 40-49 and 50-59). Methods applied for analysis of cancer morbidity and calculation of OERs were identical as in the former study. This allowed both to analyse separately the results for the decade of 1980-1989 and to combine the two groups.

During the period of 1970-1989 a total of 2493 malignancies have been diagnosed in the population, 2355 (94.46%) in non-exposed and 138 (5.53%) in RF/MW-exposed, giving the OER of 1.86 for the exposed subpopulation (significant at $p < 0.01$). The differences in cancer morbidity were higher for younger age groups (20-49 years); OERs for these age groups ranged from 3.05 to 3.38 (all types and locations of malignancies), while for the 50-59 years old personnel with generally high morbidity rates of neoplasms (above 350 cases per 100,000 per year) the difference between non-exposed and RF/MW-exposed has been less pronounced (OER = 1.51), although still significant ($p < 0.05$). Analysis of morbidity for particular types of malignancies have shown that significant OERs (for all age groups) related to skin neoplasms (all types, including melanomas), brain tumours (astrocytomas and gliomas) and certain types of haemopoietic/lymphatic malignancies (lymphomas, acute myeloblastic and chronic myelocytic leukaemias).

A comparison of cancer morbidity rates during the first (1970-1979) and the second decade (1980-1989) and during the whole 20-year period revealed the same trends and significances for all periods, however, the higher differences in OERs were noticed during the decade of seventies.

D-5

SICKNESS ABSENCE FROM 1978 TO 1992 OF ELECTRICITE DE FRANCE (EDF) WORKERS EXPOSED TO ELF EMF. M. Souques¹, A. Chevalier², F. Coing², W. Dab¹ and J. Lambrozo¹. ¹Service des Etudes Médicales (SEM) and ²Service Général de Médecine de Contrôle (SGMC), EDF-GDF, 75382 Paris Cedex 08, France.

Several researches have described some deterioration in the health of workers exposed to ELF EMF. One of the ways to explore the state of health is by studying the absence from work for medical reasons. Several studies have shown that absence from work, and more specifically the duration of this absence, is in direct relation to the state of health of the workers. Since 1978, the social security department (SGMC) of EDF (French Electric Utility) records sickleaves and its medical causes in an epidemiological computerized database.

The aim of this study is to describe the profile of sickness absence over a period of 15 years (1978-1992) for EDF employees in the Transmission Division, where are all the employees concerned by high voltage (≥ 90 kV/m). Their absence is compared with a sample of non exposed workers chosen at random and matched on the first day of employment.

Among the 2963 exposed/control pairs included in the study, this paper concerns the live line group, composed of 121 live linemen, and the substation group, composed of 2327 substation workers and substation technical maintenance and operation (STMO) workers, exposed for at least one year, and their controls. In the exposed groups, the average length of exposure is 5.1 years for the live line group and 11.8 years for the substation group, up to 1992. Among the 2327 exposed workers of the substation group, 132 have also been live line men during a period of their employment. In 1992, 303 exposed workers had left EDF (more often for retirement) and 243 no longer had an exposed job. The analysis of the sickness absence will concern absence rate, average number of absences, average duration of an absence and medical causes of absences, particularly psychiatric diseases, cardiovascular diseases and accidents at work.

The absenteeism of the exposed group is very close to that of their referees: the absence rate per year is 2.67% versus 2.58% for the live line group and 1.98% versus 2.49% for the substation group.

The medical diagnoses are significantly different: exposed men have 3.21 (1.78-5.80) times more accidents at work, 1.89 (1.10-3.27) times more osteoarticular pathologies. On the other hand, exposed workers have a lower frequency of psychiatric diseases [RR = 0.06 (0.01-0.47)] in the live line group. Results are similar in the substation group.

According to the length of the exposure, workers exposed from 1 to 4 years have the same indexes of absenteeism than that of their referees, but workers exposed from 5 to 13 years have an absenteeism significantly less important than that of their referees.

A complementary study of the circumstances of the accidents at work of the exposed live linemen has shown that they are probably not linked to magnetic fields. Except the accidents at work, the live workers have better health indexes than their referees, and it is not very surprising because they are carefully selected to do this job. The importance of the accidents at work seems more linked to the conditions of their specific job than to exposure to magnetic fields.

No pathology, which has been described as possibly linked to electromagnetic fields like psychiatric diseases (especially depression), has appeared through the medical absenteeism surveillance in our study.

CANCER REGISTRATION RATES IN PROXIMITY TO POWER LINES. A.W. Preece¹, G.R. Iwi¹, P. Grainger¹ and D.J. Etherington². ¹Medical Physics University Research Centre, Bristol Oncology Centre, Bristol BS2 8ED, United Kingdom. ²Cancer Epidemiology Unit, Department of Social Medicine, University of Bristol, Bristol BS8 2PR, United Kingdom.

OBJECTIVE: We previously showed that non-melanoma skin cancer rates were elevated in persons whose address, at registration of that cancer, was in a high radon area (1). Following the study on radon daughters in high electric fields (2) we hypothesised that this effect would be increased close to power lines and this appears to be so. In all areas we found an enhanced incidence of skin cancer within 20m of a power line (3). As a follow up we looked in detail at all cancers for the South West of England, with a distance from power lines to see if there was a detectable increase in the common cancers, in particular with lung cancer as has been reported for occupational exposure to high EM fields (4) and particularly electric fields (5).

METHOD: Cancer cases were taken from the South West regional cancer registry for 1985-92 and classified by ICD9 class, age, sex and address at time of diagnosis. Addresses of nursing or long stay homes were eliminated and postcodes classified as industrial rather than residential were excluded. All remaining addresses were then sorted by use of the NHS postcode directory (grid reference for the house to ± 50 m accuracy) to identify all cases within 400m of power lines. Those cases were then converted to 7 digit grid reference eastings and northings to give a point somewhere within the home accurate to ± 1 m. These were used to calculate the perpendicular distance from the power lines of 132, 275 or 400kV type located from Ordnance Survey data after removing spurious structures (such as overhead gantries and mining structures). Each cancer classification was converted to a proportion of all cancers and postal delivery point (approx. equals a residential address) was used as a measure of population density.

RESULTS: Table 1. Residential density and relative incidence of all cancers with distance from ETLs

Distance band	No. of postcodes	No. of delivery points	Cancer registrations	Cancers per postcode	Cancers per delivery point
0-50m	206	3538	378	1.83	0.107
50-100m	269	4639	476	1.77	0.103
100-150m	273	4593	492	1.80	0.107
150-200m	296	4592	530	1.79	0.107

Table 2. Proportion of cancers registered as skin cancer with distance from ETL (all SW England)

	0 to 20 metres	20 to 400 metres
Non-melanoma skin cancer	29 (exp 19.9) 23.2%	799 (exp 808) 15.7%
Odds ratio	1.62 (p = 0.03) (1.06, 2.47)	

The commonest malignancy, skin cancer (with a relative occurrence of 17%), showed an odds ratio for living within 20m of HV power lines of 1.62 which was statistically significant. Within 50m (or 20m) of HV lines, lung cancer (normal incidence 11.7%) was not elevated at 10.3%; breast cancer (normal incidence 9.0%) was not elevated at 7.7%.

Other cancers (uterus/cervix, bladder, colon, rectum, stomach and leukaemia) were not sufficiently numerous to give a statistically meaningful result. The remainder called "other cancers" at 13.2% distant from power-lines were non-significantly elevated at 14.3% within 50m of HV lines.

CONCLUSIONS: Skin cancer in proportion to all other cancers is more common with residence near HV power line in the South West of England, however breast and lung cancer were not increased in incidence.

References:

- (1) Etherington D, Pheby D and Bray F. (1996) An ecological study of cancer incidence and radon levels in the SW of England. *Eur. J. Cancer* 32 1189-1197.
- (2) Henshaw D, Ross A, Fews P and Preece A. (1996) Enhanced deposition of radon daughter nuclei in the vicinity of power frequency EM fields. *Int. J. Rad. Biol.* 69 25-38.
- (3) Preece A W, Iwi G R, and Etherington D J. (1996) Radon, skin cancer and interaction with power line sources. Annual review of research on biological effects of electric and magnetic fields from the delivery generation and use of electricity. pps 4344 San Antonio, Texas.
- (4) Erren T C. (1996) Re "Association between exposure to pulsed EM fields and cancer in electricity utility workers in Quebec, Canada and France. *Am. J. Epidemiol.* 143:841 (letter).
- (5) Miller A B, To T, Agnew D A, Wall C, Green L M. Leukaemia following occupational exposure to 60Hz Electric and Magnetic fields among Ontario electricity workers. (1996) *Am. J. Epidemiol.* 144. 150-160.

CHRONIC HEALTH PROBLEMS IN ADULTS LIVING NEAR HIGH-VOLTAGE TRANSMISSION LINES: EVIDENCE FOR A DOSE-RESPONSE RELATION WITH MAGNETIC FIELD EXPOSURE. I.L. Beale¹, R.J. Booth² and N.E. Pearce³. ¹Department of Psychology, ²Department of Molecular Medicine, University of Auckland, PB 92019 Auckland, New Zealand. ³Wellington Asthma Research Group, Wellington Medical School, Wellington, New Zealand.

As part of a larger cross-sectional study, 560 adults living near 50-Hz 110 kV and 220 kV transmission lines in Auckland, New Zealand completed questionnaires about their demographic characteristics and existing health problems. Magnetic field measurements were taken to provide an estimate of time-integrated magnetic field exposure for each participant. Participants were divided into five groups (quintiles) of 112, based on their time-integrated exposure. Summary statistics for several health variables were calculated for each quintile and quintiles were then compared for evidence of a linear relation between health variables and magnetic field exposure. Significant linear dose-response patterns were found for self-rated overall health, asthma, rheumatoid arthritis, type-II diabetes and all chronic health problems combined, but not for infections or allergies. Next, time-integrated exposure was dichotomised to test hypotheses that higher exposure was associated with increased risk for

various health problems. Estimates of relative risk were calculated for each health variable, adjusted for the influence of possible confounders such as age, SES, gender, ethnicity, smoking, alcohol use, years resident at address, educational qualification, life changes and perceived effect of powerlines on health. Significantly elevated adjusted risk ratios were found for asthma, arthritis, type-II diabetes and combined chronic health problems. The results are consistent with the hypothesis that 50-Hz environmental magnetic fields may affect human immune function.

D-8

CANCER AND PROXIMITY TO TV TOWERS. B. Hocking¹, I. Gordon², G. Hatfield³ and H. Grain⁴.
¹Consultant in Occupational Medicine, Melbourne, Victoria, Australia. ²Melbourne University, Statistical Centre, Melbourne, Victoria, Australia. ³Consulting Engineer, Melbourne, Victoria, Australia. ⁴Data Consultant, Melbourne, Victoria, Australia.

BACKGROUND: There is ongoing controversy about the health effects of low level electromagnetic fields. Studies of health effects of radio-frequency radiation on civilian populations are rare.

METHOD: A population-based study has compared cancer incidence and mortality from 1972-90 in nine northern Sydney municipalities, three of which immediately surround three major TV towers, and six of which are adjacent but more distant. Radio-frequency radiation decreases as the square of the distance causing different exposures.

RESULTS: The rate ratio (all ages) for leukaemia was increased (1.24, 95% CI: 1.09-1.40) in the inner ring of municipalities compared to the outer ring. For children the rate ratio was 1.58 (95% CI: 1.07-2.34) for incidence, and 2.32 (95% CI: 1.35-4.01) for mortality. The rate ratio for childhood lymphatic leukaemia (the most common type) was 1.55 (95% CI: 1.00-2.41) for incidence and 2.74 (95% CI: 1.42-5.27) for mortality. Brain cancer risk was not increased. The calculated power density ranged from 8.0 $\mu\text{W}/\text{cm}^2$ near the towers, to 0.2 $\mu\text{W}/\text{cm}^2$ at 4Km and 0.02 $\mu\text{W}/\text{cm}^2$ at 12Km.

CONCLUSION: There is an association between childhood leukaemia and proximity to these TV towers. The calculated power density is much below the present Australian Standard. Further studies are needed to confirm an association and determine any dose-response relationship before firm conclusions may be reached.

Reference:

Hocking, B *et al*, Cancer Incidence and Mortality and Proximity to TV Towers. *Medical Journal of Australia* 1996. 165: 601-605.

D-9

ELECTROMAGNETIC FIELDS AND CHILDHOOD LEUKEMIA: POOLED ANALYSES OF TWO GERMAN CASE-CONTROL-STUDIES. J. Schüz¹, J. Michaelis¹, R. Meinert¹, J.P. Grigat², E. Zemann², P. Kaatsch¹, U. Kaletsch¹, A. Miesner¹, K. Brinkmann², H. Kärner³.
¹Institut für Medizinische Statistik und Dokumentation, University of Mainz, D-55101 Mainz, Germany. ²Forschungsverbund: EMV Biologischer Systeme, D-38023 Braunschweig, D-10587 Berlin, Germany. ³Institut für Hochspannungstechnik, University of Braunschweig, D-38023 Braunschweig, Germany.

At the 1996 meeting of the Bioelectromagnetics Society we presented the results of a population-based case-control-study on residential magnetic fields and childhood leukemia in the northwestern part of Germany (Lower Saxony) [1]. Because of the rural character of this area, elevated magnetic fields were detected in only 1.5% of all dwellings. We therefore expanded the EMF-measurements to an ongoing case-control-study on childhood leukemia in the capital of Germany, Berlin. The same methods of exposure assessment were applied with the intention to pool the data of the two studies and to calculate combined risk estimates.

METHODS: Cases with childhood acute leukemia were identified from the nationwide German Childhood Cancer Registry. Controls were drawn at random from the complete files of local government offices for registration of residents. We estimated the child's exposure to magnetic fields by 24h-measurements in the child's bedroom and in the living room and performed short-term measurements in all rooms of the dwelling. More detailed information on the design of the study and exposure assessment have been described elsewhere [1, 2]. The evaluation was done by multivariate conditional logistic regression analyses.

RESULTS: In Berlin, 24h-measurements were made at dwellings of 47 cases and 86 controls. As expected, the percentage of highly exposed subjects was higher than it had been for Lower Saxony (Berlin-East: 11.5%, Berlin-West: 4.9%). Associations between the median of the 24h-measurement in the child's bedroom and childhood leukemia were analysed for categories $\geq 0.2 \mu\text{T}$ versus $< 0.2 \mu\text{T}$. After adjustment for gender, age, West-/East-Berlin and socioeconomic status had been made, the logistic regression revealed an odds ratio (OR) at 1.0 (95%-confidence interval (CI): 0.2-4.9). Thus, the statistically nonsignificant odds ratio of 3.2 which was observed in Lower Saxony could not be confirmed by the study in Berlin. In contrast to the main hypothesis specified prior to the conduct of the study, additional exploratory analyses confirmed observations from the study in Lower Saxony: Odds ratios of 3.5 and 1.9 were observed for younger children and for those being exposed to stronger magnetic fields during the night.

In both studies altogether, 24h-measurements were performed for 176 cases and 414 controls. In this combined analysis the odds ratio was 2.3 (95%-CI: 0.8-6.5) based on nine leukemia cases (5.1%) and eight controls (1.9%) with median values above 0.2 μT . Like in the individual studies, stronger

associations were seen for younger children (OR 6.8, 95%-CI: 1.3-35.6) and for those being exposed to stronger magnetic fields during the night (OR 3.7, 95%-CI: 1.2-11.6). Concerning the short-term measurements we observed a decreased odds ratio of 0.7 (95%-CI: 0.3-1.8). The predominant causes for elevated magnetic fields were indoor sources. Only three out of seventeen median magnetic fields above 0.2 μ T were caused by nearby high-voltage power lines.

DISCUSSION: Our findings lend some support to the hypothesis that increased exposure to magnetic fields may be associated with childhood leukemia. Nevertheless, our observations are still based on only small numbers of subjects exposed to magnetic fields above 0.2 μ T and we intend to expand the study on a nationwide basis in order to increase statistical power and to obtain smaller confidence intervals for the derived odds ratios.

[1] Michaelis J, Schuz J, *et al.*: A population-based case-control study on electromagnetic fields and childhood leukemia. BEMS, 18th annual meeting, 1996.

[2] Michaelis J, Schuz J, *et al.*: Electromagnetic fields and childhood leukemia: results of a population-based case-control study. *Cancer, Causes & Control* 1997, 8:2.

D-10

APPLICATION OF THE CASE-SPECULAR EPIDEMIOLOGIC INVESTIGATION METHOD TO THE SAVITZ DENVER STUDY HOMES. K.L. Ebi¹,

L.E. Zaffanella², D.A. Savitz³ and S. Greenland⁴. ¹Electric Power Research Institute, Palo Alto, California 94306, USA.

²Enertech Consultants, Lee, Massachusetts 01238, USA.

³Department of Epidemiology, University of North Carolina School of Public Health, Chapel Hill, North Carolina 27599, USA. ⁴Department of Epidemiology, University of California

- Los Angeles, School of Public Health, Los Angeles, California 90095-1772, USA.

OBJECTIVE: The residential case-specular method is an approach to epidemiologic studies of the association between wire codes and childhood cancer which controls for neighborhood and may eliminate control selection bias. The distribution of wire codes of case residences is compared to the distribution of wire codes of identical residences (specular residences) located in a virtual situation in which the position of the residence is switched around the center of the street. The method was applied to the case and control homes in Savitz 1988 study in Denver. The main objective was to evaluate the neighborhood hypothesis, which postulates that childhood cancer is affected by some characteristics of the neighborhood other than magnetic field and wire codes are a proxy for those characteristics.

METHODS: The wire codes of 308 case and 256 control residences (from the 1988 Denver Savitz study) and their speculars were determined by a field crew who inspected power lines adjacent to the residences. The study offered an opportunity to study the discrepancies in wire coding between the 1988 study and the 1996 inspection. In addition, the following other variables were recorded systematically for both residences and speculars: the wire code components

(wire class and distance), the difference in traffic and the difference in neighborhood type between residence and specular, and the geographical orientation. The data were analyzed three ways using maximum-likelihood logistic regressions: 1) Conventionally, using only the actual cases and controls; 2) As a case-specular study, using only the cases and their speculars; and 3) Using all the data (cases, case speculars, controls, and control speculars).

RESULTS: The results of the case-specular method appear to indicate that the association between childhood cancer and wire codes reported by Savitz is not due to a neighborhood effect. The matched odds ratio of VHCC (Very High Current Configuration) and OHCC (Ordinary High Current Configuration) grouped together versus the other codes was found to be 2.0 (95% CI 1.2 to 3.3). The same analysis performed on the control residences and their speculars found no significant association (1.1, 95% CI 0.57 to 1.9). A higher matched odds ratio (2.9, 95% CI 1.6 to 5.5) was found for wire classes 1 and 2 (three-phase overhead power lines within 150 feet) versus the other wire classes (single phase overhead power lines or buried lines). An unexpected association was found between childhood cancer and distance as a continuous variable. Greater distances within the range of 0 to 100 feet appear to be associated with higher risks. To better understand these unexpected results all the sketches describing the residence, the neighborhood, and the associated power system are being reviewed. Other factors (traffic gradient, neighborhood gradient, geographical orientation) were not significantly associated with childhood cancer.

Support for this study was provided by the Electric Power Research Institute.

D-11

DELAYED OCCURRENCE OF BRAIN TUMORS AMONG PEOPLE WITH RESIDENTIAL EXPOSURE TO POWER FREQUENCY MAGNETIC FIELDS. R.S.

Lin¹ and C.Y. Li². ¹College of Public Health, National Taiwan University, Taipei 10018, Taiwan. ²Department of Public Health, Fu Jen Catholic University, Taipei Hsien 24205, Taiwan.

BACKGROUND: Animal models have shown that extremely low frequency(ELF) presents certain characteristics compatible with a cancer promoter rather than a cancer initiator. This study aims to examine whether people with elevated exposure to power frequency magnetic fields may have experienced a shorter latency of cancer.

MATERIALS AND METHODS: We utilized study subjects comprising cases of 870 leukemia, 577 brain tumors, and 1,980 female breast cancer and a total of 3,321 age and time-matched controls with a diagnosis of other cancers not known to be associated with magnetic fields exposure. Both cases and controls were diagnosed between 1987 and 1992, age \geq 15 years, from Taiwan Cancer Registry. The residence occupied by each study subject at the time of diagnosis was assessed for electro-magnetic fields (EMF) exposure, which was estimated from residential and utility route maps, wire

configuration and the load on the power lines. Some 400 residences were sampled for validation of exposure. Two exposure indices, estimated magnetic flux density and distance from major power lines, were used to study between latency of cancer and EMF exposure. We compared the mean age of diagnosis in high EMF exposed cases of leukemia, brain tumors, and female breast cancer with that of low EMF exposed cancer cases, respectively. The controls group was also compared to the mean age of diagnosis between the high and low EMF exposed populations.

RESULTS: We noted a significant delayed age of occurrence of brain tumors in persons with residential magnetic field exposure ≥ 2 MG (50.6 vs 44.8, $p=0.01$). Such delayed occurrence was not observed for leukemia (48.9 vs 48.7, $p=0.93$) or for breast cancer (49.5 vs 49.7, $p=0.81$). Nor was observed for control cancers (48.5 vs 48.6, $p=0.84$). Further analyses by histologic type indicated that the delayed development of brain tumors was limited to astrocytoma (42.0 vs 38.1, $p=0.31$) and unclassified brain tumors (55.0 vs 46.1, $p=0.01$). Almost identical results were observed with distances less than 100 meter from major power lines as used to characterize high EMF exposure.

CONCLUSIONS: Residential exposure to high electromagnetic fields may delay the occurrence of brain tumors which suggests a possible protective or hormetic effect worthwhile for further study.

D-12

BRAIN CANCER INCIDENCE IN NORTH CAROLINA: RESONANCE COUPLING OF POWER LINES TO GMF. R.A. Chastain, Jr.¹, C. Hanchette¹, K. Andrews², T.E. Aldrich³ and A.R. Liboff⁴. ¹North Carolina State Center for Health Statistics, Raleigh, North Carolina 27626, USA. ²School of Public Health, University of North Carolina, Chapel Hill, North Carolina 27599, USA. ³Department of Family and Preventive Medicine, University of Utah, Salt Lake City, Utah 84132, USA. ⁴Department of Physics, Oakland University, Rochester, Michigan 48309, USA.

The reported epidemiological link between power lines and cancer has been difficult to settle in an unambiguous way in part because there is uncertainty as to the proper magnetic field metric to be used as the independent variable. The use of AC magnetic intensity as the metric of choice in such studies is common, despite various biophysical models that stress other factors. Recent attempts have been made to reexamine the power line/cancer link using alternate metrics (1,2). In the present work, a Geographic Information System (GIS) has been assembled to study the possibility of residential biological hazard arising from the ion cyclotron resonance (ICR) combination of that component of the (total) geomagnetic DC field (GMF) that lies parallel to the AC magnetic field generated by the power line at the residence, and the 60 Hz AC frequency.

One major advantage in using this model is that residential access is not required. In addition, due to the computational strength of the GIS large samples of recorded cases can be readily tested against selected changes in the choices of GMF

or other geographic data.

In the present study, four variables are required at each residence to assess all resonance possibilities: the elevation of the line relative to the residence, the compass heading of the line, the GMF dip angle and total intensity. Once these variables are determined for a suitably-sized cohort of case and control residences, each different ICR choice is characterized by a unique bounding curve in 4-space. The relative number of case residences compared to control residences falling within a given boundary is a measure of the risk for that particular ICR combination.

The USGS 1995 EPOCH World Magnetic Model was used to obtain GMF dip angle and total intensity at each residence; the USGS Digital Elevation Model was used for line elevations. Out of a total of 251 brain cancer residences listed in the NC Cancer Registry, 216 were deemed successful address matches for this study, to be compared to 639 control addresses.

References:

1. J. Bowman *et al* (1995) *Bioelectromagnetics* 16:48-59
2. A.R. Liboff and B.R. McLeod (1995) *Bioelectromagnetics* 16:227-230.

Biological Sciences II

E. *In Vivo* and *In Vitro* Studies

Chairs: Michael Repacholi and James Weaver

E-1

ALTERATIONS OF ELECTRON TRANSFER AND ENERGY CONSERVATION IN MITOCHONDRIAL COMPLEX I (NADH-COENZYME Q OXIDOREDUCTASE) IN AGING. G. Lenaz, C. Bovina, G. Parenti Castelli, G. Formiggini, R. Fato, M.L. Genova, M. Merlo Pich and F. Pallotti. Dipartimento di Biochimica "G. Moruzzi", Università di Bologna, 40126 Bologna, Italy.

The mitochondrial theory of aging proposes that the accumulation of somatic mutations in mitochondrial DNA (mtDNA), induced by progressive attack by oxygen reactive species, is a key factor in determining the cellular energetic decline characterizing senescence. MtDNA encodes for 13 hydrophobic polypeptide chains belonging to the three enzymatic respiratory complexes involved in energy transduction by proton translocation and to the proton-driven ATP-synthase. Since 7 out of those chains are subunits of Complex I, NADH-Coenzyme Q (CoQ) oxidoreductase, it is predicted that this enzyme would be the most frequently affected. We have investigated the properties of Complex I in different systems in relation to aging.

(i) Mitochondrial populations (non-synaptic and synaptic) from brain cortex of 4- and 24-month-old rats. PCR analysis revealed that a 5 kb deletion analogous to the "common" deletion of human mtDNA was present only in the old animals. Since the specific activity of NADH-CoQ reductase is underestimated using CoQ analogs or homologs as acceptors, we considered total aerobic NADH oxidation,

which is related to NADH-CoQ reductase by the "pool equation". The largest changes were found in non-synaptic mitochondria, with a significant decrease of both Complex I content and enzymatic turnover. Titration with the Complex I inhibitor, rotenone, exhibited a higher titer for half-inhibition in the old rats. Since rotenone binds to hydrophobic subunits encoded by mtDNA, this finding is in accordance with the mitochondrial theory of aging. Moreover, since the same subunits are involved in CoQ acceptor binding and in proton translocation, this effect may be considered diagnostic for decreased energy conservation. The reason why only non-synaptic mitochondria are affected by aging may be related to their higher respiratory rate making them more prone to oxidative stress.

(ii) Mitochondrial membranes from platelets of young and old human individuals. NADH-CoQ reductase was not significantly different in the two groups, but there was a significant decrease of the rotenone sensitivity in the old individuals with a striking increase of the distribution of half-inhibitory concentrations to higher classes. The postulated energy decline was indirectly confirmed by the decreased inhibition of platelet aggregation in old individuals by the mitochondrial respiratory inhibitor, antimycin A, in contrast with the effect of the glycolytic inhibitor, deoxyglucose, suggesting that energy availability in the old is mainly provided by glycolysis. Surprisingly, a mtDNA deletion different from the "common" deletion was present in a consistent number of samples from old individuals.

The study was supported by grants from MURST, Rome.

E-2

MEASUREMENT OF DNA DAMAGE BY THE ALKALINE COMET ASSAY IN RAT BRAIN CELLS AFTER *IN VIVO* EXPOSURE TO 2450 MHz ELECTROMAGNETIC RADIATION. R.S. Malyapa, E.W. Ahern, W.L. Straube, E.G. Moros, W.F. Pickard and J.L. Roti Roti. Radiation Oncology Center, Mallinckrodt Institute of Radiology, Washington University School of Medicine, St. Louis, Missouri 63108, USA

Recent reports suggest that *in vivo* exposure to 2450 MHz electromagnetic radiation causes DNA single- and double-strand breaks in rat brain cells (Lai and Singh, *Bioelectromagnetics* 3: 207, 1995; *Int. J. Radiat. Biol.* 69: 513, 1996). Therefore, we have simulated the 2450 MHz continuous wave (CW) experimental irradiation conditions of the above mentioned studies, performed our study with positive and negative controls and assayed for DNA damage using the alkaline comet assay/single cell gel electrophoresis. The alkaline comet assay in this study was performed at pH 12.5 according to the method described by Olive *et al* (*Exp. Cell Res.* 198: 259-267, 1992). We have previously determined that this assay is very sensitive and can detect DNA damage following γ -radiation at doses as low as 0.3-0.6 cGy. In addition, we also studied whether the method of euthanasia influenced the results of the comet assay. Male Sprague-Dawley rats weighing approximately 250 g were irradiated with 2450 MHz, CW, microwaves for 2 h in a

cylindrical wave guide system (Guy *et al*, *Radio Science* 14: 63, 1979) connected to a Hewlett Packard 8616A signal generator. The SAR to the brain was calculated to be 1.2 W/kg. There was no associated temperature rise in the core body temperature of the rats. Following the irradiation or sham-treatments, rats were euthanized by either CO₂ asphyxia or decapitated by guillotine (8 pairs of animals per euthanasia group) according to the guidelines of the Animal Studies Committee. After euthanasia the brains were immediately immersed in cold Ames saline, the cells of the cerebral cortex and the hippocampus dissociated separately and subjected to the alkaline comet assay. The agarose gels were stained with propidium iodide, viewed under a fluorescence microscope and the images digitized and analyzed using a PC-based image analysis system. The "comet moment" and "comet length" were determined as described by Kent *et al*, (*Int. J. Radiat. Biol.* 67: 655, 1995). The results of our study indicate that irrespective of whether the rats were euthanized by CO₂ asphyxia or decapitated by guillotine, no significant differences ($p < 0.8$) were observed between sham-treated and the 2450 MHz, CW irradiated brain cells from either the cerebral cortex or the hippocampus. Furthermore, the results of the CO₂ asphyxia group when compared to that of the guillotine group showed more experiment to experiment variation although no significant differences were observed between the irradiated and the matched sham groups. We conclude from our results that (1) guillotine method of euthanasia is the most appropriate in studies relating to DNA damage and (2) no DNA damage was observed in cells of the rat cerebral cortex or the hippocampus after a 2 h exposure to 2450 MHz, CW microwaves.

Support: Motorola Corporation.

E-3

ENHANCEMENT OF T-CELL-MEDIATED IMMUNITY BY MILLIMETER WAVES. M.K. Logani and M.C. Ziskin. Richard J. Fox Center for Biomedical Physics, Temple University School of Medicine, Philadelphia 19140, Pennsylvania 19140, USA.

In recent years there has been an increasing interest in the medical applications of millimeter waves. Excellent clinical results have been reported in the treatment of various diseases, including peptic ulcers, bronchial asthma, infantile cerebral palsy, arthritis, skin disorders, and cancer (Mikhail *et al.*, 1996). The mechanisms by which mm-waves provide the beneficial health effects are not clear. It is generally believed that therapeutic effects of mm-waves are mediated through an indirect mechanism, possibly through the general enhancement of the immune system.

OBJECTIVE: The present study was undertaken to investigate whether mm-waves of 53.6 GHz at 10 mW/cm², a commonly used frequency and intensity in medical treatment, can modify T-cell mediated immunity. A delayed type hypersensitivity (DTH) assay in mouse skin was used to study this effect (Scheper and von Blomberg, 1994). A direct relationship exists between T-cell mediated immunity and the DTH response (Denkins *et al.*, 1989). We hypothesized that

if mm-wave radiation enhances the immune function, it should also increase the DTH response in mouse skin. The present study was performed to test this hypothesis.

METHODS: In order to study the effect of mm-wave irradiation on the immune system we have used the DTH assay in hairless mice. The SKH hairless mice were used for these studies to avoid the energy loss that would result from the absorption of mm-waves by hair. The hairless mouse is immunocompetent and has been used previously in cutaneous DTH studies (Cole *et al.*, 1989). DTH assay was conducted in two phases, the sensitization phase and the challenge phase. In the first phase, the animals were sensitized on the right ear with a topical application of dinitrochlorobenzene (DNCB, 10 μ l, 2.5%) solution in acetone: 1,2 - propane diol (4:1). On days 5, 6 and 7 following sensitization the experimental group of animals was irradiated each day with 53.6 GHz frequency mm-waves at 10 mW/cm² for 30 minutes under anesthesia. For irradiation, the horn aperture of the Russian-made millimeter wave generator (YAV-1) was positioned 5 mm above the surface of the mid-back of each mouse. The distribution of absorbed energy was determined thermographically using an infrared camera (Khizhnyak and Ziskin, 1994). The SAR was measured and found to be 167 W/kg, and the maximum temperature elevation was 0.9°C. The sham control group was treated in a similar manner but not irradiated. In the second phase, beginning on day 7, both groups were challenged with a much smaller dose of DNCB solution (10 μ l, 0.6%) on the left ears. Development of the DTH reaction was determined by measuring increase in ear thickness at the site of challenge.

RESULTS: Irradiation of animals with mm-waves prior to challenge with 0.6% DNCB produced a significant enhancement of the DTH reaction as compared to the sham control animals (Fig. 1). The unsensitized control group (challenge only) showed a low grade DTH response. This is in agreement with previous studies where a moderate increase in DTH reaction had been observed in unsensitized controls (Enk *et al.*, 1993). The vehicle control group, as expected, did not show any DTH response.

CONCLUSIONS: Irradiation of mouse skin with 53.6 GHz continuous millimeter waves at 10 mW/cm² (SAR = 167 W/kg) induced a statistically significant ($p < 0.05$) enhancement of the DTH reaction as compared to the sham control animals. The present study shows that mm-waves of the above frequency and intensity do enhance antigen-specific, T-cell mediated immunity.

Figure 1: Effect of mm-waves on delayed type hypersensitivity

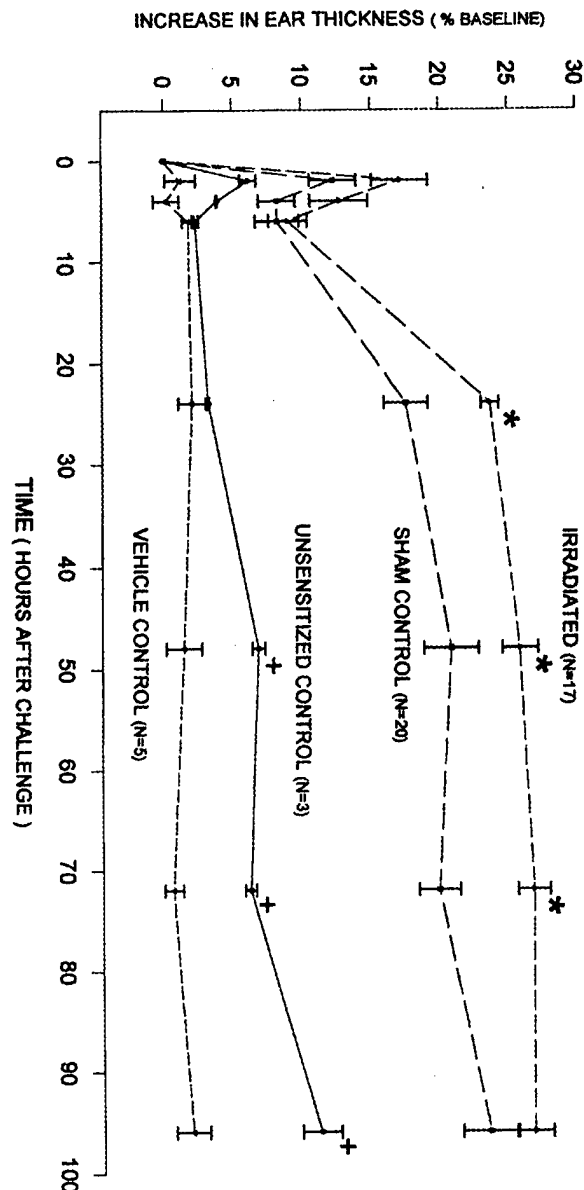

References:

Cole, C.A., Forbes, P.D., and Ludwigsen, K. 1989. Sunscreen testing using the mouse ear model. *Photo-Dermatology*. 6:131-136.

Denkins, Y., Fidler, I.J., and Kripke, M.L. 1989. Exposure of mice to UVB-radiation suppresses delayed hypersensitivity to *candida albicans*. *Photochem. Photobiol.* 49: 615-621.

Enk, A.H., Angeloni, V.L., Udey, M.C., and Katz, S.I. 1993. An essential role for Langerhans cells derived IL-1B in the initiation of primary immune responses in skin. *J. Immunol.* 150: 3698-3704.

Khizhnyak, E., and Ziskin, M. 1994. Heating patterns in biological tissue phantoms caused by millimeter wave electromagnetic irradiation. *IEEE Trans. Biomed. Eng.* 41: 865-872.

Mikhail, T., Novikova, L., Grigoriev, S., and Avakian, R. 1996. Extremely high frequency (EHF) therapy. *Complementary Medicine International* 32: 29-35.

Scheper, R.J. and Blomberg, M.E. von. 1994. Immunoregulation of T-cell mediated skin hypersensitivity. *Arch. Toxicol. (suppl.)*. 16:63-70.

BRAIN TUMOR INCIDENCE IN RATS CHRONICALLY EXPOSED TO FREQUENCY-MODULATED (FM) CELLULAR PHONE FIELDS.

W.R. Adey¹, C.V. Byus², C.D. Cain¹, W. Haggren¹, R.J. Higgins³, R.A. Jones¹, C.J. Kean¹, N. Kuster⁵, A. MacMurray¹, J.L. Phillips¹, R.B. Stagg¹ and G. Zimmerman⁴.
¹J.L. Pettis Memorial Veterans Administration Medical Center, Loma Linda, California 92357, USA. ²University of California, Riverside, California 92521, USA. ³University of California, Davis, California 95616, USA. ⁴Loma Linda University School of Allied Health Professions, Loma Linda, California 92350, USA. ⁵Swiss Federal Institute of Technology (ETH), Zurich, Switzerland.

Frequency-modulated mobile phone systems have been the dominant technology for many years. Their continuing use worldwide appears certain in many applications, with typical RF carrier frequencies in the range from 0.1-1.5 GHz. Body tissues, specifically in the head and hand of the user, absorb up to 40% of the radiated signal. Portable FM phones, with average output powers of 0.6W in the 800 MHz frequency band, induce field strengths in the most exposed tissues equivalent to 1W/kg \pm 6db, depending on the device's position and design. Although occupational exposures of certain microwave workers to radar and other pulsed fields have been reported to carry an increased risk of brain tumors (e.g., Thomas *et al.*, 1987), no comparable data have been reported for FM mobile phone users.

OBJECTIVE: Previous universal use of FM technology in mobile communication systems, as well as its continuing availability, suggest need for assessment of possible human brain tumor risks in a suitable animal model; and to compare findings with our previous study in rats exposed to North American Digital Cellular (NADC) signals (Adey *et al.*, *Proc. Bioelectromagnetics Society, 18th Annual Meeting*, 1996). We have sought evidence for perturbation by FM phone fields of spontaneous brain tumor incidence, and in rats exposed to a single dose of the short-lived carcinogen ENU *in utero*, and thereafter exposed intermittently to FM phone fields for 24 months. (Mean life span 26 months). Low ENU dosage was selected to give maximum sensitivity to possible tumor modulation by FM phone fields over the lifetime of the animal.

METHODS: We tested a frequency modulated 836.55MHz signal, with \pm 12.5kHz maximum deviation. Modulation was by a recorded pattern of "balanced speech" that generated all major speech components in a 2 min epoch that recycled continuously. Pregnant Fischer 344 rats were randomly assigned to 6 groups. They received either a single tail-vein injection of the carcinogen ethylnitrosourea (ENU, 4 mg/kg) or inert buffer solution on gestational Day 18. Far-field exposures (horn radiator, 836 MHz, circularly polarized) began on Day 19 and continued after parturition until weaning at age 23 days. Offspring (n = 540) of the 6 maternal groups then became treatment cohorts: 1) Sham/Control (SC), n=90, 45M, 45F; ENU/Control (EC), n=90, 45M, 45F; Sham/Sham (SS), n=90, 45M, 45F;

Sham/Field (SF), n=90, 45M, 45F; ENU/Sham (ES), n=90, 45M, 45F; ENU/Field (EF), n=90, 38M, 52F. Exposures simulating near-fields at a phone user's head began at 35 days, and continued for the next 23 months. Exposures were for 2h daily, antenna power 2.5W, field-on 7.5min, field-off 7.5min. Far-field averaged SARs (modeled): pregnant dam (uterus) 1.0W/kg; fetus (brain) 0.9W/kg; isolated pup (brain) 0.1W/kg; young rat (brain) 0.4W/kg. Averaged near-field brain thermographic SARs: average males 2.3W/kg; average females 1.8W/kg. Survivors of the original 540 rats (n=372, 69%) were sacrificed at 730-733 days.

RESULTS: There were no effects on brain tumor incidence attributable to the FM fields in either the control or the ENU groups. There was the expected higher incidence of brain tumors in the ENU-exposed groups (EC,15; ES,17; EF,15), in comparison with the low incidence of spontaneous brain tumors in the sham and control groups (SC,2; SS, 1; SF,3), $p < .001$. Comparing survival rates, lifetimes of ENU-exposed animals were significantly shorter than controls ($p < .0005$), but these differences were not influenced by FM field exposures.

DISCUSSION: The findings here are consistent with our previous study in rats exposed to NADC signals. The apparent "protective" effect in the NADC study, which did not gain statistical support, was not detected with FM fields. These effects have been modeled in the normal homeostatic balance between mechanisms regulating damage and repair in cell growth. They may indicate sensitivities to the 50/sec pulsed characteristics of TDMA fields. Other packet frequencies in current use or proposed for cell phone use (GSM = 217, iDEN = 22, Iridium = 11) may therefore merit specific study.

This study was supported by the Motorola Corporation.

E-5

LYMPHOMA INCIDENCE IN *E μ -pim1* TRANSGENIC MICE EXPOSED FOR UP TO 18 MONTHS TO PULSED 900-MHz FIELDS.

M. Repacholi¹, A. Basten², V. Gebiski³, D. Noonan⁴, J. Finnie⁵ and A. Harris⁶.
¹Royal Adelaide Hospital, Adelaide, South Australia, Australia.
²Centenary Institute for Cancer Medicine & Cell Biology and
³NHMRC Clinical Trials Unit, Sydney University, Sydney, New South Wales, Australia.
⁴Institute of Medical & Veterinary Science and
⁵Central Veterinary Laboratory, Adelaide, South Australia, Australia.
⁶Walter & Eliza Hall Institute of Medical Research, Melbourne, Victoria, Australia.

The aim of this study was to determine whether long-term exposure to plane-wave radiofrequency (RF) fields (900 MHz), pulse-modulated with a pulse repetition frequency of 217 Hz and a pulse width of 0.6 ms, similar to that used in mobile telecommunications, would increase the incidence of lymphoma in *E μ -pim1* transgenic mice, a genetically engineered mouse strain that is moderately predisposed (some 15% over 18 months) to develop lymphoma spontaneously. Specific pathogen-free female *E μ -pim1* mice aged 4-6 weeks were purchased from GenPharm, California, transported to Adelaide, and entered into the study 10 days later. They were

maintained pathogen-free throughout. One hundred of the mice were sham exposed and 101 were exposed for two 30-min periods per day for up to 18 months to RF fields with incident power densities of 2.6-13 W/m² and specific absorption rates (SAR) of 0.008-4.2 W/kg, averaging 0.13-1.4 W/kg. The range of SARs reflected the varying orientation of the mice to the RF field while they were moving freely in their cages. Details of the methodology and the results of monitoring the animals for lymphoma development will be presented and discussed.

E-6

LACK OF PROMOTING EFFECTS OF THE ELECTROMAGNETIC NEAR-FIELD USED FOR CELLULAR PHONES (929 MHz) ON RAT LIVER CARCINOGENESIS IN MEDIUM-TERM BIOASSAY.

T. Shirai¹, K. Imaida¹, S. Watanabe², K. Wake³, A. Aimoto⁴, Y. Kamimura⁵ and M. Taki³. ¹Department of Pathology, Nagoya City University Medical School, Nagoya 467, Japan. ²Communications Research Laboratory, MPT, Tokyo 184, Japan. ³Department of Electronics and Information Engineering, Tokyo Metropolitan University, Tokyo 192-03, Japan. ⁴Department of Medical Electronics, School of Medicine, Tokai University, Kanagawa 259-11, Japan. ⁵Department of Information Engineering, Utsunomiya University, Tochigi 321, Japan.

INTRODUCTION: The possible cancer promotion potential of local exposure to a 929 MHz electromagnetic near-field with the TDMA modulation of PDC (Personal Digital Communication, Japanese cellular telephone standard) on chemically-initiated rat liver carcinogenesis was investigated employing a medium-term bioassay.

EXPOSURE CONDITION: A 929 MHz near-field with a modulated of TDMA signal (PDC) was directed to rats through a quarter-wavelength mono-pole antenna. The maximum local SARs on temporal average were 7.2 - 6.6 [W/kg] within the whole body and 2.0 - 1.7 [W/kg] within the liver which was the target organ. The whole-body average SARs on temporal average were 0.80 - 0.58 [W/kg]. Temporal peak SARs had three times these values due to the duty ratio of the PDC signal. Exposure lasted 90 min. a day, for 5 days a week, over 6 weeks.

BIOLOGICAL PROTOCOL: Male F344 (aged 6 weeks) rats were initially (at week 0) given a single dose of diethylnitrosamine (DEN, 200 mg/body weight ip). After two weeks (at week 2), exposure (47 rats) or sham-exposure (48 rats) was started. At week 3, all rats were subjected to a 2/3 partial hepatectomy. At week 8 (i.e. after 6 weeks exposure or sham-exposure), all rats were sacrificed. Carcinogenic potential was scored by comparing the numbers and areas of the induced glutathione S-transferase placental form (GST-P) positive foci in the livers of the exposed and sham-exposed rats. A further group of 24 animals, given only DEN and partial hepatectomy, served as the controls.

RESULTS: The numbers (*No./cm²*) of GST-P positive foci were 4.61 ± 1.77, 5.21 ± 1.92 (*p* < 0.05, vs control), 4.09 ± 1.47, and the areas (*mm²/cm²*) were 0.30 ± 0.16, 0.36 ± 0.21, 0.28

± 0.15, for the exposed, sham-exposed, and control groups, respectively. There were no significant differences between the exposed and sham-exposed groups for either the areas or the numbers of GST-P positive loci.

CONCLUSION: Local body exposure to a 929 MHz field modulated in a PDC waveform, had no significant effect on rat liver carcinogenesis under the experimental conditions we employed.

E-7

EFFECT OF ELECTRIC FIELD ON CALCIUM CHANNEL CURRENTS: MODEL CALCULATIONS.

J.P. Novak¹ and D. Goulet². ¹Institut de recherche d'Hydro-Québec, Varennes, Québec J3X 1S1, Canada. ²Hydro-Québec Environmental Branch, Montréal, Québec H2Z 1A4, Canada.

A mathematical model of a three-dimensional ion transport is formulated in an approximation assuming rotational symmetry. The model consists of three particle conservation equations for sodium, calcium and chlorine ions complemented with the Poisson equation. A numerical method of solution is based on the Gummel-Scharfetter semianalytical approach, the program is written in FORTRAN and the system of discrete equations is solved explicitly in the axial direction and by iterations in the radial direction. The present report deals with numerical calculations of calcium flux toward a channel opening in an insulating impermeable membrane under influence of an external electric field, assuming membrane depolarization to zero potential. The calculations were carried out for the imposed fields of +100 mV/cm and -100 mV/cm and CaCl concentrations in an external medium between 0.01 and 1 mM. The initial molar concentration of NaCl was 145 mM and the calcium concentration in the circle representing the channel entry was set to 1 μM. The boundary conditions require constant concentrations of all ions at the plane infinitely distant from the channel opening and zero normal ion fluxes at the membrane surface except for the calcium ions in the circular area representing the channel opening, where a constant concentration is prescribed; zero concentration gradients at the axis of symmetry and cylinder boundary are required. Furthermore, the value of the electric potential at the membrane surface is set to zero, while at the distant parallel plane representing the outer boundary the electric field is set to + or -100 mV/cm; at the axis and surface of a cylinder zero potential gradient is postulated.

The values of the calculated calcium current at the times approaching the steady state were approximately proportional to the calcium concentration, while the difference between the currents at +100 mV/cm and -100 mV/cm increased with decreasing Ca concentration. At 1 mM of CaCl and +100 mV/cm, for example, the calcium ion current rises from zero to the maximum of 0.7 pA at 2.5 ns and subsequently gradually decreases to 0.43 pA at the last calculated time 4.4 μs. At this moment the calcium flux through the channel opening is about 2.8 × 10¹⁹ cm² and the flux at the boundary parallel to the membrane wall about 6.8 × 10¹⁵ cm². The axial component of the electric field induced by the calcium efflux in the channel opening at the axis of symmetry is 2.2 kV/cm;

the maximum value of the radial field component is 140 V/cm. The difference between the calcium currents at the imposed fields of + and -100 mV/cm and 1 mM of CaCl is about 0.5%, rising to several percent at 0.01 mM.

E-8

ALTERED CUMULATIVE CALCIUM INFLUX FOR BIOLOGICAL CELLS: AN ILLUSTRATION OF THE THEORY OF SIGNAL AVERAGING BY RECTIFICATION OF WEAK ELF ELECTRIC FIELDS.

J.C. Weaver¹, T.E. Vaughan¹ and R.D. Astumian². ¹Harvard-MIT Division of Health Sciences and Technology, Massachusetts Institute of Technology, Cambridge, Massachusetts 02139, USA. ²Departments of Surgery and Biochemistry, University of Chicago, Chicago, Illinois 60637, USA.

We present a theoretical model for field-altered influx of calcium ions (Ca^{++}) in an elongated cell, to illustrate signal averaging by a biological cell for a case that may have a lower field threshold than an isolated spherical cell [Astumian *et al.* 1995]. The primary target of interaction is the cell membrane, where field-altered change in cumulative altered flux of Ca^{++} is a biophysical mechanism for altering a cell's biochemistry. This primary effect of altered Ca^{++} accumulation precedes downstream events that result in biological effects. In this way we have an explicit connection between a purely physical phenomenon, the electric field exposure, and a downstream biological effect that might be involved in any possible human health hazards.

The cumulative influx is compared to fundamental fluctuations (molecular shot noise) in the number of inwardly transported Ca^{++} , and is the basis of a signal-to-noise ratio criterion for estimating the minimum induced electric field that could cause an effect. If the field-induced molecular change is not detectable in the noise of typical molecular fluctuations, then an effect is presumably not possible. More importantly, the dependence of the cumulative influx on cell and exposure parameters yields a "signature" for this underlying biophysical interaction mechanism.

Our purpose is two-fold: (1) explicit illustration of the rectification mechanism in which a membrane associated activity is altered by an ELF electric field, and (2) construction of a model with greater sensitivity to the electric field, so that the predicted threshold, E_{min} , will be smaller. We adopt assumptions that will lead to the largest effect (signal) and/or the smallest competing fluctuations (noise). This approach allows realistic quantitative predictions to be made, without explicitly including complicated features of real cells. By considering both the parametric dependence of the primary effect, and realistic values of the model's parameters which give the smallest values of E_{min} , this biophysical mechanism can possibly be ruled out as the basis of some reported experimental results.

Astumian, R. D., J. C. Weaver, Adair, R. K. Rectification and signal averaging of weak electric fields by biological cells. *Proc. Natl. Acad. Sci. USA* 91:3740-3743, 1995.

E-9

LOW FREQUENCY ELECTROMAGNETIC FIELDS AFFECT THE TIME COURSE OF ORNITHINE DECARBOXYLASE ACTIVITY IN CHICK EMBRYOS.

J.M. Farrell, M. Barber, D. Krause and T.A. Litovitz. Vitreous State Laboratory, Catholic University of America, Washington, District of Columbia 20064, USA.

It has been reported that time-varying magnetic fields (MFs) can induce morphological abnormality (particularly of the neural tube) in chick embryos. In an attempt to understand the mechanism by which these abnormalities arise, the present work explores the effects of weak MFs on the activity of the enzyme ornithine decarboxylase (ODC) in chick embryos. The results presented here demonstrate that a 4 μT , 60 Hz sinusoidal magnetic field significantly enhances ODC activity during the first peak in the time course (15 hours - which corresponds to gastrulation), and diminishes the second peak (23 hours - which corresponds to neurulation). It is also shown that the superposition of a weak, temporally incoherent MF on a 60 Hz MF inhibits the 60 Hz-induced alteration in ODC activity in both activity peaks. In another set of experiments, slightly older (48 hour) embryos were analyzed for gross morphology. It was found that the abnormality rate among MF-exposed embryos was approximately three times that of control embryos - with the vast majority of malformations being neural tube abnormalities. When embryos with morphological abnormalities were assayed separately from those which were morphologically normal, it was found that the ODC activity in the abnormal group was significantly less than that in the normal group. It was also found that there was no difference between the ODC activity of control normal embryos and those normal embryos which had been MF-exposed, and similarly there was no difference between the ODC activity of control abnormal embryos and MF-exposed abnormal embryos. It seems reasonable to presume that the modifications of a critical growth related enzyme such as ODC could be an important part of the biochemical basis by which neural tube abnormalities in chick embryos are induced by exposure to magnetic fields.

This work was supported by Maryland Department of Natural Resources Contract #CD-94-001-004 and NIEHS Grant #R01 ES06872-02.

E-10

EXPERIMENTAL AND THEORETICAL EVALUATION OF THE INTERACTION OF BIOGENIC MAGNETITE WITH ELECTROMAGNETIC FIELDS.

J.P. Dobson^{1,2}, T.G. St.Pierre¹ and P.P. Schultheiss-Grassi². ¹Department of Physics, Biophysics Programme, University of Western Australia, Nedlands, Western Australia 6907, Australia. ²Institut für Geophysik, ETH- Hönggerberg, CH-8093 Zürich, Switzerland.

The recent discovery and independent confirmation of biogenic magnetite in human tissue has led to speculation not

only on its role in the central nervous system but also on mechanisms for explaining the possible interactions of weak electromagnetic fields with human physiology. Experimental evaluation of human tissue samples indicates that biogenic magnetite is present in human brain tissue as well as the heart, liver and spleen. This has led to theoretical models showing how these particles may interact with electromagnetic fields at both extremely low frequency (ELF) bands and microwave frequency bands (e.g. Kirschvink, 1992 & 1996; Dobson and St. Pierre, 1996).

In addition to the implications for interactions due to the magnetic properties of these magnetite particles, they also have very different electrical conductivity when compared to human tissue. We present a model which examines eddy current generation in individual particles due to low-power microwave radiation as well as the possible formation of complex electrical circuits on a cellular scale in human brain tissue. These theories will be discussed in the context of preliminary experimental results which show differences in the magnetic properties of human tissue and those of rat brains. This data has implications for the extrapolation of laboratory animal studies to humans.

References:

Dobson, JP and TG St. Pierre (1996) Application of the Ferromagnetic Transduction Model to D.C. and Pulsed Magnetic Fields: Effects on Epileptogenic Tissue and Implications for Cellular Phone Safety. *Biochem. Biophys. Res. Commun.*, 227(3):718-723.

Kirschvink, JL (1992) Comments on "Constraints on biological effects of weak extremely-low-frequency electromagnetic fields". *Phys. Rev. A*. 46:2178-2184.

Kirschvink, JL (1996) Microwave absorption by magnetite: A possible mechanism for coupling non-thermal levels of radiation to biological systems. *Bioelectromag.* 17: 187-194.

E-11

PULSED MAGNETIC FIELD IN THERAPY OF PATIENTS WITH SECONDARY CHRONIC PYELONEPHRITIS. V.A. Kiyatkin. Russian Research Center of Rehabilitation and Physical Therapy, Public Health Ministry of Russian Federation, Moscow 121099, Russia.

Actual problem of urology is the development of new methods in pyelonephritis treatment.

Antibacterial and anti-inflammatory therapy of patients with chronic pyelonephritis often gives short-time effect and prolonged repeated courses lead to bacteria resistance, auto-aggression, impairment of kidneys functional state, give nephrotoxic effect.

Application of physical factors in particular pulsed magnetic field to patients with chronic pyelonephritis have anti-inflammatory and immunoactive effect, improve blood circulation without negative side effect.

Therapy efficiency have been studied on the state of cell and humoral immunity, peroxide oxidation of lipids, functional state of kidneys and upper urinary tracts according to dynamic scintigraphy with pertechnate ⁹⁹Tc, glucocorticoid function of adrenal cortex, calcium, natrium, potassium content in blood and urine, daily excretion of

oxalates with urine before and after treatment.

Positive results have been marked in treatment of patients with secondary chronic pyelonephritis by pulsed magnetic field, unlike "placebo" group, namely changes in cell and humoral immunity system, improvement of urodynamics of upper urinary tracts, strengthening of glucocorticoid function of adrenal cortex with anti-inflammatory effect expressed in reduction of leukocyturia and erythrocyturia, decrease of products quantity of peroxide oxidation of lipids and decrease of oxaluria and calciuria.

E-12

DIFFERENTIAL APPLICATION OF PHYSICAL FACTORS (460 MHz ELECTROMAGNETIC WAVES PULSED CURRENTS) IN COMMON SYSTEM OF SPORTSMEN REHABILITATION. G.R. Giginishvili. Russian Research Center of Rehabilitation and Physical Therapy, Public Health Ministry of Russian Federation, Moscow 121099, Russia.

After our reports at the First World Congress for Electricity and Magnetism in Biology and Medicine we conducted investigations with the goal to develop the unified program of rehabilitation measures in sport medicine since in present program a number of data appeared in experimental physiology and medicine particularly in physical therapy have not been taken into account.

Recent findings in detecting activation mechanisms of physical factors made it possible to reveal a number of new methods of their application to obtain the needed effect on endocrine and immune systems of sportsmen. Today we have a clear view about two-component structure of homeostasis on basic and dependent functions permitting to exercise a new approach towards theoretical aspects of adaptation to sport loading as well as the associated problem of restoring sportsmen working capacity. According to the given concept special attention should be paid to problems of restoring the body basic functions (e.g. protective power) and central nerve system, as the disturbance of the adaptation mechanisms of these systems leads to the changed somatic and vegetative functions of a sportsman. Consequently, physical factors effecting the immune and endocrine systems in a certain way should be initiated from the very beginning of the rehabilitation measures to be taken.

Physical Sciences

F. Dosimetry

Chairs: Guglielmo D'Inzeo and Asher Sheppard

F-1

COMPARISON OF RESIDENTIAL EXPOSURE TO ELF MAGNETIC FIELD BETWEEN ITALY AND THE USA. L.E. Zaffanella¹ and I. Visintainer². ¹Enertech Consultants, Lee, Massachusetts 01238, USA. ²CESI, 20134 Milano, Italy.

OBJECTIVE: Several studies have found an association between childhood cancer risk and proximity to sources of residential magnetic field. A comparative assessment of exposure between Italy and the USA was made by analyzing the major sources of residential magnetic fields: power lines, house wiring, and electrical appliances.

METHODS: The characteristics of distribution system and house wiring that affect magnetic fields were studied. This was complemented by measurements of personal magnetic field exposure.

Example of Residential Night-Time Field

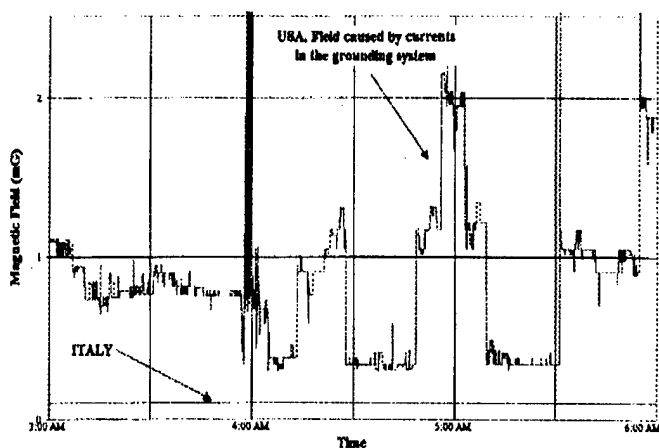

Exposure to electrical appliances was assessed by comparing typical appliance field values, appliance usage, and residential energy consumption.

RESULTS: Residential exposure to ELF magnetic field is significantly less in Italy than in the USA, because of a much greater proportion of underground distribution in Italy, the "net current" is a significant source of field in the USA due to its grounding practices, and electrical appliance use is lower in Italy. The energy consumption is quite different:

	50% of Homes	25% of Homes	10% of Homes
Italy (35 homes in Northern Italy)	>175 kWh/month	>250	>310
USA (EPRI's 1000 home survey)	>750 kWh/month	>1200	>1700

Comparison of measured fields near appliances (data from

EPRI's 1000 home survey and few appliance measurements in Italy) shows fields from Italian appliances on average equal to 0.75 times the US data, with 95% of the measurements between 0.5 and 1.45 times the US medians. Electrical appliance use, however, is significantly lower in Italy. Only a third of the sampled homes used an electric range, compared to about 2/3 in the USA. Microwave oven were used in about 10% of the homes (>50% in the USA). Clock radios were used in about 1/3 of the homes (>2/3 in the USA). Dishwashers were present in 50% of the homes, and window unit air conditioners were not used. Residential exposure caused by proximity to high voltage lines may be relatively greater in Italy than in the USA, because of the greater population density and different right of way practices. While residential exposure in Italy is significantly lower for more than 99% of the population, possibly by a factor of ten or more, a larger percentage of the population (estimated 0.54% in Italy versus 0.2% in the USA) is affected by high voltage line field in Italy. This conclusion has implications for epidemiological studies, and for risk assessment and management.

F-2

BACKGROUND ELF MAGNETIC FIELDS IN A GREAT URBAN AREA. G. d'Amore, L. Anglesio, A. Benedetto and M. Tasso. Regional Environmental Protection Agency, ARPA Piemonte, Department of Ivrea, 10015 Ivrea, Italy.

Epidemiologic studies about risk of cancer associated to ELF magnetic field exposure classify as "exposed" or "non exposed" their subjects on the basis of a *a priori* assumption of magnetic field value cutpoints.

In the great majority of studies these cutpoints are defined equal to 0.1 μ T or 0.2 μ T, which are considered threshold exposure level typical of group of population residing near high voltage facilities.

Really, situations in which an environmental magnetic field level not associated to high voltage transmission lines, comparable with the above reported cut-off points, can exist. In this study we present the results of ELF magnetic field survey in an Italian urban area of about 1 million of inhabitants (Turin). In this great metropolitan area average magnetic field level was correlated to urban population density characterizing different districts.

By data collected in the survey we obtained several exposure indexes: daily average of magnetic field strength, time integral of magnetic field exposure, proportion of time above specified thresholds.

These exposure indexes were compared with those evaluated in studies regarding domestic exposure. Urban background magnetic field level resulted comparable to cut-off points considered in epidemiologic studies. In some urban districts with high population density (ancient town center) the average background reached values much higher than 0.1 μ T. These results show the interest in the knowledge of background magnetic field level in urban areas, which can assume a significant role in the exposure assessment in epidemiologic studies.

F-3**RELEVANCE OF OCCUPATIONAL GUIDELINES TO UTILITY WORKER MAGNETIC-FIELD EXPOSURES.**

T.D. Bracken¹, R.S. Senior¹, R.F. Rankin², W.H. Bailey³ and R. Kavet⁴. ¹T. Dan Bracken, Inc., Portland, Oregon 97202, USA. ²Applied Research Services, Inc., Lake Oswego, Oregon 97035, USA. ³Bailey Research Associates, Inc., New York, New York 10017, USA. ⁴Electric Power Research Institute, Palo Alto, California 94303, USA.

Several organizations have recommended guidelines for occupational exposure to extremely low frequency magnetic fields. Electric utility workers represent perhaps the largest occupational group that encounter fields at or near the levels cited in these guidelines. The purpose of this investigation was to estimate the magnitude, duration, and frequency of occurrence of magnetic field exposures approaching guideline levels among electric utility workers. The focus was on exposures to magnetic fields above 0.05 millitesla (mT). Data were examined from five data sets of magnetic-field personal exposure (PE) measurements for US electric utility workers. Four of the data sets were from general PE surveys of worker exposure and collectively contained measurements from over 7000 work days. The fifth data set was from a study of line workers performing transmission and distribution live-line tasks. For each data set, exposure measurements above specified levels within job category, work environment, and/or task were summarized. For the job categories specific to the electric utility industry, exposure above 0.05 mT generally occurred during less than 1.0 percent of work time and exposure above 0.2 mT generally occurred during less than 0.1 percent of work time. Although most periods of exposure above these magnetic field levels were brief, some lasted several minutes and a few exceeded one hour. In the general PE surveys, measured fields above 1.0 mT were extremely rare, occurring less than 0.002 percent of the total work time for utility-specific job categories. This is the whole-body ceiling guideline level recommended by the American Conference of Governmental Industrial Hygienists (ACGIH). No exposure measurements were observed that either exceeded 5 mT for 2 hours, the short-term limit recommended by the International Radiation Protection Association (IRPA), or exceeded 1.3 mT for a work day, the limit recommended by the Comité Européen de Normalization Electrotechnique (CENELEC) and the National Radiological Protection Board (NRPB). Thus, data from the general PE surveys indicated that workers performing tasks on or very near high field sources at electric utility facilities only infrequently encounter fields that exceed the recommended ACGIH exposure guideline. In the majority of cases, high magnetic field exposure is transitory. PE data from workers using bare-hand methods while bonded to the conductors of energized 500-kilovolt transmission lines had exposures above 1.0 mT during three of four measured tasks. Such tasks were not likely to have been included in general surveys either due to their rarity or to safety considerations related to workers wearing meters. Therefore, targeted data collection is necessary to provide a detailed

characterization of high field exposure scenarios on transmission lines and at other electric utility facilities. The study of the magnitude, extent and frequency of magnetic field exposures in the electric utility industry provides perspective for assessing the potential impact of guidelines. Work supported by the Electric Power Research Institute under WO2699-14.

F-4

MEASUREMENTS OF PERSONAL EXPOSURE TO EMF IN KOREAN POPULATION. Y.S. Kim, S.C. Hong, S.W. Kim, W.O. Choi and J.Y. Park. Institute of Environmental and Industrial Medicine, Hanyang University, Sungdong-Ku, Seoul 133-792, Korea.

Arguments of relationship between human health effects and weak extremely low frequency (ELF) electromagnetic fields (EMF) become increasingly of considerable interest in Korea in recent years and lead to necessity the study of field sources of EMF exposures of Korean general population. Exposure data relating to a wide range of occupations is needed to provide better exposure assessment methods for future epidemiological research.

OBJECTIVE: This study was designed to evaluate EMF levels of various sources in daily activity pattern and the 24-hr personal exposure levels between occupational groups and non-occupational groups.

METHODS: Twelve subway drivers and telephone operators as an occupational group were compared with twelve housewives and twelve students as a non-occupational group, respectively. The 24-hr personal exposure levels of EMF was measured on 3-sec interval basis using the EMDEX II dosimeter.

RESULTS: Results of the EMF levels between occupational and non-occupational groups is presented in Table 1.

Table 1. Personal exposure levels (μ T) of EMF between occupational and non-occupational groups.

Category	Occupational		Non-occupational		Ratio O/NO
	Subway driver (n=12)	Telephone operator (n=12)	Housewife (n=12)	Student (n=12)	
Indoor					
At Work	0.36	0.27	0.08	0.13	3.0
Transportation	0.19	0.13	0.08	0.09	1.8
At Home	0.04	0.06	0.07	0.04	0.9
Outdoor	0.08	0.04	0.04	0.03	1.7
24-hr	0.22	0.14	0.08	0.06	2.6

The difference between personal mean exposure for 24 hours between occupational and non-occupational groups is evident and statistically different from zero. The personal exposure by different occupational varies by different indoor sources and working status.

CONCLUSION: The personal exposure levels of EMF is generally 3 times during the at-work period for exposed compared to unexposed population. The results suggest necessity of an epidemiological study for risk assessment of EMF.

F-5

ASSESSMENT OF THE EXPOSURE OF INDUCTION FURNACE OPERATORS USING A MODIFIED EMDEX II DOSEMETER. P. Chadwick. National Radiological Protection Board, Chilton, Oxon OX11 0RQ, United Kingdom.

Magnetic fields in the vicinity of induction furnaces exhibit a marked spatial variation. The magnetic flux density close to furnaces may exceed levels specified in exposure standards and it is clear that working practices, and in particular the times that an operator will spend at various distances from a furnace during the course of a day, will be major factors in determining both average exposure and its temporal variability.

Spot measurements of magnetic flux density around a furnace would result at best in an estimate of exposure. An alternative is to use a magnetic field dosimeter to measure the field strengths to which a worker is actually exposed. Such a dosimeter would be useful for epidemiological studies of workers exposed to magnetic fields from induction furnaces as well as in the assessment of compliance with exposure standards.

A modified EMDEX II dosimeter with a frequency range of up to 3 kHz and a dynamic range of up to 10 mT has been used to assess the exposure of operators of eight induction furnaces with frequencies between 50 Hz and 1 kHz and powers of up to 4.5 MW. Spot measurements of magnetic flux density were made around each furnace and waveforms and spectra of magnetic fields recorded. These measurements indicated that it would be possible to exceed the NRPB investigation levels for magnetic flux density close to three systems - a 50 Hz billet heater and two 1 kHz airmelt furnaces. The data from the dosimeter indicate that the operator of the billet heater was not in fact exposed to magnetic flux densities above the investigation levels but that the operators of the airmelt furnaces were. The maximum exposure levels recorded by the dosimeter, up to 5 mT in one case, indicate that the operators of airmelt furnaces do stand very close to the coils from time to time. This behaviour was not apparent at the time that spot emission measurements were made. If operator exposures were to be inferred from these spot measurements and from observed working practices, they would be underestimates.

F-6

ELECTRIC FIELD FROM A COMPUTER MONITOR DEPENDING ON GROUND OF POWER SYSTEM. D.W. Kim and C.Y. Ryu. Department of Biomedical Engineering, Yonsei University, Seoul 120-752, Korea.

INTRODUCTION: In Korea both 110V and 220V power system are used concurrently. Thus one-phase three-line power system with center tap grounded is widely used to supply both voltages. However, most receptacles are not

grounded or/and two prong plugs for both voltage are widely used.

OBJECTIVES: We have measured electric field generated by a 17-inch monitor with grounded and ungrounded, with the monitor on and off for 110V and 220V power system.

METHODS: Electric field generated by the monitor directly on its screen was measured using HI 3604 ELF survey meter and HI3616 fiber optic remote control receiver (Holaday Industry Inc., USA). For each measurement background electric field was measured first and then it was subtracted from the measured value to estimate the electric field from the monitor. The measurement was made with the survey meter positioned parallelly on the screen directly. The monitor has free voltage power supply (110V/220v).

RESULTS: The background electric field was approximately 3V/m. As shown in Table 1 ungrounded monitor generates very high electric field even in the case of switch "off" for both 110V and 220V power system compared to the grounded one. Therefore, it is recommended that the plug be taken out during no use of computer to avoid electric field exposure for ungrounded system.

Table 1. Electric field(V/m) from the monitor

Power system	110V(on/off)	220V(on/off)
Grounded	45/10	102/12
Ungrounded	558/546	602/520

F-7

EVALUATION OF INDUCED CURRENTS IN HUMAN MODELS BY POWER FREQUENCY ELECTROMAGNETIC FIELDS USING A BEM TECHNIQUE. O. Bottauscio¹ and R. Conti². ¹Istituto Elettrotecnico Nazionale "G. Ferraris", I-10100 Torino, Italy. ²ENEL, Centro Ricerca Elettrica, I-20093 Cologno Monzese, Italy.

Given the problems that might arise from the possible health effects of power frequency EMF, the evaluation of the current density induced in the human body by such fields becomes particularly important not only from the strictly scientific point of view but also for standardization purposes. ENEL, within the framework of a wide-ranging research programme, which has been in progress for a number of years, has developed, in co-operation with the National Electrotechnical Institute "Galileo Ferraris", a highly sophisticated digital procedure based on the Boundary Elements (BE) technique, for calculating the current density induced in the human body due to the presence of electric and magnetic fields. The BE approach is particularly convenient for these problems because it does not require boundary conditions and moreover it reduces the cost of the preprocessing phase. In addition to setting up the appropriate computer program, which makes it possible, among other things, to model field sources however complex they may be, particular attention has been paid to the sophisticated modelling both of the morphology and of the electrical characteristics of the chief human organs and of the various other parts of the body. In particular, the numerical approach is based on a numerical formulation using the

Green vector theorem, which leads to the solution of the following equations

$$\xi E(P_s) = -\int_{\Omega} (n - E) \nabla \psi dS - \int_{\Omega} (n \times E) \times \nabla \psi dS + \int_{\Omega} j \omega \psi (n \times B) dS - j \omega \mu \int_V \psi J_s dV + \frac{1}{\epsilon} \int_V \rho \nabla \psi dV$$

$$B(P_s) = \mu \int_V \psi J_s \times \nabla \psi dV \quad (1)$$

where E is the electric field, B the magnetic flux density, ω the angular frequency and the volume integrals represent the field sources (current sources J_s and charge sources ρ); the Green function ψ is given by $\psi = \exp(-jkr)/4\pi r$, where k depends on material characteristics ($k^2 = \mu(\epsilon - j\sigma/\omega)\omega^2$) and r is the distance between *source point* and *computational point*. Taking into account that the conductivity of the biological tissue is very low, the induced currents do not sensibly affect the local value of the magnetic flux density which consequently only depends on the imposed currents. The field equations are then represented by (1) together with the boundary conditions on E at the separation of two different materials.

Applying the BE technique, the surfaces are discretized into triangular elements and the set of integral equations (1) is reduced to an algebraic system of equations where the only unknowns are the normal and tangential components of the electric field.

On the basis of BE formulation, a computer code has been worked out. The pre-processing module enables the description and discretization of complex surfaces and volumes; the surfaces are obtained by translating, rotating or deforming a 2D grid previously generated, while the volumes are described by a set of 8 or 20 vertex hexaedra, arranged to build usual field sources as bars, coils, etc.

The evaluation of the matrix coefficients, in the solver phase, involves the computation of surface and volume integrals of Green function and its gradient. This operation requires particular care because it strongly affects the accuracy of the numerical results. The adaptive Kronrod scheme is found to be a good compromise between accuracy and computational burden.

The numerical method has been successfully applied to the analysis of the interaction between human body and electromagnetic fields, with particular reference to the analysis of induced currents by different electrical plants and devices. Examples of application to situations of practical interest will be presented.

F-8

MAGNETOPHORESIS OF BIOLOGICAL MOLECULES IN LIQUID CHROMATOGRAPHY. M. Iwasaka and S. Ueno. Institute of Medical Electronics, Faculty of Medicine, University of Tokyo, Tokyo 113, Japan.

Recently developed techniques using superconducting magnets have revealed several phenomena of effects of strong

magnetic fields on materials. In the previous study, we reported that fibrin polymers in gradient magnetic fields drifted in a specific direction, and concentrations of the fibrin changed [1]. When a solution, containing water and diamagnetic macromolecules is exposed to gradient fields, magnetic forces act on the water and diamagnetic macromolecules. Diamagnetic molecules in water drift in a specific direction due to the difference in the diamagnetic susceptibility of the molecules and water. The results indicate that "magnetophoresis" of biological molecules occurred in gradient magnetic fields of up to 8 T and 50 T/m.

In the present study, we investigated the magnetophoresis of biological molecules by using a high performance liquid chromatography (HPLC) system. Magnetophoreses of glycine, catalase, albumin, and DNA in water under magnetic fields of up to 14 T were measured. A chromatography column was filled with a water, and placed horizontally in the magnet's bore. The magnetic field in the superconducting magnet has maximum intensity at center of the magnet's bore. After injection of sample solution, the absorbance at of the solution from an outlet of the column was measured by a spectrophotometer.

Significant effect of magnetic field exposure on the chromatography of glycine was obtained when the center of the column was positioned at an 8T magnetic field. Peak intensity of the glycine that arrived at the spectrophotometer through an intense magnetic field was 430% of that without an intense magnetic field.

The position of the column in the magnetic field distribution was changed, and the time-courses of the absorbance of the eluted solution were measured. The retention time in the chromatogram of glycine was significantly prolonged when the direction of magnetic forces opposed the direction of the flow. In contrast, the retention time was reduced when the direction of magnetic forces was the same direction of the flow. The results indicate that the direction and the product of the magnetic field and its gradient are concerned with the mechanism of changes in peak intensities.

The retention times of catalase, albumin, and DNA under gradient magnetic fields also increased 100%-370% when the direction of magnetic forces was opposing the direction of the flow. It is a possible to investigate the magnetophoreses and diffusion processes of weak magnetic biological molecules under intense magnetic fields with chromatographic analysis.

Reference:

[1] M. Iwasaka and S. Ueno, *IEEE Transactions on Magnetics*, 30, 6, 4695, 1994.

F-9

PERSONAL EXPOSURE FROM LOW FREQUENCY ELECTROMAGNETIC FIELDS IN AUTOMOBILES. K. Vedholm¹ and Y.K. Hamnerius². ¹Volvo Truck Corporation, S-405 08 Göteborg, Sweden. ²Microwave Technology, Chalmers University of Technology, S-412 96 Göteborg, Sweden.

The human exposure to magnetic fields in automobiles can vary quite considerable in different car models. In this study

measurements were performed on cars both with the battery located in front of the engine, as well as on cars having the battery in the back of the car.

OBJECTIVE: To study the electromagnetic field exposure in the frequency range 5 Hz - 400 kHz from automobiles, mainly inside the cars and to identify the major field sources.

METHOD: Electric and magnetic fields as well as currents were measured both in the time and frequency domain. Most of the measurements have been performed on parked cars with the engines running idle. Some measurements were performed while driving the car.

RESULTS: The results show that magnetic fields are quite dominating compared to electric fields which is natural as we have low voltage and high currents in cars. The main fields were found inside the car, outside levels were comparable to the background fields. There is a considerable spatial variation of the magnetic fields inside the car, with the highest levels often found at the driver and front passenger foot position, measured values 0,2 - 13 μT (5 Hz - 2 kHz) 10 - 700 nT (2 kHz - 400 kHz). The levels are usually lower at head position, measured values 0,03 - 1,1 μT (5 Hz - 2 kHz) 2 - 30 nT (2 kHz - 400 kHz). The levels varies considerable between different car models as indicated by the span in the values above. The cars with low levels of magnetic fields had the battery close to the motor with a short cable to the ignition system. The higher levels of magnetic fields were all found in cars with the battery located in the back of the car. As a general rule, magnetic fields were approximately 10 times higher with the battery located in the back - with the engine's ignition sequence as the totally dominating source of magnetic fields.

The levels inside the cars were somewhat higher for rolling cars compared to the cases where the cars were parked with the motor idle. The increase in magnetic fields when driving were found to originate from the wheels and the tires in particular. The metal cord in the tires is often permanently magnetized which gives rise to an alternating magnetic field when the car is rolling. On the back seat, a level of 0,02 μT (5 Hz - 2 kHz) was measured with a parked car with idle motor, this increased to up to 5 μT when the car was rolling at 90 km/h.

DISCUSSION: The magnetic field levels resulting from cars with the battery in the front, 0.1 - 0.4 μT in the ELF range, do not differ much from the ordinary occupational exposure. Cars having their battery in the trunk or under the back seats, have magnetic flux densities that are considerably higher. This depends on the electric system in cars with a single conductor from the battery and the return currents go in the chassis. As the forward and return currents are separated, the fields from these currents will not cancel. In cars with the battery in the back these currents will pass the passenger compartment. Permanently magnetized rotating metal parts, such as the cord in the tires, can give considerable magnetic exposure in positions close to the tire as in the back seat.

F-10

SPECIALIZED E-FIELD PROBES FOR RF EXPOSURE EVALUATION OF *IN VIVO* AND *IN VITRO* EXPERIMENTS. K. Pokovic, T. Schmid and N. Kuster. Swiss Federal Institute of Technology (ETH), CH-8092 Zurich, Switzerland.

INTRODUCTION: An essential requirement for good laboratory experiments are a well defined field strength distribution in the exposed organ, tissue or cell culture. Computer simulations are the best technique to optimize the exposure setup and perform the detailed dosimetric analysis. However, since the scope for possible errors is large and some of the simplifications used in the modeling can turn out to be quite inappropriate, any results obtained by simulations must necessarily be validated. This validation is best done by measurements. The difficulties of measuring lies in the poor coupling efficiency (i.e., large ambient fields compared to those induced in the tissue) and in the large spatial variations of the induced SAR distribution.

OBJECTIVE: Development of a specialized E-field probe for the dosimetric assessment of *in vitro* and *in vivo* experimental setups. The probe should satisfy the following requirements: 1) spatial resolution of better than two millimeters; 2) high sensitivity of better than 0.1 mW/g; and 3) non-sensitivity to RF interference.

DESIGN: A temperature probe with significantly improved sensitivity (<0.4mW/g for 10s exposure time) has recently been presented for such assessments [1]. However, the sensitivity of this probe is not sufficient for many applications. For example, in the case of *in vitro* experiments using liquid mediums, precise temperature measurements are extremely difficult, since the SAR distribution is often greatly non-homogeneous [1] and convection coefficients and surface to volume ratios are usually very large.

SAR assessment by E-field measurements has the advantage of being independent of heat energy dissipation but requires measurement of three orthogonal vector components. A new miniature probe has been constructed which consists of a single dipole (1 mm) directly loaded with a Schottky diode and connected by highly resistive lines to the amplifier. The angle of the dipole is 54.7° with respect the probe axis, so that the isotropic response can be evaluated by turning the probe around its axis, i.e., measuring at the angular positions 0°, 120°, 240°. The probe is completely compatible with the dosimetric assessment systems DASY2&3 [2]. Despite its small size a respectable sensitivity of about 20 $\mu\text{W/g}$ was achieved, which translates into a significantly better sensitivity than that of temperature probes. The probe can be used to well above 10 mW/g and the frequency range is at least 10 MHz to >10 GHz. Susceptibility to RF and ELF fields is also very low.

APPLICATIONS AND DISCUSSION: The probe has recently been successfully used for the dosimetric assessment of an *in vitro* RTL setup in which cells were exposed in sixteen T75 flasks at a frequency of 835 MHz. An evaluation of an *in vivo* near field setup for 1.6 GHz has also been performed with this probe with an accompanying evaluation using a temperature probe.

References:

- [1] Michael Burkhardt, Katja Pokovic, Marcel Gnos, Thomas Schmid and Niels Kuster, "Numerical and experimental dosimetry of petri dish exposure setups", *Journal of the Bioelectromagnetic Society* (in press).
- [2] Thomas Schmid, Oliver Egger and Niels Kuster, "Automated E-Field Scanning System for Dosimetric Assessments", *IEEE Transactions on Microwave Theory and Techniques*, vol. 44, no.1, pp. 105-113, 1996.

F-11

CALIBRATION OF SAR PROBES IN WAVEGUIDE AT 900 MHz. L.O. Puranen, K.T. Jokela and P.E. Hyysalo. Finnish Centre for Radiation and Nuclear Safety, 00881 Helsinki, Finland.

In recently published radio frequency (RF) exposure standards limit values of 2 W/kg and 1.6 W/kg are given for the maximum local specific absorption rate (SAR) induced in the head and torso [1], [2]. Hand-held mobile phones and other mobile telecommunication equipment should comply with these exposure limits. SAR can be best determined by using the equation $SAR = \sigma E^2 / \rho$ where E is the electric field strength measured inside a phantom simulating a human head, σ is the conductivity and ρ is the mass density of the tissue simulating material. Compliance tests have shown that the induced SAR is typically near the limit values and may in some cases exceed them [3]. Hence, high precision is needed for the SAR measurements. The fundamental limit for the accuracy of SAR measurements is imposed by the calibration of miniature implantable E-field probes, SAR probes. In this study we present a novel calibration method based on the precise measurement of the temperature rise in a tissue simulating liquid placed in a rectangular waveguide. The uniformity of the E field in the calibration place was significantly improved to reduce the error caused by steep gradients of the E field. Compared to open field calibration systems the waveguide system is smaller and more compact. No anechoic chamber is needed and high SAR values are achieved with minimum power.

The central part of the calibration system is a vertically mounted rectangular waveguide. RF power is fed to the waveguide through a conventional coaxial-to-waveguide adapter located at the bottom. The electromagnetic wave excited by the post of the adapter propagates through the lower sections filled with air and acrylic plastics and is absorbed in the upper section filled with tissue simulating liquid. Two different liquid mixtures composed of water, sugar and salt (NaCl) are used to simulate muscle and brain. The section filled with acrylic plastics matches the liquid to the air. The calibration space is located in the centre of the liquid section where temperature and E-field probes are inserted. An optimally uniform E-field distribution is achieved by adjusting the thickness of the liquid section which changes the amplitude and the phase of the wave reflected from the liquid-air interface. In the uniform space the decay of the E-field due to the losses is compensated by the in-phase summation of forward propagating and reflected

waves. E-field scans performed at the maximum of the standing wave pattern located at distances 20-30 mm from the acrylic-fluid boundary showed that E-field varies less than 7% in a space with dimensions of 14 mm x 30 mm x 30 mm. In addition, E-field scans indicated no signs of higher order modes. The SAR in the calibration position is determined by measuring the temperature rise ΔT during an irradiation time Δt with a non-perturbing thermistor-type Vitek temperature sensor supplied by BSD Medical. SAR is calculated from $SAR = c\Delta T/\Delta t$ where c is the specific heat of the liquid mixture. The thermistor sensor is calibrated from 18°C to 30°C against a calibrated mercury thermometer. The specific heat of the liquid mixtures were determined with a simple calorimetric procedure. The estimated uncertainty of the SAR probe calibration at 900 MHz is $\pm 15\%$. Preliminary intercomparison calibrations performed with another dosimetric laboratory showed that differences were well within these limits.

[1] European Committee for Electrotechnical Standardization, Human exposure to electromagnetic fields. High frequency (10 kHz to 300 GHz). *European Prestandard ENV 50166-2*, Brussels, Belgium, 1995.

[2] Institute of Electrical and Electronic Engineers. IEEE Standard for Safety levels with Respect to Human Exposure to Radiofrequency Electromagnetic Fields, 3 kHz to 300 GHz. *IEEE Std C95.1-1991*, New York, USA 1992.

[3] K. Meier, O. Egger, T. Schmid and N. Kuster. Dosimetric laboratory for mobile communications. *Proc. 11th International Zurich Symposium and Technical Exhibition on Electromagnetic Compatibility*. Zurich, March 7-9, 1995.

F-12

A PARAMETRIC STUDY ON THE SAR DISTRIBUTION. L. Lafon, C. Delaveaud, P. Leveque and B. Jecko. Institut de Recherche en Communications Optiques et Microondes, Université de Limoges, 87069 Limoges, Cedex, France.

INTRODUCTION: Concerning cellular phones, our research team's antennas designers has developed a new kind of radiating structure, the Monopolar Wire Patch (M.W.P.), already shown at the BEMS 96 in Victoria. Through its monopolar radiation pattern and its small dimensions, the M.W.P. antenna is easy to be mounted on the handset. A new research topic close to electromagnetic compatibility had also been installed in our lab: the analysis of an antenna placed in its use context. The M.W.P. antenna was also studied close to the phoning man's head with the hand around the box. The match, the radiation pattern, the specific absorption rate, the absorbed power and the electromagnetic field induced in biological tissues were also computed.

THE MONOPOLAR WIRE PATCH ANTENNA OPTIMIZATION: It was essential to preserve the advantages of the antenna (monopolar radiation and small space required) while obtaining a satisfying induced electromagnetic field. Indeed, the capacitive effect caused by the antenna top hat above the «ground plane» induces near E-field levels greater than those obtained with a classical

G-1

THE IMPACT OF ELF-EMF ON THE INTRACELLULAR CALCIUM ACTIVITY AFTER MITOGEN ACTIVATION SEEMS TO BE CELL STATE DEPENDENT IN HUMAN SKIN FIBROBLAST AND RAT OSTEOBLASTIC CELLS. S. Thumm², M. Loeschinger¹, H. Hämmerle² and H.P. Rodemann¹. Section of ¹Radiobiology and Molecular Environmental Research and ²NMI-Reutlingen, Eberhard-Karls-University of Tuebingen, 72076 Tuebingen, Germany.

It has been previously demonstrated that non activated human skin fibroblasts (HSF) can react to ELF-EMF (20Hz, sinus; 6-8mT) with an induced accelerated terminal differentiation process. This may be due to a change in the intracellular free calcium activity, an increase in cAMP-dependent protein kinase (PKA) and a reduced proliferation potential.

In order to gain more information about the signal transduction pathways that might be affected by ELF-EMF (20Hz, 50Hz), we stimulated the cells with bradykinin (0,005-1,25ng/ml medium) and PDGF (0,25-2,5 ng/ml medium). Both mitogenes are known to alter the intracellular calcium $[Ca^{2+}]_i$ homioistase in these cells and we were interested whether there are interactions between mitogene- and ELF-EMF-induced calcium and PKA responses. By means of confocal laser scanning microscopy we observed $[Ca^{2+}]_i$ at the single cell level (Fluo-3) after the following scheme:

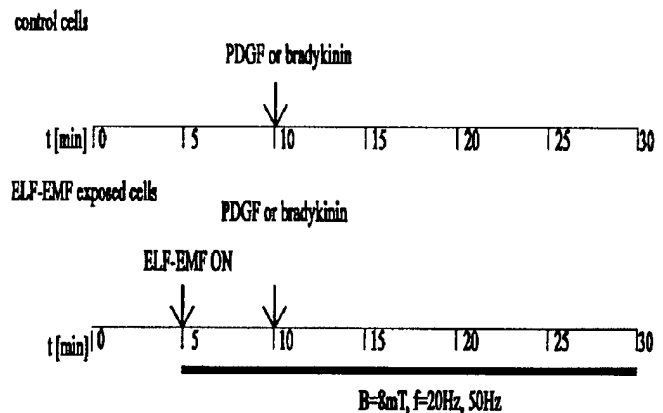

Fig. 1: Scheme of observation

RESULTS: Repeats of our earlier experiments showed that there is a strong dependance of $[Ca^{2+}]_i$ -field responses according to the differentiation state of the cells and the serum lot. When HSF cells were activated with PDGF (0,5ng/ml) we found that approx. 50% of mitotic fibroblasts (HS-MF) and postmitotic fibroblasts (HS-PMF) react with a calcium activation. Under field exposure (8mT, 20Hz) the HS-MF showed a 22% increase whereas the HS-PMF reacted with a 16% (0,25ng/ml) and 55% (0,5ng/ml) decrease of $[Ca^{2+}]_i$ -responding cells. Ongoing experiments will focus on

monopole. The same comment can be done about the peak SAR values.

We also tried to remove this last drawback by simulating various positions of the antenna on the metallic box. The first results obtained considering the M.W.P. antenna on the box bottom show a significant decrease and a different location of the peak SAR value. As when considering the antenna mounted on the top of the handset, the same radiation pattern alteration is noticed. Head, neck and hand were, in this case, simply modeled: we have now to consider more realistic models for biological structures.

A parametric study of the SAR distribution: The FDTD method allows both complex radiating structures and lossy dielectric media to be modeled. But, in spite of the implementation of the Perfectly Matched Layers in our code, the processing of the complete grid mesh still requires big memory space and time calculation. So, we asked us if it was really essential to discretize the whole biological structure concerning either its dimensions, or its composition. The influence of the head modelization on the SAR distribution was also estimated, using different models from the less complicated (cubical and homogeneous) to the more realistic (based upon scan datas), all illuminated with a monopole on a metallic box, working at 1.8 GHz.

Finally, in order to establish a complete and accurate list of all the M.W.P. antenna's properties (to be able to compare it to the other more usual sources), we assessed the influence of the excitation on the quantities already quoted above. An homogeneous sphere was also placed near different sources: a plane wave, an Hertzian dipole, a finite-length dipole, a monopole on a metallic box and the M.W.P. antenna on the same box.

CONCLUSION: It seems serious to think, the whole accurate head modelization isn't so essential to perfect an new antenna design. For more precise SAR values, a zoom around the inner ear is perhaps sufficient to evaluate the absorption of energy in the head of a phoning man. About the M.W.P. antenna, we keep on trying to adapt it, to find its optimal position in order to minimize the peak SAR values without degrading its electrical characteristics.

the differentiation state dependence of the field induced PKA induction in HSF and rat osteoblastic cells.

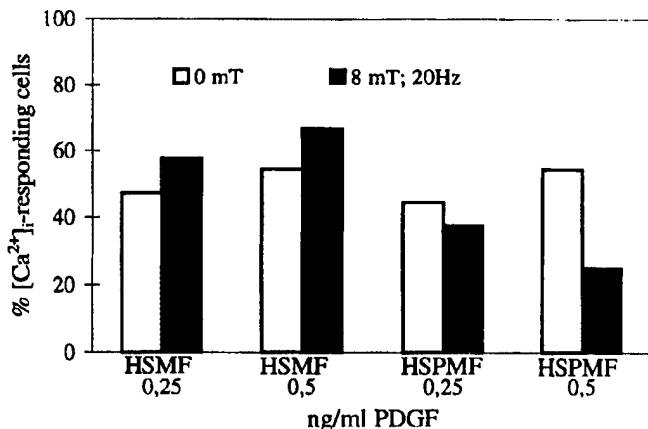

Fig. 2: Reverse field effects in HSMF and HSPMF

DISCUSSION: Our data provide evidence that the ELF-EMF effect is predominantly determined by the individual cell state. And furthermore this may be an explanation for the variation in experimental studies dealing with $[Ca^{2+}]_i$ -measurements and field exposure of heterogenous cell populations.

Supported by the Deutsche Forschungsgemeinschaft (Ha 2358/1).

G-2

WEAK INDICATION FOR 50 Hz MF EFFECTS ON JURKAT T-LYMPHOCYTES REVEALED BY REFINED SINGLE CELL CALCIUM ANALYSIS. F. Gollnick, H. Bock and R. Meyer. Physiologisches Institut, Universität Bonn, D-53111 Bonn, Germany.

Since Lindström *et al.* demonstrated the initiation of calcium oscillations in quiescent human lymphocytes by 50 Hz magnetic fields in 1993 (*J. Cell. Physiol.* 156, 395-398; 100 μ T application, more recently 200 μ T application), some working groups failed to reproduce their results adequately. With regard to our earlier investigations, a new refined approach was made to analyze the problem in more detail. Jurkat cells show spontaneous calcium oscillations that depend strongly on the passage number of the cell culture. Cells in the present investigation were taken from low passage numbers (nos. 14 to 18) where they develop many spontaneous oscillations and are particularly reactive upon stimulation. Possible MF effects on the free intracellular calcium concentration, $[Ca^{2+}]_i$, could be changes of the basal concentration, the amplitude and/or frequency of already existing calcium oscillations, or could be an induction of calcium transients in quiescent cells. But all these changes may also happen spontaneously. The aim of this work was to separate spontaneous changes from those caused by one of the applied stimuli.

METHODS: The $[Ca^{2+}]_i$ of human T-lymphocytes (T-cell line Jurkat, clone E6-1, cultured in RPMI medium) was analyzed by use of the fura-2 calcium imaging technique.

Cells were not preselected and not tacked with poly-L-lysine to the bottom of the cell chamber. The $[Ca^{2+}]_i$ in up to 120 cells/experiment was measured simultaneously in Krebs-Ringer solution at 37°C (fura-2/AM incubation: 4 μ M, 30 min at 37°C) with a time resolution of 10 s. The MF was applied by two coils in Helmholtz arrangement. Sham exposures were carried out in the same arrangement.

In principle, each experiment consisted of three intervals of 500 s duration, a sham exposure at the beginning, a test interval in the middle, and a positive control interval (application of anti-CD3 antibody) at the end. The experimental parameters in the second and third interval were varied to give five different types of experiments. During the test interval a sham exposure, a 50 Hz MF exposure (100 or 200 μ T), or a 50 Hz 100 μ T MF + 4-fold external calcium concentration, $[Ca^{2+}]_o$, exposure was carried out. During the third interval the antibody (0.1 mg/ml; intermediate effective concentration) was applied either alone or in combination with a 50 Hz MF (100 or 200 μ T) or a 50 Hz 100 μ T MF + 4-fold $[Ca^{2+}]_o$ to test for additive effects. The standardized ratios of about 600 single cell measurements were averaged for each type of experiment. For more detailed analysis the cells were separated into different groups, anti-CD3-positive and anti-CD3-negative cells, initially quiescent cells and oscillating cells. The experiments were statistically evaluated after counting and rating the amount of calcium oscillations in each interval for each cell separately. A total of more than 3000 single cell registrations was evaluated.

RESULTS: Averaged ratios of the $[Ca^{2+}]_i$ summarize all possible changes. The reliability of this method of evaluation was demonstrated by a dose/effect relationship for the used anti-CD3 antibody. Moreover, an intermediate effective antibody concentration was determined by this procedure. Nearly 90% of the cells responded to the antibody. Elevation of the $[Ca^{2+}]_o$ clearly increased the averaged ratio, whereas the MF neither alone nor in addition to the antibody caused any (or only very small non-significant) changes. Less than 20% of the anti-CD3-positive cells were quiescent during the first sham exposure interval. Only these could respond to the MF by starting calcium oscillations. The number of cells that began to oscillate during field application was in its tendency larger vs. the control. However, this difference was weakly significant only in case of the application of a 50 Hz 200 μ T field.

DISCUSSION: If the influence of the field on the whole anti-CD3-positive cell population is regarded, a significant field effect cannot be detected. If the subpopulation of quiescent cells is evaluated, an influence of the field can be shown which is very small compared to the results of Lindström *et al.*

STATIC μ T-LEVEL MAGNETIC FIELDS MODULATE MYOSIN PHOSPHORYLATION VIA KINETIC EFFECTS ON CALCIUM BINDING TO CALMODULIN.

M.S. Markov and A.A. Pilla. Bioelectrochemistry Laboratory, Department of Orthopaedics, Mount Sinai School of Medicine, New York, New York 10029, USA.

INTRODUCTION: Calcium ion binding is emerging as essential in the transduction of exogenous physical signals into physiological responses through modulation of relevant biochemical cascades. Cell-free Ca^{2+} /calmodulin (CaM) dependent myosin phosphorylation is studied here to assess weak static magnetic field effects on a physiologically important biochemical process. It is now well accepted that myosin phosphorylation occurs as follows: Ca^{2+} binds to CaM, causing a conformational change in CaM; the Ca^{2+} /CaM complex then interacts with the inactive catalytic subunit of MLCK to form a catalytically active holoenzyme complex; the kinase proceeds to phosphorylate MLC. This study examines the effect of static magnetic fields at 44 μ T (ambient) and 200 μ T over a Ca^{2+} concentration range sufficient to perform an enzyme kinetic analysis on CaM.

METHODS: The cell-free reaction mixture was chosen for phosphorylation rate to be linear in time for several minutes, and to be rate limited by Ca^{2+} . The experiments were performed by using MLC and MLCK isolated from turkey gizzard (kindly supplied and assayed by H. Ikebe). The reaction mixture consisted of 40 mM Hepes buffer, pH 7.0; 0.5 mM magnesium acetate; 1 mg/ml bovine serum albumin; 0.1% (w/v) Tween 80; 1 mM EGTA; 70 nM CaM; 160 nM MLC and 2 nM MLCK. Free Ca^{2+} was varied in the 1-7 μ M range. The low MLC/MLCK ratio was chosen to obtain linear time behavior in the minute range. The reaction mixture was aliquoted in 100 μ L portions into 1.5 ml Eppendorf tubes, placed in a specially designed water bath maintained at $37 \pm 0.1^\circ\text{C}$. The reaction was initiated with 2.5 μ M ^{32}P ATP, and was stopped with Laemmli Sample Buffer solution containing 30 μ M EDTA. Phosphorylation was allowed to proceed for 5 min and was evaluated by counting ^{32}P incorporated into myosin light chains. The magnetic exposure system consisted of two orthogonal pairs of 60 turn, 20 cm square Helmholtz coils. The vertical, and remaining horizontal, components of the static magnetic field at the sample site were adjusted using one precision current source for each direction. All static B fields were measured to $\pm 0.1 \mu\text{T}$. Stray ambient AC fields were $< 0.1 \mu\text{T}$. Overall ambient static magnetic field fluctuations at the exposure site were $37 \pm 1 \mu\text{T}$ vertical and $24 \pm 1 \mu\text{T}$ horizontal, giving a magnitude of $44 \pm 1.4 \mu\text{T}$, 57 from horizontal. All exposures and experiments were repeated at least five times for each experiment. A Student's paired t-test was performed for each time and exposure condition with significance accepted at $P \leq 0.05$.

RESULTS AND DISCUSSION: The results showed phosphorylation increased at 200 μ T (vs. 44 μ T) for Ca^{2+} concentrations below saturation with the magnetic field effect disappearing as Ca^{2+} approaches saturation for CaM. Effects

between 1 and 5 μ M Ca^{2+} were analyzable using a Lineweaver-Burk plot, allowing comparison of K_D (number of binding sites) and V_{MAX} (kinetics) for 44 and 200 μ T. The results showed K_D varied by $0.23 \times (\pm 0.05, P = \text{NS})$, and V_{MAX} by $1.52 \times (\pm 0.17, P < 0.001)$. This suggests calcium binding kinetics, and not affinity, to CaM are modulated by weak static magnetic fields. The effects observed are consistent with a kinetic model which assumes one rate-determining (EMF-sensitive) step for Ca^{2+} binding. This model assumes Ca^{2+} competes with bound water in the binding site as it alternately resides in the outer Helmholtz layer at the electrified interface and in the binding site (inner Helmholtz layer). The normal variations in dielectric constant in the bound water layer due to its librational degrees of freedom can be modulated by μ T magnetic fields in the presence of thermal noise via Larmor precession, affecting binding kinetics. This, coupled with a dynamical systems model describing the trajectory of the calcium ion between the inner and outer Helmholtz layers, enables the ratio of time free to bound (binding kinetics) to be evaluated as a function of static field amplitude. This model has successfully predicted the effect of variations in static field amplitude on myosin phosphorylation. It is important to note that the effects reported here are only apparent if the reaction is studied far from steady state and free Ca^{2+} concentration levels are well below saturation for CaM. These conditions could well correspond to the requirement that a cell be in a particular stage of its cycle or a tissue system be in a growth or repair phase (e.g., bone fracture or wound repair) for an EMF bioeffect to be observed. It is suggested that this simple cell-free model can be employed to test specific EMF or mechanical signal configurations for the creation and development of therapeutic modalities for tissue growth and repair.

This work was supported in part by the Horace W. Goldsmith Foundation and Electropharmacology, Inc., Pompano Beach, FL, USA.

MITOCHONDRIA ENZYME ACTIVITY IN HBV155 CELLS FOLLOWING 10 MIN. EXPOSURE TO COMBINED MAGNETIC FIELD DEPENDS ON AC MAGNETIC INTENSITY. R.J. Fitzsimmons¹, S.D. Smith² and A.R. Liboff³. ¹J.L. Pettis Memorial Veterans Administration Medical Center, Loma Linda, California 92357, USA. ²Department of Neurobiology, University of Kentucky, Lexington, Kentucky 40536, USA. ³Department of Physics, Oakland University, Rochester, Michigan 48309, USA.

INTRODUCTION: One of us (R.J.F) previously reported that a combined magnetic field (CMF) with parallel DC and AC components, respectively, of 20 μ T and 20 μ Tp oscillating at 15.3 Hz increased (^3H -TdR) incorporation in normal human bone cells. The same ICR exposure was also found to enhance IGF-II receptor density and Ca^{2+} concentration. The present work adds to these observations, by: (a) using a different assay of cell proliferation, (b) examining non-(Ca^{2+})

resonant CMF effects, and (c) concentrating on the functional response to the AC magnetic intensity.

METHODS: Vertebral cells from a normal human male (HBV155) were placed in 24-well tissue culture plates in DMEM + 0.1% BSA. After 24 hrs the cells were exposed to the CMF for ten minutes. The cultures were grown for an additional 24 hrs and then assessed for cell proliferation by ^3H -thymidine incorporation or for cell number by the MTS method. The latter is a colorimetric assay of a mitochondrial enzyme that bears a linear relationship to cell number. The specific CMF that was used was obtained by first measuring the vertical geomagnetic component (35 μT) and then, without applying any other DC field, varying the applied AC frequency to achieve a maximum response (18 Hz), as shown in Fig. 1. The AC intensity at this frequency was then varied from 0 to 60 μT . Data are reported as triplicate means, each relative to one triplicate control.

RESULTS: Relative cell number, averaged over four runs (35 total data points, each in triplicate) is plotted in Fig. 2 as a function of AC intensity. It is clear that varying the AC intensity component of the CMF has a profound effect on cell count. The shape of the curve is particularly interesting. Two separate effects appear to be occurring, the first an overall increase with increasing intensity, and the second, a sharp perturbation in cellular activity below 5 μT .

DISCUSSION: Even though the (18 Hz, 35 μT) CMF used in this work is not an appropriate Ca^{2+} resonance combination, we cannot rule out other possibilities, e.g., an interaction with partially shielded or hydrated Ca^{2+} ions that might decrease net charge or increase effective mass. Another possible interactive ion is glutamic acid, with its 5th ICR harmonic in a 35 μT field occurring at 18.2 Hz. None of the simple ions (e.g., Mg^{2+} , K^+ , Cl^-) have charge-to-mass ratios that correspond to this (18 Hz, 35 μT) combination. Whatever the mechanism, it must be noted that our data, especially that observed below 5 μT , are in conflict with the theoretical constraints of Weaver/Astumian/Adair.

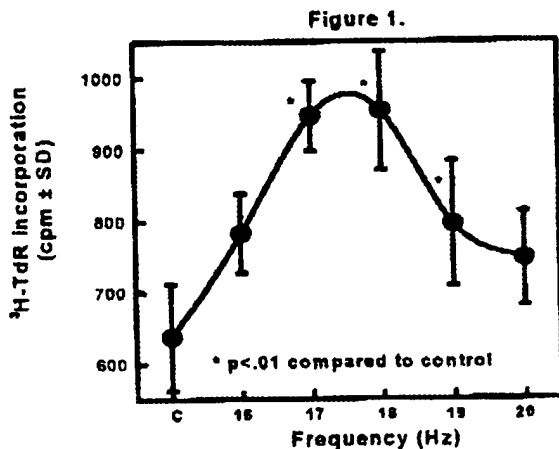

Figure 1. Frequency response HBV155 cells were exposed for 10 minutes to an EMF at an amplitude of 20 μT . The AC field was in the vertical direction. The DC vertical component was 35 μT . Control (C) was placed within the coils but without any power applied to the coils. The AC background field was 60 Hz with an amplitude of 0.04 μT . The results are from one experiment with an $n = 6$.

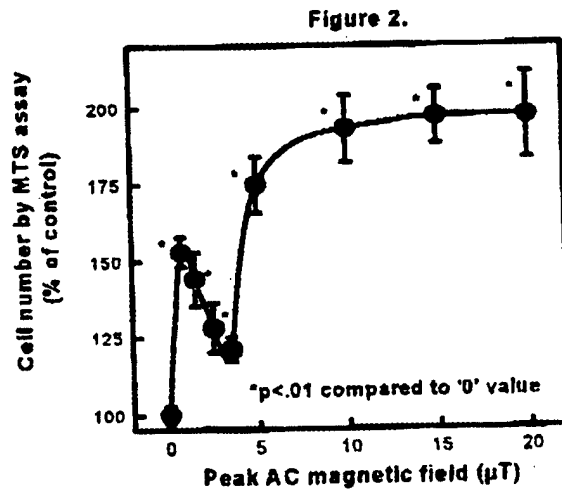

Figure 2. Effect of varying AC amplitude. HBV155 cells were exposed for 10 minutes to an EMF at 18 Hz with an amplitude as indicated. The AC field was in the vertical direction. The DC vertical component was 35 μT . The AC background was 60 Hz with an amplitude of 0.04 μT . After 24 hours cell number was assessed by the MTS method. The results are the mean of 4 independent experiments \pm SEM.

G-5

ACTIVATING THE Na/K PUMPING RATE BY WEAK OSCILLATING ELECTRICAL FIELDS. W. Chen and Y. Han. Department of Plastic and Reconstructive Surgery, The University of Chicago, Chicago, Illinois 60637, USA.

It has been decades to investigate using an external electrical field to enhance performance of the voltage-dependent membrane proteins. People dreams one day electrical energy can be directly transformed into organic energy. Electrogenic-pump molecules in cell membrane are essential voltage-dependent proteins for active transport systems moving ions across cell membrane against electrochemical gradients. Large amount of ATP molecules consumed in human body is used by the electrogenic-pumps to maintain the electrochemical potential difference across the cell membranes. It has been postulated coupling an external oscillating electrical field with the electrogenic-pump molecules in cell membranes (5, 6).

However, no direct evidence of the field-induced activation of the electrogenic pumps has been reported by simultaneously measuring the pump currents during exposing to an oscillating electrical field. Studies intended to investigate oscillating electrical field-enhanced performance in electrogenic pump molecules have been inconclusive.

We now report the results of our recent studies in oscillating electric field-induced activation of the Na/K pumps in cell membrane of skeletal muscle fibers. All experiments were performed using an improved double-Vaseline-gap whole-cell patch clamp technique after maximally blocking the Na , K and Ca channels in cell membrane. Both the steady-state and transient (up to 700 μs) currents were recorded and shows marked nonlinear voltage-dependence similar to the features of rectifier. When the cell membrane is held at its resting

potential of -90 mV, depolarizing the membrane potential can significantly increase the pump rate; while hyperpolarizing the membrane potential leads only a little decrease. The I-V curve of the Na/K pump molecules implies that when the potential bias of cell membrane is held at the membrane resting potential of -90 mV, input of an alternating current (A.C.) electrical field can generate a net outward direct current (D.C.). This asymmetric voltage-dependence of the steady-state currents implies that an oscillating electrical field can activate the Na/K pumps.

The question then rises that whether optimum frequencies exist where an oscillating electrical field will activate the Na/K pumps more effectively than other frequencies. The Na/K pump currents were directly monitored when the fibers were exposed to an oscillating electrical field with different frequencies. We applied a continuously oscillating waveform with different frequencies to the cell membrane and recorded the responding transmembrane currents. The same waveforms were reapplied to the cell membrane with 1 mM ouabain in the external solution. We then integrated the transmembrane currents over multiple full cycles to obtain the oscillating field-induced transmembrane ion flux. Subtracting the ion flux obtained by integrating the transmembrane currents in the presence of ouabain from the flux in the absence of ouabain yields the net ion flux carried by the Na/K pumps. The net amounts of ion flux carried by the Na/K pump currents responding to each frequency field were plotted as a function of the field frequency.

The results show an existence of frequency windows, such as around 1 kHz, where the oscillating membrane potential-induced net ion flux is larger than those outside the windows. When the bathing solution was changed to with 1 mM ouabain, this oscillating field-induced net ion flux was eliminated. These results clearly show that an external oscillating electrical field with optimum frequency can activate pumping rate of the Na/K molecular pumps. The frequency windows can be explained by analogy to the sum of the Lorentzian form, a Laplace transform of the time-domain solution to the enzymatic kinetic equations.

G-6

COMBINED MAGNETIC FIELDS AFFECT THE NF- κ B TRANSCRIPTION FACTOR PATHWAY IN OSTEOBLAST-LIKE CELLS. J.T. Ryaby¹, F.F. Cai¹, T.L. Howard² and J.A. DiDonato². ¹OrthoLogic Corporation, Phoenix, Arizona 85034, USA. ²Department of Pharmacology, University of California San Diego, La Jolla, California 92093-0636, USA.

INTRODUCTION: Musculoskeletal tissue is uniquely sensitive to biophysical input as demonstrated by the ability of both mechanical and electrical stimuli to increase bone formation. We have previously reported that exposure to combined magnetic fields (CMF) can partially reverse the loss of bone mass due to ovariectomy. Since the cytokines, IL-1 α , TNF- α , and IL-6 are involved in osteoblastic regulation of osteoclastic differentiation, these studies were designed to test whether CMF would affect IL-1 α and TNF-

α -dependent signaling pathways in osteoblastic cells. These studies specifically addressed the effect of CMF on the NF κ B and STAT transcription factor pathway.

METHODS: The mouse osteoblast line MC3T3-E1 was maintained by weekly passage in α -MEM/10% calf-serum. CMF were generated by a circular (30 cm diameter) double-wound Helmholtz coil pair with a toggle switch providing for true sham or active exposure conditions. Multiwell plates were oriented horizontally (i.e. coplanar to the coil pair) and exposed to CMF (Wavetek 395, 0.4, 1.0, 4.0 G sinusoidal p-p AC, 0.2 gauss DC, 15.3 Hz). In some experiments, MC3T3-E1 osteoblasts were transiently transfected with a 2X NF κ B-luciferase plasmid construct (J16) in a p20Luc plasmid vector and luc activity expressed as light units/culture. Electrophoretic mobility shift assays were performed on nuclear extracts using ³²P-labeled dsNF κ B or STAT3/5 oligonucleotide and exposed to Kodak Biomax-MR ARG film. For positive controls, supershift analysis was performed with MABs to the p50/p65 of NF κ B and STAT3/5. The mean and standard deviations were evaluated for each sample group; and compared using ANOVA and t-test (Bonferroni). Significance was accepted at P<0.05.

RESULTS: CMF exposure for 30 minutes demonstrated no direct effect on NF κ B activity in transiently transfected MC3T3-E1 osteoblasts. However, treatment of cultures with IL-1 α induced luciferase activity 3.0 fold over sham exposed cultures. Of interest, combined treatment with CMF and IL-1 α showed an amplitude dependent decrease of cytokine stimulation at submaximal doses of cytokine (1pM). Similar results were observed with TNF- α as the inducer of NF- κ B activity. Gel shift analysis showed that exposure to CMF for 30 minutes did not induce NF κ B directly, however, pre-exposure to CMF for 30 min. demonstrated an inhibition of both IL-1 α or TNF- α -induced NF κ B activity at low concentrations of cytokine (0.1pM and 0.1ng/ml, respectively). No CMF effects have been observed on STAT3 or 5 binding activity as determined by gelshift analysis.

DISCUSSION: These results demonstrate that short term exposure to CMF can affect cytokine induction of NF κ B activity in transfected MC3T3-E1 osteoblast cultures. This inhibition of NF κ B is dependent on both the amplitude of the magnetic field as well as on the concentration of the inducing cytokine. In summary, these results suggest that one mechanism by which CMF may prevent bone loss is by inhibition of cytokine signaling activity *in vivo*.

This work was supported by the NIH and OrthoLogic.

G-7

CHANGES OF INTERCELLULAR COMMUNICATION INDUCED BY ALTERNATING ELECTRIC FIELDS CORRELATE WITH CHANGES OF cAMP. K.F. Weibezahn, G. Knedlitschek, W. Sontag, J.-C. Stein, E. Gottwald and H. Dertinger. Research Center Karlsruhe, Institute of Toxicology, D-76021 Karlsruhe, Germany.

Monolayers of a mouse fibroblastic cell line (SV40-3T3) and suspension cultures of a human lymphoblastoid cell line

(HL60) were treated for 5 minutes with amplitude-modulated electric fields of approx. 4 kHz (so-called interferential fields, generated by superposition of 2 fields with frequencies of 4 kHz and (4 kHz + δ); the values for δ used were 50 Hz and 100 Hz respectively). Exposure of culture dishes was carried out in air using a capacitor arrangement. After treatment or sham exposure intercellular communication was investigated by measurement of electrical coupling between cells using microelectrode techniques (SV40-3T3). Similarly treated cells were used to determine the content of intercellular cAMP (SV40-3T3 and HL60) by radioimmunoassay.

Using interferential fields we observed a strong influence of the modulation frequency. Significant changes in intercellular communication (SV40-3T3) as well as in content of intercellular cAMP (SV40-3T3 and HL60) were induced by the frequencies used. Whereas 50 Hz modulation decreased the intercellular communication by about 35%, 100 Hz modulation caused an increase of approx. 45% when measured directly after treatment. The relative amount of cAMP content for the two modulation frequencies and both cell types were as follows:

	50 Hz modulation	100 Hz modulation
SV40-3T3	-25%	+8%
HL60	-14%	+30%

A correlation between the change in the cyclic AMP content and the intercellular communication via gap junctions is well established [1]. The variations of both parameters with time after treatment were examined. The changes in cAMP are obviously followed by changes in cell coupling.

Interferential currents influence cAMP content as well as intercellular communication. The cell types investigated seem to react to the fields depending on the frequency used with respect to detectable changes in cAMP content and to changes in intercellular communication. The control of gap junctional communication is believed to play an important role in development and differentiation of cells but also in tumour promotion and progression. Changes in intercellular communication as described here, indicate an influence of electric fields upon these processes, whereby frequency and periodic changes in intensity (modulation) appear to be important modifying factors.

[1] M.V.L. Bennett, L.C. Barrio, T.A. Bargiello, D.C. Spray, E. Hertzberg and J.C. Saez, Gap Junctions: New tools, new answers new questions, *Neuron*, 6, 305-320, 1991.

MOLECULAR TRANSPORT ACROSS STRATUM CORNEUM DUE TO ELECTRIC PULSES: BEHAVIOR OF LOCALIZED TRANSPORT REGIONS (LTRs). U.F. Pliquett^{1,2}, R. Vanbever^{1,3}, G.T. Martin¹, V. Preat³ and J.C. Weaver¹. ¹Harvard-MIT Division of Health Sciences and Technology, Massachusetts Institute of Technology, Cambridge, Massachusetts 02139, USA. ²Fakultät für Chemie, Universität Bielefeld, D-33615 Bielefeld, Germany. ³Universite Catholique de Louvain, Unite de Pharmacie Galenique, 1200 Brussels, Belgium.

BACKGROUND: The main barrier addressed by transdermal drug delivery is the skin's stratum corneum (SC), an approximately 20 μm thick dead layer. Previous studies show that "high voltage" (HV; resulting transdermal voltages of $U_{\text{skin}} \approx 20$ to 150 V) rapidly increase molecular transport of such molecules by several orders of magnitude.¹⁻³ Because this enhanced molecular transport is concentrated within localized transport regions (LTRs)⁴, the behavior of LTRs have become the topic of basic and applied investigations.

METHODS: Conventional human skin preparations consisting of (1) full thickness (about 2 mm) skin, (2) heatstripped skin (20 μm SC + 30 μm epidermis), or (3) trypsinated stratum corneum (20 μm) were clamped in a side-by-side permeation chamber.¹ The donor chamber contained 1 mM fluorophore in 150 mM PBS at $25 \pm 2^\circ\text{C}$, and faced the SC. The receptor chamber contained only PBS, and was sampled by a flowing stream. In one apparatus, a miniaturized special receptor chamber allowed real time imaging by fluorescence microscopy.⁴ In this case ring shaped electrodes were used to apply pulses, and images were recorded electronically. After pulsing the skin preparation was removed, "washed" for several hours in fresh saline, and re-examined by fluorescence microscopy, which revealed ring-shaped fluorescent regions.

RESULTS AND DISCUSSION: LTRs were observed for all of the skin preparations, showing that skin thickness is unimportant. LTR sizes range from about 50 μm in diameter up to about 1 mm diameter, depending on the pulse duration (exponential pulses used with time constants ranging from $\tau_{\text{pulse}} = 1$ ms to 400 ms. The LTR surface density ranged from 2 to 80 LTRs cm^{-2} , with the density depending mainly on the maximum pulse voltage across the stratum corneum ($U_{0,\text{sc}} \approx U_{0,\text{skin}}$; 40 to 100 V). Microscopy revealed that during long pulses the LTR begins at what is eventually its center, and emerges over the duration of the pulse. After several hours of washing the interior of the LTR becomes dark, leaving a bright fluorescent ring. By mapping the electrical resistance of the skin after pulsing there was a clear coincidence between LTRs and regions of low resistance which had not recovered. A candidate explanation is that a primary electroporation process produces aqueous pathways, followed by secondary processes that include localized ohmic heating, as this could create persistent changes of regions involved in transport of ions and molecules. The fraction of the skin involved in LTRs is less than 10%. Thus, the current density during pulsing is high ($>1\text{A cm}^{-2}$), and consideration of local heating, and its biological consequences, is important.

1. Prausnitz, M. R., V. G. Bose, R. Langer, and J. C. Weaver, "Electroporation of Mammalian Skin: A Mechanism to Enhance Transdermal Drug Delivery," *PNAS*, vol. 90, pp. 10504 - 10508, 1993.
 2. Vanbever, R., N. Lecouturier, and V. Preat, "Transdermal Delivery of Metoprolol by Electroporation," *Pharm. Res.*, vol. 1662 - 1665, 1994.
 3. Pliquett, U. and J. C. Weaver, "Electroporation of Human Skin: Simultaneous Measurement of Changes in the Transport of Two Fluorescent Molecules and in the Passive Electrical Properties," *Bioelectrochem. Bioenerget.*, vol. 39, 130. 1 - 12, 1996.
 4. Pliquett, U. F., T. E. Zewert, T. Chen, R. Langer, and J.C. Weaver, "Imaging of Fluorescent Molecule and Small Ion Transport Through Human Stratum Corneum During High-Voltage Pulsing: Localized Transport Regions are Involved," *J. Biophys. Chem.*, vol. 58, pp. 185 - 204, 1996.
- Supported by NIH grant RO1-ARH4921, and Whitaker Foundation grant RR10963.

G-9

EVIDENCE THAT THE MODULATORY EFFECTS OF LIGHT ON EXTREMELY LOW FREQUENCY MAGNETIC FIELDS OCCUR AT THE MAGNETIC FIELD DETECTION STAGE. F.S. Prato, M. Kavaliers, A.W. Thomas and K.P. Ossenkopp. Bioelectromagnetics Western, Faculty of Dentistry, Department of Psychology and Neuroscience Programme University of Western Ontario and Lawson Research Institute, Department of Nuclear Medicine & Magnetic Resonance, St. Joseph's Health Centre, London, Ontario N6A 4L6, Canada.

The attenuation of opioid-induced analgesia by exposure to extremely low frequency (ELF) magnetic fields is one of the best established magnetic field effects. This effect has been demonstrated in snails, rodents, birds and humans by a number of independent laboratories. Recently, we and others have shown that the extent of this attenuation is dependent on the presence of light. When the exposure is carried out in the absence of light, the inhibitory effect of the magnetic field has been reported to be either reduced [1,2] or abolished [3]. We have proposed that this modulating effect of light occurs at the primary magnetic field detection mechanism [1]. However, it could be argued that light just acts as a "post-detection amplifier", i.e. light could affect the responses of opioid systems to a fixed stimulus produced by the magnetic field exposure. The present experiments with the land snail, *Cepaea nemoralis*, were designed to resolve these possible modes of action. We compared the effects of the presence and absence of light on the attenuation of opioid-induced analgesia by: 1) an ELF magnetic field and 2) the prototypic opiate antagonist, naloxone. Experiments were performed during both the day (relatively high ambient illumination) and night (relatively low ambient illumination) using four different "lighting" conditions: day-light (DL), day-dark (DD), night-light (NL), and night-dark (ND). During the day, exposures were carried out at 1.9W/m^2 (light) or $< 10^{-6}\text{W/m}^2$ (dark) with measurements of nociceptive sensitivity

and opioid-induced analgesia carried out in both cases under light (1.9W/m^2) conditions. During the night period, all "light" exposures and nociceptive measures were carried out under a red incandescent light (1.0mW/m^2) while dark exposures were identical to those used in the day time.

Groups of 10 animals were first tested for the length of time they would remain on a 40°C surface before displaying an aversive foot-raising response. This latency time (nociceptive sensitivity) was measured a second time 15min after the injection of an enkephalinase inhibitor (SCH34826; $2\ \mu\text{g}$ in $2\ \mu\text{l}$ saline vehicle), which augments endogenous opioid activity, and either sham (60Hz peak $< 0.4\ \mu\text{T}$) or magnetic field exposure (60Hz, $144\ \mu\text{T}$ peak, horizontal). In both cases, the DC field was $28.3\ \mu\text{T}$ vertical and $16.8\ \mu\text{T}$ horizontal with $15.2\ \mu\text{T}$ parallel to the 60Hz field. Other groups of snails were tested before and 15min after SCH injection with either naloxone ($1\ \mu\text{g}$) or saline vehicle ($1\ \mu\text{l}$). The inhibitory effect of the magnetic field on opioid-induced analgesia (expressed as % reduction of augmented response latency) was significantly greater for the day-light ($50 \pm 3\%$; mean \pm SEM) than the day-dark ($23 \pm 4\%$) exposure condition. Similarly, at night, the magnetic fields elicited a greater attenuation of opioid-induced analgesia in the presence of light (light; $43 \pm 4\%$) than in the absence of light (dark; $28 \pm 3\%$). The percent reduction of opioid-induced analgesia elicited by naloxone, however, was independent of the lighting conditions (DL, $52 \pm 4\%$; DD, $53 \pm 3\%$; NL, $52 \pm 6\%$; ND, $51 \pm 3\%$) and similar to that recorded after day-light (DL) 60Hz exposure.

This work extends prior findings, demonstrating that both the inhibitory effects of ELF magnetic fields and their light dependency are similar during the day and night. These results further show that the functioning of endogenous opioid systems, as exemplified by their sensitivity to naloxone antagonism, is unaffected by the presence or absence of light. This suggests that the modulatory effects of light on the actions of the ELF magnetic fields occur at the detection mechanism rather than through any modifications in opioid function.

1. Prato FS, *et al. Proc R Soc Lond B* 1996, v263, p1437-1442
2. Prato FS, *et al.* accepted for publication in *Bioelectromagnetics* 1996
3. Betancur C, *et al. Neurosci Lett* 1994 182: 147-150.

G-10

ULTRASTRUCTURAL DISTRIBUTION OF CALCIUM AFTER ELF MODULATED MICROWAVE AND GSM MODULATED RF IRRADIATION IN THE TEMPORAL CORTEX OF RAT BRAIN. Z. Somosy¹, A. Kittel² and G. Thuróczy¹. ¹"Frédéric Joliot-Curie" National Institute for Radiobiology and Radiohygiene, H-1775 Budapest, Hungary. ²Institute of Experimental Medicine, Hungarian Academy of Sciences, H-1450 Budapest, Hungary.

The disturbance of calcium homeostasis in different tissues, including brain, is a known biological consequence of electromagnetic field (EMF) exposition (Goodman *et al*,

1995)¹. As we reported earlier^{2,3}, ELF modulated microwave irradiation (2.45 GHz, 16 Hz modulation frequency, 1 mW/cm² power density) induced changes of calcium localization in mouse small intestine and in central nervous system (habenule), which phenomenon exist during 24 hour. The increasing popularity of mobile telecommunication promoted us to study the calcium content of GSM modulated RF field exposed central nervous system. In the present study we have attempted to identify particular ultrastructural counterparts of pyroantimonate precipitable calcium of temporal cortex's neurons in rat brain after ELF modulated microwave and GSM modulated RF. The localization of calcium was investigated electron microscopically in the temporal cortex of rats upon ELF modulated microwave (16-Hz 2.45 GHz) and GSM modulated RF (900 MHz, 271 Hz, 1/8 duty-cycle) irradiation.

Rats were whole-body irradiated by ELF modulated microwave (16 Hz) for 2 hr at 1 mW/cm² power density and head of rats by GSM modulated RF (900 MHz, 271 Hz, 1/8 duty-cycle) field. The mode of exposures was based upon international standards. The specificity of histochemical reaction was checked by electron spectroscopic imaging technique.

In the control tissue, calcium-containing pyroantimonate precipitates were regularly localized in mitochondria and between the lamellae of myelin sheets of axons. Synaptic vesicles often contained fine reaction products, which frequently attached to the vesicular membrane. Modulated microwave irradiation caused marked changes of calcium localization immediately after exposition and it remained for 24 hours; reaction products were seen abundantly in the synaptic cleft and elsewhere extracellularly. The GSM modulated RF exposition caused similar, but moderated effects to calcium distribution in temporal cortex of rat brain after immediately and 1 hour, however after 24 hour the localization of calcium was the same as in control samples. We conclude that both low-frequency modulated microwave and GSM modulated RF exposition caused changes in cellular localization of calcium in temporal cortex of rat brain. However, the GSM modulated RF was less effective to calcium distribution than ELF modulated microwave.

1. M. Goodman, B. Greenebaum and M.T. Marron, Effects of electromagnetic fields on molecules and cells. *Int. Rev. Cytol.* 158 279-338.(1995)

2. Z. Somosy, G. Thuróczy and J. Kovács, Effects of modulated and continuous microwave irradiation on pyroantimonate precipitable calcium content in junctional complex of mouse small intestine. *Scanning. Microsc.* 7 1255-1261.(1993)

3. Á. Kittel, L. Siklós, G. Thuróczy and Z. Somosy, Qualitative enzyme histochemistry and microanalysis reveals changes in ultrastructural distribution of calcium and calcium-activated ATPases after microwave irradiation of the medial habenula. *Acta Neuropathol.* 92 362-368.(1996).

G-11

HUMAN ENDOGENOUS ELECTROMAGNETIC FIELD FLUCTUATION IN RELATION TO AN ORGANISM'S REACTION TO THE EMF OF BODY CONSTITUENT SUBSTANCES. G. Lednyiczky, J. Nieberl, O. Zhalko-Tytarenko, S. Topping and T. Buzási. Hippocampus Research Facilities, 1031 Budapest, Hungary.

Extremely-low-intensity (ELI) EMFs of body constituent substances (e.g., amino acids, enzymes, co-enzymes, proteins, lipids, minerals, trace elements, micro-organisms, nutrients, etc.) are used to trigger and catalyze adaptational processes by human volunteers. This procedure is called Functional Electrodynamical Testing (FEDT).

Adaptation, or any reaction, of a living system can be described as a phase change in the ongoing processes of homeostasis. FEDT is based on the existence of W.R. Adey's notion of 'biological windows', and on supposition that the mechanism of EM biocommunication is resonance interaction between different subsystems of an organism. It has been demonstrated repeatedly (by ourselves, M. W. Ho, F.A. Popp, and others) that bio-chemical processes are controlled by endogenous EM activity, and indirectly controlled by exogenous EM activity. Alterations in the phase of coherent excitational states in the body produce millivolt changes which are detectable on the surface of the skin and can be transformed into medically informative data by using FEDT.

We used an ECG-like system with 12 channels which measure the dynamics of active voltage in the form of vectors which are compared to the center point in the range of ± 3 mV with a resolution of 4096 times. The electrodes (surface is silver on the extremities and nickel on the forehead) are placed on the forehead, wrist, ankles, and the 3rd knuckle of the middle finger. The person is serially exposed to the EMFs of the above mentioned substances (most of which are homeopathically prepared) for 40ms, with a relaxation time of 80ms between substances. The measurement of the changes in voltage starts 1 ms after the exposure begins and continues for 80 ms with a sampling rate of 2 ms. In this way, the device measures 480 data points per substance.

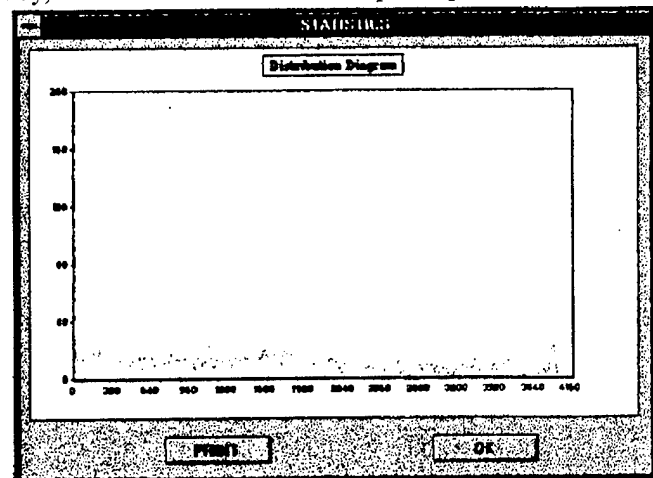

Pathological distribution diagram

The volunteers were observed for a period of 10 weeks and the data are compared with the test results of patients with

different illnesses (also under long-term observation). The distribution diagram of the reactions by healthy volunteers remains fairly constant unlike that of the distribution diagrams of the patients during their recovery period. The distribution diagrams which indicate illness tend to approach the average normal distribution diagram during this time.

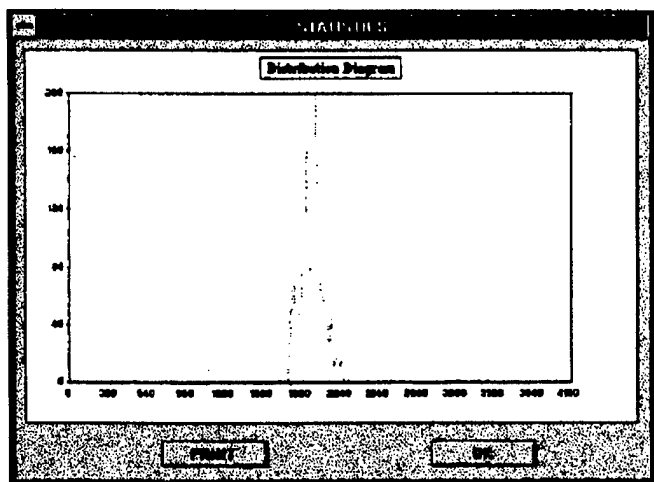

Physiological distribution diagram

G-12

THE Π -VECTOR FIELD AS A UNIVERSAL BIOLOGICAL DESCRIPTOR. A.R. Liboff. Department of Physics, Oakland University, Rochester, Michigan 48309, USA.

Following E. J. Lund's demonstration of a measurable electric surface potential in living things about 75 years ago, Yale Professor H. S. Burr suggested the existence of an electrostatic field (L-field) that is a function of human wellness and illness. R. O. Becker added to this notion, providing evidence that trauma is accompanied by alterations in the intrinsic bioelectric field, corresponding to what others call the "current of injury". Athenstaedt, and later, Jaffe and Nuccitelli gave further evidence for endogenous electric charge distributions, particularly as related to developmental processes. In the following, we seek to build on this earlier work, replacing electrostatic potentials with a more inclusive electromagnetic (EM) field description.

We utilize the Hertz polarization vector Π in our description, mainly because it avoids the need to separately characterize E and B . At any point in space Π is defined by its joint dependence on the vector and scalar potentials, A and ϕ , as per $A = \mu\epsilon\partial\Pi/\partial t$ and $\phi = -\nabla\cdot\Pi$. The corresponding vector field is obtained by specifying Π at all points in space.

EM fields, whether originating in non-biological or biological systems, are always the result of charge and current distributions (sources) within the system. Thus, any biological system containing sources will also produce an EM field described by $\Pi = \Pi(\rho, \mathbf{j})$, where ρ and \mathbf{j} are respectively the charge and current densities within the system. This field will vary in time as well as spatially, such that $\Pi(t) = \Pi\{\rho(t), \mathbf{j}(t)\}$. We state that sources are always present in living systems, arising from static and moving charge distributions

associated with the molecular components of the system, e.g., enzymes, proteins, nucleic acids, carbohydrates, and sugars. In short, there is no question concerning the existence of the Π -field, only its strength.

There are obvious difficulties in trying to reduce this abstract concept to specific details; particularly daunting would be the elaboration of innumerable charge and current sources. Nevertheless there are potential advantages in rethinking the long-held view that the visible characteristics represent the best (or final) scientific description of genome expression. A correct field representation, in principle, will contain the same loosely organized biological information found scattered within the body, presently described as biological characteristics. However, in addition, unlike the traditional biology based on such characteristics, an EM field descriptor holds out the further possibility of a more formal approach to the way in which biological expression is linked to DNA sequencing.

Technology

H. Instrumentation, Measurements and Standards

Chairs: Kjell Hansson Mild and William Kaune

H-1

EXPERIMENTAL CALIBRATION PROCEDURE AT 1.8 GHz OF ELECTRIC FIELD PROBES IN A SLOTTED WAVEGUIDE. F. Apollonio¹, L. Ardoino¹, M. Breccia¹, M. Guelfi² and G.A. Lovisolo². ¹Department of Electronic Engineering, La Sapienza University, 00184 Roma, Italy. ²Department of Environment, C.R. Casaccia, ENEA, 00060 Roma, Italy.

The world wide diffusion of hand held mobile devices has been focusing the attention of researchers on the energy coupling of the RF electromagnetic fields produced by this type of devices with biological living systems. This kind of interaction is well described by the physical quantity SAR (Specific Absorption Rate), it is therefore worthwhile to define a measurement procedure of SAR distribution in biological samples. Moreover the necessity to base an experimental measurement on a rigorous standard procedure is a matter of primary importance particularly when different laboratories and research groups are involved in the same problems.

In the case of SAR measurements electrically short probes are commonly used in order to measure the local radio frequency electric field induced in biological systems exposed to a mobile device. Hence in the global experimental procedure becomes important the problem of calibrating in a standard way the electric field probe.

OBJECTIVE: the goal of this work is to present a method for calibrating electric-field probes for use both in air and in tissue at the frequency of 1.8 GHz.

METHODS: A waveguide technique (Hill) has been used for the calibration of electric-field probes. A section of

waveguide is filled with tissue-equivalent liquid separated from the air-filled waveguide by a very thin planar dielectric spacer. The probe response is measured as a function of position on each side of the spacer and extrapolated on the interface. The ratio of probe response in air to that in test liquid is determined assuming continuity of tangential E-field across the spacer.

RESULTS AND DISCUSSION: Different laboratory-made probes have been tested for calibration with this waveguide method. With each calibration measure we are able to associate to the probe a well defined constant (calibration factor) referred to the medium we are considering: in this way for the fixed frequency of 1.8 GHz we can have several calibration factors for each equivalent-tissue is needed for SAR measurements.

An evaluation of the uncertainty of the calibration procedure is proposed together with the results.

M. Guelfi, F. Apollonio, N. Grazioli, S. Nocentini, G. Marrocco, and G.A. Lovisolo. "Dosimetric procedures for compliance tests of mobile communication devices". *Physica Medica*, in press.

F. Apollonio, M. Guelfi, G.A. Lovisolo. "An analytical approach toward the definition of a standard calibration procedure of electric field probes". *Proceedings of Workshop Cost 244*, Zagreb, 1996.

H-2

FDTD ANALYSIS OF SAR RESONANCES INSIDE HUMAN HEAD EXCITED BY CELLULAR PHONE ANTENNAS. G. Cerri, R. De Leo and F. Moglie. Dipartimento di Elettronica ed Automatica, University of Ancona, 60131 Ancona, Italy.

The evaluation of electromagnetic power deposition inside a human head radiated by a cellular phone is important to determine possible health implications due to thermal and non thermal effects. In this paper the effect of geometrical and dielectric parameters of the tissues on Specific Absorption Rate (SAR) distribution and on global power absorption is investigated by means of the Finite Difference in the Time Domain technique (FDTD).

The aim of the work is to verify resonance effects in power absorption on a function of frequency. In particular Weil [1] found a resonance for plane wave excitation in a stratified sphere and the authors found a similar behaviour for a stratified sphere excited by a short dipole near to it [2].

This resonance does not appear for a homogeneous sphere. This leads to consider a "quarter wave matching layer" formed by intermediate wave impedance tissues (i.e. skin, bone and fat) located between the air and the brain.

A multifrequency evaluation of SAR, in a realistic model obtained by the magnetic resonance, is therefore performed using the FDTD [3]. The dimensions of the different tissues are automatically recognized by the program that assigns the corresponding dielectric constant and the conductivity.

The results are useful in order to identify the effects of new frequencies used for cellular phones in conjunction with different typical anatomical dimensions of human heads.

[1] C. Weil, "Absorption characteristic of multilayered sphere

models exposed to UHF/ Microwave radiation," *IEEE Transaction on BME*, Vol. 22, No. 6, November 1975, pp. 468-476.

[2] R. De Leo, G. Cerri, GE Rosellini, "Power deposition into a layered model of human head radiated by linear antennas: an analytical model," *Proceedings of Third International Congress of EBEA*, Nancy, France, February 1996.

[3] G. Cerri, R. De Leo, F. Moglie, and A. Schiavoni, "Accurate evaluation of the interaction between linear antennas at microwave frequencies and human head," *3rd ESA European Workshop on Electromagnetic Compatibility and Computational Electromagnetics*, Pisa, Italy, October 1993, pp. 11-17.

H-3

CALCULATION OF THE POWER DEPOSITED IN TISSUES CLOSE TO AN HANDSET ANTENNA USING A NON UNIFORM FDTD. J. Wiart, S. Chaillou and S. Drago. France Telecom C.N.E.T., DMR/RMC, 92794 Issy Moulineaux, Cedex 9, France.

Recent years have seen an explosive growth in the area of wireless. According to the European Community (IBC meeting, London, Nov 1996), in 2010 more than 200 M users will use wireless. Questions have arisen about power absorbed by the head. When an antenna is close to the head, a large part of the emitted power is absorbed by the tissues. Standards have been established (ANSI/IEEE, CENELEC) for the absorbed power by the tissues, which must be below the limits. In the future, mobile phones will have to be in compliance with these standards.

To compute the local absorbed power, numerical techniques are necessary, and the Finite Difference in Time Domain (FDTD) method has been more and more used for this purpose. Previous studies have shown that power is mainly absorbed by tissues close to the antenna. To improve the knowledge of the power deposition in these tissues finer mesh is required. The decrease of the mesh size in a uniform FDTD code is impractical due to memory and CPU time limitations. To refine the mesh at the tissues close to the antenna with only a moderate increase of memory size, two avenues can be considered: sub-gridding and non uniform mesh. The second approach has been adopted in this work, with a Non Uniform FDTD code.

The non uniform model of the head has been generated from a fine uniform M.R.I model (voxels $1 \times 1 \times 1.5 \text{ mm}^3$) through a non uniform sampling. At regions close to the antenna, e.g., the inner ear, a fine mesh from the original M.R.I data is used, whereas on the other side of the head and close to the neck the mesh has been enlarged to about $3 \times 3 \times 3 \text{ mm}^3$. Two kinds of antenna have been modeled. The first one is a $\lambda/2$ dipole, and the second one is a handset comprising of a $\lambda/4$ monopole on top of a metal box surrounded by a plastic layer. The monopole has been meshed with small cells ($1 \times 1 \times 1 \text{ mm}^3$) near the excitation gap and larger cells ($1 \times 1 \times 3 \text{ mm}^3$) far away from this gap. In both case the antenna is located at a distance of 1.5 cm away from the head, few millimeters from the ear. The dipole and the handset are oriented to be lined

up with the ear and the mouth. The well known «PML» absorbing boundary conditions have been used. The numerical results show that when the dipole antenna is used the head absorbs 50% of the emitted power (EP), and the skin absorbs 14% of this EP. When the handset is used, the head absorbs 45% of the EP, the skin absorbs 14%. Next, we have considered the power deposition in a small volume including the inner ear. Numerical simulations show that for the case of a $5 \times 5 \times 5 \text{ cm}^3$ cube, about 60% of the power is absorbed in the cube. The skin of this area absorbs 70% of the power absorbed by all the skin.

H-4

DETERMINATION OF BRAIN SAR IN RATS EXPOSED TO MICROWAVES IN THE CHAMBERETTE IRRADIATOR. E.G. Moros¹, W.L. Straube¹ and W.F. Pickard². ¹Radiation Oncology Center and ²Department of Electrical Engineering, Washington University, St. Louis, Missouri 63108, USA.

The development and performance of a chamberette irradiator, a shielded small-volume exposure system for the simultaneous irradiation of large numbers of small rodents at cellular phone frequencies, have been described previously. The basic irradiating unit consists of a 'carousel' where ten rats are positioned in specially designed restrainers with their heads toward a central radiating antenna like spokes on a wheel. These carousels are positioned in a collinear array inside a shielded chamber. Results from a complete experimental dosimetric evaluation are reported.

OBJECTIVES: A precise assessment of Brain SAR distribution induced in experimental animals when exposed to cellular phone RF signals in a chamberette irradiator, is required for the proper planning, execution, evaluation and interpretation of bioeffects studies.

METHODS: SAR was measured in tissue-equivalent rat phantoms and in rat cadaver phantoms. Three different measurement methods were employed: 1) relative SAR measurements using a calibrated diode, 2) thermometric measurements using fluoroptic probes, and 3) thermographic measurements using an infrared camera and splittable phantoms. Thermometric measurements in rat cadavers were made soon after euthanasia by inserting a catheter into the cerebellum, through the cerebrum, to the olfactory lobes in the medial portion of the brain. A four-sensor probe was used with all the sensors in brain tissue. Splittable phantoms were fabricated for the thermographic methods. The splittable rat cadaver phantom was prepared by first freezing the cadaver soon after euthanasia, it was later dipped in paraffin while frozen, and finally cut in half longitudinally along a vertical plane with a band saw. The plane of the split was covered with cellophane. The paraffin coating provided a stable shell for the thawed cadaver for handling during the experiments. For both the thermometric and thermographic measurements a fully loaded carousel was irradiated at net power levels of 50 to 60 watts for 2 minutes. SAR was estimated from the initial slope of the temperature-time curves using a least squares method and by subtracting an infrared image taken

after the exposure from an image taken right before exposure. The diode detector measurements served mainly to evaluate the dependence of SAR on positional variations of the phantom with respect to the antenna, and on carousel loading.

RESULTS AND DISCUSSION: Thermometric measurements showed an average SAR of 0.53 W/kg per watt input to the central antenna. The values were found to be mildly dependent on head position and the standard deviation of all four points measured in three different rats was $\pm 1 \text{ dB}$. The thermographic measurements in the split rat cadaver showed an average brain SAR of 0.5 W/kg per watt input to the antenna which was in very good agreement with the thermometric measurements. The maximum measured SAR using the thermographic camera in the rat cadaver was 0.8 W/kg and no portion of the cadaver appeared to be heated more than the brain. The thermographic images of the split phantom showed good qualitative agreement with the split cadaver and will be presented also. The diode measurements showed negligible SAR dependence on angular position or other carousels' antennas which form the collinear array. We did find a 1.5 dB increase in SAR as phantoms on the carousel were removed; this is compensated for by ensuring that the carousels are always fully loaded with rats or rat phantoms.

CONCLUSION: The SAR delivered to the rats is concentrated in and near the rats' brains. The power levels can easily be set to those relevant to cellular phone use. The rats should not be under any stress from any unintended RF heating.

Research supported by Motorola Corporation.

H-5

ESTIMATION OF SAR IN CELLS EXPOSED TO MICROWAVES IN A RADIAL TRANSMISSION LINE IRRADIATOR. W.F. Pickard¹, W.L. Straube², E.G. Moros² and X. Fan². ¹Department of Electrical Engineering and ²Radiation Oncology Center, Washington University, St. Louis, Missouri 63108, USA.

The development and performance of a Radial Transmission Line (RTL) irradiator, a large flask-capacity *in vitro* microwave exposure system, were described. Although there is sufficient evidence that the RTL can induce experimentally meaningful SAR levels for bioeffects studies, the accurate estimation of the SAR distribution at the cell layer is a very difficult task and requires a multifaceted approach.

OBJECTIVES: 1) To summarize the major difficulties and limitations in the estimation of SAR at the cell layer in culture medium using thermal techniques, and 2) to describe both theoretical and experimental avenues developed at Washington University to improve the estimation of SAR.

METHODS: The normal calculation of SAR using thermal techniques assumes that thermal diffusion is negligible during the short period of time following an high power insult. This assumption does not hold for the physical configuration of cells in culture resting on the bottom of a flask in a TEM type irradiator. To minimize the contribution of thermal

conduction to the measured SAR value a minimum of three things are needed: 1) a probe able to measure very small increments in temperature, 2) a high power source, and 3) an low-noise environment. To improve the estimation of SAR induced by the RTL irradiator a multifaceted approach was developed: 1) a novel differential thermometry system was engineered employing a standard Bowman probe, 2) a 2-D frequency-domain multilayer guided-wave analytical model was developed, and 3) analytical and numerical thermal conduction models were employed to assess the confounding contributions of thermal diffusion to the measured SARs.

RESULTS AND DISCUSSION: The novel differential thermometry system is able to measure millikelvin temperature offsets with subsecond resolution. The technique has been used to map the SAR distribution at 836 and 2450 MHz. Illustrative data will be presented as well as efforts at reducing the measurement noise when using this system. The multilayer analytic model yielded results that are qualitatively comparable to those of computationally intensive 3-D time-domain free-field scattering models (Burkhardt *et al.*, private comm.). Predicted SARs are in reasonable agreement with the measured SARs. However, thermal modeling revealed that SARs values inferred from initial temperature rise curves are seriously confounded by thermal diffusion. The electromagnetic and thermal models were used to estimate the present experimental uncertainties and to aid in correcting for the diffusion effect.

CONCLUSION: It is concluded that in the absence of major engineering developmental efforts (a miniature hypersensitive thermal probe and/or a miniature electric field detector) the local measurement of SAR is accurate only to within ± 3 dB. Research supported by Motorola Corporation.

H-6

EXPOSURE TO MAGNETIC FIELDS AT WORK AND PUBLIC AREAS AT THE FINNISH RAILWAYS. A.M. Hämäläinen¹, M. Hietanen¹, P. Juuti^{1,2} and J. Juutilainen². ¹Finnish Institute of Occupational Health, 01620 Vantaa, Finland. ²University of Kuopio, 70210 Kuopio, Finland.

BACKGROUND AND OBJECTIVE: The purpose of this study was to assess the exposure of the workers and passengers to low-frequency magnetic fields at the Finnish railways. Electrification of the railways began in the end of 1960's in Finland and 2000 km of the railway (total length 6000 km) is electrified at present. Although the electric railway systems have been used for several decades in many countries, only few studies on exposure to electromagnetic fields at railway jobs have been done.

METHODS: Exposure to low frequency fields was determined using field strength measurements and personal dosimeter registrations. Magnetic flux densities were measured in local and long-distance trains, electric locomotives and at passenger coaches. Measurements were also taken in a power supply station, in a reserve power plant, in a rail welding station, in an engine shop and in a locomotive hall. In addition, personal magnetic field exposure of 11 locomotive and 11 local train drivers, of 3 conductors, of one worker of the wheel heater and of one

cleaner was assessed.

RESULTS AND CONCLUSIONS: Magnetic field exposure varied greatly depending on the conditions of acceleration and deceleration of a train. The average magnetic flux density at the working areas of engine drivers and conductors was 0.5 μ T. The corresponding value for local train drivers was 0.3 μ T and for a wheel heater's user the average exposure ranged from 6.6 to 11.4 μ T. The magnetic field exposure of a cleaner was 0.28 μ T.

In conclusion, exposure of railway personnel and passengers to ELF fields is generally low compared with the present recommendations by various international agencies. The recommendations were, however, exceeded in some places, such as in the corridor between the cabs of the electric locomotives, in the power supply station and in the engine shop. At least special groups of workers, e.g. pacemaker wearers, should avoid exposure to high fields. As for possible chronic health effects, an extensive epidemiological study based on realistic measurements of exposure is needed before any causal relationship can be established.

H-7

MAGNETIC FIELD MONITORING ON BOARD OF DC ELECTRIFIED TRANSPORT IN RUSSIA. G. Villorosi¹, N.G. Ptitsyna², Y.A. Kopytenko², M.I. Tyasto², E.A. Kopytenko², N. Iucci³, P.M. Voronov², D.B. Zaitsev². ¹IFSI-CNR Frascati c/o Università "Roma 3", Dip. di Fisica, 00146 Rome, Italy. ²SPbFIZMIRAN of Russian Academy of Science, 191023 St. Petersburg, Russia. ³Università "Roma 3", Dip. di Fisica, 00146 Rome, Italy.

We performed magnetic field (MF) measurements on board of locomotive-hauled (EL) and electric motor-unit (EMU) Russian trains, powered by 3000 V DC. We used a special computer-based magnetometric system, designed by the SPbFIZMIRAN, that allows the recording and storing of MF wave forms in the ultra-low frequency range (0-10 Hz). These measurements have been done in passenger compartments and crew areas. MF records were analyzed for typical train conditions: accelerating, braking and normal motion. We found that MFs from DC trains are quite different from the almost sinusoidal power-line fields; they show complex structures, as from Maglev trains. MF records show irregular wave forms, sharp changes in direction when passing substations, sharp pulses during the accelerating phases. The highest MFs have been found in the horizontal Y component perpendicular to rails. Typically, the greatest pulses, up to 1000-1500 mG, are observed in the Y component in the driver's cabin of EL and in passenger compartments of EMU trains. In crew area of EMU and passenger coaches of EL the MF fluctuations are smaller (100-500 mG). The greatest MF variations are observed below 0.15 Hz. Usually, MF variations at higher frequencies do not exceed 10 mG.

New measurements are in progress to get a more detailed spatial distribution of MFs inside EL and EMU trains. Moreover, we are planning a survey of MF measurements inside subway trains.

H-8

EXPOSURE GUIDELINES FOR RADIOFREQUENCY ELECTRO-MAGNETIC FIELDS. E. van Rongen. Health Council of the Netherlands, 2280 CE Rijswijk, The Netherlands.

In January 1997 the Health Council of the Netherlands published an advisory report on the health effects of exposure to radiofrequency electromagnetic fields and radiation and proposed exposure guidelines on the basis of the available scientific literature, taking existing guidelines into consideration. The frequency range considered is 300 Hz to 300 GHz. Different basic restrictions are selected for various subranges:

frequency range	current density (mA/m ²)		SAR (W/kg) ^a		power density (W/m ²) ^b	
	workers	public	workers	public	workers	public
300 Hz - 1 kHz	10	2				
1-100kHz	$f/100^c$	$f/500^c$				
100 kHz-10 MHz	$f/100^c$	$f/500^c$	0.4	0.08		
10 MHz - 10 GHz			0.4	0.08		
10 - 300 GHz					100	$6.727Xf^{0.473d}$

(a) - averaging time = 6 min. (b) - averaging time = $68 / f^{1.05}$ min (frequency f in GHz). (c) - frequency f in Hz. (d) - frequency f in GHz

Derived exposure limits were calculated for the electric and magnetic field strengths using these basic restrictions and clearly defined conditions and mathematical models. Clear rationales are given for all steps in the establishment of field limits. The proposed electric and magnetic field limits are shown in the figures.

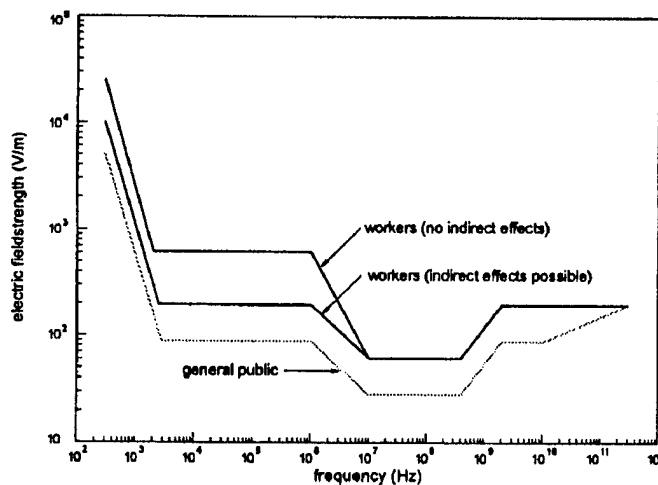

Additional limits are given for partial body exposures, exposures of short duration, exposure to multiple frequencies and contact currents. Specific exposure situations are given special attention: the use of hand-held telephones (including their influence on pacemakers), sealing equipment and diathermy apparatus used in physical therapy.

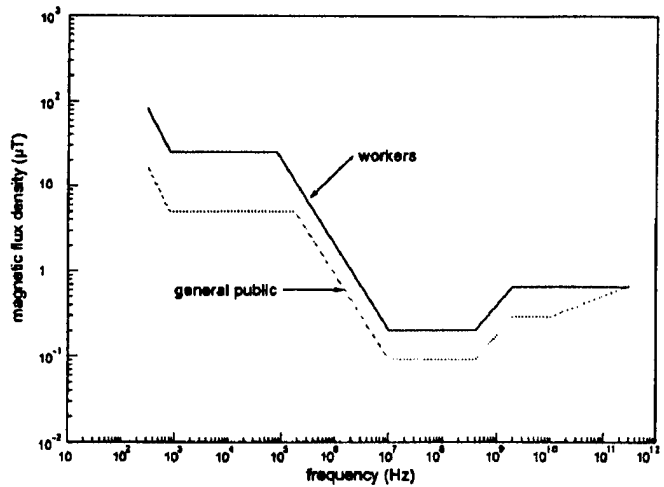

Reference:

Health Council of the Netherlands, Microwaves and Radiofrequency Radiation Committee. Electromagnetic fields of 300 Hz to 300 GHz: health aspects and exposure limits. Rijswijk: Health Council of the Netherlands, 1997.

H-9

REGULATIONS FOR RESTRICTION OF HUMAN EXPOSURE TO ELECTRIC, MAGNETIC AND ELECTROMAGNETIC FIELDS AT WORKPLACES - A PROJECT OF AN "ACCIDENT-PROTECTION-ORDER" IN GERMANY. S. Eggert¹, N. Krause² and S. Goltz¹. ¹Federal Institute for Occupational Safety and Health, D-10317 Berlin, Germany. ²Berufsgenossenschaft für Feinmechanik und Elektrotechnik, Köln, Germany.

Until 1996 in Germany there were no regulations with legal force on restriction of human exposure to electric, magnetic and electromagnetic fields at workplaces and for the general population. Since 1984 in different issues of the German standard series DIN VDE 0846 "Safety in electromagnetic fields" limits values, evaluation procedures and methods for measurement and calculation of those fields have been published.

These standards are produced by the Deutsches Institut für Normung (DIN), which is a private organisation and therefore these standards are generally not of obligatory or compulsory nature, i.e. their application is voluntary.

But in 1993 the Federal Ministry of Labour and Social Affairs, the German institute for Normalization (DIN) and Legal Accident Insurances agreed, that the establishment of limit values for protection of human health at workplaces shall no longer be a subject of normalization but a definite task of legal authorities.

Due to the lack of harmonized European regulations in this field, the Federal Ministry of Labour and Social Affairs started a project of a national rule on the form of an "Accident-Protection-Order" in 1996. This order is under elaboration by a working group of EMF-protection specialists in charge of the Berufsgenossenschaft für Feinmechanik und Elektrotechnik.

The draft order contains exposure restrictions corresponding to the IRPA/ICNIRP guidelines as basic restrictions (SAR

and tissue current density) and permitted values as derived values (fieldstrength and power densities).

Methods for measurement and procedures for evaluation of measurement results are presented.

H-10

MEASURING MODULATED AND PULSED RF FIELDS ACCORDING TO SAFETY STANDARDS. H. Keller. Wandel & Goltermann, D-72800 Eningen u.A., Germany.

The safety standards for RF fields allow to measure exposure levels instead of the specific absorption rate (SAR). The requirements for the measurement equipment is not described very good in the standards but there are some hints to select the right equipment. In this paper it is described what is necessary to take measurements according to the standards and which accuracy can be achieved when using compact fieldstrength meters. The focus here are the problems with such meters when they respond to modulated signals. Namely pulsed signals used for GSM and radar can lead to great measurement deviations.

In the first section the standards are reviewed. As a conclusion an ideal broadband fieldstrength meter is worked out as a reference for real world measurement equipment. The ideal meter has isotropic E-field and H-field sensors. It has a shaped frequency response which fits the standard. The detector circuit following the frequency shaping is quite complex if it has to be conform to the standards. The ideal detector is described in detail.

In the second section a real world fieldstrength meter is described. The measurement deviations even for extremely pulsed signals are documented. For moderate modulated or pulsed signals the measurement deviations are in the same order of magnitude as other measurement deviations. For extremely pulsed signals however the deviation may be more then the factor often. A comparison between diodes and thermocouples as detectors shows, that only with diodes real world radar signals can be recovered.

H-11

EDUCATION AS A BASIC REQUIREMENT IN LABOUR PROTECTION. H. Trzaska. EM Environment Protection Laboratory, Technical University of Wroclaw, 50-370 Wroclaw, Poland.

The basic need in the labour (and the general public) protection these are national and international standards, recommendations and regulations. In the case of Polish standards they determine in details (apart from the permitted exposure levels): the ways and the methods of EM environment control (measurements) on working places, periods of obligatory EMF measurements near sources and medical investigations of personnel involved in the work performed in conditions found as hazardous as well as introductory preparation and training, in the aspect, the

people going to work with EM radiation sources, permanent control of their knowledge and issue (or renew) formal certificates confirming the training completed. Then the certificate is absolutely required by the sanitary inspection or other respecting bodies under personal responsibility of a person of concern and the labour safety supervisor involved. The training is performed under auspices of The Polish Society of Electrical Engineers. It includes: basic electromagnetics, introduction to bioelectromagnetics, bioeffects and possible risk and health effects in the result of an exposition, standards and limits including rights and obligations of a person working in hazardous environment as well as understanding and applications of protection means (legal, technical and organizational).

The author has been involved in the training for many years. The paper presents his experience on the field and necessary steps in the future. It may be summarized in following points.

1. Knowledge on the field of bioelectromagnetics is below any imagination. However, the knowledge and the experience of general public is far below those of the professionally involved persons. Here may be the source of, so called, electromagnetic phobia

2. The best level of experience, understanding the problems and the most correct approach is represented by the people working in radiocommunication. It results in the relatively best protection of communication devices, within these objects and the lowest exposures of their personnel. Identical education level (university one) is represented by medical doctors. Usually they know nothing about the specificity of nonionizing radiation, their knowledge is often wrong, they do not understand the reasons of the risk created by EM field and neglect the necessity to apply any protection means. It is to stress that in the case of the ionizing radiation their approach is completely opposite one that only confirms necessity of farther and intensive training.

3. The lowest level of education, knowledge and understanding is represented by the industry workers. They usually do not like to take into account any hazard. They dismount screens and other protection means that decrease their exposure but make the work more difficult. From the other hand side they do everything to take an advantage of their rights (financial compensation, shorter work period, special medical care). The group is the most active, however, in the case of any non-professional exposure caused by nearby power substation, a BC or a TV transmitter, a radiotelephone or CB station or, even, a receiving satellite dish antenna. It is difficult to judge whether the behaviour is a result of the 'homo sovieticus' type of mentality or more general reasons.

The experience shows that the knowledge represented by professionals is not enough and needs farther steps to improve it. The situation with non-professionals is much worse. Their feelings are usually created by irresponsible journalists, looking in the majority for a sensation. The quantity and quality of these publications is well known and it requires a strong counterwork in the form of publications written or/and presented in an understandable for the public language and addressed to the wide public. Such a work was initiated and it is hoped it will be widened in the future.

H-12

COMBINATION OF THE EFFECTS FUNCTION APPROACH AND DECISION ANALYSIS IN EVALUATING POWER FREQUENCY FIELD POLICY OPTIONS.

J.G. Adams¹, D.v. Winterfeldt² and I. Nair³.
¹Merrimack College, North Andover, Massachusetts 01845, USA. ²Decision Insights, Irvine, California 92621, USA. ³Carnegie Mellon University, Pittsburgh, Pennsylvania 15213, USA.

MOTIVATION: Policy making in the area of public exposure to EMFs from the power grid takes place in an environment of major uncertainties as to what if any risks are posed by these fields. There is a wide variety of stakeholders involved in this issue, from concerned citizens to the electric utilities. Due to the uncertainties the various stakeholders are often at odds, and decision making can take place in a very adversarial environment.

OBJECTIVE: The goal of the current work is to provide decision makers with a tool to develop and assess policy options to mitigate potential health effects from exposure to EMFs due to the existing and planned power grid in California, including transmission, distribution and substations. This tool is expected to quantitatively address many of the concerns brought forth by the various stakeholders, including the environmental justice implications of policy options. This policy analysis tool is to be embedded in a user friendly, flexible and adaptable computer software package.

METHODS: The overall approach of this work is to combine a decision analytic method developed by Von Winterfeldt [1] with the Effects Function approach developed at Carnegie Mellon [2]. The decision analytic approach allows for a wide variety of values such as equity and environmental justice to be included in the assessment of policy options. The Effects Function approach allows for engineering considerations, biological uncertainty, and population density to be qualitatively incorporated in the analysis. As part of assuring that a wide range of opinions, values, and concerns are accounted for during the development of this policy tool a stakeholder involvement process is a key element of the project.

RESULTS: The two approaches ([1], [2]) have been combined in a preliminary way, and example calculations carried out. Our group has already had significant interaction with the Stakeholders Advisory Committee, a group composed of a range of California stakeholders, and a great deal of valuable feedback has been received from this committee.

[1] D. von Winterfeldt and T. Trauger, *Bioelectromagnetics* 17, No. 2, p. 71, 1996.

[2] J. Adams *et. al*, *Risk Analysis* 15, p. 313, 1995.
 This project is being supported by the California Public Health Foundation and the California Department of Health Services.

I. Electromagnetic Injury and Therapy

Chairs: Ruggero Cadossi and Raphael Lee

I-1

STATE OF THE ART IN ELECTROMAGNETIC THERAPEUTICS: SOFT TISSUE APPLICATIONS.

A.A. Pilla. Bioelectrochemistry Laboratory, Department of Orthopaedics, Mount Sinai School of Medicine, New York, New York 10029, USA.

INTRODUCTION: There is increasing use of pulsed electromagnetic fields (PEMF) as adjunctive therapy for a variety of musculoskeletal injuries. PEMF in current orthopaedic clinical practice has been employed to treat delayed and non-union fractures, rotator cuff tendinitis, spinal fusions and avascular necrosis. A clinically relevant response to the PEMF signals in current clinical use is generally not immediate, requiring daily treatment for several months in the case of non-union fractures (although experimental signals now exist which elicit significantly faster response). Until recently, application of EMF signals to other pathologies such as soft tissue and musculoskeletal injuries and post-surgical, post-traumatic and chronic wounds has been sparse. This review summarizes the present status of the use of low or non-thermal pulsed radio frequency (PRF) signals for such pathologies.

PEMF AND PRF SIGNALS: The group of most commonly used electromagnetic signals for therapeutic applications are pulse type (PEMF) signals having maximum spectral density in the low frequency range. PEMF signals induce maximum electric fields in the mV/cm range at frequencies below 5 kHz. The PRF signal consists of a burst of sinusoidal waves in the short wave band, usually in the 15-30 MHz range. PRF signals induce peak electric fields in the V/cm range at much higher frequencies than PEMF waveforms. Spectral analysis of both signals reveals that the PRF signal has components in the MHz range of significantly higher amplitude than those for the PEMF signal. In addition, since the PRF signal is a repetitive pulse burst it has low frequency components nearly equivalent in amplitude to those for the PEMF signal. This means that the PRF signal has frequency components which extend over a broader band than those for the PEMF signals. Thus, the PRF signal could couple to targets having a wider array of kinetics. It has already been reported that the signal to noise ratio for the PRF signal is sufficient to allow the induced electric field to be detected above thermal noise even at the macromolecular level.

CLINICAL APPLICATIONS OF PRF SIGNALS: The most prevalent and effective clinical applications of PRF signals are related to the reduction of pain and edema. The tissue inflammation that accompanies the majority of traumatic and chronic injuries is essential to the healing process, however the body often over-responds and the resulting edema causes delayed healing and pain. For soft tissue and musculoskeletal injuries and post-surgical, post-traumatic and chronic wounds, reduction of edema is thus a major therapeutic goal to accelerate healing. Clinically

effective electromagnetic treatment of sprains, strains, contusions and other soft tissue injuries such as wounds, requires a physiologically meaningful response in hours or days. Non-thermal PRF signals were originally employed for the treatment of infections in the pre-antibiotic era. Since this original work, PRF therapeutics usually consists of daily 30 minute applications for several days, after which a significant reduction in edema and associated pain has been observed. Double-blind clinical studies have now been reported for chronic wound repair, acute ankle sprains, and acute whiplash injuries. In all cases objective assessments of edema volume and/or pain were carried out. It is important to note that a physiological response to PRF is often reported during or immediately after treatment, in contrast to the significantly slower response customary for the PEMF signals utilized for bone repair. Although the exact mechanism for PRF bioeffects is not completely understood, it is certain that the broader frequency spectrum of PRF signals allows more efficient coupling to the kinetics of the target pathway. For example, it has recently been reported that the voltage changes induced by PRF at binding sites in macromolecules are sufficient to affect ion binding kinetics with resultant modulation of biochemical cascades relevant to the inflammatory stages of tissue repair.

This work was supported in part by the Horace W. Goldsmith Foundation.

I-2

PULSED MAGNETIC FIELDS : A GLIMMER OF HOPE FOR PATIENTS SUFFERING FROM AMYOTROPHIC LATERAL SCLEROSIS. A. Bellossi¹ and R. Berget². ¹Laboratoire de Biophysique, Faculté de Médecine, 35043 Rennes Cedex, France. ²Locminé, France.

Amyotrophic lateral sclerosis (ALS) is a degenerating disease which is characterized by an elective attack of motory cells of the anterior horn of spinal cord, brain stem and corticospinal tracks. These lesions are at the root of peripheral motory symptoms (motory deficiency, amyotrophy, fasciculations) and pyramidal syndrome at the same spot. As a general rule these lesions are first seen in the upper limbs and they progressively reach the bulbar nucleus involving then breathing and swallowing troubles which lead to death. On an average 50% of the patients are dead after 36 months, and for 20% of them it takes place after 5 years of suffering. Fifteen per cent manage to live more than 10 years while some of them manage to keep alive for 20 years. In France, the incidence of this disease is about 1.5 through 500,000 inhabitants. In general this disease rather affects men than women (1.5/1) aged between 45 and 75. Although its etiology remains hypothetical, at least a cellular hyperexcitability linked to calcium penetration into motoneurons and cytoskeleton anomalies have already been noticed. To make the remaining muscles work, to avoid any joint stiffening and to contend with spasticity physiotherapy can be used. The three following patients underwent a physiotherapy with pulsed magnetic fields (PMF). PMF were generated through a Magnobiopulse apparatus (Societe

ATLAS, Paris, France). The signal consisted of unipolar asymmetrical pulses (rise time 90 ns, width 7 μ s, fall time 700 ns) supply with 90 μ s pulse bursts. The PMF were delivered through 2 discs 12 cm in diameter. The field strength was either 4, 5 or 6 mT at the surface of the discs. Three sessions took place each week. Each session lasted 2 hours.

M.H. was a 45-year-old man. In October 95 ALS was diagnosed and physiotherapy with PMF took place in June 96. Actually his upper and lower right limbs were affected by the disease and a paralysis of the upper right limbs was to be noticed. At the end of 35 sessions the patient could easily put his right hand on the top of his head and he managed to drive his car. At the end of 75 sessions M.H. managed to recover his autonomy and has resumed part of his activity.

J.P.L. was a 50-year-old man. In May 96 an ALS was diagnosed. Physiotherapy with PMF began in June 96. He suffered from a left hemiparesia and fasciculations disturbed his sleep. After 25 sessions he expressed a feeling of well-being. A particular improvement in his use of the left upper limb and in his walking was to be noticed. When an introduction of drugs in his treatment took place at this very moment a deterioration of his condition was to be noticed in spite of a carrying of this treatment by physiotherapy. At the end of 53 sessions drugs were stopped involving an improvement of his state. At the end of 69 sessions spasticity and fasciculations had lessened, walking became easier for him, the left upper limb began gently to work again.

M.L. was a 60-year-old woman. In October 1993 ALS was diagnosed. In August 1996 a complete paralysis of the lower limbs, a paralysis of the upper limbs with allowed only the motion of wrists and fingers, a difficulty to speak, a total lack of autonomy were noticed. After 23 sessions she expressed a feeling of well-being and some active gestures could be made. After 44 sessions the improvement, which was slow but unceasing, allowed to move the lower limbs in a triple flexion, and the patient had a better tonus, a greater mobility and endurance.

I-3

TREATMENT OF WRIST PAIN IN THE WORK PLACE WITH A STATIC MAGNETIC DEVICE - INTERIM REPORT OF A CLINICAL TRIAL. M.J. McLean^{1,2}, R.R. Holcomb^{1,3}, J.E. Torgerson⁴, B. McCullough^{1,3} and Medical Staff of Bil Mar Foods⁵. ¹Departments of Neurology, Vanderbilt University and ²Department of Veterans Affairs Medical Centers, Nashville, Tennessee 37212, USA. ³Holcomb Medical Research Institute, Nashville, Tennessee, USA. ⁴Sara Lee Corporation, Chicago, Illinois, USA. ⁵Bil Mar Foods, Zeeland, Michigan, USA.

Pain associated with repetitive use injuries results in billion of dollars of lost productivity and medical costs in the US annually. We tested a magnetic treatment device against work-related wrist pain in a high risk group at a turkey processing plant. The protocol was approved by the Vanderbilt University Medical Center Institutional Review

Board. Data handling was supervised by an oversight committee appointed by the Dean of the Vanderbilt Medical School. The study of parallel groups was randomized, double blind and placebo controlled. Plant medical personnel determined eligibility according to inclusion and exclusion criteria. Informed consent was obtained from subjects entering the study. Each painful wrist was treated randomly with either an active or placebo magnetic device of similar appearance and weight, and the blind remains intact. The devices were tested for effects on cultured sensory neurons by published methods (*Bioelectromagnetics* 16:20-32, 1995). The active device blocked 80-90% of action potentials reversibly while the placebo was ineffective. Devices were taped over the carpal tunnel and secured with a flexible elastic wrap daily. Subjects were evaluated by plant medical personnel at the time of enrollment, weekly during the one month double blind period, and monthly during an open label extension period. Between February and December 1996, 38 wrists (29 evaluable) were randomized. Results of an interim analysis of completed data sheets received by the PI without breaking the blind are as follows: a. Pain by the Visual Analog Scale (VAS; 100 mm full scale) improved in 18/29 wrists (62%) improved during the blinded phase and all subjects continued to work. Pain decreased an average of 53%: 15/29 improved $\geq 25\%$; 9/29 $\geq 50\%$; 5/29 $\geq 80\%$; and, 3/29 were pain-free. (b.) Pain worsened an average of 59.2% in 11/29 wrists (38%) during the blinded phase: $\geq 40\%$ in 8 and $\geq 100\%$ in 3. One individual stopped working. (c.) In the open label phase, 25 wrists were treated for 1-5 months with active devices: 18 improved and 7 worsened. (d.) Dynamometry did not parallel changes in pain scores consistently. (e.) No significant side effects or injuries have been reported. Updated results will be reviewed.

Supported by the Sara Lee Corporation in collaboration with the Holcomb Medical Research Institute and Vanderbilt University Medical Center.

I-4

TRANSCRANIAL MAGNETIC STIMULATION OF HUMAN PARIETAL LOBE RELIEVES INDUCED PAIN THROUGH ENDORPHIN RELEASE. V.E. Amassian, M.S. Vergara, M. Somasundaram, P.J. Maccabee and R.Q. Cracco. Departments of Physiology and Neurology, SUNY Health Science Center at Brooklyn, Brooklyn, New York 11203, USA.

In five of us, after occluding the circulation in the upper arm, ischemic muscle pain was induced in the left forearm by brief contractions of the digit flexors. Repetitive transcranial magnetic stimulation (rTMS) was applied to the right parietal lobe through an ovoid coil (5.5 x 6cm, o.d.), which was energized by the Cadwell Laboratories 'rapid' stimulator. A train of 10 polyphasic pulses at 20 Hz was used; after correcting for the average attenuation (by 10%) within the train, the train intensities ranged from 56-72% of maximum output. A more useful measure of stimulus intensity was obtained by stimulating the motor cortex and measuring the single pulse threshold intensity for hand movement during

voluntary contraction (TIVC). The intensities used on parietal lobe ranged between 1.05 - 1.4 x TIVC; 1.2 ± 0.13 (mean, S.D.). No seizures occurred. (The fifth subject had a high TIVC and it was considered potentially hazardous to use maximum output intensities).

Local discomfort initially made difficult observations during the train; however in four of us, a clear temporary relief of pain occurred after a delay of a number of seconds. The higher the stimulus intensity, the earlier the relief and the greater its duration. In the two subjects yielding the most precise timing, the delay for the pain relief from the start of the train was 3-6 sec and it lasted 30-35 sec. The delayed pain relief was often accompanied by pleasurable feelings, e.g. of warmth, but not numbness, i.e. it was not accompanied by 'neglect'.

Delayed relief of pain was elicited when the anterior windings of the coil lay 6-3.5cm posterior to the interaural line (passing through Cz) and the medial tip of the coil was 0-6cm from the midline. Thus, the effective loci were distant from motor cortex (there were no movements) and presumably lay in posterior parietal cortex.

In four of us, the initial administration of Naloxone (4-6mg. I.V.), abolished the delayed relief of pain implying that right parietal lobe stimulation had caused endorphin release. In such absence of delayed relief, a very brief stimulus related relief became more obvious, implying an additional short latency effect of parietal lobe stimulation.

I-5

THERAPEUTIC EFFICACY OF A STATIC MAGNETIC DEVICE IN THREE ANIMAL SEIZURE MODELS: SUMMARY OF EXPERIENCE. M.J. McLean^{1,2}, R.R. Holcomb^{1,3} and R.M. Thomas¹. ¹Department of Neurology, Vanderbilt University and ²Department of Veterans Affairs Medical Centers, Nashville, Tennessee 37212, USA. ³Holcomb Medical Research Foundation, Nashville, Tennessee, USA.

It is estimated that 30% or more of patients with epilepsy are unsatisfactorily treated with conventional antiepileptic medications. We have been developing a static magnetic field treatment device as a potential alternative and/or adjunctive therapy. To date, benefit of pretreatment with the device has been observed against death and seizure manifestations produced in mice by three different methods.

(1.) Intracerebroventricular (ICV) injection of N-methyl-D-aspartate (NMDA): NMDA, an analog of the excitatory amino acid neurotransmitter glutamate, induced 5 min seizures with running, loss of righting, tonic and clonic stages then recovery or death (10-30%). Pretreatment with the field produced by a DC powered (AC ineffective) electromagnetic device consisting of four heads wired for alternating polarity prevented death and all seizure stages except running in a variable percentage of mice depending on pole strength (5-90 mT) and time of exposure (5-30 min). The device was modelled after an array of four permanent magnets of alternating polarity that blocked action potentials of cultured neurons reversibly (*Bioelectromagnetics* 16:20-32,1995). At

best, 80% of mice ran only. The magnetic field was as potent as a selective NMDA antagonist, MK-801.

(2.) ICV injection of α -amino-3-hydroxy-5-methylisoxazole-4-propionic acid (AMPA): AMPA, another glutamate analog, induced NMDA-like seizures but with $\geq 60\%$ mortality. The anti-epileptic drug phenytoin alone or magnetic field pretreatment reduced mortality significantly but did not prevent seizures. After intraperitoneal administration of a maximum non-toxic dose of phenytoin, mice had prolonged *status epilepticus* (SE; 4-24 hr). Only 10-50% (compared to concomitant controls) of magnetically pretreated mice had SE after AMPA injection; deaths were rare. Mice with protracted SE had severe hippocampal neuron loss compared to minimal cell loss in pretreated mice.

(3.) Fring's mice (collaboration with H.S. White, U. of Utah): An 11 kHz, 85 dB tone triggered NMDA-like seizures followed by tonic hind limb extension in control animals. After 30 min pretreatment with the magnetic field (75 mT pole strength), the tone failed to produce any effect in 69% of mice; 23% only ran and 8% had control-like seizures. Threshold was raised for 72 hr. Thus, the magnetic field had anticonvulsive effects suggesting potential use for patients with refractory epilepsy.

Supported by the Holcomb Medical Research Institute in collaboration with Vanderbilt University Medical Center.

I-6

EFFECTS OF ELF ELECTROMAGNETIC FIELDS ON CRYSTALLINE LENS. EXPERIMENTAL STUDY. A. Zati¹, T.W. Bilotta¹, R. Giardino², M. Fini², L. Martini², F. Broccoli and P. Versura. ¹Department of Physiotherapy and ²Department of Experimental Surgery, Institute of Orthopedic Rizzoli Ophthalmologic Clinic of University, 40136 Bologna, Italy.

INTRODUCTION: It is known that radio-waves with freq. from 3 KHz (VLF, $\lambda = 100$ Km) to 300 GHz. (EHF, $\lambda = 1$ mm.) can cause severe damages to crystalline lens(1). It is a common opinion that this alteration is the consequence of increased temperature caused by dielectric leakage of electromagnetic waves (*e.m.w.*). The eyes are very vulnerable to this waves in consequence to easy exposure to emitting instruments and for their delicate structures. The *e.m.w.* with freq. less than 3 KHz (ELF, $\lambda > 100$ km) are considered "probably" not dangerous for the eyes, because, even very penetrating, these *e.m.w.* have got minimal thermic effect. In fact, the ELF *e.m.w.* are acting on biological tissues by magneto-mechanical effects and induced micropotentials. Despite to numerous epidemiologic and experimental studies have been conducted about the effects of ELF *e.m.w.* on hematopoietic and nervous systems(2,3), we don't know studies concerning the long term effect on eyes. Otherwise, the use of ELF *e.m.w.* is in increasing interest; in Medicine, the ELF *e.m.w.* are employed to stimulate bone tissue. Goal of our study is to value the consequences on the eyes by exposition to ELF *e.m.w.* used in Orthopaedics; our purpose is to determine the opacity lens risk of the workers operating this instruments.

MAT. AND METHOD: 32 Sprague Dowly (10 months aged) rats are used. At the start of the study the animals were examined with slit lamp; then were subdivided in 4 groups of 8 rats: *Gr. A*, Control (no treatment). The remaining animals were exposed to different ELF waves: *Gr.B*: sinusoidal monodir. 50Hz. *e.m.w.*. *Gr. C*: sinusoidal monodir. 100Hz. *e.m.w.*. *Gr. D*: rectangular bidir. 70Hz. *e.m.w.*. Intensity of field was 70G. in the all groups. The time irradiation was 1 h./daily for 4 months. At the end, all animals were examined with slit lamp again, than were sacrificed and the lens tissues were submitted to histology.

RESULTS: The slit lamp observation didn't show any cortical or nuclear lens opacities in the all animals of the 4 groups. The histological crystalline examination didn't evidence significant difference between the treated groups and the control: the capsule appeared integral and the epithelium had a normal shape. The cortical fibres were strictly adherent without any inter/intra cytoplasmatic vacuoles. In conclusion, as theoretically expected, the examined ELF waves do not appear able to cause damage to crystalline lens.

Reference:

1. Hollows FC, Douglas JB: Microwave cataract in radiolinemen and controls. *The Lancet*, 1984, 18, 406:407.
2. Olsen J.H *et al.*: Residence near high voltage facilities the risk of cancer in children. *Br. Med. J.*, 1993, 307, 891:895.
3. Sahl J.D. *et al.*: Cohort and nested case-control studies of hematopotent cancers and brain cancer among electric utility workers. *Epidemiology*, 1993,4, 104:114.

I-7

POTENTIAL CLINICAL APPLICATION OF TAXOL AND POWER FREQUENCY ELECTROMAGNETIC FIELDS EXPOSURE ON HUMAN PROSTATE DISORDERS. J.T. Ning^{1,2}, V. Gajendran², C. Porter², J. Medica², B.S. Stein², A. Zabbo³, S.I. Cohen⁴, E.M. Czerska⁵ and J. Casamento⁵. ¹Indian Health Service, U.S. Public Health Service, Rockville, Maryland 20857, USA. ²Department of Urology, Brown University, Rhode Island Hospital, Providence, Rhode Island 02905, USA. ³Department of Urology, Veterans Administration Medical Center, Providence, Rhode Island 02908, USA. ⁴Department of Urology, Brown University, Roger Williams Hospital, Providence, Rhode Island 02908, USA. ⁵U.S. Food and Drug Administration, United States Public Health Service, Rockville, Maryland 20857, USA.

OBJECTIVE: Taxol, a diterpene, with unique mechanism of action has been found to be effective in monotherapy for advanced ovarian and head and neck cancers but not in prostate cancer. This let us to investigate the effects of taxol on prostate cancer cells. Due to our interest of investigating potential biological effects, public health relevance and clinical therapeutic effects of power frequency electromagnetic fields (EMF), we also investigated the effects of EMF on human prostate cancer cells.

METHODS: Human prostate cancer cell lines, LNCaP and PC-3 were obtained and grown under standard conditions.

Taxol was added to cell cultures at various concentrations diluted in medium. Power frequency EMF exposure were performed with time-varying magnetic fields at 60 Hz from one to five gauss. Cell proliferation and cell cycle kinetics were assessed by laser flow cytometry and DNA gel electrophoresis.

RESULTS: 50% inhibitory concentration (IC50) of taxol on LNCaP and PC-3 were found to be 5 ng/ml and 50 ng/ml, respectively. Taxol at low dose range exhibited dose dependent inhibition of cellular proliferation. Deviation from linearity was observed at high dose range. This was accompanied by a change from cell cycle specific blockage at G2/M phases of cell cycle at low dose range to nonspecific blockage at high dose range of taxol. After 48 hours of treatment with taxol near IC50, prostate cancer cells underwent apoptosis. Power frequency EMF exposure also induced apoptosis in human prostate cancer cells. The effect appears to be synergistic with combination of taxol and power frequency EMF exposure.

DISCUSSION: Lack of activity of high dose taxol in published phase II clinical trials for advanced prostate cancer may be due to suboptimal dosing of taxol. Our data suggest optimal dose of taxol close to IC50 and may vary with different prostate cancer cells. Taxol and power frequency EMF exposure appeared to induce prostate cancer cells into apoptosis. The effects appeared to be synergistic with combination of taxol and power frequency EMF exposure. These encouraging results suggest an alternative anti-cancer effect of taxol and power frequency EMF exposure in human prostate cancer cells. Further investigation is warranted.

CLINICAL RELEVANCE: Advanced stage hormone resistant prostate cancer currently has very poor prognosis and no effective therapy. The eventual goal of this research is to offer a new effective combination therapy for treatment of advanced stage prostate cancer using taxol and power frequency EMF exposure.

PUBLIC HEALTH RELEVANCE: Effects of power frequency EMF on human prostate cancer cells demonstrate potential clinical therapeutic effects of EMF. Thus, power frequency EMF exposure may harbour both public health risks and benefits to the population.

I-8

SUPRAMEMBRANE POTENTIAL-INDUCED ELECTROCONFORMATIONAL CHANGES OF THE VOLTAGE-GATED Na CHANNELS ARE A POSSIBLE MECHANISM IN ELECTRICAL INJURY. W. Chen, Y. Han and R.C. Lee. Department of Plastic and Reconstructive Surgery, The University of Chicago, Chicago, Illinois 60637, USA.

Electrical injury, which has become more and more common, continues to present problems in clinical management and treatment. Understanding the mechanisms of electrical injury will significantly improve our capability of patient management and therapeutical treatment. *In vivo* studies on rat skeletal muscle showed a decrease in the magnitude of the membrane action potential after the muscle was shocked by a

high intensity electrical field. A question raised is how an intensity electrical field affects the voltage-gated Na channels in cell membrane, which is a major determinant factor in generating the action potential.

To answer this question, we studied supramembrane potential-induced damages in the voltage-gated Na channel proteins by using an improved double Vaseline-gap voltage clamp techniques. We evaluated the membrane potential threshold that damage the voltage-gated Na channels, differentiated this threshold with the threshold of membrane electroporation, addressed the shock field-induced reduction of the Na channel conductance and discussed the reversibility of the damaged channel proteins.

The membrane holding-potential was -90 mV. Two group of pulses were employed in this study. Stimulation pulses were a sequence of pulses range from 30 to 100 mV that held the membrane potential from -60 mV to +10 mV. Shock pulse held the cell membrane at a suprphysiological membrane potential in a range from -200 mV to -600 mV. Before the application of a suprphysiological shock pulse, a sequence of stimulation pulses with 10 ms duration was applied to the cell membranes and the evoked Na channel currents were recorded. Then a 4 ms suprphysiological potential pulse was delivered to the membrane by the voltage clamp to electrically shock the cell membrane. The responding transmembrane currents were simultaneously monitored during the shock to identify an occurrence of electroporation. Right after the pulsed-shock the same stimulation pulse sequence was reapplied to the membrane to identify the shock-induced effects on the Na channel currents. The P/N method was used to identify the Na channel currents by subtracting the capacitance current and the linear leakage currents recorded using sub-stimulation pre-pulses from the total transmembrane currents.

By comparing the Na channel currents recorded before and after the electrical shock, the Na channel currents were reduced after electrically shocked by a single pulse of -400 mV suprphysiological membrane potential. The membrane potential threshold of damaging the voltage-gated Na channels is ranged between -350 to -400 mV, which is higher than the threshold of electroporation of cell membrane, in a range from -250 to -300 mV. The Na channel peak currents were plotted as a function of the membrane potential. From the channel's I-V curve, the post-shocked Na channel conductance shows a significant reduction compared with the pre-shock fibers. The damaged Na channel's functions showed some reversibility dependent on the magnitude and duration of shock pulse.

These results of *in vitro* study show that a supramembrane potential shock can cause electroconformational damages in the voltage-gated Na channels in cell membranes, resulting in functional reductions of the skeletal muscle fibers. These results indicate that electrical field-induced conformational changes in membrane proteins, especially in the voltage-dependent ion channels is one of the mechanisms in electrical injury.

PREDICTION OF E.M. SUSCEPTIBILITY OF LIGAND BINDING TO HYDROPHOBIC METALLOPROTEINS.

S. Bruna¹, W. Rocchia¹, E. Moggia¹, B. Bianco¹, J.J. Kaufman² and A. Chiabrera¹. ¹ICEmB at DIBE, University of Genoa, 16145 Genoa, Italy. ²Orthopaedics Department, Mount Sinai School of Medicine, New York, New York 10029, USA.

The binding site of several metalloproteins is hydrophobic, so that the ligand metal ion is attracted by the receptor protein in a dehydrated environment. Therefore the ion collision frequency can be several order of magnitude lower than in bulk water because the residual water molecules are few. Furthermore, the protein atoms are slightly displaced by the approaching ion, with respect to their equilibrium positions obtained from the protein data bank. The actual net attracting force is lower than the value calculated on the basis of these fixed atomic positions. Both features are necessary conditions for a ligand-protein system to be susceptible to low-intensity e.m. exposure [1]. Once the resulting ion potential energy $U(\bar{r})$ is available versus the ion distance \bar{r} from the centre of the binding site, a quantum Zeeman-Stark model of the binding process allows the prediction of its susceptibility to the e.m. exposure [2]. An analytical simple relationship for $U(\bar{r})$ has been developed, which can be fitted to the characteristics of the ion-protein system obtained by the protein data bank. The binding potential energy depends on three parameters only, i.e. U_0 , ω_{end} and ξ . The minimum value of the potential energy at $\bar{r} = 0$ is $U(0) = -U_0$. For small values of \bar{r} it is $U(0) \cong U_0 + 1/2 \omega_{end}^2 r$ and, for large values of \bar{r} , $U \cong -\xi/r$, where the order of magnitude of the characteristic distance is $\xi/(3 U_0)$. After accomplishing the fitting procedure, the frequency range of the ion-protein susceptibility to e.m. fields can be anticipated on the basis of the characteristic frequency $f_0 = \frac{3}{8} \xi^2 M/(2\pi \hbar^3)$, where M is

the ion mass and \hbar is the Plank's constant divided by 2π . In conclusion, we derived a simple and effective procedure for predicting the frequency ranges in which the ligand binding to a receptor protein can be affected by exogenous e.m. exposure.

[1] M. Cavanna, A. Chiabrera, E. Moggia, Reaction of a receptor protein to a binding ligand under e.m. exposure, *Proceedings of the 18th. Ann. Int. Conf. IEEE Engineering in Medicine and Biology Soc.*, pp 396-397, Amsterdam, The Netherlands, Oct. 31-Nov. 3, 1996.

[2] B. Bianco, A. Chiabrera, E. Moggia, T. Tommasi, Enhancement of the interactions between low-intensity R.F.E.M. fields and ligand binding due to cell basal metabolism, *Wireless Networks J.*, in press, 1997.

ELECTRIC SYMPATHETIC BLOCK: AN ADVANCED CLINICAL TECHNIQUE FOR THE TREATMENT OF COMPLEX ACUTE AND CHRONIC PAIN.

R.G. Schwartz. Medical University of South Carolina, Charleston, South Carolina 29245-0001, USA.

Electroceutical medicine involves the use of electrical modalities of pharmaceutical strength. Along with electrodes of specific size, shape and configuration, specialized medical devices can be utilized to obtain pharmacologic effects. The medical literature refers to alternating currents (AC) of 1000Hz - 100000Hz as middle frequency currents. While physical therapy devices utilize AC of 1Hz - 4000Hz and intensities of 1Ma -20Ma, electroceutical devices take advantage of decreased patient current perception and increased let-go thresholds in the 4000Hz - 20000Hz range to make it possible to employ intensities of up to 140Ma. The basic and physical science literature is replete with references demonstrating the effects of AC in the ELF range upon cell membranes and voltage dependent gates. There is an even larger body of literature concerning the impact of pharmacologic agents upon cell membrane surface energy, voltage dependent gates and cell transmembrane potential. The medical community recognizes the use of radiofrequency currents, magnetic energy and ionizing radiation for both the diagnosis and treatment of clinical conditions. While also felt to have clinical usefulness, physical therapy modalities create effects that are couched in subjective assessments and have mechanisms of action that are incompletely understood.

The medical literature contains mixed results describing the effectiveness of electrically induced sympathetic ganglia/neuron blockade when outcomes are measured objectively. This is due to inadequate awareness by the medical community of current concepts concerning molecular cell biology, cell membrane physiology, and basic electricity. The problem had been further compounded by an incomplete understanding of complex acute and chronic pain syndromes. Hence, published reports contain nonstandardized, poorly chosen parameter selections and inadequately defined patient populations.

These problems have now been minimized through computerization of AC parameters. Applications which are based upon accepted research for different nerve fiber types and pathology are available. These improvements, combined with higher frequencies and usable intensity, have increased clinical potency. Advances in defining the neurophysiology behind complex pain syndromes has also occurred. Enhanced definition of the symptoms under treatment has improved patient selection and clinician expectation. In multiple clinical studies, AC of 4000Hz - 20000Hz, utilizing electrodes of proper size, shape and configuration, with intensities up to 140Ma, produced sympathetic blockade and perceived pain relief of at least 75 per cent in two thirds of those treated. Results were measured objectively by thermography or skin galvanic impedance, and subjectively by pain score tests.

Standardizing the parameters used and enhancing patient selection has improved the effectiveness of electrically

induced sympathetic ganglia/neuron block. Electroceuticals should only be utilized by physicians familiar with all of the precautions and side effects that can occur with pharmaceuticals that produce similar results.

I-11

MECHANICAL STIMULATION OF CARTILAGE BY ULTRASOUND. J.T. Ryaby¹, F.F. Cai¹, P.L. Culley¹, J.J. Kaufman² and L. Lippiello³. ¹OrthoLogic Corporation, Phoenix, Arizona 85034, USA. ²Mt. Sinai School of Medicine and CyberLogic Inc., New York, New York 10029-6574, USA. ³Harrington Arthritis Research Center, Phoenix, Arizona 85006, USA.

INTRODUCTION: The ability to enhance cartilage biosynthesis using a non-invasive mechanical input (i.e. non-thermal ultrasound (US)) offers the potential to stimulate the healing of cartilage damaged by either degenerative joint disease or acute traumatic joint injury. The hypothesis of this research proposes that specific non-thermal US signals, as a method of noninvasively delivering mechanical input to cartilage, can be used to stimulate cartilage biosynthesis. The specific goals of this study were to investigate the effect of US on articular cartilage explants utilizing both single and multiple frequency signals with varying duty cycles in order to identify US signals which are maximally stimulatory.

MATERIALS AND METHODS: The US exposure system was a submerged shallow tank where the cartilage samples to be exposed were completely immersed in physiological buffer. This exposure system allowed for both perpendicular orientation of the cartilage sample to the impinging US wave at the near field/far field transition point and media diffusion through the dialysis membranes in order to maintain pH during exposure. The US signals were pulsed sinusoidal waveforms of intensity (SATA) 60 mW/cm² with center frequency of 1 MHz, and a pulse repetition rate of 1 Hz. The duty cycle and amplitude were varied inversely with respect to each other such that the time averaged intensity was maintained constant at 60 mW/cm². The cartilage cultures were adult bovine or porcine cartilage disk explants 8mm diameter, 1 mm thick, grown in Ham's F-12/20% FCS/50 µg/ml ascorbic acid/pen-strep cultured for 4-5 days in 100 mm petri dishes to reach a metabolic steady-state. US exposure was performed for 30 minutes/day. Stimulation of cartilage biosynthesis with growth factors was used as positive controls. Proteoglycan biosynthesis was assessed by pulse labeling with ³⁵SO₄ for 4 hours post-exposure in serum-free medium, and incorporation is expressed as cpm/dry weight of tissue.

RESULTS: Under steady-state growth conditions (20% serum), all the US exposure parameters demonstrated variable response with no consistent effects on proteoglycan biosynthesis ranging from no effect to a 3-fold increase. In addition, no consistent effects were observed by varying the duty cycle. Interleukin-1 α , which increases catabolism of cartilage, consistently inhibits proteoglycan biosynthesis. Preliminary data with cartilage grown under maintenance conditions demonstrated a 6-fold increase in proteoglycan

synthesis with continuous ultrasound exposure. This was also observed with the positive control, insulin-like growth factor-I. Variation of duty cycle under maintenance conditions has not been completed to date.

DISCUSSION AND CONCLUSION: These results demonstrate that US may have the ability to stimulate proteoglycan biosynthesis under the appropriate experimental conditions. The experimental data on variation in duty cycle will allow us to construct and validate analytical models of US affecting fluid microstreaming in the cartilage extracellular matrix. Positive results with these experiments may provide for novel therapeutic approaches for non-invasive cartilage stimulation in clinical arthritis and associated musculoskeletal conditions.

Supported by OrthoLogic and NIH SBIR AR 43281.

I-12

TRANSCRANIAL MAGNETIC STIMULATION IN ANTIDEPRESSIVE TREATMENT. A. Krawczyk¹ and T. Zyss². ¹Institute of Electrical Engineering, 04-703 Warsaw, Poland. ²Institute of Psychiatry, Jagiellonian University, Cracow, Poland.

The paper shows the recent developments in the transcranial magnetic stimulation (TMS) that is applied to healing of deep depression of endogenous nature. The therapy that uses electromagnetic field is believed to substitute electroshocks used widely in psychiatry some years ago. The magnetic stimulation, which has to generate eddy currents in undercortical layers in order to excite neural cells, is based on low frequency (10/100 Hz) pulse magnetic field. To penetrate deep layers of brain by magnetic field one needs the exciting field to be of high value, up to 2 T. There is a real technical problem in reaching parameters of stimulation that are required [1].

Some experiments, already made on rats and humans, are described in the paper. The results of the experiments, although made with the parameters not as required, allow to evaluate the method as promising for further research and applications [2]. The experiments which are planned are to confirm the applicability of the method in clinical practice.

In order to make the experiments consciously one needs to predict some physical phenomenon in a quantitative way. Thus, the mathematical investigations should be carried out parallel to clinical or physical experiment. The value of current density which is therapeutically required in neural cells is known to some extent, thus one needs to evaluate the magnetic field that causes such a current. This has to be done by mathematical modelling. The system of TMS is to be modelled as a multilayer sphere that is subjected to time-varying magnetic field. Prescribing values of electrical parameters to each particular layer, one establishes the mathematical model which is described by set of partial differential equations. In the paper such a model is described. The model is different than the typical model which is proposed in modelling of electrical devices since it has some special features. Thus, the numerical methods which are to solve the model should be object-oriented [3]. For the

purpose considered, the finite element method has been used and the method is oriented towards some specific features of the brain. The discussion of the model and some numerical results are presented.

The paper discusses three groups of problems: technical, medical and mathematical, thus it deals with TMS in a holistic way.

References:

- [1] A. Krawczyk *et al.*, "Magnetic stimulation in antidepressive treatment - theory and experiments", *JSAEM Studies in Applied Electromagnetics*, Tokyo, No.4, pp.204-210, 1996.
- [2] T. Zyss and A. Krawczyk, "The magnetic brain stimulation in treatment of depression: the search for the perfect stimulus", *Polish Psychiatry*, vol.30, No.4, pp.611-628, 1996 (in Polish).
- [3] A. Krawczyk and J.A. Tegopoulos, *Numerical Modelling of Eddy Currents*, Clarendon Press, Oxford, 1993.

Biological Sciences II

J. Human Physiology, Electromagnetic Hypersensitivity and Melatonin

Chairs: Charles Graham and Jorg Reußenweber

J-1

EFFECTS OF CIRCULARLY POLARIZED MAGNETIC 50 Hz FLUX DENSITIES OF 100 MICROTESLA ON NIGHT TIME MELATONIN SERUM LEVELS IN HEALTHY VOLUNTEERS. R. David, E. David and J. Reußenweber. Institute of Physiology and Physiopathology, University of Witten/Herdecke, D-58448 Witten, Germany.

Kato *et al.* from Hokkaido University School of Medicine, Sapporo, found changes in melatonin serum levels in albino Wistar-King male rats using in their experiments circularly polarized magnetic 50-Hz flux densities of 1, 5, 50 and 250 microtesla (Kato *et al.*, *Bioelectromagnetics* 14:97-106, 1993). A significant decrease of melatonin was observed by Kato *et al.* during these experiments between the control group and groups of rats exposed to a magnetic field at a flux density of 1 microtesla during night time. This finding speaks in favour of the melatonin hypothesis. That is why we wanted to investigate possible associations or correlations between melatonin serum levels on the one hand and exposure in circularly polarized fields in humans on the other hand.

OBJECTIVE: The German Federal Government, Ministry of Environment, has put into force a new order concerning the electromagnetic immissions in the end of 1996 (so called *Verordnung nach dem Bundesimmissionsschutzgesetz*). This order contains a threshold magnetic 50-Hz flux density of 100 microtesla. Now, in our study we wanted to clarify what is happening in the biological system of man and animal as regards melatonin serum levels if we apply this above mentioned threshold magnetic flux density of 100 microtesla

to healthy volunteers. So the investigation of an association between melatonin serum levels on the one hand and external magnetic flux densities of 100 microtesla in humans on the other hand was a major objective of our research.

METHODS: Three magnetic coils of 180 cm diameter each were constructed and placed on the surface of a equilateral triangle. Into this triangle a bed was placed where volunteers could sleep. Every participant slept one night in the circularly polarized field and one night without field the volunteers being blinded concerning status field/without field. In the head region of the bed we measured magnetic flux densities of 100 microtesla, in the thorax region of the volunteers even more (up to 153 microtesla). Thus the volunteers' pineal glands were exposed to exactly 100 microtesla, the new threshold value.

Blood samples were taken at 22.00 p. m., 2.00 a. m. and 6.00 a. m. by venous puncture.

Melatonin serum levels were determined by radioimmunoassay kits in an external laboratory. Furthermore pulse frequency, frequency of respiration and motility (pattern of motions) of the volunteers were registered under field exposure and without field exposure conditions.

RESULTS: The preliminary results of this ongoing study show relatively low melatonin serum levels in the evening. Higher levels were found between 2.00 a.m. and 6.00 a.m. For example the results of a volunteer in the above mentioned circularly polarized magnetic 50-Hz field are demonstrated:

Between 22.00 p.m. and 2.00 a.m. the melatonin serum level was about 65 pg/ml and between 2.00 a.m. and 6.00 a.m. the serum level reached 102 pg/ml.

Results concerning differences (status field/without field) of pulse frequency, frequency of respiration, and motility (pattern of motions) will be demonstrated in detail.

DISCUSSION: The above mentioned results show relatively high melatonin serum levels in a young male healthy volunteer who slept in the circularly polarized field.

If the melatonin hypothesis came true we would have to expect a decrease of melatonin serum levels under field exposure condition.

Our preliminary data don't confirm any melatonin-lowering effect of that circularly polarized magnetic 50-Hz field and we cannot support the above mentioned melatonin hypothesis. Thus the new threshold value of 100 microtesla seems to be sufficient as regards our preliminary data. Further research must integrate a maximum of volunteers in order to get statistically more reliable data.

Confounding factors like illumination density, temperature, sleep quality and others must also be drawn into consideration.

We are indebted to Mrs. F. Gholamrezaei and Mrs. D. Klunker for technical assistance.

NO EFFECT IN HUMANS OF MICROWAVES EMITTED BY GSM AND DCS MOBILE TELEPHONES ON THE CIRCADIAN RHYTHM OF PLASMA MELATONIN. R. de Seze¹, J. Ayoub¹, P. Fabbro-Peray², L. Miro¹ and Y. Touitou³. ¹Laboratoire de Biophysique Médicale, Faculté de Médecine, 30900 Nîmes, France. ²Département d'Information Médicale - CHU, 30029 Nîmes, France. ³Biochimie Médicale - CHU Pitié-Salpêtrière, 75013 Paris, France.

INTRODUCTION: A decrease of melatonin secretion has been observed in small mammals under exposure to ELF electromagnetic fields (EMF). As melatonin is potentially a strongly protective molecule against free radicals, it is important to know if such effects can occur: i) with radiofrequency EMF; ii) in humans. This experiment explores the effects of listening to a GSM phone on melatonin in healthy male volunteers.

PROTOCOL: Two groups of 19 men, 20 to 32 years old, were volunteers for the study. They were in good health, from both clinical and routine biological examination. The subjects were synchronized before the experiment with light on at 7 ± 1 h and light off at 23 ± 1 h. Main exclusion criteria were: night or shift work, stressful work, usual exposure to electromagnetic fields, GSM phone user, ENT, endocrine or neuropsychiatric disease, unusual sleep pattern, recent transcontinental flight. They used GSM or DCS cellular telephones 2 hours per day, 5 days per week, for 4 weeks, at a maximal peak power of 2 watts, corresponding to a peak SAR in the temporal region of the brain of about 0.1 W/kg. Field parameters were: carrier frequency: 900 or 1800 MHz, modulated impulse frequency: 217 Hz, duty cycle 1/8 or 1/16. To detect any change in the circadian rhythm of epiphyseal and hypothalamo-hypophyseal systems, the following hormones were assayed: Melatonin, TSH, GH, Prolactin, ACTH, Cortisol. Blood samples were collected hourly from 10 p.m. to 10 a.m. and every 3 hours from 10 a.m. to 10 p.m., i.e. 17 assays per day. Samplings were performed under moderate red light below 10 luxes. Four sampling sessions were performed: the first one before the beginning of the listening period, the next one at the middle of the listening period, the third one at the end of the listening period and the last one 15 days later, to evaluate the retentivity of any potential effect. Studied parameters were: the maximum of the serum concentration, the time of this maximum, the area under the curve of the hormone profile. As the statistical distribution of the values was normal, the repeated measures ANOVA test was performed.

DCS Results

X Labels	area		time		maximum	
	mean	SEM	mean	SEM	mean	SEM
pre-exposure	515	46	3.6	0.3	65	6
2wk-exposure	546	46	3.8	0.4	70	6
4wk-exposure	535	54	4.0	0.5	72	8
post-exposure	576	52	4.5	0.5	72	7

Melatonin mean \pm sem, N = 19

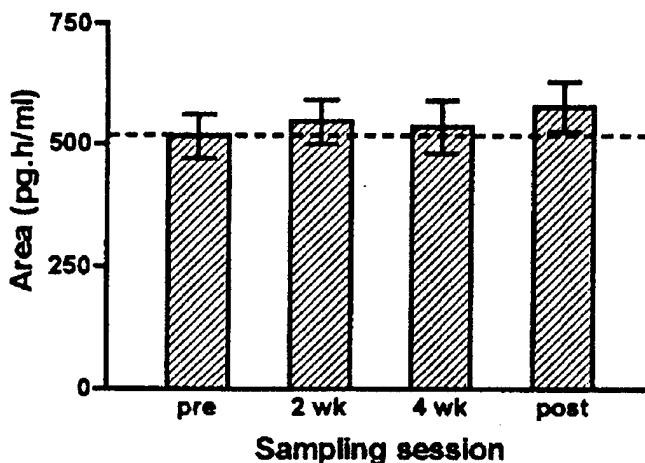

Melatonin - mean \pm sem, N = 19

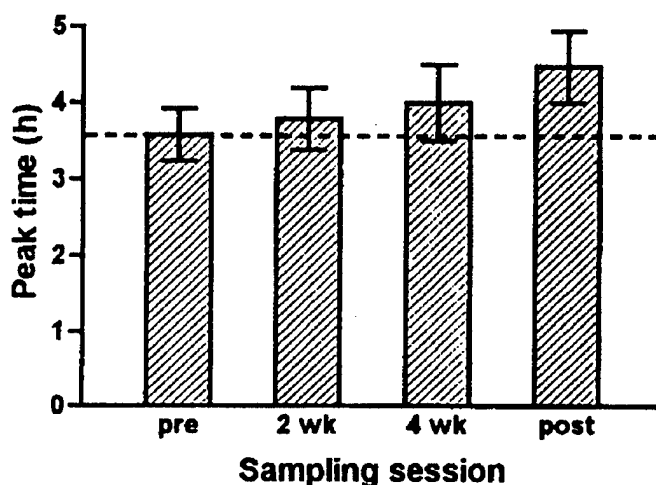

Melatonin - mean \pm sem, N = 19

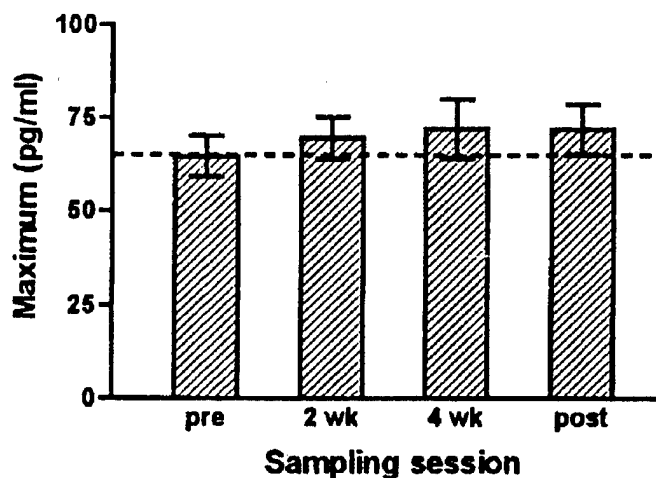

Inter-individual CV

CV inter	area	max
pre-exposure	39.1	37.3
2wk-exposure	36.4	35.4
4wk-exposure	44.0	47.2
post-exposure	39.3	40.2
mean	39.7	40.0

Intra-individual CV

CV intra	area	max
VOL 1	7.8	11.3
VOL 2	8.3	6.4
VOL 3	21.7	40.4
VOL 4	19.6	12.9
VOL 5	33.6	29.0
VOL 6	19.3	17.7
VOL 7	18.5	14.9
VOL 8	22.3	24.9
VOL 9	17.2	13.8
VOL 10	13.9	16.6
VOL 11	25.7	25.1
VOL 12	10.6	17.2
VOL 13	14.7	14.0
VOL 14	4.9	5.5
VOL 15	8.4	19.1
VOL 16	18.8	23.6
VOL 17	6.9	14.0
VOL 18	39.4	36.4
VOL 19	11.6	13.0
Mean	17.0	18.7

MAGNETIC FIELD EFFECTS ON CARDIAC CONTROL MECHANISMS. C. Graham, A. Sastre and M.R. Cook. Midwest Research Institute, Kansas City, Missouri 64110, USA.

Heart rate variability (HRV) results from the action of neuronal and cardiovascular reflexes, including those involved in the control of temperature, blood pressure and respiration. Quantitative spectral analyses of alterations in HRV using the Digital Fourier Transform provide useful *in vivo* indicators of beat-to-beat variations in sympathetic and parasympathetic nerve activity. Recently, decreases in HRV have been shown to have clinical value in the prediction of cardiovascular morbidity and mortality. While previous studies have shown that exposure to power-frequency electric and magnetic fields alters mean heart rate in human volunteers (Cook *et al.*, 1992; Graham *et al.*, 1994), the studies reported here are the first to examine effects of exposure on HRV. This report describes the fourth of four double-blind studies involving a total of 101 human volunteers. The purpose of the final study was to examine the organ system source of the previously observed field-related changes in HRV. In the previous studies, nocturnal exposure to an intermittent, circularly polarized magnetic field at 200 mG significantly reduced HRV in the spectral band associated with temperature and blood pressure control mechanisms, and increased HRV in the spectral band associated with respiration. When the field was presented continuously rather than intermittently, no significant effects on HRV were found (Sastre *et al.*, in press). Since the changes seen as a function of intermittent magnetic field exposure are similar to those reported during stage II sleep, it is important to ascertain if the primary organ interaction with magnetic fields is the nervous system, the respiratory system or the cardiovascular system. This study used a randomized, double blind, repeated measures design in which each volunteer served as his own control. The 24 volunteers in the study slept (11 pm to 7 am) on three separate nights in the laboratory exposure facility at Midwest Research Institute. On one night, each volunteer was exposed to the continuous, 200 mG, circularly polarized 60-Hz magnetic field, on another night to the intermittent 200 mG field, and on another night the volunteer was Sham exposed. Order of exposure and sham exposure was counterbalanced across volunteers. Endpoints included continuous recordings of cardiac interbeat interval, respiration rate, and brain electrical activity (EEG). Findings from this study will be discussed in terms of their potential to identify particular physiological processes where field-related biophysical interactions might occur.

References:

Cook MR, C Graham, HD Cohen, MM Gerkovich. *Bioelectromagnetics*, 13:261-285, 1992.
 Graham C, MR Cook, HD Cohen, MM Gerkovich. *Bioelectromagnetics*, 15:447-463, 1994.
 Sastre A, Cook MR, Graham C. *Bioelectromagnetics*, in press.

The attention of the volunteers was sustained by TV projection of cinematographic movies. For the GSM phones, the audio signal was given by the "audio" output of the television set and distributed to four receiver telephones. Each volunteer called one of the receiving telephones from his own GSM phone, and could then hear the movie sound track. For DCS phones, the exposure was performed by the use of a test-card.

RESULTS: This protocol with repeated measures showed an intra-individual coefficient of variation (CV) of less than 20% for the maximum of the peak and the area under the curve, much lower than the inter-individual (CV) about 40%. Even in these conditions, no statistical difference was found in the melatonin secretion of 19 volunteers during and after exposure to GSM and DCS mobile phones in the conditions of the protocol.

This work was supported by Motorola Inc.

J-4

HIGH-INTENSITY STATIC MAGNETIC FIELDS MODULATE HEMODYNAMICS AND BODY TEMPERATURE *IN VIVO*. S. Ichioka, M. Iwasaka, M. Shibata, S. Ueno, A. Kamiya and K. Harii. Institute of Medical Electronics and Department of Plastic Surgery, Faculty of Medicine, University of Tokyo, Tokyo 113, Japan.

Among various biological parameters, cardiovascular and thermoregulatory response to magnetic fields have been studied relatively often. However, reports in the literature concerning these biological effects of static magnetic fields have been incompatible and confusing. Especially, experimental *in vivo* studies are quite limited in this field.

OBJECTIVES: This study was designed to assess the effect of strong, static magnetic fields of 8T from a superconducting magnet on the peripheral blood flow, blood pressure, heart rate, and body temperature.

METHODS: We used a horizontal cylindrical type of superconducting magnet with a bore 100 mm in diameter and 700 mm long. The magnet produced 8 T at its center. A male Wistar rat, weighing 150 to 170 g was anesthetized with an intraperitoneal injection of Urethane (1 g/kg). An intra-arterial catheter was cannulated into the carotid artery to record the mean arterial pressure and heart rate. Probes of a laser Doppler flowmeter and a thermistor were inserted in a subcutaneous pocket and positioned at the mid dorsum. Another thermistor probe was put into the rectum. The data acquisition phase consisted of a 15 minute baseline interval followed by a 20 minute exposure by inserting the animal into the center of the bore and a 30 min post-exposure outside the bore.

RESULTS: The blood flow measured by a laser Doppler flowmeter decreased by 10% during magnetic field exposure. Significant post-exposure increase in blood flow was observed 1 to 5 min after exposure. The blood pressure, heart rate, and subcutaneous temperature continuously decreased during magnetic field exposure and recovered after removal from the magnet. The rectal temperature showed a trend to decrease in the magnet but was not statistically significant.

DISCUSSION: Possible mechanisms responsible for observed blood flow decrease may be associated with magnetically induced voltages and currents based on the previous theoretical analyses. A significant role for baroreceptor stimulation is envisaged in the decline of blood pressure and heart rate. Subcutaneous temperature decrease was postulated to be secondary to the reduction in peripheral blood flow. Magneto-hemodynamic and thermal reactions in the present study are not inconsistent each other and they also agree with some of the results of previous reports. At a minimum, this study suggests that a static magnetic field of 8 T induces some significant changes in hemodynamics and body temperature in anesthetized animals that are susceptible to physical and environmental changes due to the suppression of autoregulatory function.

J-5

PHYSIOLOGICAL AND PERCEPTUAL RESPONSES OF HUMAN VOLUNTEERS DURING WHOLE-BODY RF EXPOSURE AT 450 MHz. E.R. Adair¹, S.K. Hartman², L.G. Berglund³ and G.W. Mack². ¹Armstrong Laboratory, Brooks Air Force Base, Texas 78235, USA. ²John B. Pierce Laboratory, New Haven, Connecticut 06519, USA. ³Tohoku University, Aoba-ku, Sendai 980-77, Japan.

PURPOSE AND METHODS: In order to characterize fully the potential hazard to humans of inadvertent whole-body exposure to radio frequency (RF) fields, a battery of physiological and perceptual/sensory tests was designed. The battery included thermoregulatory responses of heat production and heat loss (skin and deep body temperatures, metabolic heat production, peripheral blood flow and sweating rate) and periodic judgments of thermal sensation, comfort, preference and acceptability. These responses were measured in seven adult volunteers (4 females and 3 males, aged 21-57 yr, clad in bathing suits) during 9 test sessions that involved 45-min exposures of the whole body to 450 MHz CW RF fields inside an anechoic chamber. Two power densities [peak PD = 18 and 24 mW/cm²; peak specific absorption rate (SAR) = 0.033 (W/kg)/(mW/cm²)], were tested in each of three ambient temperatures (T_a = 24, 28, and 31°C) plus T_a controls (no RF). Each test session included a 30-min equilibration to the prevailing T_a, a 45-min RF (or sham) exposure, and a 10-min re-equilibration. At minutes 25, 45, 65, and 80, the subject was asked to rate thermal comfort, thermal sensation, skin wettedness, sweating, T_a preference and T_a acceptability using specific category scales.

RESULTS: With regard to the physiological thermoregulatory responses, no significant change in metabolic heat production occurred; infrequently, slight increases in peripheral blood flow were measured. During RF exposure, vigorous increases in sweating rate from back and chest (directly related to both T_a and power density) cooled the skin and ensured efficient regulation of the deep body (esophageal) temperature to within 0.1°C of the control (baseline) level. These physiological responses reflected the perceptual and sensory judgments. During control (no RF) tests, warmth sensation increased with T_a, as did a preference for cooling, but thermal comfort was identical in all T_a. A T_a of 24°C was judged "slightly cool", 28°C was judged "neutral and acceptable", and 31°C was judged "warm". During RF exposure, both PD exerted similar effects in "cool" and "warm" T_a, but showed graded responses in the "neutral" T_a (i.e., 24 mW/cm² felt warmer, less comfortable and less preferred than 18 mW/cm²). At T_a = 24°C, RF exposure changed a "cool" sensation to "neutral" or "slightly warm" and increased thermal acceptability (R.V. Pound, *Science* 208:494, 1980). At T_a = 31°C, RF exposure increased warmth, thermal discomfort and a desire for cooling. Generally, perceptions of sweating, skin wettedness and thermal sensation were directly related to the measured skin temperatures and sweating rate of individual subjects.

CONCLUSIONS: The data indicate that whole-body exposures of adult humans to this supra-resonant frequency, at whole-body SARs at or slightly above the ANSI/IEEE C95.1-1992 guideline of 0.4 W/kg, will be efficiently counteracted by normal thermophysiological heat loss mechanisms, principally sweating. Further, humans so exposed are aware of their altered thermal environment and their own physiological state, perceptions that could lead to effective evasive action, if necessary.

Supported by AF Contract F33615-90-C-0604 DO-C9.

J-6

DOES EXPOSURE TO ELECTROMAGNETIC FIELDS (EMF) AFFECT BLOOD PRESSURE? S. Ghione¹, C. Del Seppia², L. Mezzasalma¹, M. Sucz¹, P. Luschi² and F. Papi².

¹Istituto di Fisiologia Clinica, CNR Pisa, I-56126 Pisa, Italy.

²Dipartimento di Scienze del Comportamento Animale e dell'Uomo, University of Pisa, I-56126 Pisa, Italy.

EMF may suppress stress-induced hypoalgesia in animal and man. Since arterial hypertension is associated to a hypoalgesia similar to stress-induced hypoalgesia, we wondered whether EMF also alters blood pressure (BP). We here provide evidence that exposure to EMF may in fact increase BP.

Study 1: In 9 volunteers (4F and 5M; age 31 ± 7yrs) BP was continuously monitored for 1 hr with Finapres. Measurements were repeated twice in random order under double blind conditions. In condition A an oscillating magnetic field (37.5 Hz, 130 µT) was induced after 20 min. and maintained for the following 40 min. In condition B the magnetic field was induced after 40 min. and maintained for the following 20 min. No subjective difference was experienced by the subjects. For systolic BP (SBP) a trend to increase was observed under both conditions but the increase became steeper and statistically significant after exposure to EMF. Diastolic BP (DBP) values remained stable until the EMF was turned on and, at that time, they started to increase slightly but consistently. No consistent effect was observed for heart rate (HR).

Study 2: In 10 male volunteers (41 ± 7 yrs) BP was measured every 3 min by Dinamap for 1 hr during exposure to an EMF (as in Study 1) and under placebo (in random order). Repeated measures ANOVA showed a significant difference (p < 0.01) for SBP which was higher under EMF. A similar but non-significant trend was present for DBP. HR was unaffected and decreased in both conditions.

CONCLUSION: These results are consistent with the idea that slight but significant increases of arterial blood pressure are produced by exposure to EMF.

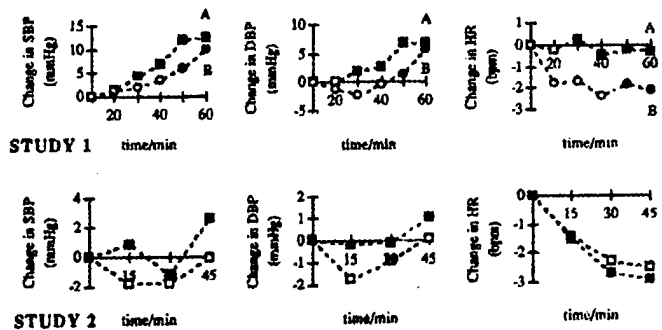

Figure: In both studies for all diagrams full symbols refer to measurements obtained during exposure to EMF and empty symbols to measurements under placebo conditions.

J-7

MAGNETIC PROPERTIES OF THE HEART, SPLEEN AND LIVER: EVIDENCE FOR BIOGENIC MAGNETITE IN HUMAN ORGANS. P.P. Schultheiss-Grassi¹, J. Dobson², H.G. Wieser³ and N. Kuster⁴.

¹Institute of Geophysics, ETH Zurich, CH-8093 Zurich, Switzerland.

²Department of Physics, Biophysics Programme, University of Western Australia, Nedlands, Western Australia 6907, Australia.

³Department of Neurology, University Hospital Zurich, CH-8091 Zurich, Switzerland.

⁴Laboratory of EMF and Microwave Electronics, ETH Zurich, CH-8092 Zurich, Switzerland.

INTRODUCTION: Isothermal remanent magnetization (IRM) acquisition and alternating field (AF) demagnetization investigations of the magnetic properties of brain tissue have revealed the presence of low coercivity ([1],[2],[3]), ferrimagnetic particles that are thought to be magnetite. To our knowledge no literature exists about the presence or absence of magnetic particles in other human organs.

OBJECTIVES: The purpose of this study is to assess the presence of magnetic particles in human organs other than the brain. Therefore, various analyses were performed on samples of heart, spleen and liver tissues, resected from cadavers with different pathologies.

METHODS: The samples, resected from cadavers during routine autopsy, were placed in sealed, acid-cleaned vials, and stored at liquid nitrogen temperature before measuring. IRM of the samples were obtained both at 77 K and at 273 K. The samples were exposed to DC magnetic fields in step-wise increments up to one Tesla (T) at 77 K using an Oxford Instruments water-cooled electromagnet. After each step the remanent magnetization was measured on a 2G SQUID magnetometer. After the final 1T magnetization step, the samples were allowed to warm up in the magnetometer and were continuously measured. The samples were then completely demagnetized using an AF Schoensted Demagnetizer, and eventually remagnetized in steps up to 1 T at 273 K. The samples were then demagnetized step-wise, and measured with the SQUID magnetometer in order to generate demagnetization curves. Tests to control for airborne contamination, and for the reproducibility of the measurements, were regularly carried out.

RESULTS: Results of the magnetic analyses of the heart tissue as well as of the spleen and the liver indicate the presence of ferrimagnetic, fine-grained, magnetically interacting particles (magnetite and/or maghemite). The presence of superparamagnetic particles in the tissue can be inferred from the increase in saturation IRM values when measured at 77 K compared to measurements at 273 K. The concentration of magnetic particles in the samples varies from 13 ng/g to more than 300 ng/g, with the heart tissue having generally the highest concentrations. The concentration of magnetite in the human brain has an average value of about 100 ng/g.

[1] Kirschvink JL, Kobayashi-Kirschvink A, Woodford BJ (1992): Magnetite Biomineralization in the Human Brain. *Proc. Natl. Acad. Sci. USA* 89: 7683-7687.

[2] Dunn JR, Fuller M, Zoeger J, Dobson J, Heller F, Hammann J, Caine E, Moskovitz BM (1994): Magnetic Material in the Human Hippocampus. *Brain Res. Bull.* 36: 155-159.

[3] Dobson J, Grassi PP (1996): Magnetic Properties of Human Hippocampal Tissue - Evaluation of Artefact and Contamination Sources. *Brain Res. Bull.* 39: 255-259.

J-8

SYMPTOMS CHARACTERISTIC OF ELECTROSENSITIVITY. L. Hillert¹, B.B. Arnetz^{1,2} and E. Söderman¹. ¹Department of Occupational and Environmental Medicine and Southern Division of Community Medicine, Huddinge University Hospital, Karolinska Institute, S-141 86 Huddinge, Sweden. ²National Institute for Psychosocial Factors and Health and Karolinska Institute, S-104 01 Stockholm, Sweden.

Patients coined the *electrosensitivity* syndrome label. There is a lack, however, of validated and reproducible criteria. This creates a difficult situation, both with regard to investigations of individual patients and definition of study groups in research. In more than 90% of the cases the syndrome starts as temporary skin symptoms during work with VDU's, but in almost all cases where symptoms are also reported triggered by other electrical equipment the patients also complain of neurovegetative symptoms. Little is known about the difference in perceived symptoms between persons who report electrosensitivity and persons who do not consider themselves suffering from this syndrome. We here report an investigation focused on the difference in reported skin and neurovegetative symptoms.

MATERIAL AND METHODS: Two groups of persons reporting electrosensitivity were compared to a group without this syndrome. One of the affected groups (40 persons) and the unaffected comparison group (201 persons) were derived from a controlled occupational health survey at a high tech multinational telecommunication corporation. Information on individual and occupational factors were collected from a standardized questionnaire answered by 241 employees (response rate = 71%). 23 patients referred to the Occupational and Environmental Health Centre because of electrosensitivity during 1994-1995 also completed this

questionnaire.

Two indices (range of 0 to 3) were formed based on the three most commonly reported skin symptoms (flash, heat sensation and tingling) and neurovegetative symptoms (tiredness, headache, difficulty concentrating) respectively, by patients at the Occupational and Environmental Health Centre in another questionnaire. Students non-paired T-test and one way ANOVA were used for the analysis. Significance levels were set to $p < 0.05$.

RESULTS: The group of electrosensitive persons in the health survey scored significantly higher in the skin index as compared to the non-sensitive group (mean score 0.98 and 0.20, $p < 0.01$) but not regarding the neurovegetative index (mean score 0.98 and 0.88). The group of patients referred to our department because of perceived electrosensitivity scored significantly higher in the skin index (mean 1.71) than both the other electrosensitive group ($p < 0.01$) and the non-sensitive group ($p < 0.01$), but not with regard to the neurovegetative index. The differences were significant also after adjusting for age and sex. Analyzing the scores of the indices for groups with no symptoms, suffering from electrosensitivity < 2 years and ≥ 2 years, a significant increase in the skin index ($p < 0.01$) but not in the neurovegetative index was observed.

DISCUSSION: The present results indicate that the characteristic symptoms of electrosensitivity are the skin symptoms. Persons suffering from electrosensitivity do report non-specific vegetative symptoms like tiredness, headache and difficulty concentrating, but not to a significantly higher degree than persons not reporting this sensitivity. This conclusion was further supported by the fact that the persons with more severe suffering (having sought medical care at our department) scored higher than the other sensitive group with regard to skin symptoms but not to neurovegetative symptoms. One explanation for these results, considering the frequent complaints of neurovegetative symptoms from electrosensitive persons, might be that given the skin symptoms, persons are apt to start attributing also other existing complaints to the same causal factor. Our results may be of value in forming better definitions of study groups concerning electrosensitivity.

J-9

ELECTROMAGNETIC HYPERSENSITIVITY. N. Leitgeb and H. Flühr. Institute for Biomedical Engineering, A-8010 Graz, Austria.

An increasing number of people with adverse health symptoms claim the cause of their problems to be the electromagnetic environment in general or some specific field sources in particular. The fact, that the overwhelming number of people exposed to similar fields does not experience any effects at all is explained by the hypersensitivity hypothesis. However, whether at all there exist people with such an increased sensitivity to daily life's electric and magnetic fields, to lead to significant health problems, is still to be proven. If so, and if significant percentage of people would be involved, this could have a

significant impact to the discussion of general exposure limits. Estimations reported in public media sometimes amount to 30% of the general population.

In the ELF range electric and magnetic fields interact with living tissue primarily by intracorporal current densities. Electromagnetic hypersensitivity therefore should cause significantly reduced perception thresholds of directly applied alternating electric currents as well. With this assumption a mobile computer controlled experimental setup was developed to investigate people's sensitivity in their daily life's environment.

In the meanwhile, more than 900 people were investigated, among them a 200 people sized cross sectional study of the general population and specific target groups like panic patients and members of electromagnetic hypersensitivity self aid groups.

The relevance of the electric current perception threshold as an indicator for electromagnetic field sensitivity was shown by comparison with the reaction potential to externally applied magnetic fields.

The measured perception thresholds were compared with the people's self classified sensitivity grade. The influence of physiologic and psychologic parameters are analyzed.

From these quantitative results, estimates of the maximum percentage of potentially hypersensitive people within the general population are derived. Results of sex dependent reactions and correlations with individual cofactors will be reported.

J-10

ELECTROMAGNETIC HYPERSENSITIVITY AS A PROGRESSIVE DISEASE. M.M. Hughes. U.S. Department of Labor, Occupational Safety and Health Administration, Technical Data Center, Washington, District of Columbia 20210, USA.

Electromagnetic hypersensitivity is a new, progressive, disabling disease associated with computers that has received little attention from the bioelectromagnetic community. It has many names: electro trauma, electro-hypersensitivity and hypersensitivity to electricity. Several million people all over the world who are working with computers complain of symptoms. Some acquired such severe disability that they became unable to work. The afflicted also suffer stress because of the uncertainty as to whether the medical profession will recognize their illness, disability boards award their claims, health insurance pay for their treatment and their employers provide an atmosphere in which they may continue to work.

Findings are based on my investigation of scientific literature, the results of which are published in my books, *Computer Health Hazards*, v. 1 & v. 2, 1990 and 1993 and in *Computers, Antennas, Cellular Telephones and Power Lines: Health Hazards*, v. 3, 1996. In this research, I find that since 1980, Swedish scientists have documented skin symptoms as the most common result of computer sensitivity. These include sensations of burning, prickling, itching, stinging, redness, swelling and rashes, tightness and "dry skin".

Knave, B., *Scandinavian Journal of Work, Environment & Health*, 1994. Severe erythema, dermatitis with blisters, swollen eyes and lids, and mucosal injury in the cheeks and soft palate also occur. Hughes, M., *The 2nd Electromagnetic Hypersensitivity Conference*, Denmark, 1995. The high number of mast cells present may explain the clinical symptoms of itch, edema and erythema. Johansson, O., *Experimental Dermatology*, 1994.

VDT dermatitis is suspected to be rosacea. Dr. Bjorn Lagenholm, the Chief of Dermatology at the Karolinska Hospital in Stockholm, says ordinary rosacea seldom appears anywhere other than on the face. He reports redness and dilated blood vessels on the face, neck, chest, back and even under the clothing of computer operators. He found, besides elastosis solaris, remarkable in very young computer operators, an absence of elasticity under the epidermis. He attributed these injuries to ultraviolet light and X-rays. Nordstrom, G., *Sick From Computers*, 1989.

VDT gastrointestinal symptoms include nausea, anorexia, diarrhea and constipation. Additional symptoms include sand in the eyes, hair loss, pain and numbness, difficulty concentrating, nosebleeds and sudden loss of consciousness, often leading to auto accidents and broken limbs. Liboff, A.R., *Microwave News*, 1995.

Others also reported VDT-evoked symptoms including such as nervous system symptoms: headaches, dizziness, fatigue and faintness, tingling and pricking sensations in the extremities, shortness of breath, heart palpitations, profuse sweating, depression, memory difficulties, sleep disturbances, difficulty concentrating, emotional instability, fine tremor of the hands and unconsciousness. Rea, W., *Journal of Bioelectricity*, 1991. Knave refers to Rea's double blind laboratory provocation study which documented that hypersensitive persons are able to detect and identify weak fields. Frequencies used range from 0.1 Hz to 5 MHz. Knave, B., *The 2nd Electromagnetic Hypersensitivity Conference*, Denmark, 1995. Afflicted individuals cannot watch TV, work on computers or listen to the radio. They react to stereos, fluorescent lights, telephones, electric heaters, high voltage power lines, electric security systems and electric trains. Becker, R., *Cross Currents*, 1990.

There have been two Electromagnetic Hypersensitivity Conferences held in Copenhagen, Denmark, in 1994 and 1995. Bengt Knave and Jurki Katajainen organized the second conference. The international scientists at those conferences concluded that electromagnetic hypersensitivity is a progressive disease and many afflicted are permanently disabled. The worldwide introduction of computers and other electronic equipment into our environment make it urgent that this catastrophic disorder be given widespread attention by the international scientific community.

J-11

NOCTURNAL SECRETION OF 6-HYDROXY-MELATONIN SULPHATE IN MICE EXPOSED TO 900 MHz RADIOFREQUENCY RADIATION OR 50 Hz MAGNETIC FIELDS. T. Kumlin¹, P. Heikkinen¹, J. Laitinen² and J. Juutilainen¹. Departments of ¹Environmental Sciences and ²Physiology, University of Kuopio, FIN-70211 Kuopio, Finland.

Amplitude modulated radiofrequency (RF) radiation, similar to that emitted by mobile telephones, has been suggested to exert biological effects similar to the reported cancer-related effects of extremely-low frequency (ELF) magnetic fields (MF). Suppression of nocturnal melatonin production in animals is one of the few biological effects of MFs that seem to be reproducible in several laboratories. We assessed the nocturnal melatonin production by measuring the concentration of 6-hydroxymelatonin sulphate (6-OHMS) in the urine of mice exposed to 900 MHz RF radiation or to a 50 Hz magnetic field. Twelve female CBA/S mice were used per group. Biological effects of MFs on this strain of mice have been observed in two independent laboratories. The exposure groups were: 1) 50 Hz MF with regularly varying intensity (1.3-130 μ T); 2) sham MF; 3) 900 MHz RF radiation pulse-modulated at 217 Hz, SAR 0.35 W/kg; 4) 900 MHz continuous RF radiation, SAR 1.5 W/kg; 5) sham RF and 6) cage controls. The MF group was exposed continuously except for the nights when urine was collected. The RF exposures were given during the light period, 1.5 hours daily on 5 days/week. The lights in the animal room were on between 7 am and 7 pm. After 17 months of exposure the animals were kept for two nights (with one week interval) in metabolic cages, three mice per cage, and all urine excreted between 6 pm and 7 am was collected. The concentration of 6-OHMS was determined by radioimmunoassay. No significant differences were found between the exposure groups. The results do not support the reported effects of ELF MFs on nocturnal melatonin production. Additional experiments with other animal models are needed to determine whether effects of amplitude modulated RF radiation can be found in animal models that respond to ELF exposure.

J-12

NOCTURNAL MELATONIN LEVELS IN WOMEN RESIDING IN HOMES WITH HIGH AND LOW LEVELS OF POWER-FREQUENCY MAGNETIC FIELDS. W.T. Kaune¹, S. Davis², R.G. Stevens³, D.K. Mirick² and N.M. Logan². ¹EM Factors, Richland, Washington 99352, USA. ²Fred Hutchinson Cancer Research Center, Seattle, Washington, USA. ³Pacific Northwest National Laboratory, Richland, Washington, USA.

In 1987, Stevens (*Am J Epidemiology* 125:556-561, 1987) proposed that female breast cancer risk might be affected by exposure to power-frequency magnetic fields. Steven's initial idea, suggested by the results of several laboratory

experiments, was that exposure to magnetic fields might inhibit the normal nocturnal increase in the secretion of melatonin from the pineal gland. Since melatonin appears to be involved in the regulation of gonadal function, Stevens hypothesized that a magnetic-field effect on pineal function would lead to reduced levels of circulating melatonin and, possibly, increased estrogen release by the ovaries. Several lines of evidence suggest that increased estrogen may lead to increased breast cancer.

We have performed a research project, funded by the Electric Power Research Institute, to test whether nocturnal melatonin levels are lower in women living in homes with larger magnetic fields. The study included 203 women, selected from a population of control subjects who had previously participated in a much larger study of female breast cancer and residential magnetic-field exposure. Our sample was drawn to include all subjects living in VHCC homes (26) and with the remainder divided between subjects living in homes with the highest (83) and lowest (94) measured bedroom magnetic fields. Mean bedroom magnetic fields in the latter two groups differed by about a factor of 10. Data collection for each subject consisted a three-day session followed, after a period of three or six months, by a second three-day session. Information collected during each session included: 1) questionnaire data focused on patterns of electric blanket usage, medication use, personal and medical history updates, and occupational status; 2) 72-h personal exposure measured with a worn Emdex Lite meter; 3) 72-h activity diary; 4) 72-h recordings of bedroom magnetic fields and light levels using an Emdex II meter and attached light sensor; and 5) collection of nocturnal urine during three consecutive nights. Urine samples were transported daily to the Core Laboratory at the Fred Hutchinson Cancer Research Center, where their total volumes were measured and aliquots stored at -80°C. Periodically during the study, accumulated samples were assayed for 6-sulfatoxymelatonin, the primary metabolite in urine of melatonin, using a commercially available radioimmunoassay kit. Creatinine concentrations were also measured and were used to normalize 6-sulfatoxymelatonin concentrations for changes in total urine volume.

Nocturnal melatonin levels are known to be affected by nighttime light levels, subject age, and season of the year and are thought to be influenced by use of certain medications, alcohol consumption, smoking, body height and mass, and shiftwork. Consequently, statistical analysis of the relation between nocturnal melatonin levels and magnetic-field exposure must also account for the effects of the parameters listed above. We are using multivariate repeated-measures regression methods to accomplish this task, which will be completed in early 1987. Preliminary results confirm that nocturnal melatonin levels are dependent on subject age and season of the year, as reported by others. Final results concerning the relation between nocturnal melatonin levels, residential magnetic fields, personal exposures, and wire codes will be reported at the World Congress in June.

Physical Sciences

K. Low Frequency Mechanisms

Chairs: Ferdinando Bersani and Charles Polk

K-1

LOW-FREQUENCY-DEPENDENT EFFECTS OF OSCILLATING MAGNETIC FIELDS ON RADICAL PAIR RECOMBINATION IN ENZYME KINETICS. C. Eichwald and J. Walleczek. Bioelectromagnetics Laboratory, Department of Radiation Oncology-AO38, School of Medicine, Stanford University, Stanford, California 94305-5124, USA.

OBJECTIVE: We have recently proposed the possibility of low-frequency-dependent effects of oscillating magnetic fields ($f \approx 1 - 1,000$ Hz) on radical pair recombination kinetics in biological systems, in particular on magnetic field-sensitive enzyme systems [1]. Others have argued against the possibility of such effects, because of the different time scales involved; radical pair recombination takes place in the nanosecond time domain, compared to the millisecond time scale of the external field oscillations [2]. In this contribution we test the theoretical feasibility of our proposal by studying a model of a magnetic field-sensitive enzyme system. The response behavior of the enzyme to low-frequency pulsed as well as to combinations of static and sinusoidally oscillating magnetic fields is investigated.

METHODS: A previous model of an enzyme reaction cycle that includes the generation of a transient spin-correlated radical pair state is the starting point for this investigation [3]. Model calculations combine methods from enzyme kinetics studies with a quantum-statistical description of magnetic field-sensitive radical pair recombination kinetics.

RESULTS: Calculations show that the enzyme behaves like a frequency sensor that is responsive at low field frequencies but less responsive at frequencies that are much faster than the time-scales inherent in the kinetic properties of the reaction cycle. There is a characteristic transition region in the frequency domain that reflects the enzyme's relaxation behavior to time-dependent external perturbations. Figures a, b (solid lines) show as a function of magnetic field frequency (a) the oscillation amplitudes of an intermediate enzyme-substrate complex, x , and (b) the phase shift between the oscillations in x and the external magnetic field. Investigations with combined static and oscillating magnetic fields reveal a variety of oscillation patterns of the intermediate enzyme substrate complexes and of the enzyme reaction rate in dependence on combined magnetic interactions.

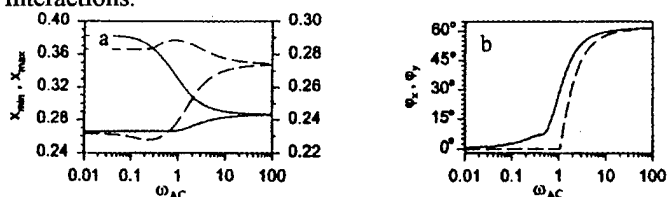

DISCUSSION: Model simulations show that low frequency-dependent effects from magnetic fields may arise as a

consequence of system-inherent time dependencies of the exposed biological system. These dependencies have their origin in the kinetic properties of the enzyme reaction cycle. Thus, time-dependent magnetic fields could be used as a tool to study the response behavior of magnetic field-sensitive enzymes. In conclusion, we find that our proposal [1] is consistent with the results of this study. They show that time-dependent magnetic field effects within biochemical or biological systems may be more complex than previously discussed by others [2].

References:

- [1] Walleczek (1995) *ACS Adv. Chem.* 250, 395-420; Eichwald and Walleczek (1996) *Bioelectromagnetics* 17, 427-35;
- [2] Scaiano, Cozens and Mohtat (1995) *Photochem, Photobiol.* 62, 818-29; Brocklehurst and McLauchlan (1996) *Int. J. Radiat. Biol.* 69, 3-24;
- [3] Eichwald and Walleczek (1996) *Biophys. J.* 71,623-31.

K-2

ELECTROMAGNETIC FIELDS AND SELF-ORGANIZED, NONLINEAR DYNAMICAL STATES: METHOD FOR STUDYING FIELD EFFECTS ON THE PEROXIDASE-OXIDASE OSCILLATOR. J.J.L. Carson and J. Walleczek. Bioelectromagnetics Laboratory, Department of Radiation Oncology, A0-38, School of Medicine, Stanford University, Stanford, California 94305-5124, USA.

OBJECTIVE: We have proposed the possibility of frequency-dependent effects of oscillating magnetic fields on radical pair recombination kinetics in biological oscillators [1]. To experimentally test the validity of this hypothesis we have selected the peroxidase-oxidase (PO) oscillator as a model. Recently, the PO enzyme was found to be magnetic field-sensitive through the radical pair mechanism [2]. With this biosystem we have been able to observe stationary, oscillatory and chaotic dynamical states. However, we have been unable to maintain the PO oscillator in a defined dynamical state for a period suitable for magnetic field perturbation experiments. Here we report on a new technique for maintaining the PO oscillator in a dynamical state for an extended period. This will enable us to verify whether or not concepts of self-organization should be included in models of magnetic field interactions with biosystems.

METHODS: We have previously studied the PO oscillator using a well-stirred semibatch reactor loaded with a phosphate-buffered solution of horseradish peroxidase (HRP), methylene blue (MB) and 2,4-dichlorophenol (DCP); infused with NADH; and supplied with O_2 using a controlled mixture of O_2 and N_2 in the headspace above the reaction [3]. With this technique we were able to observe steady, oscillatory and chaotic dynamics in dissolved O_2 and various reaction intermediates (using absorbance spectroscopy). However, these states were relatively short-lived and difficult to reproduce due to uncontrolled degradation of NADH in the reactor. To overcome these limitations we redesigned the experimental setup moving from a semibatch reactor to a

truly open flow reactor. During open flow experiments, fresh reactants (Mix 1, Mix 2) were continuously supplied to the reactor at a fixed rate through inflow ports and spent reactants were removed at an identical rate through an outflow port. Oxygen delivery was controlled by purging both mixtures to a known O₂ concentration prior to infusion. This feature eliminated the complexities of a gas headspace and enabled the precise and reproducible delivery of O₂. It also decoupled O₂ delivery from stirring effects, which is not possible with batch or semibatch reactors.

RESULTS AND DISCUSSION: To verify the ability of this technique to maintain a stable oscillatory state, we carried out the open flow experiment shown in the Figure. The time course of dissolved O₂ demonstrated PO oscillations whose stability exceeded that observed with the semibatch reactor. It also illustrated the high level of resolution achievable, revealing that the PO system is ideal for examining potentially frequency-dependent influences of oscillating magnetic fields.

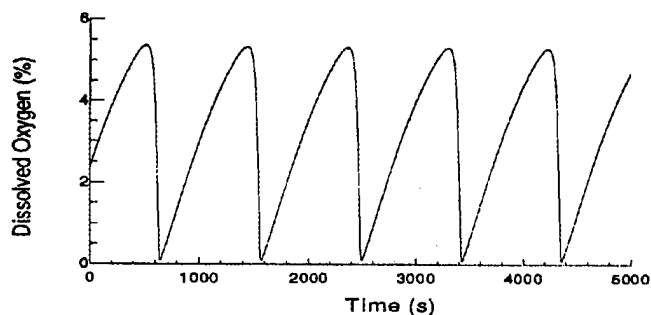

Figure. Sustained oscillations from the peroxidase-oxidase enzyme system (28.0±0.1°C). Mix 1: 20U/ml HRP; 8U/ml glucose-6-phosphate dehydrogenase; 451aI/min; 20% O₂. Mix 2: 49mM glucose-6-phosphate; 400gM NAD; 451aI/min; 20% O₂. Both mixtures also contained 0.1gM MB, 50tam DCP, 0.1M MES at a pH of 6.10. Reactor volume = 2.5ml.

References:

- [1] Walleczek (1995) ACS Adv. Chem. 250, 395-420.
- [2] Grissom (personal communication).
- [3] Carson and Walleczek (1996) US Dept. of Energy Contractors Review, San Antonio, TX.

Supported by US Dept. of Energy, Fetzer Institute and MRC of Canada.

K-3

TWO THEORETICAL MODELS EXAMINE THE PC-12 CELL RESPONSE TO PARALLEL AC AND DC MAGNETIC FIELDS. J.P. Blanchard¹, G. D'Inzeo² and A. Palombo². ¹Bechtel Corporation, San Francisco, CA 94119-3965 USA. ²Dept. Of Electronic Eng. University of Rome "La Sapienza", Italy.

Experimental data provides a way of measuring how well theoretical models describe actual physical processes. Previous analyses revealed a good fit between the predictions of an ion parametric resonance (IPR) model and the response of at least two biological systems (PC-12 cells and Clone-9

cells) to controlled variations in parallel AC and DC magnetic fields. The consistency of fit persisted over more than two non-linear cycles of the response function predicted by the IPR model (1). While the IPR model does not consider damping of molecular interactions imposed by the environment of an ion, recent works (2, 3) begin to consider the impact of damping on theoretical predictions on the basis of Lorentz-Langevin approach. This approach considers the influence of the local viscosity experienced by ions at a subcellular scale and examines its influence on the motion of particles (ions) influenced by those magnetic fields. In particular D'Inzeo et al. obtained a closed form solution for the case of parallel AC and DC magnetic fields and compared its predictions against several sets of experimental data reported in the literature. They identified a range of values for the viscosity parameter that allowed a fit between theory and experiments (3). Here the predictions from this closed form of solution of the D'Inzeo model and the predictions of the IPR model are compared against the PC-12 data (1). This was done in order to (a) test whether the D'Inzeo model, in its present form, could provide a more accurate prediction of the data than the IPR model, (b) examine the sensitivity of the D'Inzeo model to small variations in key parameters, and (c) identify whether those variations could be responsible for distinct characteristics of the observed response of PC-12 cells to magnetic fields. Although preliminary results indicate the current D'Inzeo model does not fit the experimental data as the IPR model does, the D'Inzeo model may provide additional insight into possible submolecular level processes influenced by magnetic fields.

(1) C. F. Blackman, J. P. Blanchard, S. G., Benane, D.E., House, "The ion parametric resonance model predicts magnetic field parameters that affect nerve cells", *FASEB J*, vol 9, 1995, pp. 547-551.

(2) Chiabrera *et al.*, "Water concentration and dielectric permittivity in molecular crevices", *Il Nuovo Cimento*, 11D: 7, 1989.

(3) G. D'Inzeo, A. Galli, A. Palombo, "Fitting between theoretical and experimental data for ELF ion transport effects", *Medical & Biological Engineering & Computing*, vol 31, July 1993, pp. 580-586.

Funding for JPB was provided by the United States Department of Energy through its contractor, Lockheed Martin Energy Systems, Inc. (Subcontract No. 62X-SU524V, Prime Contract No. DE-AC05-84OR21400).

WEAK COMBINED MAGNETIC FIELD, TUNED TO THE PARAMETRIC RESONANCE OF THE NUCLEAR SPINS OF HYDROGEN ATOMS, INCREASES PROLIFERATIVE ACTIVITY OF NEOBLASTS IN REGENERATING PLANARIANS. V.V. Lednev¹, L.K. Srebnitskaya¹, E.N. Ilyasova¹, Z.E. Rojdestvenskaya¹, A.N. Klimov¹ and K.P. Tiras². ¹Institute of Theoretical and Experimental Biophysics, ²Institute of Cell Biophysics, Russian Academy of Sciences, Poushino, Moscow Region 142292, Russia.

OBJECTIVES: Earlier we have shown [1,2], that weak combined magnetic fields (CMF), tuned to the parametric resonance of such ions as Ca^{2+} , Mg^{2+} and K^{+} substantially affects the rate of regeneration of flatworms, planarians *Dugesia tigrina*, after amputation of their head portions. The field's effect was estimated by the changes in the value of mitotic index, ΔMI (%), in the pool of undifferentiated cells (neoblasts) located just under the wound. While the effects of the ion-tuned CMF on the biosystems are comparatively well substantiated by experimental and theoretical data, there is a great deal of controversy concerned with the possibility to affect biosystems via the interaction of weak magnetic fields with the nuclear spins of some atoms present in biosystems such as ^1H , ^{39}K , ^{23}Na , ^{35}Cl , ^{14}N and ^{31}P (compare [3,4,5]). Here we present the experimental evidence demonstrating that weak CMF tuned to the parametric resonance of the nuclear spins of hydrogen atoms, ^1H , affects the rate of regeneration of planarians by the amount similar to that achieved with the Ca^{2+} -tuned CMF [6].

MATERIALS AND METHODS: The species of planarians used, the method of rearing them, the technique employed to determine the MI and the exposure system have been described earlier [1,2]. The measurements of the MI in "experimental" and "control" animals were performed after 24 hours of regeneration. Regenerating planarians were exposed to the CMF composed of collinear static, B_{DC} , and alternating (sinusoidal), $B_{\text{AC}} * \cos 2\pi ft$, components, where B_{DC} , and B_{AC} denote the magnetic flux densities. The later was tuned to the Larmor frequency of ^1H nuclear spins according to the equation $f_{\text{AC}} (\text{Hz}) = 42.577 * B_{\text{DC}} (\mu\text{T})$. The values of B_{AC} and B_{DC} were selected depending on the purpose of the experiment.

RESULTS AND DISCUSSION: In regenerating planarians exposed to the CMF tuned to the parametric resonance of ^1H nuclear spins ($B_{\text{DC}} = 42.70 \pm 0.01 \mu\text{T}$, $B_{\text{AC}} = 1.84 * B_{\text{DC}} \cong 78.5 \pm 0.7 \mu\text{T}$, $f_{\text{AC}} = 1818.0 \pm 0.1 \text{ Hz}$ - experimental field, $B_{\text{DC}} = 43.00 \pm 0.01 \mu\text{T}$ - control), the value of MI averaged over six experiments increased by about $46 \pm 10 \%$. CMF tuned to the second subharmonic of the basic (Larmor) frequency is also biologically effective: maximum and minimum values of ΔMI ($30.5 \pm 9\%$ and $2.0 \pm 8\%$) were found correspondingly at $B_{\text{AC}}/B_{\text{DC}} = 1.5$ and 2.6 in accordance with the theory.

The $B_{\text{AC}}/B_{\text{DC}}$ -dependence of bioeffect was determined using CMF with $B_{\text{DC}} = 20.87 \pm 0.01 \mu\text{T}$, $f_{\text{AC}} = 889.0 \text{ Hz}$, $B_{\text{AC}}/B_{\text{DC}} = 0.0; 0.5; 1.0; 1.8; 2.6$ and 3.8 for the experimental animals

and static field, $B_{\text{DC}} = 20.90 \pm 0.01 \mu\text{T}$, for the animals in control. The experimental points were found to be well approximated by the theoretical curve - squared Bessel function of the first order, $J_1^2 (B_{\text{AC}}/B_{\text{DC}})$.

The value of bioeffect is frequency dependent: the half width at half maximum equals $\lambda = k/2\pi = 4.2 \text{ Hz}$, where $k = 26.4 \text{ sec}^{-1}$ is the rate of the transient process, which proceeds with participation of the particular hydrogen atoms interacting with magnetic field.

Significant, that the obtained value of k is close to the dissociation rate of Ca^{2+} from the "strong" Ca^{2+} -binding sites in Ca^{2+} -dependent enzymes. Therefore, it is possible to suggest, that ^1H -spin-tuned CMF interacts with the hydrogen atoms involved into rather labile intraenzyme hydrogen bonds conveying subtle conformational changes in the Ca^{2+} -dependent biochemical reaction.

It is likely, that the same hydrogen atoms, may be involved in the effects of the H^{+} -tuned CMF on the neurone outgrowth [7] and on the regeneration of planarians [8]. The attempts to explain these effects as a result of CMF interaction with H^{+} -ions in a bulk solution are not compatible with an extremely short life-time of such ions in the same environment; in addition there is no reason to accept the charge of these protons equal to 1. The effect of the "near-zero" static magnetic field on the rate of neoblasts proliferation in regenerating planarians [1] seems to be also conveyed via ^1H nuclear spins.

In disagreement with the data of Jafari-Asl *et al* [3], we have not observed bioeffects of ^1H -spin-tuned CMF with perpendicular directed B_{DC} - and B_{AC} -components.

CONCLUSIONS: Contrary to some theoretical predictions [5] our data demonstrate unambiguously, that weak magnetic fields do affect biosystems via interaction with nuclear spins of the particular hydrogen atoms. The frequency- and $B_{\text{AC}}/B_{\text{DC}}$ -dependencies of the observed effects may be at least formally accounted for in the frame of the magnetic parametric resonance theory (in biosystems).

References:

1. Tiras KhP, Srebnitskaya LK, Ilyasova EN, Klimov AA, Lednev VV. 1996. 18th Annual Meeting of the BEMS, Victoria, Canada, June 9-14, p.235; *Biofizika*, 1996, v.41, n.4, pp. 825-831 (In Russian).
2. Lednev VV, Srebnitskaya LK, Ilyasova EN, Rojdestvenskaya ZE, Belova NA., Klimov AA, Tiras KhP. 1996. 18th Annual Meeting of the BEMS, Victoria, Canada, June 9-14, p.63; *Biofizika*, 1996, v.41, n.4, pp. 815-824 (In Russian).
3. Jafari-Asl AH, Solanski SN., Aarholt E, Smith CW. *J. Biol. Phys.*, 1992, v.11, 15-22.
4. Polk C. *Bioelectromagnetics*, 1992, Suppl.1,209-235.
5. Adair RK. *Physical Review A*, 1991, v.48, 1039-1048.
6. Lednev VV., Srebnitskaya LK., Ilyasova EN., Rojdestvenskaya ZE., Klimov AA., Tiras KhP. 1996. *Dokl. Acad. Nauk*, v.348, n.6, pp.830-833. (In Russian).
7. Trillo MA, Ubeda A., Blanchard JP, House DE, Blackman CF. *Bioelectromagnetics*, 1996, v.17, 10-20.
8. Lednev VV, Srebnitskaya LK, Ilyasova EN, Klimov AA, Tiras KhP. 1997. see an accompanying Abstract.

Supported by RFFI Grant No. 95-04-11739.

K-5**PC-12 CELL RESPONSE TO PARALLEL AC AND DC MAGNETIC FIELDS TUNED FOR CALCIUM IONS.**

C.F. Blackman¹, S.G. Benane¹, J.P. Blanchard² and D.E. House¹. ¹NHEERL, U.S. Environmental Protection Agency, Research Triangle Park, North Carolina 27711, USA. ²Bechtel Corporation, San Francisco, California 94119, USA.

A clear consistency has been demonstrated under a variety of conditions (1-4) between the neurite outgrowth (NO) response of PC-12 cells exposed to parallel AC and DC magnetic fields tuned for Mg²⁺, Mn⁴⁺, and H⁺ ions and the predictions of the Ion Parametric Resonance (IPR) model. We recently extended the ions tested using the PC-12 system by tuning for Ca²⁺ resonance (Bdc = 590 mG; fac = 45 Hz) and varying the magnitude of the AC field from 250 to 620 mGrms. According to the IPR model, this exposure may also be resonant for Co³⁺, Ni³⁺ and Fe³⁺. The treatment and assay of the PC-12 cells used in this test was consistent with previous protocols: frozen PC-12 cells primed with nerve growth factor (NGF) were thawed, rinsed, then plated on six dishes with 5 ng/ml NGF, an amount shown to stimulate neurite outgrowth (NO) in half the population of cells when not exposed to controlled levels of parallel oriented AC and DC magnetic fields. Four additional dishes of cells not exposed to magnetic fields served as controls: two dishes not treated with NGF were used to establish the minimal response (e.g., 0% NO), and two dishes treated with 5 ng/ml NGF were used to establish the reference response (e.g., 100% NO). Note that in this assay scheme, a reported response of more than 100% in exposed cells would indicate the magnetic field exposure enhances neurite production beyond that stimulated by NGF alone, whereas a response of less than 100% would indicate a reduction in neurite production stimulated by NGF. Six dishes containing PC-12 cells with NGF were stacked on the center line of Helmholtz-configured coils in a region of decreasing AC magnetic field flux density. All of this was contained in a mu-metal box in a CO₂ incubator maintained at 37°C. Following a 23-hour exposure to magnetic fields, we observed a consistent reduction in the NO response by the cells over the range tested in four replicate exposures (see Figure below), with the minimal response (37%) occurring when the AC magnetic field flux density was 377 mGrms. This value, corresponding to 2Bac(pk)/Bdc = 1.8, is consistent with the predictions of the IPR model.

References:

1. Blackman, C.F., Blanchard, J.P., Benane, S.G., House, D.E. Empirical Test of an Ion Parametric Resonance Model for Magnetic Field Interactions with PC-12 Cells. *Bioelectromagnetics*, 15:239-260, 1994.
2. Blackman, C.F., Blanchard, J.P., Benane, S.G., House, D.E. The ion parametric resonance model predicts magnetic field parameters that affect nerve cells. *FASEB J*, 9:547-551, 1995.
3. Trillo, M.A., Ubeda, A., Blanchard, J.P., House, D.E., Blackman, C.F. Magnetic fields at resonant conditions for the hydrogen ion affect neurite outgrowth in PC-12 cells: a

test of the ion parametric resonance model. *Bioelectromagnetics*, 17:10-20, 1996.

4. Blackman, C.F., Blanchard, J.P., Benane, S.G., House, D.E. Effects of AC & DC magnetic field orientation on nerve cells. *Biochemical and Biophysical Research Communications* 220: 807-811, 1996.

This abstract does not reflect EPA policy. Partial support for this work is through an interagency agreement with the Department of Energy, Office of Energy Management, IAG# DE-AI01-94CE34007.

Neurite Outgrowth Response in PC-12 Cells Exposed to Magnetic Fields Tuned for Calcium Resonance

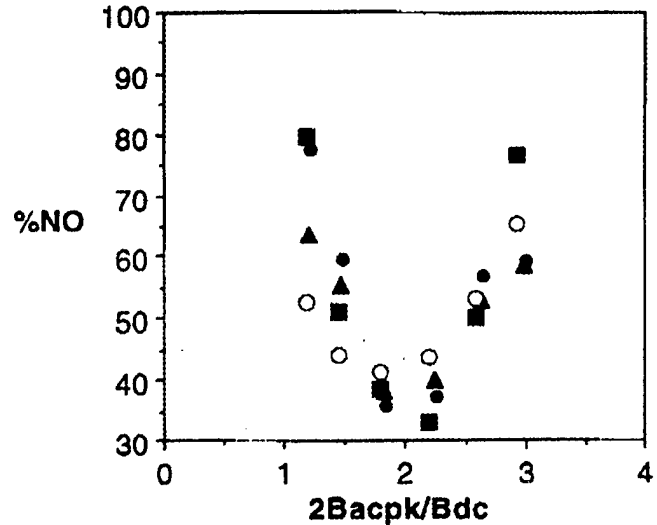
**K-6**

NONLINEAR MODELS FOR BIOLOGICAL SYSTEMS EXPOSED TO EMR.

C.J. Thompson¹, S.Y.S. Yang¹, D.C. Bardos² and K.H. Joyner³. ¹Mathematics Department, University of Melbourne, Parkville, Victoria 3052, Australia. ²Aeronautical and Maritime Research Laboratories, Melbourne, Victoria 3000, Australia. ³Telstra Research Laboratories, Clayton, Victoria 3168, Australia.

Nonlinear models for biological systems, such as the Hodgkin-Huxley model for nerve conduction [1], have been formulated and studied for decades. It is only relatively recently, however, that nonlinear models for interactions between biological systems and EMR have been considered [2]. We have examined several models for cells exposed to EMR where the primary source of nonlinearity is membrane conductance. These include nonlinear cable models for cylindrical cells and modified Fitzhugh-Nagumo models with recovery variables designed to model slower membrane response to potassium activation and sodium inactivation. Modelling cellular end effect with an exponential two-diode cable model produces limit cycle solutions which show strong rectification of the transmembrane potential for large amplitude, low frequency external fields. The cellular response for other combinations of power and frequency is typically quasi-linear and in accord with observations[3]. With a quadratic Fitzhugh-Nagumo form for membrane

conductance the wave form of the cable model in the presence of a sinusoidally varying external field reduces to a generalized forced Duffing oscillator which is known to have kink, solitary wave solutions, as well as limit cycles and chaotic strange attractors for various choices of parameter values[4]. For EMR parameter values, however, the model response is typically quasi-linear over a wide range of power and frequency and systematic perturbation theory recovers generic limit cycle solutions. For the space-clamped Fitzhugh-Nagumo model, which is equivalent to a forced asymmetric van der Pol oscillator, we observe subharmonic and quasiperiodic response to sinusoidally varying external fields over a range of power and frequency. An example is given in the figure where we have shown a phase-plane plot of transmembrane potential (V) vs recovery variable (W). For cells with time constants of the order of milliseconds, membrane peak to threshold and membrane peak to external amplitude ratios of the order of ten we observe narrow bands of quasiperiodic and chaotic behaviour in the frequency range 50-150 Hz. We conclude that nonlinear models for biological systems can show a range of behaviour from quasi-linear limit cycles to subharmonic, quasiperiodic and chaotic response to periodic external fields.

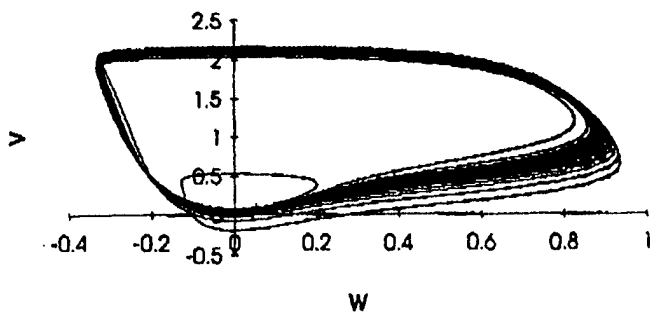

[1] H. C. Tuckwell, *Introduction to theoretical neurobiology* vol.2, Cambridge University Press, 1988

[2] C. Eichwald and F. Kaiser, *Bioelectromagnetics* 16: 75-85 (1995)

[3] A. d'Arsonval, *Arch. Physio. Norm. Path.* 5: 401-408 (1893)

[4] J.M.T. Thompson and H.B. Stewart, *Nonlinear dynamics and chaos*, J. Wiley and Sons, 1988

This research was sponsored by a collaborative Australian Research Council - Telstra Australia Research Grant.

K-7

A COMPARISON OF THE ACTIVATION ENTHALPIES FOR IONIC CONDUCTION IN ANIMAL AND PLANT TISSUE. F.X. Hart. Department of Physics, The University of the South, Sewanee, Tennessee 37383, USA.

The electrical properties of biological materials are determined by the transport of ions. Knowledge of the mechanisms for ionic polarization and conduction could lead to an understanding of how electric and magnetic fields interact with tissues. Furthermore, such knowledge may lead

to an effective correlation between changes in the physiological state of a biological system, such as a phase change in the cell membrane or wall, and variations in its electrical properties. There are two stages in the transport of an ion along a surface, such as a cell membrane: (1) "detrapping" of the ion from a binding site and (2) "hopping" of the freed ion from site to site. An activation enthalpy can be associated with each stage. These enthalpies can be determined by measuring the impedance spectrum of the tissue over a range of temperatures. The impedance spectrum is the variation of the real and imaginary parts, ReZ and ImZ , of the electrical impedance with frequency. A Hewlett Packard 4192A Low Frequency Impedance Analyzer, interfaced to a Hewlett Packard Model 300 personal computer, was used to measure the impedance spectra of apples and of crayfish tail muscle over a range of temperatures from about 15°C to 35°C. At each temperature a complex-valued, non-linear, least-squares fit of the impedance data was made to a three-component circuit model. The basic component of the circuit model was a parallel combination of a resistor and a constant phase angle element (CPE). One component represented the bulk tissue; a second, the electrode-tissue interface. An additional series resistance was required as a third component to model the high-frequency impedance. From the fitted model values the low frequency tissue conductivity and the high frequency power-law exponent and prefactor are obtained. Arrhenius plots of the low-frequency conductivity and the frequency at which ImZ is a maximum yield separate activation enthalpies for the detrapping (H_f) and hopping (H_m). For apples H_f is on the order of kT (0.025 eV) whereas H_m is on the order of 0.15 eV. Preliminary measurements made on crayfish tail muscle yield similar values.

K-8

RESONANCE EFFECTS OF WEAK ELF ON *E. COLI* CELLS AND HUMAN LYMPHOCYTES: ROLE OF GENETIC, PHYSIOLOGICAL AND PHYSICAL PARAMETERS. I.Y. Belyaev^{1,2}, Y.D. Alipov² and M. Harms-Ringdahl^{1,3}. ¹Department of Radiobiology, Stockholm University, S-106 91 Stockholm, Sweden. ²Department of Radiation Physics, Biophysics and Ecology, Moscow Engineering Physics Institute, 115409 Moscow, Russia. ³Biomedical Unit, Swedish Radiation Protection Institute, 117 16 Stockholm, Sweden.

It was proposed that the space-topological organization of cell genome, determined by the DNA interactions with proteins, membranes and micro-medium could be altered by exposure to weak electromagnetic fields (EMF). The sensitive method of measuring these alterations, called anomalous viscosity time dependence (AVTD), was developed and used to evaluate changes in the chromatin (genome) conformational state (CCS) of bacterial and mammalian cells. The effects of weak ELF magnetic field (21 μT r.m.s.) on cells of different *E. coli* K12 strains (AB1157, EMG2, GE499, GE500) and human lymphocytes were studied by the AVTD method within the 6-69 Hz frequency range. We tested whether the

resonance ELF frequencies can be different for cells of different strains. All experiments were run at the fixed static magnetic field which was shown to be critical for studied ELF effects. Four frequency windows with resonance frequencies of 8.9 Hz, 15.5 Hz, 29.4 Hz, and 62 Hz was observed when exposing the AB 1157 cells. In the same frequency range the wild-type EMG2 cells had only three effective windows with resonance frequencies of 8.3 Hz, 27 Hz and 56.5 Hz. The resonance frequencies were very close but significantly different ($p < 0.01$) between these strains. Within the frequency range of 6-24 Hz, two resonances (9 Hz, 16 Hz) and one resonance (8.5 Hz) were observed in response of GE499 and GE500 cells, correspondingly. The data with four strains indicated that shifts in resonance frequencies and appearance of resonances were dependent on genome structure. Based on known genetic differences between strains, a possible genetic determination of the resonance ELF effects on *E. coli* cells is discussed. These data supported an idea that individual response of other cells (i.e. human lymphocytes) may also have a genetic component. In human lymphocytes, the condensation of chromatin increased in response to ELF in contrary to the chromatin decondensation which was observed after ionizing irradiation or treatment with specific compounds such as ethidium bromide and etoposide VP-16 which are known to affect a conformation of DNA and chromatin. The resonance effects of weak ELF on human lymphocytes was observed at 8 Hz and 58 Hz. These frequency-dependent effects differed significantly between studied donors, but were reproducible in independent experiments for the same donors. The data suggested, that the ELF affected the conformation of chromatin in cells of different types at very close frequencies. It has been shown, that cell response to ELF depended on the cell density during exposure, being increased with increase of cell density. The possible role of chemical messengers such as radicals or ions was suggested to explain the cooperative response. Since calcium was necessary for an ELF effect which was measured by transcript levels for *c-fos* and *c-myc* (Karabakhtsian *et al.*, 1994), we run experiments exposing the cells with calcium scavenger EGTA, 5 mM. The ELF effect was halved with EGTA. The radical scavenger glycerol (3%) totally abolished the ELF effect. Thus, both calcium and radicals seem to be involved in cooperative reaction of cells to weak ELF. The DNA-gyrase inhibitor nalidixic acid (1 $\mu\text{g/ml}$) significantly decreased the ELF effect in *E. coli* cells. The results suggested that DNA-gyrase may be involved in the primary reaction of ELF-sensitive cells. The complex dependence of ELF effects on physical, genetic, and physiological parameters is discussed in relation to the problem of reproducibility for ELF effects on cells.

K-9

QUEST FOR BISTABLE BEHAVIOUR IN THE FRÖHLICH SYSTEMS. F. Srobár and J. Pokorný. Institute of Radio Engineering and Electronics, Academy of Sciences of the Czech Republic, CZ-192 51 Praha 8, Czech Republic.

The phenomenon of bistability (or, more generally, multistability) has been in the focus of attention of several sciences (e.g. systems theory, optics, electronics) for the past, say, fifteen years. On the theoretical side this topic touches the ongoing reconstruction of our vision of the world as a substantially nonlinear entity; on the applications side, digital texture of contemporary information processing and storage techniques presupposes availability of vast arrays of bistable elements. In this broad context one can pose a heuristically motivated question: are not some observed properties of the living organisms manifestations of some underlying physical or chemical bistabilities?

We believe one likely candidate for validating this conjecture might be the Fröhlich oscillators system [1] modelling collective behaviour of polar species (protein molecules) embedded in cellular membranes. The model envisages that energy (pumping of the oscillators from metabolic sources) flows through the oscillator system to the surroundings acting as a heat bath. Coupling of the oscillators with the heat bath is both linear and nonlinear. Time evolution of the occupation numbers n_i of common vibration modes under excitation s_i is given by the system of nonlinear coupled kinetic equations

$$\frac{dn_i}{dt} = s_i - \phi_i \{n_i \exp(\beta v_i) - (n_i + 1)\} - \sum_{ij} [n_i (n_j + 1) \exp(\beta v_i) - (n_i + 1) n_j \exp(\beta v_j)]$$

($\beta = h/kT$, v_i is frequency of the i th mode, ϕ_i and X_{ij} are the linear and nonlinear transition probabilities, respectively.)

In [2] we used an original version [3] of the signal flow graph method to analyse causal patterns implied in the kinetic equations. (The basic convention: differential relation $\delta y = t_{xy} \delta x$ is represented by the diagram $x \rightarrow y$; t_{xy} is termed the *transmission function* of the diagram edge xy . Diagrams are composed of such atomic units.) The result of this study for the case of three oscillators is shown in the figure. Uniform pumping $s_1 = s_2 = s_3 = s$ is assumed. The diagram depicts situation in which change in pumping, δs , is considered as the sole cause of changes in the system (or as the excitatory input of the diagram), and the reaction, δn_1 , is monitored at the output vertex n_1 . The diagram contains five oriented paths connecting input s with the output vertex n_1 (one of them is $ss_1 n_1$) and five closed paths - *feedback loops* (one of them is $loop_1 \equiv n_2 s_3 n_3 s_2 n_2$). The transmission function $t_{sn1} \equiv \delta n_1 / \delta s$ of the whole diagram is given by a fraction containing a regular function in the numerator and the expression $1 - \sum_i t(loop_i)$ (where the sum extends over all five loops) in the denominator. If the latter expression assumes the critical value of unity for two distinct states (as distinguished by two different values of n_1), the n_1 -versus- s characteristic has a sigmoidal shape, which means bistability. Our aim is to find this for a set of realistic parameter values.

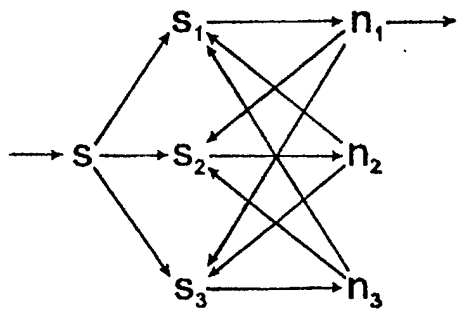

- [1] H. Fröhlich: *Phys. Lett. A* 26 (1968) 402.
 [2] F. Šrobár, J. Pokorný: *Bioelectrochemistry and Bioenergetics* 41.(1996) 31.
 [3] F. Šrobár: *Eur. J. Phys.* 13 (1992) 1.

K-10

EMF SIGNALS, TARGET KINETICS AND THE PREDICTION OF BIOEFFECTIVE WAVEFORM PARAMETERS. A.A. Pilla¹, D.J. Muehsam¹, M.S. Markov¹ and B.F. Sisken². ¹Bioelectrochemistry Laboratory, Department of Orthopaedics, Mount Sinai School of Medicine, New York, New York 10029, USA. ²Center for Biomedical Engineering and Department of Anatomy and Neurobiology, University of Kentucky, Lexington, Kentucky 40506, USA.

INTRODUCTION: The first report of a therapeutic EMF effect on infections using a waveform with a scientific basis appears to be by Ginsberg in 1934, who used bursts of sinusoidal signals in the short wave band, normally used for diathermy, to treat infection (pre-antibiotics). Ginsberg reasoned that at low duty cycles there may be a non-thermal bioeffect. Since then there has been little change in pulsed radio frequency (PRF) signals for therapeutic applications. The more recent emergence of bone repair signals (PEMF) was based on strain generated potentials, Lorentz forces or electrochemical kinetics at cell surfaces and junctions. With the exception of early studies based on the latter, there have been no systematic studies of the dynamics of EMF signal coupling to the kinetics of the target pathway. This work considers the coupling of target kinetics to EMF signals and the choice of optimum waveform parameters.

BINDING KINETICS AND WAVEFORM CONFIGURATION: Analysis of binding kinetics equations yields resistance/capacitance electrical equivalent circuit analogs. This, along with recently available knowledge of kinetics from, e.g., enzyme studies, allows simulations using a wide variety of waveforms, including those in current clinical use. Signals are assessed in the frequency domain with respect to the appearance of a detectable (i.e. SNR≈1) voltage across the pathway with the specific kinetics of the pathway altering the sensitivity to specific signals. The kinetics for ion/ligand binding at molecular clefts have been reported in the 1 Hz-10 MHz time-constant range. Therefore, it is clear that some knowledge of the specific target pathway

to be affected is necessary. An example is the 27.12 MHz PRF signal which typically has bursts <100 μsec repeating at >50/sec, and induces relatively high peak amplitude electric fields (V/cm range) in the tissue target to achieve bioeffects. The frequency spectrum of this signal does not match well with the characteristic low-pass frequency response of the binding pathway. It is clear that this PRF signal should be configured to have higher amplitude frequency components within the bandpass of the target pathway. In a first step this may be achieved by simply increasing the burst width, which allows the peak amplitude and repetition rate to be significantly decreased. An alternate, and somewhat more efficient, approach is to configure the waveform with bursts of pulses vs the sinusoidal waves utilized in clinical PRF signals.

EXPERIMENTAL: A simple version of the above approach has been tested at the enzyme, cellular and animal level using a PRF signal. The current PRF signal in clinical use consists of a 65 μsec burst of 27.12 MHz sinusoidal waves, repeating at 80-600/sec inducing ≈2G peak magnetic field in the target. The reconfigured PRF signal had a 500 μsec burst, repeating at 1/sec, inducing ≈0.2G peak field. Comparison of these signals showed 195% vs 217% (P<.01) increase in myosin phosphorylation; 46% vs 43% (P<.01) increase in neurite outgrowth length from dorsal root ganglia explants; and 43% vs 39% (P<.03) increase in torsional breaking strength in a rabbit fibula model. In all cases the reconfigured PRF signal produced a positive result which was not significantly different from that obtained with the original signal in three vastly different systems.

CONCLUSIONS: The model presented demonstrates tuning EMF signal parameters closer to the kinetics of the target can result in more efficient coupling to the pathways relevant to a desired physiological response. The tuning process induces significantly lower peak amplitude electric fields, resulting in the same SNR, and increasing waveform selectivity with respect to the biological window.

This work was supported in part by the Horace W. Goldsmith Foundation.

K-11

ON A ROLE OF ENDOGENOUS ELECTRIC FIELDS IN A FUNCTIONAL CELL ACTIVITY. E.Z. Gak¹ and N.K. Belisheva². ¹Agrophysical Institute of Saint-Petersburg, 195220 Saint-Petersburg, Russia. ²Institute of Physics, University of Saint-Petersburg, Saint-Petersburg, Russia.

The role of bioelectric fields stipulated by volumetric charges of different phenomenology and functioning of the cells (E. Z. Gak, 1995) has been investigated in continuation of previous works.

OBJECTIVE: As is known (P. Mitchell, 1961, V. P. Sculachev, 1972) the cellular membranes are surrounded along both sides by spatial electric charges of high density ρ_m and low width δ_m , which generate electric fields of order $E_{m,n} \approx 10^2$ kV/cm in the direction normal to the membrane and define to significant degree also the currents flowing through the membrane $j_{m,n}$. As the spatial charge densities are

different on the membrane in respect to the cell surface, therefore the currents flowing through the membrane will also variate. Moreover, tangential electric fields $E_{m,t}$ and corresponding surface currents of density $j_{m,t}$ are generated [L. T. Friedhoff, 1983]. Additionally to spatial charges of density ρ_m there have been early noted the opportunity of generation the macroscopic spatial charges (MSC) outside Mitchell layers with larger length δ_{msc} but significantly lesser density ρ_{msc} , that is $\delta_{msc} \gg \delta_m$, $\rho_m \gg \rho_{msc}$ [E.Z. Gak *et al.*, 1978]

METHODS: Three electrode electrochemical cell filled by aqueous electrolyte has been used as an experimental model of such system. Permanent voltage $U=$ was supplied to cathode and anode. The alternating sinusoidal voltage $U \approx$ or impulse unipolar one were supplied to the system: cathode-moving grid electrode (electrode-grid located between cathode and anode in a distance r from cathode. The volt-ampere characteristics have been measured at different $U \approx$ and r . It was shown that in condition of diffuse kinetics the macroscopic spatial negative diffuse charge ρ was originated in vicinity of cathode outside the double layer δ_{dl} , that is confirmed by the theory [M. Plank is cited by 1975, V. G. Levich, 1958]. This charge is stipulated by diffuse and electromigration processes in electrolytes with cations and anions of different diffusion coefficients. It operates as an electric barrier against access the cathode by cations and brakes the approach of anions, thus being one of the reasons of ultimate currents. Nevertheless, under influence of alternating electric field or impulse positive field this charge may be dispersed. The electric field strength generated by such spatial charge is estimated as 0.1-1 kV/cm relating to the electrolyte contents and its concentration. The charge length is limited by a diffusion layer realized in a space.

RESULTS: Due to the presence in the living systems of low and high molecular cations and anions with different diffusion coefficients, the above charge not only performs but, by our opinion, functions as a preliminary electric barrier for the living cell. But due to generation of the bioelectric field outside the cell, it must stipulate the particular structural characteristics of a medium as well as the variations in its relaxation time under influence of endogenous and exogenous physical impacts that are not lethal for the cell. In living systems the ions have rather large variations in diffusion coefficients, therefore ρ_{msc} and E_{msc} may be considerably larger than in electrolytes that contain only low-molecular ions. In last case E_{msc} may be followed by values of 1 kV/cm, at least [E.Z. Gak *et al.*, 1984, 1995]. Similar considerations correlate with known phenomena of asymmetric electroporation of living cells [E. Tekle *et al.*, 1992]. Thus, the effect of primary destruction of the single living cell permeability by the short-time unipolar voltage pulses supplied to the whole cell begins only from the anode side. Moreover, the electric field strength obtained by the authors in experiments, that is necessary to reduce the cell permeability and then develop the typical electroporation corresponds to the quantitative estimations for E_{msc} of the aqueous solutions (or gels), i.e. $E_{msc} = 1.1$ kV/cm. As an example of functional significance of such charges and their role in metabolism processes in living tissues the generation

of unsteady local electric fields at break-down of the transendothelium cell spatial charges in single blood capillars [E. Z. Gak *et al.* 1995] and larger vessels [M.J. Vinogradova *et al.* 1969] may be noted. It should be also noted that any impacts following by the reduction of total spatial cell charge provide also the reduction of their permeability and electric "outward thrust", that is mostly significant for the blood cells [A.L. Chigevskii, 1990]. Similar phenomena may be observed on various bioobjects during magnetic storms. The man erythrocyte adhesion in microcapillar beds [Ju.J. Garfinkel *et al.*, 1996] enlarges. In the cell cultures of different philogenetic and ontogenetic origin the mass merging takes place for the cells synchronized with sudden variation of the natural electromagnetic field strength [N.K. Belisheva, 1994, 1995]. Finally, it is to be noted that electrical phenomena in living systems are of high functional significance, moreover the electric charge of each cell and of a total living system is not an abstract but a spatial-time cooperative system which is able to interact with endogenous and exogenous influences, cosmic ones among others. As was noted by [V. R. Protasov, 1982], electric phenomena are an objective reality and also an integral part of living system being evidently one of its fundamental properties.

K-12

INTERACTION OF PULSED MAGNETIC FIELDS WITH CELL MEMBRANE STUDIED BY FREQUENCY DOMAIN DIELECTRIC SPECTROSCOPY. C. Cametti¹, G.E. Gigante¹, G. Zimatore¹ and F. Bersani². ¹Dipartimento di Fisica Università di Roma "La Sapienza", Roma 00100, Italy. ²Dipartimento di Fisica, Università Bologna, Bologna 40100, Italy.

The characterisation of the electric properties of biological cell suspensions and biological tissue by means of frequency domain dielectric spectroscopy has become in the last two decades greatly popular in fundamental and applied bioelectrochemistry and, in general, in biophysical field with the availability of high-quality impedance bridge covering the Hz to GHz frequency range.

When an electric field in an appropriate frequency range is applied to an heterogeneous system composed of biological cells dispersed in a continuous medium, a surface electric polarisation appears, leading to a marked frequency dispersion of the electric conductivity and permittivity of the whole system. The parameters characterising the changes of the conductivity and permittivity depend on passive electrical properties of the cytoplasmic cell membrane and offer a totally non-invasive method to investigate their structure and physiology.

In particular, it was possible to follow changes of dielectric properties of individual cells after exposure to physical and chemical agents (ionic strength, pH, temperature), including electromagnetic fields.

In this work, we report some preliminary measurements on the alterations observed in lymphocyte membrane induced by the exposure of the cell suspension to a pulsed magnetic field.

We used suspensions of human lymphocyte prepared using a standard procedure exposed for one hour to a symmetrical square wave pulsed magnetic field having a repetition frequency of 3 Hz and a magnetic field intensity of 1 mT. The magnetic field was generated by a current of 0.5 A passing through a pair of coaxial 40-turn Helmholtz coils 18.5 cm diameter. Conductivity measurements were carried out by means of a conventional impedance technique using a Hewlett-Packard L.F. Impedance Analyser mod. 4192A. The conductivity cell consists of a section of a 50 W characteristics impedance coaxial cable connected to the meter by precision APC7 connector. The cell constants were determined from calibration with standard liquids. The temperature was maintained constant at 20° within 0.1°C. The dielectric spectrum was acquired in the frequency range 10 kHz to 100 MHz, in order to completely cover the region where the conductivity and permittivity dispersions appear. Analysis of data revealed both membrane permittivity and membrane conductivity changes as a consequence of magnetic field exposure. These changes indicate that the magnetic field modifies the ion transport and the ion permeation across the cell membrane. The mechanism at the molecular level responsible for the observed behaviour is not yet understood.

Biological Sciences I

L. Immunology and Cancer

Chairs: Meike Mevissen and Lyle Sasser

L-1

EVALUATION OF 60 Hz MAGNETIC FIELD AS A POSSIBLE COPROMOTOR OF CHEMICALLY INDUCED CARCINOGENESIS IN SKIN OF SENCAR MICE. L.B. Sasser¹, J.E. Morris¹, J. DiGiovanni², T. Rupp², D.A. Johnston², R.I. Kavet³ and L.E. Anderson¹. ¹Battelle, Pacific Northwest National Laboratory, Richland, Washington 99352, USA. ²Science Park Research Division, University of Texas M.D. Anderson Cancer Center, Smithville, Texas 78957, USA. ³Electric Power Research Institute, Palo Alto, California 94303, USA.

Experimentation was undertaken to ascertain if exposure to a 2 mT magnetic field (60 Hz, 6 hr/day, 5 days/week) exerts a copromotional effect on chemically induced skin tumorigenesis in mice. The experimental design allowed assessment of potential effects on tumor development and on early biomarkers of skin tumor promotion. Skin tumorigenesis in female SENCAR mice was initiated by dermal application of a single subcarcinogenic dose of 7, 12-dimethylbenz(a)anthracene (DMBA) and subsequent promotion by repeated (2x/wk) applications of three different doses of 12-O-tetradecanoylphorbol-13-acetate (TPA). Comparisons were made between mice exposed to the imposed field or an ambient field (<0.2µT) during the 23-week promotion period. Each dose-exposure group contained 80 mice. After 1, 2 and 5 weeks of TPA promotion 8 mice

from each dose-exposure group were sacrificed and skin specimens utilized to assess the following early biomarkers of tumor promotion: 1) the induction of epidermal hyperplasia, measured as an increase in epidermal thickness or labeling [bromodeoxyuridine (BrdUrd)] index, 2) the induction of epidermal ornithine decarboxylase (ODC) activity, and 3) the down regulation of epidermal protein kinase C (PKC) activity. Tumor development was assessed weekly by counting skin tumors in mice (56 mice/dose-exposure) maintained for the entire 23-week period. Pilot experiments were performed to select the most appropriate TPA doses and to demonstrate that there were no significant differences in early biomarkers or tumor development between mice housed in a null field within the exposure facility and those housed in an ambient field remote from the exposure facility. The three TPA doses utilized in the study, i.e. 0.85, 1.7 and 3.4 nmol/200µl, yielded an excellent dose response as measured by the number of papillomas/mouse at 23 weeks, i.e. 2.5, 7.4 and 10.6 papillomas/mouse, resp. in mice housed under ambient conditions. Evaluation of the tumor data did not reveal any substantial effect of magnetic field exposure on tumor development, measured as time to first tumor or tumor incidence. Statistical evaluation of the papillomas/mouse after 23 weeks revealed no significant ($p < 0.05$) differences between the ambient and field-exposed groups (see Figure 1). Evaluation of epidermal thickness and labeling (BrdUrd) index (48 hr post-final dosing) and induction of epidermal ODC activity (6 hr post-final dosing) after 1, 2 or 5 weeks of TPA promotion revealed no significant ($p < 0.05$) differences between the ambient and field-exposed groups. Evaluation of the down regulation of PKC activity (6 hr post-final dosing) revealed no significant ($p < 0.05$) differences between the two exposure groups treated with 1.7 or 3.4 nmol TPA; while in the groups treated with 0.85 nmol TPA the field-exposed group exhibited significantly ($p = 0.045$) less down regulation than the ambient group. In summary, under the experimental conditions employed, exposure to a 2 mT (60 Hz) magnetic field did not exert a demonstrable copromotional effect on DMBA/TPA-induced skin tumorigenesis in SENCAR mice. This work was supported by Contract Nos. WO9103-03 and RP2965-30 from the Electric Power Research Institute.

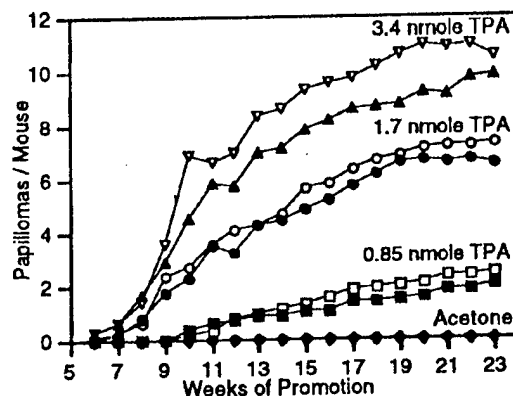

Figure 1. Effect of exposure to a 2 mT magnetic field on the development of DMBA/TPA-induced skin tumors in SENCAR mice. The mean number of papillomas/mouse was measured in mice exposed to the magnetic field (closed

symbols) or an ambient field (open symbols). Mice were promoted using dermal application (2x/week) of 0.85 (squares), 1.7 (circles) or 3.4 nmol TPA (triangles). The acetone controls for the field-exposed and ambient groups, which exhibited no papillomas, are designated by the closed diamonds.

L-2

POWER FREQUENCY MAGNETIC FIELDS AND CANCER. R.C. Miller¹, S. Martin² and E.J. Hall¹. ¹Center for Radiological Research, Columbia University, New York, New York 10032, USA. ²CRC Academic unit of Clinical Oncology, University of Nottingham, Nottingham NG5 1PB, United Kingdom.

Pregnant hamsters were exposed *in utero* to 60Hz power frequency magnetic fields. The Syrian hamster embryo (SHE) model system is sensitive to initiators and promoters of cancer development and therefore has been used for many years to evaluate the carcinogenic potential of both radiation and chemicals as initiators and enhancers of carcinogenesis. The effects of 60Hz power frequency magnetic fields were examined using a magnetic field exposure system for *in utero* studies of Syrian hamster embryos. The Quad-4x system from Columbia Magnetics, Inc. is capable of neutralizing stray magnetic fields while producing a uniform magnetic field virtually free of heat, vibration or visual queues for double-blinded experiments. Magnetic field exposures with a field strength of 2.5 mT were administered for 48 hours to pregnant hamsters in their 7th, 10th or 15th day of gestation. Animals were exposed to magnetic fields alone, 1Gy of 250 kVp X rays alone, 0.1 µg/ml TPA alone or various combinations of magnetic fields, TPA and X rays. While the 9 and 12 day old embryos showed no effects from exposure to magnetic fields, in two separate double-blinded experiments, 15 day old embryos exposed to the X rays followed by magnetic fields and TPA showed a significant rise in morphologic transformants compared to 15 day old embryos exposed to X rays and TPA but no magnetic fields. In subsequent studies, the sequence of exposure was reversed so that late gestational age embryos were first treated to 2.5 mT magnetic fields for 48 hr before being given 1Gy of X rays. Results were similar to previous studies in that magnetic fields significantly enhanced the expression of X-ray induced oncogenic transformation. Studies have now been directed at understanding the mechanism by which power frequency magnetic fields enhance X-ray induced morphologic transformation regardless of the sequence of administration of a carcinogen and magnetic fields.

Supported by Grant RO1 ES07124 from the National Institute of Environmental Health Sciences.

L-3

TWO-YEAR TOXICITY/ONCOGENICITY STUDIES OF 60 Hz MAGNETIC FIELDS IN F344 RATS AND B6C3F1 MICE: FINAL SURVIVAL, BODY WEIGHT, CLINICAL OBSERVATION, AND GROSS PATHOLOGY DATA. D.L. McCormick¹, J.C. Findlay¹, B.M. Ryan¹, T.R. Johnson¹, J.R. Gauger¹, R.L. Morrissey² and G.A. Boorman³. ¹IIT Research Institute, Chicago, Illinois 60616, USA. ²Pathology Associates International, Chicago, Illinois 60616, USA. ³National Institute of Environmental Health Sciences, Research Triangle Park, North Carolina 27709, USA.

Because epidemiologic investigations of the relationship between exposure to magnetic fields and risk of cancer have yielded contradictory results, it appears unlikely that definitive assessments of human risk associated with magnetic field exposure can be developed on the basis of epidemiology data alone. As such, the importance of studies in animal model systems increases. Well-controlled animal studies permit evaluation of the biological effects of magnetic fields *in vivo* under tightly controlled exposure conditions, and in the absence of potential confounding variables. To evaluate the chronic toxicity and potential oncogenicity of 60 Hz magnetic fields, F344 rats and B6C3F1 mice (100/sex/species/group) were exposed continuously (18.5 hrs/day) for two years to linearly polarized, pure sinusoidal 60 Hz magnetic fields at levels of 10 G, 2 G, 20 mG, or 0 G (sham control). A fifth group (100/sex/species) received intermittent (1 hr on, 1 hr off) exposure to 10 G fields for two years. Body weights and clinical observation data were collected weekly for the first 3 months and last 3 months of exposure, and monthly during months 4 to 20. All animals, whether dying intercurrently or surviving until study termination, received a complete necropsy; approximately 50 tissues per animal are being evaluated histopathologically. Magnetic field strength, magnetic field waveform, noise, vibration, temperature, humidity, light, and air flows were monitored continuously in the five identical animal exposure rooms; dc magnetic fields have been mapped extensively in all exposure rooms. Experimentally generated 60 Hz magnetic fields were $\pm 3\%$ of the 2 G and 10 G targets, and $\pm 7\%$ of the 20 mG target at all times during the two-year exposure period. Mean ambient 60 Hz fields to which sham controls were exposed were approximately 0.7 mG. In female rats, survival at two years ranged from 59% to 68% in groups exposed to magnetic fields, versus 60% in sham controls; in male rats, survival in exposed groups ranged from 49% to 59% versus 57% in sham controls ($p > 0.05$ for all comparisons in rats). In female mice, survival in exposed groups ranged from 75% to 79%, versus 71% in sham controls ($p > 0.05$). By contrast, a statistically significant reduction in survival was seen in male mice exposed chronically to 10 G fields: survival in the 10 G group was 62%, versus 77% in male sham controls ($p < 0.02$). Survival at two years in other groups of male mice exposed to magnetic fields ranged from 72% to 84% ($p > 0.05$). Clinical observations revealed no evidence of exposure-related toxicity in any group, including male mice in the 10 G group that

demonstrated reduced survival. Body weight gains were comparable at all times in all groups, and no pattern of tissue effects related to magnetic field exposure was identified on the basis of gross pathology of intercurrent deaths or at the terminal necropsy. The results of these studies demonstrate no evidence of exposure-related toxicity in female rats, in male rats, or in female mice exposed either continuously or intermittently to magnetic field strengths of up to 10 G. Similarly, no toxicity was seen in male mice exposed continuously to magnetic field strengths of 2 G or less, or intermittently to 10 G fields. Evaluation of the biological significance of the reduced survival observed in male mice exposed chronically to 10 G fields, and determination of whether this reduction is related to an altered incidence of neoplasia, will await completion of histopathologic classification of tissues. Comparison of tumor incidences in groups exposed to magnetic fields with both concurrent sham controls and with historical controls increases the ability of the study design to identify rare events, thereby improving the overall power of the experimental design.

Supported by NIEHS (National Toxicology Program) contract N01-ES-25351.

L-4

EFFECTS OF MAGNETIC FIELD EXPOSURE (100 μ T; 50-Hz) ON THE DEVELOPMENT AND GROWTH OF MAMMARY CANCERS IN A DMBA-MODEL OF BREAST CANCER IN RATS: REPLICATE STUDY. M. Mevissen, M. Häubler and W. Löscher. Department of Pharmacology, Toxicology and Pharmacy, School of Veterinary Medicine, D-30559 Hannover, Germany.

OBJECTIVE: Regarding methodological problems of epidemiological studies on 50/60-Hz magnetic fields (MF) showing an increased risk of several types of cancers, laboratory studies are necessary to determine if 50/60-Hz MF may affect tumor development in a manner similar to tumor promoters or co-promoters.

A few years ago we reported that alternating (50-Hz) MF of low flux density exert tumor promoting or co-promoting effects in a model of breast cancer in female rats. Mammary cancers were chemically induced by 7,12 dimethylbenz(a)anthracene (DMBA). At the end of the exposure period (91 days) the incidence of palpable and microscopically visible tumors was 50% higher compared to sham-exposed animals at a flux density of 100 μ T (Löscher *et al.*, *Cancer Letters*, 71, 75-81, 1993).

The aim of the present study was to determine if a replicate experiment carried out in the same laboratory under the same experimental conditions yields a significant increase in tumor development and growth of similar magnitude.

METHODS: Groups of 99 female Sprague-Dawley rats were either sham-exposed or exposed to a horizontally-polarized MF of 50-Hz, 100 μ T (i.e., 1 G) r.m.s., 24h/day, 7 days/week for a period of 13 weeks. The experiment was done in a "blind" fashion, the exposure chambers were identical for MF-exposed and sham-exposed animals. The chemical carcinogen DMBA was administered orally at a dose of 5

mg/rat at the first day of exposure and at weekly intervals up to a total dose of 20 mg/rat. In order to assess the development of the cancers the mammary gland of each animal was palpated weekly. At the end of the exposure period the rats were sacrificed and number and size of macroscopically visible tumors were determined.

RESULTS: The first tumors could be palpated 6 weeks following the first DMBA application in both groups. The MF exposed group tended to exhibit a higher tumor incidence than sham-exposed animals. The difference between the groups became statistically significant after 9 weeks of exposure, when evaluated by the chi-square test. At the end of the exposure period (91 days), the tumor incidence in MF-exposed rats was 30% higher compared to sham-exposed rats, the difference being statistically significant ($P < 0.01$). After autopsy, the incidence of macroscopically visible cancers was 62% in controls, but 83% in MF-exposed animals, the 35% difference between groups being statistically significant ($P < 0.001$).

DISCUSSION: The data again indicate that long term exposure of DMBA-treated female Sprague Dawley rats exposed to an alternating MF of low flux density (100 μ T) promotes the development and growth of mammary tumors, thus strongly indicating that MF exposure exerts tumor promoting and/or co-promoting effects in the above mentioned model. Besides the presence of "dose-response", reproducibility is a criterion for causality with regard to carcinogenesis. The data show that the effects of MF exposure in the DMBA model of breast cancer are reproducible if the experiment is repeated in the same laboratory. Replicate experiments in other laboratories are under way.

This experiment was supported by the U.S. Department of Energy, Office of Utility Technologies, through Oak Ridge National Laboratory and the Berufsgenossenschaft für Feinmechanik und Elektrotechnik (Köln, Germany).

L-5

THE STIMULATION OF PROLIFERATION OF CARCINOGENICALLY INITIATED INIT/C3H/10T_{1/2} CELLS BY IMPOSING 60 Hz MAGNETIC FIELD: A MAGNETIC FIELD OR A THERMAL EFFECT? S.W. Hui, Y.L. Zhao and P.G. Johnson. Membrane Biophysics Laboratory, Biophysics Department, Roswell Park Cancer Institute, Buffalo, New York 14263, USA.

The INIT/C3H/10T_{1/2} transformed mouse fibroblasts cell line was used to test the hypothesis that 1-4 gauss, 60 Hz magnetic field (MF) may act as a carcinogenic promotor. These cells have been carcinogenically transformed by methylcholanthrene, but the expression of the carcinogenic phenotype is suppressed indefinitely by the presence of 0.3 μ g/ml of retinoic acetate (RAC) in the culture medium. Upon the withdrawal of RAC, carcinogenic expression is observable as the lost of contact inhibition in 1-3 weeks, depending on plating density. (Mordan *et al.*, *Carcinogenesis*, 3, 279-85, 1982).

Cells were exposed or sham-exposed to 1 to 4 gauss (rms) 60

Hz magnetic fields, generated by two identical pairs of square shaped 37 cm x 37 cm Helmholtz coils, in matching Forma 3158 incubators 3 meters apart. The magnetic field is uniform to 1% within the central zone of 17 cm x 17 cm x 5 cm. Each coil of the two identical pairs of Helmholtz coils may be energized in reinforcing (exposure) or bucking (sham) mode, the latter mode producing a residue field less than 0.05% of that produced by the former. The background 60 Hz magnetic field was less than 0.5 mGauss (rms). Cells were exposed for various durations and sequences, and at various times after RAC withdrawal. At the end of the 8th, 14th and 21st days, ³H-thymidine was added to the culture, and the extent of thymidine incorporation, which is an indication of proliferation, was determined by scintillation counting.

We found that, if ³H-thymidine was added on the 8th day after RAC withdrawal and exposure, MF-exposed cells showed slightly but persistently lower incorporation than did sham-exposed cells, and both had counts significantly higher than those of unexposed cells. The differences diminished if ³H-thymidine was added on the 14th or the 21st day. This finding was echoed by the number of transformed clones found in the culture plates. We also found that the ³H-thymidine incorporation rate on the 8th day after RAC withdrawal was very sensitive to small (0.1°C) and transient (30 min) increases in incubation temperature, without imposing magnetic fields, during the first few days of RAC withdrawal. Both MF and sham exposures caused a slight increase in temperature in the exposed areas within the incubator, and the temperature increase in the sham-exposed area was usually slightly higher than that in the MF-exposed area. The difference became detectable only after several hours of exposure at a field intensity >2 gauss. Cells cultured in the presence of RAC showed none of the above responses.

The differences between ³H-thymidine incorporation rates in MF-exposed, sham-exposed and unexposed cells may be attributed, at least in part, to a slight temperature elevation (~0.1°C) during exposure. This phenomenon is observed only in INIT cells at a time period before the transformed phenotype is fully expressed. Since these cells are extremely sensitive to small temperature increases during their carcinogenic expression process, measurements of magnetic field effects must be made and interpreted with caution.

This work is supported by a grant ES 07091 from the U.S. National Institute of Environmental Health under the RAPID program.

L-6

DIFFERENTIAL INHIBITION OF TAMOXIFEN'S ONCOSTATIC FUNCTIONS IN A BREAST CANCER CELL LINE BY A 12 mG (1.2 μTesla) MAGNETIC FIELD. J.D. Harland, M.Y. Lee, G.A. Levine and R.P. Liburdy. Lawrence Berkeley National Laboratory, University of California, Berkeley, California 94720, USA.

OBJECTIVE: Previously, we have reported that 12 mG (1.2 μT), 60Hz magnetic fields reduce the inhibition of tamoxifen's cytostatic action in the human mammary tumor

cell line MCF-7 [1]. Tamoxifen is a nonsteroidal antiestrogen, the most frequently prescribed drug for the treatment of human estrogen-receptor (ER) positive breast cancer, and known to bind specifically to the estrogen receptor. However, tamoxifen's action is multifactorial; besides its oncostatic activities in ER+ cells, it also inhibits the growth of some ER- breast cancer cells. The latter has been ascribed to tamoxifen's other cellular activities, such as protein kinase C (PKC) inhibition, calmodulin inhibition, and reduction of cell cycle regulators such as D1 cyclins [2]. In an effort to determine a possible site of interaction of the 12 mG field with the cell, we are investigating the effect of the 12 mG field on the action of drugs known to differentially mimic one of tamoxifen's cytostatic activities in MCF-7 cells. Initially, we have looked at 12 mG effects on the steroidal, pure antiestrogen ICI 182,780 which binds to the ER [3], the calmodulin antagonist W-13 [4], and the PKC inhibitor staurosporine.

METHODS: We measure MCF-7 cell growth in a 2 mG vs. a 12 mG field over a seven-day period (seeding density: 0.1 x 10⁵ cells/35mm plate or 1700 cells/0.1 ml in a 96-well plate), using either hemacytometer counts or an automated, colorimetric Promega MTS plate reader assay based on dehydrogenase enzyme activity in metabolically active cells. For field exposures, we employ matched incubators with mu-metal chambers (to eliminate any extraneous magnetic fields) enclosing 4-square Merritt coils. Experiments are blinded with respect to chemical treatments.

RESULTS: We observe a blocking effect of a 12 mG magnetic field of the pure antiestrogen ICI 182,780 at 10⁻¹⁰ M, but not at the dose of 10⁻⁹ M. This blocking effect appears to be even greater than that seen for tamoxifen: from 18% inhibition at 2 mG, to 15% enhancement of growth at 12 mG (p<0.001). This could be interpreted as support for the hypothesis that the estrogen receptor is the site of interaction for the 12 mG field. However, we also find that the 12 mG field has an even greater inhibition of the calmodulin antagonist W-13 (10⁻⁵ M), from 16% inhibition at 2 mG to 28% enhancement of growth at 12 mG (p<0.001). Since W-13 has no reported interaction with the estrogen receptor, the 12 mG field may also interact with the cell at some site other than the estrogen receptor (e.g., one involving [Ca²⁺]_i, calmodulin, and/or PKC). In contrast, preliminary data from one experiment indicate that staurosporine cytostatic activity (PKC inhibition) may not be affected by the 12 mG field (no effect on an average inhibition of 30% by 10⁻⁸ M staurosporine across three days, p>0.85).

DISCUSSION: The activities of a) ER binding (ICI 182,780) and b) calmodulin inhibition (W-13) both appear to be blocked by the 12 mG field, suggesting a possible biological mechanism of interaction involving these two activities. The activity of PKC inhibition (staurosporine) may not be blocked by the 12 mG field based on a preliminary study. Future research will be directed at further characterizing the specificity of the 12 mG field interaction, using site-specific drugs, and measuring ER-ligand binding and ERE gene expression. Furthermore, we will perform these assays in ER- human mammary tumor cell lines, to further delineate the site of interaction.

- [1] Liburdy, R.P., *et al.* (1993). *J. Pineal Res.* 14:89-97.
 [2] Watts, C.K.W., *et al.*, (1995), *Molec. Endocrin.* 9, 1804-1813.
 [3] Wakeling, A.E., *et al.* (1991), *Cancer Res.*, 51, 3867-3873.
 [4] Strobl, J.S., *et al.*, (1994), *Biochem. Pharmac.* 47, 2157-2161.

Supported by the Office of Energy Management, Utilities System Division, U.S. Department of Energy under contract DE-ACO3-76SF00098, the NIH/NIEHS through Project CA07279, and by the Department of Army, US Medical Research and Development Command through Project 2198.

L-7

MAGNETIC FIELDS REDUCE THE GROWTH INHIBITORY EFFECT OF TAMOXIFEN IN HUMAN BRAIN TUMOR CELLS. S.M.J. Afzal, M.Y. Lee and R.P. Liburdy. Lawrence Berkeley National Laboratory, University of California, Berkeley, California 94720, USA.

OBJECTIVE: During the past decade, several epidemiological studies have examined the relationship of occupational exposure of electric and magnetic fields to the cancer of the central nervous system (CNS). Recently, Kheifets *et al.* [1] published an extensive combined meta-analysis of 29 of these occupational exposure studies and concluded that there is a small but significant increase in the incidence of the cancer of the CNS among workers exposed to electric and magnetic fields. Biases were found unlikely to have influenced the outcome of these studies. Furthermore, the risk was found to be higher for gliomas (an excess of ~40%) in workers with some specific job assignments. We have previously demonstrated that environmental-level 12 mG (1.2 μ T), 60 Hz magnetic fields significantly reduce the growth-inhibitory effects of tamoxifen in human breast cancer (MCF-7) cells *in vitro* [2]. Tamoxifen, a synthetic antiestrogen, is currently being used to treat gliomas and anaplastic astrocytomas in human clinical trials [3,4] and has also been shown to inhibit the growth of human glioma cell lines *in vitro* [5]. We therefore decided to extend our ongoing studies of the effects of 12mG fields in blocking/reducing the growth inhibitory effects of tamoxifen to human brain minor cell lines.

METHODS: SF-767 human glioma cells were obtained from the Brain Tumor Research Center Tissue Bank at the University of California, San Francisco. This cell line was derived from a grade 4 malignant glioma and is being maintained at our cell culture facility under uniform, low-level, well-defined 2 mG (0.2 μ T), 60 Hz, sinusoidal magnetic field exposure conditions, as described previously [6]. We characterized SF-767 cell growth during exposure at 2 and 12 mG 60 Hz magnetic fields in the presence or absence of 5×10^{-6} M tamoxifen using identically matched incubators with mu-metal chambers enclosing 4-square Merritt coils. Cell growth was measured under various treatments and exposure conditions for up to 8 days using the Cell Titer 96TM Aqueous cell proliferation assay [7], and experiments were blinded to chemical treatments.

RESULTS: Data from 3 experiments indicate that tamoxifen (5×10^{-6} M) decreases the SF 767 cell growth by 31% ($p < 0.0001$) to that of control under 2 mG exposure conditions during exponential growth (days 4-6). However, under 12 mG field exposure conditions the growth inhibitory effect of tamoxifen was reduced to 16% ($p = 0.0001$). No significant difference in the growth rate of cells was observed between 2 mG and 12 mG 60 Hz magnetic field exposure conditions.

CONCLUSIONS: The present findings suggest that environmental-level magnetic fields reduce the growth-inhibitory effects of tamoxifen *in vitro* in human brain tumor cells. The blocking of tamoxifen's action by EMF is observed in two human cell lines of different origin, i.e., a) human breast cancer cells (MCF-7, epithelial origin) [2], and, as shown here, b) human brain cancer cells (SF 767, glial origin). These observations help in defining the scope of interaction by which environmental-level 60 Hz magnetic fields reduce the antineoplastic effect(s) of tamoxifen.

- [1] L.I. Kheifets *et al.*, (1995) *J. Occup. Environ. Med.*, 37: 1327-1341.
 [2] J.D. Harland and R.P. Liburdy (1995) *BEMS Meeting*, abstr. 3-3; *Ibid* (1996) *BEMS Meeting*, abstr. A-1-1.
 [3] G. Baltuch *et al.*, (1993) *Can J. Neurol. Sci.*, 28: 168-70.
 [4] W.T. Couldwell *et al.*, (1993) *Neurosurgery*, 32: 485-90.
 [5] G. Baltuch *et al.*, (1993) *Neurosurgery*, 33: 493-501.
 [6] S.M.J. Afzal and R.P. Liburdy (1996) *BEMS Meeting*, abstr. P-206B.
 [7] Technical Bulletin 169, *Promega*, 2800 Woods Hollow Rd., Madison, WI 53711.

Support provided in part by the office of Energy Management Utilities Systems Division, U.S. Department of Energy under the contract DE-AC76 SF00098.

L-8

EFFECTS OF ELF MAGNETIC FIELD EXPOSURE ON MURINE IMMUNE SYSTEM. D. Frasca, P. Barattini, D. De Grandis, P. Galloni, C. Goso and C. Marino. Unit of Toxicology and Biomedical Sciences, ENEA, Casaccia, 00060 Rome, Italy.

The immune system seems to be more sensitive to extremely low frequency (ELF) than other systems and several data in literature have been aimed on this object but no determinate findings have been obtained.

Effects of the exposure to electromagnetic field (EMF) at ELF (50 Hz) on the of C57BL/6 female adult mice were investigated. The animals have been exposed to EMF for 6 hours for 5 days for 2 weeks to simulate a professional exposure. Exposure has been performed by a triaxial system composed of 3 groups of 4 coils, designed by ENEA in collaboration with the Dept. of Electronic Engineering, University of Rome, (Marino *et al.*, 1994; Raganella *et al.*, 1994). The four coils have been connected to electric net (50 Hz) by a voltage stabilizer and a transformer. An uniform magnetic field of 2 mT was adopted and generated inside the system where the mice were placed. Mice were sacrificed at different times (1, 7 and 14 days) after the end of exposure and their thymuses and spleens were individually tested for

cell count, proliferative responses and cytokine production. Bone marrow cells were also collected and tested for cell count. Results show that the treatment induced a 50% reduction, as compared to untreated controls, in both thymocyte count and ability to respond to ConA. These effects were still evident at day 14 after the end of exposure. In the spleen, cell count is increased 1 day after the end of the treatment to 150% of the untreated controls and subsequently decreased to 60-75%. No significant effects of the treatment were observed on proliferation of splenic T lymphocytes to ConA, whereas the proliferative activity of splenic B lymphocytes to LPS was decreased to 75% at all times investigated. As to the cytokines produced by spleen cells, both Th1-derived Interleukin (IL-2) and Th2-derived IL-4 were found decreased at 1 and 7 days and recovered to normal levels at day 14 after the end of the treatment. Conversely, the other Th1 cytokine IFN- γ was found increased at all times investigated. No effects of the treatment were evident at the level of bone marrow cells. In conclusion, these preliminary results indicate that exposure of mice to an electromagnetic field induces a long lasting reduction in T and B lymphocyte numbers and functions. Further investigation on the long term recovery of these detrimental effects on the immune system will be considered.

References:

Marino C. *et al.* 50 Hz magnetic field effects on tumoral growth in *in vivo* system. BEMS 17th Annual Meeting. Boston, USA, 1995.

Raganella L. *et al.* Triaxial exposure system providing static and low frequency magnetic fields for *in vitro* and *in vivo* biological studies. *Bioelectrochemistry and Bioenergetics*, 35: 121-126, 1994.

L-9

MITOGEN STIMULATED DNA-SYNTHESIS BY FRESH HUMAN T-LYMPHOCYTES IS NOT AFFECTED BY A ONE GAUSS 60 Hz MAGNETIC FIELD IN THE PRESENCE OF STATIC MAGNETIC FIELDS BETWEEN 0 AND 0.7 GAUSS. S. Mehta¹, K. Johnson¹, D. Blackinton¹, D. Cherlin² and C. Polk².

¹Department of Surgical Research, Roger Williams Medical Center, Providence, Rhode Island 02908, USA. ²Department of Electrical and Computer Engineering, University of Rhode Island, Kingston, Rhode Island 02881, USA.

T-cells isolated from fresh human blood, obtained from 16 different, healthy adult donors (ages 18 to 45 years) were treated with ³H-thymidine and incubated continuously for 72 hours, both with and without addition of the mitogen phytohemagglutinin (PHA). Incubation was inside two identical chambers, supplied with warm, moist air and CO₂ from the same central incubator. One of these "satellite" chambers was subjected to a spatially uniform, vertically oriented 1 Gauss (rms) 60 Hz magnetic field, while in the other, the 60 Hz field was less than 2 mG. In both satellites the horizontal static magnetic field was less than 10 mG and the vertically oriented static field was adjusted at different predetermined locations to values from nominally zero (< .08

G) to 0.71 G. Although in two out of 62 comparisons between ³H-thymidine uptake of 60 Hz exposed cells and 60 Hz unexposed cells, the ratio was relatively high (1.49 and 0.641), it remained near 1 in most experiments. The average ratio in 62 comparisons at the same DC field level (e.g. average number of cells per well exposed to 1 G 60 Hz in the presence of a 0.55 G static field ÷ corresponding number of cells exposed to the same DC field but no 60 Hz field) was 1.041. For specific DC levels (always with a 1 G, 60 Hz field in the "active" satellite) the ratios were 1.007 at 0 DC field (16 cases) and 1.043 at 0.55 G and 0.71 G (15 cases). These numbers apply to experiments performed at cell densities of 10⁶/ml. Similar results were obtained at (0.5) 10⁶/ml and also in experiments over a wider static flux density range (0 to 0.86 G) using blood from 6 different donors. We conclude that proliferation of T-lymphocytes from healthy human donors, as measured by ³H-thymidine, is in general not affected by exposure to a 1 G (rms) 60 Hz magnetic field in the presence of parallel directed static magnetic fields between 0 and 0.8 G, although increases up to 52% and decreases by 36% have been observed with a few donors. It should be pointed out that none of the AC/DC field combinations employed in these experiments corresponded to a Ca²⁺ "resonance" discussed in the bioelectromagnetics literature. Furthermore, absence of an effect on proliferation of immune cells, by itself, does not imply that the applied magnetic field cannot affect other immune cell function, for example through modification of cytokine secretion. Results of experiments measuring effects of field exposure on cytokine secretion are discussed in a separate paper.

This work was supported by grants from NIEHS (R29 ES 05970) and the Johns Hopkins Center for VDT and Health Research.

L-10

LOCAL MICROWAVE HYPERTHERMIA IN TREATMENT OF NEOPLASTIC AND NON-NEOPLASTIC DISEASES OF THE PROSTATE - RELATION OF CLINICAL EFFECTS TO MORPHOLOGIC AND IMMUNOLOGIC RESPONSES.

S. Szmigielski¹, B. Stawarz², J. Ogrodnik², H. Zielinski² and K. Chomiczewski¹. ¹Center for Radiobiology and Radiation Safety of the Military Institute of Hygiene and Epidemiology, 00-909 Warsaw, Poland. ²Department of Clinical Urology, Central Hospital of the Military Medical Academy, 00-909 Warsaw, Poland.

The prostate is a good target for thermotherapy (Th-TR) with use of electromagnetic (radiofrequency [RF] and microwave [MW]) energy, due to convenient conditions for uniform heating both from transrectal and transurethral applicators. However, the distribution of heat during Th-TR in the prostatic tissues depends strongly on technical parameters of the emitting applicators. These parameters determine both the character and range of morphologic changes in the prostatic tissues and the subsequent clinical effects.

Thermosensitivity of prostatic tissues indicates that inhibiting and degenerative phenomena in glandular and epithelial cells

EFFECTS OF 60 Hz MAGNETIC FIELDS ON LEUKEMIA IN RATS. L.B. Sasser¹, J.E. Morris¹, D.L. Miller¹, C.N. Rafferty², K.L. Ebi² and L.E. Anderson¹.
¹Battelle, Pacific Northwest National Laboratory, Richland, Washington 99352, USA. ²Electric Power Research Institute, Palo Alto, California 94303, USA.

can be detected after increasing their temperature above 42°C. At the range of 42-45°C the intensity of the heat-evoked cytopathic effect shows a straight correlation with time of Th-TR, whereas above 45°C more or less expressed symptoms of necrosis are found in morphologic observations. Th-TR can be applied both in advanced prostate cancer (PC) and in non-neoplastic diseases of the prostate, including benign prostatic hyperplasia (BPH) and chronic abacterial prostatitis (CPs), but a different strategy of treatment and different modes of heating should be used for each of these syndromes.

For Th-TR of PC a uniform heating of the whole prostate to 43-44°C is needed. The whole treatment should be divided into 5-10 sessions of Th-TR, applied every 2-3 days to avoid the thermotolerance of neoplastic cells. Morphologic investigations of Th-TR-treated PC revealed symptoms of inflammation of prostatic tissues with diffuse and massive infiltrations of lymphoidal cells. These morphologic changes in the prostate are accompanied by general reaction from the immune system with stimulation of phagocytosing cells (granulocytes and macrophages) during 14 days after completion of Th-TR, followed by activation of T lymphocytes and NK cytotoxic cells. The stimulation of cell mediated immunity in Th-TR-treated PC patients seems to be of clinical relevance, since it was more pronounced in these who responded to Th-TR with transient remissions than in those who did not respond to the therapy.

For BPH two different modalities of Th-TR can be applied - 1. intensive, single (3 hr) heating of periurethral region of the prostate to 45-47°C with local necrosis, followed by scarification, aimed to provide a transient improvement in urination; 2. moderate, repeated (5-10 sessions, 1 hr each) heating of the periurethral region to 43-45°C with limited necrosis and pronounced inflammatory response of the glandular tissues, aimed to provide a longer lasting improvement in urination and benefits in subjective symptoms of BPH. Limited morphologic data on Th-TR-treated BPH indicate that the clinical effects of the therapy depend on type of hyperplasia (glandular v. fibrotic) and range of the inflammatory response to Th-TR. The immune reaction to Th-TR in BPH is detectable, although less pronounced than in PC patients.

For CPs, treatment with Th-TR results in disappearance of subjective symptoms, although it is difficult to prove the benefits in urologic tests. The strategy of Th-TR is generally similar to that applied for PC, but the heating is mostly limited to 42-43°C. Therefore, the heat-evoked inflammation of stromal and glandular tissues is weakly pronounced and no general reaction from the immune system can be found. Nevertheless, the available experience indicates that transrectal Th-TR appears to be a useful alternative for adjunct treatment of CPs.

Associations between exposure to 60-Hz magnetic fields in residential and occupational environments and the incidence of leukemia and other cancers have been reported in human epidemiology studies. We have previously reported results of two studies showing that neither continuous nor intermittent 10 G magnetic fields significantly altered the clinical progression of LGL leukemia in young Fischer male rat recipients of spleen cells from donor rats showing signs of large granular lymphocytic (LGL) leukemia). These results were based on red blood cell indices for two studies. Results presented here extend these data to include white blood cell differentials for the intermittent magnetic field exposure and a comparison of results of both studies.

OBJECTIVE: The objectives of these studies were to determine if continuous or intermittent 60-Hz magnetic fields can alter the clinical progression of leukemia and to evaluate the influence of different cell inoculums on the model system.

METHODS: An animal model for LGL leukemia was developed using the male Fischer rat. Spleen cells from aged leukemic rats were transplanted into young rats, producing leukemia in a relatively short period of time. The time course of this disease can be manipulated by changing the number of cells used in the transplant inocula or by whole body irradiation of the animals with Cobalt-60. Fischer rats were randomly assigned to four treatment groups (18/group) as follows: (1) 10 G continuous field, (2) 10 G intermittent field (off/on at 3 min intervals), (3) Ambient Controls (<1 mG), and (4) Positive Controls (5 Gy whole body irradiation from Cobalt-60 4 days prior to initiation of exposure). The fields were 60 Hz sinusoidal magnetic fields linearly polarized in the horizontal direction. All rats were injected (ip) with either 2.2×10^7 or 2.2×10^6 fresh, viable spleen cells (taken from spleens of live leukemic animals) at the beginning of the study. The fields were activated for 20 hours per day, 7 days per week and all exposure conditions were superimposed over the natural ambient magnetic field. The rats were weighed and palpated for splenomegaly weekly. Hematological evaluations were performed at 0, 5, 6, 7, 8, 9, 10, 12 and 14 weeks of exposure for those rats injected with 2.2×10^7 spleen cells. Rats injected with 2.2×10^6 spleen cells were bled and evaluated at 6, 8, 10, 12, 14, and 16 weeks.

RESULTS: The onset of the disease (splenomegaly) occurred earlier in the 2.2×10^7 group than the 2.2×10^6 group for all exposure groups. Differences in body weight between exposure groups were not detected for either the 2.2×10^7 nor the 2.2×10^6 , except for the positive controls. Peripheral nucleated cells increased dramatically in all treatment groups after onset of the leukemia, with no apparent difference between magnetic field exposure groups. An exception was that the positive control groups developed signs of leukemia

earlier than other groups for both the 2.2×10^7 and 2.2×10^6 treatments.

DISCUSSION: In general, there were no consistent differences between magnetic field exposed groups and the control group for the early parameters evaluated. These data suggest that the 10 G magnetic fields (continuous or intermittent) do not alter the clinical progression of LGL leukemia based on the results of two studies.

Work supported by EPRI under contract RP 2965-16.

L-12

LEUKOCYTES OF CANCER PATIENTS GIVE EVIDENCE OF FUNDAMENTAL PHYSICAL FORCES: A PATHWAY FOR A NEW VIEW. A. Jandová¹, J. Pokorný² and M. Costato³. ¹Institute of Physiology, 1st Medical Faculty, Charles University, 12800 Prague, Czech Republic. ²Faculty of Math. and Phys., Charles University, 12116 Prague 2 and Institute of Radio Engineering and Electronics, Academy of Sciences of Czech Republic, 18251 Prague 8, Czech Republic. ³Department of Physics, Università di Modena, 41100 Modena, Italy.

Adherence to solid state surfaces and cluster formation of CD₄Ly cells, a subpopulation of T lymphocytes, were examined. Adherence properties manifest the leukocyte mediated immunity. In the presence of antigen CD₄Ly cells taken from immunized individuals (e.g. from cancer patients) exhibit decreased adherence to solid state surfaces but these cells mutually interact and form clusters. Cluster formation seemingly contradicts the decreased adherence. Both effects evidently depend on certain long range interactions whose biophysical mechanisms have not been satisfactorily explained and proved yet.

CD₄Ly cells were prepared from venous blood of healthy humans (512 blood donors) and cancer patients (551 patients with ca cervicis, ca endometrii, ca ovarii, and ca mammae). "Specific" tumor antigens were prepared from tumors by means of careful isolation of the immunoactive parts of tumors and purification using high pressure gel chromatography (HPGC). A more detailed description of CD₄Ly cells and antigen preparation is given in [1, 2]. Leukocyte adherence data were given as an index of positivity $IP = M/33$ where M is a relative number (in %) of non adhering cells. The results are negative (no adherence inhibition), positive (adherence inhibition), or suspicious if $IP < 1.3$, ($M < 43\%$), $IP > 1.6$ ($M > 53\%$), and between these limits, respectively. Antigen makes complexes with receptors in cell membranes within 30 min after giving antigen in the suspension.

Fig. 1 shows IP values of CD₄Ly cells of healthy human groups ($IP \leq 0.94$, negative values) and cancer patients ($IP \geq 1.88$, positive values). Meaning of the symbols: C -ca cervicis, HC - healthy control; E - ca endometrii, HE -healthy control; O - ca ovarii, HO - healthy control; M - ca mammae, HM - healthy control. The antigens were prepared from corresponding tumors. CD₄Ly cells taken from immunized humans (cancer patients) from clusters in more than 60% of all cases (Fig. 2). Intense clustering appeared in the initial

time within the first few minutes and was always completed before 20 min elapsed. Clusters of CD₄Ly cells in suspension with antigen are formed if their adherence to solid state surfaces is decreased. CD₄Ly cells from healthy humans with no adherence inhibition do not form clusters.

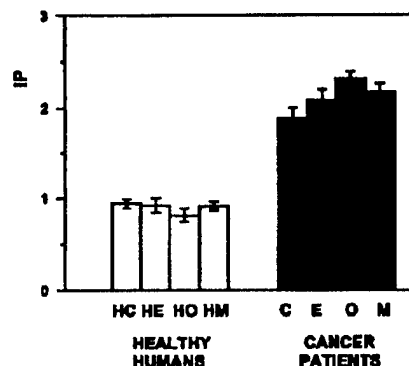

Fig. 1: IP of CD₄Ly.

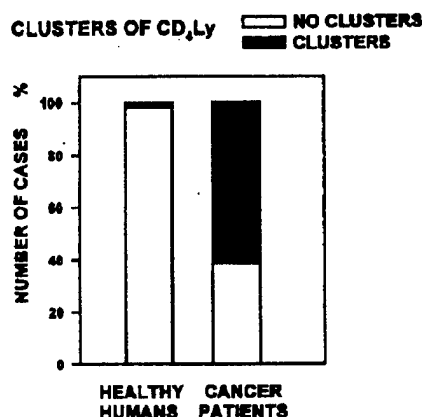

Fig. 2: Clusters of CD₄Ly.

The high frequency electromagnetic field generated by coherent oscillations in cells are assumed to mediate the long range interaction. Antigen makes complexes with receptors in plasma membranes of CD₄Ly which can result in strong damping of oscillations. In the transient period only certain areas of oscillations are damped (the damped "spots" and the oscillating "spots" are distributed randomly) but in the steady state the effect of damping is complete which may explain both cluster formation and decreased adherence.

References:

- [1] Pokorný J., Jandová A., Šorfová J., Kobilková J., Trojan S., Costato M., Milani M.: Leukocytes of cancer patients give evidence of fundamental physical forces: a pathway for a new view. *Laser & Technology* 6, 1996, 1-2, 15-23.
- [2] Jandová A., Kobilková J., Nedbalová M., Šorfová J., Dohnalová A., Trojan S., Pokorný J.: Study of interaction forces in human CD₄Ly. *Bioelectrochem. and Bioenerg.* 41, 1996, 1.

Technology

M. Mobile Telephones and Communication Technology

Chairs: Om Gandhi and Niels Kuster

M-1

BLOOD-BRAIN BARRIER PERMEABILITY IN RATS EXPOSED TO ELECTRO-MAGNETIC FIELDS FROM A GSM WIRELESS COMMUNICATION TRANSMITTER. B.R.R. Persson, L.G. Salford and A. Brun. Lund University, S-221 85 Lund, Sweden.

The mammalian brain is protected from potentially harmful compounds in the blood by the so called blood brain barrier (BBB). It is a selectively permeable, hydrophobic barrier that is crossed by small, lipid-soluble molecules and glucose. The intact BBB protects the brain from damage by toxic substances, whereas a dysfunctioning BBB, allows influx of normally excluded hydrophilic molecules into the brain tissue. This might lead to cerebral edema, increased intracranial pressure and in the worst case, irreversible brain damage.

In the present investigation biological effects of RADIO FREQUENCY electromagnetic fields (EMF) on the blood-brain barrier (BBB) have been studied in Fischer 344 rats of both sexes. We exposed male and female Fischer 344 rats in a Transverse Electromagnetic Transmission line chamber connected to a GSM transmitter. In each experiment we exposed 4 rats with 4 controls randomly placed in excited and non excited TEM-cells respectively. The rats were not anaesthetised during the exposure. In previous studies we have investigated the effect on the BBB of amplitude pulse modulated (217 Hz, 0,57 ms) 915 MHz microwaves.

All animals were sacrificed by perfusion-fixation of the brains under chloralhydrate anaesthesia after the exposure. The brains were perfused with saline for 3-4 minutes, and thereafter perfusion fixed with 4% formaldehyde for 5-6 minutes. Whole coronal sections of the brains were dehydrated and embedded in paraffin and sectioned at 5 μ m. Albumin was demonstrated immunohistochemically and used to detect pathological leakage.

The results indicate that the average ratio of albumin leakage between exposed and controls are about the same both at exposure with 217 Hz modulated 915 MHz microwaves (ratio = 2.3) and with a real GSM transmitter (ratio = 2.1). The compared types of exposure were performed during 2 hours with peak power 0.001-5 W and 0.001-1 W respectively.

M-2

HUMAN STUDIES ON POTENTIAL INFLUENCE OF RF EXPOSURE EMITTED BY GSM CELLULAR PHONES ON CEREBRAL CIRCULATION AND ELECTROENCEPHALOGRAM (EEG). G. Thuróczy¹, G. Kubinyi¹, H. Sinay¹, J. Bakos¹, K. Sipos², A. Lenárt² and L.D. Szabo¹. ¹Research Institute for Radiobiology and Radiohygiene, H-1775 Budapest, Hungary. ²Hungarian University of Physical Education, H-1123 Budapest, Hungary.

Human studies on healthy volunteers (N=76, 45 women aged 48.7 \pm 10.5 year, 31 Men: aged 41 \pm 12.8 year) have been carried out in order to examine the possible acute effects of radiofrequency (RF) exposure emitted by GSM cellular phones. Cerebral circulation and brain electrical activity have been recorded simultaneously before, during and after the intermittent exposure from the common used handy-devices.

In anechoic chamber half-lying position of subjects with close eyes have been exposed to GSM handy-phone. The cellular device was positioned close to the head as the users commonly place during the application. The level of output power and the switching on/off the cellular-phones controlled by computer interface. During the experiment the GSM device have been switch on twice for 7.5 min without the knowledge by the exposed subject. The output power of the handy device was 2 W. The polygraphic curves have been recorded before, during and after the exposure periods

A computer based polygraphic system (CERBERUS) have been used in the experiments including questions subjects about risk factors, stresses, blood pressure, cerebral circulation measurement by using impedance pulse waves of the head (Rheoencephalography - REG; Fp1-F7; Fp2-F8), electroencephalogram (EEG: T5-O1; T6-O2 in bipolar configuration) both of them according to the International 10-20 system of EEG, and ECG (using Einthoven I and II derivation). Data processing of the recorded physiological data included Fourier analysis (FFT), averaging (No = 20) the spectrum of EEG epochs, and automatic cursor operation. Determination of the coordinates of the dominant frequency peak from the EEG power spectrum, and calculation of the pulse wave minimum/maximum time from the REG waveforms and its delay to the ECG R peak and the heart rate (HR). The sampling rate of each channel was 250 Hz. The FFT analysis was made using 256 points with 0.5 Hz resolution (epoch time = 2 s, total analysis time is 40 s). The averaging of the various polygraphic records was triggered by the ECG R peak

In the analyzing procedure the exposed and non-exposed hemisphere have been compared in all variations of the output data. The cerebral circulatory disturbances and electrical activity changes were observed by analyze the disturbances took the form of pulse wave distortion, peak delay, or asymmetry of pulse amplitude of REG and the power spectrum of the EEG. In some physiological variables slight changes have been found during and after the acute RF exposure emitted by GSM handy phone, but the level of measured psychophysiological changes did not exceed the normal autoregulation processes. Difference of baseline

values and response to the exposure have been found in some variables between the women and men. The most definitive changes occurred during the first exposure period in the spectral power of peak frequency of EEG in the alpha band without significant shifting in peak frequency. Simultaneously slight decrease in the cerebral circulation measured during the exposure. We also found changes in the level of anxiety and blood pressure which represent the importance of the measurement the level of stress in the procedure. Otherwise the measurement of cerebral blood flow simultaneously with other psychophysiological variables is important, because the changes in regional cerebral blood flow are also associated with cognitive processing and local cerebral metabolisms.

M-3

VARIATIONS IN ENERGY ABSORPTION BETWEEN HEADS OF CHILDREN AND ADULTS AT 900 MHz AND 1800 MHz. F. Schönborn, M. Burkhardt and N. Kuster. Swiss Federal Institute of Technology (ETH), CH-8092 Zurich, Switzerland.

INTRODUCTION: The testing of mobile phones for compliance with safety standards is currently only performed with phantoms representing the heads of adults. Additional studies on the absorption in children's heads have become necessary, since recently published data [Gandhi] have claimed a significant difference between adults and children.

OBJECTIVES: The objective of this study was to investigate possible differences of the SAR distribution and averaged SAR values for anatomically realistic children's phantoms compared to those for phantoms derived from adult persons.

METHODS: Two head phantoms of children the ages of three and seven were developed for this study based on MRI scans. Ten tissue types were distinguished and the simulations were performed with a spatial resolution of $1 \times 2 \times 2 \text{ mm}^3$. Four different adult heads with similar spatial resolutions were already available, three of which are described in [Hornbach]. Since the objective was to evaluate the differences of the absorption between the heads of children and adults, it was important to have a well defined source at a well defined distance from the head. A 0.45λ dipole was chosen and oriented parallel to the body's axis. The numerical simulations were performed with the software tool MAFIA, which is based on the FDTD like Finite-Integration-Technique.

RESULTS AND DISCUSSION: The spatial peak SAR values averaged over 1 g and 10 g of tissue and normalized to an antenna feedpoint current of 100 mA were 3.8 mW/g and 2.8 mW/g for the 3-year old child and 4.0 mW/g and 2.9 mW/g for the 7-year old child. These values are within the ranges of $3.4 \pm 16\%$ mW/g and $2.7 \pm 14\%$ mW/g found for the four head phantoms of different adults. The small differences are due to anatomical variations. As expected, the ratio of absorbed to emitted power decreases with decreasing head size. The dependency of the SAR_{1g} and SAR_{10g} values to the distance of the antenna was the same for the adult and child phantoms. [Gandhi] simulated the children's heads by

scaling down an adult's head. Since the anatomy of such a head greatly differs from the anatomy of an actual child's head, scaled-down heads were simulated as well to explore the reasons for the different findings. The adult phantom was scaled-down with three different factors (0.93, 0.88, 0.67) to create head phantoms of reduced size, corresponding approximately in size to heads of a seven year old child, a three year old child, and a small baby. The SAR distribution in the scaled down head phantoms differs from that in the full scale phantom only in shifts in maxima and minima caused by shifts in the location of the different tissues due to the scaling. There was no significant difference in the spatial peak SAR values.

CONCLUSIONS: There are no significant differences between adults and children in the absorption of electromagnetic fields at 900 MHz and 1800 MHz. For identical excitation the SAR_{1g} and SAR_{10g} values are not higher for children than for adults, i.e., it is sufficient to perform compliance tests with a shell phantom representing the worst-case shape of an adult head.

References:

O. P. Gandhi, G. Lazzi, C. Furse, "Electromagnetic Absorption in the Human Head and Neck for Mobile Phones at 835 and 1900MHz", *IEEE Trans. Microwave Theory Tech.*, vol. 44, no. 10, pp. 1884-97, Oct. 1996.

V. Hornbach, K. Meier, M. Burkhardt, E. Kuhn, N. Kuster, "The dependence of EM Energy Absorption Upon Human Head Modeling", *IEEE Trans. Microwave Theory Tech.*, vol. 44, no. 10, pp. 1865-73, Oct. 1996.

M-4

AN AUTOMATED SAR MEASUREMENT SETUP FOR COMPLIANCE TESTING OF CELLULAR TELEPHONES: COMPARISON WITH FDTD-CALCULATED SARS FOR SIX COMMERCIAL TELEPHONES. Q.S. Yu, D. Wu, O.P. Gandhi and G. Lazzi. Department of Electrical Engineering, University of Utah, Salt Lake City, Utah 84112, USA.

Determination of peak 1-g SAR is required for the new personal wireless devices in order to ensure that it is within the RF safety guidelines approved by the U.S. Federal Communications Commission. We have developed an automated SAR measurement setup which uses a 3-D stepper motor system to move the Narda Model 26089/BRH-15 internal E-field probe to determine E^2 distributions along three orthogonal axes. Model of the head and neck used for the measurements of the SAR distributions is the previously described Utah Heterogeneous model [1] for which tissue-equivalent materials simulating the electrical properties of skull, brain, eyes, and ears have been used. While a $KC \lambda$ -solution laced epoxy composition is used to form the outer shell of thickness 5-7 mm in the shape of the head and neck, different compositions of water, salt, polyethylene powder, and a gelling agent TX 151 (available from Oil Center Research, Lafayette, LA) are used for ear, eyes, and the brain. To simulate the hand, a composition simulating dielectric properties equivalent to two-thirds muscle is used to fill a thin

surgical rubber glove to create the shape of the hand. The "hand" thus created is wrapped around the cellular telephone under test and the combination held in a block of Styrofoam so that the telephone is in a realistic slanted position against the model of the head at an angle of 30° relative to the vertical.

A coarser sampling with a step size of 4.0 mm is done in the first instance to locate the region of the highest SAR. The region thus identified is then sampled with a finer step size of 2.0 mm along each of the three orthogonal axes. A best-fitting extrapolation algorithm is used to project the SARs thus determined to the internal surface of the model. This is necessary since the miniature dipole sensors used for the Narda E-field probe are somewhat recessed from the front tip of the probe and are, therefore, incapable of measuring the SARs up to the surface of the model.

This automated SAR measurement setup has to date been used for six commercial telephones, three each at AMPS (835 MHz) and PCS (1900 MHz) frequencies, using helical, monopole, or helix-monopole antennas. Using the MRI-derived, anatomically-based, 15-tissue model of the head and neck with a resolution of approximately 2 x 2 x 3 mm, we have also calculated the SAR distributions for the same telephones. Even though peak 1-g SARs from 0.13 to 5.41 W/kg are obtained, agreement between the measured and the calculated data is excellent and generally within ±25 percent.

1. O.P. Gandhi, J. Y. Chen and D. Wu, "Electromagnetic Absorption in the Human Head for Mobile Telephones at 835 and 1900 MHz," *Proceedings EMC'94 Roma-International Symposium on Electromagnetic Compatibility*, Vol. I, pp. 1-5, September 1994.

M-5

IMPLEMENTATION AND CHARACTERIZATION OF AN *IN VITRO* SYSTEM FOR EXPOSING CELL CULTURES TO CELLULAR TELEPHONE FREQUENCY FIELDS. J.A. McDougall¹, K.W. Chan¹, C.K. Chou¹ and A.W. Guy². ¹Department of Radiation Research, City of Hope National Medical Center, Duarte, California 91010, USA. ²WTR, L.L.C., Washington, District of Columbia 20036, USA.

Transverse electromagnetic (TEM) exposure systems have been used to expose cells or animals to radio frequency fields. Test tubes or cell culture flasks are commonly placed either perpendicular or parallel to the electric field. Monolayer cells should be uniformly exposed to RF fields, and the cells should be maintained at a constant temperature to isolate field effects from thermal effects. Coupling of RF energy to the culture medium is highest when the E field is parallel to the long axis of a flask. However, the SAR is nonuniform across the media. The other choice is to expose cells with E field perpendicular to the cell monolayer. The disadvantage is that coupling is much smaller than in the previous case and much more power is necessary to produce high SAR levels. Our tasks were to experimentally test a temperature controlled exposure system previously developed at the University of Washington for exposing a number of vessels containing

monolayer cell cultures. The system is be used for exposing cell cultures at 37°C to 837 MHz fields for two hours at SAR levels of 10, 5, 2, and 1 W/kg.

OBJECTIVE: To instrument and characterize a temperature controlled *in vitro* RF exposure system so that WTR sponsored researchers can conduct experiments on genetic effects of radio frequency radiation *in vitro*.

METHODS: The system consists of TEM cells, a signal generator, a 500 W Kalmus broadband linear amplifier, two 6 liter constant temperature Lauda circulators, and one Luxtron 4 channel fiberoptic temperature sensor. Ancillary components include power meters, directional couplers, attenuators, and high power loads. The system includes a HP Vectra 500 series computer with National Instruments LabWindows/CVI software and a IEEE-488 (GPIB) card. The TEM cells are horizontal in position and have upper and lower brass wall water jackets for temperature control, surrounded by an insulating Styrofoam box. Two fans blowing air through the Styrofoam box and through the upper and lower compartment of the TEM cell keep the cell cultures at a constant temperature. The cell culture flasks are placed on fishnet platforms centered between the central septum and the top or bottom walls of the TEM cell. LabWindows was utilized to control the exposure power, duration, circulator bath temperature, and to monitor incident, reflected and transmitted power, as well as temperatures at various locations in the air and fluid medium. Electromagnetic leakage was measured with a dipole antenna to satisfy FCC rules of 200 µV/m at 3 meter. Steady state temperatures were monitored for various power inputs and circulator water temperatures. Averaged SAR and SAR distributions in the culture medium were calculated from the temperatures measured with the Luxtron sensors.

RESULTS: Leakage tests inside an RF shielded room showed that the Kalmus power generator connected to a load and operating at 500 W emitted 254 mV/m at 3 meters. This is 62 dB above the FCC limit. This result alone, not considering leakages from the cables and TEM cells, prohibit the use of the frequency in an open space. For control samples, the cell culture temperature remains constant during the 2 hour period. For different SAR levels, the temperature of the circulator is set to lower temperatures to compensate for temperature increase due to RF absorption. Because of low wall loss and low energy coupling in this configuration, most energy is absorbed by the load.

CONCLUSION: An automated *in vitro* exposure system is being assembled and characterized to be used for exposing cells to 837 MHz fields at 37°C to various SAR levels.

M-6

EVALUATION AND DESIGN OF AN OPTIMIZED *IN VITRO* EXPOSURE SETUP FOR THE MOBILE FREQUENCY RANGE OF 1.5-1.9 GHz. M. Burkhardt, K. Pokovic, F. Schönborn and N. Kuster. Swiss Federal Institute of Technology (ETH), CH-8092 Zurich, Switzerland.

INTRODUCTION: The difficulties in designing suitable *in vitro* RF exposure setups has often been underestimated in the

past. Shortcomings in the setup make it difficult or nearly impossible to appropriately reproduce an experiment. A number of requirements must be satisfied to achieve the technical conditions for a good experiment: (1) the RF source must be precisely defined in terms of frequency, modulation scheme, power stability and noise level; (2) the field distribution in the cell culture should be as homogeneous as possible; (3) the setup should allow the induction of field strengths which are at least as large as those induced in human tissue in daily life situations and (4) control of the requirements for the environment (e.g., temperature, atmosphere, etc.). In addition, 5) all relevant technical and biological parameters should be monitored during the experiment [1].

OBJECTIVE: Development of an optimized *in vitro* exposure setup for the mobile frequency bands of 1.5 to 1.9 GHz, whereby different possible exposure setups shall be evaluated, e.g., transverse electromagnetic (TEM) cells, radial transmission lines (RTL), waveguides, quasi plane-wave setups, etc. The setup shall satisfy the above requirements and be practical to use and of reasonable cost.

METHODOLOGY: The setup evaluation was performed using two different FDTD codes and the hybrid code GMT++. The near-field scanner DASY2 was used to experimentally assess the field distribution in the exposure setups with E- and H-field probes [2]. The assessment of the resulting SAR distribution in the plane of cells was performed numerically, providing data on the average absorption and standard deviation. These results were experimentally validated by SAR measurements at specific locations in the cell culture either using a newly developed E-field probe or a temperature probe.

RESULTS AND DISCUSSION: The advantages and disadvantages of different RF exposure setups are presented. The efficiency and homogeneity strongly depend on various parameters, such as field polarization, shape of the dish, amount of medium, the location of the cells in the dish, coupling effects, etc. These effects are even more pronounced at 1.6 GHz than at 900 MHz. Different ways of improving the exposure have been investigated. A new setup has been realized and thoroughly analyzed by numerical and experimental means.

References:

- [1] N. Kuster, Q. Balzano, "Experimental and numerical dosimetry" In: *Mobile Communications Safety*, Editors: N. Kuster, Q. Balzano, J. C. Lin, Chapman & Hall, London., pp. 13-64, 1996.
- [2] T. Schmid, O. Egger, N. Kuster, "Automated E-field Scanning System for Dosimetric Assessments", *IEEE Transactions on Microwave Theory and Techniques*, vol. 44, no.1, pp. 105-113, 1996.

M-7

INTEGRATED HANDSET ANTENNA WITH LOW ABSORPTION AND HIGH COMMUNICATION PERFORMANCE. G.F. Pedersen and J. Bach Andersen. Center for Personkommunikation, Aalborg University, DK-9220 Aalborg Ø, Denmark.

There are several goals for the design of integrated antennas for handportables. One is to obtain high antenna performance due to the limited power available, and this goal can be translated into questions of matching, polarization, and mean effective gain seen in the context of practical ergonomic use of the handset. The second goal which has received increasing attention during the recent years is absorption in the human head. The mean effective gain which expresses the communication performance of an antenna, depends on its radiation pattern and the environment in which the antenna operates. This environment includes the head of the operator apart from the general multipath environment. In this work we discuss directive antennas for handhelds with respect to both peak SAR and the mean effective gain, i.e. the performance of the communication. The analysis is based on Finite-Difference Time-Domain (FDTD) analysis of the antenna including the head, as well as measurements of angular information in the environment and mean effective gain.

DIRECTIVE PATCH ANTENNA: In some earlier work [Toftgaard] it was shown how a monopole on a box radiated in the presence of the head of the user. The main effects demonstrated a considerable change in the radiation pattern, including a large change of polarization, and a considerable absorption of the order 50% for close proximity to the head. In [Pedersen] a so-called FS-PIFA (Full Short-circuit Planar Inverted F Antenna) was introduced. The main point is that the current is distributed over the surface of the handset leading away from the head. This has two advantages in the sense that the distribution over a surface leads to low peak density of current (or local SAR, if biological tissue is near by), and in general the casing of the telephone leads to considerable shielding. Measurements of local SAR showed maximum values of 0.1 - 0.2 mW/cm³ for 1W of input power, an order of magnitude below present standards. The average gain as measured in typical environments showed a reduced gain of about 2 dB relative to a halfwave whip on the same phone. This reduction is, however, dependent on the actual materials used. Three years after the initial investigations a commercial GSM-900 handheld has been introduced with a thickness of only 17 mm. Still the shielding is effective with considerable Specific Absorption Rate (SAR) reduction. The communication performance is investigated both as direct measurements in the "real environments" [Bach] as well as calculated mean effective gains [Jakes] in the environment as a function of handset orientation.

As far as the matching is concerned efforts have been made to match the antenna at both duplex frequencies spaced 45 MHz apart, while in between a considerable mismatch can be accepted. Since the antenna essentially is a slot radiator the user's hand should not cover the slot completely, in which case the performance is degraded. The antenna is situated in

such a manner that this is unlikely, and the user is also advised about this phenomenon.

[Toftgaard] Toftgaard J., Hornsleth, S.N., Bach Andersen, J.; Effect on Portable Antennas by the Presence of a Person, *IEEE Trans. Antennas and Propagation*, vol. 41, No. 6, June 1993.

[Pedersen] Pedersen, G.F., Bach Andersen, J.; Integrated Antenna for Handheld Telephones with Low Absorption, VTC Conference, Stockholm 1994.

[Jakes] Jakes, W.C.; *Microwave Mobile Communications*, New York, Wiley & Sons, 1974

[Bach] Bach Andersen, J., Hansen, F.; Antennas for VHF/UHF Personal Radio: A Theoretical and Experimental Study of Characteristics and Performance, *IEEE Trans.* Vol. VT-26, No. 4, November 1977.

M-8

OPTIMIZATION OF HANDSET ANTENNAS TO REDUCE INTERACTION WITH THE USER. H.O. Ruoss and F.M. Landstorfer. Institut für Hochfrequenztechnik, University of Stuttgart, 70550 Stuttgart, Germany.

INTRODUCTION: When using a handset close to the human body a considerable mutual interaction between the antenna and the biological tissue occurs. When investigating this interaction, the main emphasis can be put to either dosimetry or engineering aspects such as the optimization of the antenna. In either case a theoretical and experimental evaluation of the electromagnetic fields is necessary to determine the relevant parameters. These are the specific absorption rate (SAR) in the case of dosimetry and input impedance, radiation patterns, power budget and efficiency when considering the antenna performance. In our work we have developed methods for numerical calculations and measurement techniques in order to design an antenna concept that reduces interaction with the user.

NUMERICAL CALCULATIONS: For the development of a new antenna concept it is advantageous to carry out numerical calculations first (the variation of parameters is unproblematic and can be done very fast) and then to validate these results by measurements. When investigating handset antennas the user's influence has to be taken into account. The main interaction is caused by the human head and hand, for a more sophisticated model neck and shoulder can be added. With models of the human head and hand, simplifications in shape and heterogeneity have to be accepted. Investigations with different head models have shown that a homogeneous sphere is appropriate for investigating the antenna performance, while to evaluate a detailed SAR-distribution a more sophisticated model has to be used. For antenna design we have modified the conventional method of moments, which enables very accurate design of the case and antenna. By using a Green's function method, scattering at a homogeneous dielectric sphere can be considered as well as at a layered one. Hence, calculation requirements (e.g. main memory) can be reduced significantly.

MEASUREMENT TECHNIQUES: Measurements have to prove the validity of theoretical modelling and the results of numerical calculations. For EMC-investigations it is advantageous to apply nearfield scanning techniques (farfield data can accurately be evaluated by an appropriate nearfield to farfield transformation). In most cases head and hand phantoms are used to take the influence of man into account. To generate realistic conditions, the influence of human test persons has to be taken into consideration. Consequently, a number of specific criteria has to be fulfilled by the measurement technique, as conventional nearfield scanning is not applicable. To overcome these drawbacks we have developed new scanning methods (e.g. scanning on a double-cone surface and multiple probe scanning). Measurement results will be presented at the time of the conference.

ANTENNA CONCEPTS: Commercial handsets mostly use monopole antennas with omnidirectional radiation pattern in the azimuth. This yields losses of up to 70% of radiated power in worst-case situations, where the antenna is close to the human head. New conformal antenna concepts (e.g. slot antennas) minimize the electromagnetic fields induced in the biological tissue by causing a minimum of radiation in a small solid angle in direction of the human head. Hence, the absorption factor and the peak SAR-values can be reduced significantly, while antenna performance, stand-by and operating time can be improved. The performance of such a slot antenna concept will also be presented at the time of the conference.

M-9

EXPERIMENTAL AND FDTD-COMPUTED RADIATION PATTERNS OF CELLULAR TELEPHONES IN PRESENCE OF THE HUMAN HEAD. G. Lazzi, S.S. Pattnaik and O.P. Gandhi. Department of Electrical Engineering, University of Utah, Salt Lake City, Utah 84112, USA.

Radiation patterns of some typical cellular telephones have been numerically calculated and compared with the results obtained from measurements. The effect of the human head and hand grasping the telephone has been considered for both numerical and experimental results. Understanding of the grossly altered performance due to the head and the hand is particularly important for the design of handsets with low SAR while maintaining good radiation efficiency. Numerical calculations of the radiation patterns have been performed using the Finite-Difference Time-Domain (FDTD) method. Near- to far-field transformation in the frequency domain has been implemented in the FDTD code, and the radiation patterns in three planes of interest have been obtained. The handsets have been modeled carefully by describing with a reasonable accuracy the antennas and their feeds. Helical antennas, monopoles, and helix-monopole antennas are amongst the considered antennas. For numerical calculations, we have used an anatomically-based model of the human head derived by MRI-scans of a male volunteer, with a resolution of approximately $2 \times 2 \times 3$ mm and with 15 tissue types identified. The hand has, instead, been modeled

by using 2/3 muscle surrounding three sides of the handsets. Experimental radiation pattern measurements have been performed in our laboratory by using a computer-controlled automated set up. The measurements have been done in an anechoic chamber with or without the use of the Utah heterogeneous four-tissue (skull, ear, eyes, and brain) head model and a thin surgical glove filled with 2/3 muscle-simulant homogeneous material representing the hand. In all of the considered situations, the co- and cross-polarized components have been measured in order to characterize the performances of the telephones in various conditions. Both simulations and measurements have been performed using vertical and 30°-tilted positions of the telephone vis a vis the head in order to reproduce realistic positions of a person holding a cellular telephone.

CONCLUSIONS: An automated measurements set-up and the FDTD simulation code can provide extremely useful information on the coupling between the human head and the cellular telephone. These tools can be used for the design of better hand-held devices in terms of radiation performance including coupling with the human head. The FDTD code used as an initial design tool, and the measurements used for verification of the designed prototype, may be extremely helpful for the design of mobile wireless devices.

M-10

SAR CALCULATION AND MEASUREMENTS INTO A NOT-HOMOGENEOUS HEAD LIKE PHANTOM RADIATED AT MOBILE PHONES FREQUENCIES. A. Schiavoni¹, C. Gabriel², P. Bielli¹, G. Richiardi¹ and P. Bertotto¹. ¹CSELT, 10148 Torino, Italy. ²MCL, London E18 2EL, United Kingdom.

INTRODUCTION: CENELEC [1] document considers measurements into four types of phantoms; an homogeneous right or left human head phantom, an homogeneous right and left phantom, a not homogeneous human head phantom and a simplified phantom constituted by a sphere delimited by two parallel planes. All these phantoms are filled with a brain simulating solution whose electromagnetic characteristics are similar to those of the human brain at the working frequency. Beside the measurement, CENELEC standard considers also the use of numerical tools to determine the SAR (Specific Absorption Rate). In previous works we have compared measured and calculated SAR radiated both by a dipole and cellular phones into the homogeneous human head phantom [2]. The aim of this contribution is the comparison between measured and calculated SAR into the not-homogeneous anthropomorphic phantom radiated by a dipole and by cellular phones.

THEORETICAL APPROACH: The electromagnetic problem has been solved by using the FDTD technique developed in a Cartesian system of co-ordinates [3] truncating the grid with PML (Perfect Matching Layer) ABC [4]. A pre-processing system has been used to describe the cellular phone and to approach the phantom to the phone in the right position.

PHANTOM: PHYSICAL AND NUMERICAL MODELS: The phantom is a five tissue-type head model previously described [5]. The numerical model of the phantom has been obtained by taking a MR (Magnetic Resonance) scanning of the phantom. The data obtained by the MR system have been furtherly elaborated so to obtain a 3D array of labels each one corresponds to a tissue constituting the phantom. The numerical representation of the phantom is then re-discretized with the same space discretization step used in the electromagnetic elaboration.

MEASUREMENTS: Measurements will be performed by means of a robotized system [6] which moves a miniaturised E-field probe into the phantom filled with the liquid simulating solution. The probe is moved on a grid into the phantom following the internal surface in order to determine the maximum SAR region. Following to the first scanning a measure on a 3D grid, placed in the maximum SAR region, is performed in order to determine the SAR averaged over cubes of 10.0 g mass.

COMPARISONS: Theoretical and measured results will be compared on SAR averaged on a cube of 10.0 g mass, SAR distribution on the internal surface of the phantom and on the penetration curve. A discussion about errors due to measurements and calculations will be performed.

References:

- [1] "Considerations for human exposure to EMFs from mobile telecommunications equipment (MTE) in the frequency range 30 MHz-6 GHz", 3rd draft, CENELEC, Secretariat SC 211/B, WGMTE 96/4, September 1996.
- [2] Schiavoni A., G. Richiardi, "FDTD analysis of the electromagnetic field into a human head like phantom and comparison with measurements," 13th International Wroclaw Symposium and Exhibition on Electromagnetic Compatibility, June 25-28 1996, Wroclaw, Poland.
- [3] K.S. Yee, "Numerical solution of initial boundary value problems involving Maxwell's equations in isotropic media", *IEEE Transactions on Antennas and Propagation*, May 1966.
- [4] J.P. Berenger, "A perfectly matched layer for the absorption of electromagnetic waves", *J. Computational Physics*, vol. 114, 1994.
- [5] Gabriel, C., 1996, Physical Models for Electromagnetic Dosimetry, in P.J. Dimbylow (Editor): *Voxel Phantom Development, Proceeding of an International Workshop*, NRPB Publications, (UK).
- [6] T. Schmid, O. Egger, N. Kuster, "Automated E-field scanning system for dosimetric assessments", *IEEE Transaction on Microwave Theory and Techniques*, vol.44, no. 1, Jan. 96.

NUMERICAL APPROACHES FOR MICROWAVE BIOELECTROMAGNETIC APPLICATIONS.

S. Caorsi¹, R. Azaro², G.L. Gragnani², A. Massa², M. Pastorino² and M. Raffetto². ¹Department of Electronics, University of Pavia, I-27100 Pavia, Italy (Interuniversity Center for the Interactions between EM Fields and Biosystems). ²Department of Biophysical and Electronic Engineering, University of Genoa, I-16145 Genova, Italy (Interuniversity Center for the Interaction between EM Fields and Biosystems).

In the present paper, we consider several numerical approaches for the computation of the electric field and related quantities (power deposition, specific absorption rate [SAR] distribution) inside a biological body when it is *illuminated* by an incident electromagnetic field. In this context, the effects of the apparatus for personal mobile communications on human health have become, for example, a subject of great interest, as they involve aspects connected both to the analysis of the non-thermal biological effects of the bioelectromagnetic interaction and to the problem of a suitable standardization.

It is usually extremely difficult to provide *a priori* evaluations, starting from the only knowledge constituted by the e.m. source and by the estimated mean values of the permittivity distributions used to model a single biological body. This is the reason for which the present paper addresses both direct and inverse numerical techniques for the evaluation of the internal electromagnetic fields and related quantities, using (as much as possible) actual data on the specific case considered. Concerning the possibility of using inverse methodologies, we focus on microwave-imaging techniques, which have the potential advantage that also the dielectric properties of the medium can be reconstructed, hence they can be kept as unknowns. Of course, it seems appropriate to consider imaging techniques that can include all available *a priori* information (e.g., ranges of values of the complex dielectric permittivities of the various tissues; spatial locations of boundaries between media inside an investigation domain large enough to contain all the possible volumetric variations in the human head). The input information can be derived starting from the measurements of the electromagnetic source and of the external scattered electric field. Recently, significant advances have been made in the development of probes for near-field measurements of electromagnetic fields. This supports the proposal of exploring the use of imaging techniques.

Moreover, both deterministic "model-driven" [1] approaches and probabilistic approaches [2] will be considered, the later involving the complete nonlinear formulation of the inverse scattering problem. When an iterative computation is applied for the inverse problem and when a direct problem is concerned for field computation and dosimetric prediction, suitable numerical methods must be applied in order to discretize the continuous model.

[1] S. Caorsi, G. L. Gragnani, M. Pastorino, M. Rebagliati, "A model-driven approach to microwave diagnostics in biomedical applications", *IEEE Transactions on Microwave*

Theory and Techniques, special issue on "Medical Applications and Biological Effects of RF/Microwaves", vol. 44, Oct. 1996.

[2] S. Caorsi, G. L. Gragnani, S. Medicina, M. Pastorino, G. A. Pinto, "A Gibbs random field-based active e.m. method for noninvasive diagnostics in biomedical applications", *Radio Sci.*, Special Issue on Medical Applications, vol. 30, pp.291-301, 1995.

TEMPERATURE DISTRIBUTION IN A MODEL OF THE HUMAN EYE EXPOSED TO THE FIELD EMITTED BY A WIDE BAND WIRELESS LAN.

P. Bernardi, M. Cavagnaro, S. Pisa and E. Piuze. Department of Electronic Engineering, University "La Sapienza" of Rome, 00184 Rome, Italy.

Wireless personal communication is a rapidly expanding sector, particularly in the fields of cellular mobile phones, and wireless local area networks (WLANs). The existing applications of WLANs are unlicensed spread spectrum systems operating at the ISM frequencies of 2.45 GHz and 5.8 GHz, and licensed cellular systems operating at 18-19 GHz. More recent WLANs projects contemplate the use of wide band at millimeter-wave frequencies (WWLAN). As examples, we can cite two projects oriented towards the implementation of WWLANs operating around 30 and 60 GHz: one project of the Italian National Research Council (PS-WWLAN) and one of the European Community (MEDIAN). To transmit data, millimeter wave WLAN use a directive antenna placed at a mobile personal terminal (computer, phone, camera, etc.) and a wide beam antenna placed at a fixed site (the base station) usually located on the room ceiling. In this arrangement, the user can find himself in close proximity to the radiating mobile antenna, where the electromagnetic field assumes its highest values. As a consequence, it is important to consider the possible health hazard due to such systems.

The most considered adverse effects of the EM fields are of thermal nature (in particular those on the eye); consequently in this work we have evaluated the temperature distribution in models of the human eye exposed to WWLAN fields. In particular, we have considered WWLANs operating between 6.0 and 30.0 GHz. The field emitted has been simulated with a plane wave with an incident power density of 1.0 mW/cm². As a first step, we have computed the specific absorption rate (SAR) distribution in a human eye model, developed from the visible human data set, by using the finite difference time domain (FDTD) numerical technique [1]. Starting from the calculated SAR values, the temperature distribution has been derived through the bio-heat transfer equation. This equation has been solved with an explicit finite difference scheme and by using the thermal constants given in [2]. The entire procedure has been validated through the analysis of canonical problems (e.g. a plane wave incident on a multilayered dielectric slab, and on a homogeneous infinite cylinder). The first results obtained by considering the eye

anatomical model show temperature increase lower than 0.1°C with an incident power of 1.0 mW/cm².

[1] P. Bernardi, M. Cavagnaro, and S. Pisa, "Evaluation of the Power Absorbed in Human Eyes Exposed to Millimeter Waves," *Int. Symp. on Electromagnetic Compatibility*, Rome (Italy), pp. 194-199, September 1996.

[2] P.M. van den Berg, A.T. de Hoop, A. Segan, and N. Praagman, "A Computational Model of Electromagnetic Heating of Biological Tissue with Application to Hyperthermic Cancer Therapy", *IEEE Trans. Biomed. Eng.* vol. 30:12, pp. 797-805, December 1983.

Work supported by the Italian National Research Council (CNR) under the contract ST74-WWLAN

Medical Sciences

N. Bone Healing and Nerve Regeneration

Chairs: Ewa Herbst and Marko Markov

N-1

GENE EXPRESSION DURING THE EARLY PHASES OF BONE REPAIR IN transcortical HOLES IN THE HORSE: EFFECTS OF ELECTROMAGNETIC FIELD EXPOSURE. P. Zucchini¹, R. Cadossi¹, V. Canè² and S. Ferrari³. Departments of ¹Medical Oncological and Radiological Sciences, ²Morphological and Forensic Medicine and ³Biomedical Science, University of Modena, 41100 Modena, Italy.

We have previously demonstrated that pulsing electromagnetic fields (PEMFs), by increasing the osteogenetic response, favour bone repair in transcortical holes drilled in the metacarpal bone in adult horses. The effect was constant and reproducible in the diaphyseal region. Here we have investigated the effect of PEMF exposure during the earliest phases of bone repair, we evaluated the expression of TGF- β 1, TNF- α and IL-6 mRNAs.

Five horse were operated. Holes (4.5 mm \varnothing) were drilled into the 4th metacarpal bone. The left metacarpal bone was exposed to PEMF continuously 24 hours/day. The characteristics of the electromagnetic field were: 75Hz, 1.3 ms impulse width, 2.8 mT (Biostim Igea). Right metacarpals were used as controls and exposed to non-energised coils. Eight days after surgery animals were sacrificed. The soft tissue present in the holes was collected and frozen in liquid nitrogen. The weight of the tissue recovered was recorded. RNA was extracted using a modification of guanidium isothiocyanate-phenol-chloroform procedure. Gene expression was evaluated by reverse transcriptase polymerase chain reaction amplification (RT-PCR), followed by Southern blot analysis. Paired Student's t-test was used for statistical analysis.

We found that the weight of soft tissue present in metaphyseal holes was always larger than that of diaphyseal ones ($p < 0.05$). For what refers to diaphyseal holes, in average we recovered 0.088 \pm 0.03 mg of soft tissue from PEMF exposed

and 0.069 \pm 0.02 mg from controls ($p < 0.05$). From metaphyseal holes we recovered 0.139 \pm 0.06 mg from PEMF exposed holes and 0.104 \pm 0.03 mg from controls ($p < 0.05$). When the level of mRNA was investigated we observed a trend toward a decrease of TNF- α expression in holes exposed to PEMF. No significant difference was observed in mRNA levels of TGF- β 1 and IL-6 between exposed and control holes. We found that IL-6 mRNA expression was higher in metaphyseal holes than in diaphyseal one in PEMF exposed holes.

Our results show that the amount of soft tissue present in the holes of metacarpals exposed to PEMF is always higher than in control ones. TNF- α expression showed a tendency to decrease holes exposed to PEMFs compared to unexposed controls. The expression of the other mRNAs investigated was not affected. IL-6 increased expression in the metaphysis compared to the diaphysis suggests that the healing process is more advanced at the metaphyseal level. The difference in IL-6 expression was more evident in PEMF exposed metacarpal bones than in control ones.

N-2

TOPOGRAPHIC MAPPING USING DEXA PROVIDES A TECHNIQUE FOR ASSESSING THE EFFECTS OF ELECTRICAL STIMULATION ON BONE REMODELLING. M.J.H. Bonneau, L.J. Mulder and M.K. MacDonald. North Shore Bone Density Clinic, West Vancouver, British Columbia V7V 4T4, Canada.

What Is Bone Density?

Bone density is a measurement of the mineral content of bone and it's calcification.

How Is It Measured?

Until fairly recently, the only way to measure bone density was to make an educated guess from standard X-rays. This method required at least a thirty percent change in bone density to reliably detect a difference. More recently the use of radioactive isotopes has enabled more accurate measurements to be done. Even more recently, using a method called Dual Energy X-ray Absorptiometry, very accurate and highly reproducible measurements can be made.

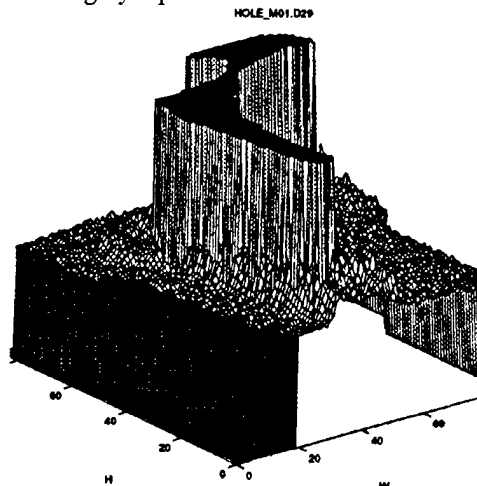

Bone Density Image of Hip Prosthesis

No ionizing radiation is used in this process.

When it was realized that the Gruen zones were too coarse to display subtle changes, raw pixilated data was used. The data is in the form of rows of numbers, with each row representing a scan line and each number the intensity of a scan pixel. The number of rows in a file and the number of pixels in each row varies from scan to scan and is under operator control. The intensity for each scan pixel ranges from; full saturation (no blockage of the X-ray beam), to; unsaturated (full blockage of the X-ray beam). To process the raw data files, an algorithm was written to convert them to readable, plain text ASCII tables, where in each table entry represents the intensity of a specific scan pixel. These ASCII tables were then imported into various graphics processing software packages to produce the desired images; isometric (shown above), contour or false colour.

It became clear that some form of averaging would have to be applied to the data to reduce the effects of random noise. The target area for the average consisted of a block of ten pixels. The scheme employed here was a running average over a block of ten consecutive pixels, pixel by pixel. From these tables of raw data in, ages were produced. These images provide for easy gross analysis of structure and features. As an extension of the analysis, a differencing algorithm was written to allow for the comparison of two scans done at different times. The corresponding pixel value in each file was matched and subtracted resulting in a difference table. In turn these tables were rendered as a three dimensional image. It is through this comparative analysis of images that the evolution of bone deterioration or augmentation can be tracked.

CONCLUSION: The results to date are extremely encouraging and warrant further exploration. We remain particularly interested in the use of DEXA to evaluate bone density changes during electromagnetic stimulation.

N-3

ELECTROSTIMULATION IN AVASCULAR NECROSIS OF THE FEMORAL HEAD. H.P. Delport. Stdskliniek, Department of Orthopaedic Surgery, 9100 St. Niklaas, Belgium.

DEFINITION AND AETIOLOGY: Avascular necrosis of the femoral head is characterised by the development of localised necrotic areas in the bone. Although there is a natural repair process, in 80 to 100% of the patients overall, a progression in the disease is experienced. If not treated in the adult, progressive avascular necrosis of the femoral head often leads to collapse of the femoral head and secondary osteo-arthritis. The aetiology of avascular necrosis of the femoral head is multiple:

- Chronic steroid use
- Alcohol abuse
- Femoral neck fracture
- Traumatic hip dislocation
- Idiopathic aetiology

CURRENT TREATMENT OPTIONS:

- Conservative treatment. Consist of restricting weight bearing and the use of analgesics.
- Core Decompression. During a surgical intervention multiple channels are drilled into the osteonecrotic area of the femoral head. This results in inter osseous pressure reduction and rapid pain relief.
- Sugioka rotational osteotomy. The femoral neck is osteomized and the femoral head is rotated so that the necrotic area turns away from the maximum load area.
- Use of electrical fields in a non-invasive fashion with capacitive or inductive coupling. This technique is used sole or in conjunction with core decompression, with or without bone grafting.
- Total hip replacement as a radical treatment.

SURGICAL APPLICATION OF ELECTRO-STIMULATION: The electrical current is applied through a surgically implanted electrode in which the cathode is placed into the avascular area and the anode in the adjacent soft tissue. The main goal of the procedure is to conserve the femoral head. We had seen the success of electrical stimulation in augmenting bone repair on the one hand. On the other hand, we know the beneficial effect of core decompression through a minor surgical intervention. Therefore, we thought the combination of these two techniques would be a valid option in the treatment of this difficult pathology in the younger adult.

MATERIAL AND METHODS: We did a prospective study to evaluate the use of an implantable direct current electrical stimulator in patients with avascular necrosis of the femoral head. Between September 1994 and August 1996 we treated 12 patients with avascular necrosis of the femoral head, Ficat stage 1 and 2. Our average follow-up is 12 months (between 24 and 6)

SURGICAL TECHNIQUE: The patient is in supine position on the traction table, in a similar way as to the nailing of a pertrochanteric hip fracture. The use of an image intensifier with C arm is required for AP and lateral control. A small incision is used, laterally 5 to 6 cm distal to the tip of the greater trochanter. A guide pin is introduced into the avascular area under fluoroscopic control. A channel is drilled using cannulated drills up to 17 mm, to allow smooth insertion of the graft. If no autograft can be used, an allograft is taken from a femoral head of the bone bank. To harvest the graft, a high speed hollow drill is used. The graft is now prepared to receive the electrode. Two small holes are drilled into the graft, one distal end one proximal in order to fix the electrode. The electrode is than attached to the graft in a helicoidal way around the cylindrical graft. It is fixed with a Vicryl I type suture. Using a K wire as a "lollipop stick" the graft is advanced through the channel into the avascular area under fluoroscopic control. The remaining opening of the channel is now filled with small compacted grafts. The titanium covered stimulator and battery is placed between muscle layers, not against the bone.

As a post operative regimen, we subscribed non-weight bearing for two weeks, followed by progressive partial weight bearing for 4 weeks. All patients were pain free, immediately post-operative.

RESULTS: Within 6 months, all patients except 1 were walking without support and free of pain. Their Harris hip scores improved dramatically.

Revisions: 2 patients had to undergo a total hip operation. One at 3 months and one at 6 months. At 1 year, radiographic follow-up of all other patients remained stable. Total result after 12 months: 10 out of 12 patients remained pain free.

N-4

EFFECT OF ELECTROMAGNETIC FIELD STIMULATION ON FRACTURES OF THE FEMORAL NECK. A PROSPECTIVE RANDOMIZED DOUBLE-BLIND STUDY. E. Betti¹, S. Marchetti¹, R. Cadossi² and A. Faldini¹. ¹Department of Orthopaedics and Traumatology, University of Pisa, Pisa, Italy. ²Department of Medical Oncological and Radiological Sciences, University of Modena, Modena, Italy.

Fractures of the femoral neck represent a frequent occurrence in elderly following a trauma of small entity. Their treatment foresees either the use of an internal synthesis device or hip arthroplasty. The use of internal synthesis devices is frequently associated to complications like delay in the healing process or avascular necrosis of the femoral head (AVN). Low frequency pulsing electromagnetic fields (PEMFs) have been used for many years to favour bone healing and to treat AVN. In this study we have investigated whether the use of PEMF could positively interfere with the outcome of the conservative treatment of fractures of the femoral neck.

Seventy-seven patients with fracture of the femoral neck were enrolled in the study: 14 males and 63 females, average age 69 ± 6. Patients underwent surgery within 7 days from the trauma. All fractures were fixed by screws. PEMF stimulation (Biostim, Igea, Italy) was initiated within 15 days from trauma: either with active or placebo devices. The stimulation parameters in active devices were the following: 75 Hz, 1.3 ms impulse width, 2.5-3.0 mT magnetic field peak amplitude. Patients were instructed to use the stimulator for 90 days 8 hours per day. Patients' compliance was monitored by means of a clock within the stimulator. On entrance to the hospital patients were included in the active (experimental) or placebo (control) group. A computer-generated schedule prepared by biostatistician was used to maximise the randomisation criteria. Controls were performed at day 30, 60 and 90 after surgery and follow-up evaluations at 6 and 18 months. The clinical performances of the patients were taken into account and the X-ray images were carefully investigated. 13 patients have been excluded from the study: 8 active and 5 placebo. We will consider 30 patients in the active and 34 in the placebo group. No difference was observed for: ratio male to female, average age and fracture type (Garden I to IV) between the 2 groups. At day 90, the % of healed fractures, was respectively 70 and 78.5 for placebo patients and active compliant patients (i.e.: average 8.4 ± 1.9 hours of use of the stimulator every day). At the 18 months follow-up the incidence of non-healed fractures was 7% in the

experimental group and 17.6% in the control group. At follow-up necrosis of the femoral head was present in 28.5% of subjects using active stimulators and in 47% of those using placebo stimulators. Overall the radiographic evaluation showed a more positive outcome among those using active stimulators than among those patients using placebo stimulators ($p < 0.02$). From a clinical point of view in the experimental group we observed a diminished pain score in the active group at day 30 ($p < 0.02$), 60 ($p < 0.03$) and 90 ($p < 0.05$).

This double blind study show that the use of active stimulators is associated to an in early pain relief, to an increase in the number of healed fractures and, to a lower incidence of AVN of the femoral head.

N-5

EFFECT OF APPLIED ELECTRIC FIELDS ON ASTROCYTIC SCAR FORMATION AFTER SPINAL CORD INJURY. T. Khan, N. Chauhan and S. Sayers. Rehabilitation Research & Development Center, Hines Veterans Administration Hospital, Hines, Illinois 60141, USA.

Historically, injury to the spinal cord resulted in an astroglial reaction which leads to the formation of scar tissue. The astrocytic scar was considered to be the major impediment to the regrowing axons. However, recent studies have shown that in addition to creating a mechanical barrier, the molecular properties on the surface of the reactive astrocytes play a role in inhibiting the regrowth of injured fibers. Another study has shown that the balance between growth promoting versus growth inhibiting factors within the local environment of the astrocytic scar determine the outcome of regenerative events after spinal cord injury. The mechanism by which glia cells block regenerative events still remains unresolved. In addition, the chronic application of direct current, or pulsed electrical fields, to the injured mammalian spinal cord has been shown to promote some axonal growth and functional improvement. Our results agree with these observations. The purpose of this study was to evaluate the effect of pulsed DC electrical stimulation on the injury-associated astroglial response and axonal regeneration following severe contusion injury to the cat spinal cord by *in situ* immunofluorescence.

Six cats were anesthetized, and sustained a severe contusion injury to their spinal cord at the T8 level by dropping a 30g weight from a height of 18 cm. The animals were divided into two groups; Group One consisted of three cats which received electrical stimulation of the injury site and Group Two consisted of three cats which served as an injury control. The animals received daily care in accord with AAALAC guidelines. Electrophysiological and behavioral tests were performed before injury and then bimonthly after injury through the duration of the six-month experimental period.

At the end of the survival period, all animals were perfused with an initial saline flush, followed by 4% buffered paraformaldehyde (100 mM phosphate buffer, pH 7.2). Immunofluorescence studies were performed on 20 µm thick

cryostat sections. The astroglial response was assessed by *in situ* expression of immunoreactive glial fibrillary acidic protein (GFAP), and the neuro-axonal profile was assessed by immunoreactive phosphoneurofilament protein (NF). The results showed the dramatic increase of GFAP-immunoreactivity (IR) at the site of the lesion following contusion injury compared to normal controls, indicating injury-associated astrogliosis. The application of an electric field to the lesion site limited the astroglial response, as evidenced by the depletion of GFAP-IR, and augmented the growth of the NF-IR positive axons within the lesion site. In conclusion, the application of small electric fields around the lesion site of the injured spinal cord may facilitate neuronal regeneration by reducing astrogliosis, and by providing directionality to regrowing axons.

Supported by funds from the Department of Veterans Affairs, Rehabilitation R&D Service (423-3RA), DVA.

N-6

EFFECT OF MILLIMETER WAVES ON POLYSYNAPTIC CONDUCTION IN ISOLATED SPINAL CORD. A.G. Pakhomov, H.K. Prol, S.P. Mathur and Y. Akyel. U.S. Army Medical Research Detachment and McKesson BioServices, Brooks Air Force Base, Texas 78235-5324, USA.

Previously we have demonstrated that low-intensity millimeter waves (MMW) may change the tolerance of the isolated nerve to a high-rate stimulation. As concluded from over 200 experiments performed, this effect depended on frequency rather than on the intensity of the radiation, and apparently was not a result of microwave heating. In this study, we explored the effect of one of the "effective" frequencies (41.34 GHz) in the isolated spinal cord. Conduction from primary afferents to motoneurons in the spinal cord is a classic and sensitive model for studying effects of various factors on the nervous function.

METHODS: Experiments were carried out on hemisectioned spinal cord of a bullfrog *Rana catesbiana*. The cord with dorsal and ventral roots (9th-11th pairs) was placed into an exposure bath with a constant flow of Ringer's solution chilled to 10-12°C. One or two pairs of the roots were extended from the solution and placed on recording and stimulating electrodes. The bath was designed so as to limit the irradiation to the cord itself, and to avoid any possible artifacts from field interaction with the electrodes. The bath was positioned above a dielectric rod antenna fed from a G1-141 generator. The spinal cord was gently pushed to the bottom of the bath (0.5 mm thick Plexiglas) to prevent formation of a saline gap which would strongly attenuate the radiation. Dorsal root stimulation and ventral root response (VRR) recording was performed every 30 s. The preparation stabilized for 0.5-3 hr before the onset of the experiment, without any alterations of the stimulation or other conditions. During a sham exposure, all equipment was turned on, but the output MMW attenuators were tuned to maximum attenuation (about 80 dB). A transition from a sham to an MMW exposure was not accompanied by any side effects

such as vibrations or changes in low-frequency fields. Each experiment lasted for 65 min and included two 5-min exposures (at 25 and 50 min, $41,340 \pm 2$ MHz, 2.6 ± 0.2 mW/cm² at the bottom of the bath), and the rest of the time the cord was sham exposed. A fluoroptic temperature probe situated in the saline close to the cord did not record any heating caused by exposure. The data were analyzed by χ^2 and Student's t-tests.

RESULTS: In the frog spinal cord, the excitation from primary afferents comes to motoneurons mostly via a polysynaptic pathway, and the VRR appears as a complicated polyphasic wave in about 10 ms after the stimulus. The VRRs were averaged for 5-min intervals, thus yielding 13 averaged waveforms (W_1, W_2, \dots, W_{13}). The integral of the difference (ID) of sequential waveforms (i.e., $W_n - W_{n-1}$) was used to quantify VRR changes from one 5-min interval to another. The mean ID was virtually stable for the first 5 intervals (sham) and sharply increased for the 6th interval (MMW); then it returned to the initial value and was stable again. In fact, this ID increase due to the 1st exposure occurred in 9 out of the 13 tested preparations. Most unexpectedly, the 2nd MMW exposure caused no ID changes in the 9 preparations which reacted to the 1st exposure; however, it caused a significant ID increase in the other 4 preparations which did not react to the 1st exposure. Though the MMW effect was mostly limited to changes in the fine structure (shape) of the potential, in some preparations the area and/or peak amplitude of the potential demonstrated noticeable reactions as well.

CONCLUSIONS: We must emphasize that the conditions of the 1st and the 2nd exposure for each particular preparation were exactly the same. Even the pattern of "hot spots" (if any formed) remained unchanged. If the MMW effect were thermal, it would have been practically identical under the 1st and the 2nd exposures. However, it was not the case, and this fact infers involvement of MMW-specific mechanisms which are different from mere heating.

The work was performed while A.G. Pakhomov held a National Research Council-AMRMC Research Associateship, and was supported by the US Army Medical Research and Materiel Command under contract DAMD17-94-C-4069 awarded to McKesson BioServices. The views, opinions and findings contained in this report are those of the authors and should not be construed as an official Department of the Army position, policy or decision.

N-7

EFFECT OF EXPOSURE TIME ON STIMULATION OF HEALING IN THE RABBIT TIBIAL OSTEOTOMY MODEL BY A TIME VARYING PULSED ELECTROMAGNETIC FIELD, AND BY A COMBINED MAGNETIC FIELDS. J.V. Nepola¹, D. Fredericks¹, B. Simon² and J. Abbott². ¹Department of Orthopaedics, University of Iowa Hospitals and Clinics, Iowa City, Iowa 52242, USA. ²Electro-Biology, Inc., Parsippany, New Jersey 07054-1079, USA.

OBJECTIVE: This study was designed to analyze quantitatively the effect of different exposure times per day of

two different clinical signals on the healing of a rabbit tibial osteotomy.

METHODS: Tibial osteotomies were created with a gigli saw in 59 New Zealand white rabbits weighting 3.0-3.5 kg. The periosteum was elevated, preserved and the osteotomy stabilized with an external fixator. Two different applied stimuli were used. The PEMF signal was a 15 Hz time-varying pulsed magnetic field. The CMF signal consisted of a static magnetic field in parallel with a sinusoidal magnetic field at 76.6 Hz. Rabbits were randomly assigned to either one or the other treatment device and exposed daily for either 0.5 hour, 3 hours or 6 hours. Sham groups were handled identically but not exposed to either signal. For the duration of exposure, both active and sham treated rabbits were placed in holders to which the treatment coils were attached. Treatment were initiated 24 hours post osteotomy and continued for 14 days. All tibias were tested mechanically to torsional failure at day 14. A Mann Whitney test was used to determine statistical significance between treatment groups.

RESULTS: Both signals showed a clear dose response. At 0.5 hour per day neither signal stimulated a difference in biomechanical strength from sham controls. At three hours per day both signals stimulated increased in biomechanical strength above sham controls but did not reach statistical significance (CMF by 37.8% and PEMF by 44.3%). Six hours per day treatment showed the greatest increases in biomechanical strength (CMF by 70% and PEMF by 91.0%) and were significantly greater than sham controls. There was no statistical difference between the biomechanical strength of tibias exposed to the PEMF signal compared to the CMF signal at each exposure time.

CONCLUSION: These results show that both the PEMF and the CMF clinical signals are more efficient in stimulating bone repair in the rabbit tibial osteotomy model when used for exposure times greater than 0.5 hour per day, with six hours per day showing the greatest response.

N-8

THE EFFECT OF ELECTRICITY ON JOINT CONTRACTURE DUE TO IMMOBILIZATION; DIRECT CURRENT STIMULATION IN RAT EXPERIMENT. M. Akai¹, T. Maeshima¹, Y. Shirasaki² and T. Tateishi². ¹Department of Physical Therapy, Tsukuba College of Technology and ²Mechanical Engineering Laboratory, Agency of Industrial Science and Technology, Tsukuba, Ibaraki 305, Japan.

OBJECTIVE: To examine whether electrical stimulation could decrease the amount of joint contracture in a rat's lower extremity model. We try to turn the object of electrical stimulation from bone to soft tissue, and to expand it from the repair aspect to a remodeling one of musculoskeletal systems.

DESIGN: Thirty-three rats (Wistar, 9 to 10 week-old male) were operated on by immobilizing the knee joint in a flexed position. The electrodes were arranged with 2 stainless steel cathodes onto the medial and lateral collateral ligaments and with a platinum anode over the hamstring muscles. All rats were then assigned to three groups. A power pack, which

was secured on the back of the animals, delivered 20 μ A, 50 μ A constant direct current for a period of 3 weeks, and a dummy pack worked as a negative with sham electrodes. The degree of joint contracture was assessed after 3 weeks on both soft and hard (bone and cartilage) tissues; e.g., 1) spectral analysis of transfer function measurement of the knee joint using random mechanical noise with frequency range from 1 to 50 Hz, 2) dynamic indentation test for the articular surfaces around the knee joint, which provided dynamic stiffness (which represented elastic resistance of the sample) and phase-lag (which related to the amount of dissipation of energy, i.e., its viscous nature), and 3) bone densitometry of the femur and the tibia using dual energy X-ray absorption.

RESULTS: The results of the indentation testing in the analysis of hard tissue showed that electrical stimulation partly prevented the decrease of the stiffness caused by immobilization among stimulation groups. These were found significantly at the osteoarticular surfaces of the femoral medial condyle and the tibial lateral plateau, while no general trend by electrical stimulation was revealed at other sites. No difference was found in the phase-lag in mechanical testing and in the bone densitometry. However, in the analysis of soft tissue behavior of the entire joint, the spectral analysis of transfer function measurement revealed more obvious effect on joint stiffness in the stimulation groups than in the sham group. It showed more deformation against load and more viscous nature with electricity, especially in the low frequency band.

The stimulated doses for 20 μ A, 50 μ A constant direct current to prevent immobilized influence were appropriate for the soft tissue, but were not fit for the hard tissue.

CONCLUSION: Electrical stimulation has a possibility of reducing the amount of joint contracture caused by immobilization. But further investigation is needed to identify more appropriate conditions for effective stimulation. The other arrangement of the electrodes around the knee joint is also to be investigated. It will be an answer to the question of whether electrical signal is able to replace mechanical signal.

N-9

EFFECT OF PULSED RADIO FREQUENCY STIMULATION ON CHRONIC WOUNDS: A DOUBLE-BLIND PILOT CLINICAL STUDY. L.C. Kloth¹, J.E. Berman¹, C.H. Sutton², D.C. Jeutter¹, A.A. Pilla³ and M.E. Epner¹. ¹Department of Physical Therapy, Marquette University, Milwaukee, Wisconsin 53201, USA. ²Zablocki Veterans Administration Medical Center, Milwaukee, Wisconsin 53295, USA. ³Department of Orthopaedics, Mount Sinai School of Medicine, New York, New York 10029, USA.

PURPOSE AND HYPOTHESIS: This double-blind, placebo-controlled, prospective clinical pilot study was aimed at determining the effect of pulsed radio frequency (PRF) therapy on the healing of chronic wounds in spinal cord injured patients. Based on other reports that invasively

applied electric currents accelerate wound healing, it was hypothesized that an electric current having similar parameters induced non-invasively into wound tissues by an electromagnetic field would have a similar effect.

METHODS: Ten patients with chronic wounds were equally divided between PRF active and sham groups. Patients were treated with an active or sham device (sofPulse™ model 912, EPI, Pompano Beach, FL) for 30 minutes, Monday through Friday for four consecutive weeks. The active PRF unit delivered a 65 μ sec burst of 27.12 MHz sinusoidal waves (short wave band), 600 times per second to the treatment area. The peak magnetic field in tissue was approximately 2 Gauss, corresponding to a peak induced electric field and current density of approximately 1 V/cm and 1 mA/cm², respectively. The signal was applied via a 23 cm diameter applicator placed within 0.5-1 cm of the external surface of the wound. The sham unit had the same operational outward appearance and was applied in the same manner as the active unit, but did not broadcast a PRF signal to the wound tissue. The wound surface area was evaluated from the measured length and width dimensions prior to the start of treatment, and after 4 weeks. Mean wound area ratio was compared for the active and sham groups and defined as percentage healing. Significance was assessed using the Mann-Whitney test and accepted at the $P \leq 0.05$ level.

RESULTS AND DISCUSSION: Initial mean wound opening area was not significantly different for the PRF sham and active groups. In contrast, after 4 weeks of PRF therapy, wounds treated with PRF were $47 \pm 8.1\%$ healed (wound closure) vs $-18 = 16\%$ (wound enlargement) in the sham treated group. $P=0.0079$ ($T = 40$, Mann-Whitney). The results obtained in this small pilot study suggest that PRF therapy may be beneficial as an adjunct treatment for chronic wounds. The results are similar to those obtained with high voltage pulsed current, with the added clinical advantage of a non-contact application and dosimetry relatively independent of the wound state. Further research is needed to determine if similar results may be obtained in a larger homogeneous population of chronic wounds.

This work was supported in part by the Horace W. Goldsmith Foundation (AAP) Electropharmacology, Inc., Pompano Beach, FL.

N-10

MATRIX-RHYTHM-THERAPY FOR BONE REPAIR AND REMODELING. U.G. Randoll¹, D. Schmidtbleicher², A. Scheller³ and F.F. Hennig¹. ¹Department of Traumatology, University of Erlangen-Nuremberg, D-91054 Erlangen, Germany. ²Institute of Sport-Sciences, University of Frankfurt/Main, D-60487 Frankfurt/Main, Germany. ³Leonardis Fachklinik, D-70806 Kornwestheim, Germany.

SUMMARY: This study applies recent concepts from the fields of cybernetics, synergetics, and non-linear thermodynamics of irreversible processes to bioscientific problems in medicine. These concepts proceed on the presumption of the existence of universal space-time structures. [1,2,3,4,8] Within the field of medicine, this above all allows previously-

neglected temporal structures to regain their original significance. Rhythmic, temporal processes in the realms of substance-concentration and enzymatic activity influence the physiological events occurring within the body in an organizational manner. When such time-based sequences undergo chaotic mutation, they lose these organizing properties. [5,7]

From a cybernetic, control-technical aspect, loss of bone repair or remodeling are conditions of de-compensated regulatory mechanisms which occur subsequent to threshold-value reactions at micro levels. Osteoporosis can result as consequences of phasic transition due to processes of adaptation to a chronically altered milieu or function, the ultimate result of which is the loss of temporal-rhythmic organization, i.e. chaotic mutation of cellular dynamics. Thus, chronic diseases are "dynamic diseases".

Corresponding to the insight gained from this viewpoint, the apt objective is to identify such bodily-intrinsic organizers and use them therapeutically. This therapeutic goal, therefore, is to regenerate and stabilize the basic autonomic rhythm of the organism and/or to change the amplitude and frequency values of the nutritional-flow density at the locality of the body's cells (the cell matrix) in such a manner as to exclude an existence of deterministic chaos. [6]

Ultimately, all bodily structures which recognize electromagnetic, chemical, or mechanical rhythms are to be considered organizers of that organism.

On the example of the skeletal musculature, viewed as a neuromyogenous, rhythmic structure (and, with 40% of the entire bodily mass, the largest organ of the body as well), the mode of action of matrix-rhythm-therapy is first theoretically developed, then introduced in actual application.

Literature

[1] Frohlich H.: Evidence for Base Condensation like Excitations of Coherent Models in biological Systems.

Phys. Letters 51 A (1975) 21

[2] Haken H.: *Pattern Formation and Pattern Recognition*. Springer, Berlin 1979

[3] Paerisch, M: Elektromyostimulation, Grundlagen, Moglichkeiten und Grenzen. *Biolog. Med.* 1/1997

[4] Randoll U.G., Pangan R.: The role of complex biophysical-chemical therapies for cancer.

Bioelectrochemistry and Bioenergetics 27 (1992) 341-346

[5] Randoll U.G.: Die Bedeutung von Regulation und Rhythmus fur arztliche *Diagnostik und Therapie*. Albrecht H. (ed.): Gesundheit und Krankheit aus der Sicht der Wissenschaften. Hippokrates-Verlag, Stuttgart, August 1993

[6] Schuster H.G.: *Deterministic Chaos*; VCH Verlagsgesellsch. (1988)

[7] Thomas: Die Anwendung einfacher Prinzipien der Regulation komplexer Systeme auf die Human-medicin. *DLR Mit.*, 84-13, Braunschweig, 1984

[8] Wiener N.: *Kybernetik-Regelung und Nachrichtenubermittlung im Lebewesen und in der Maschine*. Econ-Verlag, Dusseldorf 1963.

N-11

THE USE OF IMPLANTABLE DIRECT CURRENT STIMULATION IN BONE GRAFTED FOOT AND ANKLE ARTHRODESES: A RETROSPECTIVE REVIEW. J.C. Reynolds. Seton Medical Center, Austin, Texas 78705, USA.

A retrospective review to assess fusion success rates, clinical outcome and return to work status was performed in 19 patients who had undergone bone grafted foot or ankle arthrodesis and were adjunctively treated with implantable direct current stimulation. Fusion was determined by chart and radiographic review at the last recorded office visit and was considered successful upon evidence of trabeculation at the fusion site. Arthrodesis was required for a variety of reasons, but mainly due to arthritis. This patient population consisted of 5 males and 14 females with an average age of 50 years (19-76 years), and mean length of follow-up was 20.2 months (3.9-51.3 months). Fusion success was noted in 95% of the patients. Eighty-five percent of the patients were able to return to work while 88% returned to normal activity. Twenty-two percent of patients felt the improvement in their life due to the fusion was very significant, 72% felt the improvement was significant, while 6% noted an improvement, although very insignificant. In this series, bone grafted arthrodeses with direct current stimulation showed excellent fusion success rates and significant clinical outcomes.

N-12

THE USE OF ELECTROMAGNETIC FIELD IN ORTHOPAEDIC SURGERY: OUR EXPERIENCE. R. Giacomini, C.F. De Biase and A. Carfagni. Ospedale San Carlo di Nancy, Divisione di Ortopedia, 00185 Roma, Italy.

We report our experience with the use of electromagnetic field in different orthopaedic pathologies. From January 1990 until December 1996 we treated 130 patients with a minimum age of 17 and a maximum of 80 and with a follow-up of six years.

The pathology we studied were:

- 40 pseudoarthrosis
- 45 fractures
- 20 thigh pain in hip prosthesis
- 15 algodistrophy
- 10 tendinitis.

We divided the results in excellent, good, fair and poor.

POSTERS

I. PHYSICAL SCIENCES

Mechanisms

P-1-A

INFLUENCE OF INTENSE MAGNETIC FIELDS ON ENZYMATIC PROCESSES OF SOD, PEROXIDASE, XANTHINE OXIDASE, AND CATALASE. M. Iwasaka and S. Ueno. Institute of Medical Electronics, Faculty of Medicine, University of Tokyo, Tokyo 113, Japan.

The question of whether magnetic fields affect enzymatic activity is of considerable interest in biomagnetics and biochemistry. Numerous studies on enzymatic reactions in static magnetic fields were reported [1][2]. The present study focuses on whether magnetic fields affect the activity of enzymes such as superoxide-dismutase (SOD), peroxidase, xanthine oxidase, and catalase.

We used a spectrophotometric system with an external optical cell room in a superconducting magnet. As substrates for enzymatic reaction of SOD, peroxidase, and xanthine oxidase, SOD-525 (5,6,6a, 11b-tetrahydro-3,9,10-trihydroxybenzo[c]fluorene), hydrogen peroxide (0.02%), and xanthine were used respectively.

We observed no effect of magnetic fields of up to 14T on SOD, peroxidase, and xanthine oxidase. However, we obtained an effect of magnetic fields of up to 14 T on the reaction of catalase with 50 mM of hydrogen peroxide. We observed changes in the absorbance of the reaction mixture of hydrogen peroxide and catalase at 240 nm, during and after magnetic field exposures. When the reaction mixture was not treated with nitrogen-gas-bubbling, it was observed that the initial reaction rate of the mixture which was exposed to magnetic fields was 50 - 85% lower than the control data. This magnetic field-effect was not observed, however, when the reaction mixture was bubbled with nitrogen gas to remove the dissolved oxygen molecules which were produced in the solution.

We also measured the concentration of dissolved oxygen that was produced by the decomposition of hydrogen peroxide. The dissolved oxygen concentration in the reaction mixture that was exposed to magnetic fields increased 20 - 25% compared to the control solution.

Furthermore, we carried out the same experiments by changing the gas-pressure around the optical cell in superconducting magnet. Oxygen gas was introduced into the bore of the magnet, and the gas-pressure was measured by differential gas-pressure meter. When the oxygen gas pressure around the optical cell increased over 2 mmH₂O, it was observed that the initial reaction rate of the mixture significantly decreased in a magnetic field at 14T.

The results of the present study indicate that magnetic fields affect the dynamic movement of oxygen bubbles that are produced in the reaction mixture by the decomposition of

hydrogen peroxide, but not the catalytic activity of catalase itself.

References:

- [1] W. Haberditzl, *Nature*, 213, 72, 1967
- [2] S. Ueno and K. Harada, *IEEE Trans. Magn.*, MAG-22, 5, 868, 1986.

P-2-B

EFFECTS OF 14 TESLA MAGNETIC FIELD ON HYDRATION AND STRUCTURE OF WATER MOLECULES. M. Iwasaka and S. Ueno. Institute of Medical Electronics, Faculty of Medicine, University of Tokyo, Tokyo 113, Japan.

Water, an important material for living systems, is a diamagnetic material. We have observed the phenomenon that the surface of water was parted by magnetic fields and the bottom of the water chamber appeared when the water was exposed to magnetic fields up to 8 T [1]. The so called "Moses' effect" can be explained by the diamagnetic property of water. Since water is diamagnetic, when a magnetic force acting on some volume of water reaches a high enough value it presses back the water. It is also important to clarify the mechanism of interactions of magnetic fields with organic molecules and water molecules. In this study, we investigated the effects of strong magnetic fields of up to 14T on the thermal agitation and the hydration of water with sugars.

We investigated the near-infrared spectrum of water molecules by using a near-infrared spectrophotometer which has an external optical cell box in a superconducting magnet. Two optical fibers connected the external optical cell with the spectrophotometer. We used a horizontal type of superconducting magnet which produces 14 T at its center. We measured the near-infrared spectrum of water around 1930nm that originated from the united state of two types of water-molecule-vibrations, ν_2 and ν_3 . Each of spectra was obtained from 7 measurements. The optical path length of a cell was 0.1 min. The peak wavelength of water shifted from 1930 nm to 1932~1933 nm under a 14T magnetic field. The peak wavelength of 50% ethanol solutions also shifted to 2~3 nm higher wavelengths. The results indicate that the species of water-molecules which have two hydrogen bonds increased in number under a 14T magnetic field. There is a possibility that the formation of hydrogen bonds is enhanced under strong magnetic fields of up to 14T.

We also measured a near-infrared differential absorbance under a magnetic field at 14T to investigate the hydration of solutes in aqueous solution. The hydration of water with solutes was evaluated by the differential absorbance at 958nm. We measured the differential absorbance at 958 nm of 1M and 0.1M of D-glucose solutions. When the magnetic fields were changed from 0 T to 14 T, the differential absorbance at 958 nm increased 40% - 50%. The results indicate that the water molecules that are hydrated by the other molecules rise in population under magnetic fields of up to 14T. It is possible for a strong magnetic field to stabilize water structures and enhance water hydration.

Reference:

[1] S. Ueno and M. Iwasaka: Properties of Diamagnetic Fluid in High Gradient Magnetic Fields, *Journal of Applied Physics*, 75(10), 7177, 1994.

P-3-C

AN APPROACH TO RECOGNIZE EFFECTS OF LOW-INTENSITY MICROWAVES BY A SEGMENTATION OF TIME SERIES. A.P. Andrushchenko and Y.I. Samoilenko. The Space Research Institute of Ukraine Academy of Sciences, Kiev, Ukraine.

At present, biological effects of low-intensity microwaves (MW) is not quite well studied. In particular, the problem often occurred is to detect the presence of a MW influence by an analysis of signals measured. For this purpose, the signals are analyzed by various methods to find out features necessary to distinguish bioobjects irradiated from some control group. The conventional statistical approaches (like the Student's t-test) are usually applied here. Notice that these approaches are ineffective to reveal MW effects in a statistically significant way for a number of practical situations. However, MW exposure can lead sometimes to nontrivial changes of the signals. To detect such changes, appropriate methods are needed. One of these methods which consists of dividing of a time series measured into the deterministic chaotic and stochastic segments is proposed here. It is supposed that the whole time series has a complicated statistically homogeneous character like the random "jumps" without obvious periodicities. At the same time, the process is nonstationary when segments with different-type dynamics (i.e., deterministic chaotic or stochastic) replace each other in time. To analyze the time series in a correct way, it is necessary to distinguish these segments and to characterize them properly.

This approach series was applied to data regarding MW exposure of native retinas of the *Rana Temporaria* eyes. The data consisted of 20 electroretinograms (ERG), where only ERG was recorded for each retina. The problem was how to reveal appropriate peculiarities of the ERG data to discern a group of retinas with MW exposure (group A) from a control group without the exposure (group B), where each of the groups had 10 retinas. Notice that the problem was not trivial since the conventional spectral and statistical approaches were ineffective to detect the statistically significant difference between the groups by the Mann-Whitney nonparametric criterion. Therefore, the data were analyzed by the segmentation algorithm. The preliminary data processing was carried out to subtract the averaged curve from every ERG time series. Then, new time series with the statistically homogeneous character were obtained. It was shown that each such a time series can be divided into 2 or 3 segments of different-type dynamics. These segments were studied to find the peculiarities mentioned. Features of the stochastic segments were improper for our purpose. At the same time, the averaged value of the local nonlinear predictability (AVLNP) for the deterministic chaotic segments turns out to be useful parameter to distinguish the

groups ($p < 0.05$). The results for AVLNP are presented in the table.

N	1	2	3	4	5	6	7	8	9	10
Group A	0.13	0.18	0.22	0.10	0.08	0.17	0.14	0.21	0.25	0.16
Group B	0.29	0.35	0.42	0.24	0.38	0.41	0.40	0.33	0.28	0.32

It is seen that the MW exposure results in decreasing of AVLNP since only the one value characterizing the group A is greater than that for group B. This corresponds to a better predictability of the ERG behaviour for the deterministic chaotic segments. Thus, dividing of the ERG signals into segments with stochastic and deterministic dynamics can be helpful to detect effects of low-intensity microwaves.

P-4-A

BIOLUMINESCENCE OF THE FIREFLY *LUCIOLA CRUCIATA* UNDER STRONG DC MAGNETIC FIELDS M. Iwasaka and S. Ueno. Institute of Medical Electronics, Faculty of Medicine, University of Tokyo, Tokyo 113, Japan.

Many studies on the biological effects of DC magnetic fields have been reported, however, the mechanisms of effects were not clarified completely. In the area of spin chemistry, chemists have investigated the effects of DC magnetic fields on radical recombination processes, and clarified the mechanism of chemical reactions that involve radical pairs under magnetic fields from mT order to over 10 T. Recently, radical pair model is often used for the discussion and explanation of biomagnetic effects. Several enzymatic processes have radical pairs. It is not easy to examine the products of radical reaction *in vivo*. If the products could be measured by light emission, real time measurement of radical reaction could be available in an *in vivo* system.

It is proper to use bioluminescence to investigate the interaction of magnetic fields with *in vivo* biochemical processes which involve radical pairs. In the present study, the effect of magnetic fields on the emission of light by a living system was studied.

The firefly *Luciola cruciata* was used as the bioluminescence system. The firefly light organ was fixed at the edge of an optical fiber. The emitted light was introduced into a photoncounting system using an optical fiber. We measured both the spectrum of a constant light emission and the time course of bioluminescence pulses. As the magnetic fields generator, a horizontal type of superconducting magnet, which produced an 8 T magnetic field at its center, was used. The experiments were carried out during seven nights when the frequency of light emission increased. It is reported that the bioluminescence reaction is the oxidation of luciferin by luciferase in the presence of ATP and oxygen molecules.

For the first time, we measured emission spectra of firefly over the intervals 500-650nm and 400-450 nm, at 25°C and 37°C. The peak intensity and wavelength at 435nm changed significantly in the range of 25°C and 37°C. However, two peak wavelengths, at 435nm and 550nm, did not change in an 8T magnetic field.

We also measured the time course of bioluminescence pulses at 550 nm, with and without an 8T magnetic field. We observed that the pulses in a magnetic field had more symmetric shapes compared to that of control group. The symmetry of the pulses increased 37% in an 8T magnetic field.

It is possible that the change in pulse shape under a magnetic field is related to change in the metabolic systems of the firefly, such as the enzymatic process of luciferase and the excited singlet state with subsequent light emission.

Assessment

P-5-B

MEASUREMENT OF EXPOSURE TO MAGNETIC FIELDS FROM ELECTRICAL APPLIANCES. J.T. Isokorpi¹, L.H. Korpinen¹, T. Keikko¹ and J. Partanen². ¹Tampere University of Technology, Power Engineering, FIN-33720 Tampere, Finland. ²Lappeenranta University of Technology, Laboratory of Electrical Engineering, FIN-53850 Lappeenranta, Finland.

The objective of the study was to investigate how to measure exposure to magnetic fields from electrical appliances and to develop a procedure for measurements. Measuring the magnetic fields of electrical appliances is important in order to find out how fields vary in different environments. Usually, magnetic fields of household appliances are less than 10 μT , but some appliances may cause magnetic fields of up to 100 μT . The EMC standard sets the magnetic field immunity level for electrical appliances.

In this study measurements are carried out both in laboratory and practical environments. In laboratory environment the measurements were first done around appliances in five directions, front, back, left, right and above. The measurements were done at equal distances from the supposed geometrical center of the appliance. In laboratory environment the background magnetic flux density was also measured in each direction. In the practical environments the measurements were done only in the normal using direction of the appliance. To evaluate the distance attenuation of the magnetic field from an appliance, measurements were done at different distances in one direction. The measurement distances depend on the size and the use of the appliance.

This method was used for measuring the magnetic fields from different appliances. A three-axial meter was used to measure the resultant magnetic flux density in the measuring point. A one-axial meter was used to measure the maximum (RMS) magnetic flux density in the measuring point. The maximum magnetic flux density values of the five measurement points from different appliances were: electric typewriters (n = 4, distance 50 cm) 3.7 μT , 3.7 μT , 1.1 μT and 0.1 μT ; overhead projectors (n = 4, distance 40 cm) 7.1 μT , 5.6 μT , 3.8 μT and 3.4 μT ; coffee makers (n = 4, distance 30 cm) 0.08 μT , 0.05 μT , 0.05 μT and 0.04 μT ; radios (n = 4, distance 20 cm) 1.7 μT , 1.0 μT , 0.9 μT and 0.8 μT . These measurements were carried out in laboratory environment.

The background magnetic flux densities in the measurements ranged between 0.03 and 0.05 μT . Three appliances, a coffee maker, a toaster and an iron, were measured in practical environments. Results at using distance were 0.04 μT , 0.3 μT and 0.2 μT , respectively. To evaluate the rate of distance attenuation of magnetic fields, the measurements were done at four distances from all measured appliances. In the measurements the rate of attenuation varied from inversely proportional to r^2 to r^3 . That is congruent with results previously presented in literature.

In this study, a method for measuring the exposure to magnetic fields from appliances has been tested. The measurement is not supposed to give the absolute maximum value because the maximum magnetic field probably does not coincide with the measurement points. However, five measurement points give a comprehensive indication of the appliance's field and exposure.

P-6-C

LONG-TERM MEASUREMENT OF MAGNETIC FIELDS IN EXPOSURE ASSESSMENT. J.P. Rautee, J.T. Isokorpi, T. Keikko and L.H. Korpinen. Tampere University of Technology, Power Engineering, FIN-33720 Tampere, Finland.

The number of magnetic field measurements has increased in recent years. One reason for this trend is public concern about the possible health risks of magnetic fields from electrical appliances and wiring. Another important reason is the technical EN-standard for electromagnetic compatibility (EMC) of appliances. The aim of this study was to investigate the extremely low frequency magnetic fields in work and living environments and test procedures for measurement. The measurements have been done with three procedures: five-points-procedure, mapping, and long-term measurement in one point. The study included four kinds of measurement places; I) a single-family house (6 rooms), II) an office workroom, III) an apartment (4 rooms) and IV) a students clubroom. In the five-points-procedure the magnetic field was measured in the center of the room (crossing point of diagonals) and in the middle of the halved diagonals. In the mapping a measuring grid was created in the room. The size and density of the grid depend on the room size. The grid was at least 0.5 m apart from the walls, and the distance between the measurement points was set at about one meter. Magnetic field was measured in each point of the grid. Based on the five-points procedure or the mapping, one measurement point was chosen for long-term measurements. Long-term measurements lasted from 1 to 7 days. Measurement interval in long-term measurements varied from 10 s to 150 s. Measured values were stored in the memory of the meter (Radianns Innova ML-1). Three meters were available for measurements. They were all used simultaneously in students clubroom. The average \pm standard deviation (SD) of magnetic fields of the places were calculated from the results of the five-point-procedure and the mapping. The results were: I) single-family house; five-point-procedure (total) 0.05 \pm 0.04 μT , max. 0.26 μT , min.

0.02 μT ; (kitchen) 0.07 $\pm 0.02 \mu\text{T}$, max. 0.09 μT , min. 0.05 μT ; mapping (25 points, kitchen) 0.04 $\pm 0.02 \mu\text{T}$, max. 0.11 μT , min. 0.02 μT ; II) office workroom; five-point-procedure 0.17 $\pm 0.15 \mu\text{T}$, max. 0.41 μT min. 0.05 μT ; III) apartment; five-point-procedure (total) 0.03 $\pm 0.01 \mu\text{T}$, max. 0.07 μT , min. 0.01 μT , (bedroom 1) 0.02 $\pm 0.01 \mu\text{T}$, max. 0.03 μT , min. 0.01 μT ; mapping (16 points, bedroom 1) 0.03 $\pm 0.01 \mu\text{T}$, max. 0.05 μT , min. 0.01 μT ; IV) students clubroom; five-point-procedure 0.08 $\pm 0.04 \mu\text{T}$, max. 0.13 μT , min. 0.04 μT ; mapping (71 points) 0.08 $\pm 0.05 \mu\text{T}$, max. 0.22 μT , min. 0.02 μT . The average \pm standard deviation (SD) of the magnetic field in the measurement point was calculated from the stored data of long-term measurements. The results are: I) single-family house (n = 4092, kitchen); 0.07 $\pm 0.02 \mu\text{T}$, max. 0.09 μT , min. 0.05 μT ; III). The apartment (n = 4092, bedroom 1); 0.02 $\pm 0.01 \mu\text{T}$ max. 0.03 μT min. 0.01 μT , IV) students clubroom; (interval 150 s), point 1 (n = 21098) 0.06 $\pm 0.02 \mu\text{T}$, max. 0.21 μT , min. 0.02 μT ; point 2 (n = 21152) 0.15 $\pm 0.03 \mu\text{T}$, max. 0.40 μT , min. 0.00 μT ; point 3 (n = 21158) 0.54 $\pm 0.17 \mu\text{T}$, max. 1.26 μT , min. 0.00 μT ; (interval 10 s) point 3 (n = 4092) 0.67 $\pm 0.18 \mu\text{T}$, max. 1.30 μT , min. 0.20 μT . When comparing long-term measurement results with momentary results, it can be seen that the average values are similar. However, in long-term data the maximum values are higher than the values in the five-point-procedure and in the mapping. Based on this study it can be stated that five-point procedure is adequate for practical measurement, but long-term measurement is helpful in exact exposure assessment.

P-7-A

RESIDENTIAL EXPOSURE TO POWER FREQUENCY ELECTRIC AND MAGNETIC FIELDS GENERATED BY ITALIAN ELECTRICAL SYSTEM COMPONENTS. R. Conti¹, L.D. Caracciolo² and L. Sartore³. ENEL S.p.A., ¹Electrical Research Center, ²Transmission Division and ³Distribution Division, I-20093 Cologno Monzese (MI), Italy.

During the last years, the increased concern about possible health effects of electromagnetic fields, and the appearance of a number of national and international initiatives aimed at the protection of people from both residential and occupational exposure to these fields, have stimulated new research efforts in the area of personal exposure assessment.

Since the early-seventies, ENEL has been making a significant research effort on this subject and has acquired valuable experience in computing and measuring methods, including the assessment of exposure to 50 Hz electromagnetic fields due to electrical system components, as well as to domestic, public and industrial appliances.

This paper will present the results of measurements surveys carried out by ENEL on its electrical system, mainly in relation to specific requests from central and local authorities and with the primary aim of checking compliance of the associated fields with the limits recommended by IRPA/INIRC for the general population, which were officially adopted in Italy in 1992 by a Decree of the Italian Prime Minister.

In particular, measurements were performed outside and inside building located in the vicinity of overhead lines, as well as in areas interested by the presence of substations.

In summary, results of measurements carried out under normal operating service conditions have shown that average field levels where people live or spend a substantial part of the day are far below the above mentioned limits. As regards, in particular, the magnetic field, extrapolation of measurement results to maximum load conditions has confirmed that, even under these extreme and rare conditions and in the points closest to line conductors or substation components, the B-field strengths are still well below (at least one order of magnitude) the limit of 100 μT .

P-8-B

MEASUREMENTS OF THE ELECTRIC UTILITY WORKERS' EXPOSURE IN THE THERMO-POWER PLANT. P. Gajsek. Slovenian Institute of Quality and Metrology (SIQ), 1000 Ljubljana, Slovenia.

OBJECTIVE: Recent occupational studies indicate concern for worker exposure to 50/60 Hz magnetic fields (MF). In this regard, the SIQ is takes part in an ongoing program with the aim to characterize the occupational MF environment in Thermo-power plant in Sostanj, Slovenia. The objectives were to make the available descriptive information useful for possible exposure reduction and worker education and provide better exposure information for a planned clinical study

METHODS: The workplace characterization program consists of source characterization by mapping of workplaces, personal monitoring and integration of the two by an analysis of exposure with focus on task and occupation. In our sampling design, we defined different sampling strata based on different tasks of craft occupation in the power station: generator unit worker, plant operator, maintenance worker and machinist and craft supervisor. There were two generators in full use - block 3 (75 MW) and block 5 (345 MW).

We collected more data from the generator unit because of expected high exposures or high variability of exposure. Throughout the personnel were recruited at their work facility when they started their shift Each participant was a volunteer. The meter was worn at the waist at day and night shifts. Personal monitoring of exposure to magnetic fields was made by an EMDEX-2. The sampling rate was 3 s.

RESULTS: Generator unit workers tend to experience higher average and peak magnetic fields than other studied workers. Workers in block 5 had the highest exposure. The exposure to the magnetic fields by occupation during shift is presented in Table 1.

Table 1.

Occupation	magnetic field (μT)			
	min.	max	mean	median
Generator unit worker				
block 3	0.04	186.08	3.42	0.27
block 5	0.02	428.32	14.07	3.10
Machinist	0.05	340.80	4.65	3.83
Maintenance worker	0.02	328.30	3.45	0.10
Technician	0.02	224.28	15.42	0.32
Craft Supervisor	0.03	80.40	5.52	0.19

DISCUSSION: As expected, the major source for magnetic field is the generator unit. This monitoring has demonstrated that some occupations are exposed to higher MF as the others. The systematization of the jobs as well as working conditions must be foreseen. There is still a requirement for quantitative correlation of high exposure tasks and occupations with the measured fields and sources.

The results suggest a clear strategy for designing a clinical study in the near future.

P-9-C

EVALUATION OF THE RISK LEVELS RELATED TO E.M. FIELDS EXPOSURE IN DIFFERENT OPERATIVE CONDITIONS IN BOLOGNA (ITALY). C. Bernardi, G. Testoni, R. Zannoli, F. Rossi, R. Zuin and E. Trevisoi. Health Physics Service, University of Bologna, 40187 Bologna, Italy.

INTRODUCTION: In the last few years, the whole population have been repeatedly solicited from media, about the possible negative effects of EM Fields involved in all the social activities. This determinates the need of evaluations of the risks in different conditions, supported by accurate measurement protocols. This paper describes the procedures and the results of measurements in five different conditions, which involve the whole population and/or the workers of a specific field. The results have been used both to increase the knowledge of the EM exposure levels and to evaluate the risks, with respect to the national rules and guidelines.

METHODS: The measurement protocols were dedicated to the following situations: a) systems for communications purposes (telephone and radio-television antenna local subsystems), b) industrial systems using magnetic induction and dielectric heating, c) high voltage (132 kV) power transmission lines. Measurement were performed using ALENIA Electromagnetic Field Meter System 27SB with dedicated sensors for the specific frequency range of interest, HOLIDAY HI-3637 VLF Magnetic Field Meter, HOLIDAY HI-3604 Power Frequency Field Strength Measurement System, in the positions where people can or must stand. Single measurements in stable conditions were performed.

RESULTS: For the telephone and radio-television antenna local subsystems the maximal Electric Field strength was 11.0

V/m. For the industrial heating systems (dielectric) the maximal Electric Field strength was 21.0 V/m, for the magnetic heating the maximal value of the Magnetic Field was 120 μT . For the high voltage power transmission lines, the maximal values were 283V/m and 295 nT.

DISCUSSION: Our results highlight that the EM exposure levels related to telephone and radio-television antenna local subsystems and high voltage power transmission lines are lower than those proposed as minimal acceptable values. In workplaces the level measured are sometimes comparable with reference levels, and requires deeper evaluation, concerning exposure times and distances.

As conclusive remarks our data highlight the need of a major and more accurate information devoted to the whole population and a complete screening of the operative conditions in workplaces.

P-10-A

RADIOFREQUENCY MAGNETIC FIELDS GENERATED BY POWER TRANSMISSION LINES AND UNDERGROUND CABLES. M. Vignati and G. Livio. I.S.P.E.S.L., Dipartimento di Impatto Ambientale, 00184 Roma, Italy.

Many epidemiological studies have shown the existence of a relationship between an increased incidence of leukemia and tumours in children and in people residing in the vicinity of high voltage lines, or in condition of exposure to the magnetic fields of high voltage lines (50 - 60 Hz, 0.2 to 0.3 μT), in comparison to controls. The present study does not question such results, but is intended to draw attention on the existence of a possible factor of confoundment, which may have played a role in determining some of the conclusions of the epidemiological studies. This factor consists in the possible presence of magnetic fields at frequencies much higher than 50 - 60 Hz. Many observations of radiofrequency (RF) magnetic fields ranging from 130 to 270 kHz underneath high voltage lines were made by us in Italy and Sweden. Every emission is stable in frequency and the magnetic field intensity is found to be in the order of magnitude of 0.3 nT, at minimum distance from the centre of high voltage lines. They consist of the so-called "conveyed waves" that are use for communication purposes. Means for generating these waves have been noticed in plants of other countries, like Portugal and Israel. Notwithstanding the low intensities of these fields, the corresponding voltages induced within underlying electric conductors, are comparable with the voltage induced by the 50 - 60 Hz magnetic field, since it depends on two factors: field intensity and field frequency. If we consider that at constant magnetic field exposure, the current density induced within a human body increases with frequency, and that the interaction between living tissues and magnetic fields is not clearly understood, we conclude that it is necessary to take into account the existence of this possible factor of confoundment.

P-11-B

ASSESSMENT OF MAGNETIC INDUCTION LEVELS NEAR DISTRIBUTION TRANSFORMERS MT/BT (MIDDLE AND LOW TENSION). P. Bevitori¹ and A. Ravaioli². ¹Regional Agency for Environment Protection (ARPA) of Rimini, 47037 Rimini, Italy. ²Rimini Hospital, Oncology Department, 47037 Rimini, Italy.

The increase of the consumption of electric power in industrialized countries has rise to new and more potent energy transmission power lines. The amount of people exposed to low and extremity low electromagnetic fields (ELF) is of course as well increasing.

There is a big debate in the scientific fields for the possible role of ELF in the induction of some human cancers, particularly child leukemia and child brain tumors. Transmission power lines are the main source of electromagnetic risk, but also distribution transformers from high to middle, and from middle to low power are taken attention, particularly when transformer room are located inside people buildings.

This problem is becoming of particular center for the actual trend in inside placing of transformers room.

In our work we try to measure and estimate the temporal trend of magnetic fields induction in the residential area near box line transformers.

The values of the fields are also measured and calculated considering various distances from power box.

The data will be presented with some consideration for the correct location of transforming stations.

Modeling

P-12-C

2D AND 3D FINITE ELEMENT METHOD IN BIOELECTROMAGNETIC RESEARCH. I. Ticar¹ and O. Biro². ¹University of Maribor, Faculty of Electrical Engineering and Computer Science, 2000 Maribor, Slovenia. ²Kurt Preis Technical University Graz IGTE, Graz, Austria.

Recently the supposed biological effects of the electric and magnetic fields are often discussed as actual problems of the protection of environment. The designer of the high voltage equipment and high voltage lines have to know the field exposition in the surroundings of the equipment and HV lines.

New procedures for the numerical computation of electromagnetic field by the method of the finite elements (FEM) have been intensively developed in the last years. This 2D and 3D methods enable the calculation of any geometrical and electromagnetical configurations, at the same time enabling optimization of the geometrical and electromagnetical configurations. Simultaneously with the development of the mathematical formulations and numerical procedures the post processing in form of stationary graphics and animation was created. Calculations and animation of

time harmonic and transient problems, coupled electromagnetic-thermal problems, problems with moving geometry, microwave problems are possible.

Using both - measurement (static and alternating electric fields are measured using the principle of field-inducing electrostatic charging; to record magnetic field the Hart effect or the voltage induced on a coil is exploited) and calculation with all possibilities in bioelectromagnetic research we hope to gain a new quality of the results.

Calculations of two systems of electrical field in 3D (15kV/m zone in high voltage lines zone) and magnetic field in 2D (sugar-mill 20kV zone-20-mT) were made. Graphics, graphs and cross-geometry animation are presented.

P-13-A

COMPUTATIONAL MODELING OF THE SCALING OF INDUCED CURRENT-TO-GROUND: NEAR FIELD EXPOSURES, THE ROLE OF BODY COMPOSITION. R.A. Stark. Naval Surface Warfare Center, Carderock Division, West Bethesda, Maryland 20817, USA.

Several recent studies have shown that currents, whether induced or through contact, flowing through the extremities, at frequencies near or lower than body resonance (~75 MHz), are a possible source of localized SAR which is dramatically higher than the average body SAR. In response to these findings, several national and international committees have recommended limits on these currents. One difficulty in implementing these standards is the large person-to-person variation in currents observed in subjects for identical exposure conditions. For induced currents there are at least three sources of this variation: body dimensions, body composition (fat to muscle ratio), and shoe impedance. The peer reviewed literature has confirmed a relationship between induced current-to-ground for $f < 40$ MHz for grounded (barefoot) subjects which is proportional to the product of the square of stature, the frequency, and the electric field strength. However this relationship is for exposures to radiation in the far field; it represents results averaged over only a few subjects, hence is representative of an average physique. The author has previously reported¹ the results of a computational study to find the scaling of induced current-to-ground on human body dimensions. This study showed that stature and leg resistance are the principle predictors of induced current-to-ground in the far field. This abstract outlines an extension of that computational study to near field exposures and to quantify the effects of the person-to-person variations in body composition.

OBJECTIVE: To find the dependence on human body dimensions of the induced current-to-ground in grounded humans exposed to RF radiation in the HF band (3 - 30 MHz) of the near field of a monopole antenna. To find the dependence on body composition of the induced current-to-ground of grounded humans exposed to HF band radiation in the far field. To parameterize this dependence on a few bioimpedance quantities (e.g. leg impedance).

METHOD AND STATUS: Finite difference time domain (FDTD) calculations are being performed for the human body

shape exposed to far field radiation and the near field radiation of a 35 ft whip antenna in the HF band. Details of the FDTD code and cuboid human models are given in the reference¹. To simplify the calculation of the fields, the spatial variation of the antenna current along the monopole is modeled as a sinusoid. Exposure distances modeled varied from 2 to 10 m, typifying exposure distances on US Navy Vessels. Some preliminary results of these simulations are: 1) Only the vertical component of the electric field (E_z) induces the current. 2) As with far field exposures¹, stature and leg resistance together are excellent predictors of the induced current-to-ground.

As a first step in the modeling of the dependence of the induced current on body composition, the sensitivity to trunk and leg tissue composition (fat/muscle) is being investigated with simulations using a range of uniform trunk and leg compositions. Human models with more detailed spatial resolution will be implemented if needed. Preliminary results indicate that the leg conductivity is much more important than the trunk conductivity in determining induced current.

CONCLUSION: The work outlined here, along the work previously reported study¹, is the first attempt to parameterize the induced current-to-ground in terms of human body factors other than stature alone. Here FDTD calculations were used to show that the scaling law for the dependence of induced current on body dimensions found for far field exposures applies to exposures in the near field of monopole antennas. FDTD calculations using human body shapes with various trunk and leg conductivities to access how the induced current depends on fat-to-muscle ratio are in progress. Successful completion of this work should account for much of the person-to-person variation observed in grounded humans exposed to radiation in the HF band, and hence help in the implementation of induced current standards. A follow-on task will be validation of these computational scaling relationship with measurements using human subjects on a ground plane facility.

1. R. Stark, 18th Annual BEMS Meeting, P-18B, Victoria, BC, Canada, June, 1996.

Work supported by the U. S. Naval Medical Research and Development Command, and the U. S. Naval Sea Systems Command.

P-14-B

DETECTABILITY OF BIOLOGICAL EFFECTS OF 60 Hz POWER LINE ELECTRIC AND MAGNETIC FIELD USING SIGNAL DETECTION THEORY. D.H. Nguyen¹, J.F. Burchard² and E. Block². ¹Institut de Recherche d'Hydro-Québec, Varennes, Québec J3X 1S1, Canada. ²Department of Animal Science, McGill University, Sainte-Anne de Bellevue, Québec H9X 3V9, Canada.

OBJECTIVE: Signal detection theory (SDT) is appropriate for studies of sensory perception. This methodology provides estimation of sensory sensitivity without bias affecting perceptual judgments through an individual's expectancies, motivation, and decision criteria¹. The STD methodology was used to evaluate the sensitivity of dairy cows exposed

simultaneously to an electric field of 10 kV/m and a magnetic field of 30 μ T at power frequency (E&MF).

METHODS: Variables such as progesterone, dry matter intake, milk fat content and production were monitored during an experimental trial. The experiment was carried out as a switchback design of six consecutive periods of 28 days, each one divided into two sequence groups of 3 periods each. During the first sequence the E&MF were off, on and off during periods 1, 2 and 3, respectively. During the second sequence the E&MF were on, off and on during periods 1, 2 and 3, respectively. The SDT analysis complemented the conventional statistical methodology identifying the percentage of the population which was positively or negatively affected. This method is particularly efficient when detecting a small bias of variables values having a larger normal variation. The data collected from the switchback trial were reprocessed and divided in two groups, E&MF ON and E&MF OFF without taking into account the sequence group.

RESULTS: Conventional statistical analysis (analysis of variance using linear regression models) detected, overall, an increase of 4% in the variables studied². Due to the nature of the switchback design (the animals are their own control during OFF period) used for the study, these changes were associated to E&MF and the SDT method can be rigorously applied. The STD method allowed to detect the percentage of exposed cow that reacted to E&MF. Positives responses and negative responses varied from 0 to 34%, and 13 to 44%, respectively.

1. J.P. Blondin, D.H. Nguyen, J. Sbeghen, D. Goulet, C. Cardinal, P.S. Maruvada, M. Plante, W.H. Bailey, "Human Perception of Electric Fields and Ion Currents Associated with High-Voltage DC Transmission Lines", *Bioelectromagnetics* Vol 17, pp 230-241

2. J. Burchard, D. H. Nguyen, L. Richard, E. Block. 1996 "Biological Effects of Electric and Magnetic Fields on Productivity of Dairy Cows", *J. Dairy Sci.* 79: 1549-1554

This study was sponsored by Vice-Presidence Environnement et Collectivites of Hydro-Quebec.

P-15-C

A FORMULA FOR FREQUENCY AND AMPLITUDE WINDOWS OF SOME ELF AND NULL MF BIOEFFECTS FOLLOWS FROM THE SCHROEDINGER EQUATION. V.N. Binghy. International Institute of Theoretical and Applied Physics NSA, Institute of Cell Biophysics RAS, Moscow 125190, Russia.

Chiabrera and co-authors [1] described, in a quantum mechanical way, the process of ion binding with a protein under exposure to time-varying magnetic field (MF), parallel static H_{DC} and alternating H_{AC} fields. They calculated *formally* the transition probability between ion states ψ_0 , ψ that were the ion wave functions without and under the MF exposure correspondingly. They suggested that transition probability and the value of magnetic bioeffect are connected. However, this idea is weakly consistent with the fact that the

above MF, affecting only the phase of the quantum state does not actually cause any transition. The population of each state remains exactly constant regardless of the MF parameters. The other hypothesis by the authors is that biological effects of MFs are related to the probability for ion to be inside the virtual centered sphere smaller than the binding cavity size. At the same time no closed formula has been derived for that probability. There are many other more speculative models where bioeffects are associated with resonant quantum transitions in Zeeman sublevels, but their probability in collinear static and alternating MFs equals zero.

A consistent physical model is proposed that explains weak ELF MF effect on biological systems. An interference is described of quantum states of bound ions in a protein cavity. The ion quantum dynamics is investigated in idealized case in the collinear MFs. There is taken into account a nonlinear protein response on the redistribution of ion probability density and a nuclear spin of ion [2]. In the case, solution of the Schroedinger equation results in a formula for magnetic-dependent part of an ion-protein dissociation probability:

$$\rho = \sum_{(i),n} |a_{(i)}|^2 \left(\frac{\sin[\Xi(\Delta_{(i)} + nf')]}{\Xi(\Delta_{(i)} + nf')} \right)^2 J_n^2[\Delta_{(i)} \frac{h'}{f'}]$$

where $f' = \Omega/\Omega_c$ and $h' = H_{AC}/H_{DC}$ are dimensionless frequency and amplitude of the MF. $\Omega_c = qH_{DC}/Mc$ is the cyclotron frequency in Gauss system, $\Xi = T\Omega_c$ is a dimensionless parameter that depends on the conformational reaction time T of a protein. J_n is n -order Bessel function, $\{i\}$ is a set of indices that mean quantum numbers; elements of the density matrix $a_{(i)}$ are constants that relate to initial conditions for ion in the protein cavity. If isotope of ion nucleus does not possess a spin, then $\Delta_{(i)} = \frac{1}{2}(m - m')$, $\{i\} = m, m'$, m is magnetic quantum number, else, $\Delta_{(i)} = \frac{1}{2}(m - m') - \Gamma(s - s')$, $\{i\} = m, m', s, s'$, s is spin quantum number, $\Gamma = \Omega_N/\Omega_c$ is a combination of the fundamental constants and ion constants, charge q , mass M , and magnetic momentum μ , $\Omega_N = 2\mu H_{DC}/\eta$ is NMR frequency.

Typical frequency and amplitude spectra of the interference, in various magnetic conditions, are calculated and compared with the different known experiments. The overall correlation factor is about 0.9 between the theory predictions calculated with the above formula and experimental data, including those displaying many peaks of bioeffect, both in amplitude and frequency spectra, on each side of the cyclotron frequency, and bioeffects of null MF. It follows that proposed quantum processes are likely to be a physical basis for some magnetobiological effects.

[1] A. Chiabrera, B. Bianco, J.J. Cauffman, and A.A. Pilla. In *Electromagnetics in Medicine and Biology*, C.T. Brighton and S.R. Pollack, eds., San Francisco, San Francisco Press, 21-26; 27-31, 1991.

[2] V.N. Binghy. Nuclear spins in primary mechanisms of bioeffects, *Biophysics*, 40, 677-691, 1995.

P-16-A

NEW APPROACH TO THE PROBLEM OF ELECTROMAGNETOBIOLOGY. A.E. Akimov, G.I. Shipov and V.N. Binghy. International Institute of Theoretical and Applied Physics NSA, Moscow 125190, Russia.

The interaction of electromagnetic or EM fields with biological systems is an acute problem. In the last decades it has received a powerful pulse of development. At present, the number of experiments is accumulated that prove that EM fields influence biological objects in a very wide range of amplitudes and frequencies. At the same time there is no conventional idea so far about the physical nature of biological reception of EM fields as small as geomagnetic fluctuations. Quanta of energy of such fields, which cause bioeffects, are three-five order below those of ELF MF of 1G. This fact is paradoxical and dramatic for physics. Theoretical study of possible mechanisms of biological amplification does not result in any outcome for a long time.

The well-known equations for particle in EM fields are the Lorentz force equation in classical approach and the Dirac or the Schroedinger equations in quantum case. They are hardly applied or even rather unable to explain bioeffects of the infinitesimal EM fields. It is interesting that there is an opportunity to come out the framework of these equations. We mean an extensive experimental and theoretical material on so-called spin-torsion interactions, see the review [1]. The scientific area of geometrization of physical fields exists since the past century. There have been achieved recently significant results [2]. The general object of the new nonlinear theories is torsion fields that relate to the known geometric property of space-time, property of torsion. Mathematically, they are tensor fields that describe the torsion and curvature of space. The Dirac equation and the Schroedinger equation arise in this theory as linear approximations. There are no theoretical restrictions on the magnitude of nonlinear effects. Parameters of the theory in this regard should be established experimentally. Torsion fields are produced, in particular, by spins of microparticles. They accompany EM fields also. Specially designed macroscopic equipment generate torsion fields as well.

Nonlinear extensions of the known equations may be gained from the general equations of torsion field. Such extensions include additional correction term that describes «torsion» contribution. It makes sense to use them for the explanation of biological effects of weak EM fields. It should be noted that torsion fields cannot change energy of any system [2], in particular the energy of quantum particle, which is governed by the Schroedinger equation. Therefore we introduce into the equation a «torsion term» that acts on the phases of wave functions. The charged particle like ion in a protein cavity, which experiences a biologically significant interference of its quantum states, is shown to be affected by the alternating torsion field in resonance-like manner. The frequency spectrum for bioeffect of torsion field accompanying ELF EM field is calculated first.

In the report we display many unusual experiments with infinitesimal EM fields and torsion field generators affecting

live systems and give them an explanation from the viewpoint of torsion-field physics.

[1] A.E. Akimov, V.Ya. Tarasenko, and G.I. Shipov. Torsion fields as a cosmophysical factor. *Biophysics*, 1995, 40, No.4, pp.939-943.

[2] G.I. Shipov. The theory of physical vacuum. *Moscow: NT-Center*, 1993, 362p.

P-17-B

TWO IONS OSCILLATING COHERENTLY: A CONJECTURE TO ILLUMINATE THE BEAUTIFUL AGREEMENT OF IPR MODEL WITH CELL-CULTURE DATA. S. Machlup¹ and C.F. Blackman².

¹Case Western Reserve University, Cleveland, Ohio 44106, USA. ²NHEERL, U.S. Environmental Protection Agency, Research Triangle Park, North Carolina 27711, USA.

Blackman *et al.* (1994)¹ were able to tune, i.e. find ion parametric resonance (IPR) frequencies corresponding to half a dozen different ions [$\omega_c = (q/m)B_{DC}$] by microscopic examination of cell cultures after immersion in parallel DC (steady) anti AC (oscillatory) magnetic fields. Note that the wavelength corresponding to the 45-Hz frequency they used is close to 10^9 Petri dishes. As the amplitude B_{AC} of the oscillatory field is varied, the biological response curves agree with the equations (Bessel functions of integer order n , argument $n B_{AC}/B_{DC}$) proposed by Lednev (1991)² provided the argument $n B_{AC} / B_{DC}$ is doubled. A rationale for this doubling was given by Blanchard and Blackman (1994)³. Both models^{2,3} postulate that the quantum-mechanical transition probability corresponding to radiation is proportional to $|A|^2$, where A is the vibration amplitude of the resonating ion. The two-coherent-ion conjecture here proposed is an alternative explanation of the apparent doubling of the Bessel-function argument. We observed that using the Lednev² formalism and assuming that the biological effect goes as $|A|^4$ gives an argument of the Bessel functions that is consistent with the periodicity found experimentally. One way to get such a fourth-power dependence is to postulate that two identical ions have to oscillate (radiate) coherently. Such a requirement places special conditions on the molecular structure of the protein to which the ions are attached and further defines potential reaction sites for field interactions. Remember, the resonance is observed for Mn, V, Mg, H and possibly Ca, Li and Fe. What else does our conjecture predict? It predicts a much sharper frequency dependence as a result of the multi-ion coherence.

C.F. Blackman, J.P. Blanchard, S.G. Benane, and D.E. House, "Empirical Test of an Ion Parametric Resonance Model for Magnetic Field Interactions With PC-12 Cells", *Bioelectromagnetics* 15: 239-260 (1994).

V.V. Lednev "Possible Mechanism for the Influence of Weak Magnetic Fields on Biological Systems" *Bioelectromagnetics* 12: 71-75 (1991).

J.P. Blanchard and C.F. Blackman, "Clarification and Application of an Ion Parametric Resonance Model for Magnetic Field interactions With Biological Systems", *Bioelectromagnetics* 15:217-238 (1994).

P-18-C

ESTIMATION OF ELECTRIC AND MAGNETIC FIELDS PRODUCED BY 154KV AND 345KV TRANSMISSION LINES SIDE BY SIDE. D.W. Kim and C.Y. Ryu. Department of Biomedical Engineering, Yonsei University, Seoul 120-752, Korea.

INTRODUCTION: The construction of 345kV transmission lines (TL) near existing 154kV TL has been suspended for several months because of the objection of the residents in Guachun City. Thus a special committee was called out to settle the dispute by estimating how much EMF would be produced.

OBJECTIVE: The objective of this study was to estimate the total EMF produced by the existing 154kV and the planned 345kV TLs which would be constructed side by side near 154kV TL.

METHODS: We measured EMF from the existing 154kV TL and from the 345kV TL which is similar to the planned one located other area using HI3604 ELF survey meter and HI3616 fiber optic remote control receiver (Holaday Industry Inc., USA). Electric and magnetic field was measured in x, y, and z direction and summed up vectorially. Electric field was measured using a dielectric tripod and fiber optic remote control receiver to avoid interference by human. The load current of the 154kV and the 345kV TLs was 850A and 600A, respectively and both have four conductors. The height of the transmission line from ground of the former and the latter was 18.4m and 22.7m, respectively.

RESULTS: Fig. 1 is measured electric fields from 154kV and 345kV TLs, and calculated one from both TLs. The distance between the 154kV and 345kV TLs was assumed 35m. The 0m in Fig. 1 is the center of the 345kV TL tower. Fig. 2 is a calculated magnetic field from both the 154kV and the 345kV TL together. The magnetic field from the 154kV TL was approximately 1mG at the center of 345kV tower which is 35m apart from the 154kV one. Thus the contribution of the 154kV TL to the total magnetic field was negligible. As shown in Fig. 2 3mG is expected at 50m apart from the center of the 345kV TL tower. For the typical 500kV TL in the United States 3mG was measured at 60m from the tower.

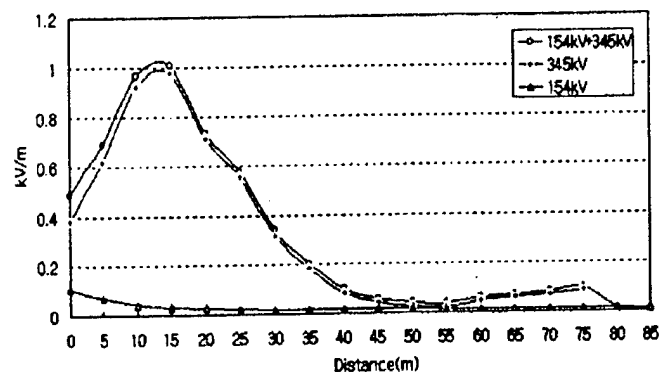

Fig. 1 Electric fields from 154kV, 345kV and both

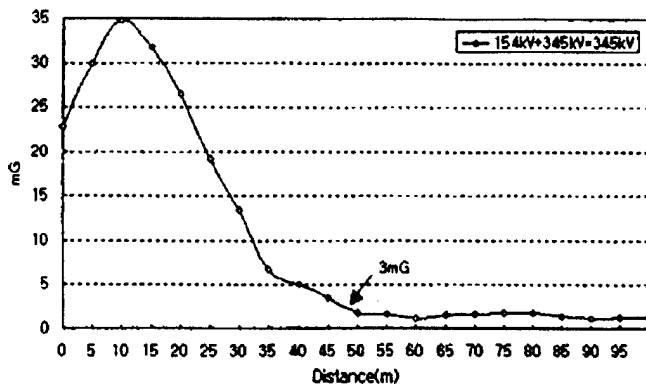

Fig. 2 Magnetic fields from 154 and 345kV together

P-19-A

EVALUATION OF MAGNETIC FIELDS GENERATED BY UNDERGROUND CABLE AND AIR POWER TRANSMISSION LINES. CALCULATION MODELS TO COMPARE THE EXPOSITION. P. Bevitori¹ and A. Ravaioli². ¹Regional Agency for Environment Protection (ARPA) of Rimini, 47037 Rimini, Italy. ²Rimini Hospital, Oncology Department, 47037 Rimini, Italy.

Some recent researches suggest that possible relationship exist between the exposition to electromagnetic fields and the increase frequency of some human cancers.

These findings were the cause of the public concern regarding the health risk from residential exposures to low strength, low frequency electric and magnetic field produced by power lines, generating also considerable debate among scientists and public officials.

Starting from these considerations some local and National Italian Authorities (USL, ARPA, CNR etc.) asked the researchers to determine whether there is sufficient scientific basis and literature to assess health risk from such exposure.

The local Regional Agency for Environment Protection (ARPA) of Rimini in 1994 performed a study measuring magnetic fields of many houses located near a high transmission power line.

The great majority of these houses with a direct measure a magnetic field equal or more than 0.2 μ T was found.

These data moved the people living near the transmission electric line and their majors to ask for the change of the line. Local authorities (Municipality, District, Energy Providers) are deciding to study the possibility of modifying power lines with underground cables.

This project is underway. We will show with this work a theoretical model that will allow us to calculate magnetic induction on the surface of underground cable with the same characteristics of the actual air power-line. Magnetic fields on the ground of a high power line will be also compared considering the air and underground setting.

P-20-B

HUMAN EXPOSURE TO 60 Hz ELECTRIC OR MAGNETIC FIELDS: MODELING METHODS AND RESULTS. T.W. Dawson, K. Caputa and M.A. Stuchly. Department of Electrical & Computer Engineering, University of Victoria, Victoria, British Columbia V8W 3P6, Canada.

This paper describes the computational methods used for organ dosimetry in an anatomically realistic human model in a uniform power-frequency electric or magnetic field. The objective of the research was to reliably compute induced electric fields in a realistic human model with a final resolution better than 4 mm. The motivation was provided by a recent epidemiological study (Miller, *et. al.*, 1996, *Am. J. Epid.*, vol. 144, pp. 150-160) which reported elevated odd ratios for hematopoietic malignancies due to occupational exposure to electric fields, as well as to exposure to both the electric and magnetic fields. Other studies previously reported increases of some cancers associated with exposure to magnetic fields. Additionally, at least some (but not all) experimentally observed effects depend on the induced currents in the biological medium.

All computations are for an anatomically-derived human full-body model discretized into a set of uniform 3.4 mm material cubes. In the development of the model, particular attention has been paid to the surface continuity for specific organs, the continuity of the main blood vessels and the continuity and encapsulation of the bone marrow in bone tissue. The anatomical correctness of the model (within limits of acceptable simplifications) was verified using visualization software (Data Explorer by IBM) and manual corrections were performed, when needed, with an aid of our software developed for this purpose. A coarser model with resolution of 7.2 mm was also developed and used.

For electric field induction a hybrid method was used. In this method, a new quasi-static FDTD formulation (De Moerloose *et. al.*, *Radio Science*, 1997) was used to compute the fields with the lower resolution of 7.2 mm. The electric field at the body surface (which is normal to it) is used to compute the surface charge density. The charge densities from the FDTD are interpolated onto a 3.6 mm grid and used as the source of the body interior potentials and electric fields in the scalar potential finite difference (SPFD) method. In the SPFD, the electric field is expressed in terms of potential and the Laplace's equation is solved inside the body with the boundary condition at the body surface, where the normal component of the interior electric field is equal to the surface charge density divided by the dielectric constant of free space. This model gives rise to a system of about 1.8 million equations for the interior potential. The resultant matrix after preconditioning is diagonally dominant, symmetric and has 7 bands. It is efficiently solved using a conjugate gradient solver. For magnetic induction the SPFD method was used with the magnetic vector potential as the source.

Organ average, organ maximum and spatial maps of the induced electric and current density fields were obtained. The data are for exposures to 60 Hz uniform magnetic fields in three orthogonal orientations, and vertical electric fields in

free space, above perfect ground and in contact with the ground. These dosimetric data are for 30 different organs and tissues. The massive data obtained, can be analyzed from various perspectives. For the total body and cross-sectional data comparisons are made with the previously published results for lower resolution models or measurements. Overall agreement is good. The differences, e.g. in the magnetic field induced currents can be well explained on the basis of different values of conductivity used in different calculations. This is further quantified by our computations for models having different tissue conductivity. The effect of the change in tissue conductivity is relatively small for the tissue induced electric fields, but predictably larger and directly proportional to a difference in the conductivity.

This work was supported by the NSERC/BCHydro/TransAlta Industrial Research Chair and a contract from the Ontario Hydro.

P-21-C

ANALYSIS OF CURRENT DENSITY IN HUMAN HEAD ASSOCIATED WITH

MAGNETOPHOSPHENES. K. Wake¹, T. Tanaka¹, M. Taki¹ and M. Kawasumi². ¹Department of Electronics and Information Engineering, Tokyo Metropolitan University, Tokyo 192-03, Japan. ²Department of Information and Communication Engineering, Tokyo Denki University, Tokyo 101, Japan.

INTRODUCTION: The mechanism of magnetophosphenes is thought to be derived from the stimulation of retinal cells by induced current [1]. The magnitude of the induced current density which can evoke magnetophosphenes has been estimated by calculation using a homogeneous sphere [2] as a head model. It is not clear, however, whether the induced current density estimated in this study is valid for humans, because it may be strongly affected by the anatomically complex shape and electrical heterogeneity of the human head. In this study, we calculate the current density distribution in a human head exposed to an ELF magnetic field, taking the complex shape and electrical heterogeneity of the human head into consideration.

METHOD AND MODEL: As the condition of calculations, we assumed the incident magnetic field of 10 mT near the retina at 20 Hz generated by a U-shaped magnet placed beside the temporal area of the human head. This condition simulates our previous experiment on the threshold of magnetophosphenes. The induced current density in a heterogeneous anatomical model of a human head was calculated using the impedance method [3].

RESULTS AND DISCUSSION: The calculated current density at retina was not uniform, and was higher in the peripheral part than in the central part. This is consistent with the experimental observation that magnetophosphenes were perceived more clearly in the peripheral part of the visual field than in its central part. The maximum value for induced current density at retina was about 3 mA/m². This is much smaller than the value that was estimated in the previous study [2].

The induced current density in a homogeneous model was calculated and compared with that in a heterogeneous model to investigate whether the electrical heterogeneity of a human head could influence the distribution of induced current density. The induced current density at retina was almost uniform in the homogeneous model.

The results in this study suggest that the electrical heterogeneity in human head especially around eyes is an important factor in magnetophosphenes.

We also investigated the influence of muscle anisotropy near the eyes. It caused little effect on calculated current density around the eyes.

[1] P. Lövsund, P.A. Oberg and S.E.G. Nilsson, *Med. & Biol. Eng. & Comput.*, 18, 326-334, 1980.

[2] Z.J. Seinkiewicz, R.D. Saunders and C.I. Kowalczyk, *NRPB-R239*, 1991.

[3] N. Orcutt and O.P. Gandhi, *IEEE Trans. Biomed. Eng.*, BME35, 577-583, 1988.

P-22-A

FINITE ELEMENT COMPUTATION OF INDUCED CURRENTS IN CELL CULTURES. I. Chatterjee, G.L. Craviso and N.G. Publicover. Departments of Electrical Engineering, Pharmacology and Physiology and Cell Biology, University of Nevada, Reno, Nevada 89557, USA.

The finite element method was used to solve Maxwell's equations for the detailed electric field distribution and currents induced in various types of cultured cell preparations exposed to 60 Hz magnetic fields. This technique has the advantage over previously used impedance methods [1,2] that complicated cell shapes are not restricted to cubical grid models. A commercially available software package, Maxwell 3D (Ansoft Corporation, Pittsburgh, PA), was used to perform the numerical modeling and computations.

The specific objectives of this work are to address the following questions: (1) Does the density of cells in a cell-culture medium affect the distribution of induced electric fields and hence induced current densities? (2) Does the shape of cells (e.g. circular versus elongated) influence induced electric fields and currents? (3) Does the location of cells affect induced electric fields and currents?

The pre-processor module of Maxwell 3D was used to construct accurate finite-element models of Helmholtz coils energized with currents in the same direction in both coils, circular 35 mm Petri dishes placed midway between the two coils, and cell-culture media in the dishes. The applied magnetic fields in the region of the dishes, and the induced electric field and current distributions in the media were computed using the "eddy-current" solver module of Maxwell 3D. Results were compared with those expected from analytical expressions for the electric field and induced current distributions.

Two cell geometries commonly found in excitable cells were used. The first is based on the elongated, cigar-like shape of the interstitial cell of Cajal which is considered to be the pacemaker of the gastrointestinal tract. The second is based on the circular geometry of the chromaffin cell found in the

adrenal medulla. Chromaffin cells manufacture, store and secrete several hormones including adrenaline and are considered a model of sympathetic neurons. In addition to their circular cross-section, these cells also tend to clump together and hence there is speculation that experimental effects observed upon exposure of these cells to 60 Hz magnetic fields may be influenced by such non-uniform distributions.

Photographs of actual cell cultures were then taken and scanned directly into a computer. These scanned images were processed using the manual meshing capability of Maxwell 3D to obtain detailed finite element meshes using tetrahedral elements to accurately represent cell shapes. The solution module was then used to re-solve Maxwell's equations for the induced electric fields and current distributions in media containing cells. A single layer of cells in the bottom of a dish was considered in order to simulate cells in the "plated down" culture configuration. Calculations for cells in "suspension culture" were computed for uniformly distributed cells and cell clusters cells with less-flattened geometries. Results will be compared for media: (1) containing no cells, (2) containing a range of cell densities (3) with different cell geometries, (4) with cells positioned in different locations, and (5) with different types of culture conditions (plated down versus suspension).

References:

1. Hart, K. Evely and C.D. Finch, "Use of a spreadsheet program to calculate the electric field/current density distributions induced in irregularly shaped, inhomogeneous biological structures by low-frequency magnetic fields", *Bioelectromagnetics*, vol. 14, 1993, pp. 161 - 172.
2. Stuchly and W. Xi, "Modeling induced currents in biological cells exposed to low-frequency magnetic fields", *Phys. Med. Biol.*, Vol. 39, 1994, pp. 1319-1330.

P-23-B

EFFECTS OF 50 Hz MAGNETIC FIELDS ON LIPID PEROXIDATION AND ANTIOXIDASE ACTIVITIES IN BRAIN TISSUE OF MICE. B.Y. Zheng, G.D. Yao, L.H. Xie, Y. Lin, D.Q. Lu and H. Chiang. Microwave Institute, Zhejiang Medical University, Hangzhou 310006, P.R. China.

External magnetic fields (MFs) could influence the recombination kinetics of spin-correlated radical pairs that are formed as intermediates in (bio)chemical reactions is known as radical pairs mechanism(RPM) by which MFs could increase the production or prolong the half-life of free radicals. A number of recent experiments have suggested that the pineal product melatonin is one of the most potent endogenous scavengers of free radicals and a variety of studies have showed that low-intensity MFs can reduce endogenous levels of melatonin in animals and humans. Therefore, it is suggested that MFs could increase the oxidative stress of free radicals, which appears mainly to enhance lipid peroxidation.

OBJECTIVE: This study is to find if exposure to 50Hz MFs may increase lipid peroxidation and change the antioxidant activities in brain tissue of mice, to seek the mechanism of

MFs interaction with biological systems.

METHODS: The ELF exposure system is composed of three Helmholtz coils which 50Hz AC passed through during exposure and MF intensities distributed uniformly with a variation of $\pm 6\%$ within the coils. ICR male mice were randomly assigned to four groups, twelve for each, as follows: (1) sham MF, (2) 0.20mT, (3) 1.00mT, (4) 5.00mT. Each group was exposed for 3 hours per day, and continued for 30 days. The mice were sacrificed at the 31st day and their brain tissue were extracted to assay the following indices: Lipid peroxides (LPO) concentration by thiobarbituric acid reaction, Glutathione Peroxidase (GSHpx) activity by 5,5'-dithionbis(2-nitrobenzoic acid) reaction, Superoxide dismutase (SOD) activity by 1,2,3-thrihydroxybenzene self oxidative reaction, protein concentration by biuret reaction.

RESULTS: The LPO concentrations in both 1.00mT MF and 5.00mT MF groups were significantly increased than that in sham exposed group, there were no statistical differences among groups in GSHpx and SOD activities (Table 1).

Table 1: Effects of MFs on LPO, SOD and GSHpx in brain tissue of mice ($X \pm SD$).

groups	N	LPO(nmol/mg)	SOD (U/mg)	GSHpx (U)
sham	12	2.76 \pm 0.75	16.91 \pm 5.97	27.60 \pm 11.90
0.20mT	12	3.21 \pm 0.35	17.14 \pm 5.00	32.85 \pm 14.40
1.00mT	12	3.78 \pm 0.73*	18.21 \pm 8.85	26.25 \pm 8.95
5.00mT	12	4.05 \pm 0.66*	20.11 \pm 6.48	34.25 \pm 8.70

* $P \leq 0.05$ vs. sham group

DISCUSSION: This experiment was conducted with animal brain tissue considering the CNS is sensitive to MFs exposure. It is generally agreed that the toxicity of free radicals is removed mainly by following three ways: (1) Free radicals reciprocally collided and recombined, (2) endogenous or exogenous scavengers of free radicals, (3) specific removing enzymes. In the present study, the results showed that exposure to 1.00mT and 5.00mT MFs significantly increased the LPO concentration, but specific removing enzymes SOD and GSHpx activities did not change. It was reported that MFs even much less than 0.2mT could reduce levels of melatonin in animals and humans. However, in this study the LPO concentration did not increase significantly in 0.20mT group. Some experiments have showed that the effective MFs strengths for radical-pair reactions vary from 1mT to 100mT. Our results support the RPM of MFs interaction with biological systems.

P-24-C

FDTD HANDSET ANTENNA MODELLING AT 900 MHz FOR ELECTRICAL PERFORMANCE AND SAR RESULTS. J.T. Rowley¹, R.B. Waterhouse² and K.H. Joyner¹. ¹Telstra Research Laboratories, Clayton, Victoria 3168, Australia. ²Royal Melbourne Institute of Technology, Melbourne, Victoria 3000, Australia.

The increasing use of mobile communications devices has led to a need for accurate assessment of handset antenna radio performance and SAR deposition. Sophisticated measurement systems have been developed [1] to directly measure SAR in homogeneous phantoms. There has been considerable interest in developing numerical methods and

comparing the accuracy and utility of different methods [2]. The Finite Difference Time Domain Technique (FDTD) has been favoured by a number of researchers because of the relative ease of modelling complex dielectric bodies. The current investigation compared the performance using canonical sphere problems of a commercial FDTD code with published data for a range of numerical methods. Building on these investigations a range of typical handset antennas have been modelled for electrical characteristics in free space. Further calculations of radio performance parameters and SAR deposition have been performed using uniform and layered dielectric spheres of cubic voxel grid 2.5 mm as well as a 4 tissue realistic model of the head using a cubic voxel size of 32 mm.

The antennas modelled included a half wavelength dipole as a reference, also a monopole, planar inverted F antenna (PIFA) and normal mode helical antenna (NMHA). Antenna free space characteristics have also been measured to assess calculation accuracy. The trend in the energy deposition results is to confirm the observation of others [3] that the simpler dielectric models tend to overestimate SAR in comparison to realistic head models. Electrical characteristics of the antennas are also changed by the presence of the head with a general lowering of the resonance frequency and deterioration of VSWR response resulting in a greater antenna mismatch. Directional handset antennas can reduce the energy deposited in the head but they often have a narrower impedance bandwidth which means greater care is needed in matching design to ensure good performance in the presence of the body and in its absence. Also energy absorption in the hand becomes a significant factor.

[1] Schmid, T. and Kuster, N. (1995). Automated E-Field Scanning System for Dosimetric Assessments. *IEEE Transactions on Microwave Theory and Techniques*, Vol. 44, No. 1, January. pp. 1-9.

[2] Dhondt, G. and Martens, L. (1994). A canonical case with an analytical solution for the comparison of electromagnetic field solvers. *Proceedings of the COST244 meeting on Reference Models for Bioelectromagnetic Test of Mobile Communication Systems*, pp. 98-104, 1-7, November 1994.

[3] Hornbach, V., Meier, K., Burkhardt, M., Kuhn, E. and Kuster, N. (1996). The Dependence of EM Absorption upon Human Head Modelling at 900 MHz. Submitted to *IEEE Transactions on Microwave Technology*, October 1995; Revised February 1996. pp. 1-9.

P-25-A

MODELING OF THE PROCESSES OF PORE CREATION AND DISAPPEARANCE IN A CELL UNDER THE INFLUENCE OF STRONG ELECTRIC FIELD AS RANDOM ONE-STEP PROCESSES. G. Saulis. Department of Biology, Vytautas Magnus University, Kaunas 3000, Lithuania.

The formation of pores in the cellular membrane under the action of strong electric field and disappearance of them after the field is turned off are investigated on the basis of a kinetic

model in which the creation and disappearance of a pore are described as random one-step processes. Two characteristics are derived: (i) the dependence of the fraction of porated cells F_p on both the electric field strength E_0 and the pulse duration τ_i

$$F_p(E_0, \tau_i) = 1 - \sum_{n=0}^{n_c-1} [k_f(E_0, \tau_i)]^n \exp[-k_f(E_0, \tau_i)] (1/n!) \quad (1)$$

and (ii) the dependence of the fraction of resealed cells on the time passed after the pulse

$$F_r(t) = \exp^{-(k_f/k_r)(1-\exp(-k_r t))} \sum_{n_i=1}^{\infty} P_{n_i}(0) [1 - \exp(-k_r t)]^{n_i} \quad (2)$$

Here k_f and k_r are the rates of pore formation and resealing respectively, n is the number of pores in a cell, n_c is the number of pores which is sufficient for a cell to be regarded as porated, n_i is the number of pores created during the pulse, and $P_{n_i}(0)$ is the probability that there are n_i pores in a cell just after the electric pulse.

Theory is compared with experiments. Dependences $F_p(\tau_i)$ for human erythrocytes are determined at different E_0 . The pore formation rate k_f for various E_0 is calculated from the $F_p(\tau_i)$ obtained. The values of the energy barrier to pore formation $\Delta W_f(0)$ and the pore radius r corresponding to the top of this barrier are estimated from the $k_f(E_0)$ dependence obtained in this way ($\Delta W_f(0) \approx 40 kT$ and $r \approx 0.34$ nm). The theoretical dependences $F_p(E_0)$, calculated using these values, are in good agreement with the experimental results.

Distribution functions $F_r(t)$ of human erythrocyte resealing times are determined experimentally for the electric pulse the intensity of which is only slightly greater than that required for electroporation. The shape of the functions $F_r(t)$ obtained depends on the electroporation protocol, however, they can be described by theoretical expressions quite well.

By obtaining a "best-fit" of Eq. 2 to experimental data, an average number of pores, \bar{n}_i , which appeared in a cell during an electric pulse, the rate of pore resealing k_r , and the ratio k_f/k_r between the rates of pore formation and resealing in the absence of an external electric field were estimated, assuming that the probabilities $P_{n_i}(0)$ that n_i pores have appeared in a cell during an electric treatment are given by the Poisson distribution ($\bar{n}_i \approx 1-5$, $k_r = 10-20$ min, and $k_f/k_r \approx 0.1$).

P-26-B

ELECTRO-ORIENTATION AND AGGREGATION EFFECTS OF ELLIPSOIDAL CELLS. A MONTE CARLO SIMULATION. V. Giner, R. Peña and M. Sancho. Departamento Física Aplicada III, Facultad de Física, Universidad Complutense de Madrid, 28040 Madrid, Spain.

The phenomenon of electro-orientation of non spherical cells has recently attracted wide attention.

The orientation plays an important role in different biotechnological processes, such as electro-fusion or viability testing. The existing theory, based on the effective dipole concept, deals with individual cells. In this work we propose

a model in order to investigate the influence of collective aspects on the turnover frequencies in a cell suspension. The cells are modeled as layered ellipsoids with permittivities and conductivities corresponding to those of cytoplasm and membrane, then the system energy is computed through the multiple interactions between the effective dipoles induced by the external field in each cell.

In order to achieve quantitative results for the suspension, a Monte Carlo simulation has been carried out. The computation assumes a two dimensional distribution of sedimented cells on a plane, in a uniform electric field. It uses a Metropolis algorithm to explore possible set configurations and works out the orientation and aggregation structures as a function of frequency. We compare the numerical results with experimental observations found in literature.

P-27-C

A LARMOR PRECESSION/DYNAMICAL SYSTEMS MODEL ALLOWS μ T-RANGE MAGNETIC FIELD EFFECTS ON ION BINDING IN THE PRESENCE OF THERMAL NOISE. A.A. Pilla and D.J. Muehsam. Bioelectrochemistry Laboratory, Department of Orthopaedics, Mount Sinai School of Medicine, New York, New York 10029, USA.

INTRODUCTION: Thermal noise forces and resonance-like responses have presented consistent difficulties in the formulation of mechanistic explanations for weak electromagnetic field (EMF) bioeffects. In many cases, biologically active field strengths appear to lie substantially below the threshold required for electric and magnetic fields to compete directly with thermal forces. Several approaches have characterized the effects of magnetic fields on ion binding and/or transport via the magnetic Lorentz force or the Zeeman-Stark effect. However, these models have limitations in the treatment of thermal noise effects and in attempts to relate low-frequency resonance behavior to the charge-to-mass ratio of an unhydrated ion. This study considers the effect of weak exogenous magnetic fields on ion binding processes, taking into account bound water dynamics.

LARMOR PRECESSION OF BOUND WATER: It is postulated that the magnetic field induces precessional motion at a characteristic (Larmor) frequency in polarized water molecules forming hydration layers at an ion binding site. This modulates bound water orientation angles, causing fluctuations in the instantaneous dielectric constant at the binding site, affecting the kinetics of ion binding. Precessional motion induced by exogenous fields thus modifies the potential energy function for ion binding. A threshold in the 0.1-1 μ T range for magnetic field effects on water dipole orientation in the presence of thermal noise is predicted, based upon the lifetime of hydration at a molecular cleft. These magnetic field effects are predicted for field strengths well below the threshold for which direct Lorentz force effects on ion trajectories are predicted in the presence of thermal noise. For the latter this threshold lies in the mT range for the extreme low viscosity case and may be as high

as 10^7 T for a fully hydrated ion. Binding kinetics are predicted to increase with increasing magnetic field strength, producing no resonance behaviors for particular static field values. AC magnetic fields are predicted to yield effects on binding kinetics similar to those for static fields. However, combined AC and static fields are expected to produce differing effects, dependent upon the relative orientation of the fields. Greater effects on ion binding are expected for AC and static fields in perpendicular orientation because the time-averaged Larmor frequency for this case is always greater than or equal to that for parallel fields, and thus the time-averaged perturbation of the potential energy function is larger. The difference in effect on ion binding for these parallel and perpendicular field combinations is expected to decrease with increasing static magnetic field strength.

DYNAMICAL SYSTEMS MODEL: The dynamical systems approach represents bound and unbound states with a bistable potential well, thermal noise providing the driving force for the ion binding process. The resulting ion binding dynamics describe a chaotic hopping between bound and unbound states. Ion binding dynamics are interpreted in a statistical sense for which the instantaneous available free ion concentration is proportional to the ratio of the time the ion is free to the time bound. Exogenous magnetic fields modulate the ratio of the time the ion is free to the time bound by affecting the binding site environment via Larmor precession of bound waters. This changes the instantaneous concentrations of available ions affecting reaction kinetics. The dynamical system predicts a resonance condition for AC magnetic fields (negligible induced E) in the vicinity of the characteristic Kramer rate or mean interwell hopping frequency of the system. Resonance frequencies are determined by reaction kinetics, are thus complex functions of potential well geometry, exogenous fields and thermal noise strength, and cannot be expected to be simple functions of charge to mass ratios or cyclotron frequencies. However, knowledge of reaction rates may allow for the estimation of resonance frequencies. In addition, because the Lorentzian or, $1/f$, output of the dynamical system depends upon the Kramer frequency, it may be possible to estimate the location of resonances via measurement of noise spectra.

This work was supported in part by the Horace W. Goldsmith Foundation.

P-28-A

THE BASIC THINKING FOR BIOELECTROMAGNETIC DOSIMETRY OF ATHERMAL BIOEFFECTS OF ELECTROMAGNETIC FIELD. Z.Q.

Niu, G. Kang and Z.Y. Lu. Department of Microwave Telecommunications Engineering, Xidian University, Xi'an 710071, P.R. China.

According to the cause engendering bioeffects of electromagnetic field (EMF), the bioeffects can be divided into two classes, i.e. thermal and athermal effects. The former means that the effects are relative to the heat energy transformed from EMF in the tissue, the latter means that the effects have not direct relation with the heat energy. Bioelectromagnetic (BEM) dose means the dose which is given to biological system by EMF, and BEM dosimetry means what physics quantity is selected as the quantity describing the dose and how does obtain the quantity. At present, average specific absorption rate, SAR_a , adopted as a basic quantity of BEM dosimetry, and it is defined as that the total EMF power absorbed by biological system is divided by its total mass, usually, in order to describe the nonuniformity of the power distribution, the local specific absorption rate ($SAR(r)$) is introduced. When the physics essence of SAR is investigated, it can be seen that: (1) SAR_a or $SAR(r)$ describes the part of the energy absorbed by tissue and transformed from EMF energy into joule heat and does not include the energy not transformed into heat. Since the joule heat is not the cause of engendering athermal bioeffects, the SAR is no reasonable in studying athermal effects of EMF on biology, although they are reasonable in studying the thermal effects; (2) Certainly, due to the conductivity and loss character of a tissue, a part of EMF energy in the tissue is transformed into joule heat, but the part of energy is not the cause of the athermal effects; (3) The SAR and the other dosimetry quantities amended or derived from SAR (such as heat flux density, organ dose, etc.) are no reasonable to study the athermal effects, and are only reasonable to the thermal effects.

Based on foresaid, it is necessary to choose a physics quantity is used as dosimetry quantity for studying of the athermal bioeffects. Generally speaking, when choose or introduce a dosimetry quantity, should consider the rationality of its concept and the realizability of obtaining its value, that is to say, the chosen dosimetry quantity must be scientific in theory and should be more easy determined by theoretical analyses or experimental measurements. Here, EMF energy density w is chosen as the dosimetry quantity in the athermal effects, its physics essence is the EMF energy stored in unit volume of tissue at point r , the w includes electric and magnetic energy density. The concepts are directly from EMF theory, the part of EMF energy is not transformed into joule heat and is direct cause of engendering the athermal effects, therefore, w is more reasonable than SAR to research on the athermal effects. Sometimes, because obtaining the distributive energy

density $w(r)$ is as difficult as $SAR(r)$, so, as concerns the realizability, the average energy density w_a is chosen as the dosimetry quantity of the athermal bioeffects, w_a is defined as that the total EMF energy stored in a tissue is divided by the volume of the tissue. The ways of obtaining w are that (1) directly solve the electric and magnetic field in a tissue based on EMF theory; (2) derived from SAR, the expression can be written as

$$w_a = \frac{\rho \epsilon'}{2\sigma_e} [1 + \sqrt{1 + (\sigma_e / \omega \epsilon')^2}] SAR_a$$

where ρ is the mass density, ϵ' the reality part of the permittivity and σ_e the equivalent conductivity of the tissue, and ω the angle frequency of EMF.

The project supported by NSFC.

P-29-B

THE STATE OF THE SCIENCE FOR THE LANGEVIN-LORENTZ MODEL. S. Bruna, W. Rocchia, B. Bianco and A. Chiabrera. ICeMB at DIBE, University of Genoa, 16145 Genoa, Italy.

The published experimental results suggest that e.m. exposure (from sub-ELF to RF) at fields or SAR values below the current safety standards, can affect biological processes. Two elementary processes are good candidates to be the first interaction steps: the binding of messenger ions to the receptor proteins; the transport of messenger ions inside protein channels. In both cases the ion dynamics can be often described in terms of the classical Langevin-Lorentz (L-L) model [1]. This rather comprehensive model includes, as particular cases, all the classical models so far published. In order to analyse or predict the experimental results, the values of the various parameters which enter the L-L equation must be physically plausible, keeping the number of fitting parameters as low as possible. Toward such a goal, the following features must be considered. The binding or channel crevice must be hydrophobic, so that it repels the solvent water molecules and strips away the ion hydration shells. If the gradient of the ion potential energy inside the crevice is an highly non-linear function of the spatial coordinates, the water dipoles can be drifted away from the protein crevice by the resulting endogenous dielectrophoretic force. Therefore, the ion moves in the ballistic Knudsen regime and its Langevin collision frequency can be several order of magnitude lower than in bulk water. The resulting energy losses are small, so that the ion dynamics become more sensitive to low-intensity e.m. exposure. However, the exogenous signal is typically unable to overcome the Langevin thermal noise force if the ion-protein system is at thermal equilibrium in absence of the e.m. exposure. On the other hand, the basal state of the ion-protein systems is maintained out of thermal equilibrium by the metabolism of the living cell. Once the metabolic field effect is included in the L-L model, the small signal e.m. input is able to overcome

the thermal effects, because the power supplied by the aforesaid metabolic field may be converted, via the non-linearity of the endogenous field, into a large ion displacement induced by the e.m. Lorentz force. Finally, it must be taken into account the displacement of the protein atoms induced by the messenger ion inside the protein crevice. The resulting "reaction" field lowers the actual endogenous force sensed by the ion, so that the e.m. exposure is more effective in affecting the ion binding probability or transit time. In conclusion, when all the above features are included in the L-L model, the observed biological effects of low-intensity e.m. exposure become biophysically plausible.

[1] B. Bianco, A. Chiabrera, *Bioelectrochem. Bioenerg.* 28, pp. 355-356, 1992.

General

P-30-C

THE ELECTROMAGNETIC WHOLE. O. Zhalko-Tytarenko, S. Topping and G. Lednyiczky. Hippocampus Research Facilities, 1031 Budapest, Hungary.

Though 'holism' is quickly becoming the most over-used and ubiquitous notion in recent years, it is becoming increasingly apparent (both from modern physics and biology and the classical world views of numerous cultures) that successful therapy is highly dependent on treating the body as a whole. The inclusion of EMFs into the framework of holism has profound and far-reaching implications as the incorporation of an organism into the EM environment is essential for its well-being.

It has been experimentally proven that all organisms receive cues from the local EM environment which regulate their metabolic activities. Recent studies of epigenesis suggest that genetic expression is influenced by EMFs, but that the evolution of all organisms has been guided to a certain extent by local EMFs. In this way, organisms may be considered as an expression of the environment. This is far different from many current notions (cultural, medical, and scientific) that organisms are not linked to the environment and therefore one could hope to correct a dysfunction by altering a single component (molecule, cell, organ) and expect normalization. The list of pharmacological and other medical disasters over the last century that have resulted from this mechanistic paradigm is long indeed.

It appears that EMFs may be a physical manifestation of what quantum physics refers to as non-locality, or the wave-like character of matter. ELI signals have proven to be particularly useful in restoring various organism's parameters and have been used successfully in numerous clinics worldwide. This is suggested to be due to ELI signals being especially meaningful to the inherent mechanism of the non-specific defenses of the organism and their relation to the general levels of the maintenance of an organism. An example from our own research is the observed decrease in tumor growth and number of metastases in sarcoma-bearing mice, treated with endogenous EMFs *in vivo*; whereas EEMF

treatment of sarcoma cell cultures *in vitro* after the inoculation of treated cells in mice does not result in any antitumor effect. This makes it possible to suggest that the antitumor effect of bioresonance treatment is due to rather the activation of endogenous antitumor mechanisms in mice than to the direct influencing of tumor cells.

The model which can be suggested here is that of electromagnetically incorporating an organism into its environment. This can be accomplished by any device that can modify the EM state of an organism (naturally, the majority of concern is on humans) on a general level so that it can once again become an open dynamic system capable of unrestricted mass, energy, and information exchange with the environment, and hence well-being.

P-31-A

COMPLEX DIELECTRIC CONSTANTS OF TISSUES IN THE HEAD. C.C. Davis¹, L.S. Taylor² and E.C. Elson².

¹Electrical Engineering Department, University of Maryland, College Park, Maryland 20742, USA. ²Walter Reed Army Institute of Research, Washington, District of Columbia 20307-5100, USA.

In order to assess human exposure to the radiation from cellular telephones complex numerical modelling of the energy absorbed in models of the human head with realistic models of the cellular phone itself included are being carried out. These numerical models generally use detailed volume pixellated subdivisions of the head by tissue type determined from, for example, magnetic resonance imagery. In order to make the theoretical analysis meaningful reliable values of the complex dielectric constants of different tissues in the head are required. We have completed a comprehensive series of such measurements from 500 MHz to 10 GHz on 27 different tissues. The tissues measured were taken from the heads of freshly killed pigs, and measurements were made as soon as possible after death. Pigs were used as a model since there is general consensus that their tissues are similar to human tissue. We have monitored the change in dielectric properties of various tissues over time, and as a function of temperature, in order to determine as reliably as possible the likely value of the dielectric constants *in vivo*. We were able to make measurement of the external tissues on human subjects. The measurements were made by the "open-probe" technique [1] and the reliability of the data checked by measurements on standard materials.

The tissues that we have measured include: cortical and cancellous bone, human skin in various locations on the head, muscle, cartilage, white and grey brain matter in various locations, the medulla, cornea, aqueous humor, sclera, meningeal tissue, tongue, pons, peduncle, ventricular lining surface, and subcutaneous fat. Measurements on soft tissue are relatively easy to make, and the results generally agree with the recent data of Gabriel *et al.* However, the measurements on bone show great variability and are very strongly influenced by the degree of drying of the sample that has occurred. There is strong evidence that the real part of the dielectric constant of bone is higher than previously

thought, perhaps as high as 40, and that this may vary from location to location. The conductivity of bone varies up to about 0.5S/m at 900 MHz and about 0.8S/m at 1800 MHz. It would be very desirable for additional measurements of the complex dielectric constant of bone to be made by an independent technique.

Reference:

Jian-Zhong Bao, Mays L. Swicord, and Christopher C. Davis, "Microwave dielectric characterization of binary mixtures of water, methanol, and ethanol" *J. Chem. Phys.* 104, 4441-4450, 1995.

This research was supported by Wireless Telecommunications Research, LLC.

VDT

P-32-B

EFFECTS OF EXTERNAL MAGNETIC (50 Hz) FIELDS ON VISUAL DISPLAY UNITS. R.J. Pääkkönen¹, L.H. Korpinen², J.T. Isokorpi² and J.P. Rautee². ¹Tampere Regional Institute of Occupational Health, FIN-33101 Tampere, Finland. ²Tampere University of Technology, Power Engineering, FIN-33101 Tampere, Finland.

The objective of the study was to investigate background magnetic fields in office environment, and their effect on visual display units (VDU). The background magnetic field from wiring or other electrical appliances can disturb the function of the deflection coils of the VDU. External magnetic fields can then cause disturbances on the screen, according to our experience when the magnetic flux density exceeds 0.5-1.0 μT . These screen disturbances can be annoying and are claimed to cause headache and eye-irritation. In the home and work environment many appliances or wiring can have flux densities dearly exceeding 1.0 μT , for example, 1-100 μT . One reduction method has been to use monitor shields which cover the monitor. We have studied different sizes (13"-17") of monitor shields (n = 6) manufactured by two firms. Measurements were done in practical work environment near a regulable coil, simultaneously measuring magnetic flux densities horizontally and vertically. When vertical magnetic flux densities were used, a relatively good screen quality was received even with densities up to 10 μT , and a satisfactory screen quality with densities up to 50 μT by using two monitor shields simultaneously. The average flux density attenuation value was calculated using equation $R=20\log(B1/B2)$, where B1 is the flux density without a shield and B2 with a shield. The measured monitor shields had averaged linear attenuation values varying from 12 to 32 dB. Magnetic flux densities were reduced less horizontally than vertically due to the shield structures. The results indicate that it is possible to receive a good screen quality at relative in high magnetic flux densities (10 μT) and thus improve the visual conditions of the VDU user. However, it should not be forgotten that there are also several other

possibilities to reduce external magnetic flux densities near VDUs.

P-33-C

VDT INTERFERENCE BY POWER FREQUENCY MAGNETIC FIELDS. C.J. Kim¹, G.G. Karady² and B. Banfai². ¹Research and Technology Applications, Southern California Edison, Irwindale, California 91702, USA. ²Department of Electrical Engineering, Arizona State University, Tempe, Arizona 85287, USA.

BACKGROUND: A VDT (Video Display Terminal) is subject to distortion from low-level power frequency magnetic fields. Furthermore, recently developed VDTs become more susceptible to external power frequency fields. As a result, electric utilities and video manufacturers have recently received an increasing number of complaints from customers about the interference. Most disturbances are caused by nearby electrical equipment (such as transformers, electrical panels, and power cables).

OBJECTIVE: The purpose of this study is to perform a systematic investigation of the effect of power frequency magnetic fields on PC monitors. The following characteristics are individually studied in relationship to magnitude of jitter³: 1) strength of external magnetic fields; 2) monitor size; 3) vertical refresh rate; 4) harmonic in fields; and 5) direction of fields.

METHOD: A CRT (Cathode Ray Tube) monitor is exposed to power frequency magnetic fields produced by a Helmholtz coil. The Helmholtz coil can be adjusted to produce desired magnetic field strength at the desired direction(s). The monitor is then set to display characters (not less than 3 mm in size) located at the middle and at the four corners of the screen. The photographs are taken before and after the field exposure. The sensitivity of the monitor is then calculated by the following formula:

$$\text{Sensitivity} \left(\frac{\text{Pixel}}{\text{mG}} \right) =$$

$$\frac{\text{Magnitude of Jitter (mm: After the Exposure)}}{\text{Pixel Size (mm/ Pixel: Before the Exposure). Applied Magnetic Fields (mG)}}$$

The sensitivity testing is continued at different magnetic field levels and with different sizes and types of CRT monitors. About 20 monitors have been tested so far.

PRELIMINARY RESULTS: Test results show that a typical monitor is subject to distortion at field levels around 10 ~ 30 mG. The magnitude of jitter increases linearly with external magnetic fields; an example is shown in Figure 1. Due to the increasing tube length (or particle traveling distance emitted from CRT), bigger size monitors are found to be more susceptible to external magnetic fields. This can be fully explained with a mathematical expression shown in Figure 2. The jitter is a direct result of difference in power frequency and vertical refresh rate of a monitor. A higher refresh rate does not increase the magnitude of jitter, it only changes the jitter vibration rate. Moreover, harmonic contributions from external magnetic fields to jitter are found to be negligible. This gives us an option to build a CRT monitor and a video card running at 120 Hz to resolve the jitter problem. The field parallel to the monitor screen

produced a higher magnitude of jitter. Typical sensitivity measures are shown on Table 1.

CONCLUSION: The following observations are made: 1) The relationship between the magnitude of jitter and the strength of magnetic field is linear; 2) magnitude of jitter is proportional to the size of monitor; 3) higher refresh rates do not vary the magnitude of the vibration, but they change the vibration rate; 4) power frequency harmonics do not change the magnitude of jitter; and 5) the field parallel to the monitor screen produces a higher magnitude of jitter.

FUTURE WORK: 1) Develop cost effective methods of eliminating or reducing the disturbances, and 2) develop a National Standard and a guideline incorporating the VDT Interference considerations.

³ Jitter is defined as the peak-to-peak variation in the geometric location of picture elements displayed on a CRT.

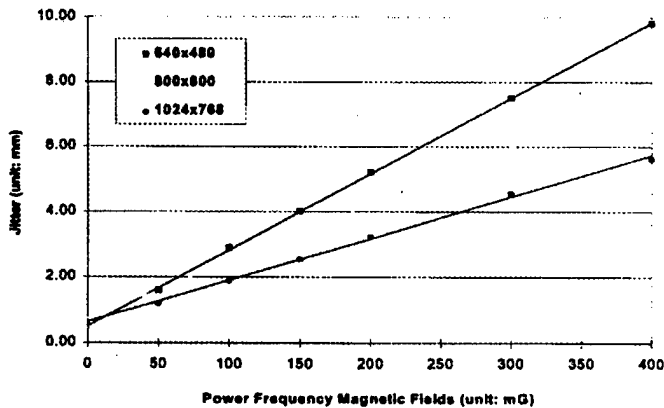

Figure 1 Magnitude of Jitter vs. Power Frequency Magnetic Fields [Monitor S]

$$F = |Q \cdot v \cdot B = m \cdot \frac{v^2}{r}$$

$$(r - x)^2 + d^2 = r^2$$

$$x = \frac{2 \cdot \frac{m \cdot v}{|Q \cdot B} - \sqrt{4 \cdot \left(\frac{m \cdot v}{|Q \cdot B}\right)^2 - 4 \cdot d^2}}{2}$$

- F: Force
- B: magnetic flux density
- Q: charge
- v: velocity
- m: mass of electron
- r: radius of electron's path
- x: jitter

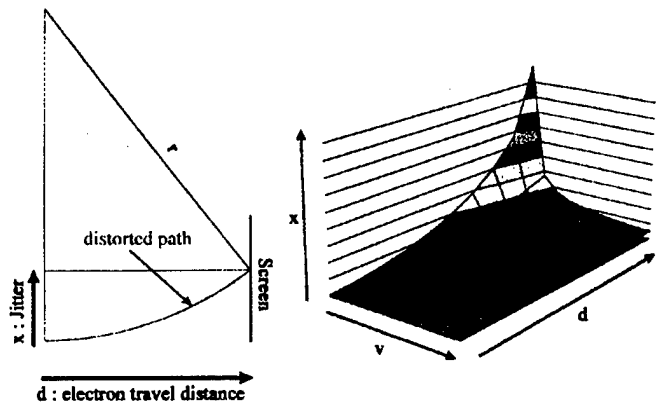

Figure 2 Magnitude of Jitter vs. Screen Size [Theoretical Model]

Table 1: Sensitivity of Typical PC Monitors

	14" VGA	14" SVGA	17" SVGA	17" SVGA	17" SVGA
	640x480	800x600	1024x768	800x600	640x480
Sensitivity (mm/mG)	0.0087	0.0087	0.016	0.018	0.023

This study, performed by Arizona State University, is sponsored by Southern California Edison, Salt River Project and American Power Association DEED.

Dosimetry

P-34-A

CO-LABORATORY RESEARCH ON DEFINITION OF DOSES OF RADIATION, RECEIVED BY THE LOCAL POPULATION IN RESULT OF FAILURE ON SIBERIAN CHEMICAL COMBINE ON APRIL 6, 1993. N. Ilyinskikh¹, A.T. Natarajan², I. Suskov³, Y. Revasova⁴, S. Kolyubaeva⁵, I. Danilenko⁶, E.N. Ilyinskikh¹ and L. Smirennii⁷. ¹Siberian Medical University, Tomsk, Russia. ²Leiden University, Leiden, The Netherlands. ³Institute of General Genet., Moscow, Russia. ⁴Institute of Toxicologic, Moscow, Russia. ⁵Institute Radiologic, St. Petersburg, Russia. ⁶Institute of Epidemiologic, Keiv, Ukraine. ⁷Center on Radiol. of Safety of Space Flights, Moscow, Russia.

The scientists from Russia, Ukraine and Netherlands have participated in the investigations of radiative doses. A cytogenetic method and investigation of tooth enamel by a method of an electronic spin resonance (ESR), as well as micronuclei test were applied for definition of radioactive doses received by the population. Four settlements located between 12-30 km away from the failure site, were investigated. At the Samus settlement, the blood of 250 schoolchildren and teachers was taken four times for the analysis at, 3-5 days, 6 months and at 1 and half years, following the failure. Moreover cytogenetic investigations of blood cells in workers of factory and on river ships were carried out. The data obtained testify that in 5% of cases of the inhabitants of the Samus settlement, a dose of radiation effect exceeding 1000 mSv, in 36% from 500 up to 1000

mSv, in 27% from 250 up to 500 mSv, and in 22% less than 250 mSv is registered. The concurrence of results of interlaboratory research has established 87% of the cases. The distinctions concerned the results of the examinations of the fishermen where the method ESR gave high results (more than 1 Gy) and chromosomic method and micronuclei gave low ones (less than 0,5 Gy). The school children of junior classes had less changes in cytogenetic apparatus than school children of the senior classes. A large number of cytogenetically aberrated cells were especially observed in the people born between 1964 and 1968. It was found that during these years, serious failures at the Siberian chemical combine occurred causing radiation pollution of the district. The number of cells with cytogenetic aberrations was considerably less in the people arriving in Samus after 1980. However, the radiation effects on blood cells (*in vitro* conditions) in a dose of 0,5 Gy causes extensive changes in the cells of migrants than in the natives. The medicinal preparations pentoxylum and leukogenum can effectively reduce the level of cytogenetically aberrated cells in 2-3 fold. It was noted simultaneously that these preparations sharply improve immunologic and haematologic parameters in the local inhabitants of the Samus settlement.

Bioenergetics

P-35-B

TEMPERATURE AND MILLIMETER WAVES COMBINED ACTION ON LUMINESCENCE CHARACTERISTICS OF THYLAKOID MEMBRANES. L.L. Traikov¹, V.N. Goltsev¹ and M.S. Markov².
¹Department of Biophysics and Radiobiology, Sofia University, Sofia, Bulgaria. ²Bioelectrochemistry Laboratory, Mount Sinai Medical Center, New York, New York, USA.

The comparative analysis of effects of an electromagnetic field with non-thermal intensities of millimeter waves and a high temperature treatment on some luminescent characteristics of photosynthetic membranes was carried out. Photosynthetic apparatus of higher plants is multicomponent, dynamic and well balanced system. This system is capable to react on fast as well as to slow changes of the environment, through modification of the structure of thylakoid membrane and changes on the level of the photosynthetic reactions. Sensible indicator for functional and morphological condition of photosynthetic apparatus is chlorophyll fluorescence. The chlorophyll fluorescence is determined by the processes of absorption on light energy and consequent transformation in thylakoid membrane. In this investigation the characteristics of chlorophyll fluorescence emitted in nanosecond (prompt fluorescence-PF) and in millisecond time range (delayed fluorescence - DF) were studied. The induction kinetics of both luminescence species giving rise complexed information about the temporal changes in redox states of electron-transport chain components and in the processes of energization of the thylakoid membrane.

The thylakoid membranes from pea leaves were incubated for 3 min at different temperatures (25°, 30°, 35°, 40°, 45°, 50°C), after that induction kinetics of PF and DF were registered simultaneously by the system FL2006 at 20°C. With increasing the temperatures over 30°C photosynthetic activity estimated by chlorophyll fluorescence yield, (PF, DF intensities and their related parameters F_v/F_m , F_m/F_s , etc.) decreased significantly.

It has been shown that EMF exposition (20 min at 4°C and field strength 1.2 mW/cm²) can initiate alterations in the membrane energization and electron transport activity. Millimeter waves (MMW) can induced changes which lead to redistribution of membrane components. Effects of EMF were similar to moderate (light) heat stress. MMW-pretreatment decreased (up to 30%) the changes in thylakoid membranes due to temperature induced transitions.

II. Biological Sciences

Mechanisms

P-36-C

THE EFFECT OF THE CONSTANT MAGNETIC FIELD ON THE DENATURATION AND RENATURATION OF THE HERTIN SPERM DNA. S.W. Yu, W.D. Zhang, Q.G. Hang and P. Hu. Life Science Laboratory, Shenzhen University, Shenzhen 518060, P.R. China.

The solution of the hertin sperm DNA is treated by the constant magnetic field (1000 gs). During the DNA denaturation, the temperature of T_m have a tendency to rise according to the change of the absorption of the UV spectra at 260 nm. During the DNA renaturation, the sample absorption at the 25°C is changed a little less than that at the T_m. The experiment is showed that the denaturation and renaturation of the hertin sperm DNA can be affected by the constant magnetic field and the effect have a one direction characteristic. That is, before the T_m, the DNA double helix status can be protected by the treatment of the constant magnetic field, and after the T_m, the DNA denaturation status can be remained by the action of the constants magnetic field.

P-37-A

SOLVENT - HEMOGLOBIN BINDING SITE INTERACTION UNDER MICROWAVE ELECTROMAGNETIC EXPOSURE: A MOLECULAR DYNAMICS STUDY. M. Zago, A. Palombo and G. D'Inzeo. Department of Electronic Engineering, "La Sapienza" University of Rome, 00184 Rome, Italy.

In most *in-vitro* experiments the biological samples exposed to electromagnetic fields are in a liquid environment. The solvent medium, especially in the case of polar solvent, can

have a relevant effect not only for the possible interaction with the electromagnetic field but also for its effect on molecular structures and conformational energies of the organic molecules. However, many molecular simulations of these experiments do not include solvents at all [1].

This expedient of ignoring the surrounding environment is useful for bioelectromagnetic purposes for small molecules with few polar (one or two) functional groups and in weakly polar solvent and it is useless for molecules having several polar functional groups and in polar solvent [2]. In the latter case we can not leave out of consideration that the electrostatically least stable structures are the most heavily solvated and thus stabilized.

Having exposed the hemoglobin binding site in chloroform (solvent less polar than water) to a microwave electromagnetic field we revealed a distortion of this molecular structure. We simulated the experiment of the same site in vacuum by means of molecular dynamics and the simulations gave us the same distortion [3].

After an investigation of the dielectric properties of chloroform by means of molecular simulations, here we present a molecular dynamics study of the hemoglobin binding site in a liquid chloroform environment both under microwave electromagnetic field exposure and in unexposed conditions. This analysis with the inclusion of the solvation effect is crucial for the molecular dynamics methodology in bioelectromagnetism.

[1] M. P. Allen, D. J. Tildesley, *Computer Simulation in Chemical Physics*; Dordrecht: Kluwer, 1993.

[2] W. F. van Gunsteren, H. J. C. Berendsen, "Computer Simulation of Molecular Dynamics: methodology, applications and perspectives in chemistry"; *Angewandte Chemie*, 29, 9:992-1093, 1990.

[3] G. D'Inzeo, A. Palombo, L. Tarricone, M. Zago, "Electromagnetic field and molecular dynamics of Zn-protoporphyrin host-guest system"; *Abstract Book of the 3rd EBEA Congress*, Nancy, 1996.

P-38-B

A DIRECT COMPARISON BETWEEN EXPERIMENTAL AND THEORETICAL RESULTS OF LIGAND-SITE BINDING IN HEME GROUPS EXPOSED TO MICROWAVE FIELDS. M. Zago and G. D'Inzeo. Department of Electronic Engineering, "La Sapienza" University of Rome, 00184 Rome, Italy.

Hemoglobin plays a significant role in the respiratory process and shape alterations of this protein determine structural deformations of erythrocytes cells in various diseases. In particular hemoglobin iron binding site (protoporphyrin IX) deformation affects tissues oxygenation.

Information on the conformational properties of the active site and on their dependence upon protein structure and ligation state is contained in the spectral absorption profile in the chromophore region (about at 400 nm). This region, known as the Soret band, appears to be coupled to high frequency vibrational modes ($h\nu > kT$) of the active site and

to low frequency modes ($h\nu < kT$) deriving from the bulk of the protein [1].

In a previous work [2] we have shown both experimentally and theoretically -in the former case by means of absorbance measures and in the latter one by means of molecular dynamics simulations - that a 2.45 GHz electromagnetic field stretches the metal active site so that the ligand-site binding time results increased. Now, starting from the conformations resulted from molecular simulations, we apply the theory of coupling between a $\pi \rightarrow \pi^*$ transition of the delocalized electron cloud to the protoporphyrin group and Frank-Condon active vibrations to the nearby atoms [3] for a direct comparison, in absorbance terms, of the experimental and the theoretical results. From this approach we obtain an analytical expression suitable for fitting the experimental spectral profile for the exposed and unexposed active site. In this manner a direct evaluation of metal ligand relative positions, i.e. of deformations of the active site that occur in presence of a microwave electromagnetic field, is allowed.

K.M. Smith, *Porphyryns and Metalloporphyryns*, Elsevier, Amsterdam, 1975.

G. D'Inzeo, A. Palombo, L. Tarricone, M. Zago, "Molecular simulation studies to understand non-thermal bioelectromagnetic interaction"; *Abstract Book of the BEMS Seventeenth Annual Meeting*, p. 74, Boston, 1995.

A. Cupane, M. Leone, E. Vitrano, L. Cordone, "Low temperature optical absorption spectroscopy: an approach to the study of stereodynamic properties of heme proteins"; *European Biophysics Journal*, 23: 385-398, 1995.

P-39-C

THE SENSITIVITY OF CELLS AND TISSUES TO EXOGENOUS FIELDS: EFFECTS OF TARGET SYSTEM INITIAL STATE. D.J. Muehsam and A.A. Pilla. Bioelectrochemistry Laboratory, Department of Orthopaedics, Mount Sinai School of Medicine, New York, New York 10029, USA.

INTRODUCTION: A biological window has often been observed in the response of cells and tissues to exogenous environmental and therapeutic electromagnetic fields (EMF). For example, only repairing bone, and not the surrounding normal bone, has a physiologically relevant response to the bone repair signals in clinical use. In this study an extension of the cell array model includes the dependence of the cell membrane impedance upon transmembrane resting potential, as described by the Hodgkin-Huxley formulation. This results in the EMF sensitivity of an array of cells in gap junction contact to be dependent upon membrane resting potential, providing a possible explanation for the existence of biological windows.

CELL-ARRAY MODEL AND MEMBRANE IMPEDANCE: The model presented here examines the electromagnetic field sensitivity of an array of cells in gap junction contact. A quantitative assessment of the thermal threshold (signal-to-noise ratio, SNR) for detectable transmembrane voltage is made via a distributed parameter electrical model. The effects of gap-junction contacts,

extracellular and intracellular resistances, membrane impedance, and applied waveform are considered. Analysis of the frequency response of the system indicates that the cell array exhibits a low-pass response to applied EMF, producing transmembrane voltages above the thermal threshold only in the low-frequency range. The specific frequency range of the array response is dependent upon the membrane model employed. Consideration of a voltage-gated ion binding process in the cell membrane results in an array response dependent upon the membrane resting potential. The addition of a constant voltage Hodgkin-Huxley K^+ -conduction pathway to the membrane model results in a resonance response for applied field frequencies in the 1-100 Hz range, centered at approximately 16 Hz, as shown in the left hand figure. Further refinement of the membrane model to include the voltage dependence the Hodgkin-Huxley K^+ pathway results in a modulation of array frequency response with changing membrane resting potential, right hand plot. Thus, the resting state of the target tissue modulates EMF response.

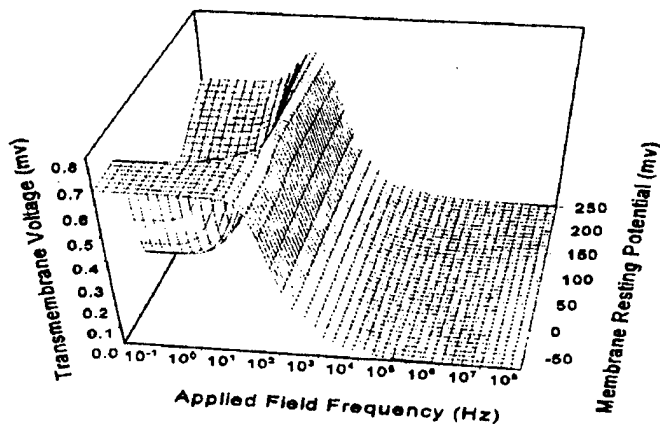
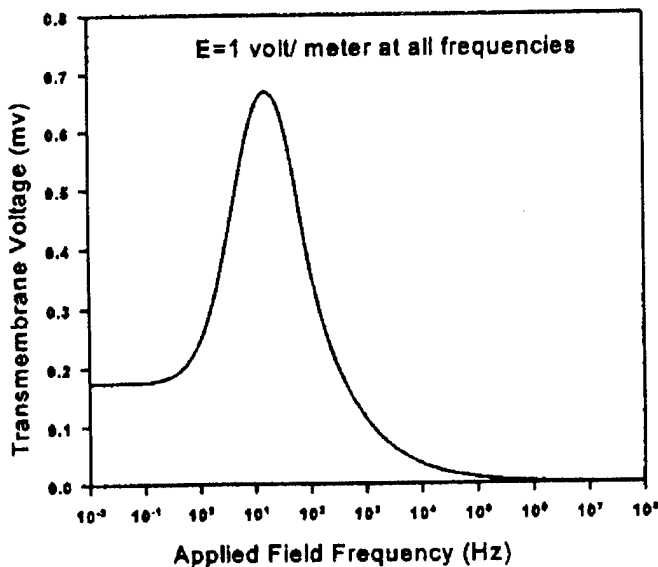

CONCLUSIONS: This model demonstrates that resonant responses to exogenous EMF can be expected if kinetics in the target pathway have properties similar to those in the Hodgkin-Huxley formulation. In addition, it is clear that induced transmembrane voltage depends upon resting voltage. Since the latter depends upon the state of the

cell/tissue in terms of stage in cycle and/or microenvironment, a physiologically relevant EMF response may only be observed if the conditions related to a given resting voltage correspond to a biological window, i.e., sufficient SNR, for the particular waveform employed.

This work was supported in part by the Horace W. Goldsmith Foundation.

P-40-A

MEMORY EFFECTS IN WATER. QUANTUM CHEMISTRY MODELLING AND VIBRATIONAL SPECTRA VERIFICATION. V.D. Khavryutchenko¹ and O.V. Zhalko-Tytarenko². ¹Computational Chemistry Group, Kiev 253091, Ukraine. ²Hippocampus Institute, 1031 Budapest, Hungary.

Quantum chemistry modelling of water clusters and verification of computer simulation via vibrational spectra (infrared (IR) and inelastic neutron scattering (INS)) was used to study the effects of the external electromagnetic field on liquid water.

Geometry and electron structure of some water clusters were simulated as a function of the value of the external electric fields by using the special quantum chemistry software [1]. Two different types of water clusters were observed: i) the space structure of the first type of water clusters completely restores itself after external electric field is switched off; and ii) the space structure of the other type of water clusters is altered irreversibly under the influence of the external electric field.

By experimental way we have observed the difference between vibrational (both: IR and INS) spectra's water before and after electromagnetic irradiation. Low frequency deviation in INS spectra shows the deviation in water cluster structure.

In the experiments, the difference between the vibrational (both IR and INS) spectra of water before and after electromagnetic is observed. Low frequency deviation in INS spectra shows the alterations in water cluster structure. By using quantum chemical software the force fields for all clusters were evaluated and theoretical IR and INS spectra were reconstructed. The comparison of experimental and computer-simulated spectra made it possible to offer most probable water structures. By using quantum chemical software, the force fields for all clusters were evaluated and theoretical IR and INS spectra were reconstructed. The comparison of experimental and computer-simulated spectra made it possible to offer most probable water structures.

A mechanism of the correlation between water cluster structure, external electromagnetic field and some biochemical processes has been proposed on the basis of the obtained data.

1. E.F. Sheka, V.D. Khavryutchenko, V.A. Zayetz. Computer Modelling of Assembly of Atoms in an Electric Field. *Int. J. Quant. Chem.* 1996, v.57, No 4, p. 741-755.

P-41-B

RF-INDUCED ANKLE HEATING IN A SITTING RHESUS MONKEY AT 100 MHz. R.G. Olsen¹, B.J. VanMatre¹ and J.L. Lords². ¹Naval Medical Research Institute, Detachment, Brooks Air Force Base, Texas 78235, USA. ²Biology Department, University of Utah, Salt Lake City, Utah 84112, USA.

In order to obtain empirical corroboration of computer-generated predictions of localized ankle SAR, we used anesthetized rhesus monkeys (*Macaca mulatta*). Subjects were positioned in a reclining posture with bare feet touching a grounded metal plate inside a horn-irradiated absorptive chamber.

On two occasions, monkey cadavers became available from another project and were used. During repeated irradiations at 100 MHz, nonperturbing temperature probes were used to record the RF-induced heating at many locations and depths in the ankle region. Body-to-ground current was measured with a commercially available current loop, and thermographic images of surface heating were also obtained. The irradiation intensity was adjusted to produce a nominal ankle current of about 100 mA in each leg for irradiations of 60 to 180 s. Results show that RF-induced ankle heating is remarkably linear and uniform throughout the (approximately 3.5-cm diameter) cross-section containing the ankle joint. Whereas, certain theoretical models would predict some localized SARs in excess of 4000 W/kg, most of the temperature rises that we recorded indicate SARs of less than 100 W/kg for the given conditions. Furthermore, we saw no "hot spot" indications such as nonlinear thermal behavior that is typically observed when a thermal probe is positioned near a high-SAR location.

In Vitro

P-42-C

EFFECT OF 50 Hz MAGNETIC FIELDS ON NATURAL KILLER CELL ACTIVITY OF HUMAN LYMPHOCYTES. C. Esposito¹, M. Tricarico¹ and E. Pasquali². ¹Istituto di Medicina Sperimentale, C.N.R., 00137 Roma, Italy. ²Istituto di Psicologia, C.N.R., 00137 Roma, Italy.

Several studies have been performed to find a possible relation between exposure to extremely low frequency magnetic fields (MF) and incidence of cancer. A possible target of these fields could be the immune system.

The aim of the present investigation was to establish their influence on natural killer cell activity of peripheral blood lymphocytes (PBL).

Field exposure was obtained with a cylindrical solenoid (cm.50 x20) with 500 turns of copper wire of 2 mm dia., wound in 4 layers. The solenoid, placed vertically, holds a

water jacketed container for the cells. In these conditions the MF were perpendicular to the bottom of the 50 ml exposure flasks, and were obtained by adjusting the current with a variable autotransformer connected to the 50 Hz power mains. The values (rms) of field density for cell exposure were set to 0.18, 1.8, 18 mT, for 72 hours in each case, resulting in a total exposure of 9 days. Controls were kept in a separate incubator at the same temperature of 37°C.

PBL were collected from five different healthy donors, separated on a Fycoll-Hypaque gradient, washed twice and resuspended in RPMI 1640 containing 10% FCS and 2mM glutamine, mononuclear cells at a concentration of 1×10^6 /ml were then exposed to the MF.

Cytotoxic activity of NK cells was determined by 4 hours-51Cr release assay, using as a target the highly sensitive K 562 erythroleukemia cell line. The results in terms of percent specific lysis at effector-ratio of 100:1, 50:1, 25:1, 12,5:1, show that there was no difference between exposed samples and controls.

In order to verify possible differences in others parameters like viability and proliferation, treated and control lymphocytes were counted after 9 days by trypan blue dye exclusion test. All determinations were made in quadruplicate and the results were expressed in terms of geometric mean \pm standard error. No significant difference was observed.

In conclusion, we could not find any effect on the parameters studied for the particular MF and exposure conditions used.

P-43-A

THE EFFECT OF PULSED ELECTROMAGNETIC FIELDS ON THE INDUCTION OF CYTOKINES BY PERIPHERAL BLOOD MONONUCLEAR CELLS. C. Aldinucci¹, G. Fanetti² and G. Paolo Pessina¹. Institute of General Physiology¹ and Blood Bank Service², University of Siena¹ and USSL 30², 53100 Siena, Italy.

Current evidence suggests that several cellular activities may be influenced by weak electromagnetic fields (EMFs). Cytokines may be used as a sensitive indicator of perturbation of the immunoregulatory network by EMFs. So far we have examined the effects of weak EMFs, applied for different periods to peripheral blood mononuclear cells (PBMC), on the induction of cytokines.

PBMC were obtained from buffy coats after separation on Ficoll-Hypaque gradient. 200 μ l of washed cells (10^6 /ml in RPMI 1640 containing antibiotics and 10% heat-inactivated FCS) were distributed in 96-well culture plates and, either with or without phytohaemagglutinin (PHA), were placed in an air:CO₂ incubator between two Helmholtz coils formed by a 1250 turn coil that gave a homogeneous vertical magnetic field with a frequency of 50 Hz and a duty cycle of 2/5. Both cultures were exposed to EMFs applied for short times (3 cycles of 15 min each over 6 h) or longer times (12h). After treatment microwells were incubated in the same incubator for 24 and 48 h. Controls were put in a sham exposure apparatus not energized. At each time plates were centrifuged and supernatants were collected for the

determination of Interleukin-1 (IL-1), interleukin-2 (IL-2), Interferon γ (IFN γ) and tumor necrosis factor α (TNF α). The proliferative responses were evaluated in quadruplicate by [3-(4,5-Dimethylthiazol-2)-2,5-diphenyltetrazolium bromide] (MTT) colorimetric assay.

Our results demonstrate that, after exposition to short cycles of EMFs, the proliferative responses of both normal and PHA-challenged PBMC were negligible. In such cases also levels of either IL-2, or IFN γ , or TNF α remained similar to control cells, indicating the lack of an effect of EMFs on PBMC. Furthermore we were unable to note any increase in the levels of all cytokines when the normal cells were subjected to EMFs of the same frequency, but applied for 12 h. However the results were strikingly different when PBMC were challenged with PHA immediately before the longer exposure to EMFs. In these cases levels of cytokines, measured 24 and 48 h after the treatment were 701 \pm 512 pg/ml and 1033 \pm 605 pg/ml for IL-1, 934 \pm 506 pg/ml and 4827 \pm 4300 pg/ml for IFN γ , 688 \pm 454 pg/ml and 944 \pm 584 pg/ml for TNF α , respectively. These values were significantly higher ($p < 0.05$) as compared with controls. IL-2 levels were significantly higher only at the end of the EMFs exposition and, as a consequence of this increase, also proliferation indexes were significantly increased 48 h after the EMFs treatment. Our results clearly indicate that short cycles of EMFs do not exert any effect on PBMC and do not induce cytokines either in normal or in PHA challenged cells. On the other hand EMFs applied continuously for 12 h appear to enhance biological responses when the cells are firstly stimulated with PHA.

Work supported by a contribution of MURST (60%).

P-44-B

CYTOKINE PRODUCTION BY HUMAN PERIPHERAL BLOOD MONONUCLEAR CELLS (PBMC) AFTER *IN VITRO* EXPOSURE TO 50 Hz MAGNETIC FIELDS. C. Petrini¹, M.L. Dupuis², A. Polichetti¹, C. Ramoni² and P. Vecchia¹. ¹Laboratorio di Fisica and ²Laboratorio di Immunologia, Istituto Superiore di Sanità, I-00161 Rome, Italy.

The possibility of long term effects on the human health of chronic exposure to 50/60 Hz magnetic fields has been suggested by some epidemiological and experimental data, but at the moment is unproved. The experimental studies, both *in vitro* and *in vivo*, in spite of their considerable number and completeness, have not furnished a biological plausibility to the epidemiological observations. It is in general assumed that, in the case that extremely low frequency (ELF) fields exposure is really a harmful agent, it may be a tumor promoter but not a tumor inducer.

We have performed experiments on cytokine production by human lymphocytes exposed *in vitro* to 50 Hz sinusoidal magnetic fields. The typology of the diseases for which a causal relationship with 50/60 Hz magnetic fields exposure is suspected suggests indeed the possibility of an involvement of the immune system in the pathogenesis.

PBMC were prepared and cultured with usual techniques. Different biological and chemical stimuli were used for cell activation.

The exposure system, placed inside an incubator, consisted of a pair of Helmholtz coils enclosed in a Plexiglas jacket in which thermostatically-controlled air was circulated, in order to avoid heating due to Joule effect.

Each experiment was performed with independent cultures from different donors (five in most cases). After exposure to 0.05, 0.1, 0.2, 1 or 2 mT magnetic flux densities for different times (24, 48, 72 h), the quantities of Interferon γ (IFN γ), Tumor Necrosis Factor α (TNF α) and TNF β produced in the culture medium by exposed cells and controls were measured by enzyme-linked immunosorbent assays. Each sample was assayed in duplicate.

We have not observed variations in the IFN γ production between exposed cultures and not exposed controls.

Statistically significant decreases in the TNF α and TNF β production by exposed cells have been observed. It is not easy to suggest any hypothesis to explain these data. We suppose that the observed effect neither takes place in the biochemical pathway that leads to gene activation (we employed mitogens that act with deeply different mechanisms) nor causes a damage directly on TNF genes. According to many published experimental data, the eventuality of an interaction at the membrane level or in the molecular transport through membranes seems more likely.

P-45-C

THYMIC MICROENVIRONMENT PEPTIDES AS POSSIBLE TARGETS OF THE CHRONIC EXPOSURE TO 50 Hz-SINUSOIDAL ELECTRIC AND MAGNETIC FIELDS. M. Capri¹, D. Quaglino¹, D. Monti¹, L. Zecca³, A. Cossarizza¹, F. Bersani², I. Pasquali-Ronchetti¹ and C. Franceschi¹. ¹Department of Biomedical Sciences, Section of General Pathology, University of Modena, Modena, Italy. ²Department of Physics, University of Bologna, 40100 Bologna, Italy. ³Laboratory of Neurochemistry, C.N.R., Milano, Italy.

Results are presented on the presence and distribution of interleukin-2 (IL-2) and β -endorphin positive cells in the thymus of Sprague Dawley rats, after chronic exposure to 50 Hz-sinusoidal electric and magnetic fields (EMFs) of two different intensities. IL-2 is one of the several cytokines produced during T-cell development by thymic epithelial cells (TEC) and by mature T cells; β -endorphin is a pro-opiomelanocortin (POMC)-derived peptide expressed by TEC and is one of the mediators of the immuno-neuroendocrine function of the thymus. The presence of the two peptides was investigated by immunocytochemistry.

Groups of rats were exposed: i) from the second day after conception up to 15, 30 and 90 days after birth; ii) from 2 months of age up to 5 and 8 months of age. Animals were caged and exposed in a specific apparatus built into the Italian Electrotechnic Experimental Center (Milan) as follows: A) sham-exposure; B) 5 μ T-1 kV/m; c) 100 μ T-5 kV/m. Exposure was performed for 8 hours per day and for 5

days per week. Animals were killed by decapitation and the thymus was cut and fixed in 4% paraformaldehyde, dehydrated in alcohol and embedded in paraffin. Serial sections were treated following a standard protocol for immunoperoxidase cytochemistry and observed in a Zeiss Axiophot microscope; for each experimental group at least 5 rats were evaluated and each determination was made counting positive cells on 5 random areas in the medulla and cortex respectively. Statistical analysis was performed by the chi square test.

The results indicate that exposure to EMFs affects the presence of IL-2 and B-endorphin-positive cells in the thymus. At almost all exposure times, the percentage of IL-2 positive cells appeared statistically diminished both in the medulla and in the cortex compared to unexposed animals of the same age. Surprisingly, in the rats exposed from conception to the lowest electromagnetic intensity, an increase of IL-2 positive cells in the thymic cortex after 90 days was evident. The percentage of B-endorphin-positive cells decreased with time in almost all groups of exposed rats compared with sham-exposed animals of the same age. Exceptions were found in the thymus medulla and cortex, respectively, of fetus-exposed rats after 15 and 90 days from birth, where an increase of β -endorphin-positive cells was found. These results suggest that EMFs are able to modulate the amount of IL-2 and β -endorphin in thymic cells. It will be interesting to study the EMFs effects on other POMC-derived peptides.

This work was supported by grants from CNR-ENEL - Interaction of Energetic Systems with Human Health and Environment.

P-46-A

ROLE OF LONG TERM ELECTROMAGNETIC FIELD EXPOSURE ON THE MORPHO-FUNCTIONAL CHARACTERISTICS OF THE RAT THYMUS. D.

Quaglino¹, G. Bergamini¹, M. Capri¹, E. Euclidi¹, L. Zecca², C. Franceschi¹ and I. Pasquali-Ronchetti¹. ¹Department of Biomedical Sciences, General Pathology, University of Modena, Modena, Italy. ²Laboratory of Neurochemistry, C.N.R., Milano, Italy.

The significance of the interactions between electromagnetic field (EMF) exposure and biological systems is still unresolved, although innumerable investigation have been performed in order to assess the potential health hazard of EMF. Since thymus represents one of the main organs of the immunological system and can be modulated, even in adulthood, by exogenous factors, aim of this study was to investigate the effects of a prolonged exposure to extremely low EMF on the rat thymus.

Male Sprague-Dawley rats (Charles River, Calco, Italy), 2 months old, were housed in the CESI (Milan, Italy) animal care facilities and were fed *ad libitum* in a dark-light cycle (12:12). Temperature and humidity were always maintained constant. Animals were divided into three groups that were exposed or sham-exposed to 50 Hz sinusoidal EMF at two levels of field strength (1kV/m-5 μ T and 5kV/m-100 μ T),

respectively. Exposure was performed for 8 months, 5 days/week, 8 hours/day. At sacrifice, the thymus was removed and processed for cytofluorimetric analyses and for electron microscopy. The expression of CD8-CD4-, CD8+CD4-, CD8-CD4+ and CD8+CD4+ thymocytes was investigated by FACS, whereas semithin sections, stained with toluidine blue, were observed in a Zeiss Axiophot light microscope. For morphometrical analyses, scores, between 0 and 5, have been attributed by two different investigators to several parameters, at 40x magnification, in the areas that appeared comprised of both cortex and medulla. Selected fields were further analyzed by electron microscopy.

A long term exposure to EMF was associated with an enhanced cellular turnover as suggested by the increased number of mitotic and apoptotic events, whereas necrosis was only slightly modified; furthermore, collagen deposition leading to fibrosis was frequently observed in the exposed animals. Interestingly, the effects of the EMF were generally independent from the field strength, since major changes were noted in association with the exposure to the lowest field intensity. Structural changes, however, were not sustained by significant changes in the characteristics of maturation and/or differentiation of thymocytes as demonstrated by FACS analysis.

In conclusion, these data may contribute to the understanding of the interactions between EMF and biological systems and suggest, by the combination of morphological and cytofluorimetric analyses, that: i) EMF exposure can interfere with the structural characteristics and/or tissutal organization of the thymus, without altering, however, the phenotypic features of thymocytes and ii) the biological effects are exerted independently from field strength and are conceivable with the existence of window effects.

Work supported by grants from CNR-ENEL: Interaction of energetic systems with human health and environment.

P-47-B

MAGNETIC FIELDS, MELATONIN, AND LIPOIC ACID INFLUENCE THE RESPIRATORY BURST IN ACTIVATED RAT PERITONEAL NEUTROPHILS. Y. Noda¹, R.P. Liburdy², A. Mori¹ and L. Packer¹. ¹University of California, Berkeley, California, USA. ²Lawrence Berkeley National Laboratory, Berkeley, California 94720, USA.

OBJECTIVE: Previously we have demonstrated that when rat peritoneal neutrophils are simultaneously exposed to 60Hz, 1G, magnetic fields and activated by phorbol ester they undergo an enhanced respiratory burst [1]. We have continued these studies to addressed several questions. First, is this bioeffect field intensity-dependent, and, importantly, will a static magnetic field elicit this bioeffect? The latter addresses the question of whether free radical production may be involved in this field interaction. Second, what effect do antioxidants and free radical scavengers play in mediating this field interaction. Here are presented preliminary observations dealing with several aspects of this research.

METHODS: We have designed and implemented a new

magnetic field exposure system to monitor real-time fluorescence changes of cell suspensions for these follow-on studies. This system is an adaptation of a commercially available fluorescence cuvette-based spectrometer from PTI, International, N.J, USA, that employs fiber optic technology to deliver identical excitation light to two matched cuvette modules. We have adapted a computer-controlled, dual monochromator source to simultaneously excite samples in two temperature-controlled cuvette modules, and each cuvette module is fitted with a square Helmholtz-type exposure coil to establish a uniform magnetic field in which the cuvette is placed. The cellular studies were conducted as described [1]. Briefly, rat peritoneal cells were obtained from male Sprague-Dawley rats, 12-14 hrs after i.p. injection of 2% casein dissolved in phosphate buffered saline at pH 7.4. Cells were loaded with the fluorescent probe, 2', 7'-dichlorofluorescein diacetate (DCFH-DA) which diffuses through the cell membrane and is deacetylated to form the reduced form of dichlorofluorescein (DCFH). Oxidant species generated during the respiratory burst are detected by the fluorescent changes generated by formation of the oxidized form of the fluorescence probe ($\lambda_{ex} = 502$ nm, $\lambda_{em} = 530$ nm). The respiratory burst assay during exposure to magnetic fields was performed by adding 50nM PMA (phorbol ester) to the DCFH-DA loaded neutrophil cell suspension. Temperature control in the cell suspensions was maintained at $37 \pm 0.2^\circ\text{C}$, or better.

RESULTS AND DISCUSSION: Experiments are in progress to confirm our previous findings using the new dual-monochromator exposure system, and in preliminary studies we have observed that a 1G, 60Hz magnetic field may act to enhance or elevate the production of fluorescence, as described [1], using this new system; additional studies are underway. Dose-response studies employing static DC and 60 Hz AC magnetic fields of up to 20 G are planned since preliminary observations suggest that DC fields may also enhance fluorescence production during the respiratory burst. We have also assessed how melatonin, a free radical scavenger, and lipoic acid, an antioxidant, influence the respiratory burst. Pretreatment of cells for 10-15 minutes at 37°C with melatonin (0 - 10 μM) or lipoic acid (0 - 500 μM) significantly elevates fluorescence production in a dose-dependent manner. Use of these compounds in the presence of magnetic fields during the respiratory burst may aid in understanding biological aspects of this field interaction.

[1] Roy, S., Noda, Y., Eckert, V., Traber, M.G, Mori, A., Liburdy, R.P. and Packer, L. The phorbol myristate 13-acetate(PMA)-induced oxidative burst in rat peritoneal neutrophils is increased by a 0.1 mTesla (60Hz) magnetic field. *FEBS Letters* (1995) 376(3): 164-6.

Supported in part (RPL) the Office of Energy Management, Utilities System Division, U.S. Department of Energy under contract DE-AC03-76SF00098.

P-48-C

EVENT-RELATED AND MODELLED SLOW OSCILLATIONS IN THE MAMMALS BRAIN ELECTROCHEMICAL POTENTIAL FIELD.

T.B. Shvets-Teneta-Gurii¹, A.G. Dubinin² and M.R. Novikova¹.
¹Institute of Higher Nervous Activity and Neurophysiology RAS, Moscow, Russia. ²Mendeleev University of Chemical Technology of Russia, Moscow, Russia.

Powerful electrochemical processes occur in the brain tissue being related to various brain states and brain functions. They create a compromise brain electrochemical potential field. The values of the compromise potential can be measured by inert metal electrodes as the electrochemical potential (E) which is generated at the tissue-electrode interface. We used platinum electrodes, which were implanted in the various brain structures, to monitor event-related variations in the brain electrochemical potential field [Shvets-Teneta-Gurii, 1980, 1986, 1987, 1990; Shvets-Teneta-Gurii, Sarkisova, 1989; Shvets-Teneta-Gurii *et al.* 1990; 1994; 1996; Dubinin *et al.*, 1993].

It has been found that slow (above 2 s) E oscillations of various patterns, periods (from 2 s to several days) and amplitudes (from 0.1 mV to several dozens millivolt) are rather usual phenomena for the mammals brain (rats, rabbits, cats).

Among the wide spectrum of the brain E oscillations, the oscillations were differentiated which were related to a high level of vigilance (EEG was depressed). It turned out that the probability of E oscillations with quasisinusoidal shape and periods of 3-10 s increases: in animals which are placed in a new situation; during consummatory behavior in the starvation and the thirst; during episodes of hypnosis (immobilization stress); during the first stage of defensive conditioning.

As the brain gets energy mainly from the blood-burn glucose and the lactate/pyruvate couple is the most representative redox couple in the brain tissue [Siesjo, 1978], it was supposed that the event-related E-oscillations were determined by the cooperative oscillations in the brain glycolytic system redox balance.

To support our supposition, experiments were performed in which traditional method for making biochemically synchronized oscillations in the glycolytic redox balance in a population of yeast cells were used. The method was based on a sharp increasing rate of glycolysis which was induced by a hard energy deficit which was created by an inhibition of a tissue respiration by KCN [Aon *et al.*, 1992].

KCN injection (i/p, 3.5-5 mg/kg, rats, E were recorded with the use of DC amplifier, input resistance 4 GOhm, frequency range 0-20 Hz) induced a significant decrease in the brain E (in all traces) and quasisinusoidal oscillations in E (in 52 $\pm 6\%$ of traces). The oscillations were similar in pattern and periods to cooperative glycolytic oscillations occurring after KCN injection in a population of microorganisms [Aon *et al.* 1992].

The data presented enable us to believe that the cooperative oscillations in the redox balance of glycolysis, which occur when glycolytic rate sharply rises to meet rising brain energy

requirement, is one of the sources of the brain E event-related oscillations. We suppose that our initiation to investigate the event-related brain E variations by implanted platinum electrodes holds a lot of promise in revealing the event-related changes in the brain energy metabolism and in investigations of the nature of the brain oscillatory events.

P-49-A

MODIFICATION OF ACETYLCHOLINE *IN VITRO* CONTRACTILE EFFECT WITH A PULSED ELF MAGNETIC FIELD. R. Santini. INSA, 69621 Villeurbanne, France.

INTRODUCTION: Electromagnetic fields can interact with drugs effects. Results from our laboratory have shown that ELF pulsed 50 and 100 Hz magnetic fields significantly increase atropine-inhibiting effect of intestinal transit (1 - 2). Here we reported incidence of a pulsed ELF magnetic field on pharmacological effect of acetylcholine on rat's duodenum *in vitro*.

MATERIALS AND METHODS: Acetylcholine contractile effect is studied *in vitro* on rat duodenum with the Magnus technic: after sacrifice 2 cm of rat duodenum (from adult male Wistar rat) is put in a 25 ml isolated organs bath full of tyrode solution correctly oxygenated and kept at a constant temperature of $37 \pm 0.5^\circ\text{C}$. An acetylcholine solution of 1 $\mu\text{g/ml}$ in distilled water is divided in 2 solutions: - *Solution A* (control) which is waiting during experiment in the ambient 50 Hz magnetic field of the laboratory (0.1 μT - EFM 130 magnetic field meter) - *Solution B* which is exposed at least 20 min till the end of experiment (120 to 150 min), to a south pulsed 50 Hz magnetic field of 90 μT . The magnetic field is generated by a coil (60 mm diameter and 15 mm thick) connected to a Magpulse apparatus. For each experiment, 0.2 μg of acetylcholine (vol. 0.2 ml) from solution A or B is added in the isolated organs bath and tested (several times alternatively for each solution), for its contractile effects on rat duodenum. Each contractile response is obtained on an oscillograph by the way of an isotonic lever, height of response in millimeters is measured with a ruler. Five independent experiments are done using 5 rats. The possibility of pooling results from those 5 experiments is tested with Kruskal-Wallis non parametric rank test. Comparison between duodenum contractile responses from solutions A and B are performed for each experiment with the non parametric sign test.

RESULTS: For each independent experiment an increase of duodenum contractile response is observed with solutions B as compared to solution A, but the increase is significant only for experiment 3 ($P < 0.05$). When results of the 5 experiments are pooled (allowed by Kruskal-Wallis tests results) a significant increase of duodenum contractile response appears with solutions B as compared to solutions A ($P < 0.05$).

DISCUSSION: Our results show that acetylcholine pharmacological effect on intestinal smooth muscle (contractile effect) is significantly enhanced by a pulsed 50 Hz magnetic field. Others experiments have to be done to

determine the level of magnetic field action: is it an effect on acetylcholine molecule or on water used to dilute acetylcholine? Or is it a magnetic field effect on Metamolecular Informed Signals (MIS) released by drugs (3)? In view of drugs efficiency and to prevent pharmacological modifications of medicines, it seems important to take in consideration electromagnetics fields in places where drugs are manufactured and stored (plants, laboratories, pharmacies, ...).

1. R. Santini. Incidence of 50 and 100 Hz magnetic fields on digestive transit in mice: modulation of atropine effect. *In Electricity and magnetism in Biology and Medicine*. San Francisco Press inc. Martin Blank Editor. 1993. 825-827.

2. R. Santini. A pulsed ELF magnetic field can alter pharmacological effect of atropine in solution. *European Bioelectromagnetic Association (EBEA). Third International Congress*. Nancy. 1996. Abstract book. page 133.

3. M. Citro *et al.* Non molecular informed signals coming from drugs: possible application in anti-inflammatory therapy. *6th Interscience World Conference on inflammation*. Geneva. 1995.

P-50-B

ELECTRICALLY INDUCED MORTALITY OF *E. COLI*. E. Nathalie¹, B. Gueguen¹, P.A. Cabanes² and J. Teissié. ¹IPBS-CNRS, UPR 9062, 31062 Toulouse, France. ²SEM-EDF, Paris, France.

Long term effects of electric pulses on *E. coli* cells are analysed. It is known for several years that cell electropulsation modulates the cell membrane potential difference. Enhancing the intensity of electropulsation beyond a threshold value leads to membrane restructuring and associated electroporabilization of the cell (exchange of cellular and external components across the transient permeabilization structures) [1] In the same intensity range, cell mortality is observed [2], [3]

Mortality of *E. coli* by application of electric field appears as a complex mechanism in which not only the electrical injury but also physiological parameters are involved. Analysis is made by variation of the intensity of the electric field, but also, for a "constant cumulated pulsation duration", by variation of the frequency, unitary pulse duration and number.

Cell mortality depends not directly on the electrical intensity but are related to the extend of permeabilization. For a constant intensity and "constant cumulated pulsation duration", modulation of the permeabilization by change of any pulse parameter induced a correlated variation of cell mortality.

For a given pulsation parameter, cell mortality depends on physiological and environmental parameters. Cell mortality is reduced when the electro-induced flow is artificially stopped after electropulsation and depends on physiological parameters like growth state, or level of cell energy.

When non permeabilizing pulses are applied, we observe cell mortality if given pulsation conditions are applied. This observation is made for short and intense pulses (where

permeabilization threshold is reached but where pulse durations are not long enough to induce transmembrane exchange) but also for long pulses applied below permeabilization threshold (when no transients permeabilization structures are induced). In these cases, and for "constant cumulated pulsation duration", cell mortality is related to the pulse number as if each pulse, whatever its duration, is considered as an independent cellular stress.

1. Neumann, E. and Rosenheck, K. (1972,) *J. Membr. Biol.* 10, 279-290.

2. Hamilton, W.A. and Sale, A.J.H. (1967) *Biochim. Biophys. Acta* 148, 789-800.

3. Dower, W.J., Miller, J.F. and Ragsdale, C.W. (1988) *Nucleic Acids Res* 16, 6127-45.

This work was supported by a grant of the "service des études médicales d'EDF".

P-51-C

CONTROL BY PULSE DURATION OF THE LOSS OF CELL VIABILITY INDUCED BY ELECTROPULSATION: THE CASE OF CHINESE HAMSTER OVARY (CHO) CELLS. M.C. Vernhes¹, P.A. Cabanes² and J. Teissie¹. ¹IPBS-CNRS, UPR 9062, 31062 Toulouse Cédex, France. ²SEM-EDF, Paris, France.

Short lived electric pulses applied on cell suspension (electropulsation) induce a sharp increase in membrane permeability when strong field intensities are used. This electropermeabilization can be reversible but drastic conditions induce a loss in viability. It is well known that this loss can be dramatic when high intensities pulses are applied but the pulse duration is nevertheless controlling the process.

Square wave pulses were applied on CHO cells in suspension. Permeabilization was assayed by the penetration of the hydrophilic intercalant propidium iodide. Viability was evaluated in reference to unpulsed control cells. The influence of physical parameters (medium conductivity, post pulse temperature, osmotic pressure, vectoriality of the field) was evaluated.

A systematic investigation of the effect of the pulse duration and number at a given field strength was run. For a given cumulated pulse duration, one single pulse was less damaging than a train of very short pulses at an 1Hz frequency. As a conclusion, the loss in viability is not related to the energy delivered to the system during the pulsation. An accumulation of small stresses is very effective to induce the loss in cell viability.

Control experiments showed that these differences in the damaging effects of the field are not related to the temperature increase, to the level of permeabilization or to the oxidative stress.

The work was supported by a grant of the Service des études médicales of E.D.F.

P-52-A

THE EFFECT OF REPETITIVE MAGNETIC STIMULATION ON THE EXPRESSION OF HEAT SHOCK PROTEIN IN NORMAL AND ONCOGENICALLY-TRANSFORMED FIBROBLAST CELLS. G. Tsurita^{1,2}, S. Ueno¹, N. Tsuno³, H. Nagawa² and T. Muto². ¹Institute of Medical Electronics, ²First Department of Surgery, ³Department of Transfusion Medicine, Faculty of Medicine, University of Tokyo, Tokyo 113, Japan.

OBJECTIVE: This study focused on the effects of repetitive pulse magnetic stimulation on normal and malignant fibroblast cells. We measured changes in the expression of heat shock protein 70 (HSP70), before and after magnetic stimulation.

METHODS: The Swiss mouse embryo-derived fibroblast cell line (NIH-3T3) and the Ret-II (a colon cancer-derived oncogene)-transformed cells (Ret-II cells) were used as a model of normal anti malignant cells, respectively. Both NIH-3T3 and Ret-II cells were seeded 1×10^6 cells per flask in a 25cm² flask. The cells were positioned at the center of a Helmholtz coil, 140mm in diameter and 50mm in distance between coils, and the cells were exposed to train-pulsed magnetic fields at 50 Hz for periods of 3hrs, 6hrs and 12hrs. The wave form of each pulsed field was a biphasic sinusoidal shape with at 200 μ sec duration. The magnetic field intensity was 34mT. The coil had a liquid cooling system, and the coil temperature was kept 22°C. The cells receiving or not magnetic stimulation were incubated in an atmosphere of 5% CO₂ and in a temperature of either 37°C, 40°C, or 42°C. For protein extraction, cells were lysed in a laemmli buffer, and the HSP70 expression was determined by Western-blotting analysis. The level of HSP70 expression was analyzed in a Luminous Imager.

RESULTS: When incubated at 37°C, the expression of HSP70 in NIH-3T3 slightly increased after 3hrs magnetic stimulation, but no changes were observed after 6 hrs stimulation. The expression of HSP70 in Ret-II cells did not change at 37°C. When incubated at 40°C, the expression of HSP70 on both NIH-3T3 and Ret-II cells strongly increased after 3hrs stimulation but decreased after 6hrs stimulation. When incubated at 42°C, an increase in expression of HSP70 was observed due to the increase in the temperature, but no changes after magnetic stimulation were observed for both cells

DISCUSSION: Under normal conditions (37°C), both normal and malignant cells are stable, and the expression of HSP70 is very weak. In this condition, the expression is less affected by magnetic stimulation. Under mild heat stress (40°C), the expression of HSP70 increases for 3-4 hrs and keeps stable. The multiplication of both magnetic stimulation and heat stress may affect on the expression for the first 3 hrs, that seem to be the transient and unstable period. Under intense heat stress (42°C), the expression of HSP70 increases more rapidly and strongly than in case at 40°C. In this condition the expression is determined mainly by the heat stress itself.

P-53-B

THYMIC STRUCTURAL CHANGES AS A CONSEQUENCE OF THE SYNERGISTIC EFFECTS OF STRESS AND ELECTRO-MAGNETIC FIELD EXPOSURE. D. Quaglino¹, G. Bergamini¹, M. Capri¹, L. Zecca², C. Franceschi¹ and I. Pasquali-Ronchetti¹.

¹Department of Biomedical Sciences, General Pathology, University of Modena, Modena, Italy. ²Laboratory of Neurochemistry, C.N.R., Milano, Italy.

Thymus represents one of the main organs of the immunological system and can be modulated by environmental factors, such as electromagnetic fields (EMF). Several reports already focused on the effects of EMF and biological systems and on the possible incidence of malignancies in exposed subjects. Since it has been recently demonstrated that continuous light or dark can greatly affect the immune response, the present study has been undertaken with the aim to investigate the role of long term exposure to EMF on the thymic structure of rats stressed by continuous light.

Male Sprague-Dawley rats (Charles River, Calco, Italy), 2 months old, were housed in the CESI (Milan, Italy) animal care facilities and were fed *ad libitum* under continuous light. Temperature and humidity were always maintained constant. Animals were divided into three groups that were exposed or sham-exposed to 50Hz sinusoidal EMF at two levels of field strength (1kV/m-5 μ T and 5kV/m-100 μ T), respectively. Exposure was performed for 8 months, 5 days/week, 8 hours/day. At sacrifice, the thymus was fixed in 2.5% glutaraldehyde in phosphate buffered saline (PBS) and processed for electron microscopy. Semithin sections, stained with toluidine blue, were observed in a Zeiss Axiophot light microscope. For morphometrical analyses, scores, between 0 and 5, have been attributed by two different investigators to several parameters, at 40x magnification, in the areas that appeared comprised of both cortex and medulla. Selected fields were also analyzed by electron microscopy.

Thymus consists of lobes surrounded by a thin fibrous capsule, which penetrates and divides the parenchyma into functionally distinct lobules mainly comprised of lymphocytes, macrophages and epithelial-reticular cells. With time, the thymus progressively diminishes in size, undergoing gradual atrophy and replacement by fat. This physiological involution may be accelerated by endogenous or exogenous factors. Under continuous light, in fact, the thymus rapidly diminishes in size, because of massive death of cortical small lymphocytes and their destruction by macrophages. The concomitant exposure to EMF, especially of the lowest field strength, was associated with increased cellular turnover, as suggested by the augmented number of mitotic and apoptotic events, and with increased collagen deposition. On the contrary, nuclear degenerations and necrotic areas were more frequently observed in animals exposed to the higher field strength, which therefore caused more pronounced degenerative features.

In conclusion, it can be suggested that long term exposure to low frequency EMF, in animals caged under continuous light,

may reinforce the alterations due to a stress status; moreover, in these conditions, the effects on the thymic structure were proportional to the field strength. Even though it is not possible to define the functional features of this thymic cell population, it could be hypothesized that stress and EMF exposure can act in a synergistic manner determining a more rapid involution of the thymus and might be responsible for an increased susceptibility to the potentially hazardous effects of EMF.

Work supported by grants from CNR-ENEL: Interaction of energetic systems with human health and environment.

P-54-C

MULTIPLEX REVERSE TRANSCRIPTASE POLYMERASE CHAIN REACTION ANALYSIS OF PROTO-ONCOGENE EXPRESSIONS IN SERUM STIMULATED C3H 10T1/2 MOUSE EMBRYO CELLS

P.C. Goswami. Section of Cancer Biology, Radiation Oncology Center, Mallinckrodt Institute of Radiology, Washington University Medical School, St. Louis, Missouri 63108, USA.

A multiplex reverse transcriptase polymerase chain reaction (RT-PCR) method has been developed for the quantitation of proto-oncogene mRNA levels. Total cellular RNA were isolated at representative time points from C3H10T1/2 cells following cells' entry into the proliferative cycle. Reverse transcriptase and oligo dT were used to synthesize cDNA. The specific target mRNA (*c-fos* and *c-myc*) and an internal standard GAPD were coamplified in one reaction using primers specific for the target mRNA and GAPD. Primers were selected flanking an intron to distinguish cDNA amplified fragment from any possible DNA contamination in the individual RNA samples. The mRNA levels of *c-fos* and *c-myc* were then corrected for cellular GAPD mRNA levels for each samples and the relative abundance calculated relative to the levels present initially at the beginning of serum stimulation. The mRNA levels of *c-fos* peaked during 15-45 minutes after serum stimulation and returned to background levels at 60 minutes. The mRNA levels of *c-myc* peaked between 30-60 minutes and remained elevated. The results obtained from the RT-PCR assay were comparable to that obtained from a Northern blot analysis performed in total cellular RNA isolated from duplicate samples. In contrast to the Northern blot analysis, the RT-PCR assay is sensitive enough to detect mRNA levels of *c-fos* and *c-myc* in less than one microgram of total cellular RNA. Thus, the RT-PCR assay could provide a rapid and accurate way to determine possible changes in specific mRNA levels following cells' exposure to various stresses including extremely low frequency electromagnetic fields.

P-55-A

UNCHARACTERIZED PHYSICAL PARAMETERS CAN CONTRIBUTE MORE THAN MAGNETIC FIELD EXPOSURE TO ODC ACTIVITY *IN VITRO*. U. Valtersson¹, K. Hansson Mild² and M.O. Mattsson¹.
¹Department of Cellular and Developmental Biology, Umeå University, S-901 87 Umeå, Sweden. ²National Institute for Working Life, Umeå, Sweden.

BACKGROUND: We have previously reported on increases in activity of the enzyme ODC in various mammalian cell lines after exposure to a 50 Hz, 0.10 mT magnetic field (MF). The increase varies between cell types, and has also been seen to be associated with growth conditions. Here we report that transfer of cell culture dishes from one incubator to another in itself leads to reproducible changes in the levels of ODC activity. Importantly, the change was always an increase with transfer from incubator type "A" to "B", and a decrease after transfer in the opposite direction.

METHODS: Human lymphoblastoid cells (Jurkat) were starved in RPMI 1640 medium with 1% FCS at an initial density of 1×10^6 cells/ml for 16 hrs at 37°C, 5% CO₂ in the presence of a controlled ambient AC field (50 Hz, 0.1 µT) and DC field (53 µT). During starvation, cells were cultured either in a VWR incubator (A) or Forma Scientific model 3039 CO₂ incubator (B). In each experiment, half of the culture dishes was kept in the same incubator whereas the other half was transferred to the other incubator. All dishes were otherwise treated similarly, including lifting etc. Each experiment was terminated after 3 hrs, and cells were subsequently collected, centrifuged, and cell pellets were stored at -70°C until further analysis. ODC activity was measured as released ¹⁴CO₂ from labelled ornithine in the presence of the co-factor pyridoxal-5'-phosphate and related to amount protein.

RESULTS AND DISCUSSION: Cells transferred between identical VWR incubators (sham-sham experiments) did not exhibit differences in ODC activity. Exposure for 3 hrs to a 50 Hz MF, 0.10 mT, in either of the incubator systems caused a 25-50% increase in ODC activity. However, transfer of cells from VWR to Forma elicited 2-3 fold increases in the enzyme activity, whereas transfer in the opposite direction caused a corresponding drop in activity. So far, the causative agent of these effects on ODC activity is unknown. Our measurements have excluded differences in back-ground magnetic fields as the explanation. The difference is not due to temperature differences or mechanical handling. However, measurements of inherent vibrations in the incubators show substantial differences in both amplitude and frequency components between the two brands of incubators. The importance of vibrations for ODC activity will be investigated further.

Supported by grants from Work Environment Fund, and ELFORSK AB.

P-56-B

EFFECTS OF ULTRAWIDE BAND MICROWAVE PULSES ON RAT HEARTS *IN VITRO*. A.L. Bottomley, S.J. Neely, S.J. Wood and J.E.H. Tattersall. Medical Countermeasures Department, CBD Porton Down, Salisbury, Wiltshire SP4 0JQ, United Kingdom.

Continuous wave 960MHz radiofrequency radiation has been reported to change the beating rate of isolated Langendorff-perfused rat hearts (Olsen, 1975). We have used this preparation to test for possible biological interactions of ultrawide band (UWB) pulsed radiation.

Male Porton strain rats (200-300g) were stunned and killed by cervical dislocation. The heart was removed and perfused via the aorta with Ringer solution at 37°C. It was mounted in a Perspex stand and contractions were recorded isometrically through a cotton thread attached to a strain gauge. Hearts were positioned 1 m from a horn antenna and exposed to UWB pulses (peak field 4.5 kV m^{-1} , rise time less than 1ns) at repetition rates of 200, 500 and 1900 pulses per second. Sham exposures were performed by replacing the antenna with a dummy load. Ten preparations were tested at each repetition rate, and each heart was exposed for three periods of 5 minutes with a 10 minutes recovery between exposures. No statistically significant changes in heart rate were detected (repeated measures ANOVA). Some preparations showed unusual changes in beating patterns, but these were not consistent and could not be correlated with exposure to UWB. In a second series of experiments, 1 mM caffeine was added to the solution perfusing the hearts. This drug increased the mean heart rate from 160 to 220 beats per minute and appeared to reduce the incidence of unusual changes in beating patterns, but exposure to UWB pulses (200 and 500pps) still had no significant effect on heart rate in these caffeine-treated preparations.

These experiments have failed to demonstrate effects of UWB pulses on rat hearts *in vitro*. This is consistent with the results of Clapman & Cain (1975) and Liu *et al* (1976), who found no effect of pulse modulated microwaves on isolated frog hearts. Olsen (1975) maintained hearts at 20°C in his study, which resulted in a much lower beating rate of 25 beats per minute. It is conceivable that the lower temperature increased the susceptibility of the tissue to irradiation, and we are now testing this possibility using continuous wave radiation.

References:

Clapman RM & Cain CA (1975) *J. Microwave Power* 10:411-419.

Liu LM, Rosenbaum FJ & Pickard WF (1976). *J. Microwave Power* 11: 225-232.

Olsen RG (1995). PhD Dissertation, University of Utah, Salt Lake City.

Supported by the Ministry of Defense.

THE ELECTRIC FIELD STRESS ON MEMBRANE DUE TO TRANSMEMBRANE POTENTIAL AND ITS POSSIBLE ROLE. Q.N. Zhong, Y.L. Zhi, K. Gang and Y.H. Cui. Department of Microwave Telecommunication Engineering, Xidian University, Xi'an 710071, P.R. China.

As well known, the two side of living cells membranes usually have an electric potential difference of the order of 100mV, called transmembrane potential, thus a very strong electric field of the order of 107V/m exists in the membranes. Furthermore, because the permittivity of the membranes differs from that of the inside plasma and outside liquid of a cell, a stress exerted on the two surfaces of membrane is engendered. We call this stress a self-electric field stress because the electric field is from membrane itself nature. The source of the stress is both dielectric non-uniformity and deformation in boundary layer between membrane and plasma, and membrane and outside liquid. The expression of the stress exerted on a boundary surface between two species of isotropic and linear dielectrics can be written as

$$P_n = \frac{1}{2}(\epsilon_2 - \epsilon_1)(E_t^2 + \frac{D_n^2}{\epsilon_1 \epsilon_2}) + \frac{1}{2}(E_1^2 \rho_1 \frac{\partial \epsilon_1}{\partial \rho_1} - E_2^2 \rho_2 \frac{\partial \epsilon_2}{\partial \rho_2}) \quad (1)$$

Where ϵ , ρ , E and D are permittivity, mass density, electric field intensity and dielectric flux density near the boundary surface respectively, the footnote 1 and 2 represent the parameters of the dielectrics located the two sides of the boundary surface respectively, the footnote t and n represent the tangential and the normal component. In terms of fluid mosaic model of cell membrane, the membrane can be regarded as a liquid dielectric, the inside plasma and outside liquid of a cell are liquid dielectric, too. Therefore, the following Clausius-Mossotti law can be used to express the relation between relative permittivity ϵ_r and the ρ for each of them

$$\frac{\partial \epsilon_r}{\partial \rho} = \frac{(\epsilon_r + 2)(\epsilon_r - 1)}{3\rho} \quad (2)$$

Let ϵ_1 and ϵ_2 express the permittivities of membrane and the outside liquid respectively, based on analyses of the electric and component characters of membrane and outside liquid, the $\epsilon_1 = 10\epsilon_0$, $\epsilon_2 = 136\epsilon_0$ ($\epsilon_0 = 8.854 \times 10^{-12} \text{F/m}$, that is the permittivity of free space), and the permittivity of the plasma is identical with that of the outside liquid. The stress P_n exerted on membrane was calculated by Eq. (1), (2) and the parameters ϵ_1 , ϵ_2 and electric field intensity in a membrane, $P_n = 10^4 \text{Pa}$. The direction of the P_n is from the outside liquid and plasma to the membrane, because $\epsilon_2 > \epsilon_1$. If the thickness of a membrane has a change of displacement dr , the electric force F_r exerted on membrane caused by the dr is expressed as $F_r = -(dw_e/dr)$, where the W_e is electric field energy in the membrane, the minus shows that the direction of F_r is contrary to that of dr , which is due to that the charges on the two surface of the membrane is constant. Based on their characters, the electric field stress and force, i.e. P_n and F_r ,

play an important role in preserving stable structure of a membrane and in that of a cell.

The Project Supported by NSFC.

EFFECTS OF MICROWAVES ON ISOLATED EYES. S.C. Hall, D. Fuller, and M. Berry. Department of Hospital Medicine, University of Bristol, Bristol Eye Hospital, Bristol BS1 2LX, United Kingdom.

To evaluate energy absorption of isolated eyes exposed to pulsed microwaves and the effect of radiation on corneal physiology, pig eyes were exposed to microwaves (1.3 - 35 GHz, 15 - 3200 Wm^{-2} , 1000Hz repetition frequency) for 6, 12 or 24 minutes. The eyes were placed in the orbits of a model human head at 25°C. Intraocular temperatures were measured using a fluoroptic probe (Luxtron, Santa Clara, Ca., USA) containing four heat sensors at 5mm intervals. Temperature was measured along the antero-posterior axis with the probe tip either at the corneal surface (A1-4) or at the retina (P1-4); within the stroma (M1-4); and transversally, midway between cornea and retina, probe tip in the sclera (L1-4). To assess microwave effects on corneal physiology, eyes were placed at 4°C overnight. The eyes were then placed in humidified, temperature controlled chambers, in physiological position, at 33°C, and corneal thickness measured for 5 hours. Maximal temperature increases and maximal rates of temperature were as follows:

frequency	power	+°C	position	rate
1.36	1505	10	L2	.04
3.3	378	4.25	L1	.015
5.3	1550	9	P4	.037
5.3	600	5.5	M1	.017
8.7	1668	6.95	L4	.022
	836	3.9	A4	.014
9.6	1615	9.75	P4	.048
	322	1.45	L4	.011
	162	.6	L4	.005
16	177	1.25	L1	.004
24.1	58	.11	A1	.002
34.8	59	.3	M2, M3, L1	.002

For longer exposures corneal surfaces became hottest. Retinal temperatures increased by 5° for 1.36, 5.3 and 9.6 GHz at ~1500 Wm^{-2} and 3.8° for 8.7 GHz and same power. Recovery from cold induced oedema is described below. Minimal thickness is expressed as percentage of cold corneal thickness.

Temperature increases inside the eye depended on microwave frequency, incident power, location in the eye and duration of exposure. The pattern of change in corneal thickness depended on the combination of frequency and incident power. The worst patterns were observed at 1.36, 5.3, and 9.6 GHz, the best at 16 and 34.8 GHz. 8.7 GHz affects corneal thinning less than 9.6. Different microwave

frequencies caused different patterns of temperature increase within the eye: their size and location may lead to different physiological effects.

Frequency	Power	Minimal thickness	thinning (min)
1.36	673	100	none
	2679	99.5	45
5.3	726	97.5	90
	1448	95	15
	2889	97.5	90
8.7	423	93	60
	3364	96.5	120
9.6	511	95.5	90
	1020	91	30
	2036	>100	none
16	160	87	150
34.8	70	90.5	180
control		86.5	120

P-59-B

ULTRASTRUCTURAL CHANGES OF MICE SKIN CAUSED BY EHF - IRRADIATION. V.N. Voronkov², S.V. Zavgorodny², E.P. Khizhnyak¹, V.B. Sadovnik² and M.C. Ziskin³. ¹Institute of Cell Biophysics, Russian Academy of Sciences, Puschino, Moscow Region 142292, Russia. ²Branch of Shemiakin, Ovchinnikov Bioorganic Chemistry Institute, Russian Academy of Sciences, Puschino, Moscow Region, Russia. ³Richard J. Fox Center for Biomedical Physics, Temple University, Philadelphia, Pennsylvania, USA.

By using electron microscopy, skin samples of hairless and standard mice (BALB/C) taken at different time intervals (just after irradiation, 30 min, 2, 6 and 12 hours later after EHF-irradiation) at the frequency of 42.253 GHz and at the power from 0.1 mW/cm² to 50 mW/cm² were analyzed. We have revealed a number of the most substantial changes in the ultrastructure of skin cells that look like destruction cavities containing, as a rule, membrane structures. The sizes of these cavities vary from 0.2 to 3.0 μm in diameter. They are located in different parts of the cell: in the cytoplasm, in the cellular nucleus and membranes. The destruction cavities, lying in the cytoplasm of the cells, contains membrane structures, remainders of organelles, unlike the cavities located in the cellular nucleus and filled with the homogeneous content. These cavities are found both in the epidermal cells and dermal ones. Appearance of destructive cavities in the epidermis cells suggest the damage of the most important structural elements of nucleus and cytoplasm. The changes with condensation and defragmentation of chromatin of nuclei are typical for a perish cell of skin 6-12 hours after millimeter-wave irradiation. The found features showed the destructive changes in the skin cells, which are able to trigger reparative processes enhancing it their turn the processes of regeneration of the epidermis cells, to take place upon irradiating the skin at the frequency of 42.253 GHz and

at the power of 40 mW/cm². Yet it should be taken into account that the epidermal cells continuously proliferate, and the effect of the death of cells may enhance the processes of proliferation and replacement of damaged cells for the new ones.

P-60-C

CAN 50 Hz MAGNETIC FIELDS MODULATE THE RESPIRATORY BURST IN ATTACHED HUMAN POLYMORPHONUCLEAR CELLS? Y. Kurokawa¹, K. Oka², H. Nitta¹ and M. Kabuto¹. ¹National Institute for Environmental Studies, Tsukuba, Ibaraki, Japan. ²Faculty of Medicine, University of Ehime, Onsen-gun, Ehime, Japan.

OBJECTIVE: Respiratory burst of free radical generation in primed rat peritoneal neutrophils was demonstrated to be enhanced by exposure of 100 μT, 60Hz magnetic field by S. Roy *et al* (*FEBS Letters*, 376,1995). The aim of this study was to examine whether the same effect of magnetic field could be observed even in adherent human polymorphonuclear cells (PMNs) or not. *In vivo*, neutrophils are thought to be triggered to their biochemical functions after attaching to the capillary endothelium in inflamed or infected tissue, and thus we evaluated the PMNs' function after being attached to the materials.

METHODS: PMNs were isolated from heparinized whole blood of healthy young volunteers by Polymorphprep (Nycomed Co.) separation and hypotonic hemolysis. Aliquots of PMNs' suspension were transferred into a round-shaped micro-chamber (5mm5mm) which adhered to a poly-l-lysine-coated cover glass and was surrounded by a Helmholtz coil. 50Hz sinusoidal magnetic field with variable intensity was generated by a low-frequency generator and an audio amplifier system.

PMNs' respiratory burst was assayed using the dye 2',7'-dichlorofluorescein diacetate (DCFH-DA). Fluorescent signals within single PMN were monitored in real-time using an adherent cell analysis system, ACAS 570 (MERIDIAN Co.). PMNs were chemically stimulated by phorbol myristate acetate (PMA, 2.0 μg/ml) and/or Concanavalin A (ConA, 50 μg/ml).

RESULTS: A great cell-to-cell variation in respiratory burst after cell attachment existed. Some cells seemed to be induced to the reaction as soon as their attachment to the bottom surface. Reaction to chemical stimulants (PMA and ConA) also varied with cells.

Our preliminary examination showed that 50Hz magnetic field in intensity ranges between 0.1 μT and 100 μT seemed to modulate neither spontaneous (or attachment-induced?) nor PMA/ConA-induced respiratory burst reactions.

We will report the results of further experiments with 50 Hz and other frequency magnetic fields in detail at the meeting.

P-61-A

EFFECTS OF HIGH VOLTAGE ELECTRIC FIELDS ON HUMAN UMBILICAL VEIN ENDOTHELIAL CELLS. H. Wakisaka¹, Y. Sawasaki¹, K. Takeuchi¹, M. Yoshioka¹, T. Goto², K. Takahashi² and A. Hara².
¹Department of Anatomy, National Defense Medical College Tokorozawa, Saitama 359, Japan. ²Hakuju Institute for Health Science Co., Ltd., Itabashi-ku, Tokyo 173, Japan.

BACKGROUND: There are many published researches on biological effects of electromagnetic fields *in vivo* and *in vitro*. On the contrary no study on the static or low frequency electric fields (EF) without magnetic fields *in vitro* are known so far. In the present study we report the effect of EF on human cell culture models, the human umbilical endothelial vein cells (HUVEC) which have been well studied biologically.

MATERIALS AND METHODS: HUVEC was obtained from umbilical cords by the method of Yaffe *et al.* (1973). The cells were cultured in Medium 199 containing 10% newborn calf serum with 10ng/ml recombinant human basic fibroblast growth factor until passage 6 to 10 and used for experiments. The two set of 24 well multidishes were arranged in tandem on a 30cm square flat metal ground plate which was obliquely opposed by a plate electrode in same size and spaced 1 to 10cm apart. By the flat electrode pair with slanting layout, dose response trends to the declining EF strength as spacing distance was expected. Two set of the plate electrodes were equipped in column in CO₂ incubator, one for exposition of EF and the other for control. The cells were continuously exposed for 4 days to following EF condition; 1) 1000V AC (50Hz) applied, 2) 1000V DC to upper anode, 3) 1000V DC to lower anode. Proliferation rate was defined as the number of cells in each well of multidishes divided by average cell number before incubation for 4 days. The proliferation rates were compared between the experimental culture and the control. The cultured cells were stained with MithoTracker (MOLECULAR PROBE) for mitochondria and with Rhodamine-Phalloidin for F-actin in order to detect any subcellular structural change by EF. Furthermore the ultrastructures were observed through conventional electronmicroscopy.

RESULTS: The cell proliferation rate of AC condition tends to exceed that of the control. Under the condition of DC with upper anode, the experimental rate was higher than the control. In contrast, with upper cathode the rate was found to be lower than the control. No clear dose responses were found in all the conditions. Morphological observation revealed no special changes between experimental and control groups. Reverse tendency in proliferation rates as reverse condition of DC is a quite interesting phenomenon.

P-62-B

50 Hz PULSED MAGNETIC FIELDS AFFECT INTRAMEMBRANE PROTEINS DISTRIBUTION IN CULTURED CELLS. F. Marinelli¹, F. Bersani², S. Santi¹, M. Riccio¹, S. Petrini³, A. Valmori¹ and N.M. Maraldi^{1,3}.
¹Instituto di Citomorfologia Normale e Patologica del CNR, 40136 Bologna, Italy. ²Dipartimento Fisica Medica Università di Bologna, Bologna, Italy. ³Laboratory Biologia Cellulare e Microscopia Elettronica, Istituto Ortopedici Rizzoli, Bologna, Italy.

Intramembrane Proteins (IMP) located in the lipid bilayer of the cell membrane have an important function as ion channels, enzymes or receptors. Biological effects of extremely low frequency (ELF) electromagnetic fields seem to be mediated by the plasma membrane. The aim of this work was to study the distribution of IMP in cells exposed to pulsed magnetic fields (PMF). The distribution of the IMP have been evaluated by calculation of a distribution factor, which allows discrimination between random, regular and clustered distribution of IMP on electron microscope images of freeze fractured membranes.

The ultrastructural observation of the IMP arrangement was performed in freeze-fractured Swiss NIH 3T3 fibroblasts. This method enables the identification of the IMP protruding from the fractured phospholipid bilayer and the evaluation of their distribution by means of image analysis techniques. The cultures were exposed to a PMF generated by a pair of rectangular horizontal coils with the magnetic field of 1.88 mT, and were exposed to PMF for 1, 2, 24, 48 and 72 h. Some cultures after exposition to PMF were left in the incubator to test the possibility of spontaneous rearrangement of IMP at natural distribution. Electron microscope micrographs of the cell membrane have been analyzed by a Quantimet 970 image analysis device (Leica-Cambridge, Cambridge, UK) in order to evaluate the type of distribution of the IMP on the cell membrane, by a statistical FV index. The results indicate that the cells exposed to the PMF undergo a significant clustering of the IMP distribution with respect to control unexposed cells. Experiments on the reversibility of the phenomenon are in progress. This study supports the view that ELF fields can act at cell membrane level, not only by local effects on ligand binding, ion fluxes etc, but also by a general effect on the overall distribution of the IMP.

P-63-C

EXPRESSION OF CANCER-ASSOCIATED GENES IN HUMAN BREAST EPITHELIAL CELLS EXPOSED TO 60 Hz MAGNETIC FIELDS. L.I. Loberg¹, J.R. Gauger², W.R. Engdahl¹ and D.L. McCormick¹.
¹Life Sciences Department and ²Electromagnetics and Electronics Systems Section, IIT Research Institute, Chicago, Illinois 60616, USA.

Data from several epidemiologic studies have suggested that human exposure to power frequency (50 or 60 Hz) magnetic fields may increase the risk of breast cancer. However, the

biochemical and molecular mechanisms underlying this possible association remain unidentified. One mechanism through which magnetic fields may stimulate cancer induction is via altered expression of oncogenes or tumor suppressor genes that regulate normal and neoplastic growth. To evaluate this hypothesis, the influence of 60 Hz magnetic fields on the expression of breast cancer-associated genes has been studied in two *in vitro* models for normal and neoplastic human breast epithelium. HBL-100 cells (American Type Culture Collection) are a transformed human mammary epithelial cell line that is estrogen-receptor negative. HBL-100 cells are not growth responsive to exogenous estradiol, prolactin, or estradiol + prolactin, and provide a model for estrogen-independent breast cancer. HME cells (Clonetics) are a histologically normal human mammary epithelial cell strain. HME cells are estrogen growth-responsive, and provide a useful model for the study of precancerous changes in the breast. HBL-100 and HME cells were exposed to magnetic fields using an exposure system (Electric Research and Management) consisting of two identical exposure chambers surrounded by identical Helmholtz coils, and a cell stock chamber in which cells were grown prior to their use in magnetic field studies. Experimentally generated magnetic fields were linearly polarized, pure 60 Hz fields; DC magnetic fields were fully characterized but not nulled. In all experiments, cells were either sham-exposed or exposed to 100 mG or 10 G magnetic fields for periods of 20 min, 1 hr, 4 hr, or 24 hr. *c-myc*, *HER2/neu*, and *p53* transcripts were quantitated by RNase protection assays (Ambion); glyceraldehyde-3-phosphate dehydrogenase (GAPDH) was included in all assays as an internal control. *p53* protein expression was analyzed by Western immunoblotting using a monoclonal antibody (Oncogene Science). All molecular analyses were performed in a fully blinded fashion. In HBL-100 cells, magnetic field exposure had no effect on basal levels of *c-myc* transcripts, and no effect on the enhancement of *c-myc* expression by the tumor promoter 12-O-tetradecanoylphorbol-13-acetate (TPA). Similarly, magnetic field exposure had no effect on basal levels of *HER2/neu* transcripts, *p53* transcripts, or *p53* protein in HBL-100 cells. Studies in HME cells also demonstrated no effect of magnetic fields on basal levels of *c-myc* transcripts or *p53* protein. Ongoing studies in HME cells are designed to investigate the effects of magnetic field exposure on expression of *HER2/neu* and two other breast cancer-related genes, cyclin E and BRCA1. The data generated to date suggest that magnetic fields are unlikely to influence mammary epithelial cell growth and neoplasia through a mechanism that involves *c-myc*, *HER2/neu*, or *p53*. These results suggest that any influences of 60 Hz magnetic fields on breast cancer induction are: (a) mediated by genes other than those studied in the present program, and/or (b) involve growth stimulatory influences that are mediated by, or interactive with, the influence of endogenous hormones (estradiol, prolactin, progesterone).

Supported by grant RO1 ES-07093 from the U.S. National Institute of Environmental Health Sciences.

P-64-A

THE MAINTENANCE OF MELATONIN AND PEROXIDATION PROCESSES AT RATS AT ACTION OF MAGNETIC FIELDS 50 Hz. L.A. Tomashevskaya. Ukrainian Scientific Hygienic Center, Kiev, Ukraine.

During the interaction EMF with organism a important role play neuroendocrinic gears regulation support metabolic homeostasis in limits adaptationic of opportunities of organism. The infringements of function hormone determine a degree of risk of cancer at the industrial exposition EMF of various frequency and intensity (H.S. Hillton, R.D. Phillips, 1988; L.B. Sasser *et al.*, 1991; S. Anisimov, 1995). In this connection the bioeffect MF 50 Hz can be connected to infringement of synthesis of melatonin, accepting participation in gears of aging and cancerogenesis, as well as to the initiating rote of peroxidations processes. In the aim of the factor simulating in laboratory conditions a special irradiating complex has been developed, that permits to aproxivate a model to the environmental factor parameters; occupied frequencies range - 50 Hz, polarization is a linear one, a modulating form is a sinusoidal signal, an affecting magnetic field is of quasistationery-type, the factor unregularity (considering the field intensity) at the place of a code with animals placing not exceeding 20%. The exposure was performed by the magnetic field of 10, 50 and 250 μ T intensity, during four months, 16 h per day. As experimental animals some white unbred rats were chosen.

The level of lipids peroxidations processes evaluated under the contents of malonic dialdehyde (MDA) in blood serum and mitochondria. The contents of melatonin determined by a radioimmunoenzymatic method.

As a result of the experiments the LPO-malonic dialdehyde (MDA) output product increase was identified under MF affecting with the intensity 50 and 250 μ T. MDA formation velocity was increasing while MF intensity was growing. LPO changes developing in the phospholipid membrane structures could be related to changing the antioxidant enzymatic systems protective effect.

The level of melatonin was reduced at long irradiation during 3-4 months. The inhibition of internal secretions of melatonin can be stipulated by decrease in these terms of supervision of serotonin-chemical predecessor of melatonin.

Thus, an essential meaning in the organism response mechanisms affected by 50 Hz MF have some peroxidation processes and antioxidant enzymatic systems state.

P-65-B

EFFECT OF ELECTROMAGNETIC FIELD ON THE ESTABLISHED CELL LINES DURING INFLUENZA VIRUS PERSISTENCE. I. Danilenko, A. Shcherbinska, S. Diadiun, V. Mirutenko, S. Rybalko, M. Kuryk and T. Grytsak. Kiev Institute of Epidemiology, 252038 Kiev, Ukraine.

Lipids belong to the main components of cell membrane where immobilized enzymes work so these components being

rather various in their chemical composition and physico-chemical patterns influence on the intensity of synthetic reactions, peroxidation and antitoxic activity both directly and mediating enzymatic activities. The goal of this work was to determine the effect of electromagnetic field (EMF) on the virus reproduction in the course of acute and persistent influenza virus infection *in vitro*. During this study such markers as intensity of free radicals formation and changes of antioxidant activity were assayed. Two established cell lines, SEM and Jurkat, with different susceptibility to influenza virus were used. The following virus strains were taken for this study: A/Ph, APR8, A/Hong Kong. Fresh cells having been added to growing cell cultures antioxidant activity was increased accompanied by decreased free radicals forming. During persistent virus infection the decrease of antioxidant cell lipids activity and intensification of free radicals forming was detected to be dependent on virus type and cell culture type. When both control and infected cell had been treated by EHF the increase of antioxidant activity and decrease of free radicals forming was also noted depending on cell type and infecting virus type. So it can be said that in our experiments activation of antitoxic lipids activity and decrease of free radicals forming takes place following EMF action. The EMF is supposed to be useful in experiments regulating influenza virus reproduction *in vitro*.

P-66-C

EFFECTS OF THE MAGNETIC FIELD ON REGULATING AND CONTROLLING NITROGENASE ACTIVITY. Q. C. Liu, Y.L. Xu and Y.J. Zhang. Soils and Fertilizers Institute, CAAS, 100081, Beijing, P.R. China.

Nitrogen is an important nutrient element on which all the living beings rely for their existence. However, many of them are not able to utilize nitrogen directly from the air, and only a few microorganisms, possessing nitrogenase, are capable of converting free nitrogen into ammonia at an ordinary temperature and pressure, thereby to meet their own requirements and a need for plant growth. This is just called as biological fixation of nitrogen, which is considered to be an important subject in agricultural research.

OBJECTIVE: Its primary objective was to study the effects of the magnetic field (MF) on regulating and controlling nitrogenase as well as the mechanism of action.

METHODS: Leguminous plants and their corresponding symbiotic N-Fixing bacteria were used as experimental materials. Ferritic permanent magnet (800-1000 gauss) was either used for treating bacterial bodies and plant seeds with or buried into the earth around plant roots. Then these treatments were compared with that without magnetization. Changes in nitrogenase activity were observed and measured by the method of acetylene reduction.

RESULTS: (1) The MF treatments raised symbiotic N-fixing capacity of leguminous plants, so as to enhance the plant biomass; (2) The MF played no role in promoting nitrogenase activity in bacterial bodies under exomatic conditions, and on the contrary, it exhibited some inhibition on enzymatic activity. Nitrogenase activity in bacterial bodies might be

restored when the extraneous MF was eliminated; (3). The MF treatments not only raised symbiotic N-fixing capacity of plants, but also increased the leghemoglobin content in their symbionts. The tendency of increase and decline in N-fixing capacity was in a complete agreement with that in the leghemoglobin content. The results are seen in the following table.

Treatment/ Measuring item	Without magnetization	Magnetized seedlings	Magnetized bacteria	Double magnetization
Acetylene-reducing value (n Mol C ₂ H ₂ /h/g fresh nodules)	1432.3	2066.5	2405.3	2565.3
Leghemoglobin content (mg/g fresh nodules)	8.44	9.24	9.9	10.70

DISCUSSION: (1) Research of former workers has proved that leghemoglobin can be combined with free oxygen molecules, and its presence is an extremely important external condition for symbiotic fixation of nitrogen. A correlation among the MF, symbiotic N-fixing capacity and the leghemoglobin content has been found in this study, and thereby to illustrate that the MF can promote synthesis of leghemoglobin. As a result, symbiotic N-fixing capacity has also been increased. The results of experiments offered a new argument and a new point of discussion for regulating and controlling nitrogenase activity by the MF. (2) This study opened new avenues for raising the leghemoglobin content in leguminous plants, improving symbiotic conditions of plants and microorganisms and increasing legume yields through a physical approach.

This work was financed by the National Funds for Natural Sciences.

P-67-A

THE RESPONSE OF PLANT CELLS TO GEOMAGNETIC FIELDS FLUCTUATIONS. E.R. Nanushyan and V.V. Murashev. Laboratory of Plant Development Biology, Lomonosow Moscow State University, Moscow, Russia.

The influence of geomagnetic field (GMF) fluctuations on the cells structure of *Allium cepa* L. meristematic tissues was established. The tips of roots and shoots were fixed twice per day during 24-day period.

Binuclear, tetranuclear cells and large cells with giant nuclei were observed in apical meristem. They were surrounded by mononuclear diploid cells. Within some days of the experiment the amount of polynuclear cells comprised 20% of all the meristem cells. The graphic explanation of this process shows picks and declinings in the number of cells with enhanced DNA content. By comparing this dynamics with the changes in the EMF characteristics at the same days, we found a striking correlation between the both.

The artificial screening of a GMF led to a significant decrease of the cells with enhanced DNA content.

The response of the same plant cells to fluctuation of GMF under the geographical conditions of high-latitude with greater effect has been experimentally established.

Several types of cell transformations can take place in the

meristem tissues of *A. cepa L.* which were observed in our experiments. Meanwhile, the uncytokinetic mitosis with formation of binuclear and then tetranuclear cells as well as a fusion of the normal and interphase nuclei resulting in formation of giant cells with giant nuclei seem to dominate in our case.

In the both cases the cell structure become disrupted. At first cell walls are eliminated leading thus to the formation of binuclear cells. Then the nuclear membrane is disrupted, the nuclei are fused and a single giant nucleus is formed.

It is known that cells with an increased content of nuclear DNA usually appear in differentiated and functionally active tissues and that processes of polyploidization and polytenization are similar in plant and animal organisms.

In our experiments phenomena were observed in nondifferentiated meristematic tissues and could be considered as the adaptive cellular response to changes of GMF activity.

P-68-B

SINGLE NEURON RESPONSE TO WEAK ELF MAGNETIC FIELD: NONLINEAR DEPENDENCIES ON FIELD AMPLITUDE, FREQUENCY, SEASON AND GEOMAGNETIC FIELD VARIATIONS. A.B. Uzdensky and O.Y. Kutko. Institute of Neurocybernetics, Rostov University, Rostov-on-Don 344090, Russia.

INTRODUCTION: Responses of single nerve cells to weak 'extremely' low frequency magnetic fields (ELF MF) were studied over the wide ranges of frequencies (from 0.001 to 100 Hz), and amplitudes (from 1 to 400 μ T).

MATERIAL AND METHODS: Isolated crayfish stretch receptor neurons are able to prolonged firing with a nearly constant frequency. This relatively stable background level provides observation of small firing frequency shifts under ELF MF with an accuracy near 3-5 %. Flat coil was used as a source of vertical sinusoidal magnetic field. Neuron was placed 8 mm above the coil center on the coil axis. Magnetic fields at neuron location were calculated from the current and coil parameters and directly measured by a small Hall effect transducer.

RESULTS: Significant neuron activity which could block the spike generation were never recorded in our experiments. Neuron firing shifts were usually weak and variable: firing frequency increased or decreased slowly during tens of minutes with the markedly variable latencies. Such shifts were certainly functional, but not destructive. We studied dependence of neuron response probability $P(F)$ on field frequency F (at different amplitudes and ignoring response types - excitatory or inhibitory) and dependence of response probability $P(B)$ on field amplitude B (at different frequencies and ignoring response types). Frequency and amplitude "action spectra", $P(F)$ and $P(B)$, included several bands (frequency and amplitude "windows"). $P(F)$ was maximal at 0.001; 0.3; 3, and 60 Hz, and minimal at 0.03; 0.8-2; 11-15, and 100 Hz. Function $P(B)$ was maximal at 5; 20; 50 and 300 μ T, and minimal at 1; 10; 30, and 100 μ T. Inhibitory neuron responses were observed more often than excitatory

ones. Neuron response probability dependencies $P(Ap)$ and $P(Kp)$ on geomagnetic variation indexes Ap and Kp (the same data array with various ELF MF frequencies and amplitudes) were also nonlinear. $P(Kp)$ was maximal at $Kp = 0$ and 5-6, and minimal at $Kp = 4$. $P(Ap)$ was maximal at 3; 14, and 18 nT, and minimal at 5-8; 17, and 25 nT. Hence, geomagnetic field variations influenced crayfish neuron sensitivity to ELF MF. We observed also that neuron sensitivity to ELF MF increased monotonously from March to October showing the dependence on season changes in neuron metabolic state.

DISCUSSION: To explain tentatively the nonlinearity, variability and instability of neuron responses we assumed participation of additional external and/or internal factors. For example, due to its fluctuations, the geomagnetic field, as an interacting constant field, may or may not meet cyclotron resonance requirements in different experiments and change or not change the neuron activity. Taking into account the cell inner state, one can speculate that magnetic field may couple with a not high probability the membrane processes controlling neuron firing with some intracellular rhythmic processes. In this case the direction of firing shift under ELF MF may depend on the initial phase of such rhythms. If the mentioned processes remain in a coupled state, then such hypothesis may explain variable and long latencies by a low probability of this coupling, "amplitude windows" - by the coupling disruption under more intense MF, "frequency windows" - by the requirement for coincidence of internal and external rhythms.

P-69-C

MORPHOLOGICAL CHANGES OF THE ADRENAL GLAND UNDER INFLUENCE OF EXTREMELY LOW FREQUENCY ELECTROMAGNETIC FIELD. G. Uscebrka¹, D. Zikic¹, M. Matavulj², V. Rajkovic² and D. Gledic³. ¹Faculty of Agriculture, ²Institute of Biology, Faculty of Science, University of Novi Sad, 21000 Novi Sad, Yugoslavia. ³Faculty of Veterinary Medicine, Beograd, Yugoslavia.

Our purpose in this study was to determine the effect of extremely low frequency electromagnetic field (ELF-EMF) of intensities that can be met in the environment on adrenal gland morphology. Investigation of the effect of ELF-EMF was performed on ten treated and ten control rats of Mil Hill strain of both, female and male sex. The treated animals were exposed to influence of ELF-EMF (50 Hz) of decaying intensity along the animals cages from 500 μ T to 50 μ T beginning from 24h after birth to five months of age, 7 hours a day, 5 day a week. Adrenal glands were isolated, weighted and fixed in the Bouin's fixative and embedded in paraffin. For the light-microscopically cytological investigations, whole left adrenal gland was serially cut at the thickness of 5 μ m. At female animals results show increase of body weight ($p < 0.05$), decrease of absolute weight of adrenal glands ($p < 0.05$) and increase of relative weights of adrenal glands ($p < 0.01$) in treated animals. In treated male animals results show decrease of absolute weight of adrenal glands ($p < 0.05$).

In outer zone fasciculata and reticularis in treated animals of both sex the number of dark cells were increased. The cells of zona reticularis of these animals are characterized by necrosis and picnosity of nuclei. Also, prominent hyperemia has been seen in cortex as well as in medulla of adrenal glands of the treated animals. These results point out that five months exposing to ELF-EMF has biological effect on the structure of adrenal gland in female and male rats.

P-70-A

MAGNETIC FIELD (MF) EFFECTS ON CELL HYDRATION. A.A. Danielian and S.N. Ayrapetyan. Biophysics Center of Armenia NAS, Yerevan 375044, Armenia.

Previously it was suggested, that cell hydration can serve as a second universal messenger through which the effect of weak physical external signals can modulate membrane functional activity. At the same time it was shown, that the biological effect of magnetic field is realized through changing of water structure near the membrane. The aim of present work was to study the MF effect on cell hydration in different cells and number of pump units (ouabain receptors in membrane) in different tissues of rats. Changes of hydration were measured in all tissues of rats after 15 minutes exposure to steady MF 0,2T. There was a tendency of increase of hydration in the cortex of brain in all experiments. The changes of hydration in heart differed from 2,6 to 12% decrease of hydration. A decrease of hydration from 3,4 to 14% was detected in liver cells. Changes of hydration of spleen cells were different - from 6,7% of increase to 6% of decrease. For half an hour of exposure in all experiments a mean 5% decrease was detected in brain, there were no changes in cerebellum, and there was a decrease of hydration in liver cells for 10-11%. The changes of hydration of spleen cells differed in different cases, they also differed for heart cells - from 5% increase to 5% decrease. The data for one hour of exposure show a slight reliable decrease of brain core cells hydration by 5,5%, of cerebellum - by 8%, of liver tissue - by 3,5%. Hydrations of other tissues were the same in control and after the exposure to SMF for one hour. The changes of ouabain H_3 ($2 \times 10^{-9}M$ concentration in Thirod's solution) binding to different cells of rats, which were exposed to SMF 0,2 T for half an hour were also shown. Under the influence of MF the ouabain H_3 binding was increased in different cases in brain - from 23% to 28%, in spleen cells - from 20 to 30%, in liver - by 17%, in heart - from 2% to 20% and it was increased in kidney cells by 27%. The mechanism of MF induced effects on cell hydration is discussed in present report.

P-71-B

EFFECT OF STATIC MAGNETIC FIELD (SMF) ON THE HYDRATION OF NORMAL AND PATHOLOGICAL TISSUES *IN VITRO*. L.L. Harutunian, G.Y. Grigorian and A.A. Danielian. Biophysics Center of Armenia NAS, Yerevan 375044, Armenia.

Recently a hypothesis was suggested (Ayrapetyan, 1996) according to which cell hydration is a second messenger with the help of which chemical, physical and metabolic factors realize their modulation effects on cell functions. The effect of SMF (190 mT) on the hydration of tissues of brain, liver, spleen, heart was studied. It was shown that the field with exposure of 0,5; 1; 1,5; 2 hours is sure to increase the hydration of brain tissue. In other internal organs the data are not defined. In breast cancers the quantity of water as compared with surrounding normal tissue is higher for about 2 times. Under the influence of SMF with exposure of 0,5 - 1 hours, the increase of water quantity in cancer and the decrease - in normal tissue is observed. At 2 hours effect of the field the effects of hydrations are identical in cancer as well as in normal tissue, i.e. the quantity of water increases.

P-72-C

THE MECHANISM OF HUMAN BLOOD NEUTROPHILS ACTIVATION BY ELECTRIC FIELD PULSES. V.S. Malinin¹, K.D. Kazarinov¹ and A.V. Putvinsky². Institute of Radioengineering and Electronics, Russian Academy of Science, Moscow 103 907, Russia. ²Russian State Medical University, Moscow, Russia.

High voltage electric field pulses, was shown previously, induced activation of blood neutrophil respiratory burst, registered as increase in luminol-dependent chemiluminescence of cell suspension. The quantitative analysis of this phenomenon by fluorescent probes and radioisotopic methods have shown that electric pulse induced neutrophil chemiluminescence is a result of Ca^{2+} ions entering the cells through reversible pores in plasma membrane. Electric pulse of amplitude 5 kV/cm generates two tens of reversible pores with average diameter nearly 2 nm and lifetime 1 minute. Total amount of calcium penetrating at this conditions from the medium (1 mM Ca^{2+}) into the cells was as high as 1.2 fmole/cell that is nearly 3.6 mM concentration per cell volume. Whereas the increase in the cytoplasmic concentration of free calcium did not exceed 1.3 mM, that is more than 3 order less. Data presented is discussed with relation to possible biological role of electroporation by natural electric fields presented in living systems.

P-73-A

A MOLECULAR SCREEN FOR GENES THAT RESPOND TO ELF-EMF IRRADIATION CONDITIONS REPORTED TO ELICIT BIOLOGICAL EFFECTS IN CELL CULTURE. R.D. Owen. U.S. Food and Drug Administration, Center for Devices and Radiological Health, Rockville, Maryland 20857, USA.

Many *in vitro* studies have been performed to characterize the biological effects of ELF-EMF exposure. Such characterizations might provide a mechanistic basis for epidemiological studies or the role of ELF-EMF in cancer promotion or other adverse health outcomes. *In vitro* biological effects are expected to cause changes in gene expression or even to be mediated by such changes. Thus, I have initiated a molecular screen for genes that respond to ELF-EMF irradiation conditions previously reported to elicit biological effects *in vitro*. The discovery of such genes would help confirm previously reported biological effects and might also explain the mechanistic basis of these effects. This work complements the replication studies I have performed to address the difficulties others have had in confirming some published ELF-EMF bioeffects results.

OBJECTIVES: To confirm and extend the results of previous replication studies, changes in gene expression were investigated by applying novel assays to cell culture exposure protocols used for replication studies. **METHODS:** Goodman, Henderson, and colleagues concluded from their results that expression of specific protooncogenes is induced by exposure to ELF-EMF. In the present work, a molecular screen was used to clone and identify genes that are differentially expressed in HL60 cells exposed to either 60 Hz magnetic fields or to the tumor promoter TPA. Cellular RNA was isolated, reverse transcribed, and enzymatically amplified with a panel of arbitrary primers. Putative positive amplimers were cloned, sequenced, and prepared for use as probes to assay specific gene expression by hybridization analysis.

RESULTS: Exposure systems that allow for control of all identified variables were used, in a blinded fashion. HL60 cells were exposed to ELF-EMF or to TPA under the conditions previously used to test the response of *MYC* to these treatments. RNA was isolated by standardized methods, and used in reverse transcription reactions to generate cDNA populations that represent the pool of expressed genes in the cultured cells. The resultant cDNA was used to generate amplimers with arbitrary primer pairs by polymerase chain reaction, and these amplimers were resolved by gel electrophoresis. Ten amplimers corresponding to putative differentially expressed genes were identified, isolated, and cloned based on differential signal intensity on autoradiograms of electrophoretically displayed amplimers. Cloned amplimers were screened by cross-hybridization to reduce duplication in the amplimer set submitted to further characterization. Some of the cloned amplimers have been sequenced. The cDNA sequence information has been used to select clones for further analysis. These clones will be analyzed by hybridization to cellular RNA to quantitate the ability of ELF-EMF or TPA to regulate their expression.

CONCLUSIONS: Preliminary work suggests that the molecular screen of cellular RNA described above may be suitable for identifying genes that respond to weak chemical or physical stimuli. Several human cDNAs have been cloned and identified by sequence analysis. The data from previously studied genes and gene products will be useful in interpreting the significance and implications of the effects of ELF-EMF and TPA on these genes.

Supported by the FDA and IAG# YOI-ES-40272 from NIEHS.

P-74-B

STATIC MAGNETIC FIELD EFFECT ON SNAKE VENOM PROPERTIES AND PHOSPHOLIPID COMPOSITION OF SNAKE LIVER AND HEART TISSUES. T.H. Avetisian, L.S. Garibova and S.N. Ayrapetyan. Biophysics Center of Armenia NAS, Yerevan 375044, Armenia.

Previously it was shown that lipid turnover is very sensitive to magnetic field. As the snake is sensitive to geomagnetic fields' changing the purpose of this work was to study the investigation of phospholipid quantity in snake (*Vipera lebetina*) liver and heart muscle and lipase A₁, A₂ and phosphodiesterase activities in snake venom under the influence of static magnetic field. As compared with the venom of snakes kept in normal conditions, in the venom of snakes kept in magnetic field the activation of lipase A₁ increases by 20,6 ±1,3%, that of A₂ by 32,1 ±2,7%, that of phosphodiesterase - by 27,9 ±2%. The levels of LPhC, PhE in heart tissue decrease, whereas in liver tissue only the levels of SPhM and PhC decrease, but PhS, MPhI, PhE levels - increase. As in both tissues the decrease of PhC level is observed, and PhC, PhS and PhE are interchangeable phospholipids, it can be supposed that the decay in liver tissue is slower, PhS and PhE have time to get restored which is not observed in heart tissue. In the present report the mechanisms of magnetic field induced lipase activity and phospholipid turnover are discussed.

P-75-C

ON THE CELLULAR MECHANISM OF THERAPEUTIC EFFECT OF STATIC MAGNETIC FIELD. S.N. Ayrapetyan, L.S. Garibova, A.A. Danielian, L.L. Harutunian and G.Y. Grigorian. Biophysics Center of Armenia NAS, Yerevan 375044, Armenia.

Earlier it was shown that in cell membrane proteins having receptor, channel and enzymatic properties are in functionally active and inactive (reserved) states and depending on membrane surface the ratio of number of active and reserved molecules is changed (Ayrapetyan, 1980). As the cell volume is a very dynamic and highly metabolic dependent structure, any pathological changes, which could lead to Na-K pump inhibition, increase membrane fluidity, or membrane cytoskeleton dephosphorylation, and it will cause cell

hydration (Ayrapetyan, 1990). In previous studies it was shown, that the target of magnetic fields is the water structure of the organism, through which the biological effect of magnetic field is realized (Ayrapetyan *et al.* 1994). Since cell hydration is much higher in pathological state than in normal state, it was suggested, that the sensitivity of cells for magnetic fields must be higher than in normal state. To check this hypothesis the effect of SMF on cell hydration, Ca uptake, intracellular cyclic nucleotides, number of ouabain receptors in the membrane, membrane lipid composition were studied in different tissues of normal and exinococus infected rats and in women breast normal and cancer tissues. It was shown that the above mentioned cell parameters are more sensitive to STMF than those in norm. The SMF leads to the decrease of cell hydration, Ca uptake, lipids oxidation and number of ouabain receptors, and to the decrease of intracellular cAMP concentration. In the report the role of cell hydration as a universal messenger for therapeutic effect of magnetic fields is discussed.

P-76-A

50 Hz MF AND LYMPHOCYTES CELL MEMBRANE: EFFECT ON DYNAMIC LIPIDS PROPERTIES AND SUSCEPTIBILITY TO OXIDATIVE DAMAGE.

C. Esposito¹, A.M. Giusti¹, T. Parasassi¹, M. Tricarico¹, E. Iorio¹ and E. Pasquali². ¹Istituto di Medicina Sperimentale, C.N.R., 00137 Roma, Italy. ²Istituto di Psicologia, C.N.R., 00137 Roma, Italy.

Accordingly with the hypothesis that cell membrane might be a primary target for the interaction of MF, we have investigated the dynamic properties of lymphocyte cell membrane by fluorescent probe 2-dimethylamino-6-laurdynaphthalene (Laurdan). Laurdan is a membrane probe that displays a relevant spectral shift depending on the lipid phase state. The value of the Generalized Polarization (Parasassi *et al.*, *Biophys. J.* 57: 1179, 1990) of this probe is a parameter related to the reciprocal of lipid "fluidity" (Parasassi *et al.*, *Biophys. J.* 60: 179, 1991). The lymphocytes exposed for 72 hours to a 0.25 mT rms, 50Hz sinusoidal MF and labeled with Laurdan showed a markedly higher GP value with respect to control lymphocytes. From the known Laurdan fluorescence features, we can state that restricted motion of lipids in membrane of lymphocytes exposed to MF can be related to a different lipidic composition in terms of increased saturated phospholipids, sphingomyelin and cholesterol.

Moreover, the lymphocytes growth for 72 hours in and out the MF have been exposed to 5 $\mu\text{mol/L}$ copper sulphate for 15 minutes at 37°C. The Laurdan GP value has been measured to investigate the modification of dynamic properties of lymphocyte membrane lipids after the oxidative stress. High values of Laurdan GP found following a membrane oxidative stress are related to hydroperoxides formation at level of double bond in phospholipids of cellular membranes. Structural consequences of the presence of hydroperoxide residues in the bilayer core are the disorder of the upper portion of the bilayer thickness and penetration of water

molecules (Parasassi *et al.*, *Int. J. Radiat. Biol.*, 65: 329, 1994). The results indicate that the lymphocytes exposed for 72 hours at the MF showed less susceptibility to oxidative stress by Cu^{2+} respect to lymphocytes not MF exposed. To explain the molecular origin of the decreased sensitivity to oxidation of lymphocytes MF exposed, two possibilities are proposed: 1) the oxidative damage occurs but it is not observable because of the ordering effect of cholesterol and of saturated lipids on the bilayer structure, that prevents the penetration of water; 2) cholesterol and saturated lipids protect against the production of oxidative damage because of a steric hindrance to the propagation of the radical chain reaction.

Lymphocytes were obtained from peripheral blood samples collected from healthy donors, were separated on a Fycoll Hypaque gradient, washed twice with RPMI 1640 containing 2% FCS and resuspended at 1×10^6 cells/ml in RPMI 1640, 10% FCS, 2mM glutamine.

The exposure system was composed of two Helmholtz coils, positioned in a CO_2 incubator, and a Variac autotransformer connected to the 50 Hz power mains. Checks were made for MF uniformity, CO_2 , temperature ($\pm 0.1^\circ\text{C}$). Stray fields, for controls, were below $2\mu\text{T}$.

P-77-B

ALTERATION OF THE BLOOD-BRAIN BARRIER BY MICROWAVE-INDUCED HYPERTHERMIA.

J.H. Merritt and J.R. Jauchem. U.S. Air Force Armstrong Laboratory, Brooks Air Force Base, Texas 78235, USA.

A number of studies have been reported dealing with the effects of microwave exposure on the blood-brain barrier. Recently, Salford, *et al.* showed penetration of albumin in the brains of rats exposed at specific absorption rates (SAR) as low as 0.33 W/kg. The results of other studies showed no effects of exposure on the barrier system. The present studies were undertaken to examine a range of microwave exposures on alterations of the blood-brain barrier for fluorescein-labeled albumin. Sodium fluorescein was infused intravenously into the femoral vein of anesthetized rats after exposure to 1.2-GHz radiation for 30 min at power densities ranging from 0 to 40 mW/cm^2 . Whole body SARs ranged from 0 to 15.2 W/kg. Temperatures were recorded at the tympanic membrane and in the colon during exposure. Fluorescein content was assayed in 7 brain regions, and was significantly elevated in animals irradiated at 40 mW/cm^2 (SAR = 15.2 W/kg; core temperature increase of 6°C). Blood volume, determined in the brain regions in a separate series of rats, was decreased slightly after exposure to 30 and 40 mW/cm^2 . The results of this study indicate that hyperthermic exposure to microwaves can alter the blood-brain barrier to fluorescein in the absence of increased cerebral blood volume. No alteration was noted for exposures that did not increase core temperature.

IN VITRO EXPOSURE OF MCF-7 HUMAN MAMMARY CELLS TO 60 Hz MAGNETIC FIELDS. J.E. Morris, W.B. Chrisler, D.L. Miller, L.B. Sasser and L.E. Anderson. Battelle, Pacific Northwest National Laboratory, Richland, Washington 99352, USA.

OBJECTIVE: A series of experiments have been initiated to replicate MCF-7 cellular studies demonstrating suppressive growth effects by melatonin and the reversal of those effects by exposure to 60-Hz magnetic fields (Liburdy *et al. J. Pineal Research*. 1993).

METHODS: The project was divided into 2 phases. The first phase was to acquire and establish the basic biological elements for the study (appropriate cells, maintenance procedures and cell handling protocols). In addition, efforts were initiated to characterize and monitor the stability of environmental conditions (i.e., temperature, humidity and CO₂ levels in incubators used for the study). These activities also included training of personnel to conduct the studies as described in the literature. A second element of phase 1 was to procure appropriate mu-metal boxes, construct exposure systems and map fields in energized systems. Phase 2 of the study is to conduct the exposure study using MCF-7 human mammary tumor cells that have demonstrable sensitivity to melatonin as described in the literature.

RESULTS: The first phase of the study has been completed. During this phase, we have worked closely with Drs. R. Liburdy and J. Harland (LBL). They have provided cells, detailed protocols, and procedures for the tissue culture requirements. Specific plans for constructing exposure system as well as, the training of personnel to conduct the *in vitro* cellular studies were provided by LBL. In the PNNL system, temperature can be controlled at 37 ± 0.1°C and monitored continuously throughout the study. The CO₂ levels are stable at 5.0 ± 0.1% and humidity at 95%. Ambient magnetic fields (60-Hz) in the incubators ranges from 3 to 15 mG, whereas inside the mu-metal boxes in the incubators the fields were greatly reduced (<0.1 mG) when the systems were not energized. The magnetic fields within the experimental region of the Merritt coil systems were 12.0 ± 0.04 mG when energized at 12 mG and 2.0 ± 0.02 mG when energized at 2mG. Phase 2, exposure of MCF-7 cells, is now in progress.

DISCUSSION: The results of these *in vitro* studies will provide data to confirm the reported positive effects of 60-Hz magnetic fields exposure on MCF-7 cells.

Supported by the U.S. Dept. Of Energy under Contract No DE-AC06-76RLO 1830.

EFFECTS OF ELF MAGNETIC FIELDS ON COLLAGEN SYNTHESIS IN OSTEOBLASTS. K.H. Park¹, A. Soda², H. Yamaguchi², Y. Kinouchi¹ and K. Yoshizaki². ¹Department of Electrical and Electronic Engineering, ²Department of Physiology, The University of Tokushima, Tokushima 770, Japan.

OBJECTIVE: The objective of this study is to examine the biological effects of ELF magnetic fields on growth of osteoblasts. It was found from our preliminary experiments that ALP activities of osteoblasts exposed to ELF magnetic fields of 30 and 60 Hz did not show large differences as compared with that of control experiments, though there existed significant differences at some points (Boku *et al*, BEMS Meeting, 1996). Accumulation of collagen was however suggested because protein contents increased almost monotonously at both frequencies. Therefore, the effects of ELF magnetic fields on collagen synthesis in osteoblasts are examined here.

MATERIALS AND METHODS: Osteoblasts of mouse (MC3T3-E1) were cultured in a modified minimum essential medium (H. Miyamoto and *et al*, Academic Press, 1976) supplemented by 10(v/v)% fetal bovine serum in plastic culture dishes of 3.5 cm in diameter. Using confluent cultures, the culture dishes were placed in special incubators to keep the temperature of the cultures constant (37 ± 0.2°C). One of the incubators was set in the gap between two solenoid coils and the other was placed outside the coils as a control. Magnetic fields produced by the coils are sinusoidal (60 Hz) and their rms values are from 1.25 to 3.0 mT. Induced current density in the medium is about 10 mA/m² in average. Duration of exposing to magnetic fields was about 14 days. Content of collagen protein and content of non-collagen protein of the osteoblasts were measured as an index of osteogenesis.

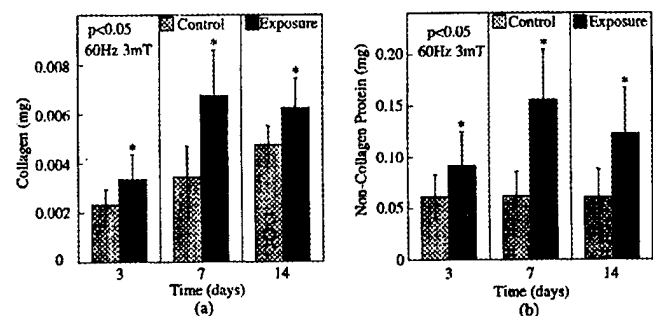

Fig. 1. Effects of magnetic fields at 60 Hz; (a) Content of collagen protein, (b) Content of non-collagen protein

RESULTS AND DISCUSSION: Fig. 1 shows experimental results. Significant differences between the exposure and control groups are observed as to collagen and non-collagen protein contents. It is found from the control experiments that collagen increases with time and accumulates, while non-collagen protein keeps almost constant. The exposure experiments show that the collagen accumulation increases more by the fields and the non-collagen protein also increases. It may be therefore suggested that collagen

synthesis, and hence osteogenesis are facilitated by ELF magnetic fields.

P-80-B

MAGNETIC FIELD, MANGANESE AND BLOOD BRAIN BARRIER. M. Vojtisek, J. Jerábek, J. Knotková, D. Hulínská, M. Hornychová, J. Formánek, D. Bittnerová, J. Svihálková, Z. Paduanová and E. Pekárková. National Institute of Public Health, Prague 10, 100 42, Czech Republic.

The aim of the project was to verify the hypothesis, that magnetic field may influence the penetration of neurotoxic manganese into the rat's brain across the blood-brain barrier after combined subchronic exposure of rats to manganese (Mn) and alternating magnetic field (AMF) as compared to exposure to Mn only.

Subchronic exposures of metal were realized by doses of 0.48 mg of Mn^{2+} / 0,5 ml of solution / kg body weight, 2 times a week, 3 months. Two types of Mn were used: Type 1.: $MnSO_4$ and Type 2.: $MnCl_2$. Exposures Type 1. were uninterrupted, exposures Type 2. were after 3 weeks periods interrupted for one week, total period of 3 months was respected.

Exposures to AMF: $B = 10mT$, $f = 50$ Hz, 1 hour, after every instillation of Mn.

Wistar females rats were divided into 3 groups: K1 without any exposure, K2 with Mn exposures only and EX with combined exposures to Mn as well as AMF.

To verify the hypothesis 3 approaches were used: analytical, physiological and morphological. Analytical: Mn retention in the brain of rats of individual groups at the end of exposures - atomic absorption spectrophotometry (AAS) or radionuclide Mn^{54} , physiological: *in vitro* and *in vivo* brain study methods, morphological: electron microscope studies of brains.

Hypothesis was confirmed by higher brain Mn content in the brains of rats with combined exposures (EX), type 1., as compared to Mn exposure only, by AAS method and by Mn^{54} method, $P < 0,05$. Physiological and morphological methods enabled to demonstrate interesting tendencies of influences of combined exposures of rats to Mn and AMF as compared to Mn exposures only.

P-81-C

KOROTKOV'S TONES FREQUENCY - INDICATOR OF CONSTANT MAGNETIC FIELD INFLUENCE ON VASCULAR TONUS. A.N. Volobuev, E.L. Ovchinnikov and L.A. Trufanov. Samara State Medical University, 443079 Samara, Russia.

Uninvasive definition of module of vessel's wall elasticity in intact cardiovascular system is executed by measurement of Korotkov's tones frequency (Priority N 93035271 Rospatent 07.07.1993). The frequency of Korotkov's tones ν is

connected with a effective module of elasticity E by the equality $E = k\nu^2$, where k - coefficient of proportionality.

OBJECTIVE: The Purpose of work was a research of dependence of the Korotkov's tones frequency, and consequently, module of vascular wall elasticity from value of a constant magnetic field (CMF) induction B and from a exposure t in CMF.

METHODS: The Registration of the Korotkov's tones frequency was conducted at constant occlusion of the shoulder's artery by phonocardiograph. The oscillograms was recorded by the high-rate oscillograph. As a results of mathematical processing was the defined of Korotkov's tones frequency. CMF was created by large electromagnet. Patient was completely placed in the solenoid. The magnetic induction inside of the solenoid was homogeneous, constant in particular experiment, and could be adjusted in a range from 0 up to 85 mT.

RESULTS: The results of experiments are submitted on the schedules (fig. 1, fig. 2). We have established that the Korotkov's tones frequency in CMF will never remain constant.

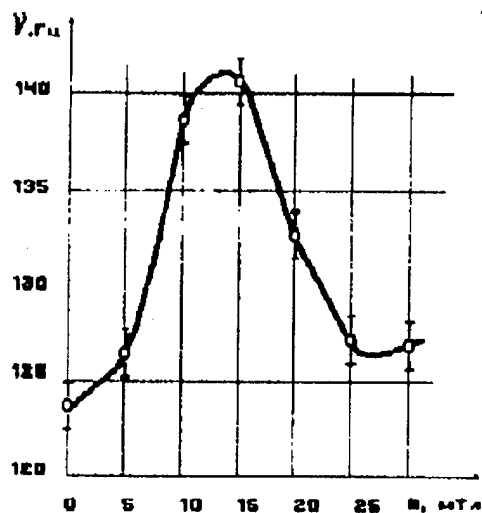
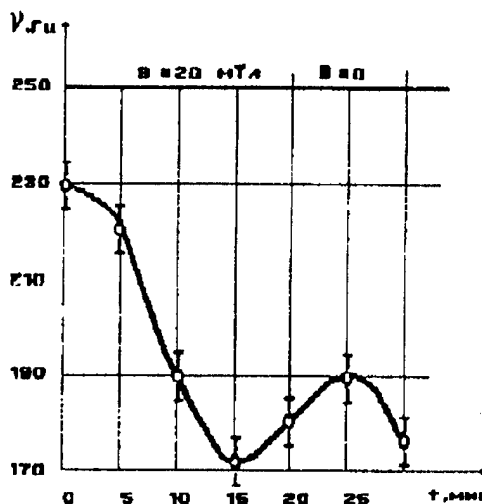

DISCUSSION: By the current of blood on elastic vessel it'll possible the instability of the type "a flow - wall", or membrane's vogue flatter. For a liquidation of this instability

in organism's evolution was generated antifractal mechanism. This mechanism is directed on prevention auto-oscillations of vessel wall and bloodstream. The essence of the mechanism consists of that before the beginning of a pulse connection rate of the bloodstream in the given place of the vessel take place the preparation of vessel to the reception of the pulse wave. The preparation has reflex character. For steady work of the antifractal mechanism is necessary the equality the pulse wave $V_{pw} = f(E)$ and nervous impulse sympathetic fibres $V_{ni} = f(B,t)$ rates: $V_{ni} = V_{pw}$. The infringement of this equality is possible to according of various effects. One of them is an effect on organism CMF. We have established, that the rate of the nervous impulse depends on a induction and exposure of external CMF. By the premise of organism in external CMF the rate of a pulse decreases. There are supervisions, in which the frequency at first grows, and then drops (fig. 1). It is connected that at first at reduction of nervous impulse rate on tod-making nervous to fibres distance between preliminary reflex by preparation vessel and pulseful increase of rate bloodment is reduced. It results in the increase of the effective module of elasticity of the wall. At backlog of nervous impulse from pulse wave, preparation vessel late. The current of blood acquires character of a flow in passive elastic pipe. The effective module of a elasticity vessel's wall is reduced. In some series of experiments has appeared, that the of Korotkov's tones frequency at patient begins at once to drop at a premise him in CMF (fig. 2). It specifies on that the work antifractal mechanism is on a limit possible. On this development arterial hypertension is possible. The effective module of elasticity of the vascular wall and of Korotkov's tones frequency is the indicator of works change antifractal mechanism which connected. Hence, our researches have diagnostic character.

P-82-A

THE MECHANISM OF EM FIELD STIMULATION OF THE STRESS RESPONSE IS SIMILAR TO OTHER ENVIRONMENTAL STRESSES. R. Goodman¹, H. Lin¹ and M. Blank². Departments of ¹Pathology and ²Physiology, Columbia University Health Sciences, New York, New York 10032, USA.

BACKGROUND: The stress response is an important homeostatic mechanism that enables cells from animals, plants and bacteria to survive a variety of environmental/physiological stresses such as heat shock, heavy metals and oxidative stress. The coordinated cellular responses to stress are known to be effected in part by the activation of heat shock factor (HSF), a transcriptional activator protein capable of binding to and inducing transcription from genes containing heat shock elements (HSEs).

Several lines of evidence show that exposure to environmental level 60Hz EM fields induces stress genes and stress response proteins *in the absence of elevated temperature*. These include:

- Activation of heat shock puff for hsp70 in *Drosophila*

salivary gland chromosomes.

- Increased transcript levels for some stress genes in dipteran, human and yeast cells.
- Identification of EM field sensitive region on HSP70 promoter.
- Increased synthesis of the 70kD stress response protein hsp70.
- Cytoprotection similar to thermotolerance

We have examined the activation of several transcription factors, including HSF and AP1, in response to EM field-induced stress.

METHODS: *EM field exposure conditions:* Human HL60 cells were exposed to 8μT 60Hz EM fields in T25 flasks at 37.5°C for 20 minutes. EM fields were generated by a pair of double-wound Helmholtz coils (Electric Research Management) shielded in a mu metal container (Ammuneal Manufacturing Corp) within the incubator. *Heat shock at 43°C* was used as a positive control. *Temperatures* were monitored using a PhysiTemp thermocouple probe. *Preparation of cell extracts and electrophoretic mobility shift assay (EMSA):* Lysates were prepared at 0, 10, 20, 30 and 40 minutes following EM field exposure and EMSA performed on protein extracts using oligonucleotides containing either HSE consensus sequences or AP1-like binding site consensus sequences. *Competition assays* established sequence specificity of the retarded band. *Supershift assays* used antibodies against HSF1 and HSF2 to confirm the identity of sequence specific retarded complex.

RESULTS AND DISCUSSION: EM field stimulation induces activation of heat shock factors (HSFs) and heat shock element (HSE)-binding. This sequence of events is similar to that observed for some other environmental stresses. The possible activation of *both* HSF1 and HSF2 however, differs from heat shock where only HSF1 is activated. Induction of heat shock factor activation and heat shock element-binding in EM field-stimulated cells provides a first step in demonstrating that EM fields induce the stress response and that stress-induced transcription is mediated by heat shock factor. These data place EM field stimulation in the context of other environmental stresses, and what is known about their regulation and control. One significant difference from thermal stress, however, was the observation that the AP1 binding site also appears to be a target for EM field stimulation. AP1 binding is *not* seen in heat shocked cells, suggesting that EM stress may also involve activation of the protein kinase cascade regulating AP1.

We thank Dr. Richard Morimoto (Northwestern University) for providing oligonucleotides and antibodies against HSF1 and HSF2, and Dr. Mark Head (Columbia University) for providing oligonucleotides.

The work was supported by grants from the Heineman Foundation, the National Cancer Institute, and a contract from the US Department of Energy.

P-83-B

EFFECTS OF ELF ELECTRIC FIELDS ON LYMPHOCYTE MOTILITY: A MICROGRAPHIC INVESTIGATION. R. Coghill. Coghill Research Laboratories, Gwent NP4 5UH, Wales.

SUMMARY: A number of studies have observed galvanotactic or galvanotropic effects on cell motility from exposure to static electric fields, where a wide variety of cell types actively migrate, develop outgrowth, or orientate towards the cathode (e.g. Cooper & Schliwa, 1985; Short, Goodwill 1994), but few have investigated effects on migration of alternating ELF electric fields and currents. Other researchers (e.g. Bessis and Boisfleurie, 1976) have noted abnormalities in the migration of leukaemic lymphocytes, which appear to lack directed motility, though no causal explanation has been forthcoming for these observations. One possibility is that weak ELF electric field exposure adversely affects lymphocyte motility, possibly by inhibiting ATP synthesis. This study examines the effects of ELF electric field exposure on human peripheral normal blood lymphocyte motility and compares performance with other immune-related disease states, by means of timelapse video microscopy.

METHOD: Peripheral blood lymphocytes were obtained by centrifugation and maintained in appropriate cell culture medium within a specially designed temperature-controlled well. Migration rates were followed by means of timelapse video microscopy using an Olympus BX50 microscope and Sony video recording instrumentation, digitised into a PC. The results were analysed statistically to compare migration with and without field exposure, and lymphocytes from normal subjects were compared with those from patients with several different immune-related disorders.

RESULTS: The study is ongoing at this time, but it is hoped to report preliminary results.

In Vivo

P-84-C

CHRONIC EXPOSURE TO 50 Hz-SINUSOIDAL ELECTRIC AND MAGNETIC FIELDS: PHENOTYPICAL STUDY OF IMMUNE SYSTEM CELLS IN AN *IN VIVO* MODEL. M. Capri¹, D. Quaglino¹, D. Monti¹, S. Salvioli¹, D. Barbieri¹, M. Guido¹, S. Macchioni¹, A. Cossarizza¹, L. Zecca³, I. Pasquali-Ronchetti¹, F. Bersani² and C. Franceschi¹. ¹Department of Biomedical Sciences, Section of General Pathology, University of Modena, Modena, Italy. ²Department of Physics, University of Bologna, 40100 Bologna, Italy. ³Laboratory of Neurochemistry, C.N.R., Milano, Italy.

In the last decade, the biological effects of extremely low frequency electromagnetic fields have been extensively studied, mostly because of a claimed correlation between exposure to powerlines and tumors in humans.

Epidemiological and experimental data are controversial due to a number of confounding factors and to the variety of experimental conditions tested. Data in the literature suggest that the immune system may be a possible target of extremely low frequency electromagnetic fields. The results shown are part of a large study performed in collaboration by different Italian research groups during the last three years.

In this report, newborn and 2 months-old male Sprague Dawley rats were chronically exposed to 50 Hz-sinusoidal electric and magnetic fields (EMFs), for 8 months under standard housing, at the Italian Electrotechnic Experimental Center (Milan). Animals were exposed for 8 hours per day and for 5 days per week to the following conditions: A) sham-exposure; B) 5 μ T-1 kV/m; C) 100 μ T-5 kV/m, and were sacrificed after 15, 30, 90, 180, 240 days of exposure and after 30 days of wash-out. Thymus, mesenteric lymph nodes and peripheral blood were immediately collected from each experimental group of six animals. Thymocytes and lymphocytes from mesenteric lymph nodes and from peripheral blood were directly labelled with the fluorescein isothiocyanate (FITC) - and phycoerythrin (PE)-conjugated mouse anti-rat monoclonal antibodies specified below, following standard conditions. All samples were acquired and analyzed by flow cytometer Facscan (Becton Dickinson). The following cell subpopulations were analysed at each exposure time: i) from the thymus: CD4+CD8+, CD4+CD8-, CD8+CD4+, CD4-CD8-, CD5+ α/β TCR-, CD5+ α/β TCR+, CD5+ subsets representing some of the most important thymocyte maturative steps; ii) from mesenteric lymph nodes and peripheral blood: CD4+CD8+ (immature T cells), CD4+CD8- (helper T cells), CD8+CD4- (cytotoxic T cells), α/β TCR+ (total T cells), α/β TCR+CD25+ (activated T cells), CD45RC+CD4+ (memory helper T cells), CD45RC+CD8+ (memory cytotoxic T cells) and B lymphocyte subpopulations. Data indicate that neither relevant effect of exposure on thymocytes nor on the principal peripheral T and B lymphocyte subsets, are evident. However, a small but significant decrease of double positive thymocytes CD4+CD8+ and of single positive CD8-CD4+, and increase of single positive CD8+CD4+ thymocytes, in rats exposed to electric and magnetic fields for 6 months from birth, were observed.

This work was supported by grants from CNR-ENEL - Interaction of Energetic Systems with Human Health and Environment.

P-85-A

INVESTIGATION OF INTERMITTENT ELF MAGNETIC FIELDS AS ZEITGEBER FOR CIRCADIAN RHYTHMS IN THE DJUNGARIAN HAMSTER, *PHODOPUS SUNGORIS*. L.A. Couch, J.A. Creim and L.E. Anderson. Molecular Biosciences Department, Battelle, Pacific Northwest National Laboratory, Richland, Washington 99352, USA.

OBJECTIVE: Light exhibits well-established effects in regulation of circadian locomotor activity, mediated through its influence on melatonin production in the pineal gland.

Extremely low frequency (ELF) electromagnetic fields have also been shown to affect the nighttime production of melatonin in the pineal. Although the photic pathway for this phenomenon is well documented, a mechanism or specific target site for the biological interaction of ELF has not been determined. The objective of this study is to determine if ELF (because of its reported inhibition of melatonin) can act as nonphotic zeitgeber and delay activity cycles in hamsters.

METHODS: Baseline activity rhythms of two groups of Djungarian hamsters were determined, both during an entrained cycle in an L:D (16:8) environment, and during free run cycles in D:D (continuous quasi darkness with red light of less than 1 lux). One group of hamsters was then exposed in the dark to 60 Hz 1G intermittent (5 min on-5 min off) ELF, for 1 hour each day. The exposure occurred one hour before the onset of the subjective dark period (activity phase of the initial light entrainment period). The other group was sham exposed. After two weeks of exposure, the ELF exposure conditions were reversed (exposed became sham animals and visa versa). To determine if any zeitgeber effects occurred due to exposure, over twenty parameters (e.g., number of revolutions run, change in time of activity onset, length of activity period) were measured and analyzed for the two groups of hamsters, as well as for each hamster individually. This analysis also included an evaluation of any changes in measured parameters, and particularly to determine if significant alteration of circadian activity rhythms was influenced by exposure. An important feature of this study was that each animal was followed individually, with individual activity rhythms analyzed.

RESULTS: Exposure to ELF fields demonstrated no zeitgeber effects. None of the parameters measured showed significant alterations in either periods of activity or in the amount of running activity between exposed and sham exposed groups. An interesting unexpected result was that more than twice as many animals in the exposed animals (when compared to sham exposed animals) became arrhythmic in their running behavior. Although the numbers are small, 12 animals per group, this difference between exposed and sham exposed animals was especially apparent during the second exposure period.

DISCUSSION: The particular increased arrhythmia in the group of animals exposed during the second period may have been due to the longer time the animals were in D:D before the exposure. It has been shown that animals which have been in an L:L or D:D environment for extended periods become dissynchronous. Splitting of circadian rhythms is known to occur particularly in hamsters in similar situations. Because the hamsters were in free run prior to the exposure periods, an individual activity onset time was established for each animal. Exposure or sham exposure then occurred at different points in their activity cycle. None of the hamsters became arrhythmic when they were exposed before or after their running (activity) phase. However, all of the arrhythmic animals had been exposed to intermittent ELF during the running phase of their activity cycle. The ELF may have interacted more readily with the group exposed during the second exposure period because of a weakening of the natural biological rhythm after the 8 weeks in quasi-darkness or

alternatively, there may have been an increased incidence of the one hour exposure occurring during the running phase in these animals. If there was an ELF interaction, it appears to have had a cycle disruptive rather than a zeitgeber effect.

This work was supported by the Department of Energy Contract DE-AC06-76RL01830.

P-86-B

RESPOND TO WEAK 50 Hz ALTERNATING ELECTRIC FIELD OF FISHES COMMUNITY. V.V. Alexandrov¹, I.I. Evdokimov¹, I.O. Shilov², D.V. Alexandrov³ and M.P. Fedorov⁴. ¹Sechenov Institute of Evolutionary Physiology and Biochemistry, Russian Academy of Sciences, St. Petersburg 194223, Russia. ²St. Petersburg State University, St. Petersburg, Russia. ³St. Petersburg Technology Institute, St. Petersburg, Russia. ⁴St. Petersburg State Technic University, St. Petersburg, Russia.

OBJECTIVE: The new experimental data are received in Sechenov Inst Physiol and Biochemistry About high sensibility of biocommunity to Electromagnetic Fields (EMF) in 1990-1996. The hydrophytic organisms (*Cyprinidae*) are investigated under stable state (control) and the action of geomagnetic disturbances or 50Hz Alternating Electric Fields(AEFs).

METHODS: Fishes locomotion activity (LA) was registered by the using of multiple electrodes installation. It measures continuous-recording natural bioelectric potentials (ΔE s), generated by groups of specimen in process of it's free motion. The power spectrum of oscillation G(f) characterise motion, behaviour and degree of perception by organisms of external influence. Fishes were stimulated by 50Hz AEFs of different voltage or high T° (28°C) on course of two weeks. Comparison of results LA-investigation were conducted on control aquarium.

RESULTS: The energetic influence to fishes demonstrated that the behaviour of fishes changes compare with control (AEFs=0, T°=20°C). Under E=0,32 V/cm (pre-lethal level of dose) or under T°=28°C LA-variability has a similar character and consist in an increase of an amplitude of the type oscillation of the registered ΔE s and also in considerable decrease of it's frequency. Decrease of high frequent component (sometimes up to complete disappearance) mostly express in group of fishes that were under AEFs, that is to say it is observed greater a good organisation of a group behaviour than for fishes subjected under T° action. It is noted stimulating role of E = 0, 12-0, 16 V/cm, j=200 μ A/m², i e new type of orientation behaviour is forming, an increase of impulses G(f) conjugated with an increase of activity. Also the action of AEFs shows the change of excitability of fishes and testimonies about absence of adopted condition (for instance appearing new biorhythms 2,5, 3,3, 4,4, 7,8 and 10,0. min). Now it is necessary to investigate LA aquabiota by multiple-electrodes methods with the consequent estimation of the oscillations under motions. This method permits to reveal the consequence technical influences on ecosystems.

P-87-C

EXPOSURE TO A SPECIFIC PULSED EXTREMELY LOW FREQUENCY MAGNETIC FIELD INCREASES BEHAVIORAL ACTIVITIES IN THE DEER MOUSE (*PEROMYSCUS MANICULATUS*). A.W. Thomas¹, M. Kavaliers², F.S. Prato¹ and C. Marcziński³. ¹BioElectroMagnetics Western, Lawson Research Institute, Department of Nuclear Medicine and Magnetic Resonance Imaging, St. Joseph's Health Centre, London, Ontario N6A 4L6, Canada. ²Division of Oral Biology, Faculty of Dentistry, University of Western Ontario, London, Ontario, Canada. ³Department of Psychology, McMaster University, Hamilton, Ontario, Canada.

Specific pulsed extremely low frequency magnetic fields (ELFMFs) have been shown to produce a variety of specific behavioral effects, such as: the augmentation of opioid induced analgesia (Fleming *et al*, 1994), the induction of analgesia (Thomas *et al*, 1996), and alterations in learning/motivation (Thomas and Persinger, 1997). To further assess the behavioral effects of pulsed ELFMFs, a specific pulsed ELFMF was designed based on a frequency of 120 Hz (primary frequency of the vestibular system). It was hypothesized that this specific pulsed ELFMF would produce a mild interference in vestibular function possibly leading to an increase in general activity. Individual Deer mice (*Peromyscus maniculatus*) (N=38) were exposed for 10 min, while being videotaped, to either a "normal Earth magnetic field, 14.7 μ T horizontal and 43.3 μ T vertical" sham condition, a "3-D zeroed Earth magnetic field, $\pm 0.1 \mu$ T" sham condition or a "100 $\pm 0.1 \mu$ T (peak) specific pulsed ELFMF" condition. The exposure chamber consisted of a 33cm Plexiglas™ cube held within three pairs of nested orthogonal Helmholtz coils (Prato *et al*, 1996) (1.2m x 1.1m x 1.0m). Videotapes of the exposed animals were analyzed by an experimenter blind to the exposure conditions. Various behavioral activities recorded (e.g. center-line crossing, duration of grooming episodes) indicated that the exposed mice had a significantly increased level of activity ($F_{2,37}=15.04$, $P<.001$, $\text{Eta}^2=.46$) compared to the sham condition. There were no significant differences in activity between the normal Earth field and 3-D zeroed earth field sham conditions. These observations indicate that relatively weak specific ELFMFs may affect specific behavioral activities, such as those associated with altered vestibular function.

Fleming JL, Persinger MA, Koren SA (1994): *Electro- and Magnetobiology* 13 (1):67-75.

Prato F S, Kavaliers M, Carson JLL (1996): *Bioelectromagnetics* 17:123-130.

Thomas AW, Kavaliers M, Prato FS, Ossenkopp K-P (1996) *Neurosci Lett* (accepted).

Thomas AW, Persinger MA (1997): *Electro- and Magnetobiology* 16(1):33-41.

P-88-A

THE EFFECTS OF A SPECIFIC PULSED EXTREMELY LOW FREQUENCY MAGNETIC FIELD ON CONDITIONED TASTE AVERSION IN RODENTS. E. Choleris², M.A. Persinger³, A.W. Thomas¹, M. Kavaliers⁴, K.P. Ossenkopp⁵ and F.S. Prato¹. ¹BioElectroMagnetics Western, Lawson Research Institute, Department of Nuclear Medicine and Magnetic Resonance Imaging, St. Joseph's Health Centre, London, Ontario N6A 4L6, Canada. ²Dipartimento di Biologia Evolutiva e Funzionale, Sezione di Biologia Animale, University of Parma, I-43100 Parma, Italy. ³Neuroscience Program, Laurentian University, Sudbury, Ontario P3E 2C6, Canada. ⁴Division of Oral Biology, Faculty of Dentistry, ⁵Department of Psychology, University of Western Ontario, London, Ontario, Canada.

Recent studies have indicated that specific pulsed extremely low frequency magnetic fields (ELFMFs) can produce a variety of specific behavioral effects (Thomas *et al*, 1996; Thomas and Persinger, 1997). In the present study, a specific pulsed ELFMF designed to interfere with vestibular processing was tested for aversive effects in two independent trials of conditioned taste aversion, or taste aversion learning. In experiment one, carried out at Laurentian University, Wistar rats (N=24) that were exposed to the specific ELFMF for one hour after being provided with a novel food item (sucrose solution) consumed significantly more sucrose solution when tested three days after exposure, as compared to sham exposed animals ($F_{1,23}=5.99$, $P=.023$, $\text{Eta}^2=.22$). In experiment two, deer mice (*Peromyscus maniculatus*) (N=43) were exposed to either the specific pulsed ELFMF or a sham condition for one hour after being exposed to a novel food item (unsweetened apple juice). On the third day after exposure, the mice were given access to water and apple juice simultaneously and the ratio of apple juice to total volume consumed (apple juice + water) was recorded. The mice exposed to the ELFMF consumed significantly more apple juice than did the sham exposed mice ($F_{1,43}=3.95$, $P=.05$). Though the exposure systems used in the two experiments were vastly different, the same specific pulsed ELFMF was used. In both cases neither induced an aversion to the novel food. Results of prior investigations had shown that the specific pulsed ELFMF were capable of inducing other specific behavioral affects in those species. Experiment one utilized a single coil (72 turns of 30AWG) wrapped around an aluminum (1.3m x 1.1m) cage rack (100-700nT ELFMF exposure, normal Earth sham (Michon *et al*, 1996)). The exposure system for experiment two consisted of three pairs of nested orthogonal Helmholtz coils (Prato *et al*, 1996) (100 $\pm 0.1\mu$ T, 3-D $\pm 0.1\mu$ T zeroed Earth field sham). These findings indicate that the effect of the specific pulsed magnetic field, in at least a taste aversion paradigm, is dependent on the "characteristics" of the magnetic field, not the exposure system, amplitude, geographical location or species tested.

Michon A, Koren SA, Persinger MA (1996): *Perceptual and Motor Skills* 82:619-626.

Prato FS, Kavaliers M, Carson JLL (1996): *Bioelectromagnetics* 17:123-130.

Thomas AW, Kavaliers M, Prato FS, Ossenkopp K-P (1996) *Neurosci Lett* (accepted).

Thomas AW, Persinger MA (1997): *Electro- and Magnetobiology* 16(1):33-41.

P-89-B

RELATIONSHIP, ON MAN, BETWEEN PERMANENT DIRECT MAGNETIC STIMULATION ON TONIC ORTHOSTATIC POSTURAL ACTIVITY AND AUTONOMIC SYSTEM REACTIONS. J.B. Baron. C.N.R.S. (e.r.), 75015 Paris, France.

Purpose of this communication is to point out the effect of a 0,3 Gauss (minimum threshold value) permanent direct magnetic stimulation on physiological sensible magnetic receptors due to:

1° Magnetite (Fe_3O_4) crystal at the level of the point provoking magnetic reactions,

2° Spindle shape deformation at the level of the red muscle fibers creating a mechanical change.

-- A transformation of tone occurs:

-- at the level of oculomotor, neck, paravertebral, lombosacral, abductor, adductor muscles of the superior, inferior limbs.

-- at the level of the ligament Golgi, Ruffini corpuscles, shoulder, elbow, wrist, hip, knee, tibioperoneal joints.

-- A decrease in the cardiac rhythm appears. The orthostatic, tonic postural activity decrease.

METHOD: Using a simple piece of steel (1 cm long, 0,1 cm thick) or a US nickel coin which placed in the earth magnetic field became a direct permanent magnet when set in Paris:

- vertically with a value of a 0,3 Gauss,

- horizontally with a value of 0,2 Gauss.

These pieces are scotched on the skin at the level of the different anatomical area described previously, corresponding at the functioning of the muscles.

For counter experiments, magnetic stimulation of a value inferior to 0,3 Gauss, bronze, copper, stick or coins were used.

RESULTS: On man standing at rest, when stimulation is performed unilaterally with steel:

· a change in the tone of converging external oculomotor muscle occurs. Convergence decrease (hypoconvergence of the eye) on the side of stimulation, when slowly the pin of a pencil 1 cm/sec approached from 50cm to 5cm in the vertical medial plan of the face, at the level of the eyeballs on the side of the orbit where the magnetic stimulation is produced.

· a change in the tone at the level of the abductor adductor muscles of the upper limbs is carry out: the two index deviated on the side of the hypoconvergence when the eyes are closed.

On man sitting:

· a change of tone appears at the level of flexor extensor muscles of inferior limbs in the same condition.

In both case standing and sitting:

· a change in the cardiac rhythm decrease appears, due to the stimulation of the vagal parasympatic and sympatic

system.

These results allow to conclude that the mechanisms of magnetic stimulation involve sensory motors loops including magnetic sensors, cranial sensori nerves, conducting the information to central mesencephalic control, ordering through the reticular formation to sensory nerves for producing change of tone of tonic slow red fibers of tonic postural activity muscle. This phenomenon occurs usually for a magnetic stimulation equal to 0,3 Gauss with a slow motion of the visual stimulus 1 cm/sec.

If the magnetic stimulation is under this level, if the speed of the visual stimulus is greater 10 cm/sec, there is no change of tone, no advent of the hypoconvergence, no index deviation, no change in the feet position, no change at the level of the heart rhythm.

All these results allow:

1) to diagnosis the etiology of some trouble of tonic orthostatic postural activity, slight disequilibrium, pain at the level of eye muscles, neck, paravertebral muscle due to a slight contraction.

2) to deliver a therapy in this different troubles of postural disorders, restoring equilibrium, curing the pain by a well drive and reasoned magnetotherapy.

P-90-C

ULTRA-WIDE-BAND PULSES FAIL TO MODIFY MORPHINE-INDUCED ANALGESIA AND HYPERACTIVITY IN MICE. R.L. Seaman, M.L. Belt, J.M. Doyle and P.J. Henry. McKesson BioServices and Microwave Bioeffects Branch, U.S. Army Medical Research Detachment, Brooks Air Force Base, Texas 78235-5324, USA.

OBJECTIVE: Effects of ultra-wide-band (UWB) pulses on morphine-induced analgesia and hyperactivity in two strains of mice were studied to investigate an increase in analgesia suggested by a previous study (Seaman *et al.*, *BEMS 18 Abstracts*, 1996, pp. 260-261) and to check for similarities to effects observed with ELF magnetic fields in other laboratories.

METHODS: Male CF-1 mice were exposed to UWB pulses and tested 7-10 hours after lights-on in a 12/12 light/dark cycle. An animal was injected with 7.5 mg/kg morphine sulfate i.p. and tested for nociception and activity after either 30-min or 45-min exposure in separate experiments. An animal was in a nonrestricting circular holder in a GTEM cell for exposure to no pulses (sham) or UWB pulses at 600/s, and to broadband acoustic noise. In each experiment, twenty animals were tested for each exposure condition, with conditions alternating. Based on compensated measurements from an EG&G ACD(A) D-dot sensor, pulses had peak amplitude of 103 ± 7 kV/m, duration of 0.98 ± 0.03 ns, and rise time of 162 ± 9 ps (mean \pm st.dev.) at the location of the animal holder center in its absence. The two measures of nociception were latency to a first response (paw lift, shake, lick; jump) and latency to licking a back paw, with a maximum of 160 s, after an animal was placed on a $50.0 \pm 0.3^\circ C$ surface. Activity was then tested in a 38.5×38.5 cm

box with the measure being number of interruptions of light beams (5x5) over 5 min. Male C57BL/6 mice were exposed and tested similarly 30 min after i.p. injection of saline or 10 mg/kg morphine sulfate. An animal was either returned to its home cage or placed in the holder in the GTEM cell for exposure to no pulses, UWB pulses at 60/s, or UWB pulses at 600/s. Twenty animals were tested for each of the resulting eight conditions in block random sequence, with activity measured first.

RESULTS: For 45-min exposure of CF-1 mice, each of the three measures had similar mean values for sham and exposure conditions that were not significantly different. For 30-min exposure, this was also the case for first response latency. Larger means for back paw latency and activity for 30-min exposure were not significantly different from respective sham exposure means. For C57BL/6 mice, the effect of morphine to increase each measure was evident ($p < .0001$, ANOVA). Although morphine-induced larger mean values of back paw latency decreased with increased repetition frequency of UWB pulses, ANOVA indicated that the mean of any measure was not significantly affected by UWB exposure condition for both saline- and morphine-injected animals.

DISCUSSION: The UWB pulses used in these studies did not have significant effects on measured variables. The larger CF-1 mean back paw latency after 30-min exposure to pulses at 600/s was consistent with results of our previous study but opposite to decreases due to ELF magnetic fields.

Supported by the U.S. Army Medical Research and Materiel Command under contract DAMD17-94-C-4069 awarded to McKesson BioServices. The views, opinions and/or findings contained in this report are those of the authors and should not be construed as an official Department of Army position, policy or decision.

P-91-A

SHORT-TERM EXPOSURE TO 50 Hz ELECTRIC FIELDS MAY REVEAL DETERIORATION OF REACTION TIME TO VISUAL AND ACOUSTIC SIGNALS IN SOME INDIVIDUALS. M. Szuba¹ and S. Szmigielski². ¹Institute of Power Engineering I-8, Technical University of Wroclaw, Wroclaw, Poland. ²Center for Radiobiology and Radiation Safety of the Military Institute of Hygiene and Epidemiology, 00-909 Warsaw, Poland.

Recent medical and epidemiological investigations indicate that a small number (below 2%) of human subjects may show symptoms of hypersensitivity to electric (EF) and electromagnetic (EMF) fields. Hypersensitive people react to weak EFs with vascular reactions, liability of blood pressure and/or heart rate, as well as with other neurovegetative reactions which are not recognized as health hazards, but may be vexatious for the victims. In this study we found that in the population of young healthy men about 2% response to exposure in weak-moderate 50 Hz with considerable prolongation of the reaction time to visual and acoustic signals. This observation may be important for selection of workers for posts with occupational exposure to EFs and

EMFs.

Seventy healthy volunteers, aged 20-46 years, were exposed in uniform vertical electric fields induced between two circular 16 sq.m. electrodes placed 250 cm apart from each other. Top electrode was powered with 50 Hz DC at a voltage of 10-35 kV that resulted in induction of uniform EF at the 9-10 sq.m. of the central part of the floor. Measurements of EF at 1 m over the floor revealed linear relationship between EF strength (kV/m) and interelectrode voltage level (kV). Capacitive currents induced and flowing throughout the human body were measured in all subjects exposed to EFs of different strength (4 - 25 kV/m). For measurements the subjects were placed on isolating plates and grounded with two band electrodes placed on extremities; the flowing currents (μ A) were measured by microamperometer connected to the grounding cable. Analysis of relations between EF strength and capacitive currents flows have shown dependence on size and mass of the body with a range of 5-12 μ A/kV/m for all investigated subjects.

Response to short-term (3-min.) exposures to EFs has been tested in the above system with registration of reaction time to acoustic (AS) and visual (VS) signals, heart rate (HR) and blood pressure (RR). A 30-min session was run with four random 3-min exposures to EFs with the subjects being unaware of the exposure. The EF strengths applied in each session amounted 0 (control), 4.4, 10.9 and 13.0 kV/m at random order with 3-min breaks between exposure periods. At the end of each exposure period reaction time to AS or VS (30 trials), HR and RR were registered. In the second set of experiments 15 sq.cm elastic zinc-coated electrodes were placed on arms and fixed with bands; electric currents, equivalent to those during exposures in EFs (50, 135 and 160 μ A, respectively) were switched on. Scheme of the 30-min. session with four 3-min exposure periods to flowing currents were identical as for EFs and the various currents intensities (0, 50, 135 and 160 μ A) were applied randomly with the subjects being unaware of the exposure. The applied EF strength and direct current stimulations were below the perception thresholds for investigated subjects.

Exposure to EFs (10.9 and 13 kV/m) and to direct current stimulation (135 and 160 μ A) caused significant elongation of reaction time to AS and VS, while weak EFs (4.4 kV/m) did not influence mean values for the whole group. Normal reaction time ranged 180 - 240 msec (mean 202, standard deviation SD = 24) and its elongation after exposure to EFs reached 20 - 100 msec. Analysis of individual changes in reaction time (preexposed-exposed) revealed however considerable differences among the investigated subjects. Most of the results (66 of 70 = 94.3%) fit lognormal distribution with 1-2 subjects showing considerable shortening or elongation of the reaction time (by 50-60 msec $\geq 2SD$). However, the remaining 4 subjects (6.7%) responded to EFs or flowing currents with significantly larger elongation of reaction time to AS or VS (70-110 msec) and two of them reacted also to weak EFs (4.4 kV/m). It is concluded that measurement of reaction time to AS and VS allows for selection of persons overreacting to exposure in 50/60 Hz EFs.

P-92-B

NEUROPHYSIOLOGICAL EXAMINATION OF PATIENTS WITH EXPERIENCED ELECTRICAL HYPERSENSITIVITY. E. Lyskov^{1,2}, M. Sandström¹, K. Hansson Mild¹ and S. Medvedev². ¹National Institute for Working Life, S-907 13 Umeå, Sweden. ²Institute of the Human Brain, St. Petersburg, Russia.

OBJECTIVES: There is an obvious contrast between a number of public discussions about electrical hypersensitivity and a lack of physiological data suggesting possible mechanisms of this specific pathology. Results of our preliminary study indicated that these patients might have an enhanced sensitivity to amplitude modulated light as well as possible involvement of the autonomic nervous system in the electrical hypersensitivity (Sandstrom *et al.* The Fourteenth BEMS Annual Meeting, Boston 1995). The aim of this ongoing study is a comprehensive examination of basic neurophysiological processes in patients with electrical hypersensitivity.

METHODS: The group of twenty patients have been selected in collaboration with the University of Umeå and the University Hospital. They have neurological and/or skin symptoms which they claimed to be resulting from VDT work, fluorescent light or TV exposure. The examination includes electroencephalography, brain evoked potentials and critical flicker fusion frequency test, monitoring of the heart and respiration rates, skin temperature and conductivity, plethysmography, sympathetic skin responses, blood pressure measurements.

All processes are recorded in rest conditions, under conventional clinical provocation tests and during the exposure to amplitude modulated light at subthreshold temporal frequencies. Additionally, special questionnaire and blood samples are checked before and immediately after examination. The test procedure is done in an electrical shielded room with the ELF magnetic field less than 20 nT and corresponding electric field less than 1 V/m. The equal number of healthy, age fitted volunteers are examined with the same protocol and they will be considered as a control group.

RESULTS: Preliminary results will be presented at the meeting.

P-93-C

IAF CHRONIC CARCINOGENICITY STUDY EVALUATION OF 60 Hz MAGNETIC FIELDS IN FISCHER RATS: STATUS REPORT. R. Mandeville, L. Gaboury, G. Mercier and S. Sidrac-Ghali. Institute Armand-Frappier, University of Quebec, Laval, Quebec H7N 4Z3, Canada.

The objective of this study was to determine whether chronic exposure to 60 Hz linear (single axis) sinusoidal continuous wave MFs of various intensities (2, 20, 200, 2000 μ T) might increase the risk of cancer development in female Fischer

rats. A group of 50 female rats were used as cage controls and kept in an adjacent conventional animal room (Transition Room) in the same facility. A separate group of animals was used as sentinels and sacrificed regularly (every three months) in order to monitor the health of our colony. The number of animals needed to reach a power of 90% and a doubling in malignant tumour incidence at any of the four MFs intensities was derived by three different statistical methods. Calculations were based on data derived from the NTP (National Toxicology Program) of the NIEHS database.

An animal facility completely dedicated to exposure of only one strain of animals under stringently controlled environment and under double blind conditions was built on the IAF campus. Five groups of 50 female rats were exposed to MFs for two years starting in the prenatal period (2 to 3 days before birth). Daily exposures to the various fields were performed for 20 consecutive hours (10 h in the dark and 10 h in the light). The fields were ramped up and down so as to avoid the production of any transients. Animals were kept in custom-made polycarbonate cages with flat stainless-steel cage cover tops that holds a 500 ml glass bottle with a glass sipper and a suspended ceramic feeder. The cage cover has been provided with a small Teflon tubing so as to interrupt the full vertical loop in the stainless-steel cover.

Clinical observations and body weight were recorded on individual animals. Animals found moribund or paralysed or unable to feed themselves were sacrificed. A necropsy was performed on all exposed and control groups. During necropsy all the organs and tissues were examined for grossly visible lesions. Tissues were preserved in 10% buffered formalin. Histopathologic examination of all tissues were performed on all visible lesions in all dose groups and controls, as specified by the NTP protocols.

We will be presenting a status report on this study and we will discuss our findings whenever possible.

This study is co-funded by a consortium of Canadian Sponsors (Hydro Quebec, Ontario Hydro and Health & Welfare Canada) and by the Institute Armand-Frappier, University of Quebec.

P-94-A

OCULAR EFFECTS IN NON HUMAN PRIMATE AFTER EXPOSURE TO HIGH PEAK POWER MICROWAVE PULSES. J.A. D'Andrea¹, J.M. Ziriak¹, S.T. Lu², S. Mathur², J.H. Merritt³, M. Johnson⁴, G. Luty⁵, D.S. McLeod⁵, H. Zwick⁶ and B. Stuck⁶. ¹Naval Medical Research Institute Detachment, Brooks Air Force Base, Texas 78235-5423, USA. ²McKesson Bioservices, Brooks Air Force Base, Texas 78235, USA. ³Radiofrequency Division, Armstrong Laboratory, Brooks Air Force Base, Texas 78235, USA. ⁴University of Maryland, Baltimore, Maryland, USA. ⁵Wilmer Eye Institute, Johns Hopkins University, Baltimore, Maryland, USA. ⁶U.S. Army Medical Research Detachment, Brooks Air Force Base, Texas 78235, USA.

Previous research has reported damage to the eye of rhesus monkeys exposed to pulsed microwave radiation at a dose rate previously thought to produce no lasting effects. The primary

objective of this study is to determine if low average power but relatively high peak power pulsed microwaves will damage the eyes of non-human primates. Specifically, we will determine dose-response characteristics of exposure of the non-human primate eye to high-peak power pulsed microwaves. Measurements of functional and pathological changes in the retina will be made with electroretinograms, fundus photographs, scanning laser ophthalmoscope (SLO) and light and electron microscopy.

Twenty monkeys will be exposed to pulsed 1.25 GHz microwaves with 1 MW peak power, 6 microsecond pulse durations and 0.6 Hz repetitions. The average specific absorption rate at the retina of the eye will be close to 4 W/kg. Each monkey will be exposed four hours per day, three days per week, for three weeks, for a total of nine exposures. The monkeys will be individually restrained in a plastic chair and placed 7.6 cm in front of a WR-650 open-end waveguide in an anechoic chamber. The monkey head will be supported on top and both sides by plastic and foam rubber restraints to prevent head movement and maintain constant SAR during each exposure. Microwave exposures will be given using an FPS-7 radar. Prior to the first exposure and immediately after the final exposure, electroretinograms will be taken from the monkey while under ketamine and xylaxine anesthesia and fundus and SLO examinations under sodium pentobarbital anesthesia. Approximately twenty-four hours after the last exposure (ninth exposure), the animals will be euthanized and the eyes collected for histology. Anticipated completion date of the first experiment is March 1997.

P-95-B

THE INFLUENCE OF ELF-ELECTROMAGNETIC FIELDS ON FRESHWATER BACTERIOPLANKTON COMMUNITIES. T. Galonja¹, S. Gajin¹, Z. Svircev¹, V. Trivunovic¹, N. Pekaric-Nadj² and I. Arsenic³. ¹Institute of Biology, Faculty of Natural Sciences, ²Institute of Energetics, Faculty of Technical Sciences and ³Faculty of Agricultural Sciences, University of Novi Sad, 21000 Novi Sad, Yugoslavia.

Today, almost each part of the Earth, including living creatures, is exposed to influence of electromagnetic manifestations. These manifestations have the power to express their influences on organisms, directly or indirectly. In case of microorganisms the effects of their activities can be expressed in the sense of favorisation, inhibition and partial or total elimination from their ecosystem. We explored influences of ELF-electromagnetic fields on bacterial communities (bacterioplankton), and, for that purpose, we used samples of water from the Danube, taken in Novi Sad. We manipulated with 18 samples, divided in two groups-untreated (control) samples (three of them) and 15 samples treated with 15 different frequencies, in 15-80 Hz diapason. We cultivated all the samples on nutritive agar for bacterial cultivation, sowing them in zero-time (only the control samples), after two and four hours, one, two, four, six, eight and ten days. We evidenced the numbers of appeared bacterial colonies and observed quantitative fluctuations,

having reference to our control samples and extracted four basal models of bacterial behaviour, as four types of response to treatments by usen frequencies. At the same time, we analysed uniformity of resonant frequencies influences and the effects of some frequencies on chosen bacterial cultures, isolated from the same fresh water sample, in the sense of causing changes in amounts, morphology and physiology of examined cultures.

P-96-C

THE INFLUENCE OF ELF-ELECTROMAGNETIC FIELDS ON FRESHWATER PHYTO- AND ZOOPLANKTON. T. Galonja¹, S. Gajin¹, Z. Svircev¹, V. Trivunovic¹, N. Pekaric-Nadj² and I. Arsenic³. ¹Institute of Biology, Faculty of Natural Sciences, ²Institute of Energetics, Faculty of Technical Sciences and ³Faculty of Agricultural Sciences, University of Novi Sad, 21000 Novi Sad, Yugoslavia.

Presence of electromagnetic manifestations can be felt nearly on every part of our planet. They express their influence on living organisms and interfere in ecosystems, causing changes in nature relations. We explored influence of ELF-EMF on freshwater phyto-and zooplankton, using 18 equal samples of water, taken from the Danube, in Novi Sad. Three of them were not treated (control samples) and 15 were treated with 15 different frequencies, from 15-80 Hz diapason. The experiment was directed in two courses. As the first, observing the influences of usen frequencies on each group (species) of planktonic organisms, by microscoping the control samples (zero-time and ten days later) and treated samples (after ten days), and noticing attendance and relative amounts of present organisms. Also, we explored the influences of ELF-EMF on entire phytoplankton, determining algal mass fluctuations, by measuring quantity of chlorophyle a. We have found 6 possible behaviour manners of planktonic organisms, as 6 possible outcomes of biotic factors activities. Comparing treated and untreated samples, we have found a great variability of ELF-EMF effects. Generally favorising effects have not been found. Generally eliminating effects have been noticed in 5 cases (four of them from algal world, among which three from Bacillariophyta division). Most organisms react differently to different frequencies exposure, in the sense of amount fluctuations, enormous corporal.

P-97-A

TREATMENT FROM ENDOGENOUS EMF ALTERS THE MEAN LIFE SPAN AND WEIGHT OF DROSOPHILA MELANOGASTER FLIES AFTER DEPRESSION BY HEAT SHOCK. T. Buzási¹, A. Waiserman², G. Lednyiczky¹, D. Sakharov³ and N. Koshel².
¹Hippocampus Research Facilities, 1031 Budapest, Hungary.
²Institute for Gerontology of the Academy of Science of the Ukraine, 252030 Kiev, Ukraine.
³Kavetsky Institute for Experimental Pathology, Oncology and Radiobiology of the Academy of Science of the Ukraine, 25202 Kiev, Ukraine.

Heat shock treatment in different regimes can either activate or depress the metabolic activity of *Drosophila Melanogaster*. We administered an ELI-EMF treatment to correct depressed vital parameters. As the source of ELI-EMF, we used the endogenous EMF of heat shock activated and heat shock intact flies, acquired and modified by a device for such purposes. Also, heat shock intact flies and heat shock activated flies were treated with the EEMF of the other groups.

The results are as follows:

Both in the case of males and females, the mean life span (MLS) of normal and activated is similar. The MLS of depressed ones is lower. The MLS of normal flies treated with the EMFs of activated ones is significantly longer. In the case when the normal flies are treated with the EMF of depressed flies, there is no significant difference. The depressed flies treated with the EMF of activated ones live longer. The other groups show no clear tendencies in any particular direction.

The survival process is most coherent in activated flies followed by the normal group, and least coherent is the depressed group. Here, we use coherence to indicate similarity of the dynamics of the mortality in the different subgroups to complement the statistical similarity of MLS values. Both in the case of males and females, the treatment of normal (intact) flies with the EMF of depressed ones makes the coherency higher (increases coherency). The other groups show no clear tendencies.

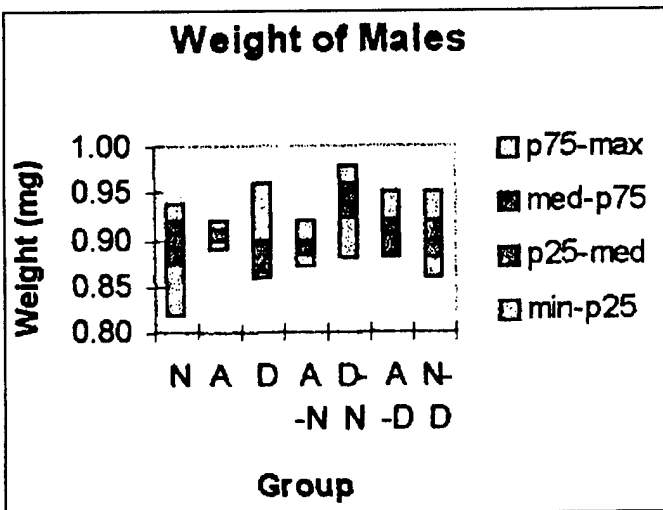

There is no significant difference between the normal and activated flies, the weight of the depressed ones is lower both in the case of males and females (see figures below). The standard deviation of activated flies is much lower than the value of the normal ones. The weight of normal flies treated with the EMF of depressed ones is higher. The other groups show no clear tendencies.

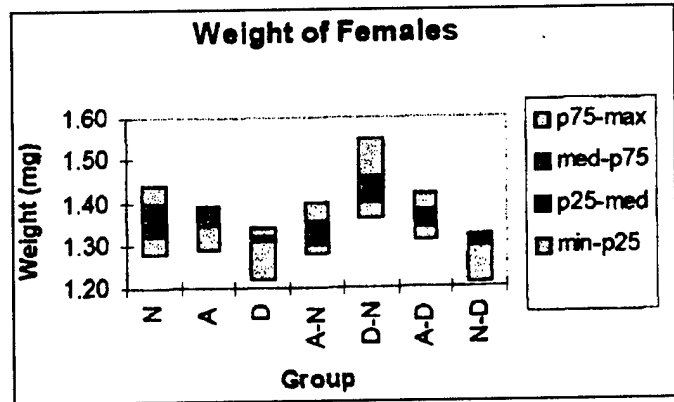

P-98-B

INFLUENCE OF LONG-DURATION EFFECT OF A MAGNETIC FIELD ON REPRODUCTION FUNCTION OF WHITE RATS. L.T. Andrienko. Ukrainian Scientific Hygienic Center, Kiev, Ukraine.

As is known, the infringements of process of reproduction are one of determining criteria of adverse effect of the physical factors of external environment.

For the analysis of function of duplication at experimental white rats (females), magnetic field subjected to long influence 50 Hz, studied prenatal and postnatal development them posterity. Thus took into account general embryonic mortality for 20-th days of development, weight of a body and craniocaudal index of embryo, as well as ability of females for conception and parameters of physical development of young rats during the first month of life.

The duration of experiment has made 4 months (effect of a magnetic field till 16 hours per days); a range of frequencies 50 Hz, polarization linear, form of modulation sine wave signal, non-uniformity of a magnetic field on a intensity in places of a presence of the experimental animals not more than 20%. Intensity of a magnetic field - 250 μT, t=22...24C, relative humidity - 70%. Till the ending of term of effect of a magnetic field experimental females coupled with non-irradiation males (in the control was 10 females, in experience - 13, from which 5 not become pregnant) and killed for 20-th days of pregnancy for realization embryological of researches; For valuation postnatal of development of young rats and other parameters of reproduction function in experience have taken 15 females (4 of them not become pregnant).

As a result of conducted experiment changes of the majority of investigated parameters of reproduction function are established:

Decrease of quantity live foetus on female in both groups of experience (9.3 ±0.649 in the control; 6.1 ±1.196 in

experience, $P < 0.05$ at realization embryological of researches; 9.25 ± 0.53 in the control; 6.18 ± 1.058 ; $P < 0.1$ at the analysis fertility). Increase general embryonic mortality almost in 3 times at experimental rats in comparison with the control (predominory owing to wreck of impregnate ovule up to implantation) is marked. To decrease viability of posterity of experimental females braking of development of embryos (small foetus them testifies also: - weight of a body in the control for 20-th days of development reached 2888.13 ± 58.44 mg, in experience - 2677.2 ± 43.19 mg, $P < 0.05$. In group of rats recently confined terms conception grew, quantity live of young rats (in the control among 233 new-born was reduced was 1 mortal-born, while in experimental to group from 414 new-born 16 dead young rats on the average 1.45 ± 0.698 . During the first month of life in control group was lost one young rat, in experimental - 13 (on the average 1.18 ± 0.399). It is in summary possible to note, that the long influence of a magnetic field 50 Hz, 250 μ T causes inhibition of reproduction function at experimental females, resulting to change of the majority of investigated parameters.

P-99-C

METABOLIC REACTIONS ON ELF MF INFLUENCE DEPEND ON CONSTITUTIONAL PECULIARITIES OF ANIMAL ORGANISM. V.S. Martynyuk, S.B. Martynyuk and Z.A. Ovechkina. Simferopol State University, Simferopol 333036, Ukraine.

The problem of individual sensitivity and reaction of organism to the magnetic field (MF) influence is actual in bioelectromagnetics. We investigate the influence of ELF MF on metabolic situation in brain of animals with different psycho-physiological characteristics.

METHODS: Randomly white rats was used in this investigation. Constitutional peculiarities of animals was estimated in "open field" test. All animals was separated on three groups according to their activity in "open field": low, middle and high activity. The MF influence on lipid peroxidation, thiols and activity of mitochondrial oxidoreductases in various brain regions (thalamus, hypothalamus, left and right cortex) was studied. A sinusoidal 8 Hz 5 μ T magnetic field was created by Helmholtz coils. The vector of MF was perpendicular to the horizontal component of the geomagnetics. The electromagnetic background in laboratory during the experiments over the frequency range 5-20000 Hz ranged between 0.2 and 0.3 μ T. The animals could move freely in the magnetic field.

RESULTS: It was revealed that MF influence on metabolic processes in brain depends on constitutional peculiarities of animals. Maximal metabolic changes in cortex was detected for animal demonstrated high and middle activity in "open field". Animals with low activity shown significant metabolic shifts in hypothalamus. These facts allow to suppose predominance of behavioral changes for active in "open field" animals and humoral changes for passive animals under the ELF MF influence.

P-100-A

THE PHYSIOLOGICAL CRITERIA OF RATS' HYPERSENSITIVITY TO VMF ELF INFLUENCE.

N.A. Temuryants, A.V. Shekhotkin, Y.Y. Grabovskaya, O.V. Khomyakova and G.I. Letjuchi. Simferopol State University, Simferopol 333036, Ukraine.

It was shown that the intensity of animals' reaction to VMF influence as well as time of its occurrence and the development of the adaptation are not similar in different animals. In 6-9% of animals the stress-reaction as a response on VMF influence may develop.

In rats with the low mobile activity we've observed more pronounced reaction to VMF influence. It was consisted in the decrease of the values, characterizing the nonspecific resistance, after 3-hours exposure by 12-25% in the increase of the adrenaline excretion with urine by 93% and the noradrenaline excretion with urine 155% ($p < 0.001$), in the increase of the intensity of excitement processes in the CNS.

These animals have some constitutional features such as low horizontal (35% from the middle rate) and vertical mobile activity in "open field" test, characterizing the level of CNS excitability. There were differences in cytochemical leukocytes' status where the succinic dehydrogenase (SDG) activity was higher than in rats with typical reaction to VMF influence by 29%.

We've found some peculiarities of infradian rhythmicity of neutrophiles' and lymphocytes' functional activity indeces as well as indeces, characterizing the CNS excitability.

Thus, in these animals the weekly (7.2^d) rhythm is characterized by the high amplitude of such indeces as SDG and activity in "open field" test. The important feature of the temporal organization of these animals is the high synchronization of studied exponents. In animals with the typical reaction to VMF influence of the synchronization is low.

Revealed constitutional peculiarities stipulate the possibility of the prognostication of animals' reaction to VMF influence.

P-101-B

ABSENCE OF OCULAR EFFECTS IN THE RABBIT FOLLOWING A SINGLE 8 HOUR EXPOSURE TO 10 mW/cm² FROM A 60 GHz CW SOURCE.

H.A. Kues^{1,2}, S.A. D'Anna², R. Osiander¹, W.R. Green² and J.C. Monahan³. ¹The Johns Hopkins University, Applied Physics Laboratory, Laurel, Maryland 20723-6099, USA. ²Wilmer Ophthalmological Institute, The Johns Hopkins University School of Medicine, Baltimore, Maryland 21205, USA. ³Food and Drug Administration, Center for Devices and Radiological Health, Rockville, Maryland 20850, USA.

Previous work in our laboratory has examined the ocular effects of exposure to many different frequencies (0.9, 1.2, 2.45 and 2.65 GHz) in the microwave region of the electromagnetic spectrum. These experiments demonstrated that exposure to relatively low RF levels could result in significant ocular effects including destruction of corneal

endothelial cells, increased vascular permeability, altered electrophysiological measures indicative of altered visual function, and destruction of photoreceptors in the retina. The present study was designed to examine the potential ocular health hazards associated with exposure to millimeter waves (60 GHz) at an incident power density of 10 mW/cm². Since the depth of tissue penetration for millimeter waves is primarily superficial, the study examined only the cornea, lens and other structures in the anterior segment of the eye. Rabbits were chosen as experimental subjects in this initial study because of their well-known ocular anatomy and physiology and their previously demonstrated sensitivity to RF effects at lower frequencies. A series of clinical diagnostic procedures, including slit-lamp biomicroscopy, iris angiography and wide-field specular microscopic examination of the cornea was used to document ocular health in each subject prior to any exposures. To select an exposure system that would yield a uniform ocular exposure, a series of energy distribution measurements was conducted with different horns to determine field distributions. An infrared camera (Santa Barbara FPA) with a sensitivity of 3 mK and a noise-equivalent temperature of 15 mK was used to detect heating patterns of various exposure systems. These distribution measurements demonstrated that the 60-GHz source, coupled into a circular horn via an integrated isolator and a short section of waveguide, produced a uniform field distribution at distances over 75 mm. The protocol specified exposure of an individual eye for a single 8-hour period. One eye in each animal was exposed and the other eye served as the sham-exposed control. During these exposure sessions the animals were restrained but not anesthetized. Following exposure or sham-exposure a variety of routine and specialized diagnostic procedures was employed to assess the effects of millimeter-wave exposure on the eye. Following the post-exposure diagnostic examinations animals were euthanized and eyes removed. Both light and TEM microscopy examination of the ocular tissue were performed. The diagnostic procedures performed on the eyes of exposed rabbits failed to find any ocular changes that could be attributed to millimeter-wave exposure at 10 mW/cm². Post-exposure histopathological examination of ocular tissue confirmed that no changes had been induced by the millimeter-wave exposures. On the basis of these data a conclusion can be reached that a single 8 hour exposure to 60-GHz radiation at 10 mW/cm² does not result in ocular damage.

This work was supported by an unrestricted grant from Hewlett-Packard Company Laboratories.

P-102-C

BIOEFFECTS OF ALTERNATING MAGNETIC AND ELECTRIC FIELDS ON LEVEL GORMONES AND BEHAVIOR OF RATS. V.P. Artyukh, S.V. Zotov, L.A. Andrychuk and M.A. Navakatikyan. Ukrainian Scientific Hygienic Center, Ministry of Health, 253 660 Kiev - 94, Ukraine.

Adult white rat (180-220g) kept was in plastic cages with performed covers. Irradiation system of electric fields of condenser type in the shielding box had following inside dimensions 1.5 x 2 x 2 m. In working zone was the sinusoidal alternating electric field (50Hz) with the vertical polarization. Intensity of an electric field in the irradiation box was regulated from 1 to 25 kW/m.

Irradiation system by magnetic fields of solenoid type was assembled on non-magnetic framework (as parallelepiped). Technical characters of the system were regulation current from 0.1 to 5.0 A by tension of field from 0.1 to 3 A/m. The alternating magnetic fields 50 Hz, by density of the magnetic stream 10, 50 and 250 μ T. Single exposures rats in magnetic fields was in the course of 0.5, 12 and 23 h. A repeated irradiating was performing in the course 10 days/ 23 h/day. The training and testing of the animals was performed by a conditioned reflex of active avoidance (CRAA) method in the shuttle-box. The serum testosterone, progesterone and insulin content was estimated by radioimmological method.

Magnetic fields (50 Hz) provoked the changes in the behavioral reactions of the rats. The magnetic field of the 10 μ T density stream at the single and repeated irradiation activated CNS but, it provoked the inhibition of CNS at the higher intensity. At the effect of the alternating magnetic field for 0.5 and 25 hours only activation of CNS took place ndconstant level tense 1 and 10 KW/m.

An increase in testosterone content was found for each test. The differences in testosterone content between control groups and irradiation groups were significant for 250 μ T/0.5 h, 50 μ T/12 h and 250 μ T/12 h exposition only.

The hormonal response patterns to, different intensity, may be used for evaluating on of a signification of biological effects magnetic fields. Especially, if to take into account the behavior reactions.

P-103-A

HUMAN HEART RATE CHANGES IN RESPONSE TO 50 Hz SINUSOIDAL AND SQUARE WAVEFORM MAGNETIC FIELDS: A FOLLOW UP STUDY. M.L. Sait and A.W. Wood. School of Biophysical Sciences & Electrical Engineering, Swinburne University of Technology, Melbourne, Victoria 3122, Australia.

We previously reported an (approximately) 5% slowing of heart rate in human volunteers in response to the turning on of a 153 mG circularly polarized 50 Hz magnetic field (Sadafi & Wood, DoE Contractor's Meeting, Savannah Ga., 1993; Wood *et al.*, 16th BEMS Meeting, Copenhagen, 1994). A similar increase in rate was observed when the field was

turned off. These changes persisted for a minute or so. The fields were presented in random sequence. These changes are similar to those reported earlier by Cook *et al* (*Bioelectromagnetics* 13:261-85, 1992).

Our previous study suffered two weaknesses: an audible cue attended the field turning off or on, secondly, the current waveform was subsequently found to contain significant harmonic distortion. This follow-up study was designed to eliminate both of these, but to contain an additional component: a comparison of sinusoidal (zero current turn-on) waveforms with square waveforms.

This follow-up study has been carried out in two phases: a group of 8 males and 6 females (with subjects involved in more than one exposure condition) has formed the first phase and the results from this group (prior to detailed trend analysis) are reported below. Results from a second group of a larger number will be available at the time of the meeting for comparison.

Heart rate was measured as previously from the interval between adjacent R-waves in the ECG. These measurements were facilitated by the use of a Labview application. Inter-subject averaging was achieved by interpolating an instantaneous RR-interval at 0.5 second intervals and synchronizing each subject at the on-off or off-on transition. Results are summarized in the following table:

Mean RR interval (milliseconds)		n = no. of subjects		
Sine Waves	n	100 sec before	100 sec after	change
off-on	10	812.2	810.9	-1.3 (0.16%)
on-off	8	837.2	838.4	+1.2 (0.15%)
Square Waves	n	100 sec before	100 sec after	change
off-on	6	785.8	796.6	+10.8 (1.4%)
on-off	5	883.1	864.2	-18.9 (2.2%)

The instantaneous RR-interval sampled data is amenable to frequency or spectral analysis. Previously, we have shown that there were significant changes in an autoregressive filter model between field-on and field-off states for that portion of data within approximately 2 minutes of the switch. Similar analyses will be presented for these present data.

We conclude that the small changes in heart rate observed for square wave but not for sine wave fields argue in favour of a phenomenon due to induced currents. We also suspect that the similar changes we reported previously are due to harmonic distortions in the waveforms used at that time.

Supported by the Australian Electricity Supply Industry Research Board.

P-104-B

AN INVESTIGATION OF CELL DEATH, REDOX STATUS AND TUMOR NECROSIS FACTOR- α IN BONE MARROW CELLS OF CARCINOGEN-TREATED MICE CHRONICALLY EXPOSED TO 60 Hz MAGNETIC FIELDS. J. McNamee, R. Brown, C. Ferrarotto, J. McLean, A. Thansandote and D. Lecuyer. Radiation Protection Bureau, Health Canada, Ottawa, Ontario K1A 1C1, Canada.

The shaved dorsal skins of SENCAR mice were initiated with 25.6 μ g of 7,12-dimethylbenz[a]anthracene (DMBA), left for 20 weeks and then exposed twice each week to 1 μ g of phorbol 12-myristate13-acetate (PMA) for 10 weeks to promote the growth of skin tumors. At that time, the mice were divided into two groups (48 mice each), with one group being exposed to a 2 mT, 60 Hz magnetic field (MF) and the other to sham conditions. MF and sham exposures continued from week 30 through to week 55. Tumor incidence was about 55% for both groups of mice. At week 55, bone marrow was flushed from the femurs with ice cold RPMI-1640, supplemented with 2 mM L-glutamine and 10% fetal calf serum. Cells were kept on ice until assessed microscopically for viability using a fluorescent dye combination (fluorescein diacetate and ethidium bromide). Viability was always > 85%. Cells were immediately cast into agarose/gelbond slabs, lysed at neutral pH and permanently stained. About 200K cells were cast per slab. The apoptotic fraction was assessed independently by 2 observers at 0.926% (12,845 cells counted) for MF exposed mice and 2.147% for sham exposed mice (17,653 cells counted). The difference is statistically significant at $p=0.05$, but the biological significance is unknown. The redox status and the concentration of tumor necrosis factor- α in the bone marrow cells will also be presented and discussed.

P-105-C

CARDIOVASCULAR EFFECTS OF SHORT TERM EXPOSURE TO FIELDS OF ELECTRICITY POWER TRANSMISSION. L.H. Korpinen¹ and J. Partanen². ¹Power Engineering, Tampere University of Technology, FIN-33720 Tampere, Finland. ²Laboratory of Electric Power Engineering, Lappeenranta University of Technology, FIN-53850 Lappeenranta, Finland.

In the electrical industry the 50 Hz electric and magnetic fields are often higher than in the average working environment. The electric and magnetic fields can be studied by measuring or by calculating the fields in the environment. For example, the electric field under a 400 kV power line is 1 to 10 kV/m, and the magnetic flux density is 1 to 15 μ T. The aim of this study is to find out the possible effects of short term exposure to electric and magnetic fields of electricity power transmission on workers' health, in particular the cardiovascular effects. The study consists of two parts; Experiment I: influence on extrasystoles, and Experiment II: influence on heart rate.

In Experiment I two groups, 26 voluntary men (Group 1) and 27 transmission-line workers (Group 2), were measured. Their electrocardiogram (ECG) was recorded with an ambulatory recorder both in and outside the field. In Group 1 the fields were 1.7 to 4.9 kV/m and 1.1 to 7.1 μ T; in Group 2 they were 0.1 to 10.2 kV/m and 1.0 to 15.4 μ T. In the ECG analysis the only significant observation was a decrease in the heart rate after field exposure (Group 1). The drop cannot be explained with the first measuring method. Therefore Experiment II was carried out. In Experiment II two groups were used; Group 1 (26 male volunteers) were measured in real field exposure, Group 2 (15 male volunteers) in "sham" fields. The subjects of Group 1 spent 1 h outside the field, then 1 h in the field under a 400 kV transmission line, and then again 1 h outside the field. Under the 400 kV line the field strength varied from 3.5 to 4.3 kV/m, and from 1.4 to 6.6 μ T. Group 2 spent the entire test period (3 h) in a 33 kV outdoor testing station in a "sham" field. ECG and blood pressure were measured by ambulatory methods. Before and after the field exposure, the subjects performed some cardiovascular autonomic function tests.

Based on this study it can be stated that the short term exposure to electric (below 4 kV/m) and magnetic fields (below 4 μ T):

- did not have an effect on the occurrence or the frequency of extrasystoles or arrhythmias
- did not influence on the pulse rate
- did not influence on the systolic or diastolic blood pressure
- did not influence on the cardiovascular autonomic function tests, which were executed 30 min after the exposure.

P-106-A

HEMATOLOGICAL CHANGES IN RATS EXPOSED TO WEAK ELECTROMAGNETIC FIELDS. A. Ubeda¹, M. Díaz-Enriquez², M.A. Martínez-Pascual¹, J. Leal¹ and A. Parreño¹. ¹Department Investigación, Hospital Ramón y Cajal, 28034 Madrid, Spain. ²Servicio Bioquímica Clínica Hospital Ramón y Cajal, 28034 Madrid, Spain.

Results from a substantial amount of experimental studies indicate that biological systems can be affected by *in vivo* exposure to low frequency and extremely low frequency electromagnetic fields. However, attempts addressed to independently replicate a number of the mentioned studies have shown that the *in vivo* response to those fields is complex and elusive. This could reveal the existence of unidentified physical and/or biological parameters which might be involved in the fields effects. The present study reports a failure to independently replicate previously published work showing that 10 days of treatment with a pulsed magnetic field at 50 Hz and 1.5 mT amplitude causes significant reduction of plasma gamma-globulin in male Sprague Dawley rats (A). Although the possibility has to be considered that the results from the seminal work were artifactual, substantial differences in levels of plasma proteins were observed between the control groups of the two studies (B), indicating that the first sample, reported to be responsive to the field exposure, suffered from an infectious illness. This

observation supports the hypothesis that the state of physiological equilibrium of a biological system is crucial to its response to a potentially effective electromagnetic field.

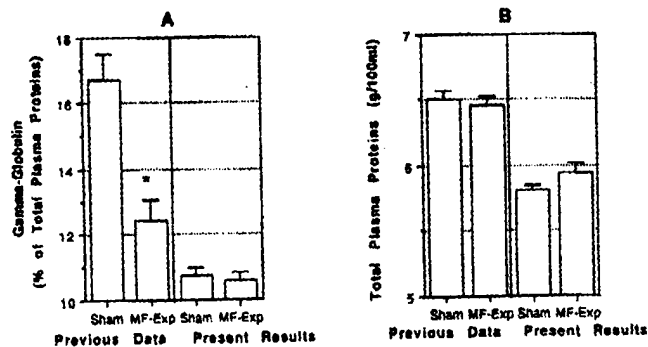

Comparative data from the two independent studies (means \pm SME). Previous Data by Parreño *et al*, *IRCS Med. Sci.*, 12, 10 92: Sham, n = 21 specimens; MF-exposed, n = 19; * $p < 0.01$ (Student's t test). Present Results: Sham, n = 24; MF-exposed, n = 24.

P-107-B

MELATONIN AND ITS URINARY METABOLITE: COMPARISON ACROSS AGE AND GENDER. M.R. Cook¹, C. Graham¹ and R. Kavet². ¹Midwest Research Institute, Kansas City, Missouri 64110, USA. ²Electric Power Research Institute, Palo Alto, California 94303, USA.

OBJECTIVE: Blood levels of the hormone melatonin can have important implications for human health and well-being. It is, however, difficult to study melatonin in epidemiological or field investigations because it is produced at night, and it is seldom feasible to draw blood samples at night in such studies. Our laboratory has been evaluating the extent to which morning concentrations of 6-sulphatoxymelatonin (aMT6s), the major urinary metabolite of melatonin, accurately reflect integrated and peak blood values of melatonin over the night. In the past, two factors have limited wide-spread application of this technique. It is not known if the relationship between melatonin and its metabolite is altered as a person grows older (metabolism slows as we age), or if this relationship is similar for men and women. The objective of the two laboratory-based studies reported here was to collect and compare relevant blood and urinary measures in a sample of healthy men 18-35 years of age, and in a sample of healthy women 40 to 70 years of age. **METHOD:** Hourly blood samples were obtained via indwelling catheter from 78 men in Study 1, and from 30 women in Study 2, as each volunteer slept overnight (11 pm-7 am) in the laboratory. The samples were immediately centrifuged and the plasma frozen for later assay using the Buhlmann melatonin RIA kit (ALPCO, Ltd., Windham, NH). In our laboratory, inter- and intra-assay CVs for this assay are routinely below 10% throughout the assay range. All urine voided at the start and end of each session was collected (the 7 am sample included all urine voided after 11 pm). Samples were assayed for 6-sulphatoxymelatonin (aMT6s), the major

urinary metabolite of melatonin, using the RIA kit distributed by Stockgrand (Guildford, Surrey, UK). In our laboratory, inter- and intra-assay CVs for this assay are routinely less than 10%. To correct for individual differences in body size, urinary creatinine was also assayed using a COBAS MIRA™ (kinetic Jaffe reaction). Results were normalized to creatinine concentration and expressed as nanograms aMT6s per milligram creatinine.

RESULTS AND DISCUSSION: The results obtained in Study 1 on a sample of men almost four times larger than any previously reported in the literature, both replicate and extend previous research. The relationship between morning aMT6s levels and total plasma melatonin secreted over the night is linear and significant ($r = .78, p < .0001$), as is the relationship between morning aMT6s levels and peak nocturnal melatonin levels ($r = .72, p < .0001$). In addition, individual differences in patterns of high versus low nocturnal melatonin secretion can be well differentiated on the basis of morning aMT6s levels alone ($p < .0001$). These results provide a basis for the inclusion of morning urine samples as a tool in occupational studies involving healthy, young men. Similar analyses are underway for the data collected on the women in Study 2. This information will help estimate the value of including morning aMT6s levels in studies of breast cancer and other health outcomes.

Supported by the Electric Power Research Institute (Contract No WO4307) and the National Institute of Environmental Health Sciences (Grant No. ES07053).

P-108-C

DO DIURNAL 50 Hz MAGNETIC FIELD EXPOSURES (CONTINUOUS AND INTERMITTENT) AFFECT MOOD, INFORMATION PROCESSING AND PINEAL FUNCTION? TWO HUMAN EXPERIMENTAL STUDIES. M. Crasson and J.J. Legros. Psychoneuroendocrinology Unit, University of Liege, 4000 Liege, Belgium.

The general aim of our studies is to evaluate psychological, psychophysiological and neuroendocrine effects of low-intensity ($100/\mu T_{rms}$) 50-Hz magnetic field exposure in human beings.

Two experimental studies were undertaken to better clarify the precise nature of psychophysiological and neuroendocrine function and the condition under which they are affected by 50 Hz magnetic fields exposure and to determine if the results could be replicated under identical exposure protocol and in the same population to control for interindividual and intergroup variability.

To examine magnetic fields effects (real exposure versus sham exposure) and to determine the impact of temporal modification (continuous versus intermittent magnetic field exposure), the volunteers were subjected to three cephalic exposures spaced at 1 week intervals and using a crossover design. One included a 30 minutes continuous exposure (30 minutes), the other an intermittent exposure (30 minutes with the field 15 sec ON/15 sec OFF) and the third was a sham field condition (30 minutes), in the afternoon. These

magnetic fields were generated through an helmet specially designed for this experiment. In each session, subjective state, attention and memory tasks were obtained before, during or after exposure. Event-Related Potentials (ERPs) paradigms, recorded immediately after exposure sessions, were chosen to evaluate sensory functions as well as automatic or controlled and effortful attentional processes. This psychophysiological examination included choice and preparation reaction time measures. 6-sulfatoxymelatonin (aMT6s) level, the metabolite of the pineal melatonin was measured from urinary samples collected during a seventeen (in the first study) and twenty nine (in the second study) hours period, and melatonin from blood samples collected during the night following exposure (in the first study only). The first study included among 21 healthy male volunteers, aged from 20 to 27. Eighteen of them took part in the second experiment, undertaken one year and a half later.

The results indicate that 30 minutes, 100 μT , 50 Hz magnetic fields' cephalic and diurnal exposure has few psychological, psychophysiological and neuroendocrine effects.

Changes observed resulted more often from continuous exposure but intermittent and continuous exposure tended to produce changes in the same direction as compared to sham condition. However, the data suggest that magnetic field exposure could alter the psychophysiological processes involved in a specific type of cognitive processing, conditioned by the active mobilization of attentional capacity, by the high mental load and by this own nature which implies filtering and activating processes involved in selective attention. This effects appears more markedly and is accompanied by a significant slowing of perceptual processing (P2 latency) and sensori-motor speed (reaction time) in a relatively easy signal detection task in the second study, in which active attention is more sustained by the number of repetitive selective attention task required. But magnetic fields would affect some aspects of attention processes without affecting the total capacity of information processing or the global arousal level.

Moreover, despite that the inhibitory or phase disturbance of 50 Hz magnetic fields on pineal activity, often reported in animals studies could be encountered in healthy human, further studies are needed to precise the nature and the conditions in which such effects could be seen.

P-109-A

THE INFLUENCE OF THE PULSATING ELECTROMAGNETIC FIELD (PEMF) ON SPRING BARLEY. M. Dragisa¹ and N. Pekaric-Nadj². ¹Faculty of Agriculture and ²Faculty of Technical Sciences, University of Novi Sad, 21000 Novi Sad, Yugoslavia.

The influence of the pulsating electromagnetic field (PEMF) on sprouting, growth and yield of the spring barley was investigated. Moistened grains were exposed to the PEMF of different frequencies for different exposure times, shortly before planting. The seeds were planted into Mitscherlich's dishes and were grown in an open field environment. During the vegetation period of 100 days the dynamics of the plants'

development was monitored. The plants were harvested at the corresponding times of their maturity. Our results suggest that the influence of the PEMF was present and was clearly depending on the applied frequency and exposure time.

INTRODUCTION: The increase of the food and corn production seems to be more than necessary. For that reason every effort in this direction is valuable. This paper describes the experiment whose main goal was to increase the yield of barley. In past decade many efforts were made to stimulate different seeds with magnetic fields of different characteristics. Although not completely understood, mechanisms of the magnetic field were used to affect some vital processes in plants. The objective of this work was to examine the single exposure of the spring barley as the stimulus for a better harvest.

MATERIALS AND METHODS: Spring barley seeds (NS-VIHOR) were moistened for two hours. Wet grains were exposed to 1 mT peak, 70 μ s wide electromagnetic pulses of frequencies: 0 (control), 8 Hz, 15 Hz, 30 Hz and 72 Hz, for the following periods of time: 30 minutes, 60 minutes and 90 minutes. The seeds were planted into Mitscherlich's dishes immediately after that. The dishes were left in the open field conditions in vegetation house. After sprouting, 15 plants were left in each dish. Each dish was given a suboptimal dose of nitrogen (N, in form of NH_4NO_3 0,5 g/dish). The plants were growing for the next 100 days. During that period the photographs were taken on different stadiums of their development. Full-grown plants were harvested and some quantitative data were collected. The results were statistically processed.

RESULTS: Different frequencies of the PEMF were found to have different effects on the plants development and the yield. immediately after sprouting the differences were visible. During the vegetation period the appearance of the plants were very variable. There were periods of time when some of the treatments had apparently better look. The differences were always visible by bare eye. After the harvest some quantitative data were collected: (1) - the heights of the plants with ears, (2) -the lengths of the ears, (3) - the yield per dish and (4) - mass of the 1000 grains.

The results clearly indicated that the stimulating effect of the PEMF was present. The results may be summarized as follows: (1) The plant lengths at harvest were increased by the PEMF 72Hz/30min and 30Hz/60min, and significantly increased by 15Hz/60min and 15Hz/90min. The lengths were significantly decreased by 72Hz/90min. (2) Average ear lengths at harvest were increased by PEMF 15Hz/60min and 20Hz/60min and significantly increased by 30Hz/30min, 72Hz/30min and 15/90min. The ear lengths were decreased by 72Hz/90min. (3) The yield at harvest was increased by PEMF 72Hz/30min and 15Hz/90min, the other treatments did not differ from the control. (4) The 1000 grains mass was significantly decreased by 8Hz/30min., the other treatments did not differ from the control.

DISCUSSION AND CONCLUSIONS: For the PEMF of 15Hz/90min the average height of the plants was found to be 12,5% greater than in controls. The ears were found to be 11% greater than in control and the yield per dish was 14% greater than in control. Considering all effects together this

regime of stimulation seems to be the most promising one. Some other treatments were useful for the increase of biomass. This possibility should be explored further.

P-110-B

THE INFLUENCE OF LONG-TERM EXPOSURE TO RANDOMLY VARIED POWER FREQUENCY MAGNETIC FLIES ON THE FERTILITY OF THE MOUSE. L. de Jager and L. de Bruyn. Department of Anatomy, U.F.S., Bloemfontein 9300, South Africa.

Recent studies suggest that there may be an interaction between powerline electric and magnetic fields and biological systems. The reproductive system is particularly vulnerable to environmental insult. To elucidate the question concerning the possible effects of power frequency magnetic fields on the fertility of mammals various biological endpoints were studied in mice after long-term exposure to randomly varied power frequency magnetic fields.

Two generations of mice, Balb/C, in a control and an experimental group were used. The experimental group was exposed to a rms electromagnetic field randomly varying between 0,5 μ T and 77 μ T with an average of 2,75 μ T for 24 hours per day and the control group was sham-exposed. Each generation consisted of 10 pairs of mice and was exposed or sham-exposed from conception. Each pair was allowed eight litters of offspring. The following biological endpoints were evaluated; gestation time, number of offspring, number of stillborn and average generation time. Furthermore, sperm concentration, sperm mobility and morphology of young adults male mice (n = 10 of controls and experimental) were assayed. The results were statistically analysed.

The results showed no statistically significant difference between the control and experimental groups for gestation time in days, litter size of number of stillborn in both generations. No statistically significant difference was found in the number of abnormal sperms or in the motility as well as in sperm concentration.

In view of the controversy surrounding the possible negative effects of electric and magnetic fields generated by overhead powerlines on reproduction, the results of the study provide further evidence that these fields do not negatively affect fertility.

P-111-C

KINSHIP BETWEEN DEHYDROEPIANDROSTERONE EFFECT AND EFFECT OF PULSED MAGNETIC FIELDS ON MICE RECEIVING SUNFLOWER OIL. A. Bellossi, C. Rocher and M. Reulloux. Laboratoire de Biophysique, Faculté de Médecine, 35043 Rennes Cedex, France.

In a previous communication (1) a loss of weight on the growing curve was noticed for mice which received not only 1st cold pressure sunflower oil but which were also exposed twice a week to a 12 Hz pulsed magnetic field (PMF) for 30

min. To confirm these first results we started the following study.

MATERIAL AND METHOD: Six sets of six-week-old Swiss female mice were followed until death time. They underwent a treatment 5 days a week. 1/19 received 0.1 ml of water per os. 2/30 received 0.1 ml of refined sunflower oil per os, 10 were exposed to a 12 Hz PMF. 3/42 received 0.1 ml of 1st cold pressure sunflower oil per os, 12 were exposed to a 12 Hz PMF, 11 to a 460 Hz PMF. PMF were generated from a Magnobiopulse apparatus (Societe Atlas, Paris, France). The signal consisted of unipolar asymmetrical pulses (rise time 70 ns, width 7 μ s, fall time 700 ns) supplied with 90 μ s pulse bursts. The peak field strength was 6 mT. Any exposure lasted 30 minutes. The mice were weighed twice a week.

RESULTS: 1/ The growing curves are shown on fig. 1. As we took into account the average weights completed for 2 weeks only a smoothing of the curves was undertaken. a) There was an obvious similarity in the growing curves until about 120 days of age. b) The slopes of the growing curves of mice receiving oil and being exposed then became distinctly lower than those receiving oil and being sham exposed. Actually these very slopes were even identical to those receiving water. c) Mice which received refined oil were rather less heavier than those receiving 1st cold pressure oil. 2/ The mean survival times were of the same order for the sham-exposed mice on one hand, for the exposed mice on the other hand. A significantly greater length of life of the exposed mice was noticed when each of these groups was taken into account as a whole (636 ± 25 days versus 577 ± 18 days) (fig. 2).

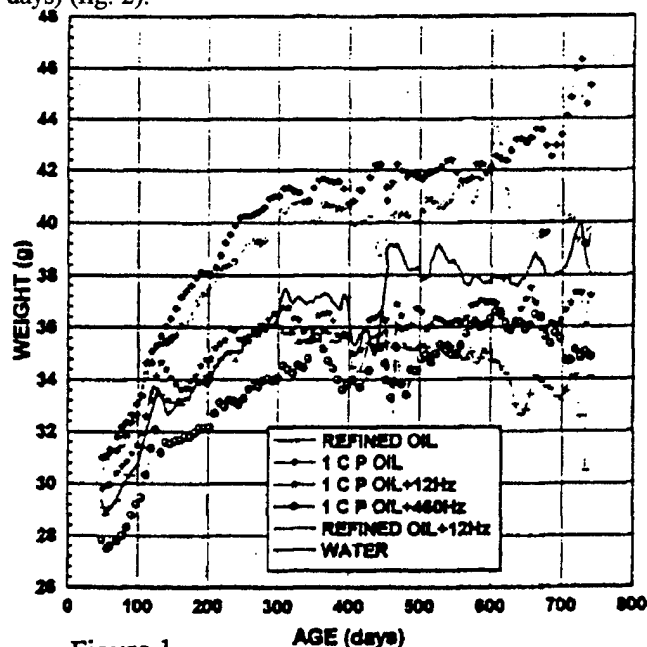

Figure 1

DISCUSSION: For the exposed mice whatever the physiological process cause of such a lack of oil efficiency, it can at least be compared with dehydroepiandrosterone (DHEA) which hinders any fat storage in mice (2, 3). Moreover the mice treated with DHEA lived longer than the controls and higher DHEA-sulfate levels are probably associated with longer survival in women (4). Here are the

accurate facts we could observe in this very experimentation. DHEA which continues to decrease with age, was also reported to enhance of immunization in aged mice (5), to modulate monocyte cytotoxicity (6), to modify triglyceride and cholesterol serum levels (7), to increase liver weight (8), to improve patients suffering from rheumatoid arthritis (4), all effects which could be obtained by magnetic fields. As the anti-cancer effect of DHEA is said to be due to the blocking of G6PD enzyme (9), there is all the more reason for suggesting a possible integration of PMF in the anti-cancer armamentarium.

References:

1. Bellossi A, Rocher C. 17th BEMS Meeting, 14-16, 1995.
2. Porter JR *et al.* *Int. J. Obes Relat. Metab. Disord.* 19(7):480-488, 1995.
3. Porter JR, *Annual NY Acad. Sci.*, 774:329-31, 1995.
4. Beaulieu EE. *JCEM* 81(9):3147-3151, 1996.
5. Danenberg HD *et al.* *Ann. NY Acad. Sci.* 774:297-299, 1995.
6. McLachtin JA *et al.* *J. Immunol.* 156(1):328-335, 1996.
7. Milewich L. *et al.* *Ann. NY Acad. Sci.* 774:149-170, 1995.
8. Friedman M. *et al.* *J. Nutr.* 126(4):989-999, 1996.
9. Gordon GB *et al.* *Adv. Enzyme Regul.* 26:355-382, 1987.

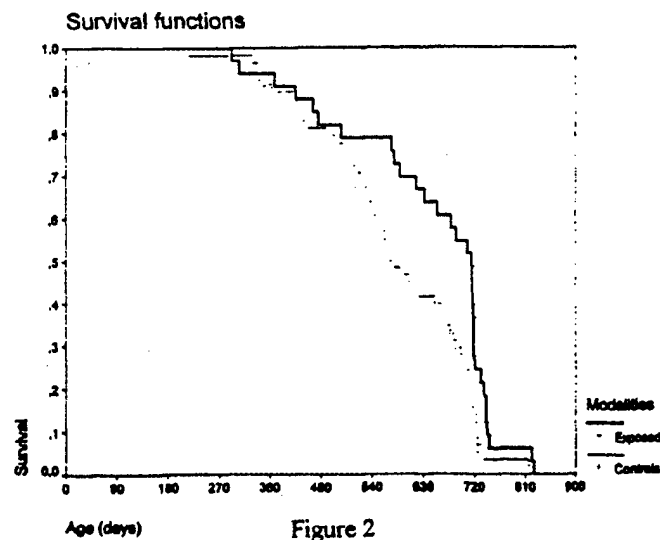

Figure 2

P-112-A

EFFECT OF MILLIMETER WAVES ON THE CONCENTRATION OF CERULOPLASMIN IN THE BLOOD PLASMA OF GAMMA-IRRADIATED RATS.
M. Kouzmanova and S. Ivanov. Sofia University, Biological Faculty, Department of Biophysics and Radiobiology, 1421 Sofia, Bulgaria.

Ceruloplasmin, the copper plasma protein is a multifunctional α_2 -globulin with ferroxidase activity (EC 1.16.3.1). It is involved in the copper transport and in the control of the level of serum biogenic amines. In the present study we have tested the participation of ceruloplasmin (CP) in the realization of the radioprotective effect of millimeter electromagnetic waves (MMW).

Electromagnetic waves (EMW) with length 5.6 mm (frequency 53.53 GHz) or 7.1 mm (42.19 GHz) were applied to the right hind leg shank of the animal for 20 min daily during 10 days using "Yav-1" generator, Russia (power density 10 mW/cm²). Two of six test groups were also irradiated with gamma rays (6 Gy) immediately following the last treatment with MMW. The concentration of ceruloplasmin in the rat plasma was determined using a Boyd-Houchin method on days 3, 7, 14, 21 and 30 after the last treatment with MMW or after the ionizing irradiation. Wholebody gamma-irradiation caused 20-40% decrease in the CP concentration compared to the control during the entire investigation period.

The treatment of the animals with MMW only showed a decrease in the CP concentration also. This decrease is lower than that observed after the ionizing irradiation (15-20% compared to the control). A decrease of the CP level after exposure to 7.1 mm EMW was observed after the day 7 following the exposure.

The treatment of rats with MMW prior to gamma-irradiation maintains the CP concentration on a higher level in comparison with the level measured after the gamma-irradiation. MMW with wavelength 7.1 mm were more effective.

The observed decrease in the CP level after the exposure to MMW can be a protective reaction of the organism direct to normalization of the changes in the metabolic processes, provoked from EMF.

A decreased level of CP in the blood plasma of the gamma-irradiated rats can result in an accumulation of excess of copper ions in some tissues and to manifestation of a functional disturbance in these tissues. The maintenance of the CP concentration in the blood plasma of the combined irradiated rats during the entire postradiation period on level significantly higher than the level of the gamma-control is a precondition for a decrease of the radiation injury of the animals.

P-113-B

ORNITHINE DECARBOXYLASE ACTIVITY IN ANIMALS EXPOSED TO DIFFERENT DOSES OF ENU AND EMF. E.K. Kaicer, M. Lalancette and R. Mandeville. Institute Armand-Frappier, University of Quebec, Laval, Quebec H7N 4Z3, Canada.

The induction of ODC in mammalian polyamine biosynthesis, is an early and obligatory event in the tumour promoting step in animal models, particularly in TPA-promotion. The enzyme activity is also elevated in some human premalignant lesions and in malignant human tumours. Actually, ODC activity is higher in adenocarcinomas of the stomach and large intestine. In tumours of skin and nervous system a correlation exists between ODC activity and differentiation. In breast cancers, a number of studies suggest that the polyamine biosynthetic pathway plays a critical role in mediating the action of hormones. A direct correlation was found between prolactinemia and ODC activity in cancer patients.

Carcinomas with higher ODC activity had higher cellularity, lower histopathologic differentiation and higher nuclear anaplasia than cancer in which ODC activity was not detectable. In the present study we have evaluated ODC activity in rats exposed to EMF alone or to EMF + ENU. One hundred and seventy animals were used in these studies. Animals were sacrificed after 5 or 15 weeks of exposure and organs were snap-frozen and stored at ~80°C until used. About 200 mg of tissue samples were cut into small portions using razor blades and homogenized in buffer containing tris-HCl (25 mM), dithiotretol (2.5 mM), pyridoxal phosphate (0.4 mM) and EDTA (0.1 mM). The enzymatic activity was evaluated in the supernatant after an incubation with 0.25 µCi of ¹⁴C-L-Ornithine (New England Nuclear) for 60 minutes at 37°C. The amount radioactivity was measured in a scintillation spectrometer (Packard).

ODC activity in rats treated with EMF alone or EMF + ENU

	EMF Exposure		EMF + ENU Exposure	
	Intestine	Spinal Cord	Intestine	Spinal Cord
5 weeks				
Sham	270 ±26	290 ±8	653 ±5	758 ±68
2 µT	441 ±174	670 ±103	442 ±276	602 ±57
20 µT	668 ±87	466 ±44	321 ±96	608 ±45
200 µT	571 ±162	697 ±197	449 ±104	730 ±131
2000 µT	891 ±69	857 ±57	481 ±199	797 ±122
p value	p < 0.0001	p < 0.0001	p = 0.34	p < 0.0001
15 weeks				
Sham	252 ±52	294 ±30	340 ±108	533 ±81
2 µT	455 ±192	604 ±130	440 ±156	645 ±110
20 µT	820 ±59	771 ±183	923 ±51	1073 ±148
200 µT	924 ±117	602 ±235	902 ±58	1785 ±59
2000 µT	859 ±165	1243 ±118	1192 ±96	1605 ±71
p value	p < 0.0001	p < 0.0001	p < 0.0001	p < 0.0001

These results clearly demonstrate an increase of ODC activity in organs of an Results are expressed as pmoles of ¹⁴CO₂ produced by 1 mg of cytosolic protein in one hour. Statistical analysis of dose-response was performed using regression analysis. We have first demonstrated that animals exposed to magnetic fields for 5 weeks and 15 weeks show an increase level of ODC in the intestine and spinal cord. A significant linear dose-response increase (p < 0.0001) was also demonstrated in both groups of animals. Animals exposed to ENU and EMF also show an increase in ODC activity in the brain, liver, intestine, spinal cord and kidneys after 5, 15 and 32 weeks of exposure when compared to unexposed animal. Moreover a significant dose/response curve could be demonstrated in several organs. The biological significance of these changes will be discussed and hypothesis presented. This study is co-funded by NIEHS (Grant No 1 R01 ES07049-01), a consortium of Canadian Sponsors (Hydro Quebec, Ontario Hydro and Health & Welfare Canada) and by the Institute Armand-Frappier

IAF CHRONIC CARCINOGENICITY STUDY EVALUATION OF 60 Hz MAGNETIC FIELDS IN FISCHER RATS: STATUS REPORT. R. Mandeville, L. Gaboury, G. Mercier and S. Sidrac-Ghali. Institute Armand-Frappier, University of Quebec, Laval, Quebec H7N 4Z3, Canada.

The objective of this study was to determine whether chronic exposure to 60 Hz linear (single axis) sinusoidal continuous wave MFs of various intensities (2, 20, 200, 2000 μ T) might increase the risk of cancer development in female Fischer rats. A group of 50 female rats were used as cage controls and kept in an adjacent conventional animal room (Transition Room) in the same facility. A separate group of animals was used as sentinels and sacrificed regularly (every three months) in order to monitor the health of our colony. The number of animals needed to reach a power of 90% and a doubling in malignant tumour incidence at any of the four MFs intensities was derived by three different statistical methods. Calculations were based on data derived from the NTP (National Toxicology Program) of the NIEHS database.

An animal facility completely dedicated to exposure of only one strain of animals under stringently controlled environment and under double blind conditions was built on the IAF campus. Five groups of 50 female rats were exposed to MFs for two years starting in the prenatal period (2 to 3 days before birth). Daily exposures to the various fields were performed for 20 consecutive hours (10 h in the dark and 10 h in the light). The fields were ramped up and down so as to avoid the production of any transients. Animals were kept in custom-made polycarbonate cages with flat stainless-steel cage cover tops that holds a 500 ml glass bottle with a glass sipper and a suspended ceramic feeder. The cage cover has been provided with a small Teflon tubing so as to interrupt the full vertical loop in the stainless-steel cover.

Clinical observations and body weight were recorded on individual animals. Animals found moribund or paralysed or unable to feed themselves were sacrificed. A necropsy was performed on all exposed and control groups. During necropsy all the organs and tissues were examined for grossly visible lesions. Tissues were preserved in 10% buffered formalin. Histopathologic examination of all tissues were performed on all visible lesions in all dose groups and controls, as specified by the NTP protocols.

We will be presenting a status report on this study and we will discuss our findings whenever possible.

This study is co-funded by a consortium of Canadian Sponsors (Hydro Quebec, Ontario Hydro and Health & Welfare Canada) and by the Institute Armand-Frappier, University of Quebec.

P-115-A

MAGNETIC FIELD ENVIRONMENT IN ULF RANGE (0-10 Hz) IN URBAN AREAS: MAN-MADE AND NATURAL FIELDS IN ST. PETERSBURG (RUSSIA). N.G. Ptitsyna¹, G. Villoresi², Y.A. Kopytenko¹, M.I. Tyasto¹, E.A. Kopytenko¹, N. Iucci³, P.M. Voronov¹ and D.B. Zaitsev¹. ¹SPbFIZMIRAN of Russian Academy of Science, 191023 St. Petersburg, Russia. ²IFSI-CNR Frascati c/o Università "Roma 3", Dip. di Fisica, 00146 Rome, Italy. ³Università "Roma 3", Dip. di Fisica, 00146 Rome, Italy.

Recently, magnetic fields (MFs) from electrified transport become of interest in health-related studies. They are different from MFs at 50/60 Hz: they show complex frequency patterns with main components below 10-15 Hz. Also the natural geomagnetic environment exhibits complex and irregular frequency patterns, mainly in the ultra-low frequency (ULF) range (0-10 Hz). In contrast to the well-studied 50-60 Hz range, there is a lack of investigation of man-made MFs in ULF range, because in this frequency range there are no systematic measurements in urban areas. Measurements have been done in different locations in downtown St. Petersburg. At a distance 3-5 meters from trains, MF fluctuations can be 200-800 mG. At a point located 80-100 meters from street cars and subway lines, the most prominent signals look like peaks, mainly in vertical component, in the frequency range 0.05-0.2 Hz, with amplitudes up to 10 mG. These peaks appear often in long sequences with duration 3-30 min. The second type of man-made fluctuations, observed in vertical component, consists in periods of increased field amplitude with frequencies below 0.005 Hz; these MF "waves" can be as big as ~4-5 mG. In general, transport-related MF patterns in ULF range are similar to records of natural MFs during geomagnetic disturbances. Magnitudes of MF fluctuations during big interplanetary-driven geomagnetic storms can be 4-5 mG at the latitude of St. Petersburg. The intensity levels of transport-related MFs decrease with distance from the sources; they become of the same order of magnitude of natural MF variations at a distance of 50-100 meters. This should be taken into account in biological and epidemiological studies of possible bioeffects of ULF MFs.

P-116-B

POWER DEPENDENT REARRANGEMENT IN THE SPECTRUM OF RESONANCE EFFECT OF MILLIMETER WAVES ON THE GENOME CONFORMATIONAL STATE OF *E. COLI* CELLS. V.S. Shcheglov¹, I.Y. Belyaev^{1,2}, Y.D. Alipov¹ and V.L. Ushakov¹. ¹Department of Radiation Physics, Biophysics and Ecology, Moscow Engineering Physics Institute, 115409 Moscow, Russia. ²Department of Radiobiology, Stockholm University, S-106 91 Stockholm, Sweden.

It has been shown that the reduction of power density (PD) from 3×10^{-3} to 10^{-19} W/cm² resulted in a significant

narrowing of the resonance response of *E. coli* cells to millimeter wave (MMW) exposure at the 51.755 GHz (1). The half-width of the resonant response showed a sigmoidal dependence on PD, changing from 3 MHz to 100 MHz. Sharp narrowing of the 51.755 GHz resonance in the PD range of 10^{-4} - 10^{-7} W/cm² was followed by an emergence of new frequency resonances. The PD dependence of the MMW effect at one of these resonance frequencies (51.674 GHz) differed markedly from the corresponding dependence at the 51.755 GHz resonance; the power window occurring in the range of 10^{-16} - 10^{-8} W/cm². The results obtained were explained in the framework of a model of electron-conformational interactions. In the present work, we studied the frequency dependencies of MMW effect within a frequency range of 51.655-51.688 GHz (around 51.674 GHz) and a power range of 10^{-18} W/cm²- 3×10^{-3} W/cm² in order to elucidate the possible reason for the PD-induced rearrangement in the frequency spectrum of MMW action. MMW of different polarization were used. Since the resonant reaction of cells to MMW appeared to be dependent on the concentration of exposed cells (1), the PD dependence of the resonant MMW effect on *E. coli* cells at different concentrations was also investigated.

The *E. coli* cells K12 AB1157 from the stationary stage of growth were exposed to MMW at power densities from 10^{-18} W/cm² to 3×10^{-3} W/cm². Frequency dependencies during exposure within the range of 51.655-51.688 GHz were studied for two cell concentrations (4×10^7 and 4×10^8 cells/ml). The changes in the genome conformational state (GCS) were analyzed by the method of anomalous viscosity time dependence (AVTD). A resonant effect with the resonance frequency of 51.675 ± 0.001 GHz was observed in the PD range of 10^{-18} - 10^{-8} W/cm². Left-handed polarized MMW was shown to be more effective than right-handed circular polarization at this resonance. At PDs more than 10^{-6} W/cm² the 51.675 GHz resonance effect decreased significantly. As the 51.675 GHz resonance decreased, a statistically significant effect was observed with its maximum at 51.668 ± 0.002 GHz. The results were compared to data of previous studies performed at the resonance frequency of 51.755 GHz. All resonance effects depended on the concentration of cells during exposure, which implies a cell-to-cell interaction during resonance response (cooperativity of resonance response). At all resonance frequencies, an effect was observed at very low non-thermal intensities: 10^{-18} W/cm² for 51.755 GHz and 51.675 GHz; 10^{-14} W/cm² for 51.668 GHz. The values of three resonance frequencies were stable in wide PD ranges within 10^{-18} - 10^{-3} W/cm². The half-widths of the resonances showed different dependencies on PD, changing from 2-3 MHz to 16-17 MHz (51.675 GHz, 51.668 GHz) or 100 MHz (51.755 GHz). The significant rearrangement in the spectrum of resonance response was observed in the 10^{-8} - 10^{-4} W/cm². All three resonances were involved in this rearrangement which can be explained in the framework of the model of electron-conformational interactions.

References:

1. Belyaev, I.Ya., Shcheglov, V.S., Alipov, Ye.D., and V.A. Polunin, Resonance effect of millimeter waves in the power

range of 10^{-19} - 3×10^{-3} W/cm² on *E. coli* cells at different concentrations, *Bioelectromagnetics*, 17, 312-321, 1996.

P-117-C

RETENTION OF ELECTROMAGNETIC ACTIVITY IN WATER. A.V. Cavopol. Food Technology Partners, Nashville, Tennessee 37080, USA.

Experiments determine long term (over 5 min.) relaxation of water after exposure to electromagnetic fields. The equipment measures microvolt level signals over a frequency range of {0, 150 kHz}. Water was exposed to EM signals : a). through electrodes temporarily inserted in the water sample, and b). through direct or induced fields whose sources are not in contact with the water sample. The same measurements were performed on distilled and tap water.

a). 1 kHz sinusoidal signals were delivered across 5cm/7cm/1mm brass electrodes in a 200ml water chamber. Labeling by R the ratio of (averaged signal strength)/(averaged strength of signal before EM excitation), the relaxation period following the 8 V excitation displays the following pattern: during a period t_1 , the signal ratio decreases from $R = [2,3]$ to $R = 1$, during t_2 the ratio decreases from before excitation levels ($R = 1$) to an absolute minimum ($R = [.5, .7]$) of it's activity and t_3 represents the recovery from minimum to before excitation level. Initial measurements for the 8 V excitation indicate the correlation ($t_1:t_2:t_3$) = (1:1.5:[4,5]), that holds for different time exposures. The absolute values of t_1 , t_2 , t_3 show a nonlinear dependence on exposure times (for t_2 , different exposures of 1/5/13 min. correspond to ~17/30/53 min. relaxation periods). Electrical activity of water also displays a nonlinear dependence on the voltage across the electrodes.

b). EM fields were generated above fluid surface by a point source (3 mm gap of a spark plug) or a distributed source (coil around the water chamber). Electric discharges from a 1-2 A current in the primary winding of an induction coil, cause a global (across the entire measured frequency spectrum of 30 kHz) decrease of 6%-10% in the electrical activity of tap water. Initial data indicates that the recovery period t_3 is linear with the exposure time (3 and 7 min. exposure times correspond to 17 and 42 min. recovery, etc.), similar to results in a). Fields generated by a sinusoidal current of .3 A at 10 kHz in the primary of the induction coil (non-discharge EM fields) do not change the global electrical activity of water above fluctuation level. After excitation, short (5-7 min.) relaxation resonances occur at excitation frequency (10 KHz). The same primary current directly fed into a coil surrounding the water chamber shows no measurable change above fluctuation. Water is a difficult medium to measure, because it displays fluctuations in the strength of electrical activity over a time scale of sec.- min., as well as fluctuations in the frequency distribution of internal resonance peaks over a time scale of min. hours. (displayed as semi-periodic grouping and ungrouping of resonance peaks). This requires an averaging procedure that makes short term relaxation data inaccessible (<5 min.) and obscures electrical trends of the same size as fluctuations. Accordingly all distilled water

measurements, corresponding to low relaxation levels are inconclusive to date.

P-118-A

INDEPENDENTLY REPLICATED BIOLOGICAL EFFECTS ON ELF ELECTROMAGNETIC FIELDS: A LITERATURE STUDY. M. Gustavsson, M. Lindgren, S. Galt and Y. Hamnerius. Microwave Technology, Chalmers University of Technology, S-412 96 Göteborg, Sweden.

Many biological effects of extremely low frequency (ELF) electromagnetic fields demonstrated over the past few decades have proven to be notoriously difficult to replicate. Many possible reasons for this problem may be postulated, for example: variations in exposure parameters, variations in biological material, variations in biological experimental protocols, or as some critics assume, lack of existence of any real effect in the original experiments. Until recently there have been very few attempts to conduct replication experiments.

The criteria a set of experiments (original and replication(s)) has to fulfill to be included in this study are: 1) conducted at a cellular level, 2) ELF EMF exposure, 3) independent replication, 4) clearly stated ambition of replication.

The field parameters considered are strength and orientation of both static and alternating fields, frequency and exposure time. Also considered are the ambient fields during cell growth and exposure. The following physical parameters have been considered: temperature, concentration of CO₂, humidity, light intensity and vibrations. Concerning the biological material, there are even more parameters to consider such as passage level, history and origin of the material used. Different batches of cell culture medium, serum and special chemicals can differ in composition and pureness. Finally, we have considered the end point and statistical methods used. However, not all of these parameters are applicable or specified in all experiments.

Although there has been a clearly stated ambition to replicate an earlier indicated biological effect in the studied replications, a majority have failed in reproducing the results. The question is whether they have overlooked some vital parameters, or whether there was no original effect. Regarding positive replications, we consider there is a need for more than one replication to confirm the effect.

The following sets of experiments have been reviewed:

Set	Experiment	Cells	Author (original)	Year	Author (replication)	Year	pos. / neg.
1	Motility	Diatoms	S. Smith	1987	J.A. Reese	1991	+
					E. Saalman	1992	-
					W.C. Parkinson	1992	-
					M.S. Davies	1992	*
2	Uridine uptake	HL-60	J.J. Greene	1991	M. Azidniv	1992	-
3	Gene expression	HL-60	R. Goodman	1992	E. Czarska	1992	+
					A. Lacy-Hulbert	1995	-
					J.D. Saffer	1995	-
					E. Balcer-Kubiczek	1996	-
4	Neurite outgrowth	PC-12	C.F. Blackman	1993	J. Bergquist	1994	-
5	Melatonin	MCF-7	R.P. Liburdy	1993	C.F. Blackman	1996	+
					R.A. Luben	1996	+
6	Gene expression	Yeast	D. Weisbrot	1993	D.M. Binninger	1996	+
7	Ca ²⁺ oscillations	Jurkat	E. Lindström	1993	F. Gollnick	1994	-
					D.E Callahan	1994	-
					J. Wallaczek	1994	-
					J. Galvanovskis	1996	-
8	CD3 binding	Jurkat	R.P. Liburdy	1994	W. Balcavage	1996	+
9	Chromosome aberrations	Amniotic	I. Nordensson	1994	S. Galt	1995	-

* A negative replication (1992), later a positive effect has been found (personal communication).

P-119-B

THE HISTORY OF ELECTRICITY IN LIFE AS REFLECTED IN THE COLLECTIONS OF THE BAKKEN LIBRARY. D. Stillings. Archaeus Project, Kamuela, Hawaii 96743, USA.

THE BAKKEN LIBRARY OF ELECTRICITY IN LIFE, located in Minneapolis, Minn., contains over 10,000 publications and over 1,000 original electrical instruments and related artifacts. The publications cover a period from about 1270 A.D. to 1940. Most of the electrical devices date from between the mid-18th century and around 1930. Other, much more ancient, artifacts, such as Sumerian magnetite cylinder seals, can also be found in the collection. This material was gathered in order to form a self-contained information resource on all aspects of the relationship between electricity and magnetism and living organisms. Exploration of the contents of this collection has barely begun. The almost totally promiscuous and theory-free experimentation with applying electricity and magnetism to living organisms-carried out from about the 2nd century A.D. until early in this century-resulted in the serendipitous discovery of important bioelectrical and biomagnetic effects that have been rediscovered only recently. It is quite possible that a thorough search of this forgotten literature could bring to light possible electromedical treatment modalities of significant value.

THE HUMAN PERCEPTION OF ELECTRIC FIELDS AND ION CURRENTS FROM JUXTAPOSED HIGH VOLTAGE AC AND DC TRANSMISSION LINES. J.P. Blondin¹, D.H. Nguyen², D. Goulet³, M. Plante⁴ and P.S. Maruvada². ¹Department of Psychology, University of Montréal, Québec H3C 3C8, Canada. ²Institut de recherche d'Hydro-Québec (IREQ), Varennes, Québec J3X 1S1, Canada. ³Environnement et Collectivités, Hydro-Québec, Montréal, Québec H2Z 1A4, Canada. ⁴Services Santé, Hydro-Québec, Montréal, Québec H2Z 1A4, Canada.

Human sensory thresholds for the detection of DC electric fields associated with high voltage DC (HVDC) transmission lines were recently assessed in a research program conducted at the *Institut de recherche d'Hydro-Québec*. Results showed that the perception of DC fields was influenced by the presence of ion currents, and that there were large variations in detection thresholds among individuals. Conditions exist where AC fields are present simultaneously with DC fields, for instance when HVDC lines cross or run side by side high voltage AC (HVAC) lines. The electrical environment created by the juxtaposition of these transmission lines might have a specific impact on human sensory reactions.

The objective of the present study was to assess the ability of human observers to detect the presence of DC electric fields and ion currents when AC fields are also present. It was expected that AC fields would lower thresholds for the detection of ionized and non ionized DC fields [Clairmont, Johnson and Zelingher, 1995]. Knowledge of these sensory reactions will be useful in developing environmental criteria for field intensities that are acceptable in the vicinity of juxtaposed HVDC and HVAC lines.

An exposure chamber that was built in order to assess DC field sensory thresholds was modified so that AC fields could be presented simultaneously with DC fields. Participants were asked to observe DC electric fields of 12, 16, 20, and 24 kV/m during series of successive trials. AC fields were continuously present during series of trials, and the observers' task was to discriminate between this constant background and changes induced by transient DC field applications. Each observer was tested in three AC field conditions: no field present, a 2 kV/m and a 4 kV/m field continuously present during series. In an additional experimental condition, 2 kV/m and 4 kV/m AC fields were presented simultaneously with DC fields, so that both fields were rising and falling at the same time. Participants were 11 male and 11 female volunteers, aged 19 to 49. Ion currents (50 nA/m² density) were added to DC fields for half the participants; no ion currents were added for other observers. Detection of electric fields was assessed using a psychophysical method, i.e., the rating procedure derived from Signal Detection Theory. Results were analyzed as a function of three factors and their interaction: Ion Current (0 and 50 nA/m²), AC Field (0, 2, and 4 kV/m), and DC Field Intensity (12, 16, 20, and 24 kV/m).

Results indicated that observers did not detect DC fields at intensities used in this study when there was no AC field present. There was a tendency for ion currents to improve

detection, but it did not reach statistical significance levels. With background AC fields, however, observers were capable of detecting the presence of DC fields, and this effect was more important with the stronger 4 kV/m AC field. Subjective self-reports collected during the experiment confirmed these results, as observers reported that detection was easier and sensations were more intense when AC fields were present. AC fields that varied simultaneously with DC fields had stronger effects than background AC fields.

The improvement in detection performance due to the presence of AC fields was estimated at 6 to 28% depending on their intensity and transient or background presentation. This effect translated in a substantial lowering of sensory detection thresholds. Compared to conditions where only DC fields were present, with or without ion currents, threshold values were half as high when AC fields were added. Moreover, twice as many observers were capable of detecting the presence of DC electric fields when AC fields were also present. Overall, these results provide evidence that AC electric fields can facilitate the sensory perception of DC electric fields. They also can be used to propose environmental guidelines that are based on the human perception of hybrid AC and DC fields.

(This research was conducted as part of Hydro-Québec's Action plan on the biological effects of electric and magnetic fields.)

P-121-A

IONIC CURRENT IN LIVING BONE IS POTASSIUM DEPENDENT. F.D. Benelli, I. Villa, E. Borgo and A. Rubinacci. Bone Metabolic Unit, Scientific Institute H. San Raffaele, Milano 20132, Italy.

Living bones drive a steady electrical (ionic) current through damage sites, which is supposed to play a role in bone repair. Such a steady current is independent from mechanical stress acting upon bone, is present only where the interior milieu of bone is exposed to the systemic interstitial fluid (damage site) and is driven by cells as demonstrated by its stability over time, by its temperature dependence and by its absence in dead bone (R. Borgens, 1984; A. Rubinacci *et al.*, 1996). It was supposed that the steady electrical current at the damage site of a bone is generated by a "pump-leak" system operating at the bone-plasma interface, devoted to maintain the internal bone fluid milieu in spite of the damage (R. Borgens, 1984).

As the potassium concentration in the extracellular fluid of the bone compartment (25mM) is higher than that of plasma (4mM), and since it is rapidly exchangeable with plasma being not incorporated into the mineralized matrix nor bound to collagen, the hypothesis is proposed that potassium ion is one of the carriers of the current.

To demonstrate the K⁺ dependence of the steady electrical current through the damage site of a bone, excised metatarsal bones of weanling mice previously subjected to mono-cortical micrometric drilling were soaked in physiological fluid media at different K⁺ concentrations, and the ionic current at the site of damage was measured by means of a voltage sensitive two-dimensional vibrating probe under control of temperature

(37°C), pH (7.3 at 37°C) and osmolarity (370 mOsm). The effects on the current of changing the K⁺ concentration of the medium and of adding to it two specific blockers of the K⁺-channels (TEA and BaCl₂) were studied.

It was observed that steady current density is significantly (F=10.75; p<0.0001; n=20) dependent upon potassium concentration ([K]⁺_{ext}) in the medium. At [K]⁺_{ext} equal to that of plasma (4mM), an inward current density of 8.3 to 28.5 μA/cm² (n=23) was recorded at the site of damage, stable for at least two hours (basal steady current). At [K]⁺_{ext} equal to that of bone endocanalicular fluid (25mM), the current density was significantly (p<0.0001; n=8) reduced by 83% after a transient reversal. At zero [K]⁺_{ext} the current density was significantly increased by a factor of 2. When 50mM TEA, 35mM TEA or 2mM BaCl₂ were added to the medium of 4mM [K]⁺_{ext}, significant (p<0.001) current density reductions of 65% (n=5), 46% (n=3) and 29% (n=4) were recorded, respectively. When 35mM TEA was added to the zero [K]⁺_{ext} medium, no increased current density was observed (n=4).

The results indicate that the steady current measured on the surface of bone at the site of a drilled transcortical damage is strongly dependent on the potassium gradient existing at the bone-fluid or bone-plasma interface. The observed inhibition of the steady ionic current by specific K⁺-channel blockers supports the view that the current is generated and maintained by cell activity. The results of this experiment also throw light on the role of the K⁺-channels in bone: they appear to maintain the potassium gradient at the bone-plasma interface, being higher the K⁺ concentration in the bone than in the plasma compartment, and their activity modulates the amplitude of the current.

In conclusion, this study throws light on the relationship among bone fluid compartmentalization, mineral homeostasis and steady electrical signals of bone. The importance is stressed that endogenous electrical signals are taken into account when electrical bone repair is investigated.

P-122-B

THE INHIBITOR PHASE OF CONSTANT MAGNETIC FIELD. L.A. Trufanov, E.L. Ovchinnikov, A.N. Volobuev and N.Y. Khokhlova. Samara State Medical University, 443079 Samara, Russia.

INTRODUCTION: The influence of constant magnetic field (CMF) has been researched on functional activity of elements of arch somatic reflex.

MATERIALS AND METHODS: The researches has been done on the volunteers of 18 - 25 years old, placed in the magnetic device of powerfully lines axially. Transcutanea stimulation of *n. femoralis* rectangular impulse 4 ms long, with periods 5 - 10 min has been used. Electrodes of stimulation has been put on the buttock field in the projection of *n. femoralis*. The set for collection of the information has been distally placed in the field of *medialis myschems* of foot. The definition indices of potential action of the sensor nerve (PAS) has been done on Rexed - Therman scale in the rate registration 500 mm/sec. The marker was a time from the

producing of the electric stimulus till the appearance of the front of depolarization wave I. The latency of potential activity of the motor nerve (PAM) has been fixed from the moment of the appearance of the stimulus till the appearance of the front of depolarization wave II. The latency and the amplitudes, PAS and PAM had been compared and correlated with the quantity of magnetic induction and the time of exposition in CMF. Control experiments has been done on the isolate nerve.

RESULTS: In CMF (B = 0) absence, the threshold level of the motor nerve excitement was marked by such the amplitude of test stimulus, that discovered the basic massif of sensors fibre of Ia group and didn't realize in the contractile final effect. In the application of external magnetic field (B = 8 - 10 mT, t = 5 - 10 min) and the preservation of constant amplitude of stimulate impulse, the latency PAS was growing and, accordingly, the latently phase of PAM became longer, with a changeable fall of it's amplitude. In the growing of magnetic induction (B < 30 mT, t = 5 - 10 min) take place the essential increase of the latency PAS and PAM, the sharp decrease of the fall of PAM amplitude, or completely lack of it. Then, in the growing of magnetic induction and the preservation of the stimulation condition (B = 20 - 30 mT), the PAS latency was growing, the critical level of depolarization for sensors fibre of second and third groups fell. At the same time, there was the "restoration" of PAM amplitude, the latency of efferency volley didn't change.

DISCUSSION: This effects were interpreted, as inhibitor phase of CMF influence on biology membranes. The essence of them, has been learned by methods of mathematic model and made up the base theory of nerve transfer. This states, that in some cases the disappearance of PAM at CMF application has at least two explanations:

1. It is the result of braking the afferents lead-ins on the moto-neuron pul. Then PAS testing becomes underthreshold and, therefore, does not form the reactions of reflexing reply.
 2. Sensor's signal, receiving delay in CMF, falls on the neuron rele with space-time disperse, to the reception of which the nerves centres may be not adopted evolutionally. Then sensor's signal loses representativity in the struggle for the definitive way and puts the brakes on interneurons, that enter the arch of generalizing reflex. The "restoration" of PAM amplitude has been stated only, when there was the appearance of the sensor afferents II and III groups, marked by Rexed - Therman scale. As the constancy of stimulation conditions preserved the appearance of potential activity in the upthreshold sensor fibres was the result of direct CMF influence on the critical level of depolarization of these fibres.
- CONCLUSION:** Staled CMF effects may be used in practical medicine, as a method for rizing the organism toleration as regards alteration factor.

P-123-C

EFFECT OF ENVIRONMENTAL MAGNETIC FIELD IN RABBIT RETICULOCYTE LYSATE TRANSLATION SYSTEM. E. Hirakawa^{1,2}, M. Ohmori¹ and W.D. Winters². ¹Department of Pathology, Kagawa Medical University, Kagawa 761-07, Japan. ²Department of Microbiology, University of Texas Health Science Center, San Antonio, Texas 78284, USA.

A few studies have shown that magnetic fields alter translation in *E. Coli* or alter the protein synthesis in a cell free transcription/translation system. This study was to investigate the effects of environmental strengths of 60 Hz magnetic fields exposure in rabbit reticulocyte lysate translation system. Cell-free translation system was prepared using rabbit reticulocyte lysate translation system (GIBCO BRL). Reticulocyte lysate reaction mixtures containing Tobacco Mosaic Virus (TMV) mRNA were placed in each of 4 exposure conditions within 2 identical magnetic field (MF) exposure units. Condition 1 was the control, i.e., no MF preexposure before reaction and no MF exposure during reaction in sham; the second condition was only MF preexposure to TMV mRNA for 45 min at room temperature before reaction and then reaction mixture reacted in sham; the third condition was no MF preexposure before reaction and then MF exposure only during reaction for 60 min at 30°C; the fourth condition was MF preexposure and MF exposure during reaction. Magnetic field strengths used for exposures of these in each experiment were 100 μ T, 50 μ T, 10 μ T and 5 μ T. Results revealed no differences between 4 conditions. These results show that sinusoidally varying 60 Hz MF at 5, 10, 50, 100 μ T can not change the amount of protein synthesis in rabbit reticulocyte lysate protein synthesis system.

P-124-A

60 Hz EMF EXPOSURE AND DNA REPAIR AS MEASURED BY O⁶-METHYLGUANINE-DNA-METHYLTRANSFERASE ACTIVITY IN C3H/10T1/2 FIBROBLASTS. C.D. Cain, M. Ghaffari and W.R. Adey. J.L. Pettis Memorial Veterans Administration Medical Center, Loma Linda, California 92357, USA.

INTRODUCTION: O⁶-methylguanine-DNA-methyltransferase (AGT) is a DNA repair enzyme that is induced by exposure to alkylating agents such as chemical carcinogens and X-ray radiation. We are using C3H/10T1/2 fibroblasts because alkylating agents such as N-methyl-N-nitro-nitrosoguanidine (MNNG) and X-ray radiation stimulate AGT activity in these cells (von Hofe & Kennedy, 1988, 1991; Dunn, *et al.*, 1986). Furthermore, these cells have been shown to be sensitive to 60 Hz electromagnetic field (EMF) exposure in a co-culture tumor promotion model (Cain, *et al.* 1993). A rationale to examine the influence of EMF exposure on AGT activity is that oxygen free radicals

are necessary for X-ray-induced AGT activity in C3H/10T1/2 cells (von Hofe & Kennedy, 1988), and it has been proposed that direct interaction between free radicals and EMF may be an mechanism by which EMFs influence biological processes. **OBJECTIVE:** We are testing the hypothesis that exposure to 60 Hz EMF (1.0 G) induces AGT activity in C3H/10T1/2 cells.

METHODS: Cells, in 60-mm petri dishes, were stacked (18 dishes) and enclosed in gas-tight 8.75 cm PVC solenoidal coils that produced 4.54 gauss/ampere. Four of these solenoids, enclosed in mu-metal cans, were placed in a custom-built incubator (*Bioelectromagnetics* 13:199-207, 1992). Two sham-exposure coils were bucked down to less than 1.0 mG. Logarithmically growing C3H/10T1/2 fibroblasts were seeded at 5×10^3 cells per dish and grown in basal BME medium with 10% FBS. Three days after seeding, cells were exposed to 60 Hz EMF (1.0 G) or sham-exposed for 4 days. At 95% confluence, cells are assayed for AGT activity (Edara, *et al.*, *Carcinogenesis* 16:1637-1642, 1995). Briefly, the substrate was prepared by alkylating calf thymus DNA with N-[³H]methyl-N-nitrosourea yielding [³H]methylated-DNA. This labeled DNA incubated for 30 mins at 37°C with supernatants from sonicated cell homogenates, 3 60-mm petri dishes per assay tube. DNA was precipitated with ice-cold perchloric acid. The DNA was then hydrolyzed in 0.1 M HCl. The modified bases, O⁶-[³H]methylguanine and O⁷-[³H]methylguanine, were then separated on reverse-phase HPLC and detected with a flow-through radioactivity monitor. O⁶-[³H]methylguanine is the product of AGT activity.

RESULTS & DISCUSSION: In one pilot experiment, 60 Hz EMF exposure did not influence basal AGT activity. AGT activities of sham-exposed and EMF-exposed cells were 248 ± 54 (SEM) (n=7) fmoles O⁶-[³H]methylguanine per mg protein and 191 ± 44 (SEM) (n=10) fmoles O⁶-[³H]methylguanine per mg protein, respectively. The rationale to study AGT activity and the possible effects of EMF exposure is based on reports of changed DNA structure associated with 60 Hz EMFs. The energy of these EMF exposures is too low for direct damage to DNA through rupture of chemical bonds. However, transient changes in DNA structure occur naturally, followed by repair. We are examining possible EMF-induced changes in repair of DNA. The importance of AGT activity and DNA repair in tumor formation is illustrated by AGT's induction by X-rays and the ensuing inhibition of ethylnitrosourea (ENU)-induced tumor formation in rats (Stammberger *et al.*, 1990). These studies address a potential influence of EMFs on DNA repair and carcinogenesis.

Supported by US DOE, Office of Energy Management, Contract No DE-AI01-90CE35035.

P-125-B

MOLECULAR CLONING AND CHARACTERIZATION OF 60 Hz EMF-RESPONSIVE GENES IN THE YEAST, *SACCHAROMYCES CEREVISIAE*. D.M. Binninger¹ and V. Ungvichian². ¹Department of Biological Sciences and ²Department of Electrical Engineering, Florida Atlantic University, Boca Raton, Florida 33431, USA.

Our long-term objective is to understand the molecular and genetic mechanism(s) that mediate effects of 60 Hz AC magnetic fields on gene expression. We have chosen the yeast *Saccharomyces cerevisiae* as our experimental organism because of the excellent genetics, well developed molecular cloning techniques and availability of the complete genomic DNA sequence. We have observed that the levels of certain messenger RNAs (mRNA) can be affected in yeast following growth in the presence of 20 μ T 60 Hz AC magnetic fields for 24 hours. We have used the technique of mRNA differential display [*Science* (1992) 257: 967-971] to identify and subsequently recover three partial cDNA clones derived from mRNAs whose abundance appears to be altered by exposure to the 60 Hz electromagnetic fields (EMF). Changes in mRNA levels have been confirmed by RNA (Northern) hybridization analyses. Full-length genomic clones for two of the three genes have been recovered by PCR. **METHOD:** The mRNA differential display technique uses reverse transcription followed by amplification using the polymerase chain reaction (PCR) to generate partial cDNA clones from purified mRNA. Comparison of PCR products using mRNA purified from sham-exposed control and EMF-exposed yeast cells reveals cDNA fragments representing potential EMF-responsive genes. An extremely valuable advantage of this technique is that cDNA fragments of interest can be recovered from the dried polyacrylamide gel, reamplified by PCR and then cloned using standard molecular biology techniques.

RESULTS: Enhanced mRNA levels have been measured by Northern (RNA) hybridization analysis for two cDNA clones - EMF-A and EMF-B. In contrast, the third cDNA - EMF-C - reveals a mRNA whose abundance is decreased in EMF-exposed cells. The complete genomic DNA sequence corresponding to each cDNA was obtained from the GenBank DNA database. Appropriate PCR primers were synthesized to recover full-length genomic clones for EMF-A and EMF-C. The EMF-A and EMF-B gene products are not known. However, the EMF-C gene maps to a genetic locus previously identified as the *SUR4* gene [*J. Biol. Chem.* 269 (27), 18076-18082 (1994)]. The *SUR4* gene of yeast functions in the transcriptional control of a plasma membrane H⁺-ATPase.

REPLICATION EXPERIMENTS: Experiments to replicate the published observation that short-term exposure of yeast cells affects gene expression [Weisbrot *et al.* (1993) *Bioelectrochem. Bioenerget.* 31:167] are in progress in close collaboration with Dr. Reba Goodman and colleagues (Columbia University). Available data will be presented.

DISCUSSION: If additional studies support our initial observations, then these molecular probes will provide an entry point for more direct investigation of molecular mechanisms. As we establish the biochemical function of each putative EMF-responsive yeast gene, other investigators might be prompted to look at the effects of EMF on the analogous gene(s) in more highly developed cells, especially human cells. Thus, identification of EMF-responsive genes in yeast offers the potential of benefiting both our project and the work of our colleagues.

We would like to thank the National Institute of Environmental Health Sciences, National Institutes of Health (R55 ES06130-01 and R01-ES07181A-01) for their support of this work.

P-126-C

TRANSCRIPTIONAL EFFECTS OF POWER FREQUENCY EMF USING THE YEAST *SACCHAROMYCES CEREVISIAE*. D.M. Binninger¹ and V. Ungvichian². ¹Department of Biological Sciences and ²Department of Electrical Engineering, Florida Atlantic University, Boca Raton, Florida 33431, USA.

Our long-term research objective is to understand the molecular mechanism(s) whereby 60 Hz electromagnetic fields (EMF) influence gene expression. We are using *Saccharomyces cerevisiae* (yeast) as our experimental model because of the excellent genetics and elegant molecular cloning techniques that are available for this unicellular eukaryotic organism. Additionally, the complete DNA sequence of the yeast genome is now available. We have observed that the abundance of specific transcripts was altered in yeast cells following exposure to 20 μ T 60 Hz AC magnetic fields for 24 hours - approximately 15 cell generations. The levels of some mRNAs were enhanced while others were reduced. Changes in mRNA levels were originally detected by utilizing two-dimensional polyacrylamide gel electrophoresis (2D-PAGE) of *in vitro* translation products [*Bioelectrochem. Bioenerget.*; in press]. Subsequently, we used mRNA differential display to identify and recover cDNA clones for three genes whose expression was altered in the presence of the EMF.

EMF EXPOSURE CONDITIONS: Yeast cells were incubated for 24 hours with vigorous shaking (270 rpm) in 500-ml Erlenmeyer flasks (No. 26500 - Kimax) using standard YPD (yeast-peptone-dextrose) medium. The EMF-exposure system is located in a walk-in warm room maintained at 30 \pm 0.4 $^{\circ}$ C. Inside this room, the earth's static magnetic fields were measured at 38 μ T with an angle of inclination of 54 $^{\circ}$ N. The applied 20 μ T 60 Hz AC magnetic fields were generated by a one-meter square loop constructed with 62 turns of 14 AWG magnet wire (based on ANSI/IEEE Standard 644.1987). The strength of the applied AC magnetic fields during the exposure period was monitored at 60 second intervals with a battery-powered EMDEXC.

RESULTS: RNA (Northern) hybridization experiments showed that two cDNA clones - EMF-A and EMF-B - identified transcripts whose levels were increased. In

contrast, transcripts identified by EMF-C were decreased in EMF-exposed cells. At present, we have used PCR to isolate full-length genomic clones for EMF-A and EMF-C. The complete DNA sequence for all three yeast genes was obtained from the GenBank DNA database. The biological function(s) of the EMF-A and EMF-B gene products has not been clearly determined. However, EMF-C cDNA is derived from the *SUR4* gene of yeast which is involved in the transcriptional control of a plasma membrane H^+ -ATPase [*J. Biol. Chem.* 269 (27), 18076-18082 (1994)].

DISCUSSION: The identification and cloning of genes that exhibit a clear and reproducible response to the 60 Hz AC magnetic fields will provide valuable molecular probes for our future studies that will focus on elucidating the underlying molecular mechanisms. Molecular mechanisms associated with fundamental cellular processes are conserved among a diverse range of eukaryotic species. Thus we anticipate that knowledge gained about how this type of electromagnetic radiation affects gene expression in yeast will be applicable to more highly developed organisms, especially humans.

We would like to thank the National Institute of Environmental Health Sciences, National Institutes of Health (R55 ES06130-01 and R01-ES07181A-01) for their support of this work.

P-127-A

ANALYSIS OF Ca^{2+} -DEPENDENT TRANSCRIPTION IN TRANSFECTED JURKAT CELLS AFTER MAGNETIC FIELD EXPOSURE. M. Still¹, K. Hansson Mild², E. Lundgren³, J. Ekstrand⁴ and M.O. Mattsson¹.

¹Department of Cellular and Developmental Biology, Umeå University, S-901 87 Umeå, Sweden. ²National Institute for Working Life, Umeå, Sweden. ³Department of Applied Cell and Molecular Biology, Umeå University, Umeå, Sweden. ⁴Astra-Hässle AB, Umeå, Sweden.

BACKGROUND: Considerable efforts have during the recent years been invested in studies on Ca^{2+} -changes in various cells exposed to magnetic fields (MF). If such exposure causes Ca^{2+} increase, it probably will affect many physiologically important down-stream events that are in various ways dependent on this ion. In order to study if Ca^{2+} -dependent transcription can be affected by MF exposure, we have designed a model system, where cells are transiently transfected with reporter gene constructs and exposed to MF. Analyses of these experiments will tell us if a particular gene's expression can be manipulated by MF and/or other agents, and if there is a Ca^{2+} -dependent component in any MF response.

METHODS: Cells belonging to the human lymphoblastoid cell line Jurkat were transfected (Lipofectamine) with constructs containing one of the following promoters/enhancers (GMSCF; NFAT; Ig- κ 2) juxtaposed to a luciferase gene acting as a 'reporter' gene. The following day, the cells were exposed to MF (50 Hz, 0.10 mT rms., 53 μ T DC-field) for up to 4 hrs, with/without combinations of phorbol ester, ionomycin and an anti-CD3 antibody. After the experiments, cells were collected, lysed, and analyzed in a

luminometer for expression levels of the reporter gene.

RESULTS AND DISCUSSION: All three constructs exhibited responses to the drug treatment, although with different magnitudes. In the experiments performed so far, MF exposure of the cells transfected with the Ig- κ 2 construct consistently increased luciferase activity when the field was added to the chemical treatment. Cells transfected with the other two constructs did not exhibit the same response pattern to the MF exposure. Ongoing studies will now further characterize the (differential) MF effects, and also address the question of important field parameters.

Supported by grants from Work Environment Fund.

P-128-B

ELECTROENDOCYTOSIS - A NOVEL METHOD FOR INCORPORATION OF MACROMOLECULES INTO CELLS AND MEMBRANE VESICLES BY LOW ELECTRIC FIELDS. Y. Rosemberg and R. Korenstein. Department of Physiology and Pharmacology, Faculty of Medicine, Tel-Aviv University, Tel-Aviv 69978, Israel.

Efficient incorporation of molecules of high molecular weight such as DNA, enzymes and antibodies into cells and membrane vesicles still presents a challenge, with an immediate impact on biotechnology and medicine. Recently we have reported that exposure of cells, in suspension, to trains of low pulsed electric fields, much lower than the threshold electric fields for electroporation, caused to an efficient uptake of macromolecules possessing molecular weights in the range of 1-2000kD. This uptake was not cell specific and was obtained using different cells such as B lymphoma cells, COS 5-7 cells, Lewis lung carcinoma cells and human erythrocytes. The present study reports on the dependence of the uptake of dextran 2000kD into erythrocytes on the electrical parameters of exposure. The incorporation was found to increase with the elevation of electric field amplitude, frequency, pulse width and the total time of exposure. The effect of osmolarity on the uptake process has been studied and showed an inhibition of the uptake in a medium of 600mOsmol. Efficient incorporation of macromolecules into different types of cells was observed at low temperatures. Moreover, a high yield of uptake was observed in membrane vesicles exposed to low pulsed electric fields. These results suggest that the uptake process does not involve classical, metabolically driven, endocytotic or pinocytotic processes. An insight into the underlying mechanism of uptake emerges from 3D sectioning by confocal microscopic studies, suggesting that the exposure of cells and membrane vesicles to low electric fields induces pronounced vesiculation which is responsible for the uptake process. This phenomena is coined by us - electroendocytosis.

P-129-C

STATIC MAGNETIC FIELD (SMF) EFFECT ON Ca - UPTAKE IN NEURONS OF HELIX POMATIA. A.A. Saghyan, T.H. Avetisyan and S.N. Ayrapetyan. Biophysics Center of Armenia NAS, Yerevan 375044, Armenia.

The pH-dependence of ^{45}Ca -uptake and the SMF effect on this Ca-uptake under Na-K pump blocking condition on Helix Pomatia neurons were investigated. Under both high pH (8.3) and low pH (6.0) condition ^{45}Ca -uptake was decreased in comparison with control pH (7.7). After exposure of extracellular solution to SMF (0.27 mT) for 20 min. in low and control pH conditions ^{45}Ca influx in neurons was decreased while in high pH (8.3) it was significantly increased. The low and control pH-induced decreasing of ^{45}Ca -uptake was enhanced slightly by SMF, whereas the high pH induced decrease of ^{45}Ca -uptake reversed to the increase by more than two times. The obtained data suggest that in Helix pomatia neurons, under Na-K pump blocking state the direction of SMF effect on Ca-uptake depends on pH.

P-130-A

MAGNETIC RESONANCE RELAXATION TIME DISTRIBUTIONS ANALYZED FOR LENGTHS OF HUMAN INTESTINE RESECTED FOR CANCER. P. Fantazzini¹ and A. Sarra². ¹Dipartimento di Fisica, Università di Bologna, Italy. ²Ospedale Civile Santa Chiara, Trento, Italy.

Relaxation curves of the longitudinal and transverse magnetization components (T_1 and T_2 data, respectively) of ^1H nuclei were acquired for samples of intestinal adenocarcinoma and of uninvolved (at histological level) tissue at the upper and lower resection margins of lengths of intestine taken at surgery from twenty patients. The problem is of great clinical importance, due to local recurrence after resection for rectal cancer, that remain common, despite growing acceptance that inadequate local excision may be implicated [1]. All curves were analyzed as discrete and quasi-continuous exponential distributions [2,3,4]. This experiment simulates what happens in Magnetic Resonance Imaging, where the patient serves as his own control, but it permits more detailed multiexponential analysis. When the data are sums of discrete or continuous distributions of exponentials, the non-robustness in measurements and computation is a possible source of data scatter [5]. Only a proper multiexponential analysis can have diagnostic utility [4,6]. All T_1 and T_2 curves were non-single-exponential and well fitted by wide distributions of exponential terms, having significant widths and not compatible with single lines [7,8]. All T_1 distributions showed major peaks with of the order of 90% of the signal centered at about 800 ms and tails at shorter times. The T_2 data corresponded to one broad peak covering up to two decades. Several kinds of relaxation time averages were computed to compare the distributions. The T_1 averages and the longest relaxation times computed from two-exponential fits for the tumor are not distinguishable from

those from lower resection margin, but they are significantly larger than those for the upper resection margin. The T_2 averages do not distinguish among groups. A distribution width parameter shows that the tumor samples have T_1 and T_2 distribution widths significantly narrower than those of both resection margin samples. This appears to suggest a narrower distribution of the environments affecting ^1H relaxation in tumor than in non-tumor samples. These results demonstrate the sensitivity of the multiexponential analysis and stress the criticality of data taking and processing.

[1] Adam I.J., Mohamdee M.O., Martin I.G., *et al.* Role of circumferential margin involvement in the local recurrence of rectal cancer *Lancet* 344: 707-711, 1994.

[2] Borgia G.C., Bortolotti V., Brown R.J.S., Castaldi P., Fantazzini P., Soverini U. A comparison among different inversion methods for multiexponential MR relaxation data. *Magn Reson Imaging* 12: 209-212, 1994.

[3] Fantazzini P., Sarra A. A comparison of the proton relaxation in human epithelial tumors and associated uninvolved tissue. *Mag Reson Mater* 2: 405-407, 1994.

[4] Fantazzini P., Sarra A. ^1H spin-lattice relaxation parameters in the length of human intestine resected for cancer. *Mag Reson Mater* 4 in press, 1996.

[5] Bottomley P.A., Hardy C.J., Argersinger R.E., Allen-Moore G. A review of ^1H magnetic resonance relaxation in pathology: are T_1 and T_2 diagnostic? *Med Phys* 14: 1-37, 1987.

[6] Graham S.J., Stanchev P.L., Bronskill M.J. Criteria for analysis of multicomponent tissue T_2 relaxation data. *Magn Reson Med* 35: 370-378, 1996.

[7] Brown R.J.S., Borgia G.C., Fantazzini P., Mesini E. Problems in identifying multimodal distributions of relaxation times for NMR in porous media. *Magn Reson Imaging* 9: 687-693, 1991.

[8] Brown R.J.S. Information available and unavailable from multiexponential relaxation data. *J Magn Reson* 82: 539-561, 1989.

P-131-B

EFFECTS OF TIME-VARYING STRONG MAGNETIC FIELDS ON K^+ UPTAKE THROUGH Ca^{2+} DEPENDANT K^+ CHANNELS. K.H. Park¹, T. Ikehara², Y. Kinouchi¹, H. Yamaguchi² and H. Miyamoto³. ¹Department of Electrical and Electronic Engineering and ²Department of Physiology, The University of Tokushima, ³Tokushima Bunri University, Tokushima 770, Japan.

OBJECTIVE: It is a basic and important problem to examine effects of magnetic fields on ion transportations through cell membrane. We reported that time-varying (intermittent) strong magnetic fields inhibited significantly K^+ influx in the Na^+ pump of HeLa cells [Yamaguchi *et al.*, "Elec. Mag. in Bio. Med." (Ed. Blank), 1993]. Here, the effects of the magnetic fields on K^+ uptake through Ca^{2+} dependent K^+ channels are successively examined.

MATERIALS AND METHODS: Time-varying magnetic fields is a field changing intermittently between 0.07 and 1.6 T by switching an electromagnet with time interval 6 seconds

(3 seconds for on and off time respectively). HeLa S3 cells cultured in 3.5 cm dishes are provided for experiments. The maximum induced currents at the point of half diameter of the dish is about 25 mA/m². To facilitate K⁺ influx through Ca²⁺ dependent K⁺ channels, a medium of high K⁺ concentration (K⁺: 145 mM, Na⁺: 1mM) containing 25 mM Hepes buffer (pH 7.2) is used. Resultant K⁺ uptake consists of the influxes through the K⁺ channel and the other channels. To separate the influxes, we also experiment using a 0.3 mM quinine added medium, which suppresses the activity of the Ca²⁺ dependent K⁺ channel uniquely. Experimental groups are exposed to the fields during one and two hours. When exposed for one hour, HeLa cells are cultured in a high K⁺ medium. For the case of two hours, they are cultured for one hour in a high K⁺ medium after cultured for one hour in a normal medium.

RESULTS AND DISCUSSION: Fig. 1 shows experimental results. Comparing the influx for normal medium (A), that for high K⁺ medium (B) increases about 2 times (1 hour culture) and 1.5 times (2 hours culture). When exposed to the magnetic fields for high K⁺ medium (D), K⁺ uptake is inhibited significantly in both culture times as compared with the control groups (B). On the other hand, when the Ca²⁺ dependent K⁺ channels are suppressed by quinine, the influxes of the non-exposure control group (C) and the exposure group (E) show no significant difference though inhibited as compared with experiments B and D due to less activity of the K⁺ channels. It may be therefore suggested that the time-varying strong magnetic fields inhibit the K⁺ influx through the Ca²⁺ dependent K⁺ channels. This may be caused by the change of cell surface charge due to the induced currents and the change of Ca²⁺ concentration in the cell.

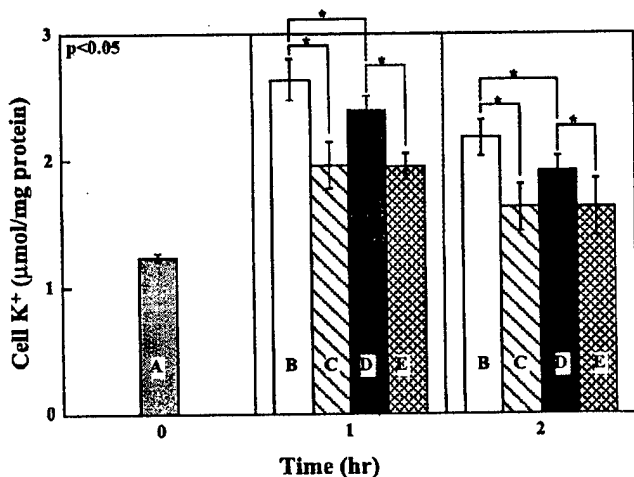

Fig. 1. Effects on K⁺ influx into HeLa cells of exposure to intermittent magnetic fields. (A) Normal medium. (B) High K⁺ medium. (C) High K⁺ medium + quinine 0.3mM. (D) High K⁺ medium + magnetic fields. (E) High K⁺ medium + magnetic fields + quinine 0.3mM.

*significant difference

P-132-C

INTERFACE WATER CONVECTION IN MEMBRANE SYSTEMS UNDER EXTRA HIGH FREQUENCY IRRADIATION. K.D. Kazarinov¹, A.V. Putvinsky² and V.S. Malinin¹. ¹Institute of Radioengineering and Electronics, Russian Academy of Science, Moscow 103 907, Russia. ²Russian State Medical University, Moscow, Russia.

Effects of low intensity extra high frequency (EHF) irradiation on artificial and biological membrane systems were investigated. Electric resistance and ionic permeability of BLM, frog skin potential, rate of lipid peroxidation (LPO) of liposome suspension, and O₂ transfer in water were used as models for studying of EHF irradiation effects. Analysis of these effects with respect to possible role of membrane unstirred layers as a limiting stage of membrane transport was made.

Direct measurements of the interface convection (Maragoni effect) in water layers absorbing EHF irradiation by laser interferometric and polarographic techniques confirm our speculations. It is supposed that thermal water convection in thin layer because of EHF absorption reduces membrane unstirred layers and increases ion and oxygen transport.

P-133-A

IN VIVO ION EFFLUX FROM HUMANS USING AN APPLIED ELECTRIC FIELD AND THE RELATIONSHIP TO SKIN IRRITATION. J.B. Phipps, M. Cormier and R. Padmanabhan. ALZA Corporation, Minneapolis, Minnesota 55432, USA.

Extraction of glucose through the skin of human subjects, resulting from an externally applied electric field, has been the focus of considerable research in recent years [1]. Prior to this research, the extraction of endogenous inorganic ions from the body had been demonstrated. In 1954, Benjamin *et al.* [2] investigated the extraction of sodium and potassium from the human skin *in vivo*. Phipps and Gyory [3] later provided evidence that the rate of extraction of sodium (i.e., sodium efflux) from humans *in vivo* was linearly dependent on current, that the sodium transport number was not dependent on current density, and that the stratum corneum did not affect the rate of extraction under galvanostatic conditions.

In this poster, measurements of the cathodic extraction of potassium from humans *in vivo* during iontophoretic treatment, using formulations with a variety of pH values, will be presented. Low pH formulations at the cathodic site were found to be less irritating than formulations of pH 6 and greater. As indicated by the data summarized in the table, a strong correlation was observed between skin irritation (i.e., skin redness or erythema) and potassium efflux, suggesting a causative link. Measurement of potassium efflux may therefore provide a new method for quantifying skin irritation and for improving iontophoretic formulation and waveform conditions. In addition, alteration of treatment conditions (e.g., current and pH) in response to sensor

feedback about the rate of potassium efflux may provide a method for minimizing irritation [4].

Mean skin irritation and potassium efflux values as a function of cathodic reservoir pH for six human subjects.

CATHODIC RESERVOIR pH	SKIN IRRITATION (red hue)	POTASSIUM EFFLUX ($\mu\text{g h}^{-1} \text{cm}^{-2}$)
3.5	0.2	2.1
4.2	0.6	2.0
6.7	2.6	13.4
8.9	2.6	18.6

- [1] Tamada, J. A., Bohannon, N. J. V. and Potts, R. O., *Nat. Med.*, 1 1198-1201 (1995)
 [2] Benjamin, F. B., Kempen, R., Mulder, A. G. and Ivy, A. C., *J. Appl. Physiol.*, 6 401-407 (1954)
 [3] Phipps, J. B. and Gyory, J. R., *Advanced Drug Delivery Reviews*, 9 137-176 (1992)
 [4] Phipps, J. B., US Patent No. 5,533,971, 9 July 1996

P-134-B

HYDROGEN PEROXIDE TOXICITY IS ATTENUATED BY PHARMACOLOGICAL CONCENTRATIONS OF MELATONIN. W.S. Baldwin and J.C. Barrett. Laboratory of Molecular Carcinogenesis, National Institute of Environmental Health Sciences, Research Triangle Park, North Carolina 27709, USA.

Electromagnetic fields reduce the quantity of melatonin, an indolic hormone, produced by the pineal gland. Melatonin has been demonstrated to be oncostatic, and it has been proposed that reduced melatonin levels may be a mechanism for the putative association between breast cancer and electromagnetic fields. Furthermore, melatonin has been shown to be an oxygen radical scavenger and this may be one mechanism in which this hormone can elicit its oncostatic effects. 400 μM hydrogen peroxide killed 97% of plated MCF-7 cells within 8 hours. Melatonin at 10 and 100 μM concentrations protected MCF-7 cells from hydrogen peroxide-induced death. At these concentrations only 76% and 64% of cells, respectively were killed by hydrogen peroxide; an increase in number of live cells by approximately 18X.

Fig. 1. Toxicity of hydrogen peroxide to MCF-7 cells in the presence of melatonin.

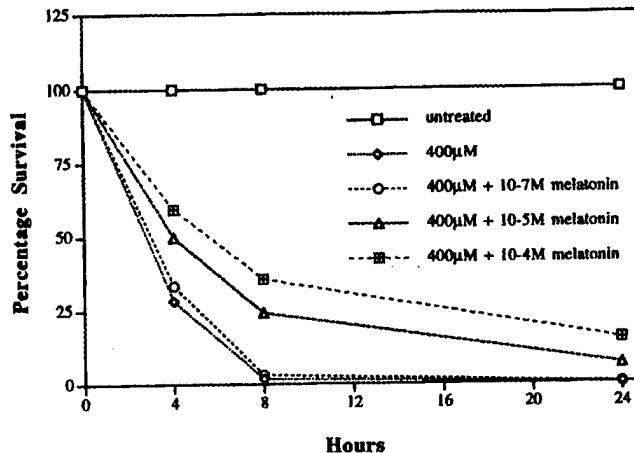

However, melatonin did not protect MCF-7 cells at physiological concentrations (0.3nM). Moreover, melatonin pre-treatment prior to hydrogen peroxide stress offered no further efficacy, and pre-treatment of melatonin followed by melatonin withdrawal eliminated melatonin's protective effect from hydrogen peroxide. This work indicates that melatonin acts directly as an anti-oxidant and does not induce enzymes important in radical scavenging or glutathione levels in MCF-7 cells. Glutathione levels were examined to substantiate this hypothesis, and they were not increased by melatonin treatment. Currently, we are examining lipid peroxidation as an indicator of oxidative stress during low level stressors to see if melatonin acts to protect cells under these conditions. Our present research suggests that melatonin is an excellent oxygen radical scavenger at pharmacological concentrations, but not at concentrations measured physiologically. Thus, electromagnetic fields would not cause perturbations in normal oxidative scavenger mechanisms in MCF-7 cells.

P-135-C

INFLUENCE OF ELECTRIC 50 Hz FIELDS ON THE PMA ACTIVATED RESPIRATORY BURST REACTION OF HUMAN NEUTROPHILS. J. Brix¹, W. Kaffenberger² and C. Egblomassé¹. ¹Institute for Radiation Hygiene, Federal Office for Radiation Protection, Oberschleissheim, Germany. ²Institute of Radiobiology, Federal Armed Forces Medical Academy, Munich, Germany.

Weak low frequency electromagnetic fields can modulate biological signal transduction pathways. It is hypothesized that the cell membrane is the target of this field interaction. There is little knowledge, how low-energy electromagnetic fields can initiate or modulate enzyme cascades. In this study modulation on a biological system which uses free radical reactions is analyzed after 50 Hz electric field exposure. Human polymorphonuclear leukocytes (granulocytes) undergo a respiratory burst reaction (RB) in response to appropriate particulate and/or soluble stimuli. During this event, the membrane-bound "respiratory burst oxidase" initiates the production of reactive oxygen species with microbicidal and/or tumoricidal activities. The oxidase can also be activated by phorbol myristate acetate (PMA). The electric

field may affect the PMA-stimulated RB, as measured by flow cytometry with the fluorescent dye DCFH. The fluorescence intensity of the cells serves as a marker for the amount of reactive oxygen species (H_2O_2) produced.

METHODS: Granulocytes were isolated from the heparinized whole blood of 36 healthy volunteers by Ficoll separation and hypotonic lysis of erythrocytes. Exposure was performed in two identical rectangular chambers, where two agar blocks (containing the electrodes) enclosed the cell suspension of 10 ml with a homogeneous 50 Hz electrical fields of 200 V/m (current density of 28 A/m²), 10 V/m (1,4 A/m²) or 1 V/m (140 mA/m²). During the experiment, the actual voltage/current was monitored. The RB assay has been described in detail (Kaffenberger *et al.*, *Clin. Immunol. Immunopathol.* 64, 57-62, 1992). The cells were loaded (15 min) with the dye DCFH (5 μ M, dichlorofluorescein-diacetate) and transferred to the chambers. Aliquots (1 ml; 10⁶ cells) were removed from each chamber before and after 2 hours of exposure time. After reading the baseline fluorescence, the suspensions were split for stimulation of the RB with PMA (100 ng/ml) - or with buffer (PBS; "sham-stimulation") as a measure of the endogenous RB activity. The cells were analyzed on a FACS analyzer flow cytometer (Becton Dickinson). The mean fluorescence intensity of 5,000 cells was determined 0, 5, 10, 15 and 45 min after stimulation.

RESULTS: The changes in fluorescence intensities induced by PMA stimulation, showed a great variability between samples of different donors as well as different samples from the same donor. The mean fluorescence intensity induced by PMA generally increased with time elapsed after stimulation. The total respiratory burst capacity however decreased with incubation time. The fluorescence signals showed high standard deviations. The same was true for the control samples not exposed to the electric field. A comparison showed a slight overall tendency of higher fluorescence intensity for the exposed cells. However, this tendency was not systematically correlated to the field strength. Granulocytes, which had been exposed 2 h at 200 V/m had significant lower fluorescence intensities before the onset of the PMA reaction ($t = 0$). After the onset, the mean value of the fluorescence intensity of the 12 trials did not change but the standard deviation was significantly larger. The maximum values and the 75% percentile were higher compared to the PMA stimulated cells without electric field exposure. Also, the field exposed cells which were chemically sham stimulated with PBS showed a broader intensity distribution than the PBS treated, non exposed cells. With 10 V/m, at $t = 0$ and PBS stimulated granulocytes showed a lower, field-evoked, endogenous RB capacity. The PMA stimulated cells showed a lower median value after the exposure. With 1 V/m no effect on the granulocytes could be seen.

CONCLUSION: These experiments show that electrical 50 Hz fields can influence a protein kinase C-dependent signal transduction pathway, in that the normally broad variability is enhanced. The reduced field-evoked endogenous capacity of RB has no influence to produce oxygen radicals of the important immune function which here is triggered by PMA. With 1 V/m, corresponding to a current density of 140

mA/m² (protection limit 2 mA/m² for ELF) no field effect can be seen. We conclude, that this immune reaction of the granulocytes, is not altered by environmental low frequency electromagnetic fields.

P-136-A

INFLUENCE THE GEOMAGNETIC FIELD ON BIOMEMBRANES PERMEABILITY AND BIOLOGICAL RHYTHMICS. A.P. Dubrov. The International Informatization Academy, Moscow, Russia.

The Geomagnetic Field (GF) is a main geophysical synchronizer of biological rhythms. There is a direct relation with the high level correlation ($r = 0,9$) between the diurnal vector variations of the GF (Inclination I and Declination D) and a diurnal variations of a cell membrane permeability to an ions, gases, un-and organic molecules and physiological processes in plants, animals and human organisms.

A magnetic storms change suddenly a cell permeability and cause heart attack, cerebral and hypertonial crises, sudden deaths. To prove the validity of our conclusions it ought to compare a daily variations of I (in thousand parts of degree!) and D (in minutes) with a circadian rhythms of any physiological parameters (in 24-hour scale!) at the same exact time on GMT and datum when the studies were done. A hourly values of the I-and D-component of the GF must be taken from the geophysical observatory what is a nearest to a location of site of a study.

For a study of this problems it needed to make of a synchronous experiments in different points of the Earth and to open Basic Global Stations (BGS) to keep lookout of influences of cosmic factors on living beings and human by using of standard methods of researches: physiological (EEG, ECG, SER, SGR, skin potential etc.), physical & chemical (studies of different parameters of water, liquid crystals, membranes etc.), medical statistics (dynamics of cardiovascular diseases, death rate etc.).

BGS should be created as a world network by using of Departments of physics and a human (animals) physiology at different Universities of world and working in close contact with regional a geophysical organizations (observatories, institutes). Our ideas about BGS and a main results of the problems was published in the book: *Geomagnetic Field and Life. Geomagnetobiology*. New York, Plenum Press Corp., 1978.

P-137-B

EFFECTS OF MAGNETIC FIELDS ON Ca^{2+} SIGNALING IN SAPONIN-PERMEALIZED RABBIT PULMONARY ARTERIAL RINGS. J.Y. Su. Department of Anesthesiology, University of Washington, Seattle, Washington 98195, USA.

In Jurkat cells, a magnetic field (MF) of 50 Hz at 0.1 mT induces Ca^{2+} oscillations (Lindstrom, *et al.*, *Bioelectromagnetics* 16:41-47, 1993) via the intracellular

signal transduction pathway. We hypothesized that intracellular Ca^{2+} signaling in vascular smooth muscle is also affected by the magnetic field. We tested the hypothesis by studying the effects of an MF emitted from a video display terminal (22 kHz) compared with emissions from a powerline (60 Hz) on the alpha adrenergic receptor/G protein/phospholipase C/second messengers (diacylglycerol and IP_3) signal pathway.

The effects of an MF on norepinephrine (NE)-induced tension transients in saponin-skinned (sarcolemma-permealized) pulmonary arterial rings of the rabbit were studied. The skinned rings were immersed sequentially in four solutions to load Ca^{2+} into and to release Ca^{2+} from the sarcoplasmic reticulum (SR) using 10 μ M NE, resulting in a tension transient (a load-release cycle) (Su & Zhang, *Anesthesiology* 71:408-417, 1989). Six cycles were performed in each ring: one ring exposed continuously to an MF (test) except the first cycle, and another without (time-control). The MF emitted from a computer or from a powerline was detected by a specific radiation survey meter which was delivered through two coils placed between the test rings. The area of the tension transient generated by NE was used as an estimate of the amount of Ca^{2+} released from the SR. ANOVA was used to analyze the significance of the effects of the MF with respect to time and intensity of the MF. The results showed that NE-induced tension transients decreased with respect to time in control rings. These decreases in tension transients were significantly accelerated in rings exposed to 0.375 μ T and to a greater extent in those exposed to 0.875 μ T of 22 kHz, and were significantly retarded in rings exposed to 0.1 mT or even prevented in those exposed to 1 mT of 60 Hz.

In summary, an MF of 22 kHz induces a slow Ca^{2+} release or inhibits one or more steps in the NE signal pathway resulting in a decreased tension transient in skinned pulmonary arterial rings. In contrast, an MF of 60 Hz causes a direct Ca^{2+} release or activation of Ca^{2+} signaling contributing to an enhanced tension transient, which is in agreement with results observed in Jurkat cells.

Supported by a contract from Johns Hopkins University and in part by NIH-GM48243.

P-138-C

A STUDY ON THE EFFECTS OF 10GHz MICROWAVE RADIATION ON NICOTINIC ACETYLCHOLINE RECEPTOR ION CHANNELS. J.E.H. Tattersall. Medical Countermeasures Department, CBD Porton Down, Salisbury, Wiltshire SP4 0JQ, United Kingdom.

Exposure to 10GHz microwave radiation at field strengths as low as $50\mu W.cm^{-2}$ has been reported to decrease the opening frequency of nicotinic acetylcholine (ACh) receptor ion channels in cultured chick myotubes (D'Inzeo *et al*, 1988). I have attempted to replicate these results using both cultured myotubes and dissociated muscle fibres.

Dissociated flexor digitorum brevis muscle fibres were prepared from adult Porton strain mice as described previously (Tattersall, 1991). Myotubes were cultured from

10 day old chick embryos as described by D'Inzeo *et al* (1988). Single channel currents were recorded at room temperature (20°C) in cell-attached patches using pipettes pulled from borosilicate glass and filled with physiological saline containing ACh (100-300nM).

Initial microwave exposures were performed as described by D'Inzeo *et al* (1988), using a Gunn generator (Philips PM7015X) and a horn antenna with a gain of 16dB (Philips PM7320X). This was fixed at approximately 25cm from the sample at an angle of 30° with respect to ground, with the E-field lying on the plane of incidence. Using this apparatus, no significant changes could be found in frequency of opening or open probability of the channels in either preparation during exposures of up to 10 minutes duration.

Later exposures were performed using a Hewlett Packard 8648C synthesized signal generator connected to a parallel plate waveguide exposure apparatus (Tattersall *et al*, 1996). This system produces a more constant field and is less susceptible to perturbation by the recording apparatus than the horn antenna. Exposures in this apparatus also produced no significant changes in opening frequency or open probability of ACh-activated ion channels in chick myotubes.

These experiments have failed to confirm the results of D'Inzeo *et al* (1988). The reason for the discrepancy is not clear. Since D'Inzeo *et al* demonstrated an increase in the rate of receptor desensitisation during exposure to microwaves, it is conceivable that differences in desensitisation could account for some of the discrepancy. This seems unlikely, however, since the present study followed their experimental procedures as closely as possible, and the rundown of channel opening frequency with time after patch formation suggested that the receptors were not greatly desensitised. Further experiments are planned to investigate receptor desensitisation and the effects of other frequencies of radiation.

References:

D'Inzeo G, Bernardi P, Eusebi F, Grassi F, Tamburello C & Zani BM (1988). *Bioelectromagnetics* 9: 363-372.

Tattersall JEH (1991). *Br. J. Pharmacol.* 101: 349-357.

Tattersall JEH, Baldwin PJ, Wood S and Crisp G (1996). *J. Physiol.* 495P: 6P.

Supported by the Ministry of Defense.

P-139-A

EXPERIMENTAL FACTORS AFFECTING DIELECTRIC SPECTROSCOPY MEASUREMENTS ON CELL SUSPENSIONS OF CHINESE HAMSTER FIBROBLASTS. G.F. Mariutti, A. Polichetti and R. Pozzi. Laboratorio di Fisica, Istituto Superiore di Sanità, I-00161 Rome, Italy.

Dielectric spectroscopy can be a suitable technique to study some properties of biological media, in particular ion exchange across cell membrane. To investigate this phenomenon we performed several series of complex conductivity measurements in the 10 kHz - 500 MHz frequency range on cell suspensions during and after physical treatments. However, various experimental factors and

procedures may alter the results of such measurements. This becomes a really serious problem when, due to the time course of the effect under investigation, conductivity measurements should be carried out repeatedly on the same sample for many hours. This paper describes our work to overcome such problems in order to obtain reliable and reproducible measurements in a large time scale.

The experimental setup consists of a computer controlled double channel Hewlett-Packard Model 4195A Network Analyzer, two temperature controlled cylindrical terminations, operating as sample holders and measuring cells, and two water-bath thermostats. A single frequency sweep from 10 kHz to 500 MHz lasts two seconds and 0.4 ml is the minimum volume of the biological sample.

We investigated the dielectric properties of suspensions of Chinese Hamster fibroblasts V-79 before, during and after hyperthermic treatments at different temperatures. When suspended into a buffer these cells have a spherical shape and exhibit in the RF spectral region a dielectric relaxation, the well known β -dispersion, due to interfacial polarization phenomena at boundaries which separate regions of different dielectric properties, namely, the cytoplasm, the very little conductive cell membrane and the buffer. One of the parameters characterizing the β -dispersion is the increment of conductivity $\Delta\sigma$ from low to high frequency endpoints. Hyperthermic treatment produces a remarkable decrease of cell suspension conductivity at low frequency while the conductivity at high frequency remains rather constant. Such reproducible results, within many hours, have been obtained when the measuring cell has been modified to preclude evaporation of the buffer during the whole time course of measurements. In the first part of our experimental work, samples under measurements were a 30% volume of cells in PBS buffer. To avoid the effects of cell sedimentation on the electric parameters of the suspension, before each measurement the sample was gently pipetted twice, to obtain an homogenous dispersed phase, by means of a particular pipetting system. When this procedure is repeated many times, a progressive increase of cell suspension conductivity, in particular at low frequencies, and even the disappearance of the β -dispersion can be observed. Further experiments demonstrated that after heat administration the cell membrane becomes extremely susceptible to any mechanical stress. The observed increase of cell suspension conductivity after hyperthermia, according to our view, is a combined effect of heating and pipetting. For this reason, we decided to perform measurements on samples obtained by centrifuging cell suspensions directly in the measuring cell. By adopting this experimental procedure, we obtained reliable and reproducible results.

P-140-B

EFFECT OF EXTREMELY LOW FREQUENCY (ELF) MAGNETIC FIELD EXPOSURE ON MORPHOLOGICAL AND BIOPHYSICAL PROPERTIES OF HUMAN LYMPHOID CELL LINE (RAJI). D. Pozzi², N. Santoro¹, A. Lisi¹, E. Pasquali³, A.L. Serafino¹, L. Giuliani⁴, M. Vignati⁴ and S. Grimaldi¹. ¹Istituto di Medicina Sperimentale and ³Istituto di Psicologia, CNR, 00137 Roma, Italy. ²Dipartimento di Medicina Sperimentale e Patologia, Università La Sapienza, Rome, Italy. ⁴I.S.P.E.S.L., Dipartimento di Impatto Ambientale, 00184 Roma, Italy.

Human B lymphoid cells Raji after exposure for 72 hrs to 50 Hz sinusoidal magnetic field at a density of 2 milli Tesla (rms) showed a decrease in membrane fluidity detected by Laurdan emission spectroscopy and DPH fluorescence polarization. Field exposure also resulted in a reorganization of cytoskeletal components. Scattering electron microscopy (SEM) evidenced a loss of microvilli in the exposed cells. This change in plasma membrane morphology was also accompanied by a different actin distribution, as detected by phalloidin fluorescence using a confocal microscopy. We also present evidence that EMF exposure of Raji cells can interfere with protein kinases activity, since after ³²P incubation the cells exposed to the field showed a different pattern in protein phosphorylation compared to sham exposed cells. Our observations strongly suggest the hypothesis that electric and magnetic fields may modify the plasma membrane structure and interfere with the initiation of the signal cascade pathways.

P-141-C

LOCATION OF MOLECULAR TRANSPORT ROUTES THROUGH HUMAN, HAIRLESS RAT, AND SHED SNAKE SKIN DURING HIGH VOLTAGE PULSING AND IONTOPHORESIS. T. Chen¹, R. Langer¹ and J.C. Weaver². ¹Department of Chemical Engineering, ²Division of Health Sciences and Technology, Massachusetts Institute of Technology, Cambridge, Massachusetts 02139, USA.

Applying a series of high voltage pulses (~1 ms, ~100 V_{skin}) to human skin has been previously shown to cause molecular transport to occur¹. This technique could be used to deliver drugs through the skin. However, the regions in the skin where transport occurs has not been well-characterized. The purpose of this study is to determine where transport regions occur during high voltage pulsing, to compare high voltage pulsing with iontophoresis. Previous studies have shown that during iontophoresis (small DC current, ~1 mA/cm²) of human skin, significant molecular transport occurs across hair follicles².

Either high voltage pulsing or iontophoresis was applied to human epidermis, hairless rat epidermis, or shed skin from the black rat snake (*Elaphe obsoleta*). Both hairless rat and snake skin have previously been used as models of human skin. Hairless rat skin, despite the name, contains more hair

follicles than human skin³, while shed snake skin does not contain any hair follicles⁴. Thus, the effects of hair follicles on pathway formation could be studied.

Prepared skin from one of the sources was loaded into diffusion chambers, water jacketed at 37°C. Two fluorescent compounds, calcein (623 Da, charge -4) and sulforhodamine (607 Da, charge -1), in phosphate-buffered saline (PBS), were placed in the donor compartment. The receptor compartment was filled with PBS. After 1 h of either pulsing or iontophoresis, the skin was removed and examined under a fluorescence microscope to determine where the fluorescent compounds were located. The location of the fluorescent compounds in the skin would indicate regions where molecular transport had occurred. Also, the receptor compartment was measured for fluorescence to determine if molecular transport had occurred.

Applying iontophoresis caused the fluorescent compounds to appear near hair follicles in human and hairless rat epidermis, as viewed by fluorescence microscopy. Fluorescence of the receptor chamber after the experiment indicated that molecular transport had occurred. In contrast, iontophoresis of shed snake skin, which does not contain hair follicles, did not cause fluorescent compounds to appear in the skin under fluorescence microscopy. The receptor chamber did not show significant fluorescence after the experiment. Iontophoresis thus appears to cause molecular transport near hair follicles, in agreement with the literature². When high voltage pulsing was applied to human and hairless rat epidermis and shed snake skin, fluorescence microscopy showed small regions where the fluorescent molecules were located. These regions were distributed around the skin, and were not associated with hair follicles or sweat ducts. These regions appear similar to the LTRs previously reported in human epidermis after high-voltage pulsing⁵. Fluorescence of the receptor compartment also indicated that molecular transport had occurred during pulsing.

Thus, high voltage pulsing causes molecular transport to occur in localized transport regions across human, rat, and snake skin. In contrast, iontophoresis causes transport to occur across hair follicles in human and rat skin, but not in snake skin, which lacks hair follicles.

1. Prausnitz, M.R., V.G. Bose, R. Langer, and J.C. Weaver. "Electroporation of mammalian skin: A mechanism to enhance transdermal drug delivery." *Proc. Natl. Acad. Sci. USA*, 90: 10504-10508, 1993.
2. Scott, E.R., A.I. Laplaza, H.S. White, and J.B. Phipps. "Transport of ionic species in skin: Contribution of pores to the overall skin conductance." *Pharm. Res.*, 10: 1699-1709, 1993.
3. Bronaugh, R.L., R.F. Stewart, and E.G. Congdon. "Methods for *in vitro* percutaneous absorption studies. II. Animal models for human skin." *Toxicol. Appl. Pharmacol.*, 62: 481-488, 1982.
4. Itoh, T.J. Xia, R. Magavi, T. Nishihata, and J.H. Rytting. "Use of shed snake skin as a model membrane for *in vitro* percutaneous penetration studies: Comparison with human skin." *Pharm. Res.*, 7: 1042-1047, 1990.
5. Pliquet, U.F, T.E. Zewart, T. Chen, R. Langer, J.C. Weaver. "Imaging of fluorescent molecule and small ion

transport through human stratum corneum during high voltage pulsing: Localized transport regions are involved." *Biophys. Chem.*, 58: 185-204, 1996.

P-142-A

STUDY OF ELECTROCHEMICAL PROCESSES WHICH TAKE PLACE DURING CELL ELECTRO-MANIPULATION PROCEDURES. G. Saulis¹ and D. Mickevicius^{1,2}. ¹Department of Biology, Vytautas Magnus University, Kaunas 3000, Lithuania. ²Department of Chemistry and Chemical Technology, Kaunas University of Technology, Kaunas 3000, Lithuania.

Exposure of cell suspension to strong electric fields (up to 30 kV/cm) leads to the formation of transient aqueous pores in the cell membrane. However, an electrically induced cell membrane perturbation is not the only consequence of the exposure of cell suspension to a strong electric field. When an electric current passes through the aqueous solution various chemical reactions occur at the electrodes. These processes lead to the changes of the temperature, pH, and the chemical composition of the experimental medium. Here some of the electrolysis effects, namely, the change of the pH of a solution during the exposure to an electric pulse and the release of metal ions from the electrodes, are studied.

The change of the pH of a NaCl solution buffered with 5-15 mM sodium phosphates (pH 7.4) during electromanipulation was studied. It has been determined that an increase in the pH value of electroporation solution of a whole chamber volume, caused by the application of an electric field pulse, can exceed 1-2 pH units.

Several materials for the cathode were tested. The aluminum cathode gave two-fold greater Δ pH in comparison with platinum, copper or stainless steel cathodes. It has also been found that the conductivity of the solution is an important factor. The change of the pH of the solution, in which sucrose was substituted for NaCl, was about 5 times less.

In addition, the change of the chemical composition of a medium due to the release of metal ions from the anode was studied. A substantial release (up to 1 mg l⁻¹) of the ions of aluminum from the aluminum anode and the ions of iron and chromium from the stainless steel anode was found. A dissolution of the aluminum cathode was observed too.

P-143-B

TEMPERATURE AND STATIC MAGNETIC FIELD COMBINED ACTION ON SURFACE ELECTRIC CHARGE ON ERYTHROCYTE MEMBRANE. L.L. Traikov¹, M.A. Kuzmanova¹ and M.S. Markov². ¹Department of Biophysics and Radiobiology, Sofia University, Sofia, Bulgaria. ²Bioelectrochemistry Laboratory, Mount Sinai Medical Center, New York, New York, USA.

It has been shown that static magnetic field can initiate alterations in the membrane and cellular activity. These changes strongly depend on the physiological state of

biomembranes as well as on the presence of certain chemical agents and the temperature as a extracellular factor, which can modulate membrane functioning.

This study was designed to search for reorganization in the surface electric charge as a changes in electrophoretic mobility (EPM), when static magnetic field (MF) was applied consequently and combined with different temperatures (20°, 25°, 39°C). All measurements was applied to a suspension of red blood cells taken from healthy volunteers.

We had been used lectins as a extracellular probe (in concentration 100-200 µg/ml), because it is well accepted that the lectin binding is a good indicator for the alterations in the membrane architecture and on the surface electric charge in particular. Lectins have large positive charge, which can modified negative electric charge of the membrane (decreasing of EPM after lectin binding).

This study explores the advantages of the immunochemical and biophysical methods for evaluation of changes that occur in the erythrocyte membrane under static magnetic field action.

Magnetic fields (MF) 5 mT generated by the system MS-2 was applied at three temperature intervals (20°, 25°, 39°C), which corresponds with state transitions in the membrane.

It has been found that combined action on MF and temperature treatment, can modify electric properties of the membrane in the way where temperature alone decrease EPM effect which is two times large than the effect of lectin binding. As oppose MF can increase EPM and modify the effects of temperature action as a arranged action. We assume that magnetic field can affect the surface electric charge and on the specific antigen determinants situated on the membrane surface. Therefore investigation of membrane electrical parameters provides substantial information about changes in the protein and lipid domain distribution as well as configuration changes in protein-protein and protein-lipids associates.

P-144-C

NERVOUS IMPULSE IN CONSTANT MAGNETIC FIELD. L. Ovchinnikov, A.N. Volobuev, L.A. Trufanov and N.Y. Khokhlova. Samara State Medical University, 443079 Samara, Russia.

INTRODUCTION: Experimental fact of membrane's Restion potential decrease [3] in the conditions constant magnetic field (CMF) was marked. But the biophysical explanation of this effect was not conducted. In work the purpose is put: to demonstrate, to which changes membraneous potential result magnetic applications?

METHOD: In our researches CMF was created with help of electromagnet. The magnetic induction inside solenoid was homogeneous, constant in particular experiment and could be adjusted in range from 0 up to 85 mT. The circuit of experiment is submitted in [2]. Oscillograms of nervous impulse after amplification were registered by loop oscillograph (500 mm/s). Simultaneously with the nervous impulse made record of stimulating signal and timesignal.

RESULTS: Are below indicated oscillograms of experiments

at stimulation of ischiadicus nerve of the healthy person. In the absence CMF small stimulating signal (fig. 1, a) cause occurrence nervous impulse of Ia group fibres. The greater stimulus cause nervous impulses and other groups of fibres (fig. 1, b) in addition. In conditions CMF two effects are observed simultaneously: (1) irritant signals cause occurrence of nervous impulses of various groups of fibres; (2) slowing down of nervous impulse transferring rate [2] is observed (fig. 2, b).

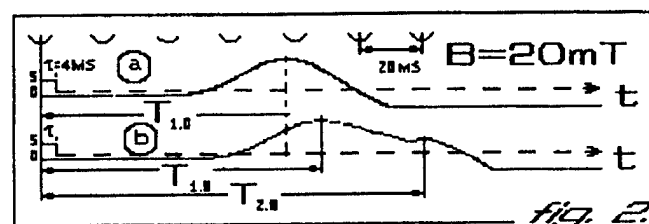
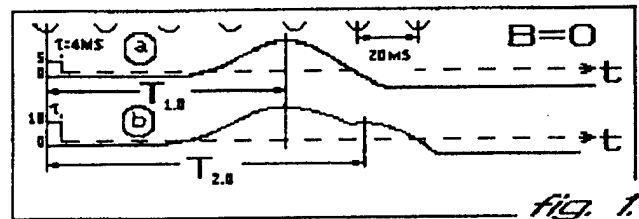

DISCUSSION. We for biophysical description of CMF influence on nervous impulse, membraneous potential's electrogenes and nervous impulse transferring rate shall consider movement of ion with rate V and charge q in biological membrane by thickness l and internal radius R from the power attitude. On such charge in CMF with induction B Lorentz force $f_L = q V B$ acts, the work which at movement of the ion through membrane is the CMF energy $dE = dA = f_L R d\psi$ marking, that the ionic trajectory driven through membrane in CMF can be approximated logarithmic spiral $r = R \exp(\psi/a)$, where $a = q u B$, u - ionic mobility, we receive expression for relative rate V_r nervous impulse in CMF $V_r = (1 + a^2)^{1/4}$. Whence follows: the nervous impulse transferring rate in CMF is reduced. This and there meets comparison of experiments (fig. 1, b and fig. 2, b). Thus energy CMF at membraneous potential U and for one mol z -valency ions:

$$E = a f_L l = a q U = a z F U,$$

where F - Faraday's constant. Then value of membraneous Restion potential Φ_r in CMF is possible to demonstrate, that at ionic permeability P and their concentration c_{ii} and C_{oi} (inside and outside of nervous fibre accordingly)

$$\Phi = RT / [(1 + a) zF] \ln \left[\frac{\sum(P_i c_{ii})}{\sum(P_i c_{oi})} \right]$$

This formula testifies: in CMF Restion potential and consequently, and the critical level of potential depolarization decreases in inverse proportion $1 + a = 1 + quB$. This and there corresponds the experimental fact (fig. 1, b and fig. 2, b).

CONCLUSION: The change of the normal ionic parity inside and outside of nervous fibre is possible [1]. It in some cases provokes occurrence of spontaneous potential of action and explains direct effect CMF on biological tissue. Just the redistribution of ions in CMF is those primary gear, due to

which CMF influence on processes in live organism is executed.

References:

1. Adey W.R. Slow electrical phenomena in the central nervous system. Report on NRP work session. Jan., 1966: *Neurosci. Res. Progr. Bull.* 1969. V. 7. P. 75-180.
2. Ovchinnikov E.L., Volobuev A.N., Trufanov L.A., Romanchuk P.I. Constant magnetic field dosimetry. *11th Intern. Zurich Symp. on Electromagnetic Compatibility*, 7-9 March, 1995, pp. 271-274.
3. Wardak A., Bulanda W., Scierczynska J. Wplyw stalegopola magn. na potencial spoczynkowy komprek Nitellopsi optusa. *Biul. LTN Mat. - fiz. - chem.* 1976. V. 18. N. 2. S. 157-162.

Cells

P-145-A

EFFECT OF EXTREMELY LOW FREQUENCIES (50Hz) MAGNETIC FIELD ON CELLULAR PROLIFERATION IN *IN VIVO* SYSTEM. C. Marino, L. Galloni and P. Galloni. Department of Environment, ENEA, Casaccia, 00060 Rome, Italy.

The aim of this study was to perform experiment in order to investigate tumoral proliferation and variation of tumoral growth rate after magnetic field (MF) at extremely low frequencies exposure.

Female hybrid mice F1 C3H x DBA/2J, 3 months old were employed; in their left foot a tumor moderately differentiated C3H/tif murine mammary adenocarcinoma was injected. Several schedules were planned where MF exposures and tumor injection were performed in different order. The animals were exposed to MF for 6 hours for 5 days for 2 weeks: exposure were carried out by a triaxial system composed of 3 groups of 4 coils, designed by ENEA in collaboration with the Dept. of Electronic Engineering, University of Rome, that allow to irradiate about 70 animals simultaneously. The four coils have been connected to electric net (50 Hz) by a voltage stabilizer and a transformer and a uniform magnetic field of 2 mT was applied. One group X-rays of unanesthetised animals inserted in perspex jigs was locally irradiated (10 Gy SD) after ELF exposure, at 250 KVp with a 0,5 mmCu filter and a 1,36 Gy min⁻¹ dose rate, when the tumoral volume reached 200 mm³. Details of experimental system and animal model were previously described (see references).

Experimental schedule (number of used animals in bracket).

I		injection	3 days gap	MF exp	(35)
Ia		injection	3 days gap	sham exp.	(15)
Ib		injection	control		(15)
II		injection	MF exp		(30)
IIa		injection	sham exp.		(20)
IIb		injection	control		(20)
III	MF exp	injection			(60)
IIIa	sham exp.	injection			(25)
IIIb		injection	control		(25)
IV	MF exp	injection	gap (to 200 mm ³)	Rx (SD)	(39)
IVa	sham exp.	injection	gap (to 200 mm ³)	Rx (SD)	(19)
IVb		injection	control		(29)
V		injection	gap (to 200 mm ³)	Rx (SD)	(19)

Tumoral growth rate (number of growth tumours divided the number of the animals in which tumoral cells have been injected) and Tumour Growth Time (TGT) (time that tumour needs to reach a specific volume defined before) were calculated.

Data show growth delay in MF exposure, while no differences exist between sham and control group. When MF treatment was performed before tumoral cells injection an increase of the proliferation rate was observed. The group exposed to MF 3 days after the tumor's injection shows a slower proliferation until 1000 mm³ respect to the control; no differences exists between the groups exposed, sham exposed and control when MF exposure occurs immediately after the injection of the tumoral cells. Furthermore animals exposed before the tumor's injection show a proliferation rate faster than other groups. Of course, when X rays and MF were applied the effect on proliferation was more evident: X rays group shows a slow tumoral growth, those exposed to MF and X rays have a proliferation rate faster than the first, but minor than the control: the delay due to the SD X rays treatment appeared.

The host-tumor system initially shows a distinctive variability in tumoral proliferation, that does not seem to be modify by the MF field. An interesting result come from schedule where MF exposure was before tumoral injection, the growth was faster than that observed in other. This could indicate that the applied MF field speeds up tumoral growth. Finally the delay obtained in the 4th experiment for animals treated with SD X rays appear modified when animals are previously exposed to MF: a modification of some biological behaviour could be hypothesized.

References:

- Marino C. *et al.* 50 Hz magnetic field effects on tumoral growth in *in vivo* system. BEMS 17th Annual Meeting. Boston, USA, 1995.
- Raganella L. *et al.* Triaxial exposure system providing static and low frequency magnetic fields for *in vitro* and *in vivo* biological studies. Proceedings of the 2nd Congress of the EBEA. Bled, Slovenia. *Bioelectrochemistry and Bioenergetics*, 35: 121-126, 1994.

P-146-B

PRELIMINARY RESULTS ON HUMAN LYMPHOCYTES EXPOSED "IN VITRO" TO CELLULAR TELEPHONE MICROWAVE FREQUENCY. G. d'Ambrosio¹, R. Massa¹, M.R. Scarfi² and O. Zeni². ¹Department of Electronic Engineering, University of Naples "Federico II", 80125 Naples, Italy. ²Research Institute for Electromagnetism and Electronic Components - CNR, Naples, Italy.

Owing to increasing use of mobile communications in recent years, it is of great interest to evaluate the genotoxic potential of irradiation of humans from cellular phones. To this end we investigated the cell cycle kinetics and the induction of micronuclei (MN) in human lymphocyte cultures.

Peripheral blood from 5 healthy donors aged between 30 and 39 years were cultured as previously described (Scarfi *et al. Mut. Res.*, 306, 129-133, 1994) and for each blood sample an unexposed (control) and a microwave exposed culture were set up.

The exposure was performed immediately after PHA-stimulation. A coax microwave circuit was used, feeding a rectangular waveguide (110 mm x 55 mm x 91.9 mm) sample holder; a thermally environment was provided by means of circulating water through a plastic pipe winding about the sample holder. A liquid slab (10 ml culture in a Falcon plastic flask, cod.3013E), kept parallel to E field, was the biological sample.

Incident, reflected and transmitted powers (P_i , P_r , and P_t) were measured and the power absorbed by the sample, P_a , was calculated as $P_a = P_i - P_r - P_t$. The ratio P_a / m [W/kg] (m being the mass of the liquid sample) gave the (mean) specific absorption rate (SAR).

Following 15 min exposures to microwave at 1.748 MHz and 5 W/kg the maximum temperature was less than $36^\circ\text{C} \pm 0.1^\circ\text{C}$ (in the middle of the sample) and the minimum was $35^\circ\text{C} \pm 0.1^\circ\text{C}$ (at the end of the sample far from the microwave source).

Cytochalasin-B (6 $\mu\text{g/ml}$) was added after 44 hours to block cytokinesis.

After 72 hours of growth, cultures were harvested and slides were made-up (Scarfi *et al. Biochem. Biophys. Res. Comm.*, 176, 194-200, 1991). MN frequency was estimated in a minimum of 1000 cytokinesis-blocked (CB) cells and expressed as the ratio of CB cells presenting MN and the total number of cells scored. Applying the cytokinesis-block proliferation index (CBPI) cell kinetics was evaluated classifying 500 cells according to the number of nuclei, as suggested by Surralles *et al (Mut. Res.*, 341, 169-184, 1995).

The results obtained indicate that, by comparing the exposed cultures with the respective controls, no statistically significant difference is present ($p > 0.1$) neither in terms of MN nor in terms of CBPI, as evaluated applying the two tailed paired Student's t test.

However the limited number of subjects considered so far does not yet allow definitive conclusions: on-going studies on a large number of individuals should provide further, more complete information on the topic.

P-147-C

EFFECTS OF 50 Hz SINUSOIDAL MAGNETIC FIELD AT DIFFERENT INTENSITIES ON HUMAN LYMPHOCYTES. M.R. Scarfi¹, M.B. Lioi², O. Zeni¹, M. Della Noce¹, C. Franceschi³ and F. Bersani⁴. ¹CNR-IRECE, 80124 Naples, Italy. ²Department of Animal Science, University of Basilicata, Potenza, Italy. ³Department of Physics, University of Bologna, 40100 Bologna, Italy.

The present study was designed to test the effect of a 50 Hz sinusoidal magnetic field (field intensities of 0.05, 0.25, 0.5, 0.75 and 1.0 mT rms) on human lymphocytes cultured *in vitro*. In particular, we evaluated the induction of genotoxic effects and the alteration of cell proliferation: for this purpose the cytokinesis-block micronucleus (MN) technique and the cytokinesis-block proliferation index (CBPI) were employed respectively.

Peripheral lymphocytes from whole blood of 42 healthy donors, aged between 26 and 49 years (mean age 34.6 ± 5.23) were cultured as previously described (Scarfi *et al., Biochem. Biophys. Res. Commun.*, 176, 194-200, 1991). After 44 h, Cytochalasin-B (6 $\mu\text{g/ml}$) was added to block cytokinesis and after 72 h of growth cell cultures were harvested and slides were made up. MN were counted in a minimum of 1000 binucleated cells and expressed per hundred micronucleated binucleated cells. On the same slides CBPI was evaluated by classifying 500 cells according to the number of nuclei, as suggested by Surralles *et al. (Mutation Res.*, 341, 169-184, 1995). For each blood sample a control (unexposed) and an exposed culture was set up. Donors were divided into 5 groups (three groups with 9 subjects, one group with 8 subjects and one group with 7 subjects) and for each group a different field intensity was tested. Exposed cultures were placed at 37°C for 72 h between a pair of circular Helmholtz coils. The statistical analysis was performed by means of the two tailed paired Student's t test for both the parameters tested and the level of significance was pre-established at $P < 0.05$.

The results obtained indicate no genotoxic effects, expressed as MN frequency, for all the field intensities tested. Cell proliferation resulted unaffected at 0.25, 0.5 and 0.75 mT, increased at 1.0 mT and decreased at 0.05, although a slight ($P=0.058$) trend towards a higher frequency was observed in samples exposed to 0.25 mT.

In conclusion, the findings of the present study suggest that a 50 Hz sinusoidal magnetic field does not affect MN frequency but the field intensity is an important parameter concerning its influence on cell kinetics.

INFLUENCE OF 50 Hz SINUSOIDAL MAGNETIC FIELD ON SEA URCHIN EMBRYOGENESIS. O. Zeni¹, M.R. Scarfi¹, M. Della Noce¹, F. La Cara², F. Bersani³ and P.P. De Prisco². ¹CNR-IRECE, 80124 Naples, Italy. ²CNR-IBPE, Naples, Italy. ³Department of Physics, University of Bologna, 40100 Bologna, Italy.

Several reports show that ELF magnetic fields influence cell division in embryonic cells. In the present study we investigated the effect of a 1.4 mT rms 50 Hz sinusoidal magnetic field on the development of sea urchin (*Paracentrotus lividus*) embryos. The sea urchin is an ideal model since it is easy to obtain and to use for *in vitro* studies. Moreover, it is a well known biological model with an high degree of developmental synchrony. The exposure system consisted of two circular Helmholtz coils, powered by a homemade amplifier connected to a function generator.

We tested the effect of the exposure on fertilized eggs. For this purpose a batch of fertilized eggs was set up and divided into two groups, i.e. exposed and control samples. At different times of exposure the development stages were followed by counting the number of cells up to 24 hours post fertilization. An evident acceleration of embryonic development was observed in exposed samples with respect to unexposed ones for each cleavage stage observed. Moreover, it is interesting to note that the observed phenomenon is more evident after the first cell division.

In order to elucidate the magnetic field effect on each gamete, unexposed and exposed egg samples were prepared from the same batch; the same procedure was followed for the spermatozoa samples. After two different exposure times (40 and 90 minutes) exposed and unexposed gametes were tested for fertilization. The results obtained suggest that the magnetic field exposure induces an accelerated development in eggs exposed after fertilization. On the contrary, when the eggs were exposed before fertilization with unexposed spermatozoa, a delay in the embryonic development was observed. On the other hand, when pre-exposed spermatozoa were used to fertilize unexposed eggs, a better fertilization capability was observed.

In conclusion, the preliminary results here reported support the hypothesis of an influence of ELF magnetic fields on fertilization and early stages of embryogenesis, although conclusions are limited by the small number of experiments performed. Further studies on this topic are in progress.

EARLY EMBRYONIC DEVELOPMENT OF *XENOPUS LAEVIS* UNDER MAGNETIC FIELDS UP TO 14T. S. Ueno¹, M. Iwasaka¹, M. Miyoshi² and K. Shiokawa². ¹Institute of Medical Electronics, Faculty of Medicine, University of Tokyo, Tokyo 113, Japan. ²Department of Zoology, Faculty of Science, University of Tokyo, Tokyo 113, Japan.

A possible influence of intense magnetic fields on the embryonic development of frogs was studied. Some of the most hazardous effects that could be induced by intense magnetic fields are teratogenic effects on developing embryos. Generally, fertilized eggs of animals divide quite actively. For example, a fertilized egg of the African clawed toad *Xenopus laevis* cleaves approximately every 25 min for the first 12 cycles of cell division. Embryos of *Xenopus laevis* provide a unique test system to examine both cytostatic and teratogenic effects, because they first divide extremely rapidly during the cleavage stage, and then later differentiate various organs, the essential mechanisms of which are comparable to those of humans.

A preliminary study on embryogenesis in *Xenopus laevis* cultured in magnetic fields of 1 T, 6.3 T and 8 T has been reported previously [1][2][3]. In these previous studies, embryos were exposed to the magnetic field after they reached 2 to 8 cell stages. It is important to see if the developing embryos are affected by strong magnetic field during such extensive cytoplasmic relocalization.

In the present experiment, the possible influence of intense magnetic fields up to 14 T on the early embryonic development of *Xenopus laevis* was studied. A female of *Xenopus laevis* which had not ovulated for at least 3 months was injected with 150 units of a gonadotropic hormone gonatropin, and unfertilized eggs were artificially inseminated.

Embryos were exposed to magnetic fields up to 14 T for the period from the pre-cleavage stage to neurula. Embryos were then cultured in Steinberg's solution until the feeding tadpole stage.

The eggs were exposed to magnetic fields after 50-min of fertilization treatment. Sample numbers of eggs in 14 T magnetic field, eggs in 10 T with gradient of 60T/m, and control group was 90, 93, and 191, respectively. The percentages of abnormality of three groups were 11.1%, 11.8%, and 9.9%, respectively. The experimental results show that no apparent malformation was observed in the 14 T magnetic field exposure group.

We concluded that static magnetic fields up to 14 T do not appreciably affect the rapid cleavage and the following cell multiplication and differentiation in *Xenopus laevis* after 50 min of fertilization treatment.

[1] S. Ueno, K. Harada and K. Shiokawa, *IEEE Trans. Magn.* vol. MAG-20,1663, 1984

[2] S. Ueno, K. Shiokawa and M. Iwamoto, *J. Appl. Phys.* vol. 67, No. 9, 5841, 1990

[3] S. Ueno, M. Iwasaka and K. Shiokawa, *J. Appl. Phys.* vol. 75, No. 10, 7165, 1994.

P-150-C

EXPOSURE OF MOLT 4 T-LYMPHOBLASTOID CELLS TO A 1 G SINUSOIDAL MAGNETIC FIELD AT 60 Hz: EFFECTS ON CELLULAR EVENTS RELATED TO APOPTOSIS. J.L. Phillips, M. Campbell-Beachler, T. Ishida-Jones, W. Haggren and W.R. Adey. J.L. Pettis Memorial Veterans Administration Medical Center, Loma Linda, California 92357, USA.

THE PROBLEM: While it is acknowledged that 50 and 60 Hz magnetic fields (MF) do not contain sufficient energy to damage DNA directly, there are nonetheless reports in the literature documenting changes in DNA structure in biological systems exposed to low-level, extremely low frequency electromagnetic fields (ELF/EMF). At issue, however, is not just whether such exposures can affect DNA structure, but also whether such exposures can affect the extent to which or the rate at which DNA can be repaired. Consequently, it is the balance between damage and repair that is the key to ascertaining whether or not ELF/EMF exposure may be associated with harmful consequences.

APPROACH: We have established a program to study the effects, if any, of exposure to sinusoidal 60 Hz MFs for various periods of time on DNA damage and repair in Molt 4 T-lymphoblastoid cells. Our approach has been to first measure the activity of the repair enzyme, poly(ADP-ribose) polymerase (PARP), in cells that are exposed concomitantly to a 1G sinusoidal 60 Hz MF and to etoposide (VP16), a chemical agent known to produce DNA damage. Second, we have used Western blot analysis to assess the effects of MF exposure on proteolytic cleavage of PARP. Third, we have quantified DNA fragmentation in exposed vs unexposed cells and we have correlated the data obtained with quantification of viable cells.

METHODS: In our experiments, Molt 4 cells have been cultured to a cell density of 1×10^6 cells/ml in RPMI-1640 tissue culture medium supplemented with 10% fetal calf serum and 2 mM glutamine. Cells were then treated with etoposide at final concentrations of 0.2, 1, 5, 50, and 100 $\mu\text{g/ml}$ and exposed to a 1 G sinusoidal MF at 60 Hz for times up to 6 hr. Following exposure, or sham exposure for controls, cells were washed with PBS and cell extracts prepared after sonication. PARP activity was assayed by measuring ^{32}P incorporation (from ^{32}P -NAD) into acid-precipitable protein. Western blotting was accomplished with a chemiluminescence assay after treatment of blotted samples with a PARP-specific antibody. DNA fragments were measured with a fluorescence assay employing bis-benzimide.

RESULTS: Our data indicated an ~50% decrease in PARP activity in MF-exposed (3 hr) cells treated with 50 and 100 $\mu\text{g/ml}$ etoposide as compared to control unexposed cells. This decrease was statistically significant in both cases when compared to the data from sham/sham experiments. Since PARP is known to be cleaved into two fragments (85 and 30 kdalton) during apoptosis, we considered the possibility that MF exposure might enhance the proteolytic cleavage of PARP. However, results indicated no differences in PARP cleavage observable between MF-treated (up to 6 hr) and control samples. In related studies, we have measured the

production of DNA fragments in cells treated \pm etoposide and \pm MF. Results indicated a 33-72% MF-induced increase in DNA fragments in cells treated with either 50 or 100 $\mu\text{g/ml}$ etoposide after 6 hr MF exposure. This correlated with an MF-induced decrease in actual viable cell number.

CONCLUSIONS: The combination of etoposide + MF may increase that portion of the cell population destined for apoptosis. The decrease in PARP activity may facilitate the activity of Ca^{2+} , Mg^{2+} -dependent endonuclease, thus increasing DNA fragmentation. Additional studies (Rb expression and phosphorylation & comet assay) are being performed, and point to a ceramide-dependent protein kinase-regulated pathway leading from MF exposure to increased apoptosis.

This work supported by the Department of Energy, Office of Energy Management, Contracts DE-AI01-90CE35035 and DE-AI01-95EE34020.

P-151-A

CAN A EXTREMELY LOW FREQUENCY ELECTROMAGNETIC FIELD (50 Hz) DISTURB NORMAL STRUCTURE OF RATS THYROID GLAND?

M. Matavulj¹, V. Rajkovic¹, G. Uscebrka², D. Zikic², D. Stevanovic¹ and B. Lazetic³. ¹Institute of Biology, Faculty of Science, ²Faculty of Agriculture and ³Department of Physiology, Faculty of Medicine, University of Novi Sad, 21000 Novi Sad, Yugoslavia.

The effects of non-ionizing radiation as a electromagnetic field on the thyroid gland has been suggested but has, unfortunately, not been supported with sufficient data. Our purpose in this study was to determine the effect of extremely low frequency (ELF-EMF) (50 Hz), of intensities that can be met in the environment, on thyroid morphology. A total of 35 male Mill Hill rats were used in these experiments. Five animals were exposed to the influence of ELF-EMF (50 Hz) of a decaying intensity along the animals cages from 500 μT (at the side of the cage near the coil which produced ELF-EMF) to 50 μT (at the opposite side of the cage) 7 hours a day, 5 days a week, beginning from 24 h after birth until the end of second months, five animals until the end of fifth months and ten animals until the end of sixth months of postnatal life. Five control animals for each group were housed to identical conditions excepting the EMF. For stereological and cytological analysis every fourth paraffin section was used from the middle of the gland to the periphery. Two months exposure increase index of activation of thyroid gland (I_a , $I_a = V_{ve}/V_{vk}$)($p < 0.01$), volume density (V_{ve})($p < 0.01$) and thickness (D)($p < 0.05$) of follicular epithelium, while volume density: of colloid (V_{vc})($p < 0.01$) as well as the capillary network (V_{vs})($p < 0.01$) was significantly decreased. Volume density of interfollicular tissue (V_{vi}) was, also, decreased but statistically insignificant. The most prominent cytological changes in the follicular cells after two months of exposition to ELF-EMF were the appearance of variously shaped apical protrusions and numerous intracellular colloid droplets. Five and six months exposure to the ELF-EMF decreased significantly index of activation of

thyroid gland (Ia)($p < 0.01$), the volume density (Vve)($p < 0.01$) and thickness (D)($p < 0.01$) of follicular epithelium, while volume density of: colloid (Vvc)($p < 0.01$), capillary network (Vvs)(only after five months) as well as the interfollicular tissue (Vvi) were significantly increased ($p < 0.01$). The most prominent cytological changes in the follicular cells after five and six months of exposition to ELF-EMF were the absence of apical protrusions, rare presence of intracellular colloid droplets and extremely low follicular epithelium in some areas of the gland. Present results indicate that exposure to ELF-EMF produce impairment in the thyroidal structure as measured by stereological and cytological parameters. The question arise: are the morphological changes of the thyroid gland the consequence of direct ELF-EMF influence on one of the hypothalamic-pituitary-thyroid axis levels or indirect consequence of changes in some other organs correlated with thyroid. In view of the broad range of functions in which thyroid hormones are involved, observed alterations in thyroid morphology could initiate a wide spectrum of subtle biological effects and from this reason further studies are needed to clarify the mechanisms by which EMF disrupts the hypothalamic-pituitary-thyroid axis.

P-152-B

COMBINED EFFECT OF CIRCULARLY POLARIZED MILLIMETER WAVES AND ETHIDIUM BROMIDE ON *E. COLI* CELLS. V.L. Ushakov¹, V.S. Shcheglov¹ and I.Y. Belyaev^{1,2}. ¹Department of Radiation Physics, Biophysics and Ecology, Moscow Engineering Physics Institute, 115409 Moscow, Russia. ²Department of Radiobiology, Stockholm University, S-106 91 Stockholm, Sweden.

It was shown previously, that left-handed and right-handed circularly polarized (CP) millimeter waves (MMW) at the same frequency exerted significantly different effects on *E. coli* cells (1). The effective circular polarization (left or right) depended on resonance frequency and was attributed to helicity (Z- or B-) of DNA sequences which can effectively interfere with MMW (1). The relationship between Z-B alternations of DNA sequences and DNA supercoiling in domains of nuclei (nucleoids) is well known. To change these alternations, the cells were irradiated with X-rays before exposure to MMW (2). The efficiency of both polarizations were inverted when the cells were irradiated at high doses. The inversion was dose-dependent and effects of both CP MMW become to be equal at the dose which produced approximately one single-strand DNA break per genome. The data supported hypothesis about relationship between sign of effective MMW polarization and DNA helicity. In this study, we used specific DNA intercalator ethidium bromide (EtBr) to test further this hypothesis. The cells of *E. coli* AB 1157 were incubated in M9 buffer with/without EtBr, 1 $\mu\text{g/ml}$. This concentration was chosen to provide effective binding to DNA and low cytotoxicity (3). The changes in the conformation of DNA-protein complexes were studied by the method of anomalous viscosity time dependence (AVTD). The cell were exposed to circularly polarized MMW (51.76

GHz, 10 min, 0.1 mW/cm^2). Then cells were lysed for AVTD measurements in the polyallomer test-tubes, 1 ml in each. Solutions of lysozyme ("Sigma", 1.5 mg/ml) - 0.3 ml, sarcosyl ("Serva", 2%) - 1 ml and papain-glycerol ("Merck", 3 mg/ml - 10%) - 0.7 ml were added to each test-tube. All solutions were prepared in 0.25 M Na_2EDTA , 0.01 M Tris-base, pH 7.1. In four independent experiments, significant increase in the AVTD peaks was observed after exposure of cells to MMW at left-handed polarization ($p < 0.00001-0.007$). Positive control with EtBr showed that this increase corresponded to decondensation of nucleoids which was produced by intercalator at the concentration of 1 $\mu\text{g/ml}$ in cell lysates. Depending on the time between exposure and lysis (40, 90, 120, 150 min), the effect of left-handed CP MMW was 2-4 times greater than effect of right-handed CP MMW. On the contrary, the left polarization affected the cells less effectively ($p < 0.0004$, paired t-test) if cells were exposed to MMW in combination with EtBr. Thus, the DNA intercalator inverted the efficiency of CP MMW as it was previously observed with X-rays. Together, these data strongly suggest that DNA is primary target for resonance interaction of nonthermal MMW with cells.

References:

1. Belyaev, I.Ya., V.S. Shcheglov, Ye.D. Alipov, Existence of Selection Rules on Helicity during Discrete Transitions of the Genome Conformational State of *E. coli* Cells Exposed to Low-level Millimetre Radiation, *Bioelectrochemistry and Bioenergetics*, 27:405-411, 1992.
2. Belyaev, I.Ya., Ye.D. Alipov, and V.S. Shcheglov, Chromosome DNA as a Target of Resonant Interaction between *Escherichia Coli* Cells and Low-intensity Millimeter Waves, *Electro- and Magnetobiology*, 11: 97- 108, 1992.
3. Lambert, B., J.-B. Le Pecq, Effect of Mutation, Electric Membrane Potential, and metabolic Inhibitors on the Accessibility of Nucleic Acids to Ethidium Bromide in *Escherichia coli* cells, *Biochemistry*, 23: 166-176, 1984.

P-153-C

STUDIES ON MITOCHONDRIAL MEMBRANE POTENTIAL IN HUMAN LYMPHOCYTES EXPOSED TO DIFFERENT ELECTROMAGNETIC FIELD. A. Cossarizza¹, F. Bersani², M. Capri¹, S. Salvioi¹, D. Monti¹ and C. Franceschi¹. ¹Department of Biomedical Sciences, Section of General Pathology, University of Modena, 41100 Modena, Italy. ²Department of Physics, University of Bologna, 40100 Bologna, Italy.

An increasing interest is present on the biological effects of 50/60 Hz electric and magnetic fields, in connection to possible health risks related to powerlines. In the present study we have addressed the question as to whether the *in vitro* exposure of lymphocytes from donors of different ages to 50 Hz electric and magnetic fields having intensities similar to those found under powerlines can affect different physiological parameters. Moreover, we have compared the results with those obtained with a 50 Hz pulsed magnetic field, which was used in previous studies, where we have demonstrated that human lymphocytes stimulated with

different mitogens are sensitive to the field exposure, in terms of proliferation and growth factors production, and that such sensitivity is an age-dependent phenomenon (1-5). The main biological parameters that we have studied were lymphocyte proliferation, by using different techniques (thymidine incorporation, cytofluorimetric analysis of cell cycle and of cell phenotype), cell death by apoptosis and mitochondrial mass and membrane potential (MMP). The latter parameter was studied by a new cytofluorimetric technique we have recently developed, which makes use of the lipophilic cation 5,5',6,6'-tetrachloro-1,1',3,3'-tetraethylbenzimidazolcarbo-cyanine iodide, JC-1) (6-9). Considering the populations studied as a whole, i.e. analyzing the means and the standard errors of the data obtained in the whole population, no major effects of field exposure were present as far as lymphocyte proliferation was concerned. However, an individual sensitivity was noted in several functional parameters. Indeed, cells from certain subjects were sensitive to the field, being their proliferative capability markedly influenced by the exposure. An individual sensitivity was present also as far as MMP modifications were concerned. Indeed, in this case too the cytofluorimetric analysis put in evidence that significant alterations were present in field-exposed cells from some donors. Further studies are in course to better identify the biological basis of such individual differences.

1. Cossarizza A. *et al.*, *Biochem. Biophys. Res. Commun.* 160: 692-698, 1989.
2. Cossarizza A. *et al.*, *FEBS Lett.* 248:141-144, 1989.
3. Cossarizza A. *et al.*, *Aging - Clin. Exp. Res.* 3: 241-246, 1991.
4. Cadossi R. *et al.*, *FASEB J.* 6: 2667-2674, 1992.
5. Cossarizza A. *et al.*, *Exp Cell Res.* 204: 385-387, 1993.
6. Cossarizza A. *et al.*, *Biochem. Biophys Res. Commun.* 197: 40-45, 1993.
7. Cossarizza A. *et al.*, *Exp. Cell Res.* 222: 84-94, 1996.
8. Polla B. *et al.*, *Proc. Natl. Acad. Sci. USA* 93: 6458-6463, 1996.
9. Cossarizza A. *et al.*, *AIDS* 11: 19-26, 1997.

P-154-A

STIMULATION OF AGROSTIS CAPILLARIS L. CARYOPSIS GERMINATION BY PULSATIVE MAGNETIC FIELDS. M. Rakocevic¹, J. Lazarevic¹, N. Pekaric-Nadj² and A. Simic¹. ¹Faculty of Agriculture, University of Belgrade, 11080 Zemun, Yugoslavia. ²Faculty of Technical Sciences, University of Novi Sad, 21000 Novi Sad, Yugoslavia.

OBJECTIVES: The seeds of some species could "memorising" the conditions of light quality climate in a phase of seed maturation (Creswell *et al.*, 1981), and to demand the similar conditions for germinating. Our intention was to relate "natural magnetic field climate" with possible stimulation by PEMF.

MATERIAL AND METHODS: Caryopsis of *Agrostis capillaris* L. are small (0.5mm) with modest reserves, and they require the red light to be ingermated in a great number (Rakoëviæ, 1997). Seeds of *Agrostis capillaris*

matured in natural pasture vegetation and originated from different populations were investigated. The populations of *Agrostis capillaris* were chosen in a basis of natural anomaly of magnetic fields in the area of natural pastures. The seed germination of eight populations was followed. Seed germination of *Agrostis capillaris* was stimulated by nonionizing electromagnetic radiation constituted in serial of single impulses in quasi-rectangular form, intensity of 1mT, frequencies of 8, 15, 50 and 75Hz, applied 2 hours after inhibition, exposition of 30 minutes. Magnetic field stimulation was applied in darkness. The experimentation was repeated in series in different dates.

RESULTS: The magnetic field of 8Hz removes the seed dormancy of seeds originated from pastures magnetic anomaly area in experimentation from February 1996. They germinated faster in increased germinating capacity. In May, June and December the PEMF stimulation had no effect on germination of seeds originated from areas with/no magnetic anomaly. To conclude about the seed "memorising of magnetic climate" we need to repeat the experiment at least one more year, and to relate the influence of earth magnetic field on seed response.

Supported by Ministry for Science and Technology of Republic of Serbia.

P-155-B

NATURAL KILLER (NK) CELL FUNCTION IN AGED B6C3F1 MICE EXPOSED TO 60 Hz MAGNETIC FIELDS. R.V. House¹, C.R. Mattis¹, J.T. Kozak¹, T.R. Johnson², J.R. Gauger² and D.L. McCormick¹. ¹Life Sciences Department and ²Electromagnetics and Electronics Systems Section, IIT Research Institute, Chicago, Illinois 60616, USA.

Modulation of host immune status has been proposed as a possible mechanism through which power frequency (50 and 60 Hz) magnetic fields may induce adverse health effects, including those related to the induction of malignancy. We have previously reported the results of a multi-endpoint evaluation of the potential immunotoxicity of exposure to 60 Hz magnetic fields in mice (House *et al.*, *Fund. Appl. Toxicol.*, 34, 228-239, 1996). In this battery of *in vivo* bioassays, the effects of magnetic fields on immunity and host resistance were limited to a modest suppression of NK cell function in 2 of 4 replicate studies in female mice only; no effects of magnetic field exposure were identified in NK cell assays conducted in male mice, or in replicate studies conducted in male and female rats. Magnetic field exposure had no effect on any other immune parameter evaluated. Although these data cannot be interpreted as definitive evidence of a biologically significant effect, they do suggest a possible mechanism of magnetic field action. In view of the putative role of NK cells in tumor surveillance, a significant suppression of NK cell function could be associated with increased risk of neoplasia. Because NK cell function declines with age, it was of interest to determine if aged animals demonstrate an NK cell response to magnetic field exposure that is comparable to that observed in young animals. To address this issue, female B6C3F1 mice were

held in quarantine for one year under defined ambient (< 1 mG) magnetic field conditions. After the one year quarantine period, mice were randomized by weight into groups of 18, and were exposed continuously (18.5 hrs/day) for 13 weeks to linearly polarized, pure sinusoidal 60 Hz magnetic fields at levels of 10 G, 2 G, 20 mG, or 0 G (sham control). A fifth group received intermittent (1 hr on, 1 hr off) exposure to 10 G fields for 13 weeks. Magnetic field strength, magnetic field waveform, noise, vibration, temperature, humidity, light, and air flows were monitored continuously in animal exposure rooms; dc magnetic fields have been mapped extensively. At the end of the exposure period, mice were euthanized, spleens were collected, and single cell suspensions of splenocytes were prepared. NK cell function was measured using a ^{51}Cr release assay in which cytolysis of YAC-1 lymphoma cells is quantitated by release of radiolabel from the target cell. Assays were performed using effector to target cell ratios of 100:1, 33:1, and 11:1, and a 4 hour incubation period. Continuous exposure of aged mice to 10 G magnetic fields for 13 weeks resulted in a modest (30%) but statistically significant reduction in NK cell function. Continuous exposure to magnetic field strengths of 2 G or less, or intermittent (1 hr on/1 hr off) exposure to 10 G fields had no effect. These data demonstrate that NK cells in young adult and aged B6C3F1 mice demonstrate qualitatively similar responses to 60 Hz magnetic fields. It is critical to note, however, that the immune system contains multiple redundancies, and that the quantitatively modest effect of 60 Hz magnetic fields on NK cell function may not be biologically significant. The functional significance of this observed reduction in NK cell function may be established by analysis of cancer incidence patterns in B6C3F1 mice exposed to 60 Hz magnetic fields for two years in a chronic toxicity/oncogenicity bioassay. The in-life phase of the two-year study was completed in November, 1996, and histopathologic evaluation of tissues is in progress. Supported by institutional research and development funds from IIT Research Institute.

P-156-C

H⁺ - TUNED COMBINED MAGNETIC FIELD DECREASES THE RATE OF REGENERATION OF PLANARIANS. V.V. Lednev¹, L.K. Srebnitskaya¹, E.N. Ilyasova¹, Z.E. Rojdestvenskaya¹, A.N. Klimov¹ and K.P. Tiras². ¹Institute of Theoretical and Experimental Biophysics, ²Institute of Cell Biophysics, Russian Academy of Sciences, Poushino, Moscow Region 142292, Russia.

BACKGROUND AND OBJECTIVE: Trillo *et al* [1] reported, that combined magnetic fields (CMF), at resonant conditions for hydrogen ions substantially decrease neurite outgrowth in PC-12 cells. The effect of the CMF was observed at different values of the B_{AC}/B_{DC} -ratio, where B_{AC} and B_{DC} correspond to the magnetic flux densities of the alternating and static components of the CMF. Surprisingly, the effect was strongly attenuated in the narrow range of B_{AC}/B_{DC} - values, where, according to the theoretical predictions, it was expected to be most pronounced. The

origin of this unusual feature, as well as the origin of the H⁺ - ions involved in the interaction with CMF remains obscure. Apparently, additional experiments with the use of the different biosystems may possibly help to elucidate these problems. Therefore we initiated the studies of the influence of H⁺-tuned CMF on regeneration of the head-amputated planarians *Dugesia tigrina*. Earlier we have studied in details the response of this test-system to the exposure in CMF tuned for the resonant conditions of different ions [2,3] and for the Larmor frequency of the nuclear spins of hydrogen atoms [4]. **MATERIALS AND METHODS:** The species of planarians used, the method of rearing them, the technique employed to determine the mitotic index (MI) and the exposure system have been described earlier [2,3]. The field's effect was estimated by the changes in the value of mitotic activity (ΔMI , %) in the pool of undifferentiated cells (neoblasts) located just under the wound. The measurements of the MI in "experimental" and "control" animals were performed after 24 hours of regeneration. Regenerating "experimental" planarians were exposed to the CMF composed of collinear static, B_{DC} , and alternating (sinusoidal), $B_{AC} \cdot \cos 2\pi ft$, components. The frequency of the later was tuned to the basic resonant (cyclotronic) frequency for the hydrogen ions. Most of the experiments were performed at $B_{DC} = 44.0 \mu\text{T}$, $B_{AC}/B_{DC} = 0.0; 0.5; 1.0; 1.4; 1.8; 2.3; 2.7$ and 3.8 . "Control" animals were exposed to a static field with $B_{DC} = 44.0 \mu\text{T}$.

RESULTS AND DISCUSSION: Exposure of regenerating planarians to the H⁺-tuned CMF resulted in the decrease of proliferative activity of neoblasts at most values of the B_{AC}/B_{DC} -ratio. The largest decrease in the MI ($\Delta\text{MI} = -27 \pm 9\%$ and $-31.0 \pm 8\%$) was observed correspondingly at $B_{AC}/B_{DC} = 1.4$ and 2.3 , while it was much less pronounced ($\Delta\text{MI} = -10 \pm 8\%$) at $B_{AC}/B_{DC} = 1.8$, where the maximum value of the bioeffect is expected. The experimental points at all tested values of the B_{AC}/B_{DC} -ratio, with the exception of $B_{AC}/B_{DC} = 1.8$, may be fitted by the theoretical curve - the squared Bessel function of the first order $J_1^2(B_{AC}/B_{DC})$ [5].

In accordance with the findings of Trillo *et al* our results confirm the "biological activity" of the H⁺-tuned CMF. However, there are some important differences between our results and those of Trillo *et al*. First, our experimental points can be approximated by the Bessel function with the argument B_{AC}/B_{DC} , but not with $2 \cdot B_{AC}/B_{DC}$, as it was the case for the data of Trillo *et al*. The additional factor of 2 in the argument of the Bessel function, used by Trillo *et al* for approximation of their experimental data, appears as a result of a mistake [6], made by Blanchard and Blackman in their calculations. It must be noticed also, that static and alternating components of the CMF used by Trillo *et al* were not parallel contrary to the situation considered theoretically. Therefore, the significance of consistence between experimental and theoretical data obtained by Trillo *et al* is not clear. Second, the sign of the observed effect in our case (a decrease in MI) is an opposite to that observed, when planarians are exposed to the Mg²⁺-tuned CMF (an increase of MI [3]), while the neurite outgrowth is affected in a similar way after exposure of PC-12 cells to Mg²⁺- and H⁺-tuned fields. This discrepancy is not essential and may be accounted for by different properties of the "targets"

interacting with magnetic fields. Also, we disagree with Trillo *et al* in the interpretation of the origin of the observed effects. There is no any reason to expect, that bioeffects of the H⁺-tuned field may be caused by its interaction with the H⁺-ions (protons) in a bulk (cytosolic) solution. The time between successive diffusional jumps of such protons is very short (about 10⁻¹⁰ sec), so that low frequency magnetic field can not possibly affect the precession of such oscillators according to the parametric resonance mechanism. It is more probable that H⁺- tuned CMF, as well as CMF-tuned for the nuclear spins of hydrogen atoms, convey their bioeffects via interaction with the particular species of H⁺- ions belonging to the network of hydrogen bonds in the Ca²⁺-dependent enzymes [4]. This idea is consistent with a very sharp frequency-dependence of the bioeffects induced by the H⁺- and ¹H- nuclear spin-tuned CMF: in both cases the half-width at the half-maximum of the effect does not exceed 4-5 Hz [4,7]. The observed drastic drop in the value of the bioeffect of the H⁺- tuned CMF in the vicinity of B_{AC}/B_{DC} = 1.8, may be explained by the field-induced attachment of the H⁺-ions to the nitrogen or to the oxygen atoms in the corresponding H-bonds, so that a concomitant loss of a charge leads it out of resonance.

CONCLUSIONS: In accordance with the finding of Trillo *et al*, our results confirm the capability of the H⁺- tuned CMF to influence the biosystems although the nature of the particular H⁺- ions interacting with the magnetic field remains to be established. There is no reason to identify these ions with the free protons in the cellular cytosol.

References:

1. Trillo MA, Ubeda A., Blanchard JP, House DE, Blackman CF. *Bioelectromagnetics*, 1996, v.17, 10-20.
2. Tiras KhP, Srebnitskaya LK, Ilyasova EN, Klimov AA, Lednev VV. 1996. 18th Annual Meeting of the BEMS, Victoria, Canada, June 9-14, p.235; *Biofizika*, 1996, v.41, n.4, pp. 825-831 (In Russian).
3. Lednev VV, Srebnitskaya LK, Ilyasova EN, Rojdestvenskaya ZE, Klimov AA, Tiras KhP. 1996. 18th Annual Meeting of the BEMS, Victoria, Canada, June 9-14, p.63; *Biofizika*, 1996, v.41, n.4, pp. 815-824 (In Russian).
4. Lednev VV., Srebnitskaya LK., Ilyasova EN., Rojdestvenskaya ZE., Klimov AA., Tiras KhP. 1996. *Dokl. Acad. Nauk*, v.348, n.6, pp.830-833.(In Russian); see also an accompanying Abstract.
5. Lednev VV. *Biofizika*, 1996, v.41, n.1,pp.224-231.(In Russian).
6. Lednev VV. *Bioelectromagnetics*, 1995. V.16, p.268-269..
7. Blanchard JP, Blackman CV, Benane SG, House DE. Annual Review of Research on Biological Effects of Electric and Magnetic Fields from the Generation, Delivery, and use of Electricity, 1994. Albuquerque, NM, November 6-10.. Abstract A-18.

Supported by RFFI Grant No. 95-04-11739.

P-157-A

RESPONSES OF HUMAN MG-63 OSTEOSARCOMA CELL LINE AND HUMAN OSTEOBLAST-LIKE CELLS TO PULSED ELECTROMAGNETIC FIELDS.

V. Sollazzo¹, G.C. Traina¹, M. De Mattei², L. Massari¹, A. Pellati², F. Pezzetti² and A. Caruso². ¹Dipartimento di Scienze Biomediche e Terapie Avanzate, Sezione di Clinica Ortopedica, Università di Ferrara, 44100 Ferrara, Italy. ²Istituto di Istologia ed Embriologia Generale, Università di Ferrara, 44100 Ferrara, Italy.

We have studied the effects of low-energy, low-frequency pulsed electromagnetic fields (PEMF) on cell proliferation, in both human osteoblast-like cells, obtained from bone specimens, and in human MG-63 osteosarcoma cell line. The assessment of osteoblastic phenotype was assayed both by immunolabeling with antiosteonectin antibody and by verifying the presence of parathormone receptors. The cells were placed in multiwell plates and set in a tissue culture incubator between a pair of Helmholtz coils powered by a pulse generator (1.3 ms, 75 Hz) for different periods of time. ³H-thymidine incorporation was used to evaluate cell proliferation. Since it had previously been observed that the osteoblast proliferative response to PEMF exposure may also be conditioned by the presence of serum in the medium (Sollazzo *et al.*, 1996), experiments were carried out at different serum concentrations. ³H-thymidine incorporation increases in osteoblast-like cells, when they are exposed to PEMF in the presence of 10% fetal calf serum (FCS). The greatest effect is observed after 24 hours of PEMF exposure. No effects on cell proliferation are observed, when osteoblast-like cells are exposed to PEMF in the presence of 0.5% FCS or in a serum-free medium. On the other hand, PEMF-exposed MG-63 cells show increased cell proliferation either at 10% FCS, 0.5% FCS and in serum-free medium. Nevertheless, the maximum effect of PEMF exposure on Mg-63 cell proliferation depends on the percentage of FCS in the medium. The higher the FCS concentration, the faster the proliferative response to PEMF exposure. Our results show that, although MG-63 cells display some similarity with human bone cells, their responses to PEMF's exposure are quite different from that observed on human bone cells.

P-158-B

AMPLIFICATION OF ELECTROMAGNETIC SIGNALS BY ION CHANNELS. THE DEPENDENCE OF THE EFFECT SIZE ON CELL AND TISSUE MORPHOLOGY.

J. Galvanovskis¹, J. Sandblom¹ and Y. Hamnerius². ¹Department of Medical Physics, Göteborg University, 413 90 Göteborg, Sweden. ²Department of Microwave Technology, Chalmers University of Technology, 412 96 Göteborg, Sweden.

Cells may respond to the exposure of low frequency electromagnetic fields with changes in cell division, ion influx, chemical reaction rates, etc. The chain of events leading to such responses are difficult to study mainly because

of the extremely small energies associated with the low frequency fields, usually much smaller than the thermal noise level. However, the presence of stochastic systems, for instance ion channels, provides a basis for signal amplification, and could therefore, in spite of the low signal-to-noise ratio of the primary response, lead to the transmission of weak signals along the signaling pathways of cells. We have explored this possibility for an ion channel model, and we present a theory, based on formalism of stochastically driven processes, which expresses the time averages of ion currents in terms of the amplitude and frequency of the applied signal. It is concluded from this theory that the signal-to-noise ratio increases with the number of channels, the magnitude and asymmetry of the rate constants and the frequency response of the intracellular sensing system, for instance the calcium oscillator, and can be summarized in a simple expression for the signal-to-noise ratio (SNR):

$$SNR = N \frac{Q}{f_s} \frac{p^2}{\tau^o + \tau^c},$$

where N is the number of channels, p is the amplitude of the external signal, τ^o and τ^c - the mean dwell times for channel open and closed times respectively, and Q characterizes the frequency response of the intracellular Ca oscillator.

The amplification properties of the stochastic system are further deduced from numerical simulations carried out on the model, which consists of multiple identical two-state channels, and the behaviour for different parameters is examined. Numerical estimates of the parameters show that under optimum conditions even very weak low frequency electromagnetic signals (<100 Hz, <100 μ T) may be detected in cellular system with a large number of ion channels.

According to the presented theory the external electromagnetic field can affect cell metabolism in several ways.

The basic result, shortly described above and summarized by the equation expressing SNR through system parameters, is the first order estimate of the field effect. Therefore, its size depends essentially on the channel distribution over the cell surface or within the complex of electrophysiologically coupled cells. In this aspect, the involvement of asymmetric (possessing so called "hot spots" with high concentration of ion channels) cells and tissues built of vectorial cells such as enterocytes and muscle cells is discussed.

Cells that display complicated spatiotemporal organization in response to calcium-mobilizing agents as, for example, *Xenopus* oocytes that are capable of creating multiple spherical or spiral waves, is another interesting and intriguing object which can be affected by the first order effects described by the presented theory. In this case the channel distribution over the cell surface needs not be asymmetric since the significant physiological effect could be invoked by the calcium-influx gradients created by the external signal on the opposite sides of a cell.

The theory also predicts the long-term accumulation of ions under the influence of the periodic external signal, independently of the channel distribution over the cell surface, which is the second order effect. Assumed that the

external field acts for a considerable time period, such accumulation may, in principle, lead to changes in cell functioning.

P-159-C

LOWER POWER MICROWAVES EFFECTS ON ERYTHROCYTES MEMBRANES. R. Pologea-Moraru, E. Kovacs, T. Savopol and A. Dinu. Biophysical Research Department, "Carol Davila" Medical University, Bucharest, Romania.

The methods used to investigate the interaction of human erythrocytes with non-thermal levels of 2.45 GHz radiation were:

- Hemoglobin release measurements at different power densities during and after irradiation
- Coulter Counter control of irradiated blood
- Measurement of the kinetics of irradiation induced hemolysis at different power levels paralleled by the measurement of the radiation induced osmotic fragility of the cells.

It was found that at the mentioned power levels, 2.45 GHz irradiation induces a significant hemoglobin loss due to transient permeabilisation of irradiated erythrocytes rather than to their lysis. The microwave induced hemoglobin loss by irradiated erythrocytes is up to 80% of the spontaneous hemoglobin loss by the controls. The rate of the increase of hemoglobin loss with increasing power density was found to be highly dependent on the initial level of spontaneous hemolysis. It seems that the membrane is as more sensitive to the radiation power as it was leakier at the start [1].

Kinetics of hemolysis degree at three different power densities was studied. While at low power densities (0.8 and 1.36 mW/cm²) there is a quasi-linear increase of hemolysis degree with time of irradiation, at higher density (5 mW/cm²) this tendency seems to reverse after first 10 hours of irradiation. The only reasonable explanation for this seems to be that the spontaneous hemoglobin loss of controls increases faster than that of the exposed samples (since each point on the plot is the ratio $\alpha_{irr}/\alpha_{control} = A_{irr}/A_{nonirr}$). It appears like long term irradiation would exert a protective action against spontaneous hemolysis caused by cells ageing [6].

This observation is paralleled by the results of kinetic measurements of the osmotic resistance of irradiated erythrocytes which show a progressive increase of the osmotic resistance with time of irradiation at exposures to 5 mW/cm² [6].

More data at higher power densities (up to 10.000 mW/cm²) and additional methods are necessary for explaining the mechanisms of low level microwaves interaction with erythrocytes membrane.

References:

1. Savopol, R. Moraru, A. Dinu, E. Kovacs, G. Sajin, *Electro- and Magnetobiology*, 14, 1995, p. 99-106.
2. M.J. Galvin, M.J. Ortner and D.I. McRee. *Radiat. Res.*, 90 (1982) 558

3. J. Thuery, *Microwaves: industrial, scientific, and medical applications*, Edward H. G., King's College London, Ed., Artech House. Boston, London, 1992, 451-455.
4. F. Keillman, in *Biological Effects and Dosimetry of Nonionizing Radiation*; M. Grandolfo, S.M. Michelson and A. Rindi Eds., Plenum Press, New York and London, 1983.
5. Savopel, R. Pologea-Moraru, A. Dinu, E. Kovacs, *Bioelectrochemistry and Bioenergetics*, 40. 1996, 171-173.

P-160-A

SENSITIVITY OF VERTEBRATE PHOTO-RECEPTORS TO LOW VOLTAGE DC ELECTRIC FIELDS. E. Kovacs, T. Savopol, R. Pologea and A. Dinu. Biophysics Research Department, "Carol Davila" Medical University, Bucharest, Romania.

It was shown that frog photoreceptors elicit a polar behavior in low voltage DC electric fields.

The polarity of rods is dependent on cell energy, vanishing out with the energetic exhaustion of the cell.

The dipolar momentum of the photoreceptor rod outer segments (ROS) was computed by measuring the velocity of ROS rotation in fields of different intensities which led to a mean dipolar charge as being $(2.10 \pm 0.17) \times 10^{-14}C$. This value is very close to that obtained by computing the charge accumulation at the rod ends due to the dark current (Snapf, J.L., 1983).

Videorecords of intact rods placed in static electric field show that distal ends of the photoreceptors are positive.

A statistical analysis of photoreceptor rods orientation patterns in fields of different intensities and at different exposure times was performed by image processing of data provided by computerized videomicroscope.

References:

- Enoch J.M., Birch D.G. and Birch E.E. (1979) *Science* 206, 705-709.
- Schnapf J.L. (1983) *J. Physiol.* 343, 147-159.
- Baylot D.A. and Nunn B.J. (1986) *J. Physiol.* 371, 115-145.
- Chirieri-Kovacs E., Savopol T. and Dinu A. (1996) *Biochim. Biophys. Acta* 1273, 217-222.

Cell Calcium and Magnetic Fields

P-161-B

EFFECT OF MAGNETIC FIELD EXPOSURE ON CALCIUM CHANNEL CURRENTS USING PATCH-CLAMP TECHNIQUE. M. Yasui¹, W. Ooba¹, M. Obo², S. Konishi³ and Y. Otaka². ¹Power Engineering Center, Tokyo Electric Power Company, Tsurumi-ku, Yokohama 230, Japan. ²Mitsubishi Chemical Safety Institute, Kashima-gun, Ibaraki 314-02, Japan. ³Mitsubishi Chemical Institute of Life Sciences, Machida-shi, Tokyo 194, Japan.

Following the presentation P-29A at the 18th BEMS Meeting(1996), we constructed a field exposure patch-clamp

recording system, examined its performance and performed the recording of calcium channel currents with the whole cell voltage-clamp mode. We replaced the stage of microscope with a plastic one, attached a pair of coils for cancellation of geomagnetism and a current sheet for the exposure of the cells. Noises from the exposure system (a function generator, a bipolar amplifier, a DC power supply for the coils and a gaussmeter) could be shielded completely. 50Hz sinusoidal noise from the current sheet at 0.1 mT generating condition amounted to about 80pA on patch-clamp signal, 500 to 1000pA, which could be compensated by adding phase-shifted signal by a half wavelength. In relation to the quantum beat hypothesis, results of measurements at the exposure parameters shown below will be presented.

Waveform :	sinusoidal superposed on DC fields
frequency :	resonant frequency for calcium and power frequency
flux density :	DC: 15~150 μ T, AC: 21~65 μ T
cell :	PC-12, Lymphocyte, (Purkinje neuron: planned)
the other factors:	temperature, chemicals

Measurements under direct exposure to weak currents corresponding to induced currents by magnetic fields are also planned.

P-162-C

ELF MAGNETIC FIELD AND IONIC RESONANCE: PRELIMINARY RESULTS ON GENOTOXICITY AND CELL PROLIFERATION. M. Della Noce¹, M.B. Lioi², O. Zeni¹, F. Bersani³ and M.R. Scarfi¹. ¹CNR-IRECE, 80124 Naples, Italy. ²Department of Animal Science, University of Basilicata, Potenza, Italy. ³Department of Physics, University of Bologna, 40100 Bologna, Italy.

Based on ionic resonance model proposed by Lednev in 1991 (*Bioelectromagnetics*, 13, 231), we have investigated on the effects of an ELF magnetic field on micronucleus (MN) induction and cell proliferation in human peripheral blood lymphocytes (HPBL).

In a previous work Tofani and coworkers (*Bioelectrochem. & Bioenerg.* 36, 9-13, 1995) exposed HPBL to a magnetic field whose characteristics fulfilled the condition of parametric resonance for the Ca^{2+} ion. The exposure conditions were: sinusoidal magnetic field at intensities of 75 μ T and 150 μ T rms, frequency of 32 Hz, with and without a parallel static component of 42 μ T. They found an increase of MN frequency only when the parallel static component was present at both the intensities of the alternated magnetic field, indirectly confirming the theoretical model.

In the present communication we report the results obtained by repeating their experiments but only employing a sinusoidal magnetic field at 32 Hz and 75 μ T rms with the static parallel component at 42 μ T.

Lymphocyte cultures from 6 healthy donors, aged between 20 and 33 years (mean age 27.8 ± 4.6) were set up and for each blood sample a control (unexposed) and an exposed culture were examined by measuring MN induction and cytokinesis-

block proliferation index (CBPI). In 3 subjects the cytokinesis-block MN assay was performed with 3 $\mu\text{g}/\text{ml}$ of cytochalasin-B (Cyt-B), following the protocol of Tofani *et al.*, while the remaining 3 were tested by using 6 $\mu\text{g}/\text{ml}$ of Cyt-B since the latter concentration seems to optimize the sensitivity of the test (Ellard and Parry, *Mutagenesis*, 8, 317-320, 1993). The proliferation was measured according to the procedure suggested by Surralles *et al.* (*Mutation Res.*, 341, 169-184, 1995).

Our results suggest that the field tested does not induce genotoxic effects nor influence cell cycle kinetics at both cyt-B concentrations tested, although the number of subjects studied is insufficient to perform a statistical analysis. More experiments are needed to confirm our preliminary findings.

P-163-A

THE WINDOW EFFECTS OF ELF ELECTRO-MAGNETIC FIELD ON BIOLOGY. Z.Q. Niu and G. Kang. Department of Microwave Telecommunications Engineering, Xidian University, Xi'an 710071, P.R. China.

The aim of this experiment study was focused on finding the frequency-window and intensity-window effects of extremely low frequency (ELF) Electromagnetic fields (EMF) on the efflux of calcium ions from chick brain tissue. This type effects were observed when the tissue was exposed to radiofrequency EMF modulated by ELF EMF. The window effects is defined as a biological response that occurs only under specific, discrete and narrow frequency or intensity region of EMF, outside of these regions the response is moderated or eliminated. The brains were removed from each chick skull and sliced along the midline, and called as brain hemispheres. The two hemispheres from a same brain were maintained as a treatment- control pair throughout subsequent treatments and analyses. The medium in the study was composed of NaCl, KCl, CaCl_2 , NaHCO_3 and glucose. For radioactive labeling of brain tissues, a part of the medium was supplemented with Ca-45. Each the hemisphere was put in a test tube containing labeled medium. All the tubes were then placed in a 37°C water bath. Following, the brain hemisphere were rinsed by the nonradioactive medium to remove Ca-45 on the brain surface. Then each hemisphere was placed in a test tube containing nonradioactive medium and called samples. The treatment or sham-treatment samples were soon placed in transverse EM wave transmission cell (TEM Cell) to expose by ELF EMF, at the same time the control samples were placed in water bath. The sham-treatment samples mean that were placed in TEM cell and input EMF power into TEM cell is zero. To measure the quantity of Ca-45 ions released from the samples during the treatment period, the radioactivity of each treatment, sham -treatment and control sample was counted by a liquid scintillation counter. The radioactivity counts of a control sample was used to normalize the counts of its paired treatment or sham-treatment sample to adjust for possible influence caused by difference in brain mass, in age and sex of animals. The basic datum was that the radioactivity counts per minute and per brain mass (CPM) of treatment or sham-

treatment sample was divided by the CPM of the paired control sample. The data from samples treated by different frequency and intensity ELF EMF were statistically analyzed, and the t-test was used to examine the statistical diversity of the efflux of Ca -45 ions from treatment sample as compared to that from sham-treatment sample. The frequency of the ELF EMF in TEM cell were 3, 16 and 31Hz and the peak-to-peak electric field intensity corresponding to aforesaid each frequency were 0 (sham-exposed), 20.4, 42.5 and 62.2V/m. The temperature in TEM cell and the water bath were controlled at 37 \pm 0.2°C. The results indicate that 16 Hz is a frequency window ($P < 0.05$), 42.5 V/m (peak-to-peak) is an intensity window ($p < 0.02$), and the window effects were produced only if the specific frequency of EMF was collocated with the appropriate intensity.

The Project Supported by NSFC.

P-164-B

INTRACELLULAR CALCIUM MOBILIZATION OF IMMUNE CELL EXPOSED TO 50 Hz LINEARLY OR CIRCULARLY POLARIZED MAGNETIC FIELDS. I. Nishimura. Biology Department, Abiko Laboratory, Central Research Institute of Electric Power Industry, Abiko, Chiba 270-11, Japan.

Because epidemiological studies suggest a correlation between magnetic field (MF) exposure and health effects, various laboratory studies have been conducted to investigate the phenomenon. Some of these studies indicate possible biological effects, including intracellular calcium ($[\text{Ca}^{2+}]_i$) mobilization. $[\text{Ca}^{2+}]_i$ is important because of its key functions in the cascade of intracellular signal transduction leading cells toward activation and proliferation. However, reproducing the effect of MF exposure on the $[\text{Ca}^{2+}]_i$ effect has been difficult. We designed and fabricated a temperature-controlled cell incubator that accommodates flow cytometry and can be placed within a Lawrence Berkeley Laboratory (LBL) Solenoid Coil (Nishimura *et al.*, P-9, 1994 Annual Review Meeting, Albuquerque NM). The flow cytometry-solenoid coil system enables us to measure the $[\text{Ca}^{2+}]_i$ of MF-exposed cells in real-time. Unlike a radioisotope such as $^{45}\text{Ca}^{2+}$ that can attach to the glycoprotein on the surface of cells, the fluorescent Ca^{2+} chelator Indo-1 detects only the $[\text{Ca}^{2+}]_i$. In addition, flow cytometry measures a large number of cells in a relatively short period of time. The patch-clamp or fluorescent microscope methods handle a limited number of cells and require some pre-treatment and pre-selection of the cells, such as cover slip attachment and appropriate rate of spontaneous spiking activity. Previously we demonstrated, using the flow cytometry system, that 50-Hz, 5 mT, vertical MF exposure for 30 min does not evoke $[\text{Ca}^{2+}]_i$ mobilization in thymocytes from specific pathogen free (SPF) Sprague-Dawley (SD) rats (Nishimura *et al.*, P-113B, 1995 BEMS; Boston MA). The objective of this study is to determine if exposure to 0.1 mT, linearly or circularly polarized MF mobilizes $[\text{Ca}^{2+}]_i$. The exposure system was modified to produce a horizontal MF in addition to, and independent of, the vertical MF. A multiple-Helmholtz-type, 5-bobbin coil

was placed around the LBL coil. The background MF at 50-Hz was less than 0.08 μ T. The geomagnetic field at the site was about 42.3 μ T. We exposed SPF SD rat thymocytes to horizontal 50-Hz MF at 0.1 mT for 30 min; we also exposed thymocytes to vertical MF under the same condition. In addition, we exposed cells to horizontal MF for 20 min followed by vertical MF for 20 min or vertical MF for 20 min followed by horizontal MF for 20 min at the same intensity. In either experiment, no $[Ca^{2+}]_i$ increase was observed with exposure. Moreover, the horizontal MF of 0.1 mT was superimposed on the vertical MF by shifting its phase by 90 degrees to produce a "rotating" field, i.e., a circularly polarized, MF of 0.14 mT, rms. That field was again applied to the cells for 30 min. No appreciable increase occurred in $[Ca^{2+}]_i$. In other experiment, thymocytes were activated by a lectin, Concanavalin A, prior to exposure to the circularly polarized MF. All these experiments indicated no sign of $[Ca^{2+}]_i$ mobilization. As a positive control in each experiment, cells were treated with a calcium ionophore, ionomycin, following MF exposure and changes in $[Ca^{2+}]_i$ were detected reliably; this indicates that the experimental system would have been able to detect a change in the $[Ca^{2+}]_i$ during the course of MF exposure, if it had occurred. These data indicate that there is no effect of 50-Hz MF exposure on $[Ca^{2+}]_i$ under the conditions tested.

The author sincerely acknowledges Dr. Robert P. Liburdy of LBL who generously offered the use of the LBL coil, along with Dr. Imre Gyuk, DOE Project Manager of a contract with LBL. The author also thanks Dr. James E. Morris of Battelle Pacific Northwest National Laboratories for providing the prototype of the incubator for the flow cytometry-solenoid coil system.

P-165-C

Moved to G-3.

P-166-A

INVESTIGATION OF EMF-INDUCED CALCIUM MOBILITY IN OXIDATIVELY STRESSED HL-60 CELLS. L.K. Fritz, J.E. Morris, R.G. Stevens and L.E. Anderson. Battelle, Pacific Northwest National Laboratory, Richland, Washington 99352, USA.

A characteristic common to many tumor promoters is the ability to generate reactive oxygen intermediates (ROI). These ROI result in oxidative damage to DNA and other macromolecules. Additionally, ROI have been linked to diverse cell signaling pathways and consequently could play a dual role in tumor promotion. The cytotoxicity of these agents has also been associated with an increase in intracellular calcium concentration ($[Ca^{2+}]_i$). Observed perturbations in $[Ca^{2+}]_i$ are a persistent theme in the EMF literature and form the basis for a postulated EMF effect.

OBJECTIVE: Based upon reported effects of EMF on $[Ca^{2+}]_i$ and its role in oxidative stress, this study addresses the hypothesis that EMF exposure predisposes cells to oxidative damage.

METHODS: To test this hypothesis, we are tracking $[Ca^{2+}]_i$ in EMF exposed (1 Gauss 60-Hz) and sham exposed HL-60 cells under conditions of normal metabolism and oxidative stress. In ongoing studies, HL-60 cells are loaded with the fluorescent indicator dye indo-1. Indo-1 is a nontoxic, intracellular, calcium chelator whose ratio of violet/blue fluorescence intensities (wavelengths 405/470 nm) allows calculation of $[Ca^{2+}]_i$. These data are collected on a Becton-Dickinson FACStar^{plus} flow cytometer that has been interfaced with a magnetic field exposure system to measure $[Ca^{2+}]_i$ in individual cells during EMF exposure. A sampling cell holder, provided to us by Izumi Nishimura at CRIEPI, was engineered to accommodate the use of organ culture dishes and to enable precise temperature control during sampling. Using our system, $[Ca^{2+}]_i$ is measured on cells at rest, stimulated with ionomycin (ionophore) and oxidatively stressed with *tert*-butyl hydroperoxide (t-BOOH).

RESULTS: We examined the effect of a 1 G, 60-Hz MF on $[Ca^{2+}]_i$ in indo-1 loaded log phase HL-60 cells. In these experiments, the ratio of violet/blue fluorescence was tracked during a 40 minute exposure time, and $[Ca^{2+}]_i$ was measured using the software program Multitime (Phoenix Flow Systems, San Diego, CA). No difference in $[Ca^{2+}]_i$ was detected between MF exposed and sham exposed HL-60 cells. To ensure that our methods were sensitive enough to detect small differences in $[Ca^{2+}]_i$, HL-60 cells were treated with various doses of ionomycin ranging from 0.3 ng/ml to 3 μ g/ml. An increase in $[Ca^{2+}]_i$ of 5.2% above resting was detected. In the next set of experiments changes in $[Ca^{2+}]_i$ in response to t-BOOH were measured. A dose dependent relationship between t-BOOH and $[Ca^{2+}]_i$ was observed. These experiments further demonstrate that assay methods are sensitive enough to detect the small changes in $[Ca^{2+}]_i$ that occur during oxidant induced stress. The effect of a MF (1 G, 60-Hz) on the $[Ca^{2+}]_i$ of HL-60 cells oxidatively stressed with t-BOOH is being examined in on-going experiments.

DISCUSSION: This investigation provides the opportunity to study in real time the interaction of magnetic fields with cellular oxidative defense mechanisms, especially as they relate to calcium flux. Reports exist suggesting that EMF, under some circumstances, may act as a tumor promoter. Investigating the possible relationship between EMF exposure, calcium flux and oxidative stress, examines one possible mechanism for potential tumor promoter or co-promoter activity.

This work is funded by U.S. Department of Energy under contract DE-AC06-76RL01830.

P-167-B**STUDIES OF MAGNETIC FIELD EFFECTS ON INTRACELLULAR CALCIUM IN JURKAT CELLS.**

H.E. Wey², D.L. Conover¹, P. Mathias², M.A. Toraason² and W.G. Lotz¹. ¹Physical Agents Effects Branch and ²Experimental Toxicology Branch, Division of Biomedical and Behavioral Science, National Institute for Occupational Safety and Health (NIOSH), Cincinnati, Ohio 45226, USA.

An effect on intracellular calcium ($[Ca^{2+}]_i$) continues to be proposed as a biochemical pathway for mediation of biological effects of power frequency magnetic fields. However, consistent reproducible results between laboratories are difficult to attain and the characteristics of magnetic field effects on $[Ca^{2+}]_i$ are not well understood.

OBJECTIVE: NIOSH has investigated the effect of a 50 Hz 1.5 G magnetic field on intracellular calcium in the Jurkat lymphocyte T-cell line.

METHODS: Changes in $[Ca^{2+}]_i$ were determined using microscopic imaging of fura-2 loaded Jurkat cells on poly-L-lysine-coated glass coverslips. A single coil constructed with bifilar wire was located in the same plane as the cells. Cells were exposed to either magnetic field (MF), sham field (SF) or no field (NF) conditions. Temperature was controlled to a set point between 36.5°C and 37°C with typical variation around the set point of $\pm 0.15^\circ\text{C}$. Each experiment consisted of an 8 minute baseline followed immediately by an 8 minute exposure period. During the exposure period one of the exposure conditions (MF, SF or NF) was randomly applied in a blind fashion. At the end of each experiment, cells were exposed to anti-CD3 antibody as a positive control. $[Ca^{2+}]_i$ was analyzed for individual cells as spatially-averaged background-corrected 340nm/380nm ratios, and a $[Ca^{2+}]_i$ transient was considered significant for positive deviations from baseline of 3-times the noise. Typically, there were 25-50 cells in the field of view and approximately 50% of these had no $[Ca^{2+}]_i$ transients in the baseline period and also responded to positive control.

RESULTS: Only cells responding to positive control and lacking changes in $[Ca^{2+}]_i$ during the baseline period were considered; the total number of qualifying cells analyzed for MF, SF and NF were 177, 174 and 167, respectively. The incidences of $[Ca^{2+}]_i$ transients during the exposure period were 19.2% for MF, 16.7% for SF, and 15.6% for NF, and were not significantly different. The variability in the incidence of spontaneous $[Ca^{2+}]_i$ transients during the exposure period was similar to that previously described (for SF and NF combined, mean \pm SD: 17.0% \pm 10.4%; range: 3.3%-33%). Replicate experiments are in progress.

CONCLUSIONS: Previous studies by Lindstrom, *et al.* (*Bioelectromagnetics*, 1995) showed a high response rate (92%) for exposure to 1.5 G 50 Hz MF when individual cells were preselected for investigation. We found no such effect when examining many cells simultaneously. These results do not preclude an effect of MF on $[Ca^{2+}]_i$, but suggest that responsive cells, if they exist, are relatively rare and their identification difficult. It might be expected that $[Ca^{2+}]_i$ transients in responsive cells be temporally linked to the start of MF exposure. In this regard, analysis of the time to the

first $[Ca^{2+}]_i$ transient in exposed populations of cells may provide useful information, and experiments are underway to address this possibility.

This research was supported by the National Institute of Environmental Health Sciences under Interagency Agreement #YOI-ES-50313, as well as by NIOSH.

P-168-C**EXPERIMENTAL SETUP FOR STUDY OF CALCIUM WAVE PROPAGATION IN ASTROGLIAL CELLS EXPOSED TO ELF MAGNETIC FIELDS.**

T. Thorlin¹, M. Lindgren², M. Gustavsson², S. Galt², L. Rönnbäck¹ and Y. Hamnerius². ¹Department of Neurology, Göteborg University, S-413 90 Göteborg, Sweden. ²Microwave Technology, Chalmers University of Technology, S-412 96 Göteborg, Sweden.

We have constructed an experimental setup for measurement of calcium waves via gap junctions between astroglial cells in primary culture from rat.

Many studies have indicated that there may be a link between ELF EMF exposure and human brain tumor. The fact that astroglial cells are the common seat of most human brain tumor has motivated our choice of cells for this study. The choice of a primary culture instead of a cell line may lead to more relevant conclusions being drawn regarding health issues. Calcium is involved in a number of cellular processes and a number of studies have implicated an effect of EMF exposure on such processes.

The system records video sequences of changes in intracellular free calcium concentration $[Ca^{2+}]_i$ at a cellular level. The cells are exposed at the focus of an inverted microscope and multiple cells can be exposed simultaneously. The parameters which primarily will be studied include velocity of wave propagation between cells, delay time across gap junctions and total propagation distance. Intracellular calcium oscillations stimulated by the initial wave can also be recorded. The calcium waves are initiated by mechanical stimulation at the surface of a central cell.

The exposure system consists of two pairs (AC and DC) of three dimensional Helmholtz coils. Initially we will be studying the effect of 50 Hz, 100 μT vertical magnetic field. The equipment maintains a stable temperature of 37 °C. The system is flexible enough to allow future studies within a wide range of frequencies and field amplitudes.

If the magnetic field exposure is found to effect calcium wave propagation in this system it will be possible to refine the experiments in order to test different propagation and interaction models.

WEAK ELF ELECTRIC FIELD EFFECTS ON Ca^{2+} - DEPENDENT REGULATORY ENZYMES IN THE RESPIRATORY PATHWAY. A MECHANISM OF INTERACTION BETWEEN ELF EM FIELDS AND ORGANIC SYSTEMS? R. Coghill. Coghill Research Laboratories, Gwent NP4 5UH, Wales.

SUMMARY: Regulatory control over metabolic pathways is essential for cellular integrity, especially in the synthesis of ATP, the universal source of cell energy. Such mechanisms, however, have evolved in an environment lacking the present artificial EM fields and radiations now permeating this planet. For example, the total adenylate pool is mostly constant, but its relative energy level is reflected in the concentrations of individual constituents (ATP-ADP-AMP). Equilibrium is progressively regulated *inter alia* according to cellular requirements by three Ca^{2+} -dependent dehydrogenases at the beginning of the TCA cycle, namely pyruvate dehydrogenase (DH), isocitrate DH, and oxoglutarate DH, the first two of which reduce NAD^+ . This study investigated whether weak ELF electric fields affect the binding capability of Ca^{2+} to these enzymes, thereby interfering with an existing and indispensable natural regulatory control process, and forcing the cell towards unstable reliance on glycolysis as an inferior ATP source.

METHOD: Tetrazolium salts turn progressively from colourless to blue during conversion of intra-mitochondrial isocitrate to α -oxoglutarate at the start of the TCA cycle as NAD^+ is simultaneously converted to NADH_2 by IDH in a Ca^{2+} -dependent reaction. Conversion of substrate to product by IDH can therefore be followed within any standard spectrophotometric cuvette by monitoring absorbance or transmission %, optimally at 510nm. In this study a weak (1-5mV/cm) electric field is applied to the reaction chamber during this reaction, while keeping temperature within 0.1 C, and kinetic changes in the reaction rate were followed using a datalogger.

RESULTS: It was found that exposing the reaction to the electric field reversibly altered the reaction rate, and that this can be repeated replicably during the reaction. The experiment was quick, robust, and easy to repeat.

DISCUSSION: This effect may be due to a number of different factors. These include that first there may simply be a polarization effect on transmission % as polar molecules in the reaction medium are constrained by the field to align between electrodes. Secondly the reaction rate may be inhibited because Ca^{2+} is unable to bind to the enzymes. Thirdly, the enzymes themselves may be inhibited by the imposed field from binding to the substrate. Further work is needed to identify which of these if any is occurring.

CONCLUSION: Though others have reported enzymatic effects from electric field exposure (McLeod *et al.*, 1991; Dutta *et al.*, 1994; Blank & Soo 1995 etc.) the concept that weak electric fields can interfere with the natural enzyme-mediated regulatory control of ATP synthesis is a novel and little investigated approach.

STARLINGS, EPIGEOUS INVERTEBRATES AND HIGH-VOLTAGE POWERLINES. A.S. Babenko and O.G. Nekhoroshev. Biology & Biophysics Research Institute, Tomsk State University, Tomsk 634050, Russia.

The number increasing of power lines (PL) leads to the fact, that they become usual not only for anthropogenic landscape, but for natural one and the possibility arises for working out of bases of ecological standartization of electromagnetic fields. One of the main tasks is the revealing of system of biological test-indices, reflecting disturbances, causing by high-voltage PL. The object of our studies is the determination of conditions influence by 500 kV PL, including alternative electric fields, on distribution of epigeous invertebrates, starling's feeding and reproduction. The works were carried out in the South-East of West Siberia during 12-years period (1984-1995).

The average intensity of alternative electric fields under wires of PL constitutes 10-15 kV/m at the level of the starling's boxes, and 4-7 kV/m at the soil surface respectively. The number of epigeous invertebrates was estimated by means of Barber soil traps located in the zone of electric-field influence. Under the PL about 12000 invertebrates were caught in the Barber traps, mostly beetles (first of all *Carabidae*, *Staphylinidae*, *Elateridae*) and multipeds (*Julidae* and *Lithobiidae*).

As result of conducted studies it has been established that:

- the number of abundant invertebrate groups under the PL did not change. The basic factor determining their number and spatial distribution were natural ecological factors, mostly temperature and humidity of soil litter;
- epigeous beetles were the main compound part of starling's food under the 500 kV PL;
- the total combination of conditions under 500 kV PL effects on metabolism ways of amino acids in organisms of starling's females, that leads to the composition changing of free amino acids in bird's eggs and - in the future - to the changing in organisms of progeny;
- the egg's size shows the different stability to changes of environmental conditions, depending on ordinal number of laying;
- the duration of "without feather "period of nestling's development is increased and their mortality is raised under influence of 500 kV PL;
- alternative electric field has cumulative effect on growth and development of nestlings and, beginning with the 1st day of birth, it strengthens its influence, including more number of indeces for nestling's flight.

Thus, electromagnetic factor is necessary to consider as a biologically low active one and strengthening the effect of environment.

WEAK MAGNETIC FIELD SPEEDS UP THE INFORMATION PROCESSING. O. Yeshchenko, K. Nikolskaya, V. Shpinkova and V. Shtemler. Faculty of Biology, Moscow State University, Moscow 119899, Russia.

AIM of the study was to investigate how weak magnetic field (wMF) affects basic cognitive processes: perception, estimation and prognosis of adult male Wistar rats.

Fig.1. Dynamics of cognitive processes in Wistar rats

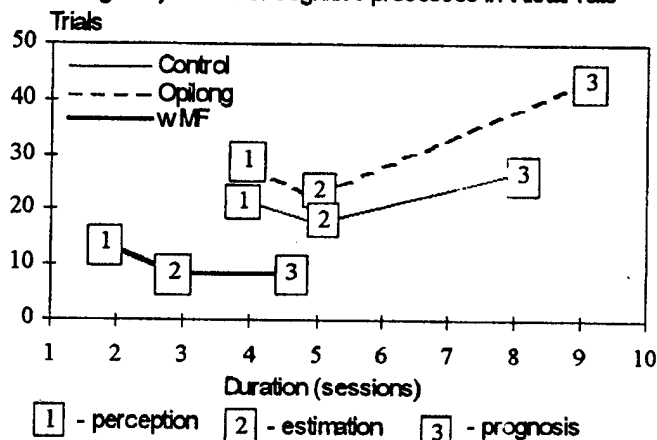

METHOD: Animals had to solve a complicated cognitive task - if a rat leaves a maze without any conditioned stimuli after getting a food and enter it again it would always find a new portion of food in the maze. In Exp.1 (control, n=20) and Exp.2 (n=20) animal learning was studied on the background of natural MF ($38 \pm 2 \mu\text{T}$). In Exp.2 Opilong - a synthetic analogue of dermorphine, μ -agonist and antidepressant was injected intramuscularly in a dose of 40 mg/kg for 5 days before learning. In Exp.3 learning was carried out on the background of wMF (up to $300 \mu\text{T}$) modulated by three magnets placed under the Plexiglas box.

Fig.2. Intensity of cognitive processes

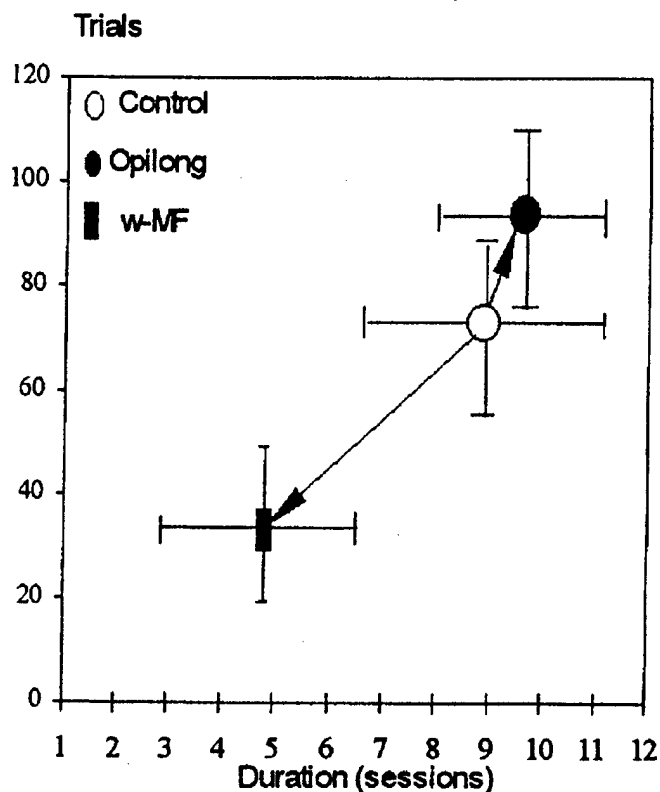

RESULTS: It was shown that only 40% of control animals (good learners) were able to solve the offered cognitive task. 21,5 trials/4,2sessions for perception and 17,5 trials/4,8 sessions were needed to recognise the basic semantic elements of the task. The process of prognosis of the goal-directed behavior took 26,5 trials/7,8 sessions (Fig.1). In 60% of rats (bad learners) failure to solve the task was related with their depressed prognostic abilities. Opilong (Exp.2) increased the number of rats which were able to solve this task up to 90%. The basic effect of opiate consisted in facilitation of prognostic functioning in "bad learners". The parameters of cognitive processes in these rats now became comparable with ones of "good learners" in control but these values had a tendency to be near boundaries of control interval (Fig.1). Unlike the Opilong wMF influenced the cognition of animals with initially good prognostic abilities. Intensity of all cognitive processes was increased sharply (Fig.2, $p < 0.05$). The information processing was more than twice quicker in comparison with Exp.1 and Exp.2: 27,6 trials/4,75 sessions were needed instead of 69,7 trials/7,8 sessions in control and 93,3 trials/9,1 sessions in Opilong-treated rats. Not only the intensity of cognitive processes has been changed, but its dynamic as well. The turn from perception and estimation to prognosis has been sped up (Fig.1).

DISCUSSION: Our data gives the evidence that the wMF increases the efficiency of information processing by sharp facilitation of associative features of CNS. To our opinion, the wMF, by the character of it's modulation of cognitive processes, can be considered as an effective psychostimulator.

P-172-A

INVESTIGATION OF THE EXPOSURE SITUATION AND THE IMMUNE RESPONSE OF HIGH FREQUENCY EXPOSED WORKERS IN AUSTRIA. G. Neubauer¹, H. Tuschl¹, H. Brusl², H. Garn¹, R. Kovac¹, R. Vitzthum¹ and H. Kremser¹. ¹Austrian Research Center Seibersdorf, A-2444 Seibersdorf, Austria. ²Allgemeine Unfallsversicherungsanstalt, A-1201 Vienna, Austria.

In Austria approximately 2000 industrial and medical radiofrequency devices were in use in 1994. In a cooperation between the Austrian Research Center Seibersdorf and the Allgemeine Unfallsversicherungsanstalt the field levels on working places nearby 69 radiofrequency medical and industrial devices were measured and evaluated. The electromagnetic fields of 29 plastic welding machines, 8 wood drying installations, 2 textile drying installations and 13 induction heater units were measured. Also the fields next to 18 therapeutic diathermy equipment units were measured. The field levels measured were compared with the derived field strength limits of the Austrian Prestandard ONORM S1120. The whole body exposure was calculated using field levels measured in 5 different body heights and two homogenous cylindrical models of a sitting and a standing man.

With 9 of 51 industrial devices, the whole body exposure was above the limit of the Austrian standard. Out of 18 medical devices 6 ones exceeded the limits. There is considerable concern regarding the long term effects of radiofrequency fields on human health. Several reports indicate associations between exposure and health consequences, e.g. heart diseases, reduced fertility or increased rates of malformations in the outcomes. No investigations on the human immune system exist, though a reduction of circulating lymphocytes, an increase in neutrophilic granulocytes, reduced natural killer cell activity and increased activation of macrophages were observed in animal experiments.

To investigate the influence of chronic exposure to high frequency electromagnetic fields on the immune system of occupationally exposed persons, blood was sampled from physiotherapists working at the above mentioned diathermy equipment units. 18 exposed and 13 control persons matched for sex and age, were examined. Total leucocyte and lymphocyte counts were performed and leucocytic subpopulations determined by flow cytometry and monoclonal antibodies against surface antigens. In addition to quantify subpopulations of immunocompetent cells, the activity of lymphocytes was measured: Lymphocytes were stimulated by the mitogen phytohemagglutinin and their proliferation measured by a flow cytometric method. No statistically significant differences between control and exposed persons were found. In both test groups all immune parameters were within normal ranges.

P-173-B

CORRECTION OF HUMORAL AND IMMUNE RESPONSE IN THE ACTION OF ELECTROMAGNETIC FIELDS (27,12 MEGAHERTZ; 460 MEGAHERTZ) ON ENDOCRINE GLANDS IN AUTOIMMUNE DISEASES. V.M. Bogolyubov and V.D. Sidorov. Russian Research Center of Rehabilitation and Physiotherapy, 121099 Moscow, Russia.

Experimental and clinical studies showed the possibility of inducing purposefully directed changes in functional activity of various links of the immune system and hormone level by a localized action of high- and ultrahigh-frequency electromagnetic fields (27,12 megahertz, HF-EMF and 460 megahertz, UHF-EMF) on the brain, thymus, thyroid, adrenals and spleen.

Experiments have demonstrated that change in the activity of the cerebral neuromediator and endogenous opioid systems in the form of stimulation of the norepinephrine, serotonin, and enkephalinergic hypothalamic systems and depression of the endorphinergic system are an important mechanism of the biological effect of bitemporal application of HF-EMF. Transcerebral application of HF-EMF stimulates adrenal corticoid function and hypocorticoid activity and leads to suppression of the primary immune response to the thymus-dependent antigen in the immune system peripheral organs but has no effect on the level of serum antibodies. In similar application, UHF-EMF, by activating hypophyseal cortico-, thyreo-, and gonadotropic functions, induces a similar process in the peripheral organs of the immune system. In distinction from HF-EMF, it increases antibody formation in the blood. Bitemporal action of HF-EMF combined with the action of UHF-EMF on the adrenal region intensifies the biological effect of each factor. Such combined application produces a marked immunosuppressive action and is effective in patients with rheumatoid arthritis of moderate and high activity. Such an effect is encountered in systemic lupus erythematosus.

P-174-C

A WEAK MAGNETIC FIELD CAUSED THE INCREASE OF PROTEINS IN THE BRAIN. V. Shpinkova¹, L. Gershtein² and K. Nikolskaya¹. ¹Department of High Nervous Activity, Biology Faculty, Moscow State University, Moscow 119899, Russia. ²Brain Research Institute, Moscow, Russia.

PURPOSE: Peculiarities of protein metabolism in sensorimotor cortex (SM) was studied in Wistar rats in the presence of weak magnetic field (wMF) during an information load.

METHODS: As an information load there was used a food operant task. Animals had to solve this task in a multialternative maze. In Exp.1 (control, n=10) behavior was observed in the "living room", which was a part of laboratory's interior. In Exp. 2 (n=10) - rats learned on the background of natural MF (nMF=38 μ T). In Exp.3 (n=10) the magnitude of MF in the maze varied from 8 to 280 μ T.

P-175-A

MUTATION INDUCTION IN HPRT GENE BY EXPOSURE TO HIGH-DENSITY 50 Hz MAGNETIC FIELD AND ITS SPECTRUM ANALYSIS. J. Miyakoshi¹, S. Tachiiri^{1,2}, N. Yamagishi¹, T. Shibata² and H. Takebe¹. ¹Department of Radiation Genetics and ²Department of Radiology, Faculty of Medicine, Kyoto University, Sakyo-ku, Kyoto 606-01, Japan.

Extremely low frequency-electromagnetic fields (ELF-EMFs) arise from a variety of sources such as electric power lines, electric transportation systems, and electric appliances that have motors. The possible health hazard due to exposure to ELF-EMFs is an issue of considerable public concern. Epidemiological studies have linked exposure to ELF-EMFs in residential and occupational environments to apparent cancer risk. The underlying mechanisms that affect human health are not clearly understood. In many previous reports on the genetic toxicity of ELF-EMFs, no clearly positive results on the mutation induction have been presented. In general, the effects of ELF-EMFs have been contradictory. The contradictions could be attributed, in most cases, to the quality and power of the experimental equipments. In addition, in contrast to ionizing radiations, ELF-EMFs do not carry enough quantum energy to induce the direct damage to DNA.

OBJECTIVES: The increased mutations by high-density 50 Hz magnetic field in the hypoxanthine-guanine phosphoribosyl transferase (HPRT) gene and its mutational spectra were analyzed in human MeWo cells and Chinese hamster ovary (CHO) cells.

METHODS: We have designed and manufactured a new device for high-density exposure of cultured cells to ELF magnetic fields (ELF-MFs) (Miyakoshi *et al.*, *J. Radiat. Res.*, 1994). The magnetic field is directed vertically. At 50 Hz and 400 mT ELF-MFs, J_{max} and E_{max} at a maximum radius of 7.5 cm in the annular culture plate are 8.47 A/m² and 4.70 V/m, respectively. MeWo and CHO-K1 cells are derived from a human malignant melanoma and from a Chinese hamster ovary, respectively. The HPRT gene is an X-linked recessive locus and single mutational event can produce a mutant cell. Synchronous MeWo cells at G1/S boundary were obtained by the treatment with aphidicolin (5 µg/ml) for 22 hours. For the spectrum analysis, HPRT cDNA was obtained by RT-PCR methods and the nucleotide sequences of the cDNA were determined by using an automated DNA sequencer (Applied Biosystems).

RESULTS AND DISCUSSION: The 6-thioguanine resistant (6-TG^r) mutation frequency (MF) of MeWo cells exposed to ELF-MF at 400 mT for up to 20 hours increased with increasing exposure periods and saturated after 10 hours exposure. Increase in the induced mutations was dependent on the mean induced current intensity up to 7.66 A/m² (Miyakoshi *et al.*, *Mutat. Res.*, 1995). When the cells were synchronized by the treatment with aphidicolin and then

The magnitude of MF in the "living room" was comparable with values in Exp. 3. Cytophotometric analysis of pyramidal neurones (layers III and V) of SM cortex was held. The area (S), protein content (M) and concentration (C) in the nucleus (n) and cytoplasm (c) were measured in 900 neurones by means of interference microscope INTERFACO in monochromatic light with wave-length 560 nm.

Fig.1. Cytochemical parameters in layer III of SM cortex

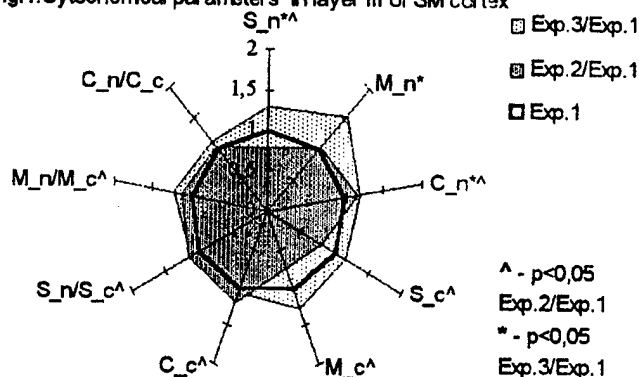
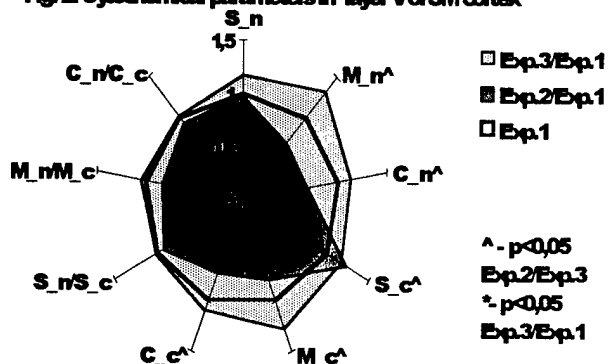

Fig. 2. Cytochemical parameters in layer V of SM cortex



RESULTS: It was found that information load Exp.2 produced significant cytochemical changes in SM cortex. Area of nucleus and cytoplasm in associative neurones (Sn, c; I III) was sharply decreased, while the protein concentration (Cn, c) was increased. These reactions were accompanied by the changes of nucleus/cytoplasm ratio. (Fig.1). Cytochemical reaction of efferent neurones (I V) was more expressed. Protein concentration and its content decreased in both nucleus and cytoplasm (Fig.2). These changes did not affect the nucleus/cytoplasm ratio. To our mind, changes in the layer III were connected with the dehydration, but in the layer V - with the swelling of neurones. It was found that the information load under background of wMF (Exp. 3) provoked the different kind of changes in both layers of SM cortex. All cytochemical parameters of protein metabolism were increased significantly (Fig.1,2) which was more expressed in nucleus of associative neurones. The osmotic state of neurones (layers III and V) and nucleus/cytoplasm ratio did not change in the presence of wMF (Exp.3).

INTERPRETATION: The data obtained testify the high sensitivity of the brain to low disturbances of MF. The combination of information load and weak MF (up to 300 µT) led to accumulation of protein in all neurones of SM cortex. These findings support the idea of the important role of proteins in perception of MF information.

exposed to ELF-MFs or X-rays at various times after release from aphidicolin, ELF-MF-induced mutations increased throughout S phase except for at early S phase. X-ray-induced mutations increased at early S phase and decreased at late S to G2 phases. For the spectrum analysis, CHO-K1 cells were exposed to ELF-MF at 400 mT for 5 hours and the 6-TG^r clones were isolated. The nucleotide sequences of the HPRT cDNA from each clone were determined. We detected several types of mutations, including base changes, partial or total deletions of exons, and suspected splicing mutations, in the 6-TG^r clones isolated after exposure to ELF-MF. Spectra of the mutations by ELF-MF were almost similar to those of spontaneous mutations. We have demonstrated that exposure of cells to the high-density ELF-MFs induces mutations in the HPRT locus, especially in the cells at S phase and the spectra of the mutations by ELF-MF appeared to be similar to those of spontaneous mutations. DNA replication errors and/or genetic instability are suspected to cause the mutations produced by high-density ELF-MF exposure.

P-176-B

GENOTOXIC EFFECTS OF 100 Hz PULSED MAGNETIC FIELDS ON HUMAN LYMPHOCYTES CULTURED *IN VITRO*. M.R. Scarfi¹, R. Barbieri², O. Zeni¹, M. Della Noce¹, F. Bersani³ and M.B. Lioi². ¹CNR-IRECE, 80124 Naples, Italy. ²Department of Animal Science, University of Basilicata, Potenza, Italy. ³Department of Physics, University of Bologna, 40100 Bologna, Italy.

In a previous study we showed an increase of micronucleus (MN) frequency and cell proliferation in cultures of human lymphocytes from healthy donors after 72 h exposure to a pulsed magnetic field (PMF) at a repetition frequency of 100 Hz (Scarfi *et al.*, *Bioelectrochem. & Bioenerg.*, *in press*). The present study was designed to extend our initial findings by evaluating the effects the PMF exposure using the chromosome aberrations assay.

Peripheral blood lymphocytes from 4 healthy subjects aged between 34 and 41 years (mean age 38.5 ± 3.11) were cultured and from each blood donor unexposed and PMF-exposed samples were set up following standard protocols. In particular, 50 µl for 10 ml cultures was added during the last 2 h of cell growth. Chromosome aberration frequency was evaluated in a minimum of 50 well spread metaphases per subject/treatment.

The exposure system and field characteristics were the same as in our previous study. Briefly, the magnetic field signal was approximately triangular, the repetition frequency was 100 Hz; rise time 1.4 ms. The signal was unidirectional and the peak intensity of the magnetic field was 1.3 mT.

The results obtained indicate a considerable enhance of chromosome aberrations in samples exposed to the field with respect to unexposed controls (Two tailed paired Student's t test: P<0.01), suggesting that the repetition frequency plays a fundamental role in eliciting the effect. In fact, in a previous work, we found no genotoxic effects in the same type of cells and with similar exposure conditions (Scarfi *et al.*, *Mutation Res.*, 306, 129-133, 1994).

P-177-C

CARCINOGENICITY TEST USING B6C3F1 MICE AFTER PARENTAL AND PRENATAL EXPOSURE TO 50 Hz MAGNETIC FIELDS. RESULTS OF HISTOPATHOLOGICAL EXAMINATION. W. Ooba¹, Y. Otaka², T. Chida² and Y. Yamagishi². ¹Power Engineering Center, Tokyo Electric Power Company, Tsurumi-ku, Yokohama 230, Japan. ²Mitsubishi Chemical Safety Institute, Kashima-gun, Ibaraki 314-02, Japan.

Following the presentation P-50B at the 18th BEMS Meeting(1996), we report here results of histopathological examination of all organs and tissues suspected of tumoral lesion of B6C3F1 mice parentally and prenatally exposed to 50Hz sinusoidal alternating magnetic fields of 0.5 and 5mTrms and euthanized at 78 weeks of age. The table below shows the tumoral lesions found in more than 5% of animals of either sex (*) with related lesions.

	male			female		
	sham	0.5	5 mT	sham	0.5	5 mT
number of animals	96	74	105	93	77	103
Lung						
Bronchiolar/Alveolar adenoma(*)	14	15	13	0	1	3
Bronchiolar/Alveolar adenocarcinoma	2	0	4	0	0	0
(Alveolar epithelium hyperplasia	4	3	1	0	0	0)
Liver						
Hepatocellular adenoma (*)	21	10	17	0	0	0
Hepatocellular carcinoma(*)	3	5	5	0	0	0
(Hepatocellular focus	16	15	8	1	1	2)
Hematopoietic organ						
Malignant lymphoma(*)	2	0	1	8	7	5

There was no significant increase in incidence in the exposed groups. Tumors found only in the exposed groups were: male: hemangioma of jejunum (1), hemangiosarcoma of liver (1), cortical adenoma (1) and malignant pheochromocytoma (1) of adrenal, benign amelanotic melanocytic tumor of skin (1), hemangioma of subcutis (2), and female : hemangioma of spleen (1), histiocytic sarcoma of hematopoietic organ (1), adenocarcinoma of duodenum (1), hemangioma of liver (1), anterior cell adenoma of pituitary (3), leiomyosarcoma of uterus (1), hemangioma of subcutis (2). These are thought to have nothing to do with the exposure as the incidences of almost all these tumors were only one case and these tumors are known to occur sometimes in old animals. Only incidence of hemangioma of liver in 5mT male group (0) was significantly different from that in the sham group (4), but the effect was suppressive. As a conclusion, parental and prenatal exposure to power frequency magnetic field is not thought to have any adverse effect on incidence of tumors.

P-178-A

EFFECT OF COMBINED MAGNETIC FIELDS (0-50 Hz) AND IONIZING RADIATION IN RODENT CELL TRANSFORMATION. I. Lagroye, F. Jouanny, I. Bailly-Despiney and J.L. Poncy. Laboratoire de Radio Toxicologie, CEA, DSV, SRCA, 91680 Bruyères le Châtel, France.

Epidemiological studies revealed possible correlation between power-frequency magnetic fields and the incidence of various cancers including childhood leukemia. Laboratory investigations generally failed to evidence direct genotoxic effect of such magnetic fields, but suggested interactions with known initiators and/or promoters agents like ionizing radiations (Moulder and Foster, *P.S.E.B.M.*, 209, 309-324, 1995). The well established rat tracheal epithelial (RTE) cell transformation assay *in vitro* (Thomassen *et al.*, *Int. J. Radiat. Biol.*, 57, 395-405, 1990) was used in this study to investigate potential interaction of combined magnetic fields (CMF) in α particle-induced cellular transformation. Alpha-irradiations used electrodeposited ^{239}Pu (6.8×10^3 to 2.5×10^4 $\alpha/\text{sec}/\text{cm}^2$). Magnetic signal generated with Helmholtz coils consisted in a $100 \mu\text{T}_{\text{rms}}$ sinusoidal magnetic field at a frequency of 50 Hz and a geomagnetic-like static field with a $55 \mu\text{T}_{\text{rms}}$ magnetic flux density. CMF exposure set-up was housed in a plastic box shielded with MUMETALL[®] and put in a CO_2 incubator. Sham exposures to CMF were performed in a similar shielded box without Helmholtz coils. Time-varying magnetic flux density corresponded to general public exposure limits. At their first passage, diploid RTE cells were irradiated with $0.04 \alpha/\mu\text{m}^2$ or mock-irradiated and transferred in culture dishes for cloning efficiency evaluation. They were then incubated either in a control incubator or in CMF exposure system for 3-4 weeks. Selective culture medium introduced at day 5 allowed the growth of preneoplastic transformed cells in the overall clonogenic cell fraction. Data were expressed as relative transformation rate (RTR) with $\text{RTR} = \text{transformation rate in exposed cells} / \text{transformation rate in control cells}$. Three independent experiments were done with at least 10 samples in each condition. Results drawn in the lower figure showed that α -radiations (at the dose used) and CMF exposure alone affected RTE cell transformation ($\text{RTR} = 4.3 \pm 1.9$ and 3.2 ± 1.6 respectively) but not significantly (U test of Mann and Whitney). However, exposure of α -irradiated cells to CMF increased significantly the RTR to 9.4 ± 3.3 . Additional experiments are in progress to improve these results suggesting that CMF may act as copromoters in cellular transformation.

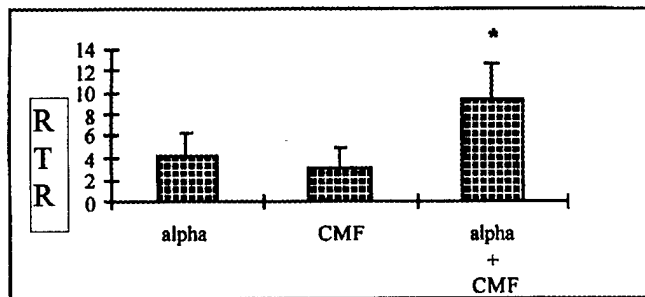

Figure : Relative transformation rate (RTR) of rat epithelial tracheal cells after α -irradiation and/or exposure to combined magnetic fields (CMF). * = $p < 0.05$ vs control (U of Mann and Whitney).

P-179-B

EFFECTS OF 60 Hz ELECTRIC FIELD ON LOSS OF HETEROZYGOSITY AND mRNA LEVEL IN p53 GENE. S.K. Dutta, A.L. Truong, H.N. Banerjee and M. Verma. Molecular Genetics Laboratory, Department of Biology, Howard University, Washington, District of Columbia 20059, USA.

Loss of heterozygosity (LOH) has been correlated with cancer which can be detected rapidly by polymorphism of dinucleotide repeats (Nakamura *et al.*: *Nucleic Acids Res.* 16: 5707-5712, 1988). This PCR based assay is an effective technique to detect at the p53 locus in cancer cell. p53 is a tumor suppresser gene which participates in cell cycle regulation also, and sometime is referred as check point. Altered-expression or mutation of p53 has been correlated with abnormal development, apoptosis and cause of cancer. It has been a matter of concern why certain kinds of cancer and other diseases have occurred in workers in electrical occupation. Our interest is to investigate whether electric field at a frequency, used commonly in everyday life, may alter mRNA levels of p53 gene or causes mutation in the gene encoding p53. Based on the published literature on NG108 and our previous work in the field of gene regulation in response to radiation exposure, we have selected NG108 cell line for our studies.

60 Hz sine waves were used to study the effects of electric (E) field (46.384 V/m) on the mRNA levels of p53 and to determine mutations in p53 coding regions. mRNA levels were determined by Northern hybridization and mutation was detected by PCR-based analysis of DNA isolated from control and exposed cells. Confluent NG108 cells were exposed for short time (30 min) at 37°C to electric field and RNA was isolated from these cells. Preliminary data indicated that these radiation's neither caused alteration in the mRNA levels of p53 nor induced mutation in p53. The authenticity of the reagents and a successful assay was accomplished by us in MCF cell line where mutation in p53 gene resulted in 116 bp byproduct due to 2,4-Am-DNT treatment. Reports from Goodman's group have demonstrated that 60 Hz affect one of the basic processes of gene regulation, viz. transcription. It appears that 60 Hz electric field exposure differentially affects

expression of genes. These basic results will be the foundation of our future studies with other genes which may get altered expression by 60 Hz radiation. The implications of these studies in understanding gene regulation will be discussed. Supported partly by an NIGMS-NIH grant #S06GM08016, and partly by an US Army Training grant #34509-RT-AAS.

P-180-C

EFFECT OF HIGH-PEAK-POWER PULSED MICROWAVE RADIATION ON THE COLONY-FORMING ABILITY, MUTAGENESIS AND RECOMBINAGENESIS IN YEAST. O.N. Pakhomova, M.L. Belt, M.E. Belt, D.D. Cox and Y. Akyel. U.S. Army Medical Research Detachment and McKesson BioServices, Brooks Air Force Base, Texas 78235-5324, USA.

OBJECTIVE: The objective of the study was to examine possible genetic effects of high-peak-power microwave pulses from a TEMPO (transformer-energized megawatt pulsed output) exposure system.

METHODS: We used yeast *Saccharomyces cerevisiae* strain D7 which carries specific gene markers *trp5-12/trp5-27*, *ade2-40/ade2-119*, and *ilv1-92/ilv1-92*. The cells were exposed at the stationary phase of growth as 7.5×10^6 cells/ml water suspension. Plastic tubes with 3 ml of the suspension were positioned in an anechoic chamber 1 m from the antenna of the TEMPO transmitter. The microwave pulse parameters were as following: 3 GHz carrying frequency, 1 pulse per 7 sec, 80 nsec pulse width, 170-180 kW/cm² peak incident power density. The transmitted energy ranged from 22 to 38 J (31.5 ± 2.3 J) per pulse. The samples were exposed to 10 or 100 microwave pulses. The irradiation did not cause any measurable heating of the samples. Each exposure was preceded or followed by a sham exposure. For a sham exposure, TEMPO generated the same number of pulses and the samples were in the same location, but shielded from microwave radiation. Immediately after the exposure, cells were appropriately diluted and plated on the minimal (10 plates per experiment) and selective synthetic media (without isoleucine and without tryptophan, 5-7 plates each). Normal and aberrant colonies were scored in 7 days of incubation at 30°C. Each type of exposure and sham exposure was repeated 10 times. The collected data were analyzed by χ^2 and Student's t-tests.

RESULTS: Irradiation with 10 TEMPO pulses did not affect the colony-forming ability (CFA) of yeast cells on either complete or selective media. The production of aberrant colonies was not different from respective sham controls. However, exposure to 100 pulses significantly ($p < 0.05$) decreased CFA on the complete medium in 5 out of 10 experiments. In the other 5 experiments, the CFA was at the same level as after the sham exposure. For all the data pooled together (for all 10 experiments), this effect still was statistically significant ($CFA_{exp}/CFA_{sham} = 0.93 \pm 0.03$, $p < 0.05$, 2-sided t-test). The yield of mutations and recombinations did not change, even in those experiments when the CFA decreased.

CONCLUSIONS: High-peak-power microwave irradiation, within the studied range of field parameters, did not induce mutation, gene conversion, or reciprocal mitotic crossing-over in yeast. The CFA decrease in cells exposed to 100 microwave pulses apparently was not caused by alterations of the chromosome structure and involved some other mechanisms (such as, for example, membrane damage). However, this finding should be taken and interpreted with care, as yet we do not know the reasons why the CFA decrease occurred in only a half of the conducted experiments.

The work was supported by the US Army Medical Research and Material Command under contract DAMD17-94-C-4069 awarded to McKesson BioServices. The views, opinions and findings contained in this report are those of the authors and should not be construed as an official Department of the Army position, policy or decision.

P-181-A

EFFECT OF A STRONG STATIC MAGNETIC FIELD ON MUTAGENICITY OF CHEMICAL MUTAGENS IN AMES ASSAY. M. Ikehata¹, T. Koana¹ and M. Nakagawa². ¹Environmental Biotechnology Laboratory and ²Fundamental Research Division, Railway Technical Research Institute, Kokubunji, Tokyo 185, Japan.

OBJECTIVE: The aim of this study is to detect the biological effect, especially genotoxicity, of strong static magnetic fields using a modified bacterial mutation assay (Ames' Test) and to estimate its safety limit. Last year, we reported at 18th annual meeting of BEMS (Abstract book, P-34B) that the mutagenicity of 2-(2-furyl)-3-(5-nitro-2-furyl) acrylamide (AF-2) was affected by exposure to a 5T static magnetic field. Here, in this report, we present the results of Ames assay in 5T and 2T static magnetic field with various kind of mutagens.

METHODS: A superconducting magnet (SCM) with a horizontal bore (20cm diameter) which generates a homogeneous static magnetic field up to 5T (50,000G) in a 20cm region at the center of the bore was used for exposure. The SCM was located in a constant temperature room ($37 \pm 0.5^\circ\text{C}$) and test plates were placed and incubated at the center of the bore. Test strain used was *Escherichia coli* WP2 uvrA (tryptophan auxotroph). Pre-cultured cell suspension was washed twice with 0.1M-phosphate buffer to prevent carrying over some unknown nutrition factors. Then the cells were resuspended in 0.1M-phosphate buffer, and 0.1ml of the cell suspension (contained $1-3 \times 10^8$ cells) was plated with 0.6ml of the phosphate buffer which contains various concentrations of chemical mutagens and 2ml of 0.05mM-tryptophan containing molten agar. Six plates were made for each concentration. The plates were randomly divided into two groups; three plates were incubated in a 5T or 2T magnetic field while the others in a conventional incubator as control. After 48 hours incubation, number of mutant colony appearing on each plate was scored and compared with control as mutation frequency.

RESULTS: When cells were incubated for 48 h in a 5T magnetic field 0.02 µg of chemical mutagen N-Ethyl-N'-nitro-N-nitrosoguanidine (ENNG) per plate, the mutation frequency increased by 40-90% compared with control without magnetic field. This effect was also observed in a 2T magnetic field exposure and depends on exposure period. Induced mutation frequency by other mutagens AF-2, 4-Nitroquinoline-N-Oxide and 2-Amino-3-methyl-3H-imidazo(4,5-f)quinoline (with S9 mix activation) were also affected in a 5T magnetic field to some extents. However, Mutagenicity of 2-Aminoanthracene (with S9 mix activation), 9-Aminoacridine, N4-Aminocytidine, Sodium azide and 2-Acetamidofluorene (with S9 mix activation) were not affected by exposure to either 2T or 5T magnetic field.

DISCUSSION: In our previous study, magnetic field alone showed no mutagenic effect. This is not peculiar as the interaction between an electron spin and a 5T static magnetic field produces much lower energy compared with heat, Ultraviolet or X-ray. On the other hand, co-exposure study shows that mutagenicity of some chemical mutagens clearly enhanced by exposure to static magnetic field. ENNG induced mutation rate increased approximately 2-fold by exposure to a 5T magnetic field. The mutagenicity of several alkylating agents was enhanced by magnetic field, and that of base analogues was not affected. It is known that alkylating agents react DNA directly and produce DNA adducts as major product. On the other hand, base analogues are incorporated into DNA sequence and produce mismatch base pair. Our results suggest that only alkylating agents were affected on its mutagenicity by exposure to static magnetic field. It suggest that the chemical reactions of DNA were affected by exposure to static magnetic field. Magnetic field effects on the radical decay rate or the rate of intersystem crossing between the singlet and triplet spin states are well known. Reactions between some chemical mutagens and DNA may be radical-mediated reactions which are affected by exposure to the magnetic field. In further studies, we hope to find the metabolic pathways of alkylating agent and proof of types of chemicals which are affected by exposure to magnetic field.

P-182-B

EVIDENCE OF CHANGES IN GENOMIC LOCATION OF TRANSPOSABLE ELEMENTS IN *DROSOPHILA MELANOGASTER* FLIES EXPOSED TO STATIC MAGNETIC FIELDS. G. Giorgi¹, S. Cavicchi¹, C. Pezzoli¹, D. Guerra² and F. Bersani². Departments of ¹Biology and ²Physics, University of Bologna, 40126 Bologna, Italy.

We showed that a chronic exposure of adult fruit flies (*Drosophila melanogaster*) to a static magnetic field (10-12 folds greater than the geomagnetic field) induces a steady increase of body size after a few generations. Body size increase was mainly associated with cell number, suggesting that the effect of the magnetic field depends on genes which control cell proliferation. The lethal mutation rate also increased by about ten times (1).

In order to investigate the possible genetic mechanisms involved in such response, we studied, by Southern blotting technique, the genomic distribution of eukaryotic transposable elements (*Copia*, *I* and *P*) in isogenic lines of two stocks of *Drosophila melanogaster* after two and twenty generations of exposure. As control the same lines were reared under local geomagnetic field.

In the control lines we failed to detect mobilization of all analyzed elements but, in the lines exposed to the magnetic field changes in the genomic location of *I* and *Copia* elements occurred.

The transposition of mobile elements, which are generally stable in time and space, is one of the main causes of gene mutation (2,3). Our results suggest that geomagnetic variations may be a cause of transposable element-mediated mutations.

References:

- 1) Giorgi G. *et al.* (1992) *Genet Sel Evol.* 24, 393-413.
- 2) Biemont C. *et al.* (1987) *Nature* 329, 742-744.
- 3) Berg D.E. *et al.* (1989) *Mobile DNA*, American Society for Microbiology, 437-519.

III. Technology

Communication/Cellular Phones

P-183-C

NERVE CONDUCTION VELOCITY AND MOBILE PHONES. V. Anderson¹, L. Davidson¹, K.H. Joyner¹ and A.W. Wood². ¹Telstra Research Laboratories, Clayton, Victoria 3168, Australia. ²Swinburne University of Technology, Hawthorn, Victoria 3122, Australia.

Two putative mechanisms by which mobile telephone handsets might affect human nerve conduction velocity (NCV) - radiofrequency irradiation and conducted heat - were investigated. In the first experiment, the ulnar nerve in the left forearm of a male subject was irradiated with an amplified GSM digital phone transmission and NCVs recorded and compared with controls. Electric fields up to 30 V/m and 60 V/m were applied with polarisations parallel and perpendicular to the forearm. No significant differences between the exposure and control NCV measurements were observed. In the second experiment, the effect of heat conduction from the handset of an analogue AMPS phone to the face was also investigated using three male subjects, one of which used a normal phone and the other two using a phone in which the antenna had been replaced with a dummy load. In all cases the analogue handset was configured for continuous transmission, allowed to warm-up and then held against the subjects face until thermal equilibrium was established. The phone was then removed and facial nerve distal motor latency to the nasalis muscle measured along with peak facial temperature until thermal equilibrium re-established at a lower temperature. No significant change in facial nerve latency was observed as a result of skin heating by the handset. An experimental procedure for testing

neurological function in the head using the blink reflex will also be discussed.

presented and discussed under consideration of the physiological significance of Slow Brain Potentials.

P-184-A

EFFECTS OF PULSED HIGH-FREQUENCY ELECTROMAGNETIC FIELDS EMITTED BY CELLULAR PHONES ON SLOW BRAIN POTENTIALS. G. Freude, P. Ullsperger, S. Eggert and I. Ruppe. Federal Institute for Occupational Safety and Health, D-10317 Berlin, Germany.

The purpose of this study was to evaluate the influence of cellular phones (CPs) on the bioelectrical brain activity. It is known that CPs emit high-frequency electromagnetic fields which may interact with the human organism. Because CPs are located near the head influences of electromagnetic fields on central nervous system and processes of information processing were hypothesized.

An appropriate and widely used psychophysiological tool for analysing aspects of information processing are Event-Related Brain Potentials (ERPs). In this study, we applied Slow Brain Potentials (SPs), especially the Readiness Potentials (RP), a preparatory SP which can be recorded in preparation to voluntary initiated movements. RPs reflect neurophysiological changes associated with response initiation, resource allocation and effort expenditure. Many investigations provided evidence that RPs have also a predictive value for performance efficiency.

16 healthy male subjects aged from 21 to 26 years participated in the experiment. They had to perform a reaction time task presented via computer monitor. Especially we applied a "clock-paradigm" which required a high level of concentration and attention. Subjects were asked to stop a quickly moving pointer after three complete revolutions as exactly as possible at the '12-o'clock position' by pressing a mouse key with the right index finger (the key press was the trigger for the backward RP analysis).

Bioelectric brain activity was registered from 28 electrode positions (FP1, FP2, F3, F4, C3, C4, Cz, O2, P3, P4, O1, O2, F7, F8, T3, T4, T5, T6, Fz, Pz, FT9, FT10, FC5, FC6, CP1, CP2, CP5, CP6) and amplified by SYNAPS amplifier (DC recording, upper frequency cut off 35Hz, reference Cz). For detection of eye movement artifacts vertical and horizontal EOGs were recorded. RPs were analysed for the time periods from -2500ms before the key press up to 500ms afterwards. Statistical analysis was performed separately for different RP parameters using the program package SPSS 6.1.2.

The digital mobile telephone with extended antenna was positioned at direct contact to the left ear of the subjects. The devices for generating the pulsed high-frequency electromagnetic energy were operated from a separate room using an extension lead to feed the mobile telephone. The telephone aerial emitted a 900 MHz electromagnetic field pulsed with a frequency of 217 Hz and a pulse width of 577 μ s. The experiments were performed with and without field application. During the different experimental stages subjects didn't know whether the field was on or off.

Results separately for different RP parameters and for the two different electromagnetic field conditions (field on/off) will be

P-185-B

EEG ACTIVITY OF THE HUMAN BRAIN DURING EXPOSURE TO CELLULAR PHONES. M. Hietanen, T. Kovala, A.M. Hämäläinen, R. Velin and P. von Nandelstadh. Finnish Institute of Occupational Health, FIN-00250 Helsinki, Finland.

BACKGROUND AND OBJECTIVE: The use of cellular phones has increased exponentially during the past decade. As a consequence, public debate regarding possible health effects from exposure to radio frequency (RF) fields has arisen. The purpose of the study was to react to the concern by evaluating whether RF exposure from cellular phones has the potential to influence on the electric functions of the human brain. The study is a part of the European COST 244 research program.

METHODS: The exposed study population included 19 healthy volunteers: 10 males (28 - 48 years) and 9 females (32-57 years). The radio frequency exposure was generated by five various types of cellular phones which included three analogue (NMT) models and two digital models (GSM and PCN). Nominal peak output powers were 1-2 W and the carrier frequencies were 900 MHz or 1800 MHz. The brain function was investigated using quantitative analysis of electroencephalograms (Q-EEG). International 10-20 system was used for electrode attachment. EEG recordings were taken while volunteers were sitting comfortable, resting, and their eyes were closed but they were awake all the time. All recordings were taken between 8 a.m. and 4 p.m. in a dark room. During EEG recordings, cellular phones were placed close to the volunteers' head against the right ear as in normal use. For each volunteer, six EEG-recordings were done, one of which was a null recording with a sham exposure. Each EEG-recording lasted 30 minutes consisting of 20 minutes field exposure and five minutes sham exposure both at the beginning and in the end of each trial. The phones were operated via a computer in order to avoid the exposed persons being aware whether the phone was on or off. All registrations were recorded on an optical mass storage device for later analyses.

RESULTS: The statistical analysis was based on comparison of the changes between real exposure and sham exposure. Only one statistically significant difference in the absolute power was observed for one phone model. However, no differences in the relative power for the same phone were found. Thus, the observed difference is probably caused by a statistical chance. As a conclusion, our study did not indicate any adverse effects on the activity of the human brain with the phone models studied.

ELECTROENCEFALOGRAPHIC FREQUENCY MAPPING IN HEALTHY SUBJECTS DURING CELLULAR HEAD TELEPHONE STIMULATION.

S. Dec, E. Cieslak and J.S. Miszczak. Department of Central Nervous System Electrodiagnostic, Air Force Institute of Aviation Medicine, Warsaw, Poland.

EEG Power variations were obtained in 5 healthy young adults 24 - 26 years during pulsed microwaves emitted par working Cellular Head Telephone and controls group 5 healthy young adults during simulation stimulation.

Multichannel electroencefalogram (Dantec-Concerto System) were recorded in a conventional 10-20 system by unipolar montage (reference electrode).

The recording procedure consisted three situation during session of stimulation: a) Phone in left ear position during transmission; b) Phone in right ear position, and c) for maximum decrease of level microwaves exposition (silence-Stimulation auditory condition). Twenty 5 s epochs were chosen in each condition from occipital, temporal, parietal and frontal unipolar derivation for Fast Fourier Transform [FFT] to frequency domain. EEG stored in optical-laser disk sampled of at 1000 MHz / channel for off-line analysts and formed functional mapping. EEG was, automatically segmented in blocks synchronized with cellular phone work. Received data were compare by data registered in subjects during simulation trials. In investigation results the amplitude of low frequencies /delta -theta decreased in frontal deviation.

Anterior and posterior alpha frequency increased linearly with high level phone stimulation. In our study in frequency edge mapping / 0,2 -30 Hz were observed dependence between local temporal increase theta/alpha index by homologous ear control group subjects during simulations trials.

NO EFFECT IN HUMANS OF MICROWAVES EMITTED BY GSM MOBILE TELEPHONES ON THE AUDITORY BRAINSTEM RESPONSES AND AUDITORY DISTORTION PRODUCTS.

C. Thimonier¹, R. Chabert², J. Ayoub¹, R. de Seze¹, J-G. Lallemand² and L. Miro¹. ¹Laboratoire de Biophysique Médicale. Faculté de Médecine, 30900 Nîmes, France. ²Otoneurologie - CHU, 30029 Nîmes, France.

INTRODUCTION: Some electrophysiological changes have been described after exposure to the low power microwaves emitted by cellular telephones. As most of the power is absorbed in the temporal area, it seems interesting to look for a possible effect of the emitted radiation in the auditory system in humans.

Protocol: Twenty healthy volunteers, 10 men and 10 women, 20-30 years old, participated in this study. Volunteers must have a stable life rhythm, particularly without night or shift working. Good health and auditory system of volunteers was assessed by doctors of our hospital. Some exclusion criteria

were: stressful work, usual exposure to electromagnetic fields, GSM phone user, ENT, endocrine or neuropsychiatric disease, unusual sleep pattern, recent transcontinental flight. Volunteers have been using GSM cellular telephones for 1 hour at a maximal peak power of 2 watts, corresponding to a peak SAR in the temporal region of the brain of about 0.1 W/kg. Field parameters were: carrier frequency: 900 MHz, modulated impulse frequency: 217 Hz, duty cycle 1/8.

Ear electrogenesis: The auditory stimulus source delivered unfiltered 100µs << cliks >>. The intensity of stimulation was 80 - 90 dB HL. Auditory brainstem responses (ABRs) and auditory distortion products (ADP) have been measured before and after this 1 hr exposure to the GSM cellular phone. ABRs averaging was performed on 2,500 recordings at a repetition rate of 20/sec, synchronised to the stimulus. ADP are detectable sounds emitted by the external ciliated cells of the inner ear when submitted to a combination of 2 pure sounds of different given frequencies. To check coherence of any observable effect, each recording is repeated at 2 different intensities of 55 and 65 dBspl. To avoid external RF noise and electromagnetic compatibility problems, the exposure was performed by the use of a test-card into a Faraday's chamber. The measured parameters were: i) for ABRs; the latencies of the different observable peaks (I, II, III and V) and the time interval between some of these peaks; ii) for ADP: the intensity of the recorded sound for each combination of stimulating sounds. The non-parametric paired <<Wilcoxon signed-rank>> test was performed.

RESULTS: No significant difference has been observed in the ABRs parameters measured between the pre-exposure and the post-exposure recordings. For ADP, a significant difference occurs only at 2 isolated frequencies at 65 dB, which is not confirmed at 55 dB and then doesn't seem to have physiological meaning.

CONCLUSION: Experiments performed in humans did not show significant physiological changes in the explored parameters of the auditory system. Other experiments are being planned to check the reproducibility of some changes in sleep patterns that were published by Röshke in Germany or to assess the reality or not of some fears like headache that could be caused by phone exposure.

This work was supported by CNET.

N = 20	Peak latencies (ms)							
	I pre	I post	II pre	II post	III pre	III post	V pre	V post
Mean	1.60	1.59	2.80	2.81	3.82	3.81	5.64	5.64
Standard Deviation	0.12	0.066	0.13	0.10	0.15	0.15	0.23	0.25
Std Error of Mean	0.026	0.015	0.030	0.023	0.033	0.032	0.052	0.055

N = 20	Peak intervals (ms)					
	I-III pre	I-III post	III-V pre	III-V post	I-V pre	I-V post
Mean	2.21	2.22	1.82	1.83	4.03	4.05
Standard Deviation	0.16	0.14	0.13	0.15	0.24	0.23
Std Error of Mean	0.036	0.030	0.030	0.033	0.054	0.051

Comparison of EAP latencies and intervals before (pre) and after (post) 1 hour phone exposure

Comparison of Auditory Distortion Products at 55 dB before (pre) and after (post) 1 hour telephone exposure

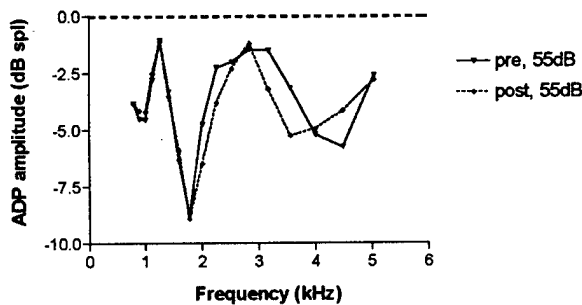

Comparison of Auditory Distortion Products at 65 dB before (pre) and after (post) 1 hour telephone exposure

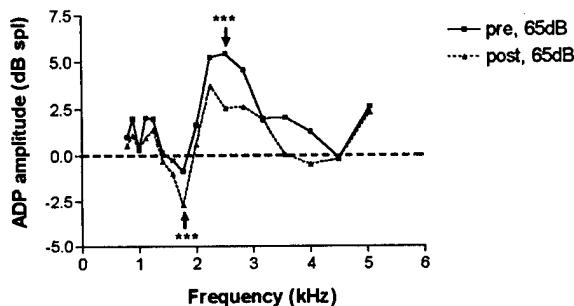

P-188-B

POWER ABSORPTION OF RATS IN A 929 MHz NEAR-FIELD EXPOSURE SYSTEM. S. Watanabe¹, M. Taki² and Y. Kamimura³. ¹Electromagnetic Compatibility Research Section, Communications Research Laboratory, Tokyo 184, Japan. ²Department of Electronics and Information Engineering, Tokyo Metropolitan University, Tokyo 192-03, Japan. ³Department of Information Science, Utsunomiya University, Utsunomiya 321, Japan.

INTRODUCTION: A near-field exposure system to study the carcinogenic effects of the radiofrequency (RF) exposure, caused by cellular phones was developed. The target tissue was a rat liver [1]. This study presents the numerical and experimental estimates of specific absorption rate (SAR) distribution for rats in the exposure system are presented.

NUMERICAL DOSIMETRY: A monopole antenna was placed between two rats on the ground plane to direct localized RF energy absorption in the liver. The finite-difference time-domain (FDTD) method was used to estimate the SAR distribution of rats in the system, using heterogeneous rat models consisting of 2.5 or 3.0 mm cubical cells. When antenna radiation power is 1 W, the maximum local SARs within the liver are 3.85 - 3.30 W/kg, while those within any tissue are 13.8 - 12.6 W/kg, whole-body averaged SARs are 0.80 - 0.58 W/kg. The SAR values vary depending on the rat size due to growth during the 6 week exposure (140 - 242 g). The ratios of the maximum local SAR within any tissue to the whole-body averaged SAR are 9.02 - 11.2, and the ratios of the maximum local SAR within the liver to the whole-body averaged SAR are 2.51 - 2.95.

EXPERIMENTAL DOSIMETRY: A thermograph measurement method was used to estimate the SAR distribution of rat phantoms in the exposure system. A preliminary study demonstrated that the maximum local SAR in a spheroidal jelly-phantom was 6.7 W/kg at an antenna radiation power of 1 W. Further experimental study is continuing, and the results will be shown at our presentation.

DISCUSSION AND CONCLUSION: The SARs of rats in the near-field exposure system were estimated by numerical and experimental approaches. Numerical study indicated that this exposure system should cause localized energy absorption in the livers of rats. Preliminary experimental study showed that the estimated maximum local SAR was fairly consistent with the numerical estimated value.

[1] Taki, M., *et al.*, in this proceedings.

[2] Kamimura, Y., *et al.*, ISAP'96, pp.1281-1284, (1996).

P-189-C

CHARACTERIZATION OF AN EXPOSURE SYSTEM OPERATING AT FREQUENCIES OF HAND HELD MOBILE DEVICES. G.A. Lovisolo¹, L. Ardoino^{1,2}, M. Breccia^{1,2} and M. Guelfi¹. ¹Department of Environment, C.R. Casaccia, ENEA, 00060 Roma, Italy. ²Department of Electronic Engineering, La Sapienza University, 00184, Roma, Italy.

In order to study biological effects of radiofrequency (RF) electromagnetic (EM) fields an exposure system operating at the frequencies of hand held mobile devices, has been developed. The characteristics of the system are related to the type of the planned experimental activity: the aim of investigation, the number and the type of samples, and the duration of exposure. The former exposure system consist in a cubic volume (side 1.2 m) lined with special materials that are only minimally reflective in the frequency range of interest. Two standard sources operating at 900 MHz and 1800 MHz respectively have been used for generating EM fields. The common requirements for all exposures systems as for instance a well-defined volume homogeneity and exposure field well monitored environment conditions and the SAR determination in the specific phantom have been tested. The measurements of SAR (Specific Absorption Rate) in homogeneous simplified phantoms, arranged as in actual experimentation, have been performed. In the case of SAR measurements electrically short probes are commonly used in order to measure the local radio frequency electric field induced in biological systems exposed to a mobile device.

OBJECTIVE: The goal of this work is to present an exposure system for biological studies at the frequencies of hand held mobile devices.

METHODS: Rat phantoms have been made with a cylinder (Φ4.5 cm, L 12 cm) ended by a cone (Φ4.5 cm, L 3 cm) of Lucite, filled of homogeneous semisolid tissue-equivalent material, to define the exposure conditions *in vivo*. Electric fields distribution in the volume radiated has been measured by E field sensor and calculated. Then with the same sensor SAR values have been measured in a few specific point of the phantoms. A thermal power pulse and waveguide technique

(Hill) has been used for the calibration of electric-field probes.

RESULTS AND DISCUSSION: The characterization of the prototype of the exposure system is proposed in air and in the experimental conditions to simulate different number of animals in specific cage or jig. The values of SAR measured in the head and in the body of the rat phantoms are presented. The different level of EM fields homogeneity in the radiated volume are defined.

C. Marino, F. Antonini, B. Avella, L. Galloni, P. Scacchi. "900 MHz effects on tumoral growth in *in vivo* systems". 17th Bioelectromagnetics Society Annual Meeting, Boston, 1995.

F. Apollonio, M. Guelfi, G.A. Lovisolo. "An analytical approach toward the definition of a standard calibration procedure of electric field probes". *Proceedings of Workshop Cost 244*, Zagreb, 1996.

P-190-A

A NEW PHANTOM FOR COMPLIANCE TESTING. R. Kästle, T. Schmid and N. Kuster. Swiss Federal Institute of Technology (ETH), CH-8092 Zurich, Switzerland.

INTRODUCTION: Various phantoms are in current use or have been proposed for compliance testing. However, none of these has been designed to either represent a reasonable cross-section of MTE users or to account for uncertainties with respect to the maximum exposure within such a group. For example, differing ear thicknesses ranging from 4 mm to 10 mm are used, which can affect the spatial peak SAR values by 3 - 6 dB.

OBJECTIVE: Development of a phantom for which the uncertainty with respect to the user group can be assessed.

METHOD AND RESULT: Homogeneous phantoms have been proven to be suitable for compliance testing. Although variations in the shape of the head do not lead to changes in the absorption mechanism, e.g., by focusing effects, they determine the distance between the currents on the device and the skin for any given MTE position which is defined in terms of angles at the auditory canal. In order to obtain a phantom providing minimum distances, an anatomical study was performed. The group selected consisted of 33 men and 19 women between the ages of 20 and 52, mainly European but of different ethnic groups. The head circumferences varied between 55 cm and 61 cm, which is in good agreement with results obtained in wider ranging medical surveys. The shape of the head in the ear region (16 x 15 cm) was determined using a specially constructed measurement device. The evaluation criterion was the 10%-percentile of the distance between the auditory canal and each of the measured points. The precision of the measurements as well as that of the positioning of the head within the device was tested and found to be better than $\pm 10\%$. The thickness of the pressed ear was determined in a similar manner.

In the next step, a generic human shell phantom was constructed by fitting the 10%-percentile surface to a human CAD phantom, whereby this surface was maintained in an area of approximately 12x12 cm around the ear with a precision of better than ± 1 mm. This generic head shape

ensures simulation of the exposure of about 90% of the users and also provides appropriate scattering conditions for the electromagnetic fields of the phone. A twin phantom was constructed by joining a mirror image of the CAD phantom to the original at the base of the torso. This allows for dosimetric assessments of left and right-hand usage of the phone with a single phantom. Based on this CAD phantom, fiberglass shells with a thickness of 2 ± 0.2 mm have been manufactured. The ear was simulated by adding a spacer on the shell to obtain the 10% percentile thickness of the ear between the tissue simulating liquid and the speaker of the phone.

Since the precise placement of the device with respect to the phantom is very critical, a special positioning device has been constructed, which enables the rotation of the MTE by $\pm 180^\circ$ around the axis of the auditory canal and from 75° up to 105° with respect to the axis normal to the axis of the auditory canal.

CONCLUSIONS: The dosimetric evaluation performed with the new phantom does not underestimate the real-world exposure in approximately 90% of the MTE users worldwide. The uncertainty caused by positioning the device has also been reduced to $< \pm 6\%$ (standard deviation). The combination with DASY2 or DASY3 enables the reliable and efficient evaluation of the spatial peak SAR values induced by any handheld mobile phone with known precision.

P-191-B

FURTHER DEVELOPMENT OF A RAT HEAD EXPOSURE SYSTEM FOR SIMULATING HUMAN EXPOSURE TO RF FIELDS FROM PORTABLE CELLULAR TELEPHONES. C.K. Chou¹, K.W. Chan¹, J.A. McDougall¹ and A.W. Guy². ¹Department of Radiation Research, City of Hope National Medical Center, Duarte, California 91010, USA. ²WTR, L.L.C., Washington, District of Columbia 20036, USA.

In the literature, dosimetry studies on human models exposed to 800-900 MHz fields from portable phones show 1-2 W/kg SAR averaged over one gram of brain tissue. The RF energy absorption inside the brain decreases exponentially with depth from the surface. The aim of our study is to produce comparable energy deposition in the rat brain, with maximum SAR of 10 W/kg. This level of SAR in a rat brain will allow a dose response relationship study. The FDTD method was used to model loop antennas for developing a localized rat head exposure system. To avoid the use of high power generators, cumbersome power splitting hardware and cables, it is desirable to use cellular telephones to power individual antennas for large scale animal studies.

OBJECTIVE: To develop an animal exposure system to study the biological exposure effects of radio frequency fields from portable cellular telephones.

METHODS: The FDTD method was initially used to calculate SAR in an ellipsoidal rat model with loop antennas of various sizes positioned at different distances from the headend. To optimize the energy transfer from the power source to tissue and to produce SAR patterns comparable to

THE SENSITIVITY STUDY OF SPECIFIC ABSORPTION RATE IN THE HUMAN HEAD MODEL NEAR THE ANTENNA OF THE CELLULAR PHONE.

A. Krasna, V. Valencic, and A. Berkopec. Laboratory for Numerical Electromagnetic, Faculty of Electrical Engineering, University of Ljubljana, Trzaska 25, 1000 Ljubljana, Slovenia.

SUMMARY: We calculated the electromagnetic field in the human head model due to a cellular phone antenna as proposed by the members of the international COST 244 project. We show that, in general, all the parameters have a considerable influence upon the results and support our conclusions by plots and tables. The authors would like to emphasize the importance of the model geometry and the type of the antenna.

MODEL DESCRIPTION: We modeled two types of the antenna: dipole and monopole, and two types of tissue: bone and brain. The antenna was made of aluminum and was placed 1,5 cm from the head. Figure 1 shows the side view of the cubic head model with dipole antenna and spherical model with the monopole antenna.

those in a human head exposed to a cellular phone, loop dimensions were selected to maximize system efficiency and enable the usage of cellular phones to power these antennas. A 3 x 1 cm loop was determined to be adequate. To calculate SAR in a rat, various tissue types were labelled based on CT imaging Hounsfield Units (HU). The original rat CT images were taken at 0.8 x 0.8 mm resolution in 2 mm slices. HU were translated to tissue dielectric parameters through curve fitting of selected tissue types. Tissue densities were also mapped from HU by a similar approach. The original CT images were transformed to 1 mm FDTD grids. A loop antenna was built with its feed lines coupled to the loop leads through an overlapping section embedded in Teflon rod to withstand high power for thermographic studies. Two male Sprague Dawley rats were exposed with 837 or 1957 MHz antennas, at 23-35 W for 22-45 seconds. SAR distributions were determined thermographically from differential temperature rises. RF shielding for compliance with FCC rules, 200 µV/m at 3 m, was studied.

RESULTS: Several loops have been constructed to operate at 837 and 1957 MHz, producing SARs of 27 and 50 W/kg/W, respectively, in elliptical muscle equivalent phantoms. FDTD calculations of rats with the 837 MHz antenna at 5 mm from the head show that SAR in the head region is 10-50 W/kg/W, mostly around 25 W/kg/W. The whole body averaged SAR is about 1.2 W/kg/W. At 1957 MHz, the average SAR in the brain is lower than that resulting from 837 MHz because of less penetration depth at higher frequencies. The whole body averaged SAR for the 1957 MHz antenna at 5 mm from the head is 1.04 W/kg/W. Thermographic data shows that the maximum SAR in a rat head exposed with the 837 MHz antenna located 5 mm away was 29.7 W/kg/W. At 2.5 and 7.5 mm spacing, the maximum SARs were 38.2 and 12.7 W/kg/W. With the 1957 MHz antenna, the maximum SAR was 60 W/kg/W at 5 mm spacing. Although the experimental configurations were not identical to that used in the numerical computations, the patterns resulting from the two methods are comparable. A prototype heavily shielded cage resulted in 83 dB shielding, still below FCC compliance. To conduct large scale animal studies involving up to one hundred animals, there are only two practical approaches to comply with FCC rules: 1) get authorization from a local cellular carrier for frequency use, or 2) conduct the biological study inside a 100 dB attenuation RF shielded room.

CONCLUSION: FDTD method was used to help design an animal head exposure system. Antennas were built to efficiently deliver RF energy to a rat head. Thermograms show that 10 W/kg exposure can be easily achieved with a 0.6 W cellular telephone. For large population exposure, an RF shielded room will be necessary to comply with FCC regulations.

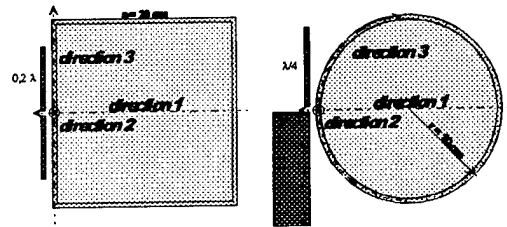

Figure 1: Side view of the cubic head model with dipole antenna and spherical head model with monopole antenna. Antenna (black), bone tissue (dark shaded) and brain tissue (bright shaded). Direction 1 to 3 show the position of the observed elements.

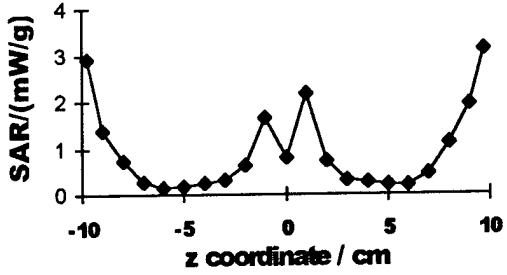

Figure 2: SAR in observed elements in cubical head model Dipole antenna, positioned 1.5 cm from the head, frequency 1800 MHz, elements with open boundaries are positioned 50 cm from the head.

RESULTS AND CONCLUSION: Several aspects were studied: differences between cubic and spherical model, the influence of bone tissue modeling, the influence of head material properties, the influence of the antenna type, the influence of the frequency, the influence of the head and antenna distance. We got lower values of SAR (specific absorption rate) in spherical model, and the distribution of maximum values were also different as in cubical model. The

reason for higher values of SAR in cubical model are sharp cubic edges and smaller distance between antenna and edge elements in spherical model. The example of the results is shown in Fig.2.

The influence of the bone tissue: cubical head model was used with dipole antenna at 1800 MHz, elements with open boundaries were at the distance 50 cm from the head surface.

The influence of different material properties: Calculation considered the influence of 10% variation of the material conductivity and permittivity of bone and brain tissue where we used cubical head model and dipole antenna with frequency of 1800 MHz. We conclude that the relative permittivity has bigger influence on SAR values in the head, than the different values of material conductivity.

References:

V. Valencic, A. Krašna, B. Jurcic - Zlobec, A. Berkopec: Numerical calculation and comparison of electromagnetic field parameters inside biological tissue, *Bioelectrochemistry and Bioenergetics*, 1994.

O. P. Gandhi: *Biological and Medical Applications of Electromagnetic Energy*, Prentice Hall, London 1990.

P-193-A

FDTD ANALYSIS OF THE INTERACTION OF CELLULAR TELEPHONE HELICAL ANTENNAS WITH THE HUMAN HEAD. G. Lazzi and O.P. Gandhi. Department of Electrical Engineering, University of Utah, Salt Lake City, Utah 84112, USA.

The Finite-Difference Time-Domain method (FDTD) is amongst the most used numerical tools for the analysis of the electromagnetic fields induced in the human head by cellular telephones. Many of today's cellular telephones use helical antennas to reduce the antenna length while maintaining good radiation characteristics. This type of antenna has always been difficult to model with the FDTD code due to the stair step approximation of the metal wire. We introduce a novel approach for modeling the helical antenna in order to avoid numerical errors caused by the stair step modeling of the metal wire. In this new approach, the antenna is substituted by a set of equivalent electric and magnetic sources capable of reproducing the near- and far-fields generated by a cellular telephone helical antenna. The main thrust of the approach is that a helical antenna used for wireless communication works in the so-called "normal mode" of radiation, i.e., the radiation pattern is that of a small loop and a small dipole. Therefore, from the analytical expression of the far fields available in the literature, it is possible to determine the relative amplitude of the equivalent magnetic sources and the electric sources. To guarantee an equivalence with the real helical antenna also in the near-field, it is necessary to physically split the electric and magnetic excitations to match the physical dimensions (height and diameter) of the actual antenna. This novel way of modeling helical antennas can also be used to model antennas involving partial helical components, such as a helix-monopole antenna. Results show a good agreement between the calculated and the measured fields, both in the

near- and far-field regions. We have then studied the coupling between several cellular telephones using helical antennas and the human head represented by a 2 x 2 x 3 mm resolution anatomically-based model.

CONCLUSIONS: A novel method to model helical antennas with the FDTD code solves the problem of analyzing such antennas without resorting to the stair step approximation, leading therefore to the possibility of avoiding numerical errors that are difficult to estimate. The method is extremely easy to implement, and it has been successfully tested against measured data in air for several cellular telephones. The specific absorption rates (SARs) induced in the human head by cellular telephone helical antennas have been also calculated and compared with the ANSI/IEEE Safety Guidelines.

P-194-B

GSM CELLULAR PHONES INTERFERENCE WITH IMPLANTABLE VENTRICULAR DEFIBRILLATORS. V. Barbaro¹, P. Bartolini¹, F. Bellocchi², F. Caruso¹, A. Donato¹, L. Gabrielli², C. Militello¹ and P. Zecchi². ¹Biomedical Engineering Laboratory, Istituto Superiore di Sanità, 00161 Rome, Italy. ²Cardiology Institute, Policlinico Universitario A. Gemelli, 00168 Rome, Italy.

Previous studies [Barbaro *et al.* PACE 95, PACE 96; Hayes *et al.*, Irnich *et al.*, Nowak *et al.*, Sparks *et al.*, Wilke *et al.* PACE 96] have shown that cellular phones can induce temporary malfunctioning in implantable cardiac pacemakers. The goal of this study is to verify whether the electromagnetic field radiated by GSM digital cellular phones can affect implantable ventricular defibrillators and induce them to deliver shock therapy.

In vitro trials have already been conducted on 4 defibrillator models and, by the time of the conference, all the models on the international market will have been tested *in vitro* and, wherever possible, *in vivo*. The devices connected to proper leads were tested both in air (worse condition case) and inside a human trunk simulator [V. Barbaro *et al.* PACE 1995 Vol. 18] at 1 centimetre depth. In order to simulate the worse condition the ventricular fibrillation cycle length, sensing threshold, and onset detection criterion were set at their minimum programmable values. Whenever EMI occurred these values were increased and tests were repeated applying a signal simulating a spontaneous cardiac activity just high enough to inhibit the pacing.

The power radiated by the cellular phones (Motorola Dynatac and Microtac) and the transmission protocol (discontinuous transmission) were controlled by an artificial base station (Rhode & Schwarz mod. CMD 52).

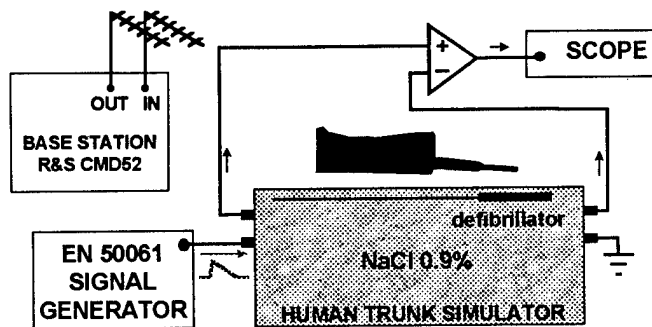

Figure 1 - The experimental set-up

The sensing circuit of two out of the four models tested interpreted the interfering signal as fibrillation, and shock therapy ensued. These events occurred only when the device was exposed to radiofrequency in air, with the phone radiating antenna in close proximity to the connectors located on the head of the defibrillator, and at worse case programming values.

Preliminary results show that, as with pacemakers, the input stages of the defibrillator detect the interfering signal when it is high enough, and interpret it as fibrillation thus inducing shock delivery. But there is evidence that implantable defibrillators are equipped with better anti-EMI protection than pacemakers are.

Maglev

P-195-C

ELECTRIC AND MAGNETIC FIELDS EMITTED BY ELECTRIFIED TRANSPORT SYSTEMS - A COMPARISON BETWEEN CONVENTIONAL RAILROAD SYSTEMS AND THE TRANSRAPID MAGLEV SYSTEM. S. Eggert, K. Hentschel, I. Ruppe and S. Goltz. Federal Institute for Occupational Safety and Health, D-10317 Berlin, Germany.

The first long-distance-relation of a MAGLEV transport system on the basis of TRANSRAPID will be build in Germany at the beginning of 1998 between Berlin and Hamburg. The TRANSRAPID has been developed in Germany during the last 10 years and a 1:1 scale test facility has been constructed in the Emsland, Northwest Germany.

During design and development questions were arising on quality and quantity of fields emitted by the lifting and propulsion magnets of the vehicles as well as of the guideway with respect to the exposure of personnel and passengers.

The knowledge of the spatial distribution of those fields is of high importance for the evaluation of a possible health risk.

To get comprehensive information on spatial and time related distribution and peak values of the electric and magnetic fields during all modes of operation, measurement investigations have been performed at different conventional electrified transport systems (railway, city express train, underground, tram) and at the Transrapid TR 07 test facility (Emsland). This investigation covered all kinds of fields generated by the vehicle as well as by the guideway up to

100m away from centerline of the tracks. Although at frequencies above 100 kHz strong electric and magnetic fields were not expected due to the technique, the frequency range from 100 kHz to 1 GHz has been observed, measured and evaluated by a spectrum analyser equipped with broadband back-up probes.

The results of the investigation can be summarized as follows:

Relevant sources of the electric and magnetic fields at conventional railway systems are the power supply installations and the motors of the engines or carriages. The measured fields included those of DC, of 16.6 Hz as well as of low frequencies up to 600 Hz. Electric fields inside the vehicles were below 100 V/m, mean values of magnetic flux density reached 22 μ T and peak values 65 μ T.

At the TRANSRAPID the main sources of the magnetic fields are the lifting and propulsion systems which produce static and LF alternating fields up to 230 Hz. Caused by the construction these fields are concentrated very close to the place of intended use and only weak stray fields reach those areas accessible for human beings and animals. The strength of the electric fields inside the vehicle and in the accessible area of the guideway is less than 10 V/m, that means it is in the order of magnitude of background intensity in urban environment and at least two orders below the internationally recommended limits.

At all measuring points inside the vehicles and outside in the vicinity of electric installations the values of the electric field strength and of the magnetic flux density are significantly below the limits recommended by IRPA/INIRC/CNIRP for exposure of workers and general population up to 24 h per day. The values of fields emitted by the TRANSRAPID System are lower than those of the investigated conventional wheel-rail-systems.

On the basis of present scientific knowledge concerning the protection of humans against adverse effects from exposure to electric, magnetic and electromagnetic fields no measures are required to reduce the exposure at conventional electrified railway systems and not at all at the TRANSRAPID.

P-196-A

SURVEY OF LOW-FREQUENCY MAGNETIC FIELDS IN LOCOMOTIVES OF THE ITALIAN RAILWAYS. P. Vecchia¹, G.A. Antonacci², A. Apostolo², S. Battisti², E. Munafò², A. Polichetti¹ and G. Puliatti². ¹Laboratorio di Fisica, Istituto Superiore di Sanità, I-00161 Rome, Italy. ²Ferrovie dello Stato S.p.A., I-00161 Rome, Italy.

In Italy, trains are normally operated in direct current (dc). However, low-frequency magnetic fields may be found in the locomotives, and in particular inside the driver's cabin. These fields are mainly due to alternators, or to the feeding of auxiliary systems.

As a first phase of a research aiming at the evaluation of exposure of railway engine-drivers, a survey of magnetic field levels in different models of locomotives presently operating in Italy has been performed. The measurements were taken during actual travels of the trains, i.e. under typical working

conditions. Signals from probes installed in the driver's cabin were reported by direct wiring connections to a special coach equipped with spectrum analyzers, data loggers and on-line computers. Measurements were taken at 3 different positions along each axis, for a total of 27 points. Field levels were monitored for the whole duration of travels, typically lasting 2 to 3 hours. Through suitable filters, data were collected for the special frequencies of 50 and 60 Hz, as well as for the following bands: 5-2000 Hz and 45-65 Hz.

Data recorded on magnetic support were later processed to get minimum, maximum and average values of magnetic flux density B, as well as the standard deviation of the B-distribution. The data analysis shows that B-values are rather stable during time. Large differences are found from point to point, and for different types of locomotives, with B varying from a few tenths to tens of microtesla.

It is planned to combine these field values with data on working history of individual workers, to get exposure profiles in view of an epidemiological study on railway engine-drivers.

P-197-B

EXPOSURE METRICS OF MAGNETIC FIELDS FROM ELECTRIFIED TRANSPORT. N.G. Ptitsyna¹, G. Villoresi², V.A. Bochko³. ¹SPbFizmiran of Russian Academy of Science, 191023 St. Petersburg, Russia. ²IFSI-CNR Frascati c/o Università "Roma 3", Dip. di Fisica, 00146 Rome, Italy. ³Electrotechnical University, Institute Prognoz, 197375 St. Petersburg, Russia.

Magnetic fields (MFs) produced by electrified transports are quite different from power-line fields with predominant frequencies at 50/60 Hz. They exhibit great time changes, pulses and complex superposition of different frequency variations. Biological and epidemiological studies of possible bioeffects of MFs indicate that there is not a well established dose-response relationship: for instance, that could depend on frequency, on field strength thresholds or windows, on transients. To characterize MFs, it is proposed a set of metrics which takes into account biological indications and also specific features of transport MFs. Two approaches have been developed. The first approach was based on the computation of a number of informative features in a MF signal block, with respect to a given intensity level:

(i) Threshold-related exposure metric: computation of the time above the given level and of the time-average value of the integrated area above it. Also the usual time-weighted average (TWA) can be computed.

(ii) Frequency-related exposure metric: computation of the time-average number of crossing the given level. This exposure metric provides also information on the time-average number of peaks higher than the given level.

The second approach was based on the computation of the same informative features of first approach within a number of field strength windows. The choice of these windows depends on the MF variability and on the level of MF background.

A special software "Waveform", for analyzing complex-

spectra MFs, was developed in C++ language for "MS Windows" application. MF records obtained in different DC electrified Russian transports were analyzed by "Weveform". Investigation of relationships between different exposure metrics, including TWA, have been done for different conditions of train motion (accelerating, braking and normal motion). This information can be utilized to provide typical MF patterns for biological experiments on possible bioeffects of electrified-transport MFs.

Standards and Public Policy

P-198-C

NEW GUIDELINES ADOPTED BY THE UNITED STATES FEDERAL COMMUNICATIONS COMMISSION FOR EVALUATING HUMAN EXPOSURE TO RADIOFREQUENCY ELECTROMAGNETIC FIELDS. R.F. Cleveland, Jr. Federal Communications Commission, Office of Engineering and Technology, Washington, District of Columbia 20554, USA.

In the United States (U.S.), the Federal Communications Commission (FCC) is responsible for licensing or authorizing radiofrequency (RF) transmitting devices and facilities, except for those actually operated by the U.S. Federal Government. For that reason, under terms of the National Environmental Policy Act (NEPA), the FCC is also responsible for determining whether there may be harmful environmental impact from the devices and facilities it approves. One of the environmental factors that must be evaluated is human exposure to RF electromagnetic fields from FCC-regulated transmitters. On 1 August, 1996, as required by the U.S. Telecommunications Act of 1996, the FCC adopted new guidelines for use in evaluating exposure to RF fields. Previously, the FCC relied primarily on the 1982 standard of the American National Standards Institute (ANSI) for this purpose. The newly adopted guidelines for Maximum Permissible Exposure (MPE) are based on ANSI's 1992 revised standard, ANSI/IEEE C95.1-1992, developed by a committee of the Institute of Electrical and Electronics Engineers, Inc. (IEEE), and on the exposure criteria recommended in 1986 by the National Council on Radiation Protection and Measurements (NCRP). Specifically, the FCC adopted the NCRP criteria for electric and magnetic field strength, power density and time-averaging. With the exception of power density limits above 1500 MHz, certain low-frequency limits for magnetic field strength and certain time-averaging periods, the NCRP limits are generally the same as those contained in ANSI/IEEE C95.1-1992. The frequency range covered by the MPE limits is 300 kHz to 100 GHz. Two exposure tiers are included, one for "occupational/controlled" exposures and another, generally more restrictive, tier for "general population/uncontrolled" exposures. In addition, limits for localized ("partial body") absorption were adopted that apply to exposure from portable and mobile devices such as hand-held cellular telephones. These latter limits are expressed in terms of specific absorption rate (SAR) and are based on the 1992 ANSI/IEEE

and NCRP recommendations. The FCC action was generally supported by U.S. Government agencies with responsibility for protecting public health, including the U.S. Environmental Protection Agency, the U.S. Food and Drug Administration, the National Institute for Occupational Safety and Health and the Occupational Safety and Health Administration. This presentation will provide details on the new FCC guidelines, their application and their implementation.

P-199-A

A NEW ORDINANCE WITH REGARDS TO HUMAN EXPOSURE TO ELECTROMAGNETIC FIELDS IN GERMANY; CONTENTS AND IMPLEMENTATION.

H. Brüggemeyer. Niedersächsisches Landesamt für Ökologie, 30449 Hannover, Germany.

With the beginning of 1997 a new "EMF-ordinance" implementing the german federal immission control act was enacted (Sechszwanzigste Verordnung zur Durchführung des Bundes-Immissionsschutzgesetzes (Verordnung über elektromagnetische Felder-26.BImSchV).

This ordinance shall apply to the erection and operation of high and low frequency installations. It contains requirements for protection and precautions of the public and the neighbourhood from harmful environmental impacts due to electromagnetic fields. The ordinance is only applicable for installations which serve commercial purposes or are used in the course of commercial undertakings. A high frequency installation according to this ordinance is a stationary radiofrequency transmitting installation with a transmission power of 10 watt EIRP or more in the frequency range 10 MHz to 300 GHz. A low frequency installation according to this ordinance is a stationary installation for the transformation and transmission of electricity (overhead power transmission lines, underground cables, traction power truck lines, transformers and switchgear systems with a high-side voltage of 1000V and over and with a frequency of 16 2/3 or 50 Hz. The immission limit values laid down in the ordinance are based on the recommendations of the IRPA/INIRC.

There are special requirements for notification. It is the duty of the operator to notify the installation with all relevant data. For a high-frequency installation the Federal Post and Telecommunication Agency (BAPT) had to confirm the agreement with the ordinance "Standortbescheinigung". For low-frequency installations there are additional precautional requirements if the installation is in the vicinity of dwellings, hospitals, schools, kindergarten, crèches, playgrounds or similar facilities.

The different federal states in Germany are responsible for the enforcement of the ordinances. For the implementation the 16 federal states established a special working group.

The chances and limitations of this new ordinance will be discussed.

P-200-B

NON-IONIZING RADIATION PROTECTION POLICY IN LATVIA: PROBLEMS AND TENDENCIES. A. Dreimanis. Division of Radiation & Nuclear Safety, Environmental State Inspectorate, Riga LV-1877, Latvia.

Current policy in the area of environmental and public protection from harmful effects of non-ionizing radiation in Latvia is determined by two main essential points: (a) establishment of appropriate legislative and structural system, capable for carrying out proper protection strategy, and (b) elaboration of appropriate national standards in conformity with recommendations of international commissions and reconsidering and transformation of the existing control policy from the previous USSR standards towards novel ones. Due to rather limited material and technical resources, the main problem in development of proper safety policy should consist in establishing of efficient cooperation as well as coordination and distribution of supervision and enforcement functions among the existing State Institutions: (a) Environmental State Inspectorate - Radiation and Nuclear Safety Division, (b) National Environmental Health Centre, (c) Labour State Inspectorate, and (d) State Inspectorate of Electrical Communications. For purposes of real coordination of relevant functions of these State Institutions as well as of several academic institutions, in 1995 there has been founded the Latvian Non-Ionizing Radiation Research Commission. Existing experience in implementation of the State Law "On Radiation and Nuclear Safety", being accepted in 1994, as well as examples of available specific Non-Ionizing Radiation Decrees, existing in several European countries, gives an actual methodology for forthcoming development in Latvia specific legislation for non-ionizing radiation safety.

In accordance with international recommendations there are developed national regulations regarding the main sources of potential hazard to public health and environment: (1) regulations for public protection in the frequency range 0.1-300,000 MHz (radars and broadcast antennae), and (2) for high voltage (maximum - 350 kV) overhead transmission lines at 50 Hz frequency

By several groups of researchers there have been performed experimental studies in order to identify possible effects of radio-frequency fields (in the range 154-162 MHz), generated by the Skrunda radar systems on various organisms (published in "The Effect of RF EM Radiation on Organisms - International Conference, Skrunda, 1994"). Some authors have found structural and functional disturbances in several plants and cultures (Y. Khrol *et. al.*, 1994; T. Selga, M. Selga, 1994). In the same time, for a series of indications, such as cancer incidence, there have not been revealed statistically significant differences between the exposed and the control group. Due to unknown action mechanisms of environmental electromagnetic fields on living organisms, for purposes of augmentation of the safety factor it is advisable to reduce, in reasonable limits, the exposure levels of these fields.

P-201-C

LOW FREQUENCY SURFACE AREA ELECTRIC FIELD RADIATION MONITOR. E.E. Aslan. Lockheed Martin Microwave-Narda, Hauppauge, New York 11788, USA.

Accurate low frequency E Field measurements, below 10 MHz, are difficult to make with reasonably sized monitors having sensors less than 20 cm. This is due mainly to the capacitor coupling to the radiator and the response to the scalar potential field. Both of these errors are a function of the sensor impedance. A short dipole of 10 cm length at 100 KHz would have an impedance in the order of 5 meg ohms. The impedance of the sensor may be far less than the impedance of the resistive transmission line, making the latter the antenna. The monitor described here eliminates these errors by using a surface area sensor in place of conventional dipoles, the impedance of which is .0006 times that of similar size dipoles. Three mutually orthogonal copper clad discs having a surface area of three square inches and a capacitance of 500 pf. comprise the sensor. The E-field normal to conductive surface produces a surface charge on the conductive surface which in turn produces a displacement current given by the equation:

$$I = \epsilon_0(AdE/dt)$$

where A = surface area of the conductive surface
 ϵ_0 = permittivity of free space, 8.85×10^{-12}
 E = field strength in volts/meter

The displacement current is proportional to the E field and frequency, while the RF voltage produced across the sensor is independent of frequency since the reactance through which the current flows is inversely proportional to frequency. The diode that monitors this voltage is operated in its square law region resulting in a dc output voltage that is proportional to the square of the field strength and independent of frequency. The monitor provides isotropic response from 0.1 to 300 MHz, and a dynamic range of 20 to 600 V/M.

P-202-A

E-FIELD PROBE FOR PHANTOM APPLICATIONS. B. Szentpáli¹, V. Van Tuyen¹ and G. Thuróczy². ¹Research Institute for Technical Physics of the Hungarian Academy of Sciences, Budapest H-1325, Hungary. ²National Research Institute for Radiobiology and Radiohygiene, Budapest, Hungary.

The most common measurements of the high-frequency EM field in phantoms are performed by dipole probes [1-4]. These devices consist of an electrically short dipole with a diode in the central gap and two resistive leads connecting the two arms of the dipole to the input of the amplifier. The total

length of the probe should cover the distances of the phantom under test.

In the present paper we are going to report on the development of a probe for the investigations of the 900 MHz EM field of the mobile phone units in head phantoms. The central ideas of the design were: the isotropy, the small size and the avoiding of the dielectric scattering. The isotropy of the probe can be ensured by applying three mutually perpendicular dipoles. Several different arrangements of the dipole antennas have been proposed [5], in our case the triangular construction was applied because of its symmetry which ensures excellent isotropy in the two directions perpendicular to the axis of the probe. The isotropy in the third direction (the E field inclines from the probe axis) depends on the symmetry of the two resistive lines against the dipole. Because the dipoles incline with an angle of 58° to the probe axis the symmetry of the resistive leads can be ensured only along a length comparable with the dipole arms. Therefore the resistive lines were divided into two parts. The first short part is perpendicular to the dipole. It has a high impedance. The subsequent second part which leads along the probe to the amplifier has medium resistance.

The probe was fabricated by thick film technology on polyester substrate (125 μm thick). The detectors are GaAs Planar Doped zero bias diodes. The individual probes are 6 mm wide strips. The dipoles are silver printed. The dipoles are contacted by small SMD resistors (3.3 M Ω) placed perpendicular to them. The resistive lines between the resistors and the amplifier (about 100 k Ω) are printed from carbon paste. The half length of the dipoles are 3 mm. This value results in a physically and electrically short antenna with reasonable sensitivity. The printed circuit is covered by isolating lack. Three individual parts are glued together at the long edges forming the triangular isotropic arrangement. This construction is self sustaining, so no any holder and outer tube are necessary. The inner part of the probe is empty, the jelly of the phantom penetrates into this hole for minimizing the dielectric scattering. The sensitivity and isotropy curves will be shown in the poster.

References:

- [1] Bowman, R.L.; *IEEE Trans. on MTT*, 24-(1), pp. 3-45, 1976.
- [2] Schmidt, T., Egger, O. and Kuster, N; *IEEE Trans. on MTT*, 44, pp. 105-113, 1996.
- [3] Anderson, V. and Joyner, K.H., *Bioelectromagnetics*, 16, pp. 60-69, 1995.
- [4] Bassen, H.I. and Smith G.S.; *IEEE Trans. on Antennas and Propag.*, 31(5), pp.710-718, 1983.
- [5] Bassen H.L. et. al., *An. of the New York Academy of Sciences*, 20(5), pp.481-493, 1975.

P-203-B

ARTIFICIAL RESULTS IN BIOMEDICAL EXPERIMENTS DUE TO DIRECT INTERACTION OF ELECTROMAGNETIC FIELDS WITH THE ELECTRODES. A. Brühn, U. Kullnick and A. Wojtysiak. Institute of Mobile and Satellite Communication Techniques, D-47475 Kamp-Lintfort, Germany.

There have been many studies published in the last years demonstrating an effect of high frequency electromagnetic fields which have been unable to reproduce by other researchers. This may be caused by ignoring the fact, that electromagnetic fields can influence the characteristics of the electrodes used in biomedical experiments.

These influences can be demonstrated in simple key experiments by measuring the frequency response of a electrolyte filled micropipette or Ag/AgCl-electrodes and calculating the resulting consequences in the circuit.

The outcome is a frequency, intensity and modulation depending effect of the applied electromagnetic fields, which can overwhelm weak biological effects or can produce artificial results.

The verifying measurements include besides the testing of the frequency response in a bridge circuit also the analysis of unmodified recorded biological signals played back into the measurement system under the influence of electromagnetic fields.

Activities to reduce these effects were discussed in the poster presentation for the example of the glass microelectrode in extracellular experiments:

This method is often used in combination with spike-detection with a window discriminator. Spikes from one cell were distinguished from spikes of neighbouring cells with aid of their amplitude, depending on the proximity of the cell to the tip of the electrode. Under the influence of an high frequency electromagnetic field, the frequency response of the electrode can be changed slowly, resulting in a modified spike amplitude. This can lead to the misinterpreting assumption of a field dependent altered time course of the biological response.

Possible solutions for experimental research were discussed, including online measurements of the electrode frequency response with help of changes in the noise, adaptive fitting of the discriminator threshold or continuous assessment of all spikes in an offline procedure.

P-204-C

FIELD GENERATING SET-UPS FOR STUDYING EFFECTS OF HIGH-FREQUENCY ELECTROMAGNETIC FIELDS ON HUMAN CELLS. K. Brinkmann, H. Eisenbrandt, R. Elsner and W. Storbeck. Forschungsverbund Elektromagnetische Verträglichkeit Biologischer Systeme, Technische Universität Braunschweig, Braunschweig, Germany.

Electrical engineers at the Research Group for the Electromagnetic Compatibility of Biological Systems at Technical University of Braunschweig have designed some field generating assemblies to the use of medical researchers and biologists which allow reproducible experiments. For the range of high-frequency electromagnetic fields these set-ups are:

TEM cells for frequencies of 380 MHz and 440 MHz,

GTEM cells for frequencies of 0.9 GHz and 1.8 GHz.

Hollow conducting tubes with rectangular shape for frequencies of 0.9 GHz and 1.8 GHz and

μ TEM cells for frequencies of 180 MHz, 0.9 GHz and 1.8 GHz.

According to their application the high-frequency signals were modulated with the requested time pattern. TEM cells, GTEM cells and hollow conducting tubes were filled with sample holders that have in summary the dimension of about $10 \times 10 \times 10 \text{ cm}^3$ or $7 \times 3.5 \times 25 \text{ cm}^3$. In case of the μ TEM cell the sample holders dimension is only $0.1 \times 1 \times 1 \text{ cm}^3$.

Using these assemblies the intracellular calcium concentration of heart muscle cells, the promotion of human leukemia HL-60 cells and both cell proliferation and sister chromatid exchange of lymphocytes were studied and analysed. Several PVC tubes were used as sample holders which were filled with about 5 ml nutritive medium. In case of studying calcium concentration using the μ TEM cell the nutritive medium was filled in a flat acrylic basin placed at the bottom of the μ TEM cell. The tubes were enclosed in a white oil circuit tempered by a bath thermostat to regulate the nutritive mediums temperature to a constant of $37 \pm 0.1^\circ\text{C}$.

In order to get the required electromagnetic field in the exposition set-up the gratitude of the electric field inside the nutritive medium was calculated by a numerical field solving program. In case of the hollow conducting tubes these calculations were done by V. Hansen at Wuppertal/Germany. According to these calculations and taking the pulsation pattern into account, the input power was determined to get a Specific Absorption Rate (SAR) of 80 mW/kg, 200 mW/kg and in two cases of 1.7 W/kg.

The field generating set-up, calculation of the electromagnetic field and results will be reported.

DESIGN OF RECTANGULAR COIL SYSTEMS FOR ACHIEVING UNIFORM MAGNETIC FIELDS AND MAGNETIC FIELD GRADIENTS. D. Cherlin and C. Polk. Department of Electrical and Computer Engineering, University of Rhode Island, Kingston, Rhode Island 02881, USA.

Considerable information is available in the technical literature [1-5] on the design of both circular and square coil systems which can generate uniform static magnetic fields over prescribed volumes. This information is also applicable for the generation of time varying fields, provided the largest dimension d of the coil system is very much smaller than one wavelength λ . Thus if $d \approx 1$ m and one requires $d = 0.001\lambda$, the information given for the design of a static field generating system is still useful at a frequency of 300 kHz, provided appropriate steps are taken to reduce inter-turn capacitance to avoid self-resonance of coils. At power frequencies (60 Hz and 50 Hz) and its first few harmonics (e.g. up to 300 Hz), the design equations for static field systems are fully applicable, although electrostatic shielding around windings is necessary to avoid exposure to unknown or undesirable electric fields which will necessarily be present due to potential differences between different parts of the coil systems and between coils and ground.

In principle, all coil design for static or low frequency magnetic field generation requires only the well known Biot-Savart law [1,2,3] and can be accomplished very efficiently on a modern personal computer. However, the writing of the appropriate computer codes is very time consuming and it is useful to have available detailed design curves giving both longitudinal and transverse fields, on and off coil axes, in terms of maximum field values and normalized coil dimensions. For example, design curves for a square quasi-Helmholtz pair (two parallel coils of $2a \times 2a$ meters, separated by the distance a would show values of B/B_{max} in terms of (z/a) and (x/a) or (y/a) where z is the axial distance perpendicular to one coil plane and x and y are the transverse coordinates in either coil plane. Since for such a pair $B_{max} = 10^{-7} (128) ni/(15a)$ Tesla, where n is the total number of turns in each coil, i the current in Amperes and a is specified in meters, field values anywhere within the volume enclosed by the coil pair can then be obtained from the design curves once n , i and a are selected. As an example the normalized longitudinal field in such a system along a diagonal line ($x = y$) in the mid-plane between coils, $(z/a) = (1/2)$ will be shown in Fig. 1. As another example the ratio of the transverse

field, $\sqrt{B_x^2 + B_y^2}$ to the axial field B_z along a diagonal line ($x = y$) in a plane at an axial distance $z = a/4$ above one coil plane will be shown in Fig. 2.

The quasi-Helmholtz pair can also be used to obtain a linear variation of field intensity with distance between coils by sending current through the two coils in opposite directions [6]. The resulting axial field variation will be shown on Fig 3. However, if this is done, the transverse field can become quite large as will be illustrated by Fig 4 which shows the

diagonal distance $x\sqrt{2}$ at which the transverse field is equal to 0.1 of the axial field if that total axial field consists of the field generated by the coils (fed in opposition) plus a constant geomagnetic field equal to B_{max} (for example B_{max} may be 35 μ T if it is to be equal to the vertical geomagnetic field at a typical mid-latitude location).

In the poster presentation of this paper many additional design curves will be shown for both square and rectangular coil pairs, fed either aiding, to obtain uniform fields, or in opposition, to obtain field gradients, as well as for the 4 coil "Merritt" system.

References:

- [1] Smythe W. R. (1950): "Static and Dynamic Electricity". McGraw Hill Book Co. p. 270.
- [2] Wendt G. (1958): Static Fields and Static Currents in "Handbuch der Physik", XVI, S. Flugge, ed. Springer-Verlag. p. 127
- [3] Weber E (1950): "Electromagnetic Fields" John Wiley & Sons. p 131.
- [4] Misakian M., AR Sheppard, D Krause, ME Frazier and DL Miller (1993): Biological, Physical, and Electrical Parameters for *In Vitro* Studies with ELF Magnetic and Electric Fields: A Primer., *Bioelectromagnetics Supplement* 2:1-73.
- [5] Merritt R., C. Purcell, and G. Stroink (1983): Uniform magnetic field produced by three, four, and five square coils. *Rev. Sci. Instrum.* 54 (7):879-882.
- [6] Polk C., Cherlin D., Platek M. and Mehta S. (1995): Cell Incubator AC/DC Magnetic Field Exposure System Allowing Simultaneous Exposures at Several DC Levels in "Project Abstracts, Annual Review of Research on Biological Effects of Electric and Magnetic Fields..." DOE/EPRI. Paper P-13, pp 66,67.

This work was supported by grants from the National Institutes of Health (R29 ES 05970) and the Johns Hopkins University Center for VDT and Health Research.

P-206-B

HYPERTHERMIA TRANSIENT TEMPERATURE RETRIEVAL BY MICROWAVE RADIOMETRY. F. Bardati¹ and P. Tognolatti². ¹DISP Roma Tor Vergata University, I-00133 Roma, Italy. ²Electrical Engineering Department, University of L'Aquila, I-67040 L'Aquila, Italy.

Multifrequency microwave radiometry has been considered for superficial hyperthermia temperature monitoring. The feasibility of a temperature retrieval from radiometric data has been investigated mostly with reference to synthesized noisy data as can be obtained from a simulation of a steady-state thermal distribution. The solution of the inverse radiometric problem has been accomplished in a Sobolev space of thermal functions, in order to introduce *a priori* information which is necessary to counteract the ill-posed nature of the problem [1]. Two-dimensional temperature retrieval from data measured on a circular phantom by a four-channel microwave radiometer has been reported [2]. A simple phantom experiment has been proposed to test the use of microwave radiometry in retrieving the one-dimensional

temperature profile by means of Kalman filtering [3]. More recently experiments on volunteers have been performed. Data were measured on a thigh during the thermal wash-out following a diathermy session [4].

In temperature monitoring during or after heating sessions we have to cope with two kinds of transient behaviour: one is intrinsic in the phenomena we are measuring and the other is related to the transient thermal state of the antenna when placed in contact with the body surface. The radiation entering the radiometer through the antenna is given by

$$\int_{\Omega} W(\underline{x})T(\underline{x})d\underline{x},$$

where T is temperature, W is proportional

to electromagnetic power dissipation at point \underline{x} in the case where the antenna radiates onto the body. Ω includes the antenna and the body [5]. We developed a transient thermal model of the antenna in order to subtract the antenna contribution from the radiometric data. The simplest approach to the transient temperature retrieval is to produce a sequence of subcutaneous temperature maps, each of them being retrieved under the hypothesis of steady-state behaviour. In this case the radiometer integration time must be kept short enough to make time-invariance an acceptable hypothesis. This may lead to excessively noisy data.

A different approach uses a finite state-space model of time-dependent temperature to be retrieved. The model is based on a suitable bio-heat equation together with boundary conditions of the radiation type towards the antenna and the environment. In this way we are able to incorporate *a priori* information without retaining a time-invariance constrain. The use of the Kalman filtering allows to comply with noisy radiometric data as well as with some unavoidable uncertainties of the thermal model (e.g. blood perfusion rate, thermoregulation, sweat, treatment-induced heat sources).

Results for two-dimensional temperature reconstruction will be presented.

[1] F. Bardati, V.J. Brown and P. Tognolatti, "Two-dimensional temperature retrieval in biological structures by multifrequency microwave radiometry: A Sobolev-space solution," *ACES Journal, Special Issue on Bioelectromagnetic Computation*, vol. 7, no. 2, pp. 110-120, 1992.

[2] F. Bardati, V.J. Brown and P. Tognolatti, "Temperature reconstructions in a dielectric cylinder by multifrequency microwave radiometry," *J. Electromagnetic Waves Applications*, vol. 7, no 11, pp. 1549-1571, 1993.

[3] F. Bardati, P. Cordiner and P. Tognolatti, "Microwave radiometry for retrieving transient hyperthermia-like temperature profiles," *The First World Congress for Electricity and Magnetism in Biology and Medicine*, Lake Buena Vista, Florida, 14-19 June, 1992, pp. 150-151.

[4] C. Di Gregorio, G. Marrocco, P. Tognolatti, M. Gagni, G. Gigante and F. Bardati, "Microwave Radiometry for Sub-Surface Temperature Monitoring in Endogenous Thermo-therapy: Preliminary Results," Conv. Naz. SIRR, Pisa 24-26 Novembre 1994, in *Radiations: from Theory to Multidisciplinary Applications*, Ed. P.A. Salvadori, Editrice Felici, Pisa, 1996, pp. 172-175.

[5] F. Bardati, V. J. Brown and P. Tognolatti, "Spectral microwave radiometry for subcutaneous temperature

imaging," in *Non-Invasive Thermometry of the Human Body*, M. Miyakawa and C. Bolomey Eds., Boca Raton, FL: CRC Press, 1995, pp. 225-253.

P-207-C

ANALYSIS OF THE MRI-USED BIRD-CAGE RESONATOR. D. Simunic¹ and P. Wach². ¹University of Zagreb, Faculty of Electrical Engineering and Computing, Department for Radiocommunications and Microwaves, HR-1000 Zagreb, Croatia. ²Graz University of Technology, Institute of Biomedical Engineering, A-8010 Graz, Austria.

Since the application of Magnetic Resonance Imaging (MRI) has become a part of the every-day medical diagnostics in the last time an interest in related possible human health effects has been raised. Our research work consists of numerical simulation of time-varying electromagnetic fields during MRI in the human body (1), (2). Two basic RF exposures are used for 1.5 T MRI machines: a pair of saddle-shaped coils and the bird-cage coil. Since the bird-cage resonator has been introduced in the last time and used more and more, we focused our attention to the analysis of this coil.

OBJECTIVE: This analysis giving the solution of a current distribution in the rods has been necessary in order to perform a correct numerical simulation later on.

METHOD: The modeled bird-cage resonator consists of 12 rods with capacitors in the ring. The radius is 32.5 cm and the length of the rods is 57 cm. It is assumed that mutual inductances exist in the bird cage between all the meshes. The evident cyclic behavior of the induction matrix leads to the eigenvector. In order to proof a necessary condition of the theory, the first-mode resonant frequency of the bird-cage has been calculated. The most general solution of mesh currents at this frequency has been established, as well.

RESULTS: The calculated value of the first-mode resonant frequency is 60.6 MHz. This difference still encourages further research in the sense of increasing accuracy. The model could be improved by careful examination of influence of neglected mutual inductances of higher order, of estimated inner inductance, etc. The column currents have been calculated and they are of the form: $\cos(2\pi(N-1)/N)$, where N is the number of rods.

This work has been supported by the Austrian Bundesministerium fuer Wissenschaft, Forschung und Kunst under grant GZ 45268/2-46a/93.

(1) Simunic D, Wach P, Renhart W, Stollberger R (1996): Spatial distribution of high-frequency electromagnetic energy in human head during MRI: numerical results and measurements. *IEEE Trans. on BME*, vol. 43(1), pp. 88-94.

(2) Simunic D, Wach P, Renhart W, Stollberger R, Karen ZT (1994): Determination of stimulation hazard for heart cells during MRI using FEM simulation. 17th Annual Meeting. Bioelectromagnetics Society, Boston, USA, June 18-22, p. 54.

THREE-DIMENSIONAL RECONSTRUCTION AND CLASSIFICATION OF MR IMAGES. M. Annunziato¹ and I. Bertini². ¹ENEA CR Casaccia, 00060 S. Maria di Galeria (Roma), Italy. ²CSELT, 10148 Torino, Italy.

In this paper a methodology for classification and the 3D reconstruction of the biological tissues and organs is described. The proposed technique finds application in the computer systems for the assistance to the diagnostics, the planning of the therapeutic treatments, the training and the project of the prothesis, the study of the effects of the radiation and the electromagnetic field on the human tissues. The system, which operates on sequences of MR images, produces the reconstruction of the tridimensional model by the composition of automatic analysis and interactive procedures. We can divide the methodologies applied in three categories: tridimensional segmentation, automatic classification and interactive classification.

The segmentation step consists of two principal modules: the pre-processing by using a neural network and the segmentation with a region growing algorithm. The pre-processing step is necessary in order to decrease the image noise preserving the region edges. The automatic segmentation, based on a region analysis methodology and in particular, by the split & merge algorithm, causes the split of an organ in more regions. The aim of classification algorithm is to find all the regions related to a specific biological organ. To solve this problem a fuzzy sets theory has been applied. For each organ a fuzzy function has been created by a defocusing process of three-dimensional model, obtained by a detailed MR scanning of the organ investigated. The automatic classification is carried out by the matching between a group of 3D regions and the model of the organ on the base of the mean value of the fuzzy function of the regions and the grey level homogeneity of the group. The tests, which were carried out on a database composed by images of different patients, have provided values of the recognition coefficient variable from 92% to 98%.

The interactive module allows to classify the different zones of the images with respect to an arbitrary list of tissues and to point out anatomical details that are, often, hidden by the presence of noise and artifacts of the images. The analysis is performed taking into account either the similarity, in terms of grey level intensity, with a sample defined by the operator (global context) either the similarity to the neighbouring pixels already classified (local context).

The set of the regions, obtained by the classification step, constitute the input data to a reconstruction algorithm for the 3D visualisation. The operator can interact real time in the three-dimensional scene rotating and zooming the object, making measurements and navigating inside of it.

The proposed system has been used in order to carry out the study of the interaction between the electromagnetic field radiated by cellular phones and the human head. In fact, in order to calculate the intensity of the electromagnetic field it would be better to have at dispose an anatomical model very detailed. The anatomical model of the head permits to assign the correct permittivity and conductivity to each tissue and

permits to determine where the electromagnetic power is deposited.

IN VIVO PHOSPHORUS MAGNETIC RESONANCE SPECTROSCOPY. A NEW LINEAR MODEL DESCRIBING THE PATTERN OF PHOSPHOCREATINE RESYNTHESIS AFTER MUSCULAR EXERCISE. G. Gottardi, S. Iotti, A. Patuelli and B. Barbiroli. Biochimica Clinica, Dipartimento di Medicina Clinica e Biotecnologia Applicata "D. Campanacci", Università di Bologna, 40138 Bologna, Italy.

Phosphorus magnetic resonance spectroscopy (³¹P-MRS) affords the *in vivo* study of several metabolic pathways in humans and animal models (1-3). The synthesis of phosphocreatine (PCr) after muscle exercise is the overall result of the interaction of several biochemical processes involving oxydative phosphorylation, the transport systems across mitochondria membrane and their regulation. It derives that precise knowledge of the *in vivo* pattern of PCr post-exercise recovery is expected to provide information on the interaction of the biochemical systems leading to PCr biosynthesis. The pattern of PCr recovery can be described by monoexponential functions such as: $[PCr](t) = C_1 e^{(-k_1 t)} + C_2$ [1], a model based on the assumption that the phenomenon is linear and depends on one arbitrary constant only, namely the initial value of [PCr]. The above function is solution of the linear differential first-order equation: $y' + ky = 0$ [2]. However, the fit of experimental data with the above function occasionally reveals non-random large least squares errors, not accounted for by experimental error. These findings suggest a more complex pattern of PCr recovery. We report here a simple linear model, better describing PCr recovery, obtained by generalising the linear model implicitly contained in the function reported and currently used.

We introduced in our model the initial rate of PCr biosynthesis as another index of intrinsic efficiency of PCr recovery together with the initial [PCr]. Therefore, dealing with two initial values assumed to be needed to describe PCr recovery, we regarded the above monoexponential function # [1] as the solution of the linear second-order differential equation: $y'' + ky' = 0$ [3].

The only possible generalisation of this model, maintaining the basic assumption of linearity, is: $y'' + ky' + by = c_0$ [4]. The term "by" implies the existence of the following theoretically possible solutions, all containing the monoexponential function as a particular case:

$$\begin{aligned}
 [PCr](t) &= C_0 + C_1 e^{(-k_1 t)} + C_2 e^{(-k_2 t)} && \text{(biexponential pattern)} && [5a] \\
 [PCr](t) &= C_0 + (C_1 + C_2 t) e^{(-k t)} && \text{(critically damped pattern)} && [5b] \\
 [PCr](t) &= C_0 + [C_1 \sin(\omega t) + C_2 \cos(\omega t)] e^{(-k t)} && \text{(damped oscillatory pattern)} && [5c]
 \end{aligned}$$

Experimental data of PCr recovery obtained from forty-nine healthy subjects were best fitted with solutions # [5a], [5b], [5c] and the least squares error compared.

We assumed a 15% decrease of the least squares error as minimum meaningful improvement of fitting equation when

compared with the monoexponential function # [1]. Sixteen cases were best fitted by solution # [5a], nine cases with solution # [5c], while twenty-four recoveries were fitted by solutions # [5a] and solution # [1] without substantial difference. All recoveries were distributed according to the best fitting equation into different regions of cytosolic pH.

Our new data-based model suggests that qualitatively different mechanisms are involved during PCr recovery depending also on pH value and possibly on pH recovery pattern.

References:

1. De Certains JD, Bove' WMMJ e Podo F, Eds (1992), "Magnetic Resonance spectroscopy in Biology and Medicine". Pergamon Press, Oxford.
2. Arnold D.L. et al. (1984); *Magn Reson Med* 1, 307-315.
3. Iotti S et al. *NMR Biomed* 1993; 6:248-253.

P-210-C

LARGE-VOLUME E.L.F. MAGNETIC FIELD COMPENSATION RESEARCH & DEVELOPMENT PROJECT. C.R. Dunnam¹, D.M. Coffman¹, R.H. Crepeau¹, C.P. Henderson¹, D.M. Winter¹ and L.D. Hall². ¹Linear Research Associates, Trumansburg, New York 14886, USA. ²New York State Electric & Gas Corporation, Binghamton, New York 13902, USA.

Public exposure to extremely-low-frequency (e.l.f.) magnetic fields has emerged as an issue of scientific and social concern due to purported linkage between e.l.f. magnetic field exposure and human cancers such as leukemia. At this point in time, it is generally accepted that accumulation of sufficient data to prove or disprove causal effects will require additional years of intensive study. Meanwhile, the uncertainty in provable causal linkage places private and institutional parties in a situation where they may wish to adopt a policy of exposure reduction in selected facilities. For inhabited structures with external magnetic field sources for which a reduction of exposure time, increased source-building separation, or passive shielding are fiscally or physically impractical, we propose development of large-volume [LV] active-feedback a.c. magnetic field shielding.

OBJECTIVES: Our project goal is to develop cost-effective electronic systems for active shielding of interior volumes up to 25,000 m³. To be generally accepted as effective, such systems must attenuate alternating magnetic fields to a level below approximately 2 milliGauss, rms, averaged about any specific area of human occupation.

METHODS: Development of LV active-shielding technology for large structures requires adequate preliminary research in two areas, simulation and measurement. To address these issues, we have developed a comprehensive, proprietary C-coded modeling package which permits concurrent simulation of EMF sources and active feedback components. We have also developed a magnetic field survey instrument and associated software which permits us to accurately record a.c. and d.c. magnitudes and relative a.c. phase over large interior volumes. Data which were taken with this apparatus throughout a school building adjacent to a transmission right-

of-way have defined an alternating magnetic field integrated into our simulation package [Figure 1]. A series of optimization runs were made in order to evaluate the net benefit of a feedback system installation and to estimate hardware requirements.

RESULTS: Initial active-feedback simulations indicate that substantial I.V magnetic field reduction may be attained, as demonstrated in Figures 2 and 3. The calculated requisite compensation power, 250-600 watts, is reasonable from equipment-design, installation and utilities cost perspectives.

DISCUSSION: Having completed our preliminary research, the LV project is at its half-way point. Simulations to date indicate that significant large-volume a.c. magnetic field reduction can be effected at modest cost using active-negative-feedback technology.

Supported by New York State Electric & Gas Corporation.

P-211-A

INVESTIGATION OF MICRO ELECTRIC AND MAGNETIC FIELDS WITH ELECTRON HOLOGRAPHY. G. Matteucci¹, C. Beeli² and B.G. Frost³. ¹Department of Physics, University of Bologna, 40127 Bologna, Italy. ²Ecole Polytechnique Federale de Lausanne - CIME, CH-1015 Lausanne, Switzerland. ³EM Facility, University of Tennessee, Knoxville, Tennessee 37996-0810, USA.

As is well known in-line electron holography was proposed by D. Gabor in 1948 as a novel method to overcome the resolution limit in transmission electron microscopy. With respect to conventional electron microscopy, electron holography is able to provide quantitative determination of the complex object wavefunction of interest.

In the medium resolution realm, phase contrast problems can be completely overcome by electron holography. Many interesting specimens, in particular in the biological field, behave as phase objects. The phase information content of the electron wave is first recovered and then displayed using digital means or interferometric optical techniques carried out on the reconstructed wavefront. A new interference pattern, called contour map, is obtained where the fringes show the loci of points with equal phase difference. In the investigations of electric or magnetic specimens, the lines in a contour map can be directly interpreted, according to the ideas of Ehrenberg, Siday, Aharonov and Bohm, as projected electric potential distributions or magnetic lines of force.

The aim of this contribution is to review the basic features of the electron holographic technique and its capabilities to display, in an easily interpretable way, the configuration of electromagnetic micro-fields. Moreover, some applications of electron holography in materials science problems will be shown, in view to extend its use to the wider and important fields of biology and medicine.

The imaging potentialities of electron holography will be evidenced with a few examples regarding the possibility to reveal maps of the electric potential distribution around charged micro-tips and the trend of the magnetic field lines

leaking from small magnetic whiskers and nano-cylindrical magnets.

Finally, because of the increasing demand for information about the nanometer scale, it will be reported how it is possible to reveal the topography and small depth variations of nano cavities in silicon foils as well as how to measure their total depth.

References:

An up dated review on electron holography can be found in: Electron Holography, *Proceedings of the International Workshop on Electron Holography*, August 29-31, 1994, Knoxville, TN, USA, (Edited by A. Tonomura et al.) North-Holland, Delta Series, Elsevier 1995.

P-212-B

EFFECT OF MAGNETIC-FIELD AFFECTING ON THE GROWTH OF CaCO_3 PARTICLES STUDIED BY LIGHT-SCATTERING SPECTROSCOPY. K. Ishizu and N. Azuma. Faculty of Science, Ehime University, Matsuyama 790, Japan.

It has been said that radiation of magnetic field results an excellent recovering effect for numerical bone destruction in the surgical treatments. In this context, the findings that the precipitation of the CaCO_3 is much accelerated in the magnetized aqueous media, have attracted our attention. In order to put these findings on the more rigorous experimental base and further, to understand the mechanism of acceleration of bone growth under some molecular level, the static magnetic field (4000 gauss) was applied to the aqueous solution of the CaCO_3 (0.56 g/l) supersaturated with $\text{Ca}(\text{OH})_2$, and the kinetics of CaCO_3 precipitation growth was investigated by a single beam turbidity spectroscope at the constant temperature (23°C).

The optical cell was tightly placed in the central gap of the magnets and the time dependent alteration of particle size of precipitate was tracked by measuring the absorbance at the region from 400 nm to 900 nm due to the light scattering. Upon standing the sample solution without application of magnetic field, the light scattering in the shorter wave length is stronger than that of the longer wave length at the initial stage of the time course (15 min). As the standing time proceeds, however, the intensity of the component of the longer wave length becomes dominant (40 min), and at the final stage of standing (60 min) no frequency dependent absorption intensity has been detected throughout the entire observing wave length. This means that Rayleigh scattering (radius of particle $r \ll$ wave length of scattering light λ) is dominant in the initial phase of growth and Mie scattering ($r \approx \lambda$) is succeeding to, as the particle size is increased upon aging. Finally particle size is grown up to show the optical scattering ($r \gg \lambda$) and no frequency dependence of the observing wave length has been detected in the absorption intensity everywhere.

When the magnetic field is applied to the sample cell, gradients of the spectral line, which decrease together under zero-field, begin to increase after induction periods and reach to fixed values. In this case, the degree of the gradient

enhancement revealed the strong frequency dependence on the observed wave length. At the initial stage of the observation after applying the magnetic field, the rapid growth of the scattering light intensity occurred at the longer wave length (Mie scattering region) and then the intensity of the shorter wave length is succeedingly increased at the longer standing time course. This suggests that the fraction of the small sized solid CaCO_3 is increased by applying magnetic field to the reaction media.

There is a big discrepancy between the result of the previous work and that of the present work. Any pH effect as reported in the previous paper was not recognized in the present work. Further investigations of the present research are now making the progress.

Mitigation

P-213-C

TRANSMISSION LINE HEALTH HAZARDS : MITIGATION UNCERTAINTIES. I. Kromer. VEIKI Institute for Electric Power Research Company, Budapest, Hungary.

There has been a significant amount of public and media attention focused on a possible health effect associated with high voltage transmission lines. A major part of the research effort has been directed at determining if statistical link exists between human electromagnetic field exposure and various forms of cancer. To date there has been no evidence suggesting that a significative correlation does exist between increased exposure and human-health hazards.

However, the current level of public concern and the effect this is having on the ability of utilities to upgrade and site new transmission lines is significant. Uncertainties surround the problem. But even if by some miracle we could resolve the fundamental uncertainty, uncertainties about social values and preferences would remain.

In this report tools from the field of decision analysis are used to generate insight into the merits of possible actions. The present application uses a simplified representation of the transmission line health hazard mitigation problem. It may prove useful for evaluating the relative merits of investigating the processes linking human behavior and uncertain health hazards and promoting international cooperation. Some perspective on the relative importance of uncertainty and lack of unified decision maker can be shown by comparing the expected values of information and of cooperation.

MODIFICATION OF THE EFFECTS FUNCTION APPROACH FOR EVALUATION OF ELF MITIGATION STRATEGIES. J.G. Adams. Merrimack College, North Andover, Massachusetts 01845, USA.

GOALS: The effects function (EF) approach incorporates biological uncertainty in the evaluation of ELF mitigation strategies, and has been presented previously [1]. As well as biological uncertainty, variable population density and exposure to background sources are also incorporated into the analysis. In the present work, this approach is modified so that it effectively dovetails with a decision analytic method developed by von Winterfeldt [2]. Modifications include making the computer program more user friendly, and creating results directly usable within the decision analytic approach. This is being done as part of the project "Power Grid and Land Use Policy Options" being carried out for the State of California.

METHODS: There are two outputs from the EF approach used within the decision tree approach: change in total exposure resulting from a specific mitigation strategy and the overall cost of that strategy. At the beginning of the present project (8/96) calculations were carried out using a research grade computer program which could take 10 CPU hours or more on a 486 class PC, acceptable in a research program but not so in a user friendly program. A major reason for this lengthy CPU time is the inclusion of variable transmission line loading using an approach developed by Olsen *et al.* [3], which when used within the EF approach requires a high number of calculations. In order to speed up the program it has been significantly reworked.

RESULTS: Both the speed and user friendliness of the EF computer program have been improved significantly during the early stages of this project. Outputs directly compatible within the decision analytic approach are now generated by the program.

DISCUSSION: This poster will give a number of technical details as to the latest version of the EF approach. This will include how the program has been sped up, and a comparison of results between the latest and the original versions. It will also include details on how specifically this approach is being dovetailed with the more general decision analytic approach developed by von Winterfeldt *et al.* [3].

This work is being supported by the California Public Health Foundation and the California Department of Health Services.

[1] J. Adams *et al.*, *Risk Analysis* 15, p. 313, 1995.

[2] R.G. Olsen and P.S. Wong, *IEEE Trans. Power Del.* 7, p. 2046, 1992.

[3] D. von Winterfeldt and T. Trauger, *Bioelectromagnetics* 17, No. 2, p. 71, 1996.

SHIELDING CONTROL EQUIPMENT. B. Szentpáli and V. Van Tuyen. Research Institute for Technical Physics of the Hungarian Academy of Sciences, Budapest H-1325, Hungary.

The shielding of rooms where intensive electromagnetic radiators work is necessary for avoiding the peoples outside of the room from the EM exposure. This is the case of the medical therapeutic equipments. There are many shielding technologies (metal nets, metalised wallpapers, bronze springs into the slit of the doors, etc.) however none of them ensures proper shielding timeless. It can get wrong due to many unforeseeable reasons, e.g. corrosion, any subsequent unworkmanlike mounting, most often from deformation of doors and/or windows, the filter in the electric network can break down from overloading, etc. The shielding efficiency is measured usually only after installation.

In the present work we are going to describe a continuously working control system which is mounted onto the outer walls of the shielded chamber in which therapeutic high frequency equipment's work. The instrument works in the State Hospital of Sopron (Hungary). There are two therapeutic equipment's in the chamber, one of them works at 27 MHz, the other at 2450 MHz. The control system consist of four detector units (their number can be increased), one central unit and one great display lamp mounted on a good conspicuous place.

The 27 MHz detectors are composed from three mutually perpendicular short dipole (8 cm half length) in triangular arrangement. The two arms of the dipole feed a tuned RC swinging circuit, its signal is demodulated by a Schottky-diode and amplified. The amplified signal of the three dipoles are summed in the second stage amplifier. The dynamic range of the circuit is about 60 dB regarding the output signal. The noise limited sensitivity of the detector is 0.2 V/m. The 2450 MHz detector differs only in the length of the dipole, which is the resonant length (2 X 6 cm). The swinging circuit is made from a coaxial waveguide choke in this case. Two discriminator circuits are built in each detector, their reference level can be regulated by built in potentiometers. The first level belongs to the field which exist if the therapeutic equipment works under normal conditions and the shielding is perfect. The second discriminator is set to a voltage, which is higher than the first one at least with 30 dB. This circuit indicates the perfectness of the shielding. The detectors are mounted onto the outer walls of the therapeutic chamber, in the vicinity of the most critical places (the door, the filter of the mains, etc.).

The central unit displays the signals of the detectors in a matrix of lamps. Two lamps belong to each detector according to the outputs of the two discriminators. The first (yellow) one shows that the equipment in the chamber is on, the second (red) lamp signs if the EM field is greater than the normal value, e.g. the door is not properly shut. It should be noted here, that the value of the electric field which belongs to the warning signal is much lower than the permissible level of the exposure standards. The field values belonging to the warning signals are related to the normal operation

conditions; the reference voltages in the discriminators are regulated according to the local conditions. The big display lamp shows the result of the detectors, it is yellow/red if any of the detectors signs yellow/red.

This work was financed by the RADIOHIGIENE Company.

P-216-C

TRANSMISSION LINE HEALTH HAZARDS : MITIGATION UNCERTAINTIES. I. Krómer. VEIKI Institute for Electric Power Research Company, 1368 Budapest, Hungary.

There has been a significant amount of public and media attention focused on a possible health effect associated with high voltage transmission lines. A major part of the research effort has been directed at determining if statistical link exists between human electromagnetic field exposure and various forms of cancer. To date there has been no evidence suggesting that a significant correlation does exist between increased exposure and human-health hazards.

However, the current level of public concern and the effect this is having on the ability of utilities to upgrade and site new transmission lines is significant. Uncertainties surround the problem. But even if by some miracle we could resolve the fundamental uncertainty, uncertainties about social values and preferences would remain.

In this report tools from the field of decision analysis are used to generate insight into the merits of possible actions. The present application uses a simplified representation of the transmission line health hazard mitigation problem. It may prove useful for evaluating the relative merits of investigating the processes linking human behavior and uncertain health hazards and promoting international cooperation.

Some perspective on the relative importance of uncertainty and lack of unified decision maker can be shown by comparing the expected values of information and of cooperation.

IV. Medicine

Epidemiology

P-217-A

AMBULATORY BLOOD PRESSURE MONITORING IN WORKERS EXPOSED TO HIGH FREQUENCY ELECTROMAGNETIC FIELDS. E. Gadzicka¹, A. Bortkiewicz¹, M. Zmyslony¹, C. Palczynski¹ and S. Szmigielski². ¹Nofer Institute of Occupational Medicine, 90-950 Łódź, Poland. ²Center for Radiobiology and Radiation Safety, 00-909 Warsaw, Poland.

The influence of occupational exposure to electromagnetic fields on Workers' blood pressure levels has not as yet been explained. The majority of data derive from the Soviet studies of 1960s and 70s reporting that chronic exposure may

induce hypotension whereas the acute one - hypertension. The purpose of our project was to verify these results using modern diagnostic methods, particularly 24-h blood pressure monitoring (ABP). The examinations were carried out in 71 workers of 4 AM Broadcast Stations (operate at frequencies 738 -1503 kHz) and 40 workers of 10 Radioservices (R-S), exposed to EM fields with the frequencies 150-170 MHz. The control group were 42 workers of 4 Radio Link Stations (RLS). The groups examined consisted of technical personnel and security service workers (men), aged 21-69, with the period of work ranging from 1 to 42 years, who were qualified by the occupational health practitioners as fit for work at permissible EMF levels.

For each worker the exposure to EM fields (maximum daily exposure level- E_{max} and dose per workshift- D_{daily}) was assessed. The D_{daily} was calculated from a series of measurements of partial doses recorded at routine tasks performed by particular groups of workers during the workshift. For the measurements HOLADAY measuring set (Holaday Ind, USA) and MEH-1a meter (Technical University, Wroclaw, Poland) were applied.

ABP was performed during everyday professional and other activities using Oxford Medilog ABP System. Mean systolic (BPS) and diastolic (BPD) blood pressure and heart rate (HR) for 24 hours (24-h), day-time activity (DAY) and night-time rest (NIGHT) were calculated, with the Staessen's standards of arterial blood pressure as reference values. The day-night ratios were determined for BPS, BPD and for HR. No significant differences were found when the mean values of BP 24-h, BP DAY and BP NIGHT were compared. Only BPD NIGHT was higher in the exposed groups (at the borderline of statistical significance $p = 0.051$). The mean HR 24-h and HR NIGHT did not differ in the groups but HR DAY was significantly higher in the subjects from AM in comparing with RLS, although the level of physical activity of these groups were almost the same. In the exposed groups (AM and R-S) the HR day-night ratio was significantly lower than in the controls (RLS).

ABP revealed elevated blood pressure in 5.6% subjects from AM, 20% from R-S and 7.1% from RLS. The difference between the latter two was statistically significant at $p = 0.045$. The difference persisted even after the age influence and confounding factors (declared alcohol consumption, shift work, smoking habit) had been eliminated ($p = 0.037$). In AM workers BPSN was significantly, positively correlated with D_{daily} ($p = 0.004$) and E_{max} ($p = 0.03$). The analysis of BP level in relation to exposure parameters did not refer to R-S workers for they are only temporarily exposed to EMF it would be difficult to accurately determine their exposure dose. In the control group the following parameters were age-related: BPD (24-h, DAY, NIGHT), BPS NIGHT, HR (24-h, NIGHT) and HRD/HRN, in AM it referred only to BPD (24-h and DAY) and in R-S only to HRD.

Our findings suggest the influence of electromagnetic fields on blood pressure. However, it is difficult to assess which of the EMF parameters (frequency, intensity) or their configuration may contribute to the development of the changes observed. As in the R-S group a significantly higher number of workers presented elevated BP it seems advisable

that this professional group be subject to regular ABP monitoring.

P-218-B

HEALTH EFFECTS AMONG ENGINE DRIVERS: ASSOCIATION WITH OCCUPATIONAL EXPOSURE TO MAGNETIC FIELDS FROM DC ELECTRIFIED TRANSPORT. G. Villoresi¹, N.G. Ptitsyna², V.A. Kudrin³, N. Iucci⁴, P.M. Voronov², D.B. Zaitsev². ¹IFSI-CNR Frascati c/o Università "Roma 3", Dip. di Fisica, 00146 Rome, Italy. ²SPbFizmiran of Russian Academy of Science, 191023 St. Petersburg, Russia. ³Institute of Railroad Workers Hygiene, Moscow, Russia. ⁴Università "Roma 3", Dip. di Fisica, 00146 Rome, Italy.

We analyzed morbidity data among Russian employees in DC-powered Railroad Systems: electric locomotive-hauled (EL), electric motor units (EMU) and subway (SUB) trains. We compared the levels of coronary heart diseases among different subgroups of engine drivers: EL, EMU and SUB drivers. For malignant diseases only the data for SUB drivers were available. EL and EMU drivers can be considered as equally exposed to classic risk factors. Possibly some of these factors could be bigger for SUB drivers because of different work conditions. The analysis was based on ~4,000 EL and ~4,000 EMU drivers per year, for the period 1975-77, on 711 SUB drivers per year (St. Petersburg, 1987-89) and on 1669 SUB drivers per year (Moscow, 1980-82). For coronary heart diseases we obtained the following results: SUB(SPet)/EMU = 4.37±0.75; SUB(Moscow)/EMU = 3.32±0.50; SUB(SPet)/EL = 2.19±0.33; SUB(Moscow)/EL = 1.66±0.21; EL/EMU = 2.00±0.27. These results can be mainly attributed to different occupational exposure to ULF magnetic fields among the considered subgroups of engine drivers. Measurements performed in their workplaces showed that the magnitude of magnetic field pulses in EL can be 2-3 times bigger than in EMU trains (see Villoresi *et al.* in this Conf.). Much bigger magnetic field variations can be expected in SUB trains because of the much lower DC voltage supply. Moreover, sharp field variations should be much more frequent in SUB trains due to the relatively high frequency of braking and accelerating phases and to the great number of trains circulating between the same electric substations.

Morbidity for malignant diseases was studied among the 2,380 SUB engine drivers. No increased risk in malignant diseases, in comparison with general male population, has been found. However, this result could be biased by the absence of drivers over 60 years old (they retire from job), while these ages largely contribute to general cancer statistics.

P-219-C

STUDY DESIGN FOR EVALUATING VHCC WIRE CODE AS A RISK FACTOR FOR CHILDHOOD CANCER. H. Wachtel¹, R. Pearson², B. Langholz³ and K. Ebi⁴. ¹Electrical and Computer Engineering Department, University of Colorado, Boulder, Colorado 80309-0425, USA. ²Radian International LLC, Denver, Colorado 80202, USA. ³Department of Preventive Medicine, University of Southern California, Los Angeles, California 90033-9987, USA. ⁴Electric Power Research Institute, Palo Alto, California 94303, USA.

OBJECTIVES: To design a study of the association between Very High Current Configuration (VHCC) wire code and childhood cancer which should minimize control selection bias and allow for the efficient exploration of VHCC wire code as a risk factor. The design is based on the feasibility of identifying large numbers of homes as neighborhood controls using automatic wire coding methods.

BACKGROUND AND RATIONALE: The U.S. National Academy of Sciences recently highlighted the association between wire code and childhood cancer as one of the major unresolved issues in the EMF health effects controversy based on the findings that children living near VHCC power lines in Denver and Los Angeles have about double the cancer risk of children living near underground and/or very low current configuration power lines. This association was originally attributed to the magnetic fields generated by the power lines. However, measurements of these fields, on a spot or 24 hour basis, showed no appreciable association with childhood cancer. Our recent studies (Wachtel, Pearson and Ebi, 1996 and Pearson, Wachtel and Ebi, 1996) suggest alternate explanations for the cancer risk associated with wire code. Using an automated wire coding technique for the Denver metro area, we found suggestions of a substantial control selection bias due to under representation of VHCC homes among the controls. We also found that rental vs owner occupancy status and distance weighted traffic density were highly associated with wire codes and were significant cancer risk factors. They also may act as confounders of the wire code cancer risk. These findings, along with those of others (Jones *et al.* 1993) demonstrate the need for an improved study design for examining the association of VHCC with childhood cancer. This design would use entire neighborhoods surrounding each case for controls and potentially eliminate a major source of control selection bias.

METHODS: A multistage study design was developed. The first stage would evaluate whether VHCC is associated with childhood cancer when, for each case, numerous controls are chosen from the surrounding neighborhood homes with eligible children. If VHCC wire code is a significant risk factor, then, in a second stage, matched controls could be chosen from the neighborhood using a counter matching technique. This method would be used to evaluate factors associated with cancer risk and VHCC residences. The feasibility of this design rests on the ability to efficiently wire code large numbers of homes.

RESULTS OF A FEASIBILITY STUDY: Using a geographic information system (GIS) power line database, we

wire coded the Denver metro area and we are confident that the same could be done in other cities with similar GIS databases. In Los Angeles, where we would have to rely only on paper power line wiring maps, we developed an approach to distinguish between the VHCC, underground, and all other wire code categories. We also explored the optimal size, configuration and homogeneity limits of the potential neighborhood control groups.

CONCLUSION: It appears feasible to use automatic wire coding techniques for entire neighborhoods even if only paper maps are available. Using this neighborhood control approach may eliminate a major source of control selection bias in studies of wire codes and childhood cancer. This neighborhood control base may also yield higher statistical power and facilitate the identification of factors which link VHCC to childhood cancer risk.

The research was supported by EPRI contract WO4305-02.

P-220-A

ASSESSMENT OF CONTROL SELECTION BIAS AS A POSSIBLE EXPLANATION OF THE ASSOCIATION BETWEEN WIRE CODE AND CHILDHOOD CANCER

K.L. Ebi¹, H. Wachtel², R.L. Pearson³ and L. Kheifets¹.

¹Electric Power Research Institute, Palo Alto, California 94303, USA. ²Electrical and Computer Engineering

Department, University of Colorado, Boulder, Colorado 80309-0425, USA. ³Radian International LLC, Denver,

Colorado 80202, USA.

OBJECTIVE: To reconstruct a population of eligible children who could have served as controls in the Savitz et al. study in the Denver metro area and to use this population to assess the possibility that observed association between wire code and childhood cancer was the result of control selection bias.

BACKGROUND: Control selection bias has been suggested as a cause of the observed associations between wire code and childhood cancer. Jones et al. (1993) speculated that because the controls but not the cases in the Savitz et al. (1988) study were constrained to be stable, there might have been an under representation of controls in the highest wire code category (VHCC). Possible differences among wire code categories in factors other than mobility might lead to bias when selecting controls, for example, accessibility by telephone and willingness to participate. An alternative to exploring the possible sources of control selection bias is to retrospectively construct a comparison population of all potentially eligible controls and to reanalyze the Savitz et al. data using wire code information from these controls. In principle such a control group could be constructed by wire coding the homes of all potentially eligible children, assuming there is a method by which to identify, in which homes the children lived.

METHODS: Two tasks were required to reconstruct an eligible population control group for the Savitz et al. study. The first task was to wire code the approximately 273,000 homes in the case ascertainment area of the Denver metro area. This was accomplished using a computer program developed to wire code homes based on information from a

power line wiring database created in 1993. Tax assessor data were used to determine the year of construction of each of the 273,000 homes. Homes built after 1985 were eliminated from the analysis because these homes would not have existed at the time of data collection for the Savitz et al. study. The wire coding method applies only to homes and not to apartments. The second task was to assign all potentially eligible children to homes. Census data were used to identify potentially eligible children. Random assignment algorithms with three different statistical distributions assigned potentially eligible children to homes.

RESULTS: The accuracy of our automatic Wire coding method was assessed by comparing it to 358 Savitz et al. homes that were recently recoded using traditional field methods (Zaffanella, et al. 1997). The wire code distributions were (VHCC, OHCC, OLCC, VLCC, buried): 6%, 23%, 39%, 3% and 29% for automatic wire coding, and 5%, 22%, 39%, 5% and 28% for the traditional field method. Children were assigned to the wire coded homes in each census block using uniform, Poisson and negative binomial statistical distributions. We examined the association between wire code and the fraction of homes in each census block having eligible children. There was no association across census blocks between wire code category and mean number of children per home, but this does not rule out the possibility of such an association existing within census blocks. The results of reanalyzing the Savitz et al. data using the reconstructed populations of potentially eligible children will be discussed.

DISCUSSION: The validity of our reconstructed potentially eligible control population is limited by two factors: a) the accuracy of the automatic wire coding method, and b) the extent to which occupancy of a house by eligible children is associated with wire code. Our results suggest that the accuracy of automatic wire coding is sufficiently large when wire coding large numbers of homes that we could easily detect control selection bias causing an association of 2.0 between wire code and childhood cancer, if we knew where the potentially eligible children lived. The second factor is more difficult to evaluate because there is no way we can be certain in which residences the eligible children lived. These methods are applicable to evaluation of control selection bias in all case control studies that use wire code as an exposure metric.

This research was supported by EPRI contract WO2964-22.

P-298-A

RESIDENCE SPECIFIC AIR POLLUTION AS A POSSIBLE CHILDHOOD CANCER RISK FACTOR AND A POTENTIAL LINK BETWEEN WIRE CODES, TRAFFIC DENSITY AND CHILDHOOD CANCER.

R.L. Pearson¹, H. Wachtel² and K.L. Ebi³. ¹Radian International LLC, Denver, Colorado 80202, USA.

²Electrical and Computer Engineering Department, University of Colorado, Boulder, Colorado 80309-0425, USA.

³Electric Power Research Institute, Palo Alto, California 94303, USA.

OBJECTIVE: To quantify residence specific air pollution (RSAP) from motor vehicles for case and control residences

and assess it as a childhood cancer risk factor and as a link between traffic density, wire codes and cancer risk.

BACKGROUND AND RATIONALE: We previously explored a variety of residential environment and lifestyle factors to evaluate whether they might explain the association between wire code and childhood cancer. This led to the findings that distance weighted traffic density (DWTd) may be a significant childhood cancer risk factor and that DWTd may be confounding the association between wire codes and childhood cancer. High levels of DWTd are suggestive of localized corridors of elevated air pollution which could selectively effect nearby homes. Very high concentrations of certain volatile organic compounds, such as benzene, are leukemogenic in adults (EPA, 1993). We hypothesize that they also may be a causal link between DWTd and childhood cancer based on two features of the DWTd to cancer risk. One is that the radius of influence was in the range of 500 to 750 feet. This is suggestive of an air pollution based factor because other possibilities such as noise or nighttime illumination levels would not be expected to have as long a distance of influence. Also, the association between DWTd and cancer was highest for 10000 to 20000 vehicles per day. This is suggestive of RSAP levels that are well above ambient background air quality levels. If DWTd estimates RSAP, then it is likely to non differentially misclassify RSAP which could tend to understate the true cancer risk.

METHODS: For the case and control homes studied by Savitz, et al. (1988), we determined DWTd for all streets surrounding each residence. Also, we will use standard EPA vehicular air pollution models (MOBILE5a and CAL3QHCR) to retrospectively estimate RSAP exposure at case and control homes. We will therefore explore the association between RSAP and childhood cancer directly using conventional motor vehicle air pollution models. We will also examine whether RSAP confounds the associations between childhood cancer and wire code and DWTd.

RESULTS: In addition to demonstrating that DWTd may be a substantial childhood cancer risk factor (Wachtel, Pearson and Ebi, 1996), recent evidence suggests that DWTd may confound the association between wire code and childhood cancer risk. For example, adjusting the VHCC vs. buried wire code to cancer association for DWTd decreases the odds ratio from 1.92 (0.45-8.12) to 0.98 (0.13-7.74). However, this was not found when adjusting other associations.

DISCUSSION: There are several suggestions that RSAP may be a risk factor for childhood cancer and may confound the wire code cancer association. If true, this may have major implications in the search for the causes of childhood cancer including exploring the underlying mechanism (e.g. benzene exposure).

This work is being sponsored by the Electric Power Research Institute under contract number WO2964-22.

P-221-B

SETIL ITALIAN MULTICENTRIC EPIDEMIOLOGICAL STUDY ON CHILDHOOD LYMPHATIC AND HEMATOLOGICAL MALIGNANCIES AND NEUROBLASTOMA (WITH SPECIAL REFERENCE TO ELECTROMAGNETIC FIELDS). C. Magnani (for the SETIL working group). Cancer Epidemiology Unit, Main Hospital and University of Torino, 10126 Torino, Italy.

Leukemias are the most frequent neoplasm in children (age 0-14). In Italy, about 430 cases are estimated each year, the vast majority being Acute Lymphocytic Leukemia (ALL). Sixty-five cases of non-Hodgkin and 45 Hodgkin lymphomas and 110 cases of neuroblastoma are also estimated to occur each year. Risk factors for these malignancies are poorly understood: those suggested in the literature include genetic, reproductive, infectious, and environmental exposures. An etiologic role of exposure to 50-60Hz electromagnetic (ELF-EM) fields cannot be definitely evaluated because published studies present limitations in design, control of confounders or sample size. Assessment of exposure to residential magnetic fields has also been limited.

Two population-based multicentric case-control studies of risk factors for childhood neoplasms of the lymphohematopoietic system and neuroblastomas will be carried out in Italy between June 1997 and June 2000. The studies are a joint effort of some of the leading Italian epidemiological centres and of the Italian Association of Pediatric Oncology. Cases will be children aged 0 to 10 years (i.e. up to the end of elementary school in Italy) diagnosed with leukemia (ALL, Acute myeloid leukemia, other leukemias), non-Hodgkin lymphoma, or neuroblastoma over a 3-year period. Case definition will take into account morphological and cytogenetic classification criteria. Controls will be population base and 2:1 matched to cases on age, sex, and, broadly, on area of residence. The expected number of cases of total leukemia occurring in the participating areas over a three-year period is around 800. An estimated 1600 controls will thus be chosen. The power is adequate to detect as statistically significant a relative risk of 1.6 to 2.6 for all leukemias given exposure prevalence among controls between 1% and 5%. These values correspond to the relative risk observed in the positive studies on childhood leukemia and ELF-EM fields.

Investigated exposures include physical (ELF EM fields, gamma radiation), chemical (solvents, passive tobacco smoke, traffic pollution, insecticides) and other risk factors (parental occupation, medical and personal history of child and parents, diet, infections, crowding, immunisation).

Exposure to ELF magnetic fields and gamma radiation will be measured by ad hoc trained personnel in the current and, possibly, in past dwellings and in the school. Assessment of exposure to ELF-EM fields will include proximity to high-voltage lines, transformer substations, distribution systems as well as indoor sources. Assessment of indoor exposure will be based both on questionnaires and on a combination of spot and long-term measurements (1 week), with consideration given to seasonal variations. The other exposures will be estimated with personal interviews to both child's parents.

A pilot study on ELF magnetic fields measurement is in progress on a total of about 100 subjects from different Italian regions and results on the prevalence of exposure to ELF magnetic fields will be presented at the congress.

P-222-C

ECG ABNORMALITIES IN WORKERS EXPOSED TO ELECTROMAGNETIC FIELDS (EMF) AT DIFFERENT EXPOSURE LEVELS. A. Bortkiewicz¹, E. Gadzicka¹, M. Zmyslony¹, C. Palczynski¹ and S. Szmigielski². ¹Nofer Institute of Occupational Medicine, 90-950 Łódź, Poland. ²Center for Radiobiology and Radiation Safety, 00-909 Warsaw, Poland.

We have undertaken the study in order to evaluate the cardiovascular function in workers occupationally exposed to EM fields at different exposure levels and frequencies. Literature data indicated that in the exposed people such symptoms develop as heart rhythm disturbances, impaired conduction and decreased amplitude of ECG records. However, these results have not as yet been verified using modern methods.

The examinations have been carried out in 71 workers of 4 AM Broadcast Stations (AM), operate at frequencies 738-1503 kHz and 40 workers of 10 Radioservices (R-S). The R-S workers were exposed to EMF with the frequencies 150-170 MHz. The control, non-exposed group were 42 workers of 4 Radio Link Stations (RLS).

The groups examined consisted of technical personnel and security service workers (men), aged 21-69, with the period of work ranging from 1 to 42 years, who were qualified by the occupational health practitioners. For each worker the exposure to EM fields (maximum daily exposure level- E_{max} , and dose per workshift- D_{daily}) was assessed. The D_{daily} was calculated from a series of measurements of partial doses recorded at routine tasks performed by particular groups of workers during the workshift. For the measurements HOLADAY measuring set (Holaday Ind, USA) and MEH-1a meter (Technical University, Wrocław, Poland) were applied. The workers had the following performed: general medical examination, an interview including cardiological and family history, resting ECG using Medea system (Gliwice, Poland) and Holter 24-hour ECG using Medilog 3000 (Oxford, England). The results obtained were then related to the international standards.

Considering the types of ECG abnormalities in the resting ECG, no statistically significant differences between the groups were observed. However, such differences could be found in the Holter records. The comparison of the number of persons with ECG abnormalities detected by at least one of the ECG recordings (resting and 24-hour) indicated that the frequency of these abnormalities was significantly higher (83%) in workers of AM than those of the RLS (40%) and R-S (55%). The difference persisted after the age influence and confounding factors (declared alcohol consumption, shift work, smoking habit) had been eliminated. The results revealed that the odd ratio of abnormalities in resting and/or 24-h ECG was 6.5 for AM workers and 2 for R-S in

comparing with RLS workers ($p < 0.001$ and $p=0.144$ respectively).

The impairments found in the resting and 24-h ECG records vary in their type and influence on the cardiac function - from the impairments of ventricular conduction to dangerous heart rhythm disturbances. However, all of them are a deviation from standard and reflect abnormalities in the cardiovascular system. It is worth noting that among the pathologies in Holter ECG records in AM workers the heart rhythm disturbances were most frequent whereas in the workers of R-S and RLS the repolarization disturbances prevailed. However it seems that the material obtained from our study is too scarce to draw any definite conclusions about the relationship between the particular types of cardiovascular impairments and exposure to EMF.

Our finding would indicate that in workers exposed to high frequency EMF the resting ECG recording is insufficient to detect numerous significant cardiovascular impairments and as such should be accompanied by other examinations, e.g. Holter 24-h monitoring.

P-223-A

URBAN-RURAL AND SOCIOECONOMIC DIFFERENCES IN CHILDHOOD CANCER RATES IN CALIFORNIA, 1988-1992. P. Reynolds and J. Von Behren. California Department of Health Services, Emeryville, California 94608, USA.

Concerns have been raised about the degree to which socioeconomic or urban/rural differences may explain observed electric and magnetic field (EMF) associated risks for childhood cancer, although these potential confounders have not been systematically studied. Of the few inconsistent studies of these relationships, most rely on convenience samples of case children from major treatment centers, from the same neighborhood, from primarily urban areas or they rely on mortality rather than incidence data. A preliminary ecologic assessment of the association of these factors with differences in incidence rates for these rare diseases was conducted based on the first five years of statewide cancer reporting in California's large heterogeneous population. During 1988-1992, a total of 5,030 newly diagnosed cancers, including 1,702 cases of leukemia and 970 cases of brain cancer, occurred among children under the age of 15 in California. Measures of income, education and urbanization were assigned to cases based on their census tract of residence at diagnosis. Rate ratios were estimated using multivariate Poisson modeling, adjusting for age, race and sex. Overall childhood cancer rates did not differ by urban nor by socioeconomic status, although children in urban areas had modestly higher rates of leukemia (RR=1.2, 95% CI=1.02-1.3). Adjusting for age, race, sex, and urbanization, children in the lowest quartile of income did not experience different rates than those in the highest quartile for either of the major cancer types (leukemia RR=0.9, brain cancer RR=1.0) nor for all cancers combined (RR=1.0). Similar results were evident for other measures of socioeconomic status. This population-based assessment for a large and heterogeneous geographic

area suggests that conflicting evidence from the sparse literature on this topic to date may have been influenced by limitations of sample size and study design. Furthermore, the general lack of association of these factors with childhood cancer outcomes suggest that it is unlikely that they could serve to confound observed environmental associations such as those reported for EMF.

Childhood Cancer Rate Ratios by Income, California 1988-1992

	All Sites	Leukemia	Brain
Quartile I (highest)	1.0	0.9	1.1
Quartile II	1.0	1.1	1.0
Quartile III	1.0	1.0	0.9
Quartile IV (lowest)	(ref)	(ref)	(ref)

Rate ratios adjusted for age, race, sex and urbanization.

P-224-B

MAPPING OF MAGNETIC FIELDS IN CITY ENVIRONMENT. M. Lindgren, M. Gustavsson, Y. Hamnerius and S. Galt. Microwave Technology, Chalmers University of Technology, S-412 96 Göteborg, Sweden.

OBJECTIVE: The objective of this study is to map the extremely low frequency (ELF) magnetic field distribution at the streets of a central part in Göteborg city. Several stores, restaurants and offices are found in this area. Thus it is one of the most frequently visited outdoor areas in Göteborg which motivates our choice of area for this study.

BACKGROUND: Several studies indicate a correlation between power frequency EMF exposure and human health effects, such as cancer. This motivates a study that will give a comprehension of the outdoor ELF magnetic field strength that people are exposed to daily.

METHODS: The measurements were done with a Radians Innova ML-1 magnetic field logger. This device measures magnetic fields in the frequency band 30-2000 Hz. The measurements were performed one meter above the ground and samples were recorded with intervals smaller than one meter. Both sides of the streets were mapped. The measurements were carried out during daytime.

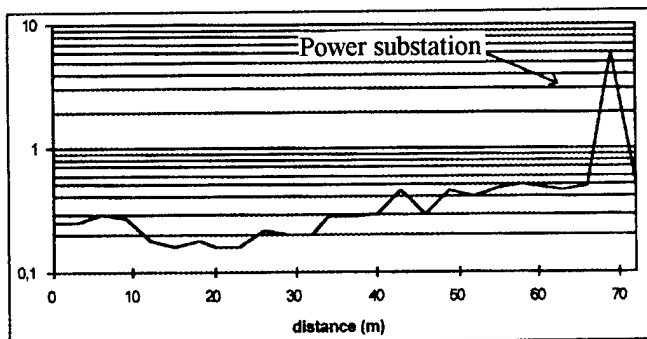

Figure 1: Magnetic field strength variation along a typical street.

RESULTS: Moderate magnetic field strengths of 0.2-1.0 μ T were commonly found in the area. A correlation between slightly stronger magnetic field strengths and power cables in the ground was found. This is due to stray currents. Significantly stronger magnetic field strengths were found in the vicinity of electric service boxes, power substations, burglar alarms and other electrical devices. The figure illustrates the magnetic field strength in a typical street. The peak (5.9 μ T) is due to the immediate vicinity of a power substation. About 25% of the analyzed street length displayed a magnetic field strength below 0.2 μ T. Field strengths higher than 1.0 μ T were found in about 10% of the street length.

DISCUSSION: The field strengths found in this study are of the order of magnitude ($>0.2 \mu$ T) where increased risks of cancer have been found in epidemiological studies. Therefore also the outdoor exposure are proposed to be considered in risk evaluation.

Electrical Trauma

P-225-C

ELF ELECTRIC FIELDS AND SUDDEN INFANT DEATH. R. Coghill. Coghill Research Laboratories, Gwent NP4 5UH, Wales.

SUMMARY: Research impetus into bio-effects from chronic exposure to weak ELF EM fields has favoured cancers, but some studies implicate other health disorders of presently unknown aetiology, such as myalgic encephalomyelitis, migraine headache, and depressive illness. Such studies are hampered by lack of a proven mechanism of interaction however. Sudden unexplained death of apparently healthy infants (SIDS) results in over 500 UK mortalities and thousands in the US, (more than childhood leukaemias) and is the largest cause of infant mortality in industrialised society today. This study reports on the correlation between ambient ELF electric fields measured in the bedplace of infants recently victims of SIDS.

It finds that infants sleeping habitually in ELF electric fields in excess of 20 V/m are at elevated risk of SIDS.

METHOD AND MATERIALS: Electric and magnetic field probes attached to dataloggers placed in the exact bedplace pillow of infants who had become SIDS victims within the last 12 months took readings every 30 seconds and averaged these into 5 minute periods. Similar readings were taken in a random selection of healthy infants matched for sex, age, social economic group and hometype.

Comparison of the data collected indicates an elevated incidence of SIDS in homes where their habitual bedplace ELF electric fields exceeded 20V/m.

Further readings in a selection of bedplaces over a longer time span established the extent of seasonal variability of these fields. Detailed results will be presented.

DISCUSSION: Infancy is the time when cell proliferation is greatest, making heavy demands on ATP synthesis and cellular signal transduction. ELF electric fields may inhibit

ATP synthesis by affecting Ca^{2+} dependent enzymes which regulate oxidative phosphorylation, hence ATP synthesis. ELF electric fields may also interfere with signal transduction. Though other mechanisms cannot be ruled out, many previous SIDS studies have implicated respiratory disturbance, opening the possibility of electric field insult as an aetiology of SIDS as a plausible option.

CONCLUSION: Infants sleeping in ELF electric fields exceeding 20V/m are at elevated risk of SIDS. Though the mechanism of interaction remains unknown, these results have important implications for the management of special baby care units in hospitals, and for location choice of infant bedplaces in the home.

Hyperthermia

P-226-A

THE HF MAGNETIC FIELD HEATING (MAGNETOTHERMIA) IN THE TREATMENT OF TUMORAL AND INFLAMMATORY DISEASES. Y.R. Medinets¹, M.V. Zemskova¹ and A.V. Kravchenko².
¹Ukrainian Research Institute of Oncology and Radiology, Kiev 252022, Ukraine. ²Kiev Medical University, Kiev 252004, Ukraine.

We use inductive radiators providing up to 100 A/m magnetic field strength in frequency range 27-40 MHz with deeply suppressed electric component (less than 100 V/m) for thermochemotherapy. Simple experiments have made it evident, that there are no circumferential currents in body, but rather microcurrents flowing in physiological fluid around insulating particles. Blood heats much predominantly - supposedly thanks to erythrocytes - bigger solid insulating particles with ferromagnetics inside. Therefore the magnetic field does not modify in tissue but penetrates into it just as it does into air. And the field can be localized by technical means: a number of specialised radiators are developed. Magnetothermia (MT) is not fit for formal Hyper-thermia because the source of heat, the blood, has minor volume in body and moves. But MT carries some other very useful effects that improve the drug transport.

At normal environments, the majority of capillaries in patient are closed. So the drug injected passes through the minor number of them and being drained off. MT opens the capillaries, widens the blood flow. And tissue is being irrigated better. After MT set off, the capillaries quickly, for seconds, return to normal state (because a cool blood enters) - and capture the drug injected in that very moment. Here is the most important difference between Electric field hyperthermia and MT: the first has a delayed transient time because all body mass is heated. So at MT, the restoration time is comparable to time of drug spreading. Thus the drug depository is being created in surroundings of tumour.

The tumoral tissue dehydrates at MT: cellular membranes are penetrable for hot ions so inner potential drops down and the cells approaches each to other pushing the interstitial fluid off. After MT, the Resorbtion process starts and the tumour

sucks the deposited drug in.

Another trick it is an artificial edema as a drug depository. The starch paste containing the drug and 2-3% of NaCl is injected peritumorally before MT. The modalities work: MT enhances local proliferation. The salt creates the interstitial edema saturated by the drug. The starch sustains the edema off the quick dissipation by blood. And during hours the edema supplies the drug into the lymphatic ways which are probable for cell migration from proper tumour.

We have used this kind of thermochemotherapy in treatment of disseminated and locally spreading tumours of various localisations especially in lung and liver. The pronounced results have obtained: life time and survival rate were being prolonged 1.5 - 2 fold and 20-30% respectively. MT has proved itself as an effective anti-inflammatory rehabilitative mean in thousands of patients.

Melatonin and Cancer Inhibition

P-227-B

27.12 MHz PRF-EMF AND MELATONIN ENHANCE THE OUTGROWTH OF NEURITES FROM DORSAL ROOT GANGLIA NEURONS. E. Leman¹, S. Ranney¹, P. Resig¹, M. Markov² and B.F. Siskin¹. ¹Center for Biomedical Engineering and Department of Anatomy and Neurobiology, University of Kentucky, Lexington, Kentucky 40506-0070, USA. ²Department of Orthopedics, Mt. Sinai, New York, USA.

INTRODUCTION AND OBJECTIVES: Electric and electromagnetic fields (DC, PEMF and PRF-EMF) have been shown to enhance neurite outgrowth from embryonic dorsal root ganglia neurons (DRG) *in vitro*. Recent studies have reported various bioeffects when different cells were exposed to melatonin and low frequency EMF. This study investigated for the first time the interaction of PRF-EMF and melatonin on nerve regeneration in DRG neurons. The specific objectives of this study were to determine: (1) the influence of melatonin on the growth and differentiation of DRG sensory neurons and (2) the effect of melatonin and 27.12 MHz pulsed radiofrequency electromagnetic fields (PRF-EMF) on neurite outgrowth. This study addressed the effects of melatonin at two different concentration levels, comparing them to two concentrations of NGF.

METHOD: Dorsal root ganglia from nine day chick embryo were explanted onto collagen-coated 12 well plates; three-four ganglia were placed in each well of two plates. They were fed with Neurobasal media containing B₂₇ supplement (Gibco Co., NY). Two concentrations of beta nerve growth factor (10 and 20 ng/cc) were added to sham (untreated) control explants and 27.12 MHz PRF-EMF to test the response to NGF. Two concentrations of melatonin (0.03 mM and 0.003 mM, Sigma, St. Louis, MO) were also tested on control and PRF-EMF plates. At the treatment time experimental plates were placed on top of a circular (20 cm diameter) pancake coil (sofPulse model 912,EPi, Pompano Beach, FL) for 30 min daily for 3 days. The PRF-EMF signal

employed was a 65 μ sec burst of 27.12 MHz sinusoidal waves, repeating at 80 pulses per sec. The incident magnetic field had an amplitude in the wells of 2 gauss peak to peak. The pancake coil was placed in an all-wood incubator heated remotely to 36-37°C. Sham controls (unexposed) were placed on top of the applicator when the coil was not powered for 30 min/day. The plates were cultured for a total of 60 hrs after which both treated and untreated cultures were fixed in 10% buffered formalin or 4% paraformaldehyde. Data were collected on photographs by recording the length of neurites from the edge of the original explant to the tips of the growth cones (Sisken *et al.*, 1995). Significance between experimental and control was determined using a Two Factor Analysis of Variance.

RESULTS AND DISCUSSION: We obtained an overall growth stimulation effect on neurite length with PRF-EMF (ANOVA, $p < 0.015$) when comparing sham controls to experimentals. The stimulation ranged from 10-50% and included groups with no added agents and those with melatonin or NGF. In addition melatonin alone induced longer neurite lengths and PRF-EMF augmented this resulting in the greatest stimulation of growth. The number of neurites/ganglia was not increased by melatonin alone but was increased when combined with PRF-EMF as it was for neurite length. This study extends our previously-reported results Sisken *et al.* (1995) on the enhancement of nerve regeneration *in vitro* by this high frequency electromagnetic field. The overall stimulation of neuronal growth and differentiation in terms of increased neurite length and neurite number strengthens the likely use of this signal for clinical application. Our results also confirm the stimulatory effect of melatonin on nerve tissue first reported by Papke *et al.*, 1986, who showed that action potentials of cultured sympathetic neurons were augmented in duration when melatonin was added to the medium.

This work was supported in part by Electropharmacology Inc. Pompano Beach, FL

References:

(1) Sisken, *et al.*, 1995. Time-dependent outgrowth of neurites and the influence of non-thermal 27.12 MHz pulsed radiofrequency. Ann Meeting of the Bioelectromagnetics Society.

(2) Papke *et al.*, 1986. *Cell Mol. Biol.* 6: 381-395.

P-228-C

EFFECT OF TWO WEEKS OF EXPOSURE TO VERTICAL, 50 Hz MAGNETIC FIELD ON URINARY 6-SULPHATOXYMELATONIN EXCRETION OF RATS. J. Bakos, N. Nagy, G. Thuróczy and L.D. Szabó. National "Frédéric Joliot-Curie" Research Institute for Radiobiology and Radiohygiene, Budapest H-1775, Hungary.

In our previous investigations we found that the urinary 6-sulphatoxymelatonin (aMT6s) excretion was not affected by short term (24 hours) exposure to 500, 100, 5 and 1 μ T vertical magnetic field during exposure. The aim of our recent experiment was the study of effect of sub-chronic (two weeks) exposure to 50 Hz, vertical magnetic field on the

excretion of urinary 6-sulphatoxymelatonin into nocturnal urine of rats. Ten male Wistar rats were kept under 9:15=light:dark conditions in metabolic cages for six weeks. After a two weeks accommodation period the nocturnal urine of animals was collected for four consecutive weeks. The concentration of aMT6s in the rat urine was measured by 125 I-radioimmunoassay. After the first week of urine collection, five-five rats were exposed for two weeks to 100 μ T and 1.0 μ T flux density magnetic field, respectively. The five of rats were exposed to 100 μ T magnetic field in the centre of two circular coils (diameter: 42 cm), the other five animals were placed in the stray field of coils, where the flux density was 1 μ T. The orientation of 50 Hz AC magnetic field was vertical. On fourth week the urine collection was continued to get possible results about shifted effects. It was found, that the excretion of the primary metabolite of melatonin in the urine - the aMT6s - shows statistically significant alteration during and after 50 Hz horizontal magnetic field exposure of rats to 100 μ T flux density. In case of 1 μ T flux density significant changes were not found in the aMT6s production of rats either during or after exposure to magnetic field.

This work was supported by the Ministry of Welfare of Hungary under Contract T-08 051/93.

P-229-A

EFFECTS OF REPEATED NIGHTTIME EXPOSURES TO 50 Hz ELECTROMAGNETIC FIELDS ON THE MELATONIN PRODUCTION AND ITS RHYTHM. S.C. Hong¹, M. Kabuto², Y. Kurokawa² and R. Ohtsuka¹. ¹Department of Human Ecology, Faculty of Medicine, University of Tokyo, Tokyo 113, Japan. ²Urban Environment and Health Project, National Institute for Environmental Studies, Tsukuba, Ibaraki 305, Japan.

OBJECTIVE: Electromagnetic field (EMF) exposure from electric blanket, which is one of the appliances used in proximity to the entire body every night for long period has been shown to suppress nocturnal melatonin productions or delay the time of peak height in some studies but not in others. The present study is planned to determine whether the effects of comparably long-term ELF-EMF (extremely low frequency-EMF) exposure on suppression and/or time-shift of the melatonin rhythm in humans could be replicated or not.

SUBJECTS & METHODS: Subjects were 9 healthy male volunteers with 23-37 years of age (mean: 28 years), 172.3 \pm 5.8 cm height and 67.3 \pm 8.8 kg weight; 8 of them were recruited from graduate students. Groups 1 and 2 consisted of 5 and 4 subjects, respectively, but both groups were subjected to the same experimental condition, except the season of experiments (June to October 1995 vs March to June 1996). The subjects were studied for consecutive 16 wk, including 11 wk exposure (6 wk of exposure-I and 5 wk of exposure-II) period. The difference in photoperiod duration between both groups ranged from 38 min (during the exposure-I period) to 3 hr 8 min (during the post-exposure period). The electric blankets, which were used for EMF exposure, were ordinary blankets remodeled with electric blanket-connected non-heating electric code to avoid possible

effects of thermal change on melatonin production; in the non-heating electric blankets, vinyl coated wire replaced an ordinary blankets hot wire. Urinary melatonin was examined for 914 urine samples, using radioimmunoassay test kits supplied by Buhlmann Laboratories AG (Switzerland). The rhythm of melatonin production was analyzed with the complex cosine curve fit. The EMF intensities generated remodeled electric blanket were $0.69 \pm 0.05 \mu\text{T}$ at head region, $8.34 \pm 2.68 \mu\text{T}$ at waist region, and $3.48 \pm 0.96 \mu\text{T}$ at heel region, respectively. To measure the actual exposure situation, the dosimeter was placed at the surface of electric blanket and measurement was done after warm up.

RESULTS: Nocturnal exposure to 50 Hz EMF generated from electric blankets was not related to melatonin production in terms of its mean values (for 8 subjects excluding one whose rhythm could not be calculated) but showed tendencies of suppressing peak value and/or delaying phase of melatonin rhythm in 7 of the 8 subjects.

DISCUSSION: The present findings may suggest a possibility that exposure to ELF-EMF by electric blankets, if magnitude and duration are sufficient, could lead to changes in melatonin production and its rhythm, at least highly sensitive individuals. However, a definitive conclusion could not be obtained from only the present results. Since the experiments were performed under unrestricted daily lives. Experiments with major possible modifying factors for melatonin metabolism being controlled are warranted.

P-230-B

COMPARATIVE STUDY ON THE BIOLOGICAL EFFECTIVENESS OF ELF-EMF (50 Hz) IN TWO DIFFERENT HUMAN CELL LINES. M. Simkó^{1,2}, S. Lange¹, R. Kriehuber¹, D.G. Weiss¹ and R.A. Luben². ¹Institute of Animal Physiology, Unit for Environmental Physiology, University of Rostock, D-18051 Rostock, Germany. ²Division of Biomedical Sciences, University of California, Riverside, California 92521, USA.

Effects on micronucleus (MN) formation and induction of apoptosis after exposure to 50 Hz electromagnetic fields (EMF) for different duration (24h, 48h and 72h) and different field intensities (0.1-1.0.mT) were studied in a human squamous cancer cell line (SCL II) and in a human amniotic fluid cell line (AFC).

The biological effectiveness of exposure to extremely-low-frequency magnetic fields (ELF-MF) applied either horizontally or vertically with respect to the surface of the culture medium were compared. We found a statistically significant increase of MN frequency and of induction of apoptosis in SCL II cells after 48h and 72h continuous exposure to 50 Hz EMF (0.8 and 1.0 mT) with MF applied vertically. AFC cells exposed to the same conditions showed no statistically significant differences in the examined biological endpoints when compared to controls.

When the MF is applied horizontally no statistically significant increase in the examined biological endpoints could be detected in SCL II cells and AFC cells. Although somewhat higher frequencies of MN and apoptosis were

observed throughout in exposed SCL II cells when compared to controls; these were, however, not statistically significant due to large variance.

These results demonstrate that different human cell types respond differently to vertically applied MF. Dose-dependent induction of apoptosis and genotoxic effects, resulting in increased micronucleus formations could be demonstrated in the transformed cell line, whereas, the nontransformed cell line did not show statistically significant effects. These findings provide evidence that EMF could be a promoter but not an initiator of carcinogenic effects. Moreover, the observed results show that the orientation of MF to the cell culture dish (surface of the cell culture medium) may be important in certain cell types for the induction of the investigated biological endpoints.

Since MF of vertical orientation induce higher current densities in petri dishes than horizontal fields, it can be concluded that the hypothesis is supported, that the increase of MN formation and apoptosis after exposure to horizontal MF in SCL II cells are due to MF-induced eddy-currents.

Supported by the University of Rostock.

P-231-C

LONG-TERM EXPOSURE OF MICE TO POWER FREQUENCY MAGNETIC FIELDS: NIGHT TIME MELATONIN PRODUCTION. L. de Jager and L. de Bruyn. Department of Anatomy, U.F.S., Bloemfontein 9300, South Africa.

OBJECTIVE: The aim of this study was to examine the effect of long-term exposure to magnetic fields on the night-time melatonin production of adult male mice and thus determine whether there is a difference in the amplitude and time of the night-time plasma melatonin peak.

METHODS: Balb/C adult male mice were used for the study when they had reached a mass of 25 to 28 grams. An exposed and sham-exposed group were used. The sham-exposed group was exposed to a rms electro-magnetic field randomly varying between $0,5 \mu\text{T}$ and $77 \mu\text{T}$ with an average of $2,75 \mu\text{T}$ for 24 hours per day. They had been exposed to the magnetic field from conception until the time of blood sampling. In a pilot study dark cycle plasma melatonin curves were determined for the sham exposed and exposed groups by collecting blood samples at half hourly intervals between 23:00 and 02:30. Pooled sera of 3 subjects were used for each time interval. To determine the night-time melatonin peak for each group, the times of sampling were selected according to the nighttime curves. Thus for the sham-exposed group, blood samples were collected as 23:30, 24:00, 00:30, 01:00 and 02:00. In the exposed group sampling was performed at 00:30, 01:00, 01:30 and 02:00. To determine the peak melatonin values, blood samples were collected from 9 subjects for each time point. The plasma melatonin values were determined by radio immunoassay. The results were summarized using medians, minima and maxima because of the small sample sizes. Statistical comparison was done by non parametric 95% confidence interval for median differences.

RESULTS AND DISCUSSION: The dark cycle plasma melatonin curve for the sham-exposed group showed a biphasic peak at 23:30 and 00:30, whereas the exposed group peaked at 00:30 and 01:30. The results of the plasma melatonin median values in the sham-exposed mice correspond to the night-time curve of the pilot study, thus demonstrating a biphasic peak at 23:30 and 00:30 and dropping to a post-peak low value at 01:00. The exposed mice also showed a biphasic peak but this was delayed by approximately 1 hour and may be seen at 00:30 and at 01:30. Although a statistically significant difference was noted in the median melatonin values between sham-exposed and exposed groups at 01:00, it may probably be explained by the delay in the peak of the exposed mice. Subsequently the peak values of the two groups were compared: i.e. the first peak of the control group with the first peak of the exposed group; the second peak of the two groups, and finally the first peak of the control group with the second peak of the exposed group. In contrast to the attenuation of the peak melatonin values reported in previous studies, we found no statistical difference between the peaks of magnetic field exposed and control groups. Long-term exposure to a randomly varied power frequency magnetic field does not influence the amplitude of the night-time melatonin peak, but delays the peak for approximately 1 hour, and as such, probably has no deleterious health effects mediated through changes to the melatonin production and secretion.

P-232-A

Moved to J-12.

P-233-B

NOCTURNAL MELATONIN CONCENTRATIONS IN DAIRY COWS AND 60 Hz ELECTRIC AND MAGNETIC FIELDS. J.F. Burchard¹, D.H. Nguyen², L. Richard² and E. Block¹. ¹Department of Animal Science, McGill University, Quebec H9X 3V9, Canada. ²Institut de Recherche d'Hydro-Québec, Québec J3X 1S1, Canada.

OBJECTIVE: Because melatonin (MLT) has been proposed as a mediator of the electric and magnetic field (EMF) biological effects in several species, this study was designed to evaluate whether EMF exposure of cows had an effect on the nocturnal concentration of MLT in blood when cows are exposed to uniform and controlled EMF.

METHOD: Sixteen multiparous, pregnant, lactating Holstein cows (weighing 600 ±50 kg, in 184.8 ±52 d of lactation, and at 101.9 ±43 d of gestation) were confined to wooden metabolism cages and exposed to a vertical electric field of 10 kV/m and a uniform horizontal magnetic field of 30 μT. The trial was conducted as a switchback statistical design. Cows were divided into two sequence groups of eight cows each. One sequence group was exposed for three periods of 28 d each. During the first period, the electric and magnetic fields were off; during the second period, they were on; and during the final period, they were off. The second sequence group

was exposed for three periods also, but the activity of the fields was reversed (first period, on; second period, off; last period, on). On d 25 of each exposure period, blood samples were obtained every half hour for a period of 14 h starting at 1700 h to determine melatonin concentration.

RESULTS: Nocturnal melatonin did not show any variation that could be attributable to exposure to electric and magnetic fields.

This work was supported by Hydro-Quebec.

P-234-C

EARLY EVENING MAGNETIC FIELD EXPOSURE DECREASES PINEAL *c-fos* EXPRESSION IN THE SHORT DAY-ENTRAINED DJUNGARIAN HAMSTER. W. Haggren, T. Ishida-Jones, T.E. Mekonnen and W.R. Adey. J.L. Pettis Memorial Veterans Administration Medical Center, Loma Linda, California 92357, USA.

OBJECTIVES: This poster will describe progress in our use of the seasonally breeding Djungarian hamster (*Phodopus sungorus*) as a model in which to relate pineal and retinal gene expression to changes in pineal melatonin synthesis caused by light or MF exposure, thereby testing our working hypothesis that light and magnetic fields (MF) are two related, but distinct, physical environmental agents which affect, in a similar manner, the expression of genes comprising the mammalian circadian clock.

METHODS: We have shown a 90% decrease in the expression of *c-fos* in response to light at night in the Djungarian hamster pineal gland. We also have demonstrated 70% decreases in serum melatonin levels, which we employ as a reference for pineal melatonin production, in response to this light pulse. We have begun examining the expression of the gene for pineal serotonin N-acetyltransferase (S-NAT), recently cloned in our laboratory from the Djungarian hamster. Our working hypothesis predicts that MF exposure in the early evening will decrease pineal *c-fos* expression in addition to decreasing serum melatonin levels, and may affect pineal S-NAT gene expression. Work in our laboratory is focused on the short day-entrained Djungarian hamster (8L:16D). In the past, we have exposed the hamsters to MF for 2 hr during the early evening hours and included a light-exposed cohort with each MF-exposed/sham-exposed group of hamsters. For our most recent experiment, MF and sham exposure began at 1 hr before lights out, extending to 2 and 4 hours after onset of darkness. We have included light-exposed and dark "cage control" groups as well. For each treatment/time, the pineals of 8 hamsters were removed and frozen together in liquid N₂ for storage at -80°C. At the same time, trunk blood was collected for serum melatonin analysis. Extracted total RNA was hybridized to gene probes for *c-fos*, S-NAT, the transcriptional repressor ICER, and a "housekeeping" gene, glyceraldehyde-3-phosphate dehydrogenase (GPDH).

RESULTS: Past results have shown a decrease in pineal *c-fos* expression in MF-exposed hamsters as compared to sham-exposed, but never as strong as the decrease in pineal *c-fos* expression caused by light exposure. The results of pineal

gene expression for the most recent experiment are being analyzed in conjunction with analysis of levels of serum melatonin (in the laboratory of Dr. R. J. Reiter).

This work supported by the Department of Energy, Office of Energy Management, Contracts DE-AI01-90CE35035 and DE-AI01-95EE34020.

Bone Healing and Nerve Regeneration

P-235-A

ELECTRICAL PROPERTIES OF HUMAN BONE TISSUE AND THEIR RELATIONSHIP WITH BONE MINERAL CONTENT. S. Saha. Bioengineering Alliance of South Carolina and Department of Bioengineering, Clemson University, Clemson, South Carolina 29634-0906, USA.

In this study, we measured the electrical properties of wet human cortical and cancellous bone tissue from distal tibia and investigated their relationship to the wet, dry, and ash tissue densities. The dielectric properties of both cortical and cancellous bone were determined for different frequencies and for the three orthogonal directions. The wet, dry, and ash tissue densities of the bone samples were also measured. Regression analysis was performed to examine the possible relationships between the electrical properties and the tissue densities for cancellous and cortical bone specimens. The electrical properties were frequency dependent and they were different for the cortical and cancellous bone tissues. Highly significant positive correlations ($p < 0.001$) were found between the wet density of the bone and the dry and ash densities. The specific capacitance of the cancellous bone specimens in all three orthogonal directions showed significant ($p < 0.01$) positive correlations with the wet, dry, and ash densities. In general, the specific capacitance depended more on density for all bone specimens, and only a weak relationship was found between the resistivity of human cortical bone and density.

P-236-B

IN VIVO RESPONSES OF NORMAL BONE TO A PULSED ELECTROMAGNETIC FIELD. J.A. Spadaro¹ and W.H. Bergstrom². ¹Department of Orthopedic Surgery and ²Department of Pediatrics, State University of New York, Health Science Center, Syracuse, New York 13210, USA.

INTRODUCTION: Electromagnetic fields are able to influence regulatory mechanisms in cultured bone cells. This work gives evidence that normal bone *in vivo* can be affected. Recent *in vivo* findings have implicated insulin-like growth factors and their receptors, expression of bone morphogenetic proteins, and calcium transport as elements of the transduction mechanism of weak electromagnetic fields (EMFs) on the up-regulation of bone cells in culture (1-4). The question arises as to whether normal bone *in vivo* is

affected by short exposures to an EMF. This was examined by exposing young rats to various amounts of pulsed-EMF (PEMF) and determining changes in cell-related Ca-uptake in the calvarial bone.

METHODS: 150 Sprague-Dawley rats (14 litters), 12-20 days of age were used. Each litter was divided into a PEMF and a control group (4-6/group). One half litter was placed in a small plastic cages within the active area of a PEMF coil for 1 to 240 minutes, while the other half was placed in a control (inactive) coil. The PEMF was a horizontal, 15Hz pulse burst waveform used for long bone fracture treatment (5 ms long burst had 20 asymmetric 2 mT pulses, 255 μ s apart). After exposure, the animals were sacrificed, 6mm discs of calvarial bone removed and net calcium uptake measured. Each disc was placed in 0.2 ml of PBS buffer containing 1.25 mM [Ca] for 15 min. at 37°C and the [Ca] remaining in the supernatant was measured by EDTA titration (2). Several additional litters were exposed for 2-4 hrs and sacrificed 1, 24, and 48 hrs. later to determine persistence of the activity changes.

RESULTS: For exposures of 2.5 min. or more net Ca-uptake activity was significantly enhanced above basal levels by 20-55% after exposure to PEMF ($p < 0.001$ to 0.05). Linear regression of relative Ca-uptake from all individual specimens showed a "log dose response" relationship with regard to exposure time, with a correlation coefficient $r = 0.64$ (Fig. 1.) The enhancement persisted to 24 hrs after exposure, while after 48 hrs. recovery seemed to occur (Fig. 2.)

DISCUSSION: This suggests that normal bone *in vivo* can actually be affected by an EMF of short duration and that the response persists for a day or so. We believe this to be the first direct evidence of this. The time frame is consistent with previous *in vitro* experiments with excised calvaria in which Ca-uptake was increased by a short exposure to a PEMF (4) and the osteoblast studies cited above (1-3) and others. The similarity of effects seen *in vitro* and *in vivo* supports the idea that PEMFs applied *in vivo* act locally, directly affecting control systems at the cellular level in bone. Systemic mechanisms, however, may also be present. The Ca uptake response may be related to the ability of some EMFs to reduce osteopenia in animal models and to enhance fracture healing clinically.

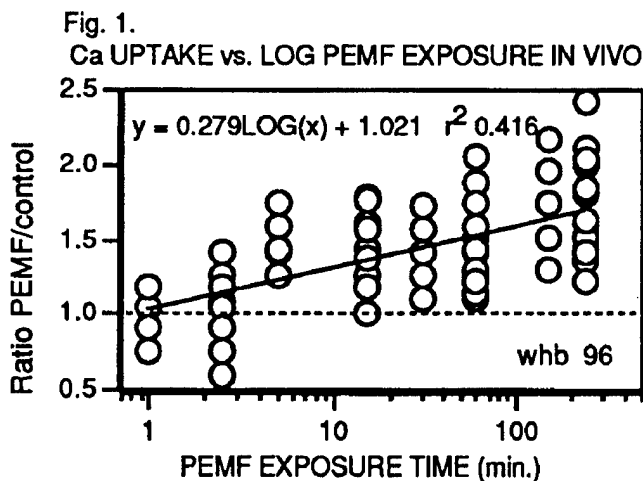
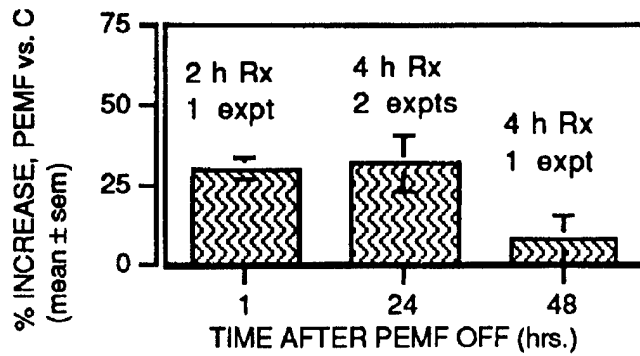

Fig.2.
Ca- UPTAKE, RECOVERY AFTER PEMF EXPOSURE



1. Fitzsimmons, R *et al*, *Proc. ORS* 21:345 (1996).
 2. Sahinoglu, T *et al*, *Proc. ORS* 21:204/34 (1996).
 3. Fitzsimmons, R *et al*, *Calc Tiss Int.* 55:376-380 (1994).
 4. Spadaro, J, Bergstrom, W., *ORS*, 20: 452, (1995).
- This work supported by the Depts. of Orthopedic Surgery and Pediatrics, S.U.N.Y-HSC, Syracuse, NY.

P-237-C

EFFECT OF PULSED RADIO FREQUENCY THERAPY ON EDEMA IN ANKLE SPRAINS: A MULTISITE DOUBLE-BLIND CLINICAL STUDY.
A.A. Pilla² and L. Kloth². ¹Bioelectrochemistry Laboratory, Department of Orthopaedics, Mount Sinai School of Medicine, New York, New York 10029, USA. ²Department of Physical Therapy, Marquette University, Milwaukee, Wisconsin 53201, USA.

INTRODUCTION: Inflammation is an essential element in the healing process, however the body often over-responds and the resulting edema causes delayed healing and increased morbidity. For soft tissue and musculoskeletal injuries and post-surgical, post-traumatic and chronic wounds, reduction of edema is thus a major therapeutic goal to accelerate healing. Pulsed radiofrequency (PRF) therapy has been suggested for edema reduction, however, a paucity of controlled trials has limited its clinical utilization. The ankle sprain serves as a good model of soft-tissue inflammation as it typically exhibits edema, pain and disability. Thus, it was the purpose of this study to determine if PRF treatment, in addition to conventional treatment (rest, ice, compression, and elevation) could accelerate the rate of edema reduction in patients presenting with Grades I or II ankle sprains.

METHODS: Patients, from 14 clinical sites, who experienced a lateral ankle sprain within 48 hours were eligible for participation in this study. They received a single 30 minute sham or active PRF treatment on Days 1 and 2. Swelling was measured before and after each treatment session and on Day 3. Swelling of the injured ankle (in ml) was measured by the water displacement method, before and after each treatment. Each clinical site had one active and one sham PRF unit. The active unit (sofPulse™ model 912, EPi, Pompano Beach, FL) delivered a 65 µsec burst of 27.12 MHz sinusoidal waves, 600 times per second to the treatment area. The peak magnetic field in tissue was approximately 2

Gauss. The signal was applied via a 23 cm diameter applicator placed within 0.5-1 cm of the external surface of skin. The change and rate of change in edema volume from Day 1 to Day 3 were evaluated. Significance was assessed using the unpaired Student's t test, and accepted at the P ≤0.05 level.

RESULTS AND DISCUSSION: This study recruited 439 subjects at fourteen centers. Of this total, 395 patients completed the protocol, 193 in the control and 202 in the active groups, respectively. There were no reports of any adverse events. Edema decrease in the PRF treated group (-12.0 ±4.1 ml) was approximately 7x greater than that in the control (sham treated) group (-1.6 ±3.6 ml), P=0.03. These results suggest edema was basically unchanged in the control group, whereas a significant reduction of edema volume was observed for the group exposed to PRF therapy over the treatment and observation period. The mean rate of edema decrease (indicative of time in inflammatory phase) for this period in the PRF treated group (-5.8 ±2.1 ml/day) was nearly 5x that in the sham treated group (-1.2 ±1.8 ml/day), P<0.05. This again suggests the rate of edema change was not significantly different from zero in the control group, while a large edema decrease could be expected in the active group. These data support previous studies with electromagnetic fields which reported edema reduction using an ankle sprain model. This study confirms the report that standard therapy for this injury merely slows edema formation since no significant volume change in the control group was observed. In contrast, both edema reduction and its rate of decrease were significant, and persisted for at least 24 hours after the last PRF treatment, in the active group. The mechanism of action of PRF in this study is not known. Recent studies suggest the transmembrane voltage changes induced by PRF are sufficient to affect ion binding and/or transport with resultant modulation of relevant biochemical cascades. In this manner the PRF signal may directly reduce extracellular fluid production and/or affect osmotic capabilities at the injury site. This study has demonstrated non-invasive PRF therapy is effective in accelerating the reduction of edema in acute Grade I or II lateral ankle sprains after two 30 minute treatment sessions. This simple, cost-effective treatment may well have applications as adjunct therapy in a variety of musculoskeletal injuries, as well as the inflammatory stages of wound repair. Acceleration of healing in these cases would have a significant impact on reduction of the cost of health care.

The authors acknowledge the significant contributions of D Martin, D Eitel, M Sicuranza, T Anderson, G Henning, T Foster, D Kiefer, S Lephart, D Rouse, L Tis, H Goitz, M Ferrara, D Perez, D Kaiser, D Wiksten and F McCue III. This work was supported in part by the Horace W. Goldsmith Foundation and Electropharmacology, Inc., Pompano Beach, FL.

Fig.2.
Ca- UPTAKE, RECOVERY AFTER PEMF EXPOSURE

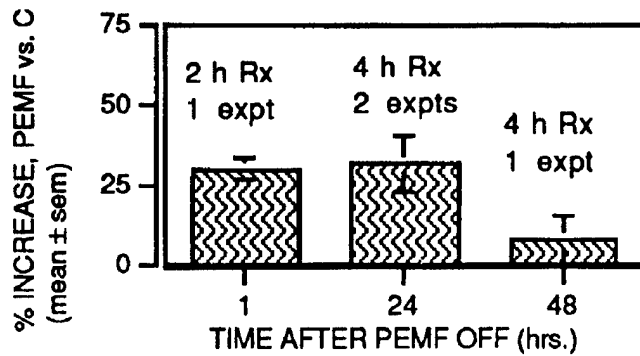

1. Fitzsimmons, R *et al*, *Proc. ORS* 21:345 (1996).
 2. Sahinoglu, T *et al*, *Proc. ORS* 21:204/34 (1996).
 3. Fitzsimmons, R *et al*, *Calc Tiss Int* 55:376-380 (1994).
 4. Spadaro, J, Bergstrom, W., *ORS*, 20: 452, (1995).
- This work supported by the Depts. of Orthopedic Surgery and Pediatrics, S.U.N.Y-HSC, Syracuse, NY.

P-237-C

EFFECT OF PULSED RADIO FREQUENCY THERAPY ON EDEMA IN ANKLE SPRAINS: A MULTISITE DOUBLE-BLIND CLINICAL STUDY.
A.A. Pilla² and L. Kloth². ¹Bioelectrochemistry Laboratory, Department of Orthopaedics, Mount Sinai School of Medicine, New York, New York 10029, USA. ²Department of Physical Therapy, Marquette University, Milwaukee, Wisconsin 53201, USA.

INTRODUCTION: Inflammation is an essential element in the healing process, however the body often over-responds and the resulting edema causes delayed healing and increased morbidity. For soft tissue and musculoskeletal injuries and post-surgical, post-traumatic and chronic wounds, reduction of edema is thus a major therapeutic goal to accelerate healing. Pulsed radiofrequency (PRF) therapy has been suggested for edema reduction, however, a paucity of controlled trials has limited its clinical utilization. The ankle sprain serves as a good model of soft-tissue inflammation as it typically exhibits edema, pain and disability. Thus, it was the purpose of this study to determine if PRF treatment, in addition to conventional treatment (rest, ice, compression, and elevation) could accelerate the rate of edema reduction in patients presenting with Grades I or II ankle sprains.

METHODS: Patients, from 14 clinical sites, who experienced a lateral ankle sprain within 48 hours were eligible for participation in this study. They received a single 30 minute sham or active PRF treatment on Days 1 and 2. Swelling was measured before and after each treatment session and on Day 3. Swelling of the injured ankle (in ml) was measured by the water displacement method, before and after each treatment. Each clinical site had one active and one sham PRF unit. The active unit (sofPulse™ model 912, EPi, Pompano Beach, FL) delivered a 65 µsec burst of 27.12 MHz sinusoidal waves, 600 times per second to the treatment area. The peak magnetic field in tissue was approximately 2

Gauss. The signal was applied via a 23 cm diameter applicator placed within 0.5-1 cm of the external surface of skin. The change and rate of change in edema volume from Day 1 to Day 3 were evaluated. Significance was assessed using the unpaired Student's t test, and accepted at the $P \leq 0.05$ level.

RESULTS AND DISCUSSION: This study recruited 439 subjects at fourteen centers. Of this total, 395 patients completed the protocol, 193 in the control and 202 in the active groups, respectively. There were no reports of any adverse events. Edema decrease in the PRF treated group (-12.0 ± 4.1 ml) was approximately 7x greater than that in the control (sham treated) group (-1.6 ± 3.6 ml), $P=0.03$. These results suggest edema was basically unchanged in the control group, whereas a significant reduction of edema volume was observed for the group exposed to PRF therapy over the treatment and observation period. The mean rate of edema decrease (indicative of time in inflammatory phase) for this period in the PRF treated group (-5.8 ± 2.1 ml/day) was nearly 5x that in the sham treated group (-1.2 ± 1.8 ml/day), $P<0.05$. This again suggests the rate of edema change was not significantly different from zero in the control group, while a large edema decrease could be expected in the active group. These data support previous studies with electromagnetic fields which reported edema reduction using an ankle sprain model. This study confirms the report that standard therapy for this injury merely slows edema formation since no significant volume change in the control group was observed. In contrast, both edema reduction and its rate of decrease were significant, and persisted for at least 24 hours after the last PRF treatment, in the active group. The mechanism of action of PRF in this study is not known. Recent studies suggest the transmembrane voltage changes induced by PRF are sufficient to affect ion binding and/or transport with resultant modulation of relevant biochemical cascades. In this manner the PRF signal may directly reduce extracellular fluid production and/or affect osmotic capabilities at the injury site. This study has demonstrated non-invasive PRF therapy is effective in accelerating the reduction of edema in acute Grade I or II lateral ankle sprains after two 30 minute treatment sessions. This simple, cost-effective treatment may well have applications as adjunct therapy in a variety of musculoskeletal injuries, as well as the inflammatory stages of wound repair. Acceleration of healing in these cases would have a significant impact on reduction of the cost of health care.

The authors acknowledge the significant contributions of D Martin, D Eitel, M Sicuranza, T Anderson, G Henning, T Foster, D Kiefer, S Lephart, D Rouse, L Tis, H Goitz, M Ferrara, D Perez, D Kaiser, D Wiksten and F McCue III. This work was supported in part by the Horace W. Goldsmith Foundation and Electropharmacology, Inc., Pompano Beach, FL.

ENZYMATIC ACTIVITY ASSESSMENT IN BONY LESION EXPOSED TO PEMFs. V. Canè¹, D. Zaffe¹, F. Cavani¹, P. Botti² and S. Soana³. ¹Department of Morphological Science and Forensic Medicine, Section of Human Anatomy, Research Unit of ICEmB, I-41100 Modena, Italy. ²Department of Animal Pathology, I-10100 Tornio, Italy. ³Institute of Experimental Veterinary Radiology, I-43100 Parma, Italy.

Our previous investigations on the rate of repair of transcortical holes in the diaphyseal region of metacarpal bone (McIII) of adult horses show that low-frequency pulsed electromagnetic fields (PEMFs) modulate TNF α - and TGF- β 1 gene expression during the early stages of bone repair, increase osteoblast activity during osteogenetic phase of the repair process, improve the closure of the above-mentioned experimental bony lesion in the shaft bones of horse and affect the physical resistance of the new bone in its contents. Recent *in vitro* studies suggest that extremely low frequency electric fields seem to modulate bone cell enzymatic activity. On the basis of these results, we carried out a new series of experiments to detect whether PEMFs are involved in modulating the enzymatic activity of alkaline phosphatase (TALP) and tartrate resistant acid phosphatase (TRAP) during the early phase of reparative process of transcortical holes drilled in long bones of horse.

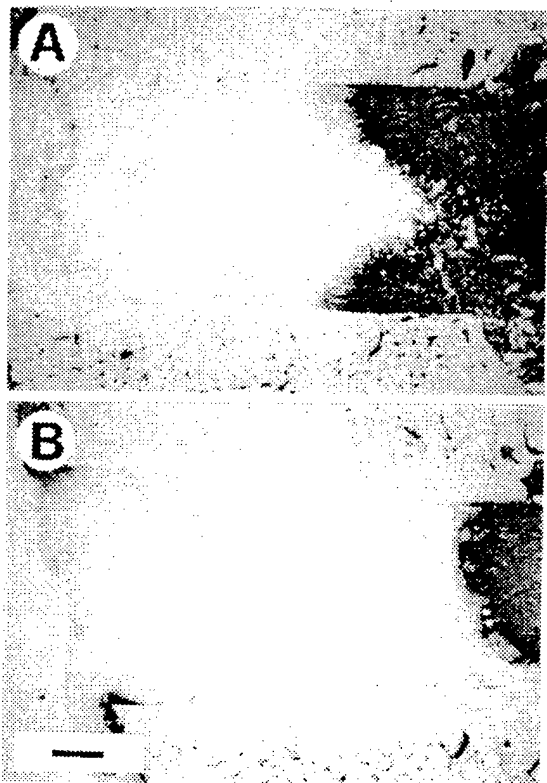

Two transcortical holes (4.5 mm diameter) were drilled at the same diaphyseal level in the lateral margin of the right and left metacarpal bone (McIII) of six adult male horses. The left McIII were exposed to PEMFs (75 Hz; 2.8 mT, 1.3 msec impulse width) 24h/day; the right untreated McIII were used as controls. Horses were sacrificed 8 and 15 days after the

operation. The bone segments containing the holes were fixed, dehydrated in ethanol solutions and, undecalcified, embedded in methylmethacrylate. The mid-longitudinal sections of the holes were either stained with toluidine blue or processed for the evaluation of the total alkaline phosphatase (TALP) and the tartrate resistant acid phosphatase (TRAP). The values of the parameters obtained on the PEMFs and control side were compared by a paired t-test. A two-tailed p value was calculated.

Fig. 1 - PEMF-treated hole (A); control hole (B); bar = 1mm; positivity = dark colour.

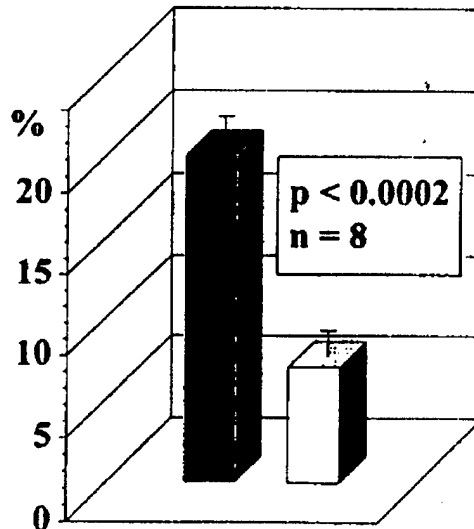

Fig. 2 - Mean and SD values of the TALP positive tissue in PEMF-treated (A) and in the control holes (B).

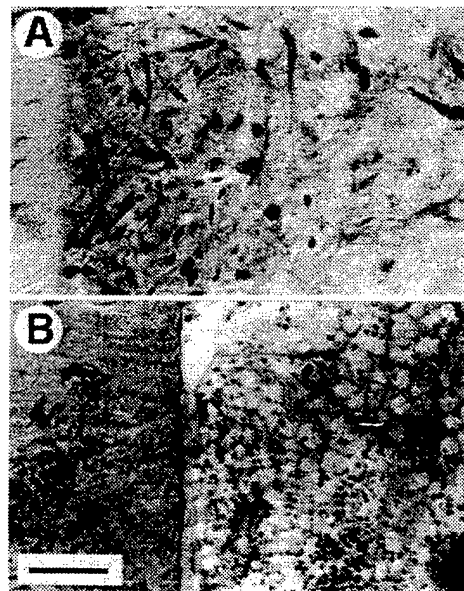

Fig. 3 - PEMF-treated hole (A); control hole (B); fibroblasts are well represented in A; bar=100 μ m.

In PEMF-treated holes we found: a) TALP is strongly positive with respect to the control ones ($p < 0.0002$) (Figs. 1, 2); b) fibroblastic cell component is well represented in repair tissue

with respect to the control ones (Fig. 3); b) the newly formed bony trabeculae are more abundant than in the controls; c) the presence of osteoclasts is much more evident than in the controls (Fig. 4).

The finding in the PEMF-treated holes of a greater expression of both TRAP (marker of the osteoclasts) and TALP, (marker of osteoblasts) with respect to the controls demonstrates that PEMFs alter cellular enzymatic activity during the early stages of bone repair. In other words PEMFs seem to accelerate the processes of bone remodelling during the early stages of the repair of transcortical holes.

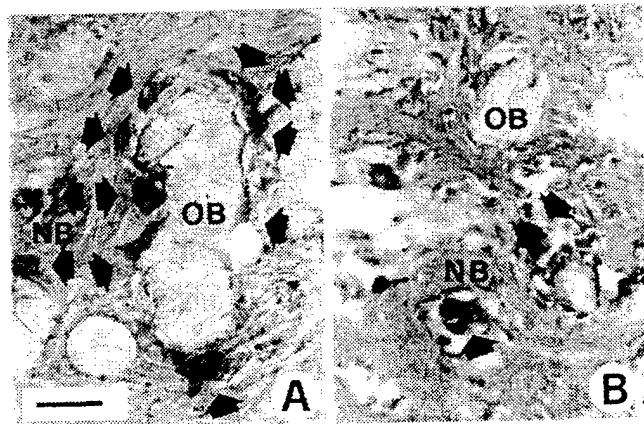

Fig. 4 - TRAP positivity is more evident in PEMF treated holes (A) than in controls (B); bar=50µm.

P-239-B

HIGH RESOLUTION VIDEO-MICROSCOPY OF VITAL HARD TISSUE. U.G. Randoll¹, A. Scheller² and F.F. Hennig¹. ¹Department of Traumatology, University of Erlangen-Nuremberg, D-91054 Erlangen, Germany. ²Leonardis Fachklinik, D-70806 Kornwestheim, Germany.

INTRODUCTION: Different theories of self organization, autopoiesis and communication became important and extends orthodox boundaries in medicine since several years. So the momentary state of the art in hard tissue research focuses more and more on functional organization and communication of single cells within the tissue. Cells are regarded as biosensors located in the interstitial matrix.

Histomorphological changes and adaptations resulting from the organism's regulative capacity begin in the microcirculation of the intra- and extracellular spaces. These minimal changes should be visualized in order to get an impression of biological fractal structures.

For this cybernetic point of research it is mandatory to look for new adequate tools which allow to observe living fractal units in all dimensions within their context. This means that natural sciences move transdisciplinary to philosophy.

MATERIAL AND METHODS: New images of vital ultrastructures of bone-, tumor- and cartilage-biopsies were taken by a modified light microscope from Nikon. This microscope has a large variable depth of focus, and thus, preparation techniques and stains which might destroy or disturb living cells are no longer necessary in order to observe cell structures and processes. The observations took place

using natural colors whereby tomographic slides *in vivo* used for 3D reconstruction could also be obtained.

Bone and cartilage were taken as needle-biopsy or during operation and put into special medium (RPMI 1640, Penicillin, Streptomycin, Glutamin, 15% FKS). Within less than two hours the videomicroscopic documentation of each probe was finished on computer hard disc.

PRELIMINARY RESULTS: The method allows a direct assessment of hard tissue biopsies in the resolution of electron microscopes (cellular structure, cellular matrix-structure). Tumor-cells and their matrix for example are totally different from normal bone growth so that borders of tumorresections can easily be found. Moving virus-like particles can be seen in the tumor probes and are subject-matter for further research..

DISCUSSION: With the help of high resolution light microscopy we were able to extend our gathering of on-line data to include subcellular, intracellular structures and processes smaller than 200 nm which were until now in light microscopy considered only as structures of amorphous dimensions. From the cybernetic point of view and according to biological morphogenesis, biochemical cellular oscillations in the sense of periodic functional processes, can turn into aperiodic, dissociated time courses resulting in pathological structures and symptoms. When those time series degenerate abnormal, they lose their organizing function, which represents a loss in periodic-rhythm order for the cell, which in turn chaotically degenerates. Threshold reactions in response to and as a result of molecular biophysical and biochemical processes which proceed according to non-linear dynamics can be recorded in future time. These types of etiological factors as possible triggers for chronic diseases like tumor or osteoporosis are increasingly gaining more attention in medical circles.

P-240-C

THE EFFECT PULSED ELECTROMAGNETIC FIELD STIMULATION ON PATIENTS TREATED OF HIP REVISIONS WITH TRANS-FEMORAL APPROACH. G. Gualtieri, D. Dallari, P.P. Calderoni, G. Bettelli and S. Gnudi. IV Department, Rizzoli Orthopaedic Institute, 40136 Bologna, Italy.

Today revision surgery of loosened hip prostheses is one of the most challenging procedures an orthopaedic surgeon has to perform.

In severe loosening we often chose the transfemoral approach with cementless long-stem total hip prostheses. Transfemoral approach provides an easy cement removal and shorter surgical steps.

In this study we present the preliminary results of a double-blind trial of pulsed electromagnetic fields for loosened prostheses treated with transfemoral approach and cementless long-stem total hip prostheses. Of the 14 patients enrolled 10 met entry criteria and were available for analysis. Bone density around prostheses was evaluated by Double X-ray Absorptiometry (DXA) at day 0, 45, 90 after surgical procedure. The bone density was measured on the bone window of the transfemoral approach. The early healing of

this zone permits an early weight-bearing. Weight-bearing on the operated limb was not allowed all over the time of the study.

Patients compliance was measured by an hour meter on the stimulator. The active group (5 patients) averaging 510 hours over the three month period (5,7 hours per day), compared with 585 hours for the control group (6,5 hours per day), with no statistical difference between the two groups. There was a correlation in the active group between hours of treatment and bone density increase ($R = 0,96$), while in the control group the regression coefficient was 0,22. In all the patients of the active group we found an increase of the bone density compared to the 60% (3 patients) of control group.

These results suggest that for hip revisions with transfemoral approach, the use of Pulsed Electromagnetic Fields like adjuvant therapy allows an early bone reconstruction which permits an early weight-bearing.

Clinical and Radiographic results will be correlated with the use of pulsed electromagnetic fields when we will have more patients in the study.

P-241-A

¹H-MR ANALYSIS OF RESTRICTED DIFFUSION APPLIED TO BIOMATERIALS CHARACTERISATION AND BONE TISSUE PATHOLOGIES. A. Bandoli, F. Bersani, E. Bettini, S. Giacobelli, M.E. Graziani, L. Lendinara, F. Romani and S. Valbonesi. Dipartimento di Fisica, Università degli Studi di Bologna, 40100 Bologna, Italy.

Pulsed-field-gradient-spin-echo NMR (PFGSE-NMR) techniques have recently attracted renewed attention as a microscopic probe of volumetrically averaged properties of materials. When the diffusion of a fluid is restricted by the presence of obstacles, experiments performed by PFGSE-NMR methods yield information about the continuing geometry as seen by the diffusing particle. It has been shown (1) that the early-time behaviour of the diffusion coefficient is related to the pore-space structure factor. The knowledge of this parameter can give information about the NMR relaxation mechanism at material-fluid interface. According to the theory the use of magnetic pulsed field gradients allows the estimation of the surface/volume ratio and from this ratio an estimation of the average linear dimension of the pore space.

As every change in the function of a bone is followed by certain definite changes in internal architecture (besides in external conformation) the recent advances in NMR methods should discriminate different bone parts and perhaps pathological alterations (including osteoporosis). We present the results obtained from PFGSE-NMR method applications to water-dextran gels and to segments of rat femoral condyle, in which an estimation of porosity is compared with other morphological methods. The PFGSE-NMR could become a new method of contrast in MRI.

(1) P.P Mitra *et al.*, *Pays. Rev. Letters*, 68, 3555, 1992.

P-242-B

PEMFs IMPROVE BONE ADAPTATION IN ORTHODONTICALLY TREATED RABBITS. D. Zaffe¹, G. Sfondrini² and D. Fraticelli². ¹Dipartimento Scienze Morfologiche e Medico Legali, Sez. di Anatomia Umana, University di Modena, I-41100 Modena (MO), Italy. ²Scuola di Specializzazione in Ortodonzia, University di Pavia, I-27100 Pavia, Italy.

PEMF-induced effects on orthodontic treatment were histomorphometrically analyzed on New Zealand male rabbit jaws. The first molar teeth were displaced in both left (control) and right (PEMF-treated) hemimandible by a Sentalloy® coil spring (25 g) fixed to the lower incisors for 14 days. Four rabbits (OT) were housed without any further treatment, whereas eight rabbits (OT-PEMF) were treated with a low-frequency pulsed electromagnetic field device (Generator = square wave, 100 Hz, duty cycle 20%), designed and tested in the Department of Electronic Engineering of Pavia University. The magnet (Field=0-53 Gauss, $V_{peak}=6.0$ V, $I_{max}=0.4$ A) was activated on the external surface of the right mandible for 6 h/day. Six additional rabbits were phantom operated and positioned in the same PEMF device: in three rabbits (CP) the device was activated, in the other three rabbits (U) the device was not activated. All rabbits received a single subcutaneous injection of oxytetracycline (30 mg/Kg) 48 hours before sacrifice. The jaws, fixed in buffered paraformaldehyde and methylmethacrylate embedded, were serially sectioned (200 μ m thick) by a circular saw according to longitudinal or transverse planes, at the level of the molar teeth. The section ground to uniform thickness of 100 μ m, were microradiographed and observed under transmitted ordinary and UV lights.

In control rabbits (U and OT), no significant differences were observed between the right and left hemimandible in bone structure and amount of newly-formed tetracycline-labeled bone. In CP rabbits, bone newformation appears to be slightly increased in the right PEMF-treated side compared with the contralateral side. In all orthodontically treated rabbits (OT and OT-PEMF), a displacement of M1 from M2 was observed; such displacement appeared to be significantly higher in the PEMF-treated hemimandible (Fig. 1). Correspondingly the amount of fluorescent new-formed bone was greater in the PEMF-treated hemimandible, particularly at the levels of the apex and the neck of M1 (Fig. 2). The displacement of M1 affects the bone structure around not only the root of M1 but, though to a lesser extent, also those of M2 and M3 (Fig. 3). Bone resorption occurred according to a similar pattern in both left and the right sides of the all jaws examined; however, intracortical bone porosity, partially due to osteoclastic activity, resulted to be lower in PEMF-treated hemimandibles (Fig. 4).

In conclusion the present results show that PEMFs stimulate bone formation and bone remodeling processes around orthodontically displaced teeth thus encouraging their therapeutical use in orthodontics practice.

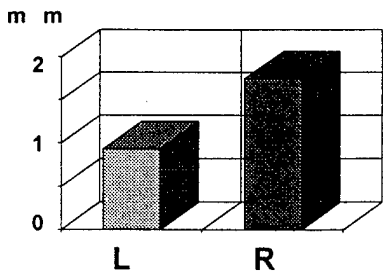

Fig. 1 - Mean distance between M1 and M2 in 8 OT-PEMF rabbits.

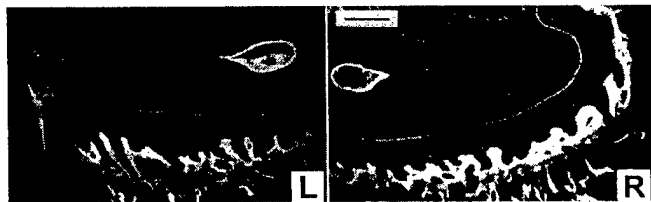

Fig. 2 - UV micrograph showing a greater amount of labeled bone of the right (R) PEMF-treated hemimandible.

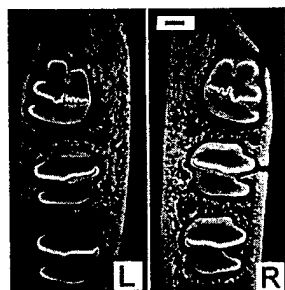

Fig. 3 - Microradiograph of a transverse section at the neck level of OT-PEMF rabbit.

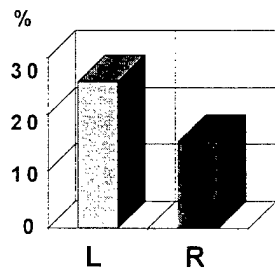

Fig. 4 - Mean percentage values of cortical bone porosity adjacent M1 at the neck level of 6 OT-PEMF rabbits.

P-243-C

ELECTROMAGNETIC STIMULATION OF BONE GROWTH ASSESSED BY BACKSCATTERED ELECTRON IMAGING. V. Ottani¹, S. Guizzardi¹, V. De Pasquale¹, P. Zaniol² and M. Raspanti¹. ¹Istituto di Anatomia Umana Normale, Università di Bologna, 40126 Bologna, Italy. ²Istituto di Radiologia, Università di Modena, 40100 Modena, Italy.

The effect of a pulsing electromagnetic field (PEMF) on the early phases of bone formation in two different ceramic materials (natural and synthetic hydroxyapatite) implanted in rabbit tibiae was comparatively studied.

Chips of natural hydroxyapatite or heat deproteinated bone (HDB) and dense synthetic hydroxyapatite (HA) were implanted into artificial defects in rabbit tibiae. One group of animals was exposed immediately after surgery and every 12 hours thereafter to thirty minutes treatments with PEMF. The shape of the pulse was a positive triangle (50 Hz, 8 mT peak) followed by a pause of 2 ms. A second group was used as control (untreated). Two and four weeks after implantation animals were sacrificed and bone samples processed for the SEM analysis. Specimens were fixed in

paraformaldehyde, dehydrated and embedded in Technovit 9100 resin; sections were cut parallel to the bone surface. To quantitate the biological response, samples from both treated and untreated rabbits were carbon coated and examined under a Philips SEM515 electron microscope using a back scatter electron detector. This method, based on the differences in density between implant, bone and soft tissue, resulted in a quantitative measure of the percentage of implant surface covered by new bone. This method relies on SEM and computerized image processing and analysis.

Two weeks after implantation we did not find any new bone formation in HDB PEMF-untreated animals (Fig. 1a), while new bone formation was clearly recognized at the periphery of the implants from PEMF-treated rabbits (Fig. 1b). On the contrary, two weeks after operation in HA specimens from control animals (Fig. 2a) some newly formed bone trabeculae were evident at implant's interface, and in the samples from PEMF-treated animals an active bone formation was present showing many areas of osteoid tissue adhering closely to the implant (Fig. 2b).

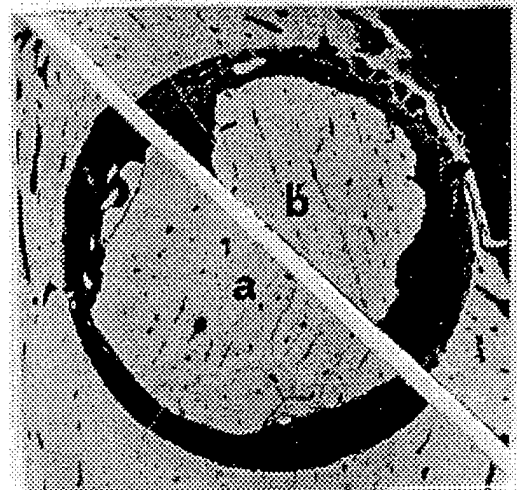

Fig. 1

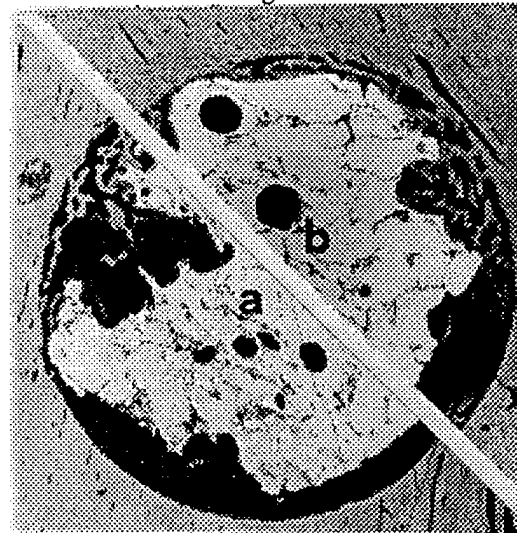

Fig. 2

Electron micrographs of HDB (Fig.1) and HA (Fig.2) implants. The implant surface areas covered with bone are larger in PEMF-treated (b) than in PEMF-untreated samples(a). 20x.

Four weeks after the operation we did not find any significant difference in the amount of newly formed bone between PEMF-treated and -untreated groups and between HDB and HA samples. This study indicates that HA has more osteoconductivity than HDB, and shows that PEMF-treatment results in a benefit in accelerating bone formation at early time periods.

P-244-A

THE EFFECTS OF MILLIMETER WAVE IRRADIATION ON THE DEVELOPMENT OF THE POSTIMPLANTED MOUSE EMBRYOS AND THEIR NEUROCHEMISTRY. Z.G. Zhao¹, Y. Guo² and F.F. Wu².
¹Oncology Department of 210th Hospital, DaLian 116021, P.R. China. ²The Fourth Military Medical University, Xi'an 710032, P.R. China.

Two-month old BALB/c mice were irradiated by millimeter wave with a frequency of 36.11 GHz at a power density of 10.0mW/cm² for 2h daily from the 6th to 15th day of gestation. The indices of the teratology at the end of gestation and psychophysiology after birth were employed respectively. The quantity of M-R in the embryos' whole brain and different parts of adult posterity brain and its affinity to ligand, the contents of AVP and SS in hypothalamus and pituitary gland of the embryos at term and adult posterity, and the contents of monoamine transmitter and main metabolic products in brain of the embryos at term, adult posterity and pregnant mice were measured by using RBA, RIA and HPLC-ECD separately. The embryos' brain at term, the different parts of adult posterity brain and the main organs of pregnant mice were observed under microscope and electron microscope.

The data showed that millimeter wave irradiation significantly decreased maternal weights at term, weight gains, mean embryo and placenta weight, body and tail length at term. It obviously delayed appearance time of 3 reflex indices of the posterity. It lowered learning capacity and memory of adult posterity, which was shown by that more error frequency appeared and more training frequency was needed to fulfill the stipulated criteria in conditional reflex test on Y-type electric maze. It could obviously cause a loss of body weight of posterity from 1st day to 8th week. It significantly reduced the content of AVP in pituitary gland of the embryos at term and in hypothalamus of adult posterity, meanwhile, it significantly increased the content of SS in pituitary gland and hypothalamus of the embryos at term and adult posterity. It obviously increased quantity of M-R in hippocampus of adult posterity. It not only obviously reduced the content of DA in brain of the embryos at term, adult posterity and pregnant mice, but also it obviously reduced the content of DOPAC in adult posterity brain and raised the content of HVA in brain of pregnant mice. It caused no structural changes in the brains of the embryos at term and the adult posterity, but caused ultrastructural changes in 4 parts of brain of the pregnant mice.

Our data demonstrate that millimeter wave irradiation can produce a series of harmful effects on the embryos. The

mechanism for the continuous reduction of the body weight of posterity is that it significantly increased content of SS in the pituitary gland and hypothalamus of the posterity, and for lowering learning capacity and memory of the adult posterity is closely related to the content changes of M-R, AVP, SS and DA in brain of the posterity.

P-245-B

PULSED CURRENTS AND TRACTING IN TREATMENT OF PATIENTS WITH OSTEOARTHRITIS. G.O. Shavianidze. Russian Research Center of Rehabilitation and Physical Therapy, Public Health Ministry of Russian Federation, Moscow 121099, Russia.

The problem of osteoarthritis treatment is still actual because of high frequency of disease (5-7%) and difficulty of correct choice of treatment caused by polyethiology and different sites of pathogenesis.

We used horizontal traction of low extremities to treat osteoarthritis patients with the purpose of extending space between joint surfaces and relieving joint. It resulted the improving of functional state of joints. But in presence of distinct muscle contractures the traction decreased spasm of soft tissues. Spasms were ceased with the help of pulsed currents. It allowed to achieve good results in more complicated cases. In the case of muscle atrophy a stimulating regime of pulsed currents was used.

Application of pulsed currents in combination with traction influenced different aspects of patogenesis of osteoarthritis. It allowed to reduce medicine (NSAID).

Clinical improvement included the increase of amplitude of affected joints and asymmetry in extremities muscle tone. The hemodynamical improvements and normalization of vessel tone correlated with decrease of muscle spasm and the improvement of blood tests under the treatment with pulsed currents and traction.

P-246-C

LOSS OF TYPE II COLLAGEN IN ARTICULAR CARTILAGE FOLLOWING INJURY: A LONGITUDINAL STUDY OF HUMAN OSTEOARTHRITIS. F.R. Nelson¹, A.R. Poole², A. Reiner², D. Collon¹, H. Goitz¹ and T. Lock¹. ¹Henry Ford Hospital Detroit, Michigan 48202, USA. ²Joint Disease Laboratory, Shriners Hospital, Montreal H3G 1A6, Canada.

Articular cartilage in human osteoarthritis has been studied mostly in late or end stage disease. Earlier changes are often reported using cartilage samples that neighbour more advanced lesions. The biochemical environment of that cartilage is likely to be very different from that of cartilage undergoing potentially reversible early changes under less extreme conditions. Anterior cruciate ligament injury is associated with later degenerative changes in the knee joint. In reconstructive surgery a small portion of articular surface

PERIPHERAL NERVE REGENERATION STIMULATED BY PULSATING ELECTROMAGNETIC (PEMF) FIELD AND LASER. B. Vukovic-Jankovic¹, S. Jankovic¹ and N. Pekaric-Nadj². ¹Special Hospital "Dr. Borivoje Gnjatic", Stari Slankamen, Yugoslavia. ²Faculty of Technical Sciences, University of Novi Sad, 21000 Novi Sad, Yugoslavia.

INTRODUCTION: Our Hospital is located in the middle of the agricultural zone, and lesions caused by agriculture machines are very frequent. Being close to the war zone, in a few last years, our Hospital also served as a rehabilitation center for the war victims. Many young people were broth with shot wounds and peripheral nerve lesions one or more months after the lesion occurred. Patients' conditions were diagnosed by electromyelogram and by blood parameters, upon arrival and several times during a three or more months long rehabilitation period, depending on the character of the lesion.

MATERIALS AND METHODS: All patients were given standard physical rehabilitation treatments. The experimental groups were given some additional treatments. The age span was from 18 to 46 years, but mainly young male patients were involved. Although the lesions were individual and very difficult to compare, four groups of patients were formed. Each group consisted of 15 patients, matched according to lesions. The first group (group A) was submitted to a combined pulsating electromagnetic field (PEMF) and a laser treatment. The second group (group B) was submitted to the PEMF treatment only. The third group (group C) was given a laser treatment only. The last group (group D) served as a control.

The PEMF treatment consisted in placing a suitable applicator over a damaged zone for 30 minutes a day, 5 days a week, 3 weeks a month. The applicator was attached to a PEMF generator which emitted 1 mT intensity, 70 μ s wide square pulses, with the repetition rate of 72 pulses per second. The laser therapy consisted in application of soft 3W infra red laser (0.8-0.95 μ m) with 1500 Hz modulation, in scanning manner, over the lesion zone. The laser procedures lasted 10 to 12 minutes a day, for 10 days, once a month.

RESULTS: It was very difficult to evaluate the results. The objective data were obtained from electromyelogram and blood count. Subjective data were obtained by subjective tests. Altogether it seems that the best results were achieved in a group A, where the patients were submitted to the additional combined PEMF and laser therapy. The groups B and C achieved similar results, but less convincing than the group A. There was no suspect that the group D, the control group, achieved much inferior results.

DISCUSSION AND CONCLUSIONS: The results which were achieved in the experimental groups A, B, and C seem to be much superior then the results in a control group D. The best results were achieved in a group A where the patients were exposed both to the PEMF and laser. Such results seem to be very promising. Synergistic efforts of the PEMF and laser deserve to be the subject of further investigations.

is removed to provide space for the graft. Although the region from which this cartilage is taken in not a high weight bearing area, it frequently exhibits early degenerative changes. Since reconstruction is performed from weeks to years following injury, examination of this tissue provides the opportunity to study the early development of human osteoarthritis.

Approximately 30 mg of articular cartilage were recovered from the medial side of the lateral femoral condyle during anterior cruciate ligament reconstruction on 22 patients aged 17 to 34 (mean 27 years) from 1 to 86 months following injury. Ten control articular cartilage samples were taken from the same region in normal appearing knees during bone bank tissue harvest within 18 hours of death. The age range was 17 to 60 (mean 41.6 years). After thawing, cartilage pieces were rehydrated in PBS, weighed, and extracted with α -chymotrypsin, then with proteinase K to isolate and determine by ELISA denatured type II collagen and total type II collagen content (COL2-3/4m epitope)¹ and collagenase cleavage site of type II collagen (COL2-3/4C). Glycosaminoglycan was assayed by the dimethylmethylene blue method². Mann Whitney analyses were used to compare groups.

Compared to the control group (n=10), patients undergoing reconstructive surgery were divided into two groups: those examined prior to 12 months following injury (n=13), and those equal to or more than 12 months following injury (n=9).

Although the mean age of subjects for the control samples was higher than the patient population, collagen content was highest in this group; slightly lower, but not significantly so, in the less than 12 months from injury group; and significantly reduced (p=0.0275) in the group 12 months or more following injury. The percent denaturation and GAG content were unchanged following injury. The COL2-3/4C short epitope was significantly higher in the surgical group than the controls (P = 0.0198).

A reduction in type II collagen content was observed following a period 12 months or more post-anterior cruciate ligament injury. This reduction in collagen content occurred in the absence of a demonstrable reduction in proteoglycan content and without a detectable increase in damage to this collagen. Such a selective loss of collagen would likely adversely affect the mechanical properties of this tissue, of which collagen plays a major role.

The use of articular cartilage normally discarded during anterior cruciate ligament reconstruction affords such an opportunity to investigate early human osteoarthritis.

1. Hollander *et al.*, *J Clin Invest* 1994;93:1722

2. Farndale *et al.* *Biochem Biophys Acta* 1986;883:173

Normal cartilage was kindly provided by the Organ Procurement Agency of Michigan.

Soft Tissue (Skin) Healing

P-248-B

THE INFLUENCE OF MAGNETIC FIELD (MF) ON AIRWAYS RESISTANCE IN RATS. I.Z. Andjelkovic¹, M.L. Rosic¹, Z.Z. Kojic¹ and I. Skokljjevic². ¹Institute of Physiology, Medical Faculty Belgrade, ²Electrotechnical Faculty Belgrade, 11001 Belgrade, Serbia, Yugoslavia.

We provoked bronchoconstriction by i.v. application of histamine in dose of 10^{-7} mol. The rats anesthetized by urethane (25% Sol., 0.7 ml/100 g b.w., sc). We registered bronchoconstriction by "bronchospasam transducer 7020" Ugo Basile. The rats exposed MF (20 kHz) during 60 minutes. We noting air ways resistance in rats was reduced by 25% under the influence of magnetic field.

P-249-C

THE INFLUENCE OF MAGNETIC FIELD (MF) ON HEART RATE IN RATS. I.Z. Andjelkovic¹, Z.Z. Kojic¹, M.L. Rosic² and I. Skokljjevic³. ¹Institute of Physiology, Medical Faculty Belgrade, ³Electrotechnical Faculty, ²Institute of Physiology, Medical Faculty Kragujevac, 11001 Belgrade, Serbia, Yugoslavia.

We examined the influence of magnetic field on heart rate in anesthetized rats. The rats anesthetized by urethane (25% Sol., 0.7 ml/100 g b.w., s.c.).

We registered heart rate of rats by electrocardiogram (EKG). The rats exposed MF during 60 minutes. We noted that heart rate was reduced after 20 minutes of exposing MF. The maximum decrease of heart rate under influence of MF was after 60 minutes and was 23% regarding the control values.

In separate experiments we examined the influence of magnetic field on ouabain induced arrhythmia. We noted that magnetic field in 30% of experiments express antiarrhythmic effect, by decreasing number of VES.

P-250-A

PEMF: EFFECTS ON COTTON PELLET GRANULOMA INHIBITION TEST. D. Grana¹, J. Miño², A. Merlo¹, E. Gómez¹, S. Galliano¹, I. Stella¹ and O. Patiño¹. ¹Facultad de Medicina, Universidad del Salvador, Buenos Aires, Argentina. ²Facultad de Farmacia y Bioquímica, Universidad de Buenos Aires, Argentina.

In previous studies we found a facilitating effect of PEMF (50Hz, 7.2mT, sinusoidal waves) on wound healing in rats [Medicina (Bs As) 1996, 56:41-44; *J Burn Care Rehabil* (in press)].

OBJECTIVE: The goal of this work was to study the effects of PEMF using the same parameters above mentioned, on the

cotton pellet granuloma inhibition test (*J Pharm Dyn*; 1981, 4:565-575).

METHODS: Thirty male Wistar rats were used. The pellets were the same weight (25 ± 1 mg), 4 pellets were bilaterally implanted subcutaneously into the dorsal area of each rat. The animals were divided in 3 groups of 10 rats each: PEMF group (treated 30 minutes twice a day during 7 days); INDO group (treated with 5mg/kg/day IP of indomethacin during 7 days); CONTROL group (without treatment). At day 8 the granulomas were carefully excised, were dried at 65 °C over night and were weighed. The granuloma production rate (GPR) was calculated as follows: $[(\text{dry wt of granuloma} - \text{Initial wt of cotton pellet}) / (\text{initial wt of cotton pellet})] \times 100$. For the statistical evaluation (ANOVA) we employed the average GPR of the 4 granulomas of each rat as individual value. The mean and SE (using the individual values) were determined for each group.

RESULTS: Significant statistical differences were found between CONTROL vs. PEMF and INDO groups ($p < 0.01$). The mean \pm SE of the GRP are shown in the figure for each group. No differences were found between PEMF and INDO groups.

CONCLUSIONS: According to the results the anti-inflammatory effects of PEMF were observed in this test. The PEMF activity was similar to indomethacine one but without the undesirable collateral effects of this drug.

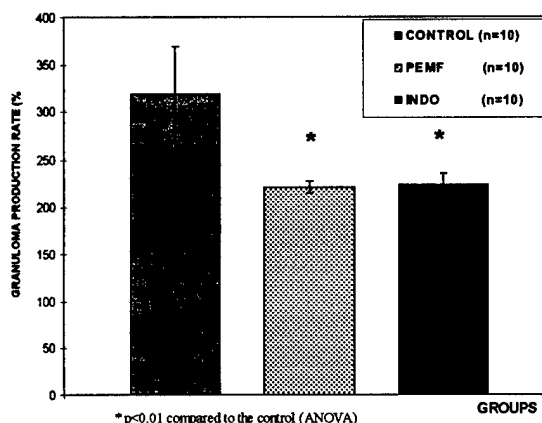

P-251-B

EHF ELECTROMAGNETIC RADIATION IN TREATMENT OF OBLITERATING DISEASES OF INFERIOR LIMB VESSELS. L.G. Vassilenko. Kiev Medical Institute, Department of Surgery, Kiev, Ukraine.

A method of exposing acupuncture points to EHF electromagnetic radiation (EMR) was used in treatment of 86 patients age from 23 to 76 suffering from obliterating diseases of inferior limb vessels. Among them were; 53 patients having obliterating endarteritis and 33 patients with obliterating atherosclerosis. The time of disease ranged 1 to 6 years. A course of treatment contained from 10 to 12, sometimes 15, procedures took 20-25 minutes every day, usually without using any pharmacological drugs or other methods of treatment.

Radiation frequency and points of exposure were selected individually depending on the severity of damage to the vessels of inferior limbs, on the degree of tropic arrangements and manifestation of sensory reactions. The later showed up as disappearance of pains, heat sensation and a variety of paresthasias. The patients with trophic disturbances also exposed to local electromagnetic radiation.

Application of this method is characterized by quick onset and pronounced manifestation of the therapeutic effect. Even after the second or third treatment procedure the feet are easen and then disappear as all, sleep, general condition of ents and rheography indexes are improved. Regenerative processes proceed better in patients having trophic disturbances. 18 patients underwent a recurrent course of treatment.

The results obtained enable us regard this method as rather efficient in treatment of obliterating diseases of inferior limb vessels which particularly looks promising at the initial stages of disease.

P-252-C

USE OF EXTREMELY HIGH FREQUENCY ELECTROMAGNETIC RADIATION FOR TREATING PERIPHERAL NEURITIS. O.L. Vassilenko and N.F. Vassilenko. Kiev Medical Institute, Department and Clinic Stomatology, Kiev, Ukraine.

We have developed a method of non-medicamentous treatment of peripheral neuritis by means of extremely high frequency electromagnetic radiation action on acupuncture points. The EMR frequency and power, points of action and their succession were selected individually depending upon the localization of a neuritis the level of nerve column disease, the cause of disease.

The industrial G4-142 generator with tunable frequency range of 53-78 GHz, the "Electronica-EnF" generator, as well as experimental "Aria" and "Porog" generators designed for medical use, were selected as the EMR EHF sources.

The course of treatment consisted of 8-10 seances. The 25 min. seances were daily (except days off) conducted. The age of patients varied from 17 to 67 years. All together 65 patients were subjected to this kind of treatment. There were 32 patients with inflammation of a facial nerve, 5 patients with inflammation of a trigminus, 17 patients with inflammation of an ulnar nerve, 4 patients with inflammation of an auditory, 3 patients with inflammation of an optic nerve. The duration of a disease and the term of a previous treatment in 62 cases varied from 1 to 64 years. Only for 3 patients EMR EHF treatment was the primary one. In 57 cases (87%) full restoration of the diseased nerve function was observed. In 8 cases (12%) just an improvement of the same method of treatment. The obtained results show that peripheral neuritis treatment using EMR EHF differs from the traditional methods of treatment in high efficiency, rapid therapeutic effect, possibility for more wide dispensary treatment.

P-253-A

A CLINICAL PLACEBO-CONTROLLED TRIAL OF AN INFRARED EMITTING MATERIAL ON CHILDHOOD ASTHMA SYMPTOMS. S. Gerasimov¹, Y. Tchachenko¹ and R. Coghill². ¹State University Hospital, Lviv, Ukraine. ²Coghill Research Laboratories, Gwent NP4 5UH, Wales.

SUMMARY: Preliminary trials have established that photon platinum, a fabric material claimed to emit far infrared (FIR) radiation, has thermal effects superior to some insulating materials. This double blind clinical trial tests its efficacy in alleviating symptoms of asthma (cough, rales) in children by means of a vest garment made of the material.

METHOD & MATERIALS: Some 60 children between 5-15 suffering from chronic asthma attending hospitals as outpatients in the region of Lviv, Ukraine will be divided into two groups and half issued with vests made of platinum photon. The other half will be given identical garments made of ordinary cotton. For a three months period the progress of both groups will be assessed by routine parental and practitioner records, as measured on a tenpoint scale and for a number of parameters. At the end of this period replacements of the reverse type will be supplied to each group for a further three months.

RESULTS: After six months the results will be analysed statistically to assess the efficacy of this treatment. Normal management of the disorder is not being interrupted during the study. The study is ongoing at this time and will not be completed until autumn 1997.

P-254-B

DIRECTED HUMAN MACROPHAGE MIGRATION INDUCED BY AC ELECTRIC FIELDS. M.R. Cho¹, H.S. Thatte¹, R.C. Lee² and D.E. Golan¹. ¹Harvard Medical School and Brigham and Women's Hospital, Boston, Massachusetts 02115, USA. ²University of Chicago School of Medicine, Chicago, Illinois 60637, USA.

INTRODUCTION: The biological processes of wound healing are complex, representing coordinated cascades of cellular events including cell migration and proliferation. At an early stage of wound healing macrophages and neutrophils are recruited by chemotactic factors to the wound site, where these cells clear contaminating bacteria and tissue debris. Intravascular monocytes transform into tissue macrophages as they crawl between endothelial cells into the extravascular space. Exogenous electric fields have been proposed to promote wound healing, although the cellular mechanisms underlying this effect remain to be elucidated. In this study, we have used digitized differential interference contrast (DIC) video microscopy to follow directed macrophage migration in response to applied AC electric fields.

METHODS: Mononuclear cells (MNCs) were separated from human whole blood by using System-Histopaque-1077 (Sigma). Macrophages were isolated from the MNC fraction by adherence to culture plates after overnight incubation, then

detached from the culture plates and replated on glass coverslips 4 hr prior to an experiment. This protocol yielded 99% pure cultures of glass adherent macrophages.

RESULTS: Using a 25x/0.8 NA objective, 2-4 macrophages per experiment were identified and followed in real time. Images of cells were recorded at 10 min intervals. An image processor (MetaMorph, Universal Imaging) was used to extract the centroid position of each macrophage from the images as a function of time, and the mean square displacement (MSD) was computed based on a previously described equation.¹ In control experiments (no applied electric field) the MSD did not vary over a period of 120 min, indicating no cell movement. In contrast, the MSD of macrophages exposed to a 1 Hz, 10 V/cm electric field increased linearly with t^2 ; this dependence is characteristic of particles undergoing uniform directed motion at a constant velocity. Least squares fitting yielded a mean velocity of 0.07 $\mu\text{m}/\text{min}$. The direction of induced migration was 106 ± 5 degrees, measured from the direction of the oscillating electric field. Depletion of Ca^{2+} from the extracellular medium caused the mean velocity of AC electric field-induced cell crawling to slow to 0.04 $\mu\text{m}/\text{min}$.

CONCLUSIONS: Human macrophages were induced to undergo directed motion by application of exogenous AC electric fields. The velocity associated with this motion was on the order of 0.1 $\mu\text{m}/\text{min}$. In agreement with previous reports that neutrophils exhibit locomotion in the absence of extracellular Ca^{2+} , AC electric field-induced macrophage migration was observed (at a reduced velocity) in the absence of extracellular Ca^{2+} . Because changes in cytoskeletal structure, particularly that of microfilaments, are closely associated with cell movement, and AC electric fields have been shown to cause microfilament reorganization,² it is possible that macrophage movement is preceded by cytoskeletal reorganization induced by AC electric fields. Detailed characterization of macrophage migration, including changes in cytoskeletal structure and redistribution of signaling transmembrane proteins, is currently under investigation.

1. Gross *et al.*, *Spectroscopic Membrane Probes*. 1988; 1:19-45.

2. Cho *et al.*, *FASEB J*. 1996; 10:1552-1558.

P-255-C

WD-HMF 6000 MULTIFUNCTION THERAPY APPARATUS WITH ROTATING STRONG MAGNETIC FIELD AND CLINIC PRACTICE. X.Y. Zhang¹, W.D. Zhang¹, D. Zheng², Y. Zhang³, Z.G. Luo¹ and H.T. Lui¹. ¹Life Science Laboratory, Shenzhen University, Shenzhen 518060, P.R. China. ²Shenzhen Welda Medical Apparatus Corporation, Shenzhen 518060, P.R. China. ³Surgical Department, International Peace Hospital, Shaijia Zhuang 050000, P.R. China.

Our main research results showed that different type of cell have different reaction to magnetic field and that neuroendocrine of human body could be affected by it. If these laws can be mastered and applied, then Chinese

traditional magnetic therapy will have great development. we took more than 10 years to study changes of cell growth, cell skeleton, enzyme, etc. under different magnetic field. Based on these basic researches we designed and made WD-6000 multifunction therapy apparatus. Now it has been used widely in clinical therapy.

Main Technical specification:

- Field intensity of magnet: ≥ 6000 Gauss
- Power Single phase, AC 220V, or three phase, AC 380V 0.75 Kilowatt
- Rotating speed of magnet body: 0~720R/M
- Noise $\leq 55\text{dB}$
- Overall dimension: 2100 x 840 x 760(mm)
- Total weight: 650Kg

Main Indication:

1. It is effective supplementary instrument of chemotherapy in tumor. Under its help, side-effects of chemical therapy can be reduced markedly. The dose of chemical therapy drug can be increased 5~10 times as much as chemotherapy drug is used without WD-HMF 6000.
2. WD-HMF 6000 possesses strong enduring analgesic action. Its physiological mechanism is than magnetic field promotes blood β -endorphin to increase significantly.
3. WD-HMF 6000 improve microcirculation of patient and make blood pressuer (BP) drop.
4. WD-HMF 6000 multifunction therapy apparatus has already got patent of China. Further more, we have applied U.S.A's patent, and will get it soon.

P-256-A

Moved to MS-15-1.

P-257-B

EFFECT OF ELECTRICAL STIMULATION OF WOUND HEALING: A REVIEW. S. Saha¹, C.E. Campbell² and J.P. Johnson². ¹Bioengineering Alliance of South Carolina and Department of Bioengineering, Clemson University, Clemson, South Carolina 29634-0906, USA. ²Prizm Medical Inc., Duluth, Georgia 30136, USA.

Modes of electrical stimulation used for treatment of dermal wounds can generally be divided into three categories; constant direct current, pulsed direct current, and high-voltage pulsed galvanic stimulation. All of these methods have been reported to be effective at accelerating or otherwise improving the healing of dermal wounds. In this paper we will review the published data on the effect of electrical stimulation on wound healing. Results from various animal and human studies will be compared.

Using continuously delivered direct currents ranging from 0.4 μ to 300 mA, investigators have reported significant acceleration of wound epithelialization and healing. In two cases where silver electrodes were employed, authors caution that the effects observed may have been at least partially attributable to the antibacterial effects of silver cations. Application of pulsed direct current stimulation involves the use of a signal-generating device capable of delivering a

monophasic pulsed current alternating between 0 and some preset current level, usually as a square or rectangular waveform. Peak current levels, when reported, generally range from 29 to 35 mA. Results of animal and clinical studies showed increased rates of wound contraction, greater extent of healing, healing of more ulcers than with standard treatment, and healing of chronic ulcers and abscesses that had failed to respond to other treatment methods.

For high-voltage pulsed galvanic stimulation, a high-voltage waveform is delivered to the stimulating electrode. Peak amplitudes may range from 100 to 200 V, but pulses are of short duration. It is believed that, because of the short duration of these high-voltage pulses, these signals cause no pain response, which is possible with direct current. Researchers using high-voltage stimulation have reported increased rates of wound healing in pigs and in human ulcers, greater reduction in wound surface area, more rapid epithelialization, increased fibroblast response, and successful prevention of gangrene in an ischemic limb. Examples of the clinical use of a newly developed wrist-watch-sized portable pulse stimulation device will also be presented.

P-258-C

METABOLIC TREATMENT AND MAGNETIC FIELDS. J.L. Bardasano¹, F. De la Hoz², D. Sodi Pallarés³ and M.L. Picazo⁴. ¹Department of Medical Specialities, ⁴Department of Cellular and Genetic Biology and ^{1,2,3,4}Institute of Bioelectromagnetism "Alonso de Santa Cruz" (IBASC), University of Alcalá de Henares, E-28871 Alcalá de Henares, Spain.

CASE REPORT: Patient diagnosed at the Navarra University Clinic and at the "Puerta de Hierro" Clinic in Madrid as having: pathological myocardial dilatation, serious congestive cardiac insufficiency (ejection fraction 15%), left ventricular systolic dysfunction, auricular fibrillar flutter and right branch occlusion. The therapy at both centres was "cardiac transplantation". A basically thermodynamic metabolic treatment was indicated. It consists of a) diet low in sodium Na⁺ and rich in potassium K⁺ (food with higher than 100 mEq of Na⁺/100 g of food was eliminated), b) polarizing intravenous glucose solution at 10% (500 ml) plus 5 intravenous rapid insulin units and 20 mEq of potassium (GIK) given daily for the first week and every other day for another two weeks. Simultaneously, c) pulsing magnetic fields with a frequency of 50 Hz and an intensity of 65 Gauss are applied for five successive days (Sodi Pallares, 1995). In this case, one tablet of digoxin/day and 2 drinkable carnitine vials/day were administered.

EVOLUTION: On the second day of treatment, the patient is very rested and the edemata decrease. On the third day, the patient sleeps on only one pillow and the edemata have completely disappeared. The thoracic radiography shows an overall decrease in the cardiac silhouette, in the signs of pulmonary congestion, etc. In three weeks' time, the ECG shows a sinus rhythm and the cardiac silhouette has decreased extraordinarily. After two months, the patient is examined at the "Puerta de Hierro" Clinic and a slight degree

of congestive cardiac insufficiency is reported (Degree 1 NYHA). A year and a half later, the patient continues asymptomatic, carrying out a normal social, professional and family life, without medication, only under a hyposodic diet.

DISCUSSION: The primary energy substrate in a normal myocardium is free fatty acids, although it is not the optimal energy source for an ischemic heart. Exogenous glucose appears to be a superior substrate during acute periods of myocardial ischemia. Polarizing solutions (Glucose-insulin-potassium, GIK) play an important role in revascularization, thus preserving cellular function and maintaining a good myocardial perfusion (Lazar, 1994). Metabolic treatment, diet low in Na⁺ and rich in K⁺, polarizing solution (GIK) and pulsing magnetic fields, improve polarization of cell membranes. Similar cases have already been reported of patients irremediably doomed to cardiac surgery and to whom metabolic treatment and pulsing magnetic fields have been applied, thus preventing transplantation. We conclude that this treatment, being noninvasive, as far as the relationship mortality/morbidity is concerned, is an alternative that should be tried prior to cardiac transplantation, which would be less costly (Sodi Pallares, 1995).

References:

- 1.- Sodi-Pallarés, D.-Magnetoterapia y tratamiento metabólico. Ed. Sodi. Mexico D.F. 1995.
- 2.- Lazar, H.L.- Enhanced preservation of acutely ischemic myocardium using glucose-insulin-potassium solutions. *J. Card. Surg.* 9 (Suppl.): 474-478. 1994.

We are grateful to the Metabolic Treatment Unit of the Dept. of Medical Specialties and to the IBASC, where this research has taken place.

P-259-A

EFFECT OF PERMANENT MAGNETIC FIELD ON POSTOPERATIVE PAIN AND WOUND HEALING IN PLASTIC SURGERY. D. Man¹, B. Man¹, H. Plosker¹ and M. Markov². ¹Aesthetic Plastic Surgery and Laser Center, Boca Raton, Florida, USA. ²Mount Sinai Medical Center, New York, New York, USA.

The process of cell/tissue repair and regeneration represents one of the most fundamental properties of the human organism. The use of electrical current, magnetic and electromagnetic field stimulation to enhance wound healing is carefully investigated recently. Although well controlled studies on animals and humans have been performed in the stimulation of bone growth by electric current and electromagnetic fields (EMF), the effects of EMF and constant magnetic fields (CMF) on soft tissues remain unclear and represent the next frontier in electromagnetic biology and medicine. It had been demonstrated in animal experimental wound models that electric current stimulation accelerated healing, increased wound tensile strength and intensified inflammatory reaction. The tensile strength was found to increase when a negative electrode is applied, while positive electrodes cause thrombi in many small vessels. Many studies of the electric current or EMF initiated bioeffects are performed with laboratory animals (mostly rats, mice and

rabbits. However, the elementary extrapolation of data obtained in animal experiments to humans, may result in an incorrect estimation of the reasons, mechanisms, and long-term effects of magnetic or electromagnetic fields on humans. This study was therefore designed to evaluate the effect of static magnetic field on postoperative wounds in 21 patients who undergo cosmetic plastic surgical procedures. The magnetic devices (Tectonic, Magnetherapy Inc., North Palm Beach, FL) in form of patches (varying in thickness from 1 to 6 mm, and magnetic field strength 2450 and 3950 G) were placed over the operative region: in 8 cases -prophylactically, and in 13 cases after pain, edema and/or discoloration had appeared. They were fixed with noncompressive dressings and oriented unidirectionally to the skin in a way to assure the best fit to the area being treated. The magnetic patches were left in place for a total of 48 hours and the treated area have been inspected at 24, 36, 48 and 72 hours after the operation. The results suggest that in approximately 60% of patinas pain, edema and discoloration were diminished and in 75% of patients pain and edema disappeared. The magnitude of the reduction in postoperative pain was therefore significant allowing for a decrease in the need for analgesic medication. In cases where significant ecchymoses or hematoma occur, it normally takes 2-3 weeks to resolve, while the application of Tectonic magnets resolved the problem in 3-5 days. The manifested clinical benefits include: a reduction of edema, anti-inflammatory effect, and analgesic effect. The most plausible mechanism should be considered as the enhance blood flow to the site of surgery, which is pooling oxygen and nutrients thereby speeding the overall healing process.

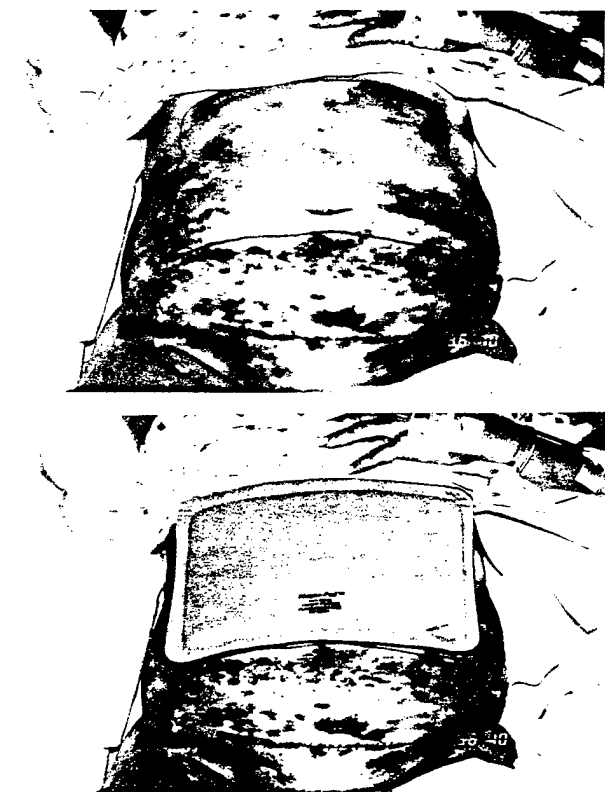

Fig. 1 The effect of unidirectional permanent magnetic field on ecchymosis following liposuction.

P-260-B

IMMUNOMODULATING EFFECT OF BITEMPORAL VHF (27, 12 MHz, 60 W) AND UHF (460 MHz, 40 W) - ELECTROMAGNETIC FIELDS UPON ADRENAL GLANDS IN PATIENTS WITH RHEUMATOID ARTHRITIS. V. Sidorov and D. Mamylaeva. Russian Scientific Center of Rehabilitation and Physiotherapy, Moscow 121099, Russia.

Research on 123 patients showed, that combine effect by EMF VHF (27,12 MHz, 60-65W) bitemporally and UHF (460 MHz, 40-45W) on the sphere of adrenals called 30% activation of corticotrophin function of hypophysis, 20% activation of F pressing, increasing by 64% ACTH/F coefficient. Isolation effect by EMF VHF didn't possess similar effect. In patients blood the number of T-cells was lowered by 10%, B-lymphocytes - by 15%. Subpopulation analysis revealed a 15% decrease: of Ty (T-cytotoxic/suppressors) with the background 1,4 time decrease of the pool sensibilizing T-lymphocytes and with 25% decrease of their mitogen-induced activity (FGA), resulting in normalization immunoregulatory index. Depression of B-cells effector function expressed itself in lowering of antibody- and autoantibodygenesis. Neuroendocrine immunomodulation under influence of EMF resulted in inversion of disorganization processes of connective tissue, exerting antiphlogistic, desensibilizing action, lowering displaies of arthral syndrome in 71% cases with II, III degree activity of Rheumatoid Arthritis.

P-261-C

IMMUNOMODULATING EFFECT OF BITEMPORAL VHF (27, 12 MHz, 60 W) AND UHF (460 MHz, 40 W) ELECTROMAGNETIC FIELDS UPON THE SPLEEN OR UPON THE THYMUS IN THE PATIENTS WITH RHEUMATOID ARTHRITIS. V. Sidorov and D. Mamylaeva. Russian Scientific Center of Rehabilitation and Physiotherapy, Moscow 121099, Russia.

The application of bitemporal VHF and UHF electromagnetic fields in the spleen area in patients with slow progressing joint and joint-visceral Rheumatoid Arthritis changes the functional status of the neuroendocrine system reducing the somatotropin activity and stimulating the corticotropin activity of the hypophysis, gluco-corticoid function of the adrenals and the regulating "feedback" mechanism. This type of combinatory treatment leads to the modulation of the potentialities of the immune system, changing the ratio of immunoregulating T-subpopulations in favor of the ripe T-cells pool with suppression activity and helper function, which mediates their effector suppression activity. This leads to the decrease in the count of sensibilized T-lymphocytes and normalization of their mitogen induced activity, to the depression of autoimmunoaggression, destruction of collagen and improvement in the locomotor function of

musculoskeletal system, mainly in patients with the seropositive Rheumatoid Arthritis form, irrespective of the degrees of its activity or the presence of synovitis. The application of bitemporal VHF- and UHF -EMF in the thymus area in patients changes the functional status of the neuroendocrine system in the form of stimulation of cortico- and, to a greater extent, the thyrotropic functions of the hypophysis, the regulating "feedback" mechanism, and in the form of activation of prostaglandin and endogenic opioid systems, and of the chain of cyclic nucleotides. The treatment has produced an immunomodulating effect, enhancing the functional potentialities of the thymus and changing the immunoregulating T-subpopulations ratio in favor of the pool of cells with suppression activity. The treatment leads to the decrease in the functioning of the sensitized T-lymphocytes, cells of the macrophage system, to the suppression of the humoral immunity chain, its effector antibody- and autoantibody forming function and immunocomplex processes. The treatment reduces the inflammation process activity, its exudate component and destruction of the connective tissues.

Electromedicine (Iontophoresis, Electroporation)

P-262-A

THEORETICAL ISSUES IN UNDERSTANDING LOCAL TRANSPORT REGIONS (LTRs) IN ELECTROPORATED STRATUM CORNEUM. T.E. Vaughan and J.C. Weaver. Harvard-MIT Division of Health Sciences and Technology, Massachusetts Institute of Technology, Cambridge, Massachusetts 02139, USA.

Experiments on the electrical pulsing of skin have shown that transport across the stratum corneum (SC) is highly localized. Two cases can be considered: (1) lower voltage, constant current that results in iontophoresis, and (2) higher voltage pulsing that causes electroporation of the stratum corneum and associated transport. In the case of iontophoresis, transport is believed to occur predominantly at sweat ducts and hair follicles. In electroporation, the transport is not confined to these appendages, but is nonetheless localized to perhaps 1-10% of the skin. These "local transport regions," or LTRs, are poorly understood theoretically.

Here we discuss some theoretical aspects of LTRs. In particular, we focus on the adequacy of the standard "brick wall model" [Michaels *et al.* 1975] of the stratum corneum in describing the electrical behavior observed during electroporation. In the brick wall model, the bricks represent the corneocytes, while the mortar represents the lipid bilayers that lie between the corneocytes. Electroporation is believed to occur in the lipid bilayers, creating aqueous pathways for ions and molecules.

The standard brick wall model does not predict LTR formation, because of the wall's uniformity. We investigate possible modifications of the model that will explain LTR formation. In particular, we investigate the effects of (1) offsetting the corneocytes vertically out of their layered

arrangement, and (2) varying the amount of lipid material between the corneocytes, to more accurately represent what is known about the structure of the stratum corneum.

Michaels, A.S., S.K. Chandrasekaran, J.E. Shaw. Drug permeation through human skin: Theory and *in vitro* experimental measurement. *AIChE J.* 21:985-966, 1975.

P-263-B

MOLECULAR UPTAKE IN YEAST BY ELECTROPORATION: EVIDENCE FOR A PLATEAU. E.A. Gift¹, L. Hui² and J.C. Weaver¹. ¹Harvard-MIT Division of Health Sciences and Technology, ²Department of Electrical Engineering, Massachusetts Institute of Technology, Cambridge, Massachusetts 02139, USA.

The biophysical mechanism by which molecules are transported towards or across the membrane of a cell subjected to strong electric field pulses is of fundamental interest. Terms such as "breakdown", "electropermeabilization" and "electroporation" are widely used in the scientific literature, but do not fully convey what controls molecular transport. Consequently, it is important to propose specific, testable hypotheses, and to construct theoretical models which will yield predictions that can be compared with experimental results. We have adopted the hypothesis that the response of a lipid bilayer membrane to an elevated transmembrane voltage, $U(t)$, involves creation of a population of hydrophilic pores, and that pore population evolution is a nonlinear, history dependent process. The theoretical model we constructed from this hypothesis predicts that electroporation caused by an exponential pulse (here $\tau_{\text{pulse}} \approx 0.5$ ms) results in a nearly constant transmembrane voltage during much of the pulse, and this value is nearly independent of pulse magnitude for large pulses. [1] Experimentally, we have measured the number of fluorescence-labeled charged molecules (either calcein; 623 gm mol⁻¹; charge -4, or bovine serum albumin, BSA; $\approx 65,000$ gm mol⁻¹; charge ≈ -25) transported into individual yeast (*Saccharomyces cerevisiae*) for different magnitude electric field pulses. We found the transport approaches a plateau equal to less than 5% of the equilibrium value, $\bar{N} = c_{\text{ext}} \bar{V}_{\text{cell}}$, where c_{ext} is the molecule's extracellular concentration and \bar{V}_{cell} is the average cell volume. This implies that electroporation does not involve creating permanent holes in the membrane, but instead there is a dynamic interaction that leads to a molecular transport plateau even though the transport endpoint is far from equilibrium. These measurements compliment previous experimental studies which demonstrated a nonequilibrium plateau for charged molecule transport into red blood cell ghosts. [2,3]

References:

[1] S.A. Freeman, M.A. Wang, and J.C. Weaver, "Theory of Electroporation for a Planar Bilayer Membrane: Predictions of the Fractional Aqueous Area, Change in Capacitance, and Pore-Pore Separation", *Biophysical J.*, vol. 67, pp. 42-56, 1994.

[2] M.R. Prausnitz, B.S. Lau, C.D. Milano, S. Conner, R. Langer, and J.C. Weaver, "Quantitative Study of Electroporation Showing a Plateau in Net Molecular Transport", *Biophysical J.*, vol. 65, pp. 414- 422, 1993.

[3] M.R. Prausnitz, C.D. Milano, J.A. Gimm, R. Langer, and J.C. Weaver, "Quantitative Study of Molecular Transport Due to Electroporation: Uptake of Bovine Serum Albumin by Human Red Blood Cell Ghosts", *Biophysical J.*, vol. 66, pp. 1522 - 1530, 1994.

P-264-C

EMF THEORY: POSSIBLY CAUSAL MOLECULAR CHANGES VIA THE BIOPHYSICAL MECHANISM OF MAGNETIC PARTICLE-MEDIATED PORE CREATION AND RARE TRANSIENTS. T.E. Vaughan and J.C. Weaver. Harvard-MIT Division of Health Sciences and Technology, Massachusetts Institute of Technology, Cambridge, Massachusetts 02139, USA.

The controversy regarding possible human health hazards due to environmental electric and magnetic fields (EMF) is partly due to the absence of an established biophysical mechanism. In particular, such a mechanism must account for *causal* molecular changes by environmental field exposures. We discuss a biophysical mechanism by which large, rare magnetic field transients or local exposures might be able to create metastable cell membrane pores via interaction with membrane-attached magnetic particles. Cell membrane pores allow extracellular molecules, which are normally excluded by the cell membrane, to enter the cell's cytosol. This access may be sufficient to lead to a significant alteration of a biochemical process, and therefore be causal. Unlike steady, weak 50-60 Hz fields which cause only small changes in ongoing biochemical processes, metastable pores can generate a molecular influx burst which satisfies a molecular shot noise constraint.

Pores are not expected from differential motion of magnetic particles and the membrane because of even large translational or angular accelerations encountered by the head in the sport of boxing. However, there are sources of competing molecular changes. In particular, we discuss mechanical interference from membrane "wounding" by tissue strain in naturally moving tissues. For most cells, this offers a severe competition, with significant uptake of extracellular molecules. Therefore, only cells of bone-encased tissues (marrow and brain) remain as candidates. Any other biophysical mechanism that couples molecular change to electric or magnetic fields by cellular deformation will presumably also have this mechanical interference as a relevant factor.

Molecular change by even large magnetic field transients is thus severely constrained: to be plausibly effective in pore creation, the field magnitude must exceed $B \approx 10^{-3}$ T, durations must be in the range 10^{-5} s to 0.1 s [Vaughan and Weaver 1996], and the target cells must be mechanically protected by being within or near bone.

Vaughan, T. E., J. C. Weaver. Energetic constraints on the creation of cell membrane pores by magnetic particles. *Biophys. J.* 71:616-622, 1996.

P-265-A

SATURATED SALINE CAN ENHANCE THE EFFECT OF ELECTROCHEMICAL THERAPY. C.M. Jen¹, M.J. Sung², C.S. Chou², T.C. Chou² and X.Z. Lin¹. Department of ¹Medicine and ²Chemical Engineering, National Cheng Kung University, Tainan 704, Taiwan.

OBJECTIVE: Electrochemical therapy has been proved effective in the destruction of normal and cancer tissue by several mechanisms - including disturbing the electrolytes, creating an extreme acidic and alkaline environment, and producing free radicals that might interfere the function and the integrity of cells. In this study, we proved that high concentration of saline can enhance the effect of the therapy.

MATERIALS AND METHODS: Two parts of electrochemical reaction over tissue were designed in this study. Firstly, four flasks of egg white, 50 ml in amount, were added with 2 ml of salines, including pure water, 0.9%, 3% and saturated (26%) NaCl salines, respectively. Each pair of electrodes made of platinum, No.5 in caliber, 1 cm apart, were immersed into egg white with the depth of 2 cm. Universal pH papers were placed around the electrodes as closely as possible. A power supply, in 10 volts, was connected to each pair of the electrodes by a simple circuit which could measure the electric current conveniently. The morphology of the egg white, the electric current, and the pH values were recorded every 5 minutes for 25 minutes. Secondly, the same apparatus was applied to the porcine liver *in vitro*. The electrodes were inserted into the liver by 1 cm from the surface. The above-mentioned solutions, including pure water, 0.9%, 3% and saturated salines, 0.5 ml in each was injected into the insertion site of electrodes respectively. The severity of tissue damage was examined by gross and histological examinations.

RESULTS: In part one, the air bubble and the whitish coagulated protein developed around the cathodes and the anodes. The pH value was 14 around the cathodes and 0 around the anodes. The electric current showed on initial increase, then peak between five to ten minutes, then plateau with gradual decrease after ten minutes. These were observed in all four flasks. However, the concentration of salines injected in the flasks correlated with the amount of air bubble formation and the value of electric current during the electrochemical reactions. In part two, reddish elastic nodules developed around the cathodes and whitish fibrotic change with depressed liver surface occurred around the anodes were noted. The amount and severity of liver tissue damage was also in proportion to the reaction time and the concentration of saline injected.

CONCLUSION: Our data suggest that high concentration of saline can enhance the destructive effect of electrochemical therapy over the tissue. The combined use of saturated saline may enhance the effect of electrochemical therapy in clinical practice.

P-266-B**A THEORETICAL MODEL FOR ISOLATED CELL ELECTROPORATION: QUANTITATIVE DESCRIPTION OF ELECTRICAL BEHAVIOR.**

T.E. Vaughan and J.C. Weaver. Harvard-MIT Division of Health Sciences and Technology, Massachusetts Institute of Technology, Cambridge, Massachusetts 02139, USA.

We present a theoretical model for an isolated cell, in which basic features of the behavior of the time-dependent transmembrane voltage are predicted. The model accurately predicts behavior for both low-voltage pulses, which cause insignificant electroporation, and for higher voltage pulses, which cause reversible electrical breakdown (REB).

During electrical pulsing of a spherical cell, usually only the "polar cap" regions of the cell, nearest to the electrodes, reach voltages which are sufficient for electroporation. With this in mind, the model is based on a "cubic cell" in which two opposing faces of a cube are treated as cell-sized planar bilayer membranes, while the other four faces are treated as insulating walls that do not electroporate. For small pulses, the transmembrane voltage exhibits simple membrane charging and discharging through an extracellular conduction pathway, while for larger pulses the behavior is more complex, also involving rapidly changing transmembrane pathways (transient pores). The high voltage behavior includes rapid achievement of a high conductance state (REB) for very large pulses.

One significant experimental result is that after REB occurs for large exponential pulses, the transmembrane voltage exhibits an approximate plateau for an appreciable fraction of the pulse duration, despite the fact that the pulse itself is monotonically decaying [Prausnitz *et al.* 1993; Gift and Weaver 1995]. This is predicted by our model and is found to be due to a very strong dependence of the membrane resistance on the transmembrane voltage once a pore population has been established [Freeman *et al.* 1994]. The dynamic behavior of the underlying heterogeneous pore population that is responsible for this electrical behavior is obtained. It is described by the rapidly changing pore population density function, $n(r, t)$.

Prausnitz, M. R., B. S. Lau, C. D. Milano, S. Conner, R. Langer, J. C. Weaver. Quantitative study of electroporation showing a plateau in net molecular transport. *Biophys. J.* 65:414-422, 1993.

Gift, E. A., J. C. Weaver. Observation of extremely heterogeneous electroporative uptake which changes with electric field pulse amplitude in *Saccharomyces cerevisiae*. *Biochim. Biophys. Acta* 1234:52-62, 1995.

Freeman, S. A., M. A. Wang, J. C. Weaver. Theory of electroporation of planar bilayer membranes: Predictions of the aqueous area, change in capacitance, and pore-pore separation. *Biophys. J.* 67:42-56, 1994.

P-267-C

USE OF CANARY-POX DERIVED RECOMBINANT VIRUSES EXPRESSING VARIOUS CYTOKINES GENES AS AN ADJUVANT TREATMENT AGAINST MURINE TUMORS IN ASSOCIATION WITH ELECTROCHEMOTHERAPY. L.M. Mir¹, J. Belehradek, Jr.¹, S. Orłowski², J. Tartaglia³, W. Cox³ and P. Moingeon⁴. ¹URA 147 CNRS-Institut Gustave-Roussy, 94805 Villejuif, France. ²URA 2906 CNRS, SBPM/DBCM CEA Saclay, 91191 Gif-sur-Yvette, France. ³Virogenetics Corporation, Troy, New York 12180, USA. ⁴Pasteur Mérieux, 69280 Marcy l'Etoile, France.

Antitumor electrochemotherapy is a new treatment that combines a non permeant cytotoxic drug (e.g. bleomycin) with locally delivered electric pulses that permeabilize the tumor cells. Electrochemotherapy efficacy has been proved so far on various transplanted subcutaneous murine tumors, on internal tumors in rabbits and on subcutaneous metastases of head and neck squamous cell carcinomas, melanoma metastatic deposits and basal cell carcinomas in humans. Both local and systemic antitumor effects of electrochemotherapy can be greatly amplified by immunotherapies delivered locally at the site of the treated tumors. These immunotherapies consisted in repeated injections of the IL-2 cytokine or of IL-2-secreting cells.

The ALVAC (canary-pox derived) recombinant viruses carrying the genes encoding for cytokines are new promising agents for gene therapy in cancer treatment. We thus analyzed the effects of intratumoral injections of ALVAC recombinant viruses carrying the genes encoding for either the murine interleukin-2 (mIL-2), the murine interleukin-12 (mIL-12) or the murine granulocyte-macrophage colony stimulating factor (mGM-CSF) on established subcutaneous LPB murine fibrosarcomas in the C57BI/6 mice. When used alone, these recombinant viruses did not exhibit any major antitumoral effect. However, one injection of $10^{5.8}$ units of ALVAC-mGM-CSF given 1 hour after the electrochemotherapy increased the duration and extension of the post-treatment oedema and resulted in a clear increase in the number of mice cured (from 5 cures out of 28 treated tumors after the electrochemotherapy alone to 16 cures out of 28 treated tumors). This effect was further potentiated by the addition of 2 injections of $10^{5.8}$ units of ALVAC-mIL-2 or ALVAC-mIL-12 given at days 1 and 3 after the electrochemotherapy (from 10 cures out of 28 treated tumors after the electro-chemotherapy plus ALVAC-mGM-CSF to 15 cures out of 27 treated tumors). Systemic antitumoral effects were also evidenced on mice bearing 2 tumors, one at each flank. Only the largest tumor was treated by electrochemotherapy and the virus injections. The combination of electrochemotherapy and ALVAC-mGM-CSF and ALVAC-mIL-2 resulted in 5 complete regressions of the contralateral untreated tumor out of 27 treated mice whereas the electrochemotherapy alone had no effects on the growth of the contralateral untreated tumor. Thus, local administration of immunostimulatory cytokines using viral vectors can synergize with therapies resulting in partial lysis of the tumor, such as electrochemotherapy.

This work was supported by grants from Centre National de la Recherche Scientifique, Institut Gustave-Roussy, Association pour la Recherche sur le Cancer, and Institut Electricite Sante.

P-268-A

ANTIMETASTATIC EFFECTS OF ELECTRO-CHEMOTHERAPY AND OF HISTOINCOMPATIBLE INTERLEUKIN-2 (IL-2) SECRETING CELLS IN THE MURINE LEWIS LUNG TUMOR. S. Orłowski¹, D.J. An³, J. Belehradek, Jr.² and L.M. Mir². ¹URA 2906 CNRS, SBPM/DBCM CEA Saclay, 91191 Gif-sur-Yvette, France. ²URA 147 CNRS-Institut Gustave-Roussy, 94805 Villejuif, France. ³Department of Thoracic Surgery, Xian Dong Hospital, Liling, 412200 Hunan, P.R. China.

Murine Lewis lung tumors are characterized by the appearance of lung metastases after a rather regular period following their subcutaneous transplantation. We had previously determined that Lewis lung tumor cells are sensitive to NK cells but that immunization against Lewis lung tumor can never be obtained. Antitumor electrochemotherapy is a new treatment that combines a non permeant cytotoxic drug like bleomycin with locally delivered electric pulses that permeabilize the tumor cells. Electrochemotherapy efficacy has been proved so far on various transplanted subcutaneous murine tumors, on internal tumors in rabbits and on subcutaneous metastases of head and neck squamous cell carcinomas, melanoma metastatic deposits and basal cell carcinomas in humans. Histo incompatible (xenogeneic) cells, transfected *in vitro* with the IL-2 gene and selected for the secretion of high amounts of IL-2, can be used to stimulate the host's immune response. The combination of electrochemotherapy with the injection of these IL-2-secreting cells in the peritumoral oedema that appears after the treatment by electrochemotherapy has already allowed the obtention of systemic antitumor effects on immunogenic tumor models. We thus tested on the Lewis lung tumor model the respective efficiencies of electrochemotherapy, of the intratumoral injection of histo incompatible IL-2-secreting cells, and of their combination. The number of lung metastases was counted after whole lung staining with indian ink, 15 days after the treatment. Electrochemotherapy alone resulted in the reduction of the number of lung metastases (from 42 ± 16 (n=26) in the absolute controls to 4.6 ± 4.2 (n=29) after electrochemotherapy). This can be partially explained by the large effects of the electrochemotherapy consisting in a dramatic decrease of the number of viable cells in the subcutaneous tumor mass from which Lewis lung tumor cells escape to colonize the lungs. The injection of IL-2 secreting cells alone also reduced the number of lung metastases (from 41 ± 17 (n=10) in the controls to 14 ± 11 (n=10)), whereas the local effect on the subcutaneous tumor mass was limited. The reduction in the number of metastases could result from stimulation of host's nonspecific immune response through NK activity increase. Interestingly, the combined treatment associating electrochemotherapy and IL-2 secreting cells

resulted in antimetastatic effects additivity (from 9.1 ± 5.4 (n=27) after electrochemotherapy alone to 4.5 ± 3.6 (n=29) after electrochemotherapy plus IL-2-secreting cells). These new data, coupled to the previous results of our group, indicate that the combined therapy electrochemotherapy plus histo incompatible IL-2-secreting cells could be an interesting approach for the treatment of immunogenic and even non-immunogenic tumors.

This work was supported by grants from Centre National de la Recherche Scientifique, Institut Gustave-Roussy, Association pour la Recherche sur le Cancer, and Institut Electricite Sante.

P-269-B

ELEKTROMYOSTIMULATION - BASICS, CHANCES AND LIMITS. M. Paerisch¹, U.G. Randoll² and F.F. Hennig². ¹Previously Institute of Physical Education and Sports, D-04277 Leipzig, Germany. ²Department of Traumatology, University of Erlangen-Nuremberg, D-91054 Erlangen, Germany.

The changes of charge and its density at the biological membranes is discussed from the point of nonequilibrium thermodynamics. From the fundamental equations (Gibbs 1948) it can be derived that the process of muscular contraction is the result of electrostrictive behavior respectively of the reciprocal piezoelectrical effect. Only the process of restoration of nonequilibrium state of the membranes is an energy demanding process.

Another point of discussion is the fact that the electrical current conducting structures of the muscle fibers are build like small tubes (tubules, cisterns and sarcoplasmatic reticulum). The idea to build such structures could be that they act as waveguides which are able to transfer much higher wave frequencies than hitherto assumed.

If the lectured ideas are valid, the skeletal muscle fibers must be able to respond to stimulation with electrical impulses of much higher frequencies than is generally believed. Since the 1980th it has been proved, that indeed the muscle fibers of animals and men can respond to electrical impulses with frequencies in the order of magnitude of 10^5 and 10^6 impulses per second. The advantage of the application of such small and high frequent electrical signals applied to the muscular membrane systems is discussed and compared to the effects of broader impulses with lower frequencies.

P-270-C

TRANSCEREBRAL ELECTROSTIMULATION BY PULSE CURRENTS (ELECTROSLEEP) IN THE CLINIC. V.M. Bogolyubov. Russian Research Center of Rehabilitation and Physiotherapy, 121099 Moscow, Russia.

Electrosleep is a method for acting on the brain with direct pulse currents of low frequency (5-150 Hz) and low power (up to 10 mA) in amplitude value with pulse duration. The pulse current is supplied by four electrodes (two ocular and two

retroauricular or, in another variant, two forehead and two retroauricular). The pulse current passes through the orbits and forehead into the brain, spreads along its central structures, and produces a direct effect on all the cerebral structures. The brain bioelectrical activity may be given the needed direction by choosing the adequate frequency of the pulses. In passing through the central brain structures the pulse currents restore the impaired emotional, autonomic, hormonal, and immune equilibrium in the organism and have a beneficial effect in neuroses, arterial hypertension, duodenal ulcer, and hormonal disorders in the genesis of which disturbed psychoemotional equilibrium plays a noticeable role. In arterial hypertension the hypotensive effect of electrosleep is attended with correction of cerebral hemodynamics and hormonal metabolism. Electrosleep reduces the sugar level in type II diabetes mellitus and the blood lipid level in acquired hyperlipidemia and IHD. Electrosleep is indicated in treatment and rehabilitation of patients and prevention of stress situations and long-term emotional overloading (operators, businessmen etc.).

Medical Devices

P-271-A

MULTIFUNCTIONAL ELECTRIC AND ELECTROMAGNETIC STIMULATOR. E. Herbst. Herbst Research, Inc., Edgewater, New Jersey 07020-0089, USA.

Electric and electromagnetic fields are used in several different biological and medical applications, ranging from electrophysiology and electrochemical treatment of cancer to neuromuscular research, diagnosis and treatment of various diseases and conditions, cardiac pacing, pain relief, bone and wound healing, nerve regeneration, brain research, etc. In most cases the signal of choice is a simple or complex pulse waveform delivered to the system either through a set of electrodes or by inducing electromagnetic field using an appropriate coil configuration. To be able to perform a large number of different experiments using the same easily upgradable equipment, we have designed a system solution allowing for treatment with various modalities. This would, over a period of time, significantly reduce the costs of instrumentation, require less lab space, and would allow for comparisons between various treatment modalities, while using the same signal generator. Our system solution is based on a modular design and consists of a signal-generating unit and a set of output stages designed for specific applications; the output stages are seamlessly interchangeable. These output stages are designed for generating either voltage or current controlled signals delivered to the electrodes through single or multiple outputs, or for generating electromagnetic field(s) in the attached coil(s).

A basic module, packaged as one component approximately 6cm by 6cm in size, consists of a pulse generator and $\pm 10V$ output stage. Other output voltages are available by interfacing the electrical stimulator (ES) component with

appropriate output stages in the system. All timing and amplitude parameters are set digitally, with the timing parameters variable over six decades. The ES component can deliver the following signals: square pulse; two independent pulses A and B, which can be output separately or added to (A+B) or subtracted from (A-B) each other; alternate and biphasic pulses; constant voltage; and a DC level adjustment. The ES component can also be interfaced to a current output stage with single or multiple outputs and current levels of $\pm 200 \mu A$ (other current levels are available for custom applications). Other signals than pulse waveforms, such as sinewave, sawtooth, ramp, etc., will be added as needed. The ES component, available as a part of the overall system or as an off-the-shelf component, can be preset in manufacturing, or by the end user, to a specific pulse waveform. This makes it a good choice for the double blind studies or for a particular application.

For electromagnetic field generation, the signal generator is connected to a specially designed $\pm 10A$, $\pm 50V$ power amplifier output stage with a bandwidth of 50 kHz. Higher bandwidth and higher maximum voltage can be available as custom options.

Supported in part by NIH/NINDS grants: 1 R43 NS34218-01A1 and 1 R43 NS33033-01A1.

P-272-B

EXTRACRANIAL DEVICE FOR NONINVASIVE NEUROLOGICAL TREATMENTS WITH PULSATING ELF MAGNETIC FIELDS. J.L. Bardasano¹, E. Ramirez¹, J. De la Hoz¹, J.L. Ramos² and M.L. Picazo³. ¹Department of Medical Specialities, School of Medicine, ²Bioelectromagnetic Institute "Alonso de Santa Cruz" (BIASC), ³Department of Cellular Biology and Genetics, The University of Alcalá de Henares, E-28871 Alcalá de Henares, Spain.

AIM: To show a device for the noninvasive treatment of assorted neurological pathologies such as Parkinson's disease, multiple sclerosis, epilepsy, brain tumors, depression, etc., by means of pulsating ELF magnetic fields. This treatment can be administered alone (2) or in combination with other current therapies such as: 1) Integral metabolic treatment, with a thermodynamic basis, which is found in the following diet: low sodium, potassium rich and GIK (glucose, insulin and potassium) polarizing solution (3); 2) Chronobiological treatment with natural light or artificial light (1000-2500 lux), magnetic fields as an additional "Zeitgeber" during the day and melatonin (the main hormone of the pineal gland) as a potent oncostatic, antidepressant, anti free radicals, etc., during the night (1).

MATERIAL AND METHOD: The device consists of 1) a helmet that is placed on the patient's head and 2) an electric generator. The helmet is a semi-sphere made of flexible plastic that holds a set of coils. The generator that feeds the coils is made up of an oscillator and an amplifier. This device generates variable ELF electromagnetic fields of 8 Hz and 7.5 pT. It is small in size and works with ordinary or rechargeable batteries. It meets the European security

requirements for electromedical equipment (UNE 20 613 83) and is protected by a patent (P 9501 894). See figure.

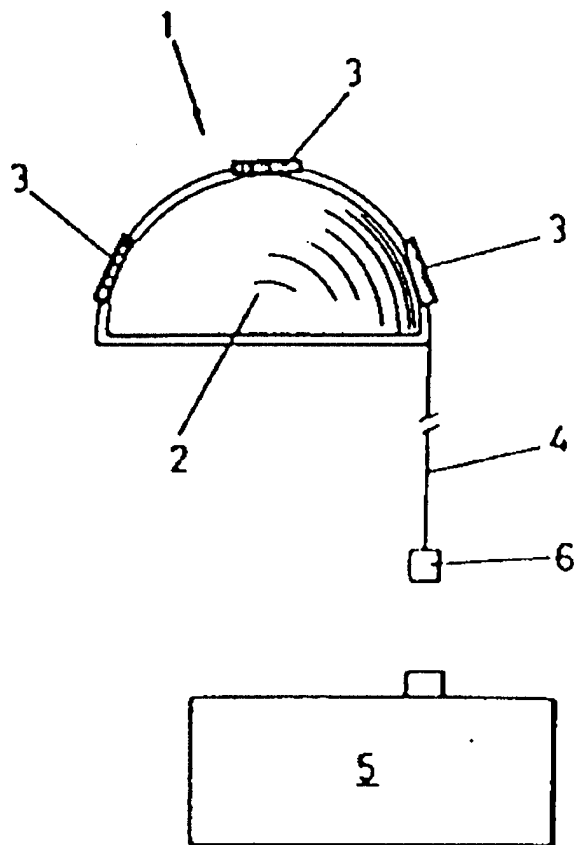

Fig. 1), 2) helmet; 3) coils; 4), 6) connection cable; 5) electric generator.

RESULTS: In the application of variable ELF magnetic fields with our device, whether alone or in combination with other therapies, good results were obtained in four cases of Parkinson's disease. After 30 minutes of treatment, the disappearance of symptoms (shaking, blinking, headache, etc.) is observed, as well as a general improvement in the overall condition of the patient. A remarkable improvement has also been observed in patients with multiple sclerosis and brain tumors (glioblastoma multiforme).

CONCLUSION: The application of ELF magnetic fields as a noninvasive therapy is a technique with promising clinical results. It seems advisable to increase the number of case studies with the purpose of statistically confirming the value of its clinical application.

References:

1. Bardasano, J.L.- Bioelectricidad, *Cronobiologia y Glandula Pineal*. Ed. IBASC. Universidad de Alcala. 1993.
2. Sandyk, R. - Magnetic Fields in the Therapy of Parkinsonism. *Int. J. Neurosci.* 66, 209-235. 1992.
3. Sodi Pallares, D. - Magnetoterapia y Tratamiento Metabolico. Ed. Sodi. Mexico. D.F. 2ª edicion. 1995.

This research was carried out in the Metabolic Treatment Unit of Department of Medical Specialities, thanks to a University of Alcala/CLIAM agreement.

P-273-C

THE CEREBELLUM MULTIFUNCTION MEDICAL INSTRUMENT. G. Lednyiczky and J. Nieberl. Hippocampus Research Facilities, 1031 Budapest, Hungary.

The deep dynamic integrity of nature as well as a self-awareness of the consciousness field as a part of the body have been applied since ancient times in various meditation (biofeedback) techniques [1 and references therein]. Apart from "common" (Eastern) transcendental meditation (which is proved to have physiological effects [2]), many of these techniques are based directly on the utilization of the endogenous electromagnetic oscillations of the human body, e.g. those measured with ECG (electrocardiogram [3]) or EEG (electroencephalogram [1]) devices. Electroacupuncture measurements and pulse-dermography diagnosis also are regarded as biofeedback methods, though they do not employ direct conscious monitoring of the measured parameters. Actually, the "orgone accumulator" invented by Reich in the mid 1930's [4] (efficiently used in the cure of cancer and other somatic and mental disorders [4]), may also be considered an "accumulator" of the biofeedback concept since it applies the accumulated environmental and personal fields. According to its design (multilayer rock- and steelwool construction), this device is aimed mostly at electromagnetic (both endo- and exo-) field accumulation. Meanwhile, as we have shown, it is just this field that mostly contributes to a natural wholeness.

A kind of ECG biofeedback compilation with environmental and endogenous EMF interactions is used in the Cerebellum Multifunction Medical Instrument (CMMI) developed by the Hippocampus Institute (Hungary).

- The CMMI is a 16 channel biofeedback device that produces ECG-like vectors by using large surface electrodes instead of point ones. This makes it less dependent on the peculiarities of a single active point which supports gate functions with respect to the anatomical subunit or metabolic process. This means that the CMMI's signals are less topologically determined than other electrophysiological testing equipment.
- The CMMI provides dynamical testing of the patient's electrophysical parameters through a very fast sampling rate ($\sim 10^{-4}$ s) and sophisticated software for the analysis of 16 x 80 sets of acquired data. Manual adjustment of any step in the process of measurement is available.
- The measuring of various electrophysical characteristics (not only conductivity) enables more exact monitoring and makes it possible to carry out real adaptation tests.

The CMMI reflects the response of patient's electrophysical characteristics to the test substances inserted into the measurement circuit while the patient is not mentally aware of the actual sequence of the examination. Bearing in mind that the obtained data are not restricted topologically, this proves the field character of what is called consciousness. Such testing equipment make it possible to estimate the patient's response to a cure (or any other substance and - more generally - electromagnetic field-carriers) essentially in advance (before its direct application) and thus forecast the future of the patient.

1. E. Green, A. Green: *Beyond Biofeedback*. Knoll: Ft. Wayne, IN, 1977.
2. R.K. Wallace: Physiological effects of transcendental meditation. *Science*, 1970, vol. 167. p.1851-1754.
3. M. Hnatiow, P. J. Lang: Learned stabilization of cardiac rate. *Psychophysiology*, 1965, vol. 1, p. 330-336.
4. W. Reich: *The Cancer Biopathy*. Orgone Institute Press: New York, 1948.

P-274-A

FRONTIER ELECTROMAGNETIC DEVICES FOR MEDICINE IN RUSSIA. A.P. Dubrov. Scientific Research Institute Untraditional Methods of Treatment of the Russian Ministry of Health, Moscow, Russia.

In Russia there are a many gifted inventors working under electromagnetic biology and medicine and a lot of different kinds of EM-devices for diagnostics and treatment. In this thesis we are cited only some of the ones as an examples.

The Russian scientists Y. Kravchenko, N. Kalashchenko have developed an instrument named the phase aurometer for measurement of human EM fields in kilohertz range of frequency (0,5 - 15,0 kHz). The aurometer records the phase shift of the oscillations of the selected frequency at an each chakra of human body at a distances of 2 mm up to 1,5 m. The phase aurometer is a high sensitive (in picovolt !) AC resonance amplifier with high input resistance. A obtained measurement results are used to plot a spatial pattern for an evaluation of patient's health and also for study harmful geopathic zones in buildings, dwellings and hospitals.

Dr. J. Blinkov, MD has developed different kinds of EM devices for treatment of sick persons on a basis of a biological resonance. He used not a sinusoidal harmonic signal but a meander with a multitude of an additional harmonics. An unusual state was recorded in a range of the 7-21 kHz for a vessels and 80-250 kHz for blocking of pain, curing of erosions, ulcers, inflammations of hollow organs etc.

In May 22-23, 1996 in Moscow was held the Int. Conference about the using of the Autonomic electrostimulator (AES) and recto-vaginal AES(ESRV) in medicine for treatment diseases - hypertonia, ischemia, gynecological diseases etc. The devices are a small metallic capsule (a size is 11 x 22 mm) for an electrostimulation of a gastrointestinal segments and an adjoining organs. The AES and ESRV are based on microelectronic elements and Hi-Fi technology including a microprocessor and microbattery cased in a sealed capsule. Upon coming in contact with a mucous membranes of intestine or vagina the AES(ESRV) turns on and starts generating special EM signals of certain power which cause an organs stimulated to respond and activating the ones. This EM devices are designed for a stimulation of a stomach, the intestines, the prostate, the uterus etc.

Portable double-channel electrostimulator was developed by electronic specialist B. Burenko. The device is designed for non-drug treatment of diencephalon disorders, pain syndrome different etiology and localization. It can be most effically applied for treatment of nerve stress and rehabilitation of persons subject to high emotional, psycho-physiological load.

The device incorporates innovative technical solutions and have the 21 controlled work regimes, spectrum etc.

The experimental researches shown that some electrical, morpho-sensory deviations found out on the patient's cochlea. The original device for auricular diagnostics with the interface unit and appropriate software was developed by Drs. E. Meizerov and A. Brzhevsky in our Institute. The complex must provide the examination of the patient's health state, the topical diagnostics of existing pathology of internal organs, forming the individual receipts of the auricular acupuncture treatments.

P-275-B

A SURVEY OF THE APPLICATION OF BIORESONANCE INTERACTIONS AS CURRENTLY APPLIED IN DIAGNOSTICS AND THERAPY. G. Lednyiczky, T. Buzási and S. Topping. Hippocampus Research Facilities, 1031 Budapest, Hungary.

Modern possibilities of detecting endogenous AC electrical oscillations in cells, organs, primates, etc., reveal that the endogenous fields are strongest when cell metabolism is most active. No signs of AC oscillations are found in dead or heavily poisoned cells. These measurements made it possible for H. Pohl to assume that endogenous oscillations must accompany cellular reproduction, and vice versa - reproductive processes cannot proceed without endogenous AC oscillations as discovered by Gurvich in the early 1920's, and found by Ho *et al.* This testifies to the key role endogenous EMFs play in the dynamic maintenance of an organism's stability.

Coherent excitational states seem to dominate in the regulation of homeostasis. The natural dynamic complementarity of inherent and environmental EM signals (frequency, amplitude, phase and the composition of complex signals) for a studied sub-system ensures a very fine selection of the available information. Endogenous information processing is analogue to self-regulation, as any biological (sub-)system seems to be a cybernetic system.

Since mitogenetic radiation was discovered, several attempts have been made to update the application of these endogenous electromagnetic activities for both diagnostic and therapeutic methods. Modern technology allows high gain processing of endogenous signals. This includes separating discrete frequency bands, and applying changes to the phase of the signal and modulating its amplitude. Detecting and triggering meta-stable states has become the central activity of those medical disciplines which aim to directly apply bioresonance interactions to health care.

Various EM therapy techniques have reported successful clinical applications and are promising with respect to the initiation of healing processes. Because of their low-intensity and non-locality, such signals come into play at very general levels and may be involved in the inherent mechanisms of the non-specific defense of the organism. Also, the monitoring of regulatory tendencies by a functional electrodynamic testing has opened a new field in diagnostics by shifting the focus of attention from isolating physiological disturbances to

enhancing functional self-regulatory activities.

In this work, we present a summary of different applications of currently applied therapeutic and diagnostic methods which are based on the direct employment of endogenous EM activity/bioresonance interactions. Some of these are biofeedback applications (synchronization of what biology calls internal pacers), some use artificially generated (but based on naturally occurring) signals, while others utilize environmental signals (known as external pacers).

P-276-C

CLINICAL INVESTIGATIONS INTO THREE WEAK PULSATING ELF ELECTROMAGNETIC FIELD THERAPY MACHINES. R. Coghill. Coghill Research Laboratories, Gwent NP4 5UH, Wales.

SUMMARY: A number of European manufacturers of pulsating EM field devices have claimed therapeutic effects including non-union fracture repair, sleep amelioration, accelerated tissue wound healing, and improvement in blood circulation. Few independent double-blind randomised crossover placebo-controlled clinical trials of these have been published however. The advent of EU Directive requirements for claims concerning such devices has given impetus to research into their efficacy, and this laboratory describes three unrelated devices, speculates on their mechanism of interaction if any, and reports clinical trials testing their effects on human subjects in the area of the makers' claims.

Medicur: This device derives from the work of Dr. Wolfgang Ludwig of Germany. It operates by claiming to identify specific EM frequencies emanating from the patient and then transmitting EM frequencies to the patient aiming to correct the disorder of interest.

Max stress controller: This device emits selectable ULF frequencies between 1 and 30Hz which it claims can affect the level of organismic activity, from sleep to high alertness. It is specifically claimed *inter alia* that ULF frequencies in the range 1-4 Hz will assist in the alleviation of sleep disorders.

Empulse: This device operates in two modes. In the first mode a headset collects what are claimed to be recordings of EEG power density output at ULF frequencies (0-25Hz). These are then interpreted as indicating ill health where the frequencies fall below norms established from a large database of such readings. In the second mode a small portable EM pulse transmitter emits pre-programmable frequencies which supplement those identified as low. The device is claimed to ameliorate conditions such as migraine and myalgic encephalomyelitis.

METHOD & MATERIALS: The three devices are each tested on 12 human subjects, and performance compared with dummy devices in a cross-over randomised trial.

COMMENT: There is well-established evidence that human EEG records are entrained by pulsating stimuli, but whether these EEG changes have any biological sequelae (on organisms or humans) is not established. With fishes and other small mammals there is evidence of ability to detect and

respond to such emissions at vanishingly small power densities, and though much present research is investigating "electrosensitivity" the results to date are equivocal.

Protocols, preliminary results, and statistical analyses of clinical trials on these three devices will be presented.

P-277-A

DETECTING EFFECTS OF LOW-INTENSITY MICROWAVES BY SPECTRAL CHARACTERISTICS OF ELECTRORETINOGRAMS. A.P. Andrushchenko. The Space Research Institute of Ukraine Academy of Sciences, Kiev, Ukraine.

Nowadays, it is necessary for the numerous biomedical applications to reveal biological effects of low-intensity microwaves (MW) by an analysis of signals recorded. In particular, such a procedure can be useful for appropriate choosing of the standards of MW fields. To clarify possible influence of the low-intensity MW radiation, we consider results of experiments regarding the MW influence on native retinas of the *Rana Temporaria* eyes. The data were recorded in two groups of retinas: with and without the MW exposure, where one electroretinogram (ERG) was registered for each retina. Here, each of the groups consisted of 10 retinas. The power density was 0.3 mW/cm². The purpose was to find ERG characteristics allowing to distinguish a set of the ERG signals registered in the group of retinas with the MW exposure (the set A) from a set of the signals measured in retinas without the exposure (the set B).

The recorded signals were studied by different conventional spectral, statistical and nonlinear dynamics methods, but the purpose was not achieved.

Thus, we were constrained to estimate more complicated characteristics of the signals. Recently, it has been shown that some periodicities can be detected in segments of time series with certain values of the local Lyapunov exponents. The segments can rarely be occurred and its positions are usually unknown. Therefore, the conventional spectral approaches are ineffective in this situation to detect such periodicities. To alleviate the problem, a modification of a method for evaluating of the order-q power spectrum based on values of the local Lyapunov exponents was applied. Here, the segments with certain values of the exponents are united in a new time series and the spectral components of this new time series (called the order-q spectral components) are estimated in the traditional way. Notice that the usual spectral parameters can also be received for a particular case of the method when the new time series is the same as the initial "old" time series.

The order-q spectral components were detected in each of the signals. The amplitude of a three-order component turns out to be a useful characteristic to distinguish the ERG signals of the groups. The values of this amplitude for the ERG signals of the groups A (with the MW exposure) and B (without the exposure) are presented in the table.

N	1	2	3	4	5	6	7	8	9	10
Set A	0.87	0.76	0.92	0.83	0.91	0.75	1.0	0.96	0.84	0.82
Set B	0.58	0.47	0.49	0.69	0.66	0.71	0.55	0.64	0.53	0.63

Here, the values are given in relative units. It is seen from the table that all the values characterizing the set A are greater than those of the set B. Thus, we found that the low-intensity MW exposure can lead to biological effects which can not be detected by the traditional methods of data processing. Instead, an analysis of more complicated characteristics of signals can be helpful in this situation.

For this purpose, the recorded signals were studied by different conventional methods. First, the statistical approach based on the Student's t-test and the Mann-Whitney nonparametrical criterion was applied. Second, we received the spectral estimates based on the maximum likelihood ratio. Third, the four statistical moments (i.e., mean, variance, skewness and excess) were calculated. Forth, we evaluated the coefficients of the appropriate regression curves with various nonlinearities. Furthermore, some characteristics of the nonlinear dynamics including the Kolmogorov entropy, the correlation and information dimensions were also computed. However, no statistically significant differences between the ERG signals of the groups A and B were revealed by the mentioned conventional methods.

P-278-B

NARROW BAND NOISY EHF-THERAPY AT USE OF THE DIAGNOSTIC "EXPRESS FOLLE" SYSTEM.
Y.A. Myasin¹, V.A. Dremuchev², V.A. Galunov², V.A. Korotkov² and V.D. Kotov¹. ²"Ozon" Ltd., ¹"Shlem" Ltd., Institute of Radio Engineering and Electronic of Russian Academy of Sciences, 141120 Fрязино, Moscow Region, Russia.

We have reported earlier [1,2] results of the some disease treatment with help of narrow band noisy millimeter wave length range radiation (narrow band noisy EHF-therapy). We have made now first step in order to connect the source of this radiation ("Shlem-2" apparatus) with the express diagnostic system. The express diagnostic system working on the basis of the doctor Folle methods was chosen for this purpose. This system named "express Folle" was created by "Oson" Ltd. The treatment methods of the some diseases with help of the "Shlem-2" apparatus were worked out by Vladimir A. Dremuchev (doctor) in clinic using this system. These different methods and the "Express Folle" system peculiarities will be represented in our report. The some news in the apparatus "Shlem-2" construction will be represented also.

References:

1. Ye. A. Myasin, V.D. Kotov, Yu. V. Andryev. International Symposium "Millimeter Waves of Non-Thermal Intensity in Medicine", October 3-6, 1991, Moscow, Russia, Digest of Papers Part1, pp. 189-195.
2. Ye. A. Myasin, V.D. Kotov, E.N. Soboleva, 19th International Conference on Infrared and Millimeter Waves, October 17-20, 1994, Sendai, Japan, Digest of Papers pp....

P-279-C

ELECTROSTIMULATION ON ADIPOCYTES ET BIOLOGICAL GIVEN'S VARIATIONS ET ECHOGRAPHIE. D. Dang vu Nguyen. Centre Hospitalier Neuilly sur Seine, 75016 Paris, France.

The current by impulse is used as a signal exciting the "lazy cells"; so, it seems to reactive the cellular physiology. The current used is a current by impulses low voltage, low frequency.

A-Lipolysis effect:

The low voltage current, low intensity (2-4 mA) impulses through acupuncture needles implanted directly in adipose tissues "cellulitis", is used as a signal to stimulate the sleeping adipocytes which are awakened now and eliminate their containt. Nearly 30 000 patients have already been treated by four or eight pairs of needles implanted directly in the adipose mass and linked in pairs to the electrostimulation apparatus "STEATRON" and stimulated during 50' at 15 Hz frequency and variable intensity "2-4 μ A". The object of this electrostimulation is to reduce the fatty volumes. The total duration of treatment is one month, with one session a week. The reduction of the abdominal circumference and on hips is on average (6,5 cm). Histological examen showed the reduction of the adipocyte size. A biological examen showed:

1-Dosage in the blood:

- The fatty acids: on 10 patients, we separated in 2 groups:
 - one group of 5 patients: no stimulation during 50'
 - one group of 5 patients: no stimulation during 10 minutes and after 10 minutes they are stimulated during 40'. We observed that the level the fatty acids on 5 patients without stimulation is quite the same; on the contrary, the level of fatty acids on 5 patients with stimulation during 40' increase in order of 250 μ mol/l.
- The glycerol:
 - on 5 patients without stimulation the level of glycerol don't change.
 - on 5 patients with stimulation the level of glycerol change lightly (50 μ mol/l).
- The glucose: the level of glycemie don't change
- Lipase hormone: the level is quite the same
- Triglycerides: with 5 patients with stimulation the level increase lightly in order of 0,03 g/l.
- The factor of risk: R/p Apo proteine B/ Apo proteine A is quite the same

2- Dosage in the urine: 2 samples of urine of 24 hours have been practized one before and one after electrostimulation session.

- on urine of 24 hours, before the treatment: no presence of glycerol
- on urine of 24 hours, after the treatment: presence of glycerol (5,8 mg/l).

B-Echographie: of fatty masses on hip and leg, has been practized on 5 patients, on the same area, before the treatment and after 6 sessions (on 5 patients) we observed a reduction about 2mm of fatty masses at grand trochanter (on hip) and 1,5 mm at epine iliaque. This echographie measurements confirmed the clinical result (lost about 3,5 cm on hip).

References:

DANG VU NGUYEN

1. traitement de l'hydrolipodystropie par electrostimulation et acupuncture *Meeridien* n°78: p.12-18;

2. Hydrolipodystrophie localisee chez la femme: *Dermatologie Pratique* n°51, March 1990, p. 18-20;

3. Electrolipolyse, traitement de la cellulite, Masson Feb 1992 Paris 06;

4. Correlation between clinical cells adipocyte lost and glycerol urinaire. 16th, Meetings of Brags, oct.93, Dana Point. U.S.A..

Electrolipolyse: Correlation between clinical cell's size adipocyte lost and urinar glycerol. Sixteenth Annual Meeting of Bioelectromagnetic Society; Copenhagen, Danemark, June 12-17, 1994.

Application of Electrical Current according to the Physiopathology of Fat; World Congress of the International Academy of Aesthetic Surgery and Aesthetic Medecine; Oct 18-21, 1994; Aruba, Venezuela.

Treatment of cellulitis by Electrolipolyse National bresilium symposium of Plastic Surgery; Nov 1994, Bello Horizonte, Brazil.

Electrolifting 1st International Congress of Facial and Body Aesthetic; Dec 2nd and 3rd 1994; Lisboa, Portugal.

Electrostimulation Facial Ille journees mediterraneennes de confrontations therapeutiques en Medecine et Chirurgie esthetique; 5 et 7 mai 1995 Barcelone.

5. The use of current by impulses on cells, symposium on acupuncture, Istanbul, Turkey oct.31, nov04, 1995;

6. Congres Biophysical Aspects of Coherence Sept 11-15, 1995; Faculty of Mathematics and Physics, Prague, CZECH Republique:

sixteenth annual meeting for Physical regulation in Biology and Medecine, Oct 9-12, 1996, Chicago, U.S.A.

M.LAFONTAN et BERLAN : la mobilisation des lipides dans le site anatomique Laboratoire de pharmacologie medicale Faculte de Medecine, *Institut Physiologie* : university Press Toulouse, 1990.

L.SCHNITZLER;. Ph. SIMONIN: Stimulation electrique cutanee (vieillessement et cicatrice) *Rev. Eur. Dermatologique*, MST 1989, p495-504.

P-280-A

THE TREATMENT OF RHEUMATOID ARTHRITIS OF THE HAND WITH PULSED ELECTRICAL FIELDS. T.M. Zizic¹, K.C. Hoffman², Y.D. He², J.R. Caldwell³, C. Deal⁴, P.A. Holt¹, D.S. Hungerford¹, M.A. Jacobs¹, L.W. Klaussen⁵, K. Krackow¹, J.R. O'Dell⁵ and C. Smith⁶. ¹Johns Hopkins University School of Medicine, Baltimore, Maryland 21239, USA. ²Murray Electronics, Hunt Valley, Maryland 21031, USA. ³University of Florida, Gainesville, Florida 32605, USA. ⁴Case Western Reserve University, University Hospitals of Cleveland, Cleveland, Ohio 44106, USA. ⁵University of Nebraska Medical Center, Omaha, Nebraska 68198, USA. ⁶Montefiore Hospital and Medical Center, Bronx, New York 10467, USA.

OBJECTIVE: To evaluate the safety and effectiveness of stimulation from pulsed electrical fields for the treatment of rheumatoid arthritis (RA) of the hand.

METHODS: Patients with rheumatoid arthritis of the hand were enrolled in a multi-center, prospective, parallel, double-blinded, randomized, placebo device controlled clinical study. Entry into the study required that the patient be over the age 20 years, meet the inclusion and exclusion criteria of the American College of Rheumatology (ACR) for rheumatoid arthritis and have active symptomatic synovitis of the treated hand. Background arthritis medications were to be maintained constant throughout the study. Patients were randomized to receive either an active device or an identical appearing placebo device that was to be used for 8 ±2 hours per day for a four week treatment period. The weekly efficacy assessments included the physician's global evaluation of the treated hand, the patient's assessment of pain and function, joint tenderness and swelling, range of motion, grip strength, morning stiffness and activities of daily living.

DEVICE: The study device provided a 100Hz spike-shaped signal with an amplitude in the range of 0-12V that was applied to the surface of the patient's skin by a cathodic glove electrode and a second electrode on the upper arm.

RESULTS: Eight-nine patients from six study centers were randomized to receive either an active device (N=45) or a placebo device (N=44). Eleven patients did not complete the study for reasons that included treatment for unrelated medical conditions, medication change, rash and failure to show-up for study visits. No significant difference was observed in the rate of dropout between active and placebo device groups. There were no significant baseline differences at entry for demographic and rheumatoid arthritis outcome variables between the active and placebo device groups. The active device group demonstrated significant improvement compared to the placebo device group using repeated measures for the primary clinical outcome assessments that included the physicians global evaluation of the treated hand, the patient's evaluation of pain in the treated hand and the patient's evaluation of function in the treated hand. There were no significant finding for the secondary clinical outcome measures. Transient skin rash, the only type of adverse event reported was comparable between groups.

CONCLUSION: The improvements in the clinical assessment of the treated hand that included the physician's

global evaluation, pain and function suggest that pulsed electrical stimulation as used in this study is effective for treating rheumatoid arthritis of the hand.

This research was sponsored by Murray Electronics.

P-281-B

EMBRYONIC RESPONSE TO A PULSED MAGNETIC FIELD GENERATED BY AN ELECTRONIC DEVICE DESIGNED TO FACILITATE RELAXATION.

M.A. Trillo¹, M.A. Martinez¹, A. Ubeda¹, J. Moreno² and J. Leal¹.

¹Department of Investigación, Hospital Ramón y Cajal, 28034 Madrid, Spain. ²Department of Ingeniería Eléctrica, Escuela Universitaria de Ingeniería Técnica Industrial, 28012 Madrid, Spain.

Nicovital® is a portable device designed to facilitate relaxation and induce sleep in humans. These putative capabilities are under investigation and in spite of the fact that they have not been fully demonstrated yet, the system is being used in a daily basis, for periods ranging from 8 to 24 hours, by about seven thousand buyers. This device emits sonic pulses and light flashes, both at a repetition rate of 9.6 pps. The system also generates a 9.6 Hz pulsed magnetic field (PMF). The magnetic signal is rectangular, unipolar, 32 ms width. The magnetic flux density in the center of the PMF-generating coil is 0.36 μ T rms. The large amount of users who are being exposed to the putative influence of this portable stimulator asks for investigation of possible effects of the PMF generated by Nicovital®. Following the Spanish regulations concerning electrical medical devices a project has been developed to analyze the potential biological effects of the mentioned stimulator.

OBJECTIVE: In this context our laboratory is in charge of investigating the possible ability of the PMF generated by Nicovital® to modify biological processes *in vivo* and *in vitro*. In the present, initial stage of the study we analyze the response of the early chick embryo to the electromagnetic signal.

METHODS: A total of 150 fertilized hen's eggs were incubated in horizontal position and exposed to the above described field parameters inside a Helmholtz coil, energized to generate a vertical PMF during the first two days of embryonic development. Simultaneously, a group of 152 sham-exposed specimens were incubated in the same controlled conditions inside non-energized Helmholtz coil. At the end of the 48-hour period of exposure and/or incubation the developmental stage and the morphology of the samples were described, independently and in blind conditions for treatment, by two investigators.

RESULTS AND CONCLUSION: The overall proportion of abnormalities and the developmental stage were not significantly changed in the field-exposed group when compared to unexposed controls. However, the electromagnetic treatment significantly increased the rate of severe abnormalities (0.0 % in controls vs. 6.6% in the exposed samples; $p=0.039$, Chi-square test) including specific malformations and arrested embryonic development. These data indicate that the electromagnetic signal generated by the

described device can induce modifications in developmental processes *in vivo*. It is obvious that in the current stage of our studies the conclusions drawn here can not be extrapolated to mammals and man. Nevertheless, after the present data the use of the stimulator is not recommended to pregnant women and children under 12. Additional research is in progress to better determine and characterize the embryonic response as a function of the duration of the exposure and field strength. Performed under contractual agreement between Hospital Ramon y Cajal and Inversiones Infoventa, S.A.

P-282-C

OPERANT BEHAVIOR TESTS IN RATS AFTER PRENATAL EXPOSURE TO HIGH FREQUENCY ELECTROMAGNETIC FIELDS.

M. Bornhausen¹, D. Kinkel¹, X.N. Wu¹ and H. Scheingraber².

¹Institute of Toxicology, GSF-Forschungszentrum fuer Umwelt und Gesundheit, D-85758 Muenchen-Neuherberg, Germany. ²Max-Planck-Institut fuer Extraterrestrische Physik, D-85740 Garching, Germany.

To assess the risk of high frequency electromagnetic fields (EMFs) to prenatal development, 12 pregnant Wistar rats were continuously exposed from post conception days 1-20 to 900 MHz, modulated by 217 Hz, 0.01 mW/cm², typical for the European digital GSM standard of hand held mobile telecommunication devices. 12 pregnant control rats were simultaneously sham-exposed in 80x80x200 cm³ containers provided by the Deutsche Telekom AG. In the context of a double blind study the male and female offspring of exposed and of control dams was coded and tested when adult in 10 simultaneously operated lever boxes by 9 different contingencies of Differential Reinforcement of High (DRH) and of Low (DRL) Rate. Rats were required to lever press for food reward (45 mg pellets) in three sets of 3 different DRH and DRL schedules each. Subjects were trained automatically. To challenge the animals further in each subsequent session, the specific test requirement was incrementally increased: 1. DRH 2/1, 4/2, 8/4 where 2, 4, or 8 lever presses were required within a time lapse of 1, 2, or 4 sec. 2. DRL 1/8, 1/16, 1/32 where a blocking interval of 8, 16, or 32 sec had to be respected after each reinforcement. 3. Alternating DRH-DRL contingencies 2/1-1/8, 4/2-1/16, 8/4-1/32. A test session lasted 15 hours, was run during night (16:00-07:00), and was subdivided into alternating 30 min ON- and 60 min OFF-periods. Food reinforcement was available during ON-periods only.

So far, no differences between exposed and control animals were observed concerning weight gain in the dams, delivery date, litter size, sex ratio, weight gain in the offspring, and developmental landmarks (eye opening, pinna detachment, incisor eruption, surface righting, vaginal opening, descent of testes, etc.) in litter mates.

Test performance in exposed and control rats was validated by a computer-assisted correlation analysis of the occurrence of test specific interresponse intervals between consecutive lever presses.

The final results of this study will be available only at the beginning of the conference.

Part of this work has been supported by contract no. 4160/55102 with Deutsche Telekom AG.

P-283-A

DESIGN OF BASIC ELEMENTS OF MOLECULAR DEVICES FOR ELECTRONICAL GENOME REGULATION. A. Tamulis¹ and V. Tamulis². ¹Institute of Theoretical Physics and Astronomy, 2600 Vilnius, Lithuania. ²Faculty of Natural Sciences, Vilnius University, 2009 Vilnius, Lithuania.

Design of basic elements of molecular devices for electronical genome regulation (BEMDEGR) is done. For this are designed molecular implementation (MI) of two variable logic functions-BEMDEGR: Converse Unitary Negation-1, Converse Unitary Negation-0, Unitary Negation-1, Unitary Negation-0, And, Nand, "0" and "1" matrix constants, MI of three variable logic functions-BEMDEGR: And, Nand analogs and MI of four variable logic functions-BEMDEGR: Or, Nor, And, Nand analogs. The design of BEMDEGR is based on *ab initio* (Gaussian 94) and semiempirical (AM1, PM3) quantum chemical investigations of organic photo-induced electron donor molecules: carbazole, 3,6-dibromcarbazole, N,N,N',N'-tetramethyl-1,4 phenylenediamine, 1,4-phenylenediamine; electron acceptor molecules: 7,7,8,8/tetracyanoquinodim-ethane, 1,2,4,5-tetracyanobenzene, small fullerene molecules: C₆₀, C₂₈, C₂₈H₄, C₂₀, C₂₀H₆, A@C₆₀, A = Be, Zn, Cd and electron insulator molecules. MI of two (complete set - sixteen), three, four variable logic functions, summators of neuromolecular networks and cells of quantum cellular automata were designed. We have described in more detail the designed MIs of: a) two variable logic functions OR, NOR, AND, NAND (two sets: one designed from planar molecules and another - from fullerene molecules), Converse Unitary Negation-1, Converse Unitary Negation-0, Unitary Negation-1, Unitary Negation-0, "0" and "1" Matrix Constants; b) three variable logic functions AND, NAND, OR, NOR analogs; c) four variable logic functions OR, NOR, AND, NAND analogs, d) molecular cell that simulates one of Life figures, e) summator of neuromolecular network that simulates sigmoidal behaviour of artificial neurone. All above mentioned a) - d) molecular devices are potential BEMDEGR.

Quantum mechanical investigations of the stability of twenty eight photoactive charge transfer supramolecules constructed from disc-like pentayne (pentakis(phenyle thynyl)phenyl) molecules with radicals R = -OC₅H₁₁, -CH₃, -CF₃, -CN and seven organic electron acceptor molecules: TNF, TeNF, TCNQ, TN₉(CN)₂F, TCNB, TeCIBQ, TeFTCNQ were performed using the PM3 method. All supramolecules have relatively small energetic gap, i.e. they are good electron donors and good electron acceptors at the same time. All investigated supramolecules are stable, possess dipole moments and are potential molecular photodiodes for electronical genome regulation.

P-284-B

THE TREATMENT OF CHRONIC LIVER DISEASES WITH INFRARED LASER. B.N. Zoukov, A.A. Suzdalcev, N.A. Lysov and E.B. Bounkova. Samara State Medical University, Samara, Russia.

Chronic hepatitis make a key problem in the modern hepatology.

The scientific meaning of the problem is caused by the absence of effective methods of treatment which are able to achieve quick reduction of the process activity and elimination of the virus from organism. The purpose of the research is to estimate the possibilities of increasing of efficiency of chronic hepatitis treatment with the help of Infra-Red therapy. 124 tested patients were divided by us to 2 groups:

1. The group of comparison (50 persons). Such kind patients were treated by the traditional therapy (desintoxication, antioxidants, antigypoxants, hepatoprotectors, vitamins of A&E, Kali) in combination with antiviruses therapy (preparation α -2 Interferoni-Realdironi, in a doze 3 mln units intramuscular daily for 10 days, then 2-3 times in a week, depending on peculiarities of disease current). 7 patients of this group got protein preparations - albumin, plasma intravenous.

2. The group of research (74 patients). All patients besides the traditional means of treatment and interferoni got the radiation treatment with IR-laser set 'UZOR' for 7-10 days in modes that were developed by us.

After the supervision the patients of 1 group the results of this treatment were that for 10 days the normalization of clinical picture wasn't found. The pain and heaviness in the right under costal arch, slight indisposition, fast tired ness, nausea and dry ness in mouth, reduced appetite, remained hepatosplenomegaly continue to disturb. Infringement of protein-synthetic function of hepatic (β & γ -globulins remained highly raised, in the most part of cases the alanine aminotraspherase activity remained (ALT)). After the serological inspection only 2 patients of 50 had seroconverse (HBeAg disappeared, antibodies appeared to it). Disappearance of HBeAg and AntiHBcJgM was found not earlier than 3-6 months of therapy with Realdironi.

The result of the treatment of 2 groups of patients showed that after 7-10 days clinical feature of the disease disappeared (appetite normalized, nausea disappeared, pains in the right under costal arch disappeared, serviceability was restored. 68 persons had the normalization of hepatic and lien size, displays of portal hypertension reduced, functions of hepatic were restored at all. After the serological testing 65 persons of tested group had the disappearance of HBsAg, HBeAg, 22 persons had the disappearance of antigens that was combined with appearance of antibodies to it, and 43 persons had the full disappearance of the hepatitis B & D markers, AntiHCVJgG remained with all patients.

Thus, this data lets us draw a conclusion about the favourable influence of complex application of IR-laser with α -2 interferoni to clinical current of chronic virus hepatitis, to process of hepatic regeneration. All this accelerates the restoration of hepatic functions and permits to get their quick

indemnification. Such method of treatment reduces the time of stay in the medical certificate, raises quality of patient's life, improves the forecast's data. Disinvasion of this method causes its availability both in hospitals and in out-patient conditions.

P-285-C

A PROTOCOL FOR ASSESSMENT OF THE HEALTH EFFECTS OF RFR PRODUCTS; PARTICULARLY PERSONAL COMMUNICATION SYSTEMS. B. Hocking. Consultant in Occupational Medicine, Camberwell, Victoria 3124, Australia.

A protocol is proposed for the assessment of radiofrequency radiation (RFR) products regarding possible health effects. National and international standards exist to control exposure of workers and public to RFR emissions. However, the basis of these standards is debated. Prudence suggests additional health assessments be conducted for new products.

Such a protocol could comprise:

- an assessment of diverse electromagnetic interference (EMI) effects and compliance with electronic immunity standards
- an assessment of biological effects including mathematical modelling, cellular and animal studies, and human exposure studies
- post-marketing surveillance.

A proposal to achieve this at international level is outlined.

It is emphasised the paper is intended to stimulate discussion, and acknowledged the scientific details need refinement.

Reference:

B. Hocking, Protocol for Assessment of Health Effects of RFR Products. *Radiation Protection in Australia*. 1996:14 (2): 43-45.

P-286-A

SUBCUTANEOUS TISSUE DIAGNOSIS THROUGH ESTIMATION OF STRUCTURE BY BIOIMPEDANCE AND ITS EQUIVALENT CIRCUITS. Y. Kinouchi¹, H. Okabe², E. Hujimoto¹ and N. Momose¹. ¹Department of Electrical and Electronic Engineering, The University of Tokushima, Tokushima 770, Japan. ²Department of Electrical Engineering, Anan National College of Technology, Anan 774, Japan.

OBJECTIVE: Bioelectrical impedance represents a response for electrical stimuli to the biological tissue. Particularly, the bioimpedance in β dispersion region gives us significant informations on biological tissue structures. It is therefore useful for physiological tissue diagnoses. The objective of this study is to estimate the structure and physiological state of local subcutaneous tissues from bioimpedances measured invasively in β dispersion region, using electrical equivalent circuits and finite element analyses.

METHODS: Impedance of the forearm tissue for normal students is measured invasively by a pulse response method in the frequency range of 0 to 200 kHz using four electrodes

configuration. Measured area in the forearm tissue is as small as about (1cm x 2cm) in surface and about 3 cm in depth as a result of a finite element analysis for the electrode configuration used. Then, equivalent lumped and distributed circuits [Hujimoto *et al*, BEMS Meeting, 1996] are derived from the measurement data. The forearms are also examined by MRI to measure the tissue structure of the arms. The distributions of currents and voltages are analyzed by a finite element method (MAGNA/FIM, CRC, Tokyo) for various actual structures.

RESULTS: The thickness T_s of the subcutaneous tissue correlates strongly with the extra-cellular resistance R_e in the equivalent circuit. The relation between R_e and T_s is almost linear in the measured range. The relation is also confirmed by the finite element analysis, where the influence of the bone for the resistance R_e is less than 1% and can be neglected. The relation is however different from sex, i.e., female students have higher R_e than that for male students. This may be due to the difference of conductivity of the subcutaneous tissue (fatty tissue) because the muscle does not show the difference for R_e . The conductivities of the fatty tissue and the muscle are estimated by fitting the results of the finite element analysis to the measured data. The conductivity of the fatty tissue may be about 0.15 S/m for the female and about 0.2 S/m for the male in ELF region, while that of the muscle is about 0.55 S/m for both. The distributed equivalent circuits are adapted satisfactorily to any measured data and useful for estimation of tissue structure.

CONCLUSIONS: Bioimpedance of local subcutaneous tissue in the range of cm can be measured. It gives useful informations on the structure and electrical properties of the tissue, e.g., the thickness of fatty tissue and conductivities. It may be estimated that the ratio of conductivity for female fatty tissue to that for male one is about 0.75. The estimated equivalent circuits may be useful to estimate nonuniformity of the tissue.

Cancer Studies

P-287-B

EFFECTS OF TAXOL AND POWER FREQUENCY ELECTROMAGNETIC FIELDS EXPOSURE ON HUMAN PROSTATE CANCER CELLS *IN VITRO*. J.T. Ning^{1,2}, E.M. Czerska³, J. Casamento³, C. Porter², J. Medica², A. Zabbo², S.I. Cohen⁴ and B.S. Stein². ¹Indian Health Service, U.S. Public Health Service, Rockville, Maryland 20857, USA. ²Department of Urology, Brown University, Rhode Island Hospital, Providence, Rhode Island 02905, USA. ³Center for Devices and Radiological Health, U.S. Food and Drug Administration, United States Public Health Service, Rockville, Maryland 20857, USA. ⁴Department of Urology, Brown University, Roger Williams Hospital, Providence, Rhode Island 02908, USA.

OBJECTIVE: Taxol, a diterpene, with unique mechanism of action has been found to be effective in monotherapy for advanced ovarian, breast and head and neck cancers but not in prostate cancer. This led us to investigate the effects of

taxol on human prostate cancer cells. Because of our interest in investigating potential biological and therapeutic effects of power frequency electromagnetic fields (EMF), we also investigated effects of power frequency EMF on human prostate cancer cells.

METHODS: Human prostate cancer cell lines, LNCaP and PC-3 were obtained from American Type Culture Collection (Rockville, MD) and grown routinely in RPMI-1640 +10% fetal calf serum (FCS) in 5% CO₂, 37°C humidified incubator. Taxol (Bristol-Myers, Princeton, NJ) was added to cell cultures at various concentrations diluted in RPMI-1640 + 10% FCS. Power frequency EMF exposure were obtained by using Helmholtz coil with time-varying magnetic field at 60Hz from one to five gauss. Cell proliferation and cell cycle kinetics were assessed by ³H-thymidine uptake assay and laser flow cytometry, respectively. Apoptosis was assessed by laser flow cytometry and DNA gel electrophoresis.

RESULTS: 50% inhibitory concentration (IC₅₀) of taxol on LNCaP and PC-3 were found to be 5 ng/ml and 50 ng/ml, respectively. Taxol at low dose range exhibited dose dependent inhibition of cellular proliferation. Deviation from linearity was observed at high dose range. This is accompanied by a change from cell cycle specific blockage at G₂/M phases of cell cycle at low dose range to nonspecific blockage at high dose range of taxol. After 48 to 72 hours of treatment with taxol near IC₅₀, prostate cancer cells underwent apoptosis as evidenced by DNA laddering on agarose gel electrophoresis and by laser flow cytometry. Power frequency EMF exposure of human prostate cancer cell lines revealed decreased cellular proliferation and induction of apoptosis. There appears to be synergistic effects of taxol and power frequency EMF exposure on human prostate cancer cells.

DISCUSSION: Lack of activity of high dose taxol in published phase II clinical trials for advanced prostate cancer may be due to suboptimal dosing of taxol. Our *in vitro* data suggest an optimal dose for taxol close to IC₅₀ and may vary with different prostate cancer cells. At doses of taxol close to IC₅₀ and with power frequency EMF exposure, we observed apoptosis. The effect appeared to be synergistic with combination of taxol and power frequency EMF exposure. These encouraging *in vitro* results suggest an alternative anti-cancer effect of taxol and power frequency EMF exposure in prostate cancer cells which may lead to novel molecularly based therapy for the treatment of advanced hormone-refractory prostate cancer. Further investigation of this new anti-cancer effects of taxol and power frequency EMF is warranted.

Clinical Relevance: Advanced stage hormone resistant prostate cancer currently has very poor prognosis and no effective therapy. The eventual goal of this research is to offer a new effective combination therapy for treatment of hormone refractory prostate cancer. It is hoped that combination therapy using taxol and power frequency EMF exposure will allow us to treat prostate cancer patients irregardless of their stage of presentation.

Public Health Relevance: Effect of power frequency EMF on human prostate cancer cells, demonstrates potential clinical therapeutic effects of EMF. Thus, Power frequency EMF

exposure may harbour both public health risks and benefits to the population.

P-288-C

THE NEW METHOD USING MICROWAVE TO TREAT GALLBLADDER POLYP. H. Qian. Nanjing Great Microwave Electronics Laboratory, Nanjing 210013, P.R. China.

It is possible to change the gallbladder polyp into cancer. The only feasible way is to resect. The thickness of gallbladder wall is 2mm. To use laser is dangerous. The special microwave probe through the peritoneoscope can cauterize the polyp. The therapeutic effects are very striking and very safe. It is an ideal way.

Therapeutic methods: To make a 5cm incision, take the gallbladder out and insert the peritoneoscope in it to find the polyp, then insert the special microwave probe through biopsy channel, suitable microwave power were selected according to the size of the polyp, then to exert a little pressure and cauterize the polyp and the polyp was scorched away.

During the operation, there is full of physiological saline in the gallbladder. It is not only to help the treatment but also to take protective cooling effect.

RESULTS: Microwave therapeutic group (18 cases), Follow-up: recheck, all polyp vanished. In comparison with the laser or high frequency treatment, it is an ideal new method using microwave to treat gallbladder polyp with safe and dependable performance.

It has no bleeding during the operation and it is very fast only several minutes. It has revealed new prospects for the treatment of gallbladder polyp.

P-289-A

PROGRESSION OF SPONTANEOUS LEUKEMIA IN AKR MICE EXPOSED TO 50 Hz, CIRCULARLY POLARIZED MAGNETIC FIELD. I. Nishimura and T. Negishi. Biology Department, Abiko Laboratory, Central Research Institute of Electric Power Industry, Abiko, Chiba 270-11, Japan.

Although a number of epidemiological studies have suggested a possible association between magnetic field (MF) exposure and increased risk of leukemia, other studies have not indicated such a relationship. The AKR mouse spontaneously develops lymphatic leukemia originating in the thymus; in females the survival half life is about 55 weeks. The objective of this study is to evaluate the possible MF effect on the progression of spontaneous leukemia in AKR/J female mice. A hundred and five specific pathogen free (SPF) mice, 4 weeks in age, were purchased from a commercial breeder (SEIWA, Inc.). The subjects were randomly assigned to one of three groups: MF-exposed (EX, n = 36), sham-exposed (SE, n = 36) or cage control (CC, n = 33). The animals spent one week for quarantine in each facility prior to the experiment. The CC facility did not have sham coils; it had

been used for SPF quarantine prior to MF exposure. To avoid any stray MF from the EX coils, the three facilities were located over 15 m apart; the MF for the SE and CC always was found to be less than 0.02 μT . The Merritt-type coils had two orthogonal sets of 4-square bobbins, one set for vertical MF and the other for horizontal. The 50-Hz MF applied to the EX group was circularly polarized, and the flux density was 363 μT , rms. Two hundred and fifty μT was in the each axis. The horizontal MF was orthogonal to horizontal component of the geomagnetic field; the geomagnetic field was about 42.3 μT . The exposure system includes three wooden shelves in the middle of the coils; each shelf could contain 12 plastic mouse cages to provide individual housing. Exposure was conducted for 24 weeks, 7 days per week and 22 hours a day. Facilities were controlled to maintain SPF conditions throughout the experiment. The exposure term was selected based on the normal survival curve. We expected that about 10% of animals in SE and CC would die of leukemia at the termination of the experiment, when the mice were 29 weeks old. We believed the definite evaluation of leukemia progression should be conducted with histopathology; mortality should not be the only endpoint. We assumed a timepoint somewhere between the onset of leukemia and the occurrence of 50% lethality would provide the maximum sensitivity to detect alterations in tumor progression. We have just completed the exposure phase of the experiment. At the cessation of exposure, the numbers of died animals of leukemia were 3 in EX, 3 in SE, and 2 in CC. All of these animals exhibited leukemia, including leukemic cell infiltration in thymus, spleen, lymph nodes and other organs. The rest of the alive animals were sacrificed with diethyl ether inhalation; then blood samples for leukocyte differential count and various organs were collected. Some of the animals developed leukemia showing enlarged thymus, spleen and lymph nodes. Histopathological examination confirmed that these organs have the infiltration of leukemic cell. Numbers of such animals were 12 in EX (36.4% of alive animals), 15 in SE (45.5%), and 11 in CC (35.6%). Body weight curves show small differences among the groups, mainly because of slight differences in mean body weight of the groups at the initiation of the experiment. Detailed histopathological examinations are in progress to evaluate the possible effects of 50-Hz, 363 μT circularly polarized MF exposure on the progression of leukemia in AKR mice.

P-290-B

EFFECTS OF RANDOMLY VARIED POWER FREQUENCY MAGNETIC FIELDS ON THE LIFE-EXPECTANCY OF TWO STRAINS OF MICE. L. de Jager and L. de Bruyn. Department of Anatomy, U.F.S., Bloemfontein 9300, South Africa.

Research shows that exposure to magnetic fields can cause biological effects such as circadian rhythm shifts and the question thus arises whether these biological effects would result in a shortened life-expectancy.

OBJECTIVE: The objective of our study was to determine the effect, if any, of a power line magnetic field on the life-

span of two strains of mice, viz Balb/C (a leukaemia-resistant strain) and AKR (a leukaemia-prone strain).

METHODS: Male and female mice *Mus Musculus* of both the Balb/C and AKR strains were paired and separated into two treatment groups, magnetic field exposed and sham-exposed. Exposed mice were subjected to a rms 50 Hz magnetic field randomly varying between 0,5 μT and 77 μT with an average of 2,75 μT for 24 hours per day. Twenty offspring from each treatment group in both Balb/C and AKR strains were paired at sexual maturity and identified as generation one and 20 offspring from generation one were paired and identified as generation two. These mice were allowed to lead a normal life and die naturally. Exposed mice of generation one and two were thus subjected the magnetic field from conception until death. The age at which death occurred was recorded in both generations and a post mortem examination was performed on all mice to search for evidence of disease and an attempt was made to establish the cause of death. The results of the age of naturally occurring death are being statistically analysed by means of the chi-square test.

RESULTS AND DISCUSSION: The second generation of mice are now dying off. The results thus far does not indicate an extreme effect on the life-expectancy of both strains. The final statistically analysed results will be available shortly.

P-291-C

SCANNING ELECTRON MICROSCOPIC OBSERVATIONS OF LYMPHOCYTES AND MELANOMA CELLS EXPOSED TO 50 Hz MAGNETIC FIELD. C. Esposito¹, A.L. Serafino¹, M. Tricarico¹, T. Parasassi¹ and E. Pasquali². ¹Istituto di Medicina Sperimentale, C.N.R., 00137 Roma, Italy. ²Istituto di Psicologia, C.N.R., 00137 Roma, Italy.

Many reports indicate that magnetic fields (MF) induce biological effects. Some of these reports, in addition to theoretical considerations, suggest that plasma membrane might be a primary site for the interaction of MF with cells. The aim of this study was to verify the ultra structural effects on cell membrane, after 72 hours of exposition to 50 Hz, 0,25 mT (rms) sinusoidal MF.

Two cell lines were used: 1) human lymphocytes, obtained from peripheral blood of five healthy donors, 2) cell line SK MEL 28, a human melanoma growing in monolayer. Both the lines were resuspended in RPMI 1640 supplemented with 10% foetal calf serum and exposed in 60 mm Petri dishes at the concentrations respectively of $1 \times 10^6/\text{ml}$ and $40 \times 10^3/\text{ml}$. The exposure system was composed of two Helmholtz coils, positioned in a CO₂ incubator, and a Variac autotransformer connected to the 50 Hz power mains. Checks were made for MF uniformity, CO₂, temperature and stray fields (for controls).

Observations by scanning electron microscopy (sem) revealed an extensive depletion of microvilli and a depletion of cell-substrate contacts, in exposed melanoma cells; moreover, they were more roundish compared to their controls. Accordingly, the exposed lymphocytes showed rare spreaded elements and were roundish; on the contrary the unexposed lymphocytes

substrate contacts, in exposed melanoma cells; moreover, they were more roundish compared to their controls. Accordingly, the exposed lymphocytes showed rare spreaded elements and were roundish; on the contrary the unexposed lymphocytes showed an evident cell flattening and cytoplasmic spreading. The data of this study, even though qualitative, are clear enough to conclude that in our conditions MF induce modifications of the plasma membrane that alter cell adhesion. Such a parameter is very important because it triggers many physiological or pathological processes such as tissue build up, spreading of metastasis, phagocytosis, T-lymphocyte cytotoxicity etc.

Anyway such modifications don't alter the growth cycle both in melanoma cell line and in lymphocytes.

Additional research is necessary to determine *in vivo*, in which physiological or pathological processes MF might induce alterations.

P-292-A

CANCER PROMOTION TEST USING AKR MICE UNDER EXPOSURE TO 50 Hz LINEARLY AND ELLIPSOIDALLY POLARIZED MAGNETIC FIELDS. T. Kikuchi¹, W. Ooba¹, T. Chida², Y. Yamagishi² and Y. Otaka². ¹Power Engineering Center, Tokyo Electric Power Company, Tsurumi-ku, Yokohama 230, Japan. ²Mitsubishi Chemical Safety Institute, Kashima-gun, Ibaraki 314-02, Japan.

Epidemiological studies showed potential increase in incidence of cancer, especially childhood leukemia and brain tumor by exposure to power frequency magnetic field. We have been studying a series of chronic exposure carcinogenicity tests of rats and mice to 50 Hz magnetic fields. No sign of increase in incidences of tumors was observed by pathological examination of F344 rats after exposure to the fields for two years and B6C3F1 offspring mice parentally and prenatally exposed to the fields. Now we undertook cancer promotion test using AKR mice.

In the present paper, we report on life tables of AKR mice exposed to the fields. AKR mouse dies of malignant lymphoma because of their weak immunity and inherent retrovirus. By preliminary test, 92.5% of the mice died of the disease within 73 weeks. We added a vertical field to the existing horizontal field (*Bioelectromagnetics*, 14, 535(1993)) and a phase controller, to generate a rotating field. 96 AKR/JSea [SPF] mice of each sex were exposed to 50Hz, 0.5mTrms ellipsoidally (horizontal component 2 · vertical component 1) and linearly polarized horizontal magnetic fields and sham field from 5 weeks of age in an SPF condition. Individual mouse was housed in a single cage placed in ±12% magnetically homogenous space. They were observed daily from cage side and body weight and food consumption were measured once a month. Average exposure was 21.5 hr/day except animal caring time. Animal found in moribund condition were euthanized and the bloods were sampled, followed by pathological examination together with ones found dead, in order to determine the cause of death. We can estimate the date of fate within 2 days. By the

logrank test, the life tables of the exposed groups were not significantly different from that of the sham group at any stage for the present. Detailed causes of deaths are going to be investigated pathologically and statistically.

P-293-B

IN VITRO/IN VIVO TUMOR MODELS FOR STUDYING 60 Hz MAGNETIC FIELDS AND MAMMARY CARCINOGENESIS. J.E. Morris, L.B. Sasser and L.E. Anderson. Battelle, Pacific Northwest National Laboratory, Richland, Washington 99352, USA.

Recent reports suggest that exposure to ELF magnetic fields enhances chemically-induced (DMBA or NMU) mammary tumors in the rat. Stevens (1987) presented a hypothesis that an increase in mammary cancer may be due to a reduction in melatonin levels in animals exposed to EMF. This hypothesis is buttressed by work conducted over several years that has shown a reduction in nocturnal melatonin production in animals exposed to ELF fields. In addition, pinealectomy in rats prior to DMBA tumor induction resulted in a increase in mammary tumor incidence. Furthermore, melatonin administration suppressed the development of mammary tumors induced by DMBA. Cellular studies by Liburdy *et al.* (1993) and Blask (1991:1994) have shown that melatonin suppression of growth in mammary tumor (MCF-7) cells is reversed by exposure to a 60 Hz magnetic field. Additional studies are needed to determine if there is a basis for extrapolating these *in vitro* results to animals and to further explore the possible role of EMF in mammary carcinogenesis.

OBJECTIVE: Development and characterization of *in vivo/in vitro* models are being explored for studying possible interactions between EMF, melatonin and hormonal status, and tumor cell growth and response. The specific objectives of this investigation are to 1) determine if exposure to 60 Hz magnetic fields will enhance mammary cancer, 2) define an *in vivo/in vitro* model systems for investigating the relationship between EMF-induced melatonin suppression and mammary tumor development and 3) utilize the strengths of an *in vivo/in vitro* exchange model system to investigate mechanisms underlying possible EMF effects on mammary tumor development.

METHODS: *In vivo* studies are based on transplantable models. In the rat, R3230AC tumor cells are injected subcutaneously in the ventral torso. Palpable mammary tumors are observed in 2 to 3 weeks following the cell transfer. In a similar system, MCF-7 cells are treated with matrigel and injected subcutaneously into nude mice with palpable tumors appearing within 3 to 4 weeks. Exposure of the animals will explore the potential of magnetic fields to enhance the tumor incidence and alter latency of tumor development. *In vitro* studies have been directed at establishing appropriate culture conditions for isolating, maintaining, and characterizing the R3230AC tumor cell culture and evaluating the oncostatic potential of melatonin (10^{-5} to 10^{-10}). Additional *in vitro* work on the cells is investigating the effect of magnetic field exposure on the oncostatic action of the hormone.

vivo when transferred to host animals. In a preliminary oncostatic study, the tumor cells were cultured with various concentrations (10^{-5} to 10^{-10}) of melatonin. A reduction in viability and cell number over time was observed for 10^{-9} and 10^{-8} M treatments.

DISCUSSION: Preliminary studies indicate that these model systems may provide the capability to address both *in vivo* and *in vitro* interactions of EMF and mammary tumor development. Furthermore, these models will allow an investigation of the role of melatonin in EMF and mammary cancer.

Supported by the U.S. Dept. Of Energy under Contract No DE-AC06-76RLO 1830.

P-294-C

ANTITUMOR EFFECT OF TURBULENT MAGNETIC FIELD (TMF) IN EXPERIMENTAL SYSTEMS. Y.V. Dobrynin¹, T.G. Nikolaeva¹, L.A. Sedakova¹, T.P. Ryabykh¹ and Y.L. Rybakov². ¹Cancer Research Center RAMS, ²Center "Health", 115478 Moscow, Russia.

The objective of this investigation was to examine the antitumor activity of low energy TMF in mice experimental system as well as it's action upon the cultures of tumor cells.

TMF (3,0 mT, 50-200 Hz, exposure 5-90 hr) was generated by experimental unit produced by Center "Health" and by therapeutic clinical unit "Magnetoturbotron-2M" (firm "AZ", Moscow).

An examination of the TMF effect upon cancer cells of human ovarian cancer (line CaOv) have revealed modest inhibition of DNA synthesis (21.5±10%) in 13 out of 45 experiments only.

The effect of TMF upon the growth of mice transplanted tumors (leukemia L1210, P388, breast cancer Ca755, lung cancer LLC, melanoma B16, uterine cancer.) was investigated. Lymphoid leukemia and carcinoma of uterine were insensitive to the action of TMF. The most sensitive to the action of TMF were breast carcinoma Ca755 and melanoma B16 (60-80% of tumor growth inhibition). Lewis lung cancer (LLC) was less sensitive (50-60% of tumor growth inhibition).

The joint action of TMF and anticancer drugs (sarcosine, 6-mercaptopurine) resulted in synergetic effect.

TMF reduced also metastatic spreading of high-metastatic tumor BMP in F₁(CBA x C57BL) mice by 26-45%.

It was documented by flow cytometry that antitumor action of TMF is not due to the redistribution of cells over the cell cycle phases only.

Thus data obtained demonstrate weak and variable inhibitory effect of TMF upon the tumor cells out of body. *In vivo* antitumor action of TMF is manifested in varying degrees relative to the tumors of different genesis. It seems likely that antitumor effect of TMF *in vivo* is not due to the specific direct action upon the tumor cells.

P-295-A

SOME BIOLOGICAL MECHANISMS OF ANTITUMOR EFFECT OF TURBULENT MAGNETIC FIELD. T.P. Ryabykh¹, T.G. Nikolaeva¹, Y.L. Rybakov² and Y.V. Dobrynin¹. ¹Cancer Research Center RAMS, ²Center "Health", 115478 Moscow, Russia.

Turbulent magnetic field (TMF) exhibits anticancer effect in several mice systems. It may be due to it's inhibitory action upon the tumor cells in themselves or to it's stimulating action upon the phagocytizing cells of natural tumor resistance system, - neutrophils and macrophages. These cells may produce high toxic reactive oxygen species (ROS) when make contact with a tumor cell, and these ROS (free radicals, hydrogen peroxide) act as killing-factors.

OBJECTIVE of this investigation was to examine the TMF action upon the function of the cells of NTR system: neutrophils and macrophages.

The process ROS production and interaction attended with super-weak irradiation -chemiluminescence (CL) which can be registered and is a measure of ROS production.

METHODS: TMF (3,0 mT, 100 Hz) was generated by clinical unit "Magnetoturbotron-2M" (firm "AZ", Moscow).

Effect of TMF upon Luminol- amplified CL of phagocytizing cells, was evaluated in specimens of mice splenic cells and in blood samples of healthy donors and tumor bearing mice. CL was measured by Biolumat (LB 9500, Berthold Wilbad, FRG)

RESULTS: TMF action upon mice splenic cells (exposure 1 h 20 min) significantly stimulated CL (58%); 2 h exposure resulted in weak inhibition of CL. Likewise TMF stimulated reliably ROS production by phagocytizing cells of whole blood of healthy donors; the effect was maximal within 10 min after the beginning of TMF action.

ROS production by blood cells was measured during tumor (melanoma B-16) growth in C57BL mice. Mice exposure to TMF (10 days, 2 hr/day) resulted in nearly two-fold increase of CL per 1 neutrophil after 17 days (p<0.05). CL of neutrophils increased also as a result of joint action of TMF and anticancer drugs (sarcosine, 6-mercaptopurine).

CONCLUSION: Anticancer action of TMF is accompanied by activation of phagocytizing cells, increase of producing of killing-factors by these cells. It is possibly one of mechanisms of anticancer effect of TMF.

P-296-B

LYMPHOMA/LEUKEMIA IN MICE EXPOSED TO 60 Hz MAGNETIC FIELDS. J.T. Babbitt³, A.I. Kharazi³, J.M.G. Taylor⁴, C.N. Rafferty⁵, C.B. Bonds¹, S.G. Mirell^{2,3}, E. Frumkin³ and T.J.M. Hahn^{1,3}. ¹Geriatric Research, Education, and Clinical Center and ²Nuclear Medicine, West Los Angeles V.A. Medical Center, Los Angeles, California 90073, USA. ³Department of Medicine and ⁴Departments of Radiation Oncology and Biostatistics, University of California at Los Angeles, Los Angeles, California 90095, USA. ⁵Electric Power Research Institute, Palo Alto, California 94304, USA.

OBJECTIVE: Epidemiological studies in humans have not been successful in resolving the role of magnetic fields as a carcinogen or cancer promoter. In this study, mice are exposed to a 60 Hz circularly polarized magnetic field having 10 gauss (G) horizontal and vertical components for 24 months, following administration of ionizing radiation which has been determined to increase the background incidence of thymic lymphoma in a dose dependent manner, according to Kaplan *et al.* (the Kaplan Model). We are using this model to test whether magnetic fields can act either as a total carcinogen or as a promoter with respect to the induction of lymphoma/leukemia.

METHOD: At four weeks of age female C57BL/6J mice are exposed to fractionated ionizing radiation (Cobalt 60) at four weekly intervals. The experimental design has four levels of total dose radiation (0 R, 350 R, 475 R, and 600 R) and two levels of magnetic field exposure (0 G and 10 G). Each of the four radiation groups receiving 0 G exposure consists of 190 mice. The four radiation groups receiving 10 G exposure are twice as large, or 380 mice. A negative control group of 380 mice received no ionizing radiation, and are exposed to ambient magnetic fields of less than 1 milliGauss. Beginning on the first day of ionizing radiation treatment and continuing for the duration of the experiment (24 months), all mice except the negative controls are housed in specially constructed modules which can be energized to generate uniform magnetic fields. Two modules are energized at 10 G for 18 hours each day. The third module (sham exposure) is not energized. Upon death or euthanasia, all mice are necropsied and 40 tissues preserved. Histopathologic evaluation of selected tissues (lymph nodes, liver, spleen, kidneys, bone marrow, thymus, and gross lesions of these tissues) will determine the presence or absence of lymphoma/leukemia. Calculations show that the study will have sufficient power to detect an odds-ratio of 1.5 or greater. The study follows FDA/EPA Good Laboratory Practice standards for the conduct of non-clinical laboratory studies.

STATUS: The study was initiated in April 1994 and the schedule of fractionated irradiation was completed in June 1994. Mortality in the first year of the study was consistent with that predicted by the Kaplan Model. Increasing mortality from "late" lymphomas continued throughout the second year. Terminal necropsy of the remaining 856 (of the original 2660) study mice began on August 19, 1996 and was completed October 9, 1996. At this time, histopathologic evaluation of all study mice is being conducted by Pathology

Associates International and will be completed in August 1997.

CONCLUSIONS: After histopathology is completed, the incidence curves for lymphoma will be compared for magnetic field exposed and unexposed groups within ionizing treatment groups. Differences will indicate the likelihood that magnetic fields can affect cancer development, either as a total carcinogen or as a promoter. Long term exposure of the unirradiated groups will allow documentation of possible toxic effects of magnetic fields on 40 tissues.

This work is sponsored by research contracts, WO2965-11, WO2965-31, and WO-2965-33 with the Electric Power Research Institute, with co-funding from B C Hydro.

P-297-C

BRAIN TUMORS IN MICE EXPOSED TO 60 Hz MAGNETIC FIELDS. A. Kharazi², J.T. Babbitt² and T.J.M. Hahn^{1,2}. ¹Geriatric Research, Education and Clinical Center, West Los Angeles VA Medical Center, Los Angeles, California 90073, USA. ²Department of Medicine, University of California at Los Angeles, Los Angeles, California 90095, USA.

OBJECTIVE: Recently published evidence suggests that electric and/or magnetic field (EMF) exposure may be associated with an increased incidence of neoplasia, particularly leukemia and brain cancer. However, to date most of the evidence linking EMF exposure to increased brain cancer incidence has been derived from epidemiologic studies, which are limited by the presence of multiple unidentified confounding factors. This study tests the hypothesis that continuous exposure to MF can induce or promote brain tumor incidence in mice, either independent of, or in association with, fractionated ionizing radiation.

METHOD: Brain tissue will be utilized from a large-scale lifetime study of the effects of continuous exposure of C57BL/6 mice to a circularly polarized 60 Hz magnetic field having 10 Gauss horizontal and vertical components. In addition, mice will receive four levels of total radiation dose; 0 Gy, 3.5 Gy, 4.75 Gy, 6.0 Gy. The H&E stained tissue sections will be evaluated at three specified levels; optic chiasma, mammillary body, and pons. The time-dependent incidence of brain toxic injury, astrocytoma, oligodendroglioma, anaplastic glioma, meninglioma, microglioma and metastatic tumors (lymphoma) will be evaluated in mice receiving continuous exposure to MF versus unexposed animals.

RESULTS: The anticipated results will determine whether EMF can be a promoter or a carcinogen in the induction of brain tumors in mice.

Supported by grant ES08895 from NIEHS.

V. General

P-299-B

THE EMF RAPID HOME PAGE:
<http://www.niehs.nih.gov/emfrapid/home.htm>. N.J. Bernheim and G.A. Boorman. Office of Special Programs, Environmental Toxicology Program, National Institute of Environmental Health Sciences, Research Triangle Park, NC 27709 USA.

OBJECTIVE: Section 2118 of the Energy Policy Act of 1992 (42 USC 13478) authorized the five-year Electric and Magnetic Fields (EMF) Research and Public Information Dissemination (RAPID) program. The EMFRAPID program is a comprehensive program to determine whether or not exposure to EMF from the generation, transmission and use of electricity has the potential to cause adverse human health effects. Two Federal Agencies, the Department of Energy (DOE) and the National Institute of Environmental Health Sciences (NIEHS) have primary responsibilities for the program, but other Federal agencies are key participants acting through an EMF Interagency Committee. The main goals of the program are health effects research, risk assessment research, engineering and mitigation and communication of the research results to private and public sectors.

METHOD: In order to communicate effectively with the stakeholders, other government agencies and private citizens, NIEHS established and maintains the EMFRAPID Home Page, (<http://www.niehs.nih.gov/emfrapid/home.htm>) for easy public access.

RESULTS: This page includes an overview of the program, an organizational overview, staff information, research information, information about the regional EMF exposure facilities, the NIEHS Science Review Symposia and other sources of EMF information. The home page has a link to the January 1995 brochure widely distributed by the RAPID Program, "Questions and Answers about EMF." The RAPID Program December 1995 Progress Report to Congress and the Annual RAPID Reports are available on the home page. The recent "EMF in the Workplace" brochure has been added. Currently NIEHS is supporting 27 investigators working mainly in the area of cancer research with some effort towards reproductive and neuroendocrine effects. An additional 21 R03 grants were awarded in January 1997. Abstracts and addresses of all of these investigators are on the EMFRAPID home page. Similar information about DOE sponsored research is also available. NIEHS will be convening three EMF science review symposia (the first one in March 1997 will review "Theoretical Mechanisms and *In Vitro* Research Findings") and one working group to review and summarize the overall quality of research findings relating to the interaction of EMF with biological systems. Information on this process is available on the Home Page.

DISCUSSION: We are now at a pivotal time in the five-year RAPID program. NIEHS needs greater emphasis on gathering information, and having the mechanisms in place to facilitate the review of the data and preparing the mandated report to Congress. As NIEHS conducts EMF

Science Review Symposia for evaluating data related to the potential human health effects of EMF, it will be able to share this information and gather responses through the EMFRAPID home page. It is envisioned that the EMF RAPID home page will be an important part of the process to distribute public information as NIEHS works to reduce the uncertainty about potential health risks associated with exposures to EMFs. This work is being supported by NIEHS and the RAPID Program.

P-300C

MODIFICATION OF ELECTROFUSION BY BIOPOLYMER ADSORPTION. H. Berg, Laboratory of Bioelectrochemistry, IMB, 07745 Jena, Germany

Starting with systematic modifications of membrane adsorption in 1990 [1], it was shown by using the electrofusion and electroporation techniques [2-4] that interactions of neutral, cationic, anionic, amphoteric, and amphiphilic substances with plant protoplast and animal cell membranes - combined with dielectrophoresis - can strongly modify the electrofusion efficiency.

Our systematic study of "biopolymer supported electrofusion" have been extended to plant protoplasts and animal cells by Dextrans, polypeptides, proteins and nucleic acids at concentrations in the $\mu\text{g/ml}$ range. The resealing rate and the electrofusion yield for a given membrane depend on charge, structure and molecular mass of biopolymers. Not only enhancement of electrofusion yield ($F > 1$) has been found but also inhibition ($F < 1$). Neutral and polycations can increase F up to 3 times. For proteins the influence of their isoelectric points (pI) is dominant in the following way: $F > 1$ at $pI > 7$ corresponding to an increase of relative membrane resealing time ($\tau_p/\tau_c > 1$) and vice versa at $pI < 7$, $F < 1$ and $\tau_p/\tau_c < 1$. These relationships have been found independently of molecular masses of different proteins and their adsorption activity (maxima of O_2 damping test) on a weakly charged dropping mercury electrode.

The explanation of "biopolymer modified electroporation and electrofusion" has to taken into account at least 4 effects. Anyway addition of biopolymers at very low concentrations to cell suspension can be used for regulation of both electroporation and electrofusion efficiencies in practical applications.

[1] L. Zhang, U. Fiedler and H. Berg. *Bioelectrochem. Bioenerg.*, 26 (1991) 87-96.

[2] Z. Jiang and H. Berg, *Bioelectrochem. Bioenerg.* 38 (1995) 383-387.

[3] U. Gröbner, S. Velizarov and H. Berg, *Bioelectrochem. Bioenerg.* 39 (1996) 181-184.

[4] M. Xiao, S. Velizarov, B. Gluck and H. Berg, *Bioelectrochem. Bioenerg.* 41 (1996) 161-166.

"ELECTRICAL WINDOWS" AS CELLULAR RESPONSES ON ELECTROMAGNETIC FIELDS. H. Berg, Laboratory of Bioelectrochemistry, IMB, 07745 Jena, Germany.

Today the most fascinating direction of bioelectrochemistry is the influence of weak electric, magnetic and electromagnetic fields on molecules, cells and higher organisms [1].

Some hundred phenomena are described in literature, last not least environmental statistics of diseases including cancer promotion.

However, to avoid controversial results it is now necessary - besides using defined biological conditions - to measure in the case of Helmholtz-coils in a broad range of frequencies (e.g. 3-300 Hz), amplitudes (e.g. 0.05-5 mT) and treatments e.g. until 60 min in order to detect "electrical windows" within these three combined dimensions.

After presentation typical examples: cell and cell-free media for comparison our results will be discussed for cellular electro-stimulations:

- of CO₂ from yeast [2],
- nourseothricin from streptom. nourseus [3],
- of cellulase production from *Trichoderma reesei* [4],
- of yeast dehydrogenases [5],
- of NADPH-oxidase from macrophage [6],
- of yeast proliferation [7], [8],
- of exonuclease activity for DNA destruction [9]

Positive as well as negative windows in the order of $\pm 20\%$ have been detected; in the case of yeast proliferation even two positive namely at 15 Hz and 50 Hz.

For the future development of weak field electrostimulation experiments are indispensable in these three dimensions - including cell-free systems - in order to derive and to verify an appropriate combined model.

[1] H. Berg, *Bioelectrochem. Bioenerg.* 38 (1995) 153-159

[2] E. Bauer, H.-E. Jacob, H. Berg, *studia biophysica* (Berlin) 119 (1987) 137

[3] H.-H. Große, E. Bauer, H. Berg, *Bioelectrochem. Bioenerg.* 20 (1988) 279

[4] G. Kerns, E. Bauer, H. Berg, *Bioelectrochem. Bioenerg.* 32 (1993) 89

[5] H. Berg, Lei Zhang, *Electro-Magnetobiol* 12 (1993) 147

[6] I. Gamaley, K. Augsten, H. Berg, *Bioelectrochem. Bioenerg.* 38 (1995) 415

[7] U. Fiedler, U. Gröbner, H. Berg, *Bioelectrochem. Bioenerg.* 38 (1995) 423

[8] M. Mehedintu, H. Berg, *Bioelectrochem. Bioenerg.* 1997, in press

[9] S. Velizarov, L. Kittler, H. Berg, *Bioelectrochem. Bioenerg.* 41 (1996) 213.

TWO EXPOSURE SYSTEMS FOR *IN VIVO* FREQUENCY-MODULATED RF FIELD STUDIES AT 836.55 MHz. R.A. Jones¹, J.L. Olivares¹, N. Kuster² and W.R. Adey¹. ¹J.L. Pettis Memorial Veterans Administration Medical Center, Loma Linda, California 92357, USA. ²Swiss Federal Institute of Technology, Zurich, Switzerland.

INTRODUCTION: We have constructed two exposure systems for *in vivo* exposures to 836.55 MHz frequency-modulated RF fields similar to those produced by handheld cellular telephones conforming to the AMPS standard.

OBJECTIVE: We wished to test the hypothesis that exposure to frequency-modulated RF fields can promote CNS tumors in Fischer F344 rats initiated by *in utero* exposure to the carcinogen ethyl nitrosourea (ENU). Our experimental design required that the subjects be exposed to the RF field *in utero* (starting on the 19th day of gestation), during the postnatal period, and throughout adulthood (2 yrs.). The systems described herein were designed to satisfy those requirements.

METHODS: A pseudo-far-field (TE₁₀ mode) exposure system was used during the time before the subjects were old enough to be handled and placed in individual restraints. In this system the subjects were exposed along with the dams in their home cages in a pyramidal horn 4.2 m long with a square 2 m x 2 m aperture. Nine extruded Lexan® cages with plastic lids were arranged in the horn aperture in a 3 x 3 array. Since the animals were free to move about their cages, we used a crossed-dipole exciter antenna that produced a circularly-polarized wavefront to minimize orientation-dependent coupling effects. Cages were approximately 11 wavelengths from the exciter. Sham exposures were conducted in a system that was identical except that the tapered horn was truncated to save space. After weaning, the subjects were exposed in a near-field system that consisted of 12 acrylic platforms with central, vertical sleeved-dipole antennas surrounded by 10 animal restraint tubes per platform. Several restraint sizes were available and each restraint could be adjusted radially (head position 5 - 7 cm from the antenna in the plane of maximum H) to maintain the desired SAR as the subjects grew. Six of the platforms were used for field exposures, and six in another room for simultaneous sham exposures (total capacity: 120 subjects per exposure shift). RF excitation supplied by a signal generator and power amplifier was routed through power dividers and identical feedlines to the six powered antennas. The modulation source was a digital audio recording of phonetically-balanced speech. Gentle forced-air ventilation was provided in both the near- and far-field systems, and forward power was recorded during exposures in both systems by chart recorders. Exposures were intermittent, with the field on for 7.5 minutes, off for 7.5 minutes, repeated for 2 hours per day, 4 days per week (far-field exposures were 7 days per week). Each group was always exposed at the same time of day.

RESULTS: All values for power density and SAR given below are time averages. For the pyramidal horn, an input power of 110 W provided a power density of 6.5 ± 1.5

mW/cm² (SD). SAR was estimated by numerical modeling to be 1.0 W/kg (uterus of pregnant dam), 0.9 W/kg (fetal brain), 0.1 W/kg (brain of isolated newborn), 0.4 W/kg (brain of isolated weanling). In the near-field system, power input to the six antennas was 2.5 ± 0.1 W. Preliminary brain average SAR estimates from infrared thermography of longitudinally sectioned rat cadavers are 2.3 W/kg (male), 1.8 W/kg (female), though thermal diffusion and uncertain IR emissivity make precise determinations difficult. Work is ongoing to refine these estimates. Ambient ELF magnetic fields were: 0.02 ± 0.01 μ T (horn), 0.03 ± 0.01 μ T (sham horn), 0.02 ± 0.01 μ T (near field), and 0.02 ± 0.01 μ T (sham near-field). Colonic temperature measurements indicated no core temperature rise in the subjects due to confinement in restraint tubes.

This work was supported by the Motorola Corporation.

P-303-C

AN ALTERNATE ANALYSIS OF PC-12 CELL RESPONSE TO PARALLEL AC AND DC MAGNETIC FIELDS. J.P. Blanchard. Bechtel Corporation, San Francisco, California 94119-3965, USA.

Previous analyses revealed a remarkable fit between the predictions of an ion parametric resonance (IPR) model and the response of at least two biological systems (PC-12 cells and Clone-9 cells) to controlled variations in parallel AC and DC magnetic fields. The consistency of fit persisted over more than 2 non-linear cycles of the response function predicted by the IPR model. While the IPR model does not consider clamping of molecular interactions imposed by the environment of an ion, recent work by D'Inzeo *et al.*, (1) begins to consider the impact of damping on theoretical predictions. Their model considers the influence of the local viscosity experienced by ions at a subcellular scale and examines its influence on the motion of particles (ions) influenced by those magnetic fields. In so doing, the D'Inzeo model considers an issue that is one of the major objections raised against the IPR model. The D'Inzeo model has a closed form solution only for the case of parallel AC and DC magnetic fields. The predictions from this form of solution are readily compared against the PC-12 data acquired earlier in tests of the IPR model to (a) test whether the D'Inzeo model, in its present form, could provide a more accurate prediction of the data than the IPR model, (b) examine the sensitivity of the D'Inzeo model to small variations in key parameters, and (c) identify whether those variations could be responsible for distinct characteristics of the observed response of PC-12 cells to magnetic fields. Preliminary results indicate the current D'Inzeo model does not predict the experimental data as well as the IPR model.

(1) D'Inzeo G. D., Galli, A., Palombo, A. Matching between Theoretical and Experimental Data for ELF ion Transport Effects, *Kyoto World Congress Supplement*, July 1993, pp. S80-S85.

Funding for this work was provided by the United States Department of Energy through its contractor, Lockheed

Martin Energy Systems, Inc. (Subcontract No. 62X-SU524V, Prime Contract No. DE-AC05-84OR21400)

P-304-A

STATIC MAGNETIC FIELD EFFECT ON SINOCAROTID BAROREFLEX SENSITIVITY. J. Gmitrov^{1,2}. ¹IV Internal Medicine Clinic, L. Pasteur University Hospital, Kosice, Slovak Republic. ²Department of Physiological Hygiene, National Institute of Public Health, Tokyo, Japan.

From our previous research in unconscious and conscious rabbits, it follows that sinocarotid baroreceptors react to a static magnetic field (SMF), and that this effect probably is the result of cell membrane calcium channel transport changes. (*Electro-Magnetobiol.* 14/3/, 217-228, 1995).

The goal of the recent research was to specify the effect of the SMF on sinocarotid baroreceptors. Two groups of experiments with different protocols were carried out in 17 healthy adult male rabbits. The first group included 83 experimental runs (38 sham and 45 SMF series). The second group included 54 experimental runs (27 sham and 27 SMF series). In both groups, rabbits trained to avoid any reaction of fear or rage during actual experiment under sedation induced by nembutal infusion (5 mg/kg/hour) were laid in a metal drum with their heads fixed during the period of observation (120 min in the first and 140 min in the second group of experiments). After 15 min adaptation period in both groups the first measurement of baroreflex sensitivity was performed with the steady-state method using sodium nitroprussid and phenylephrine pharmacological tests in the first group of experiments. In the second group only phenylephrine test was used. On the 50th min from the beginning of the experiment in both groups cylindrical Seico Epson Co., Ltd. manufactured Nd-Fe-B static magnets having a cross-sectional area of 490 mm² with intensities of 0.5 T on the pole face were positioned with south-seeking and north-seeking poles under the left and right carotid sinus area respectively. In the second group a calcium blocking agent-verapamil was infused (20 μ g/kg/min) beginning from the 10 min of sham or SMF exposure. After 40 min of exposure in both groups a second measurement of baroreflex sensitivity was performed.

The mean femoral artery blood pressure, heart rate were simultaneously recorded by a Nihon Kohden polygraph in each rabbit during the entire experiment. For each section of experiment the means and S.D. of the means of measured hemodynamic parameters were calculated by KYOWA (DAA-110B) data analyzer. The change in the values of baroreflex sensitivity and measured hemodynamic parameters were compared before, during and after sham or SMF application in the same and between sham and SMF series in each group of experiments.

SMF significantly increased baroreflex sensitivity in the first group of experiments and prevented its decrease in the second group where baroreflex sensitivity was significantly reduced by verapamil infusion in the sham series.

We concluded that SMF improved baroreceptor functional state resulting in the increase of the baroreflex sensitivity even when it was formerly reduced by verapamil. These effects may be in response to local changes at the baroreceptor or sinocarotid artery vessel wall, resulting in an increase in baroreceptor buffer capacity to blood pressure changes, realized mainly by sympathetic tonus changes.

Index of Authors

Aaron, R.K.	37	Bandoli, A.	303	Blackman, C.F.	151, 186
Abbott, J.	174	Banerjee, H.N.	269	Blanchard, J.P.	149, 151, 332
Abdulla, E.M.	91	Banfai, B.	194	Blank, M.	3, 57, 218
Adair, E.R.	143	Barattini, P.	160	Blask, D.E.	11
Adair, R.K.	81	Barbaro, V.	277	Block, E.	184, 298
Adams, J.G.	133, 288	Barber, M.	111	Blondin, J.P.	238
Adey, W.R.	7, 20, 109, 240, 254, 298, 331	Barbieri, D.	219	Blot, W.J.	35
Afzal, S.M.J.	160	Barbieri, R.	268	Bochko, V.A.	279
Ahern, E.W.	107	Barbiroli, B.	285	Bock, H.	120
Ahlbom, A.	70	Barbul, A.	91	Bogolyubov, V.M.	266, 315
Aimoto, A.	110	Bardasano, J.L.	310, 316	Bogomolni, R.A.	40
Aizawa, M.	19	Bardati, F.	283	Boheim, G.H.	30
Akai, M.	175	Bardos, D.C.	151	Boice, J.D. Jr.	35
Akimov, A.E.	185	Barnes, F.	56	Bomans, J.	21
Akyel, Y.	174, 270	Baron, J.B.	222	Bonds, C.B.	329
Aldinucci, C.	199	Barrett, J.C.	245	Bonfiglio, L.	51
Aldrich, T.E.	106	Bartolini, P.	277	Bonnay, M.	99
Alexandrov, D.V.	220	Basten, A.	109	Bonneau, M.J.H.	171
Alexandrov, V.V.	220	Batani, D.	93	Boorman, G.A.	157, 330
Alexanyan, Z.	25	Bates, D.J.	51	Booth, R.J.	103
Alipov, Y.D.	53, 152, 235	Battisti, S.	278	Borgens, R.B.	41
Amassian, V.E.	135	Baylink, D.J.	38	Borgo, E.	238
An, D.J.	95, 315	Beale, I.L.	103	Bornhausen, M.	322
Anderson, L.E.	51, 156, 162, 216, 219, 262, 327	Beeli, C.	286	Bortkiewicz, A.	289, 293
Anderson, V.	271	Belehradek, J. Jr.	95, 99, 314, 315	Bottauscio, O.	115
Andjelkovic, I.Z.	307	Belisheva, N.K.	154	Botti, P.	301
Andrews, K.	106	Bellocci, F.	277	Bottomley, A.L.	206
Andrienko, L.T.	226	Bellossi, A.	134, 232	Bounkova, E.B.	323
Andrushchenko, A.P.	179, 319	Belt, M.E.	270	Bovina, C.	106
Andrychuk, L.A.	228	Belt, M.L.	222, 270	Bowman, J.D.	65
Anger, G.	13	Belyaev, I.Y.	53, 152, 235, 255	Bozic, B.	76
Anglesio, L.	113	Benane, S.G.	151	Bracken, T.D.	64, 114
Annunziato, M.	285	Benedetto, A.	113	Breccia, M.	127, 274
Ano, T.	67	Benelli, F.D.	238	Brinkmann, K.	31, 104, 282
Antonacci, G.A.	278	Benko, H.	45	Brix, J.	245
Antonopoulos, A.	88	Berg, H.	330, 331	Broccoli, F.	136
Apollonio, F.	84, 127	Bergamini, G.	201, 205	Brown, R.	229
Apostolo, A.	278	Berget, R.	134	Brüggemeyer, H.	280
Ardoino, L.	127, 274	Berglund, L.G.	143	Brühn, A.	282
Arnetz, B.	145	Bergstrom, W.H.	299	Brun, A.	93, 164
Arsenic, I.	225	Berkopec, A.	276	Bruna, S.	138, 192
Artyukh, V.P.	228	Berman, J.E.	175	Brusl, H.	266
Aslan, E.E.	281	Bernardi, C.	182	Burch, J.B.	11
Astumian, R.D.	39, 49, 111	Bernardi, P.	53, 170	Burchard, J.F.	184, 298
Atkin, A.	69	Bernheim, N.J.	330	Burkhardt, M.	165, 166
Avetisian, T.H.	214, 243	Berry, M.	207	Buzási, T.	126, 226, 318
Avivi, L.	91	Bersani, F.	1, 57, 155, 200, 209, 219, 252, 253, 255, 260, 268, 271, 303	Byus, C.V.	109
Ayoub, J.	141, 273	Bertini, I.	285	Cabanes, P.A.	203, 204
Ayrapetyan, S.N.	213, 214, 243	Bertotto, P.	169	Cadossi, R.	47, 171, 173
Azaro, R.	170	Bettelli, G.	302	Cai, F.F.	38, 123, 139
Azuma, N.	287	Betti, E.	173	Cain, C.D.	109, 240
Babbitt, J.T.	329	Bettini, E.	303	Calabrese, P.	32, 33
Babenko, A.S.	264	Bevitori, P.	183, 187	Calderoni, P.P.	302
Bach Andersen, J.	6, 167	Bianco, B.	23, 83, 138, 192	Caldwell, J.R.	321
Bailey, W.H.	114	Bielli, P.	169	Cametti, C.	155
Bailly-Despiney, I.	269	Bilotta, T.W.	136	Campbell, C.E.	309
Bajd, T.	1	Bindoula, G.	95	Campbell, I.C.	91
Bakanova, L.	25	Binghy, V.N.	184, 185	Campbell-Beachler, M.	254
Bakos, J.	164, 296	Binninger, D.M.	58, 241	Canè, V.	171, 301
Baldwin, W.S.	245	Biro, O.	183	Caorsi, S.	170
Bamberg, E.	39	Bittnerová, D.	217	Capelli-Schellpfeffer, M.	29
		Blackinton, D.	161	Caplan, S.R.	77
				Capri, M.	59, 200, 201, 205, 219, 255

Caputa, K.	187	Cui, Y.H.	207	Dupuis, M.L.	200
Caracciolo, L.D.	181	Culley, P.L.	38, 139	Dutta, S.K.	269
Carfagni, A.	177	Czerska, E.M.	136, 324	Dzodic, R.	95
Carson, J.J.L.	148	d'Ambrosio, G.	252	Ebi, K.L.	55, 105, 162, 290, 291
Caruso, A.	87, 258	d'Amore, G.	113	Egblomassé, C.	245
Caruso, F.	277	D'Andrea, J.A.	85, 224	Eggert, S.	131, 272, 278
Casamento, J.	136, 324	D'Anna, S.A.	227	Eicher, B.	92
Cavagnaro, M.	53, 170	D'Inzeo, G.	83, 84, 149, 196, 197	Eichwald, C.	49, 148
Cavani, F.	301	Dab, W.	102	Eisenbrandt, H.	31, 282
Cavicchi, S.	271	Dallari, D.	302	Ekstrand, J.	242
Cavopol, A.V.	236	Dang, V.	97	Elsner, R.	31, 282
Cemazar, M.	46, 96, 99	Dang vu Nguyen, D.	320	Elson, E.C.	193
Cerretelli, P.	51	Danielian, A.A.	213, 214	Engbersen, J.F.J.	17
Cerri, G.	128	Danilenko, I.	195, 210	Engdahl, W.R.	209
Chabert, R.	273	David, E.	140	Engström, P.E.	93
Chadwick, P.	115	David, R.	140	Engström, S.	20, 73
Chaillou, S.	128	Davidson, L.	271	Epner, M.E.	175
Chan, K.W.	166, 275	Davidson, T.	88	Esposito, C.	199, 215, 326
Chang-Liu, C.M.	56	Davis, C.C.	23, 193	Etherington, D.J.	103
Chastain, R.A. Jr.	106	Davis, S.	147	Euclidi, E.	201
Chatterjee, I.	188	Dawe, G.S.	91	Evdokimov, I.I.	220
Chauhan, N.	173	Dawson, T.W.	187	Fabbro-Peray, P.	141
Chen, M.S.	88	De Biase, C.F.	177	Faldini, A.	173
Chen, T.	44, 248	De Bree, J.	14	Fan, X.	129
Chen, W.	122, 137	de Bruyn, L.	232, 297, 326	Fanetti, G.	199
Cherlin, D.	61, 161, 283	De Grandis, D.	160	Fang, K.S.	40
Chernyshev, M.	25	de Jager, L.	232, 297, 326	Fantazzini, P.	243
Chevalier, A.	102	De la Hoz, F.	310	Farboud, B.	40
Chiabrera, A.	18, 23, 83, 138, 192	De la Hoz, J.	316	Farrell, J.M.	111
Chiang, H.	189	De Leo, R.	128	Fato, R.	106
Chida, T.	268, 327	De Mattei, M.	87, 258	Fedorov, M.P.	220
Chizmadzhev, Y.	43, 44	De Pasquale, V.	304	Ferrari, S.	171
Cho, M.R.	308	De Prisco, P.P.	253	Ferraro, L.	93
Choi, W.O.	114	De Rossi, D.	19	Ferrarotto, C.	229
Choleris, E.	221	de Seze, R.	141, 273	Filiatrault, F.	61
Chomiczewski, K.	161	Deal, C.	321	Findlay, J.C.	157
Chou, C.K.	99, 166, 275	Dec, S.	273	Fini, M.	136
Chou, C.S.	313	DeConti, R.	96	Finnie, J.	109
Chou, T.C.	313	Del Seppia, C.	51, 78, 144	Fitzner, R.	31
Chrisler, W.B.	216	Delaveaud, C.	118	Fitzsimmons, R.J.	121
Cieslak, E.	273	Della Noce, M.	252, 253, 260, 268	Floderus, B.	70
Cincotti, S.	18	DelPizzo, V.	100	Flühr, H.	145
Ciombor, D.McK.	37	Delpont, H.P.	172	Formánek, J.	217
Cleveland, Jr., R.F.	279	Delteil, C.	68	Formiggini, G.	106
Coffman, D.M.	286	Derenyi, I.	39	Fourcault, D.	99
Coghill, R.	219, 264, 294, 308, 319	Dertinger, H.	123	Franceschi, C.	59, 200, 201, 205, 219, 252, 255
Cohen, S.I.	136, 324	Dev, N.B.	95	Frasca, D.	160
Coing, F.	102	Dev, S.B.	95	Fratlicelli, D.	303
Collins, J.J.	49	Diadiun, S.	210	Fredericks, D.	174
Collon, D.	305	Diaz-Enriquez, M.	230	Freude, G.	272
Conover, D.L.	263	DiDonato, J.A.	38, 123	Friedrich, T.	39
Conti, R.	115, 181	DiGiovanni, J.	156	Fritz, L.K.	262
Cook, M.R.	142, 230	Dinu, A.	259, 260	Frost, B.G.	286
Cooper, M.A.	27	Dobrynin, Y.V.	328	Frumkin, E.	329
Cormier, M.	244	Dobson, J.P.	111, 144	Fuller, D.	207
Cossarizza, A.	59, 200, 219, 255	Donato, A.	277	Furniss, M.	21
Costato, M.	93, 163	Doyle, J.M.	222	Furse, C.M.	85, 86
Couch, L.A.	51, 219	Dragisa, M.	231	Gaberc-Porekar, V.	96
Cox, D.D.	270	Drago, S.	128	Gaboury, L.	224, 235
Cox, W.	314	Dreimanis, A.	280	Gabriel, B.	28
Cracco, R.Q.	135	Dremuchev, V.A.	320	Gabriel, C.	169
Crasson, M.	231	Druzin, M.	25	Gabrielli, L.	277
Craviso, G.L.	188	Dubinin, A.G.	202	Gadzicka, E.	289, 293
Creim, J.A.	51, 219	Dubrov, A.P.	246, 318	Gailey, P.C.	74
Crepeau, R.H.	286	Duko, M.	25	Gajendran, V.	136
Crezee, H.	14	Dunnam, C.R.	286		

Gajin, S.	225	Grainger, P.	103	Higgins, R.J.	109
Gajsek, P.	181	Grana, D.	307	Hillert, L.	145
Gak, E.Z.	154	Graziani, M.E.	303	Hinsenkamp, M.	36
Galichenko, S.V.	43	Green, P.	43	Hirakawa, E.	240
Galliano, S.	307	Green, W.R.	227	Hiwaki, O.	89
Gallo, S.A.	97	Greenland, S.	105	Hocking, B.	104, 324
Galloni, L.	251	Griegat, J.P.	31	Hoffman, K.C.	321
Galloni, P.	160, 251	Grigat, J.P.	104	Hofmann, G.A.	95
Galonja, T.	225	Grigorian, G.Y.	213, 214	Holcomb, R.R.	134, 135
Galser, R.	92	Grigoriev, Y.G.	26	Holt, P.A.	321
Galt, S.	237, 263, 294	Grimaldi, S.	248	Hong, F.T.	17
Galunov, V.A.	320	Grissom, C.B.	48	Hong, S.C.	114, 296
Galvanovskis, J.	258	Grytsak, T.	210	Hornychová, M.	217
Gandhi, O.P.	85, 86, 165, 168, 277	Gualtieri, G.	302	Hossmann, K.A.	5
Gang, K.	207	Gueguen, B.	203	House, D.E.	151
Garibova, L.S.	214	Guelfi, M.	127, 274	House, R.V.	256
Garn, H.	266	Guerra, D.	271	Howard, T.L.	38, 123
Gauger, J.R.	157, 209, 256	Guido, M.	219	Hristova, L.	100
Gaucher, J.	56	Guizzardi, S.	304	Hu, P.	196
GebSKI, V.	109	Guo, Y.	305	Hughes, M.M.	146
Gehl, J.	94	Gustavsson, M.	237, 263, 294	Hui, L.	312
Gehlen, W.	32, 33	Guy, A.W.	166, 275	Hui, S.W.	97, 158
Genova, M.L.	106	Haggren, W.	109, 254, 298	Hujimoto, E.	324
Gerasimov, S.	308	Hagino, N.	25	Hulínská, D.	217
Gershtein, L.	266	Hahn, T.J.M.	329	Hungerford, D.S.	321
Ghaffari, M.	240	Hall, E.J.	157	Hurt, W.D.	85
Ghione, S.	51, 144	Hall, L.D.	286	Hyysalo, P.E.	118
Ghostine, R.	61	Hall, S.C.	207	Ichioka, S.	143
Giacomi, R.	177	Hämäläinen, A.M.	130, 272	Ihrig, I.	92
Giacovelli, S.	303	Hämmerle, H.	119	Ikehara, T.	243
Giardino, R.	136	Hamnerius, Y.K.	116, 237, 258, 263, 294	Ikehata, M.	270
Gift, E.A.	312	Han, Y.	122, 137	Ilyasova, E.N.	150, 257
Gigante, G.E.	155	Hanchette, C.	106	Ilyinskikh, E.N.	195
Gigineishvili, G.R.	112	Hang, Q.G.	196	Ilyinskikh, N.	195
Gilbert, R.	69, 96, 97	Hansen, P.	87	Imaida, K.	110
Giner, V.	190	Hansen, V.W.	30, 31	Indenborn, A.V.	43
Giorgi, G.	271	Hansson Mild, K.	20, 206, 224, 242	Inskip, P.I.	35
Giuliani, L.	248	Hara, A.	209	Iorio, E.	215
Giusti, A.M.	215	Harii, K.	143	Iotti, S.	285
Glass, F.	96	Harland, J.D.	89, 159	Ishida-Jones, T.	254, 298
Gledic, D.	212	Harms-Ringdahl, M.	152	Ishizu, K.	287
Gmitrov, J.	332	Harris, A.	109	Isokorpi, J.T.	180, 194
Gnudi, S.	302	Hart, F.X.	152	Issels, R.D.	16
Goitz, H.	305	Hartman, S.K.	143	Isseroff, R.R.	40
Golan, D.E.	308	Harutunian, L.L.	213, 214	Iucci, N.	130, 235, 290
Goldman, R.	45	Hatch, E.E.	35	Ivanov, S.	233
Gollnick, F.	32, 120	Hatcher, D.J.	85	Iwasaka, M.	66, 116, 143, 178, 179, 253
Goltsev, V.N.	196	Hatfield, G.	104	Iwi, G.R.	103
Goltz, S.	131, 278	Häußler, M.	9, 158	Jacobs, M.A.	321
Golzio, M.	68	Haylock, R.G.	24	Jadoul, A.	43, 68
Gómez, E.	307	He, Y.D.	321	Jandová, A.	163
Goodman, R.	57, 218	Heese, C.	92	Jankovic, S.	306
Gordon, I.	104	Heikkinen, P.	147	Jaramillo, S.A.	86
Gos, P.	92	Heller, R.	69, 96, 97	Jarm, T.	46
Goso, C.	160	Henderson, A.	90	Jaroszkeski, M.J.	69, 96, 97
Goswami, P.C.	205	Henderson, C.P.	286	Jauchem, J.R.	215
Goto, T.	209	Hennig, F.F.	98, 176, 302, 315	Jecko, B.	118
Gottardi, G.	57, 285	Henry, P.J.	222	Jelínek, F.	81
Gottwald, E.	123	Hentschel, K.	278	Jen, C.M.	313
Goulet, D.	110, 238	Herbst, E.	316	Jenrow, K.A.	91
Gouvras, G.	13	Herndon, T.O.	44	Jerábek, J.	217
Gowrishankar, T.R.	44	Heyer, W.D.	92	Jeutter, D.C.	175
Grabovskaya, Y.Y.	227	Hianik, T.	75	Johansen, C.	72, 101
Gragnani, G.L.	170	Hickey, J.	97	Johnson, J.P.	309
Graham, C.	142, 230	Hietanen, M.	130, 272		
Grain, H.	104				

Johnson, K.	61, 161	Kopytenko, E.A.	130, 235	Lee, G.	100
Johnson, M.	224	Kopytenko, Y.A.	130, 235	Lee, M.Y.	89, 159, 160
Johnson, P.G.	97, 158	Korenstein, R.	91, 242	Lee, R.C.	29, 137, 308
Johnson, T.R.	157, 256	Korotkov, V.A.	320	Legros, J.J.	231
Johnston, D.A.	156	Korpinen, L.H.	180, 194, 229	Legros, W.	21
Jokela, K.T.	118	Koshel, N.	226	Leitgeb, N.	145
Jones, R.A.	20, 109, 331	Koslov, A.	25	Leman, E.	46, 295
Jouanny, F.	269	Kotnik, A.	96	Lenárt, A.	164
Joyner, K.H.	151, 189, 271	Kotnik, V.	96	Lenaz, G.	106
Juuti, P.	130	Kotov, V.D.	320	Lendinara, L.	303
Juutilainen, J.	71, 130, 147	Kotsos, T.P.	27	Leon, B.	99
Kaatsch, P.	104	Kotte, A.N.T.J.	14	Lerchl, A.	9
Kabuto, M.	208, 296	Kouzmanova, M.	233	Letjuchi, G.I.	227
Kaffenberger, W.	245	Kovac, R.	266	Leveque, P.	118
Kaicer, E.K.	234	Kovacs, E.	259, 260	Levine, G.A.	89, 159
Kaletsch, U.	104	Kovala, T.	272	Li, C.Y.	105
Kalmijn, A.J.	79	Kozak, J.T.	256	Li, J.R.	99
Kamimura, Y.	110, 274	Krackow, K.	321	Liboff, A.R.	91, 106, 121, 127
Kamiya, A.	143	Krasna, A.	276	Liburdy, R.P.	8, 60, 89, 159, 160, 201
Kammerer, H.	30	Krause, D.	111	Lin, H.	57, 218
Kang, G.	192, 261	Krause, N.	131	Lin, J.C.	52
Karady, G.G.	194	Kravchenko, A.V.	295	Lin, R.S.	105
Karba, R.	45	Krawczyk, A.	139	Lin, X.Z.	313
Kärner, H.	104	Kremser, H.	266	Lin, Y.	189
Kästle, R.	275	Kriehuber, R.	297	Lindgren, M.	237, 263, 294
Kato, M.	10	Krómer, I.	287, 289	Lindström, E.	20
Kaufman, J.J.	83, 138, 139	Kubacki, R.	12	Linet, M.S.	35
Kaune, W.T.	63, 147	Kubinyi, G.	164	Linz, K.W.	32
Kavaliers, M.	50, 125, 221	Kudrin, V.A.	290	Lioi, M.B.	252, 260, 268
Kavet, R.I.	114, 156, 230	Kues, H.A.	227	Lippiello, L.	139
Kawasumi, M.	188	Kullnick, U.	282	Lisi, A.	248
Kazakova, I.	21	Kumlin, T.	147	Litovitz, T.A.	111
Kazarinov, K.D.	213, 244	Kunsch, B.	12	Liu, Q. C.	211
Kean, C.J.	109	Kurokawa, Y.	208, 296	Livio, G.	182
Keikko, T.	180	Kuryk, M.	210	Loberg, L.I.	56, 209
Keller, H.	132	Kuster, N.	33, 109, 117, 144, 165, 166, 275, 331	Lock, T.	305
Khan, T.	173	Kutko, O.Y.	212	Loeschinger, M.	119
Kharazi, A.I.	329	Kuzmanova, M.A.	249	Logan, N.M.	147
Khavryutchenko, V.D.	198	Kuzmin, P.I.	43	Logani, M.K.	107
Kheifets, L.I.	71, 291	Kwee, S.	58	Lords, J.L.	199
Khizhnyak, E.P.	82, 208	La Cara, F.	253	Löscher, W.	9, 158
Khokhlova, N.Y.	239, 250	Lafon, L.	118	Lotz, W.G.	263
Khomyakova, O.V.	227	Lagendijk, J.J.W.	14	Lovely, R.H.	51
Kikuchi, T.	10, 327	Lagroye, I.	269	Lovisolò, G.A.	127, 274
Kim, C.J.	194	Lai, H.	24	Lu, D.Q.	189
Kim, D.W.	115, 186	Laitinen, J.	147	Lu, S.T.	224
Kim, J.	194	Lalancette, M.	234	Lu, Z.Y.	192
Kim, S.W.	114	Lallemant, J-G.	273	Luben, R.A.	3, 297
Kim, Y.S.	114	Lambert, C.	21	Ludwig, B.	39
Kinkel, D.	322	Lambrozo, J.	102	Lui, H.T.	309
Kinne, L.J.	20	Landstorfer, F.M.	168	Lundgren, E.	20, 242
Kinouchi, Y.	216, 243, 324	Lange, S.	297	Luo, Z.G.	309
Kirschvink, J.L.	48, 79	Langer, E.	31	Luschi, P.	51, 78, 144
Kittel, A.	125	Langer, R.	44, 248	Lutty, G.	224
Kiyatkin, V.A.	112	Langholz, B.	290	Lyskov, E.	25, 224
Klauenberg, B.J.	13	Lapière, C.M.	21	Lysov, N.A.	323
Klaussen, L.W.	321	Laszlo, A.	15, 88	Maccabee, P.J.	135
Klimov, A.N.	150, 257	Lauterborn, W.	72	Macchioni, S.	219
Kloth, L.C.	175, 300	Lazarevic, J.	256	MacDonald, M.K.	171
Knedlitschek, G.	123	Lazetic, B.	254	Machlup, S.	186
Knotková, J.	217	Lazzi, G.	165, 168, 277	Mack, G.W.	143
Koana, T.	270	Leal, J.	230, 322	MacMurray, A.	109
Kohli, J.	92	Lecuyer, D.	229	Maeshima, T.	175
Kojic, Z.Z.	307	Lednev, V.	150, 257	Magee, F.P.	38
Kolyubaeva, S.	195	Lednyiczky, G.	126, 193, 226, 317, 318	Magnani, C.	292
Konishi, S.	260			Malinin, V.S.	213, 244

Malyapa, R.S.	107	Miller, R.C.	157	Nitta, H.	208
Mamylava, D.	311	Miller, S.C.	21	Niu, Z.Q.	192, 261
Man, B.	310	Milosavljevic, A.	56	Noda, Y.	201
Man, D.	310	Miño, J.	307	Noonan, D.	109
Mandeville, R.	61, 224, 234, 235	Mir, L.M.	4, 94, 95, 99, 314, 315	Novak, J.P.	110
Mantegazza, C.	51	Mirell, S.G.	329	Novikova, M.R.	202
Maraldi, N.M.	209	Mirick, D.K.	147	Nozaki, T.	25
Marchetti, S.	173	Miro, L.	141, 273	Nuccitelli, R.	40
Marczinski, C.	221	Mirutenko, V.	210	Nusgens, B.V.	21
Marinelli, F.	209	Misakian, M.	22	O'Dell, J.R.	321
Marino, C.	160, 251	Miszczak, J.S.	273	O'Neill, B.	27
Mariutti, G.F.	35, 247	Miyakoshi, J.	267	Obe, G.	88
Markin, V.S.	77	Miyamoto, H.	243	Obo, M.	260
Markov, M.S.	46, 84, 121, 154, 196, 249, 295, 310	Miyoshi, M.	253	Odashima, J.	25
Martin, G.T.	124	Moggia, E.	83, 138	Ogrodnik, J.	161
Martin, S.	157	Moglie, F.	128	Ohmori, M.	240
Martinez-Pascual, M.A.	230, 322	Moingeon, P.	314	Ohtsuka, R.	296
Martini, L.	136	Momose, N.	324	Oka, K.	208
Martynyuk, S.B.	227	Monahan, J.C.	227	Okabe, H.	324
Martynyuk, V.S.	227	Monti, D.	200, 219, 255	Okuno, K.	67
Maruvada, P.S.	238	Moreno, J.	322	Olivares, J.L.	331
Mashevich, M.	91	Mori, A.	201	Olsen, J.H.	101
Mason, P.A.	85	Moros, E.G.	14, 107, 129	Olsen, R.G.	87, 199
Massa, A.	170	Morris, J.E.	156, 162, 216, 262, 327	Ooba, W.	10, 260, 268, 327
Massa, R.	252	Morrissey, R.L.	157	Orlowski, S.	95, 314, 315
Massari, L.	87, 258	Moss, F.	73	Oseroff, A.R.	97
Mataulj, M.	212, 254	Motzkin, S.M.	54	Osiander, R.	227
Mathias, P.	263	Muehsam, D.J.	154, 191, 197	Ossenkopp, K.P.	125, 221
Mathur, S.P.	174, 224	Mulder, L.J.	171	Otaka, Y.	260, 268, 327
Matteucci, G.	286	Munafò, E.	278	Ottani, V.	304
Mattis, C.R.	256	Munck, J.N.	95	Ovchinnikov, E.L.	217, 239, 250
Mattson, M.O.	20, 206, 242	Munro, U.	78	Ovechkina, Z.A.	227
McCormick, D.L.	56, 157, 209, 256	Murashev, V.V.	211	Owen, R.D.	214
McCullough, B.	134	Murphy, M.R.	13	Pääkkönen, R.J.	194
McDougall, J.A.	99, 166, 275	Murri, L.	51	Packer, L.	201
McLaughlin, J.K.	35	Muto, T.	204	Padmanabhan, R.	244
McLean, J.	229	Myasin, Y.A.	320	Paduanová, Z.	217
McLean, M.J.	134, 135	Myerson, R.J.	14	Paerisch, M.	315
McLeod, D.S.	224	Nagawa, H.	204	Pakhomov, A.G.	174
McNamee, J.	229	Nagel, G.	39	Pakhomova, O.N.	270
Meder, S.	30	Nagy, N.	296	Palczynski, C.	289, 293
Medica, J.	136, 324	Nair, I.	6, 74, 133	Pallotti, F.	106
Medinets, Y.R.	295	Nakagawa, M.	270	Palmer, A.	41
Medvedev, S.	224	Nakamura, K.	67	Palombo, A.	83, 149, 196
Mehta, S.	61, 161	Nanushyan, E.R.	211	Palu, S.	100
Meinert, R.	104	Natarajan, A.T.	195	Paolo Pessina, G.	199
Mekonnen, T.E.	298	Nathalie, E.	203	Papi, F.	51, 78, 144
Menart, V.	96	Navakatikyan, M.A.	228	Parasassi, T.	215, 326
Mercier, G.	61, 224, 235	Neely, S.J.	206	Parenti Castelli, G.	106
Merlo, A.	307	Negishi, T.	325	Park, J.Y.	114
Merlo Pich, M.	106	Nekhoroshev, O.G.	264	Park, K.H.	216, 243
Merritt, J.H.	215, 224	Nelson, F.R.	305	Parodi, M.	18
Messerli, M.	41	Nepola, J.V.	174	Parreño, A.	230
Mevissen, M.	9, 158	Nesson, M.H.	48	Partanen, J.	180, 229
Meyer, R.	32, 120	Neubauer, G.	266	Pasquali, E.	199, 215, 248, 326
Mezzasalma, L.	144	Neumann, E.	2	Pasquali-Ronchetti, I.	200, 201, 205, 219
Michaelis, J.	104	Neutra, R.R.	100	Passechnik, V.I.	76
Micic, A.	90	Nguyen, D.H.	184, 238, 298	Pastorino, M.	170
Mickevičius, D.	249	Nicolau, C.	69	Pastushenko, V.Ph.	76
Miesner, A.	104	Nieberl, J.	126, 317	Patifio, O.	307
Migeod, F.	98	Niehaus, M.	9	Pattnaik, S.S.	168
Miklavcic, D.	1, 46, 96, 99	Nielsen, S.L.	94	Patuelli, A.	285
Milani, M.	93	Nikolaeva, T.G.	328	Paunesku, T.	56
Militello, C.	277	Nikolskaya, K.	265, 266	Pearce, N.E.	103
Miller, D.L.	51, 162, 216	Ning, J.T.	136, 324	Pearson, R.L.	55, 290, 291
		Nishimura, I.	261, 325		

Pedersen, G.F.	167	Raskmark, P.	58	Saulis, G.	190, 249
Pei, X.	73	Raspanti, M.	304	Saunders, R.D.	24
Pekaric-Nadj, N.	225, 231, 256, 306	Rautee, J.P.	180, 194	Savitz, D.A.	105
Pekárková, E.	217	Ravaioli, A.	183, 187	Savopol, T.	259, 260
Pellati, A.	87, 258	Regnier, V.	68	Sawasaki, Y.	209
Peña, R.	190	Reif, J.S.	11	Sayers, S.	173
Persinger, M.A.	221	Reiner, A.	305	Scarfì, M.R.	62, 252, 253, 260, 268
Persson, B.R.R.	93, 164	Reintgen, D.	96	Scarpa, P.	21
Peterlin, P.	76	Reißenweber, J.	140	Scheingraber, H.	322
Petersen, M.	100	Reitmeier, C.	31	Scheller, A.	98, 176, 302
Petersen, R.C.	13	Ren, R.L.	99	Schiavoni, A.	169
Petrini, C.	200	Repacholi, M.H.	14, 109	Schmid, T.	117, 275
Petrini, S.	209	Resig, P.	46, 295	Schmidbleicher, D.	176
Pezzetti, F.	87, 258	Reulloux, M.	232	Schönborn, F.	165, 166
Pezzoli, C.	271	Revasova, Y.	195	Schubert, F.	92
Phillips, J.L.	109, 254	Reynolds, J.C.	177	Schultheiss-Grassi, P.P.	111, 144
Phipps, J.B.	68, 244	Reynolds, P.	293	Schütz, J.	104
Picazo, M.L.	310, 316	Riccio, M.	209	Schwartz, R.G.	138
Pickard, W.F.	107, 129	Richard, L.	298	Seaman, R.L.	222
Pilla, A.A.	46, 121, 133, 154, 175, 191, 197, 300	Richiardi, G.	169	Sebastian, J.L.	86
Pintus, G.	57	Robinson, C.F.	100	Sedakova, L.A.	328
Pisa, S.	53, 170	Robinson, K.R.	41	Senior, R.S.	114
Piuzzi, E.	170	Rocchia, W.	83, 138, 192	Serafino, A.L.	248, 326
Plante, M.	238	Rocher, C.	232	Sersa, G.	46, 96
Pliquett, U.F.	44, 124	Rodemann, H.P.	119	Sersa, S.	99
Plosker, H.	310	Rojdestvenskaya, Z.E.	150, 257	Sestito, J.P.	100
Pokorny, J.	81, 153, 163	Rols, M.P.	68	Sfondrini, G.	303
Pokovic, K.	117, 166	Romani, F.	303	Shahidain, R.	22
Polichetti, A.	200, 247, 278	Rönnbäck, L.	263	Sharma, V.	27
Polk, C.	61, 161, 283	Rosemberg, Y.	242	Shavianidze, G.O.	305
Pollack, S.R.	4	Rosen, A.D.	65	Shcheglov, V.S.	53, 235, 255
Pologea-Moraru, R.	259, 260	Rosic, M.L.	307	Shcherbinska, A.	210
Poncy, J.L.	269	Rossi, F.	182	Shekhotkin, A.V.	227
Poole, A.R.	305	Roti Roti, J.L.	107	Shibata, M.	143
Porter, C.	136, 324	Rowley, J.T.	189	Shibata, T.	267
Potts, R.O.	43	Rubinacci, A.	238	Shigemitsu, T.	10
Pozzi, D.	248	Rüger, W.	30	Shilov, I.O.	220
Pozzi, R.	247	Ruoss, H.O.	168	Shiokawa, K.	253
Prato, F.S.	50, 125, 221	Rupp, T.	156	Shipov, G.I.	185
Prausnitz, M.R.	44, 98	Ruppe, I.	272, 278	Shirai, T.	110
Préat, V.	43, 44, 68, 98, 124	Russell, D.	73	Shirasaki, Y.	175
Preece, A.W.	103	Ryaby, J.T.	38, 45, 123, 139	Shoda, M.	67
Preminger, T.L.	95	Ryabikh, T.P.	328	Shpinkova, V.	265, 266
Preston-Martin, S.	71	Ryan, B.M.	157	Shtemler, V.	265
Proł, H.K.	174	Rybakov, Y.L.	328	Shvets-Teneta-Gurii, T.B.	202
Ptitsyna, N.G.	130, 235, 279, 290	Rybalko, S.	210	Sidorov, V.D.	266, 311
Publicover, N.G.	188	Ryu, C.Y.	115, 186	Sidrac-Ghali, S.	224, 235
Puleo, C.	96	Sadovnik, V.B.	208	Sienkiewicz, Z.J.	24
Puliatti, G.	278	Saghyan, A.A.	243	Simic, A.	256
Puranen, L.O.	118	Saha, S.	299, 309	Simkó, M.	297
Putvinsky, A.V.	213, 244	Sait, M.L.	228	Simon, B.	174
Qian, H.	325	Sakharov, D.	226	Simunic, D.	284
Quaglino, D.	59, 200, 201, 205, 219	Salford, L.G.	93, 164	Sinay, H.	164
Raaijmakers, B.W.	14	Salvioli, S.	219, 255	Sipos, K.	164
Rafferty, C.N.	162, 329	Samoilenko, Y.I.	179	Sisken, B.F.	46, 154, 295
Raffetto, M.	170	Sancho, M.	86, 190	Sisken, J.E.	22
Rajkovic, V.	212, 254	Sandblom, J.	258	Skokljević, I.	307
Rakocevic, M.	256	Sandström, M.	224	Skovsgaard, T.	94
Ramirez, E.	316	Santi, S.	209	Smirennii, L.	195
Ramirez, L.H.	95	Santini, R.	203	Smith, C.	321
Ramoni, C.	200	Santoro, N.	248	Smith, P.J.S.	42
Ramos, J.L.	316	Sarra, A.	243	Smith, S.D.	121
Randoll, U.G.	98, 176, 302, 315	Sartore, L.	181	Soana, S.	301
Rankin, R.F.	114	Sartucci, F.	51	Soda, A.	216
Ranney, S.	295	Sasser, L.B.	156, 162, 216, 327	Söderman, E.	145
		Sastre, A.	142	Sodi Pallarés, D.	310

Sollazzo, V.	87, 258	Thansandote, A.	229	Verma, M.	269
Somasundaram, M.	135	Thatte, H.S.	308	Vernhes, M.C.	204
Somosy, Z.	125	Thimonier, C.	273	Versura, P.	136
Sontag, W.	123	Thomas, A.W.	125, 221	Veyret, B.	34
Souques, M.	102	Thomas, R.M.	135	Vignati, M.	182, 248
Spadaro, J.A.	299	Thompson, C.J.	151	Villa, I.	238
Spittler, J.F.	32, 33	Thorlin, T.	263	Villoresi, G.	130, 235, 279, 290
Srebnitskaya, L.K.	150, 257	Thumm, S.	119	Visintainer, I.	113
Srobár, F.	81, 153	Thuróczy, G.	125, 164, 281, 296	Vitzthum, R.	266
St.Pierre, T.G.	111	Ticar, I.	183	Vodovnik, L.	1
Stagg, R.B.	20, 109	Tiras, K.P.	150, 257	Vojtisek, M.	217
Stark, R.A.	183	Tofani, S.	65	Volobuev, A.N.	217, 239, 250
Stawarz, B.	161	Tognolatti, P.	283	Von Behren, J.	293
Stein, B.S.	136, 324	Tomashevskaya, L.A.	210	von Bülow, J.	31
Stein, J.-C.	123	Topping, S.	126, 193, 318	von Nandelstadh, P.	272
Stella, I.	307	Toraason, M.A.	263	Vora, N.	99
Stepanov, V.S.	26	Torbet, J.	67	Voronkov, V.N.	208
Stevanovic, D.	254	Torgerson, J.E.	134	Voronov, P.M.	130, 235, 290
Stevens, R.G.	8, 147, 262	Toutitou, Y.	141	Vukovic-Jankovic, B.	306
Still, M.	20, 242	Traikov, L.L.	196, 249	Wach, P.	284
Stillings, D.	237	Traina, G.C.	36, 87, 258	Wachtel, H.	55, 290, 291
Storage, M.	18	Trevissoi, E.	182	Waiserman, A.	226
Storbeck, W.	31, 282	Tributsch, H.	40	Wake, K.	110, 188
Straube, W.L.	14, 107, 129	Tricarico, M.	199, 215, 326	Wakisaka, H.	209
Stuchly, M.A.	187	Trillo, M.A.	322	Walleczek, J.	49, 148
Stuck, B.	224	Trivunovic, V.	225	Walters, T.J.	85
Su, J.Y.	246	Trkal, V.	81	Walz, D.	77
Sucz, M.	144	Trufanov, L.A.	217, 239, 250	Wanebo, H.	61
Sung, M.J.	313	Truong, A.L.	269	Watanabe, S.	110, 274
Suskov, I.	195	Trzaska, H.	132	Waterhouse, R.B.	189
Sussman, S.S.	71	Tsong, T.Y.	39	Weaver, J.C.	28, 43, 44, 111, 124, 248, 312, 313, 314
Sutton, C.H.	175	Tsuchiya, K.	67	Weibezahn, K.-F.	123
Suzdalcev, A.A.	323	Tsuno, N.	204	Weiss, D.G.	297
Svetina, S.	76	Tsurita, G.	204	Westphalen, C.v.	32
Svihálková, J.	217	Tung, L.	27	Wey, H.E.	263
Svircev, Z.	225	Turcu, C.E.	93	Wiert, J.	128
Swicord, M.L.	34	Tuschl, H.	266	Wienand, A.	30
Szabó, L.D.	164, 296	Tyasto, M.I.	130, 235	Wieser, H.G.	144
Szentpáli, B.	281, 288	Ubeda, A.	230, 322	Wilczewski, F.	30
Szmigielski, S.	12, 101, 161, 223, 289, 293	Ueno, S.	66, 116, 143, 178, 179, 204, 253	Wilkens, L.	73
Szuba, M.	223	Ullsperger, P.	272	Wiltshcko, R.	78
Tachiiri, S.	267	Ungvichian, V.	241	Wiltshcko, W.	78
Takahashi, K.	209	Uscebrka, G.	212, 254	Winter, D.M.	286
Takebe, H.	267	Ushakov, V.L.	53, 235, 255	Winterfeldt, D.v.	133
Takeuchi, K.	209	Uzdensky, A.B.	212	Winters, W.D.	25, 240
Taki, M.	110, 188, 274	Valberg, P.A.	63	Wojtysiak, A.	282
Tamada, J.A.	43	Valbonesi, S.	303	Wolke, S.	32
Tamulis, A.	323	Valencic, V.	276	Woloschak, G.E.	56
Tamulis, V.	323	Valmori, A.	209	Wood, A.W.	228, 271
Tanaka, T.	188	Valtersson, U.	20, 206	Wood, S.J.	206
Tanelian, D.L.	77	Van der Koijk, J.F.	14	Wraber-Herzog, B.	45
Tao, Q.	90	Van Leeuwen, G.M.J.	14	Wrobel, G.	30
Tarlie, M.B.	49	Van Matre, B.J.	87, 199	Wu, D.	165
Tarricone, L.	84	van Rongen, E.	131	Wu, F.F.	305
Tartaglia, J.	314	Van Tuyen, V.	281, 288	Wu, X.N.	322
Tasso, M.	113	Vanbever, R.	43, 44, 68, 98, 124	Xie, L.H.	189
Tateishi, T.	175	Vassilenko, L.G.	307	Xie, T.D.	39
Tattersall, J.E.H.	206, 247	Vassilenko, N.F.	308	Xu, Y.L.	211
Taylor, J.M.G.	329	Vassilenko, O.L.	308	Yamagishi, N.	267
Taylor, L.S.	193	Vaughan, T.E.	44, 111, 312, 313, 314	Yamagishi, Y.	268, 327
Tchachenko, Y.	308	Vecchia, P.	200, 278	Yamaguchi, H.	216, 243
Teissié, J.	28, 68, 203, 204	Vedholm, K.	116	Yamazaki, K.	10
Temuryants, N.A.	227	Velin, R.	272	Yang, Y.S.	151
Tenforde, T.	1	Ventura, C.	57	Yao, G.D.	189
Testoni, G.	182	Vergara, M.S.	135	Yasui, M.	260

Yen, Y.....	99	Zecchi, P.....	277	Zhong, Q.N.	207
Yeshchenko, O.	265	Zeks, B.	76	Zhou, B.S.	99
Yoshioka, M.....	209	Zemann, E.	31, 104	Zielinski, H.	161
Yoshizaki, K.....	216	Zemskova, M.V.	295	Zikic, D.	212, 254
Yu, Q.S.	165	Zeni, O.	252, 253, 260, 268	Zimatore, G.	155
Yu, S.W.	196	Zewert, T.E.....	44	Zimmerman, G.	109
Zabbo, A.	136, 324	Zhalco-Tytarenko, O.V. . .	126, 193, 198	Ziriak, J.M.	85, 224
Zaffanella, L.E.	105, 113	Zhang, W.D.	196, 309	Ziskin, M.C.	54, 82, 107, 208
Zaffe, D.....	301, 303	Zhang, X.Y.	309	Zizic, T.M.	321
Zago, M.....	83, 196, 197	Zhang, Y.....	309	Zmyslony, M.	289, 293
Zaitsev, D.B.	130, 235, 290	Zhang, Y.J.	211	Zotov, S.V.	228
Zaniol, P.....	304	Zhao, Y.L.	158	Zoukov, B.N.	323
Zannoli, R.	182	Zhao, Z.G.	305	Zucchini, P.	171
Zati, A.....	136	Zheng, B.Y.	189	Zuin, R.....	182
Zavgorodny, S.V.....	208	Zheng, D.....	309	Zwick, H.	224
Zecca, L.	51, 200, 201, 205, 219	Zhi, Y.L.....	207	Zyss, T.	139

ACKNOWLEDGMENTS

The Second World Congress for Electricity and Magnetism in Biology and Medicine gratefully acknowledges the generous financial support from:

Corporate and Agency Sponsors:

Alcatel
Alza
Central Research Institute for Electric Power Industry
Clinical Electromedical Research Academy
Cyto Pulse Sciences, Inc.
Electric Power Research Institute
ENEL
Ericsson
Forschungsgemeinschaft Funk e.V.
IGEA S.r.l.
Institute Electricité Santé (Paris)
Motorola
Murray Electronics
Nokia
Omnitel Pronto Italia
OrthoLogic
Telecom Italia
Telecom Italia Mobile
U.S. Air Force, Armstrong Laboratory
U.S. Department of Energy/Oak Ridge National Laboratory
U.S. National Institute for Occupational Safety & Health
U.S. National Institute of Environmental Health Sciences
Wandel & Goltermann S.r.l.

Local Institutions for their patronage:

University of Bologna
Regione Emilia e Romagna
Provincia di Bologna
Comune di Bologna (Assessorato alla Sanita)

and by

Magnetherapy Inc.
to publish the Program & Registration.

W/L Associates, Ltd.
7519 Ridge Road
Frederick, MD 21702-3519, USA
Tel: 301-663-1915/Fax: 301-371-8955