

**4th. INTERNATIONAL CONFERENCE
SOLAR ENERGY STORAGE AND
APPLIED PHOTOCHEMISTRY
Cairo, EGYPT
1-6 January 1997**

A
I
N
S
H
A
M
S
U
N
I
V
E
R
S
I
T
Y



19970506 060



ph r n t m i m w

OTIC QUALITY ENGRAVED

Changes with rays of light

BOOK OF ABSTRACTS

DECLARATION STATEMENT A

Approved for public release
Distribution Unlimited

4th International Conference on
**SOLAR ENERGY STORAGE AND APPLIED
PHOTOCHEMISTRY**

1-6 January 1997, **CAIRO, EGYPT**

BOOK OF ABSTRACTS

M. S. A. ABDEL-MOTTALEB (EDITOR)

ORGANIZED BY

DHC QUALITY INSPECTED 3

PHOTOENERGY CENTER

IN COOPERATION WITH THE DEPARTMENT OF CHEMISTRY

FACULTY OF SCIENCE, AIN SHAMS UNIVERSITY

<THE ABSTRACTS ARE REPRODUCED DIRECTLY FROM>

<TYPESCRIPT SUPPLIED BY AUTHORS>

FORWARD

Dear Friends and Colleagues,

**WELCOME TO
THE 4TH INTERNATIONAL CONFERENCE ON
SOLAR ENERGY STORAGE AND APPLIED PHOTOCHEMISTRY**

A some of 120 foreign photoscientists join over 180 of Egyptian scientists at this International Conference on Solar Energy Storage and Applied Photochemistry that held in Cairo on January 1 - 6, 1997.

The scientific program includes extended opening lectures followed by 50 other invited lectures and short talks. More than 70 poster presentations are also scheduled.

The research reported ranged from studies of fundamental processes in light-induced electron-transfer and energy-transfer reactions in homogeneous and heterogeneous media to the different practical use of photochemistry for the synthesis of chemicals, waste water treatments and degradation of industrial effluents that polluted global as well as local environment, atmospheric photochemistry, the treatment of tumors by lasers, solar fuel generation and many other important applications. The systems under investigation includes those of organic, inorganic, biological, theoretical, electrochemical, solid state and surface chemistry.

We hope that the generality of the formal presentations and private conversations will stimulate important scientific ideas and establish a long lasting relationships among all participants.

We would like to take this opportunity in the presence of this national as well as international gathering in the occasion of this important scientific event that eagerly awaited by the scientific communities' worldwide, to give a brief overview that may be of interest for you, about Historical Background of this series of conferences that were initiated by Professor Abdel-Mottaleb and the members of his research group at Ain Shams University as well as at other Egyptian Universities:

The 1st. International Symposium and Workshop on
Molecular Mechanisms of Electron Transfer,
Basis of Solar Energy Storage
2 - 7 January 1991
Cairo (Sonesta Hotel, Heliopolis), EGYPT

The 2nd. International Conference on
SOLAR ENERGY STORAGE AND APPLIED PHOTOCHEMISTRY
[SOLAR '93]
6- 12 JANUARY 1993
CAIRO (Le Meridien Heliopolis), EGYPT

The 3rd. International Conference on
SOLAR ENERGY STORAGE AND APPLIED PHOTOCHEMISTRY
[SOLAR '95]
8 - 14 JANUARY 1995
CAIRO (Le Meridien Heliopolis), EGYPT

References:

- 1) *D Doepp and A Gilbert*, EPA Newsletter, No. 47, March 1993, pages 54-56 or IAPS Newsletter, Vol 16 (1), May 1993, pages 75-77
- 2) "Mechanisms of Photoinduced Electron Transfer"
Proceedings of the International Symposium and Workshop on Molecular Mechanisms of Electron Transfer, Basis of Solar Energy Storage Cairo, January 1991.
Proc. Indian Acad. Sci. (Chem. Sci.) Vol. 104, No. 2, April 1992.
(Special issue Guest Editors: *M S A Abdel-Mottaleb and M A El-Sayed*)
Editor V Krishnan.

All conferences attracted many eminent photoscientists from all over the world. Delegated were welcomed to Egypt and to the Conferences by dignitaries from the Egyptian Ministry of Education, Ministry of Scientific Research and the ASU. Starting from the 2nd conference this series of Conferences were held under the auspices of Mr. President *Hosny Mubarak* reflecting the commitments of the top Egyptian authorities towards the development of science and technology in Egypt through constructive international cooperation.

Starting from 1993, this series of Conferences was Organized by Photoenergy Center in cooperation with the Department of Chemistry, Faculty of Science. They were sponsored by many local as well as international organizations and institutions, such as:

Ministry of High Education, Ministry of Petroleum, Ministry of Agriculture, Ministry of Foreign Affairs, Ministry of International Cooperation, Ministry of Scientific Research, Cairo Governorate, Egyptian Environment Affairs Agency (Cabinet of Ministries), Supreme Council of the Universities, Egyptian Academy of Science and Technology, ICS and ICTP, Trieste, Italy and European Research Offices ERO in London.

The Egyptian scientific community realizes that it is of utmost importance to establish modern institutions and laboratories where young scientists and technologists have access to diversified and advanced techniques and to the frontiers of science development. For this reason, and because of our successful international activities in the field of Photochemistry, the Egyptian Government responded favorably to the proposal from *Ain Shams University (ASU)* based on the project document submitted by *Abdel-Mottaleb* and offered substantial financial contribution through the Ministry of International Cooperation to establish a science and technology center for PHOTOENERGY. The center of PHOTOENERGY is physically located in a separate building (READY FOR USE) at the Faculty of Science within ASU Campus. This center will be involved in education and training as well as in pure and applied research in photochemical processes and Solar Chemistry, their realistic industrial applications and their environmental implications.

The Photoenergy Center will serve as a national as well as international Center of excellence to promote and stimulate high - level research for the development of science - based technologies. In particular, the objectives and activities of the PHOTOENERGY Center are to support training, research and development programs aimed towards an understanding of the aspects of the realistic applied photochemical research activities and utilization in main areas of importance to sustainable development that includes environmental sciences, photocatalysis, photo degradable polymers and new materials.

The Center will provide conditions and structures (utilization of new instruments and techniques) for the professional promotion of scientists and technicians. Thus, the Center will make its facilities available for photochemists and photoscientists, in general, in other branches of Egyptian research establishments. It will also offer its assistance to establish industries, e.g. the stability of pigments, dyes used in the Ceramics and large textile industries now present in Egypt.

3) "Solar Energy and Applied Photochemistry"

Proceedings of the Second International Conference on Solar Energy Storage and Applied Photochemistry, Cairo, January 1993.

Proc. Indian Acad. Sci. (Chem. Sci) Vol. 105, No. 6 December 1993.

(Special issue, Guest Editors *M S A Abdel-Mottaleb* and *M A EL-Sayed*)

Editor *V Krishnan*.

Furthermore, the major task of the Center is to conduct basic as well as realistic applied research to develop solar energy storage and conversion systems that use sunlight directly for:

- 1- production and development of small equipment for photocatalytic degradation (destruction and transformation) of toxic substances and pollutants (detoxification of pollutants by photocatalytic 'photo-oxidation' effects 'using sunlight') including waste water treatment, water purification for re-use e.g. in irrigation.
- 2- photovoltage generation using new materials (semiconductors and some pigments and dye systems) which have potential applications in solar energy conversion.
- 3- production of valuable chemicals of pharmaceutical and agrochemical potentials using bacterial active centers (selective photosynthesis) as well as the clean synthesis of effect chemicals. The emphasis would be to use photochemistry as the key clean-technology step. Efforts should be directed to identifying and exploiting the potential of photochemical reactions. The ultimate aim would be to use sunlight to induce the reactions (i.e. factories without chimneys).
- 4- production and testing of solar energy materials: solar energy collectors and concentrators e.g. luminescent solar concentrators "LSC" for photovoltaic cells, storage and converters. This also includes photocatalysis for hydrogen production (Future fuel).
- 5- Solar thermal applications; power generation, ... etc.

Education, training and Knowledge Transfer (know - how) will be one of its major duties to initiate graduate degree programs and training programs in photochemical sciences for established industrial scientists from Egypt and developing countries to assist develop potential chemistries. Short courses and seminars in the fields of photochemistry, photophysics, laser and its environmental and production of new materials and possible medical applications sponsored by the Center are also included and particularly aimed at industrial scientists. These courses will be taught by Center faculty and invited lecturers from other international universities and corporations. The Center will also organize biannual Conferences to bring together members of the international community of photoscientists to share insights and expertise and to increase the awareness and interest in studying applied photochemical sciences. This will provide a vital link between academia and industry. The first major function of the Center was the organization of the 3rd International Conference on Solar Energy Storage and Applied Photochemistry, Cairo 8- 14 January 1995. The conference was very successful. Forty eminent photoscientists from all over the world delivered up to date lectures. The Conference attracted a sum of 300 scientists from 20 countries. A special meeting of the International Advisory and Scientific Committee was held on January 12, 1995 during the Conference to review and plan the future activities of the Centre.

Current activities of the Center are:

4) "Applied Photochemistry"

Proceedings of the 3rd. International Conference on Solar Energy Storage and Applied Photochemistry, Cairo, 6 - 12 January 1995.

Proc. Indian Acad. Sci. (Chem. Sci) Vol. 107, No. 6 December 1995.

(Special issue, *Guest Editor M S A Abdel-Mottaleb*)

Editor V Krishnan.

5) B M Uzhinov and S I Druzhinin. EPA Newsletter, No. 53, March 1995, pages 39-42 or IAPS Newsletter, Vol 18 (1), May 1995, pages 18 - 20.

1- The center is currently engaged in a research project on Silicon optoelectrodes (Corrosion and optostability) for solar applications and electronic fabrication. The project is financially supported by the European Community (EC). Partners are from France (CNRS, Drs. M Etman and Gorshov, Ecole Polytechnique; Drs. J-N Chazalviel and F Ozanam), from England (Bath University, Prof. L Peter), Algeria and Egypt (ASU, Eng. Prof. H Ragaie).

2- Two other projects were submitted to the EC within the MED-Techno Program and to CIDA program of Canadian Government.

3- The organization of the 4th. International Conference on Solar Energy Storage and Applied Photochemistry.

Funding: To date, the project of the PHOTOENERGY Center has received financial support from the Egyptian Government amounting to LE 2 millions (about \$600,000 US) and procedures are underway to secure a further donation (from the Donor Countries) to meet the total requirements of the activities of the Center in its first phase (estimated at \$3 millions US for three years).

Furthermore, the German Government agreed to offer technical/financial assistance to the Center for 1996/1997. Procedure are underway to make use of the German donation.

Ain Shams University (under Professor A. M. Abdel-Hafez, President) managed to offer (through the Ministry of Planning from foreign donations) about LE 900,000 (about \$270,000 US) and also offered the land for the building (about 400 square meter) that is ready now for use.

Infrastructure (Facilities Available): Initial infrastructure facilities required for education, training & research had been established. The facilities available are:

[A] Fast Kinetics:

(I) LIFETIME-TIME RESOLVED SPECTROSCOPY SYSTEM (EDINBURGH)

Time Correlated Single Photon Counting (TCSPC) luminescence life time decay spectrometer. Moreover, singlet oxygen high sensitive Ge detector is also available for medical as well as environmental applications and semiconductor investigations.

(II) DIODE ARRAY (MULTICHANNEL) SPECTROMETER (POLYTECH)

Adapted to fiber optics and thickness measuring system. Suitable for all possible types of applications: absorption (transmission, absorbency), reflection, emission with modules for covering wavelength range 260 - 1200 nm (UV/VIS/NIR).

[B] Photochemical Reaction Efficiencies for New Materials and Lasers:

(III) LIGHT SOURCES (PTI)

(IV) MONOCHROMATORS (PTI)

(V) QUANTUM YIELD DETERMINATION SYSTEM- QUANTACOUNT (PTI)

(VI) PHOTO REACTORS (ACE GLASS)

[C] Photodynamics and Electrochemical Stability of Semiconductors and New Materials:

(VII) POTENTIOSTATE/GALVANOSTAT (EG&G)

with capabilities to measure: cyclic Voltametry, chronoamperometry, double potential step chronoamperometry, controlled potential coulometry, square wave Voltametry, etc. Electrochemical analysis software.

(VIII) PHOTO CONDUCTIVITY SET-UP- Computer controlled.

(IX) Standard lab facilities including computer controlled viscometer and a complete lab of computers (LAN- a server and 8 workstations).

(X) A library is being established.

Organs: The Organs of the Center shall be:

(a) International Advisory Board.

(b) The Steering Committee.

(c) Associate members (About 25 scientists who will carry out research work to accomplish the objectives of the center).

The Steering Committee: The ASU, through the steering committee of the Center, is responsible for planning, operating and management of the Center. The members of the steering committee are from academia, national laboratories and industry. The ultimate responsibility for running the Center lies with its founder; the director, **Sabry Abdel-Mottaleb**.

It is greatly hoped that this Center will play an important role not only for promoting industrial photochemistry development in Egypt by transferring knowledge and skill in new technology but also to the well-being of all countries in the Middle East, Africa and other developing countries.

International Relationships: The Center has established excellent relationships with several international laboratories and institutions in Europe, North America and Japan. Specific collaborative research Agreements with the following laboratories are being established:

1. The University of Winnipeg, Canada.
2. Xerox Research Center of Canada.
3. Catholic University of Leuven, Belgium.
4. The Imperial College of Science, Department of Materials, UK.
5. The CNRS, Department of Chemical Sciences, France.
6. EPFL (Lausanne), Switzerland.
7. ICS, Trieste, Italy.

The Center wishes and is willing to cooperate in any scientific form with regional and international institutions and Centers. If you are interested, please contact us at your earliest convenience.

Once again welcome to the Conference and to Egypt at the beginning of the year 1997 and on behalf of the Organizing Committee, we wish you all a very pleasant stay in Cairo and a very stimulating and enjoyable scientific and social programs as well as a very Happy and a successful New Year 1997.

Yours Sincerely,

Abdel-Hafez, M. A.
President, A.S.U.



Rabei, A.
Dean, Fac. Science



Sabry Abdel-Mottaleb
Director, hv CENTER



ACKNOWLEDGMENTS

The Organizing Committee wishes to thank deeply the following organizations for their financial and moral support:

Ministry of High Education, Ministry of Agriculture, Ministry of Foreign Affairs Ministry of International Cooperation, Ministry of Scientific Research, Ministry of Public Sectors and Environmental Affairs (Cabinet of Ministries), Supreme Council of the Universities, Egyptian Academy of Science and Technology, ICS and ICTP, Trieste, Italy and European Research Office (ERO) of USA Army in U.K..

ABSTRACTS

FLUORESCENCE AND ENERGY TRANSFER IN SOLUBLE, ELECTROSYNTHESIZED HETEROCYCLIC OLIGOMERS

K. TAHA-BOUAMRI^a, M. FALL^b, J. J. AARON^a, M. DIENG^b, S. AEIYACH^a, M. JOUINI^a
and P. C. LACAZE^a.

Institut de Topologie et de Dynamique des Systèmes de l'Université Paris 7 - Denis Diderot,
associé au CNRS (URA 34), 1, rue Guy de la Brosse 75005 Paris.

^bDepartement de Chimie, Faculté des Sciences et Techniques, Université C. A. Diop, Dakar,
Sénégal.

In recent years, luminescence spectroscopy has been used to gain information on the structural and redox properties of electrogenerated polymers¹⁻¹³. Most of these studies concerned the effect of microstructural changes and /or electrochemical doping of polythiophene^{3,4} poly(N-vinycarbazole)⁶ and poly(paraphenylene)⁷⁻⁹ films on their fluorescence spectral properties. In contrast, little research effort has been devoted to the luminescence of soluble, conducting polymers, such as substituted poly(3,4-methylene-dioxybenzenes)¹⁰, poly(2-methoxy-5-alkoxy paraphenylenes)¹¹, poly [β -2(1-adamantyl)-2-oxo-ethoxy] naphthalene]¹² and poly[(1-methylene 2-methylnaphthalene)-N-pyrrole]¹³, showing mainly formation of excimers in organic solutions.

In the present work, we report on the fluorescence properties and energy transfer in the case of two types of soluble, electrosynthesized heterocyclic oligomers, including poly(3-methoxythiophene) (PMT) and poly[(1,2-(methylenedioxy) benzene] (PMDB).

The fluorescence emission maxima of PMT (8.8×10^{-5} mol r.u. L⁻¹ in dimethyl sulfoxide solution) and PMDB (4×10^{-6} mol r.u. L⁻¹ in dimethyl sulfoxide solution) are very strongly red shifted ($\Delta\lambda \approx 70 - 210$ nm, according to the compound), relative to those of the corresponding monomers, probably due to the formation of excimer-like, interchain associations in the singlet excited state.

In the case of PMDB, a significant quenching of the fluorescence signals(I_F) occurs in the presence of quencher (Q) molecules such as dimethyl terephthalate, potassium iodide and thallium acetate. The statistical treatment of the function $I_F / I_F^Q = f([Q])$ shows that our data obey the STERN-VOLMER relationship. The values of quenching bimolecular rate constants obtained for PMDB are discussed in terms of energy transfer and electronic energy migration through the repeat units of this soluble oligomer.

Acknowledgements. The financial support of this work by a grant (Campus projet 94/1387) of the french Ministry of Cooperation is gratefully acknowledged. One of the authors (M. Fall) thanks AUPELF-UREF for a grant (Bourse d'Excellente 1994/95) supporting this work.

REFERENCES

- (1) P. V. KAMAT, *Anal. Chem.*, 59, 1636 (1987)
- (2) P. V. KAMAT and S. GUPTA, *Polymer*, 29, 1329 (1988).
- (3) S. HAYASHI, K. KANETO and K. YOSHINO, *Solid State Commun.*, 61, 249 (1987).
- (4) J. L. SAUVAJOL, D. CHENOUNI, J. P. LERE-PORTE, J. CHORRO, B. MOUKALA and S. PETRISSANS, *Synthetic Metals*, 38,1 (1990).
- (5) S. M. OH and L. R. FAULKNER, *J. Am. Chem. Soc.*, 111, 5613 (1989).
- (6) S. BALAEILANGROODI, A. DESBENE-MONVERNAY, J. J. AARON and P. C. LACAZE, *Polymer*, 29, 929 (1988).
- (7) J. J. AARON, S. AEIYACH and P. C. LACAZE, *J. Lumin.*, 42, 57 (1988).
- (8) P. SOUBIRAN, S. AEIYACH, J. J. AARON, M. DELAMAR and P. C. LACAZE, *J. Electroanal. Chem.*, 215, 89 (1988).
- (9) W. GRAUPNER, S. EDER, M. MAURI, G. LEISING and U. SCHERF, *Synth. Metals*, 69, 419 (1995).
- (10) Y. BELABBES, J. J. AARON, MIR-HEDAYATULLAH, S. AEIYACH and P. C. LACAZE, *J. Lumin.*, 48/49, 359 (1991).
- (11) T. EL MOUSTAFID, S. AEIYACH, J. J. AARON, MIR-HEDAYATULLAH and P. C. LACAZE, *Polymer*, 32, 2461 (1991).
- (12) S. AEIYACH, T. EL MOUSTAFID, J. J. AARON, MIR-HEDAYATULLAH and P. C. LACAZE, *New J. Chem.*, 17, 287 (1993).
- (13) D. GNINGUE-SALL, A. KONE, J. J. AARON, S. AEIYACH, MIR-HEDAYATULLAH and P. C. LACAZE, *Synth. Metal.* in press.

SOLVENT EFFECTS ON THE ELECTRONIC ABSORPTION AND FLUORESCENCE SPECTRA OF CURCUMINDOID DYES: A COMPARISON OF THE GROUND AND FIRST EXCITED STATE DIPOLE MOMENTS.

J.J. AARON and M. BUNA

Institut de Topologie et de Dynamique des Systèmes, Université Paris 7 - Denis Diderot
1, rue Guy de la Brosse, 75005 Paris, France.

C. PARKANYI and R. BARTOLOMEO

Department of Chemistry and Biochemistry, Florida Atlantic University, 777 Glades Street,
P.O. Box 3091, Boca Raton, FL 33431-0991, USA.

F. ARRIETA, Fachbereich Informatik, Mathematik und Naturwissenschaften, Hochschule für
Technik, Wirtschaft und Kultur Leipzig (FH), Postfach 30066, D-04251 Leipzig, Germany.

The spectroscopic properties of the naturally occurring dye curcumin and related curcuminoids have been recently investigated.¹ In the present communication, the electronic absorption and fluorescence spectra of curcumin [1,1,7-bis-(4-hydroxy-3-methoxyphenyl)-1,6-heptadiene-3,5-dione] and its parent compound dicinnamoylmethane (2,1,7-diphenyl-1,6-heptadiene-3,5-dione) were measured at room temperature in solvents of different polarity. Using the experimental ground state dipole moments of 1 and 2, the solvatochromic shift method^{2,3} was applied to obtain their first excited singlet-state dipole moments; both sets of values were compared. The theoretical ground and first excited singlet-state dipole of 1 and 2 were calculated by a combination of the PPP method (π -component) and the σ -contribution (σ -bond moments) and compared with the experimental values.

References

1. H.H. TONNESEN, A.F. ARRIETA and D. LERNER, *Pharmazie*, **50**, 689 (1995).
2. C. PARKANYI, C. BONIFACE, J.J. AARON, M.D. GAYE, L. Von SZENTPALY, R. GHOSH and K.S. RAGHU VEER, *Struct. Chem.*, **3**, 277 (1992).
3. J.J. AARON, M. BUNA, C. PARKANYI, M.S. ANTONIOUS, A. TINE and L. CISSE, *J. Fluorescence*, **5**, 337 (1995).

The Role of Photochemical Demetallation of Organometallic Complexes in Polymer Synthesis

Alaa S. Abd-El-Aziz*, Christine R. de Denus, Karen M. Epp, Khanh Tran,
Lisa Stewart, Andrea White and Waleed E. Boraie.

Department of Chemistry, University of Winnipeg,
Winnipeg, Manitoba, Canada R3B 2E9

Our recent focus has been directed towards the synthesis and reactivities of oligomeric and polymeric ether and thioether compounds.¹ Photolytic demetallation of the oligomeric organometallic complexes provided a viable route to organic ether and thioether compounds in very good yield. These compounds were then polymerized using the Scholl reaction or ring-opening metathesis polymerization. The Scholl reaction was used for the polymerization of monomers capped with naphthol or thionaphthol groups leading to the formation of the polymeric materials. Ring-opening polymerization was implemented when cyclic alkenes were incorporated into the monomeric units. In these reactions, a number of catalysts were used to provide the polymers. The following figure represents two examples of these polymers. Functionalization of the monomeric or the polymeric materials may be achieved via nucleophilic addition or substitution reactions where the metal was pendant to the arene rings. Full experimental and characterization details will be presented.

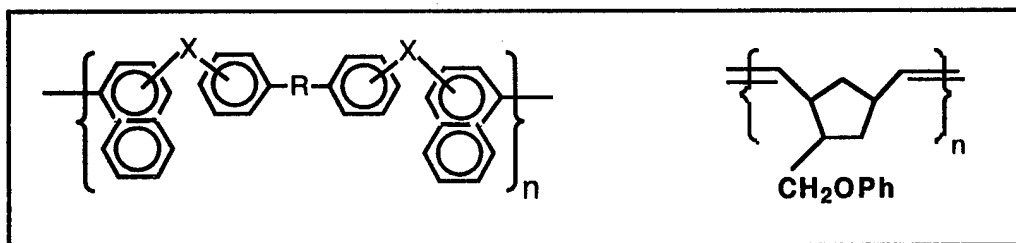

- (a) Abd-El-Aziz, A.S., de Denus, C.R., Zaworotko, M.J. and MacGillivray, L.R., *J. Chem. Soc., Dalton Trans.* **1995**, 3375.
(b) Abd-El-Aziz, A.S., Epp, K.M., de Denus, C.R., Fisher-Smith, G., *Organometallics*, **1994**, 13, 2299.
(c) Abd-El-Aziz, A.S., Armstrong, D.A., Bernardin, S., Hutton, H.M., *Can. J. Chem.*, accepted for publication.

Photoinduced Graft Copolymerization of Isobutyl Methacrylate onto Ethyl Cellulose in Homogeneous Media

By

E.A. Abdel-Razik , M.M. Ali , M.I. Ahmed and E.M. Abdel-Bary
Chemistry Department, Faculty of Sci., Mansoura University
Mansoura, Egypt

Abstract

Homogeneous photoinduced graft copolymerization of isobutyl methacrylate (IBMA) onto ethyl cellulose (EC) in presence of ammonium persulphate (APS), potassium persulphate (KPS) and azobisisobutyronitrile (AIBN) as photoinitiators was investigated in benzene/DMSO (3/1 v/v) for persulphates and benzene only for AIBN. The UV spectra of APS, KPS and AIBN showed higher absorption in the near UV region. UV irradiation in the range between 310-460 nm was used. Various parameters effect on graft yield (GY) such as time of UV irradiation as well as concentrations of ethyl cellulose, isobutyl methacrylate and initiator were extensively studied. The increase in sulphuric acid content was found to increase the GY in presence of APS. The homopolymer percent decreases in presence of the mentioned photoinitiators as in the order: APS > KPS > AIBN. The highest rates of graft copolymerization of IBMA onto EC in presence of AIBN, KPS and APS were found to be 0.26 % min⁻¹, 0.184 % min⁻¹ and 0.138 % min⁻¹ respectively. Thus, the activity of the used photoinitiators for increasing GY is as follows: AIBN > KPS > APS. A suitable mechanism for photoinduced grafting reaction and according to the obtained results is discussed.

A NEW DESIGN OF SOLAR WATER HEATER

ZEINAB SAYED ABDEL REHIM

Mechanical Engineering Department

National Research Center, Dokki, Cairo, EGYPT

ABSTRACT

This investigation presents a new design of solar water heater as a frustum of pyramid shape. The proposed design is compact system which collectors and water storage tank are integrated together into one unit. The concept of using the frustum of pyramid as external shape for collecting the solar radiation and as a container for hot water storage tank will be presented. The frustum of pyramid solar water heater has five surfaces, four surfaces represent liquid flat-plate collectors as roof and three sides which received all the solar radiation incident on them. The roof and one of the sides facing the south direction but the other sides facing the south-east and south-west directions, respectively. The three sides tilted the horizontal plane with 30° while the roof tilted with 15° . The total surfaces area of the collectors is about of 1.68 m^2 and the capacity of the water storage tank is about 150 liters. The absorber consists of copper tubes formed as serpentine shape which are connected to the tank by two openings (inlet & outlet). A regulator is connected to the piping line to control the hot water consumption and the reverse flow after the sunset. The thermal analysis of the liquid flat-plate collector and the performance of the solar water heater are derived based on the steady state analysis. The comparison between the compact unit and another one type which has an elevated tank is done.

The results show that the proposed solar water heater gives a good performance and can provide a quantity of hot water of about 175 liters/day at an average temperature ranges from $40^\circ - 60^\circ \text{ C}$ depending on the weathering conditions and solar intensity.

A NEW DESIGN OF SOLAR WATER HEATER

ZEINAB SAYED ABDEL REHIM

Mechanical Engineering Department

National Research Center, Dokki, Cairo, EGYPT

ABSTRACT

This investigation presents a new design of solar water heater as a frustum of pyramid shape. The proposed design is compact system which collectors and water storage tank are integrated together into one unit. The concept of using the frustum of pyramid as external shape for collecting the solar radiation and as a container for hot water storage tank will be presented. The frustum of pyramid solar water heater has five surfaces, four surfaces represent liquid flat-plate collectors as roof and three sides which received all the solar radiation incident on them. The roof and one of the sides facing the south direction but the other sides facing the south-east and south-west directions, respectively. The three sides tilted the horizontal plane with 30° while the roof tilted with 15° . The total surfaces area of the collectors is about of 1.68 m^2 and the capacity of the water storage tank is about 150 liters. The absorber consists of copper tubes formed as serpentine shape which are connected to the tank by two openings (inlet & outlet). A regulator is connected to the piping line to control the hot water consumption and the reverse flow after the sunset. The thermal analysis of the liquid flat-plate collector and the performance of the solar water heater are derived based on the steady state analysis. The comparison between the compact unit and another one type which has an elevated tank is done.

The results show that the proposed solar water heater gives a good performance and can provide a quantity of hot water of about 175 liters/day at an average temperature ranges from $40^\circ - 60^\circ \text{ C}$ depending on the weathering conditions and solar intensity.

Intra- and Intermolecular Energy and Electronic Transfer in Bichromophoric Molecules

A. A. Abdel-Shafi, M. S. Antonious, M. S. A. Abdel-Mottaleb,
Department of Chemistry and Photoenergy Center, Faculty of Science,
Ain Shams University, Abbassia, Cairo, Egypt.

C. R. de-Denus, and A. S. Abd-El-Aziz
Department of Chemistry, The University of Winnipeg, Winnipeg, Canada.

The evaluation of the rate constant of the intramolecular step in excited state interactions in bichromophoric systems is crucial to understand the role of various molecular parameters in determining reaction rates. The macromolecular systems allow the study of the effects of distance and driving force on electron and energy transfer rates and give a valuable opportunity for testing theoretical models. The studied bichromophore 1-naphthoxy-1'-phenoxy diphenyl ether (I) was subjected to a number of spectroscopic studies to elucidate the intramolecular as well as intermolecular (exciplex) interactions.

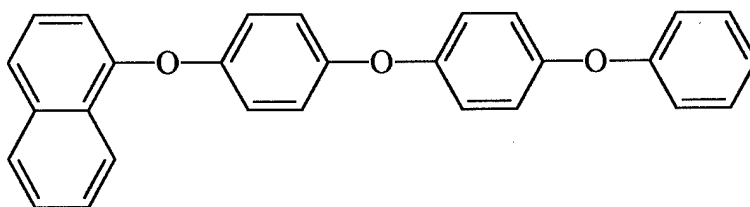

(I)

In this work, we report on preliminary photophysical studies (lifetime fluorescence kinetics, stationary fluorescence measurements, etc.) of molecule (I). The intra-molecular energy transfer rate constant was measured relative to the reference donor (benzene) in ethyl acetate by following the decay of the donor and rise and decay of the acceptor at their emission maxima respectively using single photon counting technique. The observed fluorescence decay profiles were found to fit well by a biexponential function. The possibility of the folded geometry of the studied bichromophore, enables the approach and overlap of the π -orbitals of benzene and naphthalene moieties through space and hence energy transfer occurs. The results could be explained on the bases of either through bond or through space intramolecular energy transfer. Further studies are in progress using single photon counting technique.

**Imperatorin, Alloimperatorin and
Alloimperatorin Acetate Hydroperoxides as
Natural Efficient Photochemical Hydroxy Radical
Generators. As the Novel DNA-Cleaving Agents**

E.M. Elgendy^a and M.M. Abou-Elzahab^b

^a) Department of Home Economy, Faculty of Specific

Education, Mansoura, Egypt

*^b) Department of Chemistry, Faculty of Science, Mansoura
University, Mansoura, Egypt*

The photolysis of imperatoin hydroperoxide derivative (1) in benzene gave isogosferol (2), isogosferone (3) and phenol. The hydroxy photoproduct (5) was obtained through the photo-irradiation of alloimperatorin acetate hydroperoxide derivative (4). Also, the photolysis of alloimeratorin hydroperoxide derivative (6) gave the hydroxy photoproduct (7).

**INCLUSION OF AZULENE BY β - AND γ -CYCLODEXTRINS: FORMATION OF
STABLE DIMERS IN AQUEOUS SOLUTION AND IN
A LOW TEMPERATURE GLASS**

Osama K. Abou-Zied and Gary W. Scott

Department of Chemistry, University of California, Riverside

Riverside, California 92521

Azulene (Az) is found to form inclusion complexes with β - and γ -cyclodextrins (CD). The inclusion of azulene into the cavity of either CD is axial, and the stoichiometry is 1:1 at low concentrations of CD. This result was inferred from uv absorption and ^1H -NMR spectra (the latter in D_2O), as well as the induced circular dichroism. From the ^1H -NMR and circular dichroism results it is deduced that Az rotates freely inside the γ -CD cavity due to the large cavity size. As the concentration of either CD increases over ten fold that of Az, the changes in absorption and ^1H -NMR spectra, as well as the measured fluorescence spectra at 100 K in a glycerol-water glass, all suggest the inclusion of two Az molecules inside the cavity of β -CD and γ -CD to form a stable dimer. The dimer configuration is calculated using Lennard-Jones (6-12-1) atom-atom potential functions and is found to be "head-to-tail", stabilized by dipole-dipole interactions between the two polar Az molecules.

EFFECTS OF VARIOUS SALTS ON THE SPECTRAL PROPERTIES OF MEROCYANINE 540, A FLUORESCENT PROBE, IN AQUEOUS MEDIA

Alain ADENIER, Fabrice DUVILLE and Jean-Jacques AARON

Institut de Topologie et de Dynamique des Systèmes (associé au C.N.R.S-URA 34), Université Paris 7 Denis Diderot, 1 rue Guy de La Brosse, F-75005 Paris, France.

Merocyanine 540 (MC-540), an anionic fluorescent dye, has been used as a photosensitizer in the photographic industry¹ as well as an external biological probe in the staining of various cellular membranes²⁻⁵ and in the phototreatment of human cancer cells⁶⁻⁸.

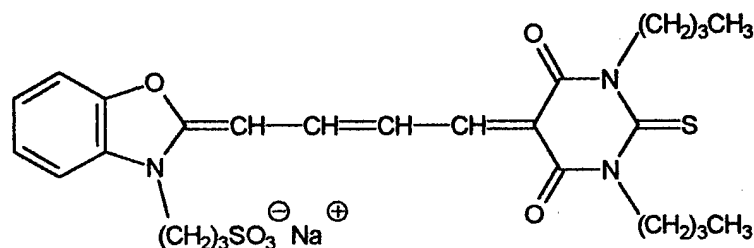

MC-540

In previous studies on MC-540, we have investigated the solvent and concentration effects on its electronic absorption and emission fluorescence spectra^{9,10}. The aim of the present study was to determine the effects of various inorganic salts on the photophysical properties of MC-540, in view of the use of this fluorescent probe for biological and

analytical applications. The electronic absorption and fluorescence excitation and emission spectra of MC-540 were recorded at 298 K in aqueous solutions and in the presence of various concentrations of salts, including sodium, potassium, calcium and magnesium chloride, sodium bromide, sodium iodide, magnesium sulfate and erbium acetate. Spectral shifts and various types of fluorescence quenching were observed, depending of the nature and concentration of the ions under study. An interpretation of these effects is proposed, leading to the possibility of using MC-540 as a selective means of detection of inorganic ionic species in aqueous media.

REFERENCES

1. Hamer F.M. « The Cyanine Dyes and Related Compounds ». 1964; John Wiley & Sons, New York.
2. Dragsten P., Webb W. Biochemistry . 1978; 17: 5228.
3. Lelkes P., Miller R. J.Membrane.Biol. . 1980; 52: 1.
4. Verkman A.S., Frosch M.P. Biochemistry . 1985; 24: 7117.
5. Verkman A.S. Biochemistry . 1987; 26: 4050.
6. Sieber F. Photochem.photobiol. 1987; 46: 1035.
7. Sieber F. Bone Marrow Transpl. 1987; 2: 29.
8. O'Brien J.M., Montgomery R.R., Burns W.H., Gaffney D.K., Sieberg F. J. Lab. Clin.Med. 1990; 116: 439.
9. Adenier A., Aaron J.J., Parkanyi C., Deng G., Sallah M., Heterocycl.Commun., in press.
10. Parkanyi C., Adenier A., Aaron J.J., « Analytical Use of Fluorescent Probes in Oncology », Kohen, ed., 1996, 371, Plenum Press, New-York

CHARGE RECOMBINATION OF PHOTOSYNTETIC REACTION CENTERS IN DIFFERENT MEMBRANE MODELS

Angela Agostiano

Dipartimento di Chimica, Università di Bari,

via Orabona 4, 70126 Bari, ITALY

Photosynthetic reaction centers from *Rhodobacter sphaeroides* were reconstituted in phospholipid vesicles, reverse micelles and organogels. The light-dark spectra showed that the photochemical activity of the reaction center was retained in all the systems examined.

The kinetics of charge recombination between the primary photo-oxidized electron donor (P^+) of the reaction center and the primary (Q_A^-) and secondary (Q_B^-) quinone acceptors were investigated by time-resolved absorption spectroscopy. Kinetic analysis of flash-generated P^+ decay demonstrated that the light-induced charge separation involved Q_B .

In all the lipid systems examined (proteoliposomes, hexane extract, organogel) the recombination kinetics of the charge separated state $P^+Q_B^-$ never fits to a single exponential decay. To account for the multiphasic kinetics observed, multiple conformational states of the reaction center (possibly determined by local heterogeneity of the lipid systems) are considered. An alternative (or additional) factor, affecting the recombination kinetics of the $P^+Q_B^-$ state is the exchange interaction of the excess quinone with the Q_B binding site.

The dependence of the kinetics parameters from the quinone concentration and lipid composition in reverse micelles and organogels has been studied. The influence of the viscosity has been also considered.

To account for the observed multiphasic kinetics, the influence of system microstructure is examined and the ^{31}P -NMR spectra of the different RC hosting systems are reported, in a first attempt of a structural characterization of the phospholipids microenvironment in which the RC is embedded.

The Coupling of Photoisomerization Processes and Chromatography Separation

S. Akhlu, C. Zetzi, D. Barth, M.L. Viriot

GRAPP/DCPR and LTS, Ecole Nationale Supérieure des Industries Chimiques, F-54001 Nancy, France

R.M. Nicoud

NOVASEP, 15 rue du Bois le Duc, F-54500 Vandœuvre Les Nancy, France

J. Masselink

SOLVAY Health, NL-1320 Weesp, The Netherland

Abstract

The photoisomerization is an important process in the industrial photochemistry, one of the problems in these processes is a yield of photoisomerization reaction which produce the desired isomer (for example $A \rightleftharpoons B$) mostly limited by thermodynamics equilibrium state. Due to increase the continuous production of desired isomer and even to shift the chemical equilibrium, we present here an application of the Simulated Moving Bed Chromatography coupling with a photochemical reactor.

The coupling between a photochemical reactor and a Simulated Moving Bed Chromatography can be called Irradiated-Simulated Moving Bed System. In this system, the reactant (A) is introduced in the middle of the moving bed and the concentration front of the reactant is stabilized in the reactive zone. The conversion product (B) is immediately transported out of the reactive zones as a result of different adsorption isotherm, the pure product stream leaves the system at the raffinate outlet (see figure 1).

The countercurrent movement of the chromatographic phase can be simulated by a cyclic connection of different modules (each module consist of one photoreactor and one fixed bed column), whereby the inlet and-outlet points are periodically shifted in the same direction as the fluid phase (see figure 2).

The numerical modeling results verified by a laboratory experiments showed that this system can be realized.

1. C. Ching, D. Ruthven, *Chem. Eng. Sci.*, 44 (1989), 1011-1038.
2. G. Ganetsos, P.E. Barker, *Preparative and Production Scale Chromatography, Chromatographic Science Series*, Vol 61, Dekker Inc (1993), 375 - 394.

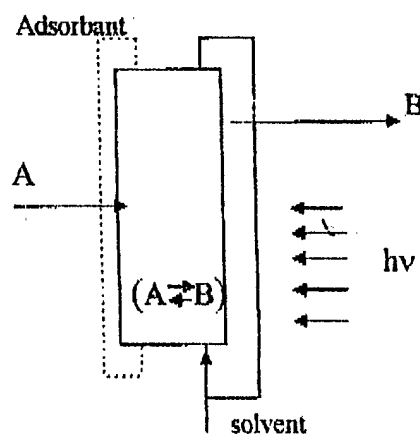

Figure 1: Irradiated Moving Bed

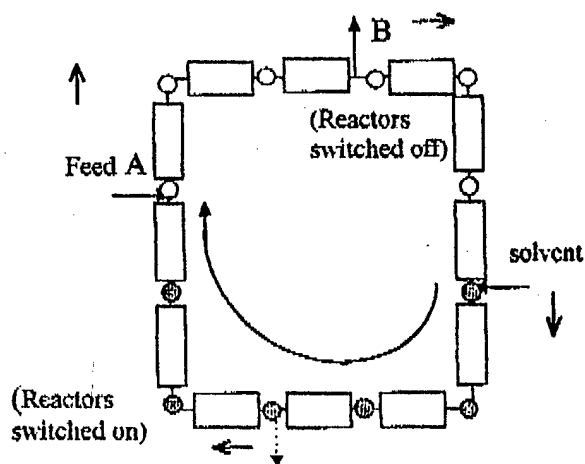

Figure 2: Irradiated Simulated Moving Bed

ADVANCES OF THE STEREOLITHOGRAPHY PROCESS TOWARDS MICROTECHNIQUES

A. Bertsch, S. Zissi, J.Y. Jézéquel, S. Corbel, S. Akhlus, J.C. André

GRAPP-DCPR, URA 328 et GdR 1080 CNRS,
ENSIC-INPL, 1 rue Grandville, B.P. 451, 54 001 Nancy Cedex, France

The laser stereolithography (SPL) is a process which allows the manufacture of 3D parts by light-induced space-resolved polymerization [1]. In view to manufacture microparts, it is necessary to reduce the number of mobile elements along the optical path. The irradiation light remains fixed, whereas in classical SPL, the laser beam is deflected by low inertia galvanometric mirrors.

Two new processes have been developed in our laboratory [2, 3].

The first one is based on vectorial tracing : the part is moved under a focalized laser beam. Its main advantage is to allow an irradiation light at any wavelength. However, a disadvantage comes from the very important increase of the light flux at the focus point. Then, it is necessary to place optical devices along the path and to add new chemicals to the reactive medium.

The second one allows to manufacture a complete layer by one irradiation only. This is obtained by placing a dynamic mask-generator along the optical path. At the output of this computer-controlled liquid crystal display, the laser beam « carries » the pattern of the layer to polymerize. Its main advantage is that the manufacture time of one layer is independent of its geometrical complexity. A disadvantage is that the irradiation light needs to be in the visible range. So we had to develop new photopolymerizable reactive media.

With the first process we manufactured parts composed of more than 20 layers having a simple 3D geometry with a typical resolution of $30 \times 30 \times 20 \mu\text{m}$ of the elementary polymerized volume. With the second one the typical resolution is $5 \mu\text{m}$ in the three space directions and we already manufactured 3D parts composed of more than 1000 layers having a complex geometry. The typical volume of these parts is about 1 mm^3 .

[1] J.C. André, S. Corbel, « Stéréolithographie laser », Ed. Polytechnica, Paris, 26-51 (1994).

[2] S. Zissi, A. Bertsch, J.Y. Jézéquel, S. Corbel, J.C. André, D.J. Loughnot, « Stereolithography and Microtechnologies », Micro. Tech., 2, 97-102, (1996).

[3] A. Bertsch, S. Zissi, J.Y. Jézéquel, S. Corbel, J.C. André, « Nouveau procédé de microstéréolithographie utilisant des filtrages dynamiques », Proceedings of the 4th european conference on rapid prototyping, Remark S.A., Ed., Paris, France, 12 p. (1995).

FLUORESCENCE PROBES FOR AMPHIPHILIC POLYMERS

M. Adibnejad¹, A. Benjelloun², C. Damas²,
M.C. Carré¹, A. Brembilla², S. Akhlus¹, M.L. Viriot¹, P. Lochon²

¹ DCPR(GRAPP) - URA 328 CNRS and ² LCPM - URA 494 CNRS
ENSIC-INPL, 1, rue Grandville, BP 451, 54001 Nancy Cedex, France

Cationic amphiphilic polymers (*e.g.* polyvinylpyridinium and polyvinylimidazolium bromides) adopt a compact coiled form in aqueous solutions, which can be detected by using polarity and/or viscosity sensitive fluorescent probes [1, 2, 3].

In this work, we report on a comparative study on the polarity, sensed by pyrene and a cinnamylidene molecular rotor, of hydrophobic microdomains resulting from intra and/or intermolecular associations of the cationic amphiphilic polymer (polyhexadecylvinylimidazolium bromide) in an aqueous medium. The polarity of the aggregated polymer is compared for the two probes with that of conventional surfactants, HMIB (3-hexadecyl-1-methylimidazolium bromide) an analogue of the polymer repetitive unit or the widely used surfactant CTAB (cetyltrimethylammonium bromide).

The good agreement between the informations obtained with each probe leads us to put trust in the results relative to the use of the molecular rotor alone, as for polyhexadecylvinylpyridinium bromide and its analogous model surfactant HEPB (1-hexadecyl-3-ethylpyridinium bromide), for which pyrene cannot be used because of fluorescence quenching by long alkyl chain quaternized pyridine rings.

Then, by using the molecular rotor for the two types of polymers, their analogous surfactants and CTAB, we can compare the influence of the polar head group nature and the type of aggregates (micelles or polymer microdomains) on the polarity value estimated by the wavelength at the maximum of emission, $\lambda_{f \max}$. Moreover, the variation of the relative fluorescence efficiency Φ_f/Φ_{f0} (where Φ_{f0} and Φ_f represent respectively the fluorescence quantum yield in water and in the aggregated system) indicates also the formation of either micelles or polymer microdomains and their respective local viscosity.

- [1] C. Damas, A. Brembilla, F. Baros, M.L. Viriot, P. Lochon, *Eur. Polym.*, **30** (1994), 1215-1222
- [2] C. Damas, A. Brembilla, P. Lochon, F. Baros, M.L. Viriot, *Polymer*, **36** (1995), 2095-2101
- [3] A. Benjelloun, A. Brembilla, P. Lochon, M. Adibnejad, M.L. Viriot, M.C. Carré, *Polymer*, **37** (1996), 879-883

A New Coumarin Laser Dye

3-(Benzothiazol-2-yl)7-hydroxycoumarin (BTHC)

by

Sadiq M. Al-Hazmy

(Department of Chemistry, Faculty of Science, Sana'a University, Sana'a, Yemen)

J. Sauter and E. Daltrozzo

(Fakultat für Chemie, Universität Konstanz, Germany)

E.M. Ebeid

(Department of Chemistry, Faculty of Science, Tanta University Tanta Egypt)

Current address: Misr University of Science and Technology, 6th of October City (MUST), Egypt.

In continuation of the program of studying some new laser active dye systems, electronic absorption, emission and excitation spectra of 3-(Benzothiazol-2-yl)7-hydroxycoumarin (BTHC) were recorded.

The fluorescence (ϕ_f) and photochemical (ϕ_c) quantum yields were measured. It was found that ϕ_f increases with increasing solvent polarity. Likewise, BTHC absorption spectra are strongly affected by solvent where a red shift is observed upon increasing E_T of the solvent.

Ethanol as a base is basically enough to deprotonate the dye partially in a diluted solution. Addition of a diluted triethylamine (TEA) to an ethanolic solution of BTHC results in decreasing the extinction coefficient at the original peak (394nm) and increasing the absorption maxima associated with the deprotonated form. The fluorescence intensity thereby increases to reach a maximum at 0.4 % of TEA indicating the formation of highly fluorescent species.

The deprotonation is an irreversible process; the original absorption spectra is not regenerated by addition of strong acid to the deprotonated form.

The absorption spectra of a fresh and alkalized solution of BTHC in H₂O were measured.

BTHC in ethanol gives amplified spontaneous emission (ASE) maximum at about 500 nm. From the experimental results, the excited state absorption (ESA) occurs at around 540 nm.

Dye solutions in ethanol give laser emission around 508 nm. and 522 nm for the protonated form. The laser intensity increases with increasing concentration of the dye itself and also with increasing the percent of TEA as a deprotonator. The highest laser intensity is reached at 1.6 % of TEA.

The lifetime of BTHC is 2.82 ns and is not strongly influenced by the presence of molecular oxygen ($\tau = 2.78$ ns)

In diluted solution (1×10^{-5} mol dm⁻³) the absorption spectrum of the dye tautomer appears at low temperature. The normal low temperature effect is observed as structured vibronic bands either for the acidified or relatively neutral solutions in ethanol.

Quantum chemical calculations were performed and correlated to experimental data.

Emission Characteristics and Photostability of 9-Phenyl, 10-methoxyanthracene (PMA)

by

Sadiq M. Al-Hazmy

(Department of Chemistry, Faculty of Science, Sana'a University, Sana'a, Yemen)

E. Daltrozzo and Chr. Jost

(Fakultat fur Chemie, Universitat Konstanz, Germany)

S. A. El-Daly and E.M. Ebeid^a

(Department of Chemistry, Faculty of Science, Tanta University Tanta Egypt)

^aCurrent address: Misr University of Science and Technology (MUST), 6th of October City, Egypt.

9-Phenyl 10-hydroxyanthracene (PHA; 1a) was prepared and was found to exist almost totally in the tautomer (1b). The process of tautomerization was blocked by preparing the methoxy derivative (PMA; 2)

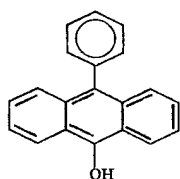

PHA

(1a)

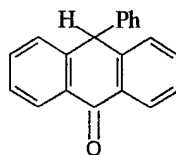

(1b)

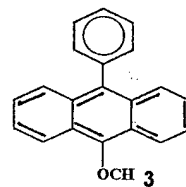

PMA

(2)

No change in the absorption pattern of PMA with solvent polarity was observed, whereas a small bathochromic shift was observed by increasing the solvent polarity.

The fluorescence efficiencies values (ϕ_f) of PMA have been measured in different media in addition to photochemical quantum yield (ϕ_c) and absorption and emission spectra. It was found that ϕ_f and the lifetimes (τ) increase upon increasing medium viscosity.

Molecular oxygen acts as a quencher of PMA fluorescence with a quenching rate constant in the range of $5 \times 10^{10} \text{ dm}^{-3} \text{ mol}^{-1} \text{ s}^{-1}$ in ethanol.

The low temperature absorption and emission spectra of PMA were measured. The fluorescence quantum yield increased sharply by lowering the temperature down to 80K and no significant structural change occurred.

The quenching rate constants of PMA by CCl_4 were measured using Stern-Volmer plots. A rapid deterioration of the PMA dye in halomethane solvents using 254nm excitation light was observed. The photodecomposition of PMA in different media including W/O and O/W microemulsion systems using 365 nm was also studied.

Photochemical and Spectral Behaviour of 3-(5-Phenyl-1,3,4-oxadiazol-2-yl)-7-hydroxycoumarin (POHC)

by

Sadiq M. Al-Hazmy

(Department of Chemistry, Faculty of Science, Sana'a University, Sana'a, Yemen)

K. Kassab

NILES. Cairo University, Cairo, Egypt

E.M. Ebeid

(Department of Chemistry, Faculty of Science, Tanta University Tanta Egypt)

Current address: Misr University of Science and Technology, 6th of October, Egypt.

The electronic absorption, emission and excitation spectra of POHC were measured in different solvents. Emission in glycerol represents an exception due to the effect of solvent viscosity.

The increase in solvent polarity in term of π^* solvent parameter results in a red shifts in absorption spectra. A red shift in both emission and absorption spectra is observed with increasing Richardt and Dimorth solvent parameter (E_T). The fluorescence quantum yield of POHC decreases with increasing (E_T) value of the solvent.

The position of the emission maximum is excitation wavelength dependent.

In dilute solutions POHC is almost totally present in its tautomer form. Further dilution or addition of a base (e.g. triethyl ammine ;TEA) results in deprotonation. The deprotonation is a reversible process. The original absorption is regenerated by addition of trifluoroacetic acid (TFA) to the alkalized ethanolic solution. The deprotonation of POHC by dilution is inhibited by addition of drops of TFA.

The normal effect of lowering the temperature of the solution is observed in the form of a structured vibronic absorption spectra. A shoulder in the absorption spectra at ≈ 437 nm indicating the presence of a portion of the tautomer disappeared by lowering the temperature.

Molecular oxygen acts as a quencher with quenching rate constant of $1.8 \times 10^{10} \text{ dm}^3 \text{ mol}^{-1} \text{ s}^{-1}$ indicating a diffusion controlled mechanism. Energy transfer from POHC to rhodamine 6G in ethanol was studied.

Quantum chemical calculations were carried out and correlated to experimental observations.

RULES OF METAL IONS ON LASER INTERACTION WITH A CONJUGATED ORGANIC SYSTEM

R. R. Amin, I. S. Al-Naimi and L. Z. Ismail *

**Chemistry and Physics* Departments , Faculty of
Science , University of Qater, P.O. Box 2713 , Doha,
State of Qater**

Abstract

1,1,4,4-buta(1,3-diene)tetrakis(iso)yltetracarbohydrazone and its metal (Zn and Pb) complexes were prepared. Elemental analysis, GC, IR and ¹H-NMR spectral studies have been used to elucidate and investigate the structure of the compounds .

A different molar concentration of the conjugated system and its metal complexes were prepared. Laser absorption studies show a transmitted bands starting from 485 up to 575 nm while it was opaque for the other laser wave lengths tuned from 400 up to 800 nm.

Laser induced fluorescence (LIF) technique also have been used to study the behaviour of the organic compound and its metal complexes . From the measurements, the complexes show an independence maximum peak position on the interacted laser wave lengths, while a dependence of the maximum emission wave length on the type of metal ions . A maximum peak for lead complex observed at 510 nm while for zinc case at 500 nm . The measured fluorescence of lead complex show a better emission (amplified) at maximum intensity and shorter half width (15 nm) in comparable with zinc complex.

Electronic energy transfer and charge exchange in photon-induced elementary processes. *

Vincenzo Aquilanti
Dipartimento di Chimica
Università degli Studi di Perugia
Via Elce di Sotto, 8
06123 Perugia

This presentation reviews recent experimental and theoretical progress from our group on the proper representation of potential energy surfaces involved in photoinitiated nonadiabatic processes and on the formulation of the dynamics for the transitions. Some specific examples are discussed, updating those reported at SOLAR '95. A collection of papers is now available. [1]

The basic ingredients for the mapping of potential energy surfaces are empirical, and rely on results from spectroscopic and molecular beam scattering techniques. Progress on semiempirical correlation rules [2] allow the characterization of features to the level of accuracy which is needed for the dynamics of photon induced molecular processes. On the other hand, the dynamics requires treatments of transition probabilities beyond classic formulas, such as the Landau-Zener, to include tunneling and interference effects, and to separate time scales for electronic transitions and redistribution of vibrorotational modes.

Applications from our own work are presented [3-5].

References

- [1] V. Aquilanti, A. Giardini-Guidoni and Y.T. Lee (Editors) - "Photon-induced Molecular Dynamics". Special issue, in Chem. Phys. **187**, 1-226 (1994)
- [2] V. Aquilanti, D. Cappelletti and F. Pirani - "Range and Strength of interatomic forces: dispersion and induction contributions to the bonds of dications and of ionic molecules" in Chem. Phys., **209**, 299-312 (1996), and references therein.
- [3] V. Aquilanti, R. Candori, S.V.K. Kumar and F. Pirani - "On the dynamics of the selective electronic and vibrational excitation of nitrogen in the recombination between F and N_2^+ " in Chem. Phys. Letters **237**, 456-462 (1995)
- [4] M. De Castro Vitores, R. Candori, F. Pirani, V. Aquilanti, M. Menéndez, M. Garay and A. González Ureña - "Translation energy effects in the excited $Ca(1D_2) + HCl \rightarrow CaCl(A) + H$ reaction. Experiments and a harpooning mechanism" in J. Phys. Chem. **100**, 7997-8002 (1996)
- [5] M. De Castro Vitores, R. Candori, F. Pirani, V. Aquilanti, M. Garay and A. González Ureña - "Determination of D^0_0 ($Ca...HBr$) from full and half collision studies: Van der waals and charge transfer contributions to the formation of $Ca...HX$ ($X=Cl, Br$) complexes" in Chem. Phys. Lett. (1996).

* Presented at 4th International Conference on Solar Energy Storage and Applied Photochemistry [SOLAR '97], Cairo, Egypt, 1-6 January 1997

THEORETICAL STUDIES OF ELECTRON TRANSFERS IN PHOTOSYNTHETIC BACTERIA REACTION CENTERS

L. G. Arnaut and S. J. Formosinho

Chemistry Department, University of Coimbra, 3049 Coimbra Codex, Portugal

One of the most relevant tasks for the theories concerned with the rates of electron transfer reactions (ET) is the quantitative description of the charge separation between the special pair $(BChl)_2$ of the photosynthetic reaction center and a quinone. Significant advances in this field were made following the publication of the structure of the reaction center. The energetics and kinetics of the consecutive electron transfer steps are known. In Figure 1 we show the structure of the reaction center, with the edge-to-edge distances (in Å) between the active redox species and their free energy differences (in eV). In this study we present the results of a new theoretical model that gives a quantitative account of the distance and free-energy dependencies of the ET rates in the reaction center, at room temperature, using only one adjustable parameter that is constant for all the reactions at the same temperature.

The intersecting-state model [1] is used to calculate the free energy barriers of the electron transfer reactions. Such barriers are calculated with the bond lengths, force constants and bond orders of the reactive bonds. An electron tunneling model based in the WKB solution for the permeability of a square potential energy barrier is used to calculate the distance-dependent factors of ET processes [2]. The tunneling barrier height is calculated as the potential energy of the highest energy electron in the donor, relative to the energy of the electron at rest in the vacuum, corrected by the optical dielectric constant of the medium, $\epsilon_0=2.2$. When $|\Delta G^0| < 50$ kJ/mol, no adjustable parameters are necessary to calculate the ET rates from a donor - through the rigid medium - to an acceptor. The calculated rates are compared with the experimental ones in Table 1. The rates of more exothermic ET are calculated with an empirical parameter, constant for all the reactions studied here, that is related with the dynamics of the reactions. The ET reactions from BPh^- to a series of quinones, Q_A , and the charge recombination from a series of Q_A^- to $(BCh)_2^+$ have been experimentally studied to probe the ΔG^0 dependencies of ET rates. The comparison between calculated and experimental rates is shown in Figure 2.

Table 1. Experimental and calculated ET rates in photosynthesis, at room temperature.

	$k_{exp} (s^{-1})$	$k_{calc} (s^{-1})$
$*(BChl)_2 \rightarrow BChl_L$	3.2×10^{11}	1.1×10^{10}
$BChl_L^- \rightarrow BPh_L$	1.6×10^{12}	5.0×10^{10}
$BPh_L^- \rightarrow (BChl)_2^+$	5×10^7	2.7×10^8
$BPh_L^- \rightarrow Q_A$	1.0×10^9	5.3×10^8
$Q_A^- \rightarrow (BChl)_2^+$	6.3×10^1	1.8

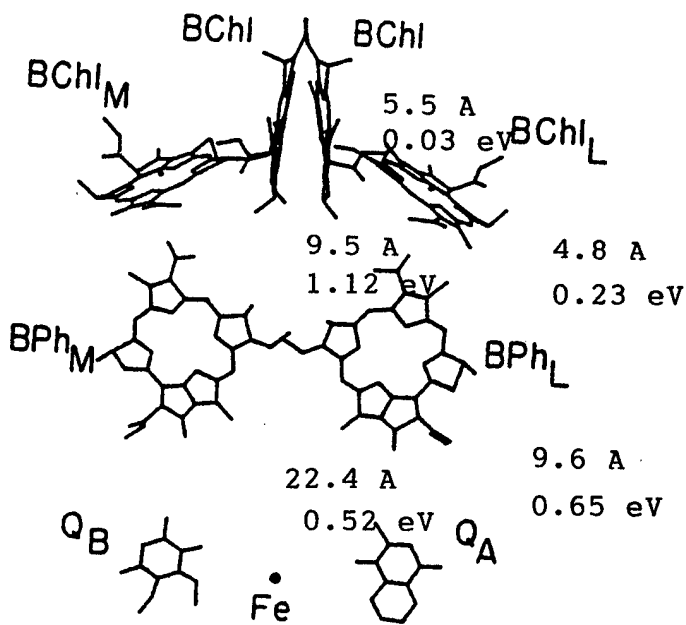

Figure 1. Structure and free-energy changes in the reaction center of *Rhodospseudomonas viridis*.

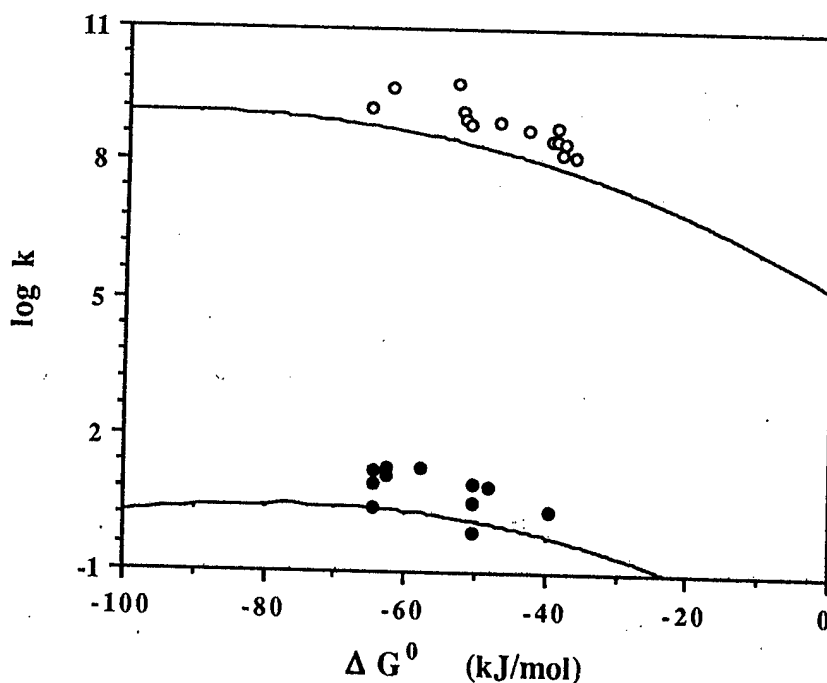

Figure 2. Free-energy dependence of ET reactions in the photosynthetic bacteria reaction center. Open circles are charge shift reactions from BPh⁻ to quinones (Q_A), and filled circles are charge recombination reactions from Q_A⁻ to the special pair, (BChl)₂⁺.

[1] S. J. Formosinho and L. G. Arnaut, *J. Photochem. Photobiol. A: Chem.*, **82** (1994) 11.

[2] L. G. Arnaut and S. J. Formosinho, *J. Photochem. Photobiol. A: Chem.*, **100** (1996) in press.

The Enhancement of Semiconductor Photocatalytic Activity During Ozone Introduction in Water and Air Purification Systems

Yu.M.Artem'ev, M.A.Artem'eva, T.I.Ilika, O.F.Lisogurskaya
Scientific and Research Institute of Chemistry, St.-Petersburg State University
Universitetskii pr., 2, Staryi Petergof, St.-Petersburg, 198904, Russia
E-mail: yuma@yuart.chem.spb.su

An activity loss by a solid photocatalyst during reaction is one among the factors repressed the photocatalysis use for water and air purification. In the case of organic contaminates this restriction may be defeated by the use of ozone as additional oxidant.

We have experimentally shown the increasing of the photocatalytic oxidation rate under the action of Solar wavelength range light ($\lambda > 320$ nm) in the case of some typical pollutants.

Experiments with methylene blue and 2,4,5-trichlorophenol aqueous solutions were carried out in a static reactor of batch type. Light-induced oxidation of toluene in air has been studied in the flow-type reactor with a honeycomb packing with titanium(IV) and niobium(V) oxides as an active substances.

The joint action of an air-ozone mixture, the light of a high pressure mercury lamp, filtered through Pyrex glass, and TiO_2 as a solid state catalyst was found to result in a substantial acceleration of decomposition of both methylene blue and 2,4,5-TCP and also in a deeper cleaning of water from these pollutants, as compared to the action of any combinations of two of these factors.

In experiments on toluene oxidative degradation in the presense of both TiO_2 and Nb_2O_5 we have established, that joint action of ozone and light is more than a sum of the separate actions of these factors. Moreover, the introduction of ozone under irradiation led to a high and constant in time (i.e., without loss of the catalyst activity) conversion of toluene. In the same time, exhausted ozone concentration was lower than tolerable level.

The results of this work point to a possible additional escape of atmospheric ozone, namely, in photocatalytic reactions on the semiconductor particles of aerosoles, which are already shown to play a significant role in the substance circulation [1]. Note, that up to now only homogeneous photolytic reactions of ozone were taken into consideration.

The observed intensification of oxidation are explained by two reasons. The first one is the photocatalytic ozone decomposition on semiconductor particles, resulted in the formation of stronger oxidizing agents than ozone itself. In aqueous media the mechanism of their formation may be similar to photolytic ozonization, but it requires light quanta of lower energy which are available in the Solar spectrum near the Earth surface. The second reason is the oxidative ozone action on hardly oxidizable intermediate products of contaminant conversion, which block the catalyst surface.

Reference

1. V. A. Isidorov, Organic Chemistry of the Earth's Atmosphere, Springer Verlag, Berlin (etc.) (1990).

PHOTOCHEMICAL REACTIONS AND EMISSION CHARACTERISTICS OF BENZIDINE IN HALOMETHANE SOLVENTS

S. A. Azim

*Chemistry Department, Faculty of Science, Tanta University, Tanta,
Egypt.*

The photochemical behaviour of benzidine in different halomethane solvents in addition to the corresponding UV absorption spectra and fluorescence emission spectra are discussed. The photochemical quantum yields (ϕ_c ; $\lambda_{ex} = 254$ nm) of benzidine in halomethane show a particular effect on the photolysis of benzidine in solution. This effect may be explained by the assumption that free radicals formed during photolysis of these solvents abstract hydrogen atoms from benzidine molecule forming macroradicals of the latter. Both mono- and diradical benzidine cations have been detected by different techniques. The well known peak at 283 nm is characteristic of neutral benzidine while those observed at ca. 370 and 565 nm are assigned to the blue- monoradical and yellow - diradical cations, respectively. The blue - monoradical cation has been isolated after irradiation as a blue precipitate. A comparison between neutral benzidine and the blue- monoradical cation are discussed using both IR and DTA techniques.

The fluorescence quenching of benzidine solutions in inert solvents using halomethane have been studied. The results obtained are interpreted in terms of a diffusional quenching mechanism.

EMISSION CHARACTERISTICS OF ANTHRALIDENE-2-AMINOPYRIDINE

S. A. El-Daly , S. A. Azim and E. M. Ebeid

*Chemistry Department, Faculty of Science, Tanta University, Tanta,
Egypt.*

ABSTRACT

The emission characteristics, molecular aggregation, micellization fluorescence quantum yields and the effect of acidity on anthralidene-2-aminopyridine (I) are reported. The dye undergoes ground state molecular aggregation at a critical concentration of $8 \times 10^{-5} \text{ mol dm}^{-3}$. Excited state molecular aggregation has also been observed in concentrated solutions (ca. $10^{-3} \text{ mol dm}^{-3}$) which shows excimeric emission at 500 nm. The enthalpy of photoassociation has been evaluated (ΔH_a) as $-21.5 \text{ kJ mol}^{-1}$. The steady state emission spectra have been studied in aqueous micellar solutions, the emission intensity increases due to micellization.

The electronic absorption and emission spectra of (I) are bathochromically shifted with increasing medium acidity. A solution of $10^{-4} \text{ mol dm}^{-3}$ of dye (I) in 98 % H_2SO_4 gives a red colour solution that changes to yellow upon dilution with water.

The Impact of the Sun on Tropospheric Reactivity: Beneficial and Adverse Effects

K.H. Becker and I. Barnes

Physical Chemistry/FB 9, University Wuppertal, D-42097 Wuppertal, Germany

The tropospheric degradation of trace substances is controlled by oxidation processes because of the atmospheric oxygen content. However, at ambient temperatures an attack of molecular oxygen on the substance is very slow. Since the 70ties it has become quite clear that the chemical reactions in the troposphere are mainly driven by OH radicals. The material balance between estimated emission rates and steady state concentrations of major degradable compounds undoubtedly indicated that only radical chains could explain the related transformation rates. More recently this could be proved in laboratory studies following the dynamics of the OH radical concentration. The key reaction steps propagating the radical chain are the reactions of HO₂/RO₂ with NO,

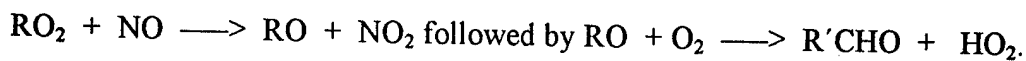
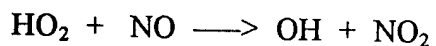

Termination steps,

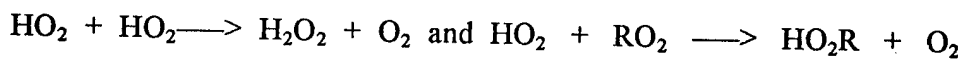
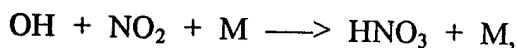

are responsible for the radical decline. Studies of photo-smog phenomena in metropolitan areas of highly developed countries showed that parallel to the oxidation of NO during the propagation steps each NO₂ produced undergoes fast photolysis in daylight resulting in the formation of O₃,

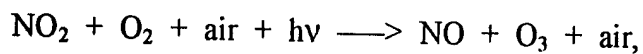

and in the presence of different VOCs to a number of other oxidants, e.g. PANs, aldehydes and organic nitrates.

The strong interaction between oxidation of, e.g. volatile organic compounds, and NO_x (NO + NO₂) is quite characteristic for tropospheric degradation processes. Superimposed on this alkane-like radical chain, are the ozonolysis of alkenes, reactions of NO₃ with alkenes and thermal decomposition of RO₂NO₂ which all increase the tropospheric radical pool. The primary radical source, however, is always photolysis in the UV spectral range; the O₃ photolysis,

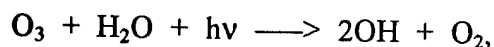

and the photolysis of carbonyls produced as intermediates during the atmospheric degradation of VOCs, e.g. of formaldehyde and other aldehydes or ketones,

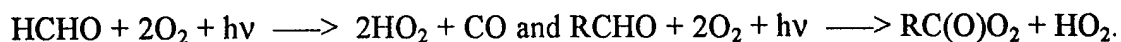

The knowledge of the role of carbonyls as radical sources is at present still very limited. Another important OH source is the photolysis of HNO_2 produced by still unknown heterogeneous processes in the dark involving NO_2 .

In the Arctic, field studies have recently shown that Cl and Br atoms can have a remarkable impact on the oxidation processes. The halogen atoms are currently thought to be formed by photolysis of halogen molecules which arise from heterogeneous reactions involving HOCl and HOBr at ice surfaces containing Cl^- and Br^- . The interaction of sea salt particles with NO_y also represents a source of photolabile Cl_2 and Br_2 , however, their source strengths are difficult to quantify. A global estimate of the primary OH radical source is based on the O_3 photolysis in the presence of water vapour. The photolysis of the carbonyl products and the formation of HNO_2 as well as Cl_2 or Br_2 have to be considered as additional photochemical radical sources supplemented by dark sources involving alkene reactions with O_3 or NO_3 .

Taking, e.g. an alkane reaction with OH radicals as a typical initiator of a chain in the presence of NO_x , it can be concluded that the major radical chain determining the tropospheric radical pool operates only in the presence of NO_x at a particular $[\text{VOC}]/[\text{NO}_x]$ concentration ratio; at the limits of high or low values of this ratio the radical pool is depleted. Globally, VOC is mainly emitted from biogenic sources whereas NO_x , as a by-product of high temperature combustion, predominantly originates from man-made activities with a strong accumulation in the northern hemisphere. Based on this situation it can be speculated that the NH has reached a higher oxidation capacity than the southern hemisphere but that it will increase in the SH with increasing technical development. Very interesting is the question in which direction the growing UV-B radiation, as a result of the stratospheric ozone depletion, might influence the oxidation rates. Under optimal $[\text{VOC}]/[\text{NO}_x]$ ratios it certainly accelerates the oxidation processes probably moving the critical ratio to lower values which under the present conditions might be beneficial in the SH and increase adverse effects in the NH. In all urban areas an increase of UV light will create adverse effects due to an increase in photo-smog formation during summer time.

and the photolysis of carbonyls produced as intermediates during the atmospheric degradation of VOCs, e.g. of formaldehyde and other aldehydes or ketones,



The knowledge of the role of carbonyls as radical sources is at present still very limited. Another important OH source is the photolysis of HNO_2 produced by still unknown heterogeneous processes in the dark involving NO_2 .

In the Arctic, field studies have recently shown that Cl and Br atoms can have a remarkable impact on the oxidation processes. The halogen atoms are currently thought to be formed by photolysis of halogen molecules which arise from heterogeneous reactions involving HOCl and HOBr at ice surfaces containing Cl^- and Br^- . The interaction of sea salt particles with NO_y also represents a source of photolabile Cl_2 and Br_2 , however, their source strengths are difficult to quantify. A global estimate of the primary OH radical source is based on the O_3 photolysis in the presence of water vapour. The photolysis of the carbonyl products and the formation of HNO_2 as well as Cl_2 or Br_2 have to be considered as additional photochemical radical sources supplemented by dark sources involving alkene reactions with O_3 or NO_3 .

Taking, e.g. an alkane reaction with OH radicals as a typical initiator of a chain in the presence of NO_x , it can be concluded that the major radical chain determining the tropospheric radical pool operates only in the presence of NO_x at a particular $[\text{VOC}]/[\text{NO}_x]$ concentration ratio; at the limits of high or low values of this ratio the radical pool is depleted. Globally, VOC is mainly emitted from biogenic sources whereas NO_x , as a by-product of high temperature combustion, predominantly originates from man-made activities with a strong accumulation in the northern hemisphere. Based on this situation it can be speculated that the NH has reached a higher oxidation capacity than the southern hemisphere but that it will increase in the SH with increasing technical development. Very interesting is the question in which direction the growing UV-B radiation, as a result of the stratospheric ozone depletion, might influence the oxidation rates. Under optimal $[\text{VOC}]/[\text{NO}_x]$ ratios it certainly accelerates the oxidation processes probably moving the critical ratio to lower values which under the present conditions might be beneficial in the SH and increase adverse effects in the NH. In all urban areas an increase of UV light will create adverse effects due to an increase in photo-smog formation during summer time.

Emission characteristics and photostability of a rigid coumarin dye

by

Sadiq M. Al-Hazmy, B. A. Zabara and A.S. Babaqi

(Department of Chemistry, Faculty of Science, Sana'a University, Sana'a, Yemen)

E.M. Ebeid

(Department of Chemistry, Faculty of Science, Tanta University Tanta Egypt)

Current address: Misr University of Science and Technology (MUST), 6th of October City, Egypt.

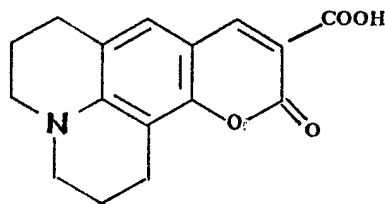

(1)

The emission, excitation and electronic absorption spectra of dye (1) in different solvents were studied. The absorption maximum is shifted towards shorter wavelengths upon increasing the value of Richardt and Dimorth solvent parameter and π^* solvent parameter in a non hydrogen bonding (NHB) solvents. Increase in the π^* of hydrogen bonding acceptor (HBA) solvents results in a red shift in the emission maximum wavelength. The fluorescence quantum yield increases with increasing π^* of NHB and decreases in case of HBA solvents. The studied dye undergoes cationic solubilization resulting in an increase in the emission intensity associated with a blue shift of about 14nm as a result of increasing concentration of cetyl trimethyl ammonium bromide. Whereas addition of anionic surfactant e.g. sodium dodecyl sulfate (SDS) results in an increase in the emission intensity. Emission intensity of the dye in methanol decreases upon addition of carbon tetrachloride (CCl_4). A rapid deterioration of the dye in CCl_4 occurs upon uv-irradiation ($\lambda_{\text{ex.}} = 254\text{nm}$).

The dye is relatively photostable in dimethylformamide ($\phi_c = 6.2 \times 10^{-5}$) and in ethanol and becomes even more stable in acidic media.

The electronic absorption and emission spectra at different pH values were measured. In acidic media a slight red shift (ca. 14nm) in absorption band is observed upon addition of trifluoroacetic acid (TFA). Addition of a drops of triethyl amine results in a slight blue shift of about 10 nm in the absorption spectrum.

UTILIZATION OF CONDUCTING POLYMERS IN RECTIFYING JUNCTION CONSTRUCTION: DARK CHARACTERISTICS AND PHOTOVOLTAIC PROPERTIES

N. Camaioni, G. Beggiato, G. Casalbore Miceli, A. Geri, L. Ventura

*Istituto di Fotochimica e Radiazioni d'Alta Energia del CNR, via Gobetti 101, 40129 Bologna -
Italy*

Organic materials offer the possibility to realize optoelectronic devices with properties unattainable with conventional inorganic semiconductors. In particular, conducting polymers can change optical spectrum and electrical conductivity as a function of the doping level.

It has been demonstrated that Schottky junctions are formed by interfacing n-doped silicon with oxidised conducting polymers [1,2]. If the polymer is semitransparent in its oxidised form, by illuminating through the polymer itself, part of the incident light can reach the silicon surface giving rise to a photovoltaic effect [3]. The presence of a resistance in series to the junction and the rather high value of the reverse saturation current density are responsible for the reduction in the capability of the cell in transforming luminous into electric energy.

In this contribution, results are reported concerning some characteristics of rectifying junctions based on conducting polymers. Dark current-voltage and capacitance-voltage characteristics are reported and discussed. Some fundamental photovoltaic parameters (such as the open-circuit voltage, the short-circuit current, the fill factor and the power conversion efficiency) are extracted from the junction current-voltage characteristics under illumination with various incident light intensities. Results concerning the junction properties under monochromatic light irradiation are also reported and compared with the absorption spectra.

References

- [1] M. Campos, G. Casalbore-Miceli, N. Camaioni, *J. Phys. D: Appl. Phys.*, **82** (1995) 2123
- [2] M. Campos, N. Camaioni, G. Casalbore-Miceli, A. Geri, G. Giro, Q. Zini, *Synth. Met.* **75** (1996) 61
- [3] *Synth. Met.*, in press

Charge separation and recombination after photoionization

A.I. BURSHTAIN

Department of Chemical Physics, Weizmann Institute of Science
76100, Rehovot, ISRAEL

The bimolecular reaction of electron transfer from excited donor (D^*) to electron acceptor (A) is an efficient mechanism of energy quenching in solutions:

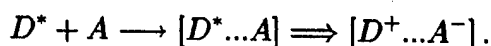

Proceeding during binary encounters this reaction, its rate constant and the distribution of products are fully determined by position dependent rate of photoionization $W_I(r)$ and encounter diffusion coefficient D . The evolution of charge distribution is governed by subsequent separation and recombination of ions according to the kinetic scheme

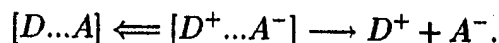

This geminate reaction, its kinetics and the charge separation quantum yield essentially depend on the shape of initial charge distribution. Unfortunately, in all conventional models it was arbitrarily chosen as $\delta(r - r_0)$ where r_0 either coincides with the closest approach distance ($r_0 = \sigma$ in "exponential model") or is considered as fitting parameter (in "contact recombination" approximation). This is never true: if photoionization is kinetic controlled the initial distribution of charged products reproduces the shape of $W_I(r)$ which is short-range and quasi-exponential in normal region of ionization ($-\Delta G_i < \lambda_c$) but remote and bell-shaped in inverted region ($-\Delta G_i > \lambda_c$), where $|\Delta G_i|$ and λ_c are the free energy and reorganization energy of ionization at contact. In between, near activationless point, where reaction is the fastest and under diffusion control, the separation of charge products is the largest because ionization occurs at far approaches to the reaction layer.

These results have been obtained within our non-model "unified theory" that completely removes the uncertainty in initial conditions for geminate recombination and enables to describe jointly the charge accumulation and separation [1]. The time evolution of charge distribution may be also calculated and used to estimate the number of ion-radicals outside the Onsager radius which are available for ESR registration. If charge recombination proceeds via proton transfer than accumulation kinetics of their products (neutral radicals) may be also traced as well as their space distribution which determines the dipole-dipole broadening of ESR spectra [2].

The geminate process is assisted by encounter diffusion of ions (\bar{D}) and proceeds with recombination rate $W_R(r)$ which also becomes non-contact with increasing of reaction exothermicity, $-\Delta G_r$. The recombination in non-polar solutions remains non-contact even with account of intra-molecular quantum modes that move ionization layer nearer contact distance

[3]. Using *unified theory* [4] we obtained the free energy dependence of charge separation quantum yield which deviates qualitatively from that predicted by "exponential model". The deviations have different sign depending on whether ions generated in contact are screened by remote recombination layer or being created outside may easily escape the recombination. The deviations are the larger the slower is diffusion that delivers ions from where they were born to recombination layer [3, 4]. Due to a difference between starting distance and the distance of discharge the geminate reaction of recombination may be diffusion controlled as well as bimolecular. In this respect the free energy gap law predicted by "exponential model" is qualitatively justified only for kinetic controlled recombination (fast diffusion limit) and may be essentially distorted in viscous solutions.

Until recently the unified theory remained an intuitive synthesis of "differential encounter theory" of binary ionization and diffusional theory of remote geminate recombination. It might not be applied to reversible ionization ($[D^*...A] \rightleftharpoons [D^+...A^-]$) or extended to bimolecular recombination ($D^+ + A^- \rightleftharpoons D + A$) that always followed the short initial geminate stage. These demerits were removed when unified theory was recognized as a particular case of our latest *universal theory* of photoseparation based on integral version of encounter theory and applied to a very general reaction scheme: [5]

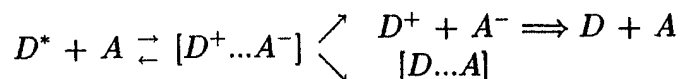

When ionization is highly exothermic and thus irreversible the integral theory supplemented by the recipe for calculating the ion distribution may be successfully reduced to our previous unified theory. However, there is no alternative to integral approach when ionization is quasi-resonant and the back electron transfer to the excited state should be accounted for. The free energy dependence of the Stern-Volmer constant of reversible photoionization accompanied by charge recombination was calculated and even in contact approximation the remarkable difference with the theory of irreversible ionization was found in Marcus' normal region. The total kinetics of charge recombination including initial accumulation and final bimolecular stage was first obtained.

References

- [1] Burshtein, A.I. *Chem.Phys.Lett.* **1992**, *194*, 247;
Burshtein, A.I., Krissinel, E., Mikhelashvili, M.S. *J.Phys.Chem.*, **1994**, *98*, 7319.
- [2] Burshtein A.I., Frantsuzov P.A. *Chem.Phys.Lett.* (in press).
- [3] Burshtein A.I., Frantsuzov P.A. *Chem.Phys.* (in press).
- [4] Burshtein A.I. *J.Chem.Phys.*, **1995**, *103*, 7927;
Burshtein A.I., Krissinel E. *J.Phys.Chem.*, **1996**, *100*, 3005.
- [5] Burshtein A.I., Frantsuzov P.A. *J.Chem.Phys.* (in press).

Photoinduced Electron Transfer and its Applications -- Study on Photochemical Solar Energy Storage and Polymeric Photorefractive Materials

Xue-song Wang, Bao-wen Zhang, Guang-qian He, and Yi Cao
Institute of Photographic Chemistry, Chinese Academy of Sciences, Beijing 100101
Hong Gao, Shuo-xing Dou, Jie-sen Zhang, and Pei-xian Ye
Institute of Physics, Chinese Academy of Sciences, Beijing 100080

In recent years, the study on photoinduced electron transfer reactions has become one of the most active fields in nature sciences. In the field of solar energy utilization, the photoinduced electron transfer reaction has immense application potential. In addition, it also has been clearly realized that the profound comprehension on photoinduced electron transfer process is of much benefit to disclosing the mysteries in photosynthesis, further more, to the development of artificial imitation of photosynthesis and the exploitation and application of novel photo-electric functional materials ^[1,2].

In this work, based on the study of photoinduced electron transfer reactions and taking practical application into consideration, the photoinduced valence isomerizations of norbornadiene substrates were carried out and the energy storage compounds --- corresponding quadricyclane products were achieved smoothly in polymer systems and aqueous systems by using carbazole groups or acridine dyes as sensitizer, respectively. A mechanism involving photoinduced electron transfer was proposed by way of fluorescence quenching, thermodynamic calculation and chemically induced dynamic nuclear polarization (CIDNP) experiment et al. These sensitized photoisomerizations open up a new path for the application of the photoinduced electron transfer reaction to solar energy conversion and storage.

Additionally, combined with the photoinduced electron transfer reaction, the research of novel photorefractive polymers was carried out simultaneously, and as a result, lots of nonlinear optical molecules were designed and synthesized. The special photophysical properties exhibited in some of these nonlinear optical dyes were discussed in details. Moreover, the photorefractive effect in some of polymer systems was initially studied and the results obtained are of great importance for further study on the relationship between structure and function as well as structure and preparation in the research of photorefractive polymers.

REFERENCES

- [1] G.Jones II and R.J.Utler, *Solar Energy*, 1982, (29), 579.
- [2] W.E.Moerner and S.M.Silence, *Chem. Rev.*, 1994, (94), 127.

Interfacial Electron Transfer from Nonstoichiometric Cadmium Sulfide Nanoparticles to Free and Complexed Copper Ions in 2-Propanol

Alex V. Isarov and John Chrysochoos

Department of Chemistry, The University of Toledo, Toledo, Ohio 43606, USA

Abstract

The surface of semiconductor nanoparticles plays a very important role on their optical, chemical and photocatalytic properties [1,2]. Interfacial electron transfer is especially sensitive to surface adsorbate - adsorbent interactions [3,4]. The present work is devoted to the investigation of the effect of coordination of Cu^{2+} ions (free, complexed) on their potential as electron acceptors in conjunction with nonstoichiometric cadmium sulfide nanoparticles.

Cadmium sulfide nanoparticles were prepared in 2-propanol at -78°C , without added stabilizers, with a $[\text{Cd}^{2+}]/[\text{S}^{2-}]$ ratio equal to 3. The band gap energy, obtained from plots of $\{\alpha(h\nu)\}^2$ vs. $h\nu(\text{eV})$, was found to be about 3.0 eV. Addition of free copper ions was carried out in the form of $\text{Cu}(\text{ClO}_4)_2 \cdot 6 \text{H}_2\text{O}$ in 2-propanol. Copper(II) acetylacetonate and copper(II)-tetraphenylporphyrin (Cu-TPP) were used as complexed Cu(II) compounds.

The presence of copper(II) perchlorate (free Cu^{2+} ions) leads to significant changes in both the absorption and emission spectra of the nanoparticles. The absorption spectra become broader and the absorption edge shifts to the red with increasing amount of Cu^{2+} ions added. The strong defect recombination luminescence of CdS (e^-/h^+ , $\nu_{\text{max}} = 17900 \text{ cm}^{-1}$) is effectively quenched by free Cu^{2+} ions. The quenched band is more complex than the original one and shows the formation of a red-shifted component. In contrast with $\text{Cu}(\text{ClO}_4)_2$, addition of copper(II) acetylacetonate did not affect the absorption spectra of CdS nanoparticles. However, the defect recombination luminescence of CdS (e^-/h^+ , $\nu_{\text{max}} = 17900 \text{ cm}^{-1}$) was quenched in the presence of $\text{Cu}(\text{acac})_2$, accompanied by the appearance of the red-shifted component. Finally, addition of Cu-TPP to CdS nanoparticles had no effect upon either their absorption or emission spectra.

The emission spectra of CdS nanoparticles in the presence of $1 \times 10^{-6} \text{ M}$ of copper(II) perchlorate or in the presence of $1 \times 10^{-6} \text{ M}$ of copper(II) acetylacetonate were deconvoluted into two bands. The first band ($\nu_{\text{max}} = 17900 \text{ cm}^{-1}$) corresponds to the emission of CdS nanoparticles. The position of the second band was found to be 14700 cm^{-1} for copper(II) perchlorate and 15100 cm^{-1} for copper(II) acetylacetonate.

Electron paramagnetic resonance spectroscopy has been used to monitor the oxidation state of copper ions in the presence of CdS nanoparticles. Reduction of Cu^{2+} to Cu^+ was observed both in the case of free copper ions and the $\text{Cu}(\text{acac})_2$ complex, but not in the case of Cu-TPP. This reduction appears to be a thermal (dark) reaction, since it could not be eliminated even under extreme protection against exposure to light.

The experimental data obtained will be discussed in terms of a chemical bond formation between copper ions and the surface of semiconductor nanoparticles. Low concentrations of free copper ions lead to the formation of isolated Cu^+ ions bound onto the surface of CdS nanoparticles. These ions create a new energy level in the band gap (about 1.2 eV below the conduction band edge) which is responsible for the new emission band ($\nu_{\text{max}} = 14700 \text{ cm}^{-1}$). The formation of a new channel

for electron - hole recombination leads to the quenching of the original emission of nanoparticles. An appropriate mechanism for the emission of copper-modified CdS nanoparticles will be discussed. Higher Cu^{2+} concentrations lead to the formation of ultras-small Cu_2S particles on the surface of CdS. These particles are not luminescent and, therefore, high Cu^{2+} concentration lead to the quenching of both emission bands. The formation of Cu_2S is supported by its extremely low solubility, compared to that of CdS. Addition of copper(II) acetylacetonate to CdS nanoparticles leads also to the formation of Cu^+ ions bound onto the surface of the nanoparticles. But in this case the formation of Cu_2S phase does not take place. Although the reaction of $\text{Cu}(\text{acac})_2$ with the surface of CdS and the reduction of the Cu^{2+} to Cu^+ leads to the detachment of one acetylacetonate ligand, the remaining acetylacetonate ligand is still bound to each adsorbed copper ion and it may prevent the formation of a copper(I) sulfide subphase.

The possibility of the thermal (dark) reduction of Cu^{2+} ions by nonstoichiometric CdS nanoparticles was analyzed in terms of the redox potentials of appropriate donor levels of CdS nanoparticle and that of the $\text{Cu}^{2+}/\text{Cu}^+$ redox couple for free and complexed copper ions. For copper(II) perchlorate and copper(II) acetylacetonate this reaction is thermodynamically allowed ($\Delta G^0_{\text{el. tr.}}$ is equal to - 0.88 eV and - 0.06 eV, respectively). The thermal reduction of Cu-TPP by CdS nanoparticle is thermodynamically forbidden ($\Delta G^0_{\text{el. tr.}} = + 0.53 \text{ eV}$). At the same time, electron transfer from the conduction band of CdS nanoparticle to Cu-TPP molecules is characterized by $\Delta G^0_{\text{el. tr.}} = - 0.30 \text{ eV}$. The lack of the recombination luminescence quenching in this case is probably due to a weak adsorption of nonpolar porphyrin molecule onto the polar surface of cadmium sulfide.

The quenching of the recombination luminescence of CdS nanoparticles by both copper(II) perchlorate and copper(II) acetylacetonate obey a static interaction model. The quenching is less effective in the case of copper(II) acetylacetonate, compared to that by $\text{Cu}(\text{ClO}_4)_2$, probably due to a weaker binding of $\text{Cu}(\text{acac})_2$ molecules onto the surface of CdS nanoparticles. Finally, in spite of the extremely weak interactions of Cu-TPP with the surface of nonstoichiometric CdS nanoparticles and the lack of recombination luminescence quenching by Cu-TPP, the latter is very unstable under the UV irradiation ($\lambda = 360 \text{ nm}$) in the presence of CdS. Copper ions bound onto the surface of CdS nanoparticles retard the photodecomposition of Cu-TPP. The mechanism of this process will be discussed.

References

1. Kamat, P.V. *Chem. Rev.* **1993**, *93*, 267.
2. Alivisatos, A.P. *J. Phys. Chem.* **1996**, *100*, 13226.
3. (a) Chrysochoos, J. *J. Phys. Chem.* **1992**, *96*, 2868. (b) Bhamro; Chrysochoos, J. *J. Lumin.* **1994**, *60&61*, 359.
4. Fox, M.A.; Dulay, M.T. *Chem. Rev.* **1993**, *93*, 341.

Polymers with Photosensitive Triazene Groups: Resists for Applications in Excimerlaser Microlithography

Oskar Nuyken, Ulrich Dahn

Lehrstuhl für Makromolekulare Stoffe, Technische Universität München,

Lichtenbergstr.4, 85747 Garching.

Excimer laser lithography is a promising method for structuring polymers in dry development resist applications. To obtain patterns with the desired depth and resolution, the materials must be highly sensitive to the applied irradiation and must decompose without leaving ejected residues. Our approach to these requirements is to incorporate photo- and thermosensitive groups into the polymer backbone, thus predetermined as breaking points.

We chose the 1-aryl-3,3-dialkyl-triazene group, previously described as part of polymer backbones [O.Nuyken *et.al.*, J.Phys.Chem. 97, 12296 (1993)] :

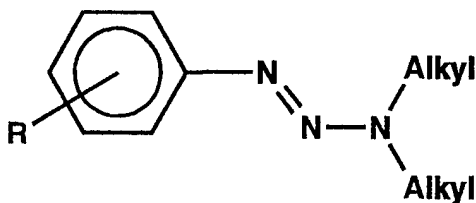

due to its suitable photo- and thermochemical properties, its easy synthesis and because its decomposition occurs immediately under release of nitrogen and mostly volatile fragments. Upon polymer ablation well defined low molecular groups are formed and ejected out of the surface with nitrogen as the propellant gas. Since the triazeno-group exhibits UV- absorptions between 190 and 350 nm, UV-lasers, for example the XeCl* excimer laser are appropriate tools for patterning.

Main-chain polymers fitted with those rated braking points are synthesized as follows: several types of bifunctional monomers containing one to two triazeno groups are reacted with corresponding bifunctional species to give polycondensates, for instance polysulfides or polyesters as schematically sketched below:

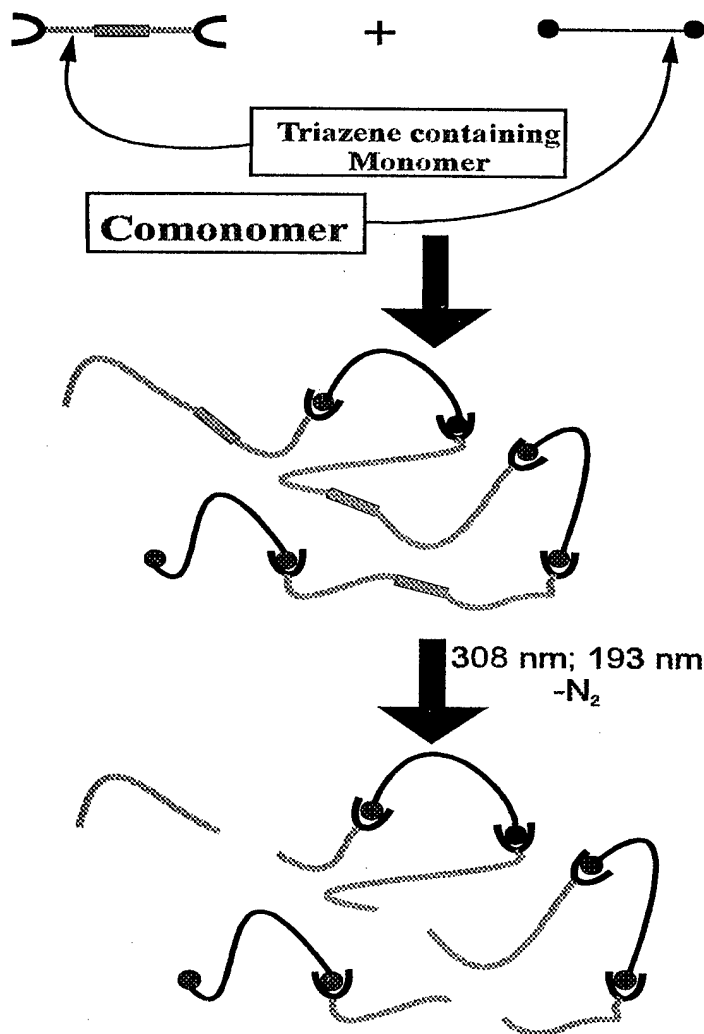

This pathway allows us to vary the polymers' topology in view of many parameters:

- density of the photosensitive groups
- functional groups (e.g. ester, amide, sulfide....) and thus polarity
- Hetero-atoms (e.g. S, Si, metal-ions...)
- Rigidity of the backbone

We present the synthesis and characterization of these polymers. The photolytical investigations as well as thermoanalytical studies are reported and results of the Excimer Laser Polymer Ablation at 193 and 308 nm will be shown by SEM, AFM and profilometric data.

A POSITRON ANNIHILATION STUDY OF POROUS SILICON

S. Dannefaer and D. Kerr

Department of Physics

University of Winnipeg

Winnipeg, Canada R3B 2E9

Positron annihilation is a nuclear-based technique which can be used to investigate gases, liquids and solids. During the last decade or so this technique has in particular been used to investigate defects in semiconducting materials. The most important aspect of positron annihilation is that vacancies (i.e. missing atoms) are easily detected by means of the change they cause in the lifetime of the positrons. Positrons probe monovacancies, divacancies and larger clusters, and can detect concentrations less than 0.1 ppm.

In this talk the capabilities of positron annihilation will be demonstrated by presenting results for porous silicon. Porous silicon is formed by anodic etching of silicon which makes a skeleton structure with an enormous surface area ($\sim 200 \text{ m}^2$ per cm^3 of material). This structure can emit light in the visible range (for which reason it is of interest in silicon-based opto-electronics), but the light yield is strongly reduced by exposure to air, although the mechanism therefor is still obscure. Positron experiments suggest that one source for the reduction in light yield arises from the introduction of vacancy clusters in the silicon oxide which covers the silicon crystallites in the porous silicon when exposed to air. Porous silicon is a very complex system which involves solid state physics, surface science and chemistry.

GROUND-STATE CONFORMATIONAL EQUILIBRIUM OF PREVITAMIN D AND ITS E-ISOMER: EFFECT ON THE PHOTOCONVERSIONS AND ABSORPTION CHARACTERISTICS

O.G. Dmitrenko¹⁾, I.P. Terenetskaya²⁾ and W.Reischl³⁾

¹⁾Institute of Surface Chemistry, National Academy of Sciences of Ukraine, 252022 Kiev, Ukraine, E-mail : dmitr@gas.freenet.kiev.ua

²⁾Institute of Physics, National Academy of Sciences of Ukraine, 252022 Kiev, Ukraine

³⁾Institute of Organic Chemistry, University of Vienna, A-1090 Vienna, Austria

The manufacturing process of vitamin D as well as its synthesis *in vivo* consists of two stages: photosynthesis of previtamin D (provitamin D photoisomerization) and its thermochemical conversion into vitamin D [1] (see scheme).

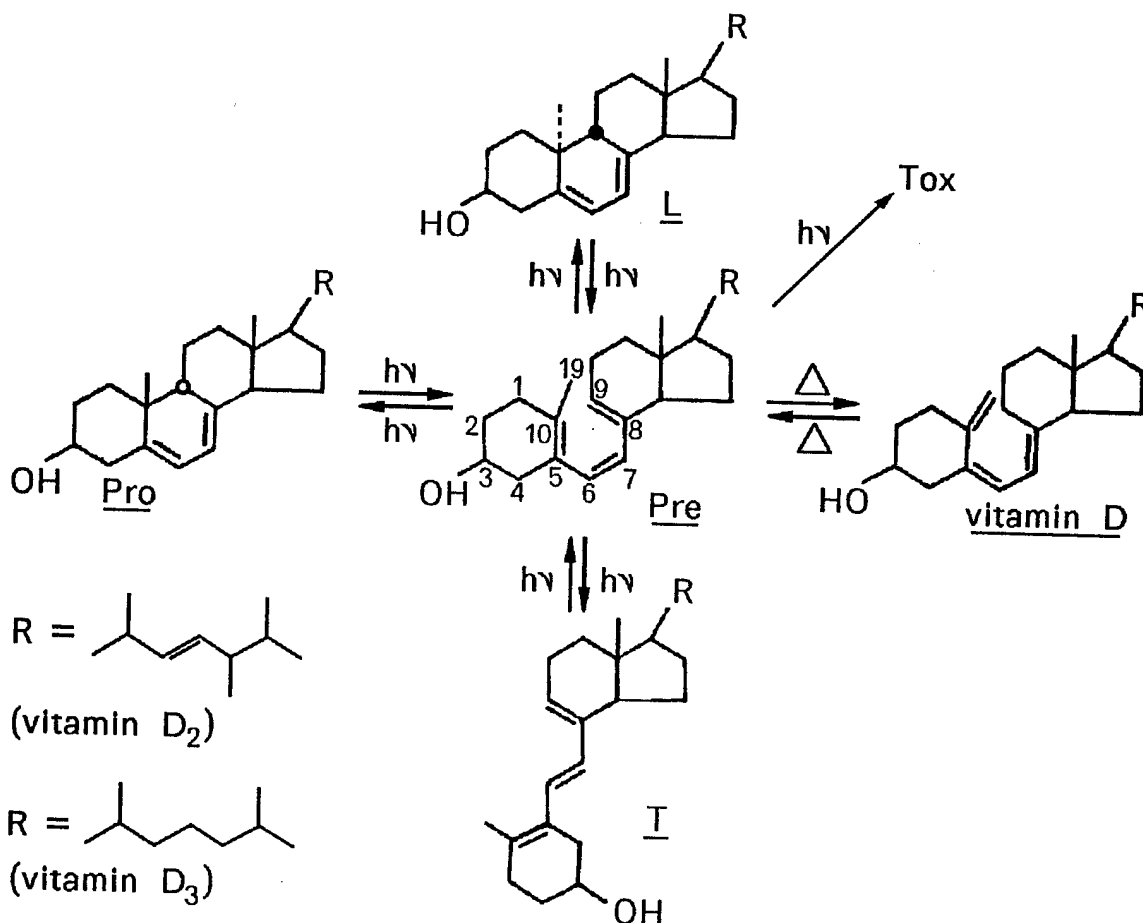

Previtamin D Z/E isomerization into tachysterol is the most efficient undesirable secondary photoprocess in this complex network of the isomerization reactions. Therefore, the detailed knowledge about the sensitivity of this reaction to the action of various external and internal physico-chemical factors is demandable.

The ground-state conformational analysis of previtamin D, its E-isomer, tachysterol, their 10-desmethyl analogues and 1-methyl-1-hydroxy-previtamins has been performed by force-field calculations [2,3]. Differences in the photochemistry and absorption characteristics of these compounds are discussed in view of the chromophore geometry and abundance (%) of the calculated conformers according to a Boltzmann distribution at 298 K. On the basis of present calculations, the red shift of previtamin D low-temperature UV and CD spectra determined earlier is attributed to the shift of conformational equilibrium in favour of more stable cZc geometries. The effect of complex formation with simplest model cluster of silica surface, $((\text{H}_3\text{SiO})_3\text{SiOH})$, on previtamin D and tachysterol conformational equilibria and on UV-absorbance maxima has been evaluated.

The effect of solvent polarity on previtamin D conformational equilibrium have been discussed in view of our force-field calculations in conjunction with NMR experimental data available in literature. It has been supposed [4] that polar reaction media shifts the conformational equilibrium toward the most non-strained cZc conformations with the pseudoequatorial OH group orientation. Provitamin D photolysis in ethanol and hexane solvents under irradiation at $\lambda=254$ nm has been studied by UV spectroscopy. Consideration of the observed differences in parallel with the simulation calculations of the reaction kinetics provide an experimental evidence to the solvent-induced changes of previtamin D conformational equilibrium in favour of cZc forms.

Acknowledgements

O.G.D. acknowledges financial support through a Fellowship of the Federal Ministry of Science and Research of the Republic of Austria and a Ukrainian President's Research Fellowship. Access to the SGI workstation was made possible by a grant of the Fonds zur Förderung der wissenschaftlichen Forschung (P09859-CHE, to W. Weissensteiner). Financial support by the Österreichische Nationalbank (Jubilaeumsfondsprojekt Nr.: 4865) is gratefully acknowledged.

REFERENCES

1. H.J.C.Jacobs and E.Havinga, *Adv. Photochem.*, **11**, 305 (1979).
2. O.Dmitrenko and W.Reischl, *Monatshefte für Chemie*, **127**, 445 (1996).
3. O.Dmitrenko and W.Reischl, *Res. Chem. Intermed.* (submitted, June 1996)
4. O.G. Dmitrenko, I.P.Terenetskaya and W.Reischl (unpublished results)

SUBMICRON PHOTOCHEMISTRY AND PHOTOPHYSICS

F.C. De Schryver^{*a}, M. Rucker^a, H. Faes^a, P. Van Oppen^a, K. Grim^a, B. Dutt^a, S. De Feyter^a

Dept. of Chemistry KULeuven^a
Celestijnenlaan 200F B-3001 Heverlee, Belgium
Frans.Deschryver@chem.kuleuven.ac.be

One of the emerging fields of photochemistry and photophysics is the interdisciplinary area where submicrometer analytical techniques are coupled with excited state processes and their analysis(1). We have shown that combining scanning tunneling microscopy and photochemistry it is possible to image with molecular resolution the phototransformation of a diazoanthrone in a dianthrone. In the present contribution we discuss some of the possibilities of optical microscopy with submicron resolution is coupled with excited state phenomena.

Polymer composite films consisting of fluorescent nanometer size dye labeled latex particles dispersed in poly-vinylalcohol matrices were imaged by scanning confocal fluorescence and near field optical microscopy.

Polyvinylalcohol films of 25 nm thickness containing 500 nm beads were imaged by confocal fluorescence microscopy with a lateral resolution of 300 nm and the decay time measured using global analysis with reference deconvolution. The decay time was independent of the bead chosen. Some beads were intentionally bleached by the excitation light and the bleaching kinetics were followed based on the residual integrated fluorescence intensity. It was furthermore established that the decay time is not influenced by the bleaching. Using multi-anode detection the spectral distribution of the emission can be reconstructed from the fluorescence decays.

Films of 25 nm thickness containing 100 nm size beads were imaged in fluorescence mode and in transmission by scanning near field optical microscopy (SNOM). The resolution of the images is below the dimension of the half wavelength of the excitation light. The SNOM could be coupled to an OMA to register the spectral distribution of the emission.

The beads were bleached under different condition allowing selective partial bleaching of the dye as well as total bleaching associated with partial destruction of the latex particle. The light emanating from the SNOM tip could be used raster scanning one bead to selectively bleach one 100 nm size bead in the ensemble of beads without any change in the topology of the ensemble (2).

This opens a wide area of novel applications to study excited state properties of small domains in self organizing structures. One such an application will be exemplified.

(1). R. Heinz, A. Stabel, J. Rabe, G. Wegner, F.C. De Schryver, D. Corens, W. Dehaen and C. Sülling Photodecomposition of 10-Diazo-2-hexadecylanthrone on HOPG studied by STM *Angew.Chemie (German ed.)*, **106**, 2154-2157 (1994); *Angew.Chemie (IEE)*, **33**, 2080-2083 (1994)

(2) M. Rucker, P. Vanoppen, F.C. De Schryver, J.J. Ter Horst, J. Hotta and H. Masuhara *Fluorescence Mapping and Photobleaching of Dye-labeled Latex Particles Dispersed in PVA Matrices with a Near-Field Optical Microscope*, *Macromolecules*, **28**, 7530-7535 (1995).

SOME NEW PHOTOREACTIONS OF NITROGEN AND SULFUR HETEROCYCLES

Dietrich Döpp

Fachgebiet Organische Chemie, Gerhard-Mercator-Universität - GH Duisburg,
D-47048 Duisburg, Germany

A progress report will be given on the following two areas of activity:

(a) Photoconversions of azines in triethylamine as solvent [1]

Phenylated azines, as 3,6-diphenylpyridazine, 2,4,5,6-tetraphenylpyrimidine, 2,4,6-triphenyl-s-triazine or 3,6-diphenyl-1,2,4,5-tetrazine, when irradiated ($\lambda \geq 290$ nm) in neat triethylamine, undergo photoreductions and photoreductive ring contractions by loss of ammonia. The most interesting case so far is that of 3,5,6-triphenyl-1,2,4-triazine (**1**). The product spectrum consists of 13% of **2**, 17% of **3**, 35% of **4** (both diastereomers) and 30% of **5** at 75% conversion of **1** showing, in contrast to the cases mentioned above, the extrusion of a phenylated ring carbon atom and the incorporation of solvent fragments into one of the products.

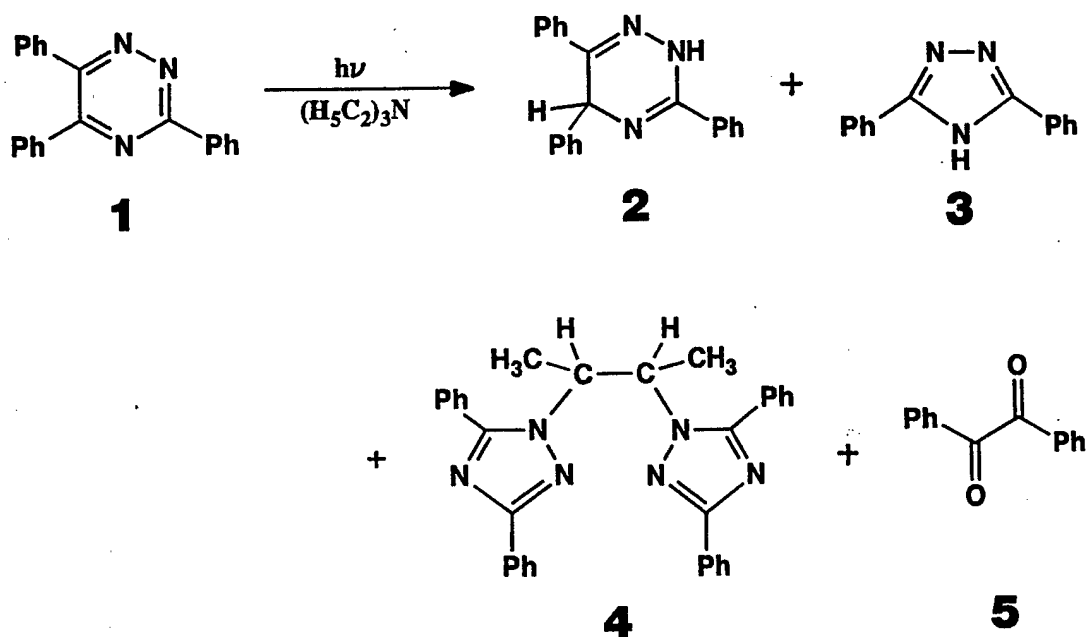

These results contrast with the photoreductions of **1** or **2** in ethanol containing hydrogen chloride as reported by Nyitrai et al. [2].

(b) Photoisomerization of saccharine related sultams [3]

The novel phototransformation of sultams of type **6** into sulfinic hydroxamic acids **7** (by a net oxygen transfer from sulfur to nitrogen) or into **8** (via a dimerization/condensation sequence when $R^1=R^2=H$) will be discussed in detail covering also stereochemical aspects, deuterium labelling studies, and quantum mechanical calculations.

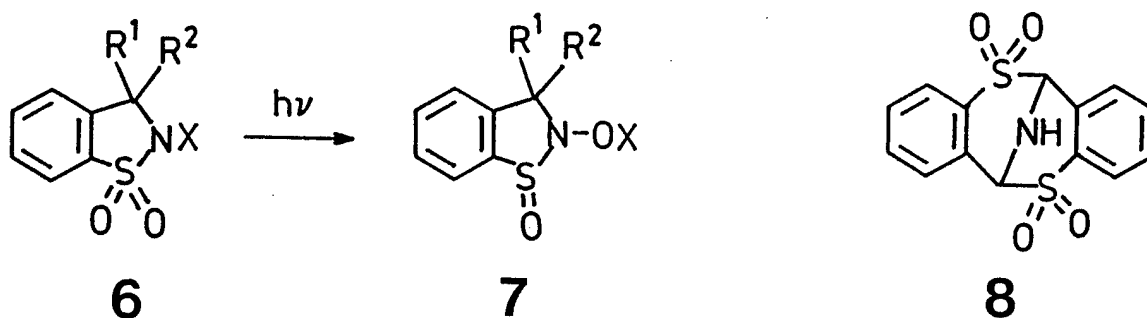

a: $R^1 = R^2 = \text{CH}_3$, X = H; b: $R^1 = R^2 = \text{CH}_3$, X = CH_2OCH_3 ; c: $R^1 = R^2 = \text{C}_6\text{H}_5$, X = H; d: $R^1 = \text{CH}_3$, $R^2 = \text{X} = \text{H}$; e: $R^1 = R^2 = \text{X} = \text{H}$.

The structure of all novel products reported is supported by x-ray crystal structure analyses.

Acknowledgement: Generous support by the *Egyptian Government* and *Fonds der Chemischen Industrie* is gratefully acknowledged.

[1] D. Döpp, W. A. F. Mostafa, G. Henkel, A. M. Kaddah, Y. M. Naguib, to be published. - W.A.F. Mostafa, Ph. D. Thesis, to be submitted to Faculty of Science, Ain Shams University.

[2] J. Nagy, R. Rapp, M. Alexovics, D. Döpp, J. Nyitrai, U. Záhorszky, H. Röttele, *J. Chem. Soc. Perkin Trans. 1*, **1993**, 661 and refs. cited therein; J. Nyitrai, J. Nagy, Z. Madarasz, Contribution XVI. IUPAC Symposium on Photochemistry, Helsinki 1996, Book of Abstracts p. 427-428.

[3] D. Döpp, P. Lauterfeld, M. Schneider, D. Schneider, U. Seidel *Phosphorus, Sulfur and Silicon* **1994**, 481. - D. Döpp and U. Seidel, unpublished.

The Photochemistry and Photophysics of Some UV-visible Laser Dyes

By

El-Zeiny M. Ebeid

Misr University of Science and Technology (MUST)

6th October City, Egypt.

Recent studies on some laser dyes emitting in the uv-visible range will be presented. The dyes in question are diolefinic dyes of the general formula.

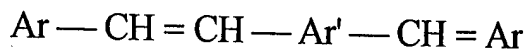

where Ar and Ar' are phenyl or heterocyclic moieties. Some anthracene and coumarin dyes will also be presented.

The spectral characteristics, fluorescence efficiencies, effect of medium, excited state absorption (ESA), quenching by molecular oxygen and amplified spontaneous emission (ASE) of these dyes will be highlighted.

Fluorescence Quenching of 2,5-Bis-2-(2-naphthyl) vinyl pyrazine (B2NVP) by Cobalt Ions and Oxygen Molecule

By

Samy A. El-Daty

*Chemistry Department, Faculty of Science, Tanta University, Tanta,
Egypt.*

Abstract:

The fluorescence quenching of 2,5-bis-2-(2-naphthyl) vinyl pyrazine B2NVP by cobalt ions and molecular oxygen was investigated in different media by using steady state emission and lifetime measurements, respectively. The quenching rate constant, k_q , and the critical transfer distance, R_0 , for quenching of B2NVP by Co^{+2} ions indicates a Forster type long-range energy transfer is obeyed. The activation energy associated with fluorescence quenching of B2NVP by Co^{+2} ions was calculated as, $E_a = 5.53 \text{ k J mol}^{-1}$ in methanol. The quenching rate constant, k_q , by molecular oxygen decrease with increasing solvent viscosity and followed a function of $A\eta^{-\alpha}$ with $\alpha = 0.73$.

**Reabsorption And Excitation Energy Transfer of
N,N-bis(2,5-tert-butylphenyl)-3,4:9,10 Perylenebis(dicarboximide)
(DBPI) Laser Dye**

By

Samy A. El-Daly,

Chemistry Department, Faculty of Science, Tanta University, Tanta, Egypt.

and Satoshi Hirayama

Kyoto Institute of Technology, Matsugasaki, Kyoto 606, Japan.

The effect of increasing concentrations of DBPI on excited state lifetime and emission intensity was investigated in chloroform. It was observed that the excited state lifetime of DBPI increases markedly and the emission intensity decreases with increasing the concentration of DBPI. The excited state lifetime of 1×10^{-6} mol dm⁻³ is 3.7 ns whereas τ_f is 8.25 ns for 1×10^{-3} mol dm⁻³. It was also seen the decay curves of diluted and concentrated solutions are monoexponential indicating the absence of excited state interaction between the dye molecules.

The degree of overlap between emission and absorption spectra of DBPI was calculated as $J = 13.4 \times 10^{-13}$ M⁻¹ cm³.

Excitation energy transfer from DBPI to malachit green (MG) was also studied in methanol, butanol and ethylene glycol by using steady state emission and fluorescence lifetime techniques. It was found that the Stern-Volmer relation is obeyed, from which the rate constants of energy transfer, k_{et} were calculated as 8.4×10^{10} , 7.7×10^{10} and 3.9×10^{11} M⁻¹ s⁻¹ in methanol, butanol and ethylene glycol, respectively.

The experimental critical transfer distances R_0 were calculated as 52.5, 50.2 and 53.9 Å for methanol, butanol and ethylene glycol, respectively. Both k_{et} and R_0 values indicate the underlying mechanism is a Forster type energy transfer mechanism. The activation energy, E_a associated with energy transfer from DBPI to MG was calculated as 4.5 kJ mol⁻¹. The fluorescence quenching of DBPI by KI was also studied in different solvents, the values of k_q are close to diffusion-controlled rate constants.

PHOTOELECTROCHEMICAL PROPERTIES OF DYE

SENSITIZED Zr-DOPED SrTiO₃ ELECTRODES

M.Y. El zayat*, A.O. Saed, and M.S.El-Dessouki

Physics Department, Faculty of Science

Cairo University, Giza, Egypt.

Abstract- Zr-doped SrTiO₃ was used as a photoanode in a three-electrode electrochemical cell. The three organic dyes; Safranin, Fluorescein and Eriochrome black T were used as sensitizers in the cell. The results showed that applying the dyes in photoelectrochemical solar (PECS) cells increased the solar efficiency to 2-3 folds its value without dyes. The efficiency reaches its maximum value when the dye concentration is sufficient to cover the surface of the semiconductor electrode with a continuous monolayer. Dye concentration higher than this value resulted in a decrease of the efficiency. Mott-Schottky plots gave a doping density of $1.34 \times 10^{16} \text{ cm}^{-3}$ for the sample and a space charge width of $1.5 - 2.0 \times 10^{-6} \text{ cm}$ (pH dependent). H₂ was produced at zero bias in the presence of Safranin dye at light intensity of 25 mW/cm^2 with an efficiency of about 39%. Both H₂ and O₂ were produced in the stoichiometric ratio. C.V. measurements showed two cathodic current peaks revealing two reduction processes at the semiconductor electrode.

* Physics Department, Faculty of Science.

Cairo University, Fayoum Branch,

Fayoum, Egypt.

LIMONENE DIHYDROPEROXIDES. AS NATURAL EFFICIENT
 PHOTOCHEMICAL HYDROXY RADICAL GENERATORS.
 NOVEL DNA-CLEAVING AGENTS

E. M. Elgendy

Department of Home Economy, Faculty of Specific Education,
 Mansoura, Egypt.

The photooxygenation reaction of limonene (1) in chloroform and in the presence of tetraphenyl porphin (TPP) as singlet oxygen generator at 0°C for 2 hr gave limonene dihydroperoxide derivatives (2 & 3), which were photolyzed in benzene at 0°C for 8 hr to give the corresponding limonene hydroxide derivatives (4 & 5) and phenol.

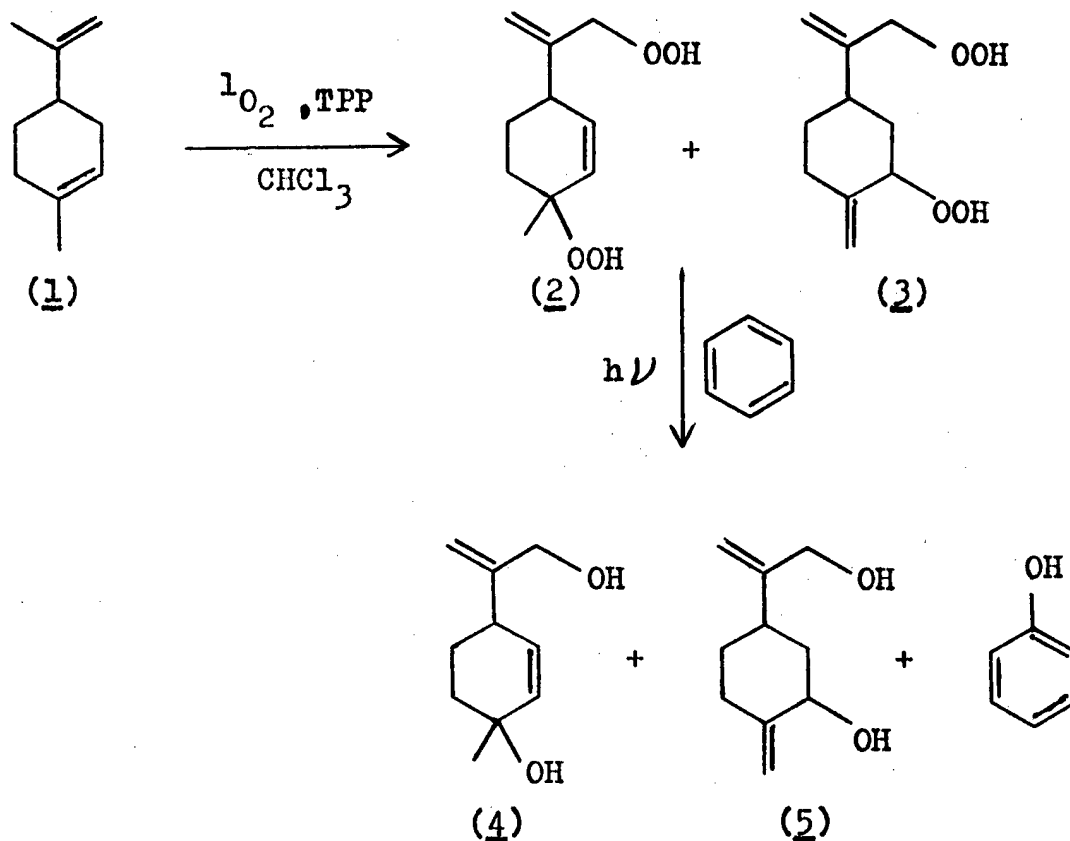

PHOTOOXYGENATION REACTIONS OF NATURAL PIPERINE

S.N. Ayyad* and E.M. Elgendy**

*Department of Chemistry, Faculty of Science in Demmiatta,
Mansoura University, Mansoura, Egypt

**Department of Home Economy, Faculty of Specific Education,
Mansoura, Egypt

The photooxygenation reaction of natural piperine (1) using tungsten-halogen lamp gave formatyl-hydroperoxyl cinnamido pyridine derivative (2_a or 2_b), whereas, the same reaction was carried out using sodium lamp to obtain 2_a or 2_b and the indoperoxide derivative (3).

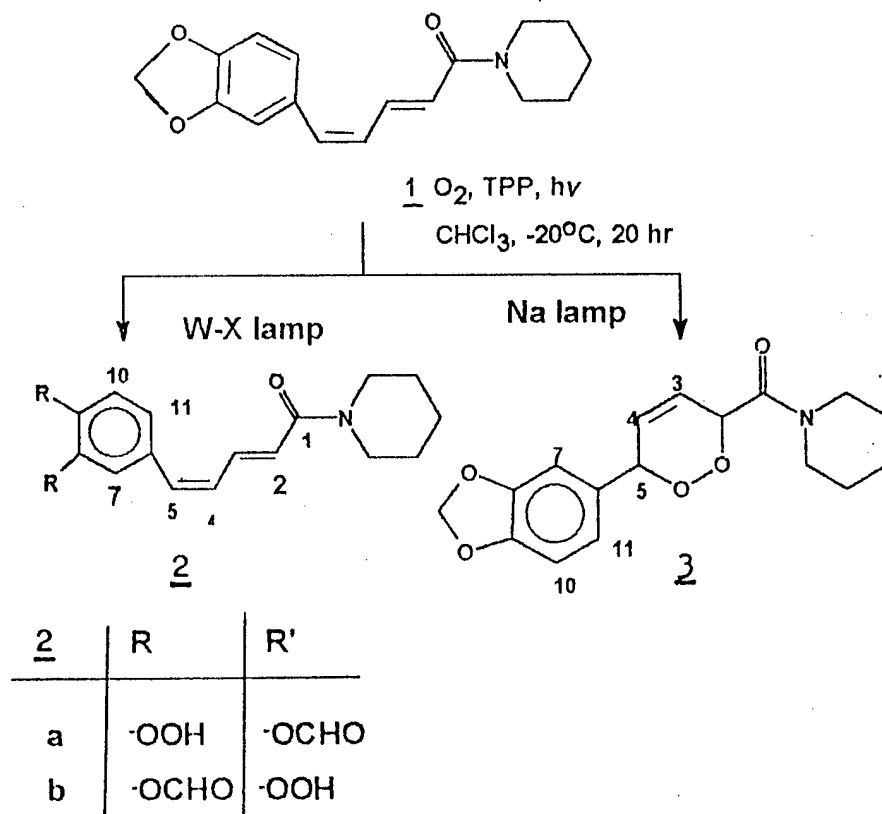

Interaction of the Excited Singlet State of 1,4- and 1,8-Dimethoxynaphthalene with Some Organic Compounds: A Fluorescence-Quenching Study

M. A. El-Kemary^{1,*} and S. A. El-Daly²

¹ Department of Chemistry, Faculty of Education, Kafr El-Sheikh, Egypt

² Faculty of Science, Tanta University, Tanta, Egypt

Summary. The fluorescence quenching of 1,4-dimethoxynaphthalene (1) and 1,8-dimethoxynaphthalene (2) by tetraphenylporphyrin (3), 9,10-diphenylanthracene (4), and 3-cyano-4-phenyl-6-(*p*-tolyl)-pyridin-2-one (5) has been studied in chloroform solution. The quenching occurs *via* a resonance energy transfer mechanism. The rate constant for the energy transfer (k_{ET}) of donor 2 is slower than that of 1 by the same acceptors, indicating that the steric effect dominates the ionization potential effect in all systems. The calculated critical transfer distances (R_0) are 17–72 Å. In contrast, charge transfer is the predominant pathway of electronic deexcitation in the fluorescence quenching of donors 1 and 2 by 7,7,8,8-tetracyanoquinone-dimethane (6) in chloroform. The roles of temperature and geometrical structure of the donors on the efficiency of fluorescence quenching of 1 and 2 by acceptor 6 have also been studied.

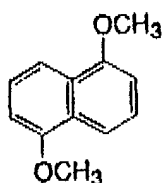

1

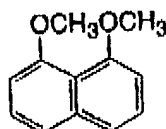

2

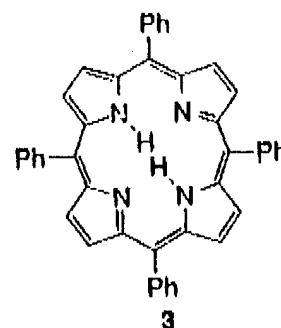

3

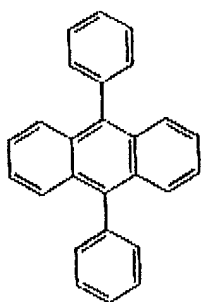

4

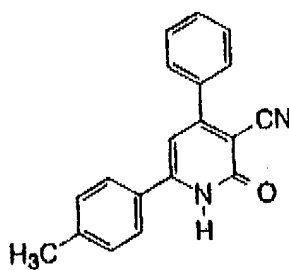

5

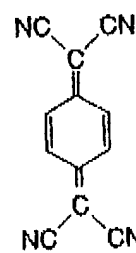

6

Photoreactions of Bianthrone and Related Substances with Thiyl Radicals as Nucleophilic Reagents

W.M. Abdou, Y.O. El-Khoshnieh and M.M. Sidky

National Research Centre, Dokki, Cairo, Egypt.

In connection with the photocleavage of ethylenes, reactions of the photosensitized ethylenic compounds bianthrone (1a), dixanthylene (1b), dithioxanthylene (1c), diflavylene (2a) and dithioflavylene (2b) with thiophenol and diphenylphosphinodithioic acid using benzophenone as a sensitizer were investigated; possible mechanisms for the reactions involving a double-energy-transfer mechanism are proposed.

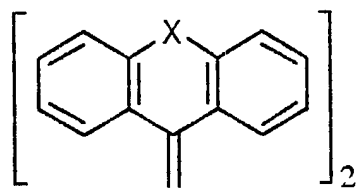

1

a, X = C(O)

b, X = O

c, X = S

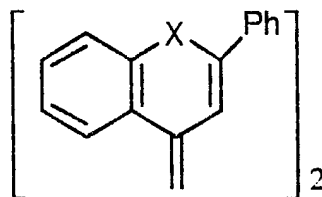

2

a, X = O

b, X = S

SOLVATOCHROMISM AND PHOTOCHROMISM OF SOME THIONES AND ANALOGS

Maged A. El-Kemary and Mohamed E. El-Khouly

Chemistry Department, Faculty of Education, Kafr ElSheikh, Tanta University, Egypt.

The fluorescence and absorption spectra of compounds I-III were obtained in solvents with various polarities. Solvent physical properties and empirical parameters, as a function of solvent induced spectral shifts, were used to explain solute-solvent interactions. The results show that the photophysical properties of the compounds are strongly influenced by the molecular structure.

Also, the effect of the solvent and molecular structure on the thermal equilibrium between coloured and colourless forms on the kinetics of thermal bleaching of the compounds are studied.

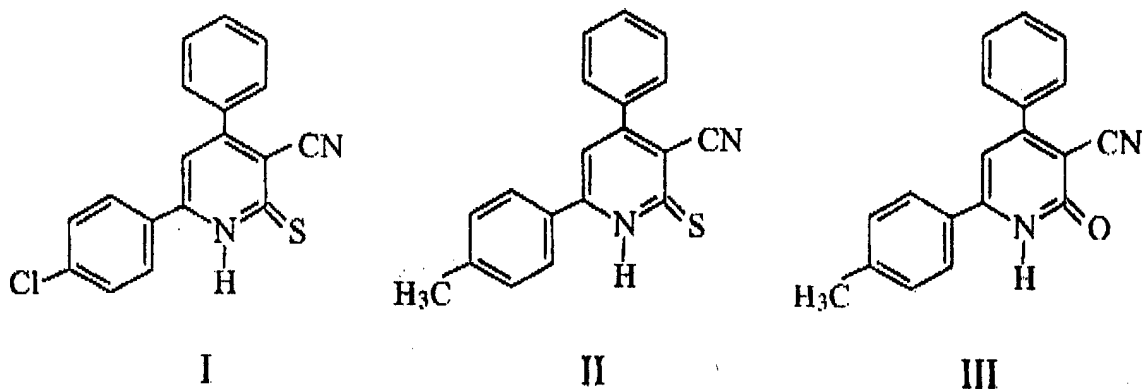

- I 3-cyano-4-phenyl-6-(p-chloro phenyl)-pyridin-2(1H)-thione.
II 3-cyano-4-phenyl-6-(p-methyl phenyl)-pyridin-2(1H)-thione.
III 3-cyano-4-phenyl-6-(p-tolyl)-pyridine-2(1H)-one.

Photoreaction of Silyliron(II) Complexes $\text{Cp}'\text{Fe}(\text{CO})_2\text{SiMe}_3$ ($\text{Cp}' = \eta^5\text{-C}_5\text{H}_5, \eta^5\text{-C}_5\text{Me}_5$) in the Presence of Di-*p*-Tolylgermane $(p\text{-Tol})_2\text{GeH}_2$ and *p*-Tolylstannane $(p\text{-Tol})_2\text{SnH}_2$

Amr El-Maradny, Hiromi Tobita, and Hiroshi Ogino

Department of Chemistry, Graduate School of Science, Tohoku University, Sendai 980-77,
Japan

The oxidative addition of Si-H bonds to low-valent transition metal centers is one of the most important reactions in the formation of transition metal-silicon bonds. The interaction of a reactive metal center with the Si-H bond of a silane can result in either complete oxidative addition to form M-H and M-Si bonds or a $\text{M}\cdots\text{H}\cdots\text{Si}$ 3-center 2-electron interaction, and often the latter is regarded as an intermediate to the formation of the former.¹ In 1989, a question was posed by Schubert et al., whether the 3-center 2-electron interaction is retained when silicon is replaced by its higher homologues.² Recently, we succeeded in preparing complexes containing two $\text{Fe}\cdots\text{H}\cdots\text{Ge}$ 3-center 2-electron bonds by the photolysis of $\text{Cp}^*\text{Fe}(\text{CO})_2\text{SiMe}_3$ ($\text{Cp}^* = \eta^5\text{-C}_5\text{Me}_5$) in the presence of primary germane RGeH_3 ($\text{R} = t\text{-Bu}, p\text{-Tol}$).

We report here the photochemical reactions of the secondary germane $(p\text{-Tol})_2\text{GeH}_2$ and the secondary stannane $(p\text{-Tol})_2\text{SnH}_2$ with both $\text{CpFe}(\text{CO})_2\text{SiMe}_3$ ($\text{Cp} = \eta^5\text{-C}_5\text{H}_5$) and $\text{Cp}^*\text{Fe}(\text{CO})_2\text{SiMe}_3$. Photolysis of $\text{CpFe}(\text{CO})_2\text{SiMe}_3$ in the presence of $(p\text{-Tol})_2\text{GeH}_2$ afforded a mixture of *cis* and *trans* isomers of diiron complexes $\text{Cp}_2\text{Fe}_2(\text{CO})_2(\mu\text{-CO})\{\mu\text{-Ge}(p\text{-Tol})_2\}$ and $\text{Cp}_2\text{Fe}_2(\text{CO})_2\{\mu\text{-Ge}(p\text{-Tol})_2\}_2$ (eq. 1).

(1) Schubert, U. *Adv. Organomet. Chem.* **1990**, *30*, 151.

(2) Schubert, U.; Kunz, E.; Harkers, B.; Willnecker, J.; Meyer, J. *J. Am. Chem. Soc.* **1989**, *111*, 2572.

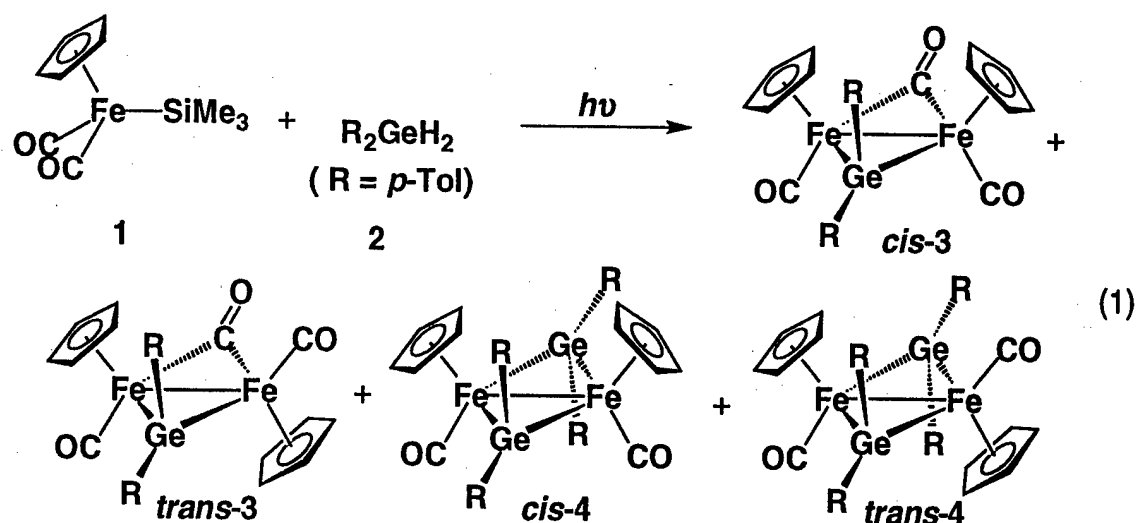

The photostationary state with *cis* : *trans* = 85 : 15 was attained by the photolysis of either *cis* or *trans* isomer of the latter complex. The analogous reaction with $(p\text{-Tol})_2\text{SnH}_2$ gave a bis(stannylene)-bridged dihydridodiferryl complex $\text{Cp}_2\text{Fe}_2(\text{CO})_2(\text{H})_2\{\mu\text{-Sn}(p\text{-Tol})_2\}_2$ (eq. 2).

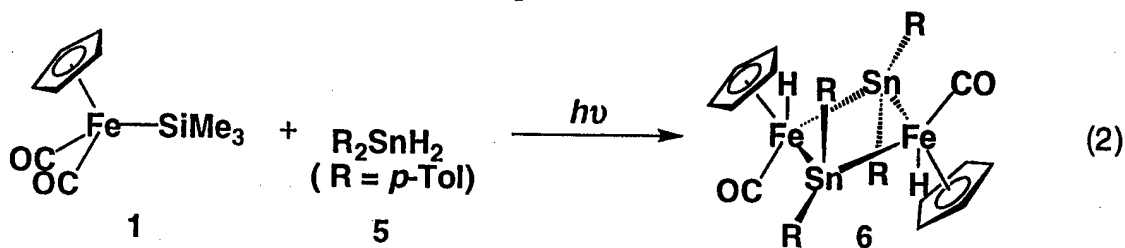

On the other hand, the photolysis of $\text{Cp}^*\text{Fe}(\text{CO})_2\text{SiMe}_3$ in the presence of $(p\text{-Tol})_2\text{GeH}_2$ gave a monoiron complex $\text{Cp}^*\text{Fe}(\text{CO})_2\text{GeH}(p\text{-Tol})_2$, while the corresponding reaction with $(p\text{-Tol})_2\text{SnH}_2$ afforded a *trans* isomer of diiron complex $\text{Cp}^*_2\text{Fe}_2(\text{CO})_2\{\mu\text{-Sn}(\text{Tol})_2\}_2$ and a monoiron complex $\text{Cp}^*\text{Fe}(\text{CO})\text{H}\{\text{SnH}(p\text{-Tol})_2\}_2$ (eq. 3), the last complex can be converted to the *trans* isomer of $\text{Cp}^*_2\text{Fe}_2(\text{CO})_2\{\mu\text{-Sn}(\text{Tol})_2\}_2$ by photolysis.

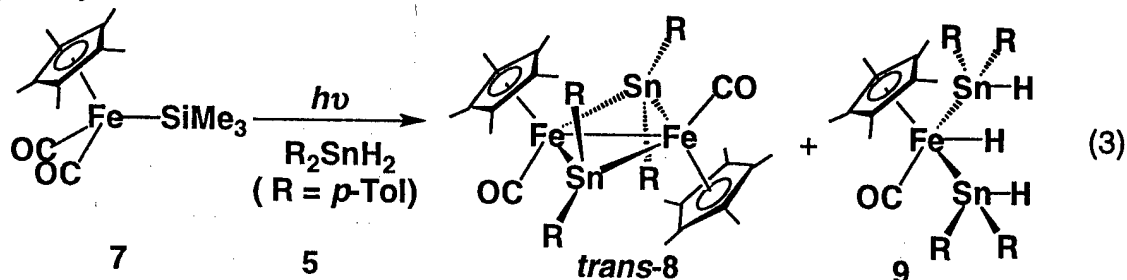

PHOTO DISSOCIATION OF H₂O MOLECULES IN INTENSE LASER FIELDS,
Walid Tawfik, M. A. Abd-Elnaser, Yosr E. Gamal and Lotfia El-Nadi, Niles National
Institute of Laser Enhanced Science and Physics Department, Faculty of Science, Cairo
University Giza, Egypt, ARE.

ABSTRACT: We study the multiphoton dissociation of H₂O Molecules when subjected to intense short pulsed laser beams of wavelength 532 nm and 355 nm delivered by Nd:YAG laser harmonics. Stimulated emission of intense spectral lines of wavelengths in the red visible region were observed. The intensity and wavelength of the emission lines dependences on laser beam intensity, wavelength and H₂O phase (ice, liquid or vapor) was studied. The results are analyzed in the frame of the three competing photodissociation processes; namely ATD (Above Threshold Dissociation), BSD (Bond-Softening Dissociation) and SD (Suppression Dissociation). The role of each in producing these emission lines are discussed and determined.

LUMINESCENCE EFFICIENCY OF COMBINED ALUMINIUM

TRIS-QUINOLATE (Alq₃) and NILE BLUE (NB) THIN FILMS.

Latifa Al Houty, M. Ragab, M. Omar and Lotfia El Nadi,

Physics Department, Faculty of Science, University of Qatar,

Doha, Qatar, Arabian Gulf

ABSTRACT : Alq₃ being an active layer in green organic light emitting devices has been investigated optically in conjunction with Nile Blue. Absorption and Luminescence efficiencies of combined thin films of Alq₃-NB thin films are measured. The effect of NB on Alq₃ optical properties for thin films of different thicknesses is studied for absorption of spectral range in UV and visible wavelength. The efficiency of the prominent luminescence band of Alq₃ due to photo and electro excitations is determined for different NB thin film thickness and geometry sequences. Shift in the luminescence band wavelength is determined and discussed.

Protein Catalysis of the Primary Process of the Other Natural Photosynthetic System, Bacteriorhodopsin

M. A. El-Sayed, Stephan Logunov, and Li Song

School of Chemistry and Biochemistry

Georgia Institute of Technology

Atlanta, GA 30332-0400

Bacteriorhodopsin (bR) is a retinal protein membrane present in bR HaloBacterium Salinarium which carries out its photosynthetic function. Upon absorption of a photon by its retinal chromophore, bR goes through the photocycle:

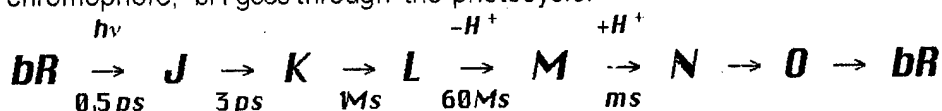

Using picosecond Raman transient spectroscopy, we were able to show that the first step is indeed a retinal photoisomerization from all-trans to 13-Cis form. The question immediately arises as to why retinal photoisomerization is so fast and specific around the C₁₃-C₁₄ bond when placed in the protein.

Using optical subpicosecond transient spectroscopy, we measured the rate and quantum yield of retinal photoisomerization in bR and for a number of its relevant mutants at different H⁺ and Cl⁻ concentrations and variable temperatures. It is found⁽²⁾ that the presence of the negatively charged Aspartate -85 and to some extent Asp212 in the retinal cavity near the 13-14 C-C bond is most effective in the protein catalysis of this process. If Asp85 is replaced by neutral residue (asparagin) or if it is neutralized at lower pH (as in acid blue bR), the photoisomerization rate is greatly reduced. For these bR variants, the rate of photoisomerization can be partially recovered by the addition of Cl⁻ solutions in which the negatively charged chloride ions are known to reside within the retinal cavity and can thus substitute for the lost Coo⁻ of Asp 85.

The above results lead us to propose the following model for the photoisomerization dynamics in bR: 1) the negative charges on Asp 85 and 212 stabilize the positive charge on the protonated Schiff base nitrogen in the ground state, giving the C₁₃-C₁₄ a double bond character in the ground state and thus prevents thermal isomerization; 2) upon excitation, the positive charge is stabilized on C₁₃, making the C₁₃-C₁₄ a single bond, thus reducing the barrier to photoisomerization; 3) the coupling between the asymmetric charge distribution of the amino acid residues and the retinal charge distribution in the excited state, triggered by the large change in the retinal dipole moment, gives the retinal system the torque necessary for its isomerization around the C₁₃-C₁₄ bond. The potential surfaces proposed for the retinal photoisomerization in bR are discussed in light of this model.

Photoluminescence of Surface - Oxidized Silicon Nanocrystals

M. Samy El-Shall
Department of Chemistry
Virginia Commonwealth University
Richmond, VA 23284-2006

In recent years, there has been an intense interest in the synthesis and characterization of nanoparticles^{1,3}. Due to their finite small size, the nanoparticles often exhibit novel properties which are different from the bulk materials' properties. Research in this area is motivated by the possibility of designing nanostructured materials that possess novel electronic, optical, magnetic, photochemical and catalytic properties. Such materials are essential for technological advances in photonics, quantum electronics, nonlinear optics and information storage and processing.

Among the many interesting nanoparticles, silicon nanocrystals show important promise for using in Si-based devices for optical communication. This exciting possibility has been hampered by the indirect band gap of bulk Si which prevents efficient electron-photon energy conversion. However, the discovery that porous silicon emits visible light with a high quantum yield has raised hopes for new photonic Si-based devices. This discovery has also stimulated interest in the synthesis of Si nanocrystals which are believed to be the luminescent centers in porous silicon^{4,5}.

In this talk, the synthesis of Si nanocrystals by a novel method which combines laser vaporization of metal targets with controlled condensation from the vapor phase will be described. Using this method, several other nanoscale metal oxide, carbide and nitride particles (10 - 20 nm) of well - defined composition have been prepared⁶⁻¹¹.

The surface - oxidized Si nanocrystals, produced by our method, aggregate into a novel weblike microstructure. These aggregates are very porous and have a large surface area. SEM micrographs show particles with ~ 10 nm diameters but the Raman shift suggests the presence of particles as small as ~ 4 nm. The Si nanocrystals, upon exposure to air, acquire a surface oxidized layer of SiO_x (x = 1-2) as indicated by XPS and FTIR.

The Si nanocrystals show luminescence properties that are similar to those of porous Si. They show a short-lived (< 20 ns) blue emission at 450 nm characteristic of the SiO₂ coating and a biexponential longer-lived red emission characteristic of the Si core. The blue photoluminescence is explained by the presence of intrinsic defects of the type Si(II)⁰ in the amorphous silica layer. The red emission of the Si core has a long-lived component of the lifetime that apparently increases (90-130 μs at 300 K) with particle size while the shorter-lived component appears to be size

independent. The long-lived red emission is consistent with excitations confined to the inner core Si atoms. The critical role played by the surface oxide layer in passivating the surface of the nanocrystals by removing competitive nonradiative relaxation processes will be discussed. The results are consistent with the quantum confinement mechanism as the source of the red photoluminescence.

-
1. See for example: a- "Nanomaterials: Synthesis, Properties and Applications", Edelstein, A. S.; Cammarata, R. C., Eds.; Institute of Physics Publishing, Bristol and Philadelphia, **1996**;
b- "Nanotechnology: Molecularly Designed Materials", Chow, G. M.; Gonsalves, K. E., Eds.; ACS Symposium Series 622, Washington DC, **1996**;
c- "Nanophase Materials: Synthesis, Properties, Applications", Hadjiipanyis, G. C.; Siegel, R. W., Eds.; Kluwer Academic Publications, London, **1994**;
d- "Frontiers in Materials Science", Science **1992**, 255, 1049.
 2. Steigerwald, M. L.; Brus, L. E. Acc. Chem. Res. **1990**, 23, 183.
 3. Alivisatos, A. P. J. Phys. Chem. **1996**, 100, 13226.
 4. Wilson, W. L.; Szajowski, P. F.; Brus, L. E. Science **1993**, 262, 1242.
 5. Brus, L. J.; Szajowski, P. F.; Wilson, W. L.; Harris, T. D.; Schuppler, S.; Citrin, P. H. J. Am. Chem. Soc. **1995**, 117, 2915.
 6. El-Shall, M. S.; Slack, W.; Vann, W.; Kane, D.; Hanley, D. J. Phys. Chem. **1994**, 98, 3067.
 7. El-Shall, M. S.; Slack, W.; Hanley, D.; Kane, D. in "Molecularly Designed Ultrafine / Nanostructured Materials", Eds: Gonsalves, K. E.; Chow, G.; Xiao, T. D.; Cammarata, R. C. Mater. Res. Soc. Proc. **1994**, 351, 369 (Pittsburgh, PA).
 8. El-Shall, M. S.; Graiver, D.; Pernisz, U.; Baraton, M. I. NanoStructured Materials **1995**, 6, 297.
 9. Baraton, M. I. ; El-Shall, M. S. NanoStructured Materials **1995**, 6, 301.
 10. El-Shall, M. S.; Li, S.; Turkki, T.; Graiver, D.; Pernisz, U. C.; Baraton, M. E. J. Phys. Chem. **1995**, 99, 17805.
 11. El-Shall, M. S.; Li, S.; Graiver, D.; Pernisz, U. C. in Ref. 1-b, Chapter 5, PP. 79-99.

Solar Detoxification of Water (a video, 30 min. long, in English)

E. Pelizzetti*, D. Bahnemann†, C. Pulgarin‡, J. Kiwi‡ and O. Enea[□]

*Università di Torino, 10125 Torino, Italy

†Institut für Solarenergieforschung, D-30165 Hannover, Germany

‡Ecole Polytechnique Fédérale, CH-1015 Lausanne, Switzerland

□Université de Poitiers, URA 350 CNRS, 86022 POITIERS, France

Water quality has become a primary concern throughout the world, especially in populated areas, where both surface and ground water are frequently found to be contaminated with toxic organic pollutants.

Efficient physicochemical processes, such as semiconductor photocatalysis, must be used in the transformation or destruction of pollutants which cannot be degraded by biological methods. This requires a new type of reactors, very active photocatalytic materials, and the use of the most advanced physico-chemical, biochemical and analytical methods, i.e. a collaboration between scientists who are specialists in biochemistry, photochemistry, electrochemistry, engineering and analytical chemistry. The aim of several European laboratories of Turin (Italy), Hannover (Germany), Lausanne (Switzerland) and Poitiers (France) is to realize a portable, solar reactor, suitable for inexpensive detoxification and sterilization of water in the Mediterranean countries, a reactor which is to be set up in Egypt in order to be tested at the Photoenergy Center (Cairo) in the real conditions of the country.

The main contributors interviewed in this scientific film present:

- the search of new photocatalysts, tested in various models of reactors (D. Bahnemann);
- the complexity of the degradation processes requiring to know the overall mass balance (E. Pelizzetti);
- the interest of combining a physico-chemical reactor with a biological one (C. Pulgarin and J. Kiwi);
- and the possibility of using TiO₂ ceramics deposited on catalytic films for performing photoassisted electro-oxidations (O. Enea).

In addition, Professor M. Gratzel (EPFL, Lausanne), was invited to present the principle of his "nanocrystalline injection" solar cell, which can provide the electrical energy required by the portable reactor planned to be realized for the treatment of polluted water.

By using a video presentation we have tried to show clearly the experimental equipment, the human resources and the ideas promoted in each of the laboratories. Our hope is that such a document will allow each of us to see and thus better understand the specificity of the other partners, a knowledge which should make working together easier and help focusing our efforts on the common project.

Metal/TiO₂ anodes for the photoassisted electrooxidations

O. Enea and D. Duprez

Laboratoire de Chimie 4, URA CNRS 350, Université de Poitiers,
40, avenue du Recteur Pineau, 86022, POITIERS, France

The aqueous suspensions of TiO₂ powders have been found very efficient in the photooxidation of various alcohols [1]-[6] but the use of a slurry of photocatalysts in the decontamination of polluted water requires their subsequent separation. This difficult problem, which has to be solved before any practical application, may be overcome by using TiO₂ ceramics, such as those prepared from different precursors [7], [8], and examined by scanning force microscopy [9].

In the present work, several types of thin, "nanocrystalline" TiO₂ membranes have been deposited onto a thin, porous metallic (Au, Pt, Pd,...) film evaporated or DC-sputtered on a commercial glass frit with fine porosity. Such composite layers, used under light irradiation to carry out photoassisted electrochemical processes, present a number of technical advantages and possibilities:

- not every semiconductor grain needs to be metallized, and thus the planar structure is easier to produce;
- since the size, distribution and optimum loading of metal deposits on TiO₂ particles are no longer determining factors, the characterization of the catalyst is simplified;
- the metallization of the planar structure is macroscopic and therefore external circuitry can be attached and electrical current drawn or driven through the layer. This possibility points toward waste water treatments in photoelectrochemical (PEC) reactors;
- the semiconducting layer is adaptable to the fabrication of more complex PEC structures, involving an array of PEC cells formed from different semiconducting layers deposited on a metallic pattern.

The morphology of TiO₂ ceramics prepared in three different ways (painting, spray pyrolysis, and spin coating) have been examined by electron microscopy and atomic force microscopy. Their efficiency in the photoassisted electro-oxidation of various organics make them promising in the decontamination of polluted air or of waste water.

References

- 1 O. Enea, A. Ali and D. Duprez, *New J. Chem.*, **12** (1988) 27.
- 2 O. Enea and A. Ali, *New J. Chem.*, **12** (1988) 853.
- 3 O. Enea, *Proc. Conf. Conversion Solar Energy* (1986) C59.
- 4 O. Enea, J.P. Ango and D. Duprez, *Proc. "Electr. Interf."* **224** (1988).
- 5 O. Enea and A.J. Bard, *ISE Ext. Abstr.*, **36** (1985) 7100
- 6 O. Enea, *Proc. "Photochem. Synthesis & Catalysis"* (1989)
- 7 O. Enea, J. Moser and M. Gratzel, *ISE Ext., Abstr.*, **40** (1989) 699.
- 8 B. O'Regan, J. Moser and M. Gratzel, *J. Phys. Chem.*, **94** (1990) 8720
- 9 O. Enea, *Coord. Chem. Rev.*, **125** (1993) 231.

PHOTOINDUCED ELECTRON TRANSFER AND CHARGE SEPARATION IN ADSORBED EXCIPLEX PYRENE - N,N-DIETHYLANILINE AT THE PRESENCE OF POLAR ADDITIONS

Eremenko A¹, Kikteva T¹, Zhang G², Thomas J.K².

1 - Institute of Surface Chemistry National Ukrainian Academy of Sciences
Prospect Nauki 31, 252022 Kiev, Ukraine

2 - Department of Chemistry and Biochemistry, University of Notre Dame, Notre Dame, Indiana
46556

Excited charge transfer (CT) complexes exciplexes are highly reactive due to their radical and polar character. The exciplex-mediated photoinduced CT phenomena play an important role in a wide area of photochemistry and photobiology. The dynamic of the radical pair and solvation of the polar CT state has generated a lot of interest in recent years. CT emission can be used as a probe to study their dynamic.

It is well known that in polar environment exciplex can dissociate rapidly, since the resulting solvent-separated ions can be stabilized by interaction with solvent molecules. In this work we deal with effect of polar environment on the luminescence spectra of singlet exciplex formed on silica surface. Photoinduced electron transfer reaction between pyrene (Py) and N,N dimethylaniline (DEA) both adsorbed onto porous silica matrices (silica gels, fractosil, silochrom) in the presence of coadsorbed polar additions as ethanol, acetonitrile and water has been studied. A reaction of exciplex formation on the surface of dehydrated silica without polar additions proceeds very effective starting from the lowest adsorption values of amine.

In the presence of polar coadsorbates, for Py-DMA adsorbed exciplex, the pyrene fluorescence is quenched. On a fractosil surface a spectrum of exciplex emission disappears and a new broad and hypsochromic shifted luminescence spectrum appears. Non-reversible changes of adsorbate take place. Non-fluorescent yellow colored product of photochemical reaction on the surface is formed. Formation of three fluorescent species on the surface as a result of interaction between Py, DMA and polar additions are established.

Non-fluorescent solvated ion pairs are formed on the surface of silica gel in polar environment. A tentative model of exciplex and ion-radical pairs formation is proposed in this work.

Studying the Ultraviolet and Visible solar Radiation over Cairo and Aswan and their Correlation with Environmental and Climatological Parameters

M.A.Mosalam Shaltout and A.M.Fathy

National Research Institute of Astronomy And Geophysics

Helwan,Cairo,Egypt

Abstract:

Studying the monthly average daily global and global ultraviolet solar radiation and the meteorological parameters over a period of three years(1990-1992)over Cairo and Aswan. The correlations between the different variables by the linear regression analysis to estimate an empirical function relating global radiation to ultraviolet radiation and the meteorological parameters (temperature, water vapor pressure ,cloudness, and ozone concentraion) has been done.

The atmospheric transparency and the extinction coefficient for the global and ultraviolet solar radiation for the same interval has been done.

Finally we do a comparison study for different places like Cairo, Aswan, Helwan, and Germany.

THE ROLE OF PHOTOCHEMISTRY IN THE DEGRADATION OF CHLORINATED ORGANIC CONTAMINANTS

Ken J. Friesen, Seif Ebrahim, Salwa A. Sadek, and Alaa S. Abd-El-Aziz
Department of Chemistry, University of Winnipeg, 515 Portage Avenue,
Winnipeg, Manitoba, Canada, R3B 2E9

The objective of this presentation is to describe the role of photochemistry in determining the fate of chlorinated chemicals of environmental concern. Persistent organic contaminants such as the polychlorinated dibenzofurans (PCDFs) which resist chemical and biological degradation may experience significant sensitized photolysis under environmental conditions. Our recent studies of the photodegradation of PCDFs in the laboratory using a xenon light source confirm previous reports that these contaminants appear to photodegrade much more rapidly in natural water than in distilled water. For example, the photodegradation of 2,3,8-trichlorodibenzofuran (TCDF) was approximately 50 times greater in natural water (first-order photolysis rate constant, $k_p = 0.45-0.59 \text{ h}^{-1}$) than in distilled water ($k_p = 0.011 \text{ h}^{-1}$). Several factors, including pH and the presence of oxygen, were found to have significant effects on the rates of photolysis of 238-TCDF in distilled water. We have, furthermore, examined the significance of aqueous photolysis of 1,2-dichlorododecane, a chlorinated alkane which does not degrade by direct photolysis. Preliminary results have shown that oxygen plays an important role in catalyzing the photolytic destruction of 1,2-dichlorododecane. We are continuing to investigate factors affecting photolytic reactions and in finding suitable catalysts for the aquatic photodegradation of organic contaminants.

TiO₂ -Photocatalytic Oxidation of Selected Condensed Heterocyclic Sulfur Compounds

Aboel-Maged A. Abdel-Wahab & Abd El-Aal M. Gaber
Chemistry Department, Faculty of Science, Assuit University, Assuit 71516, Egypt.

Continuation to our interest in photoelectrocatalytic oxidation at irradiated semiconductors motivated us to report here a recent investigation on irradiated TiO₂ (Anatase) mediated photocatalytic oxidation of sulfur containing-heterocycles (A), for mechanistic, synthetic and environmental purposes.

The physiological effects induced by contact of activated sulfides with eyes, skin or lungs can be substantially reduced upon oxidation to sulfoxides or sulfones.

The primary step in this process often involves photogeneration of electron-hole pair and the reactions are initiated by the formation of a surface bound cation radical generated by interfacial electron transfer.

Products analysis was carried out mainly using HPLC and GC/MS techniques.

C-S cleavage and S-oxidation products has been considered for mechanistic investigations.

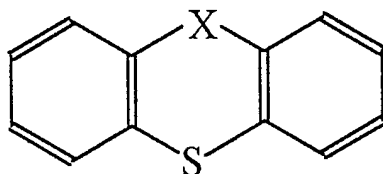

(A) X = S, CO, CH₂, -

Mechanism of the photochemical reactions of the dithiolate-diimine Zn(II) and Pt(II) complexes caused by electron transfer from the LLCT excited state.

Galin A.M., Rafikov R.R., Tyurin D.A., Weinstein J.A., Mel'nikov M. Ya.

Department of Chemistry, Moscow State University, Moscow, 119899, Russia.

In this work we have studied a mechanism of photoinduced electron transfer reactions of the dithiolate-diimine Zn(II) and Pt(II) complexes.

Our investigation of liquid solution absorption spectra and glassy solution luminescence spectra of these complexes has shown that a new long wavelength band appears only in complexes containing both thiolate and diimine ligands. This band we have assigned to the LLCT (ligand-ligand charge transfer) transition. The LLCT state in these complexes is the lowest in energy, therefore the first stage of the investigated mechanism is the formation of LLCT excited state.

The growth of the thiolate ligand donor ability in the series of complexes $(4\text{-X-C}_6\text{H}_4\text{S})_2\text{Zn}(\text{phen})$, $\text{X}=\text{H}$, Me, MeO, Me₂N and the growth of the diimine ligand acceptor ability in the series $(\text{C}_6\text{H}_5\text{S})_2\text{Zn}(\text{NN})$, NN=bpy, phen, lead to the red shift of the LLCT band. Therefore the LLCT excited state in these complexes is formed due to electron transfer from thiolate to diimine ligand.

One can assume that the LLCT excited state formed owing to this charge-separation process is consisted of thiyl radical and one-electron reduced diimine ligand. Therefore the second stage of the reaction mechanism may be:

1) **elimination** of the thiyl radical because of reducing of metal-sulfur bond strength in the LLCT state

or

2) **oxidation** of the LLCT excited state by an electron acceptor (oxygen or methylviologen) because of the high reduction ability of the one electron reduced diimine ligand.

We have observed the characteristic absorption bands of the thiyl radicals at 540nm for $\text{MeOC}_6\text{H}_4\text{S}^\bullet$ and 680nm for $\text{Me}_2\text{NC}_6\text{H}_4\text{S}^\bullet$ in pulse photolysis of degassed solutions of the corresponding zinc complexes and characteristic three-line 1:1:1 ESR signal (splitting 16G, $g=2.0065$) of the adduct of PhS^\bullet radical with $t\text{-BuNO}$ in steady state photolysis of oxygen contained solution of $(\text{PhS})_2\text{Zn}(\text{phen})$. This proves that for the zinc complexes, the main process in the second stage is the **elimination** of the thiyl radical:

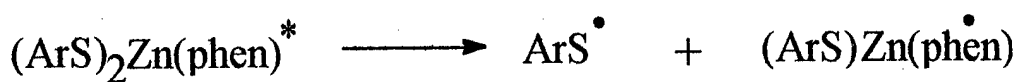

Second order decay of the thiyl radicals observed in pulse photolysis of zinc complexes and a low quantum yield of electron transfer from complexes to methylviologen (10^{-4} for $(\text{PhS})_2\text{Zn}(\text{bpy})$) in the steady-state photolysis of degassed solution have demonstrated that for the zinc complexes the main process in the third stage is back electron transfer:

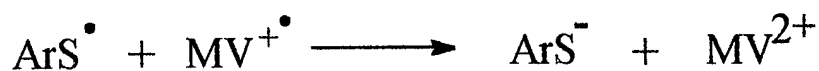

A high quantum yield of electron transfer from platinum complexes to benzylviologen (10^{-1} for $(4\text{-MeOC}_6\text{H}_4\text{S})_2\text{Pt}(\text{bpy})$) and a linear dependence of this quantum yield from the concentration of acceptor have shown that for the platinum complexes having strong metal-sulfur bound, the main process in the second stage is **oxidation**:



and at the third stage, transfer of second electron takes place:



Financial support of RFFI (N 96-03-32530) and International Soros Science Education Program (N S96-728) is gratefully acknowledged.

DYE MOLECULES IN ZEOLITES AS ARTIFICIAL ANTENNA

Niklaus Gfeller and Gion Calzaferri

Departement of Chemistry and Biochemistry, University of Bern,
Freiestrasse 3, CH-3000 Bern 9, Switzerland

A possibility to mimic essential properties of the antenna occurring in natural photosynthesis is to exchange cationic dye molecules into zeolite L, where they are arranged in the parallel channels. We have therefore studied the isothermal ion exchange of thiazine dyes in zeolite L and we found that thionine (Th) enters the large cavities. Concentrations of up to ~ 0.1 M of thionine monomers inside zeolite L have been reached. The restricted geometry of the zeolite channels excludes aggregation of dye molecules inside zeolite L. The concentration of dye molecules in the zeolite is described by the exchange degree θ , which is the ratio of dye molecules in zeolite L to the exchangeable cations in the zeolite [1].

Other dyes like pyronine (Py) and oxonine (Ox) having a structure similar to that of thionine can also enter the large channels of zeolite L. The somewhat larger alkylated analogous structures of thionine, methylene blue and ethylene blue remain on the surface of the microcrystals where they form dimers and higher aggregates.

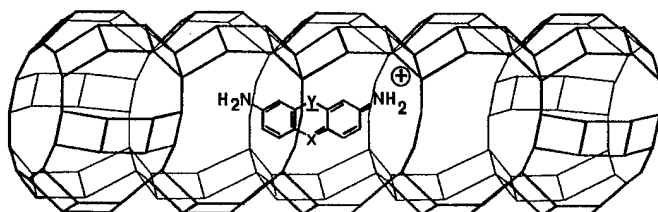

Figure 1: Schematic view of a dye molecule in the large channel of zeolite L.

Py: Y=O, X=C-H
Ox: Y=O, X=N'
Th: Y=S, X=N

The short distances between the dye molecules in zeolite L and their spectral properties allow fast energy transfer reactions. We have shown that the geometrical arrangement of the dye molecules supports very efficient anisotropic energy transfer. Since formation of aggregates is prevented, self quenching is excluded even at very high concentrations (~ 0.1 M) of dye molecules.

We report two types of experiments with dye molecules in zeolite which exhibit that such a zeolite dye system fulfills basic needs of an antenna: (i) First, it was shown that energy transfer occurs inside of the zeolite microcrystals filled with a mixture of pyronine and oxonine. The spectral properties of these dyes allow energy transfer reactions from pyronine to oxonine molecules. This was proved with stationary and time resolved fluorimetric measurements [2].

(ii) Furthermore it has been shown that the quanta absorbed by pyronine inside of the zeolite microcrystals can be trapped by a quencher with suitable right spectral properties placed on the microcrystals surface. For this we used either Methyleneblue or Cresyl fast violet, both which are too large to enter the zeolite and therefore end up forming aggregates on the outer surface. Both stationary and time resolved fluorescence have been measured. Stationary measurements show that at high exchange degrees nearly all the pyronine emission is quenched by the traps on the outer surface [3],[4]. The time resolved results show that for low exchange degrees, direct energy transfer from donors

inside to acceptors outside is dominant. At higher exchange degrees θ energy migration among the donors inside occurs.

Relevant antenna properties of dye loaded zeolite L systems have been analyzed theoretically. The investigations are based on the crystal structure of zeolite L and on the size of the molecules used. We assume that the dye molecules are positioned in given sites, arranged along the linear channels. The $S_1 \leftarrow S_0$ transition dipole moment of all molecules in zeolite L are orientated parallel to the channel axes. The dye molecules are distributed randomly among the sites and immediately after excitation, each site has the same probability of being occupied by an excited molecule. Only one excited molecule is allowed per zeolite microcrystal. Therefore interactions between two or more excited molecules are excluded. Energy transfer reactions between the molecules are governed by dipole-dipole interaction and can be described by Förster's theory.

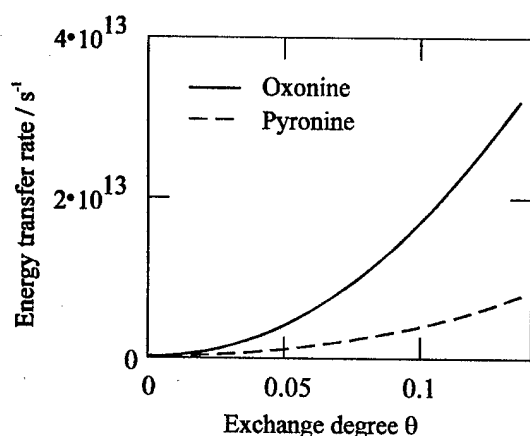

The energy transfer rate obtained in this model is plotted in Figure 3 as a function of the exchange degree. Rates higher than $1 \cdot 10^{12} s^{-1}$ are obtained. For the maximum exchange degree possible for the dyes investigated ($\theta=0.14$) energy transfer rates in the order of $6 \cdot 10^{12} s^{-1}$ for pyronine and $2.5 \cdot 10^{13} s^{-1}$ for oxonine were obtained. The difference between the two dye-L zeolite systems is due to the different spectral properties of the dyes.

Figure 2: Calculated energy transfer rate of pyronine (dashed) and oxonine (solid) in zeolite L.

In an antenna system excitation is transported from within its bulk volume to a fixed point. During this study a system was investigated whereby traps are adsorbed on the outer surface of the cylindrical zeolite microcrystals. We distinguish between energy migration along the axis of the cylinder (front trapping) and perpendicular to it (coat trapping). The energy transfer probability depends only on the immediate situation. The time evolution of the system can be described by a homogeneous Markov chain [4].

We found that the front trapping is more efficient than the coat trapping and it becomes the dominant process for crystals smaller than 100 nm even at a low exchange degree. The coat trapping efficiency is less affected by the size of the microcrystals, because of the arrangement of the channels and the angle dependence of the transfer probability. The energy migration is highly anisotropic in dye-zeolite L and directed along the channels-axis.

- [1] G. Calzaferri and N. Gfeller, *J.Phys.Chem.* **96** (1992), 3428-3435
- [2] S.Bergamasco, G.Calzaferri and K.Hädener, *J.Photochem.Photobiol.* **53A** (1990) 109-125
- [3] F. Binder, G. Calzaferri and N. Gfeller, *Sol. Energy Mater. Sol. Cells*, **38** (1995), 175-186
- [4] F. Binder, G. Calzaferri and N. Gfeller, *Proc. Indian Acad.Sci. (Chem.Sci)*, **107** (1995), 1-15

DYNAMICS OF INTRAMOLECULAR ENERGY AND ELECTRON TRANSFER

K.P. Ghiggino
Department of Chemistry
University of Melbourne
Victoria, Australia 3052

Photoinduced electron transfer (PET) and electronic energy transfer (EET) act concertedly with high efficiency in plant photosynthesis and these processes play central roles in the development of usable synthetic solar energy conversion systems. In many cases the various donor and acceptor species form part of a larger molecular framework. This framework may not just serve a passive structural function to separate and orient the "active" components but can play a key role in mediating the intramolecular energy and electron transfer processes. In this presentation the role of a linking molecular framework in determining the rate and distance dependence of PET and EET will be reviewed and illustrated with theoretical and experimental studies on model bi- and tri-chromophoric bridged donor: acceptor systems and macromolecular structures.

For the case of rigidly linked norbornane bridged naphthalene dimers, theoretical calculations¹ indicate that in the absence of direct through-space orbital overlap between the naphthalene chromophores a through-bond interaction involving the linking saturated polynorbornane bridge is the major contributor to PET and triplet-triplet EET. For singlet-singlet EET the through-bond interaction acts to reinforce the through-space Coulombic coupling and dramatically modify the distance dependence of the rate. The results of time-resolved fluorescence anisotropy experiments, which characterize the rate of energy transfer in these model bichromophoric systems, will be described which confirm the theoretical conclusions. The dynamics of energy transfer in various aromatic polymer systems have also been characterized and serve to further emphasise the important role of the connecting backbone on energy transport mechanisms.

Both electronic and nuclear factors can affect the rate and distance dependence of long-range intramolecular PET reactions.² Examples will be given where the contributions of both these factors can be resolved and experiments described which can elucidate the role of solvent dynamics on the electron transfer process. The implications of these studies for the design of supramolecular structures which optimize electron and energy transfer will be discussed.

References

1. A.H.A. Clayton, G. D. Scholes, K.P. Ghiggino and M.N. Paddon-Row, *J. Phys. Chem.*, 100: 10912-10918 (1996)
2. A.H.A. Clayton, K.P. Ghiggino, J.M. Lawson and M.N. Paddon-Row, *New J. Chem.* (in press)

RESONANT TWO PHOTON IONIZATION PROCESSES TO STUDY SPECTROSCOPY AND REACTIVITY OF VAN DER WAALS CLUSTERS OF AROMATIC MOLECULES

A.Giardini Guidoni, A.Mele.

Universita' di Roma "La Sapienza", P.le Aldo Moro 5 00185 Roma Italy

S.Piccirillo, C. Bosman

Istituto Materiali Speciali - CNR, Tito Scalo (PZ) Italy

ABSTRACT

A large number of weakly bound van der Waals (v.d.W.) clusters of small molecules bound to aromatic systems has been studied in the past in our and others laboratories¹⁻⁴. These aggregates can be generated by supersonic expansion of He gas seeded with an aromatic molecule and other partners. V.d.W. clusters of formula R_mS_n where R is the aromatic chromophore and S is the solvent atom or molecule, are produced. Subscript m and n can be quite large. Cluster distribution is affected by the supersonic beam parameters, such as stagnation pressure and temperature. The vibro-electronic spectra of vdW aggregates are characterized by a shift of the 0_0^0 electronic origin with respect to the bare aromatic chromophore. This spectral shift is affected by the position of the solute and of the solvent and their relative orientation. In the vibro-electronic spectra intramolecular vibrational modes of the $S_1 \leftarrow S_0$ transition and frequencies deriving from the intermolecular motion of the solute-solvent system are observed. The spectrum can be more complex if vdW conformers are present. Particularly interesting are also the adducts formed by chiral solvent and solute molecules. The electronic spectrum of this vdW. clusters, having the same mass, is shifted differently in case of the two diastereomer pairs.

The supersonic molecular beam apparatus for cluster production and resonant two photon ionization detection (R2PI) has already described². The vdW clusters are produced by adiabatic expansion of solute solvent mixtures seeded in helium through a pulsed nozzle with an orifice diameter of 0.4 mm in the first chamber. The supersonic beam is skimmed at 3 cm downstream from the nozzle and enters the second chamber. A frequency doubled dye laser beam emitting in the UV region crosses the molecular beam at a distance of 18 cm from the nozzle. The clusters ionized by R2PI are detected by a time of flight mass spectrometer.

This paper presents the results of the work on R2PI photoionization mass spectrometry and spectroscopy of STY and 4FSTY cluster with simple molecules. The method allows also to observe charge and proton transfer as well as aromatic substitution reactions in 4FSTYMMA adducts.

Computer modeling and calculations of the minimum energy structures and geometries for both S_0 and S_1 electronic states of 4FSTY-rare-gases adducts

have been performed in the past by the conjugated gradients method³. The association processes are evaluated in a 6D space. In case of the S_0 electronic state the Lennard Jones parameters were taken from the literature. Arbitrary Lennard Jones fitting parameters have been employed for the S_1 electronic state in order to match the experimental 0_0^0 shift (the difference between S_0 and S_1 zero point energies was neglected) and the vdW stretching frequency of the 1/0 cluster. The same parameters have been used to calculate the structures of the complexes here reported.

As an example of reactivity studies in the TOF mass spectrum of a mixture of 4FSTY and MMA seeded in He at 4 bar at a wavelength of 291 nm, the mass of 4FSTY molecule and its clusters with MMA up to $4FSTY(CH_3NH_2)_3$ are observed. Other ions at various m/e are also present. Both unprotonated $(MMA)_n^+$ ($n \geq 2$) and protonated $(MMA)_nH^+$ ($n \geq 1$) series with n up to 4 are identified. Further a quite intense peak at $m/e = 133$ is assigned to the aromatic substitution product ion $[C_8H_7NHCH_3]^+$. These ions in the mass spectrum give evidence of intracluster ion molecule reactions. The wavelength spectrum of 4FSTY·MMA is well resolved, while in the spectra of larger adducts only few spectroscopic features emerge.

In the R2PI spectrum of $(MMA)_2^+$ ion at $m/e=62$, the bands match several bands of the spectrum of the ion at $m/e=133$, the aromatic substitution product, and bands in the spectrum of 4FSTY·MMA. This would suggest that the formed ions originate from a common precursor, such as $4FSTY(MMA)_n^+$ cluster with $n > 1$. This behaviour has been reported for analogous reactions with other polar solvents⁴. It has also been assumed that the reduction of the IP of a solvent subcluster and its electron or proton transfer dynamics play an important role in the reaction mechanism.

REFERENCES

- [1] E. R. Bernstein in "Atomic and Molecular Clusters" E. R. Bernstein ed. Wlsevier N.H. 1990 p.551
- [2] D. Consalvo, A. van der Avoird, S. Piccirillo, M. Coreno, A. Giardini-Guidoni, A. Mele, M. Snels. *J. Chem. Phys.* **99**, 8398 (1993)
- [3] M. Coreno, S. Piccirillo, A. Giardini Guidoni, A. Mele, A. Palleschi P. Brechignac, P. Parneix. *Chem. Phys. Lett.* 236 580 (1995).
- [4] B. Brutchy, *Chem. Rew.* 92, 1567 (1992)

ARENE-ETHENE PHOTOCYCLOADDITION PROCESSES AND THEIR SUNLIGHT INITIATION

by David Amey, Andrew Gilbert, and Damian T. Jones,

Chemistry Department, The University of Reading, Whiteknights, P.O. Box 224,
Reading, Berkshire, RG6 2AD, U.K.

Photochemical procedures are attractive as key steps in organic sequences since many lead to considerable increase in molecular complexity of readily accessible starting materials and they do not involve aggressive reagents or produce toxic waste products. The reaction which introduces the greatest degree of molecular complexity of any general process is the *meta* photocycloaddition of ethenes to the benzene ring:¹ this yields tricyclo[3.3.0.0^{2,8}]oct-3-enes and thus creates three new rings and up to six new stereocentres. Such complexity increase has been elegantly used in the short synthesis of a number of naturally occurring and biologically active compounds.² For many inter- and intra-molecular ethene-arene systems, however, low regio- and stereo-selectivities are encountered in the photoadduct formation and this limits the wider acceptance of the process as a synthetic step.³

We have investigated the potential of using addend substituents to control the ordering of the three bonds formed during the photoaddition and thereby to induce selectivity into the reaction. Success in directing the cyclopropane ring formation in the adduct has been achieved both by using an *endo* chlorine effect of the ethene to distort the C₆ ring and from attractive interactions between 1,3-substituents on the benzene ring. For the intermolecular process these features induce regio- and stereo-specificity to the *meta* addition and have been applied to the intramolecular reaction to access either the linear or the angular triquinane skeleton specifically. The insight that these studies provide to the details of the mechanism of the *meta* photocycloaddition process will be discussed, and the feasibility of inducing such additions of arene-ethene systems using sunlight will be considered.

1. First reported by K.E. Wilzbach and L. Kaplan, *J. Amer. Chem. Soc.*, 1966, **88**, 2066; and D. Bryce-Smith, A. Gilbert, and B.H. Orger, *J. Chem. Soc. Chem. Comm.*, 1966, 512.
2. See for example P.A. Wender, L. Siggel, and J.M. Nuss, *Comprehensive Org. Synthesis*, eds. B.M. Trost and I. Fleming, Pergamon Press, Oxford, 1991, **5**, 645.
3. J. Cornélisse, *Chem. Rev.*, 1993, **93**, 615.

SOLAR SYNTHESIS OF HYDROGEN PEROXIDE

James Guillet, Yoshiyuki Takahashi, Victor P. Foyle,
Nicholas A. D. Burke, and Gad Friedman

Department of Chemistry, University of Toronto,
Toronto, Canada M5S 3H6

We have reported a method of synthesizing hydrogen peroxide by exposing a hydrogel film containing chemically bound anthraquinone (AQ) groups to natural sunlight.^{1,2} When supported on a water surface, the hydrogen peroxide diffuses into the water in quantities sufficient to kill bacteria and other pathogens, thus providing a means of purifying drinking water in remote locations. The process is autocatalytic and has demonstrated yields of up to 100 moles of HOOH per mole of the AQ sensitizer.

One of the most common causes of death and disabling illness in many less developed countries is disease caused by contaminated water. Small solar devices or ponds are proposed for use in the detoxification of drinking water. Hydrogen peroxide is ideal for this use, since it decomposes only to water and oxygen, unlike chlorine which is known to produce chlorinated organics which are believed to be toxic at very low concentrations.

More recently we have developed catalysts in which the anthraquinone units are chemically bound to a variety of polymeric and inorganic solids with very high surface area.³ These are also photochemically active, producing very high yields of HOOH in continuous reactors. The advantage of these catalysts is that they can be easily removed from the aqueous solution by filtration for recycling. They can also be used in fixed beds, or in flat plate reactors.

Both systems give higher yields of HOOH when hydrogen donors such as methanol, ethanol, isopropanol, or glycerol are present. These donors are converted to other products which may provide added value to the process. The quantum yields can be as high as 2.

This paper will outline the chemistry and mechanisms of this novel process and describe experimental reaction designs for prototype solar reactors.

1. V. P. Foyle, Y. Takahashi and J. E. Guillet, *J. Polym. Sci., Polym. Chem. Ed.*, **30**, 257 (1992).
2. V. P. Foyle, M. Nowakowska and J. E. Guillet, *Bull. Polish Acad. Sci.*, **43**, 231 (1995).
3. J. E. Guillet and G. Friedman, *U. S. Patent 5,374,339*, December 20, 1994.

A Theoretical Study on the Structures and Spectra of Distyrylpyrazine (DSP) laser Dye .

Ahmed Mahmoud El-Nahas

Chemistry Department, Faculty of Science, El-Menoufia University, Shebin El-Kom, Egypt.

Essam Hammam, and El-Zeiny M. Ebeid

Chemistry Department, Faculty of Science, Tanta University, Tanta, Egypt.

Abstract

Semiempirical molecular orbital calculations have been undertaken to study the structures of the ground and excited states of DSP dye and to assess its activity as a laser dye. The geometries of the investigated dye are fully optimized at MNDO, AM1, and PM3 hamiltonians in DMSO solvent using the precise option to tighten the SCF convergence. Based on detailed conformational analysis, it has been revealed that the most stable conformer is the trans-trans structure of C_{2h} point group which agrees very well with the available experimental data. The absorption ($S_0 \rightarrow S_1$), excited state absorption (ESA; $S_1 \rightarrow S_n$), and emission ($S'_1 \rightarrow S'_0$) spectra has been calculated at MNDO level using the PM3 optimized geometries in DMSO. The estimated absorption band is at 377 nm (exp. 380 nm) and assigned to $S_0 \rightarrow S_1$ transition. The ESA band is at 457 nm (exp. 460 nm) and assigned to $S_1 \rightarrow S_{12}$ transition. The emission band is at 458 (exp. 456 nm) and assigned to $S'_1 \rightarrow S'_0$ transition. The overlap of the emission spectrum with that of the ESA is the main reason behind the reduced laser activity of the investigated dye.

STUDIES ON THIENO[3,4-d]PYRIDAZINE AND ELECTRON ACCEPTOR COMPOUNDS

Nasr K. Mohamed, Alaa A. Hassan^{*}, Kamal U. Sadek and Ramadan A. Mekheimer

Chemistry Department, Faculty of Science, El-Minia University, El-Minia 61519, A.R. EGYPT.

Thieno[3,4-d]pyridazines **1** were found highly reactive towards activated double bond systems. Thus, phthalazine carboxylates and phthalazine dicarboxylates as well as phthalazine anhydrides were obtained on treating **1** with acrylonitrile, ethyl acrylate and maleic anhydride respectively.¹⁻³

Our interest on the chemistry of organosulfur compounds with π -deficient substances⁴ as well as the photoreactions of benzothiophene with captodative alkenes⁵ prompted us to investigate the behaviour of ethyl 5-amino-3,4-dihydro-4-oxo-3-aryl thieno[3,4-d]pyridazine-1-carboxylate **1a,b** towards some π -acceptors.

Upon solar and/or ultraviolet irradiation, the ester **1** reacted with tetracyanoethylene, 2-(dicyanomethyleneindane-1,3-dione), 2,3-dichloro-5,6-dicyano-1,4-benzoquinone and 2,3-dicyano-1,4-naphthoquinone to give compounds **2-4**.

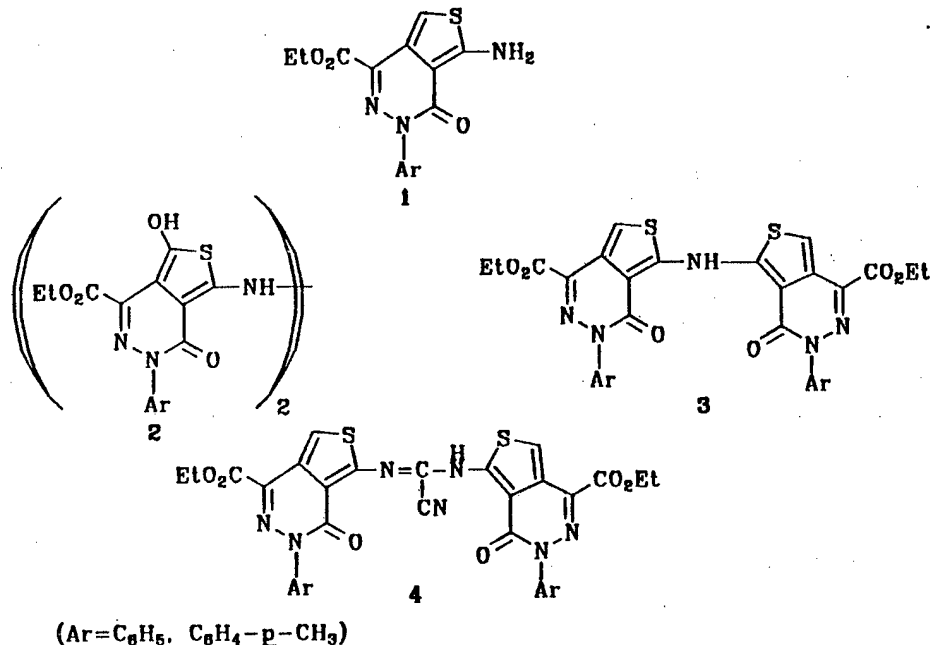

References

1. M. H. Elnagdi, A. M. Negm and A. W. Erian, *Liebigs Ann. Chem.*, 1255 (1989).
2. M. H. Elnagdi and A. W. Erian, *Liebigs Ann. Chem.*, 1215 (1990).
3. F. A. Abu-Shanab, B. Wakefield, F. Al-Omran, M. M. Abdel Khalek and M. H. Elnagdi, *J. Chem. Res(s)*, 488 and (M) 2924 (1995).
4. A. A. Hassan, *Bull. Soc. Chim. Fr.*, 131, 424 (1994), *Phosphorus, Sulfur, Silicon, Relat. Elem.*, 101, 189 (1995), 106, 55 (1995) and references cited therein.
5. D. Döpp, A. A. Hassan and G. Henkel, *Liebigs Ann. Chem.*, 697 (1996).

EFFECTS OF LASER, HPD, PHOTODYNAMIC TREATMENT AND
HYPERTHERMIA ON CELLULAR IMMUNOCOMPETENCE OF
 γ -RAY-IRRADIATED MICE

Don-mong Hau

Institute of Radiation Biology, National Tsing Hua University

Hsinchu, Taiwan, R.O.C.

The effects of laser, hematoporphyrin derivative (HPD) photodynamic treatment and hyperthermia on cellular immunocompetence were investigated in this study. All of the experimental mice were treated with 4 Gy γ -ray whole-body irradiation. Those animals were divided into many groups and then treated with laser, HPD or/and hyperthermia after γ -irradiation. Those animals were treated respectively with fractionated Hpd injection (HPD, 7.5 mg/kg, 24 hr. prior to laser treatment), laser irradiation (LT, 300 J total energy, 514.5 Å in wavelength) or/and hyperthermia (HT, 44.5 ± 1 °C for 30 minutes) once a day, for three days. Spleens of mice were removed from mice at different times after treatment and the splenic cells (1×10^6) were cultured and stimulated with mitogens such as PHA-M, PWM, Con A and LPS for measuring the cellular immunocompetence. The amounts of transformation were measured by tritiated-thymidine (^3H -TdR) uptake. The result revealed that the relative spleen weight of whole-body irradiated mice decreased significantly on the 19th day with HT and on the 12th day with HpD+LT+HT respectively. In vitro, mitogens stimulation of splenic lymphocytes of the irradiated mice caused significantly decreased in blastogenic transformation compared to that of normal animal. HT could rescue from the inhibition and enhance the functional activity to mitogens. The blastogenic response of mitogens were returned to the normal level on the 33th day in all treated groups.

Photodegradation of Surfactants with TiO₂ Semiconductor for the Environmental Wastewater Treatment

Prof. Hisao HIDAHA

Department of Chemistry, Meisei University,
2-1-1 Hodokubo, Hino, Tokyo 191 Japan

Abstract

The fundamental and applied researches for the environmental wastewater treatment have been actively advanced globally to solve severe aquatic or air contamination. In particular the photodegradation of carcinogenic chloro organics of trichloroethylene, chlorophenol etc., phosphorus-, nitrogen- or sulfur-containing agrochemicals such as pesticides and herbicides, cyanide compounds and polymers of polyvinylalcohol, polyethyleneglycol etc. was extensively reported by many researchers. Various surfactants are widely used in domestic and industrial fields. However, surfactants are not easy to be biodegraded through bacteria and are accumulated in nature of alkylphenylpolyoxyethylene generates toxic intermediates of alkylphenol derivatives immiscible in water during biodegradation. Since the cationic surfactant exhibits antimicrobial activity, the biodegradation is poor.

The photocatalytic degradation with TiO₂ catalyst is one of the most promising procedures. All kinds of surfactants can be mineralized to CO₂, H₂O and other inorganic ions and organic acids in a short time without formation of toxic intermediates irrespective of structures of surfactants. Since an amphiphilic surfactant contains both hydrophobic alkyl group and hydrophilic functional group in one molecule, the details of decomposition mechanisms and adsorption behaviors on the surface can be informed at a molecular level. (1).

When TiO₂ particles are irradiated by ultraviolet (UV) light, electrons and holes are formed within ultrafast rate below 180 fs in a crystal, followed by capturing the electrons at the defecting moiety in a lattice on TiO₂ surface. The electron holes react with the hydroxyl groups (and/or bound water) combined with TiO₂ surface in the rate within 30 ps. The transfer rate of electrons in a conduction band to O₂ molecules is relatively slow in a nano second order Gerisher et al. has been postulated. This step is a rate-determining step in a photocatalytic reaction. Consequently, no photodecomposition proceed effectively in the absence of oxygen molecules. Many charge-carriers (e⁻ and h⁺) formed by photoexcitation within 1~10 ns disappear by the recombination of e⁻ and h⁺ in a TiO₂ bulk and then the electron transfer occurs between an organic compound and TiO₂ particles.

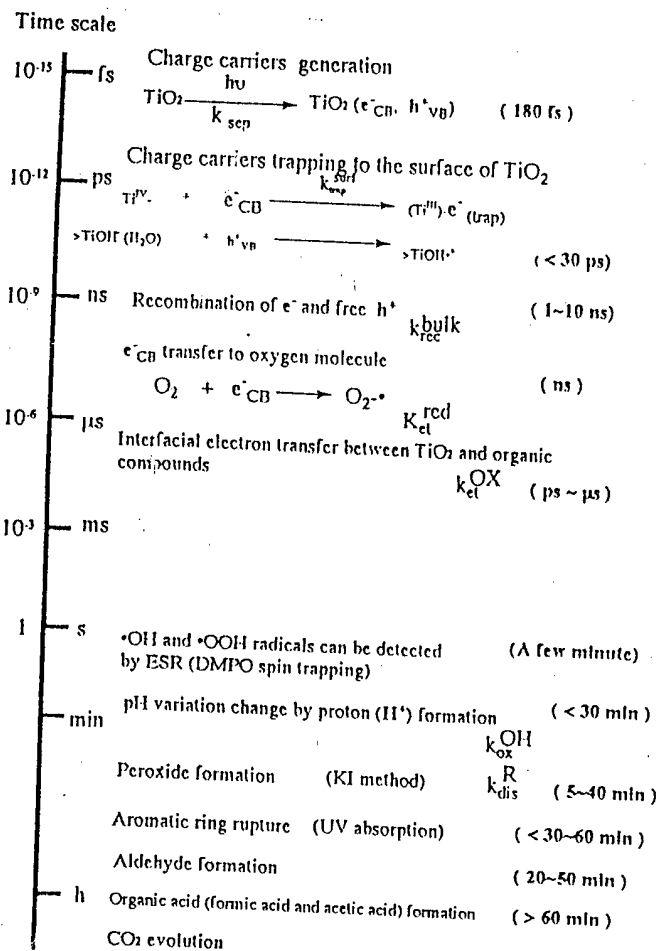

The time scale on the photooxidative degradation processes for an organic substance is summarized. Although the rate is dependent on the kind of an organic compound, this process proceeds within ps to ms. Formation of $\cdot OH$ or $\cdot OOH$ radicals is detected within 30 min and simultaneously protons are generated by photolysis of H_2O . Totally, the reaction solution becomes acidic. The hydrocarbon moiety in a surfactant is attacked by active oxidative species to prepare a hydroxylated compound and a hydroperoxide derivative (confirmed by KI method). Subsequently, these compounds are mineralized to CO_2 via aldehyde or carboxylic acid intermediates by photooxidation and/or autooxidation. A hetero atom moiety is photoconverted to inorganic ions. An aromatic moiety such as benzene or pyridine ring is easily cleaved. Formation of peroxide, the ring-opening of benzene group, formation of aldehyde and CO_2 evolution in the photodegradation of DBS (sodium dodecylbenzene sulfonate) are shown (2).

The time required for secondary oxidation on TiO_2 surface or in a bulk solution occurs in the order of several minutes to hours.

In this paper, we describe the recent experimental on the photomineralization or phototransformation for functional moieties of sulfate, phosphate and quaternary ammonium group and hydrocarbons of an alkyl chain and an ethoxyl group in TiO₂ dispersion systems. Further, the TiO₂-fixation procedure on glass fibers, glass bees, ceramic tiles, honeycombs is studied from the view point of a industrial application for a continuous and large scale treatments. There fixation procedures need no operation for removal. The photooxidative activity still maintains even in repeated runs(turn-over). The electrochemical decomposition of organic pollutants containing surfactants big TiO₂ semiconductor of TCO (transparent conductive oxide) electrode assemblies has been carried out by us (3). The other strategy of this study is also a harvest of photocurrent during the transformation process. We introduce the recent results.

Acknowledgments

This research was supported by Grants-in-Aid for Scientific Research from the Ministry of Education (No. 06640757) and by the environmental protection project foundation from the Ministry of Public Health.

References

- (1) H. Hidaka, J. Zhao, E. Pelizzetti and N. Serpone, *J. Phys. Chem.*, **96**, 2226 (1992).
- (2) H. Hidaka, K. Nohara, J. Zhao, E. Pelizzetti and N. Serpone, *J. Photochem. Photobiol. A; Chem.*, **91**, 145 (1995).
- (3) H. Hidaka, Y. Asai, J. Zhao, K. Nohara, E. Pelizzetti and N. Serpone, *J. Phys. Chem.*, **99**, 8244 (1995).

PHOTOASSISTED DISSOLUTION OF COLLOIDAL MANGANESE DIOXIDE IN THE PRESENCE OF PHENOL

Ottó HORVÁTH*, Katalin STROHMAYER

*Department of General and Inorganic Chemistry
University of Veszprém, H-8201 Veszprém, P.O.B. 158*

Solar radiation is able to excite numerous inorganic and organic compounds present in the nature, which often causes reactions taking place slowly or not at all in the dark. These processes can considerably affect the biogeochemical circulation of the elements and their distribution between different oxidation states and phases.

In the nature, manganese mainly occurs as MnO_2 and, to a lower extent, as MnCO_3 , because these compounds do not dissolve easily. Manganese dioxide as a colloid reaches, however, a significant concentration in sea water, caused by erosional processes and vulcanic eruptions under sea. The formation of MnO_2 from Mn(II) is a result of bacterial activity. At the same time, in the presence of several organic compounds an inverse process takes place, i.e., MnO_2 is reduced to Mn(II) and redissolved. This process is strongly affected by light. The photoassisted dissolution of particulate manganese oxide is expected to have a significant impact on the steady-state partitioning of manganese between the dissolved and particulate phase. Since phenol and its derivatives can be found among the anthropogen contaminations and these compounds are potential reductants, its important to know, how they influence the photochemical dissolution of MnO_2 and, thus, the biogeochemical cycle of manganese.

The absorption spectrum of colloidal manganese dioxide the UV and visual range is considerably modified by addition of phenol. The influence of the phenol concentration on the spectrum of MnO_2 indicates that at lower concentrations the added phenol is mainly bound to the MnO_2 particulates, forming a surface-located charge-transfer complex. The equilibrium constant for this reaction can be determined on the basis of spectral changes. The molar absorbances for the free and the bound MnO_2 species can also be calculated.

Photochemical investigations of the solution containing colloidal manganese dioxide and phenol indicate that during the photolysis MnO_2 is reduced, while phenol is oxidized. The rate of this photochemical reaction is influenced by the concentration of phenol. This concentration

dependence suggests that the photoactivity of the system can be attributed to the formation of the surface-located MnO_2 -phenol charge-transfer complex, because the dissolution rate is directly proportional to its partial mole fraction.

The action spectrum for this photoassisted reaction displays a close correlation with the absorption spectra of both the free MnO_2 and the surface-complex. Since these two spectra are similar to each other, on the basis of our present results, direct excitation of any of these species can lead to ligand-to-metal charge-transfer reaction. Thus, excitation of a free MnO_2 species (not bound to phenol) can also be effective if energy transfer takes place to a surface-complex.

ABSTRACT

ORGANIC PHOTSENSITIZERS OF EXTREMELY HIGH THERMAL AND PHOTOSTABILITIES, SUITABLE TO SOLAR APPLICATIONS: PERYLENE TETRACARBOXYLIC ACID-bis-ALKYL DIIMIDES

HURIYE İCİL

Department of Chemistry, Faculty of Arts and Sciences, Eastern Mediterranean University, Famagusta, N. Cyprus, Mersin 10, TURKEY

Perylene diimides with N-aryl(alkyl) derivatives are known to be extremely stable to thermal and irradiation conditions¹⁻⁴. We had synthesized and studied photochemical properties of these dyes for N-ethyl, phenyl, anisyl, α -naphthyl, β -naphthyl, and acetyl derivatives⁵. All these dyes are found to be practically insoluble in organic solvents and absorb at 480-530 nm region, suitable for solar spectrum. Thermal analysis studies present thermal stabilities reaching to 425°C^{5,6}. A recent study had proven that photooxygenation in heterogeneous phase occurs at a high rate. Oxygenated products of a diterpene acid, abietic acid, are first attributed to products of singlet oxygen photooxidations. But laser flash photolysis results show that perylene diimides do not produce singlet oxygen, instead a more favorable electron transfer mechanism is dominant.

A chloroform soluble polymer of perylene diimide also have been synthesized, which can be used for heterogeneous aqueous phase solar photodegradation purposes. Expected electron transfer photoreactions with stable perylene diimide polymer are advantageous to other known photosensitizers, used at aqueous phase solar photodegradation processes.

1. H. Langhals (1985) Synthesis of highly pure perylene fluorescent dyes in large scale amounts - specific preparation of atropic isomers. *Chem. Ber.* **118**, 4641-4645.
2. E. M. Ebeid, S.A. El-Daly and H. Langhals (1988) Emission characteristics and photostability of N,N'-bis(2,5-di-*tert*-butylphenyl)-3,4,9,10-perylene bis-(dicarboximide). *J. Phys. Chem.* **92**, 4565-4568.
3. W. E. Ford and P.V. Kamat (1987) Photochemistry of 3,4,9,10-perylenetetracarboxylic dianhydride dyes. 3. Singlet and triplet excited state properties of the bis(2,5-di-*tert*-butylphenyl)diimide derivative. *J. Phys. Chem.* **91**, 6373-6380.
4. M. Sandrai and G.R. Bird (1984) A new laser dye with potential for high stability and a broad band of lasing action: perylene-3,4,9,10-tetracarboxylic acid-bis-N,N'(2',6'-xylylidyl)diimide. *Optics Commun.* **51**(1), 62-64.
5. S. İçli and H. İcİL (1994) Fluorescence quantum yields on synthesized perylene-3,4,9,10-tetracarboxylic acid-bis-N,N'-alkyl(aryl) diimides. *Spectrosc. Lett.* **27**(3), 323-332.
6. H. İcİL and S. İçli (1995) The synthesis and spectral characteristics of a supramolecular model perylene 3,4,9,10-tetracarboxylic acid-bis-N,N'-*p*-aminophenyl diimide. *Spectrosc. Lett.* **28**(4), 595-601.

PHOTOCHEMISTRY IN TURKEY

and

A NEW CATALYST FOR SOLAR PHOTO ORGANIC CHEMICAL SYNTHESIS

Sıddık İçli* and Huriye İcil**

* Department of Chemistry, Faculty of Science, Ege University, Bornova-35100,
Izmir/TURKEY

(In part at: TÜBİTAK-Marmara Research Center, Department of Chemistry, P.O.
Box 21, 41470 Gebze-Kocaeli/TURKEY

**Department of Chemistry, Eastern Mediterranean University, Famagusta,
N. Cyprus, Mersin 10/TURKEY

Photochemistry research is being concentrated mainly at three Universities in Turkey, at a research center TÜBİTAK and one University in Northern Cyprus. Istanbul Technical University, chemistry department has laboratories on photocationic polymerizations, headed by an organic polymer chemist Professor Dr. Yusuf Yağcı. Professor Yağcı is well known in literature for his contributions to photocationic polymerization processes. Professor Dr. Yüksel İnel, a physical chemist at chemistry department of Boğaziçi (Bosphorous) University in İstanbul leads investigations on TiO_2 photodegradations in organic and aqueous media. Professor İnel is the co-partner from Turkey to an AVICIENNE-EC project for TiO_2 photooxydations. Professor Dr. Sıddık İçli directs research work on photosensitized energy-electron transfer organic reactions, aqueous phase degradations of toxic organic chemicals and applications of solar photochemical technologies (such as rose oxide production) both at Ege University in İzmir and at Marmara Research Center-TÜBİTAK in Gebze near İstanbul. Associate Professor Dr. Huriye İcil from chemistry department at Eastern Mediterranean University in northern Cyprus collaborates with Ege University and TÜBİTAK on photocemical work and investigates photostable polymer sensitizers. Some organic and organometallic chemists conduct singlet oxygen photooxygenations and photohydrogenations for synthetic purposes with limited interest on photochemical reaction mechanisms and/or applications, such as Professor Dr. Metin Balci at Atatürk University in Erzurum and Professors Saim Özkar-Bekir Peynircioğlu at Middle East Technical University in Ankara.

Photo and thermal stable N-alkyl(aryl) substituted perylene diimides, absorb at 480-530 nm, are recently found to form superoxide through electron transfer processes on photooxygenations¹. The singlet state photoelectron transfer mechanism is initiated by an electron abstraction from an olefin to perylene diimide. Molecular oxygen receives the electron from perylene diimide anion radical to form the superoxide. Superior stabilities of perylene bis-imides compared to other photosensitizers², prove them to be excellent catalysts for photoorganic chemical synthesis via olefins, in presence and absence of oxygen under solar irradiation conditions.

¹ D. G. Whitten, L. Chen, E.R. Gaillard, H. İcil and S. İçli, "*Photooxygenation reactions of perylene bis-diimides*", to be published.

² H. Langhals, *Chem. Ber.* 118, 4641-4645 (1985).

The Application of MUCAP Fluorescence Test in Salmonellae Detection.

El-Zeiny M. Ebeid

Misr University for Science and Technology, 6th October City, Egypt

El-Sadat A. Issa and Samy A. El-Daly

Department of Chemistry, Faculty of Science, Tanta University, Tanta, Egypt

Salmonella is a pathogen that belongs to the family of Enterobacteriaceae. This Family is Gram negative rods whose natural habitat is the intestinal tract of humans and animals. Many animals, including cattle, rodents, and fowl, are naturally infected with a variety of salmonellae and have the bacteria in their tissues "meat", excreta and eggs. The sources of infection are food and drink that have been contaminated with salmonellae. Infection usually results from ingestion of numerous organisms in food or water.

In the small intestine the organisms may multiply and produce an acute enterocolitis with fever, diarrhea, and inflammation of bowel. Some strains invade the mucosa and spreads to the blood stream. And some does not spread to the blood but reaches to lymph nodes where it multiplies then spreads to reticuloendothelial site in the liver, spleen and bone marrow through the lymphatic system and blood.

The presence of salmonellae in foods continues to be a major world wide problem. Since one of the major problems confronting humans today is the products which are free of salmonellae contamination.

Several attempts have been made for rapid detection of salmonella for examination of foods and food products. Fluorescence antibody method (FA) for the detection of salmonella based on enrichment and culture fluorescent antibody method (FA); the enrichment serology (ES) technique; radiometric method; A DNA-DNA hybridization assay; enzyme immunoassays (EIAS) technique. Recently [1,2] salmonella identification technique was suggested that is based on identifying parameter (microbial enzyme) which is already present in the microbe to be identified.

Rapid fluorescence method for screening salmonella from enteric differential agars based on the rapid detection of Cg esterase enzyme by using a fluorogenic 4-methylumbelliferone- conjugated substrate.

4- methylumbelliferylcaprilate reagent (MUCAP) consists of an eight-carbon- atoms ester conjugated with methylumbelliferone (hydroxy coumarine derivative), cleaved by Cg esterase of salmonella releasing strongly fluorescent compounds. Sensitivity of salmonella detection with MUCAP test is always near to 100 %.

We could identify the salmonella typhimurium in artificially infected caster; luncheon; eggs; and ground water; but samples from popular market, some of it is positive and some is negative. This method based on pre enrichment of food or water in selenit F broth " as enrichment media for salmonella " and culture on neutrant agar then scanning the fluorescence at 366nm for 1 cm inoculated agar after rinsing by 10 μ l 1 M UCAP. The positive results show build up of the fluorescence through 3 min. intervals but the negative ones show no build up of fluorescence.

[1] P.M.Aguirre, J.B.Cacho, L.Folgueire, M.Lopez, J.Garcia and A.C.Velasco, *J.Clin.Microbiol.* 28(1990) 148-149.

[2] M.Olsson, A.Syk and R.Wollin, *J.CLIN. Microbiol.* 29(1991) 2631-2632.

FAR-RED ABSORBING PHOTOCHEMOTHERAPEUTIC AGENTS FOR TUMOURS

Giulio Jori

Department of Biology, University of Padova, Italy

Recent investigations on the optical properties of human tissues indicate that the penetration of visible light is maximal in the 700-800 nm region, where light scattering is of minor importance and absorption of light by endogenous chromophores is negligible. Therefore, *in vivo* photosensitization by dyes absorbing light wavelengths above 700 nm should give optimal results from the point of view of both photodiagnosis and phototherapy. In this connection, novel phthalocyanine and naphthalocyanine have been prepared by chemical synthesis; these compounds exhibit intense absorption bands in the above mentioned spectral region and are endowed with an efficient photosensitizing activity toward cells and tissues, largely through the generation of singlet oxygen as the cytotoxic agent.

In particular, the affinity of phthalocyanines and naphthalocyanines for a variety of experimental tumors has been shown to be very high provided the molecule is characterized by a lipophilic character; the latter parameter can be measured through the n-octanol/water partition coefficient. The level of hydrophobicity can be modulated by an appropriate choice of the peripheral substituents and/or the axial ligands to the metal ion coordinated with the tetraazapyrrole macrocycle. The systemic injection of the hydrophobic phthalo-/naphthalocyanines can be readily achieved by their previous incorporation into lipid-type delivery systems, such as liposomal vesicles or oil emulsions. Pharmacokinetic studies with different phthalo-/naphthalocyanines in mice or rats bearing subcutaneously or intramuscularly implanted experimental tumours showed that ratios of photosensitizer concentration between the tumour and the peritumoural tissue as high as 20-30 can be often obtained at 24-48 h post-injection times.

On these bases, phototherapeutic studies (PDT) have been performed by using diode lasers emitting at the absorption maximum of the appropriate photosensitizing agents. The use of fluence rates lower than ca. 180 mW/cm^2 guarantees the lack of photoinduced hyperthermal effects and promotes the onset of a pure photochemical processes leading to irreversible damage of tumour tissues. The sites of photodamage and the mechanism by which tumour cure is achieved are strongly dependent on the physico-chemical properties of the photosensitizer, which in turn control its distribution among the various compartments of the neoplastic tissue: both random necrosis and apoptosis have been detected; the latter modality of tumour damage is of particular interest since it can be utilized to achieve important biological and medical effects by using very mild irradiation conditions.

PHOTOCHEMICAL SYNTHESIS OF NEW HETEROPOLYCYCLIC SYSTEM; 3-CHLORONAPHTHO[2,1-b]THIENO[3,2-b]THIOPHENE-2,6-DICARBONYL- CHLORIDE

J. Dogan, G. Karminski-Zamola, M. Bajić¹ and D. W. Boykin²

¹Department of Organic Chemistry, Faculty of Chem. Eng. and Technology
University of Zagreb, 10000 Zagreb, CROATIA and

²Department of Chemistry Georgia State University, Atlanta 30303, Georgia USA

Continuing our interest in the synthesis and photosynthesis of heteropolycyclic compounds^{1,2,3} we turned our attention on the examination of the influence of acrylic substituent, as well as, condensed thiophene nucleus on photochemical dehydrocyclization reaction of phenylthienyl-acrylic acid according to the scheme:

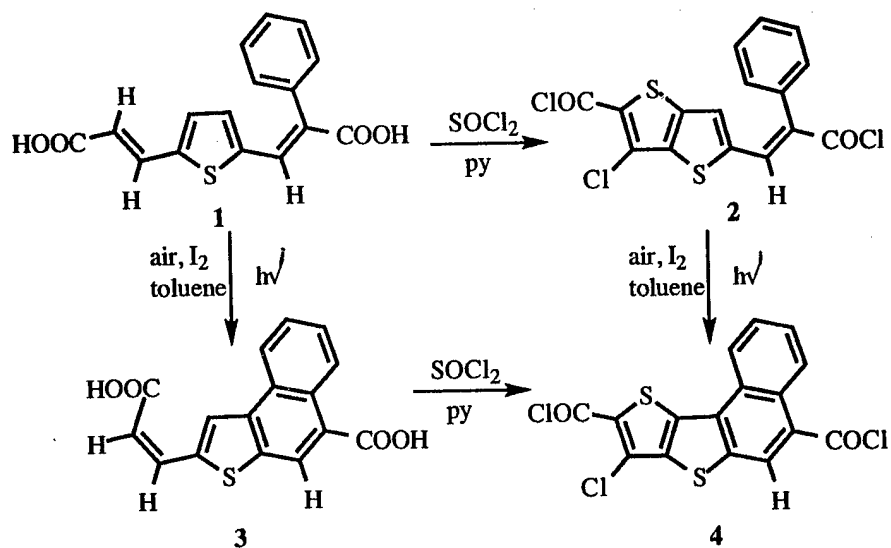

The compound 1 was prepared in multistep synthesis starting from thiophene-2-carbaldehyde and phenylacetic acid.

References:

1. G. Karminski-Zamola, D. Pavličić, M. Bajić and N. Blažević, *Heterocycles*, 1991, **32**, 2323.
2. J. Dogan, G. Karminski-Zamola and D. W. Boykin, *Heterocycles*, 1995, **41**, 1659.
3. M. Malešević, G. Karminski-Zamola, M. Bajić and D. W. Boykin, *Heterocycles*, 1995, **41**, 2691.
4. J. Dogan, G. Karminski-Zamola and D. W. Boykin, *Heterocyclic Commun.*, 1996, **2**, 213.

Characterization of the Charged Species Inside Anodic Oxides Formed in Si/HF Electrolyte Systems

K. Kirah, A. Zekry*, H. F. Ragaie*, W. Fikry, R. Basily

Department of Engineering Physics, Faculty of Engineering, Ain Shams University, Cairo, Egypt.

* Department of Communications and Electronic Engineering, Ain Shams University, Cairo, Egypt.

In recent years, the interest in semiconductor electrochemical electrodes have ever increased because of their possible uses in solar energy conversion systems, integrated circuit technology and many other applications. In this work, we have characterized a Si/ fluoride-electrolyte interface. Transient flat-band potential measurements were conducted elsewhere [1]. Starting from these measurements, we have constructed a model to calculate the charges inside the SiO_2 layer which is formed at the Si/HF interface. The value of the flat-band potential is affected by various types of charges and traps associated with the Si- SiO_2 system. They include (i) fast surface states which are charges located at the Si/ SiO_2 interface with energy states in the Si forbidden bandgap and which can exchange charges with Si in a short time. (ii) fixed oxide charges which are located at or near the Si/ SiO_2 interface and are immobile under an applied electric field; (iii) ionic charges inside the oxide layer which may be mobile under bias-temperature aging conditions. In the first step, we did not separate the interface charges from the bulk charges and we assumed that the oxide charges decay only due to etching. A simple relation between the total oxide charges and the rate of change of the flat-band potential was deduced and from which the calculation of the oxide charge density was possible. The obtained results show a decaying positive charge distribution from the electrolyte side to the Si side, with a peak near the Si/ SiO_2 interface. These results are qualitatively and quantitatively acceptable. To explain the behavior of the transient flat-band voltage in the short time range, a model in which we have separated the oxide bulk charges from the fast electronic surface states at the Si- SiO_2 interface was developed. This has enabled us to understand the role of surface states in varying the stored charge in the oxide layer. We then extended our model to explain already published measured data showing the variation of the electrochemical cell transient capacitance and current when the potential is stepped from an anodic value to a negative probe value [1]. The obtained results are in good agreement with experiments.

Reference:

[1] J. N. Chazalviel, *Electrochem. Acta*, Vol. 37, 865, 1992.

SEMICONDUCTOR PHOTOCATALYSIS FOR PREPARATIVE CHEMISTRY ?

H. Kisch

Institut für Anorganische Chemie, Universität Erlangen-Nürnberg, Egerlandstr.1, D-91058 Erlangen, Germany.

Hitherto reported semiconductor catalyzed reactions fall into two categories. In Type A reactions, which correspond to conventional photoelectrolysis, two or more products are formed. Type B reactions lead to only one single product and can be considered as „paired photoelectrolysis“. In the latter case the primary redox intermediates combine to one unique end-product .

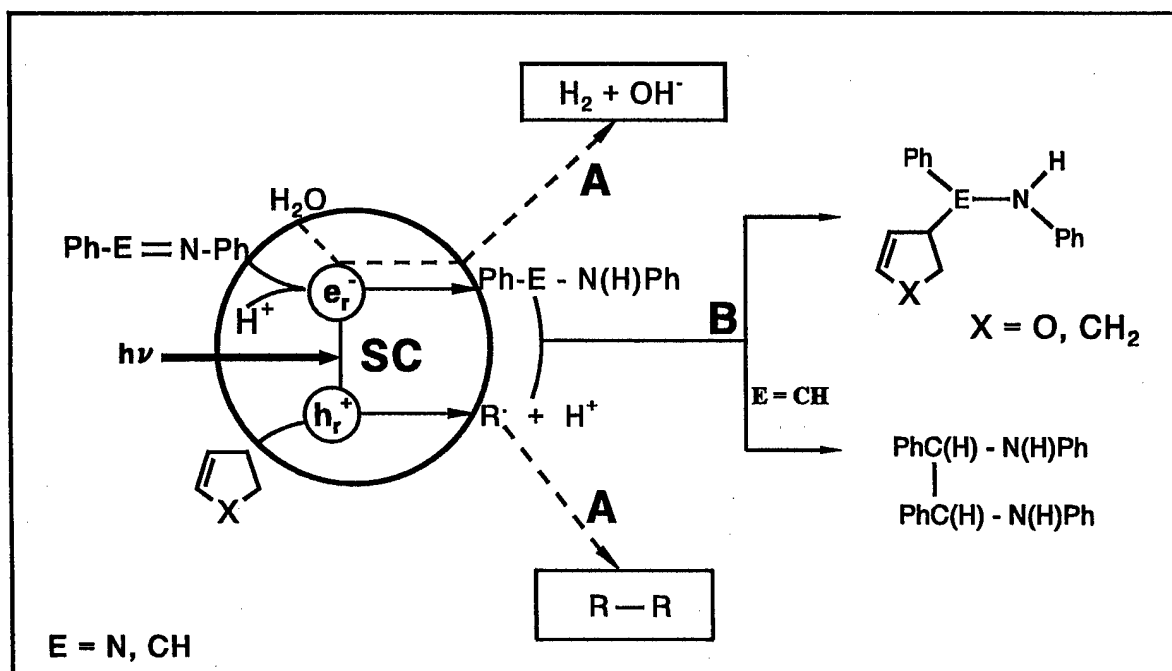

While many Type A reactions are known, only a few Type B transformations were published. To the latter belong the CdS catalyzed photoaddition of cyclic olefins to 1,2-diazenes or imines reported recently from this laboratory. Synthetic and mechanistic aspects of these novel transformations will be reported.

THE SOLAR ENERGY OPTION FOR WATER DETOXIFICATION THROUGH PHOTOCHEMICAL-BIOLOGICAL INTEGRATED FLOW REACTORS

J. Bandara¹, C. Pulgarin² and J. Kiwi*¹

¹Institute of Physical Chemistry II; ²Bioengineering, Swiss Federal Institute of Technology, Lausanne, CH-1015 Lausanne, Switzerland.

In the chemical industry the waste effluents contain nonbiodegradable man made chemicals. For this study we have taken para nitrotoluen-sulfonic acid (p-NTS) as a model compound since it was shown to be completely nonbiodegradable up to two months (Minsker, L.; Pulgarin, C.; Peringer, P.; Kiwi, J., New J. Chem., 1994, 18, 793). Heterogeneous photo-oxidation of (p-NTS) were investigated at $\lambda > 290$ nm first in a batch reactor through TiO₂ P-25 suspensions and subsequently by Fenton photoassisted systems. In *batch reactions*: photocatalytic degradation took place with pseudo-first order rate constant of 0.12 h^{-1} at 20°C and 0.25 h^{-1} at 50°C . When H₂O₂ ($6 \cdot 10^{-2} \text{ M}$) is added the observed pseudo-first rate constant order is 0.86 h^{-1} at 20°C . This confirms that the OH radical accelerates the photodegradation under study. The role of the TiO₂ photoassisted redox reactions determining the kinetics of substrate degradation will be described in detail. The evolution of toxicity in pre-treated solutions is also reported. In *flow reactor studies* the photochemical-biological flow reactor used during this work will be described in detail. Experiments were carried out to determine the point of intervention of the biological treatment after the initial photochemical degradation. This photochemical stage was applied for the minimum time necessary to eliminate the toxicity of the degradation intermediates and to increase their biodegradability. Preliminary optimization was carried out on the *flow* reactor to determine a) the solution concentration to use b) the flow rate c) the rate of H₂O₂ addition d) the recirculation and dilution rate d) the pollutant consumption rate e) the removal efficiency. The H₂O₂ was added at a rate of 0.12 ml/min. A recirculation of 24 l/h was used to degrade the initial solution of pNTS=420 mgC/l ($5.4 \cdot 10^{-3} \text{ M}$ at pH=3) into biodegradable intermediates. During pretreatment the concentration of pNTS attained zero in about 20 minutes using $2.9 \cdot 10^{-3} \text{ H}_2\text{O}_2 \text{ moles/l /hour}$. The photochemical degradation rate of 222 mg C/l/h (first stage) required about $70 \cdot 10^{-3} \text{ moles/l/h}$ of H₂O₂. Aromatic ring structures were observed to be absent after the photochemical pretreatment when the TOC of the initial solution was reduced by ~50%. The decomposition of the pollutant in the photochemical reactor is shown to proceed also when low levels of light equivalent to diffuse solar light was used. In this case actinic light sources have been employed. Systems where the H₂O₂ necessary to affect the oxidation in the photochemical stage was generated *in situ* via solar powdered electrolysis of alkaline solutions generating $(2-4) \cdot 10^{-5} \text{ M}$ of H₂O₂ needed about 30 ma and 2 V which is in the range of solar cells. This development will be presented and is being tested now in our laboratory. Such systems have promising large scale applications in countries with high intensity solar radiation throughout the whole year.

Theoretical Simulation of Vibronic Spectra at Higher Temperatures

Robert Berger and Martin Klessinger

Organisch-Chemisches Institut der Westfäl. Wilhelms-Universität
D-48149 Münster (Germany)

"Hot" bands play an important role in the vibronic analysis of forbidden electronic transitions as well as in the spectra of photochemical reaction intermediates. In addition, expressions for the temperature dependence of rate constants of photo-physical processes like fluorescence, internal conversion etc. involve the consideration of hot bands. It is therefore desirable to have methods available to treat temperature effects on vibronic transitions.

The theoretical description of absorption and emission spectra is usually based on the Franck-Condon approximation, while vibronic coupling, which is important for forbidden and weak transitions, has been allowed for in much fewer cases [1]. The multimode vibrational Franck-Condon and Herzberg-Teller integrals are usually evaluated by means of recursion relations [2] in the harmonic approximation, which is easiest if the vibrational quantum numbers of the initial state are all zero. This situation corresponds to a temperature of 0 K.

In order to allow for simulations of vibronic spectra at higher temperatures non-zero vibrational quantum numbers have to be considered also for the initial state, which increases state density considerably. A new counting algorithm for a systematic generation of all possible combinations of vibrational quantum numbers for a given spectral interval has therefore been derived and incorporated into a new program based on the necessary recursion relations for the multidimensional Franck-Condon and Herzberg-Teller integrals taking into account the Dushinsky effect. The required input data, i.e. geometries, frequencies, and normal coordi-

nates of the initial and the final state, as well as transition dipole moments and their derivatives with respect to the normal coordinates are calculated by high-level ab initio CASSCF methods.

Some applications that deal with hot bands in absorption spectra and in emission spectra of photochemical reaction intermediates are reported and scope and limitations of the method are discussed.

- [1] G. Orlandi, F. Zerbetto, M. Z. Zgierski, *Chem. Rev.* **91**, 867 (1991).
K. Gustav, M. Storch, *Int. J. Quantum Chem.* **38**, 25 (1990).
- [2] E. V. Doktorov, I. A. Malkin, V. I. Man'ko, *J. Mol. Spectrosc.* **64**, 302 (1977).

**The 4th. International Conference and Workshop on
SOLAR ENERGY STORAGE AND APPLIED
PHOTOCHEMISTRY
[SOLAR '97]
1-6 JANUARY 1997
CAIRO, EGYPT**

**THE ROLE OF SOLAR ENERGY IN THE HYDROGEOLOGIC
ASSESSMENT OF GROUNDWATER RESOURCES IN EGYPT**

BY

E.A. KORANY

(Ain Shams University, Faculty of Science, Geology Department)

ABSTRACT

The solar Radiation is a hydroclimatic element of vital importance in the hydrogeologic assessment of groundwater resources in Egypt. It is the driving energy force behind the evaporation, the evapotranspiration and precipitation of water.

In Egypt, where the arid climate prevails with desert conditions, the solar radiation reaches the higher values, ranging between 271 and 700 cal/cm²/day. It creates the factors of increasing losses by higher intensities of evaporation and evapotranspiration and decreasing gains by precipitation. This reflect a natural degradation by time in both the quantity and the quality of the groundwater resources in Egypt.

Where, the groundwater represent the sole sources of water supplies in the deserts of Egypt and the alternative sources in the Nile Valley and the Delta, certain approaches and techniques for the development of such resources must be attempted in order to protect our resources against the natural conditions.

**Donor/Acceptor substituted Fluoroarylporphyrins
for Quadratic Non-linear Optics**

V. Krishnan

(Department of Inorganic and Physical Chemistry, Indian Institute of Science, Bangalore 560 012, India and Jawaharlal Nehru Centre for Advanced Scientific Research, Jakkur, Bangalore 560 064, India)

Porphyrins bearing donor-acceptor functional groups are of considerable interest in the studies of light induced electron transfer reactions, intramolecular charge transfer reactions, non-linear optical properties and others. The fluorinated porphyrins have an advantage of non-aggregation features in solution. Several tetrakis(pentafluoroaryl)porphyrins bearing a nitro substituent at the pyrrole carbon and dimethylamino group at the mesoaryl position have been synthesised and characterised. These represent an interesting push-pull system mediated through a cyclic π -conjugation for the study of ICT reactions. Optical absorption and emission studies revealed that the singlet excited state of these porphyrins have a considerable ICT character. The hyper-polarizability measurement of all these free base porphyrins and their metal derivatives in solution indicate an enhancement in the efficiency of non-linear optical coefficient(β). The influence of electronic configurations of metal ions in governing the non-linear optical behaviour of these porphyrins and their cationic analogues is examined. Among the metal derivatives, the open shell Cu(II) (d^9) has a greater influence on β of these porphyrins than the closed shell Zn(II) (d^{10}). The magnitude of these values are rationalised in terms of two-state model.

PHOTOCHEMISTRY OF SOME CHLOROPHYLL BASED ANTHRAQUINONE AND NAPHTHOQUINONE COMPOUNDS IN SOLUTIONS AND ORGANIZED FILMS

Helge Lemmetyinen, The Institute of Materials Chemistry, Tampere University of Technology,
P.O. Box 541, FIN-33101 Tampere, Finland

Novel electron donor-acceptor dyads and triads, based on chlorophyll and its derivatives where anthraquinone and naphthoquinone moieties are covalently linked to the phytyl chain, were synthesized [1,2] for investigations of photoinduced electron transfer in solutions and in solid molecular films. The dyads consisted of pyropheophytin *a* (or its Zn(II)-complex) as the electron donor and anthraquinone (AQP and ZnAQP) and naphthoquinone (NQP) as the electron acceptor or phytychlorin (or its Zn(II)-complex) as the electron donor and anthraquinone (AQC) as the electron acceptor. The triad molecule (AQCP) contains a phytychlorin and pyropheophytin *a* as the electron donors and the anthraquinone moiety as the electron acceptor.

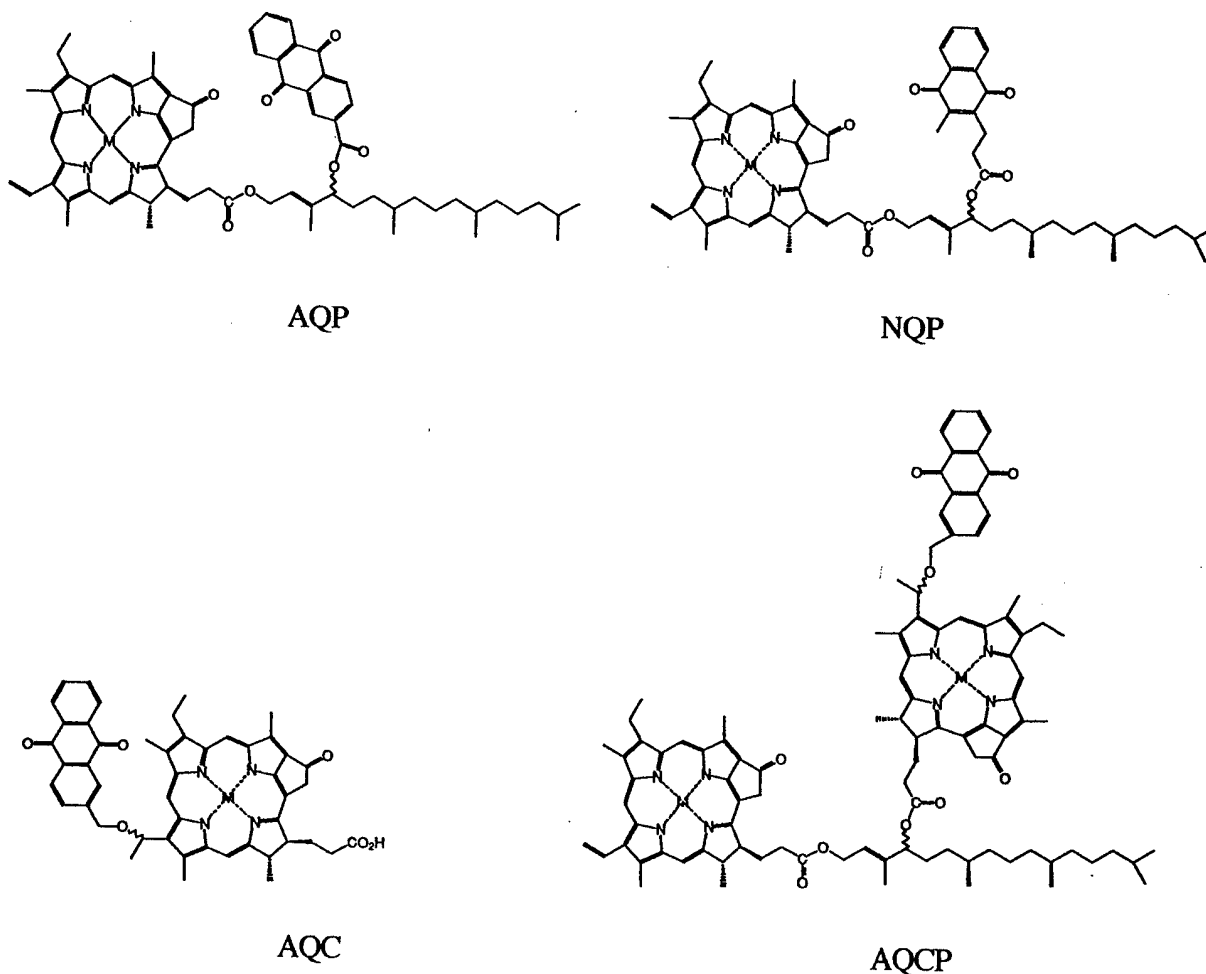

Conformational studies on the solution structures of AQP and ZnPQA revealed that the compounds occur, to a significant extent, in folded conformations. The intramolecular p-p interactions between the phorbins ring and the anthraquinone moiety is assumed to be a driving force for the observed folding. Donor-acceptor distances of 3–4 Å and 6–7 Å were estimated from the NMR studies [2] for ZnPQA for AQP compounds, respectively. A similar type of folding was not observed for the AQC compound.

The time-resolved fluorescence properties of the compounds were studied in several solvents and the pyropheophytin dyads also in Langmuir-Blodgett films.

Due to the folding the electron transfer is faster for the AQP derivatives than for the AQC compounds. Thus the fluorescence properties were mainly determined by the minor population of the open conformers with the donor-acceptor distance of up to about 20 Å. The open conformers are in equilibrium with the folded and this influences on the fluorescence lifetimes and efficiencies. In the solvents of high viscosity, transformation is slow compared to the lifetime of the excited state and the electron transfer rate can be estimated directly from the fluorescence decay measurements. Thus the electron transfer rate in cyclohexanol is $3.5 - 4.4 \times 10^9 \text{ s}^{-1}$ for AQP and as high as $20 \times 10^9 \text{ s}^{-1}$ for ZnAQP.

When the anthraquinone acceptor is replaced by naphthoquinone (compound NQP), which has a higher reduction potential, the electron transfer reaction is expected to be faster than for AQP compounds. This was the case and the observed rates were for NQP $7 \times 10^9 \text{ s}^{-1}$ in cyclohexanol and higher than 10^8 s^{-1} in toluene.

For the AQCP compound the fluorescence properties were close to those of AQC in solvents of low polarity (toluene, chloroform, dichloroethane, but in solvents of higher polarity (ethanol, methanol and acetonitrile) the fluorescence quenching was efficient with the multiexponential decay curves and decay rates $1-20 \times 10^9 \text{ s}^{-1}$. Most probably intramolecular pheophytin-pheophytin dimers act as the primary electron acceptor followed by the electron transfer to the anthraquinone moiety.

Chlorophyll and its AQP, NQP, and AQCP derivatives form Langmuir-Blodgett films [3] where molecules are oriented to fixed directions. When the films are between two electrodes and are irradiated with light pulses these create a movement of vectorial charge barrier, which can be detected as a photovoltage signal. For chlorophyll films the charge generation efficiency was close to unity [4].

The light induced vectorial photovoltage signal was observed for multilayer films of ZnAQP. The polarity of the signal, and therefore the direction of the energy transfer can be controlled by the direction of the film deposition. The formation of the charge transfer state followed the rate of the laser pulse (10 ns), recombination of the state was shorter than 500 ns and depends on the direction of the deposition.

In the solid films the folded conformer has so efficient electron transfer that the fluorescence is observed only from open conformer of AQP and is quenched by the energy transfer to the folded conformer. The Förster radius for the energy transfer is about 5 nm. The metal free compounds (AQP) have lower oxidation energy than the ZnAQP compounds and the energy transfer is for this reason less efficient. The increase of the redaction potential of the acceptor (NQP) makes the energy transfer more favourable again.

- [1] A.Y. Tauber, R.K. Kostianen, and P.H. Hynninen, Synthesis of pyropheophytin-anthraquinone linked molecules as models for the study of photoinduced electron transfer, *Tetrahedron*, 50 (1994) 4723-4732.
- [2] A.Y. Tauber, J. Helaja, J. Kilpeläinen, and P. Hynninen, Chlorophylls. VIII. Synthesis of a new chlorophyll derivative and anthraquinone based-dyad and triad molecules for executing photoinduced electron transfer, *Acta Chem. Scand.* (1996) in press.
- [3] N.V. Tkachenko, A.Y. Tauber, H. Lemmetyinen, and P.H. Hynninen, Photoinduced energy and electron transfer of covalently linked zinc(II)-pyropheophyti-anthraquinone molecules in monolayers of Langmuir-Blodgett films, *Thin Solid Films* 280 (1996) 244-248.
- [4] N.V. Tkachenko, P.H. Hynninen, and H. Lemmetyinen, Photoelectric signals of chlorophyll a Langmuir-Blodgett films, *Chem. Phys. Lett.*, 261 (1996) 234-240.

Photosensitization via stepwise excited higher electronic states of tetrapyrrolic compounds

D. Leupold, W. Freyer and H. Stiel
Max-Born-Institute for Nonlinear Optics and Short Pulse Spectroscopy
D-12474 Berlin, Germany

Higher excited electronic states of organic molecules have been a focus of research since decades, but with respect to those excited states which are populated by stepwise (resonant) or simultaneous (non-resonant) two-photon excitation, the success is still restricted. This is caused, among others, by problems with a definite and selective optical preparation of these states, which needs both laserspectroscopical and mathematical tools [1]. Nevertheless, multiphoton photochemistry is a growing field [2]. One of its aspects is to use special properties of higher excited states to improve the action of sensitizers in photodynamic therapy (PDT): The usual start mechanism of photosensitization is energy transfer from the sensitizer's triplet state to O₂ in the surrounding, thereby activating the latter to the reactive ¹Δ_g state, which finally (hopefully) causes destruction of malignant cells.

This mechanism fails in tissue regions with oxygen deficiency. To overcome this drawback we are investigating alternative routes of photosensitization by tetrapyrrolic compounds via higher excited states

- a) generation of radicals as start species of PDT [3]
- b) ejection of ¹O₂ from the sensitizer itself [4].

With respect to the light transmission properties of tissue (so-called therapeutic window in the red/NIR spectral range) the preferable way to excite such reactive, high lying states of tetrapyrroles is a stepwise two photon absorption in the window range (instead of one-photon UV excitation).

We report with respect to way a) on cation radical generation and action of the Mg-complexed compound tetra-tert-butylphthalocyanato magnesium. With respect to way b) we describe the insertion of oxygen as four endoperoxide bridges into a Pd-complexed tetraantraporphyrzine, resulting in a first candidate of a new class of sensitizers. These are able to act as repetitive internal source of (singlet) oxygen via excitation of higher states.

- [1] H. Stiel, K. Teuchner, D. Leupold, S. Oberländer, J. Ehlert and R. Jahnke, *Intell. Instr. Comp.* **9** (1991) 79
- [2] a) R. M. Wilson, K. A. Schnapp, *Chem. Rev.* **93** (1993) 223
b) cp. papers at the 1. and 2. Symposium „Multiphoton Photochemistry of Biological Systems“ in Vancouver 1993 and Bad Honnef 1996
- [3] a) D. Leupold and W. Freyer, *J. Photochem. Photobiol. B: Biology* **12** (1992) 311
b) H. Stiel, K. Teuchner, A. Paul, W. Freyer and D. Leupold, *J. Photochem. Photobiol. A: Chemistry* **80** (1994) 289
- [4] W. Freyer and D. Leupold, *J. Photochem. Photobiol. B: Biology* **30** (1995) 77

EPR Spectroscopy in Mimicking Primary Photosynthesis

Haim Levanon

Department of Physical Chemistry and

The Farkas Center for Light-Induced Processes

The Hebrew University of Jerusalem, Jerusalem 91904, Israel

The specific capability of liquid crystals (LCs) to attenuate intramolecular electron transfer (IET) in molecular assemblies embedded in these anisotropic media, originates from the existence of a potential barrier, i.e., the nematic potential, which is a function of the dielectric and anisotropic properties of LCs. This potential slows down the rotational correlation time of the solvent dipoles as compared to isotropic liquids, thus, making the IET products detectable by time-resolved EPR (TREPR) over a wide range of temperatures (over 100 degrees). Under such conditions and by tuning the reorganization energy, IET rates can be reduced quite dramatically into the solvent controlled adiabatic regime. Therefore, TREPR spectroscopy may complement optical spectroscopy because of its high spectral resolution and the recent technological advances in improving its time resolution in identifying short-lived transient paramagnetic species. Moreover, the line shape differences of the EPR spectra reflect the variation in the molecular architecture and structure of the donor-spacer-acceptor molecular assemblies being investigated. In other words, the differences in molecular structures are manifested through the magnitude of the spin-spin coupling and the dipolar interaction, thus leading to different electron spin polarization mechanisms, in a three- and four-levels spin states.

In this presentation, we will discuss IET processes in several photosynthetic model systems, oriented in LC matrices, e.g., porphyrinoids and non-porphyrinoids. These system reproduces several key properties of the reaction-center protein, namely: 1) multi-step ET to increase the lifetime of the radical pair (RP) product; 2) high quantum yield of charge separation, initiated from the photoexcited singlet state; 3) fast charge separation and slow charge recombination rates; 4) temperature independent ET rates; and 5) non-Boltzmann spin population of the radical-pair states.

References

1. K. Hasharoni, H. Levanon, J. Gätschmann, H. Schubert, H. Kurreck, and K. Möbius, *J. Phys. Chem.* **1995**, *99*, 7514.
2. H. Levanon and K. Hasharoni *Prog. Reaction Kinetics* **1995**, *20*, 309.
3. A. Berman, E. S. Izraeli, H. Levanon, B. Wang, and J. L. Sessler, *J. Am. Chem. Soc.* **1995**, *117*, 8252.
4. K. Hasharoni, H. Levanon, S.R. Greenfield, D.J. Gosztola, W.A. Svec, and M.R. Wasielewski, *J. Am. Chem. Soc.* **1995**, *117*, 8055.
5. K. Hasharoni, H. Levanon, S. R. Greenfield, D. J. Gosztola, W. A. Svec, and M. R. Wasielewski *J. Am. Chem. Soc.* in press.

Acknowledgments This work was supported by the U.S.-Israel BSF grant, the Deutsche Forschungsgemeinschaft (Sfb 337), and by the Volkswagen Stiftung. The Farkas Research Center is supported by the Minerva Gesellschaft für die Forschung, GmbH, München, FRG.

PHOTO AND THERMO ACTIVE THERMODYNAMIC METASTABLE STRUCTURES

N. V. Volbushko, B. S. Lukyanov.

Institute of Physical and Organic Chemistry of
Rostov University, Rostov on Don, 344090, Russia

The method of preparation thermodynamic metastable structures was developed. This method bases on the phenomenon of inversion of the population levels in the ground states of labile equilibrium systems (of $A \leftrightarrow B$, with prevalence of one isomer in comparison with other one) in the process of thermal vacuum deposition of this compounds onto quartz or glass surfaces. These conversions are possible only in the non equilibrium process condition. Inversion is reached at high temperature in gas phase. This non equilibrium distribution can be fixed in solid phase in process of vacuum deposition onto cooling surface (momentary frozen distribution).

There was investigated several classes of organic compounds and dependence between the thermodynamic parameters and possibility of thermodynamic metastable structures generation. In particular, this method was applied to opened merocyanine forms of spiropyrans (case when the most stable is the opened form at room temperature). In the conditions of thermal vacuum deposition ($P = 10^{-5} - 10^{-4}$ Torr, $T_{\text{evap}} = 450 - 500^{\circ}\text{C}$) the merocyanine form is fully transformed into the cyclic "closed" form of spiropyran ($\lambda_{\text{max}} = 320-380$ nm) and thin solid film is deposite onto the glass surface. The energy of ground state spiropyran is higher than corresponding energy of merocyanine, therefore the cyclic form is thermodynamic metastable and can be transformed into the coloured ($\lambda_{\text{max}} = 500-650$ nm) merocyanine form by heating of thin solid film to $90-100^{\circ}\text{C}$. During this process the difference between energies of two ground states is yielding. However, this opened form can be conversed to cyclic metastable form by photochemical reaction (by irradiation in visible region of spectrum for example solar energy irradiation). It's possible to realize the mode of conversion and storage solar energy with using metastable structures:

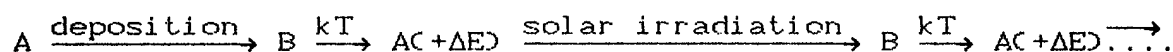

USEFULNESS OF A NEW ELECTROSYNTHESIZED POLYMER BEARING A NORBORNADIENE MOIETY FOR SOLAR ENERGY STORAGE

M.MAAFI, J.J.AARON and C.LION

*Institut de Topologie et de Dynamique des Systèmes, Associé au CNRS, URA-34,
Université Paris 7-Denis Diderot, 1 rue Guy de la Brosse, 75005, Paris-France*

In the last decade, several polymers bearing norbornadiene (NBD) moiety have been prepared for solar energy storage, using the well known NBD-quadricyclane (QC) photoisomerization system.¹ For instance, the synthesis and the photochemical properties of polymetacrylates and polystyrenes carrying a substituted substituted NBD moiety, have been described.^{1,2}

In this communication, we present the first example of photoisomerization system based on an electrosynthesized polyphenylene, substituted with a NBD group.³

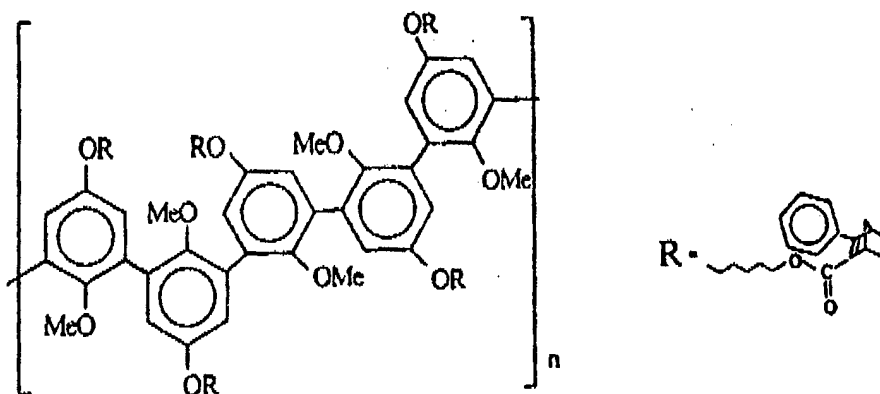

Structure of the conductive polymer

Under UV irradiation ($\lambda_{irr} = 284$ nm), the photoisomerization reaction of this conducting polymer obeys first-order kinetics in organic solution (THF), as well as in the solid state. For solid samples, photoreaction completion is reached within about 5 minutes of sunlight exposure. The advantages of this polymer for solar energy storage are discussed.

References

- 1- T.Nishikubo, A.Kameyama, K.Kishi, T.Kawashima, T.Fujiwara et C.Hijikata, *Macromolecules*, 25 (1992), 4469.
- 2- T.Nishikubo, A.Kameyama, K.Kishi et C.Hijikata, *Reactive Polymers*, 24 (1994), 65.
- 3- M.Maafi, J.J.Aaron and C.Lion, *Synthetic Metals*, in press.

A STRATEGY FOR THE PHOTOISOMERIZATION OF AROMATIC NORBORNADIENES IN AQUEOUS MEDIA BASED ON β -CYCLODEXTRIN INCLUSION COMPLEXES

J.J.AARON, M.MAAFI and C.LION

Institut de Topologie et de Dynamique des Systèmes, Associé au CNRS, URA-34, Université Paris 7-Denis Diderot, 1 rue Guy de la Brosse, 75005, Paris-France

Photochemical systems based on the reversible photoisomerization of norbornadienes (NBD) into quadricyclanes (QC) have been widely studied in the eighties because of their potential usefulness for light and solar energy storage.¹⁻² One of the limiting factors is the use of organic, toxic and ignitable solvents. In this study, we propose an approach based on the direct photoisomerization of NBD aromatic derivatives in aqueous medium containing β -cyclodextrin (β -CD).

Indeed, β -CD is able to accommodate, in its doughnut-shaped cavity, hydrophobic organic molecules from aqueous medium,³ forming hydrosoluble host-guest inclusion complexes. We have monitored spectrofluorimetrically this complexation process between the NBD aromatic derivatives and β -CD. Formation constants (K_f) ranging between 310 and 390 M⁻¹ were obtained for the NBD: β -CD inclusion complexes with a 1:1 stoichiometry. These relatively low K_f values indicate partial binding of NBD aromatic derivatives with β -CD.

NBD aromatic derivative photoisomerization kinetics were found to be similar in 0.01 M β -CD aqueous solutions and in ethanol. In both solvents, the change in the NBD derivatives absorption spectra during the photoisomerization reaction was characterized by an isosbestic point indicating the cleanliness of the photoreaction.⁴ In contrast, an erratic behaviour was observed in aqueous solution without β -CD. This confirms that complexation is a prior step to photoisomerization, and constitutes a determining factor for achievement of the photoisomerization reaction in aqueous media.

References

- 1- H.Ikezawa, C.Kutal, K.Yasufuku and H.Yamazaki, *J. Am. Chem. Soc.*, 108 (1986) 1589.
- 2- M.Maafi, *PhD Thesis*, Université Paris 7-Denis Diderot, 1996; and references therein.
- 3- a) K.H.Frömning and J.Szejtli, in *Topics in Inclusion Sciences: Cyclodextrin in Pharmacy*, Ed. J.E.Davis, Kluwer Academic Press, Dordrecht-Boston-London, 1994; b) M.Maafi, J.J.Aaron, M.C.Mahedero and F.Salinas, *J. Fluorescence*, in press.
- 4- a) M.Maafi, J.J.Aaron and C.Lion, *Chem. Letters*, 10 (1994) 1865; b) M.Maafi, C.Lion and J.J.Aaron, *New J.Chem.*, 20 (1996) 559.

ESTIMATION OF THE ATTENUATION OF
VISIBLE AND THERMAL RADIATION
BY SOME ARTIFICIAL AEROSOLS

M.Sh. Fayed, M.G. Soliman, A. Mansour, and M.Y. EL-Wakeel
Chem. Eng. Branch, M.T.C., Cairo.

Abstract :

Optical and thermal effects of aerosols represent the most spectacular and most important of all aerosol characteristics. Interactions between electromagnetic radiation and the target modulate the characteristics of emerging radiation. Being an aerosol, smoke appears as they do because of the optical and thermal properties of the individual particles and the effects of these particles on each other. In this study a pyrotechnic smoke generating mixtures based on red phosphorus, red iron oxide, magnesium, an oxidizer and a polymeric binder were tested. These mixtures were ignited thermally and the smoke generated was examined visibly and thermally inside a designed laboratory smoke tunnel. The attenuation of visible and thermal radiation by the smoke was measured by a photocell and thermal camera connected to a data processing system. The results were shown graphically and discussed indicating the factors affecting the characteristics.

SPECTROSCOPY, PHOTOSTABILITY AND OPTICAL EFFICIENCY OF LUMINESCENT SOLAR CONCENTRATOR

A.F. Mansour, A.L. Salem, N.M. El-Sayed and A.H. Bassyouni

Physics Department, Faculty of Science, Zagazig University, Egypt.

Abstract

The spectroscopic properties of 1,4,170 and 750 Oxazine dyes doped in PMMA were measured and studied. The photostability of these samples were outdoor tested during four seasons. The optical efficiency of luminescent solar concentraor of 750 Oxazine dye were measured and calculated hourly for one season (Summer 1995) considering day 21th as a reference day for each month. The performance of LSC has been tested at four different positions using X-Y traker.

EFFECT OF THE PRESENCE OF PYRIDYL AND THIENYL GROUPS ON THE EXCITED STATE PROPERTIES OF STILBENE-LIKE MOLECULES

F. Spalletti, G. Bartocci, F. Elisei and U. Mazzucato*

Dipartimento di Chimica, Università di Perugia, 06123 Perugia, Italy

The photophysics and photochemistry of stilbene-like molecules bearing polycyclic aryl groups have been widely investigated in the last decades. Less attention has been paid to hetero-analogues containing nitrogen and sulphur atoms, particularly the latter.

In our laboratory, a in-depth investigation of the trans isomers of stilbene-like compounds containing pyridine and thiophene rings and some of their polycyclic derivatives has been carried out by fluorimetric, photochemical and laser flash photolysis techniques. The availability of fast techniques and new theoretical approaches has allowed the properties of the lowest excited states of these molecules to be satisfactorily clarified..

Pyridine rings introduce n,π^* states which can play a deactivating role, mainly through vibronic coupling and consequent internal conversion to the ground state. Thiophene rings introduce a heavy atom which can favour the spin-orbit coupling and then the population of the triplet manifold through intersystem crossing. The presence of polycondensed rings leads to a decrease in the quantum yield of the photoisomerization to the cis isomers, as reported for the corresponding hydrocarbons, owing to an increase in the torsional energy barrier.

In this paper, we present new results, particularly on the sulphur-derivatives, and make a comparison of the properties which characterize the relaxation processes of the compounds containing heteroatoms with their parent hydrocarbons.

Preliminary results on diarylbutadiene and longer-chain heteroanalogues will also be reported to show the effects of the length of the polyene chain on the photophysics of some pyridyl and thienyl derivatives.

STUDIES ON THE MECHANISM OF LASER ABLATION AND THIN FILM DEPOSITION OF CERAMIC, SUPERCONDUCTORS AND SEMICONDUCTORS

A. Mele, A. Giardini Guidoni, R. Teghil*, S. Orlando**, C. Flamini, and A. Latini

Dipartimento di Chimica, Università di Roma "La Sapienza", P. le A. Moro, 5- 00185 Roma, Italy

Introduction

Laser interaction with solid targets involves many physico-chemical processes and it is expected to have important effects on the development of material science. The process starts with the coupling of laser electromagnetic radiation with the solid target. The laser beam may be absorbed or partly reflected by the target surface. The basic interaction mechanisms between the absorbed light and matter can be of thermal or photochemical nature.

The emitted particles above the target surface form a so called plume. The plume has the characteristics of a plasma and interacts both with the terminal part of the laser pulse and with the target surface where recondensation or reflection phenomena can take place. This report will concentrate mainly of studies carried out at the University of Rome. Brief review of the theoretical models on heat flow within the target and on the plume expansion and of thin film fabrication are here reported.

Models of particle release and plume dynamics.

The issue takes into account two strictly connected problems arising from the laser effects on the solid surface. One problem is related to the mechanism of particle ejection and the other to the dynamics of the particles moving away from the solid. Vaporization is due to the input of the laser on a target. The laser light absorption is described by an exponential law and the heat transport by the one dimensional heat flow equation with suitable boundary conditions for vaporization with or without boiling.

By assuming that the thermophysical properties are independent of temperature, the temperature $T(z,t)$ at a distance z from the moving surface is controlled by the laser light absorption

$$I(t) = (1 - R)I_0 e^{-\mu z} \quad (1)$$

and by the heat flow equation given by

$$\rho C_p \frac{\delta T(z,t)}{\delta t} = \frac{\delta}{\delta z} \left(\frac{K \delta T(z,t)}{\delta z} \right) + I(t) \quad (2)$$

The terms ρ , C_p , K , R and μ refer to density, heat capacity, thermal conductivity, reflectivity and absorption coefficient of the target. The use of these formulas require the knowledge of the function $I(t)$ expressed in W/cm^2 i.e. the actual laser pulse shape with time. The particles ejection can be analyzed in terms of flow equation of the gas expansion. The model assume that gas cloud is generated by laser vaporization. A relation is suggested between the three orthogonal velocities and laser spot size and shape which, at early stages, are the y and x directions of the plume, Thus the plasma becomes elongated in the shorter dimension (z) and may expand according to different velocities on y and x . This can be simply described by the final equation governing the expansion [1]:

$$X(t) \left[\frac{d^2 X}{dt^2} \right] = Y(t) \left[\frac{d^2 Y}{dt^2} \right] = Z(t) \left[\frac{d^2 Z}{dt^2} \right] = \frac{kT_0}{m} \left[\frac{X_0 Y_0 Z_0}{X(t) Y(t) Z(t)} \right] \quad (3)$$

This trend is confirmed from experiments on several systems. After laser desorption the gas cloud equilibrates to a full range Maxwellian in its center of mass system which moves with a stream velocity given by

$$u_k = M \sqrt{\frac{\gamma k T}{m}} \quad (4)$$

where $\gamma = C_p/C_v$ is 5/3 for monoatomic gases and M is the Mach number. The distribution function for the velocity component normal to the surface becomes at $t \rightarrow \infty$

$$f(v_z) = \exp\left(-\frac{m(v_z - u_k)^2}{2kT_k}\right) \quad (5)$$

where u_k is characterized by $M=1$ in eq (4) and v_z is the velocity as seen from the target surface, and T_k is the temperature of the Knudsen layer, a region within a few mean free paths of the target surface.

Plume Diagnostics

The basic equipment required for laser evaporation and for thin film deposition and growth consists of a vacuum chamber containing a rotating target, a substrate, and windows for laser entrance and plume observation. A Nd:YAG or an excimer laser hits the target at a given angle and vaporizes its constituents. The material gas cloud, the plume, travel to reach the substrate usually in front of the target. In situ analysis of the plume are carried out by viewing the emission at 90° from the target by fast intensified CCD photography. The optical emission of the plume is also collected at 90°, dispersed through a monochromator and analyzed by an optical multichannel analyzer. In situ mass spectrometry is also performed. A considerable effort was made on the plume diagnostic in order to correlate laser target interaction, plume expansion and thin film deposition. The components of the plasma plume are electrons, atoms and ions, molecular clusters and particulate. Techniques most largely used to characterize the plumes as a whole and for their main components are mass spectrometry.

Thin Film Deposition

The vacuum chamber used to monitor the laser-target interaction and the plume moving to the substrate has been also employed to establish appropriate conditions to deposit thin films. The numerous PLD processes that have been studied have clearly demonstrated the feasibility of the technique which is confirmed by the relevant results obtained. Numerous materials are amenable to PLD and in many cases this technique has been preferred over other more conventional techniques. Examples of PLD of semiconducting materials can be found. The thin film epitaxial growth of semiconductors SnSe and III-IV group elements Nitrides were obtained recently by laser ablation [2]. Ternary semiconductors $HgCd_{1-x}Te_x$ and AlNbn have been prepared. The beam flux modulation is used to produce a homogeneous alloy of the three elements with a band gap tunable in the proper range. The beam modulation for the preparation of HgCdTe and AlNbn is a very important example of band gap engineering.

[1] J. Dawson, P. Kaw, and B. Green; *The Physics of Fluids*, 12 (1969) 875

[2] A. Mele, A. Giardini, and R. Teghil in "Frontiers in Nanoscale Science of Micron/Submicron Devices" Ed. Jauho/Buzaneva, Kluwer academic publishers (1996), 0

* *Dipartimento di Chimica, Università della Basilicata, via N. Sauro 85-85100 Potenza, Italy*

** *Istituto Materiali Speciali CNR- 85050 Tito Scalo (PZ), Italy.*

PHOTOPHYSICS OF OLIGOSILANES

Josef Michl

*Department of Chemistry and Biochemistry
University of Colorado, Boulder, Colorado 80309-0215, U. S. A.*

Permethylated oligosilanes, $\text{Si}_n\text{Me}_{2n+2}$, show remarkable photophysical properties. Although these are saturated compounds, their absorption spectra have peaks in the near UV and are strongly dependent on temperature and chain conformation. Unexpectedly, in the electronic ground state, there are three rather than only two pairs of enantiomeric conformations for twisting around a SiSi bond, *gauche*, *ortho*, and *anti*, similarly as in perfluorocarbons. The effects of chain conformation on the photophysical properties of oligosilanes were examined in detail by studying cyclic compounds containing a contiguous silicon chain whose termini were attached to a chain of methylene groups or "racked" onto the ends of a rigid-rod staffane molecule. In these carbosilanes, the silicon chain conformations are fixed. The structures of the fixed conformers were obtained by single-crystal X-ray diffraction or *ab initio* calculations. The use of a sufficient number of such derivatives permits a mapping of the spectroscopic properties as a function of SiSiSiSi dihedral angles. *Ab initio* calculations were also used to compute the spectral properties as a function of chain conformation and to interpret the observations. All the experimental and *ab initio* results for previously known and newly observed spectroscopic transitions can be understood in terms of a relatively simple model (ladder H) that includes electrons in the orbitals of the backbone as well as those in the orbitals of the lateral bonds. Against traditional expectations, it is not possible to understand the results in terms of the backbone electrons alone, not even qualitatively. Also in contrast to earlier beliefs, the excitation energy of the lowest singlet transitions in $\text{Si}_4\text{Me}_{10}$ is nearly independent of conformation, while their intensities vary widely as the dihedral angles change, as a result of an avoided crossing of configurations that become $\sigma\sigma^*$ and $\sigma\pi^*$, respectively, in the limit of planar silicon skeletons.

The emission spectra of the longer chains ($n > 7$) are good mirror images of the first absorption band, exhibit very small Stokes shifts, and have short lifetimes that fit the integrated intensities of their first absorption bands. Those of the shorter chains ($n < 7$) are broad, strongly Stokes-shifted, and have long lifetimes. Permethylated heptasilane ($n = 7$) represents a borderline case and shows both types of emission, in temperature-dependent proportions. Fluorescence lifetimes and quantum yields are a strong function of temperature and chain length n , as well as conformation. The striking change in the emission behavior as a function of chain length is attributed to exciton self-trapping in the shorter chains, and a structural interpretation in terms of bond-stretching modes is offered.

ELECTRON TRANSFER AND SPIN DYNAMICS IN BACTERIAL, PLANT AND MODEL PHOTOSYNTHESIS AS STUDIED BY TIME-RESOLVED HIGH-FIELD/HIGH-FREQUENCY EPR SPECTROSCOPY

K. Möbius

Department of Physics, Free University Berlin, Arnimallee 14, 14195 Berlin, Germany

In primary photosynthesis research the elucidation of the spatial and electronic structures of the donor and acceptor ion radicals involved in the light-induced electron transfer chain is very important. Recent 3 cm (X-band, 9.5 GHz) and 3 mm (W-band, 95 GHz) high-field EPR and ENDOR studies on the primary donor cation radicals $P^{+\bullet}$ (bacteriochlorophyll dimer), the acceptor anion radicals $Q^{-\bullet}$ (quinones), and the charge-separated radical pair ($P^{+\bullet}-Q^{-\bullet}$) in photosynthetic bacteria and biomimetic model systems will be presented.

In the case of $P^{+\bullet}$, an asymmetric distribution of the unpaired electron over the dimer halves has been observed. This is of particular interest since it might be relevant for the vectorial electron transfer along only one protein subunit. From single crystals of, for instance, *Rb. sphaeroides* R-26 reaction centers both the hyperfine tensors of various protons and the g-tensor of $P_{865}^{+\bullet}$ have been determined and compared with calculated tensor values based on recent X-ray structure analyses. The results consistently reveal a breaking of the local C_2 symmetry at the primary donor side of the reaction center.

Among the quinone radical anions studied are the electron acceptors of bacterial and plant reaction centers (ubiquinone-10 and plastoquinone-9, respectively). The increased electron Zeeman interaction in high-field EPR leads to almost completely resolved g-tensor components even in disordered samples. They are sensitive probes for specific anisotropic interactions with the environment. Pulsed high-field EPR reveals anisotropic contributions to T_2 relaxation by librational motion of the primary quinone acceptor in its protein binding site.

In the case of the transient correlated coupled radical pair $P^{+\bullet}-Q_A^{-\bullet}$ of *Rb. sphaeroides* (Fe replaced by Zn) the spin-polarized high-field EPR spectra allow an unambiguous determination of the relative orientation of the g-tensors of the donor and acceptor parts. Thereby high-precision structure information is obtained on the electron transfer pigments after light-induced charge separation. The results will be discussed with regard to structure-function relationships in primary photosynthesis.

New Photogeneration Method of Some Azo-dyes

Shaaban Kamel Mohamed

Chemistry Department, Faculty of Science, El-Minia University, A.R.Egypt

In an attempt to make an ideal use of the solar energy storage in our country, this investigation tries to study the effect of direct sunlight on the solid chemical reaction of triazene 1-oxides 1a-d with 1- and 2-naphthols, this is to be able to categorize the chemical behavior of these oxides towards the sunlight. In previous work we have reported¹ the irradiation of triazene 1-oxides in aromatic and non-aromatic solvents at 320nm using 125w-Mercury lamp which gave not only the o-hydroxy azobenzene, but also arylated products of the solvent (aromatic solvent) in addition to the formation of biaryls.

In present work, we exposed the well grained solid mixture of 1m mol of each triazene 1-oxides 1a-d and 1- and 2-naphthols to the direct sunlight for 3-5 hours in October, the colour of the solid mixture immediately changed into red colours. The reaction was monitored by TLC and after the starts finished, the mixture was dissolved in a little amount of acetone and chromatographed through plate layer chromatography PLC, the coloured zone was separated in each case and compared with its authentic sample. The products 2,3 (scheme 1) were azo-dye derivatives for 1- and 2-naphthols, and they were emphasized through free radical pathway reaction mechanism (scheme 2).

1) A. M. Nour El-Din, S.K.Mohamed, and D.Doepp, Bull. Chem. Soc. Jpn., 69, 131-135, 1996.

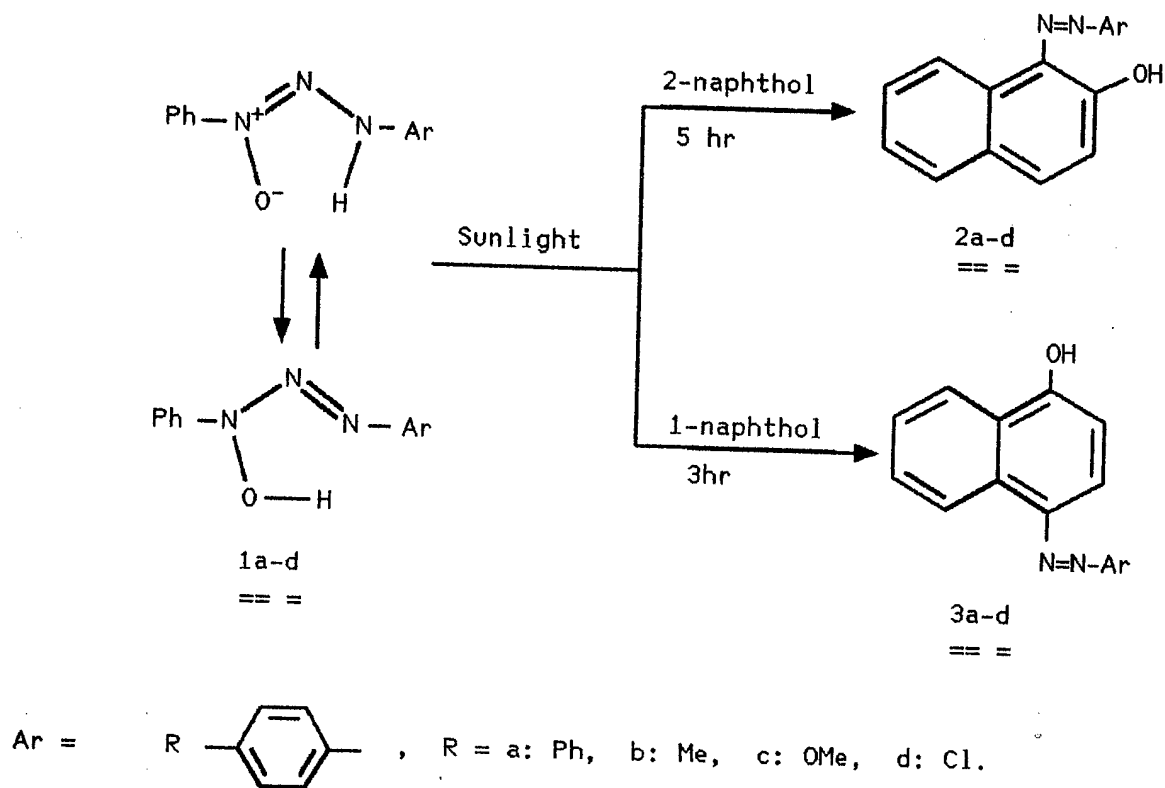

(Scheme 1)

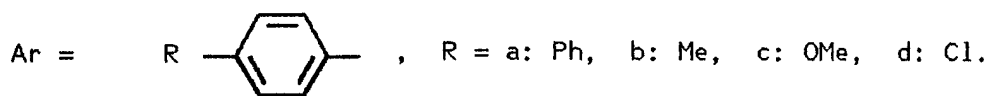
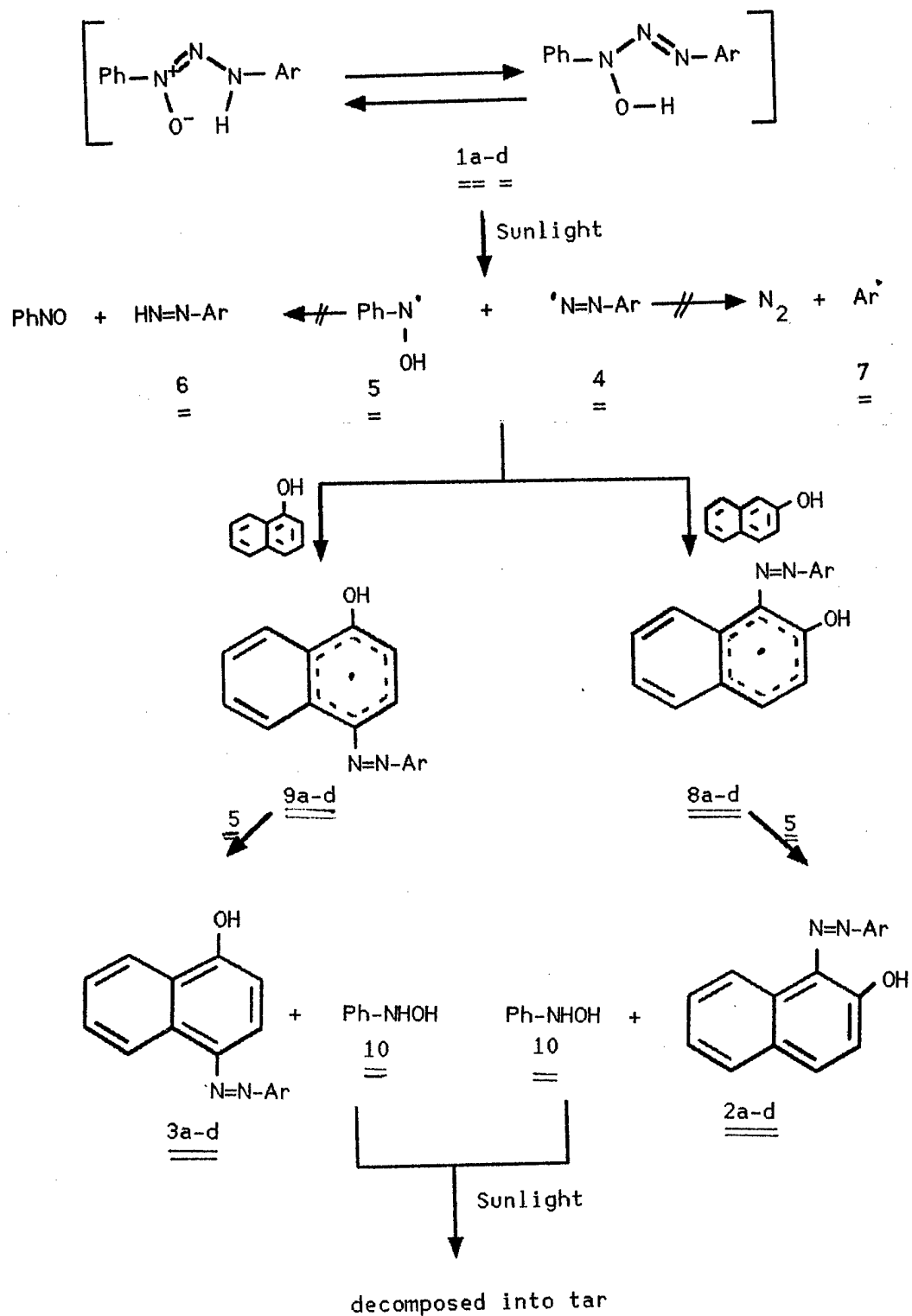

(Scheme 2)

Free volume hole distributions of Polyisoprene studied by Positron Annihilation Lifetime Spectroscopy

N. Mostafa, M. Mohsen, Y.C. Jean*, H.A. Ismail**, M.S. Abd el Keriem

Physics. Dept. Faculty of Science and Faculty of Education **, Ain Shams University, Cairo, Egypt.

* Dept. of Chemistry, University of Missouri-Kansas City, Kansas City, Missouri, U.S.A.

Positron Annihilation Lifetime (PAL) measurements are reported for three natural Polyisoprene samples with different percentages of Dicumyle Peroxide additive. The temperature dependences of their ortho-positronium (o-Ps) lifetime τ_3 and intensities I_3 measured from 77 to 315K, show a discrete change in slope at glass transition temperature T_g .

The results of τ_3 and I_3 are used to deduce the free volume fractions f_v , which are then compared with theoretical free volume fraction f_{th} using the statistical mechanical theory of Simha and Somcynsky. An agreement between f_v and f_{th} is found for $T > T_g$ in some samples. Below T_g the f_v is considerably smaller than f_{th} as temperature decreases. Furthermore, the distributions of free-volumes in polyisoprene samples are obtained from the o-Ps lifetime distribution using a Laplace inversion of PAL spectra. The results of these distributions at small volumes could be successfully interpreted by the free-volume model of Turnbull-Cohen. The deviations found at large volumes will be discussed.

Effect of sorption of CO₂ gas on free volume distributions in polyethylene and poly(1-trimethylsilyl propyne) studied by Positron Annihilation Lifetime Technique

E. A. H. Gomaa, M. Mohsen, H. Schut*, A. van Veen*, M. H. Khalil

Physics Department, Faculty of Science Ain Shams University, Cairo , Egypt.

* Reactor Physics Department, Delft University of Technology, The Netherlands

Several probe methods have been used to estimate the free volume characteristics in glassy and rubbery polymers. In the present work, the positron annihilation lifetime technique has been used because of the high relative sensitivity of ortho-positronium (o-Ps) probe to free volume holes. Lifetimes τ_3 and intensities I_3 of o-Ps have been measured using fast-fast coincidence timing technique with time resolution 250 ps for ⁶⁰Co in rubbery high density polyethylene (HDPE) and low density polyethylene (LDPE) as well as in glassy poly(1-trimethylsilyl propyne) (PTMSP) polymers. The PAL spectra have been analyzed by PATFIT and CONTIN programs.

From these results the free volume fractions f_v and their distributions $f_v(V)$ are deduced. It has been found that in HDPE, LDPE and PTMSP the free volumes are distributed around a mean volume V_3 of 0.145, 0.17 and 0.22 nm³ respectively with f_v of 8.6, 9.2 and 2.99 respectively. However only in PTMSP a large size free volume has been revealed showing a distribution around a mean value of 0.88 nm³ with a fraction f_v of 20. After sorption of CO₂ gas, the changes in f_v and $f_v(V)$ in polyethylene could be well interpreted in terms of Henry-type sorption, whereas, in PTMSP, these changes agree with the Langmuir-type sorption. An attempt is done to correlate these changes with the solubility S and diffusion D coefficients of CO₂ in these materials. Moreover the experimental results have been discussed in the frame work of the Turnbull-Cohen free volume model.

LIGHT-INDUCED REDUCTION AND RING CONTRACTION OF SOME PHENYLATED AZINES

D. Döpp^a, W. A. F. Mostafa^{a,c}, G. Henkel^b, A. M. Kaddah^c, A. A. Shalaby^c
and Y. M. A. Naguib^c

^aFachgebiet Organische Chemie and ^bFachgebiet Festkörperchemie,
Gerhard-Mercator-Universität - GH - Duisburg, D-47048 Duisburg, Germany

^cChemistry Dept., Faculty of Science, Ain Shams University, Abbasia, Cairo, Egypt

The excited-state reactions which serve as the focus of this study are based on single electron transfer (SET) from a notoriously good electron donor, triethylamine, to a variety of π -deficient-aza-heterocycles as phenylated pyridazine, pyrazine, pyrimidine, triazines [1], and tetrazine. The excited neutral aromatic N-heterocycles (**1**, **4**, **6**, **12**) are considered to act as single electron acceptors. Subsequent steps bring about the products of photoreduction (**2**, **7**, **13**) or photoreductive ring contraction (**3**, **5**, **8**, **10**, **11**, by extrusion of either a nitrogen atom or phenylmethine group). For example:

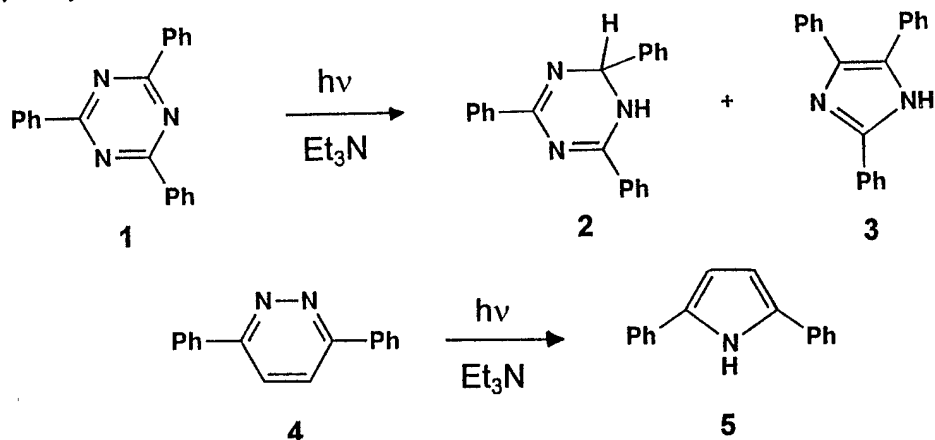

Interestingly, also products (**10**, **11**, **14**) derived from the incorporation of solvent fragments are formed. For example:

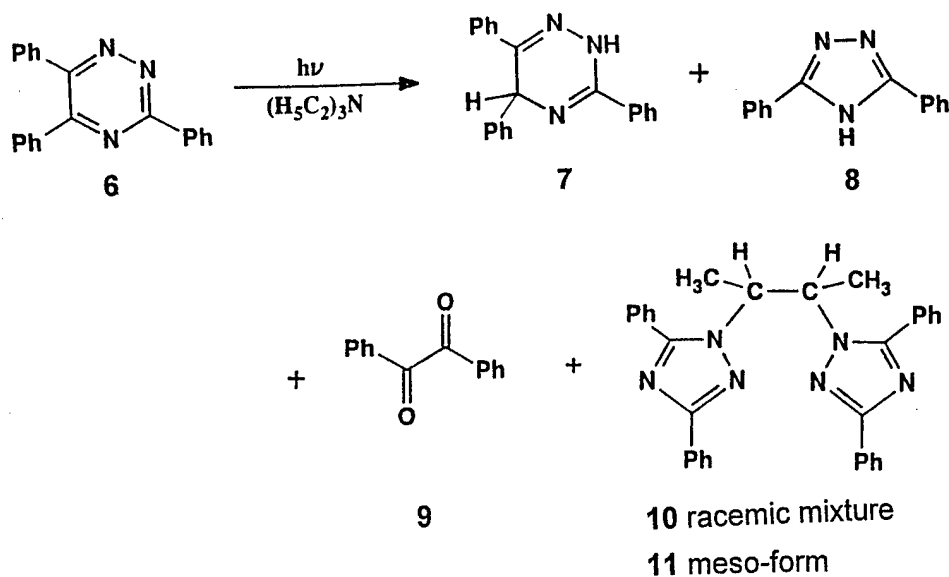

The structure of product 10 has been unambiguously confirmed by an X-ray crystal structure determination.

Diels-Alder type incorporation of a solvent derived vinyl group leads to the formation of product 14 in the following case:

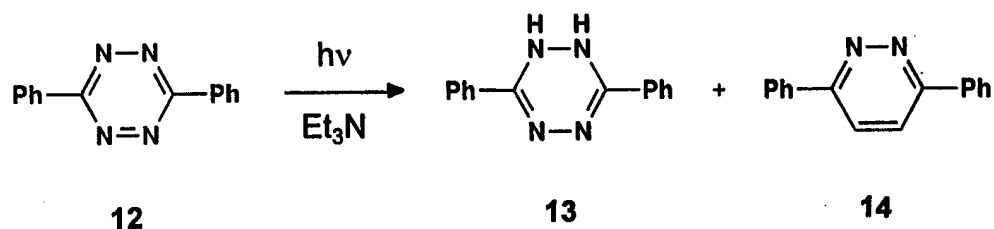

[1] Photochemistry of triazine 6 and its dihydro derivatives (either as hydrochlorides or as neutrals) in alcohol solutions has been reported:

J. Nagy, J. Nyitrai, P. Kolonits, K. Lempert, A. Gergely, L. Parkányi, A. Kálmán,
J. Chem. Soc. Perkin Trans. 1, **1988**, 3267

J. Nagy, R. Rapp, M. Alexovics, D. Döpp, J. Nyitrai, U. Záhorszky, H. Röttele,
J. Chem. Soc. Perkin Trans. 1, **1993**, 661

J. Nagy, J. Nyitrai, G. Csonka, *J. Inf. Rec. Mater.*, **21** (1994), 467

Acknowledgement: W. A. F. Mostafa is indebted to the Egyptian Government for a fellowship.

REDUCTION OF AQUEOUS CARBONATE PHOTOCATALYSED BY TREATED SEMICONDUCTORS FOR SOLAR ENERGY CONVERSION AND STORAGE

W. E. MOURAD & M. W. ROPHAEL

The National Research Centre, Surface Chemistry and Catalysis Laboratory,
Giza, Egypt (Fax No. 202-700-931)

Heterogeneous photocatalysis has been recently used to synthesise chemical compounds thereby converting solar energy to chemical energy. Transformation of CO_2 (carbonate) into organic substances allows the preparation of fuels or chemicals from a cheap and abundant carbon source¹. The undesirable accumulation of CO_2 in the atmosphere is now increasing, which leads to the so called "greenhouse" effect with dramatic consequences. Improvements in the reduction of CO_2 may be of importance in providing a process for recycling some of the CO_2 released into the atmosphere by coal or oil-burning power stations.

TiO_2 is very efficient for the chemical conversion of light energy but its absorption does not fit with the solar spectrum. A possible way to extend its response to the visible region consists of coating the semiconductor's surface with a photoactive dye². Phthalocyanine dyes appear to be most appropriate because they are very stable, have high light absorption within the solar spectrum and their redox potentials can be varied by changes in the central metal².

Heterogeneous photocatalysed reduction of CO_2 (carbonate) solution was achieved using phthalocyanine-coated titania powders (rutile). The suspensions were irradiated with U.V./ visible light under nitrogen atmosphere. Higher methanol yields were obtained compared to formaldehyde

yields. Both products were determined spectrophotometrically. Titania coated dyes gave an optimum methanol yields at 2% surface coating. At higher coating percentages, phthalocyanine screens the surface, thus reducing the light reaching the semiconductor³.

Another way to prepare a photoactive titania catalyst is by platinizing its surface. Different methods have been used for platinization of TiO_2 . The photoplatinization was found to be more satisfactory⁴. More Pt deposits infavours the recombination of charge carriers, produced during irradiation of the photocatayst, that lowers the yields of the products.

The bare MoS_2 photocatalyst gave a much higher methanol yield due to the characteristic behaviour of the semiconducting layer- type disulphide distinguished from that of classical semiconducting materials³.

The different factors probably governing the yield of products from the photocatalysed reduction of carbonate will be given in details. Band gap irradiation of the photocatalyst leads to the production of electrons in the conduction band of the semiconductor. It is likely that the photogenerated electrons reduce CO_3^{2-} initially to HCOO^- and then to HCHO and CH_3OH .

1. J.P. Collin and J.P. Sauvage; *Coord. Chem. Rev.* **93**, 245 (1989).
2. F.F. Fan and A.J. Bard; *J. Am. Chem. Soc.* **101**, 6139 (1979).
3. L.B. Khalil, N.S. Youssef, M.W. Rophael and M.M. Moawad; *J. Ccm. Tech. Biotechnol.* **55**, 391 (1992).
4. M.W. Rophael and M.A. Malati; *J. Photochem. Photobiol., A : Chemistry* **46**, 367 (1989).

Solar Photocatalytic Degradation of Organosynthetic Chemicals in Polluted Water and Effluents

L. Muszkat¹, L. Feigelson¹, and K. A. Muszkat²

¹ Agricultural Research Organization, Volcani Center,
Department of Chemical Agroecology Bet-Dagan 50250 Israel

² Weizmann Institute of Science, Rehovot 76100, Israel

ABSTRACT

TiO₂-solar photocatalytic mineralization of pesticides has been studied in several contexts. The treatment of groundwater pumped from a polluted well has shown that half life-time for most of the measured pesticides (at levels of 50-100ppb), was less than 1h. Water solutions of pesticides in commercial formulations were also effectively purified by solar photocatalysis. The remediation of rinse waters of agricultural aircraft sprayers in open and covered systems has also been achieved.

In addition, comparative studies have been carried out, relating to the background processes of direct photolysis. These were performed in the presence of hydrogen peroxide and also in solutions saturated with oxygen and with oxygen free solutions. Distinction between two different reaction patterns of longwave (> 300 nm) photooxidation has been witnessed. In the first case oxygen has a pronounced effect on the rate of photooxidation, as exemplified by metribuzin, (4-amino-6-tert-butyl-4,5 dihydro-3-methylthio-1,2,4 triazine-5-one) while the influence of hydrogen peroxide is quite moderate. The photolytic process in this case would apparently start via a reaction of the excited pesticide with an oxygen molecule, generating the hydroperoxy (HO₂[•]) free radical. In another case, exemplified by bromacil (5-bromo-3-sec-butyl-6-methyluracil), oxygen does not have a pronounced effect on the rate of photooxidation, which however is considerably enhanced by hydrogen peroxide. Here the excited substrate molecule would transfer excitation to hydrogen peroxide, generating hydroxyl radicals which propagate a chain reaction and carry out the oxidation process.

These are yet early conclusions which deserve further studies. However, the recognition that several different direct photooxidation mechanisms could be implicated in the treatment of water pollution should be of significant practical importance, indicating the need to tailor the exact photooxidation to the specific pollutant.

Spectral Output of Nanosecond Flashlamps

D.U. Nather

Edinburgh Instruments Ltd., Riccarton, Currie, Edinburgh, EH14 4AP, U.K.

Nanosecond Flashlamps are widely used as excitation sources for time resolved fluorescence spectroscopy, in particular with the method of time correlated single photon counting, due to their appropriate pulse widths, down to sub-nanosecond, and to their pulse repetition rates up to 100kHz.

The fact that nanosecond flashlamps have not been extensively superseded by picosecond and femtosecond lasers is largely due to their relatively low cost, their ease of use and maintenance, and their broad spectral radiance from vacuum UV to near infrared.

The broad spectral output and the fact that for some filler gases the pulse shape is independent of the spectral range makes the nanosecond flashlamp very attractive as a flexible routine source. Although published data of the VUV output of nanosecond flashlamps for different filler gases are available, there is, in general, a lack of data summarising their spectral output in the UV, visible and near IR spectral range.

We present measurements of the emission characteristics of nanosecond flashlamps for a variety of different filler gases and mixtures. The advantages and disadvantages of the gases are discussed and an example of the temporal pulse shape is shown for each gas. The presentation will help the user of nanosecond flashlamps to choose the most appropriate filler gas for the particular application in the field of time resolved fluorescence studies.

Action spectra of the photopotential generation for pigment and dye solutions in nematic liquid crystals located in electrochemical cell.

N.S.Naser, A.Planner and D.Frąckowiak

Institute of Physics, Poznań University of Technology, Piotrowo 3, 60-696 Poznań, Poland

Abstract

The method of the measurements of the action spectra of photopotential generation using modulated acting light beam was elaborated and applied to two systems: the solutions of stilbazolium merocyanines and to the mixture of chlorophyll *a* and luteine. Both types of samples were dissolved in nematic liquid crystal and located between two semiconducting electrodes or between transparent gold electrode and semiconducting electrode.

Changing the frequency of light modulation or the phase shift between modulated light beam and measured photopotential signal information about the kinetics of photopotential generation are obtained. The free base and protonated merocyanines forms exhibit different kinetics of potential generation. The amplitude of photopotential of the chlorophyll with luteine mixture is higher than the sum of amplitudes of photopotential of these pigments located in separated cells. In a cells with two semiconducting electrodes the light gradient e.g. different illumination of front and back electrodes due to light absorption play important role in photopotential generation.

Photoenergy Storage System Using Diiron Complexes

Hiroshi Ogino

Department of Chemistry, Graduate School of Science
Tohoku University, Sendai 980-77, Japan

We previously reported that irradiation of $\text{Cp}^*\text{Fe}(\text{CO})_2\text{SiMe}_3$ ($\text{Cp}^* = \text{C}_5\text{Me}_5$) in the presence of (*p*-tol)SiH₃ by a medium pressure mercury lamp yielded a mixture of *cis*-1 and *trans*-1 (eq 1).¹⁾

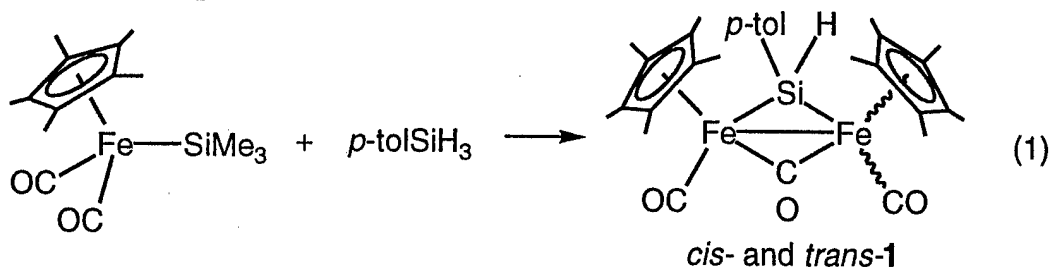

Isomerization was found to occur both thermally and photochemically. The ratio of *cis*-1 to *trans*-1 was 2 : 98 at equilibrium at 25°C. Interestingly, the photochemical isomerization proceeded mostly in the opposite way and the ratio of *cis*-1 to *trans*-1 was 70 : 30 at the photostationary state (eq 2). Therefore, this constitutes a photoenergy storage system.

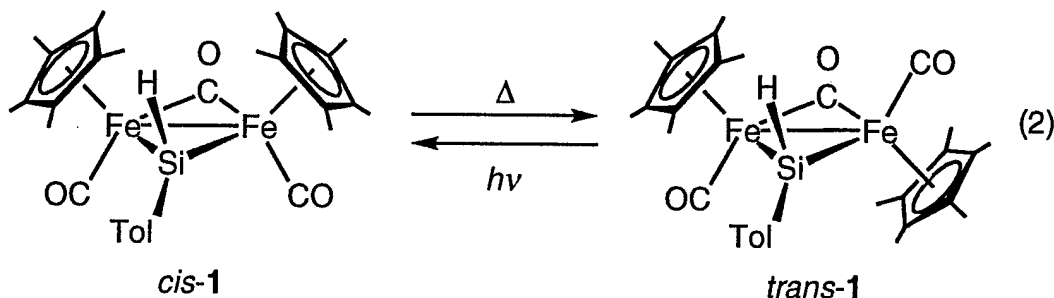

From kinetic studies, we concluded that the thermal isomerization proceeds through an intermediate **A** (eq 3).

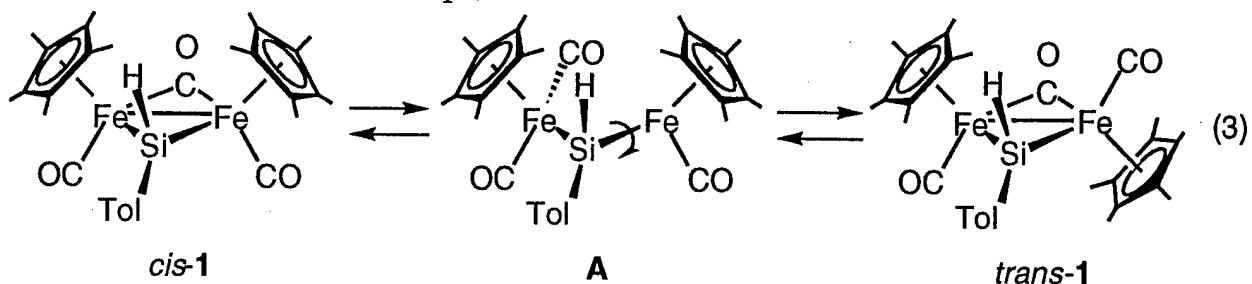

The mechanism of the photoisomerization of **1** seems to be quite different from that of the thermal isomerization. Photolysis of **1** with ejecting generated CO from the system led to the formation of $\text{Cp}^*_2\text{Fe}_2(\mu\text{-CO})_2(\mu\text{-SiHtol}^p)$ (**2**) which could be isolated as deep violet crystals and structurally characterized by X-ray crystallography. The magnetic susceptibility measurement indicates that **2** has a triplet ground state.²⁾ The results strongly support the mechanism of the photoisomerization shown in eq 4.

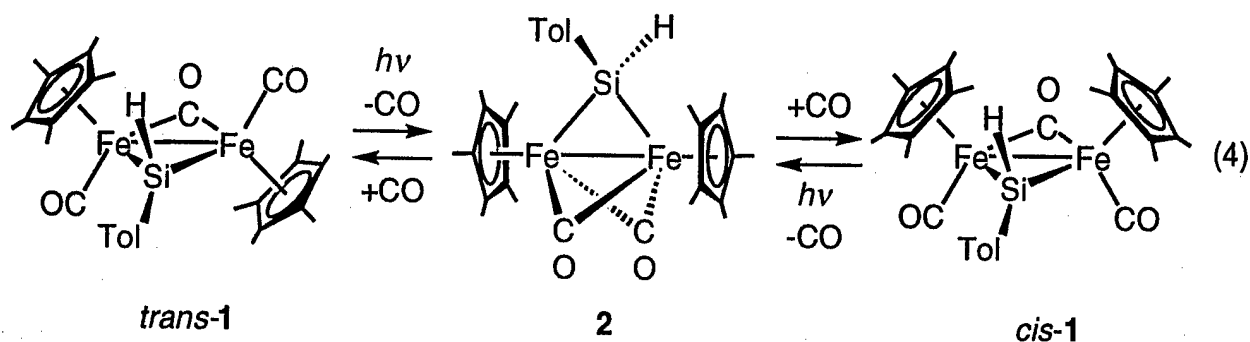

To obtain further information on this unique system, closely related complexes have been prepared and their thermal and photochemical isomerization reactions have been investigated. The results are summarized in Table 1. The details will be discussed in the talk. More examples of the photoenergy storage systems which we discovered will also be mentioned.

Table 1. *cis-trans* Ratio of Silylene-, Germylene-, and Carbene-Bridged Diiron Complexes

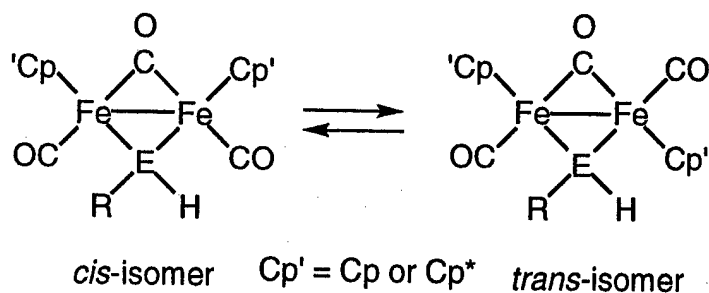

E	Cp'	R	Ratio		
Si	Cp*	<i>p</i> -tol	thermal	2	98
			photochemical	92	8
Si	Cp	CHEt ₂	thermal	100	0
			photochemical	85	15
Si	Cp	CHPh ₂	thermal	72	28
			photochemical	27	73
Ge	Cp*	<i>p</i> -tol	thermal	7	93
			photochemical	84	16
C	Cp*	H	thermal	0	100
			photochemical	12	88

Reference

- 1) Y. Kawano, H. Tobita, and H. Ogino, *Organometallics*, **11**, 499 (1992).
- 2) H. Tobita, H. Izumi, S. Ohnuki, M. C. Ellerby, M. Kikuchi, S. Inomata, and H. Ogino, *J. Am. Chem. Soc.*, **117**, 7013 (1995).

**Anodic dissolution of p-Si in fluoride media:
an electrochemical and ellipsometric study**

S. Böhm¹, R. Greef² and L.M. Peter¹

1. School of Chemistry, University of Bath, UK

2. Department of Chemistry, University of Southampton, UK

The etching of p-Si in fluoride solutions is important for the preparation of porous silicon as well as for the process of electropolishing. The present study used voltammetry, impedance spectroscopy and ellipsometry to characterise the behaviour of p-Si in a range of buffered solutions with fluoride concentrations from 0.005 M to 1.0 M and pH values from 4.5 to 1.0.

The majority of the measurements were made using p-Si(111) samples. Wafers were degreased and etched in 40% HF followed by 12 M NH₄F. Low resistance Ohmic contacts were prepared by F. Ozanam and J-N Chazalviel (Ecole Polytechnique, Palaiseau) by evaporation of 1% Al: Au and diffusion at 600° C. Electrodes were mounted in a flow cell which allowed ellipsometric measurements (λ 633 nm) to be performed under conditions where mass transport effects on the voltammetric behaviour were negligible (kinetic limit). Most of the measurements were carried out at 70° incidence angle. Impedance spectroscopy and single frequency admittance measurements were carried out in the same flow cell.

At low scan rates, excellent reproducibility and reversibility in the voltammograms was observed under conditions of electrolyte flow. By contrast, the voltammograms exhibited significant hysteresis in the absence of flow. Analysis of the impedance spectra indicated that a very thin layer of 'dry' oxide forms on the silicon in the electropolishing region. The derivation of the thickness of this oxide from the measured high frequency capacitance is complicated by the evident importance of the accumulation capacitance which appears in series with the dielectric capacitance of the oxide. The low frequency pseudocapacitance and resistance are attributed to the oxide growth/dissolution process.

The oxide thicknesses derived by ellipsometry are considerably larger than those calculated from the high frequency capacitance. This indicates that the oxide layer consists of an inner 'dry' region and an outer 'wet' region. The dependence of the oxide thickness on potential suggests that the thickness of the outer layer increases rapidly when the potential exceeds 5 V vs. SCE. At the same time, the ellipsometric response indicates that dissolution is accompanied by surface roughening. Ellipsometric results obtained using (100) samples show that surface roughening effects are much more important than with (111) samples.

Acknowledgements:

This work was supported by the European Union (Contract CII*-CT93-0070). We are grateful to our colleagues in this project (F. Ozanam, J-N Chazalviel and M. Etman) for discussions and practical help.

Accelerated Synthesis of Salicylaldoxime in Microwave Oven and the Factors Affecting It.

A. K. Rady, M.Kassem and M.Sh. Fayed

Chem. Eng. Branch, M.T.C., Cairo, Egypt.

Abstract :

Published papers demonstrate that the use of commercially available microwave ovens can lead to substantial savings in time for many laboratory syntheses. Being widely applied in several fields, salicylaldoxime was selected to be candidate in this study. It was prepared in a microwave oven from the condensation reaction of salicylaldehyde and the hydroxylamine salt. The factors that could influence such synthesis were investigated. These factors were the power of microwave setting, the time of exposure to the microwaves, the pH value of the reaction medium, the molar ratio between the two reactants, the type of hydroxylamine salt, and the effect of catalysis. The yield estimation was based on the isolated pure oxime. Structure of the latter was confirmed by mixed melting point and infrared spectrum of standard pure sample. Comparison between this method and the traditional heating shows a remarkable rate enhancement accompanied with the expected savings in time and higher yield. The results were showed, explained and discussed.

Structural Relaxation in Excited States of Large Flexible Donor-Acceptor Biaromatic Systems

W. Rettig

Inst. f. Physikal. & Theor. Chem., Humboldt-Universität zu Berlin

Bunsenstr. 1, D-10117 Berlin, Germany

It is a well-known fact that for biaromatic compounds like biphenyl, structural relaxation in S_1 leads to planarization of the molecule understandable by mesomeric theory. The fluorescence from this $\pi\pi^*$ or "delocalized excited" (DE) state is structured and depends little on solvent polarity. On the other hand, a number of biaromatic systems show strong polarity induced fluorescence spectral changes which can be traced back to the stabilization of a charge transfer (CT) state describable by biradicaloid theory and connected with decoupling from the DE state within this theory. In real systems, there exists some residual coupling between DE and CT state which may even be large, and we focus on the question how this coupling affects the excited state properties and structural relaxation.

Some large biaromatic systems will be reviewed, including biphenyls and compounds containing anthracene, perylene and pyrene. Even for symmetric systems, the unusual fluorescence properties correlate with the energetic availability of the CT state with respect to the DE state. This facilitates predictions of the fluorescence behaviour. The DE/CT coupling, on the other hand, can be responsible for multiple minima on the excited state surface and a strong polarity dependence of the equilibrium structure.

We will show how the above energetic considerations on the one hand and steric restrictions on the other hand can be used to control the CT behaviour of biaromatics up to the point of inducing artificial molecular photodiode behaviour.

THE SPECTRAL SELECTIVITY OF PHOTOCATALYSTS.

A.V.Emelin, V.K. Ryabchuk

St.-Petersburg State University, Dept. of Physics,
Ulianovskaya St. 1, St.-Petersburg, 198904, Russia

Photochemical and photocatalytical processes are often presented by the simple way as:

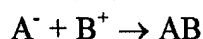
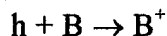
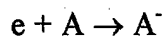
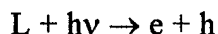

Here the first stage is a photogeneration of free carriers (electrons (e) and holes (h)) as result of photons absorption by solids (L). The second and third stages are the interaction of reagents A and B with electrons and holes respectively producing the ions or ion-radicals intermediates and forth stage is the formation of product AB of photochemical reaction.

Nevertheless it is well known the complexity of solids photo excitation processes, diversity of adsorbed molecules forms and paths of reactions. This appears, in particular, in variation of respective chemical yields of different reaction products with variation of spectral region of photocatalyst photoexcitation (the spectral selectivity of photocatalysts [1, 2, 3])

As example we consider the photoadsorption of methane on oxides leading to formation as more complex hydrocarbons (ethane, ethene, propane and so on) as products of methane oxidation including CO₂ and H₂O.

It is supposed that methane react with surface photogenerated holes O_s⁻:

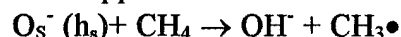

There are two different ways for following reaction

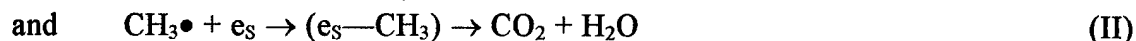
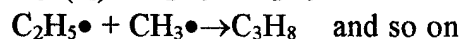
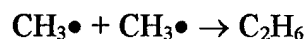

The path (I) is the dimerization of CH₃• depending on O_s⁻ concentration and leading to formation of ethane and other hydrocarbons. The path (II) is the interaction of CH₃• radicals and surface electrons with following oxidation with lattice oxygen. The reactions (I) and reactions (II) rates are controled by surface concentrations of holes and electrons respectively and, thus, the reaction path can be altered by changing of ratio of surface electrons and holes concentration.

The surface concentration of carriers can be found by the solution of infinite equation:

$$D \cdot \nabla^2 n - n/\tau + g = 0 \quad (1)$$

with corresponding boundary conditions [4, 5]. Here n is the concentration of carriers (electron or holes), the term D·∇²n describes the diffusion motion of carriers (D - diffusion coefficient), n/τ - the decay of carriers concentration (τ - time of life of carriers), g is the carriers photogeneration function.

The spectral dependencies of surface concentrations of carriers can be determined by solving eq. 1 with nonuniform function g(x)=αI·exp(-αx) [6]. For simplest case of semi infinite crystal this dependence is

$$n_s = \{ \alpha L / (\alpha L + 1) \} * f(S, D, I)$$

Here n_s is the surface concentration of given type of carriers, α - the absorption coefficient in Lambert-Buger equation, $L = \sqrt{D\tau}$ - diffusion length of corresponding type of carriers, f - function depending on surface recombination rate (S), diffusion coefficient, light intensity (I)

In this case the ratio of electrons and holes (e/h) concentrations is:

$$R = e/h = \{(\alpha L_e + \beta)/(\alpha L_e + 1)\} * F$$

Here $\beta = L_e/L_h$ is the ratio of diffusion lengths of electrons and holes respectively, $F=f_e/f_h$ does not depend on intensity of light.

Thus, the ratio R depends on α (i.e. wave length of exiting light) and β . If $\beta > 1$ the $R(\alpha)$ decreases and if $\beta < 1$ $R(\alpha)$ increases with increasing of α . Obviously that the great changing of $R(\alpha)$ can be observed at excitation in spectral region corresponding to the edge of intrinsic absorption of photocatalysts. In its turn the later can lead to alteration of reaction path. In fact such spectral dependence of reaction path (spectral selectivity) was observed in $TiO_2 - CH_4$ heterogeneous system when excitation of TiO_2 at intrinsic absorption edge spectral region. [1]. It is well known that surface of TiO_2 is negatively charged in relation to the bulk. That means that effective diffusion length of holes is higher than that of electrons ($\beta < 1$). So the function $R(\alpha)$ increases with the increasing of α that leads to alteration of reaction path. This alteration was observed in experiments when at the edge of intrinsic absorption ($\alpha \sim 10^2 \text{ cm}^{-1}$) the hydrocarbons were found as the main reaction products while the oxidation products were mainly detected under photoexcitation in intrinsic absorption bands ($\alpha \sim 10^6 \text{ cm}^{-1}$). Thus, the reaction path was changed by altering of wave length of exiting light.

The general approaches and consequences for problem of spectral selectivity of photocatalysts will be discussed in the report presented.

References

1. Kuzmin G.N., Knatko M.V., Kurganov S.V. *React. Kinet. Catal. Letters*. 1983. V. 23. N 3-4. p. 313.
2. Ryabchuk V.K., Burukina G.V. *Russian J. Phys.Chem.* 1991.V.65. N.6. pp. 1621-1633
3. Ryabchuk V.K., Basov L.L., Solonytzin Yu.P. *Russian J. Chem.Phys.* 1989. V. 8. N 11 pp.1475 - 1482.
4. Albery W.J., Bartlett P.N. *J. Electrochem. Soc.* 1984. Vol. 31. N 2. P. 315 - 325.
5. Gerihcher.H. *Electrochimica Acta*. 1993. Vol.38. No. 1. pp. 3 - 9.
6. Emelin A.V., Ryabchuk V.K., Kuzmin G.N., Purevdordge D. *IPS-11, July 28 - Aug 2 1996, Bangalore, India. Abstracts*. PC41, pp. 203 - 204.

THE MECHANISMS OF SURFACE PHOTOCHEMICAL REACTIONS.
THE PHOTOSTIMULATED ADSORPTION OF O₂ ON ZrO₂.

A.V.Emelin, V.K. Ryabchuk
St.-Petersburg State University, St.-Petersburg, Russia.

The dependence of surface photochemical reactions rate on the reagent concentration such as $A=G*(KC/[KC+1])$ (1) is typical for various heterogeneous systems. Here A - rate (initial rate) of surface photoreaction, C - reagent concentration (or P - pressure for gaseous reagent), G, K - one. There are two main approaches for reaction mechanism to interpret the dependence (1). The first one is the Langmuir-Hinshelwood (LH) mechanism and the second is Iley-Rideal (IR) mechanism. It is supposed that the kinetic studies do not allow to distinguish the true type of mechanism. In present work we make the attempt to study the mechanism of one of the simplest surface photochemical reaction - the photostimulated adsorption of O₂ on ZrO₂. The dependence (1) of photoadsorption initial rate A on oxygen pressure P was observed for ZrO₂ at various conditions (fig. 1).

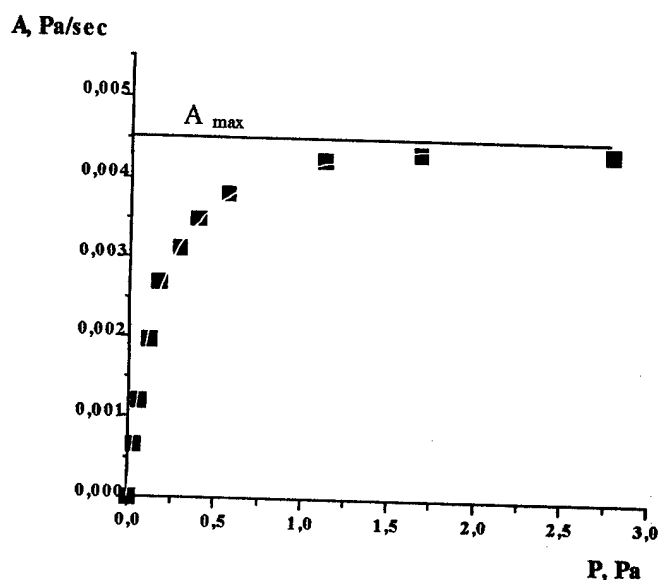

Fig. 1. The dependence of photoadsorption initial rate A on gas pressure for ZrO₂ - O₂ system at constant light intensity (I_{max}).

of view the dependence (1) may be presented as:

$$A = k_2 e \underline{O}_2 = k_2' * (KP/[KP+1]) = k'' I \tau_e * (KP/[KP+1]) \quad (2)$$

Here \underline{O}_2 - the initial surface concentration of adsorbed molecules. For Langmuire adsorption model $\underline{O}_2 / \underline{O}_{2max} = KP/[KP+1]$ (\underline{O}_{2max} is included in k_2'), e - steady state surface concentration of electrons, $e \sim I \tau_e$ (τ_e - the time of life of electrons at surface, I - intensity of illumination). So $G = k I \tau_e \sim I$ and K is a constant of Langmuire adsorption-desorption balance ($K = k_{ads}/k_{des}$).

For IR model one can supposed the next mechanism:

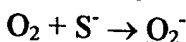
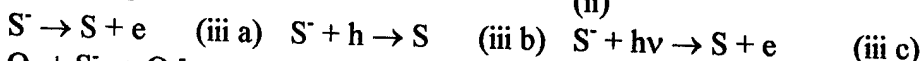
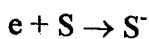
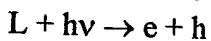

The first stage is the same as in LH model. The second stage describes the formation of surface active centres (SAC) (S^-) as the result of electron trapping by surface defects (S). The forth stage is the interaction of gaseous oxygen with SAC and the third stage describes the disintegration of SAC by the several ways (a, b, c). These ways are:

- a) - the thermo annealing of SAC if they are shallow traps of electrons,
- b) - the recombination on SAC with holes,
- c) - the photo bleaching of SAC due to their light absorption.

The LH-mechanism for photoadsorption may be presented as:

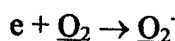
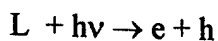

Here the first stage is the photo excitation of solid (L) leading to appearance of photo carriers (electrons (e) and holes (h)). The second stage is the trapping of electrons by adsorbed oxygen molecules (\underline{O}_2) which are under adsorption-desorption balance. This stage leads to formation of strong binding oxygen ions (for example

\underline{O}_2^-) and to shift of adsorption desorption balance. From this point

So the dependence (1) for IR model can be presented as:

$$A = k_4SP = k_2eS^*(k_4P/[k_\tau+k_4P]) = k_2'I\tau_eS^*(k_4P/[k_\tau+k_4P]) = k_2'I\tau_eS^*(KP/[KP+1]) \quad (3)$$

Here k_1, k_2, k_3, k_4 are the constants of the corresponding stages, S^* - the steady state concentration of SAC: $S^* = k_2'I\tau_eS/[k_\tau+k_4P]$ and $k_\tau = 1/\tau_s$ (τ_s - the time of life of SAC). $k_\tau = k_3$ in case a), $k_\tau = k_3h = k_3'I\tau_h$ in the case b) and $k_\tau = k_3I$ in the case c). So for IR -mechanism $G = k_2'I\tau_eS \sim I$ is practically the same as for LH-model, and $K = k_4/k_\tau$ is quite different. For the cases (b) and (c) $K \sim 1/I$.

The experimental data obtained for heterogeneous system $ZrO_2 - O_2$ show that K does not depend on temperature (in range 280 - 450 K) and depends on light intensity as $K \sim 1/I$. That reject the application of LH and IR (a) mechanisms. The estimation of lowest limit of k_τ obtained from experimental data gives us the value of $k_\tau = 3 \cdot 10^3 \text{ sec}^{-1}$.

The calculation of k_τ (IR (c)-mechanism) with known light intensity $I \approx 10^{14} \text{ photon/sec} \cdot \text{cm}^2$ and light absorption cross-section $k_3 = 10^{-16} \text{ cm}^2$ gives the value of $k_\tau \approx 10^2 \text{ sec}^{-1}$. So for interpretation of experimental data the most favorable mechanism is IR (c).

The results of studies of oxygen photoadsorption on ZrO_2 when excitation of UV-induced F- and V-type color centers may be used as an additional support of our assumption. It was shown that $k_\tau \approx 100 \text{ sec}^{-1}$ when adsorbent is excited by light in spectral region corresponding to the overlapping of F- and V-type centres absorption bands and $k_\tau < 10^3 \text{ sec}^{-1}$ when excitation of F-type color centres only. It means that k_τ depends on concentration of holes as it is assumed in IR (b) mechanism. So the dependence (1) can be presented as:

$$A = k_2'I\tau_eS^*(k_4P/[k_3'I\tau_h+k_4P]) \quad (4)$$

The analysis of equation (4) shows that the initial rate of photoadsorption (A) depends on light intensity (I) by more or less complex way. At sufficient high pressure when $k_4P \gg k_3'I\tau_h$ (i.e. initial rate does not alter with pressure) the linear dependence between A and I is expected.

$$A = k_2'I\tau_eS \sim I$$

At $k_4P \ll k_3'I\tau_h$ the initial rate of photoadsorption practically does not depend on light intensity:

$$A = (k_2'\tau_eS/k_3'\tau_h) * k_4P$$

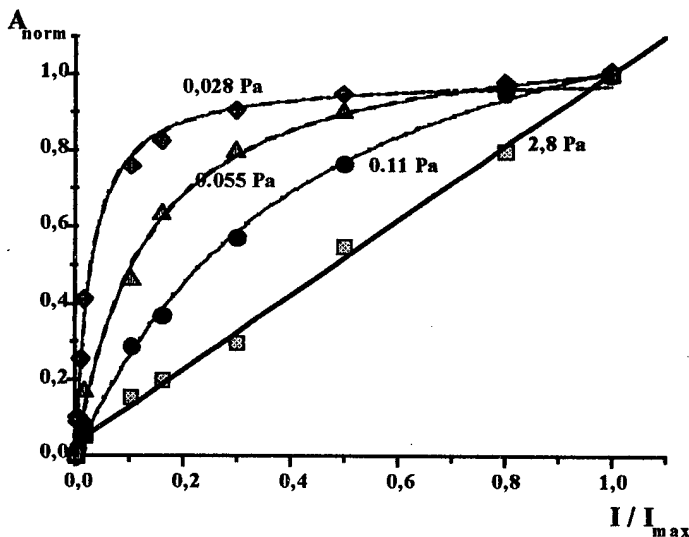

Fig. 2. The dependencies of photoadsorption initial rates A_{norm} on normalized light intensity (I/I_{max}) at several pressure for $ZrO_2 - O_2$.

It means that dependence $A(I)$ is controlled by the ratio between pressure (P) and light intensity (I).

The experimental dependencies of normalized $A_{norm} = A/A_{max}$ on normalized intensity I/I_{max} (I_{max} is the highest light intensity in our tests) for $ZrO_2 - O_2$ system at several pressures are presented on fig. 2. One can see a good agreement between experimental results and equation (4). In fact, when A does not alter with pressure ($P = 2,8 \text{ Pa}$, see fig. 1) the dependence $A(I)$ is linear. At lower pressure when A depends on P , $A(I)$ is sublinear, and at lowest pressure ($P = 0,028 \text{ Pa}$) and $0,3 \leq I/I_{max} \leq 1$ $A(I)$ it is close

to constant. Some consequences of results obtained will be presented and discussed.

Outdoor Testing and Solar Simulation for Oxazine 750 Laser Dye Luminescent Solar Concentrator

A.I. Salem , A.F. Mansour, N.M. El -Sayed , and A.H. Bassyouni
Physics Department, Faculty of Science, Zagazig University, Egypt.

Abstract:

A single dye Luminescent Solar Concentrator (LSC) has been prepared using Oxazine 750 dye and PMMA, dissolved in benzene . The solar simulation of the LSC has been performed at seven different positions using an X- Y tracker .The hourly output power has been also measured for a full year from April 1995 to march 1996 considering day 21 as a reference day . The output power curves were studied for each month separately and averaged through four seasons , Summer, Fall , Winter , and Spring .

To test the field performance expectations for LSC used , a nonlinear correlations between tracking and fixed output data has been also carried out and discussed.

NOVEL COORDINATION CHEMISTRY AND ORGANOMETALLIC CHEMISTRY OF MONOPOSITIVE METAL IONS IN THE GAS PHASE AS STUDIED BY THE LASER ABLATION-MOLECULAR BEAM METHOD

Koji FURUKAWA, Satoru NISHIO, Akiyoshi MATSUZAKI and Hiroyasu SATO
*Department of Chemistry for Materials, Faculty of Engineering, Mi'e University,
1515 Kamihamacho, Tsu 514, Japan*

In the laser ablation-molecular beam (LAMB) method developed in our group [1,2], any solid metal can be prepared in the state of monovalent atomic metal ions (M^+ s) in the gas phase. These ions are allowed to react with molecules or clusters injected nearby. A variety of novel metal complexes or organometallic compounds (both are monovalent ions) are prepared by the reactions of M^+ s with inorganic or organic compounds (clusters), respectively. Most of these compounds are new and "exotic" ones whose molecular structures are very intriguing.

In the reactions of M^+ s with metal carbonyls, like $Cr(CO)_6$ and $Mn_2(CO)_{10}$ [3,4], a variety of mixed-metal binuclear and trinuclear carbonyls, like $[MCr(CO)_n]^+$ ($n=0-6$) and $[MMn_2(CO)_n]^+$ ($n=0-10$), are prepared. As reported briefly in the previous report [4], the observed relative abundance of $[MCr(CO)_n]^+$ ($n=0-6$) for the first- and second-series transition metals manifested a very interesting trend. In the first series, the most abundant species was that with $n = 6$ for Mn. Increasingly more CO's are eliminated from the complexes when one goes to the left and to the right on the periodic table. Such a trend was not repeated for the transition metals in the second series; all of these metals showed elimination of more than two, mostly three CO's.

All of $[MCr(CO)_n]^+$ ($n=0-6$) observed are coordinatively unsaturated. The 18-electron rule or EAN rule for metal carbonyls dictates that completion of an electronic shell leads to $VCr(CO)_{12}^+$, $MnCr(CO)_{11}^+$ and $CoCr(CO)_{10}^+$. Therefore, the experimentally observed trend is not due to stable closed-shell formation. For most transition elements direct M-Cr bond formation can be safely assumed. The energy gain for the simple association reaction $M^+ + Cr(CO)_6 \xrightarrow{\Delta E} MCr(CO)_6^+$ is essentially due to the formation of the M^+-Cr bond. Because the reaction occurs in the gas phase, this energy gain is stored as internal energy, and total energy is above the dissociation limit. The ion M^+ leaves, and the net reaction does not occur. When some COs dissociate in the reaction $M^+ + Cr(CO)_6 \rightarrow MCr(CO)_n^+ + (6-n) CO$, the excess energy is absorbed in the scission of COs, and the reaction proceeds. Then the most plausible reaction is that most of the excess energy is consumed, i.e. $\Delta E \sim 0$. Our recent density functional (DF) calculations [5] shows that this is essentially valid. Low temperature matrix/FTIR studies are under way.

[1] H. Sato, *Res. Chem. Intermed.*, **19** (1993), 67-93. [2] H. Sato, *Photochemisy (Japanese Photochemistry Association)*, **20** (1995), 54-60. [3] T. Oka, K. Toya, K. Kasatani, M. Kawasaki and H. Sato, *Chem. Lett.*, (1988), 1865-1868. [4] T. Oka, K. Kasatani, H. Shinohara and H. Sato, *Chem. Lett.*, (1991), 917-920. [5] T. Wada, T. Yada, S. Hayashi, S. Nishio, A. Matsuzaki, H. Sato, H. Kobayashi and T. Yamabe, to be published.

NEW RESULTS IN ZEKE SPECTROSCOPY

E. W. SCHLAG

**Technische Universität München, Institut für Physikalische und
Theoretische Chemie,
Lichtenbergstr. 4, D-85748 Garching, Germany**

The precise spectroscopic measurement of ions, both positive and negative is important for the understanding of charge transfer processes. ZEKE spectroscopy here provides a new method that provides about a thousand fold improvements in accuracy and resolution, permitting highly precise results, even of vibrational structure of ions.

We present here new results that serve to understand the mechanism of the production of these ZEKE states.

SIDE PUMPING TECHNIQUE MODEL FOR LASER PUMPED BY SOLAR ENERGY

M. A. Mosalam Shaltout¹, M. Medhat², and Y. A. Hadi¹

- 1- National Research Institute of Astronomy and Geophysics, Helwan, Cairo, Egypt.
- 2- Department of Physics, Faculty of Science, Ain Shams University, Abbassia, Cairo Egypt.

ABSTRACT:

A model of side pumping technique for a system of solar concentrators is performed for laser generation. Measurements for the total solar radiation at hot desert area near Helwan were carried out. Where Helwan is South of Cairo by 30 km of latitude 30° N and longitude 31° E. The instrument is installed on the roof top of the National Research Institute of Astronomy and Geophysics (NRIAG). The measurements indicate that the annual average of the global solar radiation is $5.21 \text{ kWh/m}^2/\text{day}$, direct solar radiation is $6.26 \text{ kWh/m}^2/\text{day}$, diffuse solar radiation is $1.86 \text{ kWh/m}^2/\text{day}$, the clearness index K_t is 0.61, and the diffuse fraction K_D is 0.37. The performance of the laser rod is tested. Also, the performance of the system as a whole is tested. Finally, the measurements of solar radiation were applied to the model to obtain the behaviour of the laser output assuming the concentrator tracks the sun.

ELECTRONIC STRUCTURE OF SOLAR CELL INTERFACES

Yoram Shapira

Dept. of Electrical Engineering

Faculty of Engineering

Tel-Aviv University, Ramat-Aviv 69 978, Israel

A major issue in the study of heterojunction solar cells is how to construct the band diagram of both sides of the junction, to find the band discontinuities and to determine the nature of the interface states, their energy position, distribution, lifetime, capture cross section, type, density and origin. Information about these parameters is extremely valuable as they often have a major role in the final cell performance and response, particularly in the novel cell types.

Surface photovoltage spectroscopy (SPS) emerges as a very powerful and versatile tool for direct observation of interface states and band diagram determination at a variety of semiconductor interfaces. It is simple and inexpensive, contactless, nondestructive, easy to use and interpret and works in any ambient: vacuum, gas or liquid. In particular, it can be operated within the growth chamber in the vacuum system.

We report on very recent developments we have made in the technique, which make it possible to obtain the necessary surface state parameters by using laser SPS, intensity-resolved SPS and time-resolved SPS. Moreover, by measurements of SPS as a function of coverage of a thin solid film on a semiconductor surface we can resolve surface, thin film, interface and bulk states as well as construct a complete picture of the band bending and the band discontinuities at the junction. An example deriving the conduction band offset (ΔE_c) in a solar cell quality junction formed by chemical bath deposition of CdS on a polycrystalline thin film of Cu(In,Ga)Se₂ will be given and discussed, among others.

SOME NOVEL ASPECTS OF INTRAMOLECULAR ELECTRONIC ENERGY TRANSFER

Shammai Speiser

Department of Chemistry, Technion-Israel Institute of Technology, Haifa

32000, ISRAEL

Abstract

During the last decade we have studied intramolecular electronic energy transfer (Intra-EET) in specially designed bichromophoric molecules. In the first phase of the study the mechanism of short range Intra-EET *in solution* was established. Next we have examined Intra-EET in bichromophoric clusters *in supersonic jets*.

In the present paper we report on our studies of Intra-EET in anthracene-(CH₂)_n-naphthalene bichromophoric molecules. For the first time a dramatic difference in Intra-EET efficiency between jet cooled conditions and room temperature solution experiments, for n=1 (A1N) and 3 (A3N), was observed. The rich excitation spectrum of the naphthalene moiety in A1N indicates an inefficient EET process whose rate is substantially slower than that of the naphthalene moiety fluorescence ($3 \cdot 10^6 \text{ s}^{-1}$). The EET rate was high enough ($5 \cdot 10^6 \text{ s}^{-1}$) to be measured for only one vibronic band. This shows that the EET rate depends on a specific vibronic excitation that affects the molecular conformation. The EET rate was found to be at least two orders of magnitude slower in the A1N molecule compared to the A3N molecule. This is in accord with our previous Intra-EET studies of the anthracene - naphthalene cluster. Geometry calculations predict two isomers of the cluster, one of the sandwich type, and another with the two molecules π -electronic systems far apart. The experiment gave evidence for two EET rates associated with two cluster isomers.

Water Detoxification and Disinfection Using High Solar Concentration and Homogeneous Photocatalysts

Irving Spiewak
Weizmann Institute of Science, Rehovot, Israel

The objectives of the research reported were to explore the use of concentrated sunlight combined with dissolved photocatalysts to improve water quality. Initial experiments with bromacil using organic-dye photosensitizers indicated that the reaction kinetics were enhanced by concentrated light. Other pesticides (EPTC, Tribufos, Atrazine and Lindane) were also tested in normal and concentrated sunlight. Organic dyes were effective in degrading some of these compounds but did not appear to be promising for complete mineralization. For most target compounds, the reaction rates were approximately proportional to the intensity of light.

Iron compounds, especially in combination with hydrogen peroxide as the oxidizer, proved to be effective for degrading all the target pesticides. This system was also shown to mineralize phenol. Reaction rates were again approximately proportional to sunlight intensity. The photo-efficiency of this reaction was in a range high enough to indicate that visible light, as well as UV, was participating in the photo-reactions.

Preliminary disinfection tests have indicated that either organic dyes or iron compounds are effective. It is concluded from this work that solar irradiation with either organic dyes or the iron-peroxide system are promising, possibly low cost, means of improving water quality.

Keywords: solar detoxification, concentrated sunlight, water purification, photocatalysts.

ELECTRONIC ENERGY POOLING VIA EXCITED STATE ANNIHILATION

R.P. Steer, Department of Chemistry, University of Saskatchewan, 110 Science Place, Saskatoon, Saskatchewan, Canada, S7N 5C9.

Those excited state-excited state annihilation processes in which there is a finite probability of forming a product molecule in a highly excited electronic state are of interest because they can result in the (temporary) pooling of a significant fraction of the energy of two photons. Molecules containing the thiocarbonyl ($>C=S$) functional group are useful vehicles for examining and perhaps harnessing such processes because (i) they absorb light from the ultraviolet through the visible and sometimes into the near infrared regions of the spectrum, (ii) their S_1-S_0 (or T_1-S_0) and S_2-S_1 (or S_2-T_1) electronic energy spacings are similar, (iii) their S_2 states are sufficiently long-lived to be readily observable by S_2-S_0 fluorescence and other means, (iv) aromatic thiones have relatively long-lived lowest triplet states, convenient for examining triplet-triplet annihilation (TTA) in condensed media, and (v) small thiocarbonyls such as thiophosgene, Cl_2CS , have long-lived lowest excited singlet states, convenient for examining singlet-singlet annihilation (SSA).

Using a combination of spectroscopic and time-resolved kinetic measurements, we have demonstrated the occurrence of both SSA and TTA in thiocarbonyl-containing molecules, and have estimated the efficiencies of S_2 production. In the gas phase thiophosgene system, $S_1+S_1 \rightarrow S_2+S_0$ SSA is probed by following the temporal evolution of $S_2 \rightarrow S_0 + hv_f$ fluorescence following $S_1 \leftarrow S_0$ excitation, and occurs with an efficiency which is within an order of magnitude of gas kinetic. Aromatic thiones exhibit $T_1+T_1 \rightarrow S_2+S_0$ TTA, a process which occurs with a modest efficiency of *ca.* 3% for benzopyranthione in inert perfluoroalkane solutions.

The spectroscopic and kinetic evidence for these electronic excited state annihilation processes in thiocarbonyl systems will be reviewed. The prospects of using electronic energy pooling in practical devices for harvesting and storing solar energy will be briefly discussed.

This work has been supported by the Natural Sciences and Engineering Research Council of Canada. The work on TTA was carried out in collaboration with Dr. B. Nickel and coworkers, MPI, Göttingen, Germany, under the auspices of a NATO Collaborative Research Grant.

Exciton propagation in programmed arrangements of dye molecules

Rolf Steiger ILFORD AG 1700 Fribourg (Switzerland)

Hans Kuhn 3656 Tschingel (Switzerland)

ABSTRACT

As shown previously¹, analogies exist between the spectral sensitization of semiconductors used in solar systems and that of silver halides as applied to photography.

Experiments in which J-aggregated cyanine dyes were *self-organized* with *different degrees of perfection* have been carried out by adsorption of such dyes on silver halide microcrystal surfaces. Their degree of organisation was evaluated from diffuse reflection spectra in the adsorbed state, and their efficiency for electron injection into the conduction band of AgHal from the relative quantum yield of latent image formation. The highest degree of perfection was reached by controlled surface nucleation using a dye release system. The photographic sensitivity is up to 10 times higher than in the case of conventional organisation by adsorbing the dye from an organic solvent. The half-width of the J-aggregate absorption band is now 15 nm instead of 30 nm. By introducing silver halide microcrystals using this kind of spectral sensitization into certain color-photographic materials, their exposure times could be reduced by at least a factor of 10. We assume that soliton-like, moving coherent excitons are produced and trapped, accompanied by electron injection into silver halides. The solitons are strongly perturbed by imperfections, and therefore the *quantum efficiency for electron transfer is considerably increased* by the most perfect J-aggregates. In order to avoid electron-hole recombination, the size of these J-aggregates must also be controlled in addition to their degree of architectural perfection. This has been shown by studying the quantum yield for latent image formation in the *intrinsic* absorption region of silver halides, and at low light intensities where the quantum yield of electron transfer is dominated by electron-hole recombination.

The *soliton-character* of coherent excitons in J-aggregated cyanine dyes has been proved by incorporating an *exciton trap* using the LB-technique². The *present experiments* show that such an organized assembly can also be realized by *self-assembly* showing the same efficiency as LB-organisations for a UV absorbing cyanine donor², but now using a donor *absorbing green light*. By inserting only one acceptor molecule as an exciton trap into an organized, J-aggregated array containing 1000 donor molecules, the fluorescence of the donor is quenched to 20% of its original value without the energy acceptor.

In *solar energy devices based on colloidal semiconductors*, the light energy is preferably harvested by a dye followed by electron- or energy transfer

into the conduction band. The efficiency for electron transfer or for concerted energy-electron transfer from excited dyes into SnO₂ or AgBr has been shown by experiments^{3,4}. In the *present case*, we discuss the *energy transfer* from an excited *cyanine dye into SnO₂*. It is shown that the photoconductivity and the quenching of the fluorescence quantum yield show a d^2 dependence, where d is the distance between the dye aggregate and the semiconductor surface. The characteristic distance d_0 is 2.7 nm for the photoconductivity and 5.4 nm for fluorescence quenching. A d^2 dependence is expected for an extension of the coherent exciton which is large compared to d . We assume that the small d_0 value in the case of the photoconductivity is due to the fact that only a small fraction of the energy acceptors in SnO₂ are involved in electron injection.

The most important parameters to optimize light-collectors based on J-aggregated dyes for future supramolecular machines on semiconductors will be summarized.

References

1. R. Steiger and R. Beer, Abstracts of the 10th Int. Conference on Solar Energy (IPS 10), p. 161 (Interlaken 1994)
2. H. Kuhn and Ch. Kuhn in "J-aggregates", Editor Takayoshi Kobayashi, in print
3. P. Fromherz & W. Arden, Ber. Bunsenges. Phys. Chemie **84**, 1045 (1980); J. Americ. Chem.Soc. **102**, 6211 (1980)
4. H. Hediger, P. Junod, R. Steiger, J. Luminescence **24/25**, 881 (1981)

Molecular Dynamics Simulations of Probe Dynamics in Polycarbonates and the Free Volume

P. R. Sundararajan, R. Veregin, D. K. Murti, T. A. Kavassalis and

R. O. Loutfy

*Xerox Research Centre of Canada, 2660 Speakman Drive, Mississauga,
Ontario L5K 2L1, Canada*

Various types of molecular probes have been used in the literature to determine the fractional free volume in polymer materials. The fluorescent rotor probes were first used by Loutfy (1) to study the effect of molecular weight on the free volume in polymer systems. Electron spin resonance probes (2) and positron annihilation spectroscopy (3) are other methods used in recent years.

The free volume in polymers depends on the flexibility of the polymer and the molecular mobility. The polymer flexibility influences the diffusion of probe molecules in the matrix. It also determines properties such as the glass transition temperature (4) and cohesive energy. It has been shown recently that the cohesive energy plays a role in the mechanical properties such as abrasion resistance and durability of polymer films and composites (5). An example of such a composite system is the charge transport layer of a photoreceptor, which comprises of a polymer such as polycarbonate and a charge transport molecule. The polymer flexibility and the free volume are expected to play a role in the stability of such polymer-small molecule composites.

Simulation techniques using molecular mechanics and molecular dynamics methods have enabled the study of amorphous and crystalline polymer systems in recent years. In this presentation, we will demonstrate the merit of combining molecular simulations with corresponding experiments. We will illustrate the effect of substituents on the flexibility of different types of polycarbonates, using

molecular mechanics methods. Molecular dynamics simulations were performed with model systems of these polycarbonates in which the ESR spin probe, Tempol, was included in the polymer matrix. The diffusion rate of the probe in the polymer matrix was calculated with simulations performed at various temperatures, and the effect of the flexibility of the polymer chain on the probe diffusion was determined. In parallel, ESR spectroscopy was used to measure the diffusion rates of the spin probe and derive relaxation times for these polycarbonates. The effect of the flexibility and the cohesive energy of the polymer, on the probe diffusion, will be discussed.

The molecular dynamics simulations were also used to calculate the cohesive energies of these polycarbonates. The correlation between the chain flexibility and the cohesive energy derived from the simulations, and the experimentally measured abrasion resistance will be discussed.

We will finally raise the question of the *probe size* used in the different probe techniques on the measured free volume. The necessity to combine the results derived from various probe methods will be stressed, if this approach is to be of value in designing polymers and composites with target functional properties of relevance to industrial applications.

References

- (1) R. O. Loutfy and D. M. Teegarden, *Macromolecules*, **16**, 452 (1983); R. O. Loutfy, *J. Polym. Sci., Polym. Phys. Ed.*, **20**, 825 (1982); R. O. Loutfy, *Pure & Appl. Chem.*, **58**, 1239 (1986)
- (2) P. Törmälä, *J. Macromol. Sci., Rev. Macromol.Chem.*, **C17**, 297 (1979)
- (3) Y. C. Jean, *Microchem. J.*, **42**, 72 (1990); J. E. Kluin et al., *Macromolecules*, **26**, 1853 (1993)
- (4) P. R. Sundararajan, *Macromolecules*, **26**, 344 (1993)
- (5) P. R. Sundararajan, T. A. Kavassalis, D. K. Murti, and R. O. Loutfy, *to be published*.

Transmission of heat temperature in The Soil Over Agrometeorology Giza Station (Egypt)

A. A. Trabea and M. Dawod*, S.M.Abdelaty**

*Department of physics, Faculty of Education, Al-Arish,
North Sinai, Suez Canal University, Egypt.*

**Meteorological Authority of Egypt, Cairo*

***Department of physics, Faculty of Education, Port-Said,
Suez Canal University, Egypt.*

Abstract

The temperature of soil is important for a number of reasons, perhaps mainly because it is one of the limiting factors to root growth. Knowledge of soil temperature may be useful in determining the suitability of planting sites, length growth seasons and periods of most rapid growth.

In the present paper the maximum and minimum of daily soil temperature at different depths (2,5,10 and 20 cm) at El-Giza station was analyzed and discussed. These data also were correlated with the screen air temperature at 1.5 meter over the ground. A general idea is also given of the transmission of heat temperature soil at three states (dry, wet, and grass) and calculate the value of thermal diffusivity of the three states at different depths.

Peculiarities of Chemical Photoconversions in Solid Phase

L.I. Trakhtenberg

State Scientific Centre of Russian Federation "Karpov Institute of Physical Chemistry",
10, Vorontsovo Pole, 103064 Moscow, Russia

It is known that medium affects on kinetics of different solid phase chemical reactions. There are number of mechanisms of this phenomenon. Here are considered the two possible mechanisms of the medium affection the process of the monomolecular decay of particles.

The first mechanism is the rearrangement of the medium as a result of the transition and the origin of the rearrangement energy. The second mechanism is stipulated by the interaction of the terms between which the transition takes place with the molecular environment. Indeed, since the parameters which determine the interaction of the terms with the medium, corresponding to the initial and final states of the molecule are different, the displacements of these terms under the intermolecular oscillations are different, too. As a result of the molecular oscillations of the radical and molecules interacting with this radical the mutual location and the form of the terms between which the transition takes place change. The displacement of the terms are the more the larger amplitude of the thermal oscillations of the medium molecule is. The higher temperature the larger amplitude of the molecular oscillations and hence the larger displacements of the terms. Because the matrix element of the transition increases under the approach of the terms the transition rate constant increases with the increase the temperature.

In the case of classical intermolecular oscillations second mechanism leads to the temperature dependence: $k - e^{\alpha T}$ (here k is rate constant and T is the temperature; parameter α depends on medium properties). One should bear in mind that the parameter α is different for the mono- and bimolecular reactions.

To verify experimentally the kinetic regularities to which the interaction of the terms with the medium leads the experiments were set up and the experimental data on the photodissociation of hydrazine and polyvinilene alcohol radicals was gathered. Since under the extraction of a hydrogen atom no essential rearrangement of the medium takes place, only the second above-described mechanism determines the temperature dependence of the photodissociation rate constant. Experimental data on the reactions:

$N_2H_3^* \rightarrow N_2H_2 + H$ and $-C_2H_2OH^* \rightarrow -C_2H_2OH + H$ agree with theoretical results.

It also follows from theory that the parameter a for the monomolecular process is much less than the same parameter for the bimolecular reactions. Their ratio is approximately equal to the square ratio of the constant of a term coupling with the medium to the constant characterising the interaction of the splitting-off H-atom with the rest part of the radical. Comparison of the experimental data on the temperature dependence of the monomolecular and bimolecular reactions rate constant obtained in the comparative conditions shows that the experimental values of the parameters a for these reactions differ by the order of magnitude.

For the monomolecular reactions where the essential conformation transformation of the molecules and the rupture of the coupling with the split-off of large fragments take place the rearrangement of the medium will play the main role in the formation of the temperature dependence of the rate constant. As far as the discrete final intermolecular states are concerned, the given mechanism as leads to the Arrhenius temperature dependence, which is determined by the energy of the medium rearrangement. If the final states of the intramolecular subsystem belong to the continuous spectrum, then in case of the classical intermolecular oscillations the rate constant is transformed to the above mentioned form. The value a is expressed through the parameters of the barrier and the energy of the medium rearrangement.

To verify experimentally the above dependence of the radicals dissociation rate constant on temperature the experiments were set up and the experimental data on the radicals photodissociation in the frozen acetic anhydride ($CH_2C(O)OC(O)H_3$) and aminoalkyl ($CH_3CHN(C_2H_5)$) was obtained. In these systems the dissociation take place with the alkyl radicals CH_3 and C_2H_5 abstraction. Experimental study of the temperature dependence of the radicals photodissociation rate constant in according to the theoretical consideration shows that the curves become straight in the coordinates $\ln k - T$.

Thus both discussed mechanisms of the medium affect on the process of the monomolecular disintegration in the investigated range of temperatures lead to the linear dependence of the logarithm of the rate constant on temperature.

CHALLENGES AND OPPORTUNITIES IN PHOTOELECTROCHEMISTRY AND PHOTOCATALYSIS

Abstract

As compared with biological systems, where multi-electron transfer reactions for energy conversion can be catalyzed efficiently at environmental temperature, artificial systems still have to be improved and new strategies explored.

Semiconductor materials which allow electron transfer reactions via metal centered mechanisms have proven to be excellent electrocatalysts (i.e. substituted Chevrell-phases such as $\text{Mo}_4\text{Ru}_2\text{Se}_8$ for oxygen reduction, RuS_2 for photoevolution of oxygen from water). They combine a high density of transition metal states (condensed into small energy bands due to the energy gap) with the ability to initiate coordination chemical interfacial mechanisms. Changes of the electron number in the cluster or the degree of substitution with foreign atoms and by additional metal atoms inserted into channels besides the clusters allow important conclusions on requirements for electrocatalysis for single and multi-electron transfer. An exceptional additional property of catalysts with metal centered mechanisms is the ability of favoring them with respect to other types of interfacial processes. This mediates a selective catalytic property of these catalysts with interesting possibilities for application in fuel cells.

A significant challenge for photoelectrochemical energy conversion is a long term stability of electrodes. In-situ infrared studies which were performed with operating Ru-based dye sensitization solar cells are presented using a total reflection technique. They reveal that the Ruthenium complex (both trinuclear and mononuclear) attached to the TiO_2 is photoelectrochemically transformed and irreversibly consumed under conditions of insufficient regeneration by iodide or from the oxide within the nanocrystalline TiO_2 pores.

As an important criterium for the quality of a photocatalytic reaction we define the molecular order (decreased entropy) which can be accomplished during the electrocatalytical reaction. The most effective way to build up temporary order is provided by dynamic self organization in an open system. This requires the existence of autocatalytical processes. It is shown that far from equilibrium an electron transfer process can be achieved which is significantly more efficient than the mechanism described by the Marcus formula. Also cooperative electron transfer as required for many energy conversion processes is possible. A synergetic model for oxygen evolution by the manganese complex of photosynthesis is presented. The special nature of manganese chemistry and the presence of oscillations of oxygen evolution are considered to provide first evidence for such a mechanism.

LIGHT INDUCED EXCITED STATE STRUCTURAL
RELAXATION IN ORGANIC MOLECULES

Uzhinov B.M., Druzhinin S.I. and Dmitrouk S.L.

Dept. of Chemistry, Moscow State University,
Vorob'evy gory, Moscow, 119899, Russia

Two different mechanisms of excited state structural relaxation of aromatic compounds are considered.

Relaxation of excited N-alkylaminonaphthalimides is an example of barrier structural relaxation. Fluorescence quantum yield (ϕ) of amino- and N-methylaminonaphthalimides depends slightly on temperature and solvent ($\phi = 0.50 - 0.98$). The fluorescence quantum yield and lifetime of N,N-dialkylaminonaphthalimide considerably decrease as the temperature increases or as solvent polarity and viscosity decrease. This is caused by the increasing of radiationless rate constant (k_a), but not by the change of radiative rate constant (k_r). Temperature-activated radiationless deactivation in N,N-dialkylaminonaphthalimide is supposed to be associated with the formation of nonfluorescent twisted charge transfer state (TICT-state), formed by the rotation of dialkylamino-group relative to the naphthalimide ring plane. In this case the rate constant of TICT-state formation (k_t) is related with ϕ by the following equation: $k_t / k_r = 1/\phi - 1/\phi_0$, where ϕ_0 is fluorescence quantum yield from initial state without reaction. The dependence of k_t on the temperature ($170 < T < 330$ K) and solvent viscosity ($0.5 < \eta < 700$ cP) for DMAN in n-alcohols is quantitatively described by the following expression $k_t = k_0 \eta^\alpha \exp(-E/RT)$. Two assumptions are considered: 1) activation energy E linearly depends on solvent polarity parameter E_t (30) 2) activation energy E is in inverse ratio to solvent dielectric constant (ϵ). Temperature dependence of E_t (30) and ϵ has been taken into consideration. The Arrhenius plots for TICT-state formation rate constant reduced to the same solvent viscosity and polarity for DMAN in different alcohols coincide with each other ($E = 9.1$ kcal/mol for nonpolar solvents). The effect of N,N-dialkylaminogroup structure on TICT-state formation rate constant is considered. The value of k_t rises as ionization potential of N,N-dialkylaminogroup increases.

The structural relaxation of excited 2-(3-pyridyl)-5-phenyl-oxazole cations is an example of barrierless relaxation. In low viscous solvents at room temperature the fluorescence of 2-(3-pyridyl)-5-phenyl-oxazole cation (3PyPOH⁺) and its N-methylated analog (3PyPOMe⁺) is characterized by the

LIGHT INDUCED EXCITED STATE STRUCTURAL
RELAXATION IN ORGANIC MOLECULES

Uzhinov B.M., Druzhinin S.I. and Dmitrouk S.L.

Dept. of Chemistry, Moscow State University,
Vorob'evy gory, Moscow, 119899, Russia

Two different mechanisms of excited state structural relaxation of aromatic compounds are considered.

Relaxation of excited N-alkylaminonaphthalimides is an example of barrier structural relaxation. Fluorescence quantum yield (ϕ) of amino- and N-methylaminonaphthalimides depends slightly on temperature and solvent ($\phi = 0.50 - 0.98$). The fluorescence quantum yield and lifetime of N,N-dialkylaminonaphthalimide considerably decrease as the temperature increases or as solvent polarity and viscosity decrease. This is caused by the increasing of radiationless rate constant (k_a), but not by the change of radiative rate constant (k_r). Temperature-activated radiationless deactivation in N,N-dialkylaminonaphthalimide is supposed to be associated with the formation of nonfluorescent twisted charge transfer state (TICT-state), formed by the rotation of dialkylamino-group relative to the naphthalimide ring plane. In this case the rate constant of TICT-state formation (k_t) is related with ϕ by the following equation: $k_t / k_r = 1/\phi - 1/\phi_0$, where ϕ_0 is fluorescence quantum yield from initial state without reaction. The dependence of k_t on the temperature ($170 < T < 330$ K) and solvent viscosity ($0.5 < \eta < 700$ cP) for DMAN in n-alcohols is quantitatively described by the following expression $k_t = k_0 \eta^\alpha \exp(-E/RT)$. Two assumptions are considered: 1) activation energy E linearly depends on solvent polarity parameter E_t (30) 2) activation energy E is in inverse ratio to solvent dielectric constant (ϵ). Temperature dependence of E_t (30) and ϵ has been taken into consideration. The Arrhenius plots for TICT-state formation rate constant reduced to the same solvent viscosity and polarity for DMAN in different alcohols coincide with each other ($E = 9.1$ kcal/mol for nonpolar solvents). The effect of N,N-dialkylaminogroup structure on TICT-state formation rate constant is considered. The value of k_t rises as ionization potential of N,N-dialkylaminogroup increases.

The structural relaxation of excited 2-(3-pyridyl)-5-phenyl-oxazole cations is an example of barrierless relaxation. In low viscous solvents at room temperature the fluorescence of 2-(3-pyridyl)-5-phenyl-oxazole cation (3PyPOH^+) and its N-methylated analog (3PyPOMe^+) is characterized by the

anomalous Stokes shift (190 nm in EtOH) and low quantum yield. The fluorescence intensity depends slightly on solvent polarity. The fluorescence intensity rises and shortwavelength shift is observed as solvent viscosity increases. The anomalous fluorescence Stokes shift and its dependence on solvent viscosity point out that the fluorescence takes place from the continuous set of intermediate states. In low viscous solvent the picosecond fluorescence kinetics does not depend on the emission wavelength. At moderate solvent viscosity the fast fluorescence decay at the shortwavelength side and the fast fluorescence rising at the longwavelength side of the spectrum are observed in the picosecond time domain.

Effective radiative rate constant (k) has been estimated from fluorescence quantum yield and lifetime. At constant viscosity k is practically independent of the temperature. The value of k increases about 5 times as one goes from nonrigid to rigid matrices. The fluorescence maximum wavelength and k are changed simultaneously. The dependence of k on the alcohol viscosity allows to conclude that in the excited state structural relaxation consisting in the rotation of pyridinium ring relative to oxazole one takes place. In excited cation the equilibrium angle between pyridinium and oxazole fragments is greater than that in the ground state. At comparable values of the structural relaxation time and lifetime of the excited state the fluorescence arises from continuous set of non-equilibrated intermediate states with various torsional angles between pyridinium and oxazole rings and hence with different values of k .

The structural relaxation dynamics is described by the model according to which the relaxation is a molecular motion on excited state harmonic surface in friction forces field. It is assumed that temporal evolution of excited state population density is described by modified Smoluchovski equation. The calculation has been made taking into consideration the normal distribution of photophysical elementary constants on relaxation coordinate (x). It is supposed that the fluorescence spectrum has the same profile (γ -distribution) for different x . This model satisfactorily fits fluorescence kinetics data over the whole spectrum and fluorescence spectra of studied systems in wide temperature range.

This work was supported by Russian Fund of Basic Researches, grants N 96-03-34108 and N 96-03-32943.

USE OF CPC COLLECTORS FOR THE SOLAR DETOXIFICATION AND DISINFECTION OF CONTAMINATED WATER

A.Vidal, M.Romero and J.I. Ajona
CIEMAT-IER; Avda. Complutense, 22; 28040-Madrid
I.Muguruza, A.Díaz and M.Zallo
GAIKER. Parque Tecnológico, Ed. 202; 48016 Zamudio

ABSTRACT

A cooperation has been established within DLR, WIS and CIEMAT in a Specific Program of Research and Technological Development supported by European Commission (Avicenne Initiative 1994). The title of the project is "Comparative assessment of technologies for solar detoxification and disinfection of contaminated water"

The general objective of the proposed joint research project is to develop the basis for an efficient technology of solar water detoxification and disinfection which makes use of dye-sensitized and catalytic photoreactions. The eventual product of this objective would be the construction of low-cost solar collector, located in a transportable unit for its final shipment to Third Mediterranean Countries (TMC). The Task II carry out by CIEMAT is a Spanish-Moroccan joint action aiming to develop an appropriate installation for the application of CPC collector technology which makes use of titanium dioxide catalytic photoreactions into detoxification of toxics and microorganism in water. Other participants involved in this task are the spanish companies GAIKER and I.M.H.

Construction of the low-cost solar collector, located in a transportable unit, including probes, piping, pump, vessels has been already finished. The pilot plant include a monitoring test of instrumentation encompassing a UV pyranometer, probes for pH, T, O₂, etc, a PC computer for data acquisition and evaluation.

Analyses for the feasibility assessment of selected microorganism destruction (*Escherichia coli*, *Enterococcus faecalis* and spores of *Bacillus subtilis*) at engineering scale, according to EU regulations and directives and WHO recommendations, have been made at GAIKER. Photocatalytic oxidation of selected pesticides (EPTC, butiphos and γ -lindane) have been evaluated in the laboratory and in the field with sunlight at CIEMAT.

Detoxification and disinfection tests at the pilot plant carried out during the first step of the project will be presented in this paper. The evaluation of a photocatalytic process for water purification has been made with comparison to conventional drinking water treatment processes.

PHOTOCHEMISTRY OF *o*-VINYLSTYRYL CONDENSED FURANS

I. Vujković Cvijin,¹ S. Tomšić,¹ Ž. Marinić² and M. Šindler-Kulyk^{1*}

¹Department of Organic Chemistry, Faculty of Chemical Engineering and Technology, University of Zagreb, Marulićev trg 19, 10000 Zagreb, Croatia

²Institute "Rugjer Bošković", Zagreb, Croatia

In one of our previous papers^{1a} in the series on the photochemistry of heteroaryl substituted *o*-divinylbenzenes (1)¹ we demonstrated the first example of the photochemical synthesis of [3.2.1] bicyclic compounds (2) by intramolecular cycloaddition of β -(2-furyl)-*o*-divinylbenzenes (1, R=2-furyl).

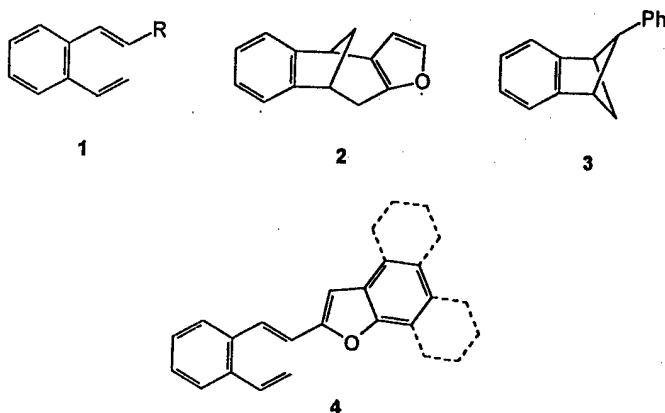

In comparison to the photochemical behaviour of β -aryl-*o*-divinylbenzenes (1, R=phenyl)² which undergo [2+2] cycloaddition and formation of the benzobicyclo[2.1.1]hexene derivative (3) β -(2-furyl)-*o*-divinylbenzene (1, R=2-furyl) is the sole system in which the β -substituent is involved in the intramolecular cycloaddition giving bicyclo[3.2.1]octadiene derivative (2), in very good yield.

Thus, it was of considerable interest from mechanistic and synthetic points of view, to study the photochemical behaviour of furan derivatives in which the furan ring is a part of the condensed systems in order to obtain the polycyclic structures. This work reports about the photochemical reactions of *o*-vinylstyryl derivatives of benzofuran, naphtho[2,1-b]- and naphtho[1,2-b]furan (4).

The structure determination of the products as well as the mechanism of the reactions will be discussed.

1. a) M. Šindler-Kulyk, L. Špoljarić, and Ž. Marinić, *Heterocycles* **29** (1989) 679; b) M. Šindler-Kulyk, S. Tomšić, Ž. Marinić, and B. Metelko, *Recl. Trav. Chim. Pays-Bas* **114** (1995) 476.
2. a) M. Šindler-Kulyk and W. H. Laarhoven, *J. Am. Chem. Soc.* **98** (1976) 1052; *ibid.* **100** (1978) 3816; *Recl. Trav. Chim. Pays-Bas*, **98** (1979) 187; *ibid.* **98** (1979) 452, b) W. H. Laarhoven and Th. J. H. M. Cuppen, *J. Photochem.* **32** (1986) 105.

HYDROGEN TRANSFER PHOTOCATALYSIS for the REDUCTION and FIXATION of CO₂

Shozo Yanagida, Yuji Wada, and Kei Murakoshi

Material and Life Science, Graduate School of Engineering, Osaka University,
Suita, Osaka 565, Japan

When oligo(*p*-phenylene), such as terphenyl and quaterphenyl, is excited by UV irradiation in the presence of cobalt-cyclam complex (Co^{III}L, L = cyclam = 1,4,8,11-tetraazacyclotetradecane) as an electron mediator and triethylamine (TEA) as an electron donor, CO and formate are formed from CO₂ as reduction products. The mechanism for the photocatalysis involves electron transfer from the radical anion of oligo(*p*-phenylene) formed by reductive quenching of the singlet excited state to the cobalt complex (see the figure).

On the other hand, selective photoreduction of CO₂ to formate (HCO₂⁻) has been achieved by UV-irradiation of the system containing phenazine (Phen) as a photosensitizer, triethylamine (TEA) as an electron donor, and Co^{III}L as an electron mediator. Reduction products are HCO₂⁻, and a small quantity of CO and H₂. Preferential electron transfer from the photoformed radical anion of phenazine (Phen^{•-}) to Co^{III}L is confirmed by EPR analysis and pulse radiolysis. The resulting Co^{II}L undergoes hydrogen transfer from phenaziny radical with a second order rate constant $k = 10^5 \text{ M}^{-1} \text{ s}^{-1}$, giving [CoL(H)]²⁺. The effective insertion of CO₂ molecule into [CoL(H)]²⁺ yields HCO₂⁻ selectively.

This shows a good example for the utilization of profitable capability of nitrogen-containing aromatics, which have a function not only for electron transfer but also hydrogen transfer through a semiquinone radical.

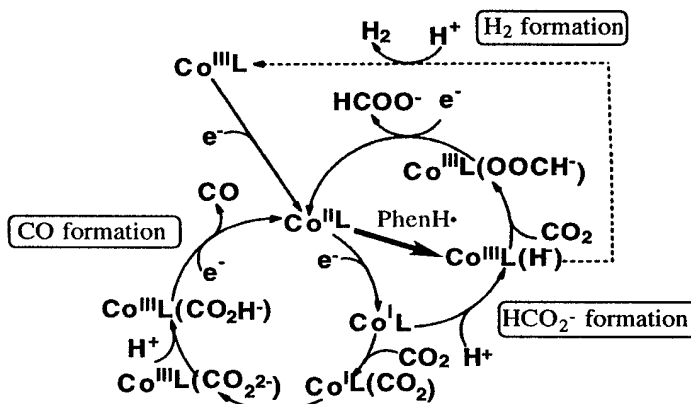

Figure. Role of cobalt macrocycles for photoreduction of CO₂.

The Photolysis of Carbendazim In Tetrahydrofuran

M.F.Zayed

National Research Centre, Cairo, Egypt

Methyl benzimidazole-2-ylcarbamate (I) is a valuable fungicide (USP 3,657,443 ; GBP I, 190,614 du Pont) marketed under the trade name Carbendazim (BASF AG and Hoechst AG). Irradiation of a solution of I (300 mg) in THF (250 ml) in a pyrex vessel ($\lambda > 313$ nm) using HPK 125 W lamp for 24 hours resulted in the disappearance of I as indicated by TLC. The photolysate was chromatographed over silica gel where by formic acid (II), dimethyloxalate (III), tetrahydrofuranyl-guanidine aldehyde (IV), 2-amino-tetrahydrofuran (V) and 2-formyl-tetrahydrofuran (VI) were isolated and identified.

Discussion of the results and a possible mechanism account for the formation of the products will be presented.

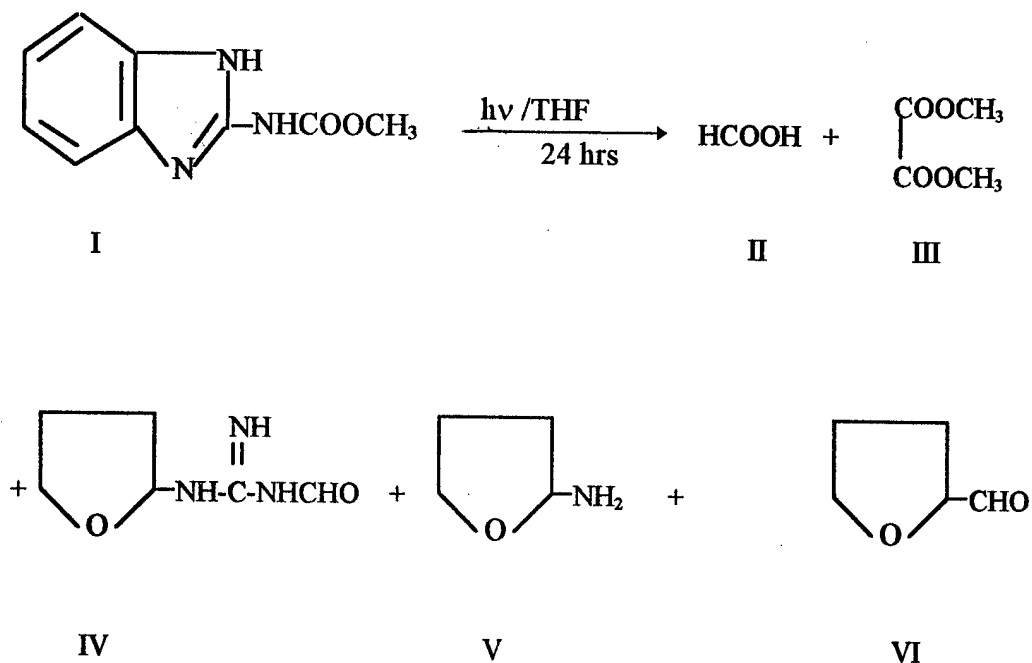

Photoelectrochemistry of n-Silicon Semiconductor in Fluoride Media

M. S. Antonious , A. A. Abdel-Shafi and M. S. A. Abdel- Mottaleb
Photoenergy Centre and Department of Chemistry,
Faculty of Science, Ain Shams University
Abbassia, Cairo, Egypt

In this work we study the effect of adding $[\text{RuL}_3]^{+2}$ complexes (where L=BYP) during photoelectrochemical etching of n-Silicon on the photocurrent generation . Considerable enhancement of photocurrent is induced due to the presence of the dye redox system. Redox stabilization of Si optoelectrode via electron transfer process based on remarkable interfacial interaction between reducing species and the photoelectrode is efficiently achieved.

Time-dependent photoelectrochemical measurements during anodic dissolution of n-Si in presence of the complex redox system resulted in inhibition of photocurrent oscillations . Practically all photogenerated holes reach Si electrode surface will be efficiently reacted with the coordination redox system resident at the electrode surface.

A mechanism for current oscillations, based on periodic buildup and decay (hole/electron recombination) of space charge within the superficial oxide layer is proposed.

The Construction of a Solar Photoreactor
for Preparative Photochemistry.
A.A.Nada¹, M. H. Barakat² and M. M. Ramla¹
National Research Centre, Dokki - Cairo.

A linearly focused solar photoreactor of pilot size was constructed to run photochemical reactions at moderate temperature. The solar concentrator design facilitates minimum suntracking requirements and achieves the desired concentration. The photoreactor loop is equipped with an external cooling system which does not obstruct solar irradiation of the chemical reaction components. The reaction parameters are carefully monitored and controlled, including flow inlet temperature, flow outlet temperature, flow rate, solar radiation intensity, spectral distribution and solar concentration.

The production of some known fine chemicals of industrial interest is currently performed for the calibration of the newly constructed photoreactor, e.g. Ascaridol from α -terpines and 5-hydroxy-2(5H)-furanone from furfurylaldehyde.

In addition and in continuation of our work on the preparation of useful intermediates in the synthesis of pesticides, some selected photoreactions are performed. Thus, 2-azido-phenylenedibenzene-sulfonimine and/or 2-azido-p-quinonedibenzene-sulfonimine were subjected to solar radiation whereby compounds (I) and (II) were isolated and identified, respectively.

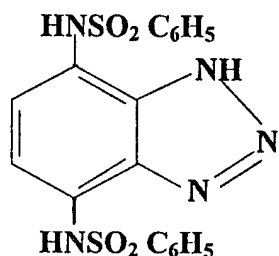

(I)

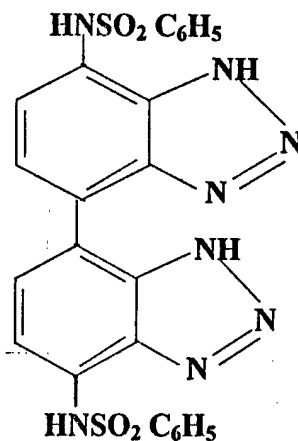

(II)

The Electron Affinity Difference in CdTe/CdS Solar Cells

S. A. alkuhaimi, N. M. Shaalan, and S. Bahammam.

Girl's College of Education. P.O. Box 3840 Riyadh-11481, Saudi Arabia.

The electron affinity difference $DE_c = \chi_1 - \chi_2$, in CdS/CdTe solar cells fabricated by four different processes has been measured from observations of the variations of open voltages with temperature. For CdS/CdTe cells, the values of DE_c is between 0.20 and 0.25 eV and are found to be independent of the process of cell fabrication. The use of CdZnTe in place of CdTe increases the value of DE_c to 0.49 eV. The method used for the measurement of DE_c is very simple. The value of the current I_0 for the different types of cells have been estimated from the slope of qV_{OC} versus kT plots and compared with those obtained from $\ln I$ versus V curves. The values of I_0 found for each cell by the two methods are in substantial agreement.

WATER DESALINATION USING SOLAR ENERGY

M.F. Abd Rabbo*, M.M. EL Fawal** & A. Lasheen

* Faculty of Engg., Zagazig University, Shoubra, Cairo
** Atomic Energy Authority

ABSTRACT

A forced convection solar still of a closed cycle type is designed and manufactured for which experimental work is conducted. The performance of such still based upon the hourly variation is presented to cover different parameters, such as fluid temperatures along the channel, productivity and efficiency. The effect of air mass flow ranging from (0.0303, to 0.05424) Kg./sec. and condenser cooling water temperature ranging from (27 to 33) °C for the basic still is investigated.

The optimum air mass flow for the basic still is found to be equal to 0.052 Kg/sec, and the reduction in cooling water temperature from 33 °C to 27 °C produce and improvement of 17% in the productivity.

The basic still is modified by introducing a humidifier to enhance its yield. The improvement in yield and efficiency is in the order of 12% and 7.75% respectively.

The heat, momentum and mass flow equations are solved by a computer program, and the obtained theoretical results are compared with existing experimental data. A maximum deviation of 7% is observed in the temperature profile along the channel.

TREATMENT OF WASTEWATER FROM REFINERIES BY H₂O₂ / UV CATALYTIC PHOTOOXIDATION .

A.M. Badawi * , F.A. Fahim ** , G. El-Diwani *** , S. Hawash***
and Sh. El-Rafi***

* Egyptian Petroleum Research Institute , Naser City , Cairo , Egypt.

** Ain Shames University , Faculty of Science , Dept. of Biochemistry
Cairo , Egypt .

*** National Research Center , Chemical Eng. and Pilot Plant Dept.,
Dokki , Cairo , Egypt .

Abstract

Laboratory studies concerning experimental remediation of wastewater from Cairo Refinery , Mostored are presented .

Chemical degradation of a sample containing emulsified oil in water using H₂O₂ combined with catalytic photolysis is evaluated .

The catalyst Fe (III) tetracarboxyphthalocyanine (as sodium salt) at a concentration of 2% based on emulsified oil in wastewater was added to the synthetically prepared sample before the treatment with H₂O₂ 165% based on water oil emulsion of 1g /L oil concentration and applying U.V. light (180 watt) .

The degradation of the oil was followed by gas chromatography after 120 hours.

Power Supply Strategy In An Electric power Utility In Canada: Solar Power As an Option

J. Carneiro

**Chief Chemist, Manitoba Hydro electric Power Commission
Winnipeg, Manitoba, Canada.**

Manitoba Hydro is a medium size electric power utility which supplies power to a large part of Central Canada. It is a Crown Corporation with under 6000 MW of industrial capacity. It serves about 1,000,000 customers spread out over 650,000 km². Between 25 and 35% of its power is exported mostly to the North/Central states in the USA. Power consumption per capita on this part of the world is one of the highest in the world due to lifestyle, extreme temperatures (high demand for heating in the winter and cooling in the summer) and long distances.

This region has a privileged geographic location from the point of view of surface water resources. Therefore, the main source of power is hydraulic, assisted by two low quality coal thermal plant. This coal is fairly abundant in this region. Nuclear energy (the Canadian CANDU System) was considered but not adopted for economic considerations. Wind power was not considered seriously nor was tidal power or biomass.

Manitoba is a very sunny area with a very large number of sunny days per year. It would therefore appear that solar power would be a viable option within the overall power supply strategy of Manitoba Hydro. Some economic considerations are presented that show that solar power is an alternate option but at this point in time under the present economic, social and environmental conditions it is not advantageous and reliable enough to compete with the other sources. This scenario may change in the not too far future.

Manitoba Hydro actively looks at all available means of producing power economically, efficiently and with the least impact on the environment. For this purpose, Manitoba Hydro sponsors and funds research, both pure and applied to remain well informed in those areas. It cultivates strong mutual bonds with private industry, research establishments and particularly universities.

ELECTRON TRANSFER IN SUPRAMOLECULAR ASSEMBLIES AS BIOMIMETIC MODELS

H. Dürr^a, M. Seiler^a, M. Kropf^a, E. David^a and I. Willner^b

a) Fachrichtung 11.2, Universität des Saarlandes, 66041 Saarbrücken, Germany

b) The Farkas Photochemistry Center, Hebrew University, 91904 Jerusalem, Israel

Model systems for the photosynthetic reaction center are currently of great interest¹. They are supposed to imitate nature's functions - in supramolecular assemblies - but not it's building blocks. Vectorial electron transfer has to be ensured to create an efficient system. We have devised artificial photosynthetic models that are based on:

- 1) covalently linked D - A₁ - A₂ - systems
- 2) supramolecularly (non covalently) linked D - A - systems

In this paper we present the preparation of the building blocks of model assemblies belonging to both 1) and 2) systems.

A study of the photophysical data by static and time resolved spectroscopy is given. So the understanding of the underlying principles of the electron transfer processes can be approached.

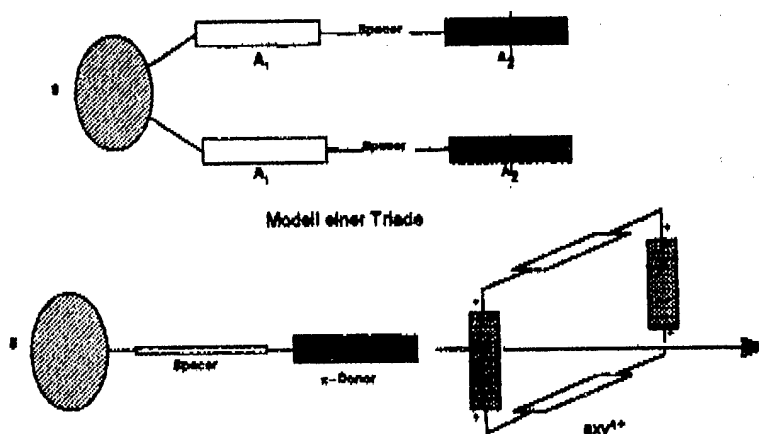

¹ H.J. Schneider, H. Dürr, *Frontiers in Supramolecular Chemistry and Photochemistry*, VCH, Weinheim, 1990.

² H. Dürr, M. Seiler, E. Zahevy, S. Marx-Tibbon, E. Joselevich, I. Willner, D. O'Connor, A. Harriman, *Angew. Chem.* 1995, 107.

³ M. Seiler, H. Dürr, *Liebigs Ann. Chem.* 1995, 407.

DEGRADATION OF ORGANIC PHOTOCHROMES: LIGHT-PROMOTED AND DARK REACTIONS

V. Malatesta

Great Lakes Chemical Italia, Via Maritano 26, 20197 S. Donato (Milano), Italy

Spiropyrans (SP) and spiroxazines (SP) are among the most well known organic photochromes⁽¹⁾. Many useful applications have been envisaged in several important areas, including high-density optical storage, optical switching, image processing and displays. Exposure of SO's and SP's in solution or in a polymer matrix to UV-A or sunlight results in a color change due to the formation of a deeply colored merocyanine (MC) form that tends to revert back to the closed spiro form either thermally⁽²⁾ or photochemically⁽³⁾.

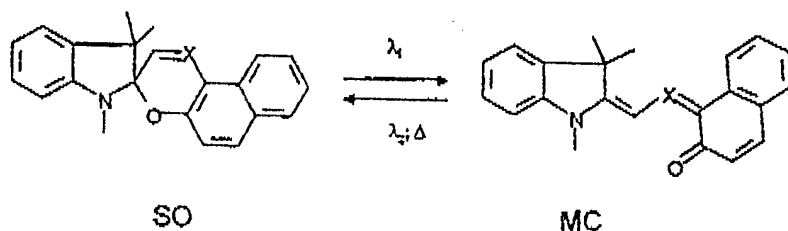

Scheme 1

Degradation processes limit the number of darkening \longleftrightarrow bleaching cycles that SO's and SP's can sustain. We have identified, beside the photochemical ones⁽⁴⁾, degradative processes based on dark reactions that include trapping of free radical species⁽⁵⁾, electron-transfers to organic and inorganic acceptors⁽⁶⁾, and reactions with nucleophiles⁽⁷⁾. The ability of spiro- and merocyanine forms to sensitize formation of singlet oxygen (1O_2) has been shown⁽⁸⁾ to be minimal and the chemical reactivity toward 1O_2 sluggish. An overview of the degradative processes will be presented.

References

- 1). Photochromism, Molecules and Systems, H. Durr, H. Bouas-Laurent, eds. Elsevier, Amsterdam, 1990
- 2). G. Favaro, F. Masetti, U. Mazzucato, G. Ottavi, P. Allegrini, V. Malatesta, J. Chem. Soc. Faraday Trans. II, **90**, 333 (1994)
- 3). C. Bohne, M. G. Fan, Z. j. Li, J. Luszytk, J. C. Scaiano, J. Chem. Soc. Chem. Commun., 517 (1990)
- 4). V. Malatesta, M. Milosa, R. Millini, S. Monti, P. Bortolus, Mol. Cryst. Liq. Cryst., **246**, 313 (1994)
- 5). V. Malatesta, M. Milosa, L. Montanari, F. Renzi, D. Scotti, L. Wis, J. Org. Chem., **60**, 5446 (1995)
- 6). V. Malatesta, R. Millini, L. Montanari, J. Am. Chem. Soc., **117**, 6528 (1995)
- 7). V. Malatesta, C. Neri, M. L. Wis, *submitted*
- 8). V. Malatesta, C. Neri, M. L. Wis, S. Monti, *submitted*

Index: Based on Names of Authors Responsible for Presentation

- Aaron J. J.** {LECTURE}
Institut de Topologie et de Dynamique des System, Paris
"FLUORESCENCE AND ENERGY TRANSFER IN SOLUBLE ELECTROSYNTHESIZED
HETROCYCLIC OLIGOMERS"
- Aaron J. J.** 01 P
"Solvent Effects on the Electronic Absorption and Fluorescence Spectra of
Curcumindoid Dyes: A Comparison of the Ground and First Excited State Dipole
Moments."
- Abd-El-Aziz A. S.** {LECTURE}
University of Winnipeg, Winnipeg
"THE ROLE OF PHOTOCHEMICAL DEMETALLATION OF ORGANOMETALLIC
COMPLEXES IN POLYMER SYNTHESIS"
- Abdel-Razik E. A.** 02 P
"Photoinduced Graft Copolymerization of Isobutyl Methacrylate onto Ethyl Cellulose
in Homogeneous Media"
- Abdel Rehim Z. S.** 03 P
"A New Design of Solar Water Heater"
- Abdel-Shafi A. A.** 04 P
"Intra- and Intermolecular Energy and Electronic Transfer in Bichromophoric
Molecules"
- Abou-Elzahab M. M.** 05 P
"Imperatorin, Alloimperatorin and Alloimperatorin Acetate Hydroperoxides as Natural
Efficient Photochemical Hydroxy Radical Generators. As the Novel DNA-Cleaving
Agents"
- Abou-Zied Osama K.** 06 P
"Inclusion of Azulene by β - and γ -Cyclodextrins: Formation of Stable Dimers in
Aqueous Solution and in a Low Temperature Glass"
- Adenier A.** 07 P
Institut de Topologie et de Dynamique des System, Paris
"Effects of Various Salts on the Spectral Properties of MEROCYANINE 540, A
Fluorescent Probe, in Aqueous Media"
- Agostiano Angela** 08 P
"Charge Recombination of Photosynthetic Reaction Centers in Different Membrane
Models"
- Akhilus S.** {LECTURE}
"The Coupling of Photoisomerization Processes and Chromatography Separation"
- Akhilus S.** 09 P
"Advances of the Steriolithography Process Towards Microtechniques"
- "Fluorescence Probes for Amphiphilic Polymers" 10 P

- Al-Hazmy M.** 11 P
 "A New Coumarin Laser Dye: 3-(Benzothiazol-2-yl)-7-hydroxycoumarin (BTHC)"
 "Emission Characteristics and Photostability of 9-Phenyl, 10-methoxyanthracene (PMA)". 12 P
 "Photochemical and Spectral Behaviour of 3-(5-Phenyl-1,3,4-oxadiazol-2-yl)-7-hydroxycoumarin (POHC)" 13 P
- Amin R. R.** 14 P
 "Rules of Metal Ions on Laser Interaction with a Conjugated Organic System"
- Aquilanti V.** {LECTURE}
 "ELECTRONIC ENERGY TRANSFER AND CHARGE EXCHANGE IN PHOTON - INDUCED ELEMENTARY PROCESSES"
- Arnaut L. G.** 15 P
 "Theoretical Studies of Electron Transfers in Photosynthetic Bacteria Reaction Centers"
- Artem'ev Yu. M.** 16 P
 "The Enhancement of Semiconductor Photocatalytic Activity During Ozone Introduction in Water and Air Purification Systems"
- Azim S. A.** 17 P
 "Photochemical Reactions and Emission Characteristics of Benzidine in Halomethane Solvents"
 "Emission Characteristics of Anthralidene-2-Aminopyridine" 18 P
- Becker K.-H.** {LECTURE}
 "THE IMPACT OF THE SUN ON TROPOSPHERIC REACTIVITY: BENEFICIAL AND ADVERSE EFFECTS"
- Babaqi A. S.** 19 P
 "Emission Characteristics and Photostability of A Rigid Coumrin Dye"
- Beggiato G.** 20 P
 "Utilization of Conducting Polymers in Rectifying Junction Construction: Dark Characteristics and Photovoltaic Properties"
- Belaidi A.** 21 P
 "pH Dependence of Flat-band Potential of n-Si"
- Burshtein A. I.** {LECTURE}
 "CHARGE SEPARATION AND RECOMBINATION AFTER PHOTOIONIZATION"
- Cao Y.** {LECTURE}
 "PHOTOINDUCED ELECTRON TRANSFER AND ITS APPLICATIONS: STUDY ON PHOTOCHEMICAL SOLAR ENERGY STORAGE AND POLYMERIC PHOTO-REFRACTIVE MATERIALS"
- Chrysochoos John** 22 P
 "Interfacial Electron Transfer from Nonstoichiometric Cadmium Sulfide Nanoparticles to Free and Complexed Copper Ions in 2-Propanol"

- Dahn U.** {LECTURE}
 "POLYMERS WITH PHOTSENSITIVE TRIAZINE GROUPS: RESISTS FOR APPLICATIONS IN EXCIMER LASER MICROLITHOGRAPHY"
- Dannefaer S.** {LECTURE}
 "A POSITRON ANNIHILATION STUDY OF POROUS SILICON"
- Dmitrenko O. G.** 23 P
 "Ground-State Conformational Equilibrium of Previtamin D and its E-Isomer: Effect on the Photoconversions and Absorption Characteristics"
- De Schryver F. C.** {LECTURE}
 "SUBMICRON PHOTOCHEMISTRY AND PHOTOPHYSICS"
- Doepp D.** {LECTURE}
 "SOME NEW PHOTOREACTIONS OF NITROGEN AND SULFUR HETEROCYCLES"
- Duerr H.** 24 P
 "ELECTRON TRANSFER IN SUPRAMOLECULAR ASSEMBLIES AS BIOMIMETIC MODELS"
- Ebeid E. M.** {LECTURE}
 "THE PHOTOCHEMISTRY AND PHOTOPHYSICS OF SOME UV-VISIBLE LASER DYES"
- El-Daly S. A.** 25 P
 "Fluorescence Quenching of 2,5-Bis-2-(2-naphthyl) vinyl pyrazine (B2NVP) by Cobalt Ions and Oxygen Molecule"
 "Reabsorption and Excitation Energy Transfer of N,N-bis(2,5-tert-butylphenyl)-3,4:9,10 Perylenebis(dicarboximide) (DBPI) Laser Dye" 26 P
- El-Dessouki M. S.** 27 P
 "Photoelectrochemical Properties of Dye Sensitized Zr-doped SrTiO₃ Electrodes"
- Elgendy E. M.** 28 P
 "Limonene Dihydroperoxides. As Natural Efficient Photochemical Hydroxy Radical Generators. Novel DNA-Cleaving Agents".
 "Photooxygenation Reactions of Natural Piperine" 29 P
- El-Kamary M. A.** 30 P
 "Interaction of the Excited Singlet State of 1,4- and 1,8-Dimethoxynaphthalene with some Organic Compounds: A Fluorescence Quenching Study".
- El-Khoshnieh Y. O.** 31 P
 "Photoreactions of Bianthrone and Related Substances with Thiyl Radicals as Nucleophilic Reagents"
- El-Khouly M. E.** 32 P
 "Solvatochromism and Photochromism of Some Thiones"
- El-Maradny Amr** 33 P
 "Photoreaction of Silyliron(II) Complexes Cp'Fe(CO)₂SiMe₃ (Cp' = η⁵-C₅H₅, η⁵-C₅Me₅) in the Presence of Di-p-Tolylgermane (p-Tol)₂GeH₂ and p-Tolylstannane (p-

- El-Nadi L.** 34 P
 "Photodissociation of H₂O Molecules in Intense Laser Fields"
 "Luminescence Efficiency of Combined Aluminium Tri-Quinolate (Alq₃) and Nile Blue (NB) Thin Films" 35 P
- EL-Sayed M. A.** {LECTURE}
 "PROTEIN CATALYSIS OF THE PRIMARY PROCESSES OF THE OTHER NATURAL PHOTOSYNTHETIC SYSTEM, BACTERIORHODOPSIN"
- El-Shall S.** {LECTURE}
 "PHOTOLEUMINESCENCE OF SURFACE- OXIDIZED SILICON NANOCRYSTALS"
- Enea O.** {LECTURE}
 "SOLAR DETOXIFICATION OF WATER" - A Video presentation
 "METAL/TIO₂ ANODES FOR THE PHOTOASSISTED ELECTROOXIDATIONS"
- Eremenko A.** 36 P
 "Photoinduced Electron Transfer and Charge Separation in Adsorbed Exciplex Pyrene-N,N-Diethylaniline at the Presence of Polar Additions"
- Fathy A. M.** 37 P
 "Studying the Ultraviolet and Visible Solar Radiation over Cairo and Aswan and their Correlation with Environmental and Climatological Parameters"
- Fotouhi B.** 38 P
 "Anodic Dissolution of n-Si in HF under Illumination"
- Friesen K.** {LECTURE}
 "THE ROLE OF PHOTOCHEMISTRY IN THE DEGRADATION OF CHLORINATED ORGANIC CONTAMINANTS"
- Funken K.-H.** {LECTURE}
 "SOLAR PHOTOCHEMICAL WATER PURIFICATION"
- Gaber A. M.** 39 P
 "TiO₂-Photocatalytic Oxidation of Selected Condensed Heterocyclic Sulfur Compounds"
- Galin A. M.** 40 P
 "Mechanism of the Photochemical Reactions of the Dithiolate-diimine Zn(II) and Pt(II) Complexes Caused by Electron Transfer from the LLCT Excited State"
- Gfeller N.** {LECTURE}
 "DYE MOLECULES IN ZEOLITES AS ARTIFICIAL ANTENNA"
- Ghigino K. P.** {LECTURE}
 "DYNAMICS OF INTRAMOLECULAR ENERGY AND ELECTRON TRANSFER"
- Giardini Guidoni A.** {LECTURE}
 "RESONANT TWO PHOTON IONIZATION PROCESSES TO STUDY SPECTROSCOPY AND REACTIVITY OF VAN DER WAALS CLUSTERS OF AROMATIC MOLECULES"

- Gilbert A.** {LECTURE}
 "ARENE-ETHENE PHOTOCYCLOADDITION PROCESSES AND THEIR SUNLIGHT INITIATION"
- Guillet J.** {LECTURE}
 "SOLAR SYNTHESIS OF HYDROGEN PEROXIDE"
- Hassan A. A.** 41 P
 "Studies on Thieno[3,4-d]Pyridazine and Electron Acceptor Compounds"
- Hau D. M.** 42 P
 "Effects of LASER, HPD, Photodynamic Treatment and Hyperthermia on Cellular Immunocompetence of γ -Ray Irradiated Mice"
- Hammam E.** 43 P
 "A Theoretical Study on the Structures and Spectra of Distyrylpyrazine (DSP) Laser Dye"
- Hidaka H.** {LECTURE}
 "PHOTODEGRADATION OF SURFACTANTS WITH TiO₂ SEMICONDUCTOR FOR THE ENVIRONMENTAL WASTE WATER TREATMENT"
- Horvath Otto** 44 P
 "Photoassisted Dissolution of Colloidal Manganese Dioxide in the Presence of Phenol"
- Houssamy S.E.** 45 P
 "Synthesis and Characterization of Some: Phthalate Phosphate, Borate, Phosphate-Borate and Phthalate Polyglycol Ester Bases of Hydraulic Fluids".
 "Hydraulic Fluids of: Phthalate Phosphate, Borate, Phosphate-Borate and Phthalate Polyglycol Bases: Are They Better?". 46 P
- Icil H.** 47 P
 "Organic Photosensitizers of Extremely High Thermal and Photostabilities, Suitable to Solar Applications: Perylene Tetracarboxylic Acid-bis-Alkyl Diimides"
- Icli S.** {LECTURE}
 "PHOTOCHEMISTRY IN TURKEY AND A NEW CATALYST FOR SOLAR PHOTOORGANIC CHEMICAL SYNTHESIS"
- Issa E.** 48 P
 "The Application of MUCAP Fluorescence Test in Salmonellae Detection"
- Jori G.** {LECTURE}
 "FAR - RED ABSORBING PHOTOCHEMOTHERAPEUTIC AGENTS FOR TUMOURS"
- Karminski-Zamola G.** 49 P
 "Photochemical Synthesis of New Heteropolycyclic System; 3-Chloronaphtho [2,1-b]Thieno[3,2-b]Thiophene-2,6-Dicarbonyl-Chloride"
- Kirah Kh.** 50 P
 "Characterization of the Charged Species Inside Anodic Oxides Formed in Si/HF Electrolyte Systems"

- Kisch H.** {LECTURE}
"SEMICONDUCTOR PHOTOCATALYSIS FOR PREPARATIVE CHEMISTRY?"
- Kiwi J.** {LECTURE}
"THE SOLAR ENERGY OPTION FOR WASTE WATER DETOXIFICATION THROUGH PHOTOCHEMICAL - BIOLOGICAL FLOW REACTORS"
- Klessinger M.** {LECTURE}
"THEORETICAL SIMULATION OF VIBRONIC SPECTRA AT HIGHER TEMPERATURES"
- Korany E. A.** 51 P
"The Role of Solar Energy in Hydrogeologic Assessment of Groundwater Resources in Egypt"
- Krishnan V.** {LECTURE}
"DONOR - ACCEPTOR SUBSTITUTED FLUOROARYLPORPHYRINS FOR QUADRATIC NON-LINEAR OPTICS"
- Lemmetyinen H.** {LECTURE}
"PHOTOCHEMISTRY OF SOME CHLOROPHYLL BASED ANTHRAQUINONE AND NAPHTHOQUINONE COMPOUNDS IN SOLUTIONS AND ORGANIZED FILMS"
- Leupold D.** {LECTURE}
"PHOTOSENSITIZATION VIA STEPWISE EXCITED HIGHER ELECTRONIC STATES OF TETRAPYRROLIC COMPOUNDS"
- Levanon H.** {LECTURE}
"EPR SPECTROSCOPY IN MIMICKING PRIMARY PHOTOSYNTHESIS"
- Lukyanov B. S.** 52 P
"Photo and Thermo Active Thermodynamic Metastable Structures"
- Maafi M.** 53 P
"Usefulness of a New Electrosynthesized Polymer Bearing a Norbornadiene Moiety for Solar Energy Storage"
"A Strategy For the Photoisomerization of Aromatic Norbornadienes in Aqueous Media Based on β - Cyclodextrin Inclusion Complexes" 54 P
- Mansour A.** 55 P
"Estimation of the Attenuation of Visible and Thermal Radiation by some Artificial Aerosols"
- Mansour A. F.** 56 P
"Spectroscopy, Photostability and Optical Efficiency of Luminescent Solar Concentrator"
- Mazzucato U.** {LECTURE}
"EFFECT OF THE PRESENCE OF PYRIDYL AND THIENYL GROUPS ON THE EXCITED STATE PROPERTIES OF STILBENE-LIKE MOLECULES"
- Mele A.** {LECTURE}
"STUDIES ON THE MECHANISM OF LASER ABLATION AND THIN FILM DEPOSITION"

- Michl J.** {LECTURE}
"PHOTOPHYSICS OF OLIGOSILANES"
- Moebius K.** {LECTURE}
"ELECTRON TRANSFER AND SPIN DYNAMICS IN BACTERIAL, PLANT AND MODEL PHOTOSYNTHESIS AS STUDIED BY TIME-RESOLVED HIGH-FIELD/HIGH-FREQUENCY EPR SPECTROSCOPY"
- Mohamed S. K.** 57 P
"New Photogeneration Method of Some Azo Dyes"
- Mohsen, M.** 58 P
"Free Volume Hole Distributions of Polyisoprene Studied by Positron Annihilation Lifetime Spectroscopy" 59 P
"Effect of Sorption of CO₂ Gas on Free Volume Distributions in Polyethylene and Poly(1-trimethylsilyl propyne) Studied by Positron Annihilation Lifetime Technique"
- Mostafa W.** 60 P
"Light-Induced Reduction and Ring Contraction of Some Phenylated Azines"
- Mourad W. E.** 61 P
"Reduction of Aqueous Carbonate Photocatalysed by Treated Semiconductors for Solar Energy Conversion and Storage"
- Muszkat L.** {LECTURE}
"SOLAR PHOTOCATALYTIC DEGRADATION OF ORGANOSYNTHETIC CHEMICALS IN POLLUTED WATER AND EFFLUENTS"
- Naser N. S.** 62 P
"Action Spectra of the Photopotential Generation for Pigment and Dye solutions in Nematic Liquid Crystals Located Electrochemical Cell"
- Naether D. U.** 63 P
"Spectral Output of Nanosecond Flashlamps"
- Ogino H.** {LECTURE}
"PHOTOENERGY STORAGE SYSTEM USING DIIRON COMPLEXES"
- Ottolenghi M.** {LECTURE}
"PROBING LIGHT ENERGY CONVERSION IN RETINAL PROTEIN: FEMTOSECOND SPECTROSCOPY AND ATOMIC FORCE SENSING"
- Pelizzetti E.**
"SOLAR PHOTOCATALYSIS FOR ENVIRONMENTAL DETOXIFICATION"
- Peter L. M.** {LECTURE}
"ANODIC DISSOLUTION OF p-Si IN FLUORIDE MEDIA: AN ELECTROCHEMICAL AND ELLIPSOMETRIC STUDY"
- Phillips D.**
"TIME RESOLVED RESONANCE RAMAN STUDIES OF ELECTRON-TRANSFER REACTIONS"

- Rady A. K.** 64 P
"Accelerated Synthesis of Salicyladoxime in Microwave Oven and the Factors affecting it"
- Rahman N.**
"HIGH ORDER HARMONIC GENERATION WITH STRONG LASERS AND MOLECULES"
- Rettig W.** {LECTURE}
"STRUCTURAL RELAXATION IN EXCITED STATES OF LARGE FLEXIBLE DONOR-ACCEPTOR BIAROMATIC SYSTEMS"
- Ryabchuk V. K.** 65 P
"The Spectral Selectivity of photocatalysts"
"The Mechanisms of Surface Photochemical Reactions: The Photostimulated Adsorption of O₂ on ZrO₂"
- Saladin F.** 66 P
"Photochemical Oxidation of Water at the Gas/Solid Interface of AgCl Supported on Zeolite A"
- Salem A. I.** 67 P
"Outdoor Testing and Solar Simulation for Oxazine 750 Laser Dye Luminescent Solar Concentrator"
- Sato H.** {LECTURE}
"NOVEL COORDINATION CHEMISTRY AND ORGANOMETALLIC CHEMISTRY OF MONOPOSITIVE METAL IONS IN THE GAS PHASE AS STUDIED BY THE LASER ABLATION - MOLECULAR BEAM METHOD"
- Schlag E. W.** {LECTURE}
"NEW RESULTS IN ZEKE SPECTROSCOPY"
- M. A. Mosalam Shaltout** 68 P
"Side Pumping Technique Model For Laser Pumped By Solar Energy"
- Shapira Y.** {LECTURE}
"ELECTRONIC STRUCTURE OF SOLAR CELL INTERFACES"
- Scheer H.** {LECTURE}
"RENEWABLE ENERGY AND ENVIRONMENT"
- Speiser S.** {LECTURE}
"SOME NOVEL ASPECTS OF INTRAMOLECULAR ELECTRONIC ENERGY TRANSFER"
- Spiewak I.** {LECTURE}
"WATER DETOXIFICATION AND DISINFECTION USING HIGH SOLAR CONCENTRATION AND HOMOGENEOUS PHOTOCATALYSTS"
- Steer R. P.** {LECTURE}
"ELECTRONIC ENERGY POOLING VIA EXCITED STATE ANNIHILATION"
- Steiger R.** 69 P
"Exciton Propagation in Programmed Arrangements of Dye Molecules"

Sundararajan P. R. {LECTURE}
"MOLECULAR DYNAMICS SIMULATIONS OF PROBE DYNAMICS IN POLY-CARBONATES AND THE FREE VOLUME"

Trabea A. A. 70 P
"Transmission of Heat Temperature in The Soil over Agrometerology Giza Station (Egypt)"

Trakhtenberg L. I. {LECTURE}
"PECULIARITIES OF CHEMICAL PHOTOCONVERSIONS IN SOLID PHASE"

Tributsch H. {OPENING LECTURE}
"CHALLENGES AND OPORTUNITIES IN PHOTOELECTROCHEMISTRY AND PHOTOCATALYSIS"

Vidal A. {LECTURE}
"USE OF CPC COLLECTORS FOR THE SOLAR DETOXIFICATION AND DISINFICION OF CONTAMINATED WATER"

Vujkovic Cvijin I. 71 P
"Photochemistry of o-Vinylstyryl Condensed Furans"

Uzhinov B. M. {LECTURE}
"LIGHT INDUCED EXCITED STATE STRUCTURAL RELAXATION IN ORGANIC MOLECULES"

Whitten D.
"SUPRAMOLECULAR AGGREGATES OF AMPHIPHILIC DYES AND AROMATICS: STRUCTURE, PHOTOPHYSICS AND PHOTOCHEMISTRY"

Yanagida S. {LECTURE}
"HYDROGEN TRANSFER PHOTOCATALYSIS FOR THE REDUCTION AND FIXATION OF CO₂"

Zayed M. F. 72 P
"The Photolysis of Carbendazim in Tetrahydrofuran"

LAST MINUTE POSTER CONTRIBUTIONS

Antonious M. S. 73 P
"Photoelectrochemistry of n-Si Semiconductor in Fluoride Media"

Shalan N. M. 74 P
"The Electron Affinity Difference in CdS/CdTe Solar Cells"

Nada A. A. 75 P
"The Construction of a Solar Photoreactor for Preparative Photochemistry"

Abd Rabbo M.F. 76 P
"Water Desalination Using Solar Energy"