



# DMSTTIAC

Defense Modeling, Simulation and Tactical Technology  
Information Analysis Center

DMSTTIAC SOAR 96-02

## Electromagnetic Spectrum Selection for Missile Seekers

Tutorial

Howard C. Race  
Chalmer D. George  
AMC-SWMO

J. Hunter Chockley  
Mark A. Scott  
IIT Research Institute

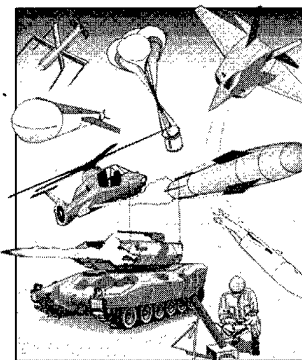

*Published by:*  
DMSTTIAC  
IIT Research Institute  
7501 S. Memorial Parkway, Suite 104  
Huntsville, AL 35802

Approved for Public Release;  
Distribution is Unlimited

March 1996

19961101 041

**NOTICES**

**State of the Art Review.** This state-of-the-art review has been published by the Defense Modeling, Simulation, and Tactical Technology Information Analysis Center (DMSTTIAC) as a service to both defense and non-defense agencies, academia and industry. DMSTTIAC is a DoD Information Analysis Center administered by the Defense Technical Information Center and operated by IIT Research Institute under contract DAAH01-95-C-0310. DMSTTIAC is funded by the Defense Technical Information Center (DTIC) and the Defense Modeling and Simulation Office (DMSO). The Director of DMSTTIAC is Mr. Hunter Chockley. The Contracting Officer is Ms. Cheryl Montoney, Defense Electronics Supply Center (DESC), Dayton, Ohio. The Technical Monitor is Mr. Chalmer D. George, and the Alternate is Mr. Howard C. Race, AMC-Smart Weapon Management Office (SWMO), Attn: AMSMI-SW, Redstone Arsenal, Alabama 35898-5222.

**Reproduction and Handling.** Unlimited Distribution

# DISCLAIMER NOTICE

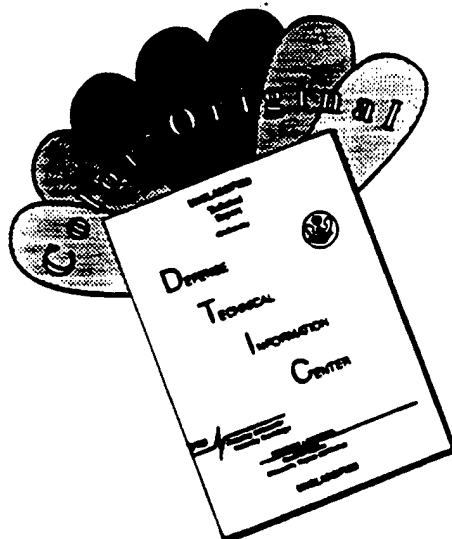

THIS DOCUMENT IS BEST QUALITY AVAILABLE. THE COPY FURNISHED TO DTIC CONTAINED A SIGNIFICANT NUMBER OF COLOR PAGES WHICH DO NOT REPRODUCE LEGIBLY ON BLACK AND WHITE MICROFICHE.

# REPORT DOCUMENTATION PAGE

*Form Approved*  
OMB No. 0704-0188

Public reporting burden for the collection of information is estimated to average 1 hour per response, including the time for reviewing instructions, searching existing data sources, gathering and maintaining the data needed, and completing and reviewing the collection of information. Send comments regarding this burden estimate or any other aspect of this collection of information including suggestions for reducing the burden, to Washington Headquarters Services, Directorate for Information Operations and Reports, 1215 Jefferson Davis Highway, Suite 1204, Arlington, VA 22202-4302, and to the Office of Management and Budget, Paperwork Reduction Project (0704-0188), Washington, DC 20503

1. AGENCY USE ONLY (Leave blank)	2. REPORT DATE March 1996	3. REPORT TYPE AND DATES COVERED State-of-the-Art-Review; March 1996
----------------------------------	------------------------------	---

4. TITLE AND SUBTITLE Electromagnetic Spectrum Selection for Missile Seekers, Tutorial	5. FUNDING NUMBERS DAAH01-95-C-0310
6. AUTHOR(S) J. Hunter Chockley Mark A. Scott	

7. PERFORMING ORGANIZATION NAME(S) AND ADDRESS(ES) IIT Research Institute/DMSTTIAC 7501 S. Memorial Parkway, Suite 104 Huntsville, AL 35802	8. PERFORMING ORGANIZATION REPORT NUMBER  DMSTTIAC SOAR 96-02
--	---

9. SPONSORING/MONITORING AGENCY NAME(S) AND ADDRESS(ES) U.S. Army Missile Command ATTN: AMSMI-SW Redstone Arsenal, AL 35898-5222	10. SPONSORING/MONITORING AGENCY REPORT NUMBER
---	--

11. SUPPLEMENTARY NOTES  
This document is available only from DMSTTIAC, IIT Research Institute, 10 West 35th Street, Chicago, IL 60616-3799.

12a. DISTRIBUTION/AVAILABILITY STATEMENT Approved for public release; distribution unlimited	12b. DISTRIBUTION CODE "A"
---	-------------------------------

13. ABSTRACT (Maximum 200 words)  
The implementation of an autonomous smart weapon system, such as surface/air-to-air or surface/air-to-ground missiles presents an engineering challenge to the system and seeker/sensor designers. This is due to a wide variety of targets, backgrounds, countermeasures, and weather conditions expected for each scenario. The seeker/sensor design requires engineering tradeoffs by the designers, such as size constraints, detection/tracking performance, and search volume to name a few. All of these tradeoffs tend to determine the selection of the electromagnetic spectrum by which the seeker/sensor will operate. Therefore, this document presents a tutorial on the electromagnetic spectrum selection for missile seekers.

DTC QUALITY IMPROVEMENT

14. SUBJECT TERMS Seeker, Sensor, Smart Weapon, Smart Missile, Millimeter Wave, Infrared, Dual Mode, Multi Mode, Multi Sensor, Electromagnetic Spectrum, Radio Frequency, RF, MMW, IR, Sensor Fusion, Data Fusion	15. NUMBER OF PAGES 30
	16. PRICE CODE \$35.00

17. SECURITY CLASSIFICATION OF REPORT Unclassified	18. SECURITY CLASSIFICATION OF THIS PAGE Unclassified	19. SECURITY CLASSIFICATION OF ABSTRACT Unclassified	20. LIMITATION OF ABSTRACT Unclassified
---	--	---	--

## Foreword

Technology is an important ingredient in having an effective military. Technology provides the military with advanced capabilities in communications resulting in rapid response as well as precision strike weapon systems resulting in robust effectiveness. As technology matures, more and more "smart" systems will evolve. The unique operational and technical nature of these smart systems has given rise to a variety of sensor/seeker technologies available to the designer.

There is no "one" perfect sensor technology to be used in a missile seeker system, but instead there is in many cases "one" better technology given the constraints. This document was written as a tutorial for those who wish to develop an understanding as to the selection of a particular technology implemented in autonomous missile sensor/seeker designs.

## Table of Contents

<b>1.0 INTRODUCTION</b> .....	1
<b>2.0 ELECTROMAGNETIC SPECTRUM DISCUSSIONS</b> .....	2
2.1 Infrared .....	3
2.2 Radio Frequency (RF) .....	6
<b>3.0 MULTISENSOR DATA FUSION</b> .....	8
<b>4.0 POTENTIAL MULTI-MODE/DUAL MODE CONCEPTS</b> .....	9
4.1 18 GHz (Ku band) Radar/ 8-12 $\mu\text{m}$ or 3-5 $\mu\text{m}$ Focal Plane Array .....	9
4.2 18 GHz (Ku band)/ 35 GHz (Ka band) Radar .....	9
4.3 35 Gz (Ka band) Radar/ 8-12 $\mu\text{m}$ or 3-5 $\mu\text{m}$ Focal Plane Array .....	10
4.4 Option 4.1, 4.2, or 4.3 with Passive RF Radiometer .....	10
<b>5.0 FUNDAMENTALS OF SENSOR FUSION</b> .....	11
<b>6.0 BATTLEFIELD PHENOMENA</b> .....	15
<b>7.0 SUMMARY</b> .....	17
<b>APPENDIX A - Electromagnetic Spectrum</b> .....	A-1
<b>APPENDIX B - Executive Wall Charts</b> .....	B-1

## List of Figures

Figure 1. Simplified Radar/Infrared Sensor Block Diagram .....	2
Figure 2. Electromagnetic Spectrum .....	3
Figure 3. Emittance vs. Wavelength for Specific Temperatures .....	4
Figure 4. Sequential and Simultaneous Sensor Fusion .....	8
Figure 5. Examples of Radar Receiver Output Amplitude for Target Returns Compared to Receiver Noise .....	11
Figure 6. Examples of IR Contrast .....	12
Figure 7. Fusion of Radar and IR Measurements into 2-D Observations .....	14
Figure A-1. Acoustic (Mechanical) Spectrum .....	A-2
Figure A-2. Electronic Spectrum .....	A-3

## List of Tables

Table 1. Comparisons of IR Regions .....	6
Table 2. Effect on Seeker Characteristics as Frequency is Increased .....	7

## List of Wall Charts

Chart 1. Weather Effects on EO/IR/MMW Sensors .....	B-2
Chart 2. Countermeasures Effects on Smart Weapon Sensors .....	B-3
Chart 3. Effects of Battle By-Products on Smart Weapon Sensors .....	B-4
Chart 4. Camouflage, Concealment, and Deception (CCD) Effects on Smart Weapon Sensors .....	B-5

## 1.0 INTRODUCTION

The implementation of an autonomous smart weapon system, such as surface/air-to-air or surface/air-to-ground missiles presents an engineering challenge to the system and seeker/sensor designers. Achievement of objectives may require missiles employing single as well as multi-spectral seekers.

The selection of the electromagnetic spectrum(s) to be used by the seeker requires engineering tradeoffs by the designers. These tradeoffs involve many variables such as missile diameter/volume constraints, acquisition range/tracking accuracies, target position uncertainty (which drives search volume requirements), target(s) characteristics (size, temperature, radar cross section, velocity, altitude), natural background (sky, ground, trees, dust, rural/urban, seasonal, night/day), weather (rain, clouds, fog, snow), and countermeasures (signature suppression, decoys, jammers).



## 2.0 ELECTROMAGNETIC SPECTRUM DISCUSSIONS

The seeker links the missile to the outside world and is used to detect and track targets. The sensor is sensitive to the electromagnetic radiation incident upon its aperture. This radiant energy can come from any of the following sources: reflection from the target, emittance from the target, and/or emittance/reflectance from the target's background (rocks, trees, sun, clouds, etc.). In response to this energy, the sensor produces internal electrical signals which are sent to the signal processing electronics. The sensor output is processed for target detection and possibly recognition by the electronics to determine the appropriate guidance commands for missile intercept. A simplified diagram is shown in Figure 1.

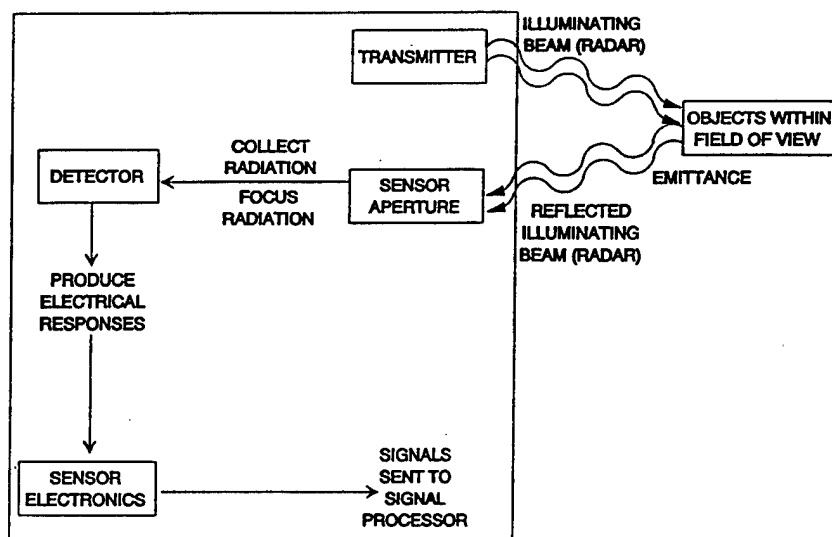

**Figure 1. Simplified Radar/Infrared Sensor Block Diagram**

The electromagnetic spectrum can be partitioned into radio frequency and infrared wavebands as illustrated on the horizontal axis of Figure 2. One important aspect of spectrum selection for a seeker is consideration of the associated atmospheric attenuation that is indicated on the vertical axis of Figure 2. The desirable points on the curve are the valleys (marked with a circle) which correspond to wavebands of minimum atmospheric attenuation or "atmospheric windows" as they are commonly referred to.

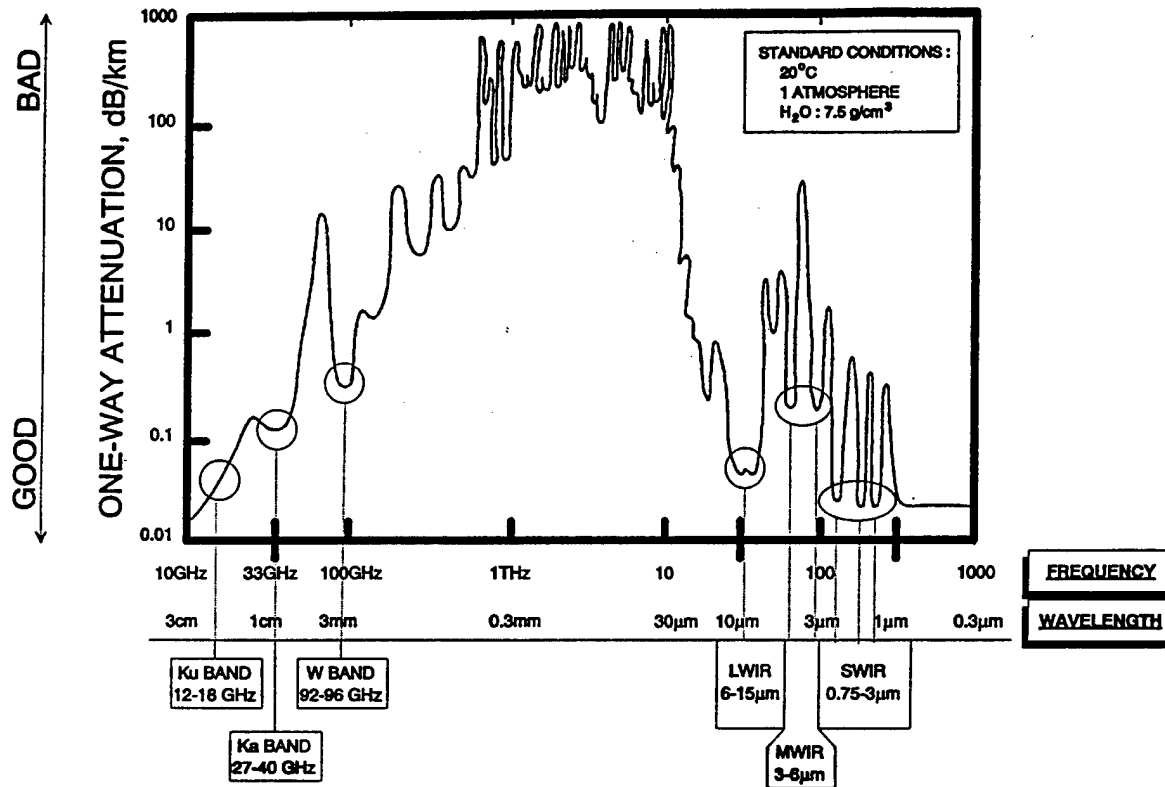

**Figure 2. Electromagnetic Spectrum**

Accordingly, the common nominal infrared wavebands are 0.75-3 µm (short wave IR), 3-6 µm (mid wave IR), and 6-15 µm (long wave IR). The corresponding common nominal radio frequency bands are 9-12 GHz (X band), 12-18 GHz (Ku band), 27-40 GHz (Ka band), and 92-96 GHz (W band). The 35 and 94 GHz regions are commonly referred to as millimeter wave frequencies by the seeker community. Appendix A contains a much broader electromagnetic spectrum which covers all sensor technologies.

**2.1 Infrared**

All objects possessing a temperature above absolute zero (minus 459.67 degrees fahrenheit) emit radiation. This thermally generated radiation occurs in all regions of the IR

spectrum. The amount of IR radiation from a particular waveband is a function of the temperature and material characteristics of an object such as emissivity (the ability to emit radiation). An ideal radiator is called a blackbody which possesses an emissivity of "one" (ideal). Plank's law provides the spectral radiant emittance of a blackbody as a function of temperature. Figure 3 shows the distribution of radiant emittance as a function of wavelength for a blackbody at various temperatures. The bottom portion has been rescaled to show the emittance of the various wavelengths at cooler temperatures.

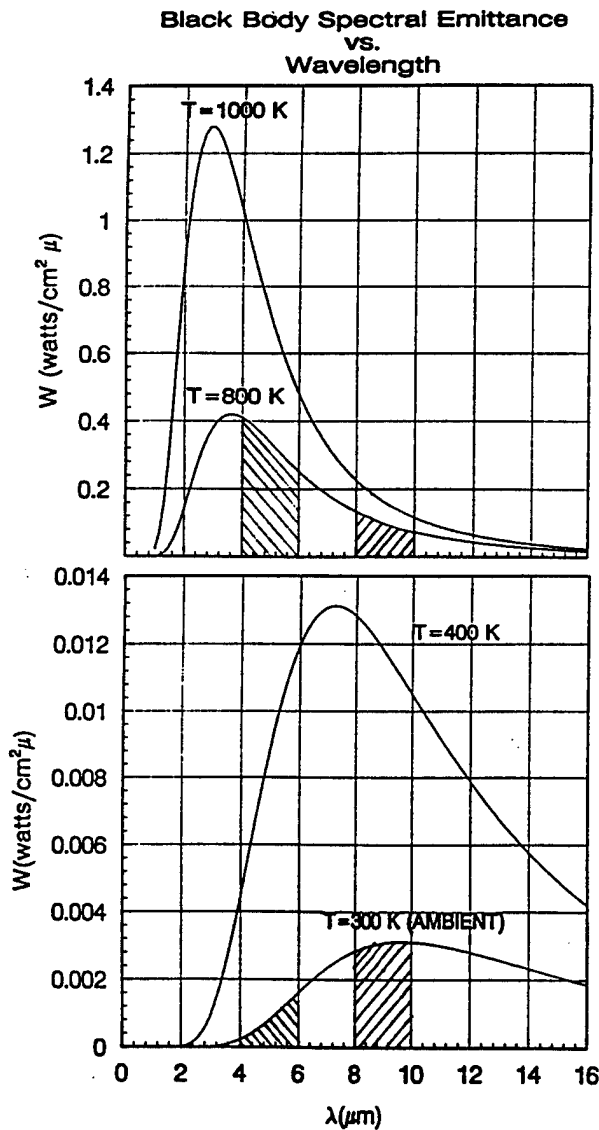

Figure 3. Emittance vs Wavelength For Specific Temperatures

The area under a particular temperature curve over the waveband of interest determines the amount of spectral emittance in that region of the spectrum. The spectral emittance resident in the 4-6  $\mu\text{m}$  and 8-10  $\mu\text{m}$  wavebands at 300° K are illustrated by the shaded areas in Figure 3. At lower temperatures there is considerably more energy in the 6-15  $\mu\text{m}$  region than in the 3-6  $\mu\text{m}$  region. For example at 80.3°F (300°K-ambient) approximately 38% of the total radiation is in the 6-15  $\mu\text{m}$  region as compared to 1.3% in the 3-6  $\mu\text{m}$  and 0.009% in the 0.75-3  $\mu\text{m}$  regions. Consequently, the 6-15  $\mu\text{m}$  region generally performs better against a cooler target than 3-6  $\mu\text{m}$  and 0.75-3  $\mu\text{m}$  regions. However, as the temperature is increased the percentage of the emittance in the .75-3  $\mu\text{m}$  and 3-6  $\mu\text{m}$  regions increase with a corresponding percentage decrease in the 6-15  $\mu\text{m}$  region. At these hotter temperatures the 3-6  $\mu\text{m}$  region performs better than the 6-15  $\mu\text{m}$  and the 0.75-3  $\mu\text{m}$  regions. At very hot temperatures (>1200°K) the percentage of emittance is greater for the 0.75-3  $\mu\text{m}$  region as compared to 3-6  $\mu\text{m}$  and 6-15  $\mu\text{m}$  regions.

The 0.75-3  $\mu\text{m}$  region is not normally used in "passive" missile seeker applications because typical targets (at temps less than 1000°K) passively emit "thermal radiation" which is characteristic in the mid/long wave IR bands. However, the 0.75-3  $\mu\text{m}$  region is used in "active" or "semi-active" missile seeker systems which require a source designator such as a LASER. Most LASER sources used produce stimulated radiation emissions in the 0.75-3  $\mu\text{m}$  window.

The advantages and disadvantages of the two IR spectral regions commonly used for "passive" missile seekers is shown in Table 1.

**Table 1. Comparison of IR Regions**

Spectrum Region	Advantages	Disadvantages
3-6 $\mu\text{m}$ (MWIR)	<ul style="list-style-type: none"> <li>• Responsive to hotspots</li> <li>• Good contrast with hot object against an ambient background</li> <li>• Technology is very mature/low cost</li> <li>• Multiple detector material selection</li> <li>• More design tolerance</li> </ul>	<ul style="list-style-type: none"> <li>• Poorer performance against cool targets</li> <li>• Atmospheric attenuation (under the conditions specified in Figure 2. See note 1).</li> </ul>
6-15 $\mu\text{m}$ (LWIR)	<ul style="list-style-type: none"> <li>• Responsive to cool targets</li> <li>• Less atmospheric attenuation (under the conditions specified in Figure 2. See Note 1)</li> </ul>	<ul style="list-style-type: none"> <li>• Technology not as mature/higher cost</li> <li>• Limited detector material selection</li> </ul>

*Note 1: Atmospheric attenuation is heavily dependent upon range, temperature and humidity. Regions of crossover exists where MWIR attenuation is lower than LWIR.*

IR seekers can be used in scanning or staring modes. LWIR scanning systems would have better performance than MWIR scanning systems. However, MWIR staring systems with longer integration times may provide the needed performance.

## 2.2 Radio Frequencies (RF)

Radio frequency selection involves engineering tradeoffs among several critical factors which impact seeker characteristics and performance. These factors include physical size, transmit power, bandwidth, beamwidth, atmospheric attenuation, cost, and maturity of components. Table 2 summarizes the effect on performance and seeker characteristics as the frequency is increased.

**Table 2. Effect On Seeker Characteristics As Frequency Is Increased**

<b>Effect on Seeker Characteristics by Increasing Frequency</b>	<b>Advantage / Disadvantage</b>	<b>Source of Effect</b>
<ul style="list-style-type: none"> <li>• Decrease size and weight</li> </ul>	Advantage	<ul style="list-style-type: none"> <li>• Smaller and lighter components</li> </ul>
<ul style="list-style-type: none"> <li>• Improve detection of stealth targets</li> <li>• Increase Doppler resolution</li> </ul>	Advantage	<ul style="list-style-type: none"> <li>• Higher frequency particularly at millimeter wave frequencies</li> </ul>
<ul style="list-style-type: none"> <li>• Increase range resolution</li> <li>• Spread spectrum for ECCM</li> </ul>	Advantage	<ul style="list-style-type: none"> <li>• Larger bandwidth practical at millimeter wave frequencies</li> </ul>
<ul style="list-style-type: none"> <li>• Improve tracking accuracy</li> <li>• Increase angular resolution</li> <li>• Reduce multi-path and clutter</li> <li>• Higher gain</li> <li>• More jam resistant</li> <li>• Improve image quality and classification</li> </ul>	Advantages	<ul style="list-style-type: none"> <li>• Narrower beamwidth &amp; lower sidelobes</li> </ul>
<ul style="list-style-type: none"> <li>• Decrease target search capability</li> </ul>	Disadvantage	<ul style="list-style-type: none"> <li>• Narrower beamwidth</li> </ul>
<ul style="list-style-type: none"> <li>• Increase atmospheric losses</li> </ul>	Disadvantage	<ul style="list-style-type: none"> <li>• Increase absorption and scattering</li> </ul>
<ul style="list-style-type: none"> <li>• Shorter Acquisition ranges</li> </ul>	Disadvantage	<ul style="list-style-type: none"> <li>• Less transmit power</li> </ul>
<ul style="list-style-type: none"> <li>• Increase cost and schedule risk</li> </ul>	Disadvantage	<ul style="list-style-type: none"> <li>• Technology less mature at higher frequencies (particularly at 94 GHz and higher)</li> </ul>

### 3.0 MULTISENSOR DATA FUSION

Missile seekers employing sensor suites require an architecture for employing the outputs of more than one sensor. Complementary sensor characteristics, such as acquisition range versus tracking accuracy, can be exploited by sequential employment of sensors. In addition, simultaneous employment of multisensor data may be required to provide the margin of performance enhancement necessary to acquire and track challenging targets such as low observable - stealth targets at low altitude (see Figure 4). Section 5.0 describes the fundamentals of using sensor fusion for increased acquisition performance.

**Coarse acquisition sensor hands off target to high resolution terminal engagement sensor**

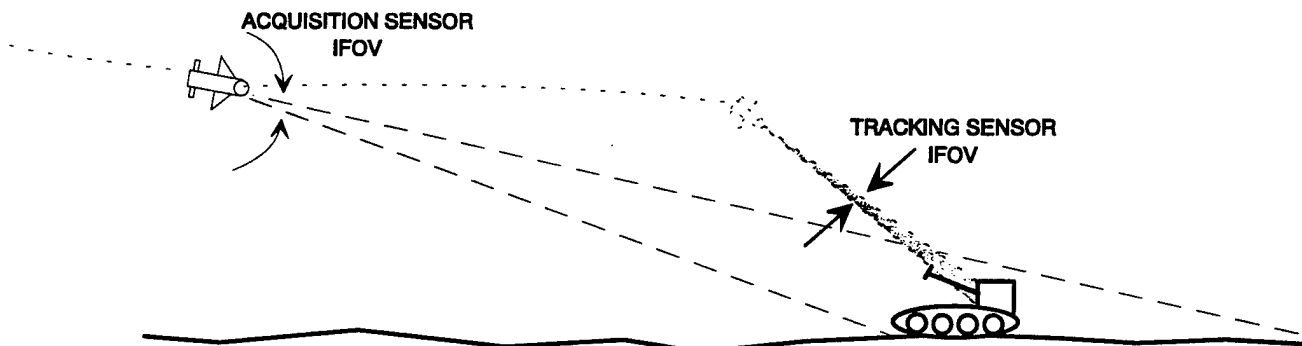

**Sequential Sensor Fusion**

**Sensor A and Sensor B provide acquisition and track functions**

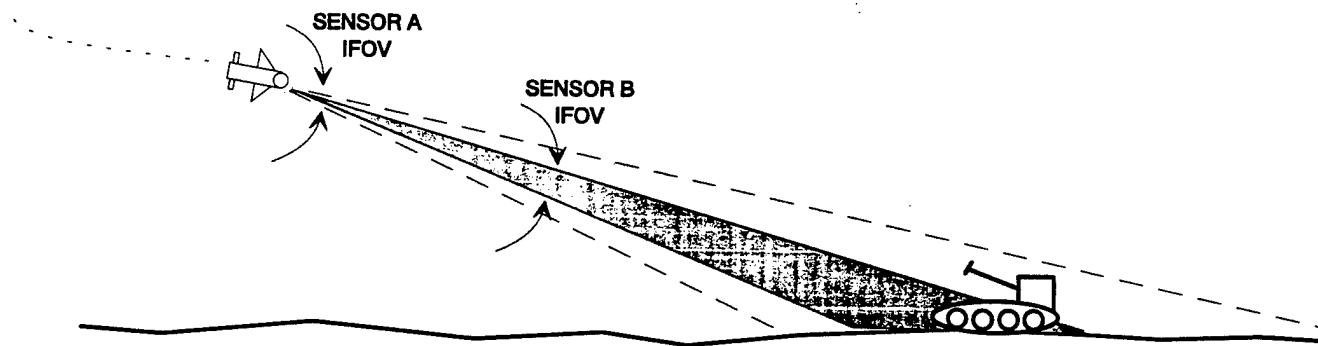

**Simultaneous Sensor Fusion**

**Figure 4. Sequential and Simultaneous Sensor Fusion**

## **4.0 POTENTIAL MULTI-MODE/DUAL MODE CONCEPTS.**

Often, due to the diversity of target and background sets, utilization of multi-mode/dual mode seeker concepts can be expected from industry. This would permit the missile to operate in a more diverse battle environment. There are numerous ways to implement multi-spectral seekers.

### **4.1 18 GHz (Ku band) Radar/ 8-12 $\mu\text{m}$ or 3-5 $\mu\text{m}$ Focal Plane Array**

The primary employment mode for this sensor suite would be sequential with the radar acquiring the target at greater ranges and then handing off to the IR sensor for more accurate tracking in the end-game. The radar could shut down after hand-off for covertness. Alternately, the radar could actively track the target in concert with the IR sensor for improved track continuity in the event of countermeasure employment or a cloud obscured line-of-sight to the target.

For low observable targets at low altitude, target acquisition performance enhancement could potentially be realized via a sensor fused operating mode where detection decisions are based on combined radar/IR observations.

### **4.2 18 GHz (Ku band)/ 35 GHz (Ka band) Radar**

The primary operating mode for this frequency diverse combination of radars would also be sequential. The 18 GHz frequency would be the primary frequency for acquisition with better ranging capability. The 35 GHz millimeter wave frequency would provide primary tracking for higher angular resolution. Frequency switching could be employed in a jamming environment. The MMW frequency could also prove useful in assisting the acquisition of heavily stealthed targets, since stealth techniques are usually aimed at microwave frequencies.



#### **4.3 35 Gz (Ka band) Radar/ 8-12 $\mu\text{m}$ or 3-5 $\mu\text{m}$ Focal Plane Array**

This combination of sensors offers the above cited advantages of millimeter wave frequencies compared to microwave frequencies at the cost of decreased radar acquisition range. Accordingly, this sensor suite would need to depend more heavily on a sensor fused mode of operation to raise the acquisition capability of the sensor suite above that of the individual sensors.

#### **4.4 Option 4.1, 4.2, or 4.3 with Passive RF Radiometer**

The addition of an RF radiometer to one of the radar/IR dual mode suites represents a potentially very powerful combination of sensors. The radiometer would be designed to detect microwave emissions from the target within the band from 2 to 18 GHz. This sensing capability could prove extremely valuable in acquiring emissions from the RF altimeters of terrain following cruise missiles. The radiometer could significantly augment the detectability of this type of low observable target whose response in the radar and IR channels will often be quite weak.

## 5.0 FUNDAMENTALS OF SENSOR FUSION

Sensors detect targets by measuring quantities associated with the target that are well-separated from the corresponding quantities associated with the background scene or other sources of interference. For example, Figure 5 shows that the radar signal returns from a target aircraft are usually greater in amplitude than the noise voltage in the radar receiver electronics. This separation between the radar measurements associated with target returns and those associated with receiver noise permits the placement of a detection threshold which effectively segregates the two "clusters" of measurements. When a radar measurement exceeds this threshold, a target can be declared present with high confidence.

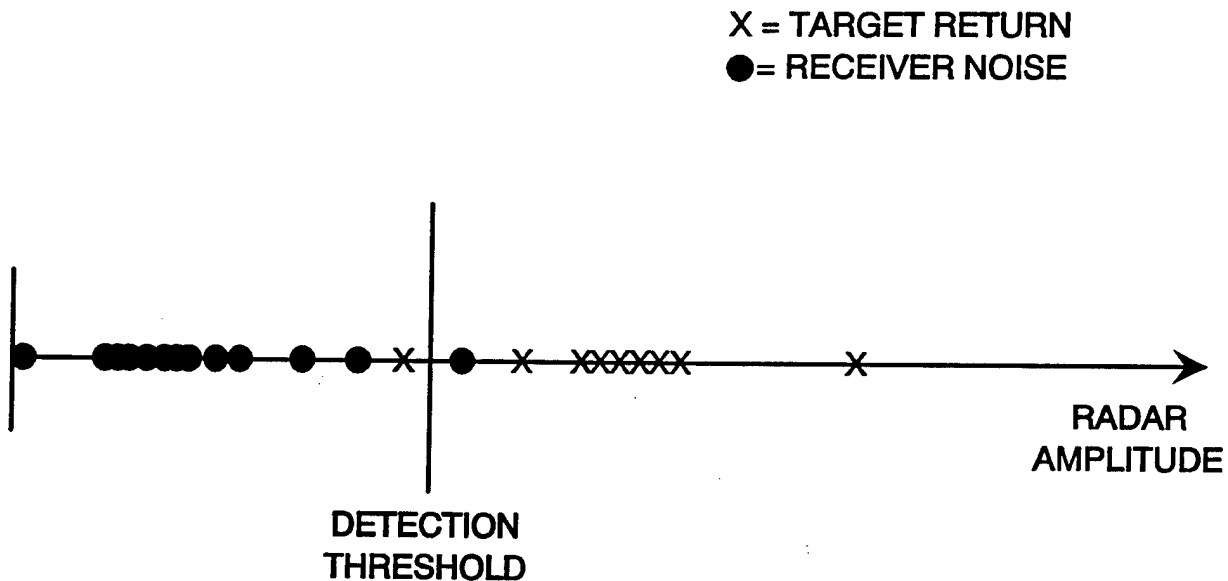

**Figure 5. Examples of Radar Receiver Output Amplitude for Target Returns Compared to Receiver Noise**

However, occurrences of usually large noise voltage can occasionally exceed the threshold (see Figure 5) resulting in the false indication of a target (i.e., a false alarm). Similarly, weak returns from a target may occasionally fall below the threshold resulting in a missed target. Accordingly, the radar designer minimizes the occurrence of false alarms and misses by maximizing the separation between the "clusters" of target and noise related measurements. Maximizing this separation is synonymous with maximizing the ratio of target signal power to noise power, i.e., maximizing the signal-to-noise ratio (SNR) that is commonly referred to in radar literature.

For an infrared (IR) sensor, the contrast in the intensity of IR radiation observed between the target and the background is usually greater than the contrast in the background scene (see Figure 6). This separation between IR measurements associated with a target and those associated with background clutter permits the placement of a detection threshold similar to the radar example just considered. Also, as in the radar case, it is possible for weak target contrast to fall below the threshold resulting in a missed target and for strong background clutter to exceed the threshold causing a false alarm. Again, designing the sensor to maximize the separation between the "clusters" of target and background contrast measurements will minimize the probability of making an erroneous decision and optimize the detection performance of the sensor.

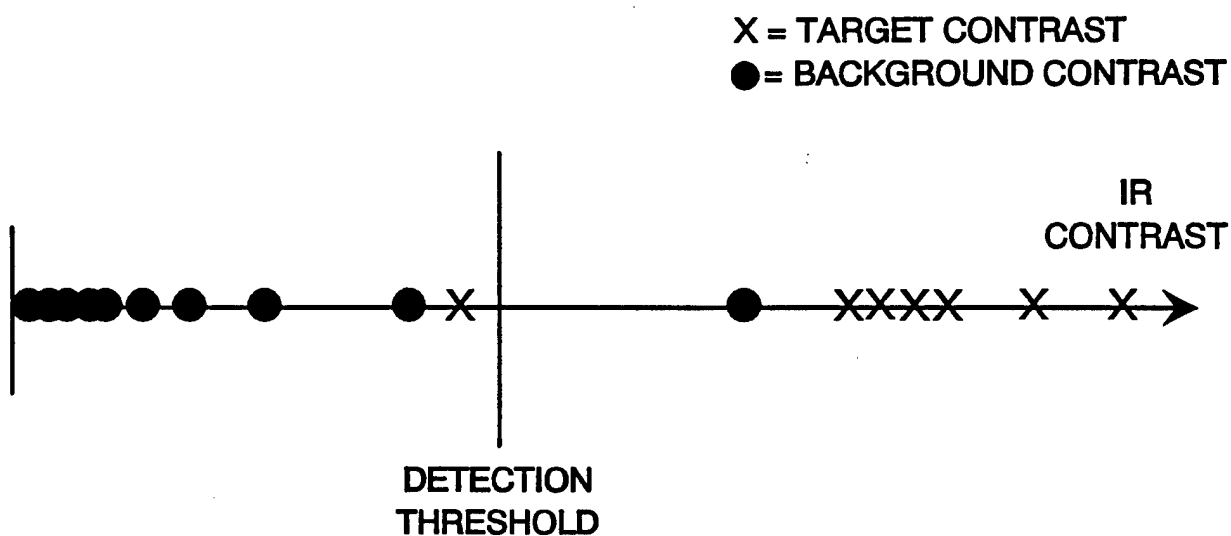
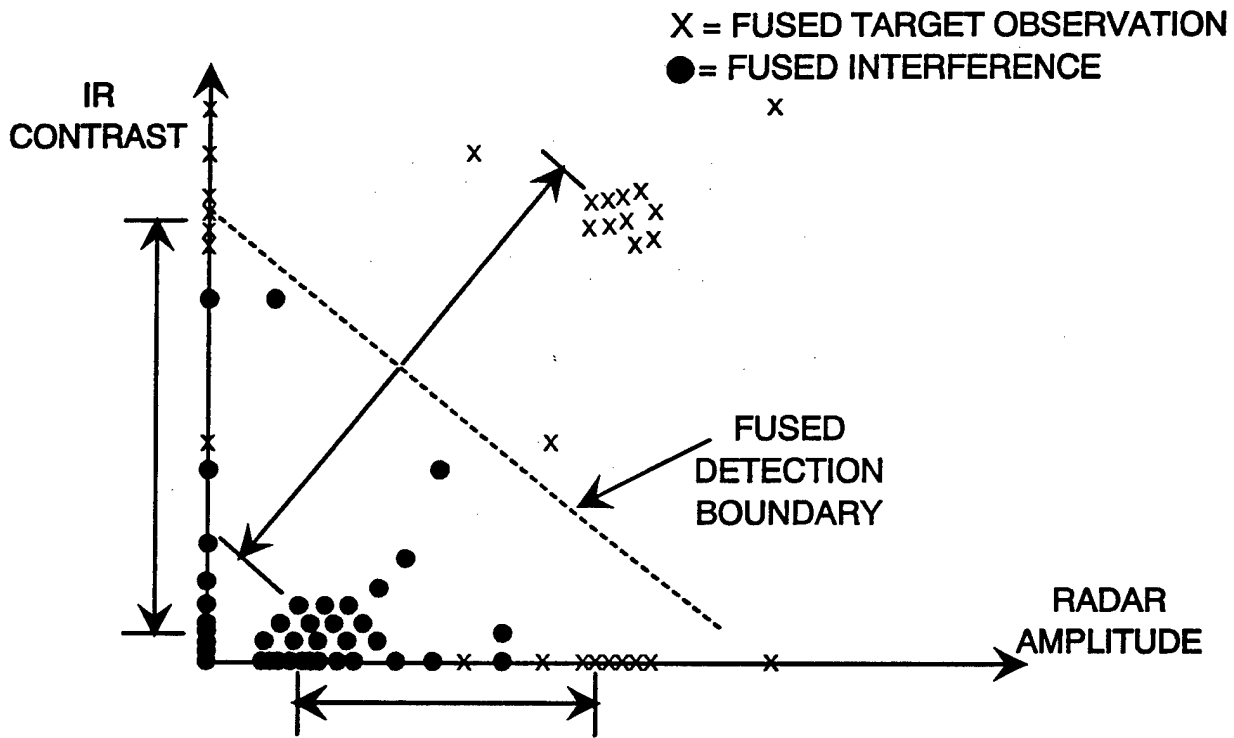

**Figure 6. Examples of IR Contrast**

Fusing synchronized sensor measurements together into a multidimensional observation is a means of achieving further separation between the "clusters" of target and interference measurements. This is apparent in Figure 7 where the sample radar and IR measurements from Figures 5 and 6 have been plotted as orthogonal coordinates. Associated radar and IR measurements are plotted 2- dimensionally (radar amplitude = x-component; IR contrast = y-component).

The separation between cluster centroids for the radar, IR, and fused measurements are indicated by the two-ended arrows in Figure 7. The increased cluster separation realized via fusion is merely a result of geometry - the magnitude of the vector separation is greater than any of its individual components.

It is this increased separation between target and interference related measurements that is the physical basis/source of detection performance enhancement for any implementation of a fused multisensor mode of operation. This increased separation effectively constitutes an increase in the signal-to-noise ratio upon which detection decisions are based. The increased separation makes it easier (compared to single sensor operation) to position a decision boundary which segregates target and interference related measurements into separate regions (see the dashed line in Figure 7). It then becomes less likely that a measurement associated with a weak target will fall below the decision boundary and cause a target to be missed. Similarly, it also becomes less likely that strong interference will rise above the boundary and cause a false alarm. Sensor fused operation thus holds the potential to simultaneously provide higher detection probability and lower false alarm probability than can be achieved with a single sensor.



**Figure 7. Fusion of Radar and IR Measurements  
into 2-D Observations**

The multidimensional measurement space concept, shown in Figure 7, represents the fundamental analytical tool for bounding the maximum theoretical fused detection performance of a given sensor suite. This performance bound can be usefully employed as a yardstick to test the reasonableness of a contractor's fusion performance claims.

## 6.0 BATTLEFIELD PHENOMENA

There are many elements of modern day battlefields that can impact the performance of missile seekers. Of these elements, it can only take one for which the sensor was not designed can defeat an entire weapon system. All effects which could potentially be a factor on the battlefield should be considered when designing and developing specifications for missile sensors/seekers.

An understanding of all realistic battlefield phenomena is crucial for successful weapon employment, weapon survivability, and training. Appendix B contains executive charts illustrating four (4) areas of battlefield phenomena (i.e., weather effects, countermeasures, dirty battlefield, and camouflage, concealment, and deception (CCD)) and the impact on smart weapon sensors and seekers. The executive charts are a product of a series of studies sponsored by the U. S. Army Materiel Command - Smart Weapons Management Office (AMC-SWMO). The primary purpose of these studies has been to identify and categorize the phenomena and develop a methodology to assess their impact.

The first study focused on the impact of weather on smart weapon sensors/seekers. One of the main objectives of this study was to present a concise methodology for preparing weather specification for sensors associated with smart weapon systems. The "Smart Weapons Weather Specification Guide", AMC-SWMO, 31 October 1990 was produced to outline the procedure. Another product from the study included a wall chart entitled "Weather Effects on EO/IR/MMW Sensors" which is included in appendix B.

Countermeasures (CMs) were the focus of the second study "AMC-SWMO Countermeasures Study, Volume I: Guide to How Countermeasures Affect Smart Weapons", January 1992. There were two primary objectives of this study - to address several technical issues on the effects of CMs on smart weapon systems and to introduce the organizations that are key in the specification, development, and evaluation of smart weapon CMs. The technical issues included a description of the various CMs, a methodology to assess the impact of CMs on

smart weapon systems, and the application of this methodology to five specific systems. The executive wall chart titled "Countermeasure Effects on Smart Weapon Sensors" was developed and is included in appendix B.

A third study addressed the effects of battle by-products on smart weapon sensors. Battle by-products is defined as "the phenomena produced by military operations that unintentionally reduce the operational effectiveness of an activity or capability". A methodology was developed to assess the impact of the battle by-products on smart weapon sensors and seekers. Several effectiveness models and phenomenology models and databases were reviewed to assess their applicability to the methodology. This was not a model survey; it was an assessment of several accepted models to demonstrate how to utilize available tools in the methodology. The methodology was then applied to two representative smart weapon concepts. Results of this study are documented in a two-volume report "The Effects of Battle By-Products on Smart Weapon Sensors", AMC-SWMO, March 1994, and an executive wall chart which is included in appendix B.

The fourth study also produced an executive wall chart included in appendix B titled "Camouflage, Concealment and Deception (CCD) Effects on Smart Weapons Sensors", AMC-SWMO. The purpose of the wall chart is to provide basic information on the Government CCD organization, the CCD development cycle and CCD techniques as they relate to the operation of smart weapons sensors.

## 7.0 SUMMARY

There is no "one" perfect sensor technology to be used in a missile seeker. The environment, target signature, background and countermeasures as well as size, cost and complexity constraints require many engineering tradeoffs leading to the final selection of seeker operating spectrum(s). It is generally accepted that the use of more than one seeker spectrum for a particular mission broadens the operational envelope.



## **Appendix A**

### **Electromagnetic Spectrum**

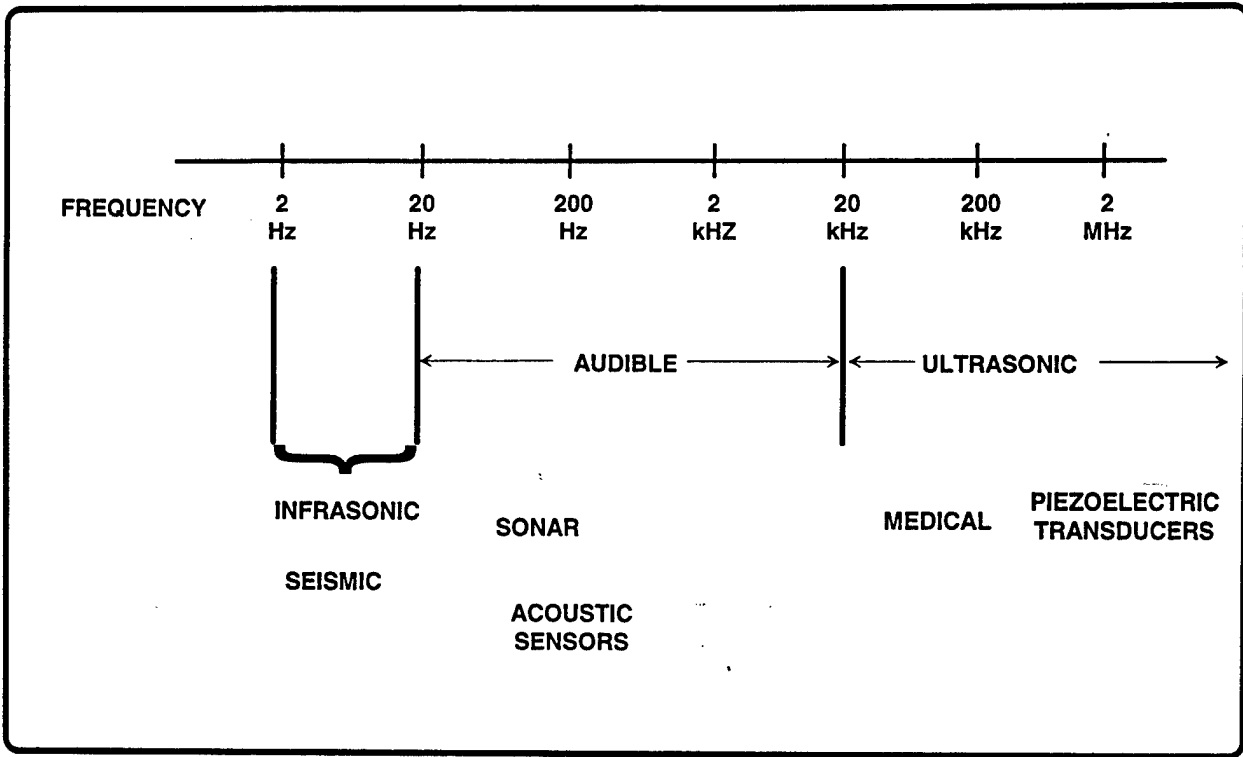

**Figure A-1. Acoustic (Mechanical) Spectrum**

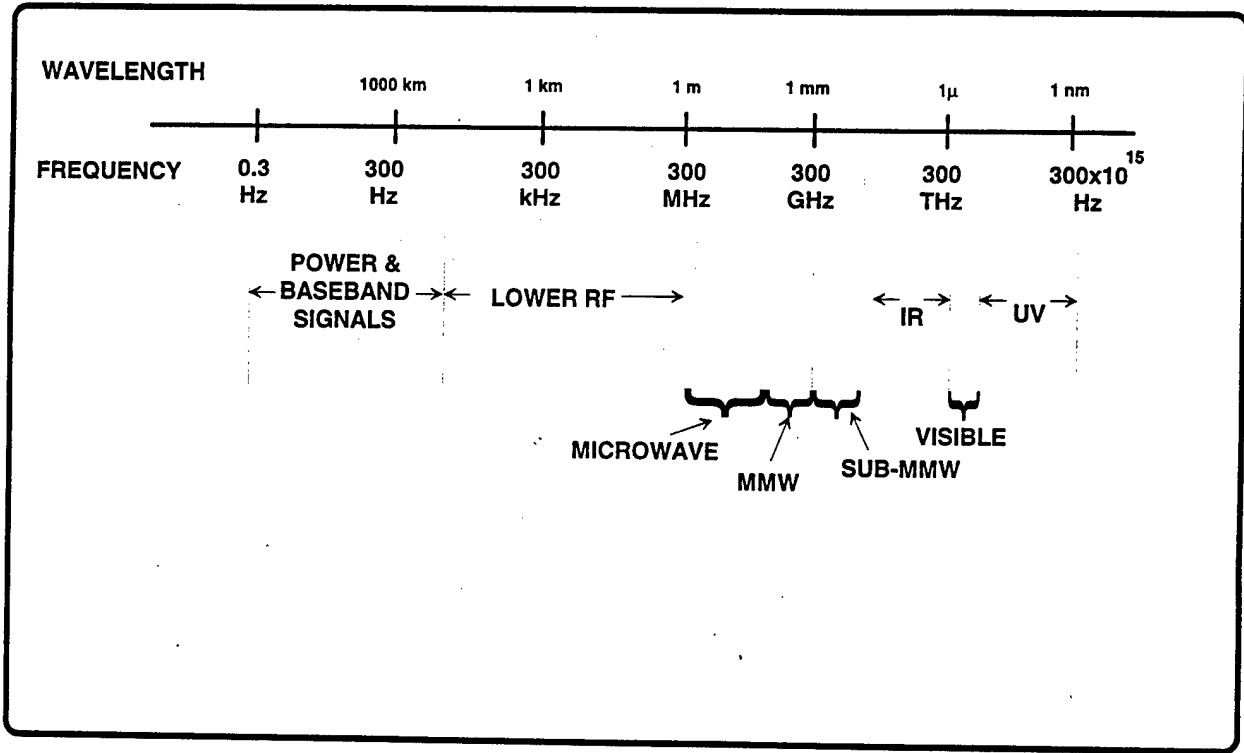

Figure A-2. Electromagnetic Spectrum

## **Appendix B**

### **Executive Wall Charts**



# WEATHER EFFECTS

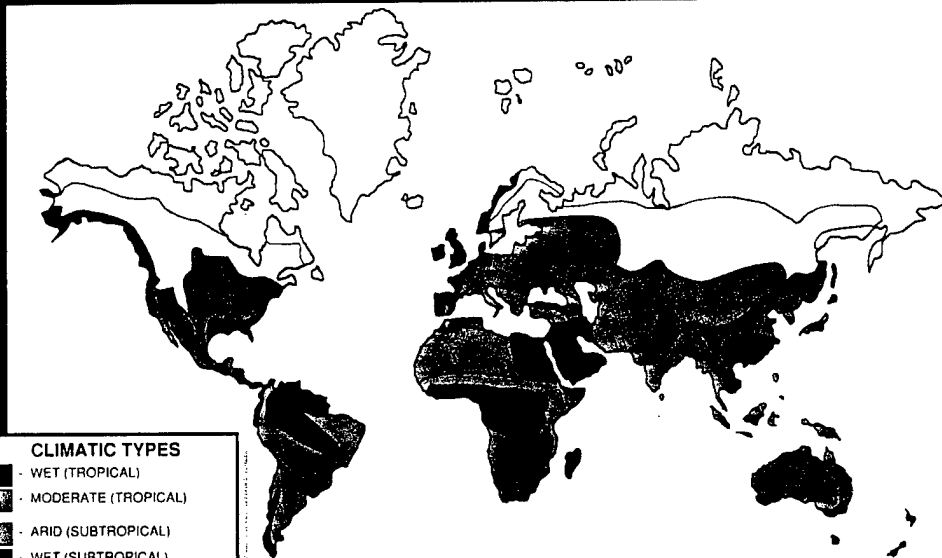

- CLIMATIC TYPES**
- - WET (TROPICAL)
  - - MODERATE (TROPICAL)
  - - ARID (SUBTROPICAL)
  - - WET (SUBTROPICAL)
  - - CONTINENTAL (TEMPERATE)
  - - MARITIME (TEMPERATE)
  - - TIGA (MODERATE)
  - - TUNDRA (DRY)

- SAMPLE CLIMATIC REGIONS**
- - CENTRAL AMERICA (ATLANTIC SIDE) - TYPICAL OF WET (TROPICAL) CLIMATIC TYPE
  - - EUROPEAN LOWLANDS - TYPICAL OF MARITIME (TEMPERATE) CLIMATIC TYPE
  - - MIDEAST DESERTS - TYPICAL OF ARID (SUBTROPICAL) CLIMATIC TYPE

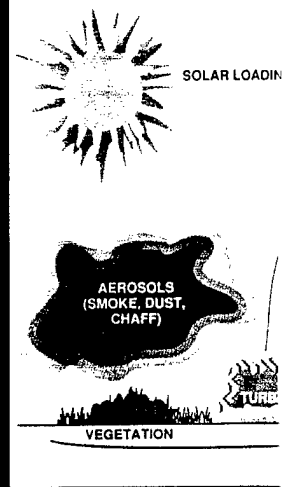

WEATHER PARAMETERS	VISIBLE AND NEAR
LOW VISIBILITY	SEVERE
RAIN/SNOW	MODERAT
HIGH HUMIDITY	LOW
FOG/CLOUD	SEVERE
PHOSPHORUS/DUST	SEVERE
FOG OIL/SMOKE	SEVERE

CUMULATIVE PROBABILITY OF OCCURRENCE YIELDS THE PROBABILITY THAT THE WEATHER PARAMETER WILL BE AT THE INDICATED VALUE OR LESS

— CENTRAL AMERICA (ATLANTIC SIDE)  
 — EUROPEAN LOWLANDS  
 — MIDEAST DESERTS

SOLID LINES - CUMULATIVE PROBABILITY  
 SHADED LINES - PROBABILITY DENSITY

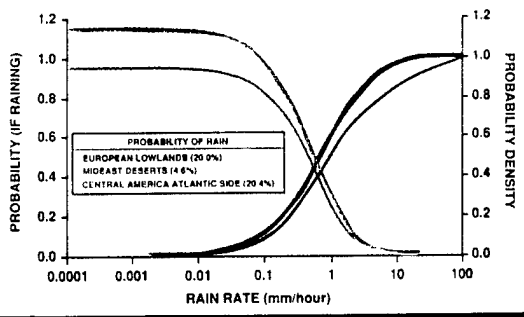
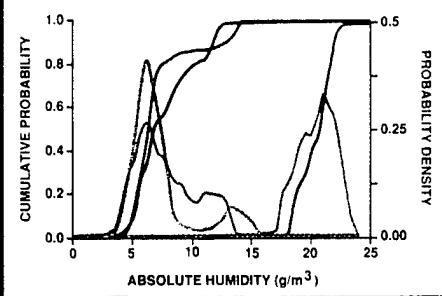
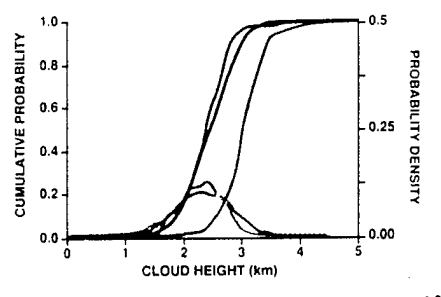
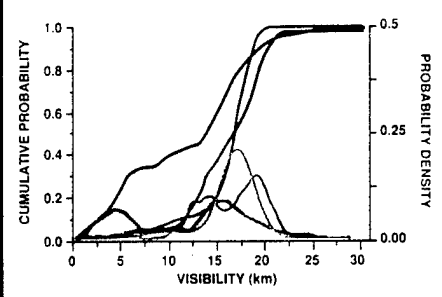

SYSTEMS	
DAYSIGHT	
Tvs	
AN/PVS-	
AN/PVS-	
AN/TVS-	
AN/TVS-	
AN/TVS-	

**GOVERNMENT**

COMMAN  
 US ARMY MATERIE  
 SMART WEAPONS MANA  
 ATTN: AMS  
 REDSTONE ARSEN

Prepared by: **Dynetics, Inc.** an employee owned company  
 Huntsville, Alabama

For: **AMC-SWMO**  
 UNDER CONTRACT NUMBER: DAAH01-89-D-0069



# ON EO/IR/MMW SENSORS

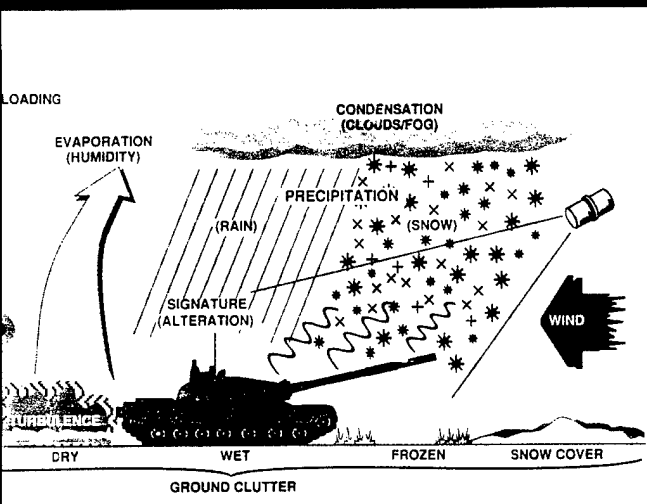

VISIBILITY NEAR IR	SHORTWAVE IR	MIDWAVE IR	LONG WAVE IR	MMW
SEVERE	MODERATE	LOW	LOW	NONE
MODERATE	MODERATE	MODERATE	MODERATE	MODERATE/LOW
LOW	LOW	MODERATE	MODERATE	LOW/NONE
SEVERE	SEVERE	MODERATE/SEVERE	MODERATE/SEVERE	MODERATE/LOW
SEVERE	SEVERE/MODERATE	MODERATE	MODERATE	LOW/NONE
SEVERE	MODERATE	LOW	LOW	NONE

SOURCE: USA ATM SCIENCE LAB

SIGHTS TVs PVS-4 PVS-5 TVS-4 TVS-5 TVS-2	TOW/DRAGON TRACKERS  GLLD  AN/GVS-5  ACTIVE IR PERISCOPE	STINGER REDEYE AN/PAS-7	AN/TAS-4 AN/TAS-5 AN/TAS-6 AN/VSG-2	LONGBOW

SOURCE: JAMES WEAPON SYSTEMS

- AGENCY CONTACTS:**
- COMMANDER/DIRECTOR**  
US ARMY ATMOSPHERIC SCIENCES LABORATORY  
ATTN: SLCAS-AE  
WHITE SANDS MISSILE RANGE, NM 88002
  - US AIR FORCE**  
ENVIRONMENTAL TECHNICAL APPLICATIONS CENTER  
SCOTT AFB, IL 62225
  - GEOPHYSICS LABORATORY**  
AIR FORCE SYSTEMS COMMAND  
US AIR FORCE  
HANSCOM AFB, MA 01731

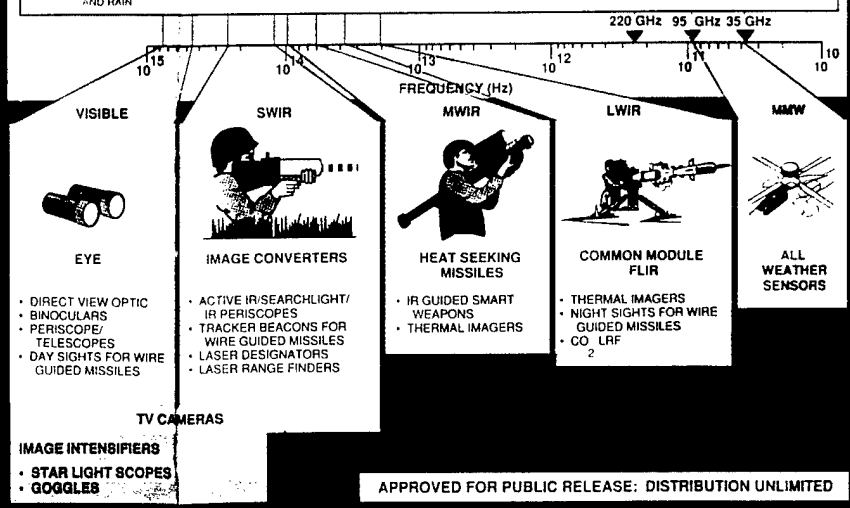
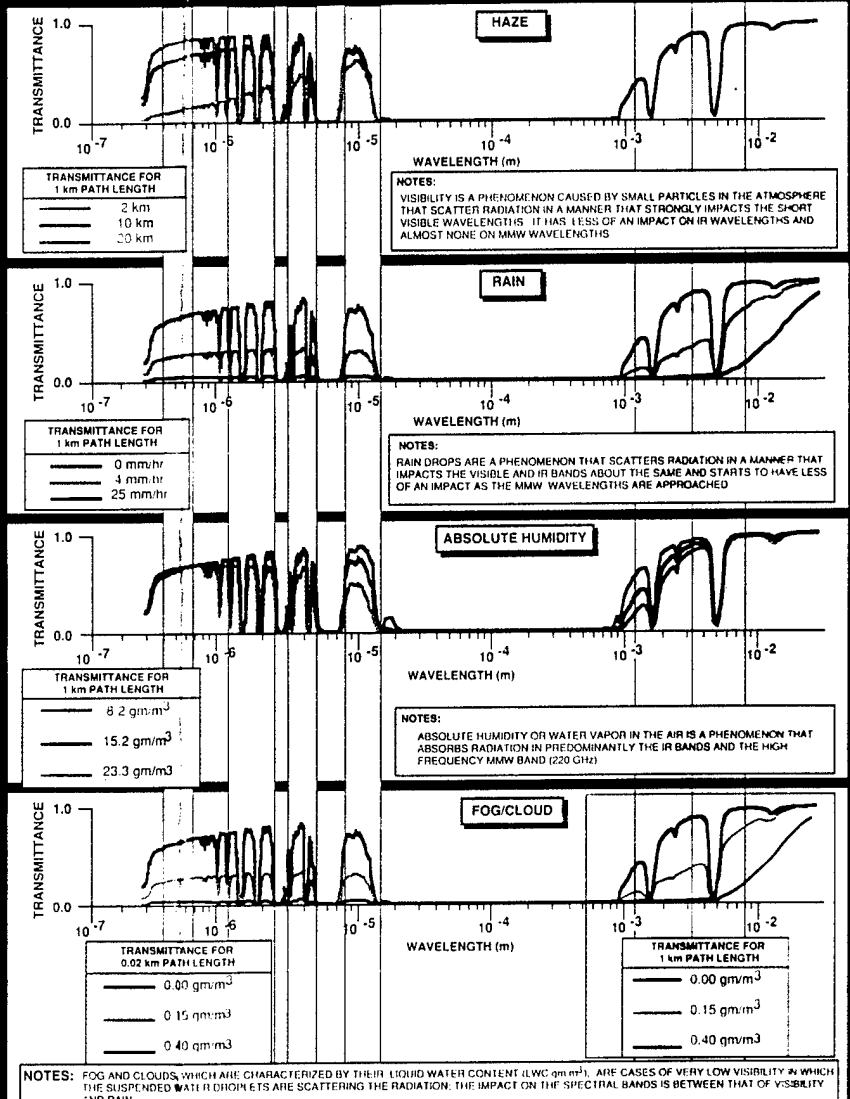



# COUNTERMEASURE EFFECT

## Signature Alteration and Deception

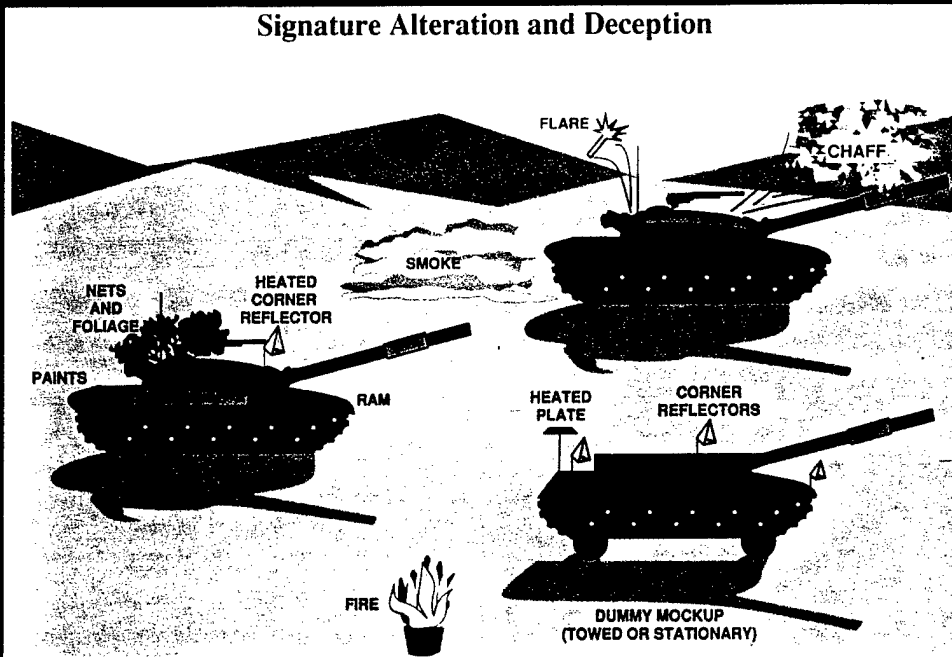

## Examples of Countermeasure Spectral Region

COUNTERMEASURE	SPECTRAL REGION	
	VISIBLE SWIR	SWIR
SIGNATURE ALTERATION	0.4 to 0.7 μm	0.7 to 2.0 μm
DECOYS/ DECEPTION		
OBSCURANTS		
DEWs / JAMMERS		

## Obscurants

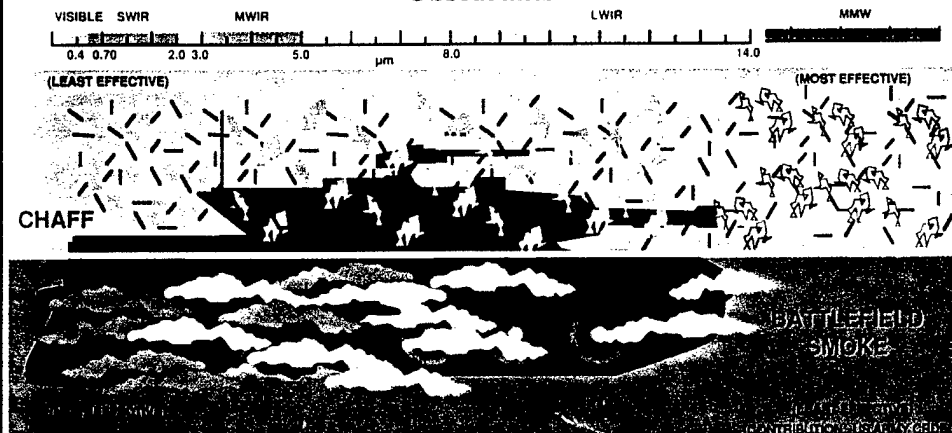

VISIBLE	SWIR
<ul style="list-style-type: none"> <li>EYE TV CAMERA</li> <li>DIRECT VIEW OPTIC</li> <li>BINOCULARS</li> <li>PERISCOPES/TELESCOPES</li> <li>DAY SIGHTS FOR WIRE GUIDED MISSILES</li> </ul>	<ul style="list-style-type: none"> <li>LASER TRACKERS</li> <li>ACTIVE IR/SEARCHLIGHT IR PERISCOPES</li> <li>TRACKER BEACONS FOR WIRE GUIDED MISSILES</li> <li>LASER DESIGNATORS</li> <li>GOOGLES</li> <li>IMAGE CONVERTERS</li> </ul>

## Survivability Analysis

CATEGORY	NAME	DEFINITION
I	ROUTINE	DCSINT applications have a high probability of being encountered.
II	LESS FREQUENT	DCSINT applications have a low probability of being encountered.
III	POTENTIAL	CMs that are technically feasible but not yet approved.

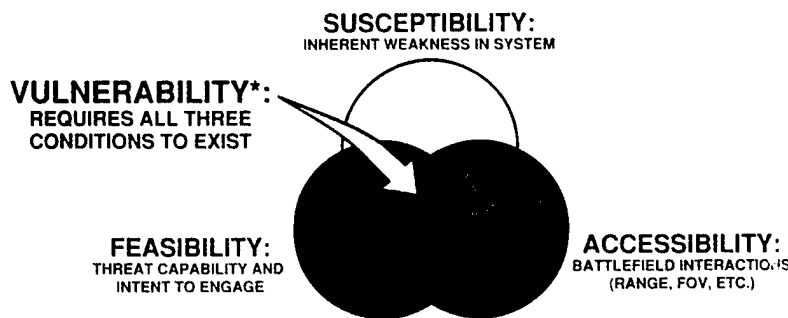

\* EW VULNERABILITY INCLUDES A FOURTH CIRCLE - INTERCEPTABILITY

Prepared by:  
**Dynetics, Inc.**  
HUNTSVILLE, ALABAMA

For: **AMC-SWMO**  
UNDER CONTRACT NUMBER:  
DAAH01-89-D-0069

APPROVED FOR PUBLIC RELEASE

III



# EFFECTS ON SMART WEAPON SENSORS

Threat Types and Effective Region of Operation				SMART WEAPON FUNCTION		
SPECTRAL BANDS				DISPENSE	ACQUIRE	AIMPOINT TRACKING
SWIR	MWIR	LWIR	MMW			
0.7 to 2.0 μm	3.0 to 5.0 μm	8.0 to 12.0 μm	95 GHz / 35 GHz			
GLAZE PAINT					●	
GLAZE NETS					●	
	REDIRECT ENGINE EXHAUST				●	○
	HOT SPOT MASKING				●	○
		RAM			●	○
REPLICAS					●	
SMOKE					●	○
	HEATED PLATES/CORNER CUBES				●	○
	FLARES				●	○
		CHAFF			●	○
WIL, SMOKE					●	○
PHOBOS SMOKE/DUST/BURNING OIL					●	○
	ADVANCED SMOKES				●	○
		CHAFF			●	○
	HOT SPOT BEACONS				●	○
		RF EMITTERS			●	○
STATE LASERS					●	○
	CO <sub>2</sub> LASERS				●	○
	HIGH-POWER MICROWAVE				●	○

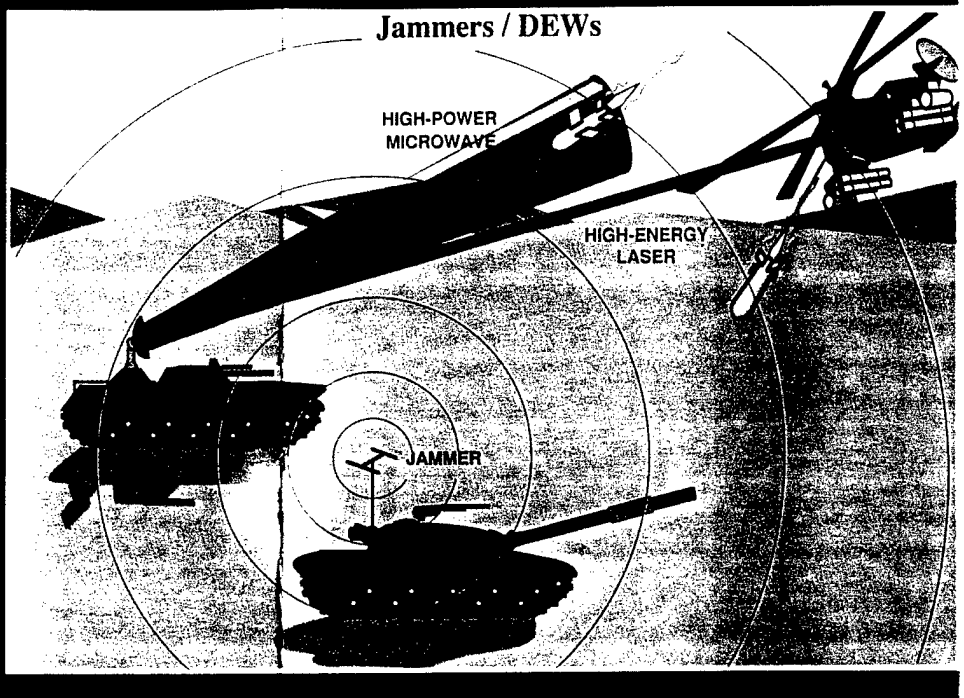

SWIR	MWIR	LWIR	MMW
TRACKERS	HEAT SEEKING MISSILES	COMMON MODULE FLIR	ALL WEATHER SENSORS
SEARCHLIGHT/IR BEACONS FOR MISSILES	IR GUIDED SMART WEAPONS	THERMAL IMAGERS	MMW GUIDED SMART WEAPONS
IGNITORS	THERMAL IMAGERS	NIGHT SIGHTS FOR WIRE GUIDED MISSILES	
VERTERS		CO <sub>2</sub> LRF	

### Category Annex CM Category Definitions

DEFINITION	IMPLICATION
DCSINT approved CMs that have a high probability of being encountered.	Performance levels specified in the presence of CMs are required in the first production.
DCSINT approved CMs that have a low to medium probability of being encountered.	Performance levels specified in the presence of CMs are required in the first production. (Performance levels may not be as stringent as would be required against Category I CMs).
CMs that are judged to be technically and tactically feasible but are not DCSINT approved.	Performance levels in the presence of CMs may be required in the first production. A P <sup>3</sup> I program should be prepared as a minimum.

SOURCE: US ARMY SMO, VAL, VLAMO (25 JUN 1991)

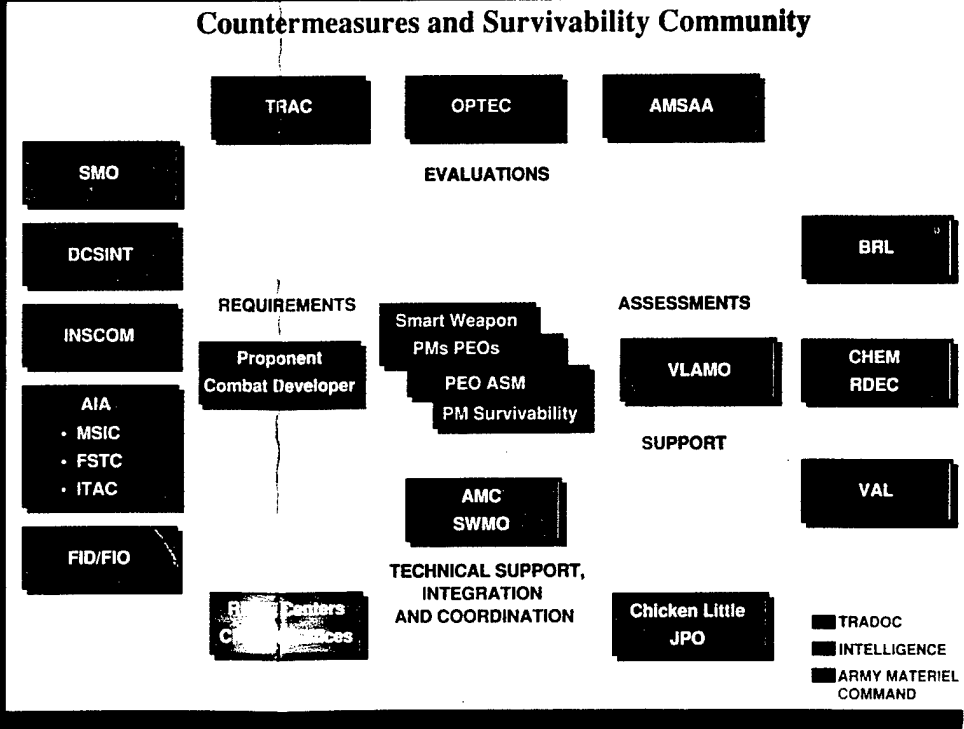

**COMMANDER**  
**US ARMY MATERIEL COMMAND**  
**SMART WEAPONS MANAGEMENT OFFICE**  
**(AMC-SWMO)**  
**ATTN: AMSMI-SW**  
**REDSTONE ARSENAL, AL 35898**

10 JUNE 1991



V



# EFFECTS OF BATTLE BY-PRODUCT

## RELATIVE IMPACT OF BATTLE BY-PRODUCTS

**BATTLE BY-PRODUCTS**  
 BATTLE BY-PRODUCTS  
 SENSOR PERFORMANCE TH  
 OR TARGET SIG

BATTLE BY-PRODUCT	SENSOR						
	VISIBLE	SWIR	MWIR	LWIR	MMW	ACOUSTIC-SEISMIC	MAGNETIC
PATH EFFECTS	DUST	[Shaded bar]					
	SMOKE	[Shaded bar]					
	PLUMES	[Shaded bar]					
CLUTTER	EMI	[Shaded bar]					
	EXPLOSIONS	[Shaded bar]					
	HULLS	[Shaded bar]					
	FIRES	[Shaded bar]					

LEGEND:  
 [Shaded bar] LOW [Dark shaded bar] SEVERE

<b>VISIBLE</b>  <ul style="list-style-type: none"> <li>DIRECT VIEW OPTICS</li> <li>BINOCULARS</li> </ul>	<b>SWIR</b>  <ul style="list-style-type: none"> <li>LASER DESIGNATORS</li> <li>ACTIVE IR/SEARCHLIGHT</li> <li>TRACKER BEACONS</li> <li>IMAGE CONVERTERS</li> </ul>	<b>MWIR</b>  <ul style="list-style-type: none"> <li>IR GUIDED WEAPONS</li> <li>THERMAL IMAGERS</li> </ul>	<b>LWIR</b>  <ul style="list-style-type: none"> <li>THERMAL IMAGERS</li> <li>CO<sub>2</sub> LRF</li> </ul>	<b>MMW</b>  <ul style="list-style-type: none"> <li>MMW GUIDED WEAPONS</li> </ul>	<b>ACOUSTIC-SEISMIC</b>  <ul style="list-style-type: none"> <li>COARSE ACQUISITION SENSORS</li> </ul>	<b>MAGNETIC</b>  <ul style="list-style-type: none"> <li>WARHEAD FUZING/TARGET CONFIRMATION</li> </ul>
--	--	---	--	--	---	---



## SMART WEAPON SENSOR LINKS

SMART WEAPONS HAVE MULTIPLE SENSOR LINKS THAT MAY BE DEFEATED BY THE REALISTIC BATTLEFIELD

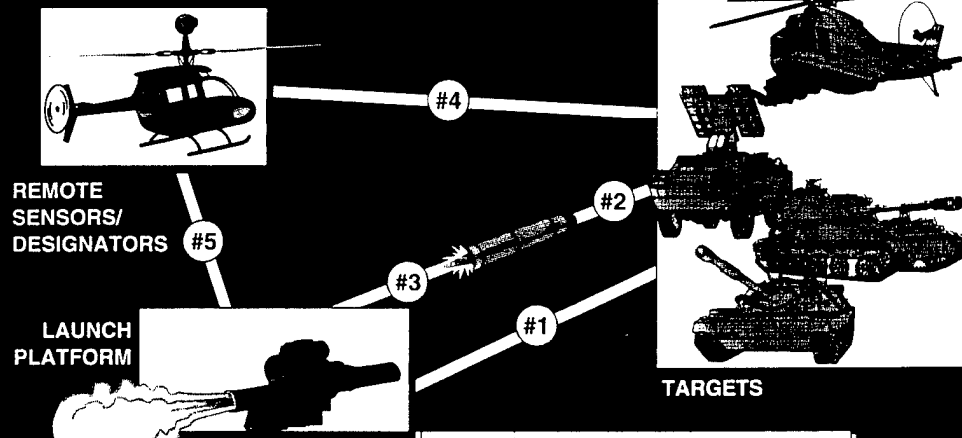

SYSTEM	TARGET	LINK #1	LINK #2	LINK #3	LINK #4	LINK #5
TOW 2B	ARMOR GND. VEH	FLIR 8 - 12 VISIBLE	SWIR 0.9 MAGNETIC	SWIR 0.9 FLIR 8 - 12 WIRE	FLIR 8 - 12 LASER 1.06	COMM LINK (RADIO)
HELLFIRE	ARMOR GND. VEH	FLIR 8 - 12 VISIBLE LASER 1.06	LASER 1.06		FLIR 8 - 12 LASER 1.06	COMM LINK (RADIO)

## RELATIONS BATTLEFIELD

**BATTLE BY-PRODUCTS:** Phenomena produced by military operations that unintentionally reduce the operational effectiveness of an activity or capability

**COUNTER-MEASURES:** Devices, techniques or actions that are intentionally designed and employed to reduce the operational effectiveness of a specific activity or capability

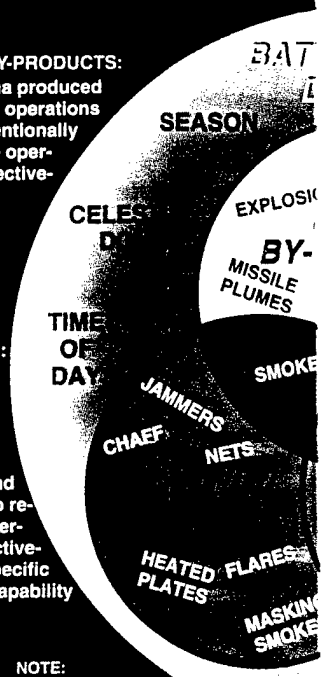

Prepared by:

**Dynetics, Inc.**

Huntsville, Alabama

For:

**AMC-SWMO**

UNDER CONTRACT NUMBER:  
 DAAH01-93-D-R001

NOTE:

Examples shown are not intended to be comprehensive

GE

# BY-PRODUCTS ON SMART WEAPON SENSORS



## BATTLE BY-PRODUCTS

BATTLE BY-PRODUCTS CAN IMPACT SMART WEAPON PERFORMANCE THROUGH PATH EFFECTS, CLUTTER, OR TARGET SIGNATURE ALTERATION



## TRANSMISSION THROUGH BATTLEFIELD BY-PRODUCT OBSCURANTS

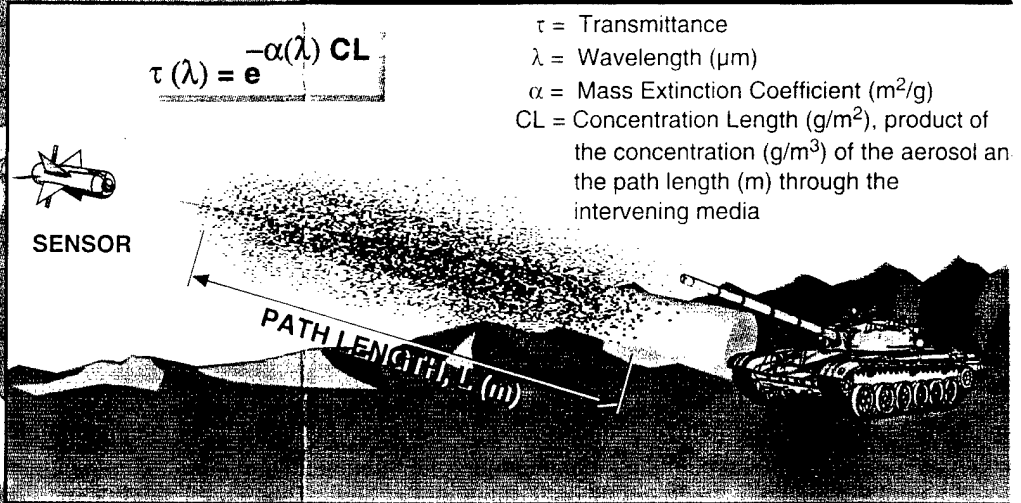

- $\tau$  = Transmittance
- $\lambda$  = Wavelength ( $\mu\text{m}$ )
- $\alpha$  = Mass Extinction Coefficient ( $\text{m}^2/\text{g}$ )
- CL = Concentration Length ( $\text{g}/\text{m}^2$ ), product of the concentration ( $\text{g}/\text{m}^3$ ) of the aerosol and the path length (m) through the intervening media

## RELATIONSHIP OF REALISTIC BATTLEFIELD ELEMENTS

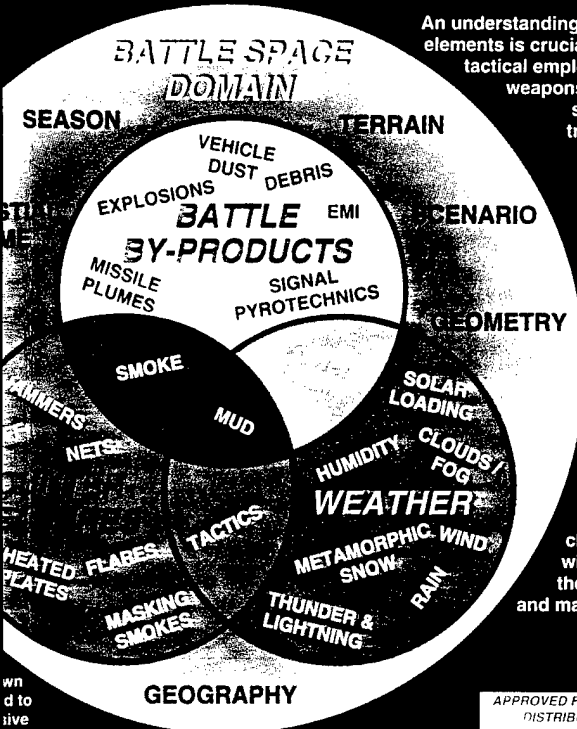

An understanding of all battlefield elements is crucial for successful tactical employment of smart weapons, smart weapon survivability, and training of troops

**WEATHER:**  
The natural state of the atmosphere including its interaction with other elements of the naturally occurring and manmade environment

## TYPICAL VALUES OF MASS EXTINCTION COEFFICIENT ( $\text{m}^2/\text{g}$ )

OBSCURANT TYPE	SPECTRAL BAND				
	VISIBLE 0.4 - 0.7 $\mu\text{m}$	SWIR 0.7 - 1.2 $\mu\text{m}$	MWIR 3 - 5 $\mu\text{m}$	LWIR 8 - 12 $\mu\text{m}$	MMW 35 / 94 GHz
BURNING DIESEL FUEL	6.40	3.69	1.34	1.00	---
PARTICULATE CARBON	1.50	1.46	0.75	0.32	0.001
VEHICULAR DUST	0.32	0.30	0.27	0.25	0.001
HIGH EXPLOSIVE DUST	0.32	0.29	0.27	0.26	0.001
PHOSPHORUS SMOKE	4.08	1.77	0.29	0.38	0.001
LOFTED SNOW	0.32	0.30	0.27	0.25	0.005-0.1

SOURCE: 61 JTCG/ME-87-10 AND DOD-HDBK-178 (E)

COMMANDER  
US ARMY MATERIEL COMMAND  
SMART WEAPONS MANAGEMENT OFFICE  
(AMC-SWMO)  
ATTN: AMSMI-SW  
REDSTONE ARSENAL, AL 35898-5222





**CCD  
TECHNOLOGY  
DEVELOPERS**

**AIR  
FORCE  
LABS**

**ATCOM/NATICK**

Tent, Shelter and  
Soldier Camouflage  
AMC DCS

**ARDEC**

**CECOM/NVSD**

Mobile, Semimobile  
Assets

**ARL**

**COE/WES**

Civil Engineering Survivability  
and Protective Structures  
Project

**ARPA**

**CECOM**

**SSDC**

PEO Missile Defense  
Survivability Engineering  
AR70

**INDUSTRY  
IR&D**

**SWMO**

Signature Requirements  
Production Management  
AAE Policy Management

**MRDEC**

**NAVY  
LABS**

**TARDEC**

Tank-automotive  
Research, Development  
and Engineering

# CAMOUFLAGE, CONCEALMENT, AND DECEPTION EFFECTS ON SMA

## CAMOUFLAGE, CONCEALMENT, AND DECEPTION

Camouflage - The use of concealment and disguise to minimize the possibility of detection and/or identification of troops, in  
 Concealment - Protection from observation or surveillance  
 Deception - Measures designed to mislead enemy forces by manipulation, distortion, or falsification of evidence to induce them to their interests

DEPARTMENT OF DEFENSE DICTIONARY OF MILITARY AND ASSOCIATED TERMS (Joint Chiefs of Staff Publication)

### CCD PRACTICES AND TECHNIQUES

VISUAL		INFRARED		RADAR/MMW		ACOUSTIC		OTHER	
ACTIVE	PASSIVE	ACTIVE	PASSIVE	ACTIVE	PASSIVE	ACTIVE	PASSIVE	ACTIVE	PASSIVE
OPTICAL LUMINANCE MATCHING		NETS, SHIELDING, DEFILADE		OPTICAL JAMMER GLINT		SIGNAL GENERATION		NOISE CANCELLATION	
SHIELDING, DEFILADE		VISUAL COATINGS, PAINTS		NETS, COATINGS, BLANKETS		ENTRENCHMENT HIDING		FALSE SURFACES	
FALSE HEAT SOURCES		ACTIVE COOLING		SCATTERING JAMMING		ABSORBING MATERIAL		INSULATION	
OPTICAL JAMMER GLINT		ACTIVE COOLING		ENTRENCHMENT HIDING		CORNER REFLECTOR MATERIAL		ISOLATION	
NETS, COATINGS, BLANKETS		SHIELDING, DEFILADE		SCATTERING JAMMING		CORNER REFLECTOR MATERIAL		ISOLATION	
NETS, COATINGS, BLANKETS		SHIELDING, DEFILADE		ENTRENCHMENT HIDING		CORNER REFLECTOR MATERIAL		ISOLATION	
NETS, COATINGS, BLANKETS		SHIELDING, DEFILADE		ENTRENCHMENT HIDING		CORNER REFLECTOR MATERIAL		ISOLATION	

### THE SURVIVABILITY EQUATION

$$1 - ((P_l) \times P(d/l) \times P(r/d) \times P(h/r) \times P(i))$$

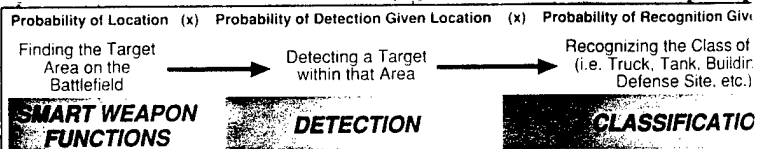

Prepared by:



BEVILACQUA RESEARCH CORPORATION  
Huntsville, Alabama

For:

**AMC-SWMO**  
U.S. ARMY UNFUNDED  
STUDY PROGRAM

VIII

# INTELLIGENCE, AND DECEPTION (CCD) SMART WEAPON SENSORS



...ops, materiel, equipment and installations  
...duce them to react in a manner prejudicial  
...ation [JCS Pub 1], 1 June 1979)

## SMART WEAPONS SYSTEM REQUIREMENTS



SMART WEAPONS  
PEOs, PMs, SPOs



## CCD CATEGORIES

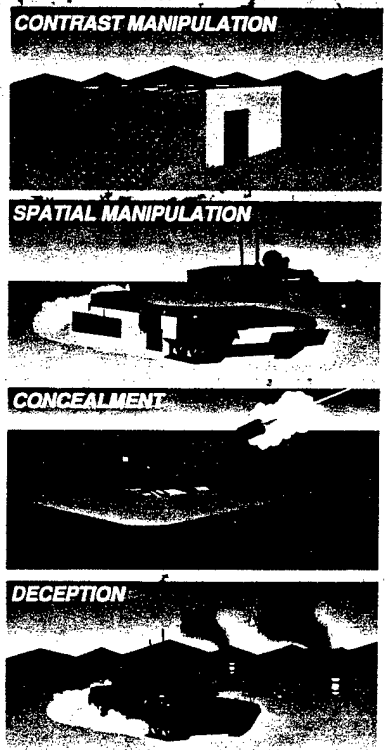

## TECHNOLOGY EVALUATORS

SMART WEAPON	PREMATURE FUZING SIGNAL LOW SIGNAL STRENGTH	LOSS OF LINE OF SIGHT	LOSS OF AIMPOINT	TRACK POINT CHANGES	TARGET FEATURES BREAK LOCK	FALSE FEATURES	LOW SIGNAL STRENGTH TARGET NOT FOUND
AFSC/CHICKEN LITTLE							
AMSAA							
ARL							
NATIONAL LABS							
SWMO							
TECOM							
TEXCOM							

- AFSC/CHICKEN LITTLE
- AMSAA
- ARL
- NATIONAL LABS
- SWMO
- TECOM
- TEXCOM

## P(k/h) = SURVIVAL PROBABILITY

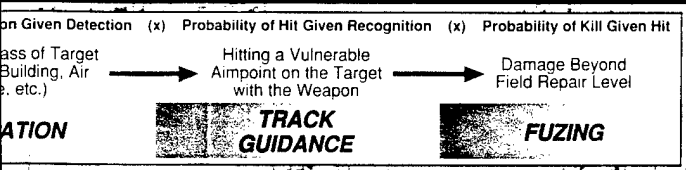

APPROVED FOR PUBLIC RELEASE:  
DISTRIBUTION UNLIMITED

COMMANDER  
US ARMY MATERIEL COMMAND  
SMART WEAPONS MANAGEMENT OFFICE  
(AMC-SWMO)  
ATTN: AMSMI-SW  
REDSTONE ARSENAL, AL 35898-5222

